

Universal Indexes for Highly Repetitive Document Collections[☆]

Francisco Claude^a, Antonio Fariña^{*b}, Miguel A. Martínez-Prieto^c, Gonzalo Navarro^d

^a*Escuela de Informática y Telecomunicaciones, Universidad Diego Portales, Chile.*

^b*Database Laboratory, University of A Coruña, Spain.*

^c*DataWeb Research, Department of Computer Science, University of Valladolid, Spain.*

^d*Department of Computer Science, University of Chile, Chile.*

Abstract

Indexing highly repetitive collections has become a relevant problem with the emergence of large repositories of versioned documents, among other applications. These collections may reach huge sizes, but are formed mostly of documents that are near-copies of others. Traditional techniques for indexing these collections fail to properly exploit their regularities in order to reduce space.

We introduce new techniques for compressing inverted indexes that exploit this near-copy regularity. They are based on run-length, Lempel-Ziv, or grammar compression of the differential inverted lists, instead of the usual practice of gap-encoding them. We show that, in this highly repetitive setting, our compression methods significantly reduce the space obtained with classical techniques, at the price of moderate slowdowns. Moreover, our best methods are universal, that is, they do not need to know the versioning structure of the collection, nor that a clear versioning structure even exists.

We also introduce compressed self-indexes in the comparison. These are designed for general strings (not only natural language texts) and represent the text collection plus the index structure (not an inverted index) in integrated form. We show that these techniques can compress much further, using a small fraction of the space required by our new inverted indexes. Yet, they are orders of magnitude slower.

Keywords: *repetitive collections, inverted index, self-index.*

1. Introduction

Large versioned document collections, such as *Wikipedia* (www.wikipedia.org) and the *Wayback Machine* from the *Internet Archive* (www.archive.org/web/web.php), are examples of the emergence of highly

[☆]Funded in part by European Union's Horizon 2020 research and innovation programme under the Marie Skłodowska-Curie grant agreement No 690941, by Fondecyt Grant 1-140796 (Conicyt, Chile), by MINECO (PGE and FEDER) grants TIN2013-47090-C3-3-P, TIN2015-69951-R, and TIN2013-46238-C4-3-R; by MINECO and CDTI grants IDI-20141259, ITC-20151305; by ICT COST Action IC1302; and by Xunta de Galicia (co-funded with FEDER) grant GRC2013/053 (Spain). An early partial version of this article appeared in *Proc. CIKM 2011*.

*Corresponding author

Email addresses: fclaude@recoded.cl (Francisco Claude), fari@udc.es (Antonio Fariña), migumar2@infor.uva.es (Miguel A. Martínez-Prieto), gnavarro@dcc.uchile.cl (Gonzalo Navarro)

repetitive document collections, where most documents are near-duplicates of others. Apart from versioned document collections, other applications where this situation arises are software repositories (where a tree of versions is maintained), biological databases (where many DNA or protein sequences from organisms of the same or related species are maintained), periodic technical publications (where the same data, with small updates, are published over and over), and so on.

These collections may be very large, but at the same time are highly compressible. While Lempel-Ziv compressors [68] are successful in capturing their repetitiveness, such compression is suitable only for archival purposes. Version control systems offer, in addition, efficient direct access to individual versions. This was done, since their early beginnings, by storing edits with respect to some previous version [52]. The applications we have enumerated require even more: fast searching capabilities on all the versions. Thus, we need to compress not only the data, but also the indexes built on them to speed up searches.

There is a burst of recent activity in exploiting repetitiveness at the indexing structures, in order to provide fast searches in the collection within little space. Both inverted indexes for word and phrase queries over natural language texts [3, 12, 35, 65, 36, 34], and other indexes for general string collections [43, 16, 19, 20, 40, 28, 29, 26, 9], have been pursued.

The focus of this paper is on natural language text collections, which can be decomposed into words, and queried for words or phrases. The classical data structure to index such collections is the inverted index, where a list of the occurrences of each distinct word is maintained. The variant where the lists are sorted by increasing document identifier has gained relevance, since such ordering is most useful for list intersections. Intersections of inverted lists arise as a fundamental task under the Google-like policy of treating bag-of-word queries as ranked AND-queries. Therefore, intersections form the heaviest part of the search process, and relevance ranking is done as a postprocessing step [64, 65, 24] or via on-the-fly filtration [25, 23, 39]. Intersections are also fundamental for solving phrase queries.

In this context, there are two different types of indexes. *Non-positional* indexes find, given a word or bag-of-words query, the documents containing all the words. They store, for each word, the increasing list of documents containing it. *Positional* indexes retrieve the precise positions in each document where a word or phrase query appears. They store, in addition to the document identifiers, the word offsets of the occurrences within each document.

Traditional techniques to compress inverted indexes [63, 5, 69, 13, 6] represent the differences between consecutive document or position values. Many of those differences tend to be small, and thus they are encoded in a way that favors small numbers. While very effective for traditional collections, this compression technique generally fails to exploit the repetitiveness that arises in versioned collections.

In this paper we introduce new techniques for compressing inverted indexes on highly repetitive collections. Instead of using the classical encoding of differences, we adapt and apply run-length, Lempel-Ziv [68],

and grammar [41] compression on the lists of differences. Run-length compression simply exploits successive differences equal to 1 in the lists, and works if the similar documents are grouped in the ordering. Lempel-Ziv compression captures more general repetitive patterns that appear within the list of the same word, and needs to decompress the whole list to access any position of it. Grammar compression can be applied to the whole set of lists because it can decompress portions of any list independently. Therefore, it can also exploit repetitions across lists. These repetitions are very interesting because they capture the case of pairs of words that appear in almost the same documents. We enrich grammar compression with additional information on the nonterminal symbols, which allows us skip them without decompressing when a particular document is sought during list intersections.

Our techniques clearly outperform classical inverted index compression in this scenario. For example, our Lempel-Ziv-based index is 15 times smaller than a Rice-encoded index (the best choice for classical text collections), at the modest price of being at most 70% slower on word and conjunctive queries. Our grammar-based compressed index is up to 30 times smaller and at most 3 times slower. Our experiments also show that some encodings designed for typical collections, such as Partitioned Elias-Fano [51] and PforDelta [37, 70, 51], improve substantially on repetitive collections, yet they still require 2.5–7 times more space than ours. These modern encodings are also 2–9 times faster than Rice codes on conjunctive queries. Other recent codes built on the last generation of SIMD-based techniques [61] are an order of magnitude faster, but they are shown to use too much space on repetitive collections.

Except for our run-length compression, which is not the best technique, our compressed representations are *universal*, that is, they do not need to identify which document is a version of which. Indeed, there is no need that the documents have a well-defined versioning structure at all: it is sufficient that most documents contain long parts that appear in others.

We also apply our compression techniques in the positional scenario, where the lists are less compressible. This time, the method that performs best in space is Lempel-Ziv compression, which is around 3.5 times smaller than classical inverted indexes, but also 2.5–10 times slower on the most common queries. The grammar-compressed index is twice as large as the Lempel-Ziv index, but it is significantly faster to solve queries, 2–5 times slower than classical indexes.

In this scenario we also consider *self-indexes*, which are compressed indexes (not based on inverted indexes) that encode both the text and the index. We use, adapt, or implement existing self-indexes designed for highly repetitive collections (mostly for computational biology scenarios) [43, 16, 19, 20, 40]. Self-indexes obtain sharp space reductions, being up to 12 times smaller than our Lempel-Ziv-compressed inverted index. Their query times, however, are 10–200 times slower on the most typical queries. While the time difference is large, this shows that there is still much redundancy to exploit in the positional scenario.

We have left our codes and experimental testbeds available at <https://github.com/migumar2/uiHRDC>.

1.1. Related work

The most relevant previous work targeting highly repetitive collections of natural language text is by He et al. [35, 36]. They presented alternative compression methods for non-positional indexes on versioned collections. Their approach, called *two-level indexing*, merges all the versions of each document for creating the inverted lists. A secondary index stores, for each entry of the main inverted list, a bitmap indicating the versions of the document that contain the term. They convert previous “one-level” techniques [3, 12] into two-level methods, and also study methods for reordering the versions in order to improve compression.

They obtained excellent compression results on a non-positional inverted index built over subsets of Wikipedia and the Internet Archive collections. The authors attribute the success of their technique to the effective management of the bitmaps in the second level of the index.

Our experiments show that our techniques still do not match the performance of He et al.’s methods. However, these work under a restricted model where there exists a set of independent documents, each of which has a number of versions, and this versioning information is known for indexing. Our universal techniques, instead, also work on settings where the versions form a tree structure (as in collaborative document creation, software repositories, or phylogenetic trees), or where the versions form a continuous stream of incremental changes (as in periodic publications of technical data), or where it is unknown or unclear which documents are versions of which (as in DNA sequence databases, or near-duplicate pages in Web crawls).

He and Suel [34] also designed a positional inverted index for the repetitive scenario. They apply a previous technique to partition documents into fragments [67] and then use their non-positional approach [36] on the fragments. They focus on answering top- k queries, by first obtaining the top- k' ($k' > k$) documents over the non-positional index and then re-ranking them using the positional information in order to return the top- k results. This is faster than using the whole positional information in the first stage [34, 57].

Although their index serves a different kind of queries than those we study here, a rough comparison is possible. The space they obtain with their best result (ZS-FREQ) is about half the space of our Lempel-Ziv inverted indexes, whereas their time to extract each position from the index is around the microsecond, that is, about 5 times slower than our Lempel-Ziv index. Our self-indexes are still up to 6 times smaller than ZS-FREQ, yet also around 20 times slower. Once again, their index is not universal, as it makes explicit use of a known and specific versioning structure.

2. Basic Concepts

In this section we briefly review the best known strategies to intersect inverted lists, and then consider compression methods that are compatible with those intersection algorithms. We then present Re-Pair and Lempel-Ziv compression methods, which are the base of the best inverted list representations we propose in

Sections 3 and 4. Finally, we provide a brief introduction to the compressed self-indexes that are well-suited to handle repetitive data, which we will adapt to our positional scenario in Appendix A.

2.1. Intersection algorithms for inverted lists

The intersection of two inverted lists can be done in a merge-wise fashion (which is the best choice if both lists are of similar length), or using a set-versus-set (*svs*) approach where the longer list is searched for each of the elements of the shortest, to check which should appear in the result. Either binary or exponential (also called galloping or doubling) search are typically used in *svs*. The latter checks the list at positions $i + 2^j$ for increasing j , to find an element known to be after position i (but probably close). All these approaches assume that the lists to be intersected are given in sorted order.

Algorithm *bys* [4] is based on binary searching the longer list n for the median of the smallest list m . If the median is found, it is added to the result set. Then the algorithm proceeds recursively on the left and right parts of each list. At each new step the longest sublist is searched for the median of the shortest sublist. Results showed that *bys* performs about the same number of comparisons than *svs* with binary search. As expected, both *svs* and *bys* improve upon *merge* algorithm when $|n| \gg |m|$ (actually from $|n| \approx 20|m|$).

Multiple lists can be intersected using any pairwise approach (iteratively intersecting the two shortest lists, and then the result against the next shortest one, and so on). Other algorithms are based on choosing the first element of the smallest list as an *eliminator* that is searched for in the other lists (usually keeping track of the position where the search ended). If the eliminator is found, it becomes a part of the result. In any case, a new eliminator is chosen. Barbay et al. [8] compared four multi-set intersection algorithms: *i*) a pairwise *svs*-based algorithm; *ii*) an eliminator-based algorithm [7] (called *sequential*) that chooses the eliminator cyclically among all the lists and exponentially searches for it; *iii*) a multi-set version of *bys*; and *iv*) a hybrid algorithm (called *small-adaptive*) based on *svs* and on the so-called *adaptive algorithm* [22]. The adaptive algorithm recomputes at each step the list ordering according to the elements not yet processed, chooses the eliminator from the shortest list, and tries the others in order. The simplest pairwise *svs*-based approach (with exponential search) performed best in practice [8].

2.2. Data structures for inverted lists

The previous algorithms require that lists can be accessed at any given position (for example those using binary or exponential search) and/or that, given a value, its smallest successor from a list can be obtained. Those needs interact with the inverted list compression techniques.

The compression of inverted lists usually represents each list $\langle p_1, p_2, p_3, \dots, p_\ell \rangle$ as a sequence of d-gaps $\langle p_1, p_2 - p_1, p_3 - p_2, \dots, p_\ell - p_{\ell-1} \rangle$, and uses a variable-length encoding for these differences, for example γ -codes, δ -codes, Rice codes, etc. [63]. Those methods assign shorter codes to smaller numeric values, this way taking advantage of the fact that, on longer lists, the d-gaps are shorter.

If the inverted lists stay on disk, minimizing I/O is the key to improve performance, and thus the codes achieving the least space are preferable. Rice codes are usually the best choice for compressing inverted lists in this case [63].

Recently, there has been an increasing interest on inverted index structures designed to reside in main memory (possibly distributed across several processors) [59, 21, 60, 13]. While space-efficient representations are still important to reduce communication and number of processors, the CPU time for traversing the lists in memory becomes relevant as well.

A proposal in this line uses byte-aligned codes [21], which lose little compression and are faster at decoding. We will use in particular `Vbyte` [62], which splits a number into 7-bit chunks and places each chunk in a byte, using the highest bit to signal the end of the codeword.

Other representations achieve space even closer to that of Rice [66]. `Simple9` [1] packs consecutive d-gaps into a 32-bit word. The first 4 bits signal the type of packing done, depending on how many bits the next d-gaps need: we can pack 28 1-bit numbers, or 14 2-bit numbers, and so on (9 combinations in total). `PforDelta` [37, 70] extends this idea by packing many more numbers, namely 128, while allowing for 10% of exceptions that need more bits than the core 90% of the numbers. The exceptions are then coded separately afterwards using, say, a variant of `Simple9`.

In recent years, new word-wise integer representations that take advantage of the large registers (typically 64 or 128-bit) of modern processors and their SIMD-based instruction set have been developed [2, 56, 58, 61, 42]. Most of these works mainly target at improving the decoding speed of existing representations by using implementations that take advantage of the capabilities of modern CPUs.

Intersections can be carried out by traversing the lists sequentially. When one list is much shorter than the other, it is advantageous to provide direct access so that the longer list can be searched for the elements of the shorter one. As said before, it was shown experimentally [8] that in practice the best is to sort the lists by length, taking the shortest as the “candidate” list, and iteratively intersect the candidate list with longer and longer lists, shortening the candidate list at each step.

One of the best techniques to intersect two lists of very different length [21] samples regularly the compressed list and stores separately the array of samples, which is searched with exponential search. Given a sampling parameter k , a list of length ℓ is sampled every $k \log_2 \ell$ positions. Very long lists (more precisely, longer than $u/8$, where u is the largest document identifier) are replaced by a bitmap [21], which marks which documents are present in the list. This is both space and time efficient when the bitmap is sufficiently dense. Another good method [60] regularly samples the universe of positions, so that the exponential search is avoided. Given a parameter B , it samples the universe of size u at intervals $2^{\lceil \log_2(uB/\ell) \rceil}$.

2.3. *Re-Pair compression algorithm*

Re-Pair [41] consists of repeatedly finding the most frequent pair of symbols in a sequence of integers

and replacing it with a new symbol, until no more replacements are useful. More precisely, Re-Pair over a sequence L works as follows: (1) It identifies the most frequent pair ab in L ; (2) It adds the rule $s \rightarrow ab$ to a dictionary R , where s is a new symbol not appearing in L ; (3) It replaces every occurrence of ab in L by s ; (4) It iterates until every pair in L appears once.

Re-Pair can be implemented in linear time [41]. We call C the sequence resulting from L after compression. Every symbol in C represents a *phrase* (a substring of L), which is of length 1 if it is an original symbol (called a *terminal*) or longer if it is an introduced one (a *nonterminal*). Any phrase can be recursively expanded in optimal time (i.e., proportional to its length). Note that replaced pairs can contain terminal and nonterminal symbols.

Larsson and Moffat [41] proposed a method to compress the set of rules R . In this work we prefer another method [33], which is not so effective but allows accessing any rule without decompressing the whole set of rules. It represents the DAG of rules as a set of trees. Each tree is represented as a sequence of leaf values (collected into a sequence R_S) and a bitmap that defines the tree shapes in preorder (collected into a bitmap R_B). Nonterminals are represented by the starting position of their tree (or subtree) in R_B . In R_B , internal nodes are represented by 1s and leaves by 0s, so that the value of the leaf at position i in R_B is found at $R_S[\text{rank}_0(R_B, i)]$. Operation rank_b counts the number of bs in $R_B[1, i]$ and can be implemented in constant time, after a linear-time preprocessing that stores only $o(|R_B|)$ bits of space [15] on top of the bitmap. To expand a nonterminal, we traverse R_B and extract the leaf values, until we have seen more 0s than 1s. Leaf values corresponding to nonterminals must be recursively expanded.

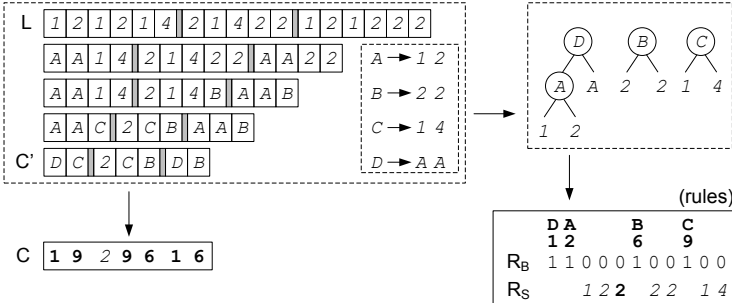

Figure 1: Example of Re-Pair compression. Solid boxes (C and *rules*) enclose the data represented. Bold numbers (nonterminals) in the final C sequence and R_S refer to positions in R_B , whereas slanted ones (terminals) refer to original values. To distinguish them, the maximum offset u is added to the bold numbers.

Figure 1 shows an example. Consider L as the sequence to be compressed (where the shaded boxes indicate that pairs cannot include symbols crossing such boxes; we will need this in Section 4). The most frequent pair in L is $\langle 1, 2 \rangle$. Hence we add rule $A \rightarrow 1\ 2$ to the dictionary R and replace all the occurrences of $1\ 2$ by nonterminal A . We go on replacing pairs; note that the fourth rule $D \rightarrow A\ A$ replaces nonterminals.

In the final sequence $DC2CBDB$, no repeated pair appears. We now represent the dictionary of four rules as a forest of four small subtrees. Now, as nonterminal A is used in the right-hand side of another rule, we insert its tree as a subtree of one such occurrence, replacing the leaf. Other occurrences of A are kept as is (see the rightmost box in the first row). This will save one integer in the representation of A . The final representation is shown in the rightmost box of the second row. In R_B , the shape of the first subtree (rooted at D) is represented by 11000 (the first 1 corresponds to D and the second to A); the other two (B and C) are 100. These nonterminals will be further identified by the position of their 1 in R_B : $D = \mathbf{1}$, $A = \mathbf{2}$, $B = \mathbf{6}$, $C = \mathbf{9}$. Each 0 (tree leaf) corresponds to an entry in R_S , containing the leaf values: $12A = 12\mathbf{2}$ for the first subtree, and 22 and 14 for the others. Nonterminal positions (in boldface) are in practice distinguished from terminal values (in italics) by adding them the largest terminal value. Finally, sequence C is $\mathbf{1929616}$.¹ To expand, say, its sixth position ($C[6] = \mathbf{1}$), we scan from $R_B[1, \dots]$ until we see more 0s than 1s, i.e., $R_B[1, 5] = 11000$. Hence we have three leaves, namely the first three 0s of R_B , thus they correspond to the first three positions of R_S , $R_S[1, 3] = 12\mathbf{2}$. Whereas 12 are already final (i.e., terminals), we still have to recursively expand $\mathbf{2}$. This corresponds to subtree $R_B[2, 4] = 100$, that is, the first and second 0 of R_B , and thus to $R_S[1, 2] = 12$. Concatenating, $C[6]$ expands to 1212 .

2.4. Lempel-Ziv compression

The Lempel-Ziv 1977 (*LZ77*) compression algorithm [68] works by decomposing the text from left to right into phrases. Each phrase i is represented as a triplet $\langle k, l, a \rangle$: a pointer to a previous position k in the text, the length l of the portion to be copied, and a new symbol a to be added. This means that phrase i represents the substring $text[k, k+l-1]$ with symbol a added at the end. The parsing maximizes the length of the phrases being added in order to obtain a small encoding. The main drawback of the LZ77 parsing is that it does not support random access, and even constructing the substring represented by a single phrase can be expensive. The pointers point to text positions and not phrases, thus obtaining more than just the last symbol of a phrase might be arbitrarily costly. Only decompression from the beginning is efficient.

An alternative parsing called *LZ-End* [40] solves this problem and achieves constant time per symbol when retrieving a whole phrase or a suffix of it. The main idea is to limit the positions where the source of a phrase may end, so that sources can only end where a previous phrase ends. Although the parsing is stricter than that of LZ77, the compression was shown to be competitive on highly repetitive collections [40].

The representation of the LZ-End parsing that supports random access to a sequence $L[1, n]$ is as follows. We keep the triplets corresponding to the phrases, but the pointer only indicates the phrase number where the source ends, and lengths are replaced by a bitmap $B[1, n]$ that marks where each phrase ends. This sparse

¹By adding the largest terminal value ($l = 4$) to the values in C we would obtain $C' = 51321310710$. Values $C'[i] > 4$ are the nonterminals $C'[i] - 4$, and the others are terminals.

bitmap is represented with gap-encoding of the distances between consecutive ones, plus some sampled absolute values, so as to support *rank* and *select* queries [15]. Operation $select_b(j)$ obtains the position where the j -th bit b appears. To extract the content of the phrase p , with pair $\langle k, a \rangle$, we recursively extract the content of phrase k and then output a (the recursion terminates when k is void). This takes $O(1)$ time per character extracted. In general, for extracting a snippet $L[i, j]$, we extract the longer one $L[i, j']$, where $j' = select_1(B, p)$ is the final position of the p th phrase, and $p = rank_1(B, j) + 1$ is the phrase where position j falls. As we have now a sequence of complete phrases, possibly started by a phrase suffix, we can extract the string in time $O(j' - i)$. This is generally efficient if $j - i$ is not too small compared to the average phrase length.

2.5. Compressed self-indexes

Self-indexes are data structures that enable efficient searches over an arbitrary string collection (called the text), and also replace the text by supporting extraction of arbitrary snippets or documents. The supported searches obtain all the positions of a substring in the collection. This enables self-indexes to compete in the positional setting.

Self-indexes have undergone much progress in the last decade [49]. Recently they have been adapted to index highly repetitive sequences [43, 16, 19, 20, 40, 28, 29, 26, 9]. While general self-indexes have been successful by targeting statistical compression, they have been proved insufficient on highly repetitive collections [43, 40].

The first self-index successfully capturing high repetitiveness was the **RLCSA** [43] (for Run-Length Compressed Suffix Array). This index adapts the well-known **CSA** of Sadakane [54] to better cope with the regularities that arise when indexing highly repetitive sequences. A **CSA** variant aimed at indexing natural language, **WCSA** [27] (for Word CSA), regards the text as a sequence of words and separators instead of characters. Another index aimed at repetitive collections is the **SLP** [19, 16], which exploits the regularities of highly repetitive sequences because its structure is determined by a grammar-based compressor (Re-Pair). We adapt the **SLP** to words (**WSLP**) in this paper. Finally, other strong indexes for repetitive sequences are **LZ77-index** and **LZend-index** [40], which are based on the LZ77 or LZ-End compression algorithms, respectively. The LZ77 parsing is at least as powerful as any grammar representation [53], and thus, becomes also a good candidate for highly repetitive sequences. All these self-indexes are explained in Appendix A.

3. New List Representations

We present inverted list compression schemes for repetitive collections capturing progressively more sophisticated regularities. First, we consider Run-Length and Lempel-Ziv compression, and in Section 4 we use grammar compression (Re-Pair, precisely). The latter is enriched so that the list can be processed in compressed form, without the need to fully decompress it when carrying out intersections.

Both non-positional and positional indexes will consist of essentially lists of increasing numbers. In the first case this will be a list of document identifiers, and list intersections will correspond to conjunctive queries.

For positional indexes, the lists will be sequences of word positions. We consider the collection as a concatenation \mathcal{D} of texts, with separators between consecutive documents to avoid false matches. Then our positional indexes store the positions (word offsets) where each word occurs in \mathcal{D} .

To find a phrase on a positional index, we use a modified intersection process to take into account the (word) offsets. Consider a phrase $w_1 w_2 \dots w_m$; we need to find the positions p_1, \dots, p_k in the list of w_1 such that $p_i + j$ is in the list of w_{j+1} for $1 \leq j < m$. For simplicity, in our descriptions we will consider plain intersections, yet adapting them to phrase queries is straightforward.

The absolute positions resulting from a query on a positional index are translated back to a document number and a word offset within the document by means of an array where the document starting positions are stored in plain form. Once the index returns the increasing list of positions where a word or phrase appears, the list is traversed and each element is found in the array of document starting positions using exponential search, starting from the position of the previous translated occurrence. This way, o occurrences are translated in time $O(o(1 + \log \frac{d}{o}))$, where d is the number of documents.

Our basic idea, for both non-positional and positional indexes, is to differentially encode the inverted lists, transforming a sequence $\langle p_1, p_2, p_3, \dots, p_\ell \rangle$ into the d-gap sequence $\langle p_1, p_2 - p_1, p_3 - p_2, \dots, p_\ell - p_{\ell-1} \rangle$, and then apply a general compression algorithm to the sequence formed by the concatenation of all the lists. Each vocabulary word will store a pointer to the beginning of its list in the compressed data that permits us to fetch any inverted list individually.

3.1. Using run-length compression

A typical regularity in highly repetitive collections arises when the versions of a document happen to receive consecutive identifiers. As most of the words in such documents will appear in all versions, a consecutive sequence of numbers will appear in each inverted list of non-positional indexes. Consider the word w_t appearing in documents d_i, \dots, d_{i+k} : the d-gapped list for w_t will contain $k - 1$ consecutive ones.

In this representation we use any variable-length encoding for the differences. However, when this difference is 1, the next encoded number is the number of 1s in that run (k , in the previous paragraph). This number is encoded in the same way as the d-gaps.

This encoding allows us to skip whole runs in a single operation when processing intersections. It also allows combining with sampling techniques that support intersection methods other than the sequential one [21, 60]. In this paper we combine run-length compression with Rice coding, giving rise to method **Rice-Runs**.

Note that run-length compression works well only under the assumption that the documents can be linearized so that close documents receive consecutive numbers. While such kinds of assumptions are used in previous work [35, 36], we aim to handle more general cases in this paper. Moreover, this technique can be efficient only for non-positional indexes.

3.2. Using LZMA

This representation (already used for compressing q-gram indexes on DNA [16]) encodes each d-gap list with `Vbyte` and then compresses it with the *LZMA* variant of LZ77 (www.7-zip.org). LZMA is applied only on the lists where it reduces space. Otherwise, the plain `Vbyte` encoded sequence is stored. A bitmap indicates which inverted lists were stored compressed with `Vbyte` plus LZMA, and which only with `Vbyte`.

This representation, called `Vbyte-LZMA`, only supports extracting a list from the beginning, that is, we cannot jump to a random position on the list, and thus the only intersection algorithm supported is the sequential one. Moreover, unlike run-length compression, it cannot skip a compressed subsequence without fully processing it.

LZMA handles more complex regularities than run-length compression. In particular, it also works well on positional indexes: Consider a long substring S that occurs in r similar documents across the collection. For each word w_t in S , with occurrences at relative positions i_1, i_2, \dots, i_k in S , the sublist $i_2 - i_1, \dots, i_k - i_{k-1}$ appears r times in the list of word w_t . Hence, LZMA will capture this repetition and represent $r - 1$ of those sublists with just one reference. Note that this will occur independently of whether the versions are consecutive, and even without any need to know which documents are close versions of which.

3.3. Using LZ-End

This method works similarly to the previous one, but instead of compressing the lists with LZMA, it uses LZ-End. Since LZ-End allows random access, the sequence of all the concatenated lists is compressed as a whole, not list-wise. Therefore, we first concatenate the `Vbyte` representation of all the posting lists (keeping track of where each posting list started in the `Vbyte` sequence), and then use LZ-End to represent it. This makes up our `Vbyte-Lzend` representation.

Note that, since the phrases of the parsing are not limited by the ends of lists, this technique does not use an array of pointers from words to compressed data to mark the beginning of the inverted lists, but pointers to the positions in the original (`Vbyte`) sequence. Then, the LZ-End capability to extract arbitrary substrings is used.

Although LZ-End is weaker than LZMA, it has the potential of spotting inter-list regularities, whereas LZMA is limited to intra-list regularities. In the same example of Section 3.2, consider a long substring S occurring r times in the collection, and that we have a phrase $w_{t_1} w_{t_2} \dots w_{t_s}$ occurring k times in S , at relative offsets i_1, i_2, \dots, i_k . Then the sequence $i_2 - i_1, \dots, i_k - i_{k-1}$ will appear r times inside each of the s

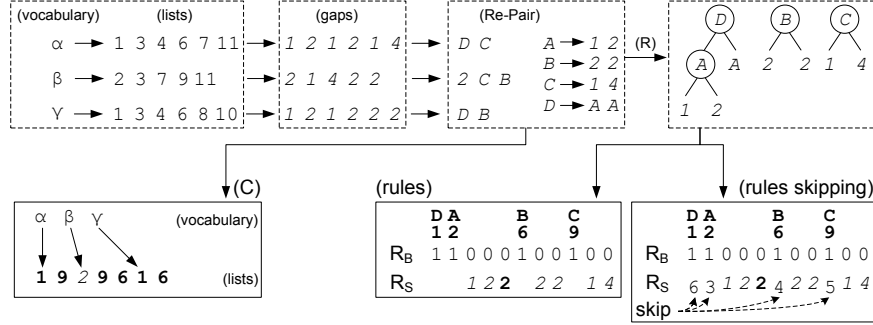

Figure 2: Example of inverted lists compressed with our Re-Pair-based method. Solid boxes enclose the data we finally keep. We include both variants of compressed rules with data aligned to the 1s in R_B (skipping) or not. Again, bold numbers (nonterminals) in the lists and R_S refer to positions in R_B , whereas slanted ones (terminals) refer to gap values.

lists, and LZ-End compression will be able to replace $rs - 1$ of the occurrences by a single reference. LZMA would have replaced only $rs - s$.

LZ-End also captures these regularities in the non-positional case. Let d_{j_1}, \dots, d_{j_r} be the r documents where the phrase $w_{t_1} w_{t_2} \dots w_{t_s}$ appears. Then, we will have the sequence $d_{j_2} - d_{j_1}, \dots, d_{j_r} - d_{j_{r-1}}$ repeated in the lists of the words that do not appear in other documents in between. Again, by compressing globally, LZ-End is exploiting inter-list similarities that LZMA could not detect.

4. Re-Pair Compressed Lists

As in the representation based on LZ-End, we aim at globally compressing the list of d-gaps. However, we will use a grammar compressor (Re-Pair) and will operate over the integer values rather than over their `vbyte` encodings (using the latter increased the space by 10% in preliminary experiments).

We prevent phrases from spanning multiple lists, which can be easily enforced at compression time. We simply have to add a separator to mark the beginning of each posting list (-1 for the first posting list, -2 for the second, -3 for the third, and so on) prior to performing the Re-Pair process. Since those separators occur only once, Re-Pair will not use them in any phrase. Therefore, we can remove them directly from the compressed sequence C after Re-Pair completes (see the shaded boxes in Figure 1). We can store pointers from the vocabulary to the points in the compressed sequence C where the lists begin, so that any list can be expanded in optimal time (i.e., proportional to its uncompressed size), by expanding all the symbols of C from its vocabulary pointer to the next. We store the Re-Pair dictionary in the compact format described in Section 2.3.

The terminal symbols are directly the corresponding differential values, for example, value $C[3] = 2$ is represented by the terminal integer value 2. This saves table accesses at decompression time. Figure 2 shows the complete inverted lists representation. Note that the Re-Pair process is identical to that in Figure 1.

4.1. Using skipping data

An attractive feature of grammar compression is that we can add extra information to nonterminals that enables fast skipping over the compressed list data without decompressing. This yields much faster sequential list intersections.

The key idea is that *nonterminals also represent differential values*, namely the sum of the differences they expand to. We call this the *phrase sum* of the nonterminal. In our example of Figure 2, as $D = \mathbf{1}$ expands into 1212 , its phrase sum is $1 + 2 + 1 + 2 = 6$. If we store this sum associated to D , we can skip it in the lists without expanding it, by knowing that its symbols add up to 6.

Phrase sums will be stored in sequence R_S , aligned with the 1s of sequence R_B . Thus *rank* is not anymore necessary to move from one sequence to the other. The 0s in R_B are aligned in R_S to the leaf data, and the 1s to the phrase sums of the corresponding nonterminals.

In order to find whether a given document d is in the compressed list, we first scan the entries in C , adding up in a sum s the value $C[i]$ if it is a terminal, or $R_S[C[i]]$ if it is a nonterminal. If at some point we reach $s = d$, then d is in the list. If instead we reach $s > d$, we consider whether the last $C[i]$ processed is a terminal or not. If it is a terminal, then d is not in the list. If it is a nonterminal, we restart the process from $s - C[i]$ and process the R_S values corresponding to the 0s in $R_B[C[i], \dots]$, recursing as necessary until we get $s = d$ or $s > d$ after reading a terminal.

In our example of Figure 2, assume we want to know whether document 9 is in the list of word β . We scan its list $2CB = 2\mathbf{9}\mathbf{6}$, from sum $s = 0$. We process 2 , and since it is a terminal we set $s = s + 2 = 2$. Now we process $\mathbf{9}$, and since it is a nonterminal, we set $s = s + R_S[9] = s + 5 = 7$ (note the 5 is correct because $\mathbf{9} = C$ expands to 14). Now we process $\mathbf{6}$, setting $s = s + R_S[6] = s + 4 = 11$. We have exceeded $d = 9$, thus we restart from $s = 7$ and now process the zeros in $R_B[6, \dots] = 100\dots$. The first 0 is at $R_B[7]$, and since $R_S[7] = 2$ is a terminal, we add $s = s + R_S[7] = 9$, concluding that $d = 9$ is in the list. The same process would have shown that $d = 8$ was not in the list.

4.2. Using sampling

Apart from the skipping capabilities above, we can add sampling to speed up the access to sequence C . Depending on whether we want to use strategies of type *svs* or *lookup* for the search, we can add the corresponding sampling of absolute values to the Re-Pair compressed lists. For *svs* we will sample C at regular positions, and will store the absolute values preceding each sample. The pointers to C are not necessary, as both the sampling and the length of the entries of C are regular. This is a plus compared to classical gap encoding methods. Strategy *lookup* will insert a new sample each time the absolute value surpasses a new multiple of a sampling step. Now we need to store pointers to C (as in the original method) and also the absolute values preceding each sample (unlike the original method). The reason is that the value to sample may be inside a nonterminal of C , and we will be able to point only to the (beginning of

the) whole nonterminal in C . Indeed, several consecutive sampled entries may point to the same position in C .

In Figure 2, imagine we wish to do the second kind of sampling on list γ , for $2^k = 4$ (including the first element too). Then the samples should point at positions 1, 3, and 5, of the original list $\gamma = \langle \underline{1} \ 3 \ \underline{4} \ 6 \ \underline{8} \ 10 \rangle$. But this list is compressed into DB , so the first two pointers point to D , and the latter to B . That is, the sampling array stores the pairs $[(0, 1), (0, 1), (6, 2)]$. Its third entry $(6, 2)$, for example, means that the first element ≥ 8 is at the 2nd entry (B) in its compressed list, and that we should start from value 6 when processing the differences. For example, if we wish to access the first list value exceeding 4, we should start from $(0, 1)$, that is, accumulate differences from D (the first entry), starting from value 0, until exceeding 4.

4.3. Intersection algorithm

To intersect several lists, we sort them in increasing order of their *uncompressed* length (which we store separately). Then we proceed iteratively, searching in step i the list $i + 1$ for the elements of the candidate list (recall Section 2.2).

At each intersection, the candidate list is sequentially traversed. Let x be its current element. We skip phrases of list $i + 1$, accumulating gaps until exceeding x , and then consider the previous and current cumulative gaps, $x_1 \leq x < x_2$. Thus, the last phrase represents the range $[x_1, x_2)$. If $x_1 = x$ we report x and shift to the next element in the candidate list. In either case, we advance in the candidate list until finding the largest $x' < x_2$. Then, we process the whole interval $[x, x']$ within the phrase representing $[x_1, x_2)$ in R_S in a recursive fashion, until one of the two lists gets empty.

This procedure can be speeded up by adding samples. The most promising choice is the one [21] that simply stores the absolute value of every s -th entry in C . Then, instead of sequentially traversing the phrases in list $i + 1$ looking for x , we can exponentially search for x in the samples and then sequentially traverse only one chunk of length at most s . Samples that are regular on the universe [60] are not so efficient because Re-Pair does not give direct access to arbitrary list elements. Moreover, note that once we switch to the recursive search inside R_S we do not have any sampling to speed up the scanning, so the impact of sampling is limited.

In the experimental section, we will present four Re-Pair variants. The first one (**RePair-Skip**) stores skipping information on nonterminals and no sampling. The second one (**RePair-Skip-CM**) uses skipping data and sampling at regular positions of C to permit exponential search within the list $i + 1$ as shown above. The third alternative (**RePair-Skip-ST**) uses sampling at domain positions and adapts the *lookup* search strategy. Finally, we also provide a simpler variant with neither skipping nor sampling data (**RePair**) where the intersection is done by first decompressing the whole lists and then applying a merge-type algorithm.

Note that, even though the use of sampling enables direct accesses to the inverted lists, these methods would experiment a slowdown compared to their uncompressed counterpart. This is because, as explained,

we can only have direct access to the Re-Pair phrase beginnings, that is, to integers in the compressed sequence C . This worsens even more in a repetitive scenario, where a single entry in C may expand to a large number of terminals, and may make the advantage of sampling vanish in practice.

4.4. Analysis

One can achieve worst-case time $O(m(1 + \log \frac{n}{m}))$ to intersect two lists of length $m < n$, for example by binary searching the longer list for the median of the shortest and dividing the problem into two [4], or by exponentially searching the longer list for the consecutive elements of the shortest [21]. This is a lower bound in the comparison model, as one can encode any of the $\binom{n}{m}$ possible subsets of size m of a universe of size n via the results of the comparisons of an intersection algorithm, so these must be $\geq \log_2 \binom{n}{m} \geq m \log_2 \frac{n}{m}$ in the worst case, and the output can be of size m . Better results are possible for particular classes [8].

We now analyze our skipping method in an idealized scenario where we assume that (1) we represent the dictionary as a binary tree, not using R_S and R_B (this can be done at the expense of worsening compression); (2) the derivation trees of our rules have logarithmic depth (this can be achieved [55], in particular the RePair implementation we use usually satisfies this property); and (3) we use an appropriate sampling (which, again, impacts on the space). We aim to show that our Re-Pair compression is able to achieve optimum performance in theory, even if in practice we opt for a more space-efficient representation.

We expand the shortest list if it is compressed, at $O(m)$ cost, and use skipping to find its consecutive elements on the longer list, of length n but compressed to $n' \leq n$ symbols by Re-Pair. Thus, we pay $O(n')$ time for skipping over all the symbols of C . Now, consider that we have to expand $C[j]$, to its length n_j , to find m_j symbols of the shortest list, $\sum_{j=1}^{n'} n_j = n$, $\sum_{j=1}^{n'} m_j = m$. Assume $m_j > 0$ (the others are absorbed in the $O(n')$ cost). In the worst case we will traverse all the $O(m_j)$ nodes of the derivation tree up to level $\log_2 m_j$, and then carry out m_j individual traversals from that level to the leaves, at depth $O(\log n_j)$. For the second part, we have m_j individual searches for one element x , which costs $O(m_j(\log n_j - \log m_j))$. All adds up to $O(m_j(1 + \log \frac{n_j}{m_j}))$. Added over all j , this is $O(m(1 + \log \frac{n}{m}))$, as the worst case is $n_j = \frac{n}{n'}$, $m_j = \frac{m}{n'}$.

Theorem 1. *The intersection between two lists L_1 and L_2 of length n and m respectively, with $n > m$, can be computed in time $O(n' + m(1 + \log \frac{n}{m}))$, where Re-Pair compresses L_1 to n' symbols using rules of depth $O(\log n)$.*

To achieve the optimal worst-case complexity we need to add sampling. One absolute sample out of $\log_2 \frac{n}{n'}$ positions in C multiplies the space by $1 + \frac{1}{\log_2 \frac{n}{n'}}$, and reduces the $O(n')$ term to $O(m \log \frac{n}{n'})$. This is absorbed by the optimal complexity as this matters only when $m \leq n'$.

Corollary 1. *With an $1 + \frac{1}{\log_2 \frac{n}{n'}}$ extra space factor, the algorithm of Theorem 1 takes $O(m(1 + \log \frac{n}{m}))$ time.*

Subset	Size (GB)	Articles	Number of Versions	Versions / Article	Avg bytes / Version
Full	108.50	240,179	8,467,927	35.26	13,757
Non-pos	24.77	2,203	881,802	400.27	23,782
Pos	1.94	4,327	149,761	34.61	13,941

Table 1: Some characteristics of the Wikipedia subcollections used.

5. Experimental results

We experimentally study the space/time tradeoffs obtained with the described inverted list representations, in both the non-positional and positional scenarios. In the positional scenario we also add a comparison with the self-indexes proposed in Appendix A.

The machine used has an Intel(R) Xeon(R) E5520 CPU (2.27GHz, 8 MB cache, 4 cores) and 72 GB of DDR3@800MHz memory. It runs Ubuntu GNU/Linux version 9.10 (kernel 2.6.31-19-server-64 bits) and g++ compiler version 4.4.1 (unless stated otherwise). Our code was compiled with the `-O9` directive². We measure CPU user-times.

We used the 108.5 GB Wikipedia collection described by He et al. [36], which contained 10% of the complete English Wikipedia from 2001 to mid 2008. This collection is formed by 240,179 articles, each of which has a number of versions. Table 1 shows its statistics.

We also chose two subsets of the articles, and collected all the versions of the chosen articles. Each version is considered as a document in our collection (we do not mark which versions belong to which article). For the non-positional setting our subset contains a prefix of 24.77 GB of the full collection, whereas for positional indexes we chose 1.94 GB of random articles. Table 1 also provides the statistics of our two subsets. As it can be seen, the 24.77 GB prefix is more repetitive than the full collection (yet, in Section 5.1.3 we will also present some results over the full collection for the non-positional scenario in order to compare with the approach of He et al. [36]), whereas the 1.94 GB subcollection is similar to the global collection.

To compare the space/time tradeoffs of the different indexing alternatives we used four different query sets, each of them containing 1,000 queries. The first two consist of one-word patterns that were chosen at random from the vocabulary of the indexed subcollection. They differ in the number of occurrences of the patterns. The first one (low-frequency scenario) includes infrequent words, which occur less than 1,000 times in the subcollection. The second query set (high-frequency scenario) includes only very frequent words,

²Some recent state-of-the-art techniques [51] used libraries and software we were unable to install in our base server. In those cases, we set a temporary Ubuntu GNU/Linux version 14.04 (kernel 3.13.4.49-generic-64 bits) on the same machine to run those experiments.

which occur more than 1,000 times in the subcollection.

The last two query sets consist of 1,000 phrases of 2 and 5 words that were chosen at random from the text of the subcollection. When dealing with non-positional indexes, such phrases are taken as conjunctive (AND) queries. In the positional scenario, we will take them as phrase queries, hence returning the documents where the words of each query occur at consecutive positions.

Finally, for the self-indexes used in the positional scenario we also include experiments to check the speed to recover the original documents. We choose two sets of random snippets of length 80 (around one line) and 13,000 (around one document, in our collection) characters.

5.1. Non-positional indexes

Our experiments compare the space/time tradeoffs of several variants of non-positional inverted indexes over the highly repetitive 24.77 GB subcollection described above. We include in this comparison some of the best classical encodings to represent d-gaps covered in Section 2, such as `Rice`, `Simple9`, `PforDelta`, and `Vbyte` with no sampling to speed up intersections (thus only merge-wise intersections are feasible). We also include two alternatives using `Vbyte` coupled with list sampling [21] (`Vbyte-CM`) with $k = \{4, 32\}$, or domain sampling [60] (`Vbyte-ST`) with $B = \{16, 128\}$. In addition, we include the hybrid variant of `Vbyte-CM` that uses bitmaps to represent the largest inverted lists (`Vbyte-CMB`) [21]. For completeness we used the same approach on `Vbyte-ST`, to build `Vbyte-STB`, and also included variants `VbyteB` and `RiceB` with no sampling. We also tested the novel `QMX`³ technique [61] that uses SIMD-instructions to boost decoding of large lists, and coupled it with an intersection algorithm [42] that also benefits from SIMD-instructions.⁴

We also tested the recent Partitioned Elias-Fano indexes [51], and used the best/optimized variant from that paper (`EF-opt`). The source code is available at authors' website.⁵ From the same authors [51], we also included in our experiments the variants `OPT-PFD` (optimized `PForDelta` variant [65]), `Interpolative` (Binary Interpolative Coding [45]), and `varintG8IU` (SIMD-optimized Variable Byte code [58]). To match their software requirements, we set our system to Ubuntu 14.04 and used `CMake` 2.8.12.2 (Release mode), `g++` version 4.8.2 with options (`-msse4.2 -std=c++11`), and `libboost` library version 1.54.0 (available with `apt`). All the experiments run on our Ubuntu 14.04 system will be marked with an '*' in the figures.

We compare all those techniques in Section 5.1.1, to determine which of the traditional techniques perform best in the repetitive scenario. Then, in Section 5.1.2 we compare them with the new variants designed to deal with repetitive data we proposed in Sections 3 and 4. In particular, we include `Rice-Runs`, `Vbyte-LZMA`, `Vbyte-Lzend`, `RePair`, `RePair-Skip`. We add no sampling to them. Therefore, only `RePair-Skip` can

³<http://www.cs.otago.ac.nz/homepages/andrew/papers/QMX.zip>.

⁴ <https://github.com/lemire/SIMDCompressionAndIntersection>. In this case we had to use `g++` version 4.7 with the `-O3 -msse4` flags, according to authors' sources.

⁵https://github.com/ot/partitioned_elias_fano.

benefit of additional data to boost the intersections (which are performed sequentially). In addition, we show the Re-Pair variants using sampling, **RePair-Skip-CM** (with $k = \{1, 64\}$) and **RePair-Skip-ST** (with $B = \{16, 256, 1024\}$). For **Vbyte-Lzend** we will obtain different space/time tradeoffs by tuning its *delta-codes-sampling* parameter ds (see [40] for details) to $ds = \{4, 16, 64, 256\}$.

Later, in Section 5.1.3, we will compare the approach of He et al. [36] with our new representations, over the same data used in their article. To make a fairer comparison, during the parsing stage of the construction of our inverted indexes we use exactly their same parsing of words. Therefore, we apply case folding, we do not consider stemming, and remove the 20 most common stopwords. After this parsing, the original 108.5 GB are reduced to around 85.55 GB, and the 24.77 GB of the indexed subcollection becomes around 19.54 GB. Anyway, from here on, the space results reported for the indexes are shown as a percentage of the index size with respect to the size of the original [sub]collection in plain text ($index_size/original_size \times 100$). Note that we are not considering in this experiment the compressed representation of the text. Times are shown in microseconds per occurrence.

5.1.1. Using traditional techniques in a repetitive scenario

As indicated above we include a comparison of well-known techniques that were initially developed for non-repetitive scenarios, now operating on repetitive collections. Figure 3 shows the space/time tradeoffs for non-positional indexes using those techniques to represent posting lists.

We can see that, among classical compression methods, both **Simple9** and **PforDelta** are much better in space than the older techniques like **Rice** (one third of the space) and **Vbyte** (one fifth of the space). In typical collections **Rice** achieves the best space, but these newer methods take advantage of the many runs of 1s. They are also several times faster than **Rice**, and roughly as fast as **Vbyte** on word queries. On conjunctive queries, however, **Vbyte** is faster. In those queries, adding samples to support *lookup*-type intersections is advantageous: **Vbyte-ST** is significantly faster than **Vbyte** (more than 3 times faster on 5-word queries). Surprisingly, in our experiments **Vbyte-CM** (sampling to support *svs* with exponential search on the longest list) turned out to be a bad choice, obtaining worse results than the simple **Vbyte** with no sampling. Note that the increase of time needed to recover an inverted list is due to the fact that values stored in the samples are removed from the differential sequence, what adds an additional branch at decompression time. Using hybrid techniques (representing the longest inverted lists with bitmaps and **Vbyte** for the others) turned out to be a good choice, as both space and time are improved with respect to the non-hybrid **Vbyte** variants. In the case of **Rice**, the **RiceB** hybrid counterpart did not improve space (as expected, since **Rice** is a bit-wise technique), yet the intersection times benefit significantly from the fast direct access to the longest lists.

The novel **QMX** shows to be an extremely fast technique when we deal with long posting lists (otherwise it cannot benefit from SIMD-optimized decompression) and the SIMD-based intersection algorithm [42] outperforms the others for long conjunctive queries. Unfortunately, its space is high, even worse than **Vbyte**.

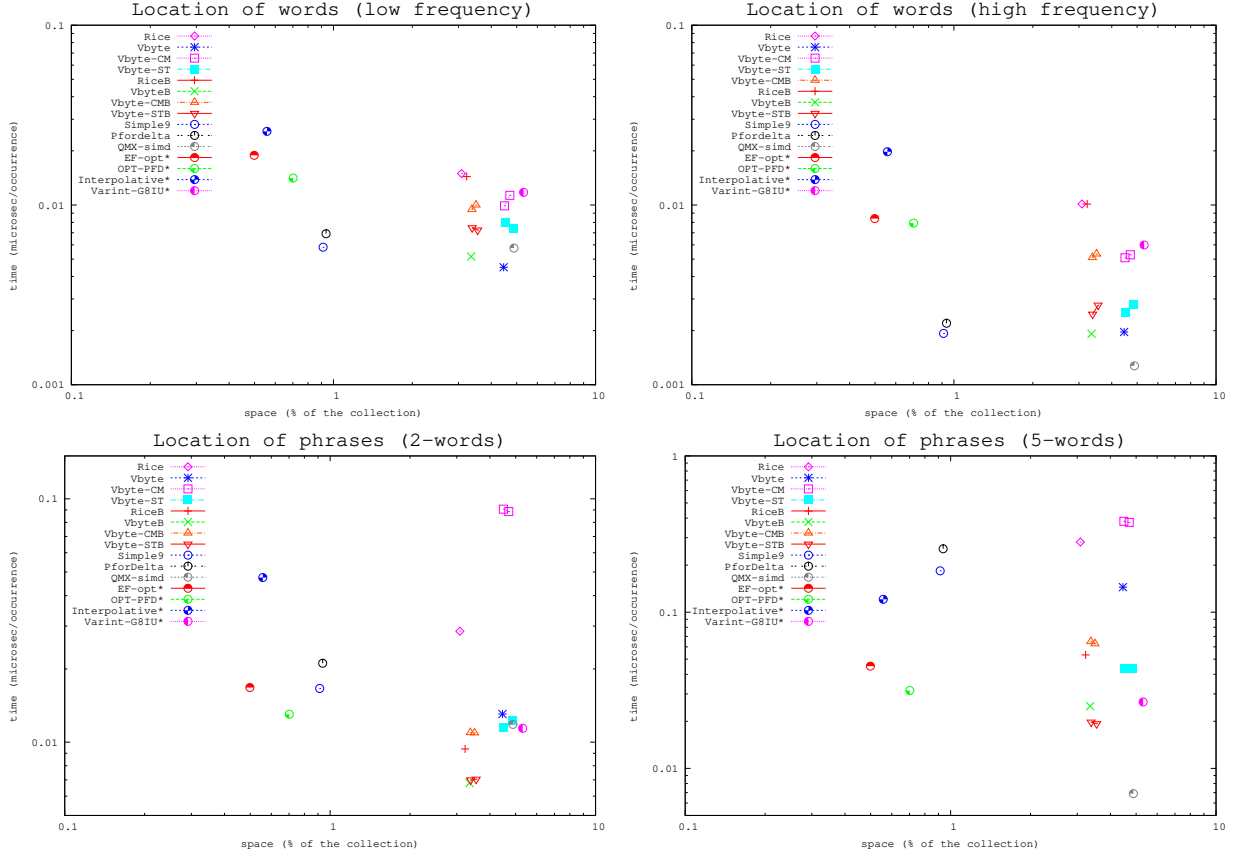

Figure 3: Space/time tradeoffs for non-positional indexes using traditional techniques. Logscale.

The comparison with the Elias-Fano indexes [51] shows that the recent `EF-opt` performs very well in the repetitive scenario. It obtains the best overall space (half the space of the above `PforDelta` variant). It also outperforms `Interpolative` in time, and is close to the times of `OPT-PFD` (which requires around 20% more space). Technique `varintG8IU` is the fastest of this group [51], yet as expected its space usage is far from the best ones (it is slightly worse than `Vbyte`). The conjunctive queries using these techniques are very fast. The use of a two-level structure enables an intersection algorithm (similar to *sequential*) where the candidate/eliminator from the shortest list is searched for in the others using *next_geq()* built-in operator. Their implementation is however somehow slow on word queries, mainly because list elements are recovered one at a time by using an operator *next*. Note that `varintG8IU` (the SIMD-optimized `Vbyte`) is slightly slower than our implementation of `Vbyte` even when fetching the posting lists of frequent words.

For the comparison with our new techniques, considering the scope of our article, we have retained three of those techniques, whose space usage is under 1%: *i)* `Simple9`, which offers good performance both for word and 2-word conjunctive queries; *ii)* `EF-opt`, which obtains the best space values and still good performance; and *iii)* `OPT-PFD`, which obtains space close to that of `EF-opt` and slightly better performance both for word

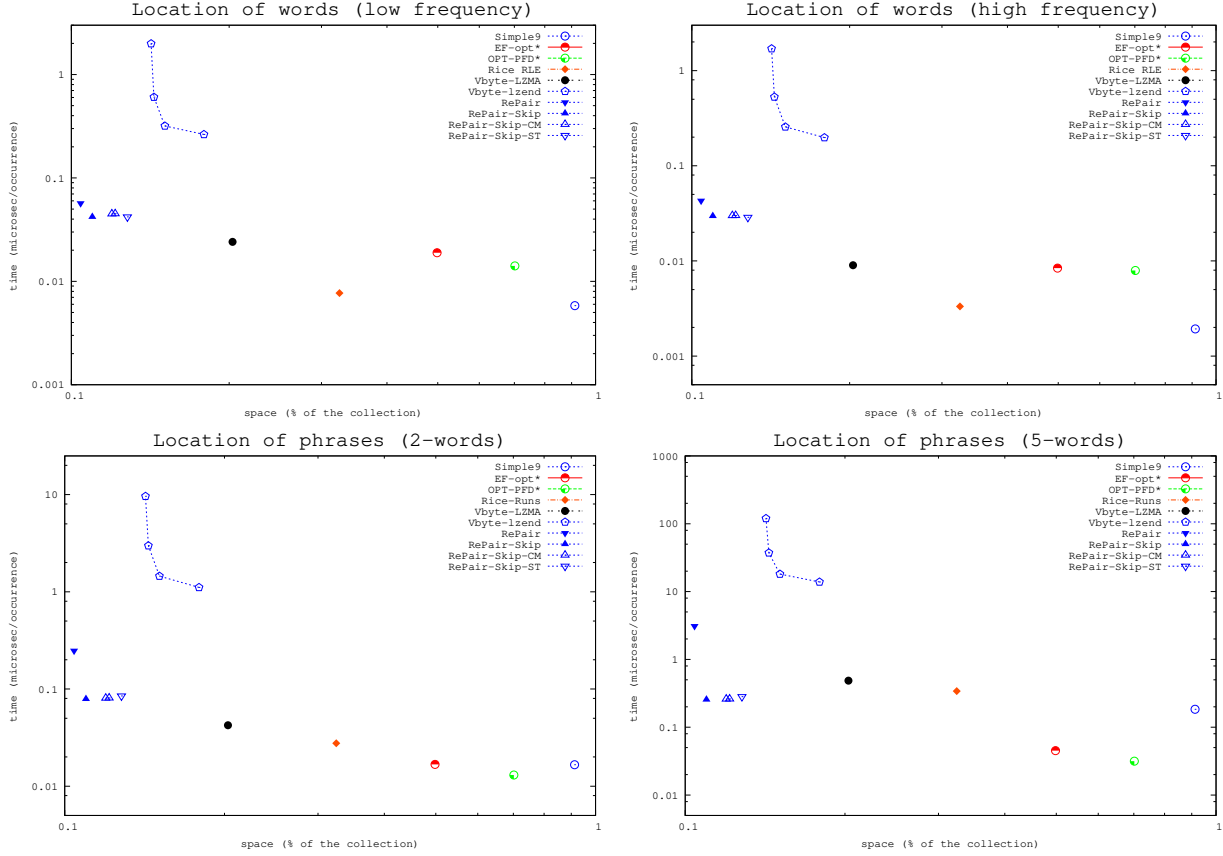

Figure 4: Space/time tradeoffs for non-positional indexes, comparing the best classical techniques with our new ones. Logscale.

and conjunctive queries.

5.1.2. Comparison with our proposals

Our next experiments compare our proposals with the best counterparts from the previous section. Figure 4 shows the space/time tradeoffs for all the resulting non-positional indexes. The most important conclusion with regard to classical encoding methods is that they are unsuitable for highly repetitive collections. Our new techniques take one order of magnitude less space than **Simple9** and up to 5 times less space than **EF-opt**. Yet, they are also significantly slower than the fastest classical variants.

Our first simple method to take advantage of repetitiveness, **Rice-Runs**, makes an interesting leap in space, from 1% taken by **Simple9** or 0.5% taken by **EF-opt**, to around 0.3%. If we compare it in Figure 3 we can see that it takes one tenth the space of plain **Rice** and is at the same time faster, as it needs much less decompression work. It does not, however, get close to the space of stronger methods like **Vbyte-LZMA**, which achieves around 0.2% space by exploiting other types of redundancy. However, **Rice-Runs** is significantly faster than **Vbyte-LZMA** (up to 3 times).

Vbyte-LZMA is close to the smallest space that we can achieve. It is significantly faster than RePair (up to 10 times) and than RePair-Skip (up to 3 times) at word queries, as it decompresses faster the inverted list. However, on conjunctive queries, where many of the decoded values have to be discarded, the ability of RePair-Skip to skip nonterminals without decompressing them finally makes it almost twice as fast as Vbyte-LZMA, and even faster than Rice-Runs.

As expected, Vbyte-Lzend succeeds at exploiting inter-list regularities and almost halves the space of Vbyte-LZMA, yet it is by far the slowest technique in our comparison, being more than an order of magnitude slower than Vbyte-LZMA.

Note that RePair obtains lower space (85%) than Vbyte-LZMA, despite the fact that LZ77 compression is more powerful than Re-Pair. This is a consequence of LZMA exploiting only intra-list regularities, and, as in Vbyte-LZMA, shows that significant further repetitions are captured when considering the inter-list redundancies. The skipping information added to RePair adds very little space (6%), but significantly improves its time performance (almost 20 times faster on long phrases). This improvement occurs even on one-word queries (up to 2.6 times faster), since RePair-Skip does not need to carry out *rank* operations on R_B (recall Section 2.3). Results also show that it is not worth adding sampling to RePair-Skip. Sampling increases the space requirements, but no improvements at intersections upon RePair-Skip are reported by RePair-Skip-CM nor RePair-Skip-ST. Note that for RePair-Skip-ST we are showing only the plot corresponding to sampling parameter $B = 1024$, which obtained the least space, since we obtain no time improvements and space usage grew from 25% to 700% using smaller values.

5.1.3. Comparison with previous work for repetitive collections

As described in Section 2.2, the best previous work for repetitive collections is by He et al. [36]. We tried hard to compile their index in our machine in order to carry out a direct comparison, with no success. On the other hand, limitations in one of our codes (Vbyte-Lzend) prevented us from indexing their full 108.5 GB collection.

We opted for the following compromise to compare the approaches as fairly as possible. The machine where they ran their experiments is very similar to ours in speed, RAM, and processors (except they have 8 cores and we have 4). Thus times are comparable. We ran the same set of 9,508 queries they used in their experiments with our new techniques. For Vbyte-Lzend (which was unable to index the whole collection) we split the 108.5 GB collection into four subcollections of approximately equal size, indexed them separately, and added up the space of the four parts. We ran the same set of 9,508 queries on each of the four subcollections, and added up the times. We believe that this gives us a very tight upper bound on the space and time Vbyte-Lzend would need for the whole collection, because we repeated the same process for the other techniques and obtained negligible differences between the estimated values and the real ones.

Figure 5 shows the space and time, the latter in milliseconds per query. We consider Rice-Runs, RePair,

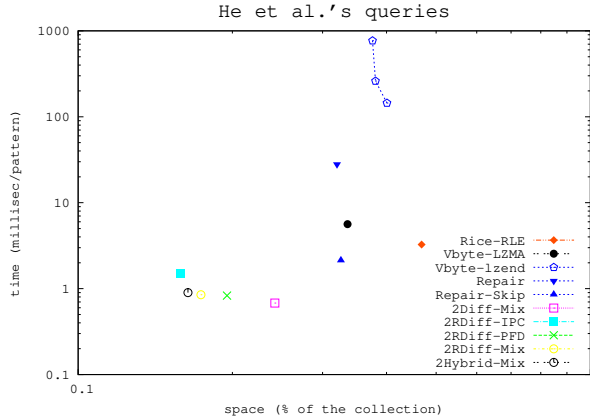

Figure 5: Space/time tradeoffs for our best non-positional indexes and those of He et al. Logscale.

`RePair-Skip`, `Vbyte-LZMA`, and `Vbyte-Lzend`, and the techniques that performed best in their experiments [36, Table 6].

As it can be seen, techniques of He et al. obtain roughly half the space and time of `RePair`, `RePair-Skip`, and `Vbyte-LZMA`. The advantage of the latter is that they are universal, that is, they work for more general scenarios where their techniques could not be applied.

Finally, note that the gap in space between `RePair` and `Vbyte-LZMA` is much smaller than in Section 5.1.2. This is because the whole collection has lower repetitiveness than the 24.77 GB subcollection and less inter-list regularities can be found. This also affected `Vbyte-Lzend`, whose results are now worse than those of `Vbyte-LZMA`.

5.2. Positional indexes

For testing the positional indexes we used the 1.94 GB subcollection because several self-index implementations are unable to handle texts larger than 2^{31} bytes.

Since self-indexes must reproduce the precise text, we cannot apply case folding nor any kind of filtering in this scenario. We index the original text as is. As explained, word-based self-indexes will regard (and index) the text as a sequence of words and separators. For fairness, the positional inverted indexes will index separators as valid words as well, and phrase queries will choose sequences of tokens, be they words or separators. Still, we note that character-based self-indexes will return more occurrences than word-based self-indexes (or than inverted indexes), as they also report the non-word-aligned occurrences. Times per occurrence still seem comparable, yet they slightly favor character-based self-indexes since the time per occurrence drops as more occurrences are reported (there is a fixed time cost per query).

We consider most of the techniques of the non-positional setting, now operating on position lists. Yet, for `Rice` and `Vbyte` we do not include the hybrid variants using bitmaps as they obtain no space/time

improvements in the positional scenario. For the `Vbyte` counterparts using sampling, we set the same sampling parameters as in the previous section: `Vbyte-CM` with $k = \{4, 32\}$ and `Vbyte-ST` with $B = \{16, 128\}$. We had to adapt `Simple9` because it is unable to represent gaps longer than 2^{28} . While such gaps do not arise on document lists, they do occur in position lists. We use the gap $2^{28} - 1$ as an escape code and then the next 32 bits represent the real gap. We exclude `PforDelta` because it has the same limitation, fixing it is more cumbersome, and its performance is not very different from that of `Simple9`. We also exclude `Rice-Runs`, as runs do not arise in the positional setting.

We did not include `Vbyte-Lzend`, as it was clearly overcome by `Vbyte-LZMA` and our Re-Pair variants. For the variants of Re-Pair using sampling, we set the sampling parameters to $k = \{1, 64\}$ for `RePair-Skip-CM` and $B = \{4, 256\}$ for `RePair-Skip-ST` (yet we will again show only results for $B = 256$, as using $B = 4$ doubled the space and brought no time improvements).

To compete in similar conditions with self-indexes, positional inverted indexes must be enhanced with an efficient decoding mechanism that allows any portion of the text to be efficiently reproduced. We choose Re-Pair for this purpose because it is well-suited for highly repetitive collections and supports fast direct access to the text. Because the text in this way represents a very small fraction of the total space, we will represent the rules as pairs of integers to speed up text extraction, instead of the slower R_B and R_S based implementation. This adds up to 1.21% of the original text size. To further improve extraction performance, we add a regular sampling of the array C , which increases space up to 1.3% for the densest sampling. As a comparison, `p7zip` (from www.7-zip.org), the best compressor for this type of repetitive texts, achieved 0.52% space on this subcollection (albeit not providing direct access).

We compare the self-indexes described in Appendix A, but first we tune SLP and the LZ-based indexes to optimize their performance. Regarding CSA-based self-indexes, we consider sampling rates of the form 2^i for $i = [5 \dots 11]$ for `RLCSA`, and seven different configurations of sampling parameters for `WCSA` (for the structures $\langle \psi, A_S, A_S^{-1} \rangle$, ranging from $\langle 8, 8, 8 \rangle$ to $\langle 2048, 2048, 2048 \rangle$). We add to both the inverted indexes and self-indexes the time and space required for converting absolute positions to (document,offset) pairs, as explained in Section 3. The extra space added by the corresponding mapping structure is just 0.03%.

In Section 5.2.1 we compare positional inverted indexes using state-of-the-art representations for posting lists. Then, in Section 5.2.2, we fine-tune the self-indexes we use, to find their best configurations. In Section 5.2.3 we compare the best state-of-the-art representations and our new representations of positional inverted lists, plus the tuned self-indexing alternatives. Our final experiments, in Section 5.2.4, study the speed to extract snippets and recover the original documents.

5.2.1. Traditional inverted list representations

Figure 6 shows the space/time tradeoffs achieved, for the four types of queries, with traditional inverted index representations. All classical inverted indexes achieve similar space, ranging from 30% to 40% of the

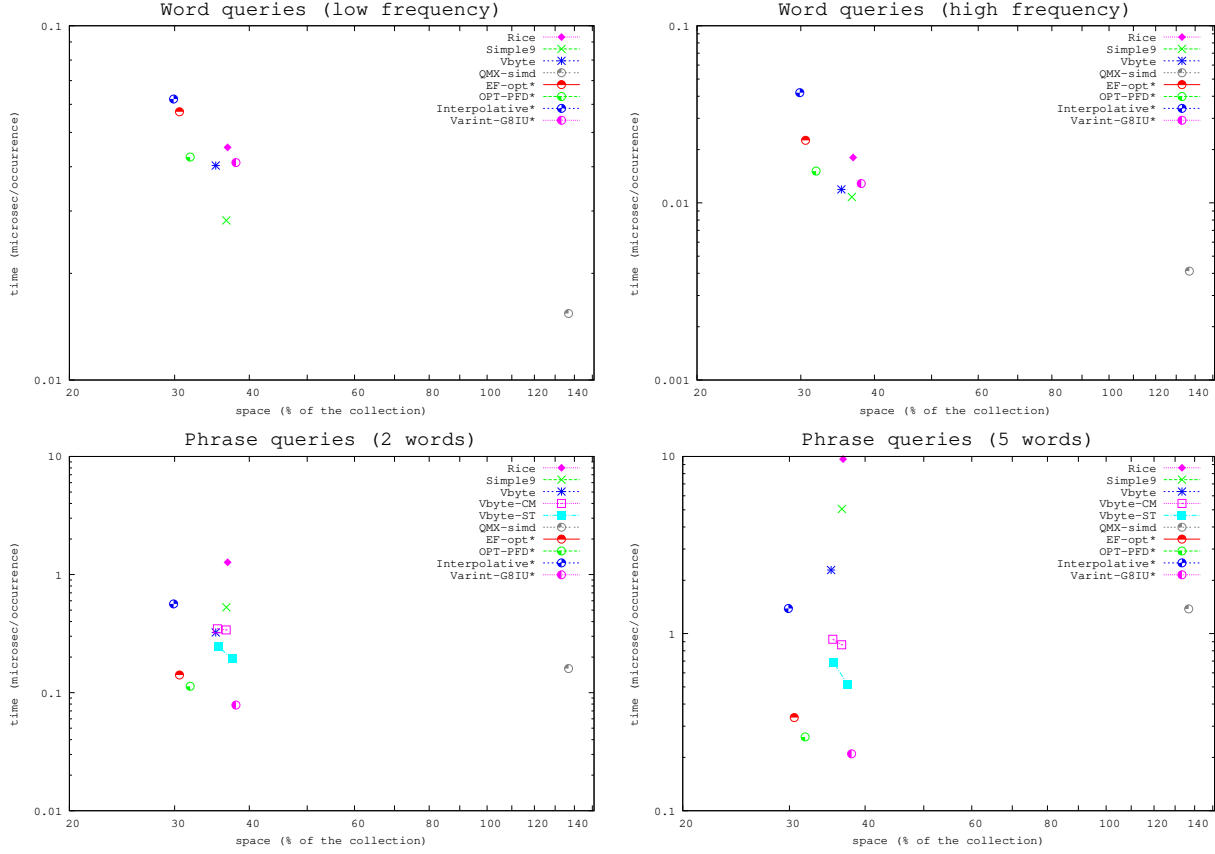

Figure 6: Space/time tradeoffs for traditional representations of positional indexes. Logscale.

text size. The more recent representations, instead, reach almost 10% of space. From those, **Interpolative** obtains the best compression, with a slight gap over **EF-opt** and **OPT-PFD**.

Simple9 is slightly faster than **Vbyte** for decompressing (i.e., for one-word queries), yet **Vbyte** becomes faster on phrases. Adding sampling, particularly **Vbyte-ST**, improves phrase query times significantly while almost not affecting the space. This is much more noticeable as the length of the pattern increases. Note that as more terms are involved in the query, it is more expectable that the ratio between the length of the shortest and longest involved lists increases. Therefore, a merge-wise intersection algorithm becomes less suitable than those that look up the longer lists. **Rice** is not competitive in this scenario. **QMX** (which occupies more space than using uncompressed posting values) is again the fastest technique at decompression (word queries). At phrase queries it is still twice as fast as **Vbyte**, but is clearly overcome by the techniques using sampling.

In particular, excluding **QMX** due to its poor compression, the most successful techniques considering phrase queries are **EF-opt**, **OPT-PFD**, and **varintG8IU** (yet it requires around 25% more space than **EF-opt**). At word-queries **Simple9** is the fastest representation. These four techniques will be used as the baselines

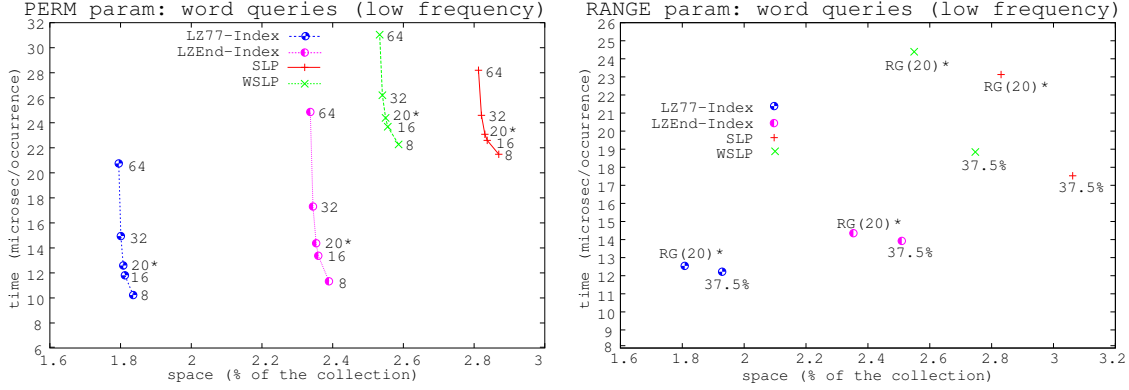

Figure 7: Space/time tradeoffs for fine tuning on `perm` (left plot) and `range` (right plot) parameters.

to compare with our inverted list representations in Section 5.2.3.

5.2.2. Tuning self-indexes

Before comparing them with inverted indexes, we tune SLP and LZ-based self-indexes to improve their space/time tradeoffs.

SLP-based self-indexes. We analyze four different parameters for tuning SLP and WSLP:

- `delta` establishes the sampling value used by the bitmap B , which records the starting positions of the symbols in C . The space/time tradeoffs are not greatly improved by this parameter, so we retain its original value `delta=16`.
- `perm` determines the largest allowed cycle length [48] in the permutation π that maps reverse to direct lexicographic ordering. We try values from `perm=64` to `perm=8`. As seen in Figure 7 (left), smaller values yield better query times at the price of slight additional space. On the other hand, this parameter does not have any influence on snippet extraction performance. Even so, we set `perm=8` to improve all types of word/phrase queries, because it only adds ≈ 800 KB to both self-index sizes.
- `range` parameterizes the bitmap configuration used for implementing the two binary relations in the self-index. We evaluate several configurations of well-known techniques from the state of the art [32]. As shown in Figure 7 (right), the technique called 37.5% (which uses 37.5% extra space on top of the bitmap) outperforms by far the original `range` configuration (which only adds 5% extra space) for all types of queries. A similar situation arises for snippet extraction. In this case, we prefer the fastest configuration at the price of increasing the self-index sizes (≈ 5 MB for SLP and ≈ 4 MB for WSLP).
- Finally, parameter `dict` affects the compressed string dictionaries used for indexing q -gram prefixes and suffixes from *LBRs*. As explained in Appendix A.2, these structures speed up binary searches on

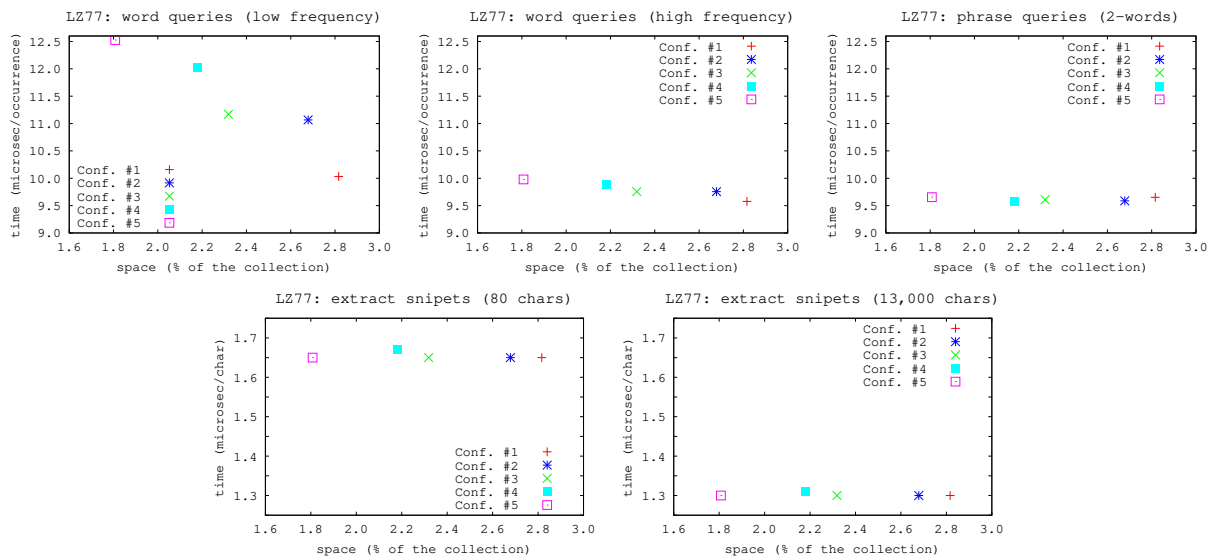

Figure 8: Space/time tradeoffs for different LZ77-index configurations.

rows and columns of *LBRs*. We consider q -grams of different length (from $q = 1$ to $q = 12$ characters), but the best tradeoffs are reported for $q = 4$. Thus, we index all prefix and suffix combinations of 4-chars using a Plain Front-Coding (PFC) dictionary [44].

All these decisions converge into new *SLP* and *WSLP* configurations that use $\approx 14\%$ more space than their original counterparts, but are clearly faster in all types of queries and snippet extraction operations. More precisely, word/phrase queries are 30%–35% faster, while the extraction speed is doubled on average.

LZ-based self-indexes. We consider five different variants of these indexes [40]. These are, ordered by decreasing space, as follows:

- **Conf. #1** uses suffix and reverse Patricia trees for representing phrase boundaries.
- **Conf. #2** performs binary search on the *id* array and holds the Patricia tree for the reversed phrases.
- **Conf. #3** holds the Patricia tree for the suffixes and performs binary search on the explicit *rid* array.
- **Conf. #4** performs binary searches on *id* and the explicit *rid* arrays.
- **Conf. #5** performs binary searches on *id* and the implicit *rid* arrays.

Figure 8 shows the space/time tradeoffs on *LZ77-index* (similar conclusions are obtained on *LZend-index*). In this case, the space used ranges from 1.8% to 2.8% of the original collection size. This means, in practice, that **Conf. #1** requires about 56 MB and **Conf. #5** about 36MB. Regarding performance, the most noticeable

difference is seen in low-frequency word queries (results range from 10 to $12.5\mu s$ per pattern occurrence). In the remaining cases, the difference between the fastest and the slowest configurations is roughly $1\mu s$ per pattern occurrence. Moreover, snippet extraction performance does not depend on the chosen configuration, as can be seen in the bottom plots. Thus, we decide to use **Conf.#5**, as it clearly reports the best compression numbers while providing very competitive performance both for query and extraction operations.

Once the configuration is defined, we tune the same **delta**, **perm**, and **range** parameters described for SLP-based indexes. In this case, **delta** parameterizes the bitmaps S and B , which encode the phrase structure. As in the previous case, it has no relevant effect in the query tradeoffs, but it affects extraction performance. Nevertheless, we discard reducing **delta** because it introduces a non-negligible space overhead (more than 20% of the space). Thus, the original value **delta=16** is maintained. Regarding **perm**, its influence is similar to that for SLP-indexes; see Figure 7 (left). Thus we also choose **perm=8** to favor query times. Finally, the **range** value is not as decisive as in the previous case. As can be seen in Figure 7 (right), query performance is barely improved, but space increases as for SLP-indexes. Thus, we retain the RG(20) bitmaps for building binary relations in both LZ-based self-indexes.

Summarizing, we only change the **perm** value on the **Conf.#5** variant. This means only 1.5% extra space, but speeds up word/phrase queries by around 20% in all cases.

5.2.3. Comparing positional inverted indexes with self-indexes

We compare the best traditional inverted indexes with the variants we developed to exploit repetitiveness. In addition, we include the self-indexes (tuned as shown above) in the comparison. Figure 9 shows the results.

RePair and **RePair-Skip** achieve almost the same space, close to 20%, and the latter is always faster for the same reasons as on non-positional indexes. While for words **RePair-Skip** is slower than the classical methods, its times become similar to those of **Simple9** on phrases. Adding sampling on top of **RePair-Skip** clearly outperforms **Simple9** on phrases. Yet, **RePair-Skip-ST** and **RePair-Skip-CM** are still clearly slower than the **EF-opt**, **OPT-PFD**, and **varintG8IU**, which obtain the best performance at phrase queries.

The best space of inverted indexes is achieved by **Vbyte-LZMA**, which reaches a compression ratio near 10% (half the space of **RePair-Skip** variants). This represents a significant improvement upon the state of the art. Moreover, for single-word queries its times are only slightly worse than those of **RePair-Skip**, yet on phrase queries its need to fully decompress the list makes it clearly slower (among the inverted indexes, only **RePair** performs worse than **Vbyte-LZMA** in this scenario).

Self-indexes are able to use much less space. First, note that **WSLP** is only slightly smaller than **SLP**. This shows that grammar-based compressors do not gain much from handling words instead of characters. They achieve around 3% compression ratio. This important reduction in space compared to the 10% of **Vbyte-LZMA** is paid with a sharp increase in search times. On words, they are up to 100–150 times slower than **Vbyte-LZMA**. This gap, however, decreases to 12 times on 2-word queries and to 1.2 times on 5-word

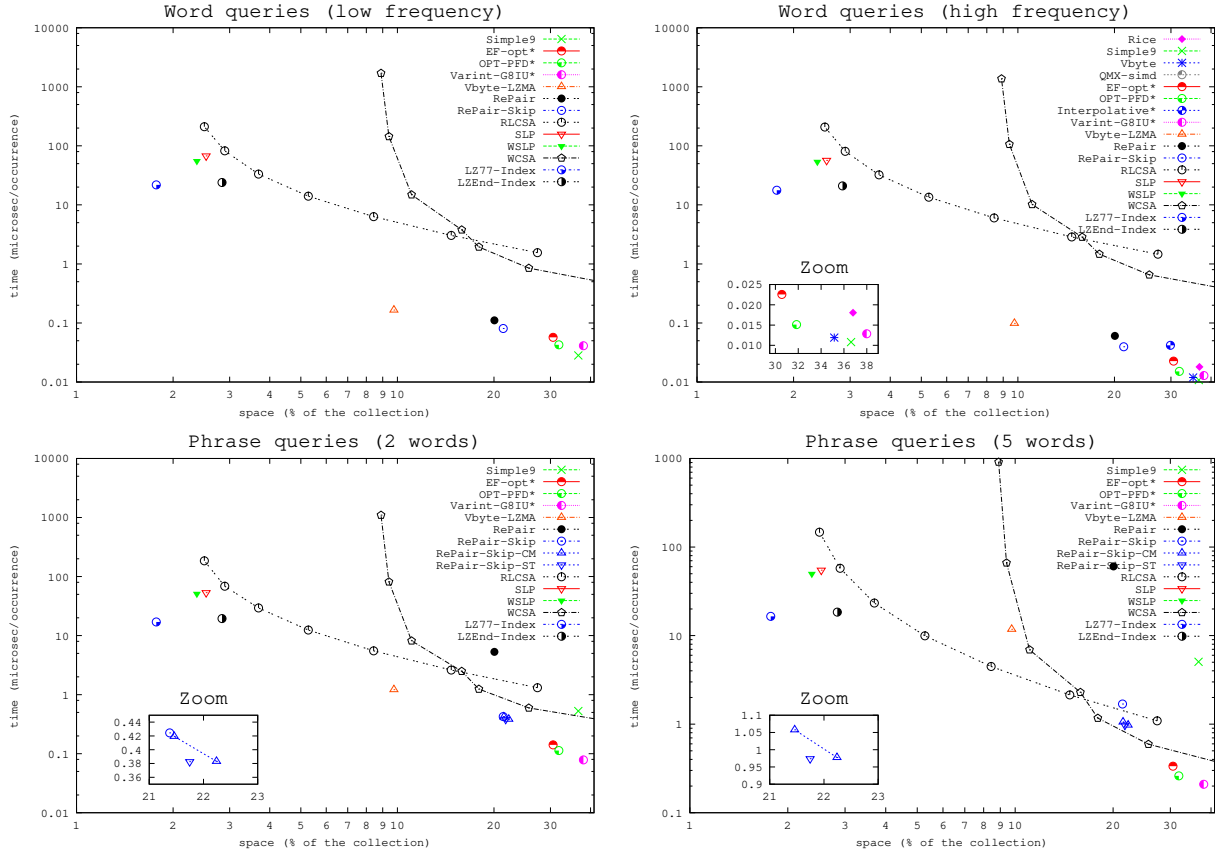

Figure 9: Space/time tradeoffs for positional indexes. Logscale.

queries. These self-indexes are mostly insensitive to the number of words in the query, whereas inverted indexes become much slower when looking for longer phrases. Thus, for long queries, SLP and WSLP are very attractive alternatives.

The RLCSA offers a wide space/time tradeoff that goes from roughly the space of LZend-index (where the latter is faster) to that reported by inverted indexes. Although these are clearly faster for word searches, differences are reduced as the search phrase becomes longer. Note that RLCSA reports similar numbers than Re-Par-based inverted indexes for 5-word phrase queries. Regarding WCSA, it can be seen as a word-based variant of the RLCSA, yet it is not so well optimized for highly repetitive sequences. As expected, WCSA is far from the space reached by other self-indexes (its best space is about 10% of the original collection). On the contrary, it reports the best self-index times for all types of queries when using sufficient space. For that space, other inverted indexes are much faster on word queries, but the WCSA retains a niche on phrase queries. In conclusion, RLCSA and WCSA build a bridge between self-index and inverted index tradeoffs, opening an interesting area for future improvements.

Finally, LZ-based self-indexes report the best numbers in compression. LZ77-index achieves the least

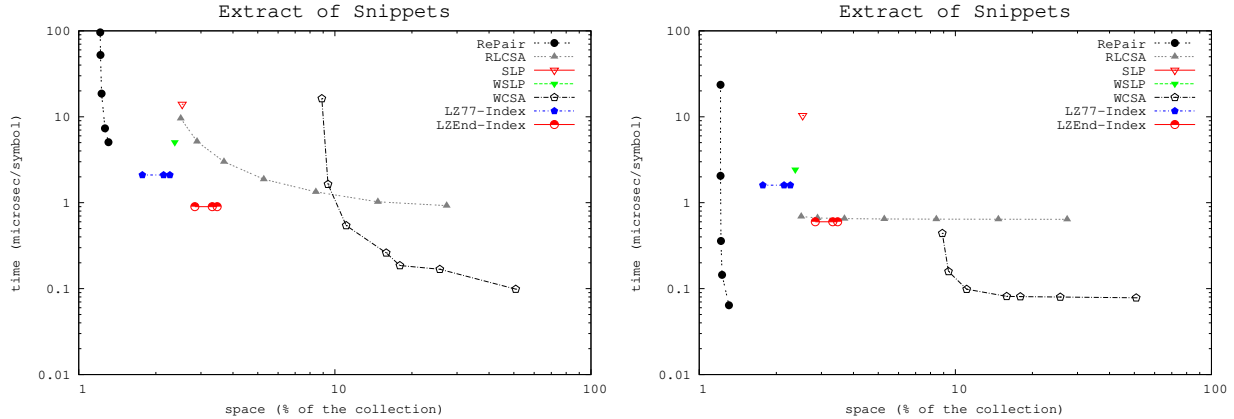

Figure 10: Space/time tradeoffs for extraction. Logscale.

space, overcoming its variant **LZend-index** and also grammar-based compressors, both in time and space. The **LZ77-index** takes less than 2% space and answers queries in 8–10 μs per occurrence. The **LZend-index** needs about 2.4% of the original space and solves queries in 9–11 μs per occurrence. Their performance is particularly interesting on 5-word phrase queries. In this case, they are faster than **Vbyte-LZMA**, and compete in the same order of magnitude of **Simple9** and all Re-Pair-based inverted indexes. Thus, for long queries these self-indexes compete with traditional approaches, but use up to 10–20 times less space.

5.2.4. Text extraction

Since self-indexes represent the text as a part of the index, it is relevant to measure how fast they are at extracting an arbitrary text snippet. For fairness we have added to our inverted indexes a Re-Pair-compressed version of the text. In order to support snippet extraction, we add a regular sampling over the C vector, which indicates the text position where the corresponding symbol starts. For decompressing an arbitrary snippet we binary search the rightmost preceding sample and decompress from there. This induces a space/time tradeoff regarding the sampling step.

Figure 10 shows the results of extracting random snippets of length 80 and 13,000 characters. Word-based indexes **WCSA** and **WSLP** extract a number of words equal to 80 or 13,000 divided by the average word length, to provide a roughly comparable result.

Here the word-based self-indexes **WCSA** and **WSLP** are significantly faster than their corresponding character-based counterparts **RLCSA** and **SLP**. **WSLP** is slightly faster than **LZ77-index**, but it is always overcome by the **LZend-index**. The fastest method overall is **WCSA**, at 0.1 μs per extracted symbol, but at the price of using much space. The second-fastest is the **LZend-index**, reaching 0.5–0.7 μs per extracted symbol (1.4–2 MB/sec) and much better space than **WCSA**, yet still far from the smaller **LZ77-index**, which takes 1.2–1.5 μs per extracted symbol. Finally, **RLCSA** competes better for long snippets, but it never dominates the com-

parison. Note that the methods that offer a tradeoff are much more sensitive to a denser sampling when extracting short snippets.

The line marked `RePair (text)` corresponds to the text represented with Re-Pair plus sampling. It uses the least space but it must be added to an inverted index in order to support searches. `RePair` is very slow to display short contexts. When displaying long contexts, however, it is the fastest option, even beating `WCSA`. This shows that the method is intrinsically fast, yet it is costly to arrive at the right starting position to extract (in the densest sampling shown, we sample every position in C).

6. Conclusions

We have studied the problem of indexing text collections that are highly repetitive, that is, where most documents are very similar to others. Many of the fastest-growing text collections today are indeed repetitive, and therefore exploiting repetitiveness in order to store and index them within little space is the key to handle the huge collection sizes that are becoming commonplace.

Repetitive collections may arise in controlled scenarios like versioned document collections, where versions have a known linear structure (such as Wikipedia) or a known tree structure (such as software repositories), but also in less controlled scenarios like DNA sequence collections of similar species or periodic publications, where the repetition structure may be chaotic and unknown. Our main focus has been natural language text collections, where the inverted index is the main actor, but we have also studied self-indexes, a new family of structures that apply on general string collections.

We first studied how known non-positional inverted indexes perform on repetitive collections. These indexes store the documents where each word appears. While classical indexes require 3%–6% of the plain text size in these collections, some of the more recent inverted indexes [45, 1, 65, 51] reach just 0.5%–1.0% and are about as fast. This is, however, significant if we consider that a Lempel-Ziv compression on the repetitive text reduces it to just 0.5% of its size. Our new non-positional inverted indexes, instead, reach 0.1%–0.2% of the plain text size, at the price of being a few times slower. Previous work [36] obtains even less space and time, but they can only be used if the versioning structure is formed by known isolated documents and their versions. Our techniques, instead, are universal: they do not need that a clear versioning structure is known or even exists.

Positional inverted indexes also store the positions of the words in the documents, and support phrase queries. Classical ones require more than 40% of the plain text size, whereas the more recent formats [45, 65, 51] reach around 30% and are about as fast. Our new repetition-tailored representations, instead require 10%–20% space and are a few times slower. Self-indexes, which offer similar functionality, reach as little as 2%–3% space, but are orders of magnitude slower.

Our main technical novelty is to apply grammar-based compression (Re-Pair, in particular) to the whole

set of differentially-encoded inverted lists, and enhance the grammar nonterminals with summary information that allows us intersecting the compressed inverted lists without fully decompressing them. This is the key to obtain significant space reductions while only moderately slowing down the operations. We also implement and tune several other simpler or existing ideas, some of which also obtain relevant results.

In the case of inverted indexes, being a few times slower is not so important if their lower space allows us holding the index in a faster and smaller memory, for example in main memory instead of disk. If both structures must reside on disk, the smaller size of our indexes allows retrieving the lists with fewer I/Os, which blurs the relatively small CPU-time differences and plays in our favor. For example, if our inverted index is 3–5 times smaller than a classical one, then a long enough list will also be read into main memory 3–5 times faster.

In the case of self-indexes, even if they are orders of magnitude slower, they may still be convenient if their smaller size allows us fit them in main memory instead of on disk. In addition, self-indexes handle general string collections, not only natural language. On the other hand, self-indexes do not perform well on disk.

These giant space/time differences clearly indicate that much more can be done in this area. An interesting line of future work is to find further regularities induced by repetitiveness in the inverted indexes, so as to match the space of self-indexes while retaining the good time performance of inverted indexes. We have shown that grammar-based compression exploits several inter- and intra-list regularities, while allowing for fast list processing, but the results on self-indexes show that we may be missing many others.

Another important line to explore is that of more sophisticated queries. One such query is to find the occurrences of a pattern within a range of document identifiers. This could correspond to a range or subtree of versions, or a temporal interval. While the task is relatively simple with an inverted index, self-indexes deliver the results out of order, and such a requirement is challenging for them [38].

Another challenging family of queries for self-indexes are the document-oriented ones. The equivalent of a non-positional inverted index is a self-index offering *document listing*, which lists the documents where a pattern appears. Only very recent proposals exist for this problem on repetitive collections [17, 30], but even the best implementations use 7% space or more. More sophisticated queries involve obtaining the k most important documents where the pattern appears, according to some definition of importance. There already exist some proposals for this problem in the repetitive scenario, but they are either inverted indexes for the particular versioning structure described above [34], or they are self-indexes using at least 20% of space [50].

We have left our codes and experimental testbeds available at <https://github.com/migumar2/uiHRDC>.

Acknowledgements

We thank Jinru He, Junyuan Zeng, and Torsten Suel, for providing their input collection and useful information on how to use their files.

References

- [1] V. Anh and A. Moffat. Inverted index compression using word-aligned binary codes. *Information Retrieval*, 8:151–166, 2005.
- [2] V. Anh and A. Moffat. Index compression using 64-bit words. *Software Practice and Experience*, 40(2):131–147, 2010.
- [3] P. Anick and R. Flynn. Versioning a full-text information retrieval system. In *Proc. 15th Annual International ACM SIGIR Conference on Research and Development in Information Retrieval (SIGIR)*, pages 98–111, 1992.
- [4] R. Baeza-Yates. A fast set intersection algorithm for sorted sequences. In *Proc. 15th Annual Symposium on Combinatorial Pattern Matching (CPM)*, pages 400–408, 2004.
- [5] R. Baeza-Yates, A. Moffat, and G. Navarro. *Searching Large Text Collections*, pages 195–244. Kluwer Academic, 2002.
- [6] R. Baeza-Yates and B. Ribeiro. *Modern Information Retrieval*. Addison-Wesley, 2nd edition, 2011.
- [7] J. Barbay and C. Kenyon. Adaptive intersection and t -threshold problems. In *Proc. 13th Annual ACM-SIAM Symposium on Discrete Algorithms (SODA)*, pages 390–399, 2002.
- [8] J. Barbay, A. López-Ortiz, T. Lu, and A. Salinger. An experimental investigation of set intersection algorithms for text searching. *ACM Journal of Experimental Algorithmics*, 14:article 7, 2009.
- [9] D. Belazzougui, F. Cunial, T. Gagie, N. Prezza, and M. Raffinot. Composite repetition-aware data structures. In *Proc. 26th Annual Symposium on Combinatorial Pattern Matching (CPM)*, pages 26–39, 2015.
- [10] D. Benoit, E. Demaine, J. Munro, R. Raman, V. Raman, and S. Rao. Representing trees of higher degree. *Algorithmica*, 43(4):275–292, 2005.
- [11] N. Brisaboa, S. Ladra, and G. Navarro. DACs: Bringing direct access to variable-length codes. *Information Processing and Management*, 49(1):392–404, 2013.

- [12] A. Broder, N. Eiron, M. Fontoura, M. Herscovici, R. Lempel, J. McPherson, R. Qi, and E. Shekita. Indexing shared content in information retrieval systems. In *Proc. 10th International Conference on Extending Database Technology (EDBT)*, pages 313–330, 2006.
- [13] S. Büttcher, C. L. A. Clarke, and G. V. Cormack. *Information Retrieval – Implementing and Evaluating Search Engines*. MIT Press, 2010.
- [14] M. Charikar, E. Lehman, D. Liu, R. Panigrahy, M. Prabhakaran, A. Sahai, and A. Shelat. The smallest grammar problem. *IEEE Transactions on Information Theory*, 51(7):2554–2576, 2005.
- [15] D. Clark. *Compact PAT Trees*. PhD thesis, University of Waterloo, Canada, 1996.
- [16] F. Claude, A. Fariña, M. Martínez-Prieto, and G. Navarro. Compressed q -gram indexing for highly repetitive biological sequences. In *Proc. 10th International Conference on Bioinformatics and Bioengineering (BIBE)*, pages 86–91, 2010.
- [17] F. Claude and I. Munro. Document listing on versioned documents. In *Proc. 20th International Symposium on String Processing and Information Retrieval (SPIRE)*, LNCS 8214, pages 72–83, 2013.
- [18] F. Claude and G. Navarro. Practical rank/select queries over arbitrary sequences. In *Proc. 15th International Symposium on String Processing and Information Retrieval (SPIRE)*, LNCS 5280, pages 176–187, 2008.
- [19] F. Claude and G. Navarro. Self-indexed grammar-based compression. *Fundamenta Informaticae*, 111(3):313–337, 2010.
- [20] F. Claude and G. Navarro. Improved grammar-based compressed indexes. In *Proc. 19th International Symposium on String Processing and Information Retrieval (SPIRE)*, LNCS 7608, pages 180–192, 2012.
- [21] J. S. Culpepper and A. Moffat. Efficient set intersection for inverted indexing. *ACM Transactions on Information Systems*, 29(1):article 1, 2010.
- [22] E. Demaine and I. Munro. Adaptive set intersections, unions, and differences. In *Proc. 11th Annual ACM-SIAM Symposium on Discrete Algorithms (SODA)*, pages 743–752, 2000.
- [23] C. Dimopoulos, S. Nepomnyachiy, and T. Suel. Optimizing top- k document retrieval strategies for block-max indexes. In *Proc. 6th ACM International Conference on Web Search and Data Mining (WSDM)*, pages 113–122, 2013.
- [24] S. Ding, J. Attenberg, and T. Suel. Scalable techniques for document identifier assignment in inverted indexes. In *Proc. 19th International Conference on World Wide Web (WWW)*, pages 311–320, 2010.

- [25] S. Ding and T. Suel. Faster top-k document retrieval using block-max indexes. In *Proc. 34th Annual International ACM SIGIR Conference on Research and Development in Information Retrieval (SIGIR)*, pages 993–1002, 2011.
- [26] H. H. Do, J. Jansson, K. Sadakane, and W.-K. Sung. Fast relative Lempel-Ziv self-index for similar sequences. *Theoretical Computer Science*, 532:14–30, 2014.
- [27] A. Fariña, N. Brisaboa, G. Navarro, F. Claude, A. Places, and E. Rodríguez. Word-based self-indexes for natural language text. *ACM Transactions on Information Systems*, 30(1):article 1, 2012.
- [28] T. Gagie, P. Gawrychowski, J. Kärkkäinen, Y. Nekrich, and S. J. Puglisi. A faster grammar-based self-index. In *Proc. 6th Language and Automata Theory and Applications (LATA)*, LNCS 7183, pages 240–251, 2012.
- [29] T. Gagie, P. Gawrychowski, J. Kärkkäinen, Y. Nekrich, and S. J. Puglisi. LZ77-based self-indexing with faster pattern matching. In *Proc. 11th Latin American Theoretical Informatics Symposium (LATIN)*, LNCS 8392, pages 731–742, 2014.
- [30] T. Gagie, K. Karhu, G. Navarro, S. Puglisi, and J. Sirén. Document listing on repetitive collections. In *Proc. 24th Annual Symposium on Combinatorial Pattern Matching (CPM)*, LNCS 7922, pages 107–119, 2013.
- [31] A. Golynski, J. Munro, and S. Rao. Rank/select operations on large alphabets: A tool for text indexing. In *Proc. 17th Annual ACM-SIAM Symposium on Discrete Algorithms (SODA)*, pages 368–373, 2006.
- [32] R. González, S. Grabowski, V. Mäkinen, and G. Navarro. Practical implementation of rank and select queries. In *Poster Proc. 4th Workshop on Efficient and Experimental Algorithms (WEA)*, pages 27–38, 2005.
- [33] R. González, G. Navarro, and H. Ferrada. Locally compressed suffix arrays. *ACM Journal of Experimental Algorithmics*, 19(1):article 1, 2014.
- [34] J. He and T. Suel. Optimizing positional index structures for versioned document collections. In *Proc. 35th International ACM SIGIR Conference on Research and Development in Information Retrieval (SIGIR)*, pages 245–254, 2012.
- [35] J. He, H. Yan, and T. Suel. Compact full-text indexing of versioned document collections. In *Proc. 18th ACM International Conference on Information and Knowledge Management (CIKM)*, pages 415–424, 2009.

- [36] J. He, J. Zeng, and T. Suel. Improved index compression techniques for versioned document collections. In *Proc. 19th ACM International Conference on Information and Knowledge Management (CIKM)*, pages 1239–1248, 2010.
- [37] S. Heman. *Super-scalar database compression between RAM and CPU-cache*. PhD thesis, Centrum voor Wiskunde en Informatica (CWI), Amsterdam, 2005.
- [38] W. Hon, R. Shah, S. V. Thankachan, and J. S. Vitter. On position restricted substring searching in succinct space. *Journal of Discrete Algorithms*, 17:109–114, 2012.
- [39] R. Konow, G. Navarro, C. Clarke, and A. López-Ortíz. Faster and smaller inverted indices with treaps. In *Proc. 36th International ACM SIGIR Conference on Research and Development in Information Retrieval (SIGIR)*, pages 193–202, 2013.
- [40] S. Krefl and G. Navarro. On compressing and indexing repetitive sequences. *Theoretical Computer Science*, 483:115–133, 2013.
- [41] J. Larsson and A. Moffat. Off-line dictionary-based compression. *Proc. IEEE*, 88(11):1722–1732, 2000.
- [42] D. Lemire, L. Boytsov, and N. Kurz. Simd compression and the intersection of sorted integers. *Software: Practice and Experience (published online)*, 2015.
- [43] V. Mäkinen, G. Navarro, J. Sirén, and N. Välimäki. Storage and retrieval of highly repetitive sequence collections. *Journal of Computational Biology*, 17(3):281–308, 2010.
- [44] M. A. Martínez-Prieto, N. Brisaboa, R. Cánovas, F. Claude, and G. Navarro. Practical compressed string dictionaries. *Information Systems*, 56:73–108, 2016.
- [45] A. Moffat and L. Stuiver. Binary interpolative coding for effective index compression. *Information Retrieval*, 3(1):25–47, 2000.
- [46] D. Morrison. Patricia-practical algorithm to retrieve information coded in alphanumeric. *Journal of the ACM*, 15:514–534, 1968.
- [47] E. Moura, G. Navarro, N. Ziviani, and R. Baeza-Yates. Fast and flexible word searching on compressed text. *ACM Transactions on Information Systems*, 18(2):113–139, 2000.
- [48] J. Munro, R. Raman, V. Raman, and S. Rao. Succinct representations of permutations. In *Proc. 30th International Colloquium on Automata, Languages and programming (ICALP)*, LNCS 2719, pages 345–356, 2003.

- [49] G. Navarro and V. Mäkinen. Compressed full-text indexes. *ACM Computing Surveys*, 39(1):article 2, 2007.
- [50] G. Navarro, S. J. Puglisi, and J. Sirén. Document retrieval on repetitive collections. In *Proc. 22nd Annual European Symposium on Algorithms (ESA B)*, LNCS 8737, pages 725–736, 2014.
- [51] G. Ottaviano and R. Venturini. Partitioned elias-fano indexes. In *Proc. 37th International ACM SIGIR Conference on Research and Development in Information Retrieval (SIGIR)*, pages 273–282, 2014.
- [52] M. Rochkind. The source code control system. *IEEE Transactions on Software Engineering*, 1(4):364–370, 1975.
- [53] W. Rytter. Application of Lempel-Ziv factorization to the approximation of grammar-based compression. In *Proc 13th Annual Symposium on Combinatorial Pattern Matching (CPM)*, LNCS 2373, pages 20–31, 2002.
- [54] K. Sadakane. New text indexing functionalities of the compressed suffix arrays. *Journal of Algorithms*, 48(2):294–313, 2003.
- [55] H. Sakamoto. A fully linear-time approximation algorithm for grammar-based compression. *Journal of Discrete Algorithms*, 3:416–430, 2005.
- [56] B. Schlegel, R. Gemulla, and W. Lehner. Fast integer compression using SIMD instructions. In *Proc. 6th International Workshop on Data Management on New Hardware (DaMoN)*, pages 34–40, 2010.
- [57] W.-Y. Shieh, T.-F. Chen, J. J.-J. Shann, and C.-P. Chung. Inverted file compression through document identifier reassignment. *Information Processing and Management*, 39(1):117–131, 2003.
- [58] A. A. Stepanov, A. R. Gangolli, D. E. Rose, R. J. Ernst, and P. S. Oberoi. SIMD-based decoding of posting lists. In *Proc. 20th ACM International Conference on Information and Knowledge Management (CIKM)*, pages 317–326, 2011.
- [59] T. Strohman and B. Croft. Efficient document retrieval in main memory. In *Proc. 30th Annual International ACM SIGIR Conference on Research and Development in Information Retrieval (SIGIR)*, pages 175–182, 2007.
- [60] F. Transier and P. Sanders. Engineering basic algorithms of an in-memory text search engine. *ACM Transactions on Information Systems*, 29:article 2, 2010.
- [61] A. Trotman. Compression, simd, and postings lists. In *Proc. 19th Australasian Document Computing Symposium (ADCS)*, pages 50–57. ACM, 2014.

- [62] H. Williams and J. Zobel. Compressing integers for fast file access. *The Computer Journal*, 42:193–201, 1999.
- [63] I. Witten, A. Moffat, and T. Bell. *Managing Gigabytes*. Morgan Kaufmann, 2nd edition, 1999.
- [64] H. Yan, S. Ding, and T. Suel. Compressing term positions in web indexes. In *Proc. 32nd Annual International ACM SIGIR Conference on Research and Development in Information Retrieval (SIGIR)*, pages 147–154, 2009.
- [65] H. Yan, S. Ding, and T. Suel. Inverted index compression and query processing with optimized document ordering. In *Proc. 18th International Conference on World Wide Web (WWW)*, pages 401–410, 2009.
- [66] J. Zhang, X. Long, and T. Suel. Performance of compressed inverted list caching in search engines. In *Proc. 17th International Conference on World Wide Web (WWW)*, pages 387–396, 2008.
- [67] J. Zhang and T. Suel. Efficient search in large textual collections with redundancy. In *Proc. 16th International Conference on World Wide Web (WWW)*, pages 411–420, 2007.
- [68] J. Ziv and A. Lempel. A universal algorithm for sequential data compression. *IEEE Transactions on Information Theory*, 23(3):337–343, 1977.
- [69] J. Zobel and A. Moffat. Inverted files for text search engines. *ACM Computing Surveys*, 38(2):article 6, 2006.
- [70] M. Zukowski, S. Heman, N. Nes, , and P. Boncz. Super-scalar RAM-CPU cache compression. In *Proc. 22nd International Conference on Data Engineering (ICDE)*, page 59, 2006.

A. Self-Indexes

Self-indexes [49] are an innovative approach for positional indexing. They process the concatenated text collection \mathcal{D} to build compressed structures that integrate the text and a positional index in a single representation. It is worth noting that self-indexes are designed for general strings, not only natural language collections where only words and phrases can be sought.

Self-indexes provide efficient pattern searching and snippet extraction. In the first operation, the self-index will find all the occurrences of the pattern, yet usually not in order. This implies that the o pattern occurrences must be sorted prior to translating them into the document and offset format, using the technique described in Section 3. This leads a total translation cost of $O(o \log n)$. The extraction operation is implemented by decoding the required text fragment from the compressed self-index, and takes proportional time to the length of the snippet.

We consider different self-indexes to compare their space/ time tradeoffs with those reported by compressed inverted indexes. On the one hand, we analyze character-oriented approaches, which regard the text as a sequence of characters and report any substring matching the pattern. We choose `RLCSA`, `LZ77-index`, `LZend-index`, and `SLP` as examples of character-oriented self-indexes. We make some tuning and improvements on the last three techniques, outperforming the original implementations. These are described in this section. On the other hand, we include two word-oriented self-indexes in our study: `WCSA` and `WSLP`, the latter designed for this paper. These techniques map words and *separators* (maximal spaces between words) to integers, and the indexes represent the resulting integer sequence. We use the spaceless words model [47], where the single whitespace separator is omitted and assumed by default. The mapping between integers and their corresponding words is provided by a simple vocabulary representation.

A.1. CSA-based self-indexes

The *Compressed Suffix Array* (CSA) of Sadakane [54] proposes a succinct suffix array encoding. In short, the *suffix array* $A[1, n]$ for a text $\mathcal{D}[1, n]$, with alphabet $\Sigma = [1, \sigma]$, is a permutation of $[1, n]$ so that $\mathcal{D}[A[i], n]$ is the i -th lexicographically smallest suffix in the text. Note that the suffix array arranges all the suffixes starting with any given search pattern $P[1, m]$ in a contiguous range, so their occurrences can be binary searched in time $O(m \log n)$.

CSA encodes \mathcal{D} and A using two main structures (plus other less important ones). A bitmap $B[1, n]$ marks where the first symbol of the suffixes changes in A . That is, $B[i] = 1$ iff $i = 1$ or $\mathcal{D}[A[i]] \neq \mathcal{D}[A[i-1]]$. The second structure is the array $\psi[1, n]$, defined so that $A[\psi[i]] = A[i] + 1$. That is, if the suffix $\mathcal{D}[j, n]$ is pointed from $A[i] = j$, then the next text suffix $\mathcal{D}[j+1, n]$ is pointed from $A[\psi[i]] = j+1$. Note that the first symbol of $\mathcal{D}[A[i], n]$ can be recovered with $rank_1(B, i)$, the second with $rank_1(B, \psi[i])$, the third with $rank_1(B, \psi[\psi[i]])$, and so on, which enables $O(m \log n)$ time binary searching for the area of A of the suffixes that start with $P[1, m]$.

Once we have found that the suffixes starting with p are in the range $A[l, r]$, its occurrences are precisely the positions $A[l], A[l+1], \dots, A[r]$. To recover each such entry $A[j]$, we also use ψ . We sample the text positions that are a multiple of some parameter s , and store the entries of A pointing to those in a sampled suffix array $A_S[1, n/s]$. We mark in a bitmap $S[1, n]$ the positions of A that are sampled, so that $A[j] = A_S[rank_1(S, j)]$ if $S[j] = 1$. If $S[j] = 0$, we take $\psi[j]$ for increasing k until it holds $S[\psi^k[j]] = 1$ for some k . Then, by the properties of ψ , it holds $A[j] = A[\psi^k[j]] - k$. Note that it is guaranteed that $k \leq s$, thus each occurrence is reported in $O(s)$ time, whereas the extra space for A_S is $O((n/s) \log n)$ bits.

For extracting a text snippet $\mathcal{D}[x, y]$, note that we can obtain any text suffix $\mathcal{D}[A[i], n]$ with B and ψ . A second sampled array stores inverse suffix array values: $A_s^{-1}[t]$ is the position of A pointing to text position $s \cdot t$. This allows us extracting $\mathcal{D}[x, y]$ in time $O(s + y - x)$, by locating the latest sampled position before x in $i = A_s^{-1}[\lfloor x/s \rfloor]$, and then using ψ and B to extract the symbols from positions $A[i] = \lfloor x/s \rfloor \cdot s$ to y .

The remaining issue in terms of space is how to compress array ψ . It has been shown that ψ can be compressed to the statistical entropy of \mathcal{D} [54, 49]. The compression achieved, however, is not good enough for highly repetitive collections. We now briefly describe the variants RLCSA and WCSA, which extend CSA from two different perspectives.

RLCSA. The *Run-Length Compressed Suffix Array* (RLCSA) [43] was the first self-index optimized for highly repetitive collections. The authors show that ψ contains long runs of successive values in such class of collections, and RLCSA exploits this fact.

RLCSA compresses ψ by performing run-length encoding of the differences $\psi(i) - \psi(i-1)$. Regular samples on ψ permit direct access to absolute $\psi(i)$ values in competitive time and space. This sampling yields different space/time tradeoffs. However, the other sampling, related to the parameter s used to build A_S and A_S^{-1} , is the one yielding the most relevant tradeoffs. The most important drawback of RLCSA is that these two sampled arrays are not easy to compress, and their space become dominant in highly repetitive scenarios.

WCSA. The *Word Compressed Suffix Array* (WCSA) [27] optimizes CSA for natural language self-indexing, by regarding the text as a sequence of words instead of characters. It was not designed specifically to cope with high repetitiveness, but it fills a particular niche in the current comparison. WCSA demands more space than the other self-indexes, but outperforms them for all types of queries. Thus, WCSA can be considered as a bridge between self-indexes and inverted indexes.

WCSA transforms the original text collection \mathcal{D} into an integer one, \mathcal{D}_w , where each position refers to a word/separator in the vocabulary. Therefore, the space/time complexities we have given stay the same if we regard n and m as the number of words in \mathcal{D} and P , respectively. This shows why both space and time improve. The drawback is that, like the inverted indexes, WCSA can only search for whole words and phrases, not for any substring of characters.

A.2. SLP-based self indexes

Grammar-based compression is a good choice for posting list encoding (see Section 4), but it is also a promising alternative for self-indexing purposes. SLP and WSLP are two grammar-based self-indexes built around the notion of *straight-line program* (SLP). In short, an SLP is a restricted type of grammar which only allows two types of rules. On the one hand, rules of the form $X_i \rightarrow j$ mean that the terminal j is generated from the rule X_i . On the other hand, rules $X_i \rightarrow X_l X_r$ expand X_i as the concatenation of X_l and X_r .

Finding the smallest grammar for a given text is NP-hard [14], so heuristics must be used to efficiently build an SLP. We choose again Re-Pair as our grammar-based compressor. RePair does not generate exactly an SLP, but it can be easily adapted. We only need to enhance its set of rules with a subset of terminal rules $X_i \rightarrow j$ for each symbol j used in the text collection. Note that RePair output comprises the grammar, but

also the reduced sequence C , which must be also indexed by SLP-based self-indexes. In the description that follows, we call $\mathcal{F}(X)$ the expansion of the rule X into terminals, and $\mathcal{F}^{rev}(X)$ the corresponding reverse string (read backwards).

SLP. The SLP self-index [19] is proved to require space proportional to that of an SLP compression of the text. It was implemented and tested on highly repetitive biological databases [16]. SLP indexes independently the resulting set of n rules, R , and the reduced sequence, $C[1, c]$, obtained by Re-Pair.

The set of rules is represented as a *labeled binary relation*, $LBR: A \times B \rightarrow \mathcal{L}$, where $A = [1, n]$, $B = [1, n]$, and $\mathcal{L} = [1, n]$ (we refer to A as the rows and B as the columns of the LBR , respectively). This structure is populated as follows. For each nonterminal rule $X_i \rightarrow X_l X_r \in R$, we store the value i in the cell $LBR[l, r]$. The rows are sorted by lexicographic order of \mathcal{F}^{rev} , while the columns are lexicographically sorted by \mathcal{F} . A permutation structure π is used for mapping from rows to columns and vice versa (this inner structure will be tuned in Section 5.2.2). This structure enables direct and reverse access to the rules in $O(\log n)$ time per retrieved element:

- $\mathcal{L}(l, r)$ returns j if $X_j \rightarrow X_l X_r$ or \perp otherwise.
- $R(l_1, l_2, r_1, r_2)$ retrieves all pairs $(l, r) \in R$ such that $l_1 \leq l \leq l_2$, $r_1 \leq r \leq r_2$.
- $\mathcal{L}(s)$ obtains the pair (l, r) such that $X_s \rightarrow X_l X_r$.

LBR is represented by traversing it by rows and writing two sequences, S_b and S_l , which concatenate respectively the r and j values for each cell $LBR[l, r] = j$. Two bitmaps, X_A and X_B , encode in unary the cardinalities of rows and columns. Sequence S_b is represented using a wavelet tree without pointers [18], whereas S_l uses a fast representation for large alphabets [31]. Both structures are tuned in Section 5.2.1.

The SLP index performs three main operations to search for a given pattern $P[1, m] = p_1 p_2 \dots p_m$. First, all the *primary occurrences* of the pattern are located in the LBR . Those are the occurrences that appear when two nonterminals are concatenated in the right hand side of a rule. We look for the $m - 1$ possible pattern partitions of the form $P = P_< P_>$, such that $P_< = p_1 p_2 \dots p_k$ and $P_> = p_{k+1} \dots p_m$, $1 \leq k < m$. For each partition, the rows and columns of LBR are binary searched for the reversed $P_<$ and for $P_>$, respectively. This determines contiguous ranges of rows $[l_1, l_2]$ and columns $[r_1, r_2]$ such that $P_<$ is a suffix of $\mathcal{F}(X_l)$, $l_1 \leq l \leq l_2$, and $P_>$ is a prefix of $\mathcal{F}(X_r)$, $r_1 \leq r \leq r_2$. Thus, the primary occurrences of P are inside of all nonterminals X_i which label LBR pairs in $[l_1, l_2] \times [r_1, r_2]$. For each nonterminal X_i found, we also store the offset of the occurrence within it.

Our current SLP implementation introduces an improvement to speed up prefix and suffix searching. It indexes all the different prefixes of length q in \mathcal{F}^{rev} and \mathcal{F} and, for each one, stores the first rule that expands to a string starting with the corresponding q -gram. This significantly reduces the number of comparisons to

be made on binary searches, at the price of a small space overhead. These indexes are implemented using compressed string dictionaries [44].

Each located primary occurrence X_i leads to *secondary occurrences*, which are obtained whenever X_i appears, directly or transitively, in other right hands of rules. We must track all the nonterminals X_s that use X_i and then find further secondary occurrences from those X_s . Thus, we locate all the labels X_s such that $X_s \rightarrow X_i X_*$ or $X_s \rightarrow X_* X_i$. We then proceed recursively from those X_s until no more nonterminals use them. We also maintain the offset where P occurs inside each retrieved nonterminal. The same nonterminal X_s may be reported several times, but with different offsets, which leads to different occurrences.

For each nonterminal X_s where P appears, we locate all its occurrences in the reduced sequence C . This is easily implemented using *select* on C : $select_{X_s}(C, i)$ retrieves the i -th occurrence of X_s in C . The original description [19] represented C with a wavelet tree without pointers, which provides *select* queries in time $O(\log n)$, but we currently discard it, as explained in the next paragraph.

We still have to locate, however, those occurrences that cross more than one symbol in C , that is, pattern occurrences that are expanded from consecutive nonterminals in the reduced sequence. For that purpose, we need a second *LBR*, which relates the set of n rules with the c positions of the sequence. That is, for $C = s_1 s_2 \dots s_c$, the *LBR* relates, with label i , the suffix from s_{i+1} (sorted in lexicographic order of $\mathcal{F}(s_i)$) and s_i (sorted in lexicographic order of $\mathcal{F}^{rev}(s_i)$). This *LBR* configuration is a novelty compared to the original SLP, because we now represent a relation of *suffixes* \times *rules* instead of the original *rules* \times *suffixes*. This subtle change makes the *select* structure for C unnecessary because *select* operations can now be resolved using the S_b wavelet tree. The occurrences that cross symbols in C are reported just like the primary occurrences using *LBR*.

Finally, to convert positions in C (and their offsets) into actual positions of \mathcal{D} , we set up a bitmap $B[1, n]$ that marks the positions of \mathcal{D} where the symbols of C begin. This bitmap is sparse, and thus represented by gap-encoding the distances between consecutive 1s, plus a sampling structure that stores regular positions of B [40]. This sampling value is also studied in Section 5.2.2.

The extraction of snippets is easily implemented by exploiting the self-indexing capabilities. To extract $\mathcal{D}[x, y]$, we find with $rank_1(B, x)$ the first symbol of C to be extracted, and then decode sequentially until reaching the symbol encoding $\mathcal{D}[y]$.

WSLP. The *Word-oriented SLP* (WSLP) is variant of SLP designed for this paper. It follows the same principles, but it adapts the structures and algorithms to perform on a word-based (i.e., integer) representation instead of a character-based one. WSLP also preprocesses \mathcal{D} to transform it into the integer sequence \mathcal{D}_w . In this case, all the different words in the text collection are appended as terminals to the set of rules. Another difference is that WSLP does not use q -gram indexes, because of the space that would require, so prefix and suffix searches are directly performed on rows and columns of the *LBR*.

A.3. LZ-based self-indexes

LZ-based self-indexes build on an LZ77-like parsing, such as LZ77 itself or LZ-End (see Section 2.4). In short, an LZ77-like parsing of a text collection $\mathcal{D}[1, n]$ is a sequence $Z[1, n']$ of phrases such that $\mathcal{D} = Z[1]Z[2] \dots Z[n']$. Each phrase encodes the first occurrence of a text substring and concatenates a *source* (a maximal substring previously seen in \mathcal{D}) and a trailing character. Both **LZ77-index** and **LZend-index** [40] use the following data structures to encode Z for efficient pattern searching and snippet extraction:

- $S[1, n + n']$ is a bitmap that encodes the structure of the phrase sources. We traverse the text from $\mathcal{D}[1]$ to $\mathcal{D}[n]$ and encode the number of sources that start at each position: if k sources start from $\mathcal{D}[i]$, we append $1^k 0$ to S (note that k may be 0). We consider that the empty-string sources start just before $\mathcal{D}[1]$. Thus, 0-bits encode text positions, whereas 1s encode the successive sources. S is stored in gap-encoded form to exploit its sparseness.
- $\pi[1, n']$ is a permutation that maps phrases to sources, that is, $\pi[i] = j$ means that the source of the i -th phrase starts at the position corresponding to the j -th 1 in S . This is implemented using the approach from Munro et al. [48], and it is one of the structures tuned in Section 5.2.2.
- $B[1, n]$ is a gap-encoded bitmap that marks the positions of \mathcal{D} where each phrase ends.
- $L[1, n']$ is an array encoding the trailing characters added at the end of each phrase.

We report each occurrence of a pattern in time $O(\log n')$. For pattern searching, we also distinguish *primary* and *secondary occurrences*. In this case, we consider primary occurrences those overlapping more than one phrase or ending at a phrase boundary.

A relation analogous to *LBR*, of size $n' \times n'$, is used to find the primary occurrences. It stores a pair (i, j) if the i -th phrase (in reverse lexicographic order) is followed by the suffix starting at the j -th phrase (in lexicographic order of those suffixes). Thus, if we partition $P = P_{<}P_{>}$ as for SLPs, and find the ranges $[l_1, l_2]$ of phrases terminated with $P_{<}$ and $[r_1, r_2]$ of phrase-aligned suffixes starting with $P_{>}$, then all the points in $[l_1, l_2] \times [r_1, r_2]$ are primary occurrences. We find them all by trying the $m - 1$ possible partitions $P = P_{<}P_{>}$. Since this relation has no labels, we implement it as a wavelet tree $R[1, n']$, with $R[i] = j$ if (i, j) is a point (note there is only one j per i value). This provides $O(\log n')$ -time access to any $R[i]$ and $R^{-1}[j]$.

Since accessing the strings is generally more expensive from the LZ-index structures than from SLPs, it is worth replacing the binary searches on the strings by trie structures built on the reversed phrases or the phrase-aligned suffixes. In this second trie, the leaves store the identifiers of the corresponding phrases, $id[1, n']$. The tries are implemented as *Patricia trees* [46], succinctly encoded as labeled trees using *dfuds* [10]. The characters labeling the edges are stored in plain form, and the skip values of the Patricia tree are stored using *Directly Addressable Codes* (DACs) [11], since most skip values are small. Once we arrive at

the node corresponding to $P_>$, covering the leaf range $[r_1, r_2]$, the corresponding phrase numbers are found in $id[r_1, r_2]$. An analogous Patricia tree can be stored to search for $P_<$, but this time the identifiers $rid[1, n']$ need not be stored, as we can find them using $rid[j] = id[R^{-1}[j]] - 1$.

Before delivering the primary occurrences associated with $P_<P_>$, the Patricia trees require a validation, because all or none of the strings they find may be actual occurrences. Thus we extract one of the reported results and compare it with P in order to determine that either all or none of the answers are valid. This costs $O(mh)$ time for **LZ77-index** and $O(m+h)$ for **LZend-index**, where h is the length of the largest phrase in the parsing. If the occurrences are valid, then for each occurrence with partition $P_< = p_1 \dots p_k$ found at $id[i] = j$, its original position in the text is $select_1(B, j-1) - k + 1$.

The secondary occurrences triggered by each primary occurrence $\mathcal{D}[t, t+m-1]$ are found using S , B , and π . Every 1 in S before the t -th 0 is a phrase starting at t or earlier. If it is the j -th 1, then it is copied to the i -th target phrase, for $i = \pi^{-1}[j]$. Its length is $select_1(B, j) - select_1(B, j-1)$, and with this we know whether the source covers the primary occurrence, and where is it copied. We report that new (secondary) occurrence and also recursively find new secondary occurrences from that one.

To extract snippets $\mathcal{D}[x, y]$ we also use S , B , π , and L . With B we find the last phrase covering position y , and then extract its contents, plus those of preceding phrases, until covering the area to extract. Each final character is found in L , and the rest is recursively obtained from the source of the phrase. The source of the i -th phrase corresponds to the j -th 1 in S , for $j = \pi[i]$, and its starting position in \mathcal{D} is found with S . For a snippet of length l , the extraction takes time $O(l+h)$ for **LZend-index** and $O(lh)$ for **LZ77-index**.

In Section 5.2.2 we study five different configurations of this index, regarding whether we use Patricia trees or binary search for each dimension of the binary relation, and whether or not we store rid explicitly.