

# 2015 RAM 2500/3500



**HEAVY-DUTY**

**BEST IN  
THE FIELD**



**WORKHORSE**



# ELEGANCE + MUSCLE



**RAM**

**HEAVYWEIGHT PERFORMANCE. HEAVY-DUTY EFFICIENCY. AND EXCEPTIONALLY HEAVY ON COMFORT.** This is where you come when the job goes beyond the ordinary—because the 2015 Ram Heavy Duty 2500/3500 models are all about the work. From hauling your boat or a trailer through mountains to ranching to managing a business, these workhorses are designed to deliver across the board, day-in and year-out.

The 2015 Ram Heavy Duty defined: uncompromising powertrains. Groundbreaking suspensions. Efficient yet unrelenting strength. And interiors with the design, telematics and connectivity to serve you with such comfort and information, they serve as aspirational benchmarks for the rest of the heavy-duty class.

Count on Ram, and you're employing figures that often reflect ultimate superiority. Available advantages that separate Ram 2500/3500 include assets like the class-exclusive<sup>[1]\*</sup> Auto-Level Rear Air Suspension System. The formidable 6.4-liter HEMI® V8 with MDS, delivering best-in-class<sup>[1]</sup> gas horsepower and torque, and contributing to the most gas V8 options in the class.<sup>[1]</sup> The best-in-class<sup>[1]</sup> 30,000-lb<sup>†</sup> diesel towing capability and best-in-class<sup>[1]</sup> 7,390-lb<sup>†</sup> payload capacity of Ram 3500. The best-in-class<sup>[1]</sup> 865 lb-ft of torque from the available Cummins® High Output Turbo Diesel. And all backed by the quality of one of the best powertrain warranties in the business. Fact: Ram Heavy Duty has clout shared by no others.

For specs, blogs and owner stories, click over to [RAMTRUCKS.COM](http://RAMTRUCKS.COM)

Information Provided by:

\*A note about this brochure: all disclaimers and disclosures can be found on the back page. <sup>†</sup>When properly equipped. Properly secure all cargo.

# PULL



# HAUL

# 30,000-LB\*

# MAX TOWING

# 7,390-LB\*

# MAX PAYLOAD



Trucks that are born and bred to pull and haul: new available 7 x 11-inch power-folding trailer towing mirrors make your Ram Heavy Duty a command and control center for towing.



Go in the know: select Ram models feature a full-color high-res screen with dozens of graphic displays for virtually every mechanical function.



In-cabin view of the cargo bed: only Ram Heavy Duty<sup>®</sup> offers an available Cargo-View Camera<sup>®</sup> to see it all.



Available frame-mounted Gooseneck Hitch from Mopar<sup>®</sup> with easy ball removal (ball not included). Optional Fifth-Wheel/Gooseneck Prep Package includes in-bed 7-pin connector.



Available Fifth-Wheel Hitch from Mopar features sliding rails and simple-to-remove engineering.



Class-exclusive<sup>®</sup> Ram Active Air<sup>™</sup> Technology switches the air-intake path to ensure optimal power and torque under all grades, climates and load/towing conditions.

\*Ram 3500, when properly equipped. Properly secure all cargo.

# RAM. SUPERIOR POWER

## 6.7L CUMMINS® TURBO DIESEL MONSTER TORQUE 385 HP/865 LB-FT OF TORQUE

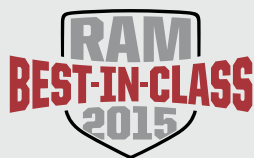

**AVAILABLE FOR RAM 2500/3500.** There's one diesel engine designed to play a pivotal role in the heavy-duty world: the Cummins Turbo Diesel. Virtually indestructible in design, the 6.7L Cummins Turbo Diesel is engineered to the tolerances, quality and durability to power semi-class big rigs. As the available diesel engine for Ram 2500 and 3500 Heavy Duty, the Cummins for 2015 is calibrated specifically for ideal job-rated use and optimal transmission output. The results give Ram Heavy Duty 3500 models awesome torque—and give you uncompromising strength for towing and hauling.

+ **Best-in-class<sup>[1]</sup> diesel towing** for Ram 3500 is part of the Cummins legacy. With the available Cummins High Output Turbo, you can take advantage of that **best-in-class<sup>[1]</sup> 865 lb-ft of torque** and 385 horsepower, with towing rated at 30,000 lb. (All towing figures apply to trucks that have been properly equipped.)

+ Incredible torque for Ram 2500 comes from the available Cummins rated at 370 hp and 800 lb-ft, mated to the proven 68RFE 6-speed automatic; this beefed-up powertrain configuration is also available for 2015 Ram 3500 models.

+ **The class-exclusive<sup>[1]</sup> G56 6-speed manual** transmission is packaged with the 350 hp/660 lb-ft Cummins Turbo Diesel. The 6-speed manual offers exceptional control when towing and hauling, and its availability for Ram 2500/3500 clearly separates Ram Heavy Duty from the contenders.

+ **Best-in-class<sup>[1]</sup> diesel oil change intervals** up to 15,000 miles seriously reduce downtime and costs of regular maintenance.

The Cummins Dual Radiator System produces more efficient operation, lessening heat by some 25% over the previous design.

**TRANSMISSIONS:** Meet components designed to manage awesome levels of torque over decades of use. Packaged with the 350 hp/660 lb-ft Cummins is the class-exclusive<sup>[1]</sup> G56 6-speed manual; available for the 370/800 Cummins is the 68RFE automatic. For the Cummins High Output Turbo Diesel and its best-in-class<sup>[1]</sup> 865 lb-ft of available torque, the AISIN® Heavy-Duty 6-speed automatic transmission ably steps up to the task.

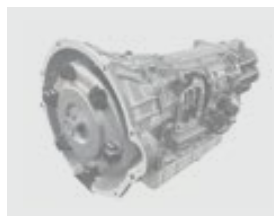

The AISIN Heavy-Duty 6-speed automatic is packaged with the available Cummins High Output Turbo Diesel. AISIN advantages include a sophisticated Transmission Control Module which momentarily turns off the exhaust brake (on the Cummins), and a ramped-up Tow/Haul Mode with a more aggressive downshift schedule to meet industrial-grade hauling demands.

# RAM. SUPERIOR POWER

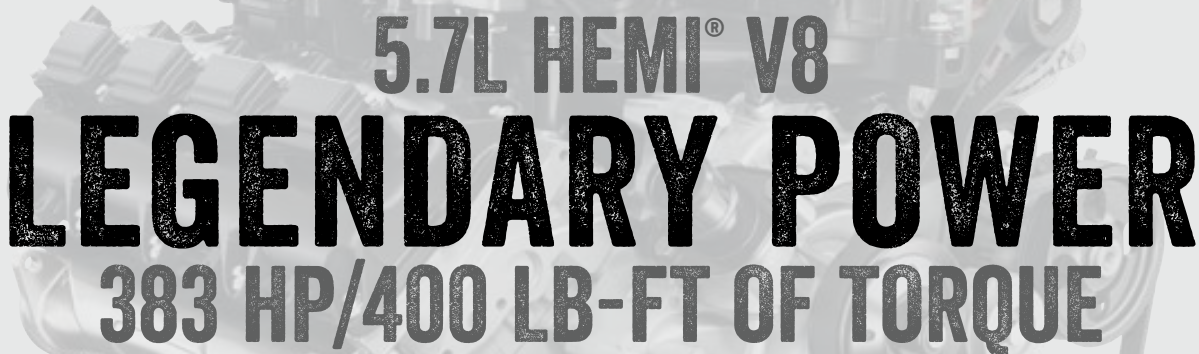

## 5.7L HEMI® V8 LEGENDARY POWER 383 HP/400 LB-FT OF TORQUE

**STANDARD ON RAM 2500/3500 SRW.** Continuing to make history, this legendary gas powerhouse ranks as an ideal example of technical proficiency. The core engineering idea behind the hemispherical engine head is to achieve maximum power, and over its lifetime the many utilizations of the hemispherical head have included WWII-era prototype aircraft and even various tank applications. With world respect attained with its use during the distinctively American Muscle Car Era, there's little wonder why it's the standard engine for 2015 Ram Heavy Duty SRW models.

+ Competitive fuel efficiency, accompanied by performance and capability measured in tens of thousands of miles. When compared to other V8 engines in the class, the 5.7-liter HEMI V8 in single-rear-wheel Ram Heavy Duty models delivers impressive fuel efficiency and incredible standard power and torque.

+ The incorporation of iDFSO (interactive Deceleration Fuel Shut-Off) adds to the fuel-efficient performance of the 5.7L HEMI V8. iDFSO turns off the flow of fuel during deceleration, with no noticeable change in engine performance—a real-world and bottom-line advantage to this powerhouse.

**THE TRANSMISSION OF CHOICE:** *In Ram Heavy Duty, the 5.7-liter HEMI V8 is partnered with the 66RFE 6-speed automatic, a powertrain that exceeds typical demands for anticipated towing and hauling. 66RFE advantages include driver-adaptive shifting, three multiple clutch packs, dual filters on a dual-stage pump and an independent lubrication cooler that delivers ample pressures under all loads and driving conditions.*

In the Ram Heavy Duty 2500/3500, the 5.7L HEMI V8 delivers every pound-foot of torque you need for trailering and hauling, and boosts your confidence levels with serious performance and unexpected V8 fuel efficiency. By incorporating technologies like Variable Valve Timing (VVT), fuel-saving measures like iDFSO, and then mating it all to the long-proven 66RFE 6-speed automatic, you're putting the 5.7-liter HEMI V8 legacy to work: this is outstanding performance melded with fuel-sipping operation.

## RAM TOUGH TRANSFER CASES

The two transfer cases employed by Ram Heavy Duty 2500/3500 are exactly what you need for ultra-4x4 capability. The BorgWarner BW 44-46 transfer case features responsive electronic shift-on-the-fly engineering, with three operating ranges, plus Neutral.

The manually activated BW 44-47 transfer case features three operating ranges, plus Neutral. Both of these impressive units offer a low-range reduction ratio of 2.64:1—an ideal ratio when off road in a slow rock-climbing situation, or when using your Ram 4x4 on challenging terrain or steep grades. You need capability and performance that exceeds the need, and Ram Heavy Duty pickups are designed to excel.

# RAM. SUPERIOR POWER

## 6.4L HEMI® V8 AWESOME CAPABILITY 410 HP/429 LB-FT OF TORQUE

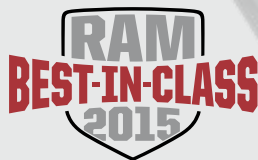

**AVAILABLE FOR RAM 2500/3500.** Take the hemispherical combustion chamber assets of the 5.7-liter HEMI V8, increase the cylinder bore and stroke for greater displacement, and employ advancements like Variable Valve Timing (VVT) and Fuel Saver Technology to help achieve the most power and efficiency possible. The results deliver an available engine for Ram Heavy Duty that puts others to shame: the 6.4-liter HEMI V8, an engine to give 2015 Ram Heavy Duty 2500/3500 pickups a raft of commercial-grade and best-in-class attributes to back you on every job.

- + **Best-in-class<sup>[1]</sup> gas horsepower** from the 6.4-liter HEMI V8: 410 working horses give you the ideal gas engine for acceleration and highway merging and cruising, even under the heaviest loads.
- + Fuel-efficient performance is engineered into the electro-mechanical heart of the 6.4-liter HEMI V8. Operating with seamless precision, our MDS/Fuel Saver Technology helps save fuel with no compromise or noticeable changes in engine operation.

- + The cooled Exhaust Gas Recirculation (EGR) System is one of the first of its kind for a gas engine; common to diesel engines, the EGR System is designed to enhance fuel efficiency in heavy-load and uphill towing situations.
- + Fuel Saver Technology plays a significant role in fuel-efficient performance. While cruising at highway speeds, the engine automatically (and imperceptibly) shuts off four of the eight cylinders, letting you maintain speeds with the efficiency of four-cylinder operation.

Our engineers looked at the truly big picture—in short, every heavy-duty assignment you could imagine—and then incorporated the 6.4-liter HEMI V8 into this powertrain lineup. What you get is a 2015 Ram 2500/3500 that delivers clout where clout is needed. The engines described here reflect the most comprehensive lineup in our history, and the 6.4-liter HEMI V8 stands out with stunning best-in-class features.

Trucks of this power and quality don't back down. Only the Ram Heavy Duty powertrains deliver these levels of horsepower and torque.

- + Matching that class-distinctive **best-in-class<sup>[1]</sup> gas horsepower** is **best-in-class<sup>[1]</sup> gas torque**; the 6.4-liter HEMI V8 torque levels are rated at a super-competent 429 lb-ft @ 4,000 rpm.

- + **Best-in-class<sup>[1]</sup> gas towing** rides hand-in-hand with **best-in-class<sup>[1]</sup> gas power**. Ram 2500 models with the 6.4L HEMI V8 offer phenomenal towing—up to 16,300 lb, and up to 16,520 lb on Ram 3500 DRW models. (All towing figures apply to properly equipped trucks.)

- + **Best-in-class<sup>[1]</sup> payload** rounds it out. The available 6.4-liter HEMI V8 in Ram 3500 delivers an impressive payload rating of 7,390 lb when properly equipped. This is pure capability at your service.

- + The 6.4-liter HEMI V8 offers one further Ram application of advanced technology. Individual Cylinder Fuel Control is a diagnostic monitoring system that enables air/fuel refinements and ensures ideal mixtures for each individual cylinder.

**THE TRANSMISSION:** Like its smaller displacement brother, the 6.4-liter HEMI V8 is mated to the long-proven 66RFE 6-speed automatic. This component delivers heavy-duty levels of capability for towing and hauling. Count on driver-adaptive shifting, three multiple clutch packs, dual filters on a dual-stage pump and an independent lubrication cooler to ensure ample pressures—and peace of mind—under all driving situations and towing/hauling conditions.

## 2500/3500 TOWING CAPABILITY

### 2500 TOWING SPECS

Maximum loaded trailer weight (when properly equipped)

				2500 — SAE J2807 STANDARD COMPLIANT								
				Regular Cab		Crew Cab				Mega Cab®		
				8' BOX		6'4" BOX		8' BOX		6'4" BOX		
				4x2	4x4	4x2	4x4	4x2	4x4	4x2	4x4	
Automatic Transmission	Engine	Axle Ratio	GCWR									
	5.7L HEMI® V8 CNG/ 66RFE 6-speed	3.73	15,000							6,940		
		4.10	20,300	11,870	11,500	11,510	11,200	11,360	11,020	11,040	10,770	
	13,870			13,500	13,510	13,200	13,360	13,010	13,040	12,770		
	6.4L HEMI V8/ 66RFE 6-speed	3.73	19,800	13,300	12,930	12,940	12,610	12,810	12,440	12,480	12,230	
4.10		17,500				10,000						
			16,300	15,930	15,940	15,610	15,810	15,440	15,480	15,230		
6.7L Cummins® Turbo Diesel I-6/ 68RFE 6-speed	3.42	25,300*	17,970	17,520	17,510	17,180	17,360	17,020	17,170	15,190		
MT	6.7L Cummins Turbo Diesel I-6/ G56 6-speed	3.42	24,300*	16,900	16,440	16,450	16,120	16,290	15,940	16,100	14,520	

### 3500 TOWING SPECS

Maximum loaded trailer weight (when properly equipped)

				3500 — SAE J2807 STANDARD COMPLIANT													
				Regular Cab				Crew Cab				Mega Cab®					
				8' BOX		8' BOX DRW		6'4" BOX		8' BOX		8' BOX DRW		6'4" BOX		6'4" BOX DRW	
				4x2	4x4	4x2	4x4	4x2	4x4	4x2	4x4	4x2	4x4	4x2	4x4	4x2	4x4
Automatic Transmission	Engine	Axle Ratio	GCWR														
	5.7L HEMI® V8/ 66RFE 6-speed	3.73	18,400	11,910	11,560			11,520	11,200	11,410	11,020			11,270	10,990		
		4.10	20,400	13,910	13,560			13,520	13,200	13,410	13,020			13,270	12,990		
	13,370			12,970	13,020	12,640	12,970	12,640	12,830	12,470	12,450	12,100	12,710	12,400	12,210	12,020	
	6.4L HEMI V8/ 66RFE 6-speed	3.73	19,900	16,370	15,970			15,970	15,640	15,830	15,470			15,710	15,400		
		4.10	22,900			16,520	16,140					15,950	15,600			15,710	15,520
	3.42			25,300	17,910	17,560	17,550	17,180	17,490	17,200	17,360	17,010	17,000	16,660	17,160	16,800	16,770
	6.7L Cummins® Turbo Diesel I-6/ 68RFE 6-speed	3.73	27,300			19,550	19,180					19,000	18,660			18,770	18,460
		4.10	30,300			22,550	22,180					22,000	21,660			21,770	21,460
				3.42	25,300	17,770	17,420			17,350	17,050	17,210	16,860			17,020	16,660
	6.7L Cummins High Output Turbo Diesel I-6/ AISIN® 6-speed	3.42	29,300			21,410	21,030					20,860	20,510			20,620	20,320
		3.73	32,300			24,410	24,030					23,860	23,510			23,620	23,320
		4.10	37,800				29,530					29,360	29,010			29,120	28,820
							30,000										
MT	6.7L Cummins Turbo Diesel I-6/ G56 6-speed	3.42	24,300	16,870	16,520	16,510	16,130	16,450	16,160	16,320	15,960	15,960	15,610	16,120	15,760	15,720	15,420
		3.73	26,300			18,510	18,130					17,960	17,610			17,720	17,420

MT = Manual Transmission | DRW = Dual Rear Wheel | Weights given in lb. | Numbers in **Black boxes** reflect max ratings.

1. Weights are rounded to the nearest 10 lb.

2. Trailer Weight Rating and Tow Vehicle Trailing Weight are calculated as specified in SAE J2807.

Passenger Weight = 300 lb

Options Weight = 100 lb

Trailing Equipment Weight: 75 lb for conventional hitch, 70 lb for gooseneck and 250 lb for 5th-wheel.

Box Off Body Completion Weight = 80 lb per foot from end of cab to end of frame.

3. Payload and Trailer Weight Rating are mutually exclusive.

4. GAWRs, GVWRs and GCWRs should never be exceeded.

5. The recommended tongue weight for a conventional hitch is 10 percent of the gross trailer weight. The maximum tongue weight for Class V (receiver hitch) is limited to 1,800 lb.

6. For gooseneck and 5th-wheel trailers, the tongue weight should never exceed any of the manufacturer recommendations including but not limited to payload and GAWR.

7. A 5th-wheel or gooseneck hitch is required for trailers over 18,000 lb, a gooseneck hitch is required for trailers over 25,000 lb.

\*2500 Regular Cab and Crew Cab vehicles with diesel engine and 17" wheels have GCWR of 23,000 lb for conventional trailers only.



## 2500/3500 PAYLOAD CAPABILITY

### 2500 PAYLOAD SPECS

Maximum payload capacities (when properly equipped)

		2500							
		Regular Cab		Crew Cab				Mega Cab®	
		8' BOX		6'4" BOX		8' BOX		6'4" BOX	
		4x2	4x4	4x2	4x4	4x2	4x4	4x2	4x4
Automatic Transmission	Engine	GVWR							
	5.7L HEMI® V8 CNG/66RFE 6-speed	9,000				1,410			
	5.7L HEMI V8/66RFE 6-speed	3,040	2,670	2,680	2,370	2,530	2,190	2,210	1,950
	6.4L HEMI V8/66RFE 6-speed	8,510			1,480				
Automatic Transmission	6.7L Cummins® Turbo Diesel I-6/68RFE 6-speed	10,000	3,970	3,610	3,280	3,480	3,110	3,160	2,900
	6.7L Cummins Turbo Diesel I-6/G56 6-speed	10,000	3,170	2,700	2,690	2,360	2,530	2,190	2,340
MT	6.7L Cummins Turbo Diesel I-6/G56 6-speed	10,000	3,070	2,610	2,630	2,290	2,470	2,120	2,280

### 3500 PAYLOAD SPECS

Maximum payload capacities (when properly equipped)

		3500															
		Regular Cab				Crew Cab								Mega Cab®			
		8' BOX		8' BOX DRW		6'4" BOX		8' BOX		8' BOX DRW		6'4" BOX		6'4" BOX DRW			
		4x2	4x4	4x2	4x4	4x2	4x4	4x2	4x4	4x2	4x4	4x2	4x4	4x2	4x4		
Automatic Transmission	Engine	GVWR															
	5.7L HEMI® V8/66RFE 6-speed	10,100	4,080														
	5.7L HEMI® V8/66RFE 6-speed	10,300		3,930													
		10,500				4,090											
		10,700					3,970										
		11,000						4,480					4,340				
		11,300							4,390					4,360			
		10,200	4,140														
	6.4L HEMI V8/66RFE 6-speed	10,400		3,940													
		10,500					4,040										
		10,800						4,010									
		11,100							4,500								
		11,200											4,480				
		11,400								4,440				4,370			
		13,300			6,890	6,510					6,320	5,970			6,080	5,890	
		13,700			7,240	6,910											
		13,800			7,390												
		13,900													6,680		
	14,000									7,020	6,670				6,590		
	6.7L Cummins® Turbo Diesel I-6/68RFE 6-speed	11,100	4,180														
11,500			4,230			4,160											
11,600													3,930				
11,700							4,070										
12,000								4,530									
12,300									4,480								
12,400														4,270			
14,000				6,720	6,350					6,170	5,830				5,940	5,630	
6.7L Cummins High Output Turbo Diesel I-6/AISIN® 6-speed	11,100	4,040															
	11,500		4,090			4,020											
	11,600												3,790				
	11,700						3,920										
	12,000							4,380									
	12,300								4,330								
6.7L Cummins Turbo Diesel I-6/G56 6-speed	11,100	4,140															
	11,500		4,190			4,120											
	11,600												3,890				
	11,700						4,030										
	12,000							4,490									
	12,300								4,430								
12,400													4,230				
14,000			6,680	6,300					6,130	5,780				5,890	5,590		

MT = Manual Transmission | DRW = Dual Rear Wheel | Weights given in lb. | Numbers in Black boxes reflect max ratings.

1. Weights are rounded to the nearest 10 lb.

2. Payload = GVWR - Base Weight.

3. Payload and Trailer Weight Rating are mutually exclusive.

4. GAWRs, GVWRs and GCWRs should never be exceeded.

5. 3500 Regular Cab, 4x2, 6.4L with 4.10 axle ratio GVWR of 13,800 lb applies to Tradesman package only. All other price classes for this configuration (Reg Cab, 4x2, 6.4L with 4.10 axle ratio), GVWR is 13,700 lb.

# CLASS-EXCLUSIVE<sup>[1]</sup>

# STRENGTH + CONTROL



## Only Ram Rides on Suspensions This Advanced.

Big Ram 2500 is defined by capability, with standards that allow zero tolerance for compromise—or for convention. In front: a unique three-link coil spring suspension. In back: a class-exclusive<sup>[1]</sup> five-link coil spring suspension. Innovative Ram technology delivers it all: phenomenal ride quality, impeccable road manners and unrivaled control. Let the others try to catch up. At Ram, we not only embrace state-of-the-art—we create it.



Properly secure all cargo.

Information Provided by:  
**DEALER**

# CAPABILITY + ADAPTABILITY

# = HEAVY DUTY CONFIDENCE

**Class-Exclusive<sup>1</sup>: the Available Auto-Level  
Rear Air Suspension System.**



Here's an uplifting lesson how to raise the bar—and your expectations: create a unique rear suspension that lets these tough high-strength steel frames ride on air. Two innovative modes offer optimal convenience, with a Normal Load-Leveling Mode and a driver-selectable Alternate Ride Height Mode, invaluable for trailer alignment. The available Auto-Level Rear Air Suspension System for Ram 2500/3500 ramps up capability, control and comfort. No surprise to find it on the same pickup that gives you available best-in-class<sup>1</sup> towing.\* Technical details on the next two pages.

\*When properly equipped. Properly secure all cargo.



# UNCOMPROMISING SUPPORT AT EVERY TURN.

## THE STANDARD 3500 DRW HOTCHKISS LEAF SPRING REAR SUSPENSION

The demands put on the 3500 weight class compel unrelenting capability. Shown here is the Ram 3500 Dually model, with its standard Hotchkiss leaf spring rear suspension ably meeting every requirement for payload and occupant comfort.

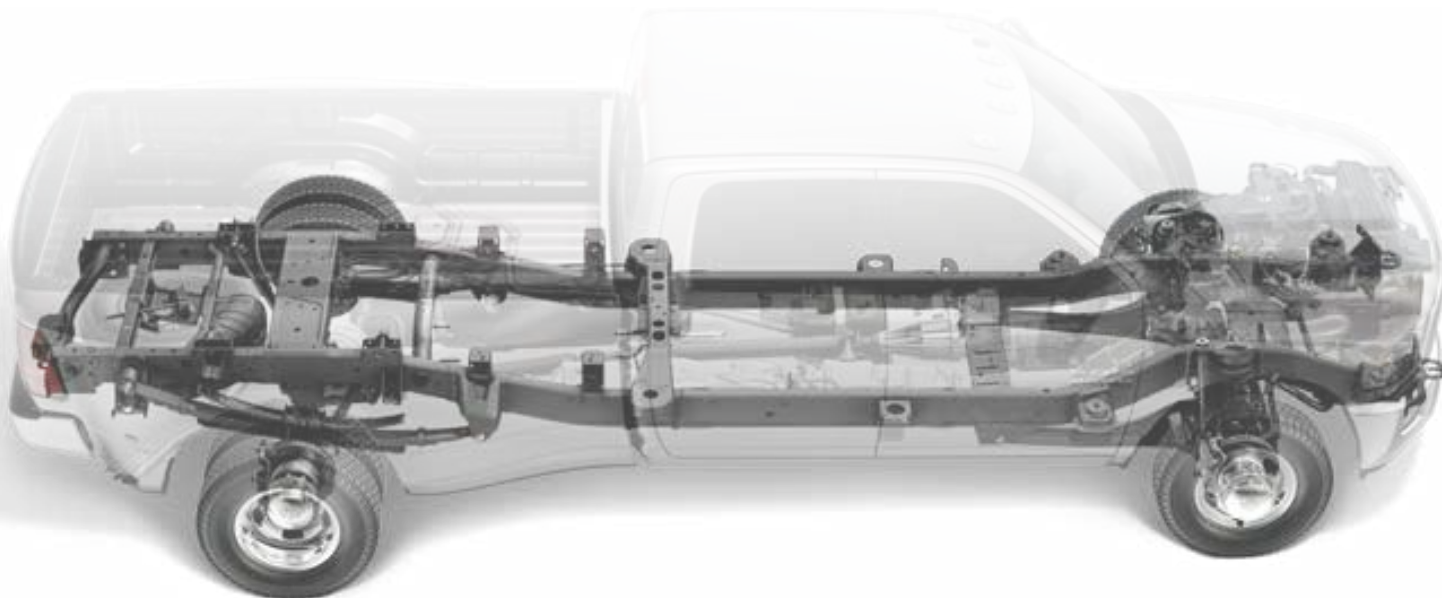

Tough rear frame structural crossmembers are characteristic of all Ram Heavy Duty models—engineering that enables fifth-wheel or gooseneck hitch capability, and which materially contributes to those best-in-class<sup>(1)</sup> towing\* numbers. Serious backbone joins strength of character; these pickups let you scoff at a lifetime at hard labor.

Both Ram 2500 and 3500 use 50 ksi steel, with eight tough crossmembers all contributing to robust towing and hauling. The front and rear sections are produced through hydroforming, a process that ensures durable strength and mass efficiencies. Rail contours are ideally placed for the suspension components and ancillary mounts.

Formidable front axle and suspension engineering makes Ram Heavy Duty the choice for front-load accessories. These Rams bring a best-in-class<sup>(1)</sup> 1,265-lb snow plow rating to work for you.

The proven ladder frame also features a large front suspension crossmember with hydroformed front and rear sections and roll-formed center rail sections in a smart, outwardly curved position to improve rear spring and shock placement.

Whether used for business or pleasure, a Ram Heavy Duty gives you the means to master the toughest tasks. This frame strength measures up with the resilient stiffness that gives you no-nonsense towing with notable structural integrity to ensure occupant comfort when hauling big payloads. The 2015 Ram Heavy Duty high-strength steel frames mean you're riding on the solidity of 50 ksi steel. This chassis enables Ram tough capability, especially when towing and hauling—the very purpose of a Ram Heavy Duty.

The Ram Heavy Duty frame is engineered to be tougher, stronger and larger than the previous generation with eight tough crossmembers. Wide rails and a front rail extension of two inches enabled front suspension springs to be positioned slightly outboard, generating more roll stiffness to improve the ride.

All Ram 2500/3500 models feature as standard equipment the unique three-link front suspension. As well as incorporating the three-link front suspension technology, we also integrated a large stabilizer bar to ensure the roll stiffness required by the high GVW ratings of Ram Heavy Duty. Those numbers are impressive, reaching up to 10,000 lb for Ram 2500 and up to 14,000 lb for Ram 3500 models.

Shared Ram 2500/3500 technology also embraces the front axle disconnect, which automatically disengages the front drive axle when reengaging the rear-wheel-drive mode on 4WD models. Our front axle disconnect design was purposeful from the get-go, helping reduce parasitic losses which in turn helps improve fuel efficiency.

\*When properly equipped.

# RAM 2500 CAPABILITY: BEST-IN-CLASS<sup>[1]</sup> TOWING\* AND GCWR SAYS IT ALL.

The 2015 Ram 2500 Heavy Duty: three-link front suspension for the front axle; electronic 4x4 front axle disconnect; fully integrated rear structural crossmember; results: an outstanding combination of ride, handling and capability.

MAX PAYLOAD*	3,970 LB	MAX TOWING*	17,970 LB
MAX GVWR	10,000 LB	MAX GCWR	25,300 LB



## CLASS-EXCLUSIVE:<sup>[1]</sup> RAM 2500

THE STANDARD FIVE-LINK COIL SPRING REAR SUSPENSION



IT STANDS APART AS THE FIRST-OF-ITS-KIND REAR SUSPENSION FOR A HEAVY-DUTY, and it's the standard for all Ram 2500 models. The class-exclusive<sup>[1]</sup> five-link coil spring rear suspension features unique multirate coil springs and heavy-duty fixed-displacement twin-tube shock absorbers; both are placed in an outboard position that optimizes performance and minimizes noise/vibration. Inside the structure, a huge 11.5-inch solid rear axle translates into exceptional handling, especially when carrying heavy loads.

## CLASS-EXCLUSIVE:<sup>[1]</sup> RAM 2500

THE AVAILABLE AUTO-LEVEL REAR AIR SUSPENSION SYSTEM



THE AVAILABLE AUTO-LEVEL REAR AIR SUSPENSION SYSTEM FOR RAM 2500 took its engineering cues from the available Ram 1500 Active-Level™ Four-Corner Air Suspension System. This Ram Heavy Duty adaptation addresses needs specific to the higher GVWRs and GCWRs of the 2500 class. The two modes include:

**NORMAL LOAD-LEVELING MODE** provides a level load profile by monitoring ride heights on both sides of the vehicle and creating a slight positive rake angle.

**ALTERNATE RIDE HEIGHT MODE** lowers the rear suspension by about an inch, keeping an even alignment between the hitch and trailer tongue for a level load and a parallel, level relationship between the vehicle and the trailer. The "rake" from pickup front end to the rear of the trailer remains consistent, ensuring level ride and handling with superb towing and hauling characteristics.

# RAM 3500 CAPABILITY: BEST-IN-CLASS<sup>[1]</sup> TOWING\*, PAYLOAD\* AND GCWR.

The 2015 Ram 3500 Heavy Duty: unique three-link front suspension with solid axle; heavy-duty Hotchkiss rear suspension and wide rails; large front suspension crossmember; fully integrated rear structural crossmember; in total, eight high-strength crossmembers with high-strength hydroformed front and rear rail sections.

MAX PAYLOAD*	7,390 LB	MAX TOWING*	30,000 LB
MAX GVWR	14,000 LB	MAX GCWR	37,900 LB



## CLASS-EXCLUSIVE:<sup>[1]</sup> RAM 2500/3500

THE AUTO-LEVEL REAR AIR SUSPENSION SYSTEM

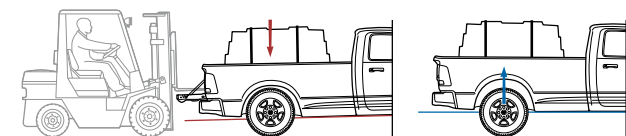

Class-pioneering, the groundbreaking Auto-Level Rear Air Suspension System for Ram Heavy Duty models is a dual-mode operator-activated system specifically engineering for the exceptional GVWRs and GCWRs expected from these relentless workhorses.

In Normal Load-Leveling Mode, the system monitors ride heights on both vehicle sides, constantly adjusting for load shifting or changes in road surfaces; a level load profile and proper headlamp-to-road angle—even while undertaking jaw-dropping hauling—is assured.

Alternate Ride Height Mode lowers the rear suspension by about an inch to maintain an even alignment between the hitch and trailer tongue. This mode ensures a level load and creates a parallel, level relationship between the vehicle and the trailer, ensuring an even "rake" from the front of the pickup through the trailer.

## CLASS-EXCLUSIVE:<sup>[1]</sup> RAM 3500

THE AVAILABLE AUTO-LEVEL REAR AIR SUSPENSION SYSTEM



THE AVAILABLE AUTO-LEVEL REAR AIR SUSPENSION SYSTEM FOR RAM 3500 deploys engineering specific to the weight class and the typically tougher assignments given to these pickups. Here, leaf springs are augmented with air springs mounted on top of the axle, resulting in the air springs and leaf springs working together for load carrying. The technology is utilized in both 2015 Ram 3500 single-rear-wheel and Dually models.

\*When properly equipped.

# LARAMIE: LIFE IS SWEET.



## OUR FINEST MOMENT. YOUR YEARS OF LUXURY.

Everything about it speaks the vocabulary of achievement: sophistication. Refinement. Luxury. Comfort. From the moment you get into a Ram Laramie, you know you've made it.

### NEXT PAGE

**TOP ROW:** Surrounded by elegant trim with stitching, even the buttons and controls convey total quality; ergonomic and easy-to-use: the dashboard-mounted rotary dial for 4x4 operation.

**MIDDLE ROW:** Contrasting trim treatment in Laramie door panels shows off the distinctive Ram aesthetic; built-in USB ports are indispensable for operating and charging electronics.

**BOTTOM ROW:** The Laramie interior in Canyon Brown/Light Frost Beige, with embossed logos on seatbacks and center console.

Few pickups stand out with such sophistication as the Ram Laramie models. The luxurious treatments and inviting interiors bring a wealth of appointments, design refinements, comfort and craftsmanship to the Ram Heavy Duty portfolio.

You'll know, feel and see it from the moment you take a seat in Ram Laramie, with features that include the distinctive six-ring instrument cluster and the understated elegance of leather-trimmed touches. When it comes to luxury, it's clear: we've reached our finest moment—and you've arrived.

### EXPLORE THE INNER SPACE OF RAM. THESE ARE CABS WITH ROOM TO MOVE.

Ram Heavy Duty models stand apart—and often stand at the top. Above, Ram 2500/3500 Mega Cab® offers best-in-class<sup>(1)</sup> interior space with generous leg and hip room.

Ram 2500/3500 Crew Cab offers a vast interior, with amenities that include in-floor storage and available fold-flat load floor.

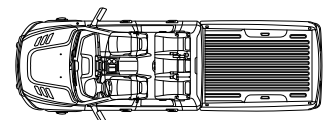

Ram 2500/3500 Mega Cab 142.65 cu-ft interior volume

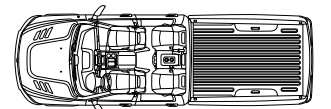

Ram 2500/3500 Crew Cab 125.3 cu-ft interior volume



# LARAMIE





LARAMIE LIMITED

# STYLE + UTILITY

Like every Ram Heavy Duty model, it was born and bred for tough jobs. Unlike every other Ram, the distinctive Laramie Limited interior features stunning Premium Natura Black leather with subtle instrument panel treatments and aged burlled European wood.







# KNOWLEDGE IS POWER.

Step into a Ram pickup and you're stepping up to technology unimaginable a decade ago. Each Ram model gives you state-of-the-art instrumentation and information through the impressive Electronic Vehicle Information Center (EVIC) display. Select models feature a six-ring cluster with full-color seven-inch Thin Film Transistor (TFT) display; the customizable

multiview screen offers astonishing clarity and tons of real-time mechanical data. Add scroll-type interfaces and intuitive steering wheel-mounted toggle switches for instant vehicle information (there are 34 menu options and graphics) and PowerNet electrical architecture with smart modules and you're in control of all of it.



Connectivity is key. Along with a full-color 8.4-inch touchscreen system—the largest in the class<sup>[15]</sup>—the brilliant universe of in-cab technology makes available a world of telematics and electronics. Uconnect can include a WiFi Hotspot<sup>[3]\*</sup> Bluetooth<sup>®</sup> sync, hands-free Voice Command<sup>[4]</sup> indispensable NAV systems with a complimentary first year of SiriusXM<sup>®</sup> Satellite Radio<sup>[5]</sup> rounding it out.

**UCONNECT<sup>®</sup> ACCESS<sup>[6]</sup> GIVES YOU EVEN MORE.**

The 2015 Ram pickups are all about keeping in touch. Next-generation Uconnect is the key. Register for the included trial<sup>[7]†</sup> of Uconnect Access<sup>[6]</sup> services, and you've got an available on-demand WiFi Hotspot<sup>[3]\*</sup> and apps via mobile, convenient Remote Commands<sup>[9]</sup> Voice Texting<sup>[9]</sup> Yelp<sup>®</sup>, emergency assistance and more.

Yelp <sup>®</sup>	Roadside Assistance <sup>[8]</sup>	Remote Vehicle Start <sup>[9]</sup>	WiFi Hotspot <sup>[3]*</sup>
Voice Texting <sup>[9]</sup>	Stolen Vehicle Assistance <sup>[12]</sup>	Remote Horn and Lights <sup>[9]</sup>	Pandora <sup>®</sup> (via mobile)
9-1-1 Call <sup>[10]</sup>	Theft Alarm Notification <sup>[13]</sup>	Remote Door Lock/Unlock <sup>[9]</sup>	iHeartRadio (via mobile)

**SIRIUSXM.** All satellite radio-equipped Ram vehicles come with a one-year trial to the SiriusXM package, providing over 160 channels of the best programming for all the places life takes you.

- In your vehicle—you'll get every channel available on your radio, including all the premium programming like Howard Stern, every NFL<sup>®</sup> game, every MLB<sup>®</sup> game, every NASCAR<sup>®</sup> race, Oprah Radio and more.
- On the go—with a SiriusXM Internet Radio subscription included with the trial, you'll get SiriusXM on your computer, smartphone or tablet. Go to [siriusxm.com/getallaccess](http://siriusxm.com/getallaccess) for more information.

With SiriusXM Travel Link<sup>[14]</sup> get national and local weather reports, fuel prices, sports scores and more. SiriusXM Traffic<sup>[5]</sup> gives you detailed information on traffic speed, accidents, construction, road closures and more. Your first 5 years of both services are included.

SiriusXM  
**TRAFFIC**  
SiriusXM  
**TRAVEL LINK**

\*Additional charges apply. †Uconnect 8.4A: 6-month trial. Uconnect 8.4AN: 12-month trial. †Certain features are not available while vehicle is in motion.



# COLOSSAL PAYLOAD



Properly secure all cargo.





# + TOP-TIER STORAGE

**Class-Exclusive<sup>®</sup>: the RamBox<sup>®</sup>  
Cargo Management System.**



This is what it takes for capability: authoritative hauling. Superb towing. Only Ram goes further, by offering extreme versatility for storing and carrying cargo. This is the only pickup in the segment<sup>®</sup> to offer the comprehensive and unique RamBox Cargo Management System. Get the specs online—or just turn the page.

Properly secure all cargo.

# WHEN YOU'RE ON THE MOVE, RAM GIVES YOU ROOM TO SPARE.

**RAM HEAVY DUTY PICKUPS** are designed to deliver incredible hauling capability and storage capacity—and we don't let you down.

A Ram pickup is designed to give you all the space you need to help friends move, haul heavy items for your next project or travel comfortably across the country. Depending on the model, rear seats fold up or down for level-floor hauling when materials are best carried inside. Front-center seats open for at-hand storage. Huge bins in the front doors offer serious volume. In-floor storage bins on Crew Cab models are removable for draining ice—and invaluable for keeping things out of sight.

Select Ram Heavy Duty models with the 6'4" bed give you a class-exclusive<sup>[1]</sup> advantage over the competition—the available RamBox<sup>®</sup> Cargo Management System. This complete package for hauling and storage consists of a bed extender/divider, cargo bed rails with four adjustable tie-down cleats and the RamBox System bins: two large, illuminated, drainable and lockable bed-side compartments. If hunting and fishing are part of your lifestyle, there are even Authentic Accessories from Mopar<sup>®</sup> for the RamBox System created specifically for the sportsman. Check it out at [MOPAR.COM](http://MOPAR.COM)

## NEXT PAGE

**TOP:** Dual glove boxes ramp up storage; seats triple-up: the front-row center position can be a seat, a fold-flat writing surface or a storage compartment with integrated cup holders.

**MIDDLE:** In-floor storage bins of Ram Crew Cab models are convenient—and removable; the extra-large in-door bins hold oversize bottles, with ample space for large items.

**BOTTOM:** Under-the-seat storage is ideal when you want to stash items unseen by outside observers—one of the many advantages to Ram Crew Cab models.

## THIS PAGE

**BELOW:** Described in detail on this page, the class-exclusive<sup>[1]</sup> available RamBox Cargo Management System ingeniously combines storage with uncompromised capability: standard 4x8 sheets of building materials still fit comfortably between the wheel wells of the cargo bed.

**REMOTE KEYLESS ENTRY, ALLSECURE<sup>®</sup> LOCKING SYSTEM.** Versatile key fobs give you more Ram conveniences. The available Remote Keyless Entry System also features the AllSecure Locking System, which locks/unlocks all doors, the tailgate and (if equipped) both RamBox System bed-side compartments. Available fob functions can also include the Remote Start function and the panic button.



PREMIUM KEYLESS ENTER 'N GO™

## THE CLASS-EXCLUSIVE<sup>[1]</sup> AVAILABLE RAMBOX CARGO MANAGEMENT SYSTEM

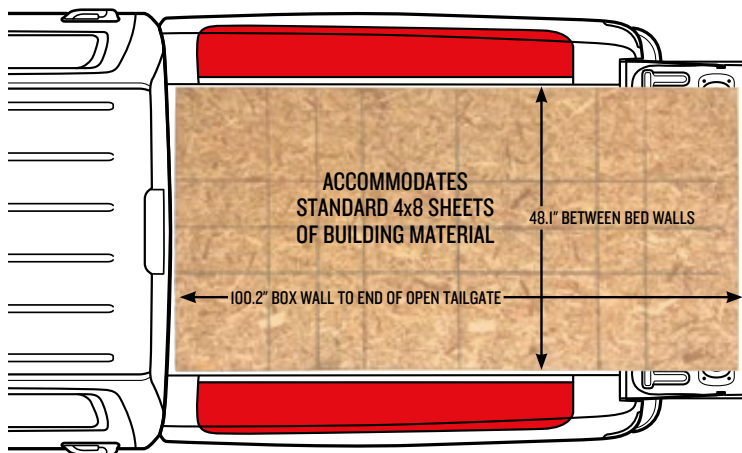
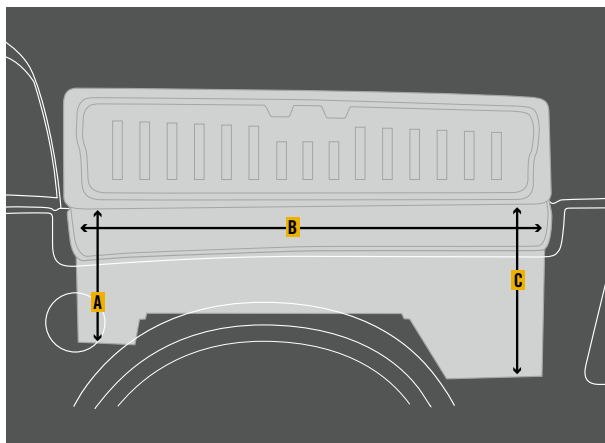

RAMBOX SYSTEM DIMENSIONS	6'4" CARGO BED
A	18.6"
B	60.2"
C	18.9"
<b>TOTAL VOLUME (both sides)</b>	<b>8.6 cu ft</b>



Light duty shown.

Properly secure all cargo.



Properly secure all cargo.

# POWER WAGON



# WITH CAPABILITY THIS TOUGH, YOU CAN GO TO EXTREMES.

**ONE PICKUP DOMINATES THE REMOTEST OFF-ROAD LOCATIONS**—and for good reason: Ram Power Wagon® carries both a reputation and a level of equipment that lets you go where others don't dare.

Like its tough Ram 2500 Heavy Duty brothers, Ram Power Wagon recently upgraded the front and rear suspensions and boosted frame strength. But this Ram is built for the ultimate in off-road capability, and that's where all comparisons take a sharp turn—right to the extreme.

This is what it takes to become the most capable off-road full-size pickup:<sup>[15]</sup> 4x4 capability bolstered by front and rear electronically locking differentials. Multiple skid plates and underbody protection. Heavy-duty Bilstein® monotube shocks on all four corners. Solid front and rear axles. New Hill Descent Control ... all standard—exactly what you'd expect for a truck created to climb over rocks and mountains. Now add a low-g geared 4.10:1 axle ratio, 14.3 inches of running ground clearance, approach and departure angles of 33.6 and 26.2 degrees respectively, all riding on monster 33-inch Goodyear® Wrangler DuraTrac tires. Some things are made to be taken to the maximum. This is one—and it stands at the top. There's a ton more at [RAMTRUCKS.COM](http://RAMTRUCKS.COM)

**BELOW, UPPER LEFT:** Ram Power Wagon gets up to that remote cabin thanks to the standard 6.4-liter HEMI® V8 mated to the tough 66RFE 6-speed transmission, for a terrain-mastering 410 horsepower and 429 lb-ft of torque.

Fuel conservation is built in: the 6.4L HEMI V8 features the hallmark Fuel Saver Technology/MDS—the Multi-Displacement System that shuts off four of the eight cylinders during highway cruising, transforming the formidable HEMI V8 into a fuel-sipping four cylinder.

**BELOW, LOWER LEFT:** Standard on Ram Power Wagon is the indispensable WARN® winch tucked away in the front bumper, giving you 12,000 lb of capability using half-inch high-strength aircraft wire. It's known to come in handy when helping other off-roaders with a less-capable truck out of a jam.

**BELOW, RIGHT:** This pickup stands out by standing up to the harshest extremes. Count on tough skid plates for the fuel tank and transfer case; electronic disconnecting front stabilizer (or sway) bar; front and rear electronic locking differentials, with heavy-duty components like the Bilstein monotube heavy-duty shocks working with the proprietary Ram Articulink™ system that delivers increased wheel travel. Put it all together, and you've got the most capable off-road full-size pickup!<sup>[15]</sup>

# POWER WAGON





# A HISTORY OF



It was a point in time marked by invention and liberation—and the mighty Power Wagon® played a significant role.

Based on trucks engineered to meet military-grade specifications for WWII, the first Power Wagon rolled off the assembly line in 1945, with the mandate to be the most capable and versatile on- and off-road vehicle ever manufactured. It fulfilled that directive with astonishing presence. Available as a Chassis Cab (for \$1,555) and a pickup (\$1,627), the first Power Wagon models could carry an unheard-of 3,000-lb payload in off-road conditions. Power Wagon provided an instant solution to a wide variety of agricultural, industrial and commercial needs, and the model was a particular favorite of fire-fighters and of the Forest Service.

Built to one-ton weight class specs, those initial Power Wagon models boasted massive strength: in-line L-head six-cylinder engine with cast-iron block (in 1946, its 94 hp/185 lb-ft of torque was exceptional). The four-speed manual transmission was mated to a two-speed transfer case, enabling eight forward speeds and two in reverse, with heavy-duty front shock absorbers and front winch.

The importance of Power Wagon throughout history is reflected in virtually uninterrupted production and ongoing improvements for nearly 70 years. The place it now holds in the Ram portfolio is unmatched in the entire segment: the 2015 Ram Power Wagon still dominates as the most capable off-road full-size pickup!<sup>[15]</sup>

# POWER WAGON



## RAM HEAVY DUTY DIMENSIONS

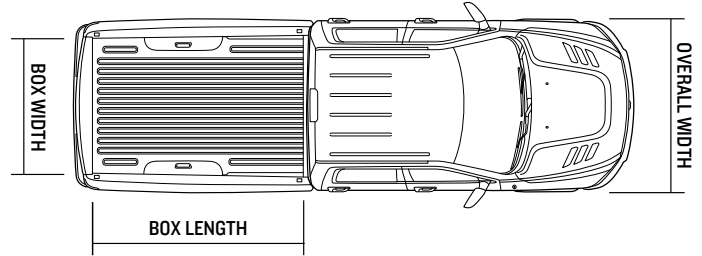
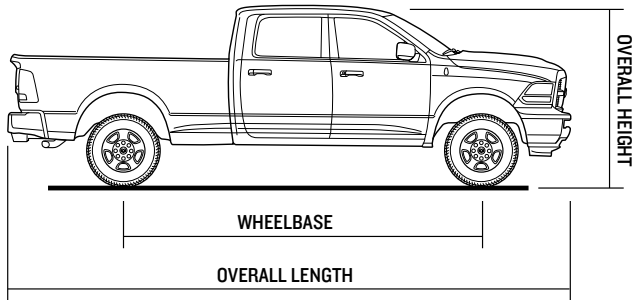

**RAM CREW CAB WITH 8' BOX SHOWN**

### RAM HEAVY DUTY INTERIOR DIMENSIONS

All dimensions are in inches unless otherwise noted.

	REGULAR CAB	CREW CAB	MEGA CAB®
HEAD ROOM FRONT/REAR	40.3	41.0 / 39.9	41.0 / 40.3
LEG ROOM FRONT/REAR	41.0	41.0 / 40.3	41.0 / 43.3
SHOULDER ROOM FRONT/REAR	66.0	66.0 / 65.7	66.0 / 65.7
HIP ROOM FRONT/REAR	62.9	63.2 / 63.2	63.2 / 63.2
BEHIND SECOND ROW (CU FT)	N/A	N/A	12.1
TOTAL INTERIOR VOLUME (CU FT)	62.5	125.3	142.65

### RAM 2500 EXTERIOR DIMENSIONS

All specs are for base models only; in inches unless otherwise noted.

	REGULAR CAB	CREW CAB		MEGA CAB
	8' BOX	6'4" BOX	8' BOX	6'4" BOX
OVERALL BODY WIDTH	79.4	79.4	79.4	79.4
OVERALL HEIGHT (4x2 / 4x4)	76.2 / 78.1	76.9 / 78.8	76.7 / 78.6	77.9 / 79.8
OVERALL LENGTH	230.4	237.3	259.4	248.4
TRACK - FRONT (4x2 / 4x4)	68.7 / 68.7	68.7 / 68.7	68.7 / 68.7	67.7 / 67.7
TRACK - REAR (4x2 / 4x4)	68.1 / 68.1	68.1 / 68.1	68.1 / 68.1	67.1 / 67.1
WHEELBASE (4x2 / 4x4)	140.2 / 140.4	149.1 / 149.3	169.1 / 169.3	160.2 / 160.4
BOX HEIGHT	20.2	20.1	20.2	20.1
BOX LENGTH	98.3	76.3	98.3	76.3
BOX WIDTH, WALL TO WALL	66.4	66.4	66.4	66.4
BOX WIDTH, BETWEEN WHEELHOUSINGS	51	51	51	51

### RAM 3500 EXTERIOR DIMENSIONS

All specs are for base models only; in inches unless otherwise noted.

	REGULAR CAB		CREW CAB			MEGA CAB	
	8' BOX	8' BOX DRW	6'4" BOX	8' BOX	8' BOX DRW	6'4" BOX	6'4" BOX DRW
OVERALL WIDTH	79.4	96.4	79.4	79.4	96.4	79.4	96.4
OVERALL HEIGHT (4x2 / 4x4)	77.7 / 79.1	77.7 / 79.1	78.4 / 79.8	77.4 / 79.6	77.4 / 79.6	78.3 / 79.7	77.5 / 79.0
OVERALL LENGTH	230.4	230.4	237.3	259.3	259.3	248.4	248.4
TRACK - FRONT (4x2 / 4x4)	67.7 / 67.7	68.6 / 69.5	67.7 / 67.7	67.7 / 67.7	68.6 / 69.5	67.7 / 67.7	68.6 / 69.5
TRACK - REAR (4x2 / 4x4)	67.1 / 67.1	75.8 / 75.8	67.1 / 67.1	67.1 / 67.1	75.8 / 75.8	67.1 / 67.1	75.8 / 75.8
WHEELBASE (4x2 / 4x4)	140.0 / 140.4	140.0 / 140.4	148.9 / 149.3	168.9 / 169.3	168.9 / 169.3	160.0 / 160.4	160.0 / 160.4
BOX HEIGHT	20.2	20.2	20.1	20.2	20.2	20.1	20.1
BOX LENGTH	98.3	98.3	76.3	98.3	98.3	76.3	76.3
BOX WIDTH, WALL TO WALL	66.4	66.4	66.4	66.4	66.4	66.4	66.4
BOX WIDTH, BETWEEN WHEELHOUSINGS	51	51	51	51	51	51	51

## 2500/3500 SRW WHEELS



17-inch Steel, Argent Painted Finish  
Standard on 2500 Tradesman (WDA)



18-inch Steel, Argent Painted Finish  
Standard on 3500 Tradesman • Optional on 2500 Tradesman (WBN)



18-inch Polished Forged Aluminum  
Standard on Big Horn/Lone Star and Outdoorsman • Optional on SLT (WBJ)



18-inch Polished Aluminum with White Gold Pockets  
Standard on Laramie Longhorn with Two-Tone Exterior Paint (WBM)



17-inch Polished Aluminum  
Standard on 2500 Power Wagon® Models (WVW)



18-inch Steel, Chrome-Clad  
Standard on SLT • Optional on Tradesman (WBH)



18-inch Polished Aluminum  
Standard on Laramie (WBL)



18-inch Polished Aluminum with Silver Pockets  
Standard on Laramie Longhorn with available Monotone Exterior Paint (WBA)

## 2500/3500 SRW WHEELS



20-inch Painted Satin Carbon Aluminum with Chrome Inserts  
Standard on Laramie Limited • Optional on SLT, Big Horn/Lone Star, Outdoorsman and Laramie (WRJ)



20-inch Black Painted Aluminum  
Included with Black Appearance Group (WF3)



20-inch Polished Aluminum with White Gold Pockets  
Optional on Laramie Longhorn with Two-Tone Exterior Paint (WRK)



20-inch Polished Aluminum with Silver Pockets  
Optional on Laramie Longhorn with available Monotone Exterior Paint (WRA)

## 3500 DRW WHEELS



17-inch Steel, Argent Painted Finish  
Standard on Tradesman (WFLU)



17-inch Steel, Chrome Finish  
Standard on SLT and Big Horn/Lone Star • Optional on Tradesman (WD4)



17-inch Polished Aluminum  
Standard on Laramie and Laramie Limited • Optional on SLT and Big Horn/Lone Star (WF7)



17-inch Polished Aluminum with Unique Longhorn Center Cap  
Standard on Laramie Longhorn (WF9)

## 2500/3500 TRIM LEVELS

**Tradesman**  
Tough, no-nonsense capability for the workman



### 2500

CABS	BEDS	SEATING
Regular Cab	SRW: 8' Box	40/20/40 Bench Seat
Crew Cab	SRW: 6'4" or 8' Box	40/20/40 Bench Seat

### 3500

CABS	BEDS	SEATING
Regular Cab	SRW: 8' Box	DRW: 8' Box
Crew Cab	SRW: 6'4" or 8' Box	DRW: 8' Box
		40/20/40 Bench Seat

## MECHANICAL

**2500:** 5.7L HEMI® V8 with heavy-duty cooling and 66RFE 6-speed automatic transmission

**3500 SRW:** 5.7L HEMI V8 with heavy-duty cooling and 66RFE 6-speed automatic transmission • 7 x 11-inch trailer tow mirrors • Tow hooks

**3500 DRW:** 6.4L HEMI V8 with heavy-duty cooling and 66RFE 6-speed automatic transmission • 7 x 11-inch trailer tow mirrors • Tow hooks

**2500/3500:** Electronic Stability Control (ESC)<sup>(MS)</sup> System, which includes 4-wheel ABS, Brake Assist, Rain Brake Support, Ready Alert Braking, All-Speed Traction Control, Electronic Roll Mitigation, Hill Start Assist and Trailer Sway Control<sup>(MS)</sup> • Manual part-time transfer case (on 4x4 models) • 31-gallon fuel tank (6'4" box models) • 32-gallon fuel tank (8' box models)

## INTERIOR

Vinyl 40/20/40 front bench seat • Vinyl folding rear bench on Crew Cab models • Vinyl floor covering • Multistage front air bags<sup>(MS)</sup> • Supplemental side-curtain air bags<sup>(MS)</sup> • Supplemental front-seat side-mounted air bags<sup>(MS)</sup> • Tilt steering wheel • Automatic headlamp control • Air conditioning • Power windows and door locks (on Crew Cab models) • Uconnect® 3.0 AM/FM system • Media hub with MP3 auxiliary jack and 1.5-amp USB port • 3.5-inch Electronic Vehicle Information Center (EVIC) located in instrument panel cluster

## EXTERIOR

Black front and rear bumpers • Black grille surround and inserts • Black fold-in sideview mirrors • Quad-lens halogen headlamps • Bed rail caps • Locking tailgate (Regular Cab) • Power locking tailgate (Crew Cab) • 4- and 7-pin trailer wiring harness/connectors • Class V trailer hitch receiver • 17-inch steel wheels (2500/3500 DRW) • 18-inch steel wheels (3500 SRW)

## 2500/3500 TRIM LEVELS

### SLT Uncompromising strength with welcome touches of comfort



2500		
CABS	BEDS	SEATING
Regular Cab	SRW: 8' Box	40/20/40 Bench Seat Bucket Seats, Opt.
Crew Cab	SRW: 6'4" or 8' Box	40/20/40 Bench Seat Bucket Seats, Opt.
Mega Cab <sup>®</sup>	SRW: 6'4" Box	40/20/40 Bench Seat Bucket Seats, Opt.

3500		
CABS	BEDS	SEATING
Regular Cab	SRW: 8' Box DRW: 8' Box	40/20/40 Bench Seat Bucket Seats, Opt.
Crew Cab	SRW: 6'4" or 8' Box DRW: 8' Box	40/20/40 Bench Seat Bucket Seats, Opt.
Mega Cab	SRW: 6'4" Box DRW: 6'4" Box	40/20/40 Bench Seat Bucket Seats, Opt.

#### MECHANICAL

**2500:** 5.7L HEMI<sup>®</sup> V8 with heavy-duty cooling and 66RFE 6-speed automatic transmission

**3500 SRW:** 5.7L HEMI V8 with heavy-duty cooling and 66RFE 6-speed automatic transmission • 7 x 11-inch trailer tow mirrors • Tow hooks

**3500 DRW:** 6.4L HEMI V8 with heavy-duty cooling and 66RFE 6-speed automatic transmission • 7 x 11-inch trailer tow mirrors • Tow hooks

**2500/3500:** Electronic Stability Control (ESC)<sup>[6]</sup> System • Electronic part-time transfer case (on 4x4 models) • Electronic trailer brake controller • Remote keyless entry • 31-gallon fuel tank (6'4" box models) • 32-gallon fuel tank (8' box models)

#### INTERIOR

Cloth 40/20/40 front bench seat • Cloth folding rear bench on Crew Cab and Mega Cab models • Carpet floor covering • Multistage front air bags<sup>[7]</sup> • Supplemental side-curtain air bags<sup>[7]</sup> • Supplemental front-seat side-mounted air bags<sup>[7]</sup> • Tilt steering wheel • Automatic headlamp control • Air conditioning • Power windows and door locks • Uconnect<sup>®</sup> 5.0 AM/FM/Bluetooth<sup>®</sup> touchscreen system with SiriusXM<sup>®</sup> Satellite Radio<sup>[5]</sup> • Media hub with MP3 auxiliary jack and 1.5-amp USB port • 3.5-inch Electronic Vehicle Information Center (EVIC) located in instrument panel cluster • Overhead console • Power sliding rear window on Crew Cab and Mega Cab models

#### EXTERIOR

Chrome front and rear bumpers • Chrome grille surround with Black inserts • Quad-lens halogen headlamps • Chrome door handles • Black, power heated fold-in sideview mirrors • Bed rail caps • Power locking tailgate • 4- and 7-pin trailer wiring harness/connectors • Class V trailer hitch receiver • 17-inch chrome steel wheels (3500 DRW) • 18-inch chrome steel wheels (2500/3500 SRW)

### Big Horn/Lone Star Subtle upgrades inside and out—with its own brand for Texas



Big Horn shown with optional Black Appearance Group. Also available on Laramie.

2500		
CABS	BEDS	SEATING
Crew Cab	SRW: 6'4" or 8' Box	40/20/40 Bench Seat Bucket Seats, Opt.
Mega Cab	SRW: 6'4" Box	40/20/40 Bench Seat Bucket Seats, Opt.

3500		
CABS	BEDS	SEATING
Crew Cab	SRW: 6'4" or 8' Box DRW: 8' Box	40/20/40 Bench Seat Bucket Seats, Opt.
Mega Cab	SRW: 6'4" Box DRW: 6'4" Box	40/20/40 Bench Seat Bucket Seats, Opt.

3500		
CABS	BEDS	SEATING
Crew Cab	SRW: 6'4" or 8' Box DRW: 8' Box	40/20/40 Bench Seat Bucket Seats, Opt.
Mega Cab	SRW: 6'4" Box DRW: 6'4" Box	40/20/40 Bench Seat Bucket Seats, Opt.

3500		
CABS	BEDS	SEATING
Crew Cab	SRW: 6'4" or 8' Box DRW: 8' Box	40/20/40 Bench Seat Bucket Seats, Opt.
Mega Cab	SRW: 6'4" Box DRW: 6'4" Box	40/20/40 Bench Seat Bucket Seats, Opt.

#### MECHANICAL

**2500:** 5.7L HEMI V8 with heavy-duty cooling and 66RFE 6-speed automatic transmission

**3500 SRW:** 5.7L HEMI V8 with heavy-duty cooling and 66RFE 6-speed automatic transmission • 7 x 11-inch trailer tow mirrors • Tow hooks

**3500 DRW:** 6.4L HEMI V8 with heavy-duty cooling and 66RFE 6-speed automatic transmission • 7 x 11-inch trailer tow mirrors • Tow hooks

**2500/3500:** ESC<sup>[6]</sup> System • Electronic part-time transfer case (on 4x4 models) • Electronic trailer brake controller • Remote keyless entry • Remote Start (requires automatic transmission) • 31-gallon fuel tank (6'4" box models) • 32-gallon fuel tank (8' box models)

#### INTERIOR

Premium cloth 40/20/40 front bench seat • Cloth 60/40 split-folding rear bench seat • Carpet floor covering • Multistage front air bags<sup>[7]</sup> • Supplemental side-curtain air bags<sup>[7]</sup> • Supplemental front-seat side-mounted air bags<sup>[7]</sup> • Leather-wrapped tilt steering wheel with audio controls • 115-volt power outlet • Automatic headlamp control • Air conditioning • Power windows and door locks • Uconnect 5.0 AM/FM/Bluetooth touchscreen system with SiriusXM Satellite Radio<sup>[5]</sup> • Media hub with MP3 auxiliary jack, 1.5-amp and 2.5-amp USB ports • 3.5-inch EVIC located in instrument panel cluster • Overhead console • Power sliding rear window

#### EXTERIOR

Quad-lens halogen headlamps • Fog lamps • Chrome front and rear bumpers • Chrome grille surround with chrome billet inserts • Black, power heated fold-in sideview mirrors • Chrome door handles • Bed rail caps • Power locking tailgate • 4- and 7-pin trailer wiring harness/connectors • Class V trailer hitch receiver • 17-inch chrome steel wheels (2500/3500 SRW) • 18-inch polished aluminum wheels (2500/3500 DRW)

### Outdoorsman This outfit is designed exclusively for the sportsman



2500		
CABS	BEDS	SEATING
Crew Cab	SRW: 6'4" or 8' Box	Bucket Seats 40/20/40 Bench Seat, Opt.

#### MECHANICAL

**2500 Crew Cab 4x4 only:** 5.7L HEMI V8 with heavy-duty cooling and 66RFE 6-speed automatic transmission • ESC<sup>[6]</sup> System • Remote keyless entry • Electronic part-time transfer case • Electronic trailer brake controller • Transfer case skid plate • Remote Start (requires automatic transmission) • Security alarm • 31-gallon fuel tank (6'4" box models) • 32-gallon fuel tank (8' box models)

#### INTERIOR

Luxury Group • Leather-wrapped tilt steering wheel with audio controls • Premium cloth front bucket seats with center console • Power driver's seat • Cloth 60/40 split-folding rear bench • Carpet floor covering • Rubber all-weather floor mats • Multistage front air bags<sup>[7]</sup> • Supplemental side-curtain air bags<sup>[7]</sup> • Supplemental front-seat side-mounted air bags<sup>[7]</sup> • Automatic headlamp control • Air conditioning • Power windows and door locks • Uconnect 8.4A AM/FM/Bluetooth/Access<sup>[8]</sup> touchscreen system with SiriusXM Satellite Radio<sup>[5]</sup> • Media hub with MP3 auxiliary jack, 1.5-amp and 2.5-amp USB ports, and SD card slot • 115-volt power outlet • Premium six-ring instrument panel cluster with full-color 7-inch multiview display • Overhead console with Universal Garage Door Opener • Power sliding rear window

#### EXTERIOR



Two-tone paint with Black front bumper, rear bumper and fender flares • Body-color grille surround with Black inserts • Black door handles • Black, power heated fold-in sideview mirrors with puddle lamps and turn signal indicators • Fog lamps • Quad-lens halogen headlamps • Bed rail caps • Power locking tailgate • 4- and 7-pin trailer wiring harness/connectors • Class V trailer hitch receiver • Tow hooks • 18-inch polished aluminum wheels

## 2500/3500 TRIM LEVELS

### Power Wagon® Tradesman

Built for extreme work—and the extreme off-road



2500		
CABS	BEDS	SEATING
		
Crew Cab	SRW: 6'4" Box	40/20/40 Bench Seat

#### MECHANICAL

**2500 Crew Cab 4x4 only:** 6.4L HEMI® V8 with heavy-duty cooling and 6GRFE 6-speed automatic transmission • 180-amp alternator • Tow hooks • Skid plates for the fuel tank and transfer case • Electronic disconnecting front stabilizer (or sway) bar • Front and rear electronic locking differentials • Hill Descent Control • 4.10:1 axle ratio • 12,000-lb WARN® winch • 31-gallon fuel tank • Electronic Stability Control (ESC)<sup>[6]</sup> System • Manual part-time transfer case

#### INTERIOR

Vinyl front 40/20/40 bench seat • Vinyl folding rear bench • Tilt steering wheel • Vinyl floor covering • Multistage front air bags<sup>[7]</sup> • Supplemental side-curtain air bags<sup>[7]</sup> • Supplemental front-seat side-mounted air bags<sup>[7]</sup> • Automatic headlamps • Air conditioning • Power windows and door locks • Uconnect® 3.0 AM/FM system • Media hub with MP3 auxiliary jack and 1.5-amp USB port • 3.5-inch Electronic Vehicle Information Center (EVIC) in the instrument panel cluster



#### EXTERIOR

Monotone paint with chrome front and rear bumpers • Fog lamps • Black grille surround and inserts • Black headlamp filler panel • Black wheel flares • Power Wagon tailgate decal • 17-inch forged aluminum wheels with 33-inch LT All-Terrain tires

### Power Wagon

The traditional Power Wagon: capability to the max



2500		
CABS	BEDS	SEATING
		
Crew Cab	SRW: 6'4" Box	40/20/40 Bench Seat

#### MECHANICAL

**2500 Crew Cab 4x4 only:** 6.4L HEMI V8 with heavy-duty cooling and 6GRFE 6-speed automatic transmission • 180-amp alternator • Tow hooks • Skid plates for the fuel tank and transfer case • Electronic disconnecting front stabilizer (or sway) bar • Front and rear electronic locking differentials • Hill Descent Control • 4.10:1 axle ratio • 12,000-lb WARN winch • 31-gallon fuel tank • Remote keyless entry • ESC<sup>[6]</sup> System • Manual part-time transfer case • Electronic trailer brake controller

#### INTERIOR

Cloth front 40/20/40 bench seat • Cloth folding rear bench • Tilt steering wheel • Carpet floor covering • Multistage front air bags<sup>[7]</sup> • Supplemental side-curtain air bags<sup>[7]</sup> • Supplemental front-seat side-mounted air bags<sup>[7]</sup> • Automatic headlamps • Air conditioning • Power windows and door locks • Uconnect 5.0 AM/FM/Bluetooth® touchscreen system with SiriusXM® Satellite Radio<sup>[5]</sup> • Media hub with MP3 auxiliary jack, and 1.5-amp and 2.5-amp USB ports • 3.5-inch EVIC in the instrument panel cluster • Overhead console • Power sliding rear window

#### EXTERIOR

Two-tone paint with front and rear chrome bumpers • Black wheel flares • Chrome grille surround with billet inserts • Black, power heated fold-in sideview mirrors • Black door handles • Black bed rail caps • Fog lamps • Premium 70-mm projector headlamps • Premium LED taillamps • Power locking tailgate • Power Wagon Decal Package • Class V trailer hitch receiver • 4- and 7-pin trailer wiring harness/connectors • 17-inch forged aluminum wheels with 33-inch LT All-Terrain tires



#### SLT POWER WAGON GRAPHICS

Tailgate Graphic	Standard		
Hood Decal	Standard		
Side Graphic	Standard		
Chrome Grille Surround with Red Billets	Standard (color-dependent)		
Exterior Color	Red Graphics	Gray Graphics	Red Grille
Bright White	X		X
Black (Monotone)	X		X
Bright Silver	X		X
Granite Crystal	X		X
Flame Red		X	X
True Blue		X	
Maximum Steel		X	
Deep Cherry Red		X	
Blue Streak		X	

### Power Wagon Laramie

The off-road giant gets the sophistication of a Laramie



2500		
CABS	BEDS	SEATING
		
Crew Cab	SRW: 6'4" Box	40/20/40 Bench Seat

#### MECHANICAL

**2500 Crew Cab 4x4 only:** 6.4L HEMI V8 with heavy-duty cooling and 6GRFE 6-speed automatic transmission • 180-amp alternator • Tow hooks • Skid plates for the fuel tank and transfer case • Electronic disconnecting front stabilizer (or sway) bar • Front and rear electronic locking differentials • Hill Descent Control • 4.10:1 axle ratio • 12,000-lb WARN winch • 31-gallon fuel tank • Remote keyless entry • ESC<sup>[6]</sup> System • Manual part-time transfer case • Electronic trailer brake controller

#### INTERIOR

Leather-trimmed heated and ventilated front 40/20/40 bench seat • Power driver and front-passenger seats • Leather-trimmed 60/40 split-folding rear bench • 115-volt power outlet • Carpet floor covering • Multistage front air bags<sup>[7]</sup> • Supplemental side-curtain air bags<sup>[7]</sup> • Supplemental front-seat side-mounted air bags<sup>[7]</sup> • Heated leather-wrapped tilt steering wheel with audio controls • Automatic headlamps • Automatic Temperature Control (ATC) • Power windows and door locks • Uconnect 8.4A AM/FM/Bluetooth/Access<sup>[6]</sup> touchscreen system with SiriusXM Satellite Radio<sup>[5]</sup> • Media hub with MP3 auxiliary jack, 1.5-amp and 2.5-amp USB ports, and SD card slot • Premium 10-speaker Surround Sound Audio System • Premium six-ring instrument panel cluster with full-color 7-inch multiview display • Overhead console with Universal Garage Door Opener • Power sliding rear window

#### EXTERIOR

Monotone paint with front and rear chrome bumpers • Body-color wheel flares • Chrome grille surround with chrome wave inserts • Chrome, power heated fold-in sideview mirrors • Chrome door handles • Black bed rail caps • Fog lamps • Premium 70-mm projector headlamps • Premium LED taillamps • Power locking tailgate • Power Wagon tailgate badge • Class V trailer hitch receiver • 4- and 7-pin trailer wiring harness/connectors • 17-inch forged aluminum wheels with 33-inch LT All-Terrain tires

## 2500/3500 TRIM LEVELS

**Laramie**  
Heavy-duty capability joins heavy-duty luxury



### 2500

CABS	BEDS	SEATING
Crew Cab	SRW: 6'4" or 8' Box	40/20/40 Bench Seat Bucket Seats, Opt.

Mega Cab <sup>®</sup>	SRW: 6'4" Box	40/20/40 Bench Seat Bucket Seats, Opt.

### 3500

CABS	BEDS	SEATING
Crew Cab	SRW: 6'4" or 8' Box	DRW: 8' Box
40/20/40 Bench Seat	Bucket Seats, Opt.	

Mega Cab	SRW: 6'4" Box	DRW: 6'4" Box
40/20/40 Bench Seat	Bucket Seats, Opt.	

### MECHANICAL

**2500:** 5.7L HEMI<sup>®</sup> V8 with heavy-duty cooling and 66RFE 6-speed automatic transmission

**3500 SRW:** 5.7L HEMI V8 with heavy-duty cooling and 66RFE 6-speed automatic transmission • 7 x II-inch power-folding trailer tow mirrors • Tow hooks

**3500 DRW:** 6.4L HEMI V8 with heavy-duty cooling and 66RFE 6-speed automatic transmission • 7 x II-inch power-folding trailer tow mirrors • Tow hooks

**2500/3500:** Electronic Stability Control (ESC)<sup>[6]</sup> System • ParkSense<sup>®</sup> Rear Park Assist<sup>[2]</sup> • Electronic part-time transfer case (on 4x4 models) • Electronic trailer brake controller • Remote keyless entry • ParkView<sup>®</sup> Rear Back-Up Camera<sup>[2]</sup> • Security alarm • 31-gallon fuel tank (6'4" box models) • 32-gallon fuel tank (8' box models)

### INTERIOR

Leather-trimmed heated and ventilated front 40/20/40 bench seat • Power driver and front-passenger seats • Leather-trimmed 60/40 split-folding rear bench • 115-volt power outlet • Carpet floor covering • Multistage front air bags<sup>[7]</sup> • Supplemental side-curtain air bags<sup>[7]</sup> • Supplemental front-seat side-mounted air bags<sup>[7]</sup> • Heated leather-wrapped tilt steering wheel with audio controls • Automatic headlamps • Automatic Temperature Control (ATC) • Power windows and door locks • Uconnect<sup>®</sup> 8.4A AM/FM/Bluetooth/Access<sup>[6]</sup> touchscreen system with SiriusXM<sup>®</sup> Satellite Radio<sup>[5]</sup> • Media hub with MP3 auxiliary jack, 1.5-amp and 2.5-amp USB ports, and SD card slot • Premium 10-speaker Surround Sound Audio System • Premium six-ring instrument panel cluster with full-color 7-inch multiview display • Overhead console with Universal Garage Door Opener • Power sliding rear window

### EXTERIOR

Two-tone paint treatment with lower body and wheel flares in Bright Silver Metallic • Chrome front and rear bumpers • Chrome door handles • Chrome grille surround with chrome wave inserts • Chrome, power heated fold-in sideview mirrors with puddle lamps and turn signal indicators • Premium 70-mm projector headlamps • Premium LED taillamps • Fog lamps • Bed rail caps • Power locking tailgate • 4- and 7-pin trailer wiring harness/connectors • Class V trailer hitch receiver • 17-inch polished aluminum wheels (3500 DRW) • 18-inch polished aluminum wheels (2500/3500 SRW)

**Laramie Longhorn**  
Impressive levels of power and refinement



### 2500

CABS	BEDS	SEATING
Crew Cab	SRW: 6'4" or 8' Box	Bucket Seats

Mega Cab	SRW: 6'4" Box	Bucket Seats

### 3500

CABS	BEDS	SEATING
Crew Cab	SRW: 6'4" or 8' Box	DRW: 8' Box
40/20/40 Bench Seat	Bucket Seats	

Mega Cab	SRW: 6'4" Box	DRW: 6'4" Box
40/20/40 Bench Seat	Bucket Seats	

### MECHANICAL

**2500:** 5.7L HEMI V8 with heavy-duty cooling and 66RFE 6-speed automatic transmission

**3500 SRW:** 5.7L HEMI V8 with heavy-duty cooling and 66RFE 6-speed automatic transmission • 7 x II-inch power-folding trailer tow mirrors

**3500 DRW:** 6.4L HEMI V8 with heavy-duty cooling and 66RFE 6-speed automatic transmission • 7 x II-inch power-folding trailer tow mirrors

**2500/3500:** Tow hooks • ESC<sup>[6]</sup> System • ParkSense Rear Park Assist<sup>[2]</sup> • ParkView Rear Back-Up Camera<sup>[2]</sup> • Electronic part-time transfer case (on 4x4 models) • Electronic trailer brake controller • Remote keyless entry • Security alarm • Remote Start (requires automatic transmission) • 31-gallon fuel tank (6'4" box models) • 32-gallon fuel tank (8' box models)

### INTERIOR

Premium leather front bucket seats • Power driver and front-passenger seats • Heated and ventilated front seats • Full-floor center console with leather console cover • 115-volt power outlet • Premium leather heated 60/40 split-folding rear bench • Carpet floor covering • Premium floor mats with removable inserts • Multistage front air bags<sup>[7]</sup> • Supplemental side-curtain air bags<sup>[7]</sup> • Supplemental front-seat side-mounted air bags<sup>[7]</sup> • Heated leather-wrapped tilt steering wheel with wood accent and audio controls • Automatic headlamps • Automatic Temperature Control (ATC) • Power windows and door locks • Uconnect<sup>®</sup> 8.4AN AM/FM/Bluetooth/NAV/Access<sup>[6]</sup> touchscreen system with SiriusXM Satellite Radio<sup>[5]</sup> SiriusXM Traffic<sup>[5]</sup> and SiriusXM Travel Link<sup>[4]</sup> • Media hub with MP3 auxiliary jack, 1.5-amp and 2.5-amp USB ports, and SD card slot • Premium 10-speaker Surround Sound Audio System • Premium six-ring instrument panel cluster with full-color 7-inch multiview display • Overhead console with Universal Garage Door Opener • Power sliding rear window

### EXTERIOR

Two-tone paint treatment with lower body, wheel flares, front bumper, rear bumper and running boards in White Gold Metallic • Premium 70-mm projector headlamps • Premium LED taillamps • Fog lamps • Chrome grille surround with chrome wave mesh inserts • Chrome, power heated fold-in sideview mirrors with puddle lamps and turn signal indicators • Unique Laramie Longhorn badging • Chrome door handles • Black bed rail caps • Spray-in bedliner • Power locking tailgate • 4- and 7-pin trailer wiring harness/connectors • Class V trailer hitch receiver • 17-inch polished aluminum wheels (3500 DRW) • 18-inch polished aluminum wheels (2500/3500 SRW)

**Laramie Limited**  
A premium all-Black leather interior sets this Ram apart



### 2500

CABS	BEDS	SEATING
Crew Cab	SRW: 6'4" or 8' Box	Bucket Seats

Mega Cab	SRW: 6'4" Box	Bucket Seats

### 3500

CABS	BEDS	SEATING
Crew Cab	SRW: 6'4" or 8' Box	DRW: 8' Box
40/20/40 Bench Seat	Bucket Seats	

Mega Cab	SRW: 6'4" Box	DRW: 6'4" Box
40/20/40 Bench Seat	Bucket Seats	

### MECHANICAL

**2500:** 5.7L HEMI V8 with heavy-duty cooling and 66RFE 6-speed automatic transmission

**3500 SRW:** 5.7L HEMI V8 with heavy-duty cooling and 66RFE 6-speed automatic transmission • 7 x II-inch power-folding trailer tow mirrors

**3500 DRW:** 6.4L HEMI V8 with heavy-duty cooling and 66RFE 6-speed automatic transmission • 7 x II-inch power-folding trailer tow mirrors

**2500/3500:** Tow hooks • ESC<sup>[6]</sup> System • ParkSense Rear Park Assist<sup>[2]</sup> • ParkView Rear Back-Up Camera<sup>[2]</sup> • Electronic part-time transfer case (on 4x4 models) • Electronic trailer brake controller • Remote keyless entry • Security alarm • Remote Start (requires automatic transmission) • 31-gallon fuel tank (6'4" box models) • 32-gallon fuel tank (8' box models)

### INTERIOR

Premium leather front bucket seats • Power driver and front-passenger seats • Heated and ventilated front seats • Full-floor center console with leather console cover • 115-volt power outlet • Premium leather heated 60/40 split-folding rear bench • Carpet floor covering • Premium floor mats with removable inserts • Multistage front air bags<sup>[7]</sup> • Supplemental side-curtain air bags<sup>[7]</sup> • Supplemental front-seat side-mounted air bags<sup>[7]</sup> • Heated leather-wrapped tilt steering wheel with wood accent and audio controls • Automatic headlamps • Automatic Temperature Control (ATC) • Power windows and door locks • Uconnect<sup>®</sup> 8.4AN AM/FM/Bluetooth/NAV/Access<sup>[6]</sup> touchscreen system with SiriusXM Satellite Radio<sup>[5]</sup> SiriusXM Traffic<sup>[5]</sup> and SiriusXM Travel Link<sup>[4]</sup> • Media hub with MP3 auxiliary jack, 1.5-amp and 2.5-amp USB ports, and SD card slot • Premium 10-speaker Surround Sound Audio System • Premium six-ring instrument panel cluster with full-color 7-inch multiview display • Overhead console with Universal Garage Door Opener • Power sliding rear window

### EXTERIOR

Monotone paint treatment • Premium 70-mm projector headlamps • Premium LED taillamps • Fog lamps • Chrome grille surround with chrome wave mesh inserts • Chrome, power heated fold-in sideview mirrors with puddle lamps and turn signal indicators • Unique Laramie Limited badging • Chrome door handles • Black bed rail caps • Spray-in bedliner • Power locking tailgate • RamBox<sup>®</sup> Cargo Management System • 4- and 7-pin trailer wiring harness/connectors • Class V trailer hitch receiver • 17-inch polished aluminum wheels (3500 DRW) • 20-inch painted aluminum wheels with chrome pockets (2500/3500 SRW) • Chrome wheel-to-wheel side steps (SRW) • Chrome cab-length side steps (DRW models)

2500/3500 EXTERIOR COLORS



Black



Black Forest Green Pearl



Bright White



Bright Silver Metallic



Blue Streak Pearl



Deep Cherry Red Crystal Pearl



Flame Red



Maximum Steel Metallic



Granite Crystal Metallic



Prairie Pearl



True Blue Pearl



Western Brown Pearl

Shown in Big Horn trim.



2500/3500 INTERIOR FABRICS



**Vinyl**  
**Diesel Gray**  
Tradesman and Power Wagon® Tradesman



**Ram Work-Grade Vinyl**  
**Diesel Gray**  
Tradesman and Power Wagon Tradesman



**Sedoso/Embossed Cloth**  
**Diesel Gray**  
Tradesman, Power Wagon Tradesman, SLT and Power Wagon



**Sedoso/Embossed Cloth**  
**Canyon Brown**  
SLT and Power Wagon



**Sedoso/Carbide Premium Cloth**  
**Diesel Gray**  
SLT, Big Horn/Lone Star, Outdoorsman and Power Wagon



**Sedoso/Carbide Premium Cloth**  
**Canyon Brown**  
SLT, Big Horn/Lone Star, Outdoorsman and Power Wagon



**Bristol Leather/Perforated Leather Trim**  
**Light Frost Beige**  
Laramie and Power Wagon Laramie



**Bristol Leather/Perforated Leather Trim**  
**Black**  
Laramie and Power Wagon Laramie



**Natura Leather/Perforated Leather with Black Piping and Black Accent Stitching**  
**Cattle Tan**  
Laramie Longhorn



**Natura Leather/Perforated Leather with Dark Saddle Piping and Tan Accent Stitching**  
**Canyon Brown**  
Laramie Longhorn



**Natura Leather with Laser Etching/Perforated Leather with Dark Saddle Piping and Tan Accent Stitching**  
**Canyon Brown**  
Laramie Longhorn



**Natura Leather/Perforated Leather with Medium Gray Stone Piping and Medium Gray Stone Accent Stitching**  
**Black**  
Laramie Limited





# RAM 2500/3500 BUYER'S GUIDE

	TRADESMAN REG./CREW	POWERWAGON TRADESMAN CREW	SRT REG./CREW/MEGA TRADESMAN CREW	BIG HORN / LONG STAR REG./CREW/MEGA	OUTDOORSMAN CREW	POWERWAGON CREW	LARAMIE CREW/MEGA	POWERWAGON LARAMIE CREW	LARAMIE LONGHORN CREW/MEGA	LARAMIE LIMITED CREW/MEGA
	2TA	2TB	2TG	2T7Z1Y	2TT	2TP	2TH	2TJ	2TK	2TM
<b>CPOS PACKAGE</b>										
<b>INTERIOR FEATURES (continued)</b>										
POWER SUNROOF (NOT AVAILABLE WITH REGULAR CAB)	—	—	0	0	0	0	0	0	0	0
SEATS — Manually adjustable driver and front-passenger seat (included with *TX and *V9 seats)	P	P	S	—	—	S	—	—	—	—
— Ten-way power driver's seat and manual front-passenger seat (included with *M9 and *MJ seats)	—	—	P	S	S	P	—	—	—	—
— Ten-way power driver's seat with memory and 6-way power front-passenger seat (included with *VL, *GJ, *XJ and *DJ seats)	—	—	—	—	—	—	S	S	S	S
— Two-way power lumbar support (included with *M9 and *MJ seats)	—	—	P	S	S	P	S	S	S	S
— Heated front seats (included in Comfort Group)	—	—	—	P	P	P	S	S	S	S
— Heated rear seats (Crew Cab and Mega Cab <sup>®</sup> only; included with *GJ seats)	—	—	—	—	—	—	P	—	—	S
— Ventilated front seats	—	—	—	—	—	—	S	S	S	S
— Ram Work-Grade Vinyl	0	0	—	—	—	—	—	—	—	—
STEERING WHEEL — Urethane	S	S	S	—	—	S	—	—	—	—
— Leather-wrapped with audio controls (included in Luxury Group)	—	—	P	S	S	P	—	—	—	—
— Leather-wrapped, heated with audio controls (included in Comfort Group)	—	—	—	P	P	—	S	S	—	—
— Leather-wrapped, heated, with real wood and audio controls	—	—	—	—	—	—	—	S	S	—
STORAGE — Behind the seat (Regular Cab and Mega Cab)	S	—	S	S	S	—	S	S	S	S
— Front center-seat-cushion storage (included in *VL and *M9 seats)	—	—	P	P	P	P	P	P	—	—
— Rear, underseat compartment (Crew Cab only)	S	S	S	S	S	S	S	S	S	S
— Rear, in-floor storage boxes (Crew Cab only)	S	S	S	S	S	S	S	S	S	S
— Flat-folding load floor (Crew Cab only; included in *M9 seats and above)	—	—	P	S	S	P	S	S	S	S
VISORS — Passenger-side, with vanity mirror	—	—	S	S	S	—	—	—	—	—
— Driver and passenger-side, with illuminated vanity mirror (included in Luxury Group)	—	—	P	P	S	P	S	S	S	S
WINDOWS — Manual windows (Regular Cab only)	S	—	—	—	—	—	—	—	—	—
— Power windows, front one-touch down (Regular Cab; included in Power and Remote Entry Group)	P	—	S	—	—	—	—	—	—	—
— Power windows, front one-touch up/down (Crew Cab and Mega Cab)	S	S	S	S	S	S	S	S	S	S
— Rear fixed window	S	S	—	—	—	—	—	—	—	—
— Rear sliding window, manual (Regular Cab)	0	—	S	—	—	—	—	—	—	—
— Rear sliding window, power (Crew Cab and Mega Cab)	—	—	S	S	S	S	S	S	S	S
— Rear window defroster (requires rear sliding window)	—	—	0	0	0	0	0	0	0	0
<b>UCONNECT<sup>®</sup></b>										
CONNECTIVITY — 12-volt DC auxiliary	S	S	S	S	S	S	S	S	S	S
— 115-volt AC auxiliary (included with *M9 and *MJ seats)	—	—	P	S	S	P	S	S	S	S
— 2.5-amp charging USB port (included with Uconnect 5.0, 8.4A and 8.4AN systems, or *M9 and *MJ seats)	P	P	P	P	S	P	S	S	S	S
MEDIA HUB (included with Uconnect 3.0 and 5.0 systems)	S	S	S	S	—	S	—	—	—	—
— 1.5-amp fully functional USB port, auxiliary jack for mobile devices	—	—	P	P	S	P	S	S	S	S
MEDIA HUB (included with Uconnect 8.4A and 8.4AN systems)	—	—	P	P	S	P	S	S	S	S
— 1.5-amp fully functional USB port, auxiliary jack for mobile devices and SD card slot	—	—	P	P	S	P	S	S	S	S
RCALL / ECALL (packaged with Uconnect 8.4A and 8.4AN systems)	0	0	0	0	0	0	0	0	0	0
SINGLE-DISC CD PLAYER	0	0	0	0	0	0	0	0	0	0
SIRIUSXM <sup>®</sup> SATELLITE RADIO <sup>®</sup> (included in Tradesman Popular Equipment Group)	P	P	S	S	S	S	S	S	S	S
SIRIUSXM TRAFFIC <sup>®</sup> and SIRIUSXM TRAVEL LINK <sup>®</sup> (included with Uconnect 8.4AN system)	—	—	—	P	P	P	P	P	P	P
SPEAKER SYSTEMS — Six-speakers	S	S	S	S	S	S	—	—	—	—
— Six premium speakers (Regular Cab only)	—	—	0	—	—	—	—	—	—	—
— Nine amplified speakers with subwoofer (Surround Sound requires ADA and *M9 or higher seat)	—	—	0	0	0	0	S	S	S	S
SYSTEM CONTROLS — Steering wheel-mounted audio controls (included in Luxury Group)	—	—	P	S	S	P	S	S	S	S
UCONNECT SYSTEMS — Uconnect 3.0 AM / FM	S	—	—	—	—	—	—	—	—	—
— Uconnect 5.0 AM / FM / SAT / Bluetooth <sup>®</sup> (5-inch touchscreen display)	0	0	S	S	—	S	—	—	—	—
— Uconnect 8.4A AM / FM / SAT / Bluetooth / Access <sup>®</sup> / NAV-ready (8.4-inch touchscreen display)	—	—	0	0	S	0	S	S	—	—
— Uconnect 8.4AN AM / FM / SAT / Bluetooth / Access <sup>®</sup> / NAV (8.4-inch touchscreen display)	—	—	0	0	0	0	0	S	S	—
UCONNECT VOICE COMMAND <sup>®</sup> (included with Uconnect 5.0, 8.4A and 8.4AN systems)	P	P	S	S	S	S	S	S	S	S
<b>TIRES AND WHEELS</b>										
TIRES — 2500	S	—	—	—	—	—	—	—	—	—
— LT245/70R17E BSW All-Season tires	—	—	—	—	—	—	—	—	—	—
— LT285/70R17E OWL All-Terrain tires	—	S	—	—	—	S	—	—	—	—
— LT275/70R18E BSW All-Season tires (included with Chrome Appearance Group)	P	—	S	S	—	S	—	—	—	—
— LT275/70R18E OWL On- / Off-Road tires (included with Popular Equipment Group)	0	—	P/0	0	S	—	—	—	—	—
— LT285/60R20E OWL On- / Off-Road tires (included with optional 20-inch wheels)	—	—	P	P	P	—	P	—	P	S
— Full-size spare tire	S	S	S	S	S	S	S	S	S	S
— Add full-size spare (requires Box Delete)	0	—	0	0	—	—	—	—	—	—
3500 Single Rear Wheel	S	—	S	S	—	—	S	—	S	—
— LT275/70R18E BSW All-Season tires	—	—	—	—	—	—	—	—	—	—
— LT275/70R18E OWL On- / Off-Road tires (included with Popular Equipment Group)	0	—	P/0	0	—	—	0	—	0	—
— LT285/60R20E OWL On- / Off-Road tires (included with optional 20-inch wheels)	—	—	0	0	—	—	0	—	0	S
3500 Dual Rear Wheel	S	—	S	S	—	—	S	—	S	S
— LT235/80R17E BSW All-Season tires	—	—	—	—	—	—	—	—	—	—
— LT235/80R17E OWL On- / Off-Road tires (included with Popular Equipment Group)	0	—	0/P	0	—	—	0	—	0	0
WHEELS — 2500	S	—	—	—	—	—	—	—	—	—
— 17 x 7.5-inch steel painted	—	—	—	—	—	—	—	—	—	—
— 17 x 8-inch polished forged aluminum	—	S	—	—	—	S	—	S	—	—
— 18 x 8-inch steel painted	0	—	—	—	—	—	—	—	—	—
— 18 x 8-inch steel chrome-clad (included with Chrome Appearance Group)	P	—	S	—	—	—	—	—	—	—
— 18 x 8-inch polished forged aluminum	—	—	0	S	S	—	—	—	—	—
— 18 x 8-inch polished aluminum	—	—	—	—	—	—	S	—	—	—
— 18 x 8-inch polished aluminum with White Gold pockets	—	—	—	—	—	—	—	S	—	—
— 18 x 8-inch polished aluminum with Silver pockets (included with Monotone paint)	—	—	—	—	—	—	—	—	P	—
— 20 x 8-inch aluminum painted Black wheel (included with Black Appearance Group)	—	—	—	P	—	—	P	—	—	—
— 20 x 8-inch aluminum painted Satin Carbon with chrome inserts	—	—	0	0	0	—	0	—	—	S

	TRADESMAN REG./CREW	POWERWAGON TRADESMAN CREW	SRT REG./CREW/MEGA TRADESMAN CREW	BIG HORN / LONG STAR REG./CREW/MEGA	OUTDOORSMAN CREW	POWERWAGON CREW	LARAMIE CREW/MEGA	POWERWAGON LARAMIE CREW	LARAMIE LONGHORN CREW/MEGA	LARAMIE LIMITED CREW/MEGA
	2TA	2TB	2TG	2T7Z1Y	2TT	2TP	2TH	2TJ	2TK	2TM
<b>CPOS PACKAGE</b>										
<b>TIRES AND WHEELS (continued)</b>										
— 20 x 8-inch polished aluminum with White Gold pockets	—	—	—	—	—	—	—	—	—	0
— 20 x 8-inch polished aluminum with Silver pockets (optional with Monotone paint)	—	—	—	—	—	—	—	—	—	0
— Steel spare	S	S	S	S	S	S	S	S	S	S
3500 Single Rear Wheel	S	—	—	—	—	—	—	—	—	—
— 18 x 8-inch steel painted	—	—	—	—	—	—	—	—	—	—
— 18 x 8-inch steel chrome-clad (included in Chrome Appearance Group)	P	—	S	—	—	—	—	—	—	—
— 18 x 8-inch polished forged aluminum	—	—	0	S	—	—	—	—	—	—
— 18 x 8-inch polished aluminum	—	—	—	—	—	—	S	—	—	—
— 18 x 8-inch polished aluminum with White Gold pockets	—	—	—	—	—	—	—	—	S	—
— 18 x 8-inch polished aluminum with Silver pockets (included with Monotone paint)	—	—	—	—	—	—	—	—	—	P
— 20 x 8-inch aluminum painted Black (included with Black Appearance Group)	—	—	—	P	—	—	P	—	—	—
— 20 x 8-inch aluminum painted Satin Carbon with chrome inserts	—	—	0	0	—	—	0	—	—	S
— 20 x 8-inch polished aluminum with White Gold pockets	—	—	—	—	—	—	—	—	—	0
— 20 x 8-inch polished aluminum with Silver pockets (optional with Monotone paint)	—	—	—	—	—	—	—	—	—	0
— Steel spare	S	—	S	S	—	—	S	—	S	S
3500 Dual Rear Wheel	S	—	—	—	—	—	—	—	—	—
— 17 x 6-inch steel painted	—	—	—	—	—	—	—	—	—	—
— 17 x 6-inch steel with chrome finish (included in Chrome Appearance Group)	P	—	S	S	—	—	—	—	—	—
— 17 x 6-inch polished aluminum	—	—	0	0	—	—	S	—	—	S
— 17 x 6-inch polished aluminum with Laramie Longhorn cap	—	—	—	—	—	—	—	—	—	S
— 17-inch steel spare (included with DRW)	S	—	S	S	—	—	S	—	S	S
<b>SAFETY AND SECURITY</b>										
AIR BAGS <sup>(17)</sup> — Multistage front and knee bolster	S	S	S	S	S	S	S	S	S	S
— Supplemental side-curtain	S	S	S	S	S	S	S	S	S	S
— Supplemental front-seat-side-mounted	S	S	S	S	S	S	S	S	S	S
BRAKES — Four-wheel antilock disc brakes	S	S	S	S	S	S	S	S	S	S
CARGO-VIEW CAMERA <sup>(2)</sup> (requires Uconnect 8.4A or 8.4AN systems)	—	—	0	0	0	0	0	0	0	0
ELECTRONIC STABILITY CONTROL <sup>(16)</sup> — Includes Brake Assist, Electronic Roll Mitigation, Hill Start Assist, Rain Brake Support, Ready Alert Braking, All-Speed Traction Control and Trailer Sway Control <sup>(2)</sup>	S	S	S	S	S	S	S	S	S	S
ELECTRONIC TRAILER BRAKE CONTROLLER	0	0	S	S	S	S	S	S	S	S
KEY ALIKE (3500 only; N / A with Keyless Enter 'n Go <sup>™</sup> ; late availability)	0	0	0	0	0	0	0	0	0	0
PARKSENSE <sup>®</sup> REAR PARK ASSIST <sup>(2)</sup>	0	0	0	0	0	0	0	0	0	S
PARKVIEW <sup>®</sup> REAR BACK-UP CAMERA <sup>(2)</sup> — Video displayed in rearview mirror with Uconnect 3.0 system or on-screen with Cargo-View Camera <sup>(2)</sup> with other systems	0	0	0	0	0	0	S	S	S	S
REMOTE KEYLESS ENTRY — Controls for power door locks, tailgate, RamBox <sup>®</sup> System, illuminated entry system, panic alarm (included in Tradesman Popular Equipment or Power and Remote Entry Group)	P	P	S	S	S	S	S	S	S	S
REMOTE START (requires automatic transmission)	—	—	0	S	S	0	0	0	0	S
SECURITY ALARM — Detects break-in	—	—	0	0	0	0	S	S	S	S
SENTRY KEY <sup>®</sup> THEFT-DETERRENT SYSTEM — Engine immobilizer	S	S	S	S	S	S	S	S	S	S
TIRE PRESSURE INFORMATION SYSTEM WITHOUT ALERT (3500 models only)	S	—	S	—	—	—	—	—	—	S
TIRE PRESSURE MONITORING (TPM) with EVIC display and alert (2500 only)	S	S	S	S	S	S	S	S	S	S
<b>PACKAGES / EQUIPMENT GROUPS</b>										
BLACK APPEARANCE GROUP — Includes Black door handles, Black exterior mirrors, Black Ram tailgate badge, Black 4x4 badge (4x4 only), blacked-out projector headlights and LED taillamps, Black painted front and rear bumpers, Black grille and 20-inch Black painted wheels with OWL tires (SRW models only)	—	—	—	0	—	—	—	—	—	—
BOX DELETE — Regular Cab, Crew Cab, with 5.7L gas engine	0	—	0	0	—	—	—	—	—	—
CHROME APPEARANCE GROUP — Includes chrome bumpers, chrome grille surround and steel chrome-clad wheels (SRW) or steel wheels with chrome finish (DRW)	0	—	—	—	—	—	—	—	—	—
CHROME LIMITED APPEARANCE GROUP — Includes chrome bodyside molding, body-color wheel flares and chrome bumpers	—	—	—	—	—	—	—	—	—	0
COLD WEATHER GROUP — Includes engine block heater and winter front grille cover (diesel only)	0	—	0	0	0	—	0	—	0	0
COMFORT GROUP — Includes heated cloth seats and heated leather steering wheel (requires *M9 or *MJ seats; included with Luxury Group); also includes remote start (with automatic transmission) and leather-wrapped steering wheel	—	—	—	0/P	0	—	—	—	—	—
CONVENIENCE GROUP — Auto High-Beam Headlamp Control, rain-sensing wipers (N / A with Cargo-View Camera <sup>(2)</sup> )	—	—	—	—	—	—	0	0	0	0
DOT-CERTIFIED ROADSIDE SAFETY KIT — Includes DOT fire extinguisher, three reflecting triangles, two red vinyl flags and spare fuses	0	0	0							

# LET'S KEEP IT AUTHENTIC.



Ram 3500 Regular Cab Tradesman in Bright White shown with Mopar® Chrome Tubular Side Steps and Gooseneck Trailer Hitch. Properly secure all cargo.

## MOPAR. SUPPORTING YOU AND YOUR RAM—FOR THE LONG HAUL.

Make your new Ram truck the ideal ride—for today, and for years to come.

The Authentic Ram Parts and Accessories by Mopar are engineered by the same experts who designed your Ram, ensuring perfect fit, function and finish. You'll benefit from trained technicians who know your make and model best and use genuine parts to keep your Ram going strong.

Today, Mopar provides more than just Authentic Accessories for your Ram truck. Our all-inclusive advantages encompass Mopar Express Lane Service to minimize waiting and downtime, Mopar Vehicle Protection® Plans (the only extended protection backed by the manufacturer) and our state-of-the-art Mopar Owner Connect Web site: online access to your service records and vehicle information, with exclusive money-saving offers that give you the best from Mopar—for less. In every way, Mopar support is all about keeping you happy, and your Ram truck at its best. For more, visit us at [MOPAR.COM](http://MOPAR.COM)



Hard-Folding Tonneau Cover



Heavy-Duty Commercial Toolbox



Heavy-Duty Splash Guards



Ladder Rack, in Aluminum or Steel



[1] Based on latest available competitive information. Class based on 250/2500 and 350/3500 pickups. [2] Always look before proceeding, electronic drive aid is not a substitute for conscientious driving, always be aware of your surroundings. [3] WiFi subscription required. Vehicle must be registered with Uconnect Access and fulfill minimum subscription requirements. Vehicle must be properly equipped and in active and usable cellular range for WiFi usage. WiFi Hotspot does not enable direct communication between multiple in-vehicle devices. Factors affecting the performance of WiFi Hotspot include: cellular network, signal strength and quality, time of day, number of channels used by the service provider, type of connection, number of clients using WiFi Hotspot and client device. This feature is not intended for use by the driver while the vehicle is in motion. Always drive safely. [4] Requires a mobile phone equipped with the Bluetooth Hands-Free Profile. Visit UconnectPhone.com for system and device compatibility. [5] SiriusXM audio and data services each require a subscription after the trial included with the new vehicle purchase, sold separately or as a package, by Sirius XM Radio Inc. **If you decide to continue service after your trial, the subscription plan you choose will automatically renew thereafter and you will be charged according to your chosen payment method at then-current rates.** Fees and taxes apply. **To cancel you must call SiriusXM at 1-866-635-2349. See SiriusXM Customer Agreement for complete terms at siriusxm.com.** All fees and programming subject to change. [6] Uconnect Access is available only on equipped vehicles purchased within the continental United States and AK. Services can only be used where coverage is available, see coverage map for details. For a complete list of Uconnect Access services, please visit [http://www.driveuconnect.com/features/uconnect\\_access/packages](http://www.driveuconnect.com/features/uconnect_access/packages). Vehicle must be registered for Uconnect Access and fulfill minimum subscription requirements. [7] Your new vehicle may come with an included trial period for use of the Uconnect Access Services. Your trial begins the day you take delivery of your vehicle, so register as soon as possible. To activate the trial, you must register with Uconnect Access. [8] Vehicle must be within the United States, have network coverage and must be registered with Uconnect Access with an active subscription that includes the applicable feature and you must fulfill minimum subscription requirements. It must also be equipped with features that enable remote commands, such as keyless entry, and must be in active and usable cellular range. The Uconnect Access App must be installed and launched on your mobile device to use these remote commands. Remote features are available only on vehicles that are properly equipped. Check state and local laws regarding the use of remote start systems. [9] Voice Text Reply and Voice Texting features require a compatible mobile device enabled with Bluetooth Message Access Profile (MAP). iPhone and some other smartphones do not currently support Bluetooth MAP. Visit UconnectPhone.com for system and device compatibility. Ensure MAP is ON and incoming message notification is enabled. Vehicle must be registered for Uconnect Access and you must fulfill minimum subscription requirements. Also requires the use of a compatible smartphone that supports text messaging and Bluetooth. Visit UconnectPhone.com for system and device compatibility. [10] The 9-1-1 Call button will connect you directly with Emergency Assistance. If you accidentally press the button, you have 10 seconds to cancel the call by either pressing the 9-1-1 button on the rearview mirror or the Cancel button on the Uconnect touchscreen. [11] Provides direct-dial access to Roadside Assistance Service. Vehicle must be within the United States, have network coverage and must be registered with Uconnect Access with an active subscription that includes the applicable feature. Additional roadside assistance charges may apply. Check warranty for details. [12] If you have this feature and have reported your vehicle as stolen to an appropriate law enforcement agency, Uconnect will try to locate your vehicle after receiving proper documents and once law enforcement contacts Uconnect Customer Care. Uconnect may refuse to locate your vehicle if you do not provide the requested information or documents. Always notify law enforcement if your vehicle is stolen and do not attempt to recover it on your own. [13] Vehicle must be registered with Uconnect Access and fulfill minimum subscription requirements. Vehicle must also be properly equipped and in active and usable cellular range. Theft Alarm Notification is only available on factory-installed alarms. [14] The SiriusXM Travel Link data displays and individual product availability vary by vehicle hardware. Not all vehicles or devices are capable of receiving all Travel Link services offered by SiriusXM. Weather Forecast, Current Conditions may not be available in all locations and features of individual systems will vary. Images within are for representative purposes only and are not real products. For actual features and images of real products, consult the vehicle manufacturer. SiriusXM is not responsible for any errors or inaccuracies in the SiriusXM Travel Link services or their use. Our satellite service is available only to those at least 18 and older in the 48 contiguous U.S.A. and DC. Our Sirius satellite service is also available in PR (with coverage limitations). Our Internet radio service is available throughout our satellite service area and in AK and HI. [15] Based on latest available competitive information. Class based on all full-size pickups. [16] No system, no matter how sophisticated, can repeal the laws of physics or overcome careless driving actions. Performance is limited by available traction, which snow, ice and other conditions can affect. When the ESC warning lamp flashes, the driver needs to use less throttle and adapt speed and driving behavior to prevailing road conditions. Always drive carefully, consistent with conditions. Always wear your seat belt. [17] The Advanced Front Air Bags in this vehicle are certified to the new U.S. federal regulations for advanced air bags. Children 12 years old and younger should always ride buckled up in a rear seat. Infants in rear-facing child restraints should never ride in the front seat of a vehicle with a passenger front air bag. All occupants should always wear their lap and shoulder belts properly.

About this catalog: Since the time of printing, some of the information you'll find in this catalog may have been updated. Ask your dealer for details. Some of the equipment shown or described throughout this catalog may be available at extra cost. Specifications, descriptions, illustrative materials and all competitive comparisons contained herein are as accurate as known at the time this publication was approved for printing. Chrysler Group LLC reserves the right to discontinue models at any time or change specifications without notice or without incurring obligation. All options are required in combination with other options. For the price of the model with the equipment you desire, or verification of specifications contained here, see your Ram dealer. Chrysler, Ram, the Ram's Head logo, Active Air, AllSecure, Big Horn, HEMI, Laramie, Laramie Longhorn, Mega Cab, Mopar, the Mopar Owner Connect design, Mopar Vehicle Protection, Outdoorsman, ParkSense, ParkView, Power Wagon, RamBox, Sentry Key, Tradesman and Uconnect are registered trademarks and Active-Level, Articulinik and Keyless Enter 'n Go are trademarks of Chrysler Group LLC. AISIN is a registered trademark of Aisin Seiki Co., Ltd. Cummins is a registered trademark of Cummins, Inc. Goodyear, Wrangler and DuraTrac are registered trademarks of The Goodyear Tire & Rubber Company. All rights reserved. WARN is a registered trademark of Warn Industries, Inc. iPhone is a registered trademark of Apple Inc. Bluetooth is a registered trademark of Bluetooth SIG, Inc. Bilstein is a registered trademark of August-Bilstein GmbH & Co. Sirius, XM and all related marks and logos are trademarks of Sirius XM Radio Inc. Facebook and logo are trademarks of Facebook, Inc. The Twitter logo is a service mark of Twitter, Inc. The YouTube logo is a trademark of Google Inc. Yelp is a registered trademark of Yelp. NASCAR is a registered trademark of the National Association for Stock Car Auto Racing, Inc. Pandora is a registered trademark of Pandora Media, Inc. All rights reserved. iHeartRadio is a registered trademark of Clear Channel Broadcasting, Inc. NFL is a registered trademark of the National Football League. MLB is a registered trademark of Major League Baseball. Bosch is a registered trademark of Robert Bosch GmbH. © 2014 Chrysler Group LLC. All rights reserved.



Join fellow Ram enthusiasts and tell your story by posting comments, participating in discussions and sharing your photos and videos. Join our community on Facebook, follow us on Twitter and check us out on YouTube.

## THE RAM OUTFITTER

Owning a new 2015 Ram Heavy Duty opens up a world of new apparel, tools and a variety of equipment for work and play. The one place to find it all is the Ram Outfitter site.

This is the online shopping center for gear and gifts for the Ram enthusiast. With the Ram identity prominently featured, you can choose from authentic wear, sports equipment, electronics and attire. Log on. It's all at [ramtrucks.com/outfitter](http://ramtrucks.com/outfitter)



# RAMTRUCKS.COM

Ram is a registered trademark of Chrysler Group LLC.

