



canadianavalancheassociation

OBSERVATION GUIDELINES AND RECORDING STANDARDS FOR WEATHER, SNOWPACK AND AVALANCHES

Prepared by:
Canadian Avalanche Association
September 2016

A revision of:
NRCC Technical Memorandum No. 132

OBSERVATION GUIDELINES AND RECORDING STANDARDS FOR WEATHER, SNOWPACK AND AVALANCHES

Prepared by:
Canadian Avalanche Association
www.avalancheassociation.ca
Phone 1 (250) 837-2435
Fax 1 866-366-2094
P.O. Box 2759
Revelstoke, British Columbia V0E 2S0
Canada

Version 6.1
First published 1981
This version published August, 2016

A revision of:
NRCC Technical Memorandum No. 132

©Canadian Avalanche Association, 2016

ISBN 0-9685856-3-9

Canadian Avalanche Association

The Canadian Avalanche Association (CAA) is a non-profit society incorporated in Alberta and British Columbia with its headquarters in Revelstoke, B.C.

No portion of this publication may be reproduced without the express written permission of the CAA. No abridgement of this report may be published without the written authority of the CAA. Extracts may be published for the purposes of review only.

Copyright of this publication belongs to the CAA.

Abstract

The type, techniques and recording format employed when taking observations for operational snow stability assessment and avalanche hazard forecasting are described in this manual. These guidelines and standards cover the weather, characteristics of the snowpack, in-situ strength tests of the snow and occurrences of avalanches.

Definitions for use in technical discussion of snow stability and forms for reporting avalanche accidents and avalanche damage are appended.

Preface

This manual describes the terminology, techniques and data codes recommended by the CAA for taking and recording observations of avalanches, snowpack and mountain weather.

In Canada, avalanche safety programs are integral to public and private sector operations involving highways, railways, parks, forestry, mining, lift-based ski areas, industrial/construction zones, and backcountry recreation involving helicopters, snowcats, snowmobiles, ski touring, snowboarding, ice climbing, mountaineering, snowshoeing, etc. The scale of operations varies widely from highway avalanche safety programs, where many winter staff operate along a well-defined corridor, to that of a commercial guide who meets clients at a trailhead for a day of backcountry travel. This manual describes standard techniques for observations relevant to many avalanche safety programs; however, it does not specify which observations or observation frequencies are relevant to any particular operation. An observer should select the observations that give relevant information to best achieve the objectives outlined in each section. The CAA intends that the enclosed terminology, techniques and data codes facilitate sound record keeping and information exchange between the wide variety of avalanche safety programs in Canada.

Additional observations not described in these guidelines include slope testing using explosives, ski-cutting, snowmobiles or other machines, previous slope use, local wind effects, incoming and outgoing radiation, probing by probe and ski pole, settlement of the snowpack, loading, and non-standard shear and stability tests. Many of these observations have no formal data collection procedures but are carried out as required.

Part 1 describes daily snow and weather observations used for evaluating changes in snow stability. Observations made at a study plot are considered, as well as field observations made over a broader area of terrain. Measurements made to these standards may be reported to the Meteorological Service of Canada (MSC). This section draws on knowledge and guidance from World Meteorological Organization (WMO) standards.

Part 2 describes techniques for snowpack observations, including profile work and snowpack tests. Snow crystal classification and symbols are taken from the *International classification for seasonal snow on the ground* (Fierz et al., 2007), a complete listing of which is given in Appendix D. Guidelines for the interpretation of snow profiles and snowpack tests are not given. For guidance on interpretation, the reader is referred to the CAA Instructor Training Program manuals (Operations Level 1 and Level 2 in particular), as well as Chapters 6, 7 and 8 of *The Avalanche Handbook*, 3rd Edition (McClung and Schaerer, 2006).

Part 3 describes recording standards for avalanche observations. Avalanches that involve people, damage to property, or near misses for either are referred to as incidents. Fatal incidents must be reported in the first instance to the RCMP. Avalanche Canada (formerly the Canadian Avalanche Centre) is responsible for maintaining the database of avalanche incidents in Canada. An avalanche incident report form is given in Appendix B.

Experience has shown that observations are best recorded in a standard surveyor's field-book with waterproof pages and a hard cover. An accurate, complete and legible field-book not only assists the analysis of the data, but could prove to be an important document when questions arise about the cause of avalanches in the event of accidents. In order to assist observers in maintaining good records, examples of field-book notes are included in this document. With the advent of mobile computing, more options for recording field observations are becoming available. It is worth giving careful thought to maintaining a well-organized digital record collection, especially if paper records are being phased out in your operation.

The CAA plans to re-examine this document periodically through a committee appointed for that purpose. Considerations for revisions are:

- omissions
- ambiguities
- significant discrepancies in terms with those of other agencies
- new techniques for accepted observations
- new observations which become accepted for standard use
- clarification of observation techniques and applications

Users are invited to comment and recommend changes at any time.

Comments should be sent to:

Canadian Avalanche Association
PO Box 2759
Revelstoke, B.C.
Canada, V0E 2S0
Phone: (250) 837-2435
Fax: 866-366-2094
Email: ogrs@avalancheassociation.ca

Acknowledgements

In 1981, a dedicated group of researchers and practitioners produced the first edition of these guidelines and standards. The initiative was led by P. Schaerer with major contributions being made by P. Anhorn of the National Research Council, V. G. Schleiss and W. Schleiss of Parks Canada at Rogers Pass, and G. L. Freer of the British Columbia Ministry of Transportation and Highways.

A second edition was published in 1989 after consultation with the guiding industry and ski area operators, Parks Canada and the B.C. Ministry of Transportation. The committee was composed of H. Bleuer, R. McCarthy, W. Schleiss and J. Johnson. P. Schaerer chaired the committee and edited the review.

A third edition was published in 1995. The 1995 revisions were made by a committee selected to represent a broad spectrum of interest in snow safety and the avalanche industry in Western Canada and the Atmospheric Environment Service (AES). The committee was chaired by P. Weir and included P. Amann, R. Atkins, J. R. Bezzola, T. Geldsetzer, B. Jamieson, K. Little, T. Riley, D. Skjonsberg and G. Thompson. The publication and distribution of the 1995 version was made possible with support from the National Search and Rescue Secretariat.

A fourth edition, incorporating suggestions received since 1995 was drafted in 2001 and published in 2002. The revisions were drafted by a committee chaired by D. Kelly. The committee included J. Goodrich, S. Gould, B. Jamieson, T. Riley, R. Whelan, and D. Wilson. The changes were reviewed by D. McClung, B. Sayer and S. Walker. Final revisions were compiled by R. Whelan and B. Strand. Translation into the French language was by M. Deschenes.

Revisions for the fifth edition were made in 2007 and addressed input from the CAA Technical Committee, the Canadian avalanche community as well as international stakeholders. A working group, representing all aspects of the Canadian avalanche community, was chaired by B. Mark and included S. Aitken, R. Atkins, S. Conger, D. Gautier, J. Goodrich, M. Klassen, M. Rubenstein, C. Stethem, I. Storm and S. Walker. The revisions were approved by the CAA Technical Committee, which was chaired by R. Whelan and included B. Jamieson, D. McClung, B. Sayer and D. Wilson. C. Campbell coordinated the revision project and compiled the final revisions.

Revisions for the current (sixth) edition were made in 2014 by the CAA Technical Committee following a period of consultation with CAA members to allow for comments and suggestions. The CAA Technical Committee comprised: C. Campbell, D. McClung, B. Jamieson, B. Sayer, R. Whelan, J. Floyer and S. Garvin. Significant input was provided by P. Haegeli, D. Gauthier, and R. Simenhois. C. Campbell was responsible for coordinating the revision project and compiled the final revisions.

Table of contents

Preface	ii
Acknowledgements	iv

1. Weather and snow observations

1.1 Objectives	1
1.2 Types of observations	1
1.3 Equipment	1
1.4 Procedure	2
1.4.1 Date	2
1.4.2 Time	2
1.4.3 Sky condition	2
1.4.4 Precipitation type and intensity	3
1.4.5 Air temperature	3
1.4.6 Relative humidity (RH)	4
1.4.7 Snow temperatures	4
1.4.8 Depth of snowfall	4
1.4.9 Total depth of snowpack (HS)	5
1.4.10 Mass of new snow	5
1.4.11 Water equivalent of new snow (H2DW or H24W)	6
1.4.12 Density of new snow (ρ)	6
1.4.13 Rain	7
1.4.14 Precipitation	7
1.4.15 Surface penetrability (P)	7
1.4.16 Form and size of surface snow	8
1.4.17 Wind	8
1.4.18 Blowing snow	9
1.4.19 Barometric pressure at station	9
1.5 Field weather observations	12
1.5.1 Objectives	12
1.5.2 Relevant measurements	12
1.5.3 Frequency and location of observations	12
1.5.4 Procedure	12
1.6 Field weather summary	13
1.6.1 Objectives	13
1.6.2 Frequency	14
1.6.3 Procedure	14
1.7 Recording	15

2. Snowpack observations

2.1 Full snow profile	16
2.1.1 Objectives.....	16
2.1.2 Site Location.....	16
2.1.3 Frequency of observations	16
2.1.4 Equipment	16
2.1.5 Field procedure	17
2.1.6 Water equivalent of snow cover (HSW) (<i>optional snow profile calculations</i>).....	22
2.1.7 Average bulk density (<i>optional snow profile calculations</i>)	22
2.1.8 Recording	22
2.2 Test snow profile	23
2.2.1 Objective.....	23
2.2.2 Site Location.....	23
2.2.3 Frequency of observations	24
2.2.4 Relevant measurements.....	24
2.2.5 Equipment	24
2.2.6 Procedure	24
2.2.7 Recording	24
2.3 Fracture line snow profile	25
2.3.1 Objective.....	25
2.3.2 Site Location.....	25
2.3.3 Relevant measurements.....	26
2.3.4 Recording	26
2.4 Ram profile	26
2.4.1 Objective.....	26
2.4.2 Equipment	26
2.4.3 Unit of measurement	26
2.4.4 Procedure	27
2.4.5 Calculation.....	27
2.4.6 Recording	27
2.5 Graphical snow profile presentation	28
2.6 Shear frame test	29
2.6.1 Objective.....	29
2.6.2 Site selection	29
2.6.3 Equipment	29
2.6.4 Procedure	29
2.6.5 Results.....	30
2.6.6 Recording	30
2.6.7 Limitations	30
2.7 Rutschblock test	32
2.7.1 Objective.....	32
2.7.2 Site selection	32
2.7.3 Equipment	32
2.7.4 Procedure	32
2.7.5 Results.....	32
2.7.6 Recording	33
2.7.7 Limitations	33
2.7.8 Test Configuration.....	34

2.8 Shovel shear test	34
2.8.1 Objective.....	34
2.8.2 Site selection	34
2.8.3 Equipment	34
2.8.4 Procedure	35
2.8.5 Results.....	35
2.8.6 Recording	35
2.8.7 Limitations	36
2.8.8 Test Configuration.....	36
2.9 Compression test	36
2.9.1 Objective.....	36
2.9.2 Site selection	36
2.9.3 Equipment	37
2.9.4 Procedure	37
2.9.5 Results.....	37
2.9.6 Recording	37
2.9.7 Limitations	37
2.9.8 Test Configuration	38
2.10 Deep tap test	38
2.10.1 Objective.....	38
2.10.2 Site selection	38
2.10.3 Equipment	38
2.10.4 Procedure	38
2.10.5 Results.....	39
2.10.6 Recording	39
2.10.7 Limitations	39
2.10.8 Test Configuration.....	39
2.11 Extended column test	39
2.11.1 Objective.....	39
2.11.2 Site selection	39
2.11.3 Equipment.....	39
2.11.4 Procedure	40
2.11.5 Results.....	40
2.11.6 Recording	40
2.11.7 Limitations.....	40
2.11.8 Test Configuration.....	41
2.12 Propagation saw test	41
2.12.1 Objective.....	41
2.12.2 Site selection	41
2.12.3 Equipment	41
2.12.4 Procedure	41
2.12.5 Results.....	42
2.12.6 Recording	42
2.12.7 Limitations	42
2.12.8 Test Configuration.....	43
2.13 Fracture character	43
2.13.1 Procedure	43
2.13.2 Observations	44
2.13.3 Recording	44

2.13.4 Examples.....	44
2.14 Snowpack summary	45
2.14.1 Objectives.....	45
2.14.2 Frequency.....	45
2.14.3 Procedure.....	45

3. Avalanche observations

3.1 Objectives	47
3.2 Identification of avalanche paths	47
3.3 Observations of individual avalanches	47
3.3.1 Date	47
3.3.2 Time	47
3.3.3 Area and path	48
3.3.4 Aspect	48
3.3.5 Incline	48
3.3.6 Size.....	48
3.3.7 Type of snow failure.....	49
3.3.8 Liquid water content	49
3.3.9 Terminus	50
3.3.10 Trigger	50
3.3.11 Comments	52
3.4 Additional observations	52
3.4.1 Number of explosive charges/number of detonations	52
3.4.2 Size of explosive charge.....	53
3.4.3 Avalanche starting location.....	53
3.4.4 Bed surface	53
3.4.5 Slab width.....	53
3.4.6 Slab thickness	54
3.4.7 Deposit on road	54
3.4.8 Toe distance mass	54
3.4.9 Total deposit dimensions	54
3.4.10 Elevations	54
3.4.11 Length of path run	54
3.4.12 Road / line status	54
3.5 Multiple avalanche events	57
3.6 Avalanche summary	58
3.6.1 Objectives.....	58
3.6.2 Frequency.....	58
3.6.3 Procedure.....	58
3.7 Recording	59

Appendix A - Weather observation sites and procedures

A.1 Precipitation, snowpack and temperature study plots.....	60
A.2 Wind stations.....	61
A.3 Meteorological instruments procedures (Source: AES MANOBS, 1977).....	61
A.3.1 Reading thermometers.....	61
A.3.2 Resetting maximum and minimum thermometers.....	61
A.3.3 Thermograph procedure and calibration.....	62
A.3.4 Hygrograph calibration.....	62

Appendix B - Reporting avalanche incidents

B.1 Objective.....	63
B.2 Reporting forms.....	63
B.3 Filing of reports.....	63
B.4 Definitions.....	64

Appendix C - International system (SI) of units and expanded equations.....72

C.1 Density.....	72
C.2 Barometric pressure.....	72
C.3 Stress and strength.....	72
C.4 Impact pressures.....	72
C.5 Windspeed.....	73
C.6 Expanded equations.....	73
C.6.1 Water equivalent of new snow (H2DW or H24W).....	73
C.6.2 Density (ρ).....	73
C.6.3 Water equivalent of snow cover (HSW).....	74
C.6.4 Average bulk density.....	74

Appendix D - International classification for seasonal snow on the ground.....75

D.1 Main and sub-classes of grain shapes.....	75
D.2 Colour convention for main morphological grain shape classes.....	84

Appendix E - Canadian Avalanche Association markup language (CAAML).....	85
E.1 Introduction.....	85
E.2 Purpose	85
E.3 Versions.....	85
E.4 Structure (CAAML V5.0).....	85
E.5 Access	86
E.6 Authors	86
E.7 Suggested references	86
Appendix F - Symbols and abbreviations.....	87
Appendix G - Stability, hazard and Risk.....	88
G.1 Stability	88
G.1.1 Definition.....	88
G.1.2 Snow stability rating system	88
G.1.3 Elevation	89
G.1.4 Trend.....	89
G.1.5 Confidence.....	89
G.1.6 Qualifiers.....	89
G.2 Hazard	89
G.2.1 Definition.....	89
G.2.2 Hazard rating system.....	89
G.3 Risk.....	90
G.3.1 Definition.....	90
Appendix H - References.....	91

1. Weather and snow observations

1.1 Objectives

Snow and weather observations represent a series of meteorological and snow surface measurements taken at a properly instrumented study plot (refer to Appendix A). Observational data taken at regular intervals provide the basis for recognizing changes in stability of the snow cover and for reporting the weather to the meteorological office.

In the long term, observations may be used to improve the ability to forecast the avalanche hazard by statistical and numerical techniques, and to increase climatic knowledge of the area. Observations should be complete, accurate, recorded in a uniform manner and made regularly.

1.2 Types of observations

Observations taken at regular daily times are referred to as *standard observations*. *Manual observations* are typically carried out at 0700 and 1600 hours, but the type of operation and availability of observers might necessitate different frequencies and times. If only one standard observation is taken per day, that observation should be made in the morning. Recording instruments (i.e. maximum and minimum thermometers) are reset only when taking a standard observation.

Observations taken between the standard times are referred to as *interval observations*. They are taken when the snow stability is changing rapidly (i.e. during a heavy snowfall). Interval observations may contain a few selected observations or a complete set of observations.

Observations taken at irregular times are referred to as *intermittent observations*. They are appropriate for sites that are visited infrequently; visits will typically be more than 24 hours apart and need not be regular (i.e. in a heli-ski operation). Intermittent observations may contain a few selected observations or a complete set of observations (see Figure 1 for sample of field-book entry).

1.3 Equipment

A study plot usually contains the following equipment:

- Stevenson screen for housing thermometers (height adjustable)
- Maximum thermometer
- Minimum/present thermometer
- Two snow boards (about 40 centimetres (cm) x 40 cm) designated as the 24-hour board and the storm board
- Snow stake, a snow depth marker (graduated in cm), and leveling stick
- Ruler (graduated in cm)
- Snow density cutter and weigh scale (graduated in grams (g)), or precipitation gauge
- Knife or plate for cutting snow samples
- Field-book (water resistant paper)
- Loupe and crystal screen

The following additional equipment is useful:

- Hygrothermograph located in a Stevenson screen
- Recording precipitation gauge or rain gauge
- One to three additional snow boards
- First section of a Ram penetrometer
- Barograph (in the office) or barometer/altimeter
- Anemometer at a separate wind station with radio or cable link to a recording instrument

- Box (shelter) for the equipment
- Small broom
- Snow shovel

1.4 Procedure

Record location and elevation of the study plot at the top of the field-book page, or on the title page. Perform and record observations in the sequence listed below. Wear gloves when touching the instruments.

1.4.1 Date

Record year, month and day, yyyy-mm-dd (e.g. December 5, 2016 is noted as 2016-12-05).

1.4.2 Time

Record time of observation using a 24-hour clock (avoid spaces, colons, etc.).

Use local time (i.e. Pacific or Mountain time, as appropriate). Operations that overlap time zones should standardize to one time (e.g. 5:10 p.m. is noted as 1710).

1.4.3 Sky condition

Classify amount of cloud cover and record it with one of the symbols below.

Class	Symbol	Data code	Definition
Clear	○	CLR	No clouds.
Few	☪	FEW	Few clouds; less than 2/8 of the sky is covered with clouds.
Scattered	☂	SCT	Partially cloudy; 2/8 to 4/8 of the sky is covered with clouds.
Broken	☃	BKN	Cloudy; more than half but not all of the sky is covered with clouds (more than 4/8 but less than 8/8 cover).
Overcast	☄	OVC	The sky is completely covered (8/8 cover).
Obscured	⊗	X	A surface-based layer (i.e. fog) or a non-cloud layer prevents observer from seeing the sky. Unable to determine vertical extent of surface based layer.

Valley fog and valley cloud

Where valley fog or valley cloud exists, estimate the elevation of the bottom and top of the fog layer in metres (m) above sea level. Give the elevation to the nearest 50 m. Data code is VF with bottom and top elevations separated by a hyphen.

Example: Clear sky with valley fog layer between 1050 m and 1200 m is coded as CLR VF 1050-1200.

Thin cloud

The amount of cloud, not the opacity, is the primary classification criterion. Thin cloud has minimal opacity, such that the disk of the sun would still be clearly visible through the clouds if they were between the observer and the sun, and shadows would still be cast on the ground. When the sky condition features a thin *scattered*, *broken* or *overcast* cloud layer then precede the symbol with a dash.

Example: A sky completely covered with thin clouds is coded as — OVC.

1.4.4 Precipitation type and intensity

Note the type and rate of precipitation at the time of observation. Snowfall is recorded in centimetres of snow accumulation per hour. Rainfall is observed in millimetres of rain per hour.

Precipitation type

Symbol and data code	Description
NIL	No precipitation
R	Rain
S	Snow
RS	Mixed rain and snow
G	Graupel and hail
ZR	Freezing rain

Precipitation rate (specify for rain and snow only):

Symbol and data code	Description
<i>Snowfall intensity (this system is open-ended; any appropriate rate may be specified)</i>	
S -1	Snow accumulates at a rate of less than 1 cm per hour.
S1	Snow accumulates at a rate of about 1 cm per hour.
S2	Snow accumulates at a rate of about 2 cm per hour.
S3	Snow accumulates at a rate of about 3 cm per hour.
S10	Snow accumulates at a rate of about 10 cm per hour.
<i>Rainfall intensity</i>	
RV	Very light rain; would not wet or cover a surface regardless of duration.
RL	Light rain; accumulation of up to 2.5 millimetres (mm) of water per hour.
RM	Moderate rain; accumulation of 2.6 to 7.5 mm of water per hour.
RH	Heavy rain; accumulation of more than 7.5 mm of water per hour.

1.4.5 Air temperature

Refer to Appendix A for detailed procedures on the use of thermometers, thermographs and hygrographs. All temperatures are measured in degrees centigrade (°C). Read the maximum thermometer immediately after opening the Stevenson screen. Secondly, read the present temperature from the minimum thermometer. Thirdly, read the minimum temperature from the minimum thermometer.

Note: Read all air temperatures from thermometers to the nearest 0.5 degree.

Read the air temperature from the thermograph and record to the nearest one degree. Use an arrow symbol to record the temperature trend shown on the thermograph over the preceding three hours.

Symbol	Data code	Description
↑	RR	Temperature rising rapidly (> 5 degree increase in past 3 hours).
↗	R	Temperature rising slowly (1 to 5 degree increase in past 3 hours).
→	S	Temperature steady (< 1 degree change in past 3 hours).
↘	F	Temperature falling slowly (1 to 5 degree decrease in past 3 hours).
↓	FR	Temperature falling rapidly (> 5 degree decrease in past 3 hours).

At the end of the temperature observation:

- Remove any snow that might have drifted into or accumulated on top of screen.
- Reset thermometers after standard observations (refer to Appendix A).
- If Stevenson screen is fitted with a height adjustment mechanism ensure that screen base is 1.2 m to 1.4 m above the snow surface.
- Check that the screen door still faces north if any adjustments are made.

1.4.6 Relative humidity (RH)

Read the relative humidity to the nearest one percent (%) from the hygograph.

Note: Hygographs are inaccurate at low temperatures. Furthermore, the accuracy of any mechanical hygograph is unlikely to be better than 5% but trends may be important especially at high RH values. Refer to Appendix A for information on instrument calibration.

Humidity measurements are more relevant from mid-slope or upper-elevation sites than from valley-bottom sites.

1.4.7 Snow temperatures

Snow surface temperature (T₀): Measure snow surface temperature by placing the thermometer on the snow surface and shade the thermometer.

10 cm snow temperature (T₁₀): Insert the thermometer horizontally 10 cm below the snow surface and shade the snow surface above the thermometer.

Allow the thermometer to come to equilibrium and then read the thermometer while the bulb or thermistor is still in the snow. Observe snow temperatures to the nearest fraction of a degree based on the accuracy of the thermometer.

Note: Digital thermometers are preferred as most display in increments of 0.1 degree.

1.4.8 Depth of snowfall

Use a ruler to measure (in cm) the depth of snow accumulated on snow boards. Take measurements in several spots on the board. Calculate the average of the measurements and record to the nearest centimetre. Record “0.1” when the depth is less than 0.5 cm (do not consider surface hoar on the boards as snowfall; clear off hoar layer after observation).

Clear the snow board after sampling the weight of new snow. Redeposit the snow in the depression left by the snow board then reposition the board level with the surrounding snow surface.

Note: Snowfall should be measured on at least two snow boards: the “24-hour” “or “HN24” and the “storm” or “HST” board. Additional snow boards (i.e. interval, twice-a-day, or shoot) may be used as required by the operation.

Board naming conventions

Interval (HIN): An interval board is used to measure the accumulated snow in periods shorter than the time between standard observations. The interval board is cleared at the end of every observation.

24-Hour (HN24): The HN24 board is used to measure snow that has been deposited over a 24-hour period. It is cleared at the end of the morning standard observation. (In earlier editions of these guidelines the HN24 board was called the HN board).

Twice-a-day (H2D): An H2D board is used to measure the depth of snow that has accumulated since the last standard observation. The H2D board is cleared at the end of each standard observation.

Note: If readings are limited to one standard observations taken in the morning then the H2D board is not used.

Storm (HST): Storm snowfall is the depth of snow that has accumulated since the beginning of a storm. The storm board is cleared at the end of a standard observation prior to the next storm and after useful settlement observations have been obtained. The symbol “C” is appended to the recorded data when the storm board is cleared.

Intermittent (HIT): Snow boards may be used at sites that are visited on an occasional basis. Snow that accumulates on the board may result from more than one storm. The intermittent snow board is cleared at the end of each observation.

Shoot board (HSB): The shoot board holds the snow accumulated since the last time avalanches were controlled by explosives. The symbol C is appended to the recorded data when the shoot board is cleared.

1.4.9 Total depth of snowpack (HS)

Observe the total depth of snow cover on the ground by reading the calibrated permanent stake to the nearest centimetre. If necessary, level settling cones, wells, drifts, etc. around the stake.

Note: Snow board and HS values are always measured vertically (i.e. line of plumb).

1.4.10 Mass of new snow

Determine the mass of new snow when the depth is 4 cm or more. With a snow sampling tube, cut a sample of snow vertically from the H2D snow board and weigh it. If only one standard observation is taken each day the sample is taken from the HN24 board. Record the mass of snow in grams.

Take a sample from the interval board for interval observations.

Note: Similar measurements can be taken from other boards.

Make a note of the cross-section area (cm²) of the snow sampling tube at the top of the page or on the title page of the field-book.

1.4.11 Water equivalent of new snow (H2DW or H24W)

Calculate the water equivalent of the new snow as follows: Divide the mass (g) of new snow by the cross-section area of the snow sampling tube (measured in cm²) and multiply by 10 (refer to Appendix C for expanded equations). Record the water equivalent to the tenth of a millimetre.

$$\text{H2DW (mm)} = \frac{\text{Mass of new snow (g)}}{\text{Cross - section area of sampling tube (cm}^2\text{)}} \times 10$$

H2DW is the water equivalent of the snow on the H2D board; *HINW* is the water equivalent on the HIN board, etc.

Note: The water equivalent is the depth of the layer of water that would form if the snow on the board melted. It is equal to the amount of precipitation.

The water equivalent of the new snow can be obtained either by melting a sample of snow and measuring the amount of melt water (i.e. with the aid of the rain gauge) or by weighing a snow sample. Weighing is commonly applied for avalanche operations because of its ease. The simplicity of conversion is an additional advantage as 1 cm³ of water weighs 1 g.

Snow depth must be recorded in centimetres (cm) but water equivalent of snow, as well as rainfall in millimetres (mm).

1.4.12 Density of new snow (ρ)

Density is a measure of *mass* per unit *volume*; density must be expressed in SI units of kg/m³. The Greek symbol rho (ρ) is used to represent density.

Calculate density as follows: Divide the mass (g) of new snow by the sample volume (cm³) and multiply by 1000 to express the result in kilograms per cubic metre (kg/m³). Record as a whole number.

$$\rho \left(\frac{\text{kg}}{\text{m}^3} \right) = \frac{\text{Mass of new snow (g)}}{\text{Sample volume (cm}^3\text{)}} \times 1000$$

Where:

$$\text{Sample volume (cm}^3\text{)} = \left(\frac{\text{Diameter of sampling tube (cm)}}{2} \right)^2 \times \text{Depth of new snow (cm)} \times 3.14$$

Alternatively, if the water equivalent of a snow sample is available, density can be computed as follows: Divide the water equivalent (mm) of the snow on the snow board by the snow height (cm) from that board and multiply by 100. Record as a whole number.

$$\rho \left(\frac{\text{kg}}{\text{m}^3} \right) = \frac{\text{Water equivalent of snow sample (mm)}}{\text{Height of snow sample (cm)}} \times 100$$

For measurements from standard observations:

$$\rho \left(\frac{\text{kg}}{\text{m}^3} \right) = \frac{\text{H2DW (mm)}}{\text{H2D (cm)}} \times 100$$

1.4.13 Rain

Measure the amount of rain that has accumulated in the rain gauge in millimetres and tenths. Empty the gauge at each standard observation.

Note: A manual rain gauge should be placed on the ground or on the snow surface when rainfall is likely to occur.

1.4.14 Precipitation

Record the amount of precipitation accumulated in the recording precipitation gauge to the nearest millimetre.

Note: Precipitation gauges collect snowfall, rainfall and other forms of precipitation and continuously record their water equivalent.

The amount of precipitation that has fallen into the gauge since the last observation is the difference between the present reading and the previous reading.

1.4.15 Surface penetrability (P)

An indication of the snowpack's ability to support a given load can be gained by the following three tests. Note that Ram penetration is the preferred method of observation of penetrability because it produces more consistent results than ski or foot penetration.

Ram penetration (PR)

Let the first section of a standard Ram penetrometer (cone diameter 40 mm, apex angle 60° and mass 1 kg) penetrate the snow slowly under its own weight. Do not allow the Ram penetrometer to accelerate. Read the depth of penetration in centimetres.

Foot penetration (PF)

Step into undisturbed snow and gently put full body weight on one foot. Measure the depth of the footprint to the nearest centimetre from 0 to 5 cm and thereafter, to the nearest increment of 5 cm.

Note: The footprint depth varies between observers. It is recommended that all observers working on the same program compare their foot penetration. Observers who consistently produce penetrations more than 10 cm above or below the average should not record foot penetrations.

Ski penetration (PS)

Step into undisturbed snow and gently put full body weight on one ski. Measure the depth of the ski track to the nearest centimetre.

1.4.16 Form and size of surface snow

Record the form and size in millimetres of snow grains at the surface using Appendix D.

Note: Experienced observers may use the sub-classes for precipitation particles and surface deposits and crusts (Appendix D).

1.4.17 Wind

Observe and record the wind direction and speed in the vicinity of the observation plot.

Distinguish between *estimates* and *measurements* of wind. Measurements are made with an instrument located at a fixed point. Estimates are made without instruments but typically represent wind in a local area rather than at a fixed point.

Wind observations (speed and direction) should be averaged over a two-minute period prior to the observation.

Wind speed

The Canadian standard for measuring and coding wind speed is kilometres per hour (km/h).

Note: The SI unit for wind speed is metres per second (m/s). Refer to Appendix A of The Avalanche Handbook, 3rd Edition, McClung and Schaerer (2006), for a discussion of SI units.

Estimate the wind speed by observing the motion of trees, flags and snow.

Class	Symbol and data code	Equivalent measured wind speed		Typical visual indicator
		(km/h)	(m/s)	
Calm	C	0	0	No air motion; smoke rises vertically.
Light	L	1-25	1-7	Light to gentle breeze; flags and twigs in motion.
Moderate	M	26-40	8-11	Fresh breeze; small trees sway, flags stretched and snow begins to drift.
Strong	S	41-60	12-17	Strong breeze; whole trees in motion and snow drifting.
Extreme	X	> 60	> 17	Gale force or higher; difficulty in walking and slight to considerable structural damage occurs.

Note: The indicators used to estimate wind speed are established by rule of thumb. Observers should develop their own relationships specific to their area.

Note the occurrence of severe gusts in *Comments*.

Wind direction

Meteorological standards require that measured wind direction data from all sites including automatic stations be rounded to the nearest 10 degrees. (i.e. 184 degrees is coded as 180). Forty-five degrees is coded as 050.

Estimate the direction from which the wind blows at the site with respect to the eight cardinal points of the compass.

If the wind direction is erratic, record as Variable (VAR).

Do not record a direction when the wind speed is 0 km/h or calm.

1.4.18 Blowing snow

Estimate the current extent of blowing snow, or wind transported snow, and note the direction, to the closest cardinal point of the compass, from which the snow is blowing.

Extent of blowing snow

Class	Symbol and data code	Typical visual indicator	Typical threshold wind speed
Nil	Nil	No evidence of blowing snow.	Calm
Light	L	Limited and localized blowing snow; snow is transported in rolling and saltation modes.	Light
Moderate	M	Windward erosion and leeward deposition of blowing snow; snow is transported in saltation and turbulent suspension modes; visibility becomes obscured.	Moderate
Intense	I	Widespread scouring; extensive downwind transport of snow in turbulent suspension mode; highly variable deposition.	Strong

1.4.19 Barometric pressure at station

The SI unit of kilopascal (kPa) is used for reporting pressure; specify to two decimal places.

A variety of instruments including barographs, barometers, altimeters and electronic sensors can be used to obtain a measure of the barometric pressure. Measurement units vary between hectopascal, kilopascal, millibars, millimetres and inches of mercury depending on instrument (refer to Appendix C for multipliers used to convert to kPa).

Absolute pressures and trend are valuable for weather forecasting while trend alone is often sufficient in avalanche operations.

Pressure tendency

Use an arrow symbol to record the pressure tendency as indicated by the change of pressure in the three hours preceding the observation.

Record the change in barometric pressure in the past three hours.

Symbol	Data code	Description
↑	RR	Barometric pressure rising rapidly (> 0.2 kPa rise per hour).
↗	R	Barometric pressure rising (< 0.2 kPa rise per hour).
→	S	Barometric pressure steady (< 0.1 kPa change in 3 hours).
↘	F	Barometric pressure falling (< 0.2 kPa fall per hour).
↓	FR	Barometric pressure falling rapidly (> 0.2 kPa fall per hour).

Relative pressure

Classify the level of pressure as “high”, “medium”, or “low” when the units of pressure are uncertain or imprecise.

Symbol and data code	Description
H	Barometric pressure high
M	Barometric pressure medium
L	Barometric pressure low

Weather plot observations						
Sampling tube area 42 cm ²	Shear frame area 100 cm ²					
Location	Snowbound Camp, Elevation: 1650 m					
Observer	<i>R.M.</i>	<i>R.M.</i>	<i>K.E.L.</i>	<i>K.E.L.</i>	<i>K.E.L.</i>	<i>K.E.L.</i>
Date	2016-02-09	2016-02-09	2016-02-10	2016-02-10	2016-02-10	2016-02-10
Time, type (Std, Int)	0700, Std	1600, Std	0700, Std	1140, Int	1600, Std	0700, Std
Sky	○	⊗	- ⊕	⊕	⊕	○
Precipitation rate	<i>Nil</i>	<i>S-1</i>	<i>S1</i>	<i>S3</i>	<i>RL</i>	<i>Nil</i>
Maximum temperature (°C)	-2.5	-3.0	-3.0	-1.5	1.0	0.0
Minimum temperature (°C)	-7.0	-6.0	-4.5	-4.0	-4.0	-11.0
Present temperature (°C)	-6.5	-3.0	-4.0	-1.5	0.0	-10.0
Thermograph (°C)	-7	-3	-4	-1	-0	-10
Thermograph trend	↗	→	↗	↗	→	↘
10-cm snow temperature (°C)	-11.2	-7.0	-5.0	-4.0	-3.0	-7.0
Relative humidity (%)	78	86	96	98	100	67
Interval (cm) HIN	0	0.1	10	12	4	0
Standard (cm) H2D	0	0.1	10	12	15	0
New (cm) HN24	0	0.1	10	12	15	14
Storm (cm) (C = cleared) HST	0	0.1	10	20	21	19, C
Snowpack (cm) HS	223	222	231	239	241	239
Weight new (g)	~	~	33.6	42	67	~
Water equivalent (mm)	~	~	8.0	10.0	16.0	~
Density (kg/m ³)	~	~	80	83	106	~
Rain gauge (mm)	~	~	~	~	3.0	~
Precipitation gauge (mm)	60	60	67	77	82	82
Foot penetration (cm)	35	35	45	50	50	45
Ram penetration (cm)	40	39	47	55	55	48
Surface form, size (mm)	~	<i>PP, 0.3</i>	<i>PP, 0.3</i>	<i>PP, 0.3</i>	<i>DF, 0.3</i>	<i>DF, 0.3</i>
Wind speed, direction	<i>L, E</i>	<i>Calm</i>	<i>M, SE</i>	<i>L, S</i>	<i>L, SW</i>	<i>M, E</i>
Blowing snow extent, direction	<i>Nil</i>	<i>Nil</i>	<i>M, SE</i>	<i>L, S</i>	<i>Nil</i>	<i>U</i>
Barometric pressure (kPa)	85.2	84.7	81.7	81.3	83.3	84.3
Pressure tendency	↘	↘	↓	→	↗	→
Shear depth 1 (cm)	~	~	14	24	15	~
Shear weight (g)	~	~	50.6	92	118	~
Shear force (g)	~	~	90	190	400	~
Shear depth 2 (cm)	~	~	30	40	~	~
Shear weight (g)	~	~	94.1	136	~	~
Shear force (g)	~	~	245	540	~	~
Comments	~	~	~	~	<i>Rain gauge frozen</i>	~

Figure 1 Field-book sample.

1.5 Field weather observations

1.5.1 Objectives

Avalanche workers in the field often observe local weather conditions during their daily operations. These observations are an important tool in helping evaluate slope-specific snow stability and avalanche hazard to ensure the safety of the party. In addition, when factored together with other field and study plot observations, field weather observations may be incorporated into a stability and hazard analysis and forecast for the operational region.

1.5.2 Relevant measurements

It is not necessary to measure every variable when undertaking field weather observations. No fixed rule applies about the type and amount of information to be collected. An observer should select the observations that give significant information to achieve the objectives outlined above.

1.5.3 Frequency and location of observations

There is no rule regarding the frequency of field weather observations. The number of readings should be adequate to achieve the objectives outlined above. Experienced workers will often make a field weather observation when they first embark on their field trip, when they arrive at a high or a low point for the day, when they change aspect, at midday, or when the weather conditions are changing.

1.5.4 Procedure

The following are guidelines for the type of observations that may be recorded during a field weather observation.

Date and time

Record date and time as outlined in Section 1.4.

Location

Record the location using latitude and longitude, grid reference, named feature or a short description of the spot.

Elevation

Measure or estimate the elevation in metres.

Sky condition

Classify the amount of cloud cover and measure or estimate the elevation of valley fog as outlined in Section 1.4.3.

If both bottom and top of the valley fog was observed within a few minutes of each other (during a helicopter flight or while skiing downhill), record both the elevations of the valley fog as well as the sky cover (i.e. valley fog between 1200 m and 1750 m with scattered clouds above is recorded as SCT VF 1200 - 1750). If not all of these conditions could be observed, record the ones that were and use a tilde (~) for the others (i.e. if the bottom elevation is 1200 m but the field teams did not get above the valley fog to observe the top elevation or sky condition, record as ~ VF 1200 - ~).

Precipitation type and intensity

Estimate the type and rate of precipitation as outlined in Section 1.4.4.

Air temperature

Observe the air temperature in the shade about 1.5 m above the snow surface. Use a dry thermometer, read after about five minutes, wait another minute and read again. Record the temperature if there is no change between the two readings. Observe the air temperature to the nearest 0.1 or 0.5 of a degree (C) based on the scale increment (analog or digital) of the thermometer.

Depth of interval snow (HIN)

Estimate the amount of snow that has fallen since the most recent field weather observation.

Depth of storm snow (HST)

Estimate the amount of snow that has fallen during a period specified in hours (i.e. 56 cm in the past 36 hours).

Total depth of snowpack (HS)

Estimate the depth of the snowpack. Probing several spots is useful in determining an average depth in the immediate area.

Surface grain form and size

Record the surface grain form and size either as an estimate or measured as per Section 1.4.16.

Wind speed and direction

Estimate wind speed and direction as shown in Section 1.4.17.

Blowing snow

Estimate the extent and direction of previous and current blowing snow as outlined in Section 1.4.18.

Comments

Make any additional comments or observations as required. These may include foot penetration, ski penetration, intensity of valley fog, etc.

1.6 Field weather summary

1.6.1 Objectives

Field weather summaries are used to create a clear and concise picture of which weather conditions encountered in the field are relevant to creating a final stability and hazard analysis and forecast for the operational region. The objective of such a summary is to filter out the extraneous data that is not required for this decision-making.

Field weather summary parameters are different from field weather observation parameters in that they are not recorded at a specific location and time but are a general summary of the range of conditions encountered in a broader geographical area during the field day.

1.6.2 Frequency

Summaries are generally done once a day, after the field day is completed.

1.6.3 Procedure

The parameters to be recorded in a field weather summary are as follows:

Date

Record the date as described in Section 1.4.1.

Time period

The time range during which field weather observations were made.

Locations and elevation range

The locations and elevation range where field weather observations were made. Many operations will record a drainage as a single location.

Percent of area observed

The area observed recorded as a percentage of the entire operational region.

Sky condition

The average amount of cloud cover and the average top and bottom elevations of valley fog.

Precipitation type and intensity

The average precipitation type and intensity encountered.

High and low temperature

Record the high and low temperatures observed.

Field HN24

The estimated average amount of snow that fell during the 24-hour period ending at the finish of the field day.

Field HST

The estimated average amount of snow that fell during a period specified in hours as described in Section 1.5.4.

Field HS

The average depth of snow on the ground. If the depth is highly variable throughout the area observed, indicate for which areas the depth is representative.

Surface form and size

The average surface condition encountered or distribution of surface form if variable throughout the area observed.

Wind speed and direction

The average estimated wind speed and direction.

Blowing snow

The average estimated extent and direction of blowing snow.

Comments

Make any additional comments as required. These may include notes on foot penetration, ski penetration, intensity of valley fog, signs of previous blowing snow, etc.

1.7 Recording

Always record the names (initials are fine) of observers with the primary observer listed first. Use a tilde (~) in the notebook when no observation was made. Code as “U” if the observation was attempted but no reliable value could be ascertained (i.e. when blowing snow cannot be observed due to darkness, cloud or fog). Do not leave blanks. Only write “0” when the reading is zero (i.e. when no new snow has accumulated on the new snow board).

2. Snowpack observations

2.1 Full snow profile

A full snow profile is a multi-observation record of snow-cover stratigraphy including characteristics of individual layers and layer interfaces.

2.1.1 Objectives

The objectives of observing full snow profiles in avalanche work are:

- To identify the weak and strong layers that make up the snowpack.
- To identify weak interfaces between layers and to determine their relative strength.
- To observe snow temperatures.
- To monitor and confirm changes in the condition, stratigraphy, temperature and stability of the snowpack.
- To determine the thickness of a potential slab avalanche.
- To determine the state of metamorphism of the snow.

Generally, full snow profiles are observed to gather class II information about the snow cover. In addition, the information can be used for climatological studies, forecasts of snow melt runoff, and studies of the effect of snow on vegetation, wildlife and structures.

2.1.2 Site Selection

Study Plot

Full snow profile observations are carried out at study plots (refer to Appendix A) by excavating each snow pit progressively in undisturbed snow. Excavation is parallel to a line marked with two poles indicating the extreme edge of previous pit disturbance and at a distance into the undisturbed area about equal to the snow depth, but at least 1 m from the previous one. After each observation, the extreme edge of the pit is marked with a pole to indicate where to dig the next pit (i.e. at least 1 m from that point).

The snow profile observation line and area should be selected and marked before the winter, and the ground between the marker poles cleared of brush and large rocks.

On Slope

The best information with respect to snow stability is obtained from snow profiles taken at avalanche starting zones. Since starting zones are not always accessible, other slopes should be selected provided that they are undisturbed, safe and representative of the conditions in starting zones. These study slopes may be pre-selected and marked in the same manner as study plots; however, marker poles on slopes will be tilted by snow creep and may have to be periodically reset. A full profile can be at a targeted site selected to satisfy a particular observation objective.

2.1.3 Frequency of observations

No firm rules can be set on how frequently snow profiles should be observed. Frequency is dependent on climate, terrain and type of avalanche operation. Usually profiles are observed at regular intervals and whenever changes in snow conditions are suspected.

2.1.4 Equipment

Recommended equipment for snow profiles:

- Collapsible probe
- Snow shovel

- Snow thermometer
- Ruler (graduated in cm)
- Loupe or magnifying glass (10x to 20x magnification)
- Crystal screen
- Snow density cutter and appropriate scale
- Field-book
- Pencil
- Gloves
- Compass
- Altimeter
- Inclinator
- Any additional equipment required for snowpack tests (i.e. a snow saw)

Additional useful equipment for snow profiles:

- Brush
- Spare thermometer
- Extra pencil
- Camera
- Global positioning system (GPS) receiver
- Calculator
- Safety belay rope (see *The Avalanche Handbook, 3rd Edition*)

Thermometers should be calibrated periodically in a snow-water mixture. Glass thermometers must be checked for breaks in the mercury or alcohol columns before every use.

Field-book should be prepared (record labels and column headings) before the observer goes to the observation site.

2.1.5 Field procedure

Equipment

Keep all observation equipment in the shade.

Wear gloves when handling the instruments.

Checking snow depth

Unless the profile is observed on a study plot, check the snow depth with a probe before digging the observation pit; make sure the pit is not on top of a boulder, bush or in a depression. Feel the hardness of the snow with the probe and obtain a first indication of weak or stiff stratigraphy.

Digging the pit

Make the hole wide enough to allow for multiple observations and to allow shoveling at the bottom. In snow deeper than 2 m it is advantageous to dig first to a depth of about 1.5 m, make the observations, then complete the excavations and observation to the necessary depth. Pile extracted snow such that the undisturbed region remains so. Exercise caution in piling debris so it does not reflect solar radiation into the observation pit (particularly in the later part of the season). The pit face on which the snow is to be observed must be in the shade. Cut the observation face and an adjacent side vertical and smooth. On inclined terrain it is advantageous to make the observations on a face parallel to fall line.

While the first observer prepares the pit, the second observer begins observations.

Date and time

Record date and time.

Location

Record location, elevation, aspect and slope inclination.

Weather observations

Observe air temperature, sky condition, precipitation and wind as described in Section 1.5.4.

Observe surface penetrability as described in 1.4.15.

Snowpack temperature (T)

Observe snow temperatures to the nearest 0.1 or 0.5 of a degree (C) based on the scale increment (analog or digital) of the thermometer.

Measure snow surface temperature by placing the thermometer on the snow surface and shade the thermometer.

Push the thermometer horizontally to its full length parallel to the surface into the snow (use the shaded side-wall of the pit on a slope). Wait at least one minute, then read with the bulb/tip still in the snow. When making measurements within the top 30 cm of the snowpack, shade the snow surface above the thermometer in order to reduce influence of radiation.

Measure the first sub-surface snow temperature 10 cm below the surface. The second temperature is observed at the next multiple of 10 cm from the previous measurement, and from there in intervals of 10 cm to a depth of 1.4 m below the surface, and at 20 cm intervals below 1.4 m. Closer measurements can be made when the temperatures are near to 0 °C or when gradients are strong.

Begin the next observation while snow temperatures are being measured.

Note: Compare thermometers first when two or more are used simultaneously. Multiple thermometers should be of identical style only.

Punch a hole in the snowpack with the metal case or a knife before inserting the thermometer into very hard snow and at ground surface.

It is important to regularly (semi-monthly) check the accuracy of all thermometers by immersing them in a mixture of water and ice slush; each should read 0.0 °C. If possible, recalibrate or note variation from 0.0 °C on the thermometer.

Layer boundaries (H)

Determine the location of each major layer boundary using a combination of visual and tactile techniques. Determine weak layers or interfaces of layers where failure might occur. In the field-book record layer boundaries by their distance from the ground or snow surface (Figure 2).

Note: When using a brush to highlight layering, it is suggested that a repeatable and reproducible method will provide consistent and satisfactory results.

Layer dating

Layers that are significant or used in referencing specific surface conditions of formation can be named by the date the layer was buried. This is most commonly done regarding rain crusts or surface hoar.

Snow hardness (R)

Observe the relative hardness of each layer with the hand test. Record the object that can be pushed into the snow with moderate effort parallel to the layer boundaries.

Data code	Hand test	Term	Symbol
F	Fist in glove	Very low	None
4F	Four fingers in glove	Low	/
1F	One finger in glove	Medium	X
P	Blunt end of pencil	High	//
K	Knife blade	Very high	✕
I	Too hard to insert knife	Ice	—

Note: In Canadian practice, the maximum force required to push the described object into the snow is 10 to 15 Newtons (1 to 1.5 kg-force), which contrasts with the 50 Newton (5 kg) force specified in Fierz, et al., in press. Gloves are worn when this test is undertaken.

Slight variations in hand hardness can be recorded using + and - qualifiers (i.e. P+, P, P-). A value of 4F+ is less hard than 1F-.

Grain form (F)

Appendix D presents the classification scheme which is used in this document. The more detailed subclass scheme from the classification should, in general, only be used by experienced observers (refer to Appendix D).

Note: Use 10x to 20x hand lens; lower power does not provide adequate resolution for shape and higher power does not provide adequate field of view for bond identification.

Any basic group may be sub-classified into different forms of solid precipitation according to Appendix D.

In warm weather the crystals may melt and their shape may change rapidly on the crystal screen. In this case, a quick decision must be made and repeated samples taken from various depths of the same layer.

*Note: The use of a subscript “r” modifier is retained to denote rimed grains in the Precipitation Particles (PP) class and its subclasses except for **gp**, **hl** and **ip** and all of Decomposing and Fragmented Particles (DF) class.*

Snow layers often contain crystals in different stages of metamorphism. The classification should refer to the predominant type, but may be mixed when different types are present in about equal numbers. A maximum of two grain forms, primary and secondary, may be displayed for any single layer with the secondary grain form recorded in parenthesis.

(Illustrations and photographs of various grain forms may be found in the following publications: LaChapelle, 1969; Perla, 1978; Fierz, et al., in press; McClung and Schaerer, 2006.)

Grain size (E)

Determine the grain size in each layer with the aid of the screen. In doing so, disregard small particles and determine the average greatest extension of the grains that make up the bulk of the snow. Record the size or range of sizes in millimetres. Record size to the nearest 0.5 mm except for fine and very fine grains which may be recorded as 0.1, 0.3 or 0.5 mm.

Where two distinct grain forms exist in a layer, record the size of the secondary grain form in parenthesis. Example: 0.3 (2.5).

Where a range in sizes exist for any single grain form, specify the minimum and maximum size separated by a hyphen. Example: 0.5-1.5.

Both notations may be mixed. Example: 0.5-1.0 (2.5).

The following table contains terms that can be used to describe grain size. These terms should not be used in field notebooks. Always document grain size with digits.

Term	Size (mm)
Very fine	< 0.2
Fine	0.2 to 0.5
Medium	0.5 to 1.0
Coarse	1.0 to 2.0
Very coarse	2.0 to 5.0
Extreme	> 5.0

Liquid water content (θ)

Classify liquid water content by volume of each snow layer that has a temperature 0 °C. Gently squeeze a sample of snow and observe the reaction.

Class	Definition	Water content (by volume)	Symbol	Data code
Dry	Usually the snow temperature (T) is below 0 °C, but dry snow can occur at any temperature up to 0 °C. Disaggregated snow grains have little tendency to adhere to each other when pressed together, as in making a snowball.	0 %	None	D
Moist	T = 0 °C. Water is not visible even at 10x magnification. When lightly crushed, the snow has a distinct tendency to stick together.	< 3 %		M
Wet	T = 0 °C. Water can be recognized at 10x magnification by its meniscus between adjacent snow grains, but water cannot be pressed out by moderately squeezing the snow in the hands (pendular regime).	3 - 8 %		W
Very wet	T = 0 °C. Water can be pressed out by moderately squeezing the snow in the hands, but there is an amount of air confined within the pores (funicular regime).	8 - 15 %		V
Slush	T = 0 °C. The snow is flooded with water and contains a relatively small amount of air.	> 15 %		S

Note: In alpine snow measurable liquid water is present only when the snow temperature is zero degrees centigrade.

Density (ρ)

Measure density of the snow in layers that are thick enough to allow insertion of the snow density cutter. Accuracy of density measurements relies in part on the orientation of the cutter when it is inserted. Tube- or box-shaped cutters should be used for thin layers in the method described below.

Sample densities from the pit face when working on flat terrain and from the pit sidewall when on an incline. Insert box or large (500 cm³) tube-shaped cutters horizontally. Insert wedge and small (100 cm³) tube shaped cutters with the long axis vertical (i.e. the opening of the tube facing down or the bottom of the wedge cutter vertical). Do this perpendicular to the layering when on an incline. When inserting a tube shaped cutter vertically, clear the snow from above the sample area and place a flat cutter or crystal screen at the depth equal to the long axis dimension. Trim the ends, remove excess external snow, and weigh. Volume of thin layers that do not fill the tube cutter can be calculated in the same manner as using a tube for new snow density (area of tube opening, pi times the radius squared, times the layer thickness).

Record weight under *Comments* and calculate density. Record cutter volume under *Comments*. Take an appropriate number of samples in thicker layers to provide an average density.

Calculate density as follows: Divide weight (g) of snow sample by sample volume (cm³) and multiply by 1000 to express result in kg/m³.

$$\rho \left(\frac{\text{kg}}{\text{m}^3} \right) = \frac{\text{Mass of snow sample (g)}}{\text{Sample volume (cm}^3)} \times 1000$$

Where:

$$\text{Sample volume (cm}^3\text{)} = \left(\frac{\text{Diameter of cutter (cm)}}{2} \right)^2 \times \text{Length of cutter (cm)} \times 3.14$$

Note: When multiple samples within one layer are averaged, the resulting value is described as average layer density.

Density measurements that include more than one layer are described as bulk density.

When using a 500 cm³ density cutter use the following calculation: Multiply net weight of snow in the cutter by 2. Multiply by 5 for a 200 cm³ and 10 for a 100 cm³ cutter.

Strength and stability tests

Perform tests of strength and stability as appropriate for slope angle of profile. See Sections 2.6 to 2.10 for test descriptions. Record under *Comments*.

Marking the site

Fill the pit and place a marker pole at the extreme edge if you plan to undertake further studies at that site.

2.1.6 Water equivalent of snow cover (HSW) (optional snow profile calculations)

The water equivalent is the vertical depth of the water layer which would form if the snow cover was melted. Information about water equivalent is needed for certain applications.

Water equivalent of the snowpack (mm) can be approximated from the density of the layers as follows: Multiply the thickness (cm) of each layer by its density (kg/m³) and sum the products over the full depth of the snow.

$$\text{HSW (mm)} = \sum \left[\text{Vertical thickness (cm)} \times \text{Density} \left(\frac{\text{kg}}{\text{m}^3} \right) \right] \times 0.01$$

2.1.7 Average bulk density (optional snow profile calculations)

Calculate average bulk density as follows: Divide water equivalent of snow cover (mm) by total snowpack depth (cm) and multiply by 100.

$$\bar{\rho} \left(\frac{\text{kg}}{\text{m}^3} \right) = \frac{\text{Water equivalent of snow cover (mm)}}{\text{Total snowpack depth (cm)}} \times 100$$

2.1.8 Recording

Always record the names (initials are fine) of observers with the primary observer listed first. Use a tilde (~) in the notebook when no observation was made. Code as “U” if the observation was attempted but no reliable value could be ascertained (i.e. when blowing snow cannot be observed due to darkness, cloud or fog). Do not leave blanks. Only write “0” when the reading is zero (i.e. the incline when the profile is performed at a level site).

Snow profile Organization <i>Heliguides Inc.</i>						Observer <i>P.M., A. LeB.</i>	Type <i>Full</i>	
Date <i>2016-03-28</i>			Time <i>1420</i>			Sky \oplus	Wind <i>Mod, SE</i>	
Location <i>Mary Lake</i>			Elevation <i>1810 m</i>			Precip <i>S-1</i>	Air Temp <i>-2.0</i>	
Aspect <i>W</i>			Incline <i>10°</i>			Foot Pen <i>75 cm</i>	Surface <i>-2.5</i>	
H (cm)	R	F	E(mm)	θ	ρ (kg/m ³)	Comments / Shears	H (cm)	T (°C)
138		+	1	~	~		128	-0.5
	F	+	1	dry	80		120	0
130							110	0
	F	/	0.5	moist	160		100	-1.0
112						<i>RB3 (MB) up 112 on sd</i>	90	-2.0
	4F	/●	0.3-0.5	dry	220		80	-4.0
80							70	-5.5
	F	V	4	~	~		60	-5.0
78						<i>STE (SP) up 78 on SH 4.0 Mar 14</i>	50	-4.0
	1F	□●	0.5	~	260		40	-3.0
45							30	-2.5
	I	-	~	~	~	<i>ice layer</i>	20	-2.0
44							10	-1.0
	K	=	1-2	~	~	<i>rain crust</i>	0	0
35								
	P	□	1	~	330			
18								
	1F	^	3-5	dry	290	<i>partially rounded</i>		
0								

Figure 2 Sample field-book page for snow profile observations.

2.2 Test snow profile

Snow profiles that contain only a few key or select observations are referred to as test profiles.

2.2.1 Objective

The prime objective of test snow profiles is to assess snow stability. Test profiles may be used to supplement data from study plots. The variation of snow structure with aspect and elevation is recorded and correlated with conditions observed at study plots. Repetition of test profiles (and most other tests) allows an observer to track changes over space and through time.

2.2.2 Site Selection

Criteria used for site selection depend on the objective of the test profile. Test profiles are often observed where snow conditions are similar to avalanche starting zones. As with full profiles they can be targeted sites selected to satisfy a desire for a particular observation. When selecting a site, keep in mind that elevation and exposure to wind and sun are the factors that have the strongest influence on the variations of the snow cover.

Profile locations should be at least 5 m from the tip of tree branches and not be in a depression, and not contain avalanche debris or tracks from skis, vehicles or animals. Safety considerations are paramount in selecting a site; consider the potential hazard of avalanches from above and the runout below.

2.2.3 Frequency of observations

No rule can be set about the frequency of test snow profiles. The number of profiles should be adequate to supplement other observations relating to snow stability.

2.2.4 Relevant measurements

It is not necessary to measure every variable when undertaking a test snow profile. No fixed rule exists about the type and amount of information to be collected. Observations may concentrate on the identification of weak layers and their relation to other layers, or may contain snow temperatures only (i.e., during snow melt periods), or may have all the information of a full snow profile (i.e., in a shallow snowpack). An observer should select the observations that give significant information about the stability of the snowpack at a specific site and time.

The pit for a test snow profile needs to be excavated deep enough to observe weak layers and relevant temperatures. The depth should be known approximately from continuously monitoring the development of the snowpack during the winter, full snow profiles and probing.

Test snow profiles may be recorded in a format similar to that of full snow profiles.

2.2.5 Equipment

Equipment required for a test snow profile depends on the observations being made. Refer to Section 2.1.4 for a list of recommended equipment for snow profiles.

2.2.6 Procedure

1. With a probe or ski pole, determine the approximate location of weak layers, the depth necessary for the pit and the total snow depth.
2. Record date, time, names of observers, location, elevation, aspect, inclination of terrain, sky cover, precipitation and wind.
3. Observe the air temperature in the shade about 1.5 m above the snow surface.
4. Measure foot penetration.
5. Dig the pit and cut a smooth face on the shady side to allow for the identification of layers.
6. Measure the snow temperatures as necessary.
7. Determine the location of significant layers and record their distance from the ground or the snow surface.
8. Observe the hardness, crystal shape, grain size and free water content of significant layers.
9. In a general comment describe any terrain features, vegetation, sun and wind effects on the snowpack and note any evidence of past avalanche activity which may influence the snowpack structure.

Perform strength and stability tests where appropriate.

2.2.7 Recording

Always record the names (initials are fine) of observers with the primary observer listed first. Use a tilde (~) in the notebook when no observation was made. Code as “U” if the observation was attempted but no reliable value could be ascertained (i.e. when blowing snow cannot be observed due to darkness, cloud or fog). Do not leave blanks. Only write “0” when the observation is zero (i.e. the incline when the profile is performed at a level site).

Test profile Organization <i>Patrol</i>						Observer <i>N Smith</i>	Type <i>Test</i>	
Date <i>2016-03-28</i>			Time <i>1045</i>			Sky ☁	Wind <i>M, N</i>	
Location <i>Skiers Delight</i>			Elevation <i>1750 m</i>			Precip <i>Nil</i>	Air temp <i>-12.0</i>	
Aspect <i>NE</i>			Incline <i>25°</i>			Foot pen <i>40</i>	Surface <i>-15.0</i>	
H (cm)	R	F	E (mm)	θ	ρ (kg/m ³)	Comments / shears	H (cm)	T (°C)
<i>0</i>						<i>Surface</i>	<i>10</i>	<i>-14.0</i>
	<i>F</i>	~	~	~	~		<i>30</i>	<i>-11.0</i>
<i>6</i>						<i>Weak bonding between</i>	<i>64</i>	<i>-8.5</i>
	<i>P</i>	~	~	~	~	<i>crust and snow above</i>		
<i>8</i>								
	<i>4F</i>	~	~	~	~			
<i>63</i>								
	~	V	<i>2 - 3</i>	~	~	<i>RB3 (WB) up 63 on SH 3.0 Mar 14</i>		
<i>64</i>								
	<i>1F</i>	□ ●	~	~	~			
<i>97</i>						<i>Profile location on lee</i>		
		~	~	~	~	<i>side of a ridge</i>		

Figure 3 Sample field-book page for a test snow profile.

2.3 Fracture line snow profile

2.3.1 Objective

Fracture line profiles are snow profiles observed near the crown or flanks of slab avalanches. Identification of the slab layer(s), weak layer(s) and bed surface(s) are of prime importance. Information is sought on the strength of the weak layer and the effect of loading from the layers above, grain form and size in the weak layer and snowpack temperatures. Knowledge of the snowpack structure at avalanche sites contributes to a better understanding of the avalanche phenomenon.

2.3.2 Site Selection

Safety considerations are paramount when selecting a site for fracture line profiles. Consider the potential for and consequences of further releases. A pit may be dug into the flanks or the crown face. If more than a short time has passed since the avalanche, dig into the exposed crown or flank at least 1 m in a manner that allows tracing the bed surface and failure planes to the profile face.

Observations can be taken at both thick and thin sections of a fracture line. Supplementary information on strength and stability may be obtained from a similar undisturbed site.

Use a sketch to describe location. Carefully describe terrain features, vegetation, and sun and wind effects on the snowpack. Note any evidence of past avalanche activity which may have influenced the snowpack's structure.

2.3.3 Relevant measurements

The following should be given special attention during full or test snow profiles:

- Dig the observation face into undisturbed snow at least 1.5 m back into the crown face or flank. Dig down below the depth of the bed surface.
- Note the location of, and the crystal shape, grain size and temperature in the initial failure plane and bed surface.
- Measure incline of the terrain with an inclinometer.
- Record the exact location of the profile with respect to the avalanche fracture geometry.

2.3.4 Recording

Always record the names (initials are fine) of observers with the primary observer listed first. Use a tilde (~) in the notebook when no observation was made. Code as “U” if the observation was attempted but no reliable value could be ascertained (i.e. when blowing snow cannot be observed due to darkness, cloud or fog). Do not leave blanks. Only write “0” when the observation is zero (i.e. the incline when the profile is performed at a level site).

2.4 Ram profile

2.4.1 Objective

The Ram profile is a record of relative hardness of snow layers measured with a Ram penetrometer. It can be applied on its own as an index of snow strength but it is not recommended for use in snow stability. When used in combination with a snow profile, the Ram profile should be taken about 0.5 m from the pit wall after observation of the snow profile, but before any shovel shear tests are performed. The Ram is used in lieu of the ruler for layer heights during profile observations. In two stage profiles (deeper than approximately 2 m) the Ram is inserted to ground in the corner of the hole to reference the layer boundaries from the ground. Then the deeper stage is dug along the lower Ram sections.

Note: The Ram profile typically describes the hardness of strong layers in the snowpack. It has two distinct shortcomings when used in snow stability work:

- *It often fails to identify thin weak layers in the snowpack.*
- *Its sensitivity is dependent on the hammer and tube weights, particularly when used in soft or very soft snow.*

Refer to Chapter 7 of *The Avalanche Handbook, 3rd Edition* (McClung and Schaerer, 2006) for a discussion on Ram profiles.

2.4.2 Equipment

The Ram penetrometer, also called Rammsonde, consists of:

- A sectional tube with a cone of 40 mm diameter and an apex angle of 60°.
- Multiple extension tubes.
- A guide rod.
- A hammer of mass 2 kg, 1 kg, 0.5 kg, 0.2 kg or 0.1 kg.

The mass of hammer chosen depends on the expected hardness of the snow and desired sensitivity.

2.4.3 Unit of measurement

Ram hardness is measured by the force that must be applied in order to penetrate the snow with the Ram penetrometer. The weight of the tubes and hammer, and a dynamic load from the falling hammer produce this force.

Weight is a gravity force that is calculated by multiplying mass with acceleration due to gravity. The average value of acceleration due to gravity is 9.81 m/s^2 but the approximate value of 10 m/s^2 is adequate for the purpose of measuring Ram hardness.

Forces, and consequently the Ram hardness, are measured in Newtons. A mass of 1 kg has a gravity force (weight) of $1 \text{ kg} \times \text{acceleration}$ which is approximately $1 \text{ kg} \times 10 \text{ m/s}^2 = 10 \text{ N}$.

Note: The observation of surface penetrability (refer to Section 1.4.15) for Ram penetration provides the depth at which the Ram hardness exceeds 10 N.

2.4.4 Procedure

1. Record type and weight of Ram penetrometer and hammer at the head of the field-book page. Obtain the weight by multiplying its approximate mass by 10.
2. Work in pairs; one person holds the Ram penetrometer in a vertical position, drops the hammer and counts the number of blows; the other person observes depth of penetration and records information.
3. Let the first sectional tube slowly penetrate the snow under its own weight. Record its weight in column $T + H$. Read the penetration (cm) and record in column p .
4. Carefully add the guide rod and hammer. Record weight of the tube plus weight of the hammer under $T + H$. Read the new penetration and record in column p .
5. Drop the hammer from a height between 1 cm and 5 cm; note the penetration. Continue dropping the hammer from the same height until rate of penetration changes. Record fall height (f), number of blows (n) and penetration (p) up to the point before rate of penetration changed. Continue with another series of blows; choose a fall height that produces a penetration of about 1 cm per blow.
6. Add another section of tube when necessary and record the new $T + H$.

2.4.5 Calculation

1. Calculate the increment of penetration (p) for each series of blows.
2. Calculate Ram hardness (R) with:

$$R = \frac{n \times f \times H}{\Delta p} + T + H$$

Where:

- R = Ram hardness (N)
- n = number of blows of hammer
- f = fall height of hammer (cm)
- Δp = increment of penetration for n blows (cm)
- T = weight of tubes including guide rod (N) = $10 \times \text{mass (kg)}$
- H = weight of hammer (N) = $10 \times \text{mass (kg)}$

3. Plot on graph paper the Ram hardness versus depth of snow.

2.4.6 Recording

Always record the names (initials are fine) of observers with the primary observer listed first. Use a tilde (~) in the notebook when no observation was made. Code as “U” if the observation was attempted but no reliable value could be ascertained (i.e. when blowing snow cannot be observed due to darkness, cloud or fog). Do not leave blanks. Only write “0” when the observation is zero (i.e. when the increment of penetration is zero).

Ram profile Organization: <i>Wilderness Tours</i>						Observer <i>P.M., A.L.</i>					
Date <i>2016-01-26</i>						Location <i>Mary Lake, Upper Waterfall</i>					
Time <i>1510</i>						Penetrometer Type: <i>Ski pole T = 10 N H = 5 N</i>					
T+H (N)	n	f (cm)	p (cm)	Δp (cm)	R (N)	T+H (N)	n	f (cm)	p (cm)	Δp (cm)	R (N)
10	~	~	32	~	~	25	1	50	123	2	150
15	~	~	36	4	15	25	4	30	128	5	145
15	4	5	43	7	29	25	2	30	132	4	100
15	6	5	49	6	40	25	6	20	137	5	145
15	9	10	57	8	71						
15	1	10	62	5	25						
15	6	10	65	3	115						
15	8	20	72	7	129						
15	7	30	78	6	190						
15	4	30	83	5	135						
15	10	30	91	8	202						
25	5	30	94	3	275						
25	9	40	96	2	925						
25	6	40	98	2	625						
25	10	50	103	5	525						
25	10	50	112	9	303						
25	7	50	117	5	365						
25	7	50	121	4	462						

Figure 4 Sample field-book page for Ram profiles.

2.5 Graphical snow profile presentation

Snow profiles can be represented graphically in a standard format for quick reference and permanent record.

- Plot snow temperatures as a curve; mark the air temperature above the snow surface.
- Plot distance of snow layers from ground or snow surface to scale.
- Use graphic symbols for the shape of grains and liquid water content. Plot a tilde (~) when hardness or liquid water content could not be determined (a blank implies fist hardness or dry snow respectively). Use of graphic symbols for hardness is optional.
- Tabulate grain size and density with values observed in the field.
- Include written comments where appropriate. If possible, label important layers by their date of burial.
- Include results of appropriate strength and stability tests in the comments column. Document grain form and size of the failure layer. Draw an arrow at the height of each observed fracture and use a shorthand notation to describe the test (i.e. CTM 17 (SC) down 34 on SH 8 mm Jan 22).
- When Ram data are not taken, plot the hand test results of snow hardness as a horizontal bar graph. Use the following lengths of bars for scale.

Object in hand test	Length of bar (mm)	Bar graphical ratio
Fist in glove	5	1
Four fingers in glove	10	2
One finger in glove	20	4
Blunt end of pencil	40	8
Knife blade	80	16
Ice	100	20

A blank snow profile form is appended at the end of this document.

2.6 Shear frame test

2.6.1 Objective

The shear test with tilt board and shear frame is an index observation of the stability of most weak layers including those in new or partially decomposed or fragmented snow.

2.6.2 Site selection

The shear frame test is performed together with snow and weather observations on a study plot. The observation site must be level and the snow surface must be undisturbed by wind for meaningful and reproducible test results.

2.6.3 Equipment

The shear frame test requires the following equipment:

- Metal cutting plate about 30 cm x 30 cm
- Shear frame, usually 100 or 250 cm² area
- Force gauge, maximum capacity 10 to 25 N (1 to 2.5 kg)
- Snow sampling tube
- Weigh scale
- Ruler
- Tilt board (optional)

2.6.4 Procedure

Locating the weak layer

There are several ways of finding a weak layer. The method described here is for study plots with tilt boards.

1. Cut a block of undisturbed snow with sides about 30 cm x 30 cm, and a 30 to 40 cm depth. A second deeper block of similar size must be collected if the suspected failure plane is deeper than 0.4 m.
2. Lift the snow block with the cutting plate onto the horizontal tilt board.
3. Tilt the board to an angle of about 15°. Tap the board gently until a shear fracture occurs in the snow.
4. Measure depth of the failure plane from the surface at the side of the block; record under “Shear depth”.
5. Collect a sample of snow on the tilt board by inserting sampling tube (perpendicular to the snow surface) to the depth of the failure plane. Weigh sample and record net weight under “Shear weight”.
6. Establish location of the failure plane in the snowpack by measuring shear depth from the surface.

Shear frame test

1. Remove overlying snow with a cutting plate leaving a few centimetres of undisturbed snow above failure plane.
2. Gently push the shear frame, by holding it with thumb and index finger, down through the snow to a few millimetres above failure plane.
3. Zero the force gauge, then hook it to the frame and pull parallel to failure plane. Read and record the force required to produce a fracture.
4. Repeat process several times to confirm consistency.

2.6.5 Results

Shear frame test

The shear frame test, as part of snow and weather observations, may be recorded at the bottom of the field-book page for snow and weather observations, or on a separate page if necessary. Note the area of the shear frame and the cross-section area of the sampling tube.

Stability ratio

Determine shear strength by dividing the force (g) at fracture by the area (cm²) of the shear frame. Determine weight of snow per unit area by dividing weight (g) of the snow sample by the cross-sectional area (cm²) of the sampling tube. Calculate stability ratio by dividing shear strength by weight per unit area:

$$\text{Stability ratio} = \frac{\text{Shear strength (g/cm}^2\text{)}}{\text{Weight per unit area (g/cm}^2\text{)}}$$

2.6.6 Recording

(Refer to Section 2.6.5)

2.6.7 Limitations

Units of measurement

Stability ratio (previously termed a stability factor) has no units of measurement. However, it is preferable to use SI units rather than metric units in its calculation.

With SI units the shear force should be expressed in Newtons and the shear frame index in Pascals (1 Pa = 1 N/m²). Since available spring balances may be calibrated in other metric units, gram (g) and gram per square centimetre (g/cm²) may be used for both the shear force index and weight per unit area.

Reliability

Experience is required to produce reliable data. Success of the test depends on:

- Carefully removing the snow block above without disturbing the layer to be tested.
- Inserting the shear frame parallel and close to the failure plane without causing a premature fracture.
- Pulling the shear frame at a constant rate.



canadianavalancheassociation

Snow Profile

Profile Type: FULL	Date: 2002-03-28
Organization: HELI GUIDES INC.	Location: MARY LAKE
Observer: P.M., A. LeB.	Time: 1420
Co-ordinates: ~	Slope Aspect: W
Sky: ☉	Precip: S-1
Wind: MOD, SE	Air Temp: -2.0
Site Characteristics: Treeline bowl, x-loaded	Elevation: 1810M
	Slope Incline: 10°
	Foot Pen: 75CM

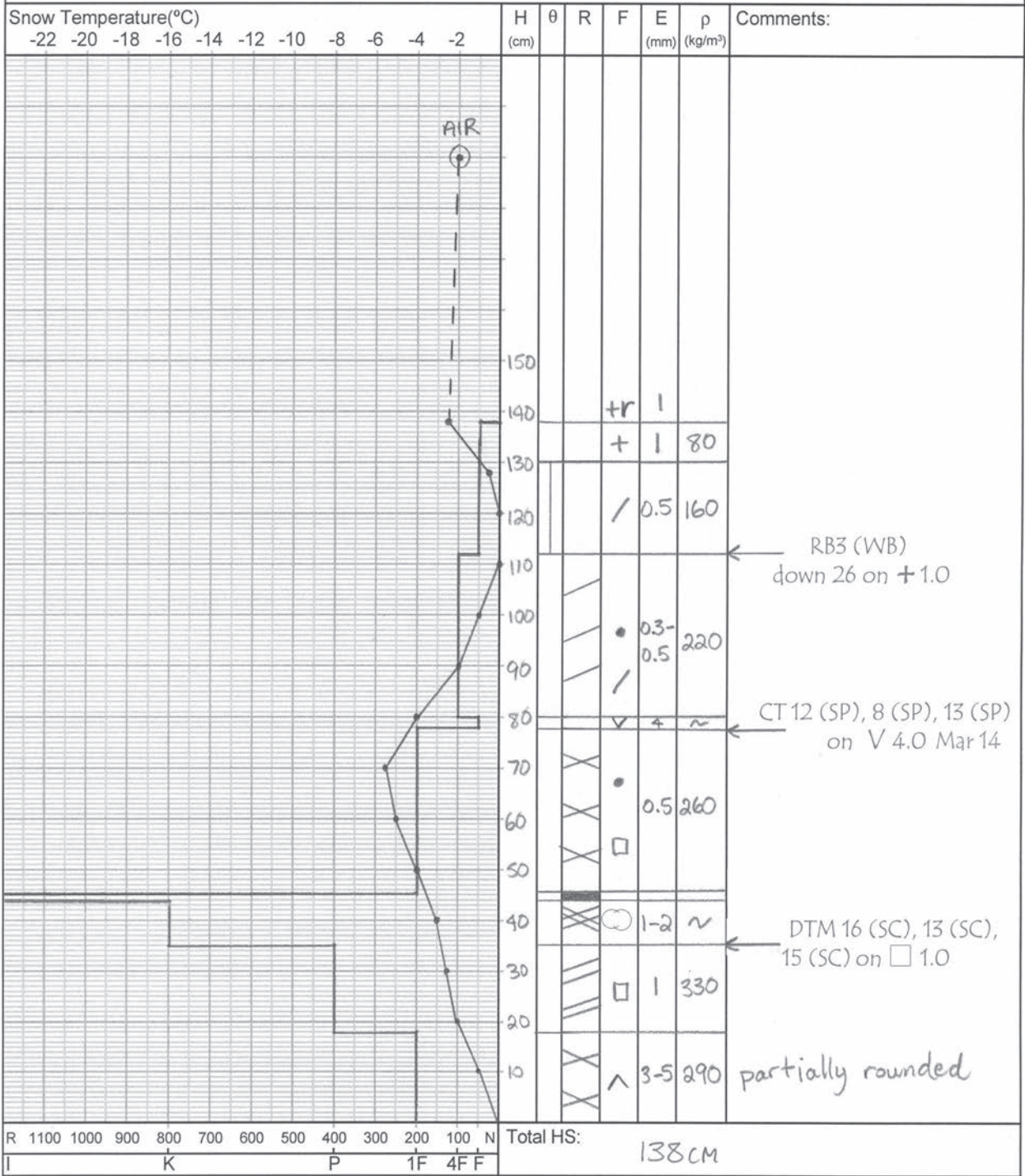

Figure 5 Hand-drafted snow profile.

2.7 Rutschblock test

2.7.1 Objective

The rutschblock (or glide-block) test is a slope test that was developed in Switzerland in the 1960s. These guidelines are based on a recent Swiss analysis of rutschblock tests (Fohn, 1987) and on Canadian research (Jamieson and Johnston, 1993).

2.7.2 Site selection

Test sites should be safe, undisturbed and representative of the avalanche terrain under consideration (i.e. to gain information about a wind-loaded slope, find a safe and undisturbed part of a similarly loaded slope for the test). The site should not contain buried ski tracks, avalanche deposits, etc., or be within about 5 m of trees where buried layers might be disturbed by wind action or by clumps of snow which have fallen from branches. Although Dr. P. Fohn (1987) recommends slope angles of at least 30°, rutschblocks on 25 to 30 degree slopes also give useful information (discussed below). Be aware that near the top of a slope, snowpack layering and hence rutschblock scores may differ from the slope below.

2.7.3 Equipment

Eight metres of 4 to 7 mm cord with overhand knots tied every 20 or 30 cm can be used to cut the upper wall and both sides of the block at the same time (provided no hard crusts are encountered). Long rutschblock-specific snow saws are useful to cut hard crusts.

2.7.4 Procedure

After identifying weak layers (and potential slabs) in a snow profile, extend the pit wall until its width is at least 2 m minimum across the slope. Do not omit the profile unless the layering is already known.

Mark width of the block and length of the side cuts on the surface of the snow with a ski, ruler, etc. The block should be 2 m wide throughout if the sides of the block are to be dug with a shovel. However, if the side walls are to be cut with a ski, pole, cord or saw, the lower wall should be about 2.1 m across and the top of the side cuts should be about 1.9 m apart (refer to Figure 6). This flaring of the block ensures it is free to slide without binding at the sides. The side cuts should extend 1.5 m up the slope.

The lower wall should be a smooth vertical surface cut with a shovel. Dig or cut the side walls and the upper wall deeper than any weak layers that may be active. If the side walls are exposed by shovelling, then one rutschblock test may require 20 minutes or more for two people to perform.

If the weak layers of interest are within 60 cm of the surface, save time by cutting both the sides and upper wall of the block with a ski pole (basket removed) or with the tail of a ski. If weak layers are deeper than 60 cm and the overlying snow does not contain any knife-hard crusts, both the sides and upper wall of the block can be sawed with cord which travels up one side, around ski poles or probes placed at both upper corners of the block and down the other side.

Once completely isolated from the surrounding snowpack, the block is progressively loaded by a person on skis or snowboard. Loading steps are outlined in Section 2.7.5.

2.7.5 Results

The following chart outlines the loading sequence (1-7) in a rutschblock test:

Field score	Loading step that produces a clean shear fracture	Data code
1	The block slides during digging or cutting, or anytime before the block is completely isolated.	RB1
2	The tester approaches the block from above and gently steps down onto the upper part of the block (within 35 cm of the upper wall).	RB2
3	Without lifting heels, the tester drops from straight leg to bent knee position, pushing downwards and compacting surface layers.	RB3
4	The tester jumps up and lands in the same compacted spot.	RB4
5	The tester jumps again onto the same compacted spot.	RB5
6	For hard or deep slabs, remove skis or snowboard and jump on the same spot. For soft slabs or thin slabs where jumping without skis might penetrate through the slab, keep equipment on, step down another 35 cm (almost to mid-block) and push once then jump three times.	RB6
7	None of the loading steps produced a smooth slope-parallel fracture.	RB7

Release type

When observing rutschblock tests, observe the amount of the block that releases for each weak layer fracture according to the following table:

Term	Description	Data code
Whole block	90 - 100% of block.	WB
Most of block	50 - 80% of block.	MB
Edge of block	10 - 40% of block releases on a planar surface.	EB

2.7.6 Recording

Record rutschblock score, release type, weak layer properties and comments. The exact percentage of the block which released can be recorded in the comments if relevant.

<data code> <(release type)> <reference point> <location in profile> <"on" layer characteristics (form, size, date of burial if known)> <comments>

Indicate the reference point for the fracture position (*down* = from surface; *up* = from ground). The snow surface is the default reference point for measuring fracture location. Measure down from the snow surface and record location of the fracture in the profile. When location of the fracture is measured up from the ground, record the reference point as *up* and indicate this clearly in the comments.

Example: A rutschblock fractures on the first jump. A planar fracture occurs beneath the skis and approximately 60% of the block releases on a layer of 6 mm surface hoar that is 75 cm below the snow surface and was buried on January 22.

Record as: RB4 (MB) down 75 on SH 6.0 Jan 22

2.7.7 Limitations

The rutschblock is a good slope test but it is not a one-step stability evaluation. This test does not eliminate the need for snow profiles or careful field observations nor does it, in general, replace other slope tests such as ski cutting and explosive tests.

The rutschblock only tests those layers deeper than ski or snowboard penetration (i.e. a weak layer 20 cm below the surface is not tested by skis snowboards that penetrate 20 cm or more). Higher and more variable rutschblock scores are sometimes observed near the top of a slope where the layering may differ from the middle and lower part of the slope (Jamieson and Johnston, 1993). Higher scores may contribute to an incorrect decision.

Effect of slope angle

Rutschblock results are easiest to interpret if the tests are done in avalanche starting zones. However, since there is a general tendency for rutschblock scores to increase by 1 for each 10 degree decrease in slope angle (Jamieson and Johnston, 1993), scores for avalanche slopes can be estimated from safer, less steep slopes (as shallow as 25°).

Note: Rutschblocks done on slopes of less than 30° require a smooth lower wall and a second person standing in or near the pit to observe the small displacements (often less than 1 cm) that indicate a shear fracture.

2.7.8 Test Configuration

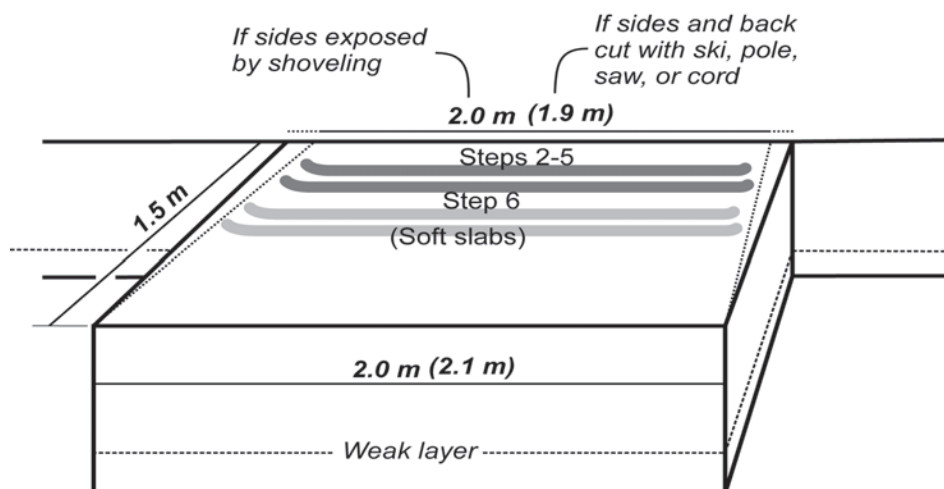

Figure 6 Rutschblock tester positions and dimensions for a block with the sides exposed by shoveling or cut with a saw, cord, ski or pole (in parenthesis).

2.8 Shovel shear test

2.8.1 Objective

The shovel shear test provides:

- Information about the location where snow could fracture in a shear.
- A qualitative assessment of weak layer strength.

2.8.2 Site selection

Select a safe site that has undisturbed snow and is representative of the slopes of interest.

2.8.3 Equipment

The equipment required is the same for test snow profiles, (refer to Section 2.1.4). A snow saw is useful for cutting the test column.

2.8.4 Procedure

1. Expose a fresh pit wall by cutting back about 20 cm from the wall of a full snow profile or test profile.
2. Remove any very soft snow (fist hardness) or soft snow (four finger hardness) from the surface of the area where the test is to be carried out.
3. On the snow surface mark a cross-section of the column to be cut, measuring 25 cm across the slope and 35 cm upslope.
4. Cut a chimney wide enough to allow the insertion of the saw (or other cutting tool) on one side of the column and a narrow cut on the other side.
5. Make a vertical cut at the back of the column and leave the cutting tool (saw) at the bottom for depth identification. The back-cut should be 0.7 m deep maximum and end in medium hard to hard snow if possible. If necessary, remove a wedge of snow near the surface at the top of the back-cut so that the shovel bend fits cleanly (see Figure 7).
6. Carefully insert the shovel into the back-cut. Hold the shovel with both hands and apply a pull force in direction of the slope.
7. When a clean shear fracture occurs in the column above the low end of the back-cut, mark the level of the failure plane on the rear (standing) wall of the back-cut.
8. When a clean shear or irregular fracture occurs in the column at the low end of the back-cut, or when no fracture occurs, remove the column above the bottom of the back-cut and repeat steps 5 to 7 on the remaining column below.
9. Repeat the test on a second column with the edge of the shovel 0.1 m to 0.2 m above the suspected weak layer.
10. Measure and record the depth of the failure planes if they were equal in both tests. Repeat steps 3 to 8 if the failure planes were not at the same depth in both tests.
11. If no fracture occurs, tilt the column and tap.
12. Use the following chart to determine the approximate effort necessary to shear the snow as shown; record results.
13. Observe, classify and record crystal shape and size at the failure planes (crystal samples are often best obtained from the underside of the sheared block).

2.8.5 Results

Rate each fracture according to the following table:

Term	Description	Equivalent shear strength (N/m ²)	Data code
Very easy	Fractures during cutting or insertion of shovel.	< 100	STV
Easy	Fractures with minimum pressure.	100 - 1000	STE
Moderate	Fractures with moderate pressure.	1000 - 2500	STM
Hard	Fractures with firm sustained pressure.	2500 - 4000	STH
No fracture	No shear fractures observed.		STN

Fracture character

Characterize the fracture according to Section 2.13.

2.8.6 Recording

Record results according to Section 2.13.3.

2.8.7 Limitations

The primary objective of the shovel shear test is to identify the location of weak layers. The ratings of effort are subjective and depend on the strength and stiffness of the slab, on the size, shape, length of the shovel, and the length of the shovel handle.

This test does not usually produce useful results in layers close to the snow surface. Soft snow near the surface is better tested with the tilt board and shear frame test (refer to Section 2.6).

2.8.8 Test Configuration

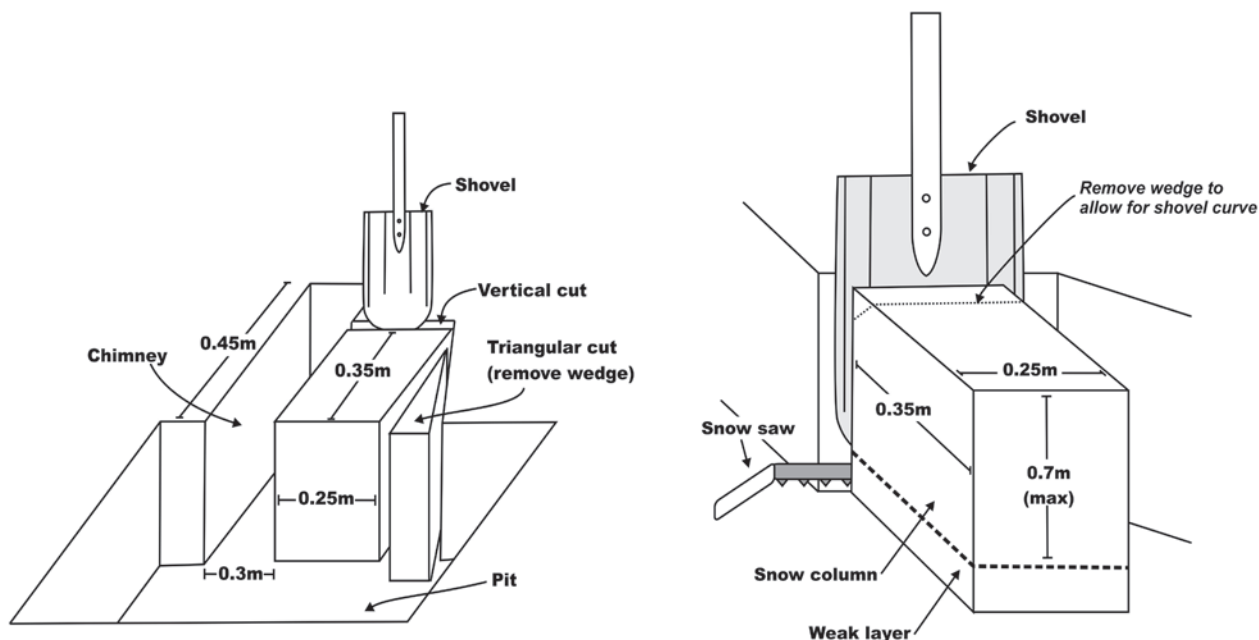

Figure 7 Shovel shear test technique and column dimensions.

2.9 Compression test

2.9.1 Objective

The compression test was first used by Parks Canada Wardens working in the Canadian Rockies in the 1970s. The following procedure was developed by the University of Calgary avalanche research project in the late 1990s. Similar tests have been developed elsewhere.

This test identifies weak snowpack layers and is most effective at finding weak layers near the snow surface. Manual taps applied to a shovel blade placed on top of a snow column cause weak layers within the column to fracture. These fractures can be seen on the smooth walls of the column. The test can be performed on level or sloping terrain.

The objectives of the compression test are to locate weak layers in the upper snowpack (approximately 1 m) and provide an indication of their triggering potential on nearby slopes with similar snowpack conditions.

2.9.2 Site selection

Select a safe site that has undisturbed snow and is representative of the slopes of interest.

2.9.3 Equipment

The equipment required is the same for test snow profiles (refer to Section 2.1.4). A snow saw is useful for cutting the test column.

2.9.4 Procedure

1. Isolate a 30 cm x 30 cm column of snow deep enough to expose potential weak layers on the smooth walls of the column. The uphill dimension is measured slope-parallel. A depth of 100-120 cm is usually sufficient since the compression test rarely produces fractures in deeper weak layers. Also, taller columns tend to wobble during tapping, potentially producing misleading results for deep weak layers.
2. Rate any fractures that occur while isolating the column as very easy (CTV).
3. Place a shovel blade on top of the column. Tap 10 times with fingertips, moving hand from wrist, and rate any fractures as easy (CTE).
4. If the snow surface slopes, remove a wedge of snow to level the top of the column.
5. If, during tapping, the upper part of the column slides off or no longer “evenly” supports further tapping on the column, remove the damaged part of the column, level the new top of the column and continue tapping.
6. Do not remove the portion of the column above a fractured weak layer, provided that it evenly supports further tapping, since further tapping may cause fractures in shallower weak layers.
7. Tap 10 times with the fingertips or knuckles moving forearm from the elbow, and rate any fracture as moderate (CTM). While moderate taps should be harder than easy taps, they should not be as hard as one can reasonably tap with the knuckles.
8. Finally, hit the shovel blade moving arm from the shoulder 10 times with open hand or fist and rate any fractures as hard (CTH). If the moderate taps were too hard, the operator will often try to hit the shovel with even more force for the hard taps - and may hurt his or her hand.
9. Rate any identified weak layers that did not fracture as no fracture (CTN).

2.9.5 Results

Score each fracture according to the following table:

Term	Description	Data code
Very easy	Fractures during cutting.	CTV
Easy	Fractures before 10 light taps using fingertips only.	CTE
Moderate	Fractures before 10 moderate taps from elbow using fingertips or knuckles.	CTM
Hard	Fractures before 10 firm taps from whole arm using palm or fist.	CTH
No fracture	Does not fracture.	CTN

Fracture character

Characterize the fracture according to Section 2.11.

2.9.6 Recording

Record results according to Section 2.13.3. The number of taps that caused fracture can be recorded in addition to the data code.

2.9.7 Limitations

The compression test may not produce useful results for weak layers that are very close to the snow surface. Deeper weak layers are generally less sensitive to the taps on the shovel, resulting in higher ratings.

2.9.8 Test Configuration

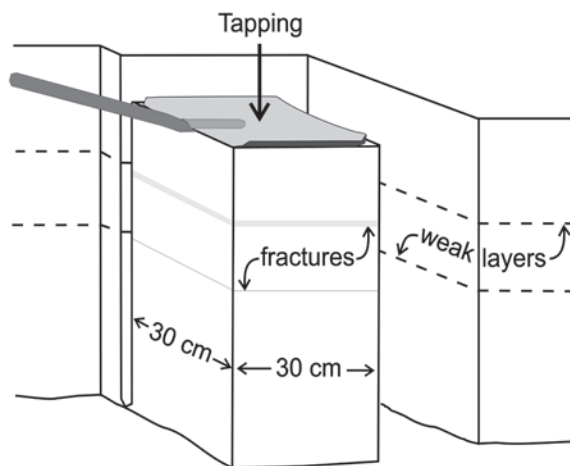

Figure 8 Compression test and deep tap test technique and column dimensions.

2.10 Deep tap test

2.10.1 Objective

The primary objective of the deep tap test is to determine the fracture character of a weak layer that is too deep to fracture consistently in the compression test. In addition, it is possible to observe the tapping force required for fracture to occur.

2.10.2 Site selection

Select a safe site that has undisturbed snow and is representative of the slopes of interest.

2.10.3 Equipment

The equipment required is the same for test snow profiles (refer to Section 2.1.4). A snow saw is useful for cutting the test column.

2.10.4 Procedure

1. Using a profile or other means, identify a weak snowpack layer that is overlain by 1F or harder snow and which is too deep to fracture consistently in the compression test.
2. Prepare a 30 cm by 30 cm column as for a compression test (note that the same column can be used after a compression test of the upper layers, provided the compression test did not disturb the target weak layer). To reduce the likelihood of fractures in weak layers below the target layer, such as depth hoar at the base of the snowpack, it may be advantageous not to cut the back wall more than a few centimetres below the target weak layer.
3. Level the column such that only 15 cm of snow (measured at the back of the sidewall) remains above the target weak layer.
4. Place the shovel blade (facing up or facing down) on top of the column. Apply 10 light, 10 moderate and then 10 hard taps as for a compression test.

2.10.5 Results

Score each fracture according to the following table:

Term	Description	Data code
Very easy	Fractures during cutting.	DTV
Easy	Fractures before 10 light taps using finger tips only.	DTE
Moderate	Fractures before 10 moderate taps from elbow using finger tips.	DTM
Hard	Fractures before 10 firm taps from whole arm using palm or fist.	DTH
No fracture	Does not fracture.	DTN

Fracture character

Characterize the fracture according to Section 2.11.

2.10.6 Recording

Record according to Section 2.13.3.

2.10.7 Limitations

While very effective for testing deeper weak layers, the number of taps required to initiate failure in the deep tap test has never been correlated with skier-triggering or avalanche activity on adjacent slopes. However, the fracture character observations have been verified (van Herwijnen, 2005) and may be interpreted as in the compression test.

2.10.8 Test Configuration

Refer to Figure 8 for deep tap test technique and column dimensions.

2.11 Extended column test

2.11.1 Objective

The extended column test is a snowpack test that aims to indicate the propensity (tendency) of slab and weak layer combinations in the upper portion of the snowpack (< 1m deep) to propagate a fracture.

2.11.2 Site selection

Select a safe site that has undisturbed snow and is representative of the slopes of interest.

2.11.3 Equipment

The equipment required is the same for test snow profiles, (refer to Section 2.1.4). Eight metres of 4 to 7 mm cord with overhand knots tied every 20 or 30 cm can be used to cut the upper wall provided no hard crusts are encountered. Long snow saws are useful to cut hard crusts. A cord with two collapsible probes can be used to cut the upper wall and both sides of the column at the same time.

2.11.4 Procedure

1. Isolate a column of snow 90 cm across the slope, 30 cm up the slope, and deep enough to expose potential weak layers. Depth should not exceed 100 cm since the loading steps rarely affect deeper layers.
2. Rate any fractures that cross the entire column while isolating it as ECTPV.
3. If the snow surface is hard and inclined, remove a wedge of snow to level the top of the column at one edge.
4. Place the shovel blade on one side of the column and apply 10 light, 10 moderate and then 10 hard taps as for a compression test (Section 2.9).

2.11.5 Results

Score each fracture according to the following table:

Data code	Observed results
ECTPV	Fracture propagates across the entire column during isolation.
ECTP##	Fracture propagates across the entire column on the ## tap OR fracture observed on the ## tap and propagates across the column on the ## + 1 tap.
ECTN##	Fracture observed on the ## tap, but does not propagate across the entire column on either the ## or the ##+1 tap.*
ECTX	No fracture observed during the test.

Note: * Fracture either propagates across only part of the column (observed commonly), or it takes more than one additional loading step to propagate across the entire column (observed relatively rarely).

2.11.6 Recording

Record test results according to the following:

<data code with ## taps><reference direction> <location in profile> <"on" layer characteristics> <comments>

Indicate the reference direction to locate the fracture position (*down* = from surface; *up* = from ground). *Down* is the default direction (i.e. from the snow surface), however, there may be situations where measuring *up* from the ground is more convenient.

Example 1: An extended column test fractures across the entire column on the 13th tap. The column releases on a layer of 6 to 10 mm depth hoar that is 35 cm above the ground and was buried on November 22.

Record as: ECTP13 up 35 on DH 6.0–10.0 Nov. 22

Example 2: During testing a slab fracture occurs, which propagates into the weak layer then across the remainder of the column on the 25th tap. The column releases on a layer of 8 mm surface hoar that is 65 cm deep and was buried on February 14th.

Record as: ECTN25 down 65 on SH 8.0 Feb. 14 WL fracture initiated from slab fracture

2.11.7 Limitations

The extended column test is not a good tool to assess weaknesses in soft (F+ or less) upper layers of the snowpack or in mid-storm shear layers. In these cases the shovel edge tends to cut those soft layers. It is not a good tool to assess fracture propagation propensity on a weak layer deeper than approximately 80 to 100 cm.

2.11.8 Test Configuration

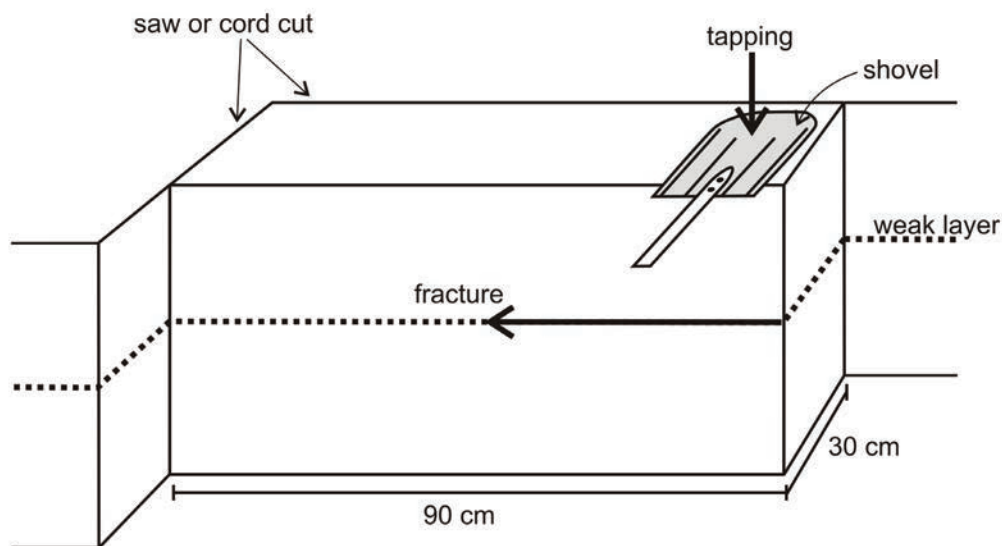

Figure 9 Extended column test setup.

2.12 Propagation saw test

2.12.1 Objective

The propagation saw test is a snowpack test that aims to indicate the propensity (tendency) of a pre-identified slab and weak layer combination to propagate a fracture.

2.12.2 Site selection

Select a safe slope or flat area that has undisturbed snow and is representative of the slopes of interest.

2.12.3 Equipment

The equipment required is the same for test snow profiles, (refer to Section 2.1.4). Eight metres of 4 to 7 mm cord with overhand knots tied every 20 or 30 cm can be used to cut the upper wall provided no hard crusts are encountered. Long snow saws are useful to cut hard crusts. A cord with two collapsible probes can be used to cut the upper wall and both sides of the column at the same time. The blade of the snow saw should be at least 35 cm long and no more than 2 mm thick.

2.12.4 Procedure

1. Isolate a column 30 cm across the slope and 100 cm up the slope when the weak layer is less than 100 cm deep. When the weak layer is >100 cm deep the column length should equal the weak layer depth in the upslope direction. The column should be isolated to a depth below the layer being tested.
2. To identify the weak layer clearly, mark the weak layer with a glove, a brush, or a crystal card along the exposed column wall.

3. Drag the blunt edge of the saw upslope through the weak layer at a 10-20 cm/s speed until the fracture propagates (jumps) ahead of the saw, at which point stop dragging the saw cutting and mark the spot along the layer where propagation began.
4. After observations are complete, remove the column and check that the saw scored the weak layer in the wall behind the test column. If the saw deviated from the weak layer, the test should be repeated.

2.12.5 Results

Once the fracture propagates ahead of the saw, one of three results can be observed as noted in the chart below.

Observed Result	Description	Data code
Propagation to end	The fracture propagates in front of the saw uninterrupted to the end of column.	End
Slab fracture	The fracture propagates in front of the saw until it is interrupted and stops at a slope-normal slab fracture that forms through the overlying slab.	SF
Self-arrest	The fracture propagates in front of the saw but self-arrests somewhere along the weak layer before reaching the end of the column.	Arr

2.12.6 Recording

Record test results according to the following:

<"PST" x/y> <fracture arrest condition> <reference direction> <location in profile> <"on" layer characteristics> <comments>

where x is the length of the saw cut when propagation starts, y is the column length up the slope.

Indicate the reference direction to locate the fracture position (*down* = from surface; *up* = from ground). *Down* is the default direction (i.e. from the snow surface), however, there may be situations where measuring *up* from the ground is more convenient.

Example: A propagation saw test fractures across the entire column after cutting 23 cm. The column releases on a layer of 6-10 mm depth hoar that is 135 cm below the snow surface and was buried on November 22. Record as: PST 23/135 End down 135 on DH 6.0–10.0 Nov. 22

2.12.7 Limitations

The propagation saw test tends to give false-stable results for soft shallow slabs and when the weak layer is too difficult to cut with the saw's blunt edge. Pre-selecting and identifying the layer of concern for testing can be challenging. The cut distance (x) may depend on the slope angle.

2.12.8 Test Configuration

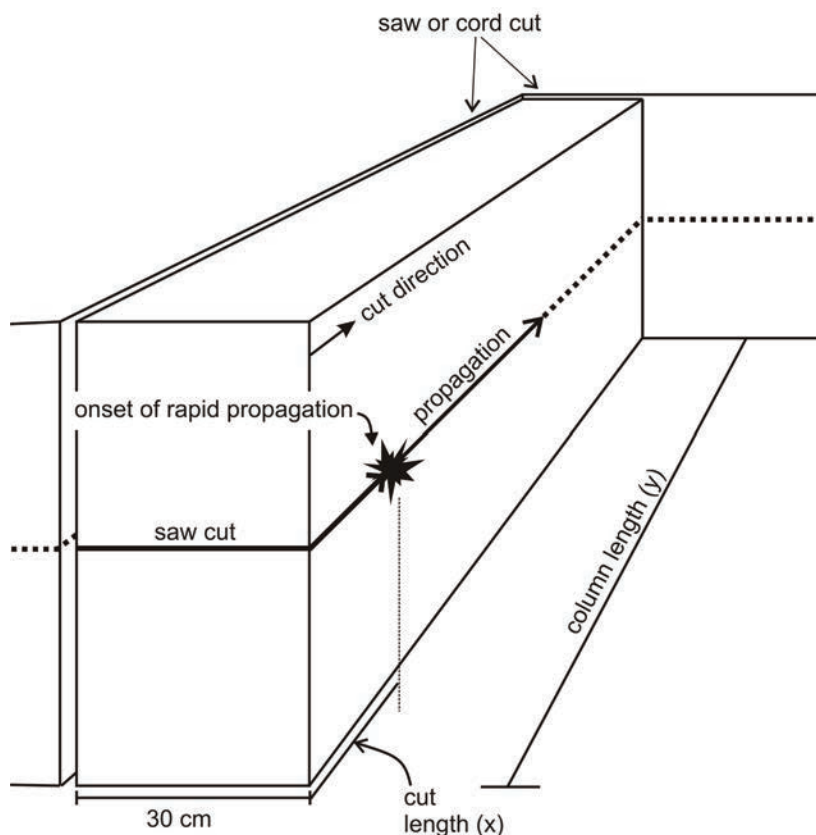

Figure 10 Schematic showing the test column (a) and the observable results of propagation to end (b), slab fracture (c), and self arrest (d).

2.13 Fracture character

Observing fracture character in stability tests can improve interpretation with respect to stability (van Herwijnen, 2005; van Herwijnen and Jamieson, 2004; Johnson and Birkeland, 2002). Experience suggests that fracture character may be observed in shovel shear tests (Section 2.8), compression tests (Section 2.9), deep tap tests (Section 2.10) and other tests which load a small column of snow until a fracture appears. Three major classes of fractures are identified: *sudden fractures*, *resistant fractures* and *breaks*. The major classes are used to qualify and communicate test results that are significant for avalanche forecasting when test conditions will not allow direct observation of the fracture character subclasses.

2.13.1 Procedure

Fracture character is best observed in tests performed on a small isolated column of snow where the objective is to load the column until a fracture (or no fracture) occurs. Typical small columns are less than 50 cm x 50 cm in cross-section.

The front face and side walls of the test column should be as smooth as possible. The observer should be positioned in such a way that one side wall and the entire front face of the test column can be observed. Attention should be focused on weak layers or interfaces identified in a profile or previous snowpack tests as likely to fracture.

For tests on low-angled terrain that produced planar fractures, it may be useful to slide the two fracture surfaces across one another by carefully grasping the two sides of the block and pulling while noting the resistance.

2.13.2 Observations

Use the following table to characterize the fracture:

Major class	Data code	Sub class	Data code	Fracture characteristics
Sudden (pops and drops)	SDN	Sudden planar (pop, clean and fast fracture)	SP	A thin planar* fracture suddenly crosses column in one loading step AND the block slides easily** on the weak layer.
		Sudden collapse (drop)	SC	Fracture crosses the column with a single loading step and is associated with a noticeable collapse of the weak layer.
Resistant (others)	RES	Progressive compression (step by step “squashing” of a layer)	PC	A fracture of noticeable thickness (non-planar fractures often greater than 1 cm), which usually crosses the column with a single loading step, followed by step-by-step compression of the layer with subsequent loading steps.
		Resistant planar	RP	Planar or mostly planar fracture that requires more than one loading step to cross column and/or the block does NOT slide easily** on the weak layer.
Break (others)	BRK	Non-planar break	BRK	Non-planar, irregular fracture.

Note: * “Planar” based on straight fracture lines on front and side walls of column.

** Block slides off column on steep slopes. On low-angle slopes, hold sides of the block and note resistance to sliding.

2.13.3 Recording

Record results of a test as follows:

<data code> <(fracture character)> <reference point> <location in profile> <”on” layer characteristics (form, size, date of burial if known)> <comments>

Example: CTM 17 (SC) down 34 on SH 8.0 Jan 22

Indicate reference point for the fracture position (*down* = from snow surface or *up* = from ground). The snow surface is the default reference point for measuring fracture location. Measure down from the snow surface and record location of fracture in the profile. When location of the fracture is measured up from the ground, record reference point as *up* and indicate this clearly in the comments.

2.13.4 Examples

If multiple tests at the same site produce results on the same layer, record results as follows:

<data code #1> <(fracture character #1)>, <data code #2> <(fracture character #2)>, <data code #3> <(fracture character #3)>, etc. <reference point> <location in profile> <”on” layer characteristics (form, size, date of burial if known)> <comments>

i.e. CTM 14 (SP), 17 (SP), 19 (RP) down 45 on SH 6.0 Feb 12 Comment: SH rounding

Example #1

Compression test: 36 degree slope, weak layer (SH, 3 mm) at 45 cm below the surface, buried on Jan 12.
Results: Column fractures at 45 cm on second tap from the elbow (CTM 12). The fracture crosses the column suddenly (“pops”), and block slides off the column.
Recording: CTM 12 (SP) down 45 on SH 3.0 Jan 12

Example #2

Shovel shear test: 25 degree slope, weak layer (DH 6 mm) at 45 cm above the ground.
Results: Column fractures at 45 cm from the ground with moderate pull applied. The fracture crosses the column suddenly and block collapses into weak layer.
Recording: STM (SDN) up 45 on DH 6.0 Comment: measured up from ground, HS = 135

Example #3

Two adjacent compression tests: 20 degree slope, 20 cm wind affected storm snow overlying PP and DF.
Results: First test - Column fractures at 22 cm on third tap from the wrist (CTE 3). There is squashing of at least part of the thickness of a soft snow layer but there is no horizontal displacement of the block. Additional loading steps continue to squash soft snow layer.
Second test - Column fractures at 22 cm on the seventh tap from the wrist (CTE 7). There is squashing of at least part of a soft snow layer but there is no displacement of the block. Additional loading steps continue to squash soft snow layer.
Recording: CTE 3 (PC), 7 (PC) down 22 on PP 4.0

2.14 Snowpack summary

2.14.1 Objectives

Snowpack summaries provide a clear and concise overview of snowpack conditions to assist stability and hazard analysis and forecasting for the operational region. The objective of such a summary is to organize and reduce data.

Snowpack summary parameters are different from snowpack observation parameters in that they are not recorded at a specific location and time but are a general characterization of the range of conditions encountered in a broader geographical area during the day. This not only includes average conditions but also potential anomalies and outliers.

2.14.2 Frequency

Summaries are generally done once a day, at the end of the day.

2.14.3 Procedure

The following parameters should be recorded in a snowpack summary:

Date

Record date as described in Section 2.1.5.

Time period

The time range during which snowpack observations were made.

Locations and elevation range

The locations and elevation range where snowpack observations were made. Many operations will record a drainage as a single location.

Percent of area observed

The area observed recorded as a percentage of the entire operational region.

Snow profile

Summarize relevant measurements as described in Section 2.2.4 for a test profile. This includes slab properties, weak layer attributes, temperature gradients, etc.

Stability tests

Characterize stability test results as described in Section 2.7.6 for rutschblock tests and Section 2.13.3 for small-column stability tests.

Comments

Make any additional comments as required. These may include notes on signs of instability, settlement, and the effects of wind, air temperature and solar radiation.

3. Avalanche observations

3.1 Objectives

Observations and records of avalanche occurrences have the following applications:

- Information about avalanche occurrences and non-occurrences is used in association with other observations in evaluating snow stability.
- Observations identify areas where avalanches have released earlier in the winter; snow stability may vary between these sites and undisturbed slopes.
- Avalanche observation data are essential when protective works and facilities are planned, when the effectiveness of control measures is assessed, and when forecasting models are developed by correlating past weather and snow conditions with avalanche occurrences.

All avalanches that are significant to an operation should be recorded. Noting the non-occurrence of avalanches is important for snow stability evaluation.

3.2 Identification of avalanche paths

Avalanche paths should be identified by a key name, number, aspect or a similar identifier which should be referred to on lists, maps or photographs. At roads, railway lines and power lines it is convenient to refer to avalanche paths by the running kilometre.

Avalanche starting zones that can produce avalanches independently are often divided into sub-zones. Separate targets for explosive control may be identified within each starting zone.

3.3 Observations of individual avalanches

The following section describes techniques used to classify individual avalanches. These guidelines should be followed for all significant events.

Section 3.5 describes a classification system which can be used to report groups of similar events or to summarize the level of avalanche activity in a particular area.

A set of core observations is best recorded on the left-hand page of the field-book (see Figures 12 and 13) or on photographs. The right-hand page may be used for comments and additional observations.

3.3.1 Date

Record year, month and day of the avalanche occurrence, yyyy-mm-dd (i.e. December 15, 2001, is noted as 2001-12-05).

3.3.2 Time

Record the observation time on a 24-hour clock (avoid spaces, colons, etc.) i.e. 5:10 p.m. is noted as 1710.

Use local time (e.g. Pacific or Mountain time). Operations that overlap time zones should standardize to one time.

Estimate and record the age (in hours) of the avalanche.

If the avalanche release was witnessed then the observation time is the time of occurrence and the age will be 0 hours.

Valid entries are 0, 0.5, or 1 to 99 hours. Zero indicates that the time is precisely known.

Note: +/- 0 is used when the time of occurrence is precisely known.

3.3.3 Area and path

Enter the name of the operation or avalanche area where the avalanche path is located.

Note: It is not necessary to note the area in every entry of a field notebook if that book is not taken from area to area.

Enter the identifier (name or number) of the avalanche path.

Some road operations may name their paths by the running kilometre. In this case two decimal places may be used to identify paths within a whole kilometre.

3.3.4 Aspect

Use eight cardinal points of compass to specify the avalanche's central aspect in the starting zone.

3.3.5 Incline

Record the estimated incline of the starting zone. Add "M" if measured.

3.3.6 Size

Estimate the destructive potential of the avalanche from the deposited snow, and assign a size number. Imagine that the objects on the following list (people, cars, trees) were located in the track or at the beginning of the runout zone and estimate the harm the avalanche could have caused.

Size and data code	Destructive potential	Typical mass	Typical path length	Typical impact pressure
1	Relatively harmless to people.	<10 t	10 m	1 kPa
2	Could bury, injure, or kill a person.	10 ² t	100 m	10 kPa
3	Could bury and destroy a car, damage a truck, destroy a wood-frame house or break a few trees.	10 ³ t	1,000 m	100 kPa
4	Could destroy a railway car, large truck, several buildings or a forest area of approximately 4 hectares.	10 ⁴ t	2,000 m	500 kPa
5	Largest snow avalanche known. Could destroy a village or a forest area of approximately 40 hectares.	10 ⁵ t	3,000 m	1,000 kPa

Note: Size 1 is the minimum size rating. In general, half sizes are not defined, but may be used by experienced practitioners for avalanches which are midway between defined avalanche size classes (i.e. size 2.5).

The destructive potential of avalanches is a function of their mass, speed and density as well as the length and cross-section of the avalanche path.

Typical impact pressures for each size number were given by McClung and Schaerer (1981).

The number "0" may be used to indicate no release of an avalanche following the application of control measures.

3.3.7 Type of snow failure

Record the type of snow failure.

Symbol and data code	Failure type
S	Slab avalanche
L	Loose-snow avalanche
LS	Loose-snow + slab
C	Cornice fall
CS	Cornice fall + slab
I	Ice fall
IS	Ice fall + slab

Note: Record the slab hardness if observed. Hardness can be measured using the hand hardness test (i.e. 1F, P, etc.) in the starting zone or from the deposit in the runout zone, where the slab is still recognizable.

3.3.8 Liquid water content

Liquid water content in starting zone

Determine the liquid water content of the avalanche snow in the starting zone at the time of failure.

Symbol and data code	Liquid water content in the avalanche starting zone
D	Dry snow
M	Moist snow
W	Wet snow

Liquid water content of deposit

Determine liquid water content of the avalanche snow at the time and location of the deposit.

Symbol and data code	Liquid water content of deposit
D	Dry snow
M	Moist snow
W	Wet snow

3.3.9 Terminus

Describe the location of the tip of the avalanche deposit with a code letter.

Symbol and data code	Terminus for long paths
SZ	Avalanche stopped in starting zone.
TK	Avalanche stopped in track.
TR	Avalanche stopped at top part of runout zone.
MR	Avalanche stopped in middle part of runout zone.
BR	Avalanche stopped in bottom part of runout zone.
	Terminus for short paths
TP	Avalanche stopped near top part of path.
MP	Avalanche stopped near middle part of path.
BP	Avalanche stopped near bottom part of path.

Note: The codes TP, MP and BP are applicable for short paths where the starting zone, track and runout zone cannot be easily separated.

Operations that have avalanche paths with well-defined features may apply additional codes. For example:

Symbol and data code	Terminus
1F	Avalanche stopped on top 1/4 of fan.
2F	Avalanche stopped halfway down fan.
3F	Avalanche stopped 3/4 of way down fan.

3.3.10 Trigger

Indicate the cause of avalanche release with a basic code letter and, where possible, a modifier. Operations may devise other trigger subclasses that apply to their specific conditions in consultation with the CAA.

Symbol and data code	Cause of avalanche release
N	Natural triggers
X	Explosives
S	Skier or snowboarder
M	Snowmobiles
V	Over-snow vehicles
O	Other (specify in comments)

A more detailed trigger classification system is presented in the following table:

Symbol and data code	Cause of avalanche release
<i>Natural triggers: N</i>	
Na	Natural (result of weather events such as snowfall, wind, temperature)
Nc	Cornice fall, natural
Ne	Earthquakes
Ni	Ice fall
Nr	Rock fall
<i>Artificial triggers, explosives: X</i>	
Xa	Artillery
Xc	Cornice controlled by explosives
Xb	Case (bag) charge placed on the roadside or trail, to trigger slopes above
Xe	Hand-thrown or hand-placed explosive charge
Xg	Gas exploder
Xh	Helicopter bomb
Xl	Avalauncher and other types of launcher
Xp	Pre-placed remotely detonated explosive charge
Xt	Tram or ropeway delivery system
Xr, __m	Remote avalanche occurring at some distance from an explosion
Xy, __m	Avalanche occurring in sympathy with one released by explosives
<i>Artificial triggers, helicopters: H</i>	
Ha	Helicopter, accidental on landing or on approach
Hc	Helicopter, controlled (i.e. deliberate landing on top of slope, etc.)
Hr, __m	Remote avalanche occurring at some distance from helicopter landing
Hy, __m	Avalanche occurring in sympathy with one released by a helicopter
<i>Over-snow vehicles (other than snowmobiles): V</i>	
Va	Over-snow vehicles (snow cats, maintenance equipment, etc.), accidental
Vr, __m	Remote avalanche occurring at some distance from a vehicle
Vy, __m	Avalanche occurring in sympathy with one released by a vehicle
<i>Artificial triggers, skiers, etc.: S</i>	
Sa	Person (skier, snowboarder, hiker, climber), accidental
Sc	Person, controlled (i.e. skier deliberately ski cutting a slope, cornice, etc.)
Sr, __m	A remote avalanche occurring at some distance from a person
Sy, __m	An avalanche occurring in sympathy with one released by a person
<i>Artificial triggers, snowmobiles: M</i>	
Ma	Snowmobile, accidental
Mc	Snowmobile, controlled (i.e. a snowmobiler crossing the top of a slope deliberately starting an avalanche)
Mr, __m	Remote avalanche occurring at some distance from a snowmobile
My, __m	Avalanche occurring in sympathy with one released by a snowmobile
<i>Artificial triggers (miscellaneous)</i>	
O	Other (specify in comments)

Note: Avalanches that start when a helicopter or other aircraft flies overhead should be considered natural.

A remote event is one occurring at some distance (typically > 5 m) from the probable trigger. Snow at the trigger point does not release. Specify the distance to a sympathetic and remote event (in metres).

3.3.11 Comments

Enter information about damage and accidents caused by the avalanche and any other significant information. Describe weather phenomena suspected as the trigger (i.e. rising or falling temperature trend, solar effect, wind loading, wind gusts, precipitation intensity).

3.4 Additional observations

Additional observations may be selected as applicable from those listed in this section. Certain additional observations are valuable in areas where avalanches are either controlled or affect traffic and/or communication lines.

For operations that control avalanches by explosives note:

- Number of explosive charges
- Size of charges (kg)
- Target
- Location of avalanche start
- Sliding surface

When explosives were used but no avalanche resulted or charges misfired note:

- Number
- Size (kg)
- Target
- Location of charges

For highway, railway, mine and forestry road operations note:

- Length of road buried
- Average and maximum depth of snow on the road
- *Toe distance mass*: distance of the toe of the avalanche mass from the uphill edge (fog line) of the road or railway

For ski areas note:

- Target
- Location of avalanche start
- Failure plane and bed surface (note the date of burial and predominant grain type where possible)
- Width and thickness of slab avalanches at their crown

3.4.1 Number of explosive charges/number of detonations

Record the number (1 to 9) of projectiles or explosive charges applied to a target. Record the number (1 to 9) of confirmed detonations.

Note: The difference in the two values gives a dud count.

3.4.2 Size of explosive charge

Note the amount of explosive per charge.

3.4.3 Avalanche starting location

Position in starting zone

Describe the location of the avalanche fracture with one of the following code letters, physical features or elevation *and*, when applicable, add the key for the starting sub-zone or the target.

Symbol and data code	Location of start
T	At the top of the starting zone.
M	In the middle of the starting zone.
B	At the bottom of the starting zone.

Incline of starting zone

Record the incline of the steepest pitch in the avalanche starting zone (excluding cliffs) averaged over a fall-line distance of 20 m.

3.4.4 Bed surface

Level of bed surface

Record the level of the bed surface (the layer over which a slab slides) in the snowpack.

Symbol and data code	Bed surface
S	Avalanche started sliding within a layer of recent storm snow.
O	Avalanche released below storm snow on an old surface or within an old snow layer. Often a persistent weak layer.
G	Avalanche released at ground, glacial ice or firn.

Note: Storm snow is defined as all snow deposited during a recent storm.

Form and age of failure plane

Record the predominant grain form observed in the failure plane (refer to Appendix D). Where possible identify the weak layer by its probable date of burial. Note the occurrence of a shear fracture that steps down to other layers in *Comments*.

3.4.5 Slab width

In a slab avalanche, record width (m) of the slab between the flanks near the fracture line. Add “M” when width is actually measured. Observers may wish to use a hip chain to calibrate their estimates.

Note: All dimensions are assumed to be estimates unless the values are followed with the letter M (measured).

3.4.6 Slab thickness

If practical, estimate or measure in a vertical direction, to nearest 10 cm (i.e. 10 - 30 cm), the average thickness of the slab at the fracture line. Add “M” when thickness is actually measured.

3.4.7 Deposit on road

Record in metres the length of road, railway line, ski run, power line or other facility buried in avalanche snow.

Record average depth and maximum depth of avalanche mass on the road, etc., in metres and tenths of a metre. Add “M” when length and depth are measured.

3.4.8 Toe distance mass

Measure or estimate the distance between the uphill edge or fog line of the road, or other development, and the farthest point reached by the mass of avalanche. Negative values are used when the deposited mass failed to reach the road or facility.

Note: Some operations may also wish to document the occurrence of snow dust on the road. Dust results from the fallout of an avalanche's powder cloud. Its main impact is on driver visibility.

3.4.9 Total deposit dimensions

Record the average width and length of the deposited avalanche snow in metres.

Record the average deposit depth in metres and tenths of a metre. Add “M” after each value is measured by tape and probing.

3.4.10 Elevations

With reference to a contour map record elevation (in m ASL) of the:

- Fracture line or point of failure in starting zone
- Deposit in runout zone

3.4.11 Length of path run

Some operations may wish to record the estimated distance an avalanche ran along a slope.

- Up to a distance of 300 m estimate the distance run to nearest 25 m.
- Beyond a distance of 300 m estimate the distance run to nearest 100 m.

3.4.12 Road / line status

Transportation operations should record the status (open or closed) of any roads or railway lines at the time when the avalanche occurred.

Basic avalanche observations						Observer: <i>B. A.</i> Location: <i>Backcountry, West</i>			
Date	Time	Path	Size	Type	Trigger	Elevation	Aspect	Incline	Comments (slab dimensions, run length, failure plane, etc.)
2016-02-08	~	<i>Moose</i>	2.5	<i>CS</i>	<i>Na</i>	1700	<i>E</i>	40	
2016-02-09	1500	<i>km 18</i>	2	<i>S</i>	<i>Sc</i>	1600	<i>SE</i>	35	<i>35 cm x 30 m x 100 m</i>
2016-02-10	1500	<i>Bear 2</i>	4	<i>S</i>	<i>Xh</i>	1850	<i>E</i>	42	<i>Several trees broken</i>
									<i>in creek, deposit</i>
									<i>up to 10 m deep</i>
2016-02-11	1110	<i>Dans</i>	1.5	<i>l</i>	<i>Na</i>	1750	<i>NE</i>	45	

Figure 11 Sample field-book page for basic avalanche observations or summary.

Avalanche observations (road)			Area <i>TCH Nth</i>		Observer <i>A. D.</i>		
Date	2016-01-12	2016-01-12					
Time	0900	1320					
Age (hours)	4	0					
Path	22.3	21.5					
Road open/closed	<i>O</i>	<i>C</i>					
Size	2.0	2.5					
Type	<i>S</i>	<i>S</i>					
Liquid water - deposit	<i>W</i>	<i>W</i>					
Terminus	<i>MR</i>	<i>BR</i>					
Trigger	<i>Na</i>	<i>Xh</i>					
Toe distance mass	-25	10					
Toe distance dust	~	~					
Length of road buried	0	20					
Max. depth on road	0	3.5					
Avg. depth on road	0	1.2					
Avg. length deposit	50	120					
Avg. width deposit	35	30					
Avg. depth deposit	4	5					
Damage/incident	<i>Nil</i>	<i>Nil</i>					
Comments		<i>glide cracks visible</i>					

Figure 12 Avalanche occurrence field-book page for road operations.

Avalanche observations (ski area)		Location <i>Pine Acres</i>			Observer <i>J. S.</i>
Date	<i>2016-02-11</i>	<i>2016-02-11</i>	<i>2016-02-11</i>	<i>2016-02-11</i>	
Time	<i>0400</i>	<i>0530</i>	<i>0820</i>	<i>0910</i>	
Age (hours)	<i>4</i>	<i>2</i>	<i>0</i>	<i>0</i>	
Path	<i>Black Jack</i>	<i>Betty</i>	<i>Jim's</i>	<i>Granite</i>	
Size	<i>1.5</i>	<i>2.5</i>	<i>2</i>	<i>3</i>	
Type	<i>L</i>	<i>S</i>	<i>S</i>	<i>S</i>	
Liquid water - starting zone	<i>D</i>	<i>D</i>	<i>D</i>	<i>D</i>	
Liquid water - deposit	<i>D</i>	<i>D</i>	<i>D</i>	<i>D</i>	
Terminus	<i>TP</i>	<i>BP</i>	<i>MP</i>	<i>BR</i>	
Trigger	<i>Na</i>	<i>Na</i>	<i>Xe</i>	<i>Sc</i>	
Target	<i>~</i>	<i>~</i>	<i>3</i>	<i>~</i>	
No. of charges	<i>~</i>	<i>~</i>	<i>1</i>	<i>~</i>	
Charge size	<i>~</i>	<i>~</i>	<i>1</i>	<i>~</i>	
No. of detonations	<i>~</i>	<i>~</i>	<i>1</i>	<i>~</i>	
Start location	<i>T</i>	<i>T</i>	<i>T</i>	<i>T</i>	
Level of bed surface	<i>S</i>	<i>S</i>	<i>O</i>	<i>G</i>	
Weak layer	<i>SH 3.0-8.0</i>	<i>SH 3.0-5.0</i>	<i>SH 5.0-10.0</i>	<i>DH 10.0</i>	
Age of failure plane	<i>940121</i>	<i>940121</i>	<i>940121</i>	<i>931120</i>	
Slab width	<i>U</i>	<i>90</i>	<i>60</i>	<i>120</i>	
Slab thickness	<i>U</i>	<i>0.8</i>	<i>0.5</i>	<i>1.6</i>	
Aspect	<i>NE</i>	<i>NE</i>	<i>E</i>	<i>N</i>	
Elevation	<i>1900</i>	<i>1900</i>	<i>1750</i>	<i>1800</i>	
Comments	<i>~</i>	<i>Stopped at edge of bench</i>	<i>~</i>	<i>Patroller Mark S. partially buried</i>	

Figure 13 Sample field-book page for avalanche observations at a ski area with active control.

3.5 Multiple avalanche events

An operation may wish to group large numbers of similar avalanche events into one record or report, especially if that information is to be sent to a central information exchange. Grouping is achieved by allowing certain fields to hold a range of values (i.e. by specifying lower and upper bounds, separated by a dash). The report should be repeated for different types of activity (i.e. natural versus artificially released avalanches).

Parameter	Criteria	Examples
Date	Most probable (median) date for activity as YYYY-MM-DD	2016-02-12
Time	Digits	0900
Age	Digits (± 0 to 99 hours)	48
Area (location)	Text (80 characters max.)	“proposed SW recreation area”
Number of occurrences	Digits or keywords acceptable	1 to 99, Several (2 - 9) Numerous (10 or more) Isolated (less than 5 over a wide geographical area)
Size	The range of any one report should be limited to 1½ size classes	1.5 - 3.0
Trigger	Key letter (do not mix natural and artificial triggers in this report)	Xe, U
Type	Key letter (do not mix slab and loose)	S, L, U
Aspect (of starting zone)	Keyword, 1 or a combination of the 8 cardinal points of the compass	All, W, SW-NW
Elevation (at fracture)	600 m max. range	1800 - 2400 m
Incline (at fracture)	20 degree max. range	32 - 42 degree
Level of bed surface	Key letter (do not mix storm snow, old snow and ground)	S, O, G or U
Grain form at failure plane	Grain form abbreviation (Fierz, et al., in press)	SH
Age of failure plane	Probable date of burial	14 Jan.
Slab width	Range (m)	60 - 110 m
Slab thickness	Range (cm)	10 - 30 cm
Length of path run	Range (m)	500 - 1500 m
Comments	Max. of 5 lines by 80 characters per line	

Note: Significant avalanches (larger than size 3), and events involving incident, damage or injury should not be described in this method. They must be described individually.

3.6 Avalanche summary

3.6.1 Objectives

Avalanche summaries provide a clear and concise overview of avalanche conditions to assist stability and hazard analysis and forecasting for the operational region. The objective of such a summary is to organize and reduce data.

Avalanche summary parameters are different from avalanche observation parameters in that they are not recorded at a specific location and time but are a general characterization of the range of conditions encountered in a broader geographical area during the day. This not only includes average conditions but also potential anomalies and outliers.

3.6.2 Frequency

Summaries are generally done once a day, after the field day is completed.

3.6.3 Procedure

The following basic avalanche observations should be recorded in an avalanche summary.

Locations and elevation range

Locations and elevation range where avalanche observations were made. Many operations will record a drainage as a single location.

Percent of area observed

The area observed recorded as a percentage of the entire operational region.

Date of occurrence

The occurrence date as outlined in Section 3.3.1. If the actual date is unknown, estimate based on previous weather, condition of the crown and deposit, etc.

Time period

The time range during which the avalanche(s) were observed and the age range of the avalanches as outlined in Section 3.3.2.

Number

The number of avalanches of each type and trigger that involved each failure plane and occurred on each date.

Size

The typical size of the avalanches observed and the maximum size observed, as described in Section 3.3.6, for each type, trigger, failure plane and occurrence date.

Trigger

Record the cause of avalanche release as outlined in Section 3.3.10.

Type

Record the type of snow failure as described in Section 3.3.7.

Incline

The average or range of starting zone inclines for each type, trigger and occurrence date.

Aspect

The average or range of starting zone aspects for each type, trigger, failure plane and occurrence date.

Elevation

The average or range of starting zone elevations for each type, trigger, failure plane and occurrence date.

Depth

The average or range of slab thickness values for slab, loose snow + slab, cornice fall + slab or ice fall + slab avalanches and for each trigger, failure plane and occurrence date.

Width

The average or range of slab width values for slab, loose snow + slab, cornice fall + slab or ice fall + slab avalanches and for each trigger, failure plane and occurrence date.

Length

The average or range of length of path run values, as described in Section 3.4.11, for each type, trigger, failure plane and occurrence date.

Failure plane

Record the predominant grain form and level in the snowpack of the failure plane as described in Section 3.4.4.

Comments

Make any additional comments as required. These may include notes on whumpfs, fracture propagation, slab properties and weak layer attributes.

3.7 Recording

Always record the names (initials are fine) of observers with the primary observer listed first. Use a tilde (~) in the notebook when no observation was made. Code as “U” if the observation was attempted but no reliable value could be ascertained (i.e. when an old avalanche is observed and the trigger or type of snow failure cannot be discerned). Do not leave blanks. Only write “0” when the reading is zero (i.e. when the length of road, railway line or ski run buried by the avalanche is zero).

Appendix A

Weather observation sites and procedures

Measurements of precipitation, temperature, wind and the characteristics of the snowpack are dependent on the observation site. It is usually impossible to find a place that would both duplicate the conditions in the avalanche starting zones and be safe and accessible for regular daily observations, so one must be satisfied by choosing a site that provides a good correlation between measurements and snow stability. This means that observational data are only indices of conditions in avalanche paths.

Site selection requires knowledge of the area and skill in meeting contradictory needs. Sometimes parallel observations may be required in several possible locations for one winter before a permanent site is chosen, or a site may have to be abandoned after yielding unsatisfactory correlations with avalanche occurrences.

Observation sites for precipitation and those for wind speed are incompatible. Data on precipitation, often the most important parameter, should be collected at a location sheltered from the wind, whereas wind observations require an exposed site. For practical reasons, temperature observations are usually carried out together with precipitation measurements, but it is preferable to supplement these data with temperature observations at a wind station.

The following guidelines apply to the selection of observation sites.

A.1 Precipitation, snowpack and temperature study plots

The observation site should be as close as possible to avalanche starting zones.

The location should be sheltered from the wind. Sites that minimize snow drifting should be selected if wind cannot be avoided. This is often the case for locations above treeline.

Precipitation gauges located at windy sites can seriously underestimate the actual precipitation amount. Gauge catch can be improved by up to 20% at such sites by fitting an Alter or Nipher shield, or a similar device around the gauge orifice.

The Meteorological Service of Canada (MSC) specify ideal distances from vertical obstructions such as trees and buildings. A preferred distance is about two times the height for precipitation gauges and Stevenson screens.

In high snowfall areas Stevenson screens should be fitted to an adjustable tower and kept 1.2 to 1.4 m above the snow surface. The screen door should open to the north to prevent insolation of the temperature sensors. If electronic sensors are not housed in a Stevenson screen then they must be fitted with radiation shields that allow for good ventilation. A louvered baffle system is commonly used.

The study plot should be on level ground with a smooth surface; grass cover is preferred. The ground should be drained.

The access should be convenient and safe under all weather conditions. Study plots for regular daily snow and weather observations should be close to the operation's headquarters.

A fence and signs should be erected to prevent trespassing. Animal-proof fences are recommended for areas where wildlife might interfere with instrumentation.

A.2 Wind stations

The main requirement for wind stations is a good correlation between the observed winds and speeds and directions in the avalanche starting zones. It may be advantageous to position a wind station on a ridge lower than the mountain peaks, but close to the avalanche starting zone. Identify the potential for snowdrift before placing wind stations.

Anemometers should be located atop a vibration-free 10 m tower. MSC specify that the distance from vertical obstructions such as trees and buildings should preferably be about 10 times the height for anemometers. Ideally, there should be no obstructions within a 100 m radius of the anemometer (this is difficult to achieve).

The station must be accessible in the winter either by foot, snowmobile or helicopter for occasional maintenance of equipment. Rime ice accretion is a common problem.

A.3 Meteorological instruments procedures (Source: AES MANOBS, 1977)

A.3.1 Reading thermometers

The main steps in reading a thermometer are:

1. Stand as far from the thermometer as is consistent with accurate reading, to prevent body heat from affecting the thermometer.
2. Ensure that line of sight from the eye to top of the liquid column makes a 90 degree angle with the thermometer tube, to avoid an error due to parallax. Read thermometer to nearest tenth of a degree.
3. Recheck reading to ensure that it was not misread by 5 or 10 degrees.

A.3.2 Resetting maximum and minimum thermometers

Reset the maximum thermometer after each standard observation. To reset, remove thermometer from its supports, grasp it firmly at the end opposite the bulb and hold it bulb down. Allow the mercury to come into contact with the constriction before starting the reset motion. Briskly swing the thermometer, through an arc that prevents the bulb from rising above the horizontal. This is to prevent damage to the thermometer.

Note: The maximum thermometer is positioned almost horizontally in the Stevenson Screen. Its bulb should be slightly lower than the opposite end.

Reset the minimum thermometer after each standard observation. To reset, remove the bulb end from its support and raise it until the index slides down and rests against the meniscus. Return the bulb end carefully to its support.

Check maximum and minimum thermometer readings after each reset. Check for occurrence of breaks or bubbles in the column and ensure that thermometer readings are representative of ambient temperature.

Note: Maximum thermometers manufactured by JUMO may appear to have a short break in the mercury column in the area of the constriction. This break is caused by a small glass rod inside the bore of the thermometer. Do not attempt to re-unite the column in this area after the thermometer has been reset to the ambient air temperature.

A.3.3 Thermograph procedure and calibration

Many stations are equipped with thermographs for a continuous record of temperature against time. Although the thermograph is not regarded as a primary standard, it may be used as a reference for temperature data (maximum and minimum for standard observations). When temperature data are not available from maximum or minimum thermometers the thermograph may be used to obtain temperatures provided that the following procedures are observed.

1. The thermograph is housed in a thermometer shelter located no farther than necessary from the one which contains the thermometers. It may be possible in some cases to house the thermograph and the thermometer in the same shelter.
2. At the time of each chart change:
 - Adjust thermograph so that the temperature indicated at the start of the trace on the new chart agrees with the present temperature at the time of chart change.
 - Enter the present temperature to the nearest degree just above the end of the temperature trace on the chart just completed.
3. At each standard observation make a time checkmark across the trace by raising and lowering the pen the width of two printed temperature intervals.
4. Adjust the thermograph promptly if at any time the recorder trace is in error by more than 1.5 °C.

A.3.4 Hygrograph calibration

Calibrate the hygrograph at least twice each winter, at the start of the season and again mid-season. Use a wet and dry bulb psychrometer (either an Assman or sling type) and appropriate tables for the site's elevation to determine the relative humidity. Ideally, calibrate the hygrograph at a time when the air temperature is close to or above freezing.

Note: Electronic humidity sensors should also be calibrated with a psychrometer. Electronic sensors often suffer long-term degradation and drift.

Appendix B

Reporting avalanche incidents

B.1 Objective

The objective of reporting avalanche accidents and damage is to collect data about the nature and extent of avalanche hazards in Canada. Summaries of the reports will draw attention to avalanche hazards and assist in the development of risk reduction measures. Reports in this long-term data set are also used to help identify trends in avalanche incidents and for educational purposes.

Individual reports will be treated confidentially and results made public in summary form only. Interesting cases may be included in publications of avalanche incident case histories with the agreement of the parties involved. Recording reporter and victim names and contact information is encouraged but not required.

B.2 Reporting forms

Forms are available for recording avalanche incidents and damage. Any person who wishes to report an avalanche incident can use these forms. Filing reports on-line is encouraged.

The short form is designed for reporting the fact that people or objects had an encounter with avalanches. This report should be submitted every time people are involved in an avalanche or property is damaged.

The detailed report can be used as a template for an incident investigation. This report should be completed when an avalanche caused a fatality, serious injury, property damage in excess of CND\$10,000, or when an incident has high educational value. It may be useful as a check list when operations wish to describe an incident and rescue work in greater detail.

B.3 Filing of reports

Fatal incidents should always be reported to the RCMP.

These forms as well as procedures for submitting avalanche incidents in Canada are currently under revision. The best place to report non-fatal recreational incidents is Avalanche Canada's Mountain Information Network at www.avalanche.ca.

The best place to report non-fatal professional incidents is the InfoEx.

For serious incidents and fatalities, please contact the Canadian Avalanche Association (for professional incidents) or Avalanche Canada (for recreational incidents) for the latest forms and submission procedures.

B.4 Definitions

The following definitions are provided for reporting incidents with the intent of delineating between different rescue scenarios.

Write “N/Av” if the information is not available or “N/App” if not applicable when completing reports.

A person is *caught* if they are touched and adversely affected by the avalanche. People performing slope cuts are generally not considered caught in the resulting avalanche unless they are carried down the slope.

For people who are *caught*, specify the degree of burial according to the following:

1. A person is *not buried* if they are on the surface, their airway is not impaired and they are free to move when the avalanche stops.
2. A person is *partially buried – not critical* if part of their body or clothing is visible and their breathing is not impaired by the snow when the avalanche stops. This requires that the person’s head is above the snow surface and their airway is not obstructed.
3. A person is *partially buried – critical* if part of their body, clothing or attached equipment is visible but their breathing is impaired by the snow when the avalanche stops. Examples include situations where a person’s head is buried below the surface, or a person’s head is above the surface but their airway is plugged by snow. A person not buried but suffering from impaired breathing (i.e. airway plugged with snow) is also classified *partially buried – critical*. For triage purposes, people who are *partially buried – critical* can be prioritized as U1 (first priority).
4. A person is *completely buried* if they are completely beneath the snow surface when the avalanche stops. For triage purposes, people who are *completely buried* can be prioritized according to the following:
 - a) U2 (second priority)
 - no visible surface clues: no attached equipment or body parts visible. Shallow – Medium burial 20cm – 190cm
 - U2-Alpha (air pocket)
 - U2-Zulu (no air pocket)
 - b) U3 (third priority)
 - no visible surface clues: no attached equipment or body parts visible. Deep 2m+
 - U3-Alpha (air pocket)
 - U3-Zulu (no air pocket)

For people that were *completely buried* or *partially buried – critical* estimate the length of time they were buried and the burial depth measured from the snow surface to their face.



Avalanche Incident Report Form

Detailed Form

This form is currently under revision. Check with Avalanche Canada or the CAA for the latest version.

General

Occurrence date:..... Time:.....

Location description:..... Mountain range:.....
Easting:..... Northing:..... UTM zone:..... Map datum: Unknown NAD27 NAD83

Group type: Commercial, operation:..... Club Family/friends Other, specify:.....

Group activity (e.g. in-bounds/out-of-bounds/backcountry, skiing/snowboarding, etc.):.....

Did the group have a clear, identifiable leader? Unknown Paid Volunteer Group member No

of: Females:..... Males:..... Juveniles (< 18 years old):.....
Skiers:..... Snowboarders:..... Snowmobilers:..... Other activity:....., specify:.....

of people with: Transceivers:..... Probes:..... Shovels:..... Avalungs:..... Balloon flotation devices:.....
RECCO devices:..... Helmets:..... Other safety equipment:....., specify:.....

People involved with avalanche

of people who were: Caught but not buried:.....
Partially buried, not critical:.....
Partially buried, critical:.....
Injured:.....

Person: (P.)	Name:	Age:	Gender:		Education:	Qualification:	Working at time?			Leader at time?		
			M	F			Unknown	Yes	No	Unknown	Yes	No
1	<input type="checkbox"/>	<input type="checkbox"/>	<input type="checkbox"/>	<input type="checkbox"/>	<input type="checkbox"/>	<input type="checkbox"/>	<input type="checkbox"/>	<input type="checkbox"/>
2	<input type="checkbox"/>	<input type="checkbox"/>	<input type="checkbox"/>	<input type="checkbox"/>	<input type="checkbox"/>	<input type="checkbox"/>	<input type="checkbox"/>	<input type="checkbox"/>
3	<input type="checkbox"/>	<input type="checkbox"/>	<input type="checkbox"/>	<input type="checkbox"/>	<input type="checkbox"/>	<input type="checkbox"/>	<input type="checkbox"/>	<input type="checkbox"/>
4	<input type="checkbox"/>	<input type="checkbox"/>	<input type="checkbox"/>	<input type="checkbox"/>	<input type="checkbox"/>	<input type="checkbox"/>	<input type="checkbox"/>	<input type="checkbox"/>
5	<input type="checkbox"/>	<input type="checkbox"/>	<input type="checkbox"/>	<input type="checkbox"/>	<input type="checkbox"/>	<input type="checkbox"/>	<input type="checkbox"/>	<input type="checkbox"/>

Avalanche training:					Experience in avalanche terrain:					Travel mode:					Skill with equipment:				
P.1	2	3	4	5	P.1	2	3	4	5	P.1	2	3	4	5	P.1	2	3	4	5
<input type="checkbox"/>	<input type="checkbox"/>	<input type="checkbox"/>	<input type="checkbox"/>	<input type="checkbox"/>	<input type="checkbox"/>	<input type="checkbox"/>	<input type="checkbox"/>	<input type="checkbox"/>	<input type="checkbox"/>	<input type="checkbox"/>	<input type="checkbox"/>	<input type="checkbox"/>	<input type="checkbox"/>	<input type="checkbox"/>	<input type="checkbox"/>	<input type="checkbox"/>	<input type="checkbox"/>	<input type="checkbox"/>	<input type="checkbox"/>
<input type="checkbox"/>	<input type="checkbox"/>	<input type="checkbox"/>	<input type="checkbox"/>	<input type="checkbox"/>	<input type="checkbox"/>	<input type="checkbox"/>	<input type="checkbox"/>	<input type="checkbox"/>	<input type="checkbox"/>	<input type="checkbox"/>	<input type="checkbox"/>	<input type="checkbox"/>	<input type="checkbox"/>	<input type="checkbox"/>	<input type="checkbox"/>	<input type="checkbox"/>	<input type="checkbox"/>	<input type="checkbox"/>	<input type="checkbox"/>
<input type="checkbox"/>	<input type="checkbox"/>	<input type="checkbox"/>	<input type="checkbox"/>	<input type="checkbox"/>	<input type="checkbox"/>	<input type="checkbox"/>	<input type="checkbox"/>	<input type="checkbox"/>	<input type="checkbox"/>	<input type="checkbox"/>	<input type="checkbox"/>	<input type="checkbox"/>	<input type="checkbox"/>	<input type="checkbox"/>	<input type="checkbox"/>	<input type="checkbox"/>	<input type="checkbox"/>	<input type="checkbox"/>	<input type="checkbox"/>
<input type="checkbox"/>	<input type="checkbox"/>	<input type="checkbox"/>	<input type="checkbox"/>	<input type="checkbox"/>	<input type="checkbox"/>	<input type="checkbox"/>	<input type="checkbox"/>	<input type="checkbox"/>	<input type="checkbox"/>	<input type="checkbox"/>	<input type="checkbox"/>	<input type="checkbox"/>	<input type="checkbox"/>	<input type="checkbox"/>	<input type="checkbox"/>	<input type="checkbox"/>	<input type="checkbox"/>	<input type="checkbox"/>	<input type="checkbox"/>
<input type="checkbox"/>	<input type="checkbox"/>	<input type="checkbox"/>	<input type="checkbox"/>	<input type="checkbox"/>	<input type="checkbox"/>	<input type="checkbox"/>	<input type="checkbox"/>	<input type="checkbox"/>	<input type="checkbox"/>	<input type="checkbox"/>	<input type="checkbox"/>	<input type="checkbox"/>	<input type="checkbox"/>	<input type="checkbox"/>	<input type="checkbox"/>	<input type="checkbox"/>	<input type="checkbox"/>	<input type="checkbox"/>	<input type="checkbox"/>
<input type="checkbox"/>	<input type="checkbox"/>	<input type="checkbox"/>	<input type="checkbox"/>	<input type="checkbox"/>	<input type="checkbox"/>	<input type="checkbox"/>	<input type="checkbox"/>	<input type="checkbox"/>	<input type="checkbox"/>	<input type="checkbox"/>	<input type="checkbox"/>	<input type="checkbox"/>	<input type="checkbox"/>	<input type="checkbox"/>	<input type="checkbox"/>	<input type="checkbox"/>	<input type="checkbox"/>	<input type="checkbox"/>	<input type="checkbox"/>
<input type="checkbox"/>	<input type="checkbox"/>	<input type="checkbox"/>	<input type="checkbox"/>	<input type="checkbox"/>	<input type="checkbox"/>	<input type="checkbox"/>	<input type="checkbox"/>	<input type="checkbox"/>	<input type="checkbox"/>	<input type="checkbox"/>	<input type="checkbox"/>	<input type="checkbox"/>	<input type="checkbox"/>	<input type="checkbox"/>	<input type="checkbox"/>	<input type="checkbox"/>	<input type="checkbox"/>	<input type="checkbox"/>	<input type="checkbox"/>
<input type="checkbox"/>	<input type="checkbox"/>	<input type="checkbox"/>	<input type="checkbox"/>	<input type="checkbox"/>	<input type="checkbox"/>	<input type="checkbox"/>	<input type="checkbox"/>	<input type="checkbox"/>	<input type="checkbox"/>	<input type="checkbox"/>	<input type="checkbox"/>	<input type="checkbox"/>	<input type="checkbox"/>	<input type="checkbox"/>	<input type="checkbox"/>	<input type="checkbox"/>	<input type="checkbox"/>	<input type="checkbox"/>	<input type="checkbox"/>
<input type="checkbox"/>	<input type="checkbox"/>	<input type="checkbox"/>	<input type="checkbox"/>	<input type="checkbox"/>	<input type="checkbox"/>	<input type="checkbox"/>	<input type="checkbox"/>	<input type="checkbox"/>	<input type="checkbox"/>	<input type="checkbox"/>	<input type="checkbox"/>	<input type="checkbox"/>	<input type="checkbox"/>	<input type="checkbox"/>	<input type="checkbox"/>	<input type="checkbox"/>	<input type="checkbox"/>	<input type="checkbox"/>	<input type="checkbox"/>
<input type="checkbox"/>	<input type="checkbox"/>	<input type="checkbox"/>	<input type="checkbox"/>	<input type="checkbox"/>	<input type="checkbox"/>	<input type="checkbox"/>	<input type="checkbox"/>	<input type="checkbox"/>	<input type="checkbox"/>	<input type="checkbox"/>	<input type="checkbox"/>	<input type="checkbox"/>	<input type="checkbox"/>	<input type="checkbox"/>	<input type="checkbox"/>	<input type="checkbox"/>	<input type="checkbox"/>	<input type="checkbox"/>	<input type="checkbox"/>

Safety equipment:									
P.	Unknown	Transceiver, type:	Probe, length:	Helmet, type:	Shovel	Avalung	Balloon	RECCO	Other, specify
1	<input type="checkbox"/>	<input type="checkbox"/> ,	<input type="checkbox"/> ,	<input type="checkbox"/> ,	<input type="checkbox"/>	<input type="checkbox"/>	<input type="checkbox"/>	<input type="checkbox"/>	<input type="checkbox"/> ,
2	<input type="checkbox"/>	<input type="checkbox"/> ,	<input type="checkbox"/> ,	<input type="checkbox"/> ,	<input type="checkbox"/>	<input type="checkbox"/>	<input type="checkbox"/>	<input type="checkbox"/>	<input type="checkbox"/> ,
3	<input type="checkbox"/>	<input type="checkbox"/> ,	<input type="checkbox"/> ,	<input type="checkbox"/> ,	<input type="checkbox"/>	<input type="checkbox"/>	<input type="checkbox"/>	<input type="checkbox"/>	<input type="checkbox"/> ,
4	<input type="checkbox"/>	<input type="checkbox"/> ,	<input type="checkbox"/> ,	<input type="checkbox"/> ,	<input type="checkbox"/>	<input type="checkbox"/>	<input type="checkbox"/>	<input type="checkbox"/>	<input type="checkbox"/> ,
5	<input type="checkbox"/>	<input type="checkbox"/> ,	<input type="checkbox"/> ,	<input type="checkbox"/> ,	<input type="checkbox"/>	<input type="checkbox"/>	<input type="checkbox"/>	<input type="checkbox"/>	<input type="checkbox"/> ,

Comment on safety equipment:.....

P.	Activity just before avalanche:	Was victim a trigger?			Position in group: (e.g. 2 nd from front)	Location just before avalanche:
		Unknown	Yes	No		
1	<input type="checkbox"/>	<input type="checkbox"/>	<input type="checkbox"/>	
2	<input type="checkbox"/>	<input type="checkbox"/>	<input type="checkbox"/>	
3	<input type="checkbox"/>	<input type="checkbox"/>	<input type="checkbox"/>	
4	<input type="checkbox"/>	<input type="checkbox"/>	<input type="checkbox"/>	
5	<input type="checkbox"/>	<input type="checkbox"/>	<input type="checkbox"/>	

People involved with avalanche (continued)

Travel direction:

Rescued by:

P.1 2 3 4 5

P.1 2 3 4 5

- Unknown
- Ascent
- Descent
- Level travel
- Traversing
- Stationary

- Unknown
- Self-rescue
- Group member
- Another group
- Organized rescue team, organization:....., rescue leader:.....
- Other, specify:.....

Time when search started:.....

of searchers:..... Names:.....

Search method(s) used: (number in chronological order)

P. 1 2 3 4 5

- Unknown
- Last seen point
- Sound (person calling)
- Visual (person visible)
- Surface clue (gear on surface), specify clue(s):.....
- Transceiver
- Hasty/spot probe, specify probe(s) used:.....
- Improvised probe, specify probe(s) used:.....
- Pinpoint probe after transceiver or dog, specify probe(s) used:.....
- Probe line
- Improvised shovel
- Specialized avalanche shovel
- Trenching
- RECCO/radar
- Dog
- Snowpack melted away
- Other, specify:.....

P. Further details about finding people:

- 1
- 2
- 3
- 4
- 5

Degree of burial:

P.	Unknown	Caught but not buried	Partial - not critical	Partial - critical, depth (face), duration before face exposed	Complete, depth (face), duration before face exposed
1	<input type="checkbox"/>	<input type="checkbox"/>	<input type="checkbox"/>	<input type="checkbox"/>cm,min	<input type="checkbox"/>cm,min
2	<input type="checkbox"/>	<input type="checkbox"/>	<input type="checkbox"/>	<input type="checkbox"/>cm,min	<input type="checkbox"/>cm,min
3	<input type="checkbox"/>	<input type="checkbox"/>	<input type="checkbox"/>	<input type="checkbox"/>cm,min	<input type="checkbox"/>cm,min
4	<input type="checkbox"/>	<input type="checkbox"/>	<input type="checkbox"/>	<input type="checkbox"/>cm,min	<input type="checkbox"/>cm,min
5	<input type="checkbox"/>	<input type="checkbox"/>	<input type="checkbox"/>	<input type="checkbox"/>cm,min	<input type="checkbox"/>cm,min

P.	Distance to crown:	Distance carried:	Burial pocket:			Carried over cliffs:			Hit trees:			Hit rocks:			Into water:		
mm	Unknown	Yes	No	Unknown	Yes	No	Unknown	Yes	No	Unknown	Yes	No	Unknown	Yes	No
1mm	<input type="checkbox"/>	<input type="checkbox"/>	<input type="checkbox"/>	<input type="checkbox"/>	<input type="checkbox"/>	<input type="checkbox"/>	<input type="checkbox"/>	<input type="checkbox"/>	<input type="checkbox"/>	<input type="checkbox"/>	<input type="checkbox"/>	<input type="checkbox"/>	<input type="checkbox"/>	<input type="checkbox"/>	<input type="checkbox"/>
2mm	<input type="checkbox"/>	<input type="checkbox"/>	<input type="checkbox"/>	<input type="checkbox"/>	<input type="checkbox"/>	<input type="checkbox"/>	<input type="checkbox"/>	<input type="checkbox"/>	<input type="checkbox"/>	<input type="checkbox"/>	<input type="checkbox"/>	<input type="checkbox"/>	<input type="checkbox"/>	<input type="checkbox"/>	<input type="checkbox"/>
3mm	<input type="checkbox"/>	<input type="checkbox"/>	<input type="checkbox"/>	<input type="checkbox"/>	<input type="checkbox"/>	<input type="checkbox"/>	<input type="checkbox"/>	<input type="checkbox"/>	<input type="checkbox"/>	<input type="checkbox"/>	<input type="checkbox"/>	<input type="checkbox"/>	<input type="checkbox"/>	<input type="checkbox"/>	<input type="checkbox"/>
4mm	<input type="checkbox"/>	<input type="checkbox"/>	<input type="checkbox"/>	<input type="checkbox"/>	<input type="checkbox"/>	<input type="checkbox"/>	<input type="checkbox"/>	<input type="checkbox"/>	<input type="checkbox"/>	<input type="checkbox"/>	<input type="checkbox"/>	<input type="checkbox"/>	<input type="checkbox"/>	<input type="checkbox"/>	<input type="checkbox"/>
5mm	<input type="checkbox"/>	<input type="checkbox"/>	<input type="checkbox"/>	<input type="checkbox"/>	<input type="checkbox"/>	<input type="checkbox"/>	<input type="checkbox"/>	<input type="checkbox"/>	<input type="checkbox"/>	<input type="checkbox"/>	<input type="checkbox"/>	<input type="checkbox"/>	<input type="checkbox"/>	<input type="checkbox"/>	<input type="checkbox"/>

Spine-axis orientation:

P.1 2 3 4 5

- Unknown
- Face-up
- Face-down
- Right-side-up
- Left-side-up

Hip-axis orientation:

P.1 2 3 4 5

- Unknown
- Head above feet
- Head below feet
- Horizontal
- Standing upright
- Sitting upright
- Other, specify:.....

Air pocket present:

P.	Unknown	Yes	No
1	<input type="checkbox"/>	<input type="checkbox"/>	<input type="checkbox"/>
2	<input type="checkbox"/>	<input type="checkbox"/>	<input type="checkbox"/>
3	<input type="checkbox"/>	<input type="checkbox"/>	<input type="checkbox"/>
4	<input type="checkbox"/>	<input type="checkbox"/>	<input type="checkbox"/>
5	<input type="checkbox"/>	<input type="checkbox"/>	<input type="checkbox"/>

People involved with avalanche (continued)

P.	Injuries:	Fatality:		Injuries assessed by an additional medical professional:			No
		Yes	No	Unknown	Yes, name, affiliation	No	
1	<input type="checkbox"/>	<input type="checkbox"/>	<input type="checkbox"/>	<input type="checkbox"/>	<input type="checkbox"/>
2	<input type="checkbox"/>	<input type="checkbox"/>	<input type="checkbox"/>	<input type="checkbox"/>	<input type="checkbox"/>
3	<input type="checkbox"/>	<input type="checkbox"/>	<input type="checkbox"/>	<input type="checkbox"/>	<input type="checkbox"/>
4	<input type="checkbox"/>	<input type="checkbox"/>	<input type="checkbox"/>	<input type="checkbox"/>	<input type="checkbox"/>
5	<input type="checkbox"/>	<input type="checkbox"/>	<input type="checkbox"/>	<input type="checkbox"/>	<input type="checkbox"/>

Ski/snowboard/snowshoe: (if applicable)

Binding release:

Left					Right				
P.1	2	3	4	5	P.1	2	3	4	5
<input type="checkbox"/>	<input type="checkbox"/>	<input type="checkbox"/>	<input type="checkbox"/>	<input type="checkbox"/>	<input type="checkbox"/>	<input type="checkbox"/>	<input type="checkbox"/>	<input type="checkbox"/>	<input type="checkbox"/>
<input type="checkbox"/>	<input type="checkbox"/>	<input type="checkbox"/>	<input type="checkbox"/>	<input type="checkbox"/>	<input type="checkbox"/>	<input type="checkbox"/>	<input type="checkbox"/>	<input type="checkbox"/>	<input type="checkbox"/>
<input type="checkbox"/>	<input type="checkbox"/>	<input type="checkbox"/>	<input type="checkbox"/>	<input type="checkbox"/>	<input type="checkbox"/>	<input type="checkbox"/>	<input type="checkbox"/>	<input type="checkbox"/>	<input type="checkbox"/>
<input type="checkbox"/>	<input type="checkbox"/>	<input type="checkbox"/>	<input type="checkbox"/>	<input type="checkbox"/>	<input type="checkbox"/>	<input type="checkbox"/>	<input type="checkbox"/>	<input type="checkbox"/>	<input type="checkbox"/>
<input type="checkbox"/>	<input type="checkbox"/>	<input type="checkbox"/>	<input type="checkbox"/>	<input type="checkbox"/>	<input type="checkbox"/>	<input type="checkbox"/>	<input type="checkbox"/>	<input type="checkbox"/>	<input type="checkbox"/>
<input type="checkbox"/>	<input type="checkbox"/>	<input type="checkbox"/>	<input type="checkbox"/>	<input type="checkbox"/>	<input type="checkbox"/>	<input type="checkbox"/>	<input type="checkbox"/>	<input type="checkbox"/>	<input type="checkbox"/>
<input type="checkbox"/>	<input type="checkbox"/>	<input type="checkbox"/>	<input type="checkbox"/>	<input type="checkbox"/>	<input type="checkbox"/>	<input type="checkbox"/>	<input type="checkbox"/>	<input type="checkbox"/>	<input type="checkbox"/>
<input type="checkbox"/>	<input type="checkbox"/>	<input type="checkbox"/>	<input type="checkbox"/>	<input type="checkbox"/>	<input type="checkbox"/>	<input type="checkbox"/>	<input type="checkbox"/>	<input type="checkbox"/>	<input type="checkbox"/>
<input type="checkbox"/>	<input type="checkbox"/>	<input type="checkbox"/>	<input type="checkbox"/>	<input type="checkbox"/>	<input type="checkbox"/>	<input type="checkbox"/>	<input type="checkbox"/>	<input type="checkbox"/>	<input type="checkbox"/>

Unknown
Manually
Automatically
Foot pulled out of boot
Binding detached from ski/board/snowshoe
Did not release

General rescue comments:.....

.....

.....

.....

.....

.....

Snowmobile: (if applicable)

Track:					Engine:					Type:					Orientation:				
P.1	2	3	4	5	P.1	2	3	4	5	P.1	2	3	4	5	P.1	2	3	4	5
<input type="checkbox"/>	<input type="checkbox"/>	<input type="checkbox"/>	<input type="checkbox"/>	<input type="checkbox"/>	<input type="checkbox"/>	<input type="checkbox"/>	<input type="checkbox"/>	<input type="checkbox"/>	<input type="checkbox"/>	<input type="checkbox"/>	<input type="checkbox"/>	<input type="checkbox"/>	<input type="checkbox"/>	<input type="checkbox"/>	<input type="checkbox"/>	<input type="checkbox"/>	<input type="checkbox"/>	<input type="checkbox"/>	<input type="checkbox"/>
<input type="checkbox"/>	<input type="checkbox"/>	<input type="checkbox"/>	<input type="checkbox"/>	<input type="checkbox"/>	<input type="checkbox"/>	<input type="checkbox"/>	<input type="checkbox"/>	<input type="checkbox"/>	<input type="checkbox"/>	<input type="checkbox"/>	<input type="checkbox"/>	<input type="checkbox"/>	<input type="checkbox"/>	<input type="checkbox"/>	<input type="checkbox"/>	<input type="checkbox"/>	<input type="checkbox"/>	<input type="checkbox"/>	<input type="checkbox"/>
<input type="checkbox"/>	<input type="checkbox"/>	<input type="checkbox"/>	<input type="checkbox"/>	<input type="checkbox"/>	<input type="checkbox"/>	<input type="checkbox"/>	<input type="checkbox"/>	<input type="checkbox"/>	<input type="checkbox"/>	<input type="checkbox"/>	<input type="checkbox"/>	<input type="checkbox"/>	<input type="checkbox"/>	<input type="checkbox"/>	<input type="checkbox"/>	<input type="checkbox"/>	<input type="checkbox"/>	<input type="checkbox"/>	<input type="checkbox"/>
<input type="checkbox"/>	<input type="checkbox"/>	<input type="checkbox"/>	<input type="checkbox"/>	<input type="checkbox"/>	<input type="checkbox"/>	<input type="checkbox"/>	<input type="checkbox"/>	<input type="checkbox"/>	<input type="checkbox"/>	<input type="checkbox"/>	<input type="checkbox"/>	<input type="checkbox"/>	<input type="checkbox"/>	<input type="checkbox"/>	<input type="checkbox"/>	<input type="checkbox"/>	<input type="checkbox"/>	<input type="checkbox"/>	<input type="checkbox"/>
<input type="checkbox"/>	<input type="checkbox"/>	<input type="checkbox"/>	<input type="checkbox"/>	<input type="checkbox"/>	<input type="checkbox"/>	<input type="checkbox"/>	<input type="checkbox"/>	<input type="checkbox"/>	<input type="checkbox"/>	<input type="checkbox"/>	<input type="checkbox"/>	<input type="checkbox"/>	<input type="checkbox"/>	<input type="checkbox"/>	<input type="checkbox"/>	<input type="checkbox"/>	<input type="checkbox"/>	<input type="checkbox"/>	<input type="checkbox"/>
<input type="checkbox"/>	<input type="checkbox"/>	<input type="checkbox"/>	<input type="checkbox"/>	<input type="checkbox"/>	<input type="checkbox"/>	<input type="checkbox"/>	<input type="checkbox"/>	<input type="checkbox"/>	<input type="checkbox"/>	<input type="checkbox"/>	<input type="checkbox"/>	<input type="checkbox"/>	<input type="checkbox"/>	<input type="checkbox"/>	<input type="checkbox"/>	<input type="checkbox"/>	<input type="checkbox"/>	<input type="checkbox"/>	<input type="checkbox"/>
<input type="checkbox"/>	<input type="checkbox"/>	<input type="checkbox"/>	<input type="checkbox"/>	<input type="checkbox"/>	<input type="checkbox"/>	<input type="checkbox"/>	<input type="checkbox"/>	<input type="checkbox"/>	<input type="checkbox"/>	<input type="checkbox"/>	<input type="checkbox"/>	<input type="checkbox"/>	<input type="checkbox"/>	<input type="checkbox"/>	<input type="checkbox"/>	<input type="checkbox"/>	<input type="checkbox"/>	<input type="checkbox"/>	<input type="checkbox"/>
<input type="checkbox"/>	<input type="checkbox"/>	<input type="checkbox"/>	<input type="checkbox"/>	<input type="checkbox"/>	<input type="checkbox"/>	<input type="checkbox"/>	<input type="checkbox"/>	<input type="checkbox"/>	<input type="checkbox"/>	<input type="checkbox"/>	<input type="checkbox"/>	<input type="checkbox"/>	<input type="checkbox"/>	<input type="checkbox"/>	<input type="checkbox"/>	<input type="checkbox"/>	<input type="checkbox"/>	<input type="checkbox"/>	<input type="checkbox"/>
<input type="checkbox"/>	<input type="checkbox"/>	<input type="checkbox"/>	<input type="checkbox"/>	<input type="checkbox"/>	<input type="checkbox"/>	<input type="checkbox"/>	<input type="checkbox"/>	<input type="checkbox"/>	<input type="checkbox"/>	<input type="checkbox"/>	<input type="checkbox"/>	<input type="checkbox"/>	<input type="checkbox"/>	<input type="checkbox"/>	<input type="checkbox"/>	<input type="checkbox"/>	<input type="checkbox"/>	<input type="checkbox"/>	<input type="checkbox"/>

Unknown
< 141"
141-159
> 159"
Unknown
< 500 cc
500-800 cc
800-1000 cc
> 1000 cc
Unknown
Trail
Utility/work
Mountain
High-performance
Unknown
Slope-parallel
Cross-slope
Other, specify:.....

P.	Distance from rider along flow:			Distance from rider across flow:			Skier's left of flow	Skier's right of flow
	Up-flow	Down-flow		Up-flow	Down-flow			
1m	<input type="checkbox"/>	<input type="checkbox"/>m	<input type="checkbox"/>	<input type="checkbox"/>	<input type="checkbox"/>	<input type="checkbox"/>
2m	<input type="checkbox"/>	<input type="checkbox"/>m	<input type="checkbox"/>	<input type="checkbox"/>	<input type="checkbox"/>	<input type="checkbox"/>
3m	<input type="checkbox"/>	<input type="checkbox"/>m	<input type="checkbox"/>	<input type="checkbox"/>	<input type="checkbox"/>	<input type="checkbox"/>
4m	<input type="checkbox"/>	<input type="checkbox"/>m	<input type="checkbox"/>	<input type="checkbox"/>	<input type="checkbox"/>	<input type="checkbox"/>
5m	<input type="checkbox"/>	<input type="checkbox"/>m	<input type="checkbox"/>	<input type="checkbox"/>	<input type="checkbox"/>	<input type="checkbox"/>

Avalanches

Date observed:..... Observed by:..... Number of avalanches (Av.):

Av.	Location description:	Easting:	Northing:	Aspect:	Incline:	Trigger pt. incline:	Max. incl. in vicinity:	Vegetation band:			
								Unknown	BTL	TL	Alp
1°°°	<input type="checkbox"/>	<input type="checkbox"/>	<input type="checkbox"/>	<input type="checkbox"/>
2°°°	<input type="checkbox"/>	<input type="checkbox"/>	<input type="checkbox"/>	<input type="checkbox"/>
3°°°	<input type="checkbox"/>	<input type="checkbox"/>	<input type="checkbox"/>	<input type="checkbox"/>

Av.	Time:	Size:	Type:			Distance Ran:	Trigger:	Remotely triggered:		# of people within	
			Unknown	Slab	Loose			Unknown	Yes, dist. to trigger	No	1 m 2 m of trigger pt.:
1	<input type="checkbox"/>	<input type="checkbox"/>	<input type="checkbox"/>m	<input type="checkbox"/>	<input type="checkbox"/> ,m	<input type="checkbox"/>
2	<input type="checkbox"/>	<input type="checkbox"/>	<input type="checkbox"/>m	<input type="checkbox"/>	<input type="checkbox"/> ,m	<input type="checkbox"/>
3	<input type="checkbox"/>	<input type="checkbox"/>	<input type="checkbox"/>m	<input type="checkbox"/>	<input type="checkbox"/> ,m	<input type="checkbox"/>

Human triggered avalanches: (if applicable)

Av. 1 2 3

Person who triggered avalanche was #: on the slope.

Weak layer:

Av.	Primary form:	Size:		Secondary form:	Size:		Burial date:
		Min.	Max.		Min.	Max.	
1mmmmmmmm
2mmmmmmmm
3mmmmmmmm

Avalanches (continued)

Bed surface:

Av.	Primary form:	Size:		Secondary form:	Size:		Level in snowpack:				Stepped:		
		Min.	Max.		Min.	Max.	Unknown	Storm snow	Old snow	Ground	Unknown	Yes	No
1mmmmmmmm	<input type="checkbox"/>	<input type="checkbox"/>	<input type="checkbox"/>	<input type="checkbox"/>	<input type="checkbox"/>	<input type="checkbox"/>	<input type="checkbox"/>
2mmmmmmmm	<input type="checkbox"/>	<input type="checkbox"/>	<input type="checkbox"/>	<input type="checkbox"/>	<input type="checkbox"/>	<input type="checkbox"/>	<input type="checkbox"/>
3mmmmmmmm	<input type="checkbox"/>	<input type="checkbox"/>	<input type="checkbox"/>	<input type="checkbox"/>	<input type="checkbox"/>	<input type="checkbox"/>	<input type="checkbox"/>

Slab avalanches: (if applicable)

Slab thickness:				
Av.	Avg.	Trigger pt.	Slab width:	Slab hardness:
1cmcmm
2cmcmm
3cmcmm

Liquid water content:

Av.	Start zone:				Deposit:			
	Unknown	Dry	Moist	Wet	Unknown	Dry	Moist	Wet
1	<input type="checkbox"/>	<input type="checkbox"/>	<input type="checkbox"/>	<input type="checkbox"/>	<input type="checkbox"/>	<input type="checkbox"/>	<input type="checkbox"/>	<input type="checkbox"/>
2	<input type="checkbox"/>	<input type="checkbox"/>	<input type="checkbox"/>	<input type="checkbox"/>	<input type="checkbox"/>	<input type="checkbox"/>	<input type="checkbox"/>	<input type="checkbox"/>
3	<input type="checkbox"/>	<input type="checkbox"/>	<input type="checkbox"/>	<input type="checkbox"/>	<input type="checkbox"/>	<input type="checkbox"/>	<input type="checkbox"/>	<input type="checkbox"/>

Start zone:

Solar exposure:				Wind exposure:				Skiability:				Relative location:			
Av.	1	2	3	Av.	1	2	3	Av.	1	2	3	Av.	1	2	3
<input type="checkbox"/>	<input type="checkbox"/>	<input type="checkbox"/>	Unknown	<input type="checkbox"/>	<input type="checkbox"/>	<input type="checkbox"/>	Unknown	<input type="checkbox"/>	<input type="checkbox"/>	<input type="checkbox"/>	Unknown	<input type="checkbox"/>	<input type="checkbox"/>	<input type="checkbox"/>	Within ski area
<input type="checkbox"/>	<input type="checkbox"/>	<input type="checkbox"/>	Solar aspect(s)	<input type="checkbox"/>	<input type="checkbox"/>	<input type="checkbox"/>	Windward	<input type="checkbox"/>	<input type="checkbox"/>	<input type="checkbox"/>	No	<input type="checkbox"/>	<input type="checkbox"/>	<input type="checkbox"/>	Adjacent to ski area
<input type="checkbox"/>	<input type="checkbox"/>	<input type="checkbox"/>	Shaded solar aspect(s)	<input type="checkbox"/>	<input type="checkbox"/>	<input type="checkbox"/>	Lee	<input type="checkbox"/>	<input type="checkbox"/>	<input type="checkbox"/>	Yes	<input type="checkbox"/>	<input type="checkbox"/>	<input type="checkbox"/>	Ski run
<input type="checkbox"/>	<input type="checkbox"/>	<input type="checkbox"/>	Non-solar aspect(s)	<input type="checkbox"/>	<input type="checkbox"/>	<input type="checkbox"/>	Cross-loaded	<input type="checkbox"/>	<input type="checkbox"/>	<input type="checkbox"/>	No-yes	<input type="checkbox"/>	<input type="checkbox"/>	<input type="checkbox"/>	Not on ski run
				<input type="checkbox"/>	<input type="checkbox"/>	<input type="checkbox"/>	Sheltered					<input type="checkbox"/>	<input type="checkbox"/>	<input type="checkbox"/>	Climbing route
				<input type="checkbox"/>	<input type="checkbox"/>	<input type="checkbox"/>	Down-flow					<input type="checkbox"/>	<input type="checkbox"/>	<input type="checkbox"/>	Other, specify:.....
				<input type="checkbox"/>	<input type="checkbox"/>	<input type="checkbox"/>	Wind pillow (obsolete)								

Usage history:

Av.	1	2	3
<input type="checkbox"/>	<input type="checkbox"/>	<input type="checkbox"/>	Unknown
<input type="checkbox"/>	<input type="checkbox"/>	<input type="checkbox"/>	Not previously skied/sledded
<input type="checkbox"/>	<input type="checkbox"/>	<input type="checkbox"/>	Previously skied
<input type="checkbox"/>	<input type="checkbox"/>	<input type="checkbox"/>	Previously sledded
<input type="checkbox"/>	<input type="checkbox"/>	<input type="checkbox"/>	Heavily skied
<input type="checkbox"/>	<input type="checkbox"/>	<input type="checkbox"/>	Heavily sledded
<input type="checkbox"/>	<input type="checkbox"/>	<input type="checkbox"/>	Previously controlled with results
<input type="checkbox"/>	<input type="checkbox"/>	<input type="checkbox"/>	Previously controlled without results
<input type="checkbox"/>	<input type="checkbox"/>	<input type="checkbox"/>	Previously slid

Comments on start zone: (terrain characteristics, ground cover, etc.)

-
-
-

Comments on trigger point: (terrain feature, proximity to ridge top, wind effects, etc.)

-
-
-

Additional avalanche comments:

-
-
-

Snowpack

Snowpack tests (T.):

T.	Type:	Location:	Test depth:	Incline:	Test result:	Fracture character:	Fracture depth:	Depth in profile:	Comments/layer ID:
1cm°cmcm
2cm°cmcm
3cm°cmcm

Tracks on slope: Unknown From the same day Since last storm Old tracks visible None

Tracks on bed surface: Unknown Yes No

Comments on snowpack:.....
.....

Weather

Weather obs. (Wx.): 1 2 3
 Date:
 Time:
 Location:
 Easting
 Northing
 Elevation: m m m
 Sky condition:
 Valley fog: (top level) m m m
 Precip. type/rate:
 Surface form/size:

Temperature: Manual Automatic
 Wx.1 Interval: Wx.2 Interval: Wx.3 Interval:
 Min.: °C hrs °C hrs °C hrs
 Max.: °C hrs °C hrs °C hrs
 Present: °C °C °C
 3 hr change: °C °C °C
 1 day change: °C °C °C

Snow height: Manual Automatic
 Water Cleared Water Cleared Water Cleared
 Wx.1 equiv.: date, time: Wx.2 equiv.: date, time: Wx.3 equiv.: date, time:
 HINT: cm mm ,cm mm ,cm mm ,
 HST: cm mm ,cm mm ,cm mm ,
 H2D: cm mm cm mm cm mm
 HN24: cm mm cm mm cm mm
 HS: cm mm cm mm cm mm

Amount of new snow at accident site within 24 hours prior to accident:cm

Wind: Manual Automatic
 Wx. 1 2 3
 Speed:
 Direction:
 Transport ext:
 Transport dir:

Precipitation: Manual Automatic
 Wx.1 Interval: Wx.2 Interval: Wx.3 Interval:
 Rain gauge: mm hrs mm hrs mm hrs
 Precip. gauge: (accumul.) mm mm mm

Comments on weather:.....

Assessment by group member(s)

	Unknown	Yes	No
Did you meet any other people on your trip previous to the avalanche?	<input type="checkbox"/>	<input type="checkbox"/>	<input type="checkbox"/>
Was your group pressured into actively pursuing a stated goal because of time or other constraints?	<input type="checkbox"/>	<input type="checkbox"/>	<input type="checkbox"/>
Were you in an obvious avalanche path when the avalanche occurred?	<input type="checkbox"/>	<input type="checkbox"/>	<input type="checkbox"/>
Was there a terrain trap (e.g. gully, cliff, trees, crevasse) below your route when the avalanche occurred?	<input type="checkbox"/>	<input type="checkbox"/>	<input type="checkbox"/>
Was your group reducing the risk when the avalanche occurred (e.g. spaced apart)?	<input type="checkbox"/>	<input type="checkbox"/>	<input type="checkbox"/>
Were you aware of any whumpfs or cracking on your route within 24 hrs previous to avalanche?	<input type="checkbox"/>	<input type="checkbox"/>	<input type="checkbox"/>
Were you aware of drifting snow on the avalanche slope within 24 hrs previous to avalanche?	<input type="checkbox"/>	<input type="checkbox"/>	<input type="checkbox"/>
Were you aware of any avalanche activity in the same mtn. range within 24 hrs previous to avalanche?	<input type="checkbox"/>	<input type="checkbox"/>	<input type="checkbox"/>
Comment on avalanche activity:.....			
Was the aspect on which the avalanche occurred declared unfavourable in the avalanche bulletin?	<input type="checkbox"/>	<input type="checkbox"/>	<input type="checkbox"/>
How would you rate your group's terrain selection with respect to conditions when the avalanche occurred?	<input type="checkbox"/> unknown		
	<input type="checkbox"/> Conservative <input type="checkbox"/> Appropriate <input type="checkbox"/> Aggressive <input type="checkbox"/> Other, specify:.....		
How familiar was your group or decision maker with the area you were travelling in?	<input type="checkbox"/> Unknown	<input type="checkbox"/> Very	<input type="checkbox"/> Somewhat <input type="checkbox"/> Not
Did your group have a clear, identifiable leader?	<input type="checkbox"/> Unknown	<input type="checkbox"/> Paid	<input type="checkbox"/> Volunteer <input type="checkbox"/> Group member <input type="checkbox"/> No

Assessment by group member(s) (continued)

What information sources did you check before the trip?	Overall importance:	Rate the source with respect to information on:			
		Avalanche activity	Whumpfs or cracking	Drifting snow	Unfavourable aspect
<input type="checkbox"/> Unknown
<input type="checkbox"/> Own observations
<input type="checkbox"/> CAA avalanche bulletin
<input type="checkbox"/> Local avalanche advisory
<input type="checkbox"/> Local backcountry operator
<input type="checkbox"/> Local ski patrol
<input type="checkbox"/> InfoEx
<input type="checkbox"/> Contacted others
<input type="checkbox"/> Trip report
<input type="checkbox"/> Guide book
<input type="checkbox"/> Terrain photo
<input type="checkbox"/> Map
<input type="checkbox"/> Other, specify:.....
<input type="checkbox"/> None

0 - N/A
 1 - Not important
 2 - Somewhat important
 3 - Important
 4 - Very important
 5 - Extremely important

Additional sources used during the trip:

<input type="checkbox"/> Unknown
<input type="checkbox"/> Own observations
<input type="checkbox"/> Other recreationists
<input type="checkbox"/> Local backcountry operator
<input type="checkbox"/> Local ski patrol
<input type="checkbox"/> Other, specify:.....
<input type="checkbox"/> None

Which human factors contributed to the accident?

	Overall importance
<input type="checkbox"/> Unknown
<input type="checkbox"/> Blue sky
<input type="checkbox"/> Lack of designated leader
<input type="checkbox"/> Poor communication within group
<input type="checkbox"/> Over importance attached to destination / goal
<input type="checkbox"/> Rush to complete trip (e.g. return to trailhead/hut)
<input type="checkbox"/> Thrill of descent (only if incident occurred immediately prior to or during descent)
<input type="checkbox"/> Overconfidence
<input type="checkbox"/> Impulsiveness
<input type="checkbox"/> Invulnerability
<input type="checkbox"/> Macho attitude
<input type="checkbox"/> Resignation
<input type="checkbox"/> Anti-authority
<input type="checkbox"/> None

Expert assessment

Name:..... Qualification:.....

	Unknown	Yes	No
Was the aspect on which the avalanche occurred declared unfavourable in the avalanche bulletin?	<input type="checkbox"/>	<input type="checkbox"/>	<input type="checkbox"/>
Was the group reducing the risk when the avalanche occurred (e.g. spaced apart)?	<input type="checkbox"/>	<input type="checkbox"/>	<input type="checkbox"/>
Were any group members in or above a terrain trap when the avalanche occurred?	<input type="checkbox"/>	<input type="checkbox"/>	<input type="checkbox"/>
Was the group in an obvious avalanche path when the avalanche occurred?	<input type="checkbox"/>	<input type="checkbox"/>	<input type="checkbox"/>
Was there evidence of any whumpfs or cracking on the route within 24 hrs previous to avalanche?	<input type="checkbox"/>	<input type="checkbox"/>	<input type="checkbox"/>
Was there drifting snow on the avalanche slope within 24 hrs previous to avalanche?	<input type="checkbox"/>	<input type="checkbox"/>	<input type="checkbox"/>
Did the group meet any other people on the same trip previous to the avalanche?	<input type="checkbox"/>	<input type="checkbox"/>	<input type="checkbox"/>
Was the group pressured into actively pursuing a stated goal because of timing or other constraints?	<input type="checkbox"/>	<input type="checkbox"/>	<input type="checkbox"/>
Did 'grouping up' play a significant role in triggering the avalanche?	<input type="checkbox"/>	<input type="checkbox"/>	<input type="checkbox"/>
Was there any relevant avalanche activity in the same mtn. range within 24 hrs previous to avalanche?	<input type="checkbox"/>	<input type="checkbox"/>	<input type="checkbox"/>
Comment on avalanche activity:.....			
How familiar was the group or decision maker with the terrain?	<input type="checkbox"/> Unknown	<input type="checkbox"/> Very	<input type="checkbox"/> Somewhat
How would you rate the group's terrain selection with respect to conditions when the avalanche occurred?	<input type="checkbox"/> Unknown		
<input type="checkbox"/> Conservative <input type="checkbox"/> Appropriate <input type="checkbox"/> Aggressive <input type="checkbox"/> Other, specify:.....			

Expert assessment (continued)

Sources of information used:	Overall importance:	Rate the source with respect to information on:			
		Avalanche activity	Whumpfs or cracking	Drifting snow	Unfavourable aspect
<input type="checkbox"/> Unknown
<input type="checkbox"/> Own observations
<input type="checkbox"/> CAA avalanche bulletin
<input type="checkbox"/> Local avalanche advisory
<input type="checkbox"/> Local backcountry operator
<input type="checkbox"/> Local ski patrol
<input type="checkbox"/> InfoEx
<input type="checkbox"/> Contacted others
<input type="checkbox"/> Trip report
<input type="checkbox"/> Guide book
<input type="checkbox"/> Terrain photo
<input type="checkbox"/> Map
<input type="checkbox"/> Other, specify:.....
<input type="checkbox"/> None

0 - N/A
 1 - Not important
 2 - Somewhat important
 3 - Important
 4 - Very important
 5 - Extremely important

Which human factors contributed to the accident?	Overall importance
<input type="checkbox"/> Unknown
<input type="checkbox"/> Blue sky
<input type="checkbox"/> Lack of designated leader
<input type="checkbox"/> Poor communication within group
<input type="checkbox"/> Over importance attached to destination / goal
<input type="checkbox"/> Rush to complete trip (e.g. return to trailhead/hut)
<input type="checkbox"/> Thrill of descent (only if incident occurred immediately prior to or during descent)
<input type="checkbox"/> Overconfidence
<input type="checkbox"/> Impulsiveness
<input type="checkbox"/> Invulnerability
<input type="checkbox"/> Macho attitude
<input type="checkbox"/> Resignation
<input type="checkbox"/> Anti-authority
<input type="checkbox"/> None

Additional comments on human factors:.....

Property damage Value of property lost or damaged: \$..... (CND)

Comments about property lost or damaged:.....

Reported by Name:..... Qualification:..... Date:.....

Address:.....

Phone #:..... Email:.....

Avalanche training: < 2 day course 2-3 day course 4-5 day course > 5 day course CAA Level 1 CAA Level 2
 Other, specify:.....

Additional contact person Name:.....

Address:.....

Phone #:..... Email:.....

Enclosures – Include additional information that is available: (e.g. weather observations in greater detail, snow profiles, map with location of incident, sketch of avalanche showing location of people and objects before and after avalanche, narrative describing how people and/or objects became involved with the avalanche, photographs, copy of the report from any rescue organization involved, etc)

Note: This information is intended for public education and information. It may be summarized and published by the CAA/AvCan. The reporter's name will not be published by the CAA/AvCan without his or her written permission.

Please send to: forecaster@avalanche.ca

Appendix C

International system (SI) of units and expanded equations

C.1 Density

Previous editions of these guidelines (1989 and earlier) described a measure known as specific gravity. This term is no longer used. Specific gravity of snow was non-dimensional and had a value of less than one. Previous data recorded as specific gravity may be converted by multiplying by 1000 as follows:

$$\text{Density (kg/m}^3\text{)} = \text{Specific gravity} \times 1000$$

i.e. A specific gravity value of 0.15 = 150 kg/m³.

C.2 Barometric pressure

Barometric pressure is expressed in kilopascals (kPa). Use the following multipliers to convert from other units.

Unit	Multiplier used to convert to kilopascals
Hectopascal (hPa)	0.1
Millibars (mb)	0.1
Millimetres of mercury (mmHg)	0.133
Inches of mercury (inHg)	3.386

C.3 Stress and strength

The strength of avalanche snow ranges from about 0.1 kPa to an upper limit of 100 kPa.

Unit	Multiplier used to convert to kilopascals
Pascal (Pa)	0.001
Newtons per square metre (N/m ²)	0.001
Grams per square centimetre (g/cm ²)	0.0981

C.4 Impact pressures

It is common engineering practice to specify impact pressures in tonnes per square metre (t/m²). A more precise unit is tonnes-force per square metre. Refer to Appendix A of *The Avalanche Handbook, 3rd Edition*, McClung and Schaerer (2006) for a discussion.

Unit	Multiplier used to convert to kilopascals
Tonnes per square metre (t/m ²)	9.81

C.5 Windspeed

Wind speed is expressed in kilometres per hour (km/h).

Unit	Multiplier used to convert to kilometres per hour
Metres per second (m/s)	3.6
Knots (kn)	1.853
Miles per hour (mph)	1.609

C.6 Expanded equations

Several equations are presented in abbreviated form in the text. The expanded versions below are intended to explain how the abbreviated versions were derived.

C.6.1 Water equivalent of new snow (H2DW or H24W)

Section 1.4.11:

$$\text{H2DW (mm)} = \frac{\text{Mass of new snow (g)}}{\text{Cross - section area of density cutter (cm}^2\text{)}} \times 10$$

Expanded:

$$\text{H2DW (mm)} = \frac{\text{Mass of new snow (g)}}{\text{Cross - section area of density cutter (cm}^2\text{)}} \times \frac{1 \text{ (cm}^2\text{)}}{100 \text{ (mm}^2\text{)}} \times \frac{1 \text{ (cm}^3 \text{ water)}}{1 \text{ (g water)}} \times \frac{1000 \text{ (mm}^3\text{)}}{1 \text{ (cm}^3\text{)}}$$

C.6.2 Density (ρ)

Section 1.4.12 first equation:

$$\rho \left(\frac{\text{kg}}{\text{m}^3} \right) = \frac{\text{Mass of new snow (g)}}{\text{Sample volume (cm}^3\text{)}} \times 1000$$

Expanded:

$$\rho \left(\frac{\text{kg}}{\text{m}^3} \right) = \frac{\text{Mass of new snow (g)}}{\text{Sample volume (cm}^3\text{)}} \times \frac{1000000 \text{ (cm}^3\text{)}}{1 \text{ (m}^3\text{)}} \times \frac{1 \text{ (kg)}}{1000 \text{ (g)}}$$

Section 1.4.12 second equation:

$$\rho \left(\frac{\text{kg}}{\text{m}^3} \right) = \frac{\text{Water equivalent of snow sample (mm)}}{\text{Height of snow sample (cm)}} \times 100$$

Expanded:

$$\rho \left(\frac{\text{kg}}{\text{m}^3} \right) = \frac{\text{Water equivalent of snow sample (mm)}}{\text{Height of snow sample (cm)}} \times \frac{1(\text{cm})}{10(\text{mm})} \times \frac{1(\text{g water})}{1(\text{cm}^3 \text{ water})} \times \frac{1(\text{kg})}{1000(\text{g})} \times \frac{1000\,000(\text{cm}^3)}{1(\text{m}^3)}$$

Section 2.1.5:

$$\rho \left(\frac{\text{kg}}{\text{m}^3} \right) = \frac{\text{Mass of snow sample (g)}}{\text{Sample volume (cm}^3)} \times 1000$$

Expanded:

$$\rho \left(\frac{\text{kg}}{\text{m}^3} \right) = \frac{\text{Mass of snow sample (g)}}{\text{Sample volume (cm}^3)} \times \frac{1000\,000(\text{cm}^3)}{1(\text{m}^3)} \times \frac{1(\text{kg})}{1000(\text{g})}$$

C.6.3 Water equivalent of snow cover (HSW)

Section 2.1.6:

$$\text{HSW (mm)} = \sum \left[\text{Vertical thickness (cm)} \times \text{Density} \left(\frac{\text{kg}}{\text{m}^3} \right) \right] \times 0.01$$

Expanded:

$$\text{HSW (mm)} = \sum \left[\text{Vertical thickness (cm)} \times \text{Density} \left(\frac{\text{kg}}{\text{m}^3} \right) \right] \times \frac{1(\text{cm}^3 \text{ water})}{1(\text{g water})} \times \frac{1000(\text{g})}{1\text{kg}} \times \frac{1(\text{m}^3)}{1000\,000(\text{cm}^3)} \times \frac{10(\text{mm})}{1(\text{cm})}$$

C.6.4 Average bulk density

Section 2.1.7:

$$\bar{\rho} \left(\frac{\text{kg}}{\text{m}^3} \right) = \frac{\text{Water equivalent of snow cover (mm)}}{\text{Total snowpack depth (cm)}} \times 100$$

Expanded:

$$\bar{\rho} \left(\frac{\text{kg}}{\text{m}^3} \right) = \frac{\text{Water equivalent of snow cover (mm)}}{\text{Total snowpack depth (cm)}} \times \frac{1(\text{cm})}{10(\text{mm})} \times \frac{1(\text{kg})}{1000(\text{g})} \times \frac{1(\text{g water})}{1(\text{cm}^3 \text{ water})} \times \frac{1000\,000(\text{cm}^3)}{1(\text{m}^3)}$$

Appendix D

International classification for seasonal snow on the ground

D.1 Main and sub-classes of grain shapes

Basic classification		Morphological classification		Additional information on physical processes and strength parameters				
	Subclass	Shape	Code	Place of formation	Physical process	Dependence on most important parameters	Common effect on strength	
+	Precipitation Particles	PP						
		Columns	Prismatic crystal, solid or hollow	PPco	Cloud; temperature inversion layer (clear sky)	Growth from water vapour at -3 to -8 °C and below -30 °C		
		Needles	Needle-like, approximately cylindrical	PPnd	Cloud	Growth from water vapour at high super-saturation at -3 to -5 °C and below -60 °C		
		Plates	Plate-like, mostly hexagonal	PPpl	Cloud; temperature inversion layer (clear sky)	Growth from water vapour at 0 to -3 °C and -8 to -70 °C		
		Stellars, Dendrites	Six-fold star-like, planar or spatial	PPsd	Cloud; temperature inversion layer (clear sky)	Growth from water vapour at high super-saturation at 0 to -3 °C and at -12 to -16 °C		
		Irregular crystals	Clusters of very small crystals	PPir	Cloud	Polycrystals growing in varying environmental conditions		
		Graupel	Heavily rimed particles, spherical, conical, hexagonal, or irregular in shape	PPgp	Cloud	Heavy riming of particles by accretion of supercooled water droplets Size: ≤ 5 mm		
		Hail	Laminar internal structure, translucent or milky glazed surface	PPhl	Cloud	Growth by accretion of supercooled water Size: > 5 mm		
		Ice pellets	Transparent, mostly small spheroids	PPip	Cloud	Freezing of raindrops or refreezing of largely melted snow crystals or snowflakes (sleet) Graupel or snow pellets encased in thin ice layer (small hail) Size: both ≤ 5 mm		
		Rime	Irregular deposits or longer cones and needles pointing into the wind	PPrm	Onto surface as well as on freely exposed objects	Accretion of small, supercooled fog droplets frozen in place Thin breakable crust forms on snow surface if process continues long enough		Increase with fog density and exposure to wind

Notes:

- Diamond dust is a further type of precipitation often observed in polar regions.
- Hard rime is more compact and amorphous than soft rime and may build out as glazed cones or ice feathers (AMS, 2000)
- The above subclasses do not cover all types of particles and crystals one may observe in the atmosphere. See the references below for a more comprehensive coverage.

References: Magono & Lee, 1966; Bailey & Hallett, 2004; Dougalik & Pershina, 2005; Libbrecht, 2005

Morphological classification		Additional information on physical processes and strength					
Basic classification	Subclass	Shape	Code	Place of formation	Physical process	Dependence on most important parameters	Common effect on strength
Machine Made snow	Round polycrystalline particles	Small spherical particles, often showing protrusions, a result of the freezing process; may be partially hollow	MMrp	Atmosphere, near surface	Machined snow, i.e., freezing of very small water droplets from the surface inward	Liquid water content depends mainly on air temperature and humidity but also on snow density and grain size	In dry conditions, quick sintering results in rapid strength increase
	Crushed ice particles	Ice plates, shard-like	MMci	Ice generators	Machined ice, i.e., production of flake ice, subsequent crushing, and pneumatic distribution	All weather safe	

References: [Fauve et al., 2002](#)

Morphological classification		Additional information on physical processes and strength					
Basic classification	Subclass	Shape	Code	Place of formation	Physical process	Dependence on most important parameters	Common effect on strength
Decomposing and Fragmented precipitation particles	Partly decomposed precipitation particles	Characteristic shapes of precipitation particles still recognizable; often partly rounded.	DFdc	Within snowpack; recently deposited snow near the surface, usually dry	Decrease of surface area to reduce surface free energy; also fragmentation due to light winds lead to initial break up	Speed of decomposition decreases with decreasing snow temperatures and decreasing temperature gradients	Regains cohesion by sintering after initial strength decreased due to decomposition process
	Wind-broken precipitation particles	Shards or fragments of precipitation particles	DFbk	Surface layer, mostly recently deposited snow	Saltation particles are fragmented and packed by wind, often closely; fragmentation often followed by rounding	Fragmentation and packing increase with wind speed	Quick sintering results in rapid strength increase

Basic classification		Morphological classification		Additional information on physical processes and strength		
Subclass	Shape	Code	Place of formation	Physical process	Dependence on most important parameters	Common effect on strength
Rounded Grains						
Small rounded particles	Rounded, usually elongated particles of size < 0.25 mm; highly sintered	RGsr	Within snowpack; dry snow	Decrease of specific surface area by slow decrease of number of grains and increase of mean grain diameter. Small equilibrium growth form	Growth rate increases with increasing temperature; growth slower in high density snow with smaller pores	Strength due to sintering of the snow grains [1]. Strength increases with time, settlement and decreasing grain size
Large rounded particles	Rounded, usually elongated particles of size > 0.25 mm; well sintered	RGlr	Within snowpack; dry snow	Grain-to-grain vapour diffusion due to low temperature gradients, i.e., mean excess vapour density remains below critical value for kinetic growth. Large equilibrium growth form	Same as above	Same as above
Wind packed	Small, broken or abraded, closely-packed particles; well sintered	RGwp	Surface layer; dry snow	Packing and fragmentation of wind transported snow particles that round off by interaction with each other in the salination layer. Evolves into either a hard but usually breakable wind crust or a thicker wind slab. (see notes)	Hardness increases with wind speed, decreasing particle size and moderate temperature	High number of contact points and small size causes rapid strength increase through sintering
Faceted rounded particles	Rounded, usually elongated particles with developing facets	RGxf	Within snowpack; dry snow	Growth regime changes if mean excess vapour density is larger than critical value for kinetic growth. Accordingly, this transitional form develops facets as temperature gradient increases	Grains are changing in response to an increasing temperature gradient	Reduction in number of bonds may decrease strength

Notes: – Both wind crusts and wind slabs are layers of small, broken or abraded, closely packed and well-sintered particles. The former are thin irregular layers whereas the latter are thicker, often dense layers, usually found on lee slopes.
 – Both types of layers can be represented either as sub-class RGwp or as RGsr along with proper grain size, hardness and/or density.
 – If the grains are smaller than about 1 mm, an observer will need to consider the process at work to differentiate RGxf from FCxr.

References: [1] Colbeck, 1997

Basic classification		Morphological classification			Additional information on physical processes and strength			
		Subclass	Shape	Code	Place of formation	Physical process	Dependence on most important parameters	Common effect on strength
Faceted Crystals	□	Solid faceted particles	Solid faceted crystals; usually hexagonal prisms	FCso	Within the snowpack; dry snow	Solid kinetic growth form, i.e., a solid crystal with sharp edges and corners as well as glassy, smooth faces	Growth rate increases with temperature, increasing temperature gradient, and decreasing density; may not grow to larger grains in high density snow because of small pores	Strength decreases with increasing growth rate and grain size
		Near surface faceted particles	Faceted crystals in surface layer	FCsf	Within the snowpack but right beneath the surface; dry snow	May develop directly from Precipitation Particles (PP) or Decomposing and Fragmented particles (DFEG) due to large, near-surface temperature gradients [1] Solid kinetic growth form (see FCso above) at early stage of development	Temperature gradient may periodically change sign but remains at a high absolute value	Low strength snow
		Rounding faceted particles	Faceted crystals with rounding facets and corners	FCxr	Within the snowpack; dry snow	Trend to a transitional form reducing its specific surface area as temperature gradient decreases; corners and edges of the crystals are rounding off		

Notes: – Once buried, FCsf are hard to distinguish from FCso unless the observer is familiar with the evolution of the snowpack.

– FCxr can usually be clearly identified for crystals larger than about 1 mm. In case of smaller grains, however, an observer will need to consider the process at work to differentiate FCxr from RGxf.

References: [1] [Birkeland, 1998](#)





Basic classification		Morphological classification			Additional information on physical processes and strength		
Depth Hoar	Subclass	Shape	Code	Place of formation	Physical process	Dependence on most important parameters	Common effect on strength
∧	Hollow cups	Striated, hollow skeleton type crystals; usually cup-shaped	DH	Within the snowpack; dry snow	Grain-to-grain vapour diffusion driven by large temperature gradient, i.e., excess vapour density is well above critical value for kinetic growth.	See FCSo .	Usually fragile but strength increases with density
	Hollow prisms	Prismatic, hollow skeleton type crystals with glassy faces but few striations	DHpr	Within the snowpack; dry snow	Snow has completely recrystallized; high temperature gradient in low density snow, most often prolonged [2]	High recrystallization rate for long period and low density snow facilitates formation	May be very poorly bonded
	Chains of depth hoar	Hollow skeleton type crystals arranged in chains	DHch	Within the snowpack; dry snow	Snow has completely recrystallized; inter-granular arrangement in chains; most of the lateral bonds between columns have disappeared during crystal growth	High recrystallization rate for long period and low density snow facilitates formation	Very fragile snow
	Large striated crystals	Large, heavily striated crystals; either solid or skeleton type	DHla	Within the snowpack; dry snow	Evolves from earlier stages described above; some bonding occurs as new crystals are initiated [2]	Longer time required than for any other snow crystal; long periods of large temperature gradient in low density snow are needed	Regains strength
	Rounding depth hoar	Hollow skeleton type crystals with rounding of sharp edges, corners, and striations	DHxr	Within the snowpack; dry snow	Trend to a form reducing its specific surface area; corners and edges of the crystals are rounding off; faces may loose their relief, i.e., striations and steps disappear slowly. This process effects all subclasses of depth hoar	Grains are rounding off in response to a decreasing temperature gradient	May regain strength

Notes: – DH and FC crystals may also grow in snow with density larger than about 300 kg m⁻³ such as found in polar snow cover or wind slabs. These may then be termed 'hard' or 'indurated' depth hoar [3].
 References: [1] [Akitava, 1974](#); [Marbouty, 1980](#); [Fukuzawa & Akitava, 1993](#); [Baumach et al., 2001](#); [2] [Sturm & Benson, 1997](#); [3] [Akitava, 1974](#); [Benson & Sturm, 1993](#)

Morphological classification		Additional information on physical processes and strength					
Basic classification	Subclass	Shape	Code	Place of formation	Physical process	Dependence on most important parameters	Common effect on strength
Surface Hoar	Surface hoar crystals	Striated, usually flat crystals; sometimes needle-like	SHsu	Usually on cold snow surface relative to air temperature; sometimes on freely exposed objects above the surface (see notes)	Rapid kinetic growth of crystals at the snow surface by rapid transfer of water vapour from the atmosphere toward the snow surface; snow surface cooled to below ambient temperature by radiative cooling	Both, increased cooling of the snow surface below air temperature as well as increasing relative humidity of the air cause growth rate to increase. In high water vapour gradient fields, e.g. near creeks, large feathery crystals may develop	Fragile, extremely low shear strength; strength may remain low for extended periods when buried in cold dry snow
	Cavity or crevasse hoar	Striated, planar or hollow skeleton type crystals grown in cavities; orientation often random	SHcv	Cavity hoar is found in large voids in the snow, e.g., in the vicinity of tree trunks, buried bushes [1] Crevasse hoar is found in any large cooled space such as crevasses, cold storage rooms, boreholes, etc.	Kinetic growth of crystals forming anywhere where a cavity, i.e., a large cooled space, is formed or present in which water vapour can be deposited under calm, still conditions [2]		
	Rounding surface hoar	Surface hoar crystal with rounding of sharp edges, corners and striations	SHxr	Within the snowpack; dry snow	Trend to a form reducing its specific surface area; corners and edges of the crystals are rounding off; faces may lose their relief, i.e., striations and steps disappear slowly		

Notes: – It may be of interest to note more precisely the shape of hoar crystals, namely plates, cups, scrolls, needles, and columns, dendrites, or composite forms [3]. Multi-day growth may also be specified.
 – Surface hoar deposits on freely exposed objects make up a substantial part of accumulation in the inland of Antarctica. This type of hoarfrost has been termed ‘air hoar’ (see [2] and [AMS, 2000](#)).
 – Crevasse hoar crystals are very similar to depth hoar.

References: [1] [Akiyama, 1974](#); [2] [Seligman, 1936](#); [3] [Jamieson & Schweizer, 2000](#)

Morphological classification		Additional information on physical processes and strength					
Basic classification	Subclass	Shape	Code	Place of formation	Physical process	Dependence on most important parameters	Common effect on strength
Melt Forms							
○	Clustered rounded grains		MFcl	At the surface or within the snowpack; wet snow	Wet snow at low water content (pendular regime), i.e., holding free liquid water; clusters form to minimize surface free energy	Meltwater can drain; too much water leads to MFsl; first freezing leads to MFpc	Ice-to-ice bonds give strength
	Clustered rounded crystals held by large ice-to-ice bonds; water in internal veins among three crystals or two grain boundaries						
	Rounded polycrystals		MFpc	At the surface or within the snowpack	Melt-freeze cycles form polycrystals when water in veins freezes; either wet at low water content (pendular regime) or refrozen	Particle size increases with number of melt-freeze cycles; radiation penetration may restore MFsl; excess water leads to MFsl	High strength in the frozen state; lower strength in the wet state; strength increases with number of melt-freeze cycles
	Individual crystals are frozen into a solid polycrystalline particle, either wet or refrozen						
Slush		MFsl	Water saturated, soaked snow; found within the snowpack, on land or ice surfaces, but also as a viscous floating mass in water after heavy snowfall.	Wet snow at high liquid water content (funicular regime); poorly bonded, fully rounded single crystals – and polycrystals – form as ice and water are in thermodynamic equilibrium	Water drainage blocked by capillary barrier, impermeable layer or ground; high energy input to snow cover by solar radiation, high air temperature or water input (rain)	Little strength due to decaying bonds	
Melt-freeze crust		MFcr	At the surface	Crust of melt-freeze polycrystals from a surface layer of wet snow that refroze after having been wetted by melt or rainfall; found either wet or refrozen	Crust of melt-freeze polycrystals from a surface layer of wet snow that refroze after having been wetted by melt or rainfall; found either wet or refrozen	Particle size and density increases with number of melt-freeze cycles	Strength increases with number of melt-freeze cycles

Notes: – Melt-freeze crusts MFcr form at the surface as layers at most a few centimetres thick, usually on top of a subfreezing snowpack. Rounded polycrystals MFpc will rather form within the snowpack. MFcr usually contain more refrozen water than MFpc and will not return to MFcl.

– Both MFcr and MFpc may contain a recognizable minority of other shapes, particularly large kinetic growth form FC and DH.









Morphological classification		Additional information on physical processes and strength						
Basic classification	Subclass	Shape	Code	Place of formation	Physical process	Dependence on most important parameters	Common effect on strength	
Ice Formations	Ice layer	Horizontal ice layer	IF	Within the snowpack	Rain or meltwater from the surface percolates into cold snow where it refreezes along layer-parallel capillary barriers by heat conduction into surrounding subfreezing snow, i.e., snow at $T < 0^{\circ}\text{C}$; ice layers usually retain some degree of permeability	Depends on timing of percolating water and cycles of melting and refreezing; more likely to occur if a stratification of fine over coarse-grained layers exists	Ice layers are strong but strength decays; once snow is completely wetted	
	Ice column	Vertical ice body	IFic	Within snowpack layers	Draining water within flow fingers freezes by heat conduction into surrounding subfreezing snow, i.e., snow at $T < 0^{\circ}\text{C}$	Flow fingers more likely to occur if snow is highly stratified; freezing enhanced if snow is very cold		
	Basal ice	Basal ice layer	IFbi	Base of snow cover	Melt water ponds above substrate and freezes by heat conduction into cold substrate	Formation enhanced if substrate is impermeable and very cold (e.g., permafrost)	Weak slush layer may form on top	
	Rain crust	Thin, transparent glaze or clear film of ice on the surface	IFrc	At the surface	Results from freezing rain on snow; forms a thin surface glaze		Droplets have to be supercooled but coalesce before freezing	Thin breakable crust
	Sun crust, Firmspiegel	Thin, transparent and shiny glaze or clear film of ice on the surface	IFsc	At the surface	Melt water from a surface snow layer refreezes at the surface due to radiative cooling; decreasing shortwave absorption in the forming glaze enhances greenhouse effect in the underlying snow; additional water vapour may condense below the glaze [1]		Buils during clear weather (radiative cooling), air temperatures below freezing and strong solar radiation; not to be confused with melt-freeze crusts MFcr	Thin breakable crust

Notes: – In ice formations, pores usually do not connect and no individual grains or particles are recognizable, contrary to highly porous snow. Nevertheless, some permeability remains, in particular when wetted, but to much a lesser degree than for porous melt forms.

- Most often, rain and solar radiation cause the formation of melt-freeze crusts MFcr.
- Discontinuous ice bodies such as ice lenses or refrozen flow fingers can be identified by appropriate remarks.

References: [1] [Ozeki & Akitaya, 1998](#)

D.2 Colour convention for main morphological grain shape classes

Class	Symbol	Code	Colour ¹	Web colour name	RGB ² (0 – 255)	HEX	CMYK ³ (%)	Greyscale ⁴ (%)	HEX
Precipitation Particles	+	<u>PP</u>		Lime	0 / 255 / 0	#00FF00	100 / 0 / 100 / 0	41	#969696
Machine Made snow	⊙	<u>MM</u>		Gold	255 / 215 / 0	#FFD700	0 / 16 / 100 / 0	20	#CBCBCB
Decomposing and Fragmented precipitation particles	/	<u>DF</u>		ForestGreen	34 / 139 / 34	#228B22	76 / 0 / 76 / 45	76	#3C3C3C
Rounded Grains	●	<u>RG</u>		LightPink	255 / 182 / 193	#FFB6C1	0 / 29 / 24 / 0	20	#CDCDCD
Faceted Crystals	□	<u>FC</u>		LightBlue	173 / 216 / 230	#ADD8E6	25 / 6 / 0 / 10	21	#CACACA
Depth Hoar	^	<u>DH</u>		Blue	0 / 0 / 255	#0000FF	100 / 100 / 0 / 0	89	#1C1C1C
Surface Hoar	∨	<u>SH</u>		Fuchsia	255 / 0 / 255	#FF00FF	0 / 100 / 0 / 0	59	#696969
Melt Forms	○	<u>MF</u>		Red	255 / 0 / 0	#FF0000	0 / 100 / 100 / 0	70	#4D4D4D
Ice Formations	☉	MFcr		Cyan/Aqua	0 / 255 / 255	#00FFFF	100 / 0 / 0 / 0	30	#B3B3B3

¹⁾ The colour convention is not optimized for people affected by colour vision deficiencies.

²⁾ RGB codes for web colours:

http://en.wikipedia.org/wiki/Web_colors
<http://www.w3.org/TR/css3-color/#svg-color>.

³⁾ RGB conversion to CMYK as well as to grey scale (both not unique!):

<http://www.usq.edu.au/users/grand/WORK/216color/ConvertRGB-CMYK-Grey.htm>

⁴⁾ Use of Greyscale is not recommended. However, values are provided for consistency:

% grey = 0.3xR + 0.59xG + 0.11xB, see http://www.dflanning.com/tp_tips/color2gray.html

Appendix E

Canadian Avalanche Association markup language (CAAML)

E.1 Introduction

Canadian Avalanche Association Markup Language (CAAML) is a standard for the electronic representation of information pertinent to avalanche safety operations. By building on existing Internet standards, CAAML expresses avalanche related information in a manner that can easily be shared over the World Wide Web. CAAML builds on the following two existing standards:

- Extensible markup language (XML): A general purpose markup language promoted by the World Wide Web Consortium (W3C).
- Geographic markup language (GML): An XML grammar defined by the Open Geospatial Consortium (OGC) to express geographic features.

E.2 Purpose

To provide the definitions for the data file structure to support electronic exchange of avalanche related information. CAAML defines the structure and elements of observations types, specifies how locations are referenced, provides a mechanism for linking observations with each other and contains a method for associating external data files.

E.3 Versions

Several different CAAML versions have been published since its first use in the fall of 2003. The following list briefly describes the primary stages in the development of CAAML.

- CAAML V1.0.3: Initial specifications were developed to support an electronic submissions of the industrial information exchange (InfoEx®) of the CAA. These specifications were limited to support observation elements that had traditionally been exchanged in the InfoEx®.
- CAAML V2.2.6: CAAML was expanded to include the majority of specification defined in the *Observation Guidelines and Recording Standards* (OGRS) of the CAA.
- CAAML V3.0.3: In order to support more detailed geographic information in CAAML, the standard was modified to incorporate key elements of GML, the XML standard for geographic information.
- CAAML V4.1: The file structure of CAAML schema files was redesigned to allow CAAML to be used as an international standard that is not necessarily tied to Canadian element definitions. At the same time, the schema was made fully GML compliant and additional modules for avalanche accident information and snow profile observations were added.
- CAAML V5.0: This is the first version of CAAML that uses the concept of CAAML Profiles to facilitate the adoption of the CAAML standard for specific applications. CAAML Profiles are logical restrictions of the overall CAAML standard that limit the CAAML data model to elements most relevant to the specific area of interest and remove unnecessary flexibility. At the same time, profiles share a common overall structure and have many similarities, since they are all derived from the same overall CAAML standard. This new structure of CAAML aims to make it easier for developers to implement the CAAML standard.

E.4 Structure (CAAML V5.0)

CAAML consists of a number of XML Schema files that define the structure of any CAAML instant files. While the schema files for the complete CAAML V5.0 standard have not been published, numerous CAAML V5.0 Profiles exist to define the rules for encoding information for specific information exchange initiatives within the Canadian and international avalanche safety and research communities. See <http://caaml.org/Schemas/V5.0/Profiles> for the currently available profiles.

The precise files structure of CAAML V5.0 Profiles depends on the complexity and extend of the specific profile. However, in general, a CAAML V5.0 Profile consists of the following three types of schema files.

- `xlinks.xsd`: Definitions for xlink elements and attributes that are use in GML and CAAML to create links between individual elements and files. Xlink is W3C recommendation.
- `CAAMLv5_NameOfProfile_GML.xsd`: A profile of GML 3.2, which includes the GML definitions required for the particular CAAML Profile.
- `CAAMLv5_NameOfProfile.xsd`: One or more schema files that include the CAAML V5.0 definitions for the specific information exchange.

E.5 Access

CAAML is under a royalty-free patent license, allowing anyone to implement it. Schema files of the various CAAML versions, example files and basic documentation can be accessed at <http://caaml.org>.

E.6 Authors

Original specifications for the CAAML schema version 1.0 were designed by the CAA's Data and Information Committee, which included Jeff Goodrich (Parks Canada), Jan Bergstrom (Canadian Mountain Holidays), Mark Myhre (Canadian Mountain Holidays), Simon Walker (B.C. Ministry of Transportation), Evan Manners (CAC) and Pascal Haegeli (University of British Columbia). External expert knowledge was provided by Graeme Irwin (University of Calgary).

All subsequent version of CAAML were primarily designed by Dr. Pascal Haegeli (Avisualanche Consulting) and Roger Atkins (Canadian Mountain Holidays). Advice on the integration of GML was provided by Dr. David Burggraf (Galdos Systems Inc.).

Individual CAAML V5.0 profiles are developed at the demand and in collaboration with interested avalanche safety organizations. See <http://caaml.org/Schemas/V5.0/Profiles> for more information on collaborators.

E.7 Suggested references

Schema files of the various CAAML versions, example files and basic documentation can be accessed at <http://caaml.org>

Open Geospatial Consortium (OGC): Open GIS ® Geography Markup Language (GML) Encoding Specifications. Available on-line at <http://www.opengeospatial.org/standards/gml> (April 7, 2007).

Lake, R., Burggraf, D.S., and Trninic, M. 2004. Geography Markup Language (GML) – Foundation for the geo-web. John Wiley and Sons Ltd, West Sussex, England. ISBN 0-470-87154-7.

World Wide Web Consortium (W3C): Extensible Markup Language (XML). Available on-line at <http://www.w3.org/XML/> (April 7, 2007).

World Wide Web Consortium (W3C): XML Linking Language (XLink) Version 1.0. Available on-line at <http://www.w3.org/TR/xlink/> (April 7, 2007).

Appendix F

Symbols and abbreviations

Symbol	Term	Units
E	Grain size	mm
F	Grain form	
H	Vertical co-ordinate (line of plumb)	cm, m
HN24	Height of new snow (daily)	cm
HNW	Water equivalent of new snow layer	mm
HS	Total height of snowpack	cm
HSW	Water equivalent of snowpack	mm
HW	Water equivalent of a layer	mm
L	Layer thickness (measured vertically)	mm, cm, m
P	Penetrability	cm
PF	Depth of foot penetration	cm
PR	Depth of penetration by Swiss ramsonde	cm
PS	Depth of ski penetration	cm
R	Hardness index (resistance to penetration)	N (for Ramsonde)
T	Temperature of snow	°C
T _a	Temperature of air	°C
T _g	Temperature of ground	°C
T ₁₀	Temperature of snow at 10 cm below surface	°C
D _p (Delta)	Change in penetration	cm
ε (epsilon)	Strain	dimensionless
θ (theta)	Liquid water content	% (by volume)
ρ (rho)	Density	kg/m ³
σ (sigma)	Stress	Pa
Σ (Sigma)	Strength	Pa
ψ (psi)	Inclination	degrees

Appendix G

Stability, hazard and risk

G.1 Stability

G.1.1 Definition

Stability refers to the chance that avalanches will not initiate. Stability is analysed in space and time relative to sensitivity to triggers and spatial distribution. Stability evaluation does not consider the size or potential consequences of expected avalanches; avalanche hazard and risk evaluation includes consideration of these factors. Complete definitions are provided in Sections G.2 and G.3.

G.1.2 Snow stability rating system

Stability rating	Observation or Triggering of Avalanches		Stability test results	
	Natural avalanches	Triggered avalanches	Test score	Fracture character
Very Good (VG)	No natural avalanches expected.	Avalanches may be triggered by very heavy loads, such as large cornice falls, in isolated terrain features.	Generally no results.	No fracture or non-planar break fractures.
Good (G)	No natural avalanches expected.	Avalanches may be triggered by heavy loads in isolated terrain features.	Generally moderate to hard results.	Generally resistant or non-planar break fractures.
Fair (F)	Isolated natural avalanches are expected on specific terrain only.	Avalanches may be triggered by light loads in areas with specific terrain features or certain snowpack characteristics.	Generally easy to moderate results.	Resistant or sudden fractures.
Poor (P)	Natural avalanches are expected in areas with specific terrain features or certain snowpack characteristics.	Avalanches may be triggered by light loads in many areas. Ski cuts or skier remotes possible.	Generally easy results.	Generally sudden fractures.
Very Poor (VP)	Widespread natural avalanches are expected.	Widespread triggering of avalanches by light loads.	Very easy to easy results.	Sudden fractures.

Note: Observation or triggering of avalanches will downgrade stability over results of stability tests.

For regional and larger forecast areas isolated natural avalanches may occur even when stability for the area as a whole is good.

Definitions and examples

- *Natural avalanches:* Avalanches triggered by weather events such as wind-loading, snowfall, rain, temperature changes, etc.
- *Triggered avalanches:* Avalanches initiated by external forces on the snowpack through human action, ice- rock- and cornice-fall, explosives, wildlife, etc.
- *Heavy load:* A cornice-fall, a compact group of people, a snowmobile, or explosives.
- *Light load:* A single person, or a small cornice-fall.

- *Isolated terrain features*: Features with geographic boundaries that limit trigger points and avalanche size such as extreme terrain, steep convex rolls, localized dispersed areas (pockets) without readily specifiable characteristics, etc.
- *Specific terrain features*: Features with identifiable characteristics such as lee slopes, sun-exposed aspects, cross-loaded slopes, etc.
- *Certain snowpack characteristics*: Shallow snowpack with faceted grains, persistent weaknesses, identified weaknesses, etc.

G.1.3 Elevation

Specify the forecast area and stability for three elevation bands if relevant:

- *Alpine*: Upper mountain elevations where trees are very sparse or nonexistent.
- *Treeline*: Elevation band describing the transitional area between closed forest below and open treeless areas above.
- *Below treeline*: Terrain from valley bottom to where the mountainside forest begins to thin.

Note: Stability is commonly evaluated according to elevation band because snowfall and snowdepth, wind, temperature and radiation balance, and the character and complexity of terrain features vary as a function of elevation. However, although alpine, treeline, and below treeline primarily describe elevation bands, specific terrain features may in some cases better reflect a different elevation category (i.e. under certain conditions logging cut-blocks may be considered treeline features found at below treeline elevations).

G.1.4 Trend

Where practical give the expected stability trend for the next 12 to 24 hours. Use the terms: *improving*, *steady* and *decreasing* to describe the trend.

G.1.5 Confidence

Comment on the confidence in the ratings with reference to the quantity and consistency of the observations and test results (i.e. *low* = limited relevant obs, *moderate* = some obs and/or inconsistent results, *high* = sufficient relevant obs, mostly consistent results).

G.1.6 Qualifiers

Observers may qualify the rating based on:

- Topography (aspect, slope angle, etc.)
- Spatial extent (localized or widespread)
- Time of day
- Level of the unstable layer in the snowpack (i.e. near surface, mid level, deep)

G.2 Hazard





G.2.1 Definition

Hazard: A source of potential harm, or a situation with the potential for causing harm, in terms of human injury; damage to health, property, the environment, and other things of value; or some combination of these (CSA, 2002).

G.2.2 Hazard rating system

Several methods for rating avalanche hazard exist. Different operations tailor their hazard ratings to their operational needs. Two examples of hazard rating systems are provided.

The North American Public Avalanche Danger Scale is provided below as an example of a hazard rating system used in public avalanche bulletins.

North American Public Avalanche Danger Scale				
Avalanche danger is determined by the likelihood, size and distribution of avalanches.				
Danger Level		Travel Advice	Likelihood of Avalanches	Avalanche Size and Distribution
5 Extreme		Avoid all avalanche terrain.	Natural and human-triggered avalanches certain.	Large to very large avalanches in many areas.
4 High		Very dangerous avalanche conditions. Travel in avalanche terrain <u>not</u> recommended.	Natural avalanches likely; human-triggered avalanches very likely.	Large avalanches in many areas; or very large avalanches in specific areas.
3 Considerable		Dangerous avalanche conditions. Careful snowpack evaluation, cautious route-finding and conservative decision-making essential.	Natural avalanches possible; human-triggered avalanches likely.	Small avalanches in many areas; or large avalanches in specific areas; or very large avalanches in isolated areas.
2 Moderate		Heightened avalanche conditions on specific terrain features. Evaluate snow and terrain carefully; identify features of concern.	Natural avalanches unlikely; human-triggered avalanches possible.	Small avalanches in specific areas; or large avalanches in isolated areas.
1 Low		Generally safe avalanche conditions. Watch for unstable snow on isolated terrain features.	Natural and human-triggered avalanches unlikely.	Small avalanches in isolated areas or extreme terrain.
Safe backcountry travel requires training and experience. You control your own risk by choosing where, when and how you travel.				

The British Columbia Ministry of Transportation and Infrastructure hazard rating system is provided below as an example of a hazard rating system used by a transportation avalanche safety operation.

Avalanche forecast	Definition
Low	Avalanches are unlikely. OR Small avalanches are possible, but are expected to terminate far above the highway
Moderate	Small avalanches are probable but are expected to terminate above the highway. AND/OR Large avalanches are possible, but are expected to terminate far above the highway.
Considerable	Small avalanches may affect the highway. AND/OR Large avalanches are probable, but are expected to terminate above the highway. AND/OR Snow dust events may affect the highway.
High	Numerous small avalanches are expected to affect the highway. AND/OR One or more large avalanches are expected to affect the highway.
Extreme	Numerous, large avalanches are expected to affect the highway.

G.3 Risk

G.3.1 Definition

Risk: The chance of injury or loss as defined as a measure of the probability and severity of an adverse effect to health, property, the environment, or other things of value (CSA, 2002).

Appendix H

References

- Akitaya, E. 1974. Studies on depth hoar. *Contrib. Inst. Low Temp. Sci., Ser. A*, 26, 1-67.
- AES. 1977. MANOBS: Manual of Surface Weather Observations. 7th Ed. Weather Services Directorate, Atmospheric Environment Service, Environment Canada. Downsview, Ontario. (Includes periodic updates.)
- AES. 1992a. AES guidelines for Co-operative Climatological Autostations. Ver 2.0. Canadian Climate Centre, AES, Environment Canada. UDC 55 1.508.824, 84 pp.
- AES. 1992b. Implementation of the AES guidelines for co-operative climatological autostations: Campbell Scientific 21x datalogger. Ver 1.0. Canadian Climate Centre, AES, Environment Canada. UDC 55 1.508.824, 121 pp.
- AES. 1993. Microcomputer Codecon specifications. Ver 2.3. Canadian Climate Centre, AES, Environment Canada. UDC 55 1.508.824, 63 pp.
- AMS. 2000. Glossary of Meteorology. 2nd edition, 12000 terms. American Meteorological Society, Boston, USA. <http://amsglossary.allenpress.com>
- Bailey, M. & Hallett, J. 2004. Growth rates and habits of ice crystals between -20 and -70 °C. *J. Atmos. Sci.* 61, 514-544.
- Baunach, T., Fierz, C., Satyawali, P. K. & Schneebeli, M. 2001. A model for kinetic grain growth. *Ann. Glaciol.* 32, 1-6.
- Benson, C. S. & Sturm, M. 1993. Structure and wind transport of seasonal snow on the Arctic slope of Alaska. *Ann. Glaciol.* 18, 261-267.
- Birkeland, K. 1998. Terminology and predominant processes associated with the formation of weak layers of near-surface faceted crystals in the mountain snowpack. *Arct. Alp. Res.* 30(2), 193-199.
- Canadian Standards Association. 1997. (Reaffirmed 2002 without change). Risk Management: Guideline for Decision-Makers, A National Standard of Canada. Canadian Standards Association CAN/CSA-Q850-97.
- Commission on Snow and Ice, 1954. The international Classification for Snow. National Research Council of Canada, Associate Committee on Geotechnical Research, Technical Memorandum No. 31, Ottawa, 15 pp.
- Colbeck, S. C. 1997. A review of sintering in seasonal snow. CRREL Report 97-10.
- Dovgaluk, Yu. A. & Pershina, T.A. 2005. Atlas of snowflakes (snow crystals). Federal Service of Russia for Hydrometeorology and Environmental Monitoring, Main Geophysical Observatory. Gidrometeoizdat, St. Petersburg, Russia.
- Fauve, M., H. Rhyner & M. Schneebeli. 2002. Preparation and maintenance of pistes. Handbook for practitioners. WSL Institute for Snow and Avalanche Research SLF, Davos, Switzerland.

- Fierz, C., McClung, D. M., Armstrong, R. L., Durand, Y., Etchevers, P., Greene, E., Nishimura, K., Satyawali, P. K. & Sokratov, S. A. The International Classification for Seasonal Snow on the Ground. International Association for the Cryospheric Sciences IACS, Technical Documents in Hydrology, UNESCO, Paris. In Press.
- Fohn, P. M. B. 1987. The rutschblock as a practical tool for slope stability evaluation. *Avalanche Formation, Movement and Effects* (Proceedings of the Davos Symposium, September 1986). International Association of Hydrological Sciences Publication no. 162, p. 223-228.
- Fukuzawa, T. & Akitaya, E. 1993. Depth-hoar crystal growth in the surface layer under high temperature gradient. *Ann. Glaciol.* 18 39–45.
- Jamieson, J. B. and C. D. Johnston. 1993. Experience with rutschblocks. *Proceedings of the International Snow Science Workshop at Breckenridge, Colorado, October 1992*, p. 150-159.
- Jamieson, J. B. and J. Schweizer. 2000. Texture and strength changes of buried surface hoar layers with implications for dry snow-slab avalanche release. *Journal of Glaciology* 46(152), p. 151-160.
- Johnson, R. F. and K. W. Birkeland. 2002. Integrating shear quality into stability test results. *Proceedings of the 2002 International Snow Science Workshop, Penticton, B.C.*, p. 508-513.
- LaChapelle, E. R., 1969. *Field Guide to Snow Crystals*. University of Washington Press, Seattle, 101 p. 86.
- Libbrecht, K. G. 2005. The physics of snow crystals. *Rep. Prog. Phys.* 68, 855-895.
- Magono, C. & Lee, C. W. 1966. Meteorological classification of natural snow crystals. *J. Fac. Sci. Hokkaido Univ. Ser. VII (Geophys.)* 2(4), 321-335.
- Marbouty, D. 1980. An experimental study of temperature-gradient metamorphism. *J. Gla-ciol.* 26(94), 303-312.
- McClung, D. M. and P. Schaerer. 1981. Snow avalanche size classification. *Proceedings of Avalanche Workshop 1980*. National Research Council, Associate Committee on Geotechnical Research; Technical Memorandum No. 133, p. 12-27.
- McClung, D. M. and P. Schaerer. 2006. *The Avalanche Handbook, 3rd Edition*. The Mountaineers, Seattle, WA, 342 pp.
- Mellor, M. 1965. *Blowing Snow*. Cold Regions Science and Engineering Laboratory. Hanover, NH: U. S. Army CRREL, 79 pp.
- Ozeki, T. & Akitaya, E. 1998. Energy balance and formation of sun crust in snow. *Ann. Gla-ciol.* 26, 35–38.
- Perla, R. I., 1978; *Snow Crystals/Les Cristaux de Neige*; National Hydrology Research Institute, Paper No. 1, Ottawa, 19 pp.
- Perla, R. I. and M. Martinelli Jr. 1976. *Avalanche Handbook (Revised 1978)*; US Department of Agriculture, Forest Service; Agriculture Handbook No. 489; Washington, DC., 238 pp.

- Seligman, G. 1936. Snow structure and ski fields. International Glaciological Society, Cambridge, UK.
- Sokratov, S.A. 2001. Parameters influencing the recrystallization rate of snow. *Cold Reg. Sci. Tech.* 33(2-3), 263-274, doi:10.1016/S0165-232X(01)00053-2.
- Sturm, M. & Benson, C. S. 1997. Vapor transport, grain growth and depth-hoar development in the subarctic snow. *J. Glaciol.* 43(143), 42-59.
- UNESCO/IASH/WMO. 1970. Seasonal Snow Cover, UNESCO, Paris, 38 pp.
- van Herwijnen, A. F. G. 2005. Fractures in weak snowpack layers in relation to slab avalanche release. PhD thesis. Dept. of Civil Engineering, University of Calgary, Calgary, Alberta, 296 pp.
- van Herwijnen, A. and B. Jamieson. 2007. Fracture character in compression tests. *Cold Regions Science and Technology*: 47(1-2), 60-68, doi:10.1016/j.coldregions.2006.08.016.
- van Herwijnen, A. F. G. and B. Jamieson. 2004. More results on fracture characterization in compression tests. *Avalanche News* 68, Canadian Avalanche Association, Revelstoke, B.C., p. 38-41.



Snow profile

Profile type:		Date:
Organization:	Location:	Time:
Observer:	Co-ordinates:	Slope aspect:
Sky:	Precip:	Elevation:
Wind:	Air temp:	Slope incline:
Site characteristics:		Foot pen:

Snow temperature (°C)											H	θ	R	F	E	ρ	Comments
-22	-20	-18	-16	-14	-12	-10	-8	-6	-4	-2	(cm)				(mm)	(kg/m ³)	
[Grid area for snow temperature data]																	
R	1100	1000	900	800	700	600	500	400	300	200	100	N	Total HS:				
I	K			P			1F		4F		F						

ISBN 0-9685856-3-9



9 780968 585634