

**GET THINGS DONE**

**beorol**

[www.beorol.com](http://www.beorol.com)



**CATALOGUE 2022/23**

# CONTENT

## ABOUT US

Beorol production	4
The development of Beorol	6
About Beorol company	8
Beorol distributive center	10
Beorol online shop	12

## PAINTING PRODUCTS RANGE 14

Paint rollers	16
Special-purpose rollers	36
Paint roller handles	38
Paint brushes	40
Buckets and bowls	51
Paint trays and grids	54
Spacers, crosses, wedges and brackets	56
Tapes	58
Scrapers	72
Bucket trowels	76
Plastering trowels	79
Spreading boards and scrapers	85
Extension poles	89
Sanding blocks and adapters	90
Mixers	92
Caulking guns	96
Cardboards, foils and mouldings	100

## MEASURING PROGRAM 104

Meters and rulers	106
Levels and screed boards	111
Marking tools	118

## TILE INSTALLATION TOOLS 120

## METAL PROGRAM 126

Utility knives and scrapers	128
Screwdrivers and nut drivers	134
Wrenches	140
Staple guns	145
Pliers and scissors	146
Clamps	153
Magnets	156
Hammers and wrecking bars	158
Spitz and chisel	162
Hacksaws	164
Jigsaw blades	168
Drills	172
Cutting and grinding discs	176
Machine brushes	180
Steel brushes	183
Rasps	186
Protective cotton and cloths	189
Boxes, bags and belts	190
Business bags	194
Ladders	196

**TECHNICAL CHEMISTRY 200**

Silicones	202
Adhesives and sealants	205
Pu foams	208
Cleaners and technical sprays	210
Spray paint	212

**PROTECTION PROGRAM 220**

Gloves	222
Protective footwear	228
Work clothes	233
Protective equipment	238

**GARDEN PROGRAM 244**

Hoses and winders	246
Couplings, sprinklers and adapters	251
Garden tools	256

**HOME PROGRAM 260**

Mosquito nets	262
Ropes and ties	264
Sealing stripes	266
Extension cords	270
Cleaning equipment	274

## BEOROL PRODUCTION

BEOROL IS THE LEADING MANUFACTURER OF ROLLERS, BRUSHES, TAPES AND PLASTICS IN SOUTHEAST EUROPE.



PRODUCTION OF PAINT ROLLERS

ANNUAL CAPACITY

**19** million paint rollers



PRODUCTION OF BRUSHES

ANNUAL CAPACITY

**14,6** million paint brushes

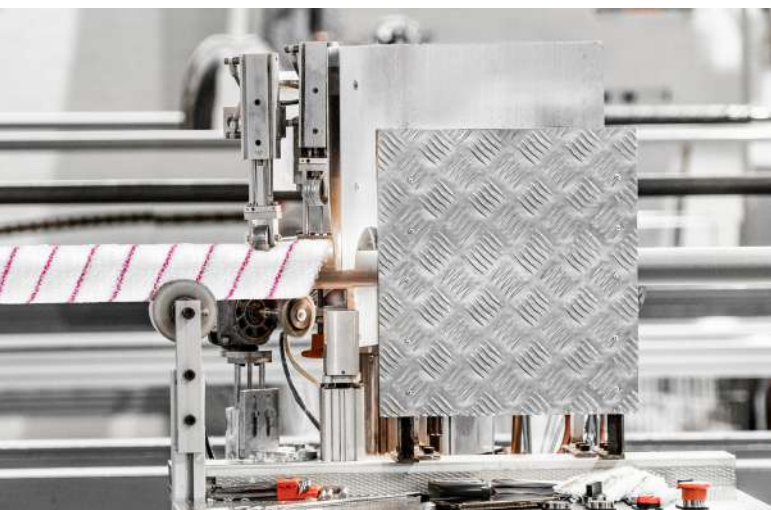

## BEOROL IS ONE OF THE LARGEST ROLLER MANUFACTURERS IN THE WORLD

"Paint Roller Market" is an expert research report on the worldwide tool manufacturing market, with focus on regions such as North America, Europe, and Asia. It covers the market's growth and forecasts its development in the upcoming years. "Paint Roller Market" also includes a section dedicated the discussion of the key worldwide suppliers.

Beorol company is reported to be the 11th production in the world, placing us next to the world's most important tool manufacturers.

*\*Source: Global Market Insights*



### PRODUCTION OF TAPES

ANNUAL CAPACITY

**11** milion m<sup>2</sup>  
tapes



### PRODUCTION OF PLASTICS

ANNUAL CAPACITY

**700** t  
plastic products



# THE DEVELOPMENT OF BEOROL

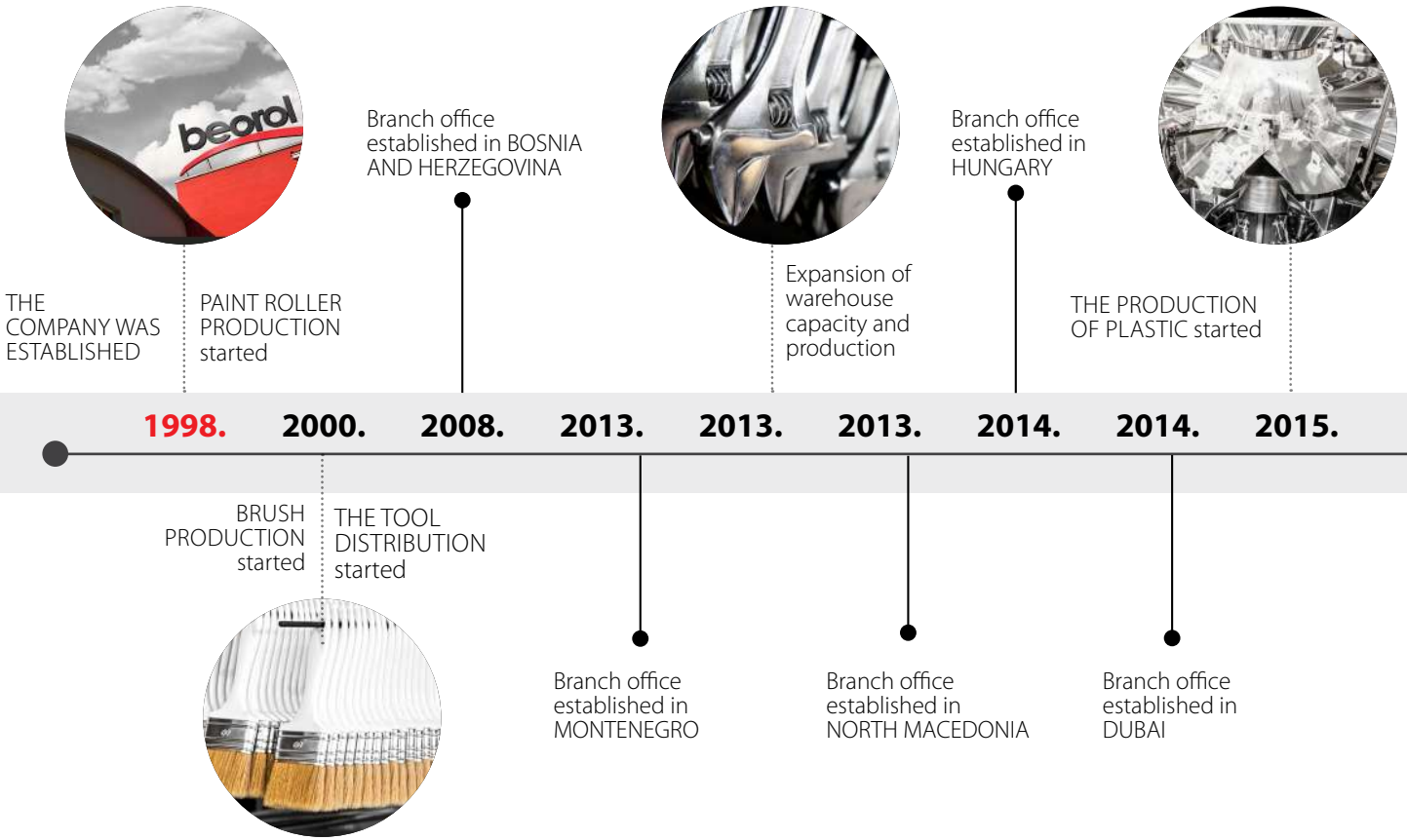

## 20 YEARS OF THRIVING

In its 20 years of operation, Beorol has become the regional leading manufacturer of painting tools as well as an importer and distributor of hand tools and accessories, protective equipment, technical chemistry, garden and home product range. The success and range of Beorol products is justified through our customer's trust. We are proud to be able to help create and decorate millions of homes.



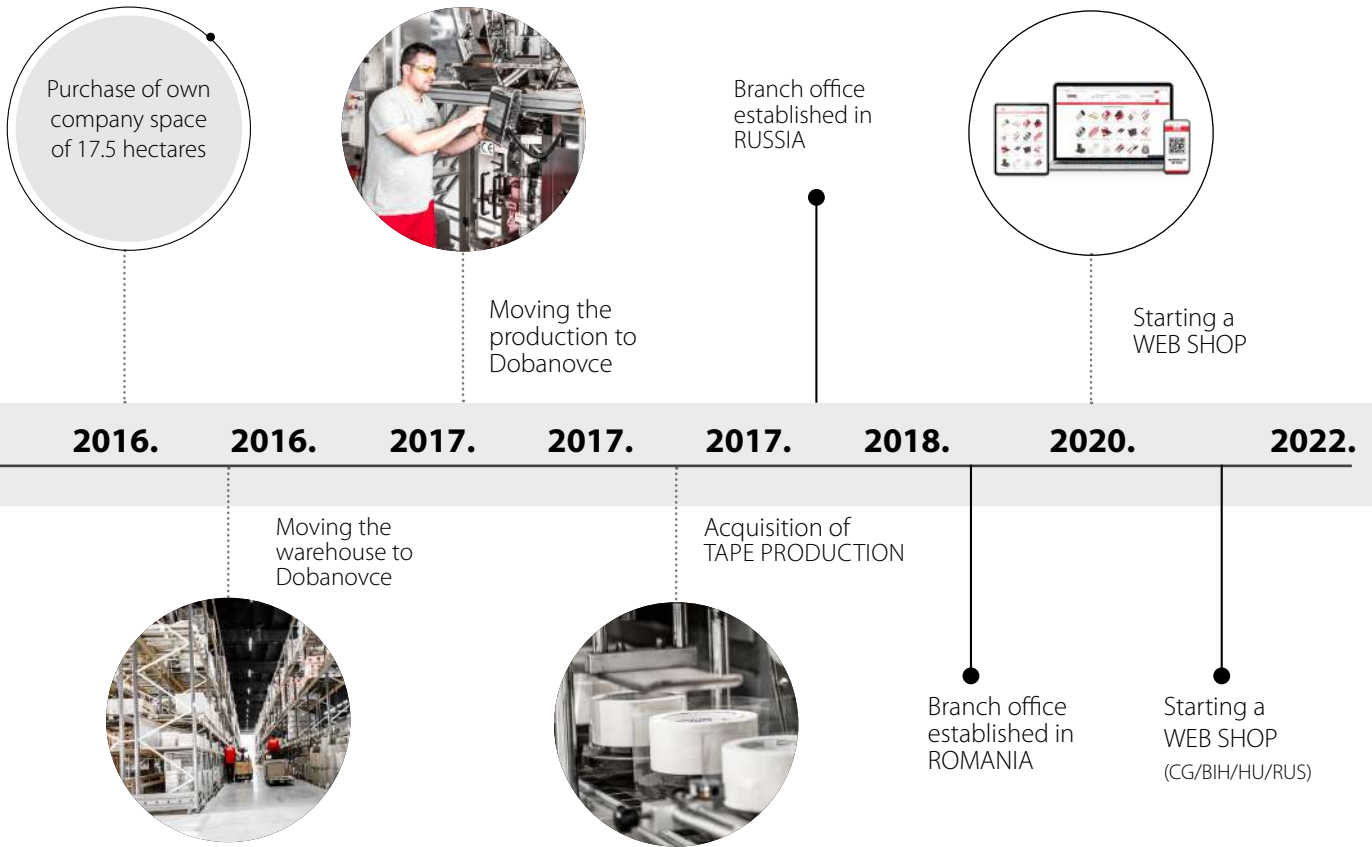

That is why we are dedicated to offer you more. Namely, our range is constantly expanding and adapting to your needs and desires. In addition to high quality and affordable prices, Beorol products are easy to use and allow you to work completely independently, without intermediaries and additional costs.



**2015.**



**2017.**



**2022.**

## ABOUT BEOROL COMPANY

Beorol is the largest exporter of tools in Serbia and a reliable partner to our customers from 48 countries around the world. We provide a reliable partnership, stable stock, support and supply system, and excellent price-quality ratio.

### Our relationship.

In all our relationships, we nurture respect, responsibility, reliability and guarantee business transparency. Our management works on high ethical principles, and we strive to strengthen the positive image and reputation of the company. Hence why our partners describe us as a respectable and desirable partner.



BEOROL EXPORTS TO

**50**

**COUNTRIES  
AROUND THE  
WORLD**

- |                        |             |              |           |
|------------------------|-------------|--------------|-----------|
| Austria                | Cyprus      | Latvia       | Georgia   |
| Bulgaria               | Mongolia    | Lithuania    | Algeria   |
| Montenegro             | Germany     | Whiterus     | Morocco   |
| Slovenia               | Netherlands | Slovakia     | Senegal   |
| Romania                | Portugal    | Poland       | India     |
| Croatia                | France      | Estonia      | Oman      |
| Hungary                | Ireland     | Russia       | Kenya     |
| Northern Macedonia     | Finland     | Iraq         | Cameroon  |
| Bosnia and Herzegovina | Denmark     | Kuwait       | Somalia   |
| Albania                | Switzerland | Saudi Arabia | Armenia   |
| Greece                 | Ukraine     | Lebanon      | Palestine |
| Malta                  | Moldova     | Suriname     | Maldives  |



## BEOROL BRANCHES

Beorol has existed since 1998, and became the market leader by offering quality products at competitive prices. Thanks to this, in addition to the Serbian market, today we operate in the markets of Bosnia and Herzegovina, Montenegro, Northern Macedonia, Hungary, Romania, Russia and the United Arab Emirates, too, with our products being present in over 50 countries.



### BEOROL SERBIA

Beorol d.o.o.  
Patrijarha Dimitrija 121a, 11090 Beograd  
e-mail: beorol@beorol.rs

[www.beorol.rs](http://www.beorol.rs)

### BEOROL MONTENEGRO

Beorol Montenegro d.o.o.  
Luke bb, Jelenak, 81410 Danilovgrad  
e-mail: beorolmontenegro@beorol.com

[www.beorol.me](http://www.beorol.me)

### BEOROL BOSNIA AND HERZEGOVINA

Beorol d.o.o. Banja Luka  
Dunavska 1c, 78000 Banja Luka  
e-mail: beorolbih@beorol.com

[www.beorol.ba](http://www.beorol.ba)

### BEOROL NORTHERN MACEDONIA

Беоорол Македонија ДООЕЛ  
Ул. 532 бр. 178 с. Марино, 1000 Скопје  
e-mail: beorolmakedonija@beorol.com

[www.beorol.mk](http://www.beorol.mk)

### BEOROL UNITED ARAB EMIRATES

Beorol Middle East  
Dubai Investments Park 1, Dubai  
e-mail: beorolmiddleeast@beorol.com

[www.beorol.ae](http://www.beorol.ae)

### BEOROL HUNGARY

Beorol HU Kft  
H-1172 Budapest, Cinkotai út 32.  
e-mail: beorolhungary@beorol.com

[www.beorol.hu](http://www.beorol.hu)

### BEOROL RUSSIA

Набережная  
пресненская дом 12  
123100 Москва

[www.beorol.ru](http://www.beorol.ru)

### BEOROL ROMANIA

Beorol Romania s.r.l.  
Strada Calea Radnei nr 288A, 310318 Arad  
e-mail: export@beorol.com

[www.beorol.com](http://www.beorol.com)



# 8.296

SHELVING POSTS

# 6.169

PALLET PLACES FOR  
**HIGH SHELVING STORAGE**

# 2.127

PALLET PLACES FOR  
**CUSTOMS STORAGE**

**FROM THIS DISTRIBUTION  
CENTER WE DISTRIBUTE ITEMS  
TO 50 COUNTRIES  
OF THE WORLD**

**BEOROL DISTRIBUTE CENTER**

Maršala Tita 212  
Dobanovci  
Belgrade, 11000



# 7.331 m<sup>2</sup>



# BEOROL ONLINE SHOP

[www.beorol.com](http://www.beorol.com)

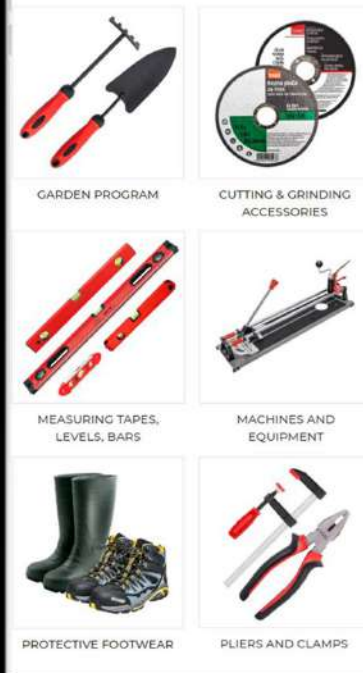
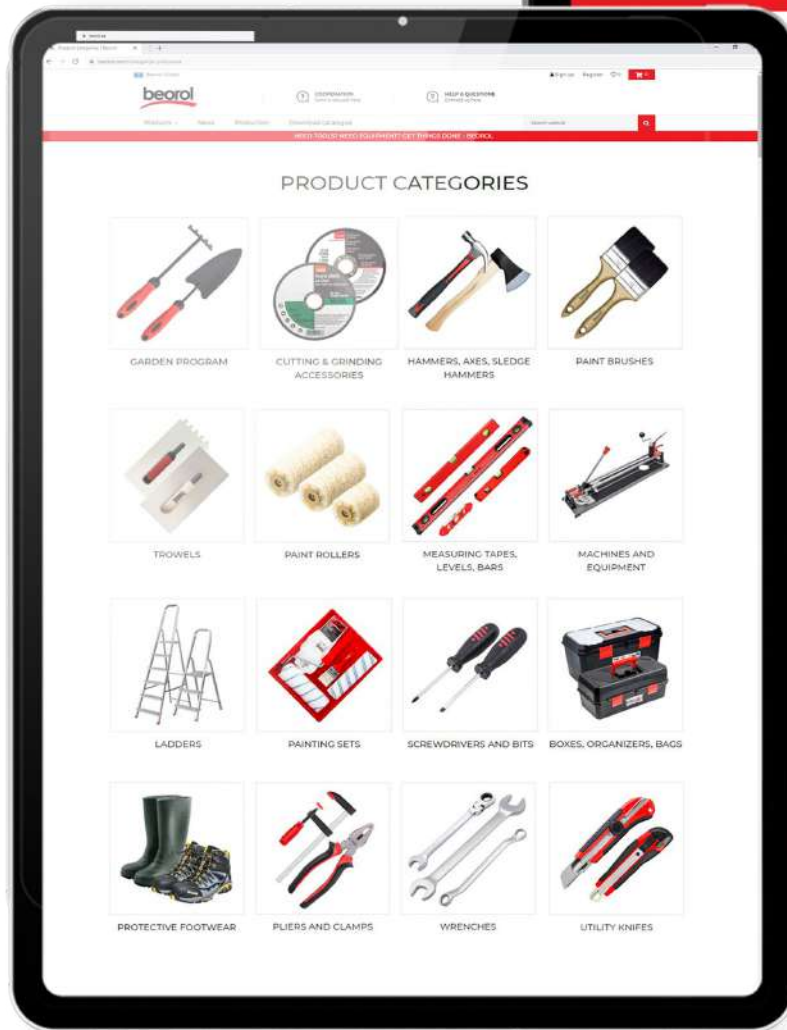
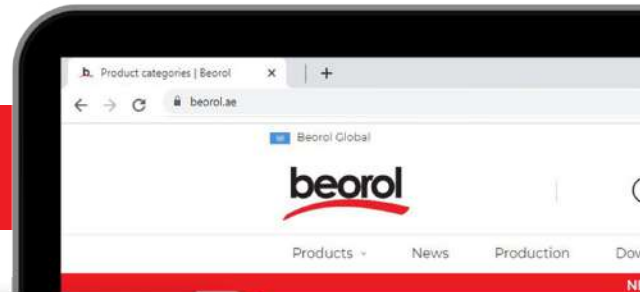

PLACING ORDERS  
**24/7**

DELIVERY  
**1 DAY**

OVER  
**2000**  
PRODUCTS

PURCHASE  
SUPPORT

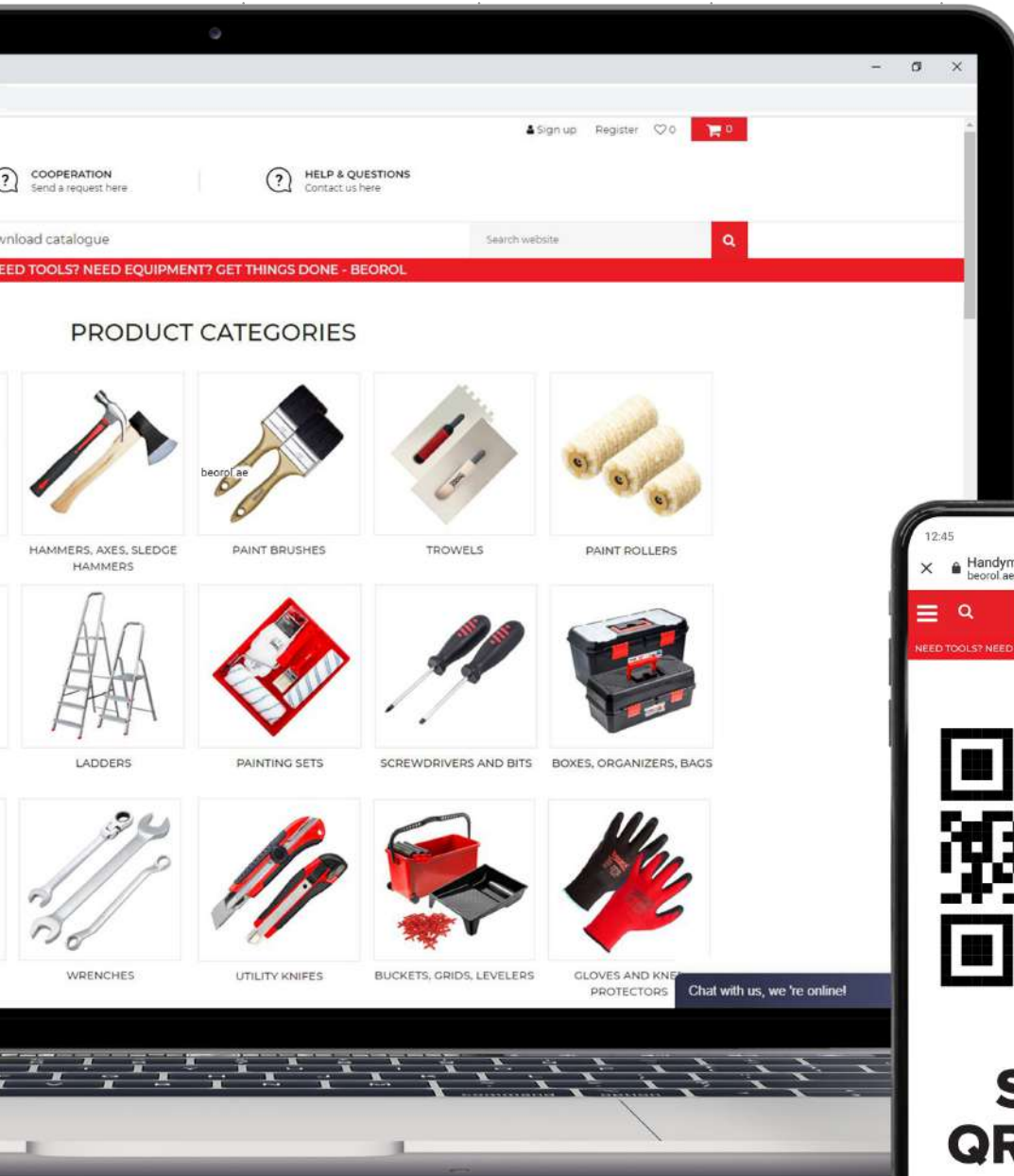



# **PAINTING PRODUCTS RANGE**

---

- **PAINT ROLLERS**
- **PAINT ROLLER HANDLES**
- **PAINT BRUSHES**
- **BUCKETS AND BOWLS**
- **PAINT TRAYS AND GRIDS**
- **SPACERS, CROSSES, WEDGES AND BRACKETS**
- **TAPES**
- **SCRAPERS**
- **BUCKET TROWELS**
- **PLASTERING TROWELS**
- **SPREADING BOARDS AND SCRAPERS**
- **EXTENSION POLES**
- **SANDING BLOCKS AND ADAPTERS**
- **MIXERS**
- **CAULKING GUNS**
- **CARDBOARDS, FOILS AND MOULDINGS**

HOW TO CHOOSE

# THE RIGHT ROLLER

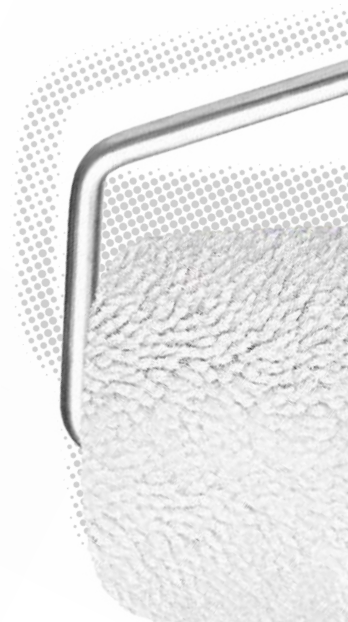
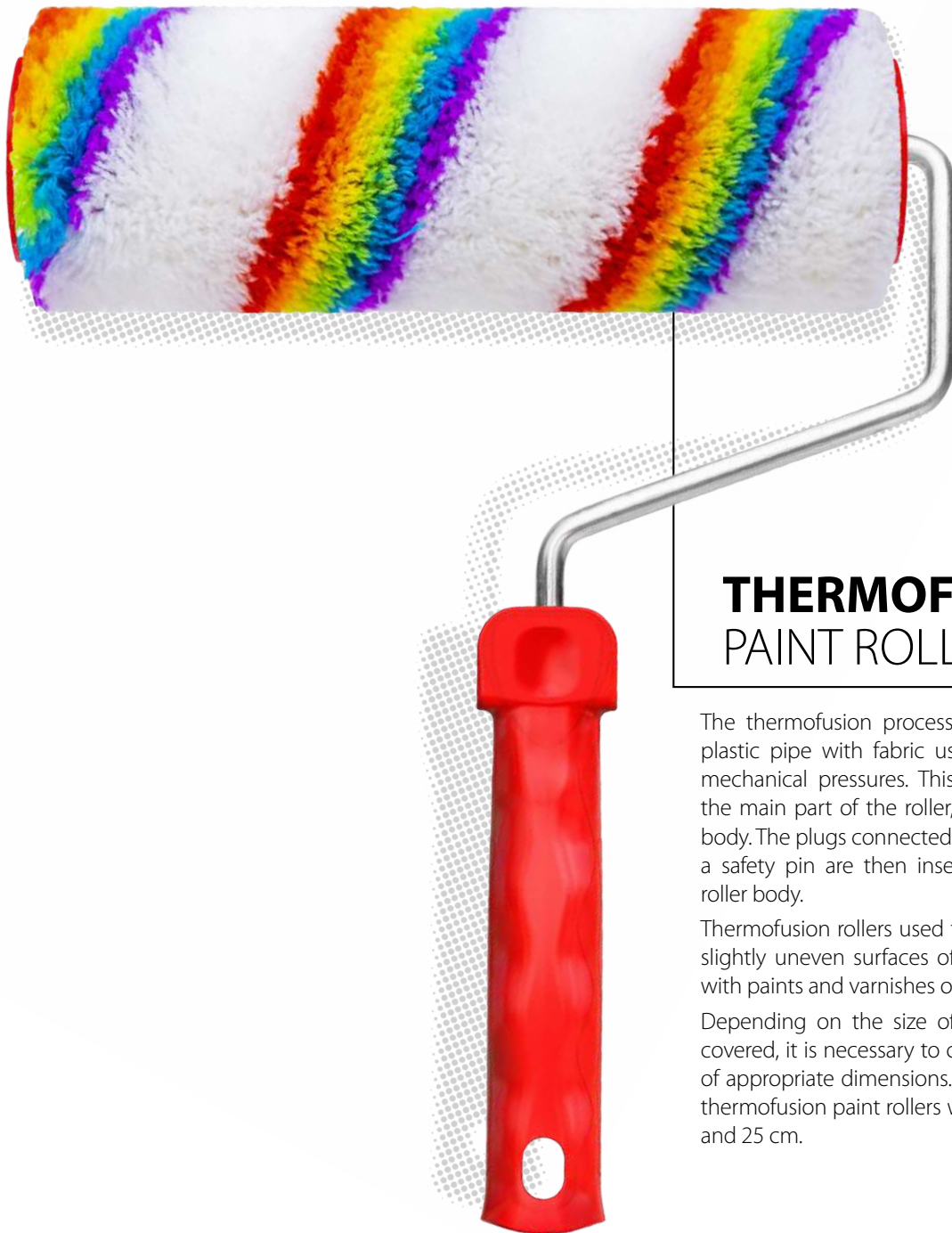

## THERMOFUSION PAINT ROLLERS

The thermofusion process includes joining a plastic pipe with fabric using both heat and mechanical pressures. This procedure creates the main part of the roller, the so-called roller body. The plugs connected by a shaft pipe with a safety pin are then inserted into the paint roller body.

Thermofusion rollers used for painting flat and slightly uneven surfaces of different materials, with paints and varnishes of all kinds.

Depending on the size of the surface to be covered, it is necessary to choose a paint roller of appropriate dimensions. Our range includes thermofusion paint rollers with a width of 9, 18 and 25 cm.



## SEWN PAINT ROLLERS

They are produced by a combined process of thermofusion and sewing. The plastic pipe and the polyurethane foam are thermofused into one whole, creating a strong supporting structure. Sewed and inverted fabric is then pulled on the tube. By pulling the fabric onto the pipe, a strong surface connection is created between the polyurethane foam and the sewn fabric. The plugs connected by a shaft pipe with a safety pin are then inserted into the roller body.

Sewn rollers are intended for painting uneven construction surfaces, mainly with semi-dispersive, dispersive and facade paints. Depending on the size of the surface to be treated, it is necessary to choose a roller of appropriate dimensions. Our range includes sewn rollers 18 and 25 cm wide.

### PAINTS



Dispersive  
paints



Latex  
(water-based paints)



Facade  
(acrylic paints)



Epoxy  
coatings



Fiberglass



Bitumen



Varnishes  
(water-based)



Varnishes  
(nitro and oil-based)



Anticorrosive  
protection



Substrates  
(primers)

### FINISH



Matte effect



Shine effect



15,000  
m²

### DURABILITY

### SURFACE ENDURANCE



Flat  
surfaces



Flat and uneven  
surfaces



Uneven  
surfaces

### TYPE



Professional



Hobby

### DIMENSIONS



Length of  
the paint  
roller



Thickness  
of the paint  
roller



Diameter  
of the  
wire

### FABRIC



Lint-free fabric

# POLYAMIDE PAINT ROLLERS

- Polyamide threads are characterized by fineness of fiber, strength, elasticity and high absorption
- They are resistant to creasing and tearing
- The fabric is high density, ensuring a longer lifespan and higher paint absorption
- They are intended for work on external, internal, flat, and uneven surfaces, for the application of dispersive, semi-dispersive and acrylic coatings
- Warranty for 15.000 m<sup>2</sup>

## PAINT ROLER **MAXI**



- Purpose: For application of dispersive and facade paints
- Method of production: Thermofusion
- Material: 100% Polyamide
- Fiber length: 20mm



CODE	BARCODE	WIDTH	FIBER	HANDLE
VMR45X90	8606107387277	9cm	20mm	RR29/40/56
VMR188	8600102480827	18cm	20mm	RV188
VMR258	8606107185774	25cm	20mm	RV258

## PAINT ROLLER **JUMBO MAXI**



- Purpose: For application of dispersive and facade paints
- Method of production: Thermofusion
- Material: 100% Polyamide
- Fiber length: 20mm



CODE	BARCODE	WIDTH	FIBER	HANDLE
VJMR258	8605043406813	25cm	20mm	RV258

## PAINT ROLLER **MASTER CLASSIC**



- Purpose: For application of dispersive and facade paints
- Method of production: Thermofusion
- Material: 100% Polyamide
- Fiber length: 20mm



CODE	BARCODE	WIDTH	FIBER	HANDLE
VMSCR45X90	8606107387260	9cm	20mm	RR29/40/56
VMSCR188	8606104807990	18cm	20mm	RV188
VMSCR258	8606107185491	25cm	20mm	RV258

## PAINT ROLLER **YELLOW LINE**



- Purpose: For application of latex water-washable and dispersive paints
- Method of production: Thermofusion
- Material: 100% Polyamide
- Fiber length: 12mm



CODE	BARCODE	WIDTH	FIBER	HANDLE
VYLR45X90	8606107185361	9cm	12mm	RR29/40/56
VYLR258	8606106732412	25cm	12mm	RV258

## PAINT ROLLER **JUMBO MASTER CLASSIC**



- Purpose: For application of dispersive and facade paints
- Method of production: Sewn
- Material: 100% Polyamide
- Fiber length: 20mm



CODE	BARCODE	WIDTH	FIBER	HANDLE
VJMSCR188	8606107185019	18cm	20mm	RV188
VJMSCR258	8605043401122	25cm	20mm	RV258

## PAINT ROLLER **BLUE LINE**



- Purpose: For application of dispersive paints
- Method of production: Thermofusion
- Material: 100% Polyamide
- Fiber length: 12mm



CODE	BARCODE	WIDTH	FIBER	HANDLE
VBLR45X90	8606107387314	9cm	12mm	RR29/40/56
VBLR188	8606007992281	18cm	12mm	RV188
VBLR258	8606107263106	25cm	12mm	RV258

PAINT ROLLER **GOLD EXCLUSIVE**



- Purpose: For application of all types of paints, especially recommended for acrylic coatings
- Method of production: Thermofusion
- Material: 100% Polyamide
- Fiber length: 20mm



CODE	BARCODE	WIDTH	FIBER	HANDLE
VGER45X90	8606107688893	9cm	20mm	RR29/40/56
VGER188	8606107688862	18cm	20mm	RV188
VGER258	8606107688886	25cm	20mm	RV258

# NYLON PAINT ROLLERS

- Nylon fibers are characterized by durability and wide application
- They are resistant to thinners
- They are intended for work on internal and flat surfaces, for spreading epoxy, acrylic paints and varnishes
- It is recommended to wash the roller before use

## PAINT ROLLER **AZZURO**



- Purpose: For application of epoxy coatings
- Method of production: Thermofusion
- Material: 100% nylon
- Fiber length: 7mm



CODE	BARCODE	WIDTH	FIBER	HANDLE
VAZR45X90	8606107387208	9cm	7mm	RR29/40/56
VAZR188	8606007992519	18cm	7mm	RV188
VAZR258	8606107185507	25cm	7mm	RV258

## PAINT ROLLER **AZZURO EPOXY**



- Purpose: For application of epoxy coatings
- Method of production: Thermofusion
- Material: 100% nylon
- Fiber length: 18mm



CODE	BARCODE	WIDTH	FIBER	HANDLE
VAZER258	8606107263236	25cm	18mm	RV258

# POLYACRYLIC PAINT ROLLERS

- Polyacrylic threads are characterized by their strength and high absorption.
- The high-density fibers provide higher paint absorption.
- They are intended for internal flat and semi-uneven surfaces, for the application of dispersive and semi-dispersive coatings.
- It is recommended to wash the roller before use.

## PAINT ROLLER **BLANCO**



- Purpose: For application of dispersive and semi-dispersive white paints
- Method of production: Thermofusion
- Material: 100% Polyacrilic



CODE	BARCODE	WIDTH	FIBER	HANDLE
VBR45X90	8606107387222	9cm	16mm	RR29/40/56
VBR188	8606104807952	18cm	16mm	RV188
VB258SET	8606017653332	25cm	16mm	SET

## PAINT ROLLER **BLANCO EXTRA**



- Purpose: For application of dispersive and semi-dispersive white paints
- Method of production: Sewn
- Material: 100% Polyacrilic
- Fiber length: 16mm



CODE	BARCODE	WIDTH	FIBER	HANDLE
VBER188	8606107263878	18cm	16mm	RV188
VBE258SET	8605043406974	25cm	16mm	SET

## PAINT ROLLER QUATTRO



- Purpose: For application of dispersive paints
- Method of production: Thermofusion
- Material: 100% Polyacrilic
- Fiber length: 18mm



CODE	BARCODE	WIDTH	FIBER	HANDLE
VQR45X90	8606107387291	9cm	18mm	RR29/40/56
VQR188	8606107185095	18cm	18mm	RV188
VQR258	8606107185408	25cm	18mm	RV258

## PAINT ROLLER PROFY



- Purpose: For application of dispersive and semi-dispersive paints
- Method of production: Thermofusion
- Material: 100% Polyacrilic
- Fiber length: 18mm



CODE	BARCODE	WIDTH	FIBER	HANDLE
VPR45X90	8606107387284	9cm	18mm	RR29/40/56
VPR188	8606104807808	18cm	18mm	RV188
VPR258	8606107185392	25cm	18mm	RV258

## PAINT ROLLER JUMBO QUATTRO

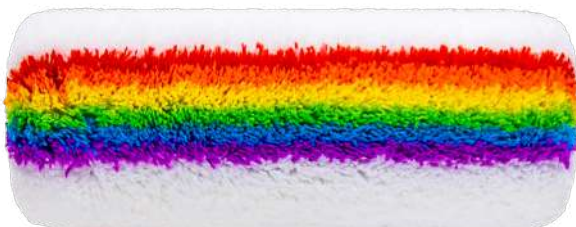

- Purpose: For application of dispersive paints
- Method of production: Sewn
- Material: 100% Polyacrilic
- Fiber length: 18mm



CODE	BARCODE	WIDTH	FIBER	HANDLE
VJQR188	8600102480124	Ø45mm	18cm	RV188
VJQR258	8605043401139	23cm	18mm	RV258

## PAINT ROLLER PROFY PLUS



- Purpose: For application of dispersive and semi-dispersive paints
- Method of production: Sewn
- Material: 100% Polyacrilic
- Fiber length: 18mm



CODE	BARCODE	WIDTH	FIBER	HANDLE
VPPR188	8606107263892	18cm	18mm	RV188
VPPR258	8606007992335	25cm	18mm	RV258

**PAINT ROLLER ULTRA RED**

- Purpose: For application of dispersive and semi-dispersive paints
- Method of production: Thermofusion
- Material: 100% Polyacrilic
- Fiber length: 18mm



CODE	BARCODE	WIDTH	FIBER	HANDLE
VURR188	8606107263410	18cm	18mm	RV188
VURR258	8606107263434	25cm	18mm	RV258

**PAINT ROLLER ELEVEN**

- Purpose: For application of dispersive, semi-dispersive paints and primers
- Method of production: Thermofusion
- Material: 100% Polyacrilic
- Fiber length: 11mm

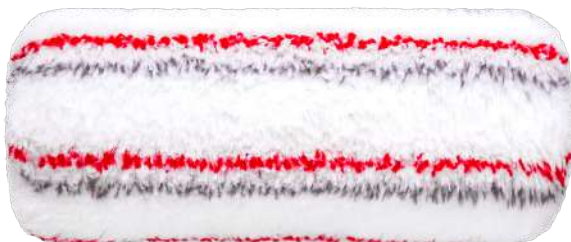

CODE	BARCODE	WIDTH	FIBER	HANDLE
VELR45X90	8606107387321	9cm	11mm	RR29/40/56
VELR188	8606104807891	18cm	11mm	RV188
VELR258	8606104807914	25cm	11mm	RV258

**PAINT ROLLER ULTRA RED PLUS**

- Purpose: For application of dispersive and semi-dispersive paints
- Method of production: Sewn
- Material: 100% Polyacrilic
- Fiber length: 18mm

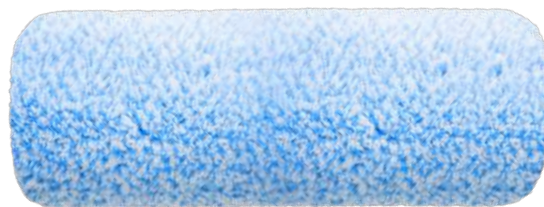

CODE	BARCODE	WIDTH	FIBER	HANDLE
VURPR188	8606107263441	18cm	18mm	RV188
VURPR258	8606007997804	25cm	18mm	RV258

**PAINT ROLLER JUMBO MELANGE SKY BLUE**

- For application of dispersive and semi-dispersive paints
- Method of production: Sewn
- Material: 100% Polyacrilic
- Fiber length: 18mm



CODE	BARCODE	WIDTH	FIBER	HANDLE
VJMSBR188	8606017651260	18cm	18cm	RV188
VJMSBR258	8606017651277	25cm	27cm	RV278



## PAINT ROLLER **MELANGE SKY BLUE**



- Purpose: For painting uneven and flat surfaces with paints of a new generation and a wide palette of colors
- Method of production: Thermofusion
- Material: 100% Polyacrylic
- Fiber length: 18mm



CODE	BARCODE	WIDTH	FIBER	HANDLE
VMSBR188	8606017651246	18cm	18mm	RV188
VMSBR258	8606017651253	25cm	18mm	RV258



# POLYESTER PAINT ROLLERS

- Polyester threads are recommended for flat and slightly uneven interior surfaces.
- Used for the application of semi-dispersive and acrylic coatings, spreading resin (viscous paints), as well as for industrial floors.
- It is recommended to wash the roller before use.

## PAINT ROLLER **HOBBY**



- Purpose: For application of dispersive, semi-dispersive, acrylic paints and primers
- Method of production: Thermofusion
- Material: 100% Polyester
- Fiber length: 16mm



CODE	BARCODE	WIDTH	FIBER	HANDLE
VHR45X90	8606107387239	9cm	16mm	RR29/40/56
VHR188	8606104807785	18cm	16mm	RV188
VHR258	8606107185415	25cm	16mm	RV258

## PAINT ROLLER **HOBBY EXTRA**

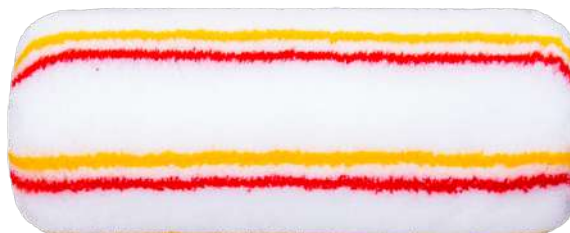

- Purpose: For application of dispersive, semi-dispersive, acrylic paints and primers
- Method of production: Sewn
- Material: 100% Polyester
- Fiber length: 16mm



CODE	BARCODE	WIDTH	FIBER	HANDLE
VHER188	8600102480605	18cm	16mm	RV188
VHER258	8605043406981	25cm	16mm	RV258

## PAINT ROLLER **LIBERO**



- Purpose: For application of all paints and primers during interior works
- Method of production: Thermofusion
- Material: 100% Polyester
- Fiber length: 12mm



CODE	BARCODE	WIDTH	FIBER	HANDLE
VLBR45X90	8606107387246	9cm	12mm	RR29/40/56
VLBR188	8606107185057	18cm	12mm	RV188
VLBR258	8606107263748	25cm	12mm	RV258

## PAINT ROLLER **ACRYL GOLD**



- Purpose: For application of acrylic paints, for interior works
- Method of production: Thermofusion
- Material: 93% Polyester / 7% Cotton
- Fiber length: 5mm



CODE	BARCODE	WIDTH	FIBER	HANDLE
VAGR45X90	8606107387215	9cm	5mm	RR29/40/56
VAGR188	8606007993158	18cm	5mm	RV188
VAGR258	8606107185569	25cm	5mm	RV258

# MICROFIBER PAINT ROLLERS

- Micro fibers are characterized by their fineness and a long lifespan.
- They are intended for work on internal and flat surfaces, for the application of lazure, latex and acrylic paints and varnishes.
- The density of the material is 15,000 threads per cm<sup>2</sup>, which enables higher paint absorption of up to 6 times its weight.
- It is recommended to lightly sand and wash the roller before use.

## PAINT ROLLER **MICROFIBER NATUR**



- Purpose: For application of latex paints
- Method of production: Thermofusion
- Material: 100% Microfiber
- Fiber length: 11mm



CODE	BARCODE	WIDTH	FIBER	HANDLE
VMFNR45X90	8606107387345	9cm	11mm	RR29/40/56
VMFNR188	8606107263656	18cm	11mm	RV188
VMFNR258	8606107263670	25cm	11mm	RV258

## PAINT ROLLER **MICROFIBER RED LINE**



- Purpose: For application of lazure and acrylic varnishes
- Method of production: Thermofusion
- Material: 100% Microfiber
- Fiber length: 13mm



CODE	BARCODE	WIDTH	FIBER	HANDLE
VMFRLR188	8605043400699	18cm	13mm	RV188
VMFRLR258	8605043400712	25cm	13mm	RV258

## PAINT ROLLER **MICROFIBER GREEN DOT**

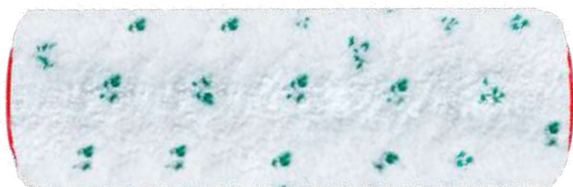

- Purpose: For application of acrylic, lazure and latex paints and varnishes in a thin layer
- Method of production: Thermofusion
- Material: 100% Microfiber
- Fiber length: 13mm



CODE	BARCODE	WIDTH	FIBER	HANDLE
VMFGDR188	8605043400767	18cm	13mm	RV188
VMFGDR258	8605043400781	25cm	13mm	RV258

## PAINT ROLLER **MICROFIBER**



- Purpose: For application of lazure and acrylic varnishes
- Method of production: Thermofusion
- Material: 100% Microfiber
- Fiber length: 9mm



CODE	BARCODE	WIDTH	FIBER	HANDLE
VMFR45X90	8606107387352	9cm	9mm	RR29/40/56
VMFR188	8600102480834	18cm	9mm	RV188
VMFR258	8606107185385	25cm	9mm	RV258

## PAINT ROLLER **MICROFIBER BLUE DOT**



- Purpose: For application of acrylic, lazure and latex paints and varnishes in a thin layer
- Method of production: Thermofusion
- Material: 100% Microfiber
- Fiber length: 9mm



CODE	BARCODE	WIDTH	FIBER	HANDLE
VMFBDR188	8605043400729	18cm	9mm	RV188
VMFBDR258	8605043400743	25cm	9mm	RV258

# WOOL PAINT ROLLERS

- Wool fibers are characterized by their fineness and a long lifespan.
- They are intended for work on internal flat surfaces and the application of enamel and two-component varnishes with the effect of a high-gloss, smooth, glass surface
- It is recommended to wash the roller before use.

## PAINT ROLLER **NATURAL WOOL**



- Purpose: For application of all types of enamel and two-component varnishes
- Method of production: Thermofusion
- Material: 100% wool
- Fiber length: 5.5mm



CODE	BARCODE	WIDTH	FIBER	HANDLE
VMPR45X90	8606107387192	9cm	5.5mm	RR29/40/56
VMPR188	8600102480803	18cm	5.5mm	RV188
VMPR258	8606107263113	25cm	5.5mm	RV258

## PAINT ROLLER **PERFETTO**



- Purpose: For application of dispersive and latex paints
- Method of production: Thermofusion
- Material: 70% Wool / 30% Polyester
- Fiber length: 20mm



CODE	BARCODE	WIDTH	FIBER	HANDLE
VPFR45X90	8606107387307	9cm	20mm	RR29/40/56
VPFR188	8606007993110	18cm	20mm	RV188
VPFR258	8606107387819	25cm	20mm	RV258

MINI PAINT ROLLER **MASTER CLASSIC**

- Purpose: For application of dispersive and facade paints
- Custom-made at the request of the painter
- Method of production: Thermofusion
- Material: 100% Polyamide
- Packaging: 10 pcs



CODE	BARCODE	DIMENSION	FIBER	HANDLE
RMSCR10	8605043400828	10cm	14mm	RR29/40/56

MINI PAINT ROLLER **YELLOW LINE**

- Purpose: For application of latex water-washable and dispersive paints
- No splashing
- Method of production: Thermofusion
- Material: 100% Polyamide
- Packaging: 10 pcs



CODE	BARCODE	DIMENSION	FIBER	HANDLE
RYLR10	8606106732535	10cm	12mm	RR29/40/56



# MINI PAINT ROLLERS

**MINI PAINT ROLLER BLUE LINE**

- Purpose: For application of dispersive paints
- Recommended for drywalls, without spraying
- Method of production: Thermofusion
- Material: 100% Polyamide
- Packaging: 10 pcs



CODE	BARCODE	DIMENSION	FIBER	HANDLE
RBLR10	8606017658924	10cm	12mm	RR29/40/56

**MINI PAINT ROLLER MICROFIBER GREEN DOT**

- Purpose: For application of acrylic, lazure and latex paints and varnishes in a thin layer
- High absorption, recommended for parquet flooring installers
- Method of production: Thermofusion
- Material: 100% Microfiber
- Packaging: 10 pcs



CODE	BARCODE	DIMENSION	FIBER	HANDLE
RMFGDR10	8605043400798	10cm	13mm	RR29/40/56

**MINI PAINT ROLLER MICROFIBER RED LINE**

- Purpose: For application of dispersive paints
- Recommended for drywalls, without spraying
- Method of production: Thermofusion
- Material: 100% Microfiber
- Packaging: 10 pcs



CODE	BARCODE	DIMENSION	FIBER	HANDLE
RMFRLR10	8605043400835	10cm	9mm	RR29/40/56

**MINI PAINT ROLLER MICROFIBER NATUR**

- Purpose: For application of latex paints
- Recommended for parquet flooring installers
- Method of production: Thermofusion
- Material: 100% Microfiber
- Packaging: 10 pcs



CODE	BARCODE	DIMENSION	FIBER	HANDLE
RMFNRR10	8606107263649	10cm	11mm	RR29/40/56



### MINI PAINT ROLLER **MICROFIBER BLUE DOT**



- Purpose: For application of acrylic, lazure and latex paints and varnishes in a thin layer
- High absorption, recommended for parquet flooring installers
- Method of production: Thermofusion
- Material: 100% Microfiber
- Packaging: 10 pcs



CODE	BARCODE	DIMENSION	FIBER	HANDLE
RMFBDR10	8605043400750	10cm	9mm	RR29/40/56

### MINI PAINT ROLLER **GOLD EXCLUSIVE**



- Purpose: For application of dispersive paints
- Recommended for drywalls, without spraying
- Method of production: Thermofusion
- Material: 100% Polyamide
- Packaging: 10 pcs



CODE	BARCODE	DIMENSION	FIBER	HANDLE
RGER10	8605043408855	10cm	20mm	RR29/40/56

### MINI PAINT ROLLER **MICROFIBER**



- Purpose: For application of lazure and acrylic varnishes
- Recommended for parquet flooring installers
- Method of production: Thermofusion
- Material: 100% Microfiber
- Packaging: 10 pcs



CODE	BARCODE	DIMENSION	FIBER	HANDLE
RMFR10	8600102480162	10cm	5mm	RR29/40/56

### MINI PAINT ROLLER **MAXI**



- Purpose: For application of dispersive and facade paints
- Method of production: Thermofusion
- Material: 100% Polyamide
- Packaging: 10 pcs



CODE	BARCODE	DIMENSION	FIBER	HANDLE
RMR10	8605043409814	10cm	20mm	RR29/40/56

**MINI PAINT ROLLER ACRYL GOLD**

- Purpose: For application of all types of enamel and two-component varnishes
- Method of production: Thermofusion
- Material: 100% wool
- Packaging: 10 / 7pcs



CODE	BARCODE	DIMENSION	FIBER	HANDLE
RAGR10	8606007998580	10cm	5mm	RR29/40/56

**MINI PAINT ROLLER ELEVEN**

- Purpose: For application of dispersive, semi-dispersive paints and primers
- Method of production: Thermofusion
- Material: 100% Polyacrilic
- Packaging: 10 pcs



CODE	BARCODE	DIMENSION	FIBER	HANDLE
RELR10	8606104807921	10cm	11mm	RR29/40/56

**MINI PAINT ROLLER NATURAL WOOL**

- Purpose: For application of acrylic paints, for interior works
- Recommended for drywalls
- Method of production: Thermofusion
- Material: 93% Polyester / 7% Cotton
- Packaging: 10 pcs



CODE	BARCODE	DIMENSION	FIBER	HANDLE
RMPR10	8600102480940	10cm	5,5mm	RR29/40/56
RMPR7	8600102480315	7cm	5,5mm	RR7

**MINI PAINT ROLLER AZZURO**

- Purpose: For application of epoxy coatings
- Method of production: Thermofusion
- Material: 100% Nylon
- Packaging: 10 pcs



CODE	BARCODE	DIMENSION	FIBER	HANDLE
RAZR10	8606017658900	10cm	7mm	RR29/40/56

### MINI PAINT ROLLER **HOBBY**



- Purpose: For application of dispersive, semi-dispersive, acrylic paints and primers
- Method of production: Thermofusion
- Material: 100% Polyester
- Packaging: 10 pcs



CODE	BARCODE	DIMENSION	FIBER	HANDLE
RHR10	8600102480322	10cm	16mm	RR29/40/56

### MINI PAINT ROLLER **ULTRA RED**



- Purpose: For the application of all types of substrates for the facade on flat surfaces
- It has a higher covering power
- Method of production: Thermofusion
- Material: Polyacrylic
- Packaging: 10 pcs



CODE	BARCODE	DIMENSION	FIBER	HANDLE
RURR10	8605043409821	20cm	13mm	RR29/40/56

### MINI PAINT ROLLER **POLYESTER**



- Purpose: For application of latex water-washable and dispersive paints
- Method of production: Thermofusion
- Material: 100% Polyester
- Packaging: 10 / 7pcs



CODE	BARCODE	DIMENSION	FIBER	HANDLE
RKR10	8600102480308	10cm	12mm	RR29/40/56
RKR7	8600102480582	7cm	12mm	RR7

### MINI PAINT ROLLER **SPONGE**

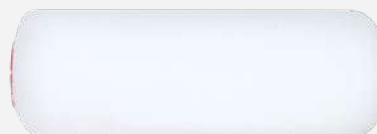

- Purpose: For applying color on an oil and acrylic base
- Material: 100% Sponge
- Package: 10 pcs



CODE	BARCODE	WIDTH	HANDLE
RSR10	8606107185781	10cm	RR29/40/56
RSUR5	8606107185804	5cm	RR5
RSUR10	8606107185798	10cm	RR29/40/56

# SPECIAL-PURPOSE ROLLERS



## VENTING ROLLER 460mm x 20mm



- Purpose: To help in leveling epoxy coatings and self-leveling floors
- With an opening for a telescopic pole
- Substrate treatment with this roller expels excess air from the material
- Material: Polyethylene

CODE	BARCODE	DIMENSION	NEEDLE
VE46020	8606017659051	460 mm	20 mm

## VENTING ROLLER WITH HANDLE



- Purpose: Venting Roller with handle for epoxy coatings and self-adhesive floors
- Plastic handle with a place for a telescopic extension pole
- Enables that bubbles, which have come into the coating during mixing, can escape direct after applying the coating

CODE	BARCODE	DIMENSION	NEEDLE
VE23020	8606017659044	230 mm	20mm

## PAINT ROLLER FOR DECORATIVE WORKS

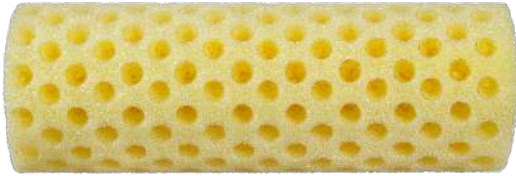

- Purpose: For decorative works on interior walls
- Paint roller for decorative works with water-based coatings
- Made of quality sponge with a density of 50g
- Compatible with 23cm handle, 8mm diameter

CODE	BARCODE	MATERIAL	DIMENSION
VDR3	8606017650430	Sponge	23cm

## PLASTERING ROLLER



- Purpose: For applying smoothing compounds and plaster on walls or ceilings, for sealing joints between plaster boards and for covering micro-perforated, self-adhesive or fiberglass grouting strips
- Made of 16 mm long durable polyamide fibers



CODE	BARCODE	WIDTH	MATERIAL
VGR258	8605043408602	25cm	Polyamide

# PAINT ROLLER HANDLES



## PAINT ROLLER HANDLE



- Purpose: For use with rollers of appropriate diameter and length
- The handle grip on the inside appropriate for telescopic shank
- Material: Polypropylene / Galvanized wire

CODE	BARCODE	DIAMETER	WIDTH	COLOR
RV188	8606007992625	ø8mm	18cm	Red
RV258	8605043406806	ø8mm	25cm	Red

## PAINT ROLLER HANDLE CAGE



- Purpose: Roller handles for the so-called "CAGE" system with plastic handle
- It consists of 5 galvanized wires and a main shaft with a diameter of 8 mm

CODE	BARCODE	DIAMETER	WIDTH	COLOR
RV18CG	8606107688466	∅8mm	18cm	Red

## PAINT ROLLER HANDLE FOR MINI PAINT ROLLERS



- Purpose: For use with mini paint rollers of appropriate diameter and length
- The handle grip on the inside appropriate for telescopic shank
- Material: Polypropylene / Galvanized wire

CODE	BARCODE	DIAMETER	WIDTH	HEIGHT
RR5	8606007991703	∅6mm	5cm	20cm
RR7	8606007992595	∅6mm	7cm	29cm
RR29	8600102480247	∅6mm	10cm	29cm
RR40	8600102480223	∅6mm	10cm	40cm
RR56	8600102480230	∅6mm	10cm	56cm

HOW TO CHOOSE

# THE RIGHT PAINTBRUSH

---



**THE BRISTLES** we use are amongst the highest quality in the world. Depending on the purpose of the application, we use natural and artificial bristles, as well as combinations of the two.

**BEOROL BRUSH HANDLE** is ergonomic, fits nicely in the hand and does not exhaust. They are produced in different shapes, dimensions and materials (wood and PVC). The handle is attached to the rest of the brush through gluing and nailing.

**QUALITY SHEET METAL** provides the final shape of the bristle and along with a strong connection of all elements into one compact whole. The sheet is made of profiled galvanized steel, with an aim for longevity.

**SPACER** – our brushes contain a plastic spacer that prevents bristle fallout.





## BRISTLE CROSS SECTION

Bristles that have a full cross-section are of the highest quality. Other types of bristles were created to reduce costs and density, while preserving the desired characteristics.

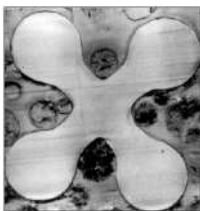

**X BRISTLE SHAPE** is good for paint retention as it features the ability to retain more liquid, whilst providing better flexibility than hollow bristle. It also has a 20% lower density than the solid form (SRT).



**HOLLOW BRISTLES** have 3 holes, providing better splitting at ends (Flag) compared to the X shape. Its hollowness allows for better paint absorption, giving a finer finish. The hollow form is significantly ahead of the X shape, as one bristle can split up to 4-5 peaks.

## BRISTLE TYPE

### BRISTLE MIX PLUS

Optimal bristle mix for the most extensive use. The composition is largely consisted of threads ranging from 12 $\mu$ m to 15 $\mu$ m in thickness, which provides greater longevity and finer paint application.

### BRISTLE MIX STANDARD

Optimal bristle mix for the most extensive use. The composition is largely consisted of threads ranging from 15 $\mu$ m to 18 $\mu$ m in thickness, which provides greater longevity.

### BRISTLE MIX STANDARD BLACK

Optimal mix of black bristles intended for extensive use. The composition of the bristle is dominated by threads ranging from 15 $\mu$ m to 18 $\mu$ m in thickness, which provides greater longevity.

### BRISTLE MIX STANDARD WHITE

Optimal mix of white bristle intended for extensive application of acrylic coatings. The composition of the bristle is dominated by threads ranging from 15 $\mu$ m to 18 $\mu$ m in thickness, which provides greater longevity.



# PAINT BRUSHES

## PAINT BRUSH PREMIUM



- Purpose: For application of oil, nitro and acrylic-based paints
- Exceptional elasticity, density and absorbcency
- Handle made of beech wood
- Hair type: Bristle Mix Plus

CODE	BARCODE	WIDTH	THICKNESS	BRISTLE LENGTH
PRB1	8600102480728	1"	16mm	51mm
PRB1.5	8606007992663	1.5"	16mm	57mm
PRB2	8606007990959	2"	20mm	64mm
PRB2.5	8606007991116	2.5"	20mm	70mm
PRB3	8606007992106	3"	23mm	76mm

## PAINT BRUSH GOLD



- Purpose: For application of oil, nitro and acrylic-based paints
- Ergonomic handle of superior varnish finish
- Hair type: Bristle Mix Plus

CODE	BARCODE	WIDTH	THICKNESS	BRISTLE LENGTH
G1	8600102480636	1"	16mm	51mm
G1.5	8600102480643	1.5"	16mm	57mm
G2	8600102480650	2"	20mm	64mm
G2.5	8600102480667	2.5"	20mm	64mm
G3	8600102480674	3"	23mm	70mm
G4	8600102480681	4"	23mm	76mm

## PAINT BRUSH SILVER



- Purpose: For application of oil, nitro and acrylic-based paints
- Fine hair tips for better and more precise color application
- Bristle type: Bristle Mix Plus

CODE	BARCODE	WIDTH	THICKNESS	BRISTLE LENGTH
SB20	8606017655183	20mm	15mm	51mm
SB30	8606017655190	30mm	15mm	51mm
SB40	8606017655206	40mm	15mm	57mm
SB50	8606017655213	50mm	15mm	57mm
SB60	8606017655220	60mm	15mm	64mm
SB70	8606017655237	70mm	15mm	70mm
SB80	8606017655244	80mm	15mm	70mm
SB90	8606017655251	90mm	15mm	76mm
SB100	8606017655268	100mm	15mm	76mm

**PAINT BRUSH PROFESSIONAL**

- Purpose: For application of oil, nitro and acrylic-based paints
- Greater absorption and release of paint
- Bristle type: Bristle Mix Standard

CODE	BARCODE	WIDTH	THICKNESS	BRISTLE LENGTH
PRO1	8606017655275	1"	16mm	51mm
PRO1.5	8606017655282	1.5"	17mm	57mm
PRO2	8606017655299	2"	18mm	64mm
PRO2.5	8606017655305	2.5"	21mm	64mm
PRO3	8606017655312	3"	23mm	70mm

**PAINT BRUSH ECONOMIC**

- Purpose: For application of oil, nitro and acrylic-based paints
- Universal brush for multipurpose use
- Bristle type: Bristle Mix Standard

CODE	BARCODE	WIDTH	THICKNESS	BRISTLE LENGTH
EB20	8600102480339	20mm	15mm	44mm
EB30	8600102480346	30mm	15mm	44mm
EB40	8600102480353	40mm	15mm	51mm
EB50	8600102480360	50mm	15mm	51mm
EB60	8600102480377	60mm	15mm	51mm
EB70	8600102480384	70mm	15mm	57mm
EB80	8600102480391	80mm	15mm	64mm
EB90	8600102480407	90mm	15mm	70mm
EB100	8600102480414	100mm	15mm	70mm

## PAINT BRUSH ACRYLIC



- Purpose: For application of oil, nitro and acrylic-based paints
- The best effect is achieved by applying acrylic paints
- Bristle type: Bristle Mix White

CODE	BARCODE	WIDTH	THICKNESS	BRISTLE LENGTH
AC20	8606007992113	20mm	15mm	51mm
AC30	8606007992120	30mm	15mm	51mm
AC40	8606007992137	40mm	15mm	57mm
AC50	8606007992144	50mm	15mm	57mm
AC60	8606007992151	60mm	15mm	57mm
AC70	8606007992496	70mm	15mm	64mm
AC80	8606007992502	80mm	15mm	64mm

## LACQUER PAINT BRUSH



- Purpose: For application of all types of varnishes
- Ultra thin, with fine bristle
- Bristle type: Bristle Mix Plus

CODE	BARCODE	WIDTH	THICKNESS	BRISTLE LENGTH
LC20	8606007994407	20mm	9mm	57mm
LC30	8606007994414	30mm	9mm	57mm
LC40	8606007994421	40mm	9mm	64mm
LC50	8606007994438	50mm	9mm	64mm
LC60	8606007994445	60mm	9mm	70mm
LC70	8606007994452	70mm	9mm	70mm

**CORNER PAINT BRUSH**

- Purpose: For application of oil, nitro and acrylic-based paints
- For treating inaccessible surfaces and corners
- Possibility of mounting a telescopic extension
- Bristle type: Bristle Mix Standard

CODE	BARCODE	WIDTH	THICKNESS	BRISTLE LENGTH
CC	8600102480568	2.5"	21mm	64mm

**BRUSH FOR DECORATIVE WORKS**

- Purpose: For application of all types of coatings and materials for decorative techniques
- Easy and fast work with materials for decorative works
- Bristle type: Bristle Mix Plus

CODE	BARCODE	WIDTH	THICKNESS	BRISTLE LENGTH
DRB70	8605043400804	70mm	9mm	64mm
DRB100	8606017655534	100mm	9mm	64mm

## RADIATOR BRUSH PROFESSIONAL



- Purpose: For application of oil, nitro and acrylic-based paints
- Suitable for inaccessible surfaces
- Bristle type: Bristle Mix Plus

CODE	BARCODE	WIDTH	THICKNESS	BRISTLE LENGTH
RBP10	8606007995657	1"	9mm	51mm
RBP15	8606007995664	1.5"	9mm	57mm
RBP20	8606007995671	2"	9mm	64mm
RBP25	8606007995688	2.5"	9mm	70mm

## RADIATOR BRUSH



- Purpose: For application of oil, nitro and acrylic-based paints
- Suitable for inaccessible surfaces
- Bristle type: Bristle Mix Standard

CODE	BARCODE	WIDTH	THICKNESS	BRISTLE LENGTH
RB10	8600102480476	1"	9mm	44mm
RB15	8600102480483	1.5"	9mm	44mm
RB20	8600102480490	2"	9mm	44mm
RB25	8600102480506	2.5"	9mm	51mm

**PARQUETRY LACQUER BRUSH**

- Purpose: For application of oil, nitro and acrylic-based paints and varnishes
- Suitable for varnishing parquet and quickly painting larger surfaces
- Dense and long bristle provide greater absorption
- Bristle type: Bristle Mix Standard

CODE	BARCODE	WIDTH	THICKNESS	BRISTLE LENGTH
PB10	8600102480964	100mm	30mm	76mm
PB12	8600102480971	120mm	30mm	76mm
PB14	8600102480988	140mm	40mm	76mm
PB15	8600102480995	150mm	50mm	76mm

**PARQUETRY LACQUER BRUSH ECONOMIC**

- Purpose: For application of oil, nitro and acrylic-based paints and varnishes
- Suitable for varnishing parquet and quickly painting larger surfaces
- Bristle type: Bristle Mix Standard

CODE	BARCODE	WIDTH	THICKNESS	BRISTLE LENGTH
EPB10	8606007991642	100mm	30mm	57mm
EPB12	8606007991956	120mm	30mm	57mm
EPB14	8606007991963	140mm	40mm	57mm



## BITUMEN BRUSH



- Purpose: For bitumen application
- Resistant to high temperatures
- Bristle type: Tampico fibers (Mexican grass)

CODE	BARCODE	WIDTH	BRISTLE LENGTH
BC	8606103238214	240mm	70mm

## WALL BRUSH - PP TOP BROKEN



- Purpose: For application of lime and all types of paints
- Easy to maintain, contains a threaded handle
- Bristle type: 100% Polypropylene

CODE	BARCODE	WIDTH	BRISTLE LENGTH
T170X70	8606007991932	170mm	70mm

## TOUCH UP BRUSH



- Purpose: For drawing precise lines and applying paint on small surfaces
- Bristle type: Natural hair

CODE	BARCODE	WIDTH	BRISTLE
PE02	8606007991451	2mm	70% PBT + 30% natural, standard
PE04	8606007991475	4mm	70% PBT + 30% natural, standard
PE06	8606007991468	6mm	70% PBT + 30% natural, standard
PE08	8606007991482	8mm	70% PBT + 30% natural, standard
PE10	8606007991499	10mm	70% PBT + 30% natural, standard
PE12	8606007991505	12mm	70% PBT + 30% natural, standard
PE14	8606007991512	14mm	70% PBT + 30% natural, standard
PE16	8606007991529	16mm	70% PBT + 30% natural, standard
PE18	8606007991536	18mm	70% PBT + 30% natural, standard
PE20	8606007991543	20mm	70% PBT + 30% natural, standard
PE22	8606107185828	22mm	70% PBT + 30% natural, standard
PE24	8606107185835	24mm	70% PBT + 30% natural, standard

**PAINTER SCHEIBEN NATURAL BRISTLE  
ECONOMY**

- Purpose: For application of all types of coatings and treating different surfaces
- Bristle type: 30% Natural bristle + 70% PBT

CODE	BARCODE	DIAMETER	BRISTLE LENGTH
MSDE	8606103238283	Ø125mm	85mm

**CEILING BRUSH PVC 7 ROWS WITH THREAD**

- Purpose: For application of lime and all types of paints
- Easy to maintain, contains threaded shank
- Bristle type: 100% Polypropylene

CODE	BARCODE	WIDTH	BRISTLE LENGTH
TPVCN	8606007992953	200mm	60mm

**PAINTER SCHEIBEN SYNTHETIC HAIR  
ECONOMY**

- Purpose: For application of all types of coatings and treating different surfaces
- Bristle type: 100% Polypropylene

CODE	BARCODE	DIAMETER	BRISTLE LENGTH
MSPVCE	8606103238290	Ø125mm	85mm

# BUCKETS AND BOWLS

## TILING BUCKET 20l



- Purpose: For rinsing tile cleaning sponges
- Three rollers placed at an angle enable fast and thorough squeezing of the sponge
- With wheels in the set for easier manipulation
- Material: Polypropylene

CODE	BARCODE	VOLUME	WIDTH	LENGTH
KK20L	8606007990973	20L	260mm	510mm

## ROLLERS FOR TILING BUCKET (SPARE)

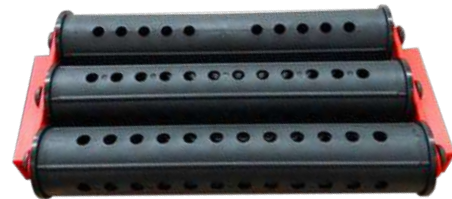

- Purpose: Spare set of rollers for article KK20L- Tiling bucket 20l
- Made of high quality plastic- PP Polypropylene
- Allows fast and thorough squeezing of sponges

CODE	BARCODE	WIDTH	LENGTH
VKK	8606017659808	140mm	265mm



**STEEL BOWL WITH WOODEN HANDLE**

- Purpose: Used for working with plaster and other construction materials
- Metal bucket scoop with a wooden handle

CODE	BARCODE	DIAMETER	COLOR
FME	8606106732429	Ø180mm	Gray

**PLASTIC BOWL WITH HANDLE PROFESSIONAL**

- Purpose: Professional plastic bowl with handle for all types of masonry works
- Made of high quality plastic with metal hanging hook

CODE	BARCODE	DIAMETER	COLOR
FPVCP	8606007993905	Ø170mm	Black

**PLASTER BOWL**

- Purpose: Bowl specially created for plaster works
- Easy plaster excess and stains removing with a squeeze of the bowl due to its rubber structure

CODE	BARCODE	DIAMETER	COLOR
GF	8606007990775	Ø130mm	Black

**PLASTIC BOWL WITH HANDLE**

- Purpose: Plastic bowl for all types of masonry works
- Plastic bowl with handle and hanging hook made of high quality plastic

CODE	BARCODE	DIAMETER	COLOR
FPVC	8606104807051	Ø170mm	Black

**MASONRY TROUGH 52l**



- Purpose: Masonry trough 52l, multipurpose trough for all construction and painting works

CODE	BARCODE	VOLUME	WIDTH	LENGTH
ZT	8606104807099	52l	430mm	740mm

**STUCCO BUCKET 12l**



- Purpose: Mortar bucket 20l for easy transportation and storage of material
- Made of high quality elastic plastic material for longer service life, adaptable to any request of the craftsman

CODE	BARCODE	VOLUME	COLOR
KZM	8606104807068	12l	Black
KZM20	8606017659266	20l	Black

**BUCKET WITH LID 18l**



- Purpose: High quality plastic paint bucket with lid 18l for multipurpose storage and craft use
- Great for sorting items in your home, garage, bathroom, industry use
- Flexible convenient metal handle

CODE	BARCODE	VOLUME	COLOR
KSP18	8606017650867	18l	Black



# PAINT TRAYS AND GRIDS

## PLASTIC PAINT TRAY 36x36cm



- Purpose: For squeezing excess paint from the rollers
- Material: Polypropylene

CODE	BARCODE	DIMENSION	COLOR
K36X36	8606017659174	36x36cm	Red

## PAINT GRID PROFESSIONAL



- Purpose: For squeezing excess paint from the rollers
- Material: Polypropylene

CODE	BARCODE	DIMENSION	COLOR
RSPVC	8605043400811	15x32cm	Red
RPVCP	8606107402260	29x39cm	Red

**PLASTIC PAINT TRAY 36x26cm**



- Purpose: For squeezing excess paint from the rollers
- Material: Polypropylene

CODE	BARCODE	DIMENSION	COLOR
K36X26	8606007990577	26x36cm	Red

**PLASTIC PAINT TRAY 15x32cm**



- Purpose: For squeezing excess paint from the rollers
- Material: Polypropylene

CODE	BARCODE	DIMENSION	COLOR
K15X32	8606007990560	15x32cm	Red

**PAINT GRID PVC**

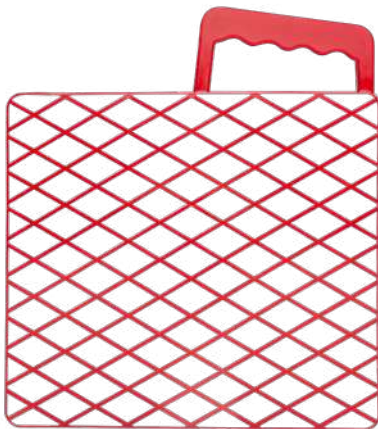

- Purpose: For squeezing excess paint from the rollers
- Material: Polypropylene

CODE	BARCODE	DIMENSION	COLOR
RMPVC	8606107185972	25.5x23cm	Red
RPVC	8606104807013	25.5x31cm	Red

**METAL GRID 30x26cm**

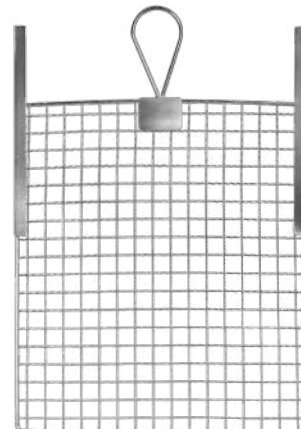

- Purpose: For squeezing excess paint from the rollers
- Material: Metal

CODE	BARCODE	WIDTH	LENGTH
RM	8606007990584	26cm	30cm

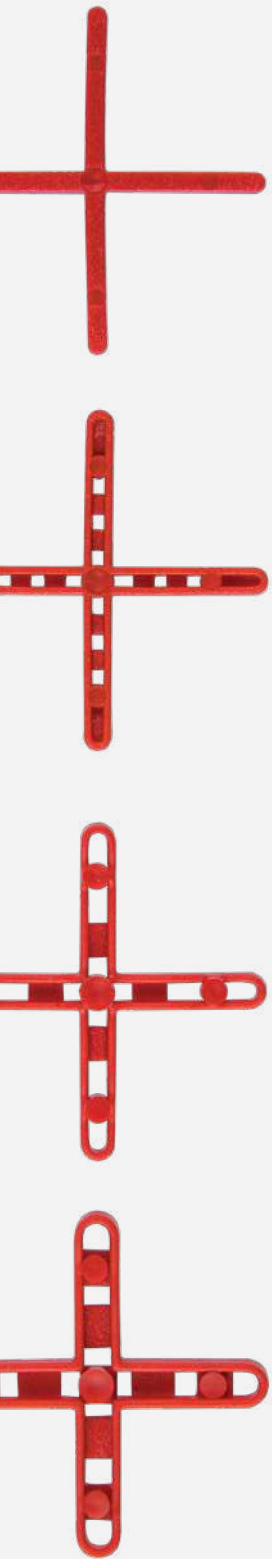

# SPACERS, CROSSES, WEDGES AND BRACKETS

## TILE STICKS 200/1



- Purpose: Plastic red tile leveling system wedges for proper tile laying
- Easy to install and disassemble
- Can be used on floors and walls, improves speed of tile laying
- Reusable

CODE	BARCODE	LENGTH	THICKNESS	PACKAGE
KAPV	8606007998559	30mm	5mm	200 pcs

## TILE CROSSES

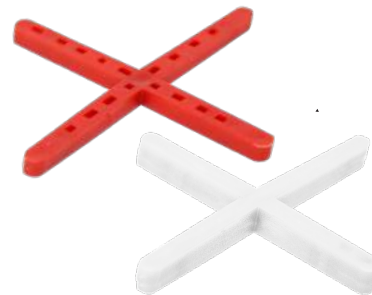

- Purpose: Plastic tile crosses for proper aligning floor and wall tiles
- Flexible, soft plastic design for easy maneuvering in tile joints
- Length 37mm

CODE	BARCODE	WIDTH	HEIGHT	PACKAGE
K1V	8606017658160	1mm	2mm	200 pcs
K2V	8606007998528	2mm	2mm	200 pcs
K3V	8606007998535	3mm	2mm	200 pcs
K4	8606007994964	4mm	2mm	100 pcs
K5	8606007994971	5mm	2mm	100 pcs



TILE LEVELING SYSTEM **WEDGES**



- Purpose: Tile leveling system wedges made to help ceramic tile installers when laying tiles
- This method ensures simple, fast and accurate installation
- Wedges can be used multiple times
- Used together with leveling spacers and pliers

CODE	BARCODE	WIDTH	COLOR	PACKAGE
NK-100	8606017652786	9mm	Red	100 pcs

TILE LEVELING SYSTEM **SPACERS**



- Purpose: Tile leveling system spacers are part of Beorol leveling system, which is used to help tile installers when laying tiles
- This method ensures simple, fast and accurate installation
- Suitable for grouting of 1, 1.5 and 2mm and tiles thickness of 4-13 mm

CODE	BARCODE	WIDTH	COLOR	PACKAGE
NS1-100	8606017652762	1mm	White	100 pcs
NS1.5-100	8606017657620	1.5mm	White	100 pcs
NS2-100	8606017652779	2mm	White	100 pcs

TILE LEVELING SYSTEM **WEDGE PRACTIC**



- Purpose: Tile leveling system wedges Practic 50pcs is part of the leveling system, which is used to help tile installers when laying tiles
- This method ensures simple, fast and accurate installation
- Wedges can be used multiple times
- Intended for tiles up to 60x60 cm and 4-13 mm thick
- Used together with leveling spacers and pliers

CODE	BARCODE	WIDTH	COLOR	PACKAGE
NKM-50	8605043404789	9mm	Red	50 pcs

TILE LEVELING SYSTEM **SPACERS PRACTIC**



- Purpose: Tile leveling system spacers Practic are used to help tile installers when laying tiles.
- This method ensures simple, fast and accurate installation.
- Practic system has a thinner base than the standard leveling system line which allow lesser glue application on smooth surfaces.
- Intended for tiles up to 60x60 cm and 4-13 mm thick.

CODE	BARCODE	WIDTH	COLOR	PACKAGE
NSM1-100	8605043404796	1mm	Yellow	100 pcs
NSM2-100	8605043404802	2mm	Yellow	100 pcs
NSM3-100	8605043404826	3mm	Yellow	100 pcs

HOW TO CHOOSE

# THE RIGHT TAPE

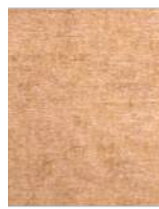

ragasztó terméskategóriában  
 felhasználták. Jellemző, hogy a  
 felületéhez való ragasztóanyagot  
 szálalag a leggyorsabb tejesítésmennyiség  
 után, azaz 72 órán belül tejesítésmennyiség  
 ellenőrzés után tesztelték, és a szálalag  
 szálalagát. Kiváló hőmérséklet- és legkörü  
 Alkalmazásuk a leggyorsabb tejesítésmennyiség  
 ragasztóanyagok és egyenlően felületek  
 a kezelt felületeken, lefeljésekör nem szakad  
 olyan felületeken, mint: külső falak, szim:

und  
 bis zu 72  
 die  
 des  
 und  
 ist  
 beim  
 keine  
 auf

Choosing the perfect tape for each project is not always an easy task, hence we provide very straightforward pictograms which indicate the most important characteristics so that every professional can instantly make the right choice.



**STRENGTH  
OF ADHESION**

Adhesion - the strength of sticking the tape on the treated surface.



**INDOOR  
USE**

Designed for indoor use.

\*The time frame displayed inside the pictogram represents the recommended removal time



**OUTDOOR  
USE**

Intended for outdoor use.

\* The time frame displayed inside the pictogram represents the recommended removal time



**HIGH  
TEMPERATURES  
RESISTANCE**

Represents the temperature that the tape can resist while retaining its characteristics.

**Without glue residue**

After removal does not leave traces.

# TAPES



## MASKING TAPE **WALL & CEILING** **STANDARD**



- Purpose: Crepe paper tape intended for indoor surface protection during painting/decorating
- The tape is based on solvent adhesive and is intended for DIY painters/decorators
- After application on the surface, the tape has optimal performance within first 48h
- Recommended application surfaces are: walls, plasterboard, cardboard
- Color: White



Without glue residue

CODE	BARCODE	WIDTH	LENGTH
MK1833	8606102760402	18mm	33m
MK2433	8606102760419	24mm	33m
MK3033	8606102760426	30mm	33m
MK3633	8606102760433	36mm	33m
MK4833	8606102760440	48mm	33m
MK1850	8606102760792	18mm	50m
MK2450	8606102760853	24mm	50m
MK3050	8606102760860	30mm	50m
MK3650	8606102760877	36mm	50m
MK4850	8606102760785	48mm	50m

## MASKING TAPE WALL & CEILING PROFESSIONAL



- Purpose: Crepe paper tape intended for interior surface protection during painting/decorating
- The tape is based on natural rubber adhesive and is intended for intermediate painters/decorators/and DIY
- After application on the surface, the tape has optimal performance within first 72h
- Upon removal within the recommended time, the tape does not tear or leave glue residue on the treated surface
- We advise not leaving the tape on the treated surface for more than one week, and on high/low temperatures
- Recommended application surfaces are: walls, plasterboard, cardboard, wood
- Color: Ivory



Without glue residue

CODE	BARCODE	WIDTH	LENGTH
BK1833	8606102760501	18mm	33m
BK2433	8606102760518	24mm	33m
BK3033	8606102760525	30mm	33m
BK3633	8606102760532	36mm	33m
BK4833	8606102760549	48mm	33m
BK1850	8606102760563	18mm	50m
BK2450	8606102760600	24mm	50m
BK3050	8606102760617	30mm	50m
BK3650	8606102760624	36mm	50m
BK4850	8605043407919	48mm	50m

## MASKING TAPE EXTERIOR WALL STANDARD



- Purpose: Crepe paper tape intended for exterior surface protection during painting/decorating
- The tape is based on natural rubber adhesive and is intended for intermediate painters/decorators/and DIY
- After application on the surface, the tape has optimal performance within first 72h
- The tape is resistant to high temperatures and various atmospheric conditions
- Upon removal within the recommended time, the tape does not tear or leave glue residue on the treated surface
- The adhesive properties of this tape make it an excellent universal solution that can be applied both indoors and outdoors
- Recommended application surfaces: walls, plasterboard, cardboard, wood, PVC, metal
- Color: Yellow



Without glue residue

CODE	BARCODE	WIDTH	LENGTH
FASK1833	8606017657316	18mm	33m
FASK2433	8606017657323	24mm	33m
FASK3033	8606017657330	30mm	33m
FASK3633	8606017657347	36mm	33m
FASK4833	8606017657354	48mm	33m
FASK1850	8606017657361	18mm	50m
FASK2450	8606017657378	24mm	50m
FASK3050	8606017657385	30mm	50m
FASK3650	8606017657392	36mm	50m
FASK4850	8606017657408	48mm	50m

**MASKING TAPE EXTERIOR WALL  
PROFESSIONAL**

- Purpose: Crepe paper tape intended for exterior surface protection during painting/decorating
- The tape is based on natural rubber adhesive and is intended for intermediary and expert painters/decorators
- After application on the surface, the tape has optimal performance within first 120h
- The tape is resistant to high temperatures and various atmospheric conditions
- Upon removal within the recommended time, the tape does not tear or leave glue residue on the treated surface
- Thanks to its properties, this tape is an excellent outdoor solution
- The tape can be applied to both smooth and rough surfaces
- Recommended application surfaces: exterior walls
- Color: Brown



Without glue residue

CODE	BARCODE	WIDTH	LENGTH
PROK1833	8606017656210	18mm	33m
PROK2433	8606017656227	24mm	33m
PROK3033	8606017656234	30mm	33m
PROK3633	8606017656241	36mm	33m
PROK4833	8606017656258	48mm	33m
PROK1850	8606017657859	18mm	50m
PROK2450	8606017657866	24mm	50m
PROK3050	8606017657873	30mm	50m
PROK3650	8606017657880	36mm	50m
PROK4850	8606017657897	48mm	50m

**MASKING TAPE STRONG**

- Purpose: Crepe paper tape intended for application where the strength of adhesion is needed
- The special paper and adhesive formula gives this tape excellent adhesive properties on surfaces such as wood, metal, and glass
- High temperature and atmospheric conditions resistance gives this tape a wide application range, including the car painting industry
- The tape has optimal performance within 30 days of application
- Upon removal within the recommended time frame, the tape does not tear or leave glue residue
- Color: Yellow



Without glue residue

CODE	BARCODE	WIDTH	LENGTH
STRONG1833	8605043408190	18mm	33m
STRONG2433	8605043408206	24mm	33m
STRONG3033	8605043408213	30mm	33m
STRONG3633	8605043408220	36mm	33m
STRONG4833	8605043408237	48mm	33m
STRONG1850	8605043408091	18mm	50m
STRONG2450	8605043408107	24mm	50m
STRONG3050	8605043408114	30mm	50m
STRONG3650	8605043408121	36mm	50m
STRONG4850	8605043408138	48mm	50m

## MASKING TAPE DOOR & WINDOW PROTECTION



- Purpose: Crepe paper tape is intended for protecting doors and windows
- The tape is based on natural rubber adhesive and is intended for intermediate and expert painters/decorators
- After application on the surface, the tape has optimal performance within first 72h
- Elastic paper properties allow for excellent coverage of corners and edges on doors and windows
- Upon removal within the recommended time frame, the tape does not tear or leave glue residue on doors and windows which makes it a unique solution for protecting such surfaces during painting/decorating
- The tape is applicable on PVC, aluminum, and wooden doors and windows
- The tape is not UV resistant, hence not recommended for exterior use
- Color: Blue



Without glue residue

CODE	BARCODE	WIDTH	LENGTH
DK1833	8606017656265	18mm	33m
DK2433	8606017656272	24mm	33m
DK3033	8606017656289	30mm	33m
DK3633	8606017656296	36mm	33m
DK4833	8606017656302	48mm	33m
DK1850	8606017657903	18mm	50m
DK2450	8606017657910	24mm	50m
DK3050	8606017657927	30mm	50m
DK3650	8606017657934	36mm	50m
DK4850	8606017657941	48mm	50m

## MASKING TAPE FLEXI LINE



- Purpose: Crepe paper tape was intended for the protection of surfaces with different contours and shapes, as well as painting/decorating that includes making irregular shapes and combined techniques
- The tape is based on a special mix of natural rubber adhesive and elastic paper which also prevent paint bleed underneath the tape
- It is intended for intermediate and expert painters/decorators
- After application on the surface, the tape has optimal performance within first 48h
- Upon removal within the recommended time frame, the tape does not tear or leave glue residue on the treated surface
- Color: Green



Without glue residue

CODE	BARCODE	WIDTH	LENGTH
PLK1833	8606017656319	18mm	33m
PLK2433	8606017656326	24mm	33m
PLK3033	8606017656333	30mm	33m
PLK3633	8606017656340	36mm	33m
PLK4833	8606017656357	48mm	33m
PLK1850	8606017657958	18mm	50m
PLK2450	8606017657965	24mm	50m
PLK3050	8606017657972	30mm	50m
PLK3650	8606017657989	36mm	50m
PLK4850	8606017657996	48mm	50m

**MASKING TAPE WOODEN FLOORS**

- Purpose: Parquet protection tape, intended for the protection of delicate wooden surfaces such as parquets, laminates, furniture, wooden doors, and windows as well as other surfaces that require special treatment
- The tape is based on natural rubber glue and uses impregnated paper that allows easy removal from treated surfaces
- The characteristics of this tape ensure its performance for up to 30 days under tough conditions, as well as easy, tear-free, and glue residue-free removal
- The tape is not UV resistant, hence not recommended for exterior use
- Not removing the tape within the recommended time frame can result in tape tearing and glue residue upon removal
- Color: Yellow



Without glue residue

CODE	BARCODE	WIDTH	LENGTH
PK3033	8605043406455	30mm	33m
PK4833	8605043406899	48mm	33m
PK3050	8605043408046	30mm	50m
PK4850	8605043408053	48mm	50m

**SENSITIVE WASHI TAPE**

- Purpose: The perfect solution for delicate surfaces such as wallpapers, freshly painted walls, kitchen elements, etc.
- Adhesive tape made from hand-made Washi paper originating from Japan
- The adhesive used is a special sensitive acrylic formula that can remain on the surface for up to 15 days without leaving glue residue or damaging the surface upon removal
- The special Washi paper is very thin but extremely strong
- The thinness allows for spotting any imperfections upon application and immediate correction before proceeding with painting
- The tape is UV resistant and waterproof
- Sharp paper edges and the special adhesive formula prevent paint to bleed underneath the tape
- The smooth paper allows writing and marking on the tape



Without glue residue

CODE	BARCODE	WIDTH	LENGTH
SW1833	8605043408060	18mm	33m
SW2433	8605043408299	24mm	33m
SW3033	8605043407841	30mm	33m
SW3633	8605043408305	36mm	33m
SW4833	8605043408312	48mm	33m
SW1850	8605043408077	18mm	50m
SW2450	8605043408329	24mm	50m
SW3050	8605043408336	30mm	50m
SW3650	8605043408343	36mm	50m
SW4850	8605043408350	48mm	50m



## SUPERIOR 180 DAYS ( WASHI PAPER )



- Purpose: The ultimate solution for all indoor and outdoor paint jobs
- Sharp edges and special acrylic adhesive formula prevent paint to bleed underneath the tape
- Highly professional adhesive tape made from hand-made Washi paper originating from Japan
- The tape is UV resistant and waterproof and can be used in various climate conditions
- High temperature and pressure resistance make it a very good solution for chamber painting use
- Recommended removal time is up to 180 days indoors and up to 90 outdoors
- Removal within the recommended time frame ensures no glue residue on the surface
- This tape is not recommended for varnished surfaces



Without glue residue

CODE	BARCODE	WIDTH	LENGTH
S180W1833	8605043408084	18mm	33m
S180W2433	8605043408367	24mm	33m
S180W3033	8605043408374	30mm	33m
S180W3633	8605043408381	36mm	33m
S180W4833	8605043408398	48mm	33m
S180W1850	8605043408633	18mm	50m
S180W2450	8605043408404	24mm	50m
S180W3050	8605043408411	30mm	50m
S180W3650	8605043408428	36mm	50m
S180W4850	8605043408435	48mm	50m

## MASKING TAPE FOR DECORATIVE TECHNIQUE



- Purpose: Crepe paper tape intended for special decorative techniques and high precision
- The tape is based on natural rubber glue and characterized by a paper width of only 5mm
- This tape is a perfect aid for performing special techniques such as travertine or others that require narrow, highlighted grout imitation, and sharp edges
- After application on the surface, the tape has optimal performance within the first 24h
- Color: Yellow



Without glue residue

CODE	BARCODE	WIDTH	LENGTH
KTDR533	8605043407933	5mm	33m

## DUCT TAPE



- Purpose: For thermal and hydro insulation, packing heavy packages, reparation and decoration
- Reinforced for greater durability and strength
- Adhesive type Hot Melt
- Advanced adhesion strength
- Color: Black

CODE	BARCODE	WIDTH	LENGTH
TT4810	8606102760303	48mm	10m
TT4850	8606017655541	48mm	50m

## ALUMINIUM TAPE



- Purpose: For thermal insulation and decoration
- For connecting pipes in ventilation and heating systems, insulating electromagnetic devices and preventing the effects of high temperatures
- Advanced bonding strength
- Resistant to low temperatures
- Tape thickness is 50 microns +/-10%.

CODE	BARCODE	WIDTH	LENGTH
AT4810	8606102760198	50mm	10m
AT4850	8606102760181	50mm	50m

## DOUBLE SIDED TAPE



- Purpose: It is designed to hold two surfaces together, on the end in a way that is not visible on the end product, because it is between two objects
- Double-sided tape based on polypropylene
- Standard bond strength
- Sticky part colored in white
- It doesn't leave glue marks
- Double-sided tape is a pressure-sensitive tape that is coated with glue on both sides
- Double-sided tape is created by applying a thin adhesive layer to each side of the carrier material

CODE	BARCODE	WIDTH	LENGTH
DT185	8606017656012	18mm	5m
DT3810	8606102760242	38mm	10m
DT485	8606102760228	48mm	5m
DT4810	8606102760211	48mm	10m

## PACKING TAPE BROWN



- Purpose: Scotch tape clear, used for moving and packing a variety of merchandise and materials
- Resistant PVC tape with acrylic glue
- Tear resistant and without glue traces
- Color: Brown

CODE	BARCODE	WIDTH	LENGTH
MT5050	8606102760068	50mm	50m

### SCOTCH TAPE TRANSPARENT



- Purpose: Scotch tape clear, used for moving and packing a variety of merchandise and materials
- Resistant PVC tape with acrylic glue
- Tear resistant and without glue traces
- Color: Transparent

CODE	BARCODE	WIDTH	LENGTH
S2550	8606102760266	25mm	50m
S5050	8606102760075	50mm	50m

### WARNING TAPE YELLOW BLACK

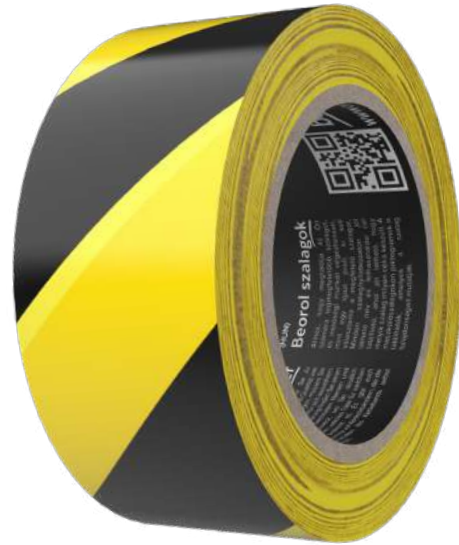

- Purpose: Universal marking PVC adhesive tape for marking a variety of surfaces when performing works
- Tear resistant and without glue marks
- Material: PVC
- Color: Yellow/black

CODE	BARCODE	WIDTH	LENGTH
SZ0ZC4833	8606102760723	50mm	33m

## WARNING TAPE RED WHITE



- Purpose: Universal marking PVC adhesive tape for marking a variety of surfaces when performing works
- Tear resistant and without glue marks
- Material: PVC
- Color: Red/white

CODE	BARCODE	WIDTH	LENGTH
SZOCB4833	8606102760716	50mm	33m

## WARNING-SEPARATING TAPE RED



- Purpose: Universal marking PVC adhesive tape 75mmx100m, for marking a variety of surfaces when performing works
- Tear resistant and without glue marks
- Material: PVC
- Color: Red/white.

CODE	BARCODE	WIDTH	LENGTH
TZOCB75100	8606102760709	75mm	100m

### FIBER GLASS ADHESIVE TAPE



- Purpose: Fiberglass mesh adhesive tape for covering drywall joints, cracks, and holes on drywalls, plasterboard and other surface
- Easy to use due to low weight
- Weight of the material: 60g/m<sup>2</sup>, 9x9
- Material type: fiberglass
- Color: White

CODE	BARCODE	WIDTH	LENGTH
BT20	8606007990102	50mm	20m
BT45	8606106732115	50mm	45m
BT90	8606007990119	50mm	90m

### FIBER GLASS ADHESIVE TAPE



- Purpose: Fiberglass adhesive tape 25m for covering drywall joints, cracks, and holes on drywalls, plasterboard and other surface
- Made of large number of glass fiber
- Material weight: 60g/m<sup>2</sup>, 9x9.
- Material type: fiberglass
- Color: White

CODE	BARCODE	WIDTH	LENGTH
BT25S	8606007998887	50mm	25m

## PTFE SEAL TAPE



- Purpose: Thread seal tape used in a variety of applications, usually involving ductwork or piping, for plumbers
- White color and thickness is 75  $\mu\text{m}$
- Material: PTFE-Teflon.

CODE	BARCODE	WIDTH	LENGTH	THICKNESS
TFT	8606007991970	12mm	10m	75 $\mu\text{m}$

## INSULATE TAPE



- Purpose: For electrical insulation and bandaging joints as well as various other uses in construction around the home

CODE	BARCODE	WIDTH	LENGTH	THICKNESS
IT19	8606007990874	19mm	10m	130 $\mu\text{m}$
IT19B	8606017652618	19mm	10m	130 $\mu\text{m}$
IT19C	8606007992885	19mm	10m	130 $\mu\text{m}$
IT19P	8606007992939	19mm	10m	130 $\mu\text{m}$
IT19Z	8606007992847	19mm	10m	130 $\mu\text{m}$
IT19ZZ	8606007997606	19mm	10m	130 $\mu\text{m}$



# SCRAPERS

## SCRAPER



- Purpose: For scraping various deposits and impurities from the base material
- Non-resistant to chemical influences

CODE	BARCODE	WIDTH	MATERIAL
S30	8605043400682	30mm	Steel
S40	8606007990324	40mm	Steel
S60	8606007990331	60mm	Steel
S80	8606007990348	80mm	Steel
S100	8606007990355	100mm	Steel
S120	8606007990362	120mm	Steel



### YORK SCRAPER, SERRATED



- Purpose: For scraping various deposits and impurities from the base material
- Polished steel blade, double nitrated handle and hanging hole
- Non-resistant to chemical influences

CODE	BARCODE	WIDTH	MATERIAL
JSN80	8606007993813	80mm	Steel

### YORK SCRAPER, ANGLED



- Purpose: For scraping-off different layers and dirt from base materials
- Polished steel blade, double nitrated handle and hanging hole
- Non-resistant to chemical influences

CODE	BARCODE	WIDTH	MATERIAL
JSZ30	8606007993820	80mm	Steel

### YORK SCRAPER



- Purpose: For scraping various deposits and impurities from the base material
- Polished steel blade, double nitrated handle and hanging hole
- Non-resistant to chemical influences

CODE	BARCODE	WIDTH	MATERIAL
JS30	8605043400668	30mm	Steel
JS40	8606007990201	40mm	Steel
JS60	8606007990218	60mm	Steel
JS80	8606007990225	80mm	Steel
JS100	8606007990232	100mm	Steel
JS120	8606007990249	120mm	Steel
JS150	8606007990256	150mm	Steel

### SCRAPER TOP PAINTING WOODEN HANDLE FLEX



- Purpose: For scraping and material coating
- Designed for the finest plaster works
- Very flexible with thin durable plastic handle

CODE	BARCODE	WIDTH	MATERIAL
SRF30	8605043400675	30mm	Stainless steel
SRF40	8600102480957	40mm	Stainless steel
SRF60	8606007991031	60mm	Stainless steel
SRF80	8606007991048	80mm	Stainless steel
SRF100	8606007991055	100mm	Stainless steel

**SCRAPER, INOX RUBBER HANDLE WITH BIT**

- Purpose: For the finest plaster works
- Made of stainless steel and rubber-plastic handle
- There is a PH2 type bit in the handle body for convenient plasterboard use

CODE	BARCODE	WIDTH	MATERIAL
SRGDU150	8606104807532	6"	Stainless steel

**MULTI-PURPOSE SCRAPER**

- Purpose: For scraping, removing paint from the roller and opening cans
- Made from stainless steel and rubber soft handle
- Resistant to chemical influences

CODE	BARCODE	WIDTH	MATERIAL
VSS	8606007993868	75mm	Stainless steel

**SCRAPER RUBBER-PLASTIC HANDLE WITH HOLE**

- Purpose: For the most detailed plastering works
- Ergonomic ABS handle with rubber covering, allows comfortable working, easily washed and maintained

CODE	BARCODE	WIDTH	MATERIAL
SRGD10	8606007990058	1"	Stainless steel
SRGD15	8606007990041	1,5"	Stainless steel
SRGD25	8606007990034	2,5"	Stainless steel
SRGD35	8606007990027	3,5"	Stainless steel
SRGD40	8606007990010	4"	Stainless steel
SRGD50	8606007990089	5"	Stainless steel
SRGD60	8606007990096	6"	Stainless steel

**STAINLESS STEEL PAINT SPATULA**

- Purpose: For the most detailed plastering works
- Extremely flexible
- Resistant to chemicals

CODE	BARCODE	WIDTH	MATERIAL
SIFPVC40	8606007993509	40mm	Stainless steel
SIFPVC60	8606007993677	60mm	Stainless steel
SIFPVC80	8606007993776	80mm	Stainless steel
SIFPVC100	8606007994810	100mm	Stainless steel

## SCRAPER RUBBER-PLASTIC HANDLE WITH HOLE, STEEL



- Purpose: For leveling the compound during plaster and facade works
- Mountable on a telescopic adapter
- Resistant to chemicals

CODE	BARCODE	MATERIAL	DIMENSION
SFS40	8606007994254	Stainless steel	400mm
SFS60	8606007993974	Stainless steel	600mm

## PLASTIC SQUARE SCRAPER, SET 4



- Purpose: For precise application of putty when working with metal, wood, and various construction materials
- Not resistant to chemicals

CODE	BARCODE	WIDTH	MATERIAL
JSPVC	8606007990911	50,80,100,120mm	PVC

## YORK SCRAPER, STAINLESS STEEL, SET 4



- Purpose: For precise application of putty when working with metal, wood, and various construction materials
- Not resistant to chemicals

CODE	BARCODE	WIDTH	MATERIAL
JS	8606007990898	50,80,100,120mm	Steel
JSR	8606007990928	50,80,100,120mm	Stainless steel



# BUCKET TROWELS

## BRICKLAYING TROWEL, WOODEN HANDLE



- Purpose: For plaster, mortar, and other liquid construction materials application and precise edges extraction
- Its size is suitable for a variety of craftsmen's works

CODE	BARCODE	LENGTH	MATERIAL
MOI	8606007991307	160mm	Steel
MO	8606007991291	180mm	Steel

## BRICKLAYING TROWEL RECTANGULAR STEEL



- Purpose: For plaster, mortar, and other liquid construction materials application and precise edges extraction
- Wooden handle margin trowel with flat edges
- Suitable for working on smaller surfaces due to its size

CODE	BARCODE	WIDTH	LENGTH	MATERIAL
MPR	8606007994490	50mm	125mm	Steel

### STAINLESS STEEL TROWEL



- Purpose: For masonry and plaster works on smaller surfaces
- High-quality paddle flat trowel made of stainless steel with a wooden handle

CODE	BARCODE	LENGTH	MATERIAL
GM80	8606017650850	80mm	Stainless steel
GM100	8606017658382	100mm	Stainless steel
GM120	8606017658399	120mm	Stainless steel

### BRICKLAYING TROWEL, WOODEN HANDLE



- Purpose: For brick and mortar joint works
- Masonry tuck pointer with wooden handle
- Width 9mm, length 150mm

CODE	BARCODE	WIDTH	LENGTH	MATERIAL
MF	8606007991246	9mm	150mm	Steel

### BRICKLAYING TROWEL, WOODEN HANDLE



- Purpose: For plaster, mortar and other liquid construction materials application and precise edges extraction
- Bricklaying trowel with flat edges
- Its size is suitable for large surfaces

CODE	BARCODE	LENGTH	MATERIAL
MKI	8606007991284	160mm	Steel
MK	8606007991277	180mm	Steel

### BRICKLAYING TROWEL, WOODEN HANDLE



- Purpose: For plaster, mortar, and other liquid construction materials application and precise edges extraction
- Wooden handle
- Trowel's pointed end is ideal for working in inaccessible areas

CODE	BARCODE	LENGTH	MATERIAL
MSI	8606007991338	160mm	Steel

**OUTSIDE CORNER TROWEL, WOODEN HANDLE, STAINLESS STEEL**

- Purpose: For precise inner angles shaping in construction
- Corner trowel made of stainless steel
- With a wooden handle

CODE	BARCODE	WIDTH	LENGTH	MATERIAL
MUU	8606007991383	60mm	80mm	Stainless steel

**INSIDE CORNER TROWEL, WOODEN HANDLE, STAINLESS STEEL**

- Purpose: For precise outer angles shaping in construction
- Corner trowel made of stainless steel
- Wooden handle

CODE	BARCODE	WIDTH	LENGTH	MATERIAL
MSU	8606007991352	60mm	80mm	Stainless steel

**BRICKLAYING TROWEL, RUBBER-PLASTIC HANDLE, STEEL**

- Purpose: Suitable for plaster, mortar, and other liquid construction materials application and precise edges extraction
- Bricklaying margin square trowel intended for professionals.

CODE	BARCODE	LENGTH	MATERIAL
MR180	8606007991321	180mm	Stainless steel

**MANUAL PUMP FOR CONSTRUCTION MATERIALS**

- Purpose: For practical application of materials on the substrate, such as walls, door and window frames, bricks
- Made of high quality ABS plastic, while the main shaft- the push rod is made of stainless steel and high-density rubber that allows the suction of materials due to the vacuum

CODE	BARCODE	DIAMETER	LENGTH	VOLUME
RPZGM	8605043407896	6 cm	61cm	1l

# PLASTERING TROWELS

## PLASTERING TROWEL RUBBER-PLASTIC HANDLE



- Purpose: For the application of all types of construction materials and adhesives
- Handle with 40° incline and long shank
- No chemical resistance

CODE	BARCODE	WIDTH	LENGTH	MATERIAL
GCE	8606007994315	130mm	280mm	Steel
GRE	8606007994308	130mm	280mm	Stainless steel

## PLASTERING TROWEL, RUBBER-PLASTIC HANDLE



- Purpose: For application of all types of construction materials and adhesives
- Handle made of plastic and rubber with a short shank for comfortable use
- No chemical resistance

CODE	BARCODE	WIDTH	LENGTH	MATERIAL
GCPG	8606007994285	130mm	280mm	Steel
GRPG	8606007994292	130mm	280mm	Stainless steel

## PLASTERING TROWEL, ABS HANDLE

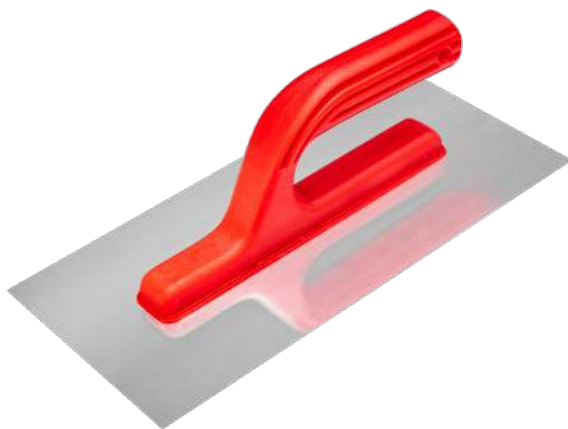

- Purpose: For the application of all types of construction materials and adhesives
- Plastering trowel with PVC handle and long shank
- Chemical resistance

CODE	BARCODE	WIDTH	LENGTH	MATERIAL
GC	8606007990126	130mm	270mm	Steel
GRR	8606007990157	130mm	270mm	Stainless steel

## PLASTERING TROWEL, STAINLESS STEEL, RUBBER HANDLE



- Purpose: For the application of all types of construction materials and adhesives
- Stainless steel plastering trowel with a soft ergonomic handle and short shank
- Chemical resistance

CODE	BARCODE	WIDTH	LENGTH	MATERIAL
GRSP	8606007994360	130mm	270mm	Stainless steel

## PLASTERING TROWEL PLASTIC HANDLE



- Purpose: For applying all types of construction materials and adhesives
- Plastering trowel with a PVC handle and short shank
- Chemical resistance

CODE	BARCODE	WIDTH	LENGTH	MATERIAL
GCA	8606007994322	130mm	280mm	Steel
GRA	8606007994339	130mm	280mm	Stainless steel

## STAINLESS STEEL NOTCHED PRO PLASTERING TROWEL



- Purpose: For applying all types of construction materials and adhesives
- Stainless steel notched professional plastering trowel with a soft ergonomic handle and short shank

CODE	BARCODE	DIMENSION	TEETH	MATERIAL
GRSPN6	8606017650829	130x270mm	6x6mm	Stainless steel
GRSPN8	8606017650836	130x270mm	8x8mm	Stainless steel
GRSPN10	8606017650843	130x270mm	10x10mm	Stainless steel
GRSPN12	8606017652724	130x270mm	12x12mm	Stainless steel



## PLASTERING TROWEL, STAINLESS STEEL, HALFROUND NOTCH



- Purpose: For application of thick layers of adhesive on large format tiles
- 7mm distance between the teeth, teeth diameter 20mm, teeth depth 15mm
- Resistant to chemicals

CODE	BARCODE	WIDTH	LENGTH	MATERIAL
GRSPP	8606017652717	130mm	270mm	Stainless steel

## VENETIAN TROWEL, STAINLESS STEEL



- Purpose: For application and processing of decorative materials
- Mirror polished stainless steel with round corners
- Resistant to chemical influences

CODE	BARCODE	WIDTH	LENGTH	MATERIAL
GSV240P	8606007990904	100mm	240mm	Stainless steel

## PLASTERING NOTCHED PLASTIC HANDLE TROWEL



- Purpose: For application of adhesive and other liquid construction materials on larger surfaces
- PVC handle
- Resistant to chemical influences.

CODE	BARCODE	DIMENSION	TEETH	MATERIAL
GRN4	8606007996203	130x270mm	4x4mm	Stainless steel
GRN6	8606007990133	130x270mm	6x6mm	Stainless steel
GRN8	8606007996210	130x270mm	8x8mm	Stainless steel
GRN10	8606007996227	130x270mm	10x10mm	Stainless steel

## PLASTERING TROWEL RUBBER-PLASTIC HANDLE



- Purpose: For application and processing of decorative materials
- Mirror polished stainless steel with round corners
- Resistant to chemical influences

CODE	BARCODE	WIDTH	LENGTH	MATERIAL
GSM	8606007990850	80mm	200mm	Stainless steel
GSV	8606007990867	100mm	240mm	Stainless steel

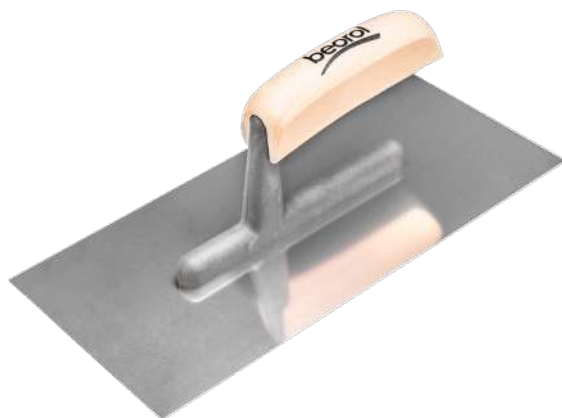
**PLASTERING TROWEL STAINLESS STEEL  
WOODEN HANDLE**

- Purpose: For application of all types of construction materials and adhesives
- Chemical resistance
- Beechwood ergonomic handle made on the long aluminum shank

CODE	BARCODE	WIDTH	LENGTH	MATERIAL
GRDM	8606007994346	130mm	270mm	Stainless steel

**STAINLESS STEEL TROWEL, ALUMINIUM  
FOOT, WOODEN HANDLE**

- Purpose: For application of all types of construction materials and adhesives
- Chemical resistance
- Beechwood ergonomic handle made on a long aluminum shank

CODE	BARCODE	WIDTH	LENGTH	MATERIAL
GRAD	8606017659037	130mm	270mm	Stainless steel

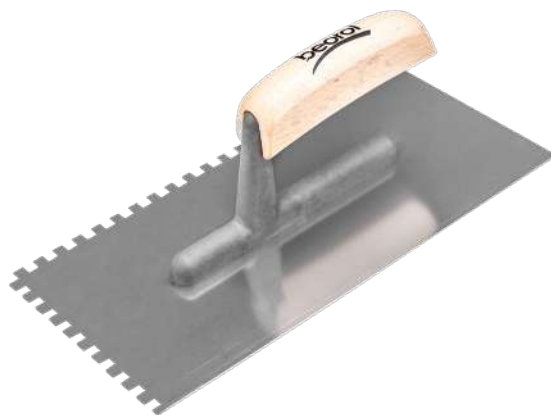
**PLASTERING TROWEL STAINLESS STEEL  
WOODEN HANDLE**

- Purpose: Stainless steel notched plastering trowel for applying all types of construction materials and adhesives
- Beechwood ergonomic handle
- Chemical resistance

CODE	BARCODE	DIMENSION	TEETH	MATERIAL
GRNDM6	8606007994353	130X270mm	6X6mm	Stainless steel
GRNDM8	8606007996241	130X270mm	8X8mm	Stainless steel
GRNDM10	8606007996258	130X270mm	10X10mm	Stainless steel

**RUBBER FLOAT TROWEL**

- Purpose: For work with liquid and low-density construction adhesives and putties
- With a wooden handle for comfortable grip
- Flexible rubber blade

CODE	BARCODE	WIDTH	MATERIAL
GG	8606007990171	180mm	Rubber

## PLASTERING TROWEL, WODEN HANDLE



- Purpose: For applying all types of construction materials and adhesives on large surfaces
- Stainless steel plastering trowel with a wooden ergonomic handle
- Chemical resistance

CODE	BARCODE	WIDTH	LENGTH	MATERIAL
GRVD	8606007990843	130mm	480mm	Stainless steel

## PLASTERING TROWEL, WOODEN HANDLE



- Purpose: For applying all types of construction materials and adhesives on large surfaces
- Stainless steel notched plastering trowel with a wooden ergonomic handle
- Chemical resistance

CODE	BARCODE	WIDTH	LENGTH	MATERIAL
GRVND8	8606007994469	130mm	480mm	Stainless steel
GRVND10	8606007994476	130mm	480mm	Stainless steel

## SCRAPER SHORT WOODEN HANDLE WITHOUT TEETH



- Purpose: Wooden handle flat scraper for ceramic works
- Non-resistant to chemical influences

CODE	BARCODE	WIDTH	MATERIAL
GKR180	8606007990812	180mm	Steel
GKR250	8606007990829	250mm	Steel

## SCRAPER SHORT WOODEN HANDLE WITH TEETH



- Purpose: Wooden handle notched scraper for ceramic works
- Non-resistant to chemical influences

CODE	BARCODE	WIDTH	MATERIAL
GK180	8606007990799	180mm	Steel
GK250	8606007990805	250mm	Steel

**PLASTIC PLASTERING TROWEL**

- Purpose: For facade materials application during construction finishing work
- High-quality resistant plastering PVC trowel

CODE	BARCODE	LENGTH	THICKNESS	MATERIAL
GPVC	8606007990140	280mm	3mm	PVC

**RUBBER TROWEL FOR GROUTING**

- Purpose: For grouting is used in the application of grouting materials
- Designed based on the extensive experience and feedback of professional tile layers

CODE	BARCODE	LENGTH	THICKNESS	MATERIAL
GFP	8606017650379	95mm	240mm	ABS / Rubber

**POLYSTYRENE TROWEL**

- Purpose: For plastering surfaces process
- Made from a special type of polystyrene
- Lightweight trowel with an extreme hardness

CODE	BARCODE	WIDTH	LENGTH	MATERIAL
GS270	8606007990546	130mm	270mm	Polystyrene
GS320	8606007990553	170mm	320mm	Polystyrene
GS450	8606007990713	130mm	450mm	Polystyrene

# SPREADING BOARDS AND SCRAPERS



## SOFT SPONGE TROWEL



- Purpose: For ceramic tiles cleaning after grouting
- High-quality absorbent sponge

CODE	BARCODE	LENGTH	THICKNESS	MATERIAL
PSS20	8606104807549	140x280mm	20mm	ABS / Sponge

## SEGMENTED SPONGE TROWEL



- Purpose: Segmented sponge trowel for ceramic tiles cleaning after grouting
- Covering a large sponge area, this trowel enables a fast and easy grout cleaning process
- A high-quality absorbing sponge provides faster and better removal of leftover grout

CODE	BARCODE	LENGTH	THICKNESS	MATERIAL
PSSG30	8606017650386	140x280mm	30mm	ABS / Sponge

**PLASTIC ROUGH SPONGE TROWEL**

- Purpose: Plastic rough sponge trowel is intended for cleaning rough tiles after grouting
- A high-quality absorbing sponge provides faster and better removal of leftover grout
- Recommended for floor tiles and large areas

CODE	BARCODE	LENGTH	THICKNESS	MATERIAL
PSG30	8606017651574	140x280mm	30mm	ABS / Sponge

**SPREADING BOARD WITH ORANGE RUBBER SPONGE**

- Purpose: For grout materials application
- The anatomic handle ensures comfortable use and protects from adhesive and grouting materials irritations

CODE	BARCODE	DIMENSION	THICKNESS	MATERIAL
PS	8606007998665	140x280mm	10mm	ABS / Sponge

**SPREADING BOARD WITH HYDRO SPONGE**

- Purpose: Hydro sponge trowel 30mm thick is designed for ceramic tiles cleaning during or after grouting
- A high-quality absorbing sponge provides faster and better removal of leftover grout
- Anatomic handle

CODE	BARCODE	LENGTH	THICKNESS	MATERIAL
PSH30	8606017651581	140x280mm	30mm	ABS / Sponge

**SPREADING BOARD WITH EVA**

- Purpose: For grouting with ABS handle
- The anatomic handle ensures comfortable use and protects from adhesive and grouting materials irritations

CODE	BARCODE	DIMENSION	THICKNESS	MATERIAL
PG	8606007991550	140x280mm	8mm	ABS / Rubber

## PLASTIC TROWEL



- Purpose: For stretching and leveling mortar and concrete materials
- Made of reinforced high-quality PVC

CODE	BARCODE	WIDTH	LENGTH	MATERIAL
PPM	8606104807044	250mm	140mm	PVC
PPS	8606104807037	320mm	160mm	PVC
PPV	8606104807020	440mm	150mm	PVC

## PLASTER SCRAPER 8 KNIVES



- Purpose: For plaster planing
- Not suitable for concrete
- The high-quality aluminum housing ensures durability and is lightweight, and the 8 steel scraper blades enable fast planing and precise work

CODE	BARCODE	WIDTH	LENGTH	MATERIAL
SM8	8606017652731	90mm	465mm	Aluminum

## METAL RASP TROWEL



- Purpose: For styrofoam scraping at facade works
- Made of reinforced plastic and metal scraping surface
- The perforated plate reduces the weight of the tool and allows easy cleaning of the styrofoam residues

CODE	BARCODE	WIDTH	LENGTH	MATERIAL
SSM270	8606007990522	270mm	130mm	ABS / Steel
SSM400	8606007990539	400mm	180mm	ABS / Steel

## METAL RASP TROWEL PERFO



- Purpose: Metal rasp board trowel Perfo is a styrofoam scraper with an anatomical handle and a metal surface used to scrape styrofoam during facade work
- The Perforated plate reduces the weight of the tool and makes it possible to clean easily styrofoam residues

CODE	BARCODE	WIDTH	LENGTH	MATERIAL
SSMP270	8606017651543	130mm	270mm	ABS / Steel
SSMP380	8606017651550	160mm	380mm	ABS / Steel
SSMP400	8606017651567	180mm	400mm	ABS / Steel

**TILING SPONGE HYDRO**

- Purpose: For ceramic tiles cleaning after grouting
- High-quality absorbent sponge
- Suitable for smaller and hard-to-reach areas

CODE	BARCODE	LENGTH	THICKNESS	MATERIAL
SKG	8606017651598	110x160mm	60mm	Sponge

**TILING SPONGE HYDRO**

- Purpose: For ceramic tiles cleaning after grouting
- High-quality absorbent sponge
- Suitable for smaller and hard-to-reach areas

CODE	BARCODE	LENGTH	THICKNESS	MATERIAL
SKH	8606017651604	110x160mm	60mm	Sponge



# EXTENSION POLES



## ALU EXTENSION POLES



CODE	BARCODE	LENGTH	MATERIAL
TA2	8606007990430	2m	Aluminum
TA3	8606007990447	3m	Aluminum

- Purpose: Aluminium 2-part threaded extension pole for paint rollers and brushes
- It is mainly used for painting ceilings and hard-to-reach areas
- Lighter than standard steel and has greater strength, making it ideal for professional use

## EXTENSION POLES



CODE	BARCODE	LENGTH	MATERIAL
T12D	8606007996074	1.2m	Steel
T2	8606007990416	2m	Steel
T3	8606007990423	3m	Steel
T4	8606017652755	4m	Steel

- Purpose: 2-part threaded steel extension pole for paint rollers and brushes
- It is mainly used for painting ceilings and hard-to-reach areas

## EXTENSION POLES



CODE	BARCODE	LENGTH	MATERIAL
T12	8606007990409	1,2m	Steel

- Purpose: It is mainly used for painting ceilings and larger surfaces, but all the cleaning brushes, household brooms, mops, and wipers for glass windows can be mounted on the Euro thread that this telescope has

## METAL HANDLE WITH THREAD 120cm



CODE	BARCODE	LENGTH	MATERIAL
MSN120	8606017659792	1,2m	Steel

- Purpose: Threaded metal tip handle 120 cm long suitable for multipurpose use
- Diameter 21 mm

# SANDING BLOCKS AND ADAPTERS



## PVC SANDING BLOCK



- Purpose: For stronger bonding of sandpaper
- With the mechanism for firmer sanding paper tying

CODE	BARCODE	LENGTH	WIDTH	MATERIAL
DSMM	8606007990744	160mm	85mm	PVC
DSMV	8606007990751	210mm	105mm	PVC

## RUBBER SANDING BLOCK



- Purpose: For stronger bonding of sandpaper
- Made of quality rubber, two-part

CODE	BARCODE	LENGTH	WIDTH	MATERIAL
DSC	8606007990737	120mm	65mm	Rubber

## PVC POLE SANDER



- Purpose: For firmer sanding paper holding to cover a greater service and inaccessible area in a shorter amount of time
- Accepts extension pole

CODE	BARCODE	LENGTH	WIDTH	MATERIAL
DST	8606007990768	210mm	105mm	PVC

## FACADE SCRAPER ADAPTER



- Purpose: Facade scraper adapter for extension pole
- Comes with 2 butterfly screws in the set

CODE	BARCODE	WIDTH	MATERIAL
AFS	8606017659105	3"	Galvanized steel



# MIXERS



## STEEL MIXER PADDLE



CYLINDRICAL SHANK

- Purpose: Used for mixing different types of masonry materials and compounds
- The carefully designed shape ensures high-quality work

CODE	BARCODE	DIAMETER	LENGTH	SHANK
M10	8606007991123	Ø55mm	400mm	Cylindrical
M15	8606007991147	Ø75mm	400mm	Cylindrical
M20	8606007991178	Ø95mm	590mm	Cylindrical

## GALVANIZED STEEL MIXER PADDLE

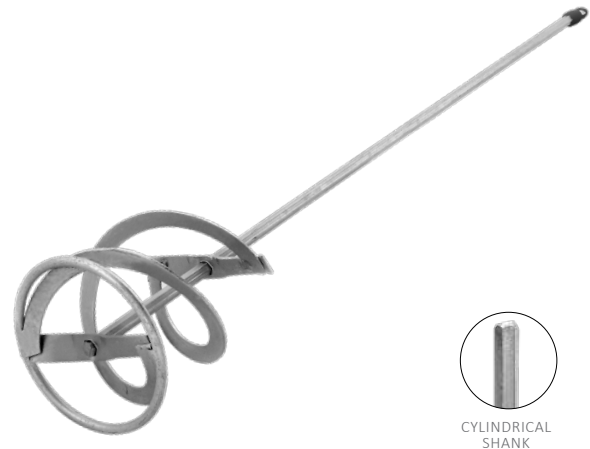

CYLINDRICAL SHANK

- Purpose: Galvanized steel mixer paddle used for mixing different types of masonry materials and compounds
- Carefully designed shape optimizes high-quality work
- Protected with zinc coating for longer service life

CODE	BARCODE	DIAMETER	LENGTH	SHANK
MA15	8606007991215	Ø75mm	400mm	Cylindrical
MA20	8606007991222	Ø95mm	650mm	Cylindrical

## MORTAR AND GLUE MIXER PADDLE SPIRAL



- Purpose: Mixer paddle with “FAST” spiral for mixing low and medium density mortar and glue compounds

CODE	BARCODE	DIAMETER	LENGTH	SHANK
MMLS110	8606017653127	Ø110mm	500mm	Cylindrical
MMLS140	8606017653134	Ø140mm	600mm	Cylindrical
MMLSM14	8606017653110	Ø140mm	600mm	M14

## MORTAR AND GLUE MIXER 2-BLADE HEAD PADDLE



- Purpose: Mortar and glue mixer 2-blade head paddle
- Allows very fast and high-quality mixing of all mortar, adhesive, and leveling compounds
- Made of steel

CODE	BARCODE	DIAMETER	LENGTH	SHANK
MMLDSM14	8606017653141	Ø130mm	600mm	M14
MMLDSSDS	8606017653158	Ø95mm	500mm	SDS

## MORTAR AND GLUE MIXER PADDLE ROUND

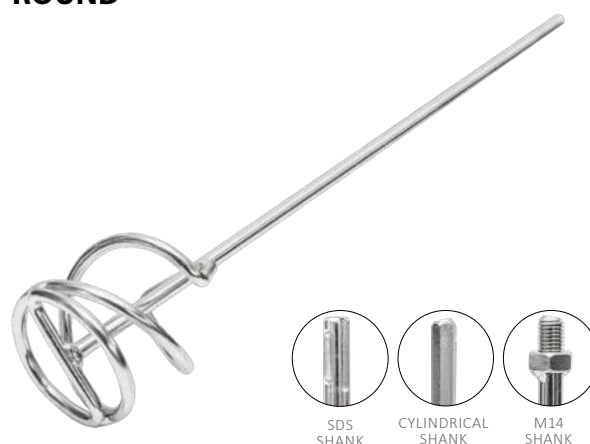

- Purpose: Universal mixer paddle round for all types of masonry materials

CODE	BARCODE	DIAMETER	LENGTH	SHANK
MMLO80	8606017653189	Ø80mm	500mm	Cylindrical
MMLO90	8606017653196	Ø90mm	600mm	Cylindrical
MMLM14	8606017653165	Ø95mm	600mm	M14
MMLSDS	8606017653172	Ø90mm	500mm	SDS

## MORTAR AND GLUE MIXER CAGE PADDLE

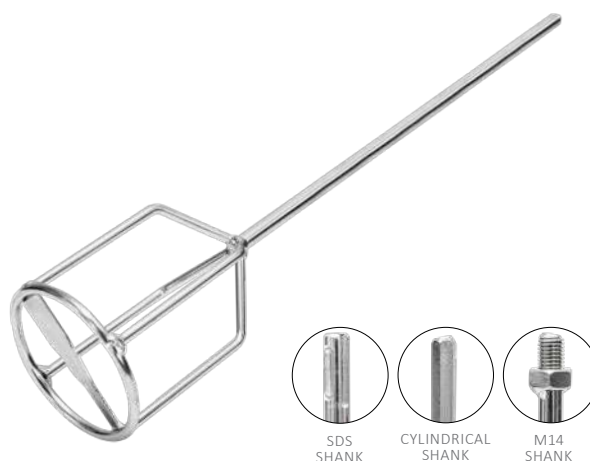

- Purpose: Universal mixer paddle for all types of masonry materials

CODE	BARCODE	DIAMETER	LENGTH	SHANK
MMLK80	8606017653226	Ø80mm	500mm	Cylindrical
MMLK100	8606017653233	Ø100mm	500mm	Cylindrical
MMLKM14	8606017653202	Ø100mm	500mm	M14
MMLKSDS	8606017653219	Ø100mm	500mm	SDS

### MORTAR AND GLUE MIXER 3-BLADE HEAD PADDLE

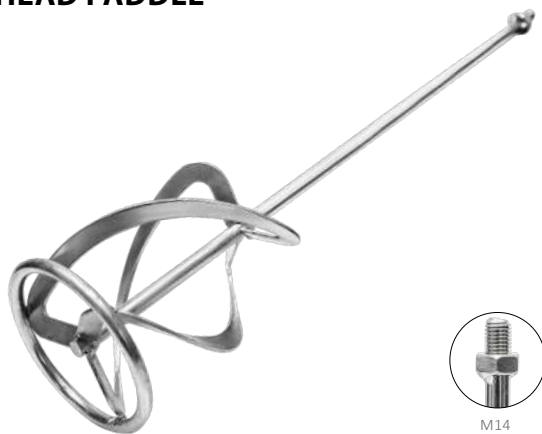

M14 SHANK

- Purpose: Mixer paddle with “FAST” 3-blade heads/spirals for mixing low and medium density mortar and glue compounds

CODE	BARCODE	DIAMETER	LENGTH	SHANK
MMLTSM14	8606017653240	∅135mm	600mm	M14

### GROUT MIXER PADDLE



CYLINDRICAL SHANK

- Purpose: Grout mixer paddle made of steel for blending grouting and epoxy batches

CODE	BARCODE	DIAMETER	LENGTH	SHANK
MMF75	8606017653271	∅75mm	300mm	Cylindrical

### PAINT AND GLUE MIXER PADDLE



CYLINDRICAL SHANK



M14 SHANK

- Purpose: Steel paint and glue mixer paddle with PVC plastic spirals used for paint and low-density glue

CODE	BARCODE	DIAMETER	LENGTH	SHANK
MFLP100	8606017653264	∅100mm	500mm	Cylindrical
MFLPM14	8606017653257	∅100mm	600mm	M14

### PAINT, MORTAR AND LEVELING COMPOUND MIXER PADDLE

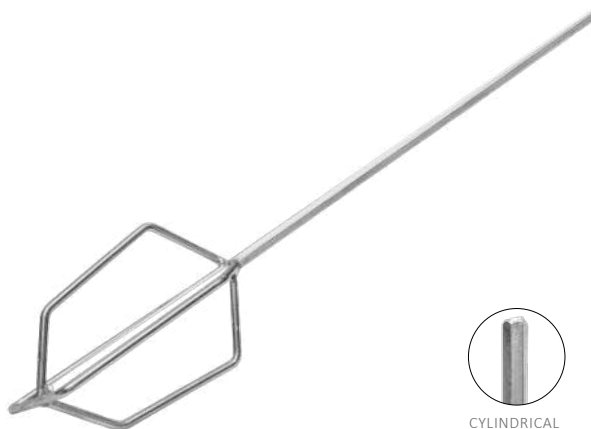

CYLINDRICAL SHANK

- Purpose: Steel mixer paddle for paint, mortar, and leveling compound
- Ensures low air intake into the mixed compound which is very important for these materials

CODE	BARCODE	DIAMETER	LENGTH	SHANK
MFML115	8606017653318	∅115mm	660mm	Cylindrical

## STEEL PAINT MIXER PADDLE



CYLINDRICAL SHANK

- Purpose: Steel mixer paddle 75mm for fast paint mixing

CODE	BARCODE	DIAMETER	LENGTH	SHANK
MF75	8606017653288	∅75mm	500mm	Cylindrical

## PAINT SERRATED PLASTIC HEAD MIXER PADDLE



CYLINDRICAL SHANK

- Purpose: Paint serrated plastic head mixer paddle for fast paint mixing

CODE	BARCODE	DIAMETER	LENGTH	SHANK
MFP80	8606017653295	∅80mm	500mm	Cylindrical

## PLASTER, MORTAR AND LEVELING COMPOUND MIXER PADDLE

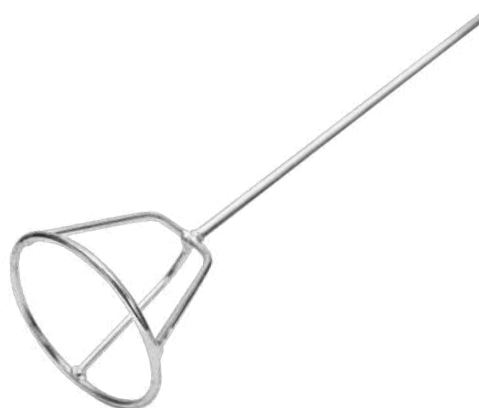

- Purpose: Steel mixer paddle for plaster, mortar and levelling compound mixing
- Ensures low air intake into the mixed compound which is very important for these materials

CODE	BARCODE	DIAMETER	LENGTH	SHANK
MGMN120	8606017653301	∅120mm	500mm	Cylindrical

# CAULKING GUNS

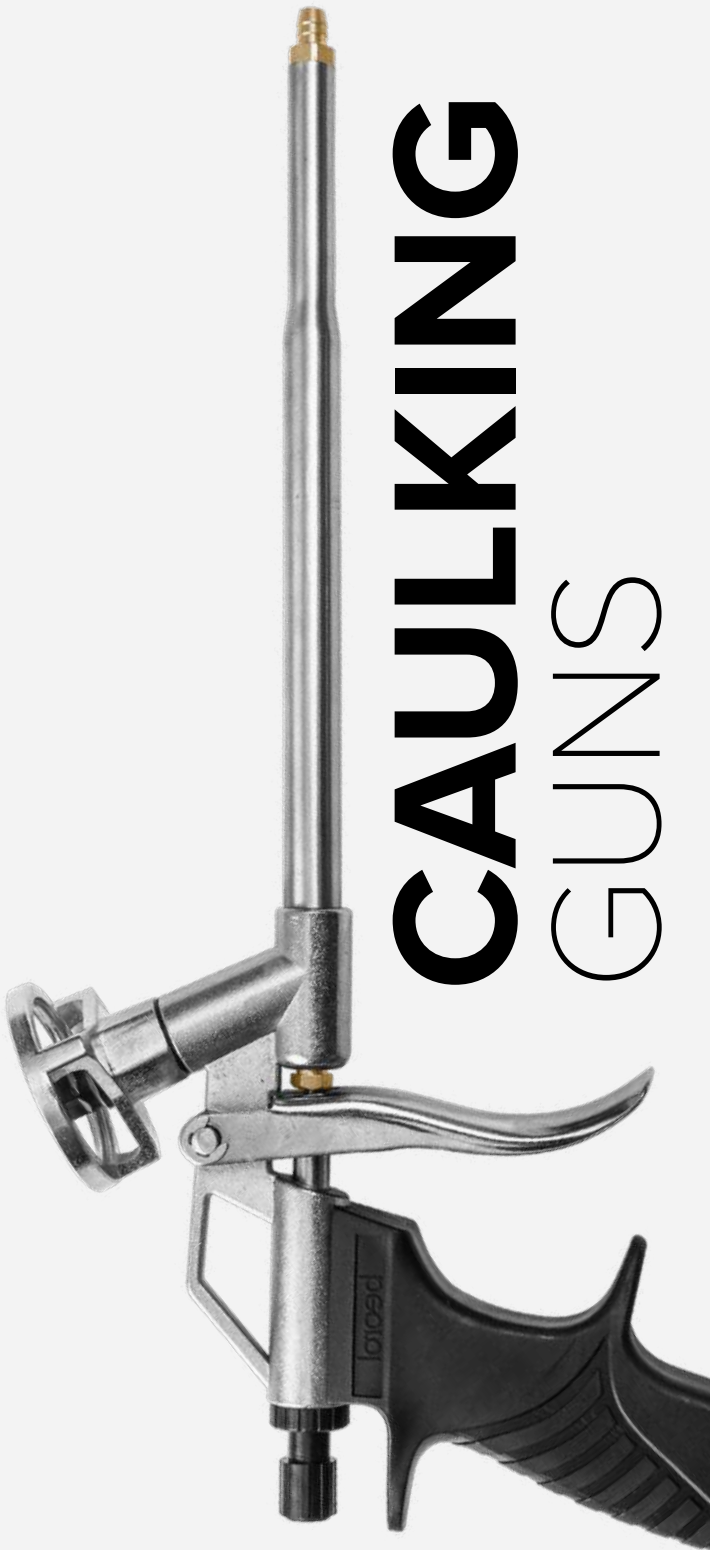

## PU FOAM GUN PROFESSIONAL



- Purpose: For directed and controlled PU spray foam application
- Made of the highest quality plastic and robust construction for long service life for professional users
- It has a foam flow regulating valve

CODE	BARCODE	MATERIAL
PPPP	8606017651970	PTFE Teflon / Steel / Copper

## PU FOAM GUN STANDARD



- Purpose: For directed and controlled PU spray foam application
- Lightweight construction and quality materials for easy use and long service life
- It has a foam flow regulating valve

CODE	BARCODE	MATERIAL
PPPS	8606017651987	Aluminum / Steel / Copper



## PU FOAM GUN HOBBY



- Purpose: For directed and controlled PU spray foam application
- Made of the highest quality plastic and designed to be extremely lightweight and economical
- It has a foam flow regulating valve

CODE	BARCODE	MATERIAL
PPPH	8606017651765	PVC / Steel / Copper

## STEEL CAULKING GUN PROFESSIONAL



- Purpose: Steel caulking gun Professional for easy application of high-density sealants and adhesives
- Solid construction with improved trigger handle lever arms
- Maximum load capacity 181.6kg

CODE	BARCODE	MATERIAL
PSPE	8606007991628	Steel

## PU FOAM GUN WITH PTFE COATING



- Purpose: For directed and controlled PU spray foam application
- Robust construction, made from high-quality steel and Teflon
- Teflon prevents PU foam adhesion, and thus gun doesn't require cleaning

CODE	BARCODE	MATERIAL
PPPT	8605043406417	Steel / Teflon

## CHROME PLATED SILICONE CAULKING GUN



- Purpose: Chrome plated steel silicone caulking gun for easy application of high-density sealants and adhesives
- Resistant to chemical influences and cartridge content
- The built-in spout and nozzle cutter with the wrist strap on the handle
- Hook for easy storag

CODE	BARCODE	MATERIAL
PSC	8606007990478	Steel chromed

**STEEL SKELETON CAULKING GUN**



- Purpose: Skeleton caulking gun for low-density sealants and adhesives application
- Built-in dripless function ( no silicone leak after trigger handle release) enables precise and clean work
- Basic silicone gun model made of steel

CODE	BARCODE	MATERIAL
PSP	8606007990461	Steel

**CAULKING GUN DENTED ROD**

- Purpose: Steel caulking gun notched for low-density sealants and adhesives application
- Reinforced basic silicone caulking gun model, suitable for all craftsmen's needs
- Gun weight 373g

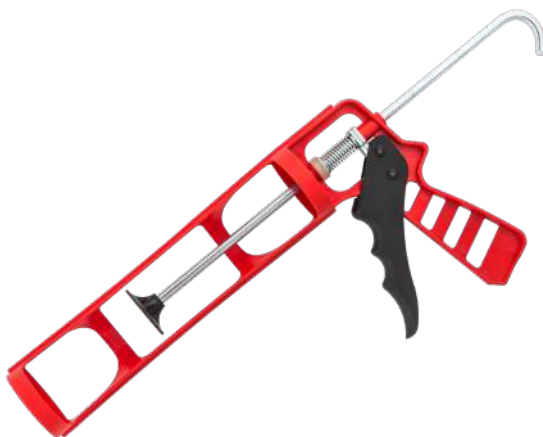
CODE	BARCODE	MATERIAL
PSN	8606007991611	Steel

**PLASTIC CAULKING GUN SKELETON**

- Purpose: Plastic caulking gun Skeleton easy application of low-density sealants and adhesives
- Extremely lightweight
- High-quality plastic and improved design ensure long service life
- Operating voltage 220 v

CODE	BARCODE	MATERIAL
PSPS	8606107912189	Polypropylene / Fiberglass

**ALUMINIUM TUBE CAULKING GUN**

- Purpose: Aluminum tube caulking gun for sealant widely used in building decoration, warehouses, parking garages, industries
- Made for professionals

CODE	BARCODE	MATERIAL
PSA	8606007991604	Aluminum

## PROFESSIONAL CAULKING GUN PLASTIC



- Purpose: Durable plastic caulking gun Professional for easy application of high-density sealants and adhesives
- Suitable for all crafts and home use
- Pressure rod made of galvanized steel

CODE	BARCODE	LENGTH	MATERIAL
PSPP	8605043401917	35cm	Polypropylene / Fiberglass

## HOT GLUE GUN 11mm



- Purpose: Used to heat glue sticks for crafting and repairing home essentials including wood, plastic, glass, metal, ceramic, magnet and other non-porous materials
- Ergonomic design for comfort use

CODE	BARCODE	MATERIAL
PZP11	8606017657750	PVC

## HOT GLUE GUN 7mm



- Purpose: Used to heat glue sticks for making and repairing basic household items, including wood, plastic, glass, metal, ceramic and other materials
- Ergonomic design for comfort
- Safe to set aside

CODE	BARCODE	MATERIAL
PZP7	8606017657743	PVC

## HOT GLUE GUN REFILLS



- Purpose: Refills for hot glue gun for crafting and repairing home essentials including wood, plastic, glass, metal, ceramic, magnet and other non-porous materials

CODE	BARCODE	DIAMETER	LENGTH	COLOR
RPZP7X10T	8606017656876	Ø7mm	100mm	Transparent
RPZP11X10B	8606017656883	Ø11mm	100mm	White
RPZP11X10C	8606017656890	Ø11mm	100mm	Black
RPZP11X10T	8606007990492	Ø11mm	100mm	Transparent
RPZP11X20T	8606017656869	Ø11mm	200mm	Transparent

# CARDBOARDS FOILS AND MOULDING



## CARDBOARD ROLL FOR FLOOR PROTECTION



- Purpose: Double-layer cardboard roll 15m protects floors during construction, painting works and varnishing
- It can be used as a base for the carpet, linoleum, laminate flooring, decking and parquet flooring, levelling the floor surface

CODE	BARCODE	WIDTH	LENGTH	THICKNESS
KZD15	8606017655862	1m	15m	3mm

## FELT 5m



- Purpose: Felt with PE pad can be used for various purposes such as protection from dirt, while painting, to protect the floor when moving heavy furniture, etc.

CODE	BARCODE	WIDTH	LENGTH	THICKNESS
FC5	8606104807587	1m	5m	6mm

## HAND STRETCH FILM



- Purpose: The manual stretch film is intended for packaging and package protection
- It has adhesive only form inside, thereby preventing foil from sticking and tearing on other pallets
- Strong, resilient and tear-resistant
- Stretchability is up to 160%

CODE	BARCODE	WIDTH	THICKNESS	MATERIAL
FSM	8606017656142	10cm	23µm	LDPE
FS2.5	8606107185842	50cm	23µm	LDPE
FS5	8606106732924	50cm	23µm	LDPE

## HEAVY DUTY PLASTIC DROP PROTECTION SHEET



- Purpose: For covering and protecting of various objects for hobby users and in construction
- The weight of 900g ensures safe objects cover protected from the external sun and moisture influences, but also dust and splashes of various liquids and paint
- High tear resistance suitable for protective tread in construction

CODE	BARCODE	WIDTH	LENGTH	MATERIAL
F4X5G900HD	8605043402723	4m	5m	LDPE

## PLASTIC DROP PROTECTION SHEET

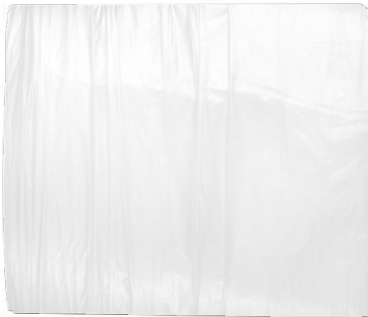

- Purpose: Plastic drop protection sheet for furniture and interior protection while painting or renovation
- Material LDPE

CODE	BARCODE	WIDTH	LENGTH	THICKNESS
F4X12.5	8600102480889	4m	12.5m	6µm
F4X5	8600102480599	4m	5m	6µm
F4X5M15	8606107185620	4m	5m	15µm
F4X5M30	8606107185637	4m	5m	30µm

## ALUMINUM PLASTER CORNER PROFILE 2.5M EXTRA

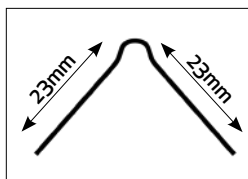

- Purpose: Aluminium plaster and construction corner profile 2.5m extra for precise corner edges forming during plastering work
- The length is 2.5m with equally wide sides 23mm

CODE	BARCODE	WIDTH	LENGTH	MATERIAL
LALU25E	8606007995725	23mm	2.5m	Aluminum

## PAPER-FACED ALUMINIUM CORNER BEAD



- Purpose: The tape is used to protect external corners and edges, in systems of dry construction, plasterboard, and gypsum
- The tape is flexible and allows for an adjustable angle of 45°
- The metal from which the strips are made is aluminium, which guarantees that no rust will appear

CODE	BARCODE	WIDTH	LENGTH	MATERIAL
PATU	8605043408640	50mm	30m	Aluminum / Paper



**GET  
THINGS  
DONE**







# MEASURING PROGRAM

---

- METERS AND RULERS
- LEVELS AND SCREED BOARDS
- MARKING TOOLS

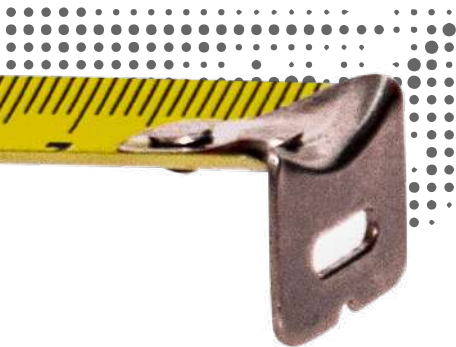

# METERS AND RULERS



## MEASURING TAPE EXTRA



- Purpose: For precise measurement of various types of surfaces
- Contains a 1mm measurement metric scale made of elastic steel and a protective PVC layer
- Heavy duty ergonomic rubberized ABS case
- Contains lock button

CODE	BARCODE	WIDTH	LENGTH	MATERIAL
M3E	8606007992823	16mm	3m	ABS / Steel / Rubber
M5E	8606007990379	19mm	5m	ABS / Steel / Rubber

## STEEL RUBBER ROLLER MEASUREMENT TAPE



- Purpose: For precise measurement of various types of surfaces
- Contains a 1mm measurement metric scale made of elastic steel and a protective PVC layer
- One-handed measurement option using a rubber roller
- The automatic stop button stops measuring tape and makes it simple to use

CODE	BARCODE	WIDTH	LENGTH	MATERIAL
MRG5	8606107185323	19mm	5m	ABS / Steel / Rubber
MRG7.5	8606106732443	19mm	7.5m	ABS / Steel / Rubber

## MEASURING TAPE AUTO-LOCK



- Purpose: For precise measurement of various types of surfaces
- Contains a 1mm measurement metric scale made of elastic steel and a protective PVC layer
- The auto-lock mechanism controls blade retraction and locks the blade in place for quick and efficient measuring

CODE	BARCODE	WIDTH	LENGTH	MATERIAL
M2A	8606106732047	16mm	2m	ABS / Steel / Rubber
M3A	8606106732054	16mm	3m	ABS / Steel / Rubber
M5A	8606106732061	19mm	5m	ABS / Steel / Rubber
M7.5A	8606106732078	25mm	7.5m	ABS / Steel / Rubber

## STEEL MEASURING TAPE



- Purpose: For precise measuring different areas
- Contains a 1mm measurement metric scale made of elastic steel and a protective PVC layer
- Ergonomic case design
- Lock button at the bottom of the case

CODE	BARCODE	WIDTH	LENGTH	MATERIAL
M2	8606007991161	16mm	2m	ABS / Steel
M3	8606007994667	16mm	3m	ABS / Steel
M5	8606007991192	16mm	5m	ABS / Steel
M7.5	8606007994674	25mm	7.5m	ABS / Steel

## MEASURING TAPE ECONOMIC



- Purpose: For precise measurement of various types of surfaces
- Contains a 1mm measurement metric scale made of elastic steel and a protective PVC layer
- Ergonomic rubberized ABS case

CODE	BARCODE	WIDTH	LENGTH	MATERIAL
M3K	8606007992359	16mm	3m	ABS / Steel
M5K	8606007992601	16mm	5m	ABS / Steel

## MEASURING TAPE PROJECT



- Purpose: For precise measuring different areas
- A durable, reliable measuring tape is an essential tool for any professional and construction work
- Strong aluminum case
- High visibility measuring tape made of highly elastic steel coated with a PVC protective layer
- Reliable auto-locking system for easy handling

CODE	BARCODE	WIDTH	LENGTH	MATERIAL
MP5	8605043404949	25mm	5m	Aluminum

**DOUBLE-SIDED-HOOKED METER**

- Purpose: For precise measurement of various types of surfaces
- Made of highly elastic steel coated with PVC protective foil
- Patented dual lock reverse locking mechanism, button with self-locking function

CODE	BARCODE	WIDTH	LENGTH	MATERIAL
MD5	8605043404956	25mm	5m	ABS / Steel / Rubber

**MEASURING TAPE MINI 40/1 PACK**

- Purpose: Mini measuring tape keychain with calibrated measuring scale
- Package: 60 pieces

CODE	BARCODE	WIDTH	LENGTH	PACKAGE
MM40	8606106732016	6mm	1m	40 pcs

**MEASURING TAPE PROFESSIONAL**

- Purpose: Open reel measuring tape professional 20m for construction areas measurement
- Opened plastic housing with ergonomic handle

CODE	BARCODE	WIDTH	LENGTH	MATERIAL
MTP20	8606007994582	11mm	20m	PVC / Fiberglass
MTP30	8606007994599	11mm	30m	PVC / Fiberglass
MTP50	8606007994605	11mm	50m	PVC / Fiberglass
MTP100	8606007994612	11mm	100m	PVC / Fiberglass

**MEASURING TAPE**

- Purpose: For construction areas measurement
- Measuring tape, with closed plastic housing and anatomic handle
- The measuring tape is made of Fiberglass

CODE	BARCODE	WIDTH	LENGTH	MATERIAL
MT20	8606007991369	11mm	20m	PVC / Fiberglass
MT30	8606007991376	11mm	30m	PVC / Fiberglass

## WOODEN FOLDING RULE PROFESSIONAL



- Purpose: For measuring in carpentry and plastering works
- Made from high-quality wood
- The double-sided metric for measurement
- Consists of 10 parts

CODE	BARCODE	WIDTH	LENGTH	MATERIAL
DM2E	8606007992298	16mm	2m	Wood

## VERNIER CALIPER, TYPE A



- Purpose: For measurements where exceptional precision is required
- Storage box included
- Measurement accuracy 0,02 mm
- Visual metric scale

CODE	BARCODE	LENGTH	MATERIAL
SUB	8606007991918	220mm	Steel

## PLASTIC FOLDING METER



- Purpose: For measuring in carpentry and plastering works
- The double-sided metric for measurement
- Consists of 10 parts

CODE	BARCODE	WIDTH	LENGTH	MATERIAL
PM2E	8606017652625	16mm	2m	PVC

## MINI FOLDING METER 50cm 60/1



- Purpose: For measuring smaller areas
- On the wrist strap
- Calibrated on both sides

CODE	BARCODE	WIDTH	LENGTH	PACKAGE
MM60	8606017652632	12mm	50cm	60pcs

## CLAMPING SQUARE ABS



- Purpose: Positioning square enables 2 elements to position or assemble any project that requires a 90-degree corner
- Both sides include inches and centimeter units for different needs

CODE	BARCODE	DIMENSION	MATERIAL
LUABS50X80	8605043401962	50x80mm	ABS plastic
LUABS100X100	8605043401979	100x100mm	ABS plastic
LUABS150X150	8605043401986	150x150mm	ABS plastic
LUABS200X200	8605043401993	200x200mm	ABS plastic

## TILE HOLE LOCATOR TOOL



- Purpose: For precise adjusting and measuring during drilling holes
- The product is used with diamond crowns and an electric drill
- It is mainly used for opening and positioning tiles

CODE	BARCODE	DIMENSION	WEIGHT
SPR	8605043407483	400x300 mm	342 g

## TRY SQUARE PROFESSIONAL



- Purpose: Professional aluminum framing square enables 2 elements positioning or assembling any project that requires a 90-degree corner
- The shorter side is lifted for easier work
- The longer side is calibrated in metric and inche

CODE	BARCODE	WIDTH	LENGTH	MATERIAL
UL35	8606007994230	153mm	35cm	Aluminum
UL50	8606017656975	160mm	50cm	Aluminum

## ALU-ALLOY STEEL ANGULAR SQUARE

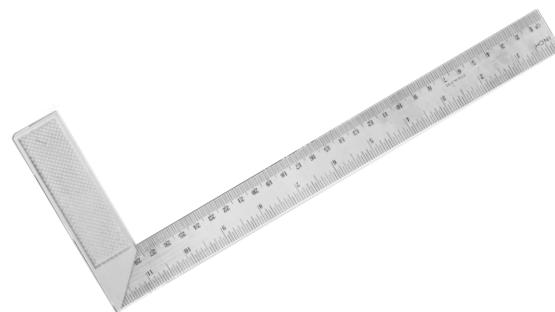

- Purpose: Professional aluminum framing square enables 2 elements positioning or assembling any project that requires a 90-degree corner
- The shorter side is lifted for easier work
- The longer side is calibrated in metric and inches

CODE	BARCODE	WIDTH	LENGTH	MATERIAL
UL	8606007992045	123mm	30cm	Aluminum

## MINI LEVEL KEYCHAIN



- Purpose: For leveling smaller surfaces
- On the wrist strap
- Package: 50 pieces

CODE	BARCODE	MATERIAL	PACKAGE
LIM50	8606106732023	PVC	50 pcs

## ANGLE LEVEL 180° 40cm



- Purpose: For transferring measured angle to another location and leveling under measured angle
- Working range of angle measurement 0 to 180 degrees
- Two leveling levels

CODE	BARCODE	LENGTH	MATERIAL
LU180	8606007996180	40cm	Aluminum



# LEVELS AND SCREED BOARDS

**PLUMB PROFESSIONAL**

- Purpose: Professional magnetic level with handles for horizontal, vertical, and 45 degrees angled leveling
- Contains three high precision axis and ribbed treading surfaces for heating and plumbing pipe leveling
- Ergonomic design and high firmness
- Rubber handles and blocks enable mechanical damage protection

CODE	BARCODE	LENGTH	MATERIAL
LP60	8606007994728	60cm	Aluminum
LP80	8606007994735	80cm	Aluminum
LP120	8606007994742	120cm	Aluminum

**PLUMB WITH HANDHOLD**

- Purpose: Level with handles for horizontal, vertical and 45 degrees angled leveling
- Contains 3 high precision vials and a ribbed tread
- Soft end caps make it more durable in case of shocks
- Axis adjustment 0-90 degrees option
- Made of high-quality aluminum

CODE	BARCODE	LENGTH	MATERIAL
LE60	8606007994681	60cm	Aluminum
LE80	8606007994698	80cm	Aluminum
LE120	8606007994704	120cm	Aluminum
LE200	8606007994711	200cm	Aluminum

**PLUMB, RED/BLACK**

- Purpose: Level for horizontal, vertical, and 45 degrees angled leveling
- Contains 3 high precision vials and a ribbed tread
- Soft end caps make it more durable in case of shocks
- Made of high-quality aluminum

CODE	BARCODE	LENGTH	MATERIAL
L60	8606007991086	60cm	Aluminum
L80	8606007990508	80cm	Aluminum
L120	8606007991079	120cm	Aluminum



## PROLEVEL STANDARD

### PROLEVEL



- Purpose: Applicable for horizontal and vertical leveling
- Double-protected alignment vial
- The highest measuring accuracy in standard and inverted positions is 0.4mm/m=0.0240
- High resistance to temperature changes -20°C do +50°C
- Resistance to UV radiation guarantees legibility of readings despite the years going by

CODE	BARCODE	LENGTH	MATERIAL
PLS40	8605043400040	40 cm	Anodized aluminum
PLS60	8605043400057	60 cm	Anodized aluminum
PLS80	8605043400064	80 cm	Anodized aluminum
PLS100	8605043400071	100 cm	Anodized aluminum
PLS120	8605043400088	120 cm	Anodized aluminum

## PROLEVEL PROFESSIONAL

### PROLEVEL



- Purpose: Applicable for horizontal and vertical leveling.
- Shock-absorbing rubber end caps provide high protection against damage
- Rubber handle provide easier and better quality work
- Double-protected alignment vial Life-time warranty for pasting of alignment vial
- Highest measuring accuracy in standard and inverted position

CODE	BARCODE	LENGTH	MATERIAL
PLP60	8605043400101	60 cm	Anodized aluminum
PLP80	8605043400118	80 cm	Anodized aluminum
PLP120	8605043400125	120 cm	Anodized aluminum
PLP200	8605043400132	200 cm	Anodized aluminum

## PROLEVEL MAX

### PROLEVEL



- Purpose: Applicable for horizontal, vertical, and leveling at the angle of 45 degrees
- Lateral magnet installation help to adhere to flat and vertical surfaces, which makes measurement reading easier
- Shock-absorbing rubber
- Rubber handles provide easier and better quality work

CODE	BARCODE	LENGTH	MATERIAL
PLM60	8605043400149	60 cm	Anodized aluminum
PLM80	8605043400156	80 cm	Anodized aluminum
PLM120	8605043400163	120 cm	Anodized aluminum

## PROFY LEVEL WITH MAGNET AND 3 AXIS



- Purpose: Professional magnetic level with 3 precise axis and vials for horizontal, vertical, and 45 degrees angled leveling
- Magnetic blocks allow easier work on metal surfaces
- Made of high-quality aluminum
- Magnetic blocks provide easier metal surfaces work

CODE	BARCODE	LENGTH	MATERIAL
LM60	8606007990515	60cm	Aluminum

## LEVEL 15cm WITH MAGNET



- Purpose: Mini magnetic level 15cm for horizontal, vertical, and 45 degrees angled leveling
- Contains 3 high precision vials and a full-length magnet for comfortable leveling without holding

CODE	BARCODE	LENGTH	MATERIAL
L15M	8606106732030	15cm	Aluminum

## PROLEVEL MINI

**PROLEVEL**



- Purpose: For horizontal and vertical alignment
- Rubberized ends and handles resistant to shocks and falls
- Lifetime guarantee on the attachment of the bubble bottle
- Maximum precision in the normal and inverted position
- Resistance to large temperature fluctuations
- Resistance to UV radiation

CODE	BARCODE	LENGTH	MATERIAL
PLMM25	8605043400095	25 cm	Anodized Aluminum

## ALUMINIUM BAR



- Purpose: For alignment of wall and floor surfaces when placing finishing construction layers
- Made of aluminum

CODE	BARCODE	LENGTH	MATERIAL
RAV15	8606007994155	1.5m	Aluminum
RAV20	8606007994162	2.0m	Aluminum
RAV25	8606007994773	2.5m	Aluminum
RAV30	8606007994179	3.0m	Aluminum

## NEW TYPE ALUMINIUM BAR 2 AXIS



- Purpose: For alignment of wall and floor surfaces when placing finishing construction layers
- It has horizontal and vertical vials for accurate surfaces alignment

CODE	BARCODE	LENGTH	MATERIAL
RAVL15	8606007994193	1.5m	Aluminum
RAVL20	8606007994209	2.0m	Aluminum
RAVL25	8606007994766	2.5m	Aluminum
RAVL30	8606007994216	3.0m	Aluminum

## ALUMINIUM BAR PROFILE



- Purpose: For alignment of wall and floor surfaces when placing protective construction layers
- Additional trapezoid-shaped profile allows precise alignment of the wall inside corners and edge

CODE	BARCODE	LENGTH	MATERIAL
RAVK15	8606007998429	1.5m	Aluminum
RAVK20	8606007998436	2.0m	Aluminum
RAVK25	8606007998443	2.5m	Aluminum
RAVK30	8606007998450	3.0m	Aluminum

**PROLEVEL SCREED**
**PROLEVEL**

- Purpose: extremely precise and a long service-life aluminum bar used for leveling wall and floor surfaces when placing finishing construction layers
- High-strength aluminum wall 0.5 cm thick
- Increased abrasion resistance
- Supreme precision of work and extended durability

CODE	BARCODE	LENGTH	MATERIAL
PLR150	8605043400170	150 cm	Aluminum
PLR200	8605043400187	200 cm	Aluminum
PLR250	8605043400194	250 cm	Aluminum
PLR300	8605043400200	300 cm	Aluminum
PLR400	8605043400217	400 cm	Aluminum

**PROLEVEL SCREED 2 VIALS**
**PROLEVEL**

- Purpose: Extremely precise and a long service-life aluminum bar used for leveling wall and floor surfaces when placing finishing construction layers
- Horizontal and vertical vial with a high accuracy
- High-strength aluminum wall 0.5 cm thick
- Increased abrasion resistance
- Supreme precision of work and extended durability

CODE	BARCODE	LENGTH	MATERIAL
PLR2150	8605043400224	150 cm	Aluminum
PLR2200	8605043400231	200 cm	Aluminum
PLR2250	8605043400248	250 cm	Aluminum
PLR2300	8605043400255	300 cm	Aluminum
PLR2400	8605043400262	400 cm	Aluminum

**PROLEVEL CONIC SCREED**
**PROLEVEL**

- Purpose: Extremely precise, and long service-life aluminum bar used for leveling wall and floor surfaces when placing finishing construction layers
- Additional angle surface allows continuous work and precise alignment of inner edges
- High-strength aluminum wall 0.5 cm thick
- Increased abrasion resistance
- Supreme precision of work and extended durability

CODE	BARCODE	LENGTH	MATERIAL
PLRK150	8605043400279	150 cm	Aluminum
PLRK200	8605043400286	200 cm	Aluminum
PLRK250	8605043400293	250 cm	Aluminum
PLRK300	8605043400309	300 cm	Aluminum

## PROLEVEL PLASTERING SCREED

# PROLEVEL



- Purpose: H-shaped aluminum profile screed suitable for precise finishing and leveling of plaster and gypsum surfaces on walls, ceilings, and floors
- Enhanced surface hardness
- Angled, hardened h-shaped profile for better pulling-off
- The ergonomic fingertip recess of the handle enables better grip
- Increased abrasion resistance
- Supreme precision of work and extended durability

CODE	BARCODE	LENGTH	MATERIAL
PLRM150	8605043400316	150 cm	Aluminum
PLRM200	8605043400323	200 cm	Aluminum
PLRM240	8605043400330	240 cm	Aluminum

## PROLEVEL SQUARE

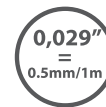

- Purpose: Allows mutual positioning of two elements under a straight angle
- Extremely rugged steel bracket with a wide working face
- Used in construction and carpenter work
- The profile is made of extra strong and light 18mic anodized aluminum
- Extended lifetime and durability

CODE	BARCODE	LENGTH	MATERIAL
PLUL30	8605043400347	30x40 cm	Anodized aluminum
PLUL40	8605043400354	40x60 cm	Anodized aluminum



# MARKING TOOLS

## PLUMB BOBS



- Purpose: For vertical leveling in construction
- Made of steel

CODE	BARCODE	WEIGHT	MATERIAL
V100	8606007992052	100g	Steel
V200	8606007992069	200g	Steel
V600	8606007992083	600g	Steel

## LINE REEL 50m



- Purpose: For leveling and marking in the construction
- Plastic carrier for easier thread work

CODE	BARCODE	LENGTH	MATERIAL
GK50	8606107185330	50m	PVC / Thread

## CHALK POWDER BOTTLE FOR CHALK LINE REEL-BLUE



- Purpose: For marking in construction, with the help of marking thread
- Pure oxide powder pigment

CODE	BARCODE	MATERIAL	QUANTITY
PP	8606007991574	Oxide pigment powder	60g
GKP	8606107185347	Oxide pigment powder	180g

## CHALK LINE REEL, ALUMINIUM CASE



- Purpose: For construction measuring and marking
- Aluminum case with high-quality thin string for marking and measuring with the help of construction chalk

CODE	BARCODE	LENGTH	MATERIAL
GK	8606007990782	30m	Aluminum / Thread

## WATER LEVEL HOSE



- Purpose: For horizontal surface leveling and fluid transfer
- Resistance to a large number of chemicals
- The hose comes with two cups with measuring scale for more precise leveling

CODE	BARCODE	LENGTH	MATERIAL	COLOR
VC20	8606007992434	20m	PVC	Transparent

## WATER LEVEL HOSE



- Purpose: For horizontal surface leveling and fluid transfer
- Good abrasion resistance
- Resistance to a large number of chemicals

CODE	BARCODE	DIAMETER	LENGTH	MATERIAL
GVC6	8606017651130	Ø6mm	50m	PVC
GVC8	8606017651147	Ø8mm	50m	PVC
GVC10	8606017651154	Ø10mm	50m	PVC

# TILE INSTALLATION TOOLS





## MANUAL TILE CUTTER 600mm



MSP	600mm	425x425mm	5-12mm	Ø16x6x1,5mm	6,2kg

- Purpose: For straight and diagonal manual cutting of ceramic tiles
- Possibility of making tile holes from Ø30-Ø80mm the cutter has a parallel cutting guide for a precise cut
- Robust construction, made of high-quality metal
- Cutting tile thickness 5-12mm

CODE	BARCODE	LENGTH REZA	TILE THICKNESS
MSP	8606007991345	600mm	up to 12mm

## MANUAL TILE CUTTER 630mm PROFESSIONAL



MSPP	630mm	450x450mm	6-14mm	Ø12x6x1,5mm	9,2kg

- Purpose: For straight and diagonal manual cutting of ceramic tiles
- Aluminum angle ruler for precise positioning
- The height of the guide rail is adjusted to the thickness of the cutting weights
- Max cutting tile thickness 14mm, length 630mm

CODE	BARCODE	LENGTH REZA	TILE THICKNESS
MSPP	8606017655060	630mm	up 6mm to 14mm

## SPARE BLADE FOR TILE CUTTING MACHINE



- Purpose: Ceramic tile cutter MSP 600mm spare blade

CODE	BARCODE	DIAMETER
NMSP	8606007992748	Outer Ø16, inner Ø6

## SPARE BLADE FOR TILE CUTTING MACHINE PROFI

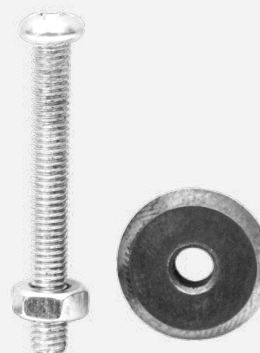

- Purpose: Ceramic tile cutter MSPP 630mm spare blade

CODE	BARCODE	DIAMETER
NMSPP	8606017655077	Outer Ø12, inner Ø6

**TILE CUTTING MACHINE TOP**

- Purpose: For straight and diagonal manual cutting of ceramic tiles
- Built-in roller bearings for outstanding cutting accuracy
- Tile thickness up to 16 mm
- Aluminum ruler with protractor for precise positioning
- Anatomically shaped ball bearing handle for precise and easy blade guidance
- The machine has wheels for easy transport

CODE	BARCODE	CUTTING LENGTH	MATERIAL
MSPT910	8605043407551	115cm	Aluminum
MSPT1220	8605043407568	145cm	Aluminum

**LASER TILE CUTTING MACHINE 900 mm**

- Purpose: Intended for cutting large tiles, porcelain, ceramics, mosaics...
- It has a laser for imaging the cut surface
- Possibility of cutting at an angle
- Linear bearing inside ensures smooth and precise cutting
- Ergonomically shaped ball bearing handle for precise and easy blade guidance
- Maximum cutting length 900 m

CODE	BARCODE	CUTTING LENGTH	MATERIAL
MSPL900	8605043407520	900mm	Aluminum

**REPLACEMENT CUTTING WHEELS FOR TILE CUTTERS**

- Purpose: Spare blade for MSPL900- Professional laser tile cutter 900mm, MSPT1220- Tile cutter TOP 1220mm, and MSPT910- Tile cutter TOP 910mm
- Quality tungsten carbide cutting wheel
- Easily replaceable

CODE	BARCODE	DIMENSION	MATERIAL
NMSP22X6X6	8605043408596	ø22xø6x 6mm	Tungsten carbide

**TOOL FOR RAISING WALL TILES**

- Purpose: For lifting wall tiles and other panels
- High strength and reliability spring
- It has support made of high load-bearing steel and durability with a maximum load of up to 70 kg

CODE	BARCODE	MATERIAL	LOAD CAPACITY
APZP	8605043407476	Steel	up to 70 kg

## CARPENTER'S PENCIL OVAL



- Purpose: For marking during all construction works

CODE	BARCODE	PACKAGE	DIMENSION
SO	8606007991833	12 pcs	170mm

## MARKING AND WRITING NEEDLE



- Purpose: For marking on hard materials including steel, ceramics, and glass
- The top is made of tungsten carbide, and the body is made of aluminum alloy
- The line of the tip is extremely precise, easy to notice, and not easily erased

CODE	BARCODE	LENGTH	TOP LENGTH
IOP8	8605043407469	14,5cm	8 mm

## CONTOUR GAUGE



- Purpose: For copying contours on laminate, parquet, tiles, itisons, car bodies and the like
- Copies the shape of an object using 91 and 175 syllabary tiles
- Magnets are arranged along the contour gauge
- Lever for locking the mirrored contour

CODE	BARCODE	LENGTH	MATERIAL
SZPUK125	8605043408442	125mm	ABS plastic
SZPUK250	8605043408459	250mm	ABS plastic

## PANEL CARRY TOOL



- Purpose: Serves as an additional aid when carrying large sheets and boards of material
- Its angled handles keep hands away from the panel for comfort
- Capacity 80kg

CODE	BARCODE	CAPACITY
ANP	8606017656968	up to 80kg

**MULTIFUNCTIONAL CIRCULAR SAW HOLDER**

- Purpose: Position fixing tool for drilling clean, precise holes in hard tiles, marble, granite, ceramics, glass, etc.
- The opening length of the adjustable plates is 20-83 mm
- Vacuum rubber is made of natural rubber, which allows a firm grip on the surface

CODE	BARCODE	MATERIAL	OPENING DIAMETAR
MDKT	8605043407452	Plastic	20-83 mm

**VACUUM TOOL FOR CENTERING DIAMOND HOLE SAWS**

- Purpose: Tool for fixing a diamond hole saw when drilling tiles, glass, marble, granite, ceramics, etc.
- Made of metal and durable plastic
- The dimensions of the drill holes are 4, 5, 6, 8,10, and 12 mm
- Vacuum rubber is extremely strong and holds the centering tool perfectly and adheres to a smooth surface

CODE	BARCODE	MATERIAL	OPENING DIAMETAR
VACDB	8605043407414	Metal / Plastic	4-12 mm

**SUCTION CUP ALUMINUM - SINGLE**

- Purpose: Intended for carrying, moving, and placing ceramic, granite, glass, and other smooth surface materials
- The mechanism allows one-handed operation
- The diameter of the vacuum rubber is 118 mm

CODE	BARCODE	MATERIAL	LOAD CAPACITY
VGAJ	8605043407490	Aluminijum / Rubber	up to 50 kg

**SUCTION CUP PVC - SINGLE**

- Purpose: Intended for carrying, moving, and placing ceramic, granite, glass, and other smooth surface materials
- The mechanism allows one-handed operation
- The diameter of the vacuum rubber is 118 mm

CODE	BARCODE	MATERIAL	COLOR
VGJ	8606017655053	PVC / Rubber	Red

### SUCTION CUP ALUMINUM - DOUBLE



- Purpose: For carrying, moving, and placing ceramic, granite, glass, and other smooth surface materials
- The mechanism allows one-handed operation
- The diameter of the vacuum rubber is 118 mm

CODE	BARCODE	MATERIAL	LOAD CAPACITY
VGAD	8605043407506	Aluminijum / Rubber	up to 80 kg

### SUCTION CUP ALUMINUM - TRIPLE



- Purpose: For carrying, moving, and placing ceramic, granite, glass, and other smooth surface materials
- The mechanism allows one-handed operation
- The diameter of the vacuum rubber is 118 mm

CODE	BARCODE	MATERIAL	LOAD CAPACITY
VGAT	8605043407513	Aluminijum / Rubber	up to 150 kg

### SUCTION CUP PVC - DOUBLE



- Purpose: For carrying, moving, and placing ceramic, granite, glass, and other smooth surface materials
- The mechanism allows one-handed operation
- The diameter of the vacuum rubber is 118 mm

CODE	BARCODE	MATERIAL	LOAD CAPACITY
VGD	8605043407391	PVC / Rubber	up to 60 kg

### SUCTION CUP PVC - TRIPLE



- Purpose: For carrying, moving, and placing ceramic, granite, glass, and other smooth surface materials
- The mechanism allows one-handed operation
- The diameter of the vacuum rubber is 118 mm

CODE	BARCODE	MATERIAL	LOAD CAPACITY
VGT	8605043407407	PVC / Rubber	up to 90 kg





# METAL PROGRAM

---

- UTILITY KNIVES AND SCRAPERS
- SCREWDRIVERS AND NUT DRIVERS
- WRENCHES
- STAPLE GUNS
- PLIERS AND SCISSORS
- CLAMPS
- MAGNETS
- HAMMERS AND WRECKING BARS
- SPITZ AND CHISEL
- HACKSAWS
- JIGSAW BLADES
- DRILLS
- CUTTING AND GRINDING DISCS
- MACHINE BRUSHES
- STEEL BRUSHES
- RASPS
- PROTECTIVE COTTON AND CLOTHS
- BOXES, BAGS AND BELTS
- BUSINESS BAGS
- LADDERS

# UTILITY KNIVES AND SCRAPERS



## UTILITY KNIFE WITH 5 SPARE BLADES



- Purpose: For cutting various types of material
- The knife case is strong and made of metal/rubber coating
- The charger has five easily replaceable blades inside the knife
- It uses unbreakable trapezoid and hook blades

CODE	BARCODE	WIDTH	MATERIAL
SP5	8606007991871	18mm	Metal / Rubber

## UTILITY KNIFE WITH 3 SPARE BLADES



- Purpose: For cutting various types of material
- Retractable utility knife with 3 spare blades inside the knife
- The knife case is strong and made of metal/rubber coating
- It uses unbreakable trapezoid and hook blades

CODE	BARCODE	WIDTH	MATERIAL
SP3	8606007991864	18mm	Metal / Rubber



**AUTO-LOAD 6 BLADES KNIFE, 18mm**



- Purpose: For cutting various types of material
- Professional retractable utility knife with rubber-plastic coating case for the firm and comfortable use
- For all demanding works, with the possibility of setting the blade while working
- Charger with 6 quality 18mm blades inside a knife

CODE	BARCODE	WIDTH	MATERIAL
SP6	8606007990966	18mm	Plastic / Rubber

**UTILITY KNIFE WITH FIXING SCREW**



- Purpose: For cutting various types of material
- Professional knife made of PVC-coated metal case
- Precise blade setting, using a locking screw
- It uses breakable 18mm blades

CODE	BARCODE	WIDTH	MATERIAL
SPF	8606007991895	18mm	Metal / PVC

**METAL CUTTER**



- Purpose: For cutting various types of material
- Suitable for all craftsmen for a wide range of materials for the most difficult jobs
- Metal case with an ergonomic handle and metal guides that is extremely durable
- It uses breakable blades

CODE	BARCODE	WIDTH	MATERIAL
SPMS9	8606007994933	9mm	Metal
SPMS18	8606007994926	18mm	Metal

**UTILITY KNIFE WITH FIXING SCREW 25mm**



- Purpose: For cutting various types of material
- Professional knife made of PVC-coated metal case
- Precise blade setting, using a locking screw
- It uses breakable 25mm blades

CODE	BARCODE	WIDTH	MATERIAL
SPF25	8606017655879	25mm	Metal / PVC

**METAL GUIDE RETRACTABLE UTILITY KNIFE**

- Purpose: For cutting various types of material
- Metal guide retractable utility knife 9mm
- The combination of metal bushings and a PVC handle guarantees the best price-quality ratio
- Can be adjusted by pulling out the blade, and there is also a brake for fixing the blade

CODE	BARCODE	WIDTH	MATERIAL
SPM9	8600102481008	9mm	Metal / PVC
SPM18	8606007991901	18mm	Metal / PVC

**RETRACTABLE UTILITY KNIFE 18mm**

- Purpose: For cutting various types of material
- The case is made of PVC plastic
- Uses breakable blade

CODE	BARCODE	WIDTH	MATERIAL
SP18	8606007991857	18mm	PVC
SP9	8606007991888	9mm	PVC

**UTILITY KNIFE OFFICE 9mm**

- Purpose: For cutting various types of material
- Retractable utility knife office 9mm made of high-quality PVC case
- Designed for all cutting purposes and suitable for office use due to its shape
- Uses breakable blades

CODE	BARCODE	WIDTH	MATERIAL
SPO9	8606106732092	9mm	PVC

**UTILITY KNIFE FOR PRECISE CUTTING - 6 BLADES**

- Purpose: For cutting various types of material
- Retractable utility knife for precise cutting with 6 blades
- The handle is made of a metal-rubber combination
- The set has 6 spare blades for precision cutting various purposes
- Plastic packaging with space for blades storage

CODE	BARCODE	SPARE BLADES	MATERIAL
SPS6	8606106732085	6 pcs	Metal

### RETRACTABLE UTILITY KNIFE SET 5pcs



- Purpose: For cutting various types of material
- 5 pieces retractable utility knife set
- Includes two 9mm and one 18mm utility knife and two spare breakable 9mm and 18mm blades
- High-quality PVC plastic case

CODE	BARCODE	WIDTH	MATERIAL
SPSET5	8606007994247	9mm; 18mm	Metal / PVC

### RETRACTABLE UTILITY KNIFE SET 3pcs



- Purpose: For cutting various types of material
- 3 pieces retractable utility knife set
- Includes two 9mm and one 18mm utility knife
- High-quality PVC plastic case
- Uses breakable blades

CODE	BARCODE	WIDTH	MATERIAL
SPSET	8606007990393	9mm; 18mm	Metal / PVC

### SPARE SCALPEL BLADES



- Purpose: Spare scalpel blades 9mm, 10pcs pack
- Breakable blades always provide sharp edges

CODE	BARCODE	WIDTH	MATERIAL
N9	8606007991413	9mm	Metal
N18	8606007991406	18mm	Metal
N25	8606017655886	25mm	Metal

### TRAPEZOID SPARE SCALPEL BLADES



- Purpose: Spare unbreakable trapezoid scalpel blades, 10 pcs
- Made in packages that allow craftsmen easy to use and safety

CODE	BARCODE	PACKAGE	MATERIAL
TN	8606007991987	10 pcs	Metal

### HOOK BLADE

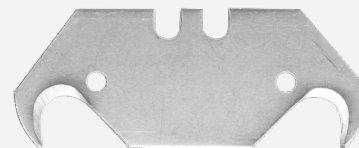

- Purpose: Spare scalpel hook blades, 5 pcs

CODE	BARCODE	PACKAGE	MATERIAL
NK	8606007997118	5 pcs	Metal

**MINI UTILITY KNIFE KEY CHAIN 60PCS/PACK**

- Purpose: For cutting thinner materials
- An attractive cardboard POS box
- Mini scalpel on a wrist strap, pocket variant

CODE	BARCODE	WIDTH	MATERIAL
SMP60	8606106732108	12mm	PVC

**METAL LONG-HANDLED SCRAPER**

- Purpose: For scraping wallpaper
- Scraping of all surfaces at an ideal angle
- Possibility of easy replacement of the spare blade

CODE	BARCODE	WIDTH	MATERIAL
SFMD	8606007994889	100mm	Metal

**TRAPEZOID PVC SCRAPER**

- Purpose: For scraping various surfaces
- Ergonomic shape of PVC housing
- Uses unbreakable scalpel blades

CODE	BARCODE	WIDTH	MATERIAL
SFT	8606007990454	65mm	PVC

**SOFT GRIP HANDLE SCRAPER**

- Purpose: For scraping various surfaces
- Metal, robust and rubber housing
- Possibility of retracting the blade for greater safety

CODE	BARCODE	WIDTH	MATERIAL
SFS	8606007992489	95mm	Metal / PVC

## GROUT SCRAPER



- Purpose: For quick and easy removal of old joints
- The opposite end of the scraper has an extension for removing excess grout from joints after application
- The set contains 5 silicone extensions of different diameters for shaping joints at corners: 3, 6, 10, 13, 17mm

CODE	BARCODE	EXTENSIONS	MATERIAL
SZF	8606017656128	5pcs	PVC

## GROUT SHAPING TOOL SET



- Purpose: For tiles grouting or when sealing windows and window frames
- Can be used for all types of mass, silicone, acrylic, polyurethane, etc.
- Set includes 4 blades with specially shaped edges for easy grout shaping, both on angles and flat surfaces

CODE	BARCODE	MATERIAL
AZF	8606017656135	PVC

## PLASTERBOARD EDGE PLANER TOOL



- Purpose: For processing and shaping the edges of gypsum boards in 4 board thicknesses: 9.5mm, 12.5mm, 15mm, and larger than 15mm
- Two types of knives with different uses
- A square blade (23mm) can be cut at an angle of 45°
- The trapezoidal (52mm) blade can cut at an angle of 22.5°

CODE	BARCODE	MATERIAL
SGU	8606017656951	PVC
*SGP	8606017659600	Steel

\*Plasterboard edge blade planer tool blades

## 4 PCS JOINT SEALANT SILICONE GROUT CAULK TOOL KIT



- Purpose: For tiles grouting or when sealing windows and window frames
- Can be used for all types of mass, silicone, acrylic, polyurethane, etc.
- Set includes 4 blades with specially shaped edges for easy grout shaping, both on angles and flat surfaces

CODE	BARCODE	MATERIAL
SSF4X1	8605043402013	Thermoplastic rubber

# SCREWDRIVERS AND NUT DRIVERS



## SCREWDRIVER SL



TIP



- Purpose: For tightening and loosening SL (Slot) type screws
- The screwdriver body is made of chrome vanadium steel with an additionally hardened and magnetized tip

CODE	BARCODE	LENGTH	TIP
OSL3X100	8606007996609	100mm	SL3,0
OSL3X150	8606007996616	150mm	SL3,0
OSL5X100	8606007996623	100mm	SL5,0
OSL5X150	8606007996630	150mm	SL5,0
OSL6X38	8606007996678	38mm	SL6,0
OSL6.5X100	8606007996647	100mm	SL6,5
OSL6.5X150	8606007996654	150mm	SL6,5
OSL8X150	8606007996661	150mm	SL8,0

## SCREWDRIVER PZ



TIP



- Purpose: Screwdriver PZ for tightening and loosening PZ (Pozidriv) type screws
- The screwdriver body is made of chrome vanadium steel with an additionally hardened and magnetized tip
- Comfortable ergonomic grip handle

CODE	BARCODE	LENGTH	TIP
OPZ0X75	8606007996760	75mm	Pz0
OPZ1X100	8606007996777	100mm	Pz1
OPZ2X100	8606007996784	100mm	Pz2
OPZ3X150	8606007996791	150mm	Pz3

## SCREWDRIVER PH



TIP



- Purpose: Screwdriver PH for tightening and loosening PH (Phillips) type screws
- The screwdriver body is made of chrome vanadium steel with an additionally hardened and magnetized tip

CODE	BARCODE	LENGTH	TIP
OPH0X100	8606007996685	100mm	PH0
OPH0X150	8606007996692	150mm	PH0
OPH1X100	8606007996708	100mm	PH1
OPH1X150	8606007996715	150mm	PH1
OPH2X100	8606007996722	100mm	PH2
OPH2X150	8606007996739	150mm	PH2
OPH2X38	8606007996753	38mm	PH2
OPH3X150	8606007996746	150mm	PH3

## SCREWDRIVER T



TIP



- Purpose: Screwdriver for tightening and loosening T (Torx) type screws
- The screwdriver body is made of chrome vanadium steel with an additionally hardened and magnetized tip

CODE	BARCODE	LENGTH	TIP
OT10X100	8606017651994	100mm	T10
OT15X100	8606017652007	100mm	T15
OT20X100	8606017652014	100mm	T20
OT25X100	8606017652021	100mm	T25
OT27X100	8606017652038	100mm	T27
OT30X100	8606017652045	100mm	T30

## SCREWDRIVER SET NORMAL SIZE 2 pcs



TIP

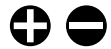

- Purpose: Set of 2 pieces normal size screwdriver used for tightening and loosening screws with SL and PH notches in their head
- Two most frequently used screwdrivers with 100mm body length

CODE	BARCODE	LENGTH	TIP
SV	8606007991925	100mm	SL5, PH2

## SCREWDRIVER SET SMALL SIZE 2 pcs



TIP



- Purpose: Set of 2 pieces small size screwdriver used for tightening and loosening screws with SL and PH notches in their head
- Two most frequently used screwdrivers with 38mm body length

CODE	BARCODE	LENGTH	TIP
SM	8606007991826	38mm	SL5, PH2

**SCREWDRIVER SET 6 pcs**

PZ2 X 100mm

 SL6 X 100mm  
SL3 X 50mm

 PH2 X 100mm  
PH1 X 75 mm  
PH0 X 50mm

- Purpose: 6 pieces screwdrivers set for tightening and loosening appropriate type screws
- Screwdriver body is made of chrome vanadium steel with additionally hardened and magnetized tip

CODE	BARCODE	SET
OSET6	8606007996814	6 pcs

**PRECISION SCREWDRIVER SET 9 pcs**

 T5 X 50mm  
T6 X 50mm  
T7 X 50mm

 SL1.5 X 50mm  
SL2.0 X 50mm  
SL2.5 X 50mm

 PH000 X 50mm  
PH00 X 50mm  
PH0 X 50mm

- Purpose: 9 pieces of precision screwdrivers set for tightening and loosening appropriate type screws
- The screwdriver body is made of chrome vanadium steel with an additionally hardened and magnetized tip Intended for smaller screws work
- Set includes: SL 1.5,SL2,SL 2.5,T5,T6,T7,PH000, PH00 and PH0

CODE	BARCODE	SET
OPSET9	8606007996821	9 pcs

**SCREWDRIVER SET 48 pcs**

TIP



- Purpose: Screwdriver set 48pieces with ratchet screwdriver for tightening and loosening appropriate type screws
- With ergonomic handle for convenient work
- Set includes 1/4" HEX socket, 28pcs of 1/4" HEX screwdriver bits 25mm, adapter, and 18 pcs of HEX socket bits. Dimensions: 18pcs socket, TX 10 pcs, PZ 4 pcs, PH 4 pcs, SL 5 pcs, HEX 5pcs.

CODE	BARCODE	SET
OSET48	8606007996807	48 pcs

**RATCHET SCREWDRIVER SET 68 pcs**

TIP



- Purpose: Screwdriver set 48pcs with foldable ratchet screwdriver for tightening and loosening appropriate type screws
- Set includes: 30 pcs 1/4" HEX bits 6.35x25mm, SL3/4/5X2kom/6mm, PH0/1/2x2kom/3mm, PZ0/1/2/3mm, T10/15/20X2kom/25x2kom/27/30mm, H3/4/5/6mm, S0/1/2/3mm. 24 pcs precision bits 4x28mm: SL1.0/1.5/2.0/2.5/3/3.5/4, PH000x2/00/0/1, PZ/1, T4/5/6/7/8, H0.7/0.9/1.3/1.5/2.0mm. 9 pcs 1/4" socket HEX bits: 4,5,6,7,8,9,10,11 i 12mm.

CODE	BARCODE	SET
OSET68	8605043400644	68 pcs



**VOLTAGE TESTER 3mm SLOTTED  
SCREWDRIVER**



- Purpose: For testing the presence of electrical voltage in electrical installations
- Owns a certificate of conformity

CODE	BARCODE	LENGTH
GLN	8606007998412	140mm

**SCREWDRIVER SET FOR ELECTRICIANS 8 pcs**



- Purpose: Set of 8pcs screwdrivers with 1000 VDE insulated safety certificate
- Set composition: SL: 0.5x3x100 mm, 0.8x4x100 mm, 1x5.5x100 mm; PH: PH2X100 mm, PH1x80 mm, 1 triangular wrench for junction box, 1 square wrench for junction box and 1 handle with the possibility of changing the type of screwdriver

CODE	BARCODE	SET	MATERIAL
OSET8	8605043406943	68 pcs	Rubber / plastic

**VDE INSULATED SCREWDRIVER SET 2pcs**



- Purpose: Set of 2pcs screwdrivers with VDE insulated safety certificate
- Screwdriver metal shank and handle ensure safe electrical installations work
- Dimensions: PH2x100mm, SL1x5.5x125mm

CODE	BARCODE	SET
OSET2	8606107263311	2 pcs

**VDE INSULATED SCREWDRIVER SET 6 pcs**



- Purpose: Set of 6pcs screwdrivers with VDE insulated safety certificate
- Screwdriver metal shank and handle ensure safe electrical installations work
- Dimesions: SL0.8x4x100mm, SL1x5.5x125mm, PH1x80mm, PH2x100mm, PH3x150mm and SL5x140mm

CODE	BARCODE	SET
OSET6	8606107263328	6 pcs

**SET OF SCREWDRIVERS WITH A RATCHET  
ARTICULATED** 13 pcs

 T10, T15,  
T20, T25

 SL 3 mm, 4 mm,  
5 mm, 6 mm

 PH0, PH1  
PH2, PH3

- Purpose: For tightening and loosening appropriate type screws
- The screwdriver has a patented system, in both directions, to accelerate unscrewing and screwing up to 5 times
- It has a ratchet with the option to change the position that allows maximum tightening force

CODE	BARCODE	SET	MATERIAL
OSETRN13	8605043406967	13 pcs	Rubber / plastic

**SCREWDRIVER SET WITH** 7 pcs

S1-S2



H3-H4

 T10-T15,  
T20-T25

 PH2-6,  
PH1-5

- Purpose: For tightening and loosening appropriate type screws
- Set contains screwdriver handle with a ratchet and 6 double-sided long bits: PH2-6 mm, PH1-5 mm, T10-T15, T20-T25, H3-H4, S1-S2
- Bit dimensions: 6.35x85 mm

CODE	BARCODE	SET	MATERIAL
OSETN7	8605043406950	7 pcs	Rubber / plastic

**SCREWDRIVER SET WITH BITS** 13 pcs

TIP



- Purpose: For tightening and loosening appropriate type screw
- 13 pieces screwdriver set with ratchet and changeable bits
- Made of high-quality CrV steel
- Ergonomic handle provides
- Dimensions: SL3mm, SL4mm, SL5mm, SL6mm, PH0, PH1, PH2, PH3, T10, T15, T20, T25

CODE	BARCODE	SET
OSETN13	8606107688008	13 pcs

**MAGNETIC BIT HOLDER**

- Purpose: Serves as an extension and support of inserts for tightening and loosening screws
- Made of high quality steel
- 60mm long and has a built-in magnet that makes it easier to work with screws

CODE	BARCODE	LENGTH
NUM60	8606017650621	60mm

## SCREWDRIVER BITS PH



TIP 

- Purpose: For tightening and loosening screws with appropriate grip
- Intended for battery, electric, and hand screwdrivers
- Fits all tools and brackets with a 6.35mm grip
- Material: CrV Steel

CODE	BARCODE	WIDTH	LENGTH	PACKAGE
PH1U10	8606017650461	6.35mm	25mm	10 pcs
PH1U2	8606017650546	6.35mm	25mm	2 pcs
PH2U10	8606017650478	6.35mm	25mm	10 pcs
PH2U2	8606017650553	6.35mm	25mm	2 pcs
PH3U10	8606017650485	6.35mm	25mm	10 pcs
PH3U2	8606017650560	6.35mm	25mm	2 pcs

## SCREWDRIVER BITS SL



TIP 

- Purpose: For tightening and loosening screws with appropriate grip
- Intended for battery, electric, and hand screwdrivers
- Fits all tools and brackets with a 6.35mm grip
- Material: CrV Steel

CODE	BARCODE	WIDTH	LENGTH	PACKAGE
SL3U10	8606017650522	6.35mm	25mm	10 pcs
SL3U2	8606017650607	6.35mm	25mm	2 pcs
SLSU10	8606017650539	6.35mm	25mm	10 pcs
SLSU2	8606017650614	6.35mm	25mm	2 pcs

## SCREWDRIVER BITS PZ



TIP 

- Purpose: Intended for battery and electric screwdrivers
- Fits all tools and brackets with a 6.35mm grip
- Made of quality CrV steel that allows them a long service life
- Material: CrV Steel

CODE	BARCODE	WIDTH	LENGTH	PACKAGE
PZ1U10	8606017650492	6.35mm	25mm	10 pcs
PZ1U2	8606017650577	6.35mm	25mm	2 pcs
PZ2U10	8606017650508	6.35mm	25mm	10 pcs
PZ2U2	8606017650584	6.35mm	25mm	2 pcs
PZ3U10	8606017650515	6.35mm	25mm	10 pcs
PZ3U2	8606017650591	6.35mm	25mm	2 pcs

# WRENCHES



## COMBINATION WRENCH



- Purpose: Combination wrench for working with Hex shank screws
- Made of high-quality chrome-vanadium steel
- Wrench length extended for easier craftsmen work and better tightening force



CODE	BARCODE	PROFILE	LENGTH	MATERIAL
KK6	8606007997873	6mm	130mm	CrV Steel
KK7	8606007997880	7mm	135mm	CrV Steel
KK8	8606007997897	8mm	140mm	CrV Steel
KK9	8606007997903	9mm	150mm	CrV Steel
KK10	8606007997910	10mm	160mm	CrV Steel
KK11	8606007997927	11mm	165mm	CrV Steel
KK12	8606007997934	12mm	174mm	CrV Steel
KK13	8606007997941	13mm	180mm	CrV Steel
KK14	8606007997958	14mm	190mm	CrV Steel
KK15	8606007997965	15mm	200mm	CrV Steel
KK16	8606007997972	16mm	210mm	CrV Steel
KK17	8606007997989	17mm	225mm	CrV Steel
KK18	8606007997996	18mm	235mm	CrV Steel
KK19	8606007998009	19mm	250mm	CrV Steel
KK20	8606007998016	20mm	264mm	CrV Steel
KK21	8606007998023	21mm	278mm	CrV Steel
KK22	8606007998030	22mm	292mm	CrV Steel

## DOUBLE OPEN END WRENCH



- Purpose: Double open end wrench for screws tightening with HEX shank
- Made of Chrome-Vanadium high-quality steel
- Wrench length extended for easier craftsmen work and better tightening force

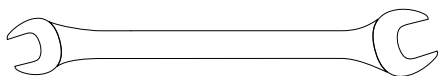

CODE	BARCODE	PROFILE	LENGTH	MATERIAL
KVI6X7	8606007998047	6x7mm	170mm	CrV Steel
KVI8X10	8606007998054	8x10mm	190mm	CrV Steel
KVI10X12	8606007998061	10x12mm	205mm	CrV Steel
KVI12X14	8606007998078	12x14mm	225mm	CrV Steel
KVI13X15	8606007998085	13x15mm	232mm	CrV Steel
KVI14X17	8606007998092	14x17mm	242mm	CrV Steel
KVI17X19	8606007998108	17x19mm	260mm	CrV Steel
KVI18X21	8606007998115	18x21mm	285mm	CrV Steel
KVI19X22	8606007998122	19x22mm	285mm	CrV Steel

## DOUBLE RING SPANNER



- Purpose: Double ring spanner for screw tightening with HEX shank
- Made of enriched Chrome-Vanadium high-quality steel
- Wrench length extended for easier craftsmen work and better tightening force

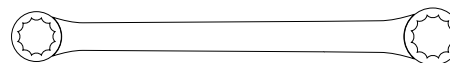

CODE	BARCODE	PROFILE	LENGTH	MATERIAL
KOK6X7	8606007998139	6x7mm	170mm	CrV Steel
KOK8X10	8606007998146	8x10mm	190mm	CrV Steel
KOK10X12	8606007998153	10x12mm	205mm	CrV Steel
KOK11X13	8606007998160	11x13mm	225mm	CrV Steel
KOK12X14	8606007998177	12x14mm	225mm	CrV Steel
KOK13X15	8606007998184	13x15mm	232mm	CrV Steel
KOK14X17	8606007998191	14x17mm	242mm	CrV Steel
KOK17X19	8606007998207	17x19mm	260mm	CrV Steel
KOK18X21	8606007998214	18x21mm	285mm	CrV Steel
KOK19X22	8606007998221	19x22mm	285mm	CrV Steel

**FLEX HEAD RATCHETING COMBINATION WRENCH**

- Purpose: Ratcheting combination wrench with flex head made to work faster in small spaces
- The 180-degree Flex-Head
- Polished chrome vanadium steel

CODE	BARCODE	PROFILE	LENGTH	MATERIAL
KKRZ10	8606107688305	10mm	159mm	CrV Steel
KKRZ13	8606107688312	13mm	178mm	CrV Steel
KKRZ15	8606107688329	15mm	201mm	CrV Steel
KKRZ17	8606107688336	17mm	225mm	CrV Steel

**DOUBLE OPEN END WRENCH SET 6-22mm 8pcs**

- Purpose: Double open end wrench set 8 pieces for screws tightening with Hex shank
- Made of Chrome-Vanadium high-quality steel
- Includes 8 wrenches, dimensions: 6x7, 8x10, 10x12, 12x14, 13x15, 14x17, 17x19 and 19x22mm

CODE	BARCODE	PROFILE	MATERIAL
KVSET8	8606007998252	6-22mm	CrV Steel

**RATCHETING COMBINATION WRENCH**

- Purpose: Ratcheting combination wrench made to work faster in small spaces
- 5-degree angle ratcheting movement is designed to access spots where standard wrenches will not have enough swing
- Polished chrome vanadium steel

CODE	BARCODE	PROFILE	LENGTH	MATERIAL
KKR10	8606007990942	10mm	159mm	CrV Steel
KKR13	8606007991093	13mm	178mm	CrV Steel
KKR15	8606107688299	15mm	201mm	CrV Steel
KKR17	8606007991109	17mm	225mm	CrV Steel

**COMBINATION WRENCH SET 6-22mm 8pcs**

- Purpose: Combination wrench set 8 pieces for working with Hex shank screws
- Made of high-quality chrome-vanadium steel
- Sets include 8 wrenches, dimensions 6,8,10,13,15,17,19 and 22mm

CODE	BARCODE	PROFILE	MATERIAL
KKSET8	8606007998238	6-22mm	CrV Steel

**CR-V STEEL POLISHED ADJUSTABLE WRENCH**

200mm



- Purpose: Adjustable wrench 200mm for working with screws up to 22mm
- Made of high-quality polished chrome vanadium steel
- Easy manual adjusting of required screw head dimension

CODE	BARCODE	PROFILE	LENGTH	MATERIAL
KLP	8606007993516	22mm	200mm	CrV Steel

**BALL END HEX KEY SET 9 pcs**

- Purpose: Ball end Hex keys set 9 pieces for working with Hex shank
- Made of chrome-vanadium steel for better work characteristics
- Ball end design to access socket cap screws up to a 25-degree entry angle
- Sizes 1.5, 2, 2.5, 3, 4, 5, 6, 8 and 10mm

CODE	BARCODE	MATERIAL	PACKAGE
SIK9	8606007991260	CrV Steel	9 pcs

**DOUBLE RING SPANNER SET 6-22mm 8pcs**

- Purpose: Double ring spanner set for screws tightening with hex shank.
- Includes 8 wrenches, dimensions 6x7, 8x10, 10x12, 12x14, 13x15, 14x17, 17x19, 19x22mm
- Wrench length extended for easier craftsmen work and better tightening force

CODE	BARCODE	PROFILE	MATERIAL
KOKSET8	8606007998245	6-22mm	CrV Steel

**BALL END HEX KEY SET 9 pcs**

- Purpose: Ball end Hex keys set 9 pieces for working with Hex shank
- Ball end design to access socket cap screws up to a 25-degree entry angle
- Sizes: 1.5, 2, 2.5, 3, 4, 5, 6, 8 and 10mm

CODE	BARCODE	MATERIAL	PACKAGE
KIHV	8606007993424	CrV Steel	9 pcs

**TORX LONG KEYS SET 9 pcs**



TYPE



- Purpose: For work in less accessible places and places where precise and safe tightening of Torx screws is required
- Set includes wrench dimensions: TR10, TR15, TR20, TR25, TR27, TR30, TR40, TR45 and TR50
- The long arm design allows maximum torque
- Convenient folding package with size markings

CODE	BARCODE	SIZE	MATERIAL
TSD9	8605043406349	T10-T50	Chrome-Vanadium steel

# STAPLE GUNS





## LIGHT DUTY STAPLE GUN 4-14mm



- Purpose: For joining materials and upholstery
- Stapler of steel construction, with lubrication hole, suitable for longer use
- Provides the ability to adjust the impact force

CODE	BARCODE	MATERIAL
HFT	8606007996838	Steel

## METAL STAPLES FOR STAPLER



- Purpose: For joining materials and upholstery
- Suitable for HFT and HFTE stapler

CODE	BARCODE	LENGTH	MATERIAL
MHF6	8606007996845	6mm	Steel
MHF8	8606007996852	8mm	Steel
MHF10	8606007996869	10mm	Steel
MHF12	8606007996876	12mm	Steel

## STAPLE GUN ERGO 6-14mm



- Purpose: For joining materials and upholstery
- Stapler with a metal front grille to strengthen the mechanism and ergo handle
- Provides the ability to adjust the impact force

CODE	BARCODE	MATERIAL
HFTE	8606017657071	Steel / ABS

# PLIERS AND SCISSORS



## COMBINATION PLIERS



- Purpose: Combination pliers for various purposes
- Made of high quality steel
- Ergonomic handle is coated with a rubber layer

CODE	BARCODE	LENGTH	MATERIAL
KLK7	8606007991000	180mm	Steel
KLK8	8606007996883	200mm	Steel

## COMBINATION PLIERS MINI



- Purpose: Combination pliers for various purposes and working with smaller elements
- Ensure precise work due to its smaller size
- Ergonomic handle is coated with a rubber layer

CODE	BARCODE	LENGTH	MATERIAL
KLKPO	8606007996920	130mm	Steel

## BENT LONG NOSE PLIERS



- Purpose: Long nose pliers 165mm for working with smaller elements at hardly reachable places
- The tip is additionally curved
- Ergonomical handle is coated with a rubber layer for better comfort use

CODE	BARCODE	LENGTH	MATERIAL
KLSPS	8606007996890	165mm	Steel

## LONG NOSE PLIERS



- Purpose: Long nose pliers for working with smaller elements at hardly reachable places
- Ergonomical handle is coated with a rubber layer for better comfort use

CODE	BARCODE	LENGTH	MATERIAL
KLSP	8606007991024	170mm	Steel

## BENT LONG NOSE PLIERS MINI



- Purpose: Bent long nose pliers mini 130mm for working with smaller elements at hardly reachable places
- The tip is additionally curved
- Ergonomical handle is coated with a rubber layer for better comfort use

CODE	BARCODE	LENGTH	MATERIAL
KLSPSO	8606007996937	130mm	Steel

## LONG NOSE PLIERS MINI



- Purpose: Long nose pliers mini designed for working with smaller elements at hardly reachable places
- Ergonomical handle is coated with a rubber layer for better comfort use

CODE	BARCODE	LENGTH	MATERIAL
KLSPO	8606007996951	155mm	Steel

**DIAGONAL CUTTING PLIERS**

- Purpose: For cutting different diameter wires
- Made from high-quality steel for durability and long service life
- Ergonomic handle coated with a rubber layer for comfort use

CODE	BARCODE	LENGTH	MATERIAL
KLSEC	8606007991017	160mm	Steel
KLSEC7	8605043400651	180mm	Steel

**BOLT CUTTER**

- Purpose: For cutting reinforcing wire up to  $\varnothing 8\text{mm}$  in diameter
- Improved cutting force transfer system and increased cutting edge hardness make it easier to work with cutters

CODE	BARCODE	LENGTH	MATERIAL
KLZ450	8606007993462	450mm	Steel
KLZ900	8606007997095	900mm	Steel

**DIAGONAL CUTTING PLIERS MINI**

- Purpose: For cutting smaller diameter wires
- Made from high quality steel for durability and long service life
- Ergonomic handle coated with a rubber layer for comfort use

CODE	BARCODE	LENGTH	MATERIAL
KLSECO	8606007996913	120mm	Steel

**TWO HANDLE PIPE WRENCH**

- Purpose: For working with pipes of different diameters
- They have the ability to adjust the size of the beak opening

CODE	BARCODE	LENGTH	MATERIAL
KLC1	8606007994759	300mm	Steel
KLC2	8606007997033	550mm	Steel
KLC3	8606007997040	650mm	Steel

## WATER PUMP PLIERS



- Purpose: Water pump pliers mostly used to cut thick metal in plumbing, automotive, and household applications
- The size of the jaws can be adjusted in multiple sections

CODE	BARCODE	LENGTH	MATERIAL
KLVP	8606007996982	250mm	Steel

## WIRE INSULATION STRIPPER PLIERS



- Purpose: For removing electrical insulation from the wire
- By turning the screw on the top of the pliers, the size of the hole is adjusted, i.e. the diameter of the wire being worked with
- Rubber-coated grip, ergonomic shape

CODE	BARCODE	LENGTH	MATERIAL
KIZ	8606007996906	170mm	Steel

## TOWER PINCERS



- Purpose: For use in wire reinforcement works
- With a rubber-coated grip that makes it easier to twist and cut the wire

CODE	BARCODE	LENGTH	MATERIAL
KLG9	8606007996968	220mm	Carbon steel
KLG10	8606007996975	225mm	Carbon steel

## CARPENTERS PINCERS CUTTING PLIER



- Purpose: For removing nails and working with wire
- Made with premium high-carbon, drop-forged, polished steel for durability

CODE	BARCODE	LENGTH	MATERIAL
KL	8606007990997	200mm	Carbon steel

**CURVED JAW LOCKING PLIERS**

- Purpose: Special curved jaws locking pliers designed for constant tightening of two or more elements
- Knurled adjustment screw for quick loosening and tightening
- Curved jaw with hardened teeth are designed to grip a variety of shapes from any angle

CODE	BARCODE	LENGTH	MATERIAL
KLF	8606007993479	210mm	Steel

**STRAIGHT JAW LOCKING PLIERS**

- Purpose: Special straight jaw locking pliers designed for constant tightening of two or more elements
- Knurled adjustment screw for quick loosening and tightening
- Straight nose provides easy access in narrow, hard-to-reach places and work on straight elements.

CODE	BARCODE	DIMENSION	MATERIAL
KLFP	8606007997101	220mm	Steel

**POP RIVETER - STANDARD**

- Purpose: High quality riveter standard set for joining different materials such as leather, fabrication, plastic parts, etc.
- Contains wrench for changing nose pieces stored inside the handle

CODE	BARCODE	LENGTH	MATERIAL
KPNS	8606106732450	250mm	Carbon steel

**HEAVY DUTY RIVETER, ECONOMIC**

- Purpose: High-quality riveter pliers for joining different materials such as leather, fabrication, plastic parts, etc.
- Ability to change contact head position which enables two working positions

CODE	BARCODE	LENGTH	MATERIAL
KPNE	8606007998368	250mm	Carbon steel

## TILE NIBBLER-FLAT



- Purpose: For breaking, shaping and opening of holes in all types of ceramic tiles up to 10mm thick

CODE	BARCODE	LENGTH	MATERIAL
KLKR	8606017655039	190mm	Steel

## TILE NIBBLER-ANGLED



- Purpose: For breaking, shaping, and opening holes in all types of ceramic tiles up to 10mm thick
- Suitable when forming inner tile part opening

CODE	BARCODE	LENGTH	MATERIAL
KLKU	8606017655046	210mm	Steel

## BREAKING AND CUTTING TILE PLIERS



- Purpose: For straight and curved manual cutting and breaking of ceramic tiles

CODE	BARCODE	LENGTH	MATERIAL
KZP	8606007992946	210mm	Steel

## ADJUSTABLE PLIERS 2IN1



- Purpose: For precise adjustment of the linear spacers when laying tiles
- It contains 2 easily replaceable extensions
- The extensions are compatible with the smaller and larger Beorol leveling spacers and wedges

CODE	BARCODE	LENGTH	MATERIAL
NKL2U1	8605043403199	220mm	Steel

**SCISSORS**

- Purpose: For cutting various soft materials, such as paper, cardboard, canvas, crepe tape, foil, etc.
- Material: Steel

CODE	BARCODE	LENGTH	MATERIAL
MAK20	8606017659921	200mm	Steel

**AVIATION SNIPS STRAIGHT CUT 10"**

- Purpose: For cutting sheet metal
- They separate the left and right part of the cut sheet metal to the side

CODE	BARCODE	DIMENSION	TIP
MKL	8606007997002	250mm	Straight

**AVIATION SNIPS 10" RIGHT**

- Purpose: For cutting sheet metal
- They separate the right part of the cut sheet metal to the right

CODE	BARCODE	LENGTH	TIP
MKLD	8606007997019	250mm	Right

**AVIATION SNIPS 10" LEFT**

- Purpose: For cutting sheet metal
- They separate the left part of the cut sheet metal to the left

CODE	BARCODE	DIMENSION	TIP
MKLL	8606007996999	250mm	Left





# CLAMPS

## F CLAMP



- Purpose: For carpentry workshop use
- Ergonomic plastic handle with anti-slippery design
- Optimized spindle, for better power transfer

CODE	BARCODE	WIDTH	LENGTH
SS50X100	8606107912110	50mm	100mm
SS50X200	8606107912127	50mm	200mm
SS80X200	8606107912134	80mm	200mm
SS80X300	8606107912141	80mm	300mm
SS120X300	8606107912158	120mm	300mm
SS120X500	8606107912165	120mm	500mm
SS120X800	8606017651895	120mm	800mm
SS120X1000	8606017651918	120mm	1000mm

## C PLASTIC CLAMP



- Purpose: C Plastic Clamp for clamping and holding the two smaller elements
- With quick release button and jaw opening adjustment

CODE	BARCODE	LENGTH	MATERIAL
CSP50	8606107912103	50mm	Polyamide / Fiberglass

**BAR CLAMP**

- Purpose: Bar Clamp is used to clamp and hold the two elements
- Steel rail and high-quality plastics ensure the long working life
- An additional function of reverse clamping

CODE	BARCODE	LENGTH
BSM100	8606107912073	100mm
BS150	8606107912080	150mm
BS300	8606107912097	300mm

**ANGLE CLAMP**

- Purpose: For easy and tight placement of workpieces at right angles

CODE	BARCODE	MATERIAL
SU	8606107912172	Aluminum

**PLASTIC SPRING CLAMP LONG**

- Purpose: For temporary clamping of two elements
- The movable tips of the jaws allow for the reception of different shapes

CODE	BARCODE	WIDTH
PSD50	8606107912059	50mm
PSD75	8606107912066	75mm

**PLASTIC SPRING CLAMP**

- Purpose: Standard plastic spring clamp for wide use from the simplest hobbies to the professional workshops
- Flexible jaws allow work with different shank types

CODE	BARCODE	WIDTH
PS38	8606107912028	38mm
PS50	8606107912035	50mm
PS68	8606107912042	68mm

**ADJUSTABLE HAND CLAMP****PROFESSIONAL** 50mm

- Purpose: For temporary clamping of two elements
- Easy to position with one hand
- Non-marking jaws for round or irregular-shaped items

CODE	BARCODE	WIDTH
SPSP50	8606017652687	50mm

**ADJUSTABLE HAND CLAMP****PROFESSIONAL** 50-150mm

- Purpose: For temporary clamping of two elements
- Non-marking jaws for round or irregular shaped items
- For small craft, woodworking, or household repair application

CODE	BARCODE	WIDTH
SPSPP	8606017652670	50-150mm

**NEEDLE NOSE HAND CLAMP****PROFESSIONAL** 75mm

- Purpose: For temporary clamping of two elements
- Non-marking jaws for round or irregular-shaped items

CODE	BARCODE	WIDTH
SPSPS75	8606017652700	75mm

# MAGNETS



## MAGNETIC WELDING HOLDER



- Purpose: For welding materials at right angles, 45 ° or straight
- The magnetic force holds the object to be welded at the required angle or in a plane
- The holder is destined to work with pipes, strips, hollow profiles, sheets and other profiles

CODE	BARCODE	DIMENSION	MATERIAL
MDV8	8605043402938	120x82x16mm	Stainless steel
MDV10	8605043402945	155x102x16mm	Stainless steel
MDV12	8605043402952	190x120x26mm	Stainless steel

## MAGNETIC BOWL ROUND



- Purpose: Thanks to the rubber protection on the bottom, this magnetic tray is useful in all areas- from service workshops to industry- it can be attached to any metal surface
- The magnet is so strong that it can hang from the metal surface together with the metal parts
- In this way, screws, fasteners, and small tools cannot be lost

CODE	BARCODE	DIMENSION	MATERIAL
MP75	8605043402877	ø75mm	Stainless steel
MP10	8605043402884	ø100mm	Stainless steel
MP15	8605043402891	ø150mm	Stainless steel

## MAGNETIC DOUBLE BOWL



- Purpose: Thanks to the rubber protection on the bottom, this magnetic tray with two strong double magnets is useful in all areas- from service workshops to industry- it can be attached to any metal surface
- The magnet is so strong that it can hang from the metal surface together with the metal parts
- In this way, screws, fasteners, and small tools cannot be lost

CODE	BARCODE	DIMENSION	MATERIAL
MPD	8605043402907	136x237x28mm	Stainless steel

## MAGNETIC WRIST BAND PLATE



- Purpose: Magnetic wristband plate can hold small metal parts strongly
- Tighten and stick it to the wrist with a strong velcro band at the convenience
- Hands are free for work and there is no need to look for small metal parts anymore

CODE	BARCODE	DIMENSION	MATERIAL
MZOP	8605043402914	50mm x 20mm	Polyester

## MAGNETIC WRIST BAND SOFT



- Purpose: Contains three strong and evenly distributed magnets which firmly hold the metal objects in place
- Easy to secure small parts and lightweight tools when working ( nails, bits, screws, etc..)
- The wrist band is adjustable, secured by a velcro tape and the size is universal
- Load capacity: 0,5 kg

CODE	BARCODE	DIMENSION	MATERIAL
MZOS	8605043402921	32x9,5cm	Polyester

# HAMMERS AND WRECKING BARS



## MACHINIST HAMMER WITH OAK WOOD HANDLE



- Purpose: For nailing, breaking and shaping, and other types of work  
Forged from quality carbon steel, hardened to 45-55 Rockwell
- Oak wood handle for long-term use

CODE	BARCODE	LENGTH	WEIGHT
C100	8606007990591	262mm	100g
C200	8606007990614	307mm	200g
C300	8606007990621	307mm	300g
C500	8606007990638	326mm	500g
C800	8606007990645	351mm	800g
C1000	8606007990607	370mm	1000g
C1500	8606007995824	394mm	1500g
C2000	8606007995831	418mm	2000g

## FIBERGLASS MACHINIST HAMMER



- Purpose: For nailing, breaking, and shaping as well as other types of work
- Forged from high-quality carbon steel, hardened to 45-55 Rockwell

CODE	BARCODE	LENGTH	WEIGHT
CM100	8606007993554	243mm	100g
CM200	8606007993561	288mm	200g
CM300	8606007993578	306mm	300g
CM500	8606007993585	337mm	500g
CM800	8606007993592	355mm	800g
CM1000	8606007993608	358mm	1000g
CM1500	8606007994124	378mm	1500g
CM2000	8606007994131	383mm	2000g

**FRAMING HAMMER WITH OAK HANDLE**



- Purpose: For nailing, breaking, and shaping as well as other types of work
- Carved oak wood handle coated with a protective layer and protective coating
- Forged from high-quality carbon steel, polished
- Hardened at 45-55 Rockwell

CODE	BARCODE	LENGTH	WEIGHT
CT	8606007993721	336mm	500g

**FRAMING FORGED HAMMER WITH FIBERGLASS HANDLE**



- Purpose: For heavy wood construction and other carpenter's work
- Ergonomic fiberglass handle coated with thermoplastic rubber for comfort use and non-slip control
- Forged from high quality carbon steel, glossy polished
- Hardened at 45-55 Rockwell

CODE	BARCODE	LENGTH	WEIGHT
CTE	8606007995770	328mm	600g

**FRAMING HAMMER WITH FIBERGLASS HANDLE**



- Purpose: For heavy wood construction and other carpenter's work
- Ergonomic fiberglass handle coated with thermoplastic rubber
- Forged from high-quality carbon steel, glossy polished  
Hardened at 45-55 Rockwell

CODE	BARCODE	DIMENSION	WEIGHT
CTL	8606007995855	333mm	600g

**ROOFING HAMMER WITH FIBERGLASS HANDLE**



- Purpose: Roofing hammer with fiberglass handle for heavy wood construction and other carpenter's work
- Ergonomic fiberglass handle
- Forged from high-quality carbon steel, glossy polished  
Hardened at 45-55 Rockwell

CODE	BARCODE	DIMENSION	WEIGHT
CTKE	8606007993738	325mm	600g

**RUBBER MALLET WITH FIBERGLASS HANDLE**

- Purpose: For floor installation, tile installation, home decoration construction, woodworking, and other surfaces
- Thermoplastic rubber coated handle

CODE	BARCODE	LENGTH	WEIGHT
CGF700	8606007995862	335mm	700g

**DUAL HEAD HAMMER WITH STEEL HANDLE**

- Purpose: For laying different flooring types and other materials on the surface
- Steel handle combined with high strength fiberglass handle
- Body made of steel with rubber and plastic heads

CODE	BARCODE	LENGTH	WEIGHT
CGK	8606007993714	280mm	700 g

**RUBBER MALLET WITH OAK WOOD HANDLE**

- Purpose: For floor installation, tile installation, home decoration construction, woodworking, and other surfaces
- Oak wood handle polished for long service life

CODE	BARCODE	LENGTH	WEIGHT
CG250	8606007990669	295mm	250 g
CG500	8606007990676	335mm	500 g

**SLEDGE HAMMER WITH OAK HANDLE**

- Purpose: For demolition projects and breaking of concrete and rocks
- Forged from high-quality carbon steel
- Double milled face hardened at 45-55 Rockwell

CODE	BARCODE	LENGTH	WEIGHT
M1000	8606007991130	261mm	1000 g
M1500	8606007991154	287mm	1500 g
M2000	8606007991185	314mm	2000 g



## FIBERGLASS SLEDGE HAMMER



- Purpose: For demolition projects and breaking of concrete and rocks
- Forged from high-quality carbon steel, black
- Hardened at 45-55 Rockwell

CODE	BARCODE	LENGTH	WEIGHT
CK1	8606007993615	255mm	1.000 g
CK15	8606007993622	281mm	1.500 g
CK2	8606007993639	295mm	2.000 g

## WRECKING BAR WITH RUBBER HANDLE



- Purpose: For removing nails and various other jobs in construction

CODE	BARCODE	LENGTH	MATERIAL
RUP	8606007993783	300mm	Carbon steel

## DOUBLE SIDED WRECKING BAR



- Purpose: For pulling nails out and various construction tough works
- Made of high-quality resistant carbon steel
- Slotted claw and beveled ends improve functionality and performance

CODE	BARCODE	LENGTH	MATERIAL
TRP450	8606007992809	450mm	Carbon steel
TRP800	8606007992793	800mm	Carbon steel

# SPITZ AND CHISEL

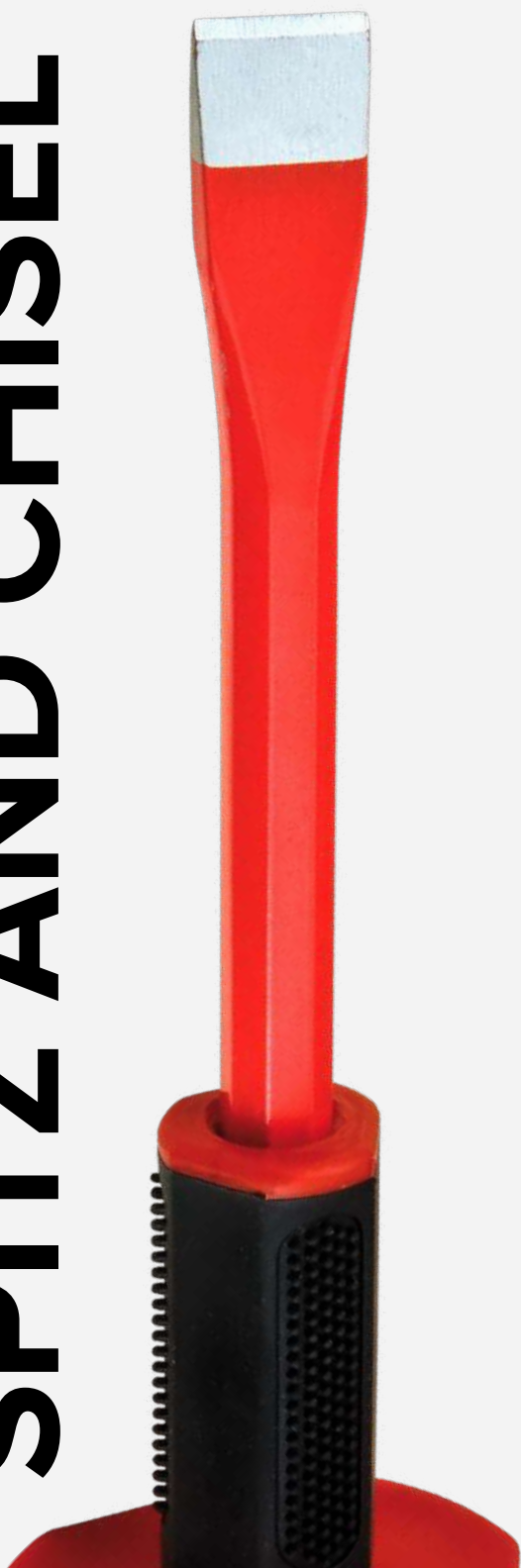

## HEXAGON POINT CHISEL



- Purpose: For demolition projects and breaking of concrete and rocks
- The hand protector has a comfortable grip and a big plate

CODE	BARCODE	DIMENSION	MATERIAL
TGSP	8606007992816	300 mm	Carbon steel

## HEXAGON SQUARE CHISEL



- Purpose: For demolition projects and breaking of concrete and rocks
- The hand protector has a comfortable grip and a big plate which can protect your hand from injury and reduce vibrations

CODE	BARCODE	DIMENSION	MATERIAL
TGSEC	8606007992830	300mm	Carbon steel

## COLD CHISEL SAND-BLASTED HEAVY DUTY PLASTIC HOLDER



- Purpose: For demolition projects and breaking of concrete and rocks
- The hand protector has a comfortable grip and a big plate

CODE	BARCODE	LENGTH	MATERIAL
GSP	8606007993752	295mm	Carbon steel

## COLD CHISEL SAND-BLASTED HEAVY DUTY PLASTIC HOLDER



- Purpose: For demolition projects and breaking of concrete and rocks
- The hand protector has a comfortable grip and a big plate which can protect your hand from injury and reduce vibrations

CODE	BARCODE	LENGTH	MATERIAL
GSEC	8606007993745	300mm	Carbon steel

## WOOD CHISEL



- Purpose: For manual woodworking
- Made of steel, with PVC and rubber handle for added comfort and non-slippery control

CODE	BARCODE	DIMENSION	MATERIAL
DZD6	8606017656913	6mm	Steel / PVC
DZD12	8606017656920	12mm	Steel / PVC
DZD19	8606017656937	19mm	Steel / PVC
DZD25	8606017656944	25mm	Steel / PVC

# HACKSAWS



## HACKSAW ERGO 30cm



- Purpose: For cutting all types of metals
- An aluminum handle with a rubber grip allows better control when cutting
- There is space in the upper area of the frame to store spare blades

CODE	BARCODE	LENGTH	MATERIAL
TME30	8606007995848	30cm	Aluminum

## HACKSAW ALU HANDLE 30cm



- Purpose: For cutting all types of metals
- Lightweight aluminum handle and saw frame

CODE	BARCODE	LENGTH	MATERIAL
TMA30	8606007995787	30cm	Aluminum

### HACKSAW, PVC HANDLE 30cm

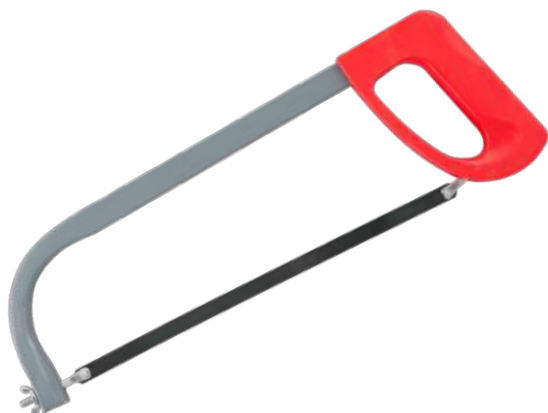

- Purpose: For cutting all types of metals
- Easy blade replacement
- Lightweight plastic handle for comfortable work

CODE	BARCODE	LENGTH	MATERIAL
TZM	8606007996005	30cm	Steel / PVC

### LIGHT CONCRETE HAND SAW 70cm



- Purpose: For cutting lightweight construction elements, blocks and bricks
- High-quality hard metal teeth combined with modern technologies
- The blade is made of high-quality manganese steel with teeth depth up to 15 mm
- The handle is made of a combination of metal, plastic, and TPR

CODE	BARCODE	LENGTH	MATERIAL
TG70	8606007991062	70cm	Plastic / TPR

### CARBON STEEL SPARE SAW BLADES SET



- Purpose: For all types of metals
- Carbon steel spare saw blade 15pcs, made of high-quality HSS steel
- 24 blade teeth per inch
- Can be used in any 30cm hacksaw frame

CODE	BARCODE	LENGTH	MATERIAL
LTM30	8606107185361	30cm	HSS steel

### GYPHUM SAW DOUBLESIDED



- Purpose: For cutting in both directions, grinding, and cutting
- The handle is made of thermoplastic material, comfortable for handling, ergonomic shape makes less cutting fatigue
- The blade is made of high-quality elastic steel

CODE	BARCODE	LENGTH	MATERIAL
TGO15	8606007995749	15cm	Steel / PVC

**BOW SAW**

- Purpose: For cutting all types of wood
- Strong bow construction provides durability and optimal blade tension
- Perfect grip and control thermoplastic handles
- Rear handle with finger guard

CODE	BARCODE	LENGTH	MATERIAL
TD45	8606007992557	45cm	Steel
TD76	8606007992588	76cm	Steel
LTD45	8606007991437	45cm	Hardened steel
LTD76	8606007991444	76cm	Hardened steel

**WOOD SAW 55cm**

- Purpose: For cutting all types of wood
- Wood saw construction provides durability and optimal blade tension
- It has a 3-sided tooth design that allows the user to cut up to 50% faster than traditional hand saws

CODE	BARCODE	LENGTH	MATERIAL
TD55	8606007991949	55cm	Steel

**WOOD SAW WITH CASE 55cm**

- Purpose: For cutting all types of wood
- Special low-friction coating ensures ease of movement of tool through the wood
- Thickness of the saw body is 1mm
- Teeth are induction hardened to 55 Rockwell
- Made of high steel with thermoplastic handle

CODE	BARCODE	LENGTH	MATERIAL
TDF	8606107185354	55cm	Steel

**WOOD SAW WITH ADJUSTABLE HANDLE**

30cm



- Purpose: For cutting all types of wood
- The handle can be positioned in five different positions
- The teeth have two angles (cutting in two directions)
- The blade is made of high-quality elastic steel

CODE	BARCODE	MATERIAL	DIMENSION
TDPR30	8600102480896	Steel	35cm

## MITER BOX & SAW SET 30cm



- Purpose: For wooden slats cutting (angle cutting)
- Comfortable handle for accurate cutting
- The saw blade teeth are inductively hardened and strengthened and don't need to be sharpened
- Measuring edge pattern

CODE	BARCODE	WIDTH	LENGTH
GABS30	8606107185378	14cm	30cm

## HOLE SAW SET 8 pcs



- Purpose: Circular saw for cutting wood and gypsum plates during installation
- Set includes 8 pieces: 51mm, 76mm, 90mm, 102mm, 127mm

CODE	BARCODE	MATERIAL
TKS8	8606007994834	High-speed steel

## U-TYPE MITRE BOX WOOD SAW



- Purpose: Mitre box without a saw for wooden slats cutting (angle cutting)
- Made of ABS plastic with high strength

CODE	BARCODE	WIDTH	LENGTH
PLG	8606007990706	9.5cm	30cm

## HOLE SAW SET 16pcs



- Purpose: Circular saw for cutting wood and gypsum plates during installation
- Includes 16 hole saws: 19mm, 22mm, 25mm, 29mm, 38mm, 44mm, 51mm, 64mm, 76mm, 90mm, 102mm, 127mm

CODE	BARCODE	MATERIAL
TKS16	8606007994841	High-speed steel

# JIGSAW BLADES



## JIGSAW BLADES FOR WOOD REVERSED TEETH

**HOBBY** 100mm 5/1



- Purpose: Jigsaw blades for wood with reversed teeth hobby
- Suitable for hardwood, softwood, laminated boards, fiberboards, and plastics

CODE	BARCODE	LENGTH	MATERIAL
TDOH100	8606104807259	100mm	High carbon steel

## JIGSAW FOR WOOD AND PLASTICS HOBBY

100mm 5/1



- Purpose: Jigsaw blades for wood and plastics
- Suitable for nonferrous metals, aluminum metals and fiberglass reinforced plastic

CODE	BARCODE	LENGTH	MATERIAL
TDPH100	8606104807273	100mm	High-speed steel



### JIGSAW FOR WOOD HOBBY, NARROW

76mm 5/1



- Purpose: Jigsaw blades for wood narrow
- Suitable for softwood, hardwood, and plastics

CODE	BARCODE	LENGTH	MATERIAL
TDUH76	8606104807266	76mm	High carbon steel

### JIGSAW FOR WOOD PROFESSIONAL

100mm 5/1



- Purpose: Jigsaw bi-metal blades for wood
- Suitable for straight cuts in hardwood, soft wood, laminated boards

CODE	BARCODE	LENGTH	MATERIAL
TDP100	8606104807334	100mm	Bi-metal blade

### JIGSAW BLADES FOR WOOD REVERSED TEETH

PROFESSIONAL 100mm set 5/1



- Purpose: Jigsaw blades for wood with reversed teeth
- Suitable for straight cuts in hardwood, softwood, laminated boards, and fiberglass plastic

CODE	BARCODE	LENGTH	MATERIAL
TDOP100	8606104807310	100mm	Bi-metal blade

### JIGSAW FOR WOOD AND PLASTIC PROFESSIONAL

100mm 5/1



- Purpose: Jigsaw blades for wood and plastic
- Suitable for straight cuts in hardwood, softwood, laminated boards, and fiberglass plastic

CODE	BARCODE	MATERIAL	LENGTH
TDPP100	8606104807327	100mm	Bi-metal blade

**JIGSAW FOR WOOD HOBBY**

100mm 5/1



- Purpose: Jigsaw blades for wood
- Suitable for hardwood, softwood, and laminated boards

CODE	BARCODE	LENGTH	MATERIAL
TDH100	8606104807242	100mm	High carbon steel

**JIGSAW FOR ALUMINUM HOBBY**

100mm 5/1



- Purpose: Jigsaw blades for aluminum  
Delivers straight fast cuts in aluminum, plastics, and fiberglass

CODE	BARCODE	LENGTH	MATERIAL
TAH100	8606104807235	100mm	High-speed steel

**JIGSAW FOR WOOD HOBBY COARSE**

100mm 5/1



- Purpose: Jigsaw blades for wood coarse  
Suitable for hardwood, softwood, and plastics

CODE	BARCODE	LENGTH	MATERIAL
TDGH100	8606104807280	100mm	High carbon steel

**JIGSAW FOR METAL HOBBY**

76mm 5/1



- Purpose: Jigsaw blades for metal  
Suitable for straight cutting on thin sheet metals, nonferrous metals and aluminum

CODE	BARCODE	LENGTH	MATERIAL
TMH76	8606104807228	76mm	High-speed steel

## JIGSAW FOR ALUMINUM PROFESSIONAL

100mm 5/1



- Purpose: For straight cutting of Aluminum, non-ferrous metals, plastic reinforced with glass fibers

CODE	BARCODE	LENGTH	MATERIAL
TAP100	8606104807303	100mm	Bi-metal blade

## JIGSAW FOR METAL PROFESSIONAL

76mm 5/1



- Purpose: Basic hacksaw for metal with PVC plastic handle
- Economic design and high-quality handle for comfortable DIY use

CODE	BARCODE	LENGTH	MATERIAL
TMP76	8606104807297	76mm	Bi-metal blade

# DRILLS



## HSS STRAIGHT TWIST DRILLS



- Purpose: For drilling holes in metal
- Metal straight twist drill bit is made of high-speed steel
- The angle between the cutting edges is 118°
- The spiral rim is made with a reduced contact surface to lower friction and work temperature which improves drilling quality and long service life

CODE	BARCODE	DIAMETER	LENGTH	CUTTING PART
BHSS1	8606007997125	Ø1mm	34mm	12mm
BHSS2	8606007997132	Ø2mm	49mm	24mm
BHSS3	8606007997149	Ø3mm	61mm	33mm
BHSS3.2	8606007992373	Ø3.2mm	65mm	36mm
BHSS3.5	8606007992564	Ø3.5mm	70mm	39mm
BHSS4	8606007997156	Ø4mm	75mm	43mm
BHSS4.2	8606007992632	Ø4.2mm	75mm	43mm
BHSS4.5	8606007992649	Ø4.5mm	80mm	47mm
BHSS4.8	8606007993028	Ø4.8mm	86mm	52mm
BHSS5	8606007997163	Ø5mm	86mm	52mm
BHSS5.5	8606007993066	Ø5.5mm	93mm	57mm
BHSS6	8606007997170	Ø6mm	93mm	57mm
BHSS8	8606007997187	Ø8mm	117mm	75mm
BHSS10	8606007997194	Ø10mm	133mm	87mm
BHSS12	8606007997200	Ø12mm	151mm	101mm
BHSS13	8606007997217	Ø13mm	151mm	101mm

## HAMMER DRILLS, SDS PLUS



- Purpose: For drilling holes in building materials
- Hammer drill bit with SDS plus shank with two TM plates on the tip for drilling concrete, masonry, rock, and other construction materials
- SDS plus shank, for electro-pneumatic hammers
- Shank should be greased to reduce friction and prevent the used machine from dust entry.

CODE	BARCODE	DIAMETER	LENGTH	CUTTING PART
BSDS6X110	8606007997354	Ø6mm	110mm	50mm
BSDS6X160	8606007997361	Ø6mm	160mm	100mm
BSDS6X210	8606104807709	Ø6mm	210mm	150mm
BSDS8X110	8606007997378	Ø8mm	110mm	50mm
BSDS8X160	8606007997385	Ø8mm	160mm	100mm
BSDS8X210	8606104807716	Ø8mm	210mm	150mm
BSDS10X160	8606007997392	Ø10mm	160mm	100mm
BSDS10X210	8606007997408	Ø10mm	210mm	150mm
BSDS10X260	8606104807723	Ø10mm	260mm	200mm
BSDS12X160	8606007997415	Ø12mm	160mm	100mm
BSDS12X210	8606007997422	Ø12mm	210mm	150mm
BSDS12X260	8606104807730	Ø12mm	260mm	200mm
BSDS12X310	8606104807747	Ø12mm	310mm	250mm
BSDS14X210	8606007997439	Ø14mm	210mm	150mm
BSDS14X260	8606104807754	Ø14mm	260mm	200mm
BSDS14X310	8606104807761	Ø14mm	310mm	250mm

## WOOD DRILL BIT HSS



- Purpose: High-quality spiral drill bit for wood, made of high-speed steel
- Precise flute design to ensure fast and easy chip clearance
- The spiral rim is made with a reduced contact surface to lower friction and work temperature which improves drilling quality and long service life
- A sharp point on the tip allows the user to pinpoint the mark with the drill bit

CODE	BARCODE	DIAMETER	LENGTH	CUTTING PART
BD4	8606007997231	Ø4mm	75mm	43mm
BD6	8606007997248	Ø6mm	92mm	54mm
BD8	8606007997255	Ø8mm	115mm	71mm
BD10	8606007997262	Ø10mm	120mm	82mm
BD12	8606007997279	Ø12mm	120mm	90mm

## MASONRY DRILLS, BLACK OXIDE

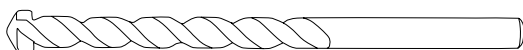

- Purpose: Masonry drill bit for drilling tough construction materials
- Contains titanium nitride coated plate on top for less friction, faster drilling, and longer service life
- Fits regular vibration drill chuck

CODE	BARCODE	DIAMETER	LENGTH	CUTTING PART
BG4	8606007997293	Ø4mm	75mm	39mm
BG6	8606007997309	Ø6mm	100mm	54mm
BG8	8606007997316	Ø8mm	120mm	80mm
BG10	8606007997323	Ø10mm	120mm	80mm
BG12	8606007997330	Ø12mm	140mm	90mm

## SDS + POINT/FLAT CHISEL



- Purpose: Designed for forging and cutting holes in walls, breaking and crushing hard materials such as concrete blocks and bricks, tiles, etc..

CODE	BARCODE	DIAMETER	LENGTH
SDSS	8606107185293	Ø14mm	250mm
SDSSEK	8606107185309	Ø14mm	250mm

## MASONRY DRILLS SET 5 pcs



- Purpose: Masonry drill bits set of 5 pcs for drilling tough construction materials
- Contains titanium nitride coated plate on top for less friction, faster drilling, and longer service life
- Fits regular vibration drill chuck

CODE	BARCODE	DIAMETER	MATERIAL
BGSET5	8606007997347	Ø4,Ø5,Ø6,Ø7,Ø8mm	High-speed Steel

## WOOD DRILLS SET 5 pcs



- Purpose: High-quality drill bit set of 5pcs made of high-speed steel for fast drilling tough wood material
- Precise flute design to ensure fast and easy chip clearance
- The spiral rim is made with a reduced contact surface to lower friction and work temperature
- A sharp point on the tip allows the user to pinpoint the mark with the drill bit

CODE	BARCODE	DIAMETER	MATERIAL
BDSSETS	8606007997286	Ø4,Ø5,Ø6,Ø8,Ø10mm	High-speed steel

## ASSORTED DRILL BIT SET 9 pcs



- Purpose: For metal, stone or wood drilling
- Made of high-speed steel

CODE	BARCODE	DIAMETER	MATERIAL
BSK	8606007993455	Ø5,Ø6,Ø8mm	High-speed steel

## HSS TWIST DRILLS SET 6 PCS



- Purpose: Masonry drill bits set of 5pcs for drilling tough construction materials
- The angle between the cutting edges is 118°
- The spiral rim is made with a reduced contact surface to lower friction and work temperature which improves drilling quality and long service life

CODE	BARCODE	DIAMETER	MATERIAL
BHSSSET6	8606007997224	Ø2,Ø3,Ø4,Ø5,Ø6,Ø8mm	High-speed steel

# CUTTING AND GRINDING DISCS

## FLAP DISC ALUMINUM



- Purpose: Flap disc aluminum is a great choice to sand, grind and remove rust, paint, and dirt from a variety of surfaces
- Laminated abrasive disc with reinforced paper lamellas
- Lamellas are at an angle of 15° to the grinding surface
- Made from high-quality aluminum oxide grain

CODE	BARCODE	DIAMETER	GRANULATION
BD40A115	8606007995244	Ø115mm	40
BD60A115	8606007995398	Ø115mm	60
BD80A115	8606007995404	Ø115mm	80
BD100A115	8606007995411	Ø115mm	100
BD120A115	8606007995428	Ø115mm	120

## FLAP DISC ZIRCON



- Purpose: Flap disc zircon is a great choice for grinding very hard materials
- Laminated abrasive disc with reinforced paper lamellas
- Lamellas are at an angle of 15° to the grinding surface
- Made from zircon grain for aggressive removal

CODE	BARCODE	DIAMETER	GRANULATION
BD40Z115	8606007995251	Ø115mm	40
BD60Z115	8606007995435	Ø115mm	60
BD80Z115	8606007995442	Ø115mm	80
BD100Z115	8606007995459	Ø115mm	100
BD120Z115	8606007995466	Ø115mm	120



## PVC GRINDING DISC



- Purpose: PVC grinding disc 127mm for paint, rust, and dirt removal from larger flat surfaces
- Made of reinforced PVC with a wire structure, able to absorb the sanded paint and rust inside its structure without the need to clean the sanded surface area

CODE	BARCODE	DIAMETER	MATERIAL
PVCBD127	8606007996548	Ø127mm	PVC

## CUTOFF WHEEL FOR STAINLESS STEEL



- Purpose: Cutting disc 115mm for cutting stainless steel elements
- Smooth and easy cutting due to the right choice of abrasive particles and binding materials
- Metal flange ensures firm contact with the angle grinder

CODE	BARCODE	DIAMETER	THICKNESS
RPI115	8606007995220	Ø115mm	1mm
RPI125	8606007995978	Ø125mm	1mm
RPI180	8606007995886	Ø180mm	1.6mm
RPI230	8606007995893	Ø230mm	1.6mm

## GRINDING WHEEL FOR METAL



- Purpose: For grinding metal elements
- Not intended for INOX
- The metal flange allows a firmer and safer connection with the angle grinder

CODE	BARCODE	DIAMETER	THICKNESS
BPM115x6	8606007996500	Ø115mm	6mm
BPM125x6	8606007996586	Ø125mm	6mm
BPM180x6	8606017653646	Ø180mm	6mm
BPM230x6	8606007996593	Ø230mm	6mm

## CUTOFF WHEEL FOR METAL



- Purpose: For cutting various types of metal, steel, and alloys
- Flange diameter: Ø22.2mm

CODE	BARCODE	DIAMETER	THICKNESS
RPM115X1	8606007998672	Ø115mm	1mm
RPM115X3	8606007996517	Ø115mm	3mm
RPM125X1	8606107779393	Ø125mm	1mm
RPM125X3	8606007996524	Ø125mm	3mm
RPM180X1.6	8606107779409	Ø180mm	1.6mm
RPM180X3	8606007998467	Ø180mm	3mm
RPM230X1.6	8606107779416	Ø230mm	1.6mm
RPM230X3	8606007996531	Ø230mm	3mm
RPM300X3.5	8606106732986	Ø300mm	3.5mm
RPM350X3.5	8606106732993	Ø350mm	3.5mm

**CUTOFF WHEEL FOR STONE**

- Purpose: For cutting construction materials such as stone, bricks, light concrete, marble, etc
- Smooth and easy cutting due to the right choice of particles and binding materials

CODE	BARCODE	DIAMETER	THICKNESS
RPK115X3	8606007996555	Ø115mm	3mm
RPK125X3	8606007996562	Ø125mm	3mm
RPK230X3	8606007996579	Ø230mm	3mm

**SEGMENTED DIAMOND CUTTING DISC**

- Purpose: For cutting highly abrasive construction materials (bricks, roofing tiles, light concrete blocks, pipes, etc)
- Turbo blade design provides quicker and cleaner cutting than standard diamond discs

CODE	BARCODE	DIAMETER
RPDS115	8606007995343	Ø115mm
RPDS125	8606007999266	Ø125mm
RPDS230	8606007999273	Ø230mm

**TURBO DIAMOND CUTTING DISC**

- Purpose: For cutting highly abrasive construction materials (bricks, roofing tiles, light concrete blocks, pipes, etc)
- Turbo blade design provides quicker and cleaner cutting than standard diamond discs

CODE	BARCODE	DIAMETER
RPDT115	8606007995336	Ø115mm
RPDT125	8606007999280	Ø125mm
RPDT230	8606007999297	Ø230mm

**DIAMOND CUTTING DISC FOR CERAMICS**

- Purpose: For accurate wet ceramic tile cutting
- Bore diameter 22.2mm, blade width 5mm

CODE	BARCODE	DIAMETER
RPDK115	8606007999303	Ø115mm
RPDK125	8606007999310	Ø125mm

## DIAMOND HOLE SAW FOR GRINDER



- Purpose: Professional dry drilling core bits M14 thread crown is suitable for drilling extremely hard ceramics, stone, marble, granite, and other very hard materials
- The top of the diamond crown is made of high-quality vacuum brazed diamonds
- Side openings for easy removal of drilled material
- Long service life and durability
- Maximum speed RPM 11.000

CODE	BARCODE	DIAMETER	MATERIAL
DKBR10	8605043407735	Ø 10 mm	Vacuum brazed diamonds
DKBR25	8605043407742	Ø 25 mm	Vacuum brazed diamonds
DKBR35	8605043407728	Ø 35 mm	Vacuum brazed diamonds
DKBR40	8605043407759	Ø 40 mm	Vacuum brazed diamonds
DKBR45	8605043407766	Ø 45 mm	Vacuum brazed diamonds
DKBR68	8605043407773	Ø 68 mm	Vacuum brazed diamonds

## DIAMOND HOLE SAW



- Purpose: They are used to make clean and precise holes in glass, ceramic tiles, marble, and granite up to 30 mm deep
- An electric drill is enough to work with diamond hole saws for ceramic (drills)
- Long service life and durability
- Basic body material: Steel
- Head material: Diamond

CODE	BARCODE	DIAMETER	MATERIAL	HEAD
DKK6	8605043400446	Ø 6mm	Nickel plated steel	Diamond
DKK8	8605043400453	Ø 8mm	Nickel plated steel	Diamond
DKK10	8605043400460	Ø 10mm	Nickel plated steel	Diamond
DKK12	8605043400477	Ø 12mm	Nickel plated steel	Diamond
DKK14	8605043400484	Ø 14mm	Nickel plated steel	Diamond
DKK16	8605043400491	Ø 16mm	Nickel plated steel	Diamond
DKK20	8605043400507	Ø 20mm	Nickel plated steel	Diamond
DKK25	8605043400514	Ø 25mm	Nickel plated steel	Diamond
DKK30	8605043400521	Ø 30mm	Nickel plated steel	Diamond
DKK35	8605043400538	Ø 35mm	Nickel plated steel	Diamond
DKK45	8605043400552	Ø 45mm	Nickel plated steel	Diamond
DKK50	8605043400569	Ø 50mm	Nickel plated steel	Diamond
DKK55	8605043400576	Ø 55mm	Nickel plated steel	Diamond
DKK65	8605043400590	Ø 65mm	Nickel plated steel	Diamond



# MACHINE BRUSHES

## CIRCULAR BRUSH, STEEL TWISTED WIRE FOR ANGLE GRINDER



- Purpose: For paint, rust, and dirt removal from metal surfaces where greater force is required
- For angle grinders
- Shank M14

CODE	BARCODE	DIAMETER	MATERIAL
CCKU100BR	8606007993233	Ø100mm	Steel
CCKU125BR	8606107387963	Ø 125mm	Steel

## CIRCULAR CUP BRUSH, STEEL TWISTED WIRE, FOR ANGLE GRINDER



- Purpose: For paint, rust, and dirt removal from metal surfaces where greater force is required
- For angle grinders
- Shank M14

CODE	BARCODE	DIAMETER	MATERIAL
CCLU65BR	8606007995084	Ø65mm	Steel
CCLU100BR	8606107387925	Ø100mm	Steel
CCLU125BR	8606107387932	Ø125mm	Steel

**CIRCULAR CUP BRUSH, STEEL WIRE,  
FOR ANGLE GRINDER**



- Purpose: For paint, rust, and dirt removal from metal surfaces where greater force is required
- For angle grinders
- Shank M14

CODE	BARCODE	DIAMETER	MATERIAL
CCL65BR	8606007993240	Ø65mm	Steel
CCL100BR	8606107387901	Ø100mm	Steel
CCL125BR	8606107387918	Ø125mm	Steel

**CIRCULAR BRASS COATED CUP WIRE  
BRUSH FOR ANGLE GRINDER**



- Purpose: For paint, rust and dirt removal from metal surfaces where greater force is required
- For angle grinders
- Shank M14

CODE	BARCODE	DIAMETER	MATERIAL
MCL65BR	8606007993257	Ø65mm	Brass plated steel
MCL100BR	8606107387949	Ø100mm	Brass plated steel
MCL125BR	8606107387956	Ø125mm	Brass plated steel

**CIRCULAR BRUSH, STEEL WIRE,  
FOR ANGLE GRINDER**



- Purpose: For paint, rust, and dirt removal from metal surfaces where greater force is required
- For angle grinders
- Shank M14

CODE	BARCODE	DIAMETER	MATERIAL
CCK115BR	8606007995091	Ø115mm	Steel

**CIRCULAR BRASS COATED WIRE  
BRUSH FOR ANGLE GRINDER**



- Purpose: For paint, rust and dirt removal from metal surfaces which require low-level aggression
- For angle grinders
- Shank M14

CODE	BARCODE	DIAMETER	MATERIAL
MCK115BR	8606007995107	Ø115mm	Brass plated steel

### CIRCULAR CUP BRUSH, STEEL WIRE, FOR DRILL



- Purpose: Intended for paint, rust, and dirt removal from metal surfaces where greater force is required
- For drill
- Shank 6mm

CODE	BARCODE	DIAMETER	MATERIAL
CCL65B	8606007995121	Ø 65mm	Steel

### CIRCULAR BRASS COATED CUP WIRE BRUSH FOR DRILL



- Purpose: Intended for paint, rust, and dirt removal from metal surfaces where greater force is required
- For drill
- Shank 6mm

CODE	BARCODE	DIAMETER	MATERIAL
MCL65B	8606007995138	Ø 65mm	Brass plated steel

### CIRCULAR BRUSH, STEEL WIRE, FOR DRILL



- Purpose: Intended for paint, rust, and dirt removal from metal surfaces where greater force is required
- For drill
- Shank 6mm

CODE	BARCODE	DIAMETER	MATERIAL
CCK75B	8606007995145	Ø 75mm	Steel
CCK100B	8606007995152	Ø 100mm	Steel

### CIRCULAR BRASS COATED WIRE BRUSH FOR DRILL



- Purpose: Intended for paint, rust, and dirt removal from metal surfaces which require low-level aggression
- For drill
- Shank 6mm

CODE	BARCODE	DIAMETER	MATERIAL
MCK100B	8606007995169	Ø 100mm	Brass plated steel



# STEEL BRUSHES

## BRASSED WIRE BRUSH



- Purpose: For all surfaces manual cleaning
- 5 rows brush intended for professional users due to its thicker, elastic corrugated wire and beech tree handle

CODE	BARCODE	LENGTH	MATERIAL
ZC	8606007992755	280mm	Brass plated steel/ Wood

## BRASS COATED 5 ROWS BRUSH



- Purpose: For all surfaces manual cleaning that requires low-level aggression
- Basic version elastic wire brush for hobbyists
- Wooden handle

CODE	BARCODE	LENGTH	MATERIAL
MCS	8606007991239	286mm	Brass plated steel/ Wood

**SCRATCH BRUSH WOODEN HANDLE  
STEEL WIRE 5 ROWS**

- Purpose: For all surfaces manual cleaning
- Basic version elastic wire brush for hobbyists
- Wooden handle

CODE	BARCODE	LENGTH	MATERIAL
CC5	8606007990652	270mm	Steel / Wood

**SCRATCH BRUSH EXTRA WOODEN HANDLE  
STEEL WIRE 5ROWS**

- Purpose: For all surfaces manual cleaning
- Intended for professional users due to its thicker, elastic corrugated wire, beech tree handle, and 5 rows of wire

CODE	BARCODE	LENGTH	MATERIAL
CC5V	8606104807778	286mm	Steel / Wood

**STEEL BRUSH WITH A SCARPER, 4 ROWS**

- Purpose: For all surfaces manual cleaning
- Made of elastic steel wire, 4 rows
- Wooden handle

CODE	BARCODE	LENGTH	MATERIAL
CCS4	8606007995046	300mm	Steel / Wood

**STEEL BRUSH, BLACK PP HANDLE**

- Purpose: For all surfaces manual cleaning
- The short brush body is suitable for work on smaller surfaces and greater pressure on the surface

CODE	BARCODE	LENGTH	MATERIAL
CC4	8606007993998	166mm	Steel / PVC



## STEEL COATED HAND BRUSH



- Purpose: For all surfaces manual cleaning
- PVC handle with a small hole at the end which can be hung up to save space

CODE	BARCODE	LENGTH	MATERIAL
CL	8606007990690	240mm	Steel / PVC

## ABRASIVE SPONGE MEDIUM



- Purpose: For all types of surface grinding
- Multifunctional sponge with grinding surfaces of different granulations 80/120

CODE	BARCODE	DIMENSION	GRANULATION
BSM	8606007990720	70x100mm	80/120

## BRASS COATED HAND BRUSH



- Purpose: For all surfaces manual cleaning which requires low-level aggression
- Easy cleaning of narrower parts of materials and corners
- PVC handle with a small hole at the end which can be hung up to save space

CODE	BARCODE	LENGTH	MATERIAL
MCL	8606007995053	240mm	Brass plated steel / PVC

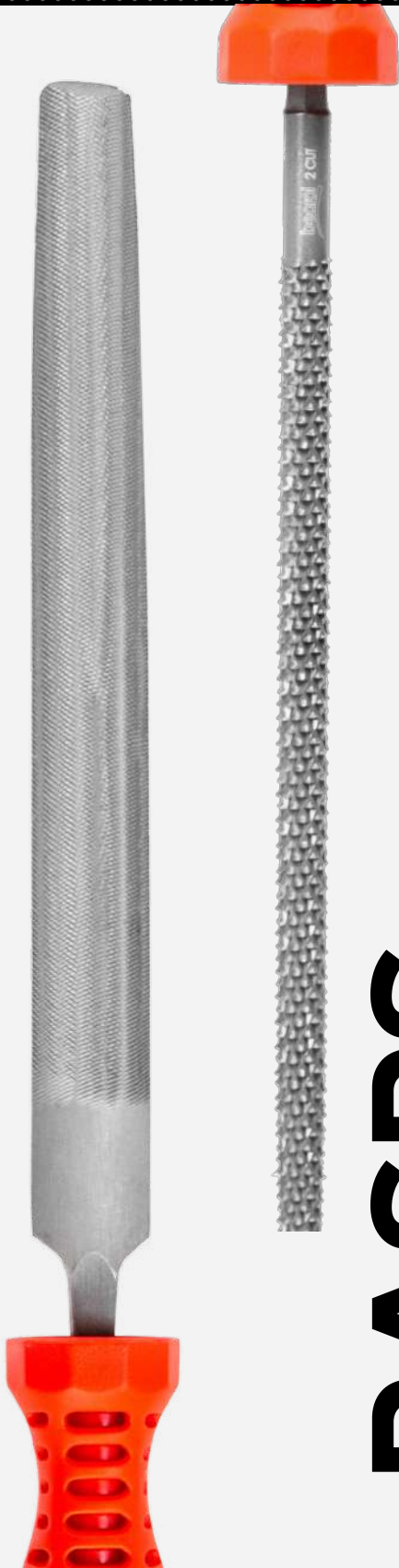

# RASPS

## RASP FOR METAL, SQUARE 200mm



- Purpose: For metal removal and surface treatment of metal parts
- It is primarily intended for work in mechanical and locksmith workshops

CODE	BARCODE	LENGTH	SHAPE
TMK200	8606017658948	200mm	■

## RASP FOR METAL, ROUND 200mm



- Purpose: For metal removal and surface treatment of metal parts
- It is primarily intended for work in mechanical and locksmith workshops

CODE	BARCODE	LENGTH	SHAPE
TMO200	8606017658962	200mm	●

**RASP FOR METAL, TRIANGULAR** 200mm

- Purpose: For metal removal and surface treatment of metal parts
- It is primarily intended for work in mechanical and locksmith workshops

CODE	BARCODE	LENGTH	SHAPE
TMT200	8606017658955	200mm	▲

**RASP FOR METAL, STRAIGHT** 200mm

- Purpose: For metal removal and surface treatment of metal parts
- It is primarily intended for work in mechanical and locksmith workshops

CODE	BARCODE	LENGTH	SHAPE
TMR200	8606017658931	200mm	▬

**RASP FOR METAL, HALF-ROUND** 200mm

- Purpose: For metal removal and surface treatment of metal parts
- It is primarily intended for work in mechanical and locksmith workshops

CODE	BARCODE	LENGTH	SHAPE
TMP200	8606017658979	200mm	◐

**WOOD RASP HALF-ROUND** 200mm

- Purpose: For metal removal and surface treatment of metal parts
- The coarse teeth allow easy and quick wood processing

CODE	BARCODE	LENGTH	SHAPE
TDP200	8606017659020	200mm	◐

## WOOD RASP ROUND, 200mm



- Purpose: For working with wood and very soft metals
- The coarse teeth allow easy and quick wood processing

CODE	BARCODE	LENGTH	SHAPE
TDO200	8606017659013	200mm	●

## CHAIN SAW FILE



- Purpose: For sharpening and maintaining chainsaws
- Allows fast work and leaves a smooth surface on the cutting edge

CODE	BARCODE	LENGTH	DIAMETER
TLMT35	8605043402464	200 mm	3.5 mm
TLMT40	8606017658986	200 mm	4.0 mm
TLMT45	8605043402471	200 mm	4.5 mm
TLMT48	8606017658993	200 mm	4.8 mm
TLMT52	8605043402488	200 mm	5.2 mm
TLMT55	8606017659006	200 mm	5.5 mm

## CIRCULAR PLASTER GRINDER



- Purpose: For shaping and enlarging holes and contour surfaces during plastering works
- Replaceable round blade dimension
- The extension is used for holes of smaller dimensions and can be removed

CODE	BARCODE	MATERIAL	DIMENSION
RZGK16X250	8605043407421	PP	16x 250 mm

## PLASTER GRINDER



- Purpose: For smoothing uneven surfaces on plaster, wood, plastic and other boards
- The body is made of aluminum alloy
- The screw allows for easy blade replacement

CODE	BARCODE	MATERIAL	DIMENSION
RZG140X40	8605043407438	Aluminum	140x40 mm
RZG250X40	8605043407445	Alumium / ABS	250x 40 mm

# PROTECTIVE COTTON AND CLOTHS

## CLEANING COTTON CLOTHS



- Purpose: Cotton cloth 10kg pack for cleaning greasy or dusty items and equipment (machines, parts, etc.) in all industry sectors

CODE	BARCODE	PACKAGE	COLOR
KBE10	8606107912219	10kg	White
KSR10	8606107912226	10kg	Dark
KSV10	8606107912233	10kg	Light

## PROTECTIVE COTTON



- Purpose: For cleaning greasy or dusty items and equipment (machines, parts, etc.) in all industry sectors

CODE	BARCODE	PACKAGE	MATERIAL
PUC1	8606107912196	1kg	Cotton
PUC10	8606107912202	10kg	Cotton



# BOXES, BAGS AND BELTS

## ADJUSTABLE TOOL VEST



- Purpose: Designed for even tool weight distribution
- It contains pockets with several organizers, an adjustable waist, and a reflective strip on the front and back
- There are four belt loops on the vest for the tool bag attaching

CODE	BARCODE	COLOR
PRAP	8605043402532	Black

## TOOL VEST



- Purpose: Tool vest with pockets for better organization and usage of tools

CODE	BARCODE	LENGTH	WIDTH	COLOR
PZA	8606007998382	50cm	60cm	Red

## TOOL BAG #1



- Purpose: Designed to hold smaller tools and accessories
- Hand tool belt bag made of 600D durable fabric with reinforced PE board
- Metal clasp for measurement tape and hanging hooks

CODE	BARCODE	DIMENSION	COLOR
FA1	8605043402600	30X10.5CM	Black

## TOOL BAG #2



- Purpose: Designed to hold smaller tools and accessories
- Hand tool belt bag is made of durable robust material resistant to wear and tear
- Compatible with the Beorol tool belt and vest

CODE	BARCODE	DIMENSION	COLOR
FA2	8605043402532	11x21x1cm	Black

## TOOL BAG #3



- Purpose: For holding smaller tools and accessories
- Made of high quality durable material with reinforced PE board
- Main pocket with a wide opening for storing small tools and accessories

CODE	BARCODE	DIMENSION	COLOR
FA3	8605043402587	21.5x15cm	Black

## TOOL BAG #4



- Purpose: For holding smaller tools and accessories
- Made of extremely durable fabric, reinforced with PE board for long-term use
- It contains a large and two smaller pockets, additional fastening, and a leg strap

CODE	BARCODE	DIMENSION	COLOR
FA4	8605043402563	29x20x8cm	Black

**TOOL BAG #5**

- Purpose: The interior consists of practical pockets for neat storage of tools and a cordless drill
- Made of high-quality durable fabric with reinforced edges
- Tool bag with a carrying handle on top, shoulder strap, and leg strap
- It has a sewn-on magnet on the front and a metal hammer holder

CODE	BARCODE	DIMENSION	COLOR
FAS	8605043402556	21.5x15cm	Black

**WORKBAG FOR BELT**

- Purpose: To carry a small number of tools
- It is attached to a belt or belt
- Material: Impregnated canvas

CODE	BARCODE	LENGTH	WIDTH	HEIGHT
TZA	8606007998375	30.5cm	26cm	2.5cm

**ELECTRIC DRILL HOLSTER**

- Purpose: Case for carrying the AKU drill
- A belt with a buckle is placed around the leg and prevents the tool from falling out when moving while working
- Contains an additional compartment for storing bits and screws, four elastic loops for drills

CODE	BARCODE	DIMENSION	COLOR
FAB	8605043402570	32x18cm	Black

**UNIVERSAL TOOL BELT**

- Purpose: Belt with reinforced seams for carrying tools, the possibility of weight distribution
- The inside of the belt is lined with Velcro for easy and quick size adjustment
- Comes with 2 easily adjustable hanging hooks

CODE	BARCODE	DIMENSION	COLOR
OPAU	8605043402549	150x5cm	Black



## TOOL BELT



- Purpose: Tool belt for easy tools wearing around the waist during the work
- Suitable for construction work
- Two tied handbags and a belt

CODE	BARCODE	LENGTH	WIDTH	HEIGHT
OZA	8606007998405	27cm	25.5cm	3.5cm

## WORKBAG



- Purpose: For carrying and storing hand tools and accessories
- Contains external and internal compartments (pockets) for easier organization of tools
- The possibility of carrying it on the shoulder or in the hand

CODE	BARCODE	LENGTH	WIDTH	COLOR
TZAV	8606007998399	40cm	27cm	Red

## ORGANIZER TANDEM BTWIN



- Purpose: Organizer with a transparent cover and a large number of compartments
- The adaptability of partitions is high and can be obtained a large number of different combinations by moving them

CODE	BARCODE	DIMENSION	COMPARTMENTS
KLSTB200	8605043407001	192x143x100 mm	10
KLSTB300	8605043407018	284x192x100 mm	20
KLSTB400	8605043407025	385x283x100 mm	42

## TOOLBOX STUFF OPTIMO



- Purpose: Toolbox with reinforced handle and aluminum fasteners
- It also has a practical recess for carrying on the sides, mobile container, as well as a hole for a padlock

CODE	BARCODE	LENGTH	WIDTH	HEIGHT
KZOB12	8605043407032	31.2cm	16.7cm	13cm
KZOB16	8605043407049	4.15cm	22.6cm	20cm
KZOB20	8605043407056	52.5cm	25.6cm	24.6cm
KZOB26	8605043407063	59.5cm	33.7cm	31.6cm



# BUSINESS BAGS

## PROJECT BUSINESS TRAVEL BACKPACK



- Purpose: Business-travel ultralight backpack
- Mesh pillows made of high-density foam ensure comfort and cooling
- Made of lightweight soft water-repellent material
- It contains numerous compartments and a USB charging port, a patented FasRelis magnetic buckle system on the shoulder straps, and a card pocket

CODE	BARCODE	LENGTH	WIDTH	HEIGHT
PPPUR	8605043402495	28cm	12cm	43cm

## PROJECT LAPTOP SLEEVE



- Purpose: Sleeve for laptop, tablet, and other electronic devices up to 15.6 inches
- With patent FasRelis magnetic buckles fastening system, anti-scratch interior lining material
- Spacious lace-up pocket for storing small parts, chargers, etc.

CODE	BARCODE	LENGTH	HEIGHT	COLOR
PLT	8605043402501	28cm	38cm	Black

## PROJECT TABLET POUCH



- Purpose: Pouch for tablet and iPad devices, compatible with Beorol business travel backpack
- Durable and water repellent with safety strap and buckle

CODE	BARCODE	LENGTH	HEIGHT	COLOR
PTF	8605043402518	20cm	24cm	Black

## PROJECT CROSSOVER BAG



- Purpose: This crossover bag can be carried as a shoulder bag or by shortening the strap as a crossover
- It is made of water-repellent materials with a reflective strip on the front
- It contains a water-repellent pocket with a zipper on the front
- Convenient and practical for everyday

CODE	BARCODE	COLOR
PCT	8605043402525	Gray



# LADDERS

## COMBINATION ALUMINIUM LADDERS



MAXIMUM LOAD **150 kg**

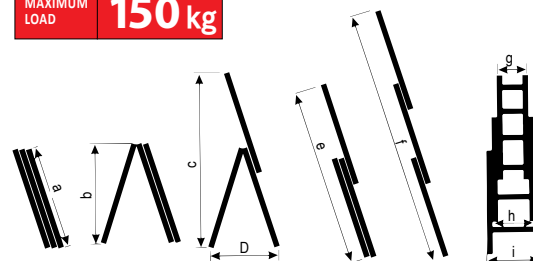

CODE	A(mm)	B(mm)	C(mm)	D(mm)	E(mm)	F(mm)	G/H/I(mm)
MERALK7	1998	1908	2992	1205	3125	4250	340/392/452
MERALK8	2280	2172	3520	1373	3680	5080	340/392/452
MERALK9	2560	2439	4044	1635	4244	5922	340/392/452
MERALK10	2840	2716	4317	1755	4521	6480	340/392/452

CODE	BARCODE	STEPS	HEIGHT	MATERIAL
MERALK7	8600102480704	7	3x2,00m	Aluminum
MERALK8	8606007993400	8	3x2,25m	Aluminum
MERALK9	8600102480858	9	3x2,50m	Aluminum
MERALK10	8606007993196	10	3x2,80m	Aluminum

## ALUMINIUM LADDER



MAXIMUM LOAD **150 kg**

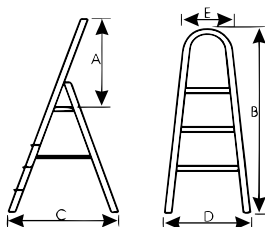

CODE	A(mm)	B(mm)	C(mm)	D(mm)	E(mm)
MERAL2	610	1253	610	405	300
MERAL3	616	1483	765	430	300
MERAL4	622	1713	920	455	300
MERAL5	627	1943	1075	479	300
MERAL6	633	2173	1230	503	300
MERAL7	639	2403	1385	528	300

CODE	BARCODE	STEPS	HEIGHT PLATFORM	MATERIAL
MERAL2	8606007993349	2	0,57m	Aluminum
MERAL3	8606007993356	3	0,78m	Aluminum
MERAL4	8606007993363	4	1,00m	Aluminum
MERAL5	8606007993370	5	1,21m	Aluminum
MERAL6	8606007993387	6	1,43m	Aluminum
MERAL7	8606007993394	7	1,64m	Aluminum

## ALUMINUM SINGLE LADDER



MAXIMUM LOAD **150 kg**



- Purpose: For work at higher heights
- The leg caps are made of a two-component material
- The base is made of a solid material that provides safety for carrying, and the bottom side is made of a softer material that protects against slipping
- Light and solid construction
- Certified according to the EN131 standard

CODE	BARCODE	STEPS	HEIGHT	WEIGHT
MERALP8	8606017659716	8	230.5cm	3.2kg
MERALP10	8606017659723	10	286.5cm	4kg
MERALP12	8606017659730	12	342.5cm	4.7kg

### ALUMINIUM LADDER COLLAPSIBLE

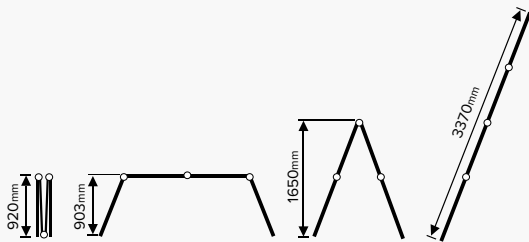

- Purpose: Aluminum folding ladder from four parts
- With four combination possibilities, this ladder is the most practical for craftsmen who perform complex jobs
- Thanks to Aluminum, the ladder is light and has a solid construction
- Certified according to the EN131 standard

CODE	BARCODE	HEIGHT	STEPS	MATERIAL
MERALS	8606007993417	337 cm	4X3	Aluminum

### DOUBLE SIDED ALUMINIUM PLATFORM 2 STEPS



- Purpose: For household use
- Small dimensions make it easy to use and store
- It is made of Aluminum, which makes it extremely strong, durable, and light
- Certified according to the EN131 standard

CODE	BARCODE	HEIGHT	STEPS	MATERIAL
DAP2	8606017653653	37 cm	2	Aluminum

## WOODEN LADDERS



- Purpose: For painting works
- They are made of high-quality and light wood (baskets of linden, sides of poplar) and painted with protective paint that protects against water and moisture, which enables them to last longer
- Hinges and reinforcements are galvanized and made of extremely strong steel
- The ladder has additional reinforcement on the third tread and a hanging hook on the side
- Certified according to the EN131 standard

CODE	BARCODE	STEPS	DIMENSION	MATERIAL
DME2X3	8606107185576	2x3	1100mm	Wood
DME2X4	8606107185583	2x4	1410mm	Wood
DME2X5	8606107185590	2x5	1740mm	Wood
DME2X6	8606107185606	2x6	2070mm	Wood
DME2X7	8606107185613	2x7	2410mm	Wood



beorol  
**UNIVERSAL SILICONE**  
**SILIKON UNIVERZAL**  
**SZILIKON UNIVERZÁL**  
 EXCELLENT BONDING  
 HIGH FLEXIBILITY  
 ANTIBACTERIAL  
 ODLIČNO VEŠTIVANJE  
 VISOKA ELASTIČNOST  
 ANTIBAKTERIJSKI  
 ODLIČNO VEŠTIVANJE  
 VISOKA ELASTIČNOST  
 ANTIBAKTERIJSKI  
 KITÓRÓ BONDING  
 MAGYRUGALMASSÁG  
 ANTIBAKTERIÁJS  
**280ml**  
**UNIVERSAL**

WHITE • BELI • БЕЛ • ALB  
 beorol  
**ACRYLIC SEALANT**  
**AKRILNI KIT**  
**AKRIL GITT**  
**UNIVERSAL**  
 CRACKS SEALING  
 COMPOUNDS FILLING  
 ZAPRTVANJE PUKOTINA  
 POPUNJAVANJE SPOJEVA  
 ЗАПТВАНЈЕ НА ПУКНАТИНИ  
 ПОПУЊИВАЊЕ НА ПУКНАТИНИ  
 REPEDESEK TÖMÍTÉS  
 ÖSSZE ILLESZÉSEK FELTÖLTÉS  
**280ml**  
**PROFESSIONAL**

beorol  
**MONTAGE KIT**  
**MONTAŽNI KIT**  
**МОНТАЖЕН КИТ**  
**MONTÁZS GITT**  
**EXTRA STRONG**  
 CONCRETE • STONE • WOOD • METAL • PLASTER  
 BETON • KÖVÉN • DRVO • METÁL • POCSTAL  
 БЕТОН • КАМЕН • ДРВО • МЕТАЛ • ПЛОСТЛИНО  
 БЕТОН • КЌ • ПА • ФЕМ • МОНТАЖ  
**290ml**  
**PROFESSIONAL**

beorol  
**NEUTRAL SILICONE**  
**NEUTRAL SILICONE**  
**SEMLEGES**  
 NON CORROSIVE  
 MOMENT FLEXIBILITY  
 SOLVENT FREE  
 NEM KÖRÖZŐDŐ  
 AZON ELASTICITÁS  
 OLDALMENTES  
 ÉRZÉKÉNY  
 ÉRZÉKÉNY  
 ÉRZÉKÉNY  
 ÉRZÉKÉNY  
**280ml**  
**NEUTRAL**

beorol  
**RUCTUAL CRACK FILLER**  
**TURNJA ISPUNJIVAČ**  
**ТЪРНА ИСПУЊИВАЧ**  
**VO REPEDESEK**  
**REPEDESEK**  
**VO REPEDESEK**  
**280ml**



# TECHNICAL CHEMISTRY

---

- SILICONES
- ADHESIVES AND SEALANTS
- PU FOAMS
- CLEANERS AND TECHNICAL  
SPRAYS
- SPRAY PAINT

UNIVERSAL SILICONE



SILICONES



- Purpose: Universal Silicone transparent 280 ml is a single-component silicone intended for sealing various building materials exposed to low and medium dilatation
- Specially designed to fill cracks in walls, ceilings, the composition between windows, doors, glass, ceramic tiles, metal, and non-aggressive PVC
- Features: Excellent sealing, extremely elastic, highly stable, UV resistant, without thinner, antibacterial, resistant to temperatures -40°C to +120°C.



CODE	BARCODE	PACKAGE	COLOR
SUTT	8606007997491	50ml	Transparent
SUT	8606007997446	280ml	Transparent
SUBE	8606007997453	280ml	White
SUC	8606007997460	280ml	Black
SUS	8606007997477	280ml	Gray
SUBR	8606007997484	280ml	Brown

## MIRROR NEUTRAL SILICONE



- Purpose: Mirror Neutral Silicone 280 ml is a permanently elastic one-component silicone sealant designed for sealing during external and internal work
- Intended for sealing and bonding the mirrors, plastic, metal, and wood materials, door and window joints, PVC carpentry
- Non-corrosive to metals, solvents free, hardens on moisture, retains its features regardless of year or weather conditions, bonds to a large number of surfaces without the use of primer coatings, resistant to UV radiation and the temperatures of -60C to + 180°C

+180°C  
-60°C

UV

+10%

CODE	BARCODE	PACKAGE	COLOR
SOG	8606007997507	280ml	White

## NEUTRAL SILICONE TRANSPARENT



- Purpose: Neutral Silicone 280 ml is a permanently elastic one-component silicone sealant designed for sealing during external and internal work
- Intended for sealing and bonding of plastic, metal, and wood materials, door and window joints, PVC carpentry
- Non-corrosive to metals, solvents free, hardens on moisture, retains its features regardless of year or weather conditions, bonds to a large number of surfaces without the use of primer coatings, resistant to UV radiation and the temperatures of -60C to + 180°C

+180°C  
-60°C

UV

+10%

CODE	BARCODE	PACKAGE	COLOR
SN	8606007998733	280ml	Transparent

**AQUARIUM SILICONE TRANSPARENT**

- Purpose: Aquarium Silicone 280 ml is a single-component kit for sealing during interior and exterior work
- Suitable for building an aquarium, gluing glass materials, ceramics, etc.
- Not harmful to fish and water flora, excellent sealing, extremely elastic, highly stable, UV resistant, antibacterial, resistant to temperatures -50°C to 200 °C



CODE	BARCODE	PACKAGE	COLOR
SA	8606007997538	280ml	Transparent

**SHOWER SILICONE TRANSPARENT**

- Purpose: Shower Silicone is a permanently elastic single-component sealant intended for sealing during interior and exterior work
- Intended for sealing and bonding of glass, wood, metal, ceramics, PVC, and construction elements in conditions of high moisture and exposure to water
- Long-term mold resistance, excellent sealing, extremely elastic, highly stable, UV resistant, no thinner, antibacterial, resistant to temperatures -40°C to +120°C



CODE	BARCODE	PACKAGE	COLOR
SST	8606007997514	280ml	Transparent
SSBE	8606007997521	280ml	White

## ACRYLIC SEALANT



# ADHESIVES AND SEALANTS



- Purpose: Acrylic Sealant is a single-component, universal, acrylic material intended for sealing and filling cracks during interior and exterior work
- It is used for sealing different construction materials exposed to low and medium dilatation
- Sealing cracks and compositions between windows, walls, doors, etc
- Excellent sealing, highly stable, no thinner, can be painted over, resistant to temperatures -10°C to +80°C

CODE	BARCODE	PACKAGE	COLOR
AK	8606007997583	280ml	White

**MONTAGE KIT**

- Purpose: Montage kit 290ml is an assembly adhesive for interior and exterior work  
Suitable for assembling all kinds of materials onto surfaces of stone, concrete, ceramics, brick, plastic, wood, etc.  
Extremely high bond strength, resistant to weather conditions, water, and chemicals, can be used for absorbent and non-absorbent surfaces

CODE	BARCODE	PACKAGE	COLOR
MNK	8606007997576	290ml	Yellow
MNKT	8606107779935	50ml	Yellow

**POLYURETHANE FLEX**

- Purpose: Polyurethane Flex is one-component permanently elastic PU-based adhesive intended for bonding concrete, brick, wood, metal, and PVC materials on window and door elements  
It is used for sealing holes that leak water, gas, air, and dust as well as in car production, containers, plumbing, and tinsmith industry

CODE	BARCODE	PACKAGE	COLOR
PUFBE	8606106732825	300ml	White
PUFBR	8606106732849	300ml	Brown
PUFCR	8606106732832	300ml	Black
PUFSI	8606106732856	300ml	Gray

## MULTIFIX HYBRID TRANSPARENT



- Purpose: Multifix hybrid transparent 290ml is a one-component adhesive for bonding, sealing, and insulation in the construction, auto, and shipbuilding industry
- Made for sealing joints in contact with air and water, for joints in construction exposed to vibrations, roof panels, vacuum systems containers, tanks, silos, and flooring

CODE	BARCODE	PACKAGE	COLOR
MFHT	8606107779966	290ml	Transparent

## CRACK FILLER



- Purpose: Crack filler 280ml is a one-component, universal, acrylic sealant material intended for sealing and filling cracks during outdoor and indoor work
- Intended for sealing various construction materials exposed to low and middle dilatation
- Specially designed for filling cracks on walls and ceilings, leaving a sandy structure that, after the walls finishing and painting, remains invisible
- It can also be used to seal the composition between windows, walls, doors, glass, ceramic tiles, metal, and non-aggressive PVC
- Suitable for use up to a maximum crack width of 25mm

CODE	BARCODE	PACKAGE	COLOR
IPZ	8606007998504	280ml	White



# PU FOAMS

## PU FOAM



- Purpose: PU polyurethane foam spray 750g is a universal foam for filling and bonding during exterior and interior construction work
- Intended for fixing doors, window frames, filling holes and cracks, and thermal pipe insulation
- It bonds to all construction materials except silicone, polyethylene, and polypropylene
- Resistant to all weather conditions including salty water vaporization and moisture

CODE	BARCODE	PACKAGE	TYPE
PP300	8606106732863	320g	Manual
PP500	8606007997552	500g	Manual
PP750	8606007997545	750g	Manual
PP750P	8606007997569	750g	Pistol



## PU FOAM LOW EXPANDING



- Purpose: Low expansion PU foam spray is universal polyurethane foam used for filling and sealing during interior and exterior work
- Intended for fixing doors, window frames, filling holes and cracks, and thermal pipe insulation

CODE	BARCODE	PACKAGE	TYPE
PPN500	8606017657590	500g	Manual
PPN814	8606104807198	814g	Manual
PPN814P	8606104807204	814g	Pistol

## PU STYRO FOAM



- Purpose: PU styrofoam 821g is a one-component foam/ glue with a very low expansion and is intended for fastening styrofoam insulation boards and stone wool

CODE	BARCODE	PACKAGE	TYPE
PPS821	8606017657453	821g	Manual
PPS821P	8606104807211	821g	Pistol



# CLEANERS AND TECHNICAL SPRAYS

## PU FOAM CLEANER



- Purpose: PU Foam Cleaner is used to easily cleaning of PU foam guns and remove fresh uncured PU foam residue and for cleaning valves and spouts of PU foam aerosols
- Prevents PU foam gun clogging, the best effect is achieved if used immediately after using the gun

CODE	BARCODE	PACKAGE	TYPE
PPC	8606007998542	500ml	Pistol

## HD-40 LUBRICANT SPRAY



- Purpose: Spray HD-40 is a lubricant used under pressure
- Intended for lubrication of automobile parts, machines, springs, and home appliances and long-term metal protection from rust and corrosion, displacing moisture on metal surfaces and electrical contacts

CODE	BARCODE	PACKAGE	COLOR
OS200	8606007998481	200ml	Transparent
OS400	8606007998498	400ml	Transparent

# SPRAY PAINT



## Color SPRAY PAINT

- Properties and areas of use: Acrylic paint designed especially to satisfy the needs of professional users
- It possesses excellent adhesion characteristics and is suitable for painting metallic materials (iron, brass, aluminium), plastic material, machine tools, doors, windows and shutters
- Fast drying and the fact that it can be painted over make it the ideal tool for hobbies and rafts as well as industry
- Features: excellent coverage, nonyellowing, durable, colourfast and lead-free pigments, fast drying, CFC-free
- The 400 ml can covers an area of 1.5 – 2 m<sup>2</sup>, depending on the colour of the paint
- Dust resistant, 10 minutes
- Dry to touch, 20 minutes.
- Fully dry, 24 hours
- May be painted over at any time
- Childproof patented safety cap

**400ml**

520

3

e





CODE	BARCODE	RAL	COLOR
S1000	8606107912691	Glossy	White
S1001	8606107912707	Matt	White
S1013	8606107912721	RAL1013	White
S1015	8606107912738	RAL1015	White
S1018	8606107912769	RAL1018	Yellow
S1021	8606107912745	RAL1021	Yellow
S1023	8606107912752	RAL1023	Yellow
S2003	8606107912776	RAL2003	Orange
S2004	8606107912783	RAL2004	Orange
S3000	8606107912806	RAL3000	Red
S3001	8606107912790	RAL3001	Red
S3002	8606017659907	RAL3002	Red
S3003	8606107912820	RAL3003	Red
S3004	8606017659471	RAL3004	Red
S3015	8606107912837	RAL3015	Pink
S3020	8606107912813	RAL3020	Red
S4001	8606107912851	RAL4001	Purple
S4005	8606107912844	RAL4005	Purple
S5005	8606017659488	RAL5005	Blue
S5010	8606107912882	RAL5010	Blue
S5012	8606107912875	RAL5012	Blue
S5013	8606107912905	RAL5013	Blue
S5015	8606107912899	RAL5015	Blue
S5017	8606107912868	RAL5017	Blue
S6002	8606107912929	RAL6002	Green
S6005	8606107912912	RAL6005	Green
S6011	8606107912943	RAL6011	Green
S6028	8606017657774	RAL6028	Green
S6029	8606107912936	RAL6029	Green
S7000	8606017659495	RAL7000	Gray
S7001	8606107912950	RAL7001	Gray
S7016	8606107912974	RAL7016	Gray
S7032	8606017659501	RAL7032	Gray
S7035	8606107912967	RAL7035	Gray
S8003	8606107779553	RAL8003	Brown
S8011	8606107912998	RAL8011	Brown
S8014	8606017659518	RAL8014	Brown
S8016	8606107779546	RAL8016	Brown
S8017	8606107912981	RAL8017	Brown
S8019	8606017657781	RAL8019	Brown
S9001	8606017650003	Matt	Black
S9000	8606017650010	Glossy	Black
S9006	8606017659525	RAL9006	Gray
S9010	8606107912714	RAL9010	White
SLBM	8606017650294	Matt	Transparent
SLBS	8606017650287	Glossy	Transparent

## ACRYLIC SPRAY

CODE: S1000 WHITE GLOSS	CODE: S1001 WHITE MATT	CODE: S9010 RAL9010	CODE: S1013 RAL1013	CODE: S1015 RAL1015
CODE: S1018 RAL1018	CODE: S1021 RAL1021	CODE: S1023 RAL1023	CODE: S2003 RAL2003	CODE: S2004 RAL2004
CODE: S3000 RAL3000	CODE: S3001 RAL3001	CODE: S3002 RAL3002	CODE: S3003 RAL3003	CODE: S3004 RAL3004
CODE: S3015 RAL3015	CODE: S3020 RAL3020	CODE: S4001 RAL4001	CODE: S4005 RAL4005	CODE: S5005 RAL5005
CODE: S5010 RAL5010	CODE: S5012 RAL5012	CODE: S5013 RAL5013	CODE: S5015 RAL5015	CODE: S5017 RAL5017
CODE: S6002 RAL6002	CODE: S6005 RAL6005	CODE: S6011 RAL6011	CODE: S6028 RAL6028	CODE: S6029 RAL6029
CODE: S7000 RAL7000	CODE: S7001 RAL7001	CODE: S7035 RAL7035	CODE: S7016 RAL7016	CODE: S7032 RAL7032
CODE: S8003 RAL8003	CODE: S8011 RAL8011	CODE: S8014 RAL8014	CODE: S8017 RAL8017	CODE: S8019 RAL8019
CODE: S8016 RAL8016	CODE: S9000 BLACK GLOSS	CODE: S9001 BLACK MATT	CODE: S9006 RAL9006	
CODE: SLBM TRANSPARENT MATT	CODE: SLBMS TRANSPARENT GLOSS			

**SPRAY DECOR**

- Purpose: Spray Decor creates a shining decorative effect on the objects on which it is applied
- Can be used for decoration of picture frames, decorative and holiday decorations, cups, decorative items, etc
- For indoor use only
- Not resistant to frequent handling, overfilling, or outdoor use  
If the object is damaged, it can be colored with the same color
- One bottle covers approximately 1,5m<sup>2</sup>
- Temperature resistance: 100-120 °C
- Childproof patented safety cap

CODE	BARCODE	VOLUME	COLOR
SDE01	8606017650232	400ml	Silver
SDE02	8606017650249	400ml	Chrome
SDE03	8606017650256	400ml	Gold
SDE04	8606017650263	400ml	Copper
SDE05	8606017650270	400ml	Gold



CODE: SDE01  
COLOR: SILVER

CODE: SDE02  
COLOR: CHROME

CODE: SDE03  
COLOR: GOLD

CODE: SDE04  
COLOR: COPPER

CODE: SDE05  
COLOR: GOLD

**SPRAY ANTIQUE**

- Purpose: Very dense acrylic paint in spray ideal for iron items, both new and partially attacked by atmospheric influences
- Special corrosion resistance provides excellent long-term protection
- This makes it ideal for use on fences and gates, elements on roofs elements, iron pipes, ladders, gutters, and doors
- Features: Excellent coverage, corrosion blocking, high resistance, and long-lasting, quick drying
- A bottle of 400ml covers an area of 1.5-2m<sup>2</sup>
- Resistant to dust after 10 minutes, touch resistance after 20 minutes, and complete drying is achieved within 24 hours
- Resistant to temperatures of 100-130 °C
- Childproof patented safety cap

CODE	BARCODE	VOLUME	COLOR
SAN01	8606017650188	400ml	Iron
SAN02	8606017650195	400ml	Gray
SAN03	8606017650201	400ml	Gray
SAN04	8606017650218	400ml	Bronze
SAN05	8606017650225	400ml	Red



CODE: SAN01  
COLOR: IRON

CODE: SAN02  
COLOR: GRAY

CODE: SAN03  
COLOR: GRAY

CODE: SAN04  
COLOR: BRONZE

CODE: SAN05  
COLOR: RED

## SPRAY DIAMOND



- Purpose: Spray paint that creates a surface with diamond, and pearl overlays on the objects to which it is applied
- It is used for decoration on various types of materials and objects (frames, bicycles, motors, refrigerators, etc.)
- Characteristics: excellent coverage, high resistance, lead-free pigment, quick-drying, without CFC
- A bottle of 400ml covers an area of 1.52m<sup>2</sup> depending on the color of the paint
- Resistant to dust after 10 minutes, resistant to touch after 20 minutes, and complete drying is achieved within 24 hours
- It is resistant to temperatures of 100-120 °C
- Childproof patented safety cap

CODE	BARCODE	VOLUME	COLOR
SDI01	8606017650126	400ml	Gray
SDI02	8606017650133	400ml	Black
SDI03	8606017650140	400ml	Blue
SDI04	8606017650157	400ml	Yellow
SDI05	8606017650164	400ml	Green
SDI06	8606017650171	400ml	Red



CODE: SDI01  
COLOR: GRAY

CODE: SDI02  
COLOR: BLACK

CODE: SDI03  
COLOR: BLUE

CODE: SDI04  
COLOR: YELLOW

CODE: SDI05  
COLOR: GREEN

CODE: SDI06  
COLOR: RED

## SPRAY FLUO



- Purpose: Spray Fluo is an acrylic reflective color in a spray that illuminates the surface and is visible from a great distance, even in low light conditions
- Suitable for use in open and closed areas on objects made of metal, plastic, wood, glass and ceramics, as well as on surfaces of brick, concrete or plaster
- Characteristics: Effective in low light conditions
- A bottle of 400ml covers an area of 1.5-2m<sup>2</sup> depending on the color of the paint
- Resistant to dust after 10min. resistant to the touch after 20 minutes and complete drying is achieved within 24 hours
- Temperature resistant: 100-120 °C

CODE	BARCODE	VOLUME	COLOR
SFL01	8606017650072	400ml	Orange
SFL02	8606017650089	400ml	Yellow
SFL03	8606017650096	400ml	Green
SFL04	8606017650102	400ml	Blue
SFL05	8606017650119	400ml	Red



CODE: SFL01  
COLOR: ORANGE

CODE: SFL02  
COLOR: YELLOW

CODE: SFL03  
COLOR: GREEN

CODE: SFL04  
COLOR: BLUE

CODE: SFL05  
COLOR: RED

**SRAY THERMO RESISTANT**

- Purpose: Special silicone spray paint resistant to high temperatures
- Suitable for use on exhaust systems, coolers, and valves on cars, radiators, chimneys, and ovens
- Features: Available in black, silver, and red color resistant to temperatures up to 600°C
- Also available in white and transparent color resistant to temperatures up to 300°C
- Bottle of 400ml covers an area of 1,5-2m<sup>2</sup> depending color paint
- Resistant to dust after 10 minutes, to touch after 20 minutes, and full cure is achieved within 24 hours

CODE	BARCODE	VOLUME	COLOR
SVT01	8606017650027	400ml	Black
SVT02	8606017650034	400ml	Aluminum
SVT03	8606017650041	400ml	Red
SVT04	8606017650058	400ml	White
SVT05	8606017650065	400ml	Transparent

**SPRAY ZINC**

- Purpose: Zinc Spray protects reservoirs, metal pillars, welded joints, fences, and carpentry parts preventively
- Can be used after making a thread, cutting, or welding to achieve corrosion resistance
- Characteristics: forming elastic film resistant to all atmospheric effects
- It may be a final protective layer or may be subsequently painted in other colors
- No lead, quick-drying, CFC-free
- 400ml bottle covers an area of 1.52m<sup>2</sup> depending on the material to be applied
- Dust resistance after 10 minutes, in contact after 20 minutes, and complete drying is achieved within 24 hours
- Temperature resistance: 180 °C

CODE	BARCODE	VOLUME	COLOR
SCIN	8606017650324	400ml	Zinc
SCIN98	8605043409661	400ml	Zinc 98%





## SPRAY HOME APPLIANCE



- Purpose: Acrylic spray paint for household appliances is used on metal surfaces for restoring the original color
- Gives appliances new shine
- Features: excellent coverage, non-yellowing, durable, colorfast and lead-free pigments, fast drying, CFC-free
- The 400 ml can cover an area of 1.5 – 2 m<sup>2</sup>, depending on the color of the paint
- Dust resistance after 10 minutes, in contact after 20 minutes, and complete drying is achieved within 24 hours
- It May be painted over at any time
- Childproof patented safety cap

CODE	BARCODE	VOLUME	COLOR
SKAP	8606017650348	400ml	White



CODE: SKAP  
COLOR: WHITE

## SPRAY CAR LINE



- Purpose: Spray for bumpers and spoilers intended for use on plastic materials
- It restores the original bumper structure
- Resistant to scratches, small impacts, chemical, and atmospheric effects
- Characteristics: excellent coverage, high resistance, lead-free pigment, quick-drying, without CFC
- A bottle of 400ml covers an area of 1.5-2m<sup>2</sup>
- Dust resistance after 10 minutes, dry to touch 20 minutes, and complete drying is achieved within 24 hours
- Temperature resistance: 100-120 °C
- Childproof patented safety cap

CODE	BARCODE	VOLUME	COLOR
SBRC	8606017650317	400ml	Black
SBRS	8606017650300	400ml	Gray
SFAL	8606017650331	400ml	Aluminum



CODE: SBRS  
COLOR: GRAY



CODE: SBRC  
COLOR: BLACK



CODE: SBRC  
COLOR: ALUMINUM

**SPRAY PRIMER**

- Purpose: Acrylic spray pad with excellent bonding for almost all types of materials: plastic, metal, wood, ceramics
- It can be used as a substrate for better adhesion of other coatings that have problems with bonding to substrates such as polycarbonates, polypropylene, and similar materials
- Characteristics: excellent coverage, high resistance, lead-free pigment, quick-drying, without CFC
- A bottle of 400ml covers an area of 1.52m<sup>2</sup> depending on the material to which it is applied
- Dust resistance after 10 minutes, in contact after 20 minutes, and complete drying is achieved within 24 hours
- Temperature resistance: 100-120 °C
- Childproof patented safety cap

CODE	BARCODE	VOLUME	COLOR
SPRU	8606017650362	400ml	Transparent



CODE: SPRU  
COLOR: TRANSPARENT

**SPRAY ANTI RUST**

- Purpose: Anti-corrosion spray gives metals long-term corrosion protection
- It can be covered with subsequent paint coatings of the appropriate composition after complete drying
- Resistant to all atmospheric influences
- Characteristics: excellent coverage, high resistance, lead-free pigment, quick drying, without CFC
- A bottle of 400ml covers an area of 1.52m<sup>2</sup> depending on the material to which it is applied
- Dust resistance after 10 minutes, in contact after 20 minutes and complete drying is achieved within 24 hours
- Temperature resistance: 100-120°C
- Childproof patented safety cap

CODE	BARCODE	VOLUME	COLOR
SAKS	8606017650355	400ml	Gray



CODE: SAKS  
COLOR: GRAY

SPRAY STAIN COVER



- Purpose: It covers and shields the stains
- Properties and area of use: high coverage matt white acrylic background
- Avoids the resurfacing after painting with dispersions and wall paints  
Reduces the number of layers of wall paint needed and painting time
- Smoke stains, soot, dirt, grease, pencil, or marker are easily masked, and you can proceed to the painting of walls after at least half an hour
- The 400 ml aerosol can cover an area of approx. 2 m<sup>2</sup> depending on the color of the surface, the thickness of each layer, and number of layers applied
- Use between +10°C and +25°C, max. air humidity 60%
- Clean the surface from grease and dust
- Do not apply synthetic paints

CODE	BARCODE	VOLUME	COLOR
SZPF	8605043409678	400ml	White matt



CODE: SFAL  
COLOR: WHITE MATT



# PROTECTION

## PROGRAM

---

- GLOVES
- PROTECTIVE FOOTWEAR
- WORK CLOTHES
- PROTECTIVE EQUIPMENT





# GLOVES



## WHAT IS EN388 STANDARD?

This standard refers to the protective qualities of gloves against mechanical risks. Protection against mechanical hazards is expressed by a pictogram followed by four numbers (performance levels), each representing test performance against a specific hazard.



**1. Resistance to abrasion:** based on the number of cycles required to abrade through the sample glove. The highest mark is 4.



**2. Blade cut resistance:** based on the number of cycles required to cut through the sample at a constant speed. The highest mark is 5.



**3. Tear resistance:** based on the amount of force required to tear the sample. The highest mark is 4.



**4. Puncture resistance:** based on the amount of force required to pierce the sample with a standard sized point. The highest mark is 4.

## BEST ONCE EXTRA GLOVES



- Purpose: For heavy-duty construction works
- The advantage is good adhesion and wears resistance
- Color: Orange / White



CODE	BARCODE	SIZE	MATERIAL
RB1L	8606106732894	L	Cotton / Latex
RB1XL	8606106732887	XL	Cotton / Latex

## LATEX FLEX UNIVERSAL GLOVES



- Purpose: For the machine industry and workshop work
- They fit perfectly with the hand for increased precision in work
- Palm and fingers coated with a thin layer of relief latex
- Color: red / Black



CODE	BARCODE	SIZE	MATERIAL
RLFU	8606007993219	L	Polyester / Latex

## MATRIX GLOVES



- Purpose: For work in industry and workshops
- The embossed rubber in which the glove is dipped allows the use of hand tools without slipping
- Color: Green / Black



CODE	BARCODE	SIZE	MATERIAL
RMTL	8606106732511	L	Polyamide / Latex
RMTM	8606017652120	M	Polyamide / Latex
RMTS	8606017652113	S	Polyamide / Latex
RMTXL	8606106732528	XL	Polyamide / Latex

## SPIDER GLOVES



- Purpose: For use in workshops and industry
- Knitted glove dipped in foam latex that allows the skin of the hand to breathe and reduces sweating
- Color: Red / Blue



CODE	BARCODE	SIZE	MATERIAL
RSJL	8606106732498	L	Polyamide / Foam latex
RSJM	8606017652106	M	Polyamide / Foam latex
RSJS	8606017652090	S	Polyamide / Foam latex
RSJXL	8606106732504	XL	Polyamide / Foam latex

## TRITON-NITRILE GLOVES



- Purpose: For jobs in the automotive industry, work with oils and other technical chemicals, in construction works, packaging, and transport
- Color: White / Gray



CODE	BARCODE	SIZE	MATERIAL
RTL	8606007996463	L	Polyester/Nitrile
RTXL	8606106732870	XL	Polyester/Nitrile

## BUNTER WHITE GLOVES



- Purpose: For painting works, and work that require high precision
- The gloves feature excellent air and moisture permeability
- Resistant to thinners, oils, and greases
- Color: White



CODE	BARCODE	SIZE	MATERIAL
RBUNL	8606007993073	L	Polyester / Polyurethane
RBUNM	8606107779607	M	Polyester / Polyurethane
RBUNS	8606107779591	S	Polyester / Polyurethane
RBUNXL	8606007998856	XL	Polyester / Polyurethane

## BUNTER BLACK GLOVES



- Purpose: For painting works, and work that require high precision
- The gloves feature excellent air and moisture permeability
- Resistant to thinners, oils, and greases
- Color: Black



CODE	BARCODE	SIZE	MATERIAL
RBUNCL	8600102480766	L	Polyester / Polyurethane
RBUNCM	8606017652069	M	Polyester / Polyurethane
RBUNCS	8606017652052	S	Polyester / Polyurethane
RBUNCXL	8600102480773	XL	Polyester / Polyurethane

## BUNTER GRAY GLOVES



- Purpose: For painting works, and work that require high precision
- The gloves feature excellent air and moisture permeability
- Resistant to thinners, oils, and greases
- Color: Gray



CODE	BARCODE	SIZE	MATERIAL
RBUNSL	8606007999792	L	Polyester / Polyurethane
RBUNSM	8606017652083	M	Polyester / Polyurethane
RBUNSS	8606017652076	S	Polyester / Polyurethane
RBUNSLX	8606106732559	XL	Polyester / Polyurethane



## DIP-COATED PREMIUM GLOVES



- Purpose: For construction, installation, garden and home work
- The base is made of knitted fivefold thread and the elastic layer of latex separate this glove from similar ones and enable them a long service life with exceptional comfort
- Color: Yellow / Green



CODE	BARCODE	SIZE	MATERIAL
RDIPPL	8606007992014	L	Cotton / Latex
RDIPPXL	8606106732917	XL	Cotton / Latex

## DIP-COATED WINTER GLOVE



- Purpose: For work in winter conditions
- In addition to the latex layer that protects the hand, the braid of this glove is made of acrylic fiber that protects the hands from the cold
- Color: Blue



CODE	BARCODE	SIZE	MATERIAL
RZDIP	8600102480902	XL	Polyester / Latex
RZDIPL	8605043406936	L	Polyester / Latex

## DIP-COATED GLOVES



- Purpose: For construction, installation, garden, and home work
- Color: Yellow / Green



CODE	BARCODE	SIZE	MATERIAL
RDIPL	8606007993035	L	Cotton / Polyester / Latex
RDIPXL	8606007998795	XL	Cotton / Polyester / Latex

## REDWING PREVENT GLOVES



- Purpose: For work in heavy-duty construction and industrial jobs
- Additionally suitable for work in forestry
- The palm is coated with a layer of thicker latex
- Color: White / Orange



CODE	BARCODE	SIZE	MATERIAL
RPREVL	8606007993042	L	Polyester / Latex
RPREVLXL	8606106732900	XL	Polyester / Latex

### FENIX GLOVES



- Purpose: For construction works, suitable for work with a grinder
- Made of inverted leather and canvas



CODE	BARCODE	SIZE	MATERIAL
RFN	8606007991697	XL	Leather/ Canvas

### HIMERA GLOVES



- Purpose: For welding works
- Made of high-quality inverted leather
- Color: Gray



CODE	BARCODE	SIZE	MATERIAL
RH	8606007996418	XL	Leather

### KERBER GLOVES



- Purpose: For rough construction works
- Reinforced gloves with a wide cuff
- Made of inverted leather and canvas
- Color: Red / Yellow



CODE	BARCODE	SIZE	MATERIAL
RKB	8606007996449	XL	Leather/ Canvas

### HEFEST GLOVES



- Purpose: For welding works
- Made of high-quality inverted leather
- They have a type A welding certificate and standards: EN ISO 388, EN ISO 407, EN 12477
- Color: Green



CODE	BARCODE	SIZE	MATERIAL
RZVH	8605043406448	14	Leather

## DEMETRA GLOVES



- Purpose: For agricultural, construction and mechanical works
- They are extremely light, flexible and ideal for protection during rough work
- They are made of beef embossed leather



CODE	BARCODE	SIZE	MATERIAL
RD	8605043406431	10	Leather

## OIL-RESISTANT PVC GLOVES



- Purpose: For work in the petroleum and oil industry
- Resistant to gasoline, oils and other petroleum products
- Color: Red



CODE	BARCODE	SIZE	MATERIAL
RZN	8606007991741	L	PVC

## GLOVES FOR PACKING



- Purpose: For packaging, transport and logistics operations
- The main advantage is excellent wear resistance, good adhesion, non-slipping
- Color: White

CODE	BARCODE	SIZE	MATERIAL
RZP	8606007991758	L	Cotton / PVC

## GARDEN GLOVES

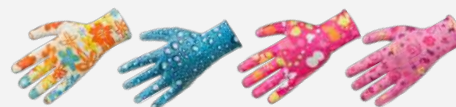

- Purpose: For gardening as well as all other medium-demanding operations
- Knitted polyester gloves with nitrile lining

CODE	BARCODE	SIZE	MATERIAL	COLOR
RZB1	8606104807143	M	Polyester / Nitril	White
RZB2	8606104807150	M	Polyester / Nitril	Pink
RZB3	8606104807167	M	Polyester / Nitril	Orange
RZB4	8606104807174	M	Polyester / Nitril	Blue
RZB5	8606104807181	M	Polyester / Nitril	Pink



# PROTECTIVE FOOTWEAR

## SAFETY SHOES CRAFT S1PS1P



- Purpose: For work in a dry environment, where leg protection is necessary
- S1P degree of protection
- They are made of quality cow leather, 2mm thick
- They have a composite protective cap, made of injection-molded polymer, the testing of which is carried out according to the EN 12568 method and must withstand an impact of 200 J, as well as be resistant to a bending force of 15 kN
- They are anatomically shaped with a replaceable anti-static and antibacterial insole
- The shoes are made according to the standard: EN ISO 20345:2011.

CODE	BAROCODE	SIZE	MATERIAL
ZCCS1PP41	8605043408473	41	Cowhide
ZCCS1PP42	8605043408480	42	Cowhide
ZCCS1PP43	8605043408497	43	Cowhide
ZCCS1PP44	8605043408503	44	Cowhide
ZCCS1PP45	8605043408510	45	Cowhide
ZCCS1PP46	8605043408527	46	Cowhide

## WORK SHOES CRAFT O1



- Purpose: This model is a working shoe model, which is recommended in jobs where long standing and movement are required without the potential danger of falling of a large load and the danger of breaking through the sole
- O1 degree of protection
- Comfortable insole for feet with a replaceable insole on polyurethane foam
- The upper part is made of quality cow leather with a thickness of 2 mm
- They are anatomically shaped with a replaceable anti-static and antibacterial insole
- The sole has an absorber in the heel area
- The shoes are made according to the standard: EN ISO 20347 standard

CODE	BARCODE	SIZE	MATERIAL
RCCO1P41	8605043409883	41	Cowhide
RCCO1P42	8605043409890	42	Cowhide
RCCO1P43	8605043409906	43	Cowhide
RCCO1P44	8605043409913	44	Cowhide
RCCO1P45	8605043409920	45	Cowhide
RCCO1P46	8605043409937	46	Cowhide

## PROTECTIVE CRAFT SANDALS S1P



- Purpose: For work in dry and warm environments where foot protection is necessary
- S1P degree of protection
- Comfortable insole for feet with a replaceable insole on polyurethane foam
- They are made of quality cowhide, 2mm thick, which indicates a quality choice of leather for this sandal
- They are anatomically shaped with a replaceable anti-static and antibacterial insole
- The insole is designed with a moisture control system and provides high breathability, as well as additional energy absorbers along the entire length of the sole
- The shoes are made according to the standard: EN ISO 20345:11

CODE	BARCODE	SIZE	MATERIAL
ZSCS1P41	8605043408534	41	Cowhide
ZSCS1P42	8605043408541	42	Cowhide
ZSCS1P43	8605043408558	43	Cowhide
ZSCS1P44	8605043408565	44	Cowhide
ZSCS1P45	8605043408572	45	Cowhide
ZSCS1P46	8605043408589	46	Cowhide

**SAFETY SHOE CRAFT S3**

CODE	BARCODE	SIZE	MATERIAL
ZCC3P41	8605043407605	41	Cowhide
ZCC3P42	8605043407612	42	Cowhide
ZCC3P43	8605043407629	43	Cowhide
ZCC3P44	8605043407636	44	Cowhide
ZCC3P45	8605043407643	45	Cowhide
ZCC3P46	8605043407650	46	Cowhide

- Purpose: For work in conditions where S3 degree of protection is required
- Composite cap and heel energy absorber
- Double layer PU sole made of Huntsman PU
- The non-metallic composite sheet (injected polymer) provides maximum protection along the entire length of the sole
- Metal toe cap, full-length metal sheet, oil-resistant sole and shock-absorbing heel insert
- The shoes are made according to the standard: 20345:2011



CODE	BARCODE	SIZE	MATERIAL
ZCC3D41	8605043407667	41	Cowhide
ZCC3D42	8605043407674	42	Cowhide
ZCC3D43	8605043407681	43	Cowhide
ZCC3D44	8605043407698	44	Cowhide
ZCC3D45	8605043407704	45	Cowhide
ZCC3D46	86050443407711	46	Cowhide

**SAFETY SHOES COMBO S1**

CODE	BARCODE	SIZE	MATERIAL
ZCPP41	8606017657125	41	Synthetic fabric/Polyurethane
ZCPP42	8606017657132	42	Synthetic fabric/Polyurethane
ZCPP43	8606017657149	43	Synthetic fabric/Polyurethane
ZCPP44	8606017657156	44	Synthetic fabric/Polyurethane
ZCPP45	8606017657163	45	Synthetic fabric/Polyurethane
ZCPP46	8606017657170	46	Synthetic fabric/Polyurethane
ZCPP47	8606017657187	47	Synthetic fabric/Polyurethane

- Purpose: To work in conditions where S1 degree of protection is required with increased comfort
- S1 degree of protection
- The upper is made of high-quality synthetic materials with a composite cap to protect the toes, and the sole is made of Polyurethane
- The sneakers feature an oil-resistant antistatic sole and a shock-absorbing insert in the heel
- The shoes are made according to the standard: EN ISO 20347



CODE	BARCODE	SIZE	MATERIAL
ZCPD41	8606017657194	41	Synthetic fabric / Polyurethane
ZCPD42	8606017657200	42	Synthetic fabric / Polyurethane
ZCPD43	8606017657217	43	Synthetic fabric / Polyurethane
ZCPD44	8606017657224	44	Synthetic fabric / Polyurethane
ZCPD45	8606017657231	45	Synthetic fabric / Polyurethane
ZCPD46	8606017657248	46	Synthetic fabric / Polyurethane
ZCPD47	8606017657255	47	Synthetic fabric / Polyurethane

## PROTECTIVE QUATRO SNEAKERS S3



CODE	BARCODE	SIZE	MATERIAL
ZQPP41	8605043406684	41	Synthetic fabric / Leather
ZQPP42	8605043406691	42	Synthetic fabric / Leather
ZQPP43	8605043406707	43	Synthetic fabric / Leather
ZQPP44	8605043406714	44	Synthetic fabric / Leather
ZQPP45	8605043406721	45	Synthetic fabric / Leather
ZQPP46	8605043406738	46	Synthetic fabric / Leather

- Purpose: To work in conditions where S3 degree of protection is required with increased comfort
- The upper is made of high quality synthetic fabric and leather, and the sole is made of thermoplastic polyurethane
- The composite protective cap provides protection for the toes while minimizing the weight of the shoe
- The shoes are made according to the standard: EN ISO 20345:2011

## WORKING SNEAKERS OZONE O1



CODE	BARCODE	SIZE	MATERIAL
RPOP41	8605043406622	41	PU fabric
RPOP42	8605043406639	42	PU fabric
RPOP43	8605043406646	43	PU fabric
RPOP44	8605043406653	44	PU fabric
RPOP45	8605043406660	45	PU fabric
RPOP46	8605043406677	46	PU fabric

- Purpose: To work in conditions where O1 degree of protection is required with increased comfort
- Protection level O1
- Feature an antistatic sole made of thermoplastic polyurethane, resistant to oil and an insert for absorbing heels
- The upper of the sneaker is made of quality PU weaving
- The shoes are made according to the standard: EN ISO 20347: 2012



CODE	BARCODE	SIZE	MATERIAL
ZQPD41	8605043406745	41	Synthetic fabric / Leather
ZQPD42	8605043406752	42	Synthetic fabric / Leather
ZQPD43	8605043406769	43	Synthetic fabric / Leather
ZQPD44	8605043406776	44	Synthetic fabric / Leather
ZQPD45	8605043406783	45	Synthetic fabric / Leather
ZQPD46	8605043406790	46	Synthetic fabric / Leather

**PVC BOOT**

- Purpose: For work in wet conditions
- Made from elastic and durable PVC material

CODE	BARCODE	SIZE	MATERIAL
CPVC39	8606106732276	39	PVC
CPVC40	8606106732283	40	PVC
CPVC41	8606106732290	41	PVC
CPVC42	8606106732306	42	PVC
CPVC43	8606106732313	43	PVC
CPVC44	8606106732320	44	PVC
CPVC45	8606106732337	45	PVC
CPVC46	8606106732344	46	PVC
CPVC47	8606106732351	47	PVC

**PVC WINTER BOOT**

- Purpose: For work in wet conditions and low temperatures
- With a thermal insulation lining made of faux fur, they have a tensioning strap inside the PU trim on the upper edge of the boot and a non-slip sole with energy absorber in the heel area
- The height of the upper part of the boot is 380 mm
- Resistant to mild acids and alkaline substances
- The boots are made according to the standard: EN ISO 20347

CODE	BARCODE	SIZE	MATERIAL
CZPVC41	8605043406462	41	PVC
CZPVC42	8605043406479	42	PVC
CZPVC43	8605043406486	43	PVC
CZPVC44	8605043406493	44	PVC
CZPVC45	8605043406509	45	PVC
CZPVC46	8605043406516	46	PVC





MATERIAL DENSITY  
per m<sup>2</sup>



MATERIAL COMPOSITION:  
100% Polyester



MATERIAL COMPOSITION:  
Polyester / Cotton



MATERIAL COMPOSITION:  
Polyester / Elastin



WATER RESISTANT



VAPOR PERMEABLE



PRESERVING HEAT



POCKETS



REINFORCED



REFLECTIVE DETAILS



POCKETS WITH  
REINFORCEMENT

## WORK JACKET SOFTSHELL



300 g /m2



94% Polyester  
6% Elastin



Water  
resistant



Vapor  
permeable

- Purpose: Work jacket softshell is ideal for wearing both outdoors and on all other occasions such as daily walks, hiking, construction work
- Made of two-layer material
- The vapor-permeable material allows the skin to breathe, which means that there is no sweating
- It is made of extremely durable material and is resistant to wear, which makes this investment worth it many times over

CODE	BARCODE	SIZE	MATERIAL
ROJSSM	8605043402341	M	94% Polyester, 6% Elastin
ROJSSL	8605043402358	L	94% Polyester, 6% Elastin
ROJSSXL	8605043402365	XL	94% Polyester, 6% Elastin
ROJSSXXL	8605043402372	XXL	94% Polyester, 6% Elastin

## WORK JACKET SOFTSHELL HOOD



300 g /m2



94% Polyester  
6% Elastin



Water  
resistant



Vapor  
permeable

- Purpose: Work jacket softshell with a hood is ideal for wearing both outdoors and on all other occasions such as daily walks, hiking, construction work
- Made of two-layer material
- The softshell material is both water-repellent and vapor-permeable
- It is made of extremely durable material and is resistant to wear, which makes this investment worth it many times over

CODE	BARCODE	SIZE	MATERIAL
ROJSSKM	8605043402426	M	94% Polyester, 6% Elastin
ROJSSKL	8605043402433	L	94% Polyester, 6% Elastin
ROJSSKXL	8605043402440	XL	94% Polyester, 6% Elastin
ROJSSKXXL	8605043402457	XXL	94% Polyester, 6% Elastin

## WORK JACKET FLEECE



280 g /m2



100% Polyester



Preserving heat



3 pockets

- Purpose: Polar fleece work jacket, made of 100% polyester fiber, 280gsm, extremely comfortable to wear, easy movement and protects from cold at the same time
- Central zipping fastening with 3 sewn-on pockets suitable for storing small items
- Elastic band in sleeve cuffs
- Possibility of additional tightening with lace at the bottom of the jacket

CODE	BARCODE	SIZE	MATERIAL
ROJFM	8605043402389	M	100% Polyester
ROJFL	8605043402396	L	100% Polyester
ROJFXL	8605043402402	XL	100% Polyester
ROJFXXL	8605043402419	XXL	100% Polyester

## WORK JACKET STANDARD



260 g /m2



80% Polyester  
20% Cotton



Reinforced



Reflective details

- Purpose: Work jacket intended for construction, workshop, warehouse, storage workers, etc
- Made of high-quality durable fabric with additional reinforcements of polyester in places exposed to greater wear, such as elbows
- The jacket has a zipper under the armpit for greater comfort and better ventilation, as well as a larger number of pockets for storing items during work

CODE	BARCODE	SIZE	MATERIAL
ROJSM	8605043402181	M	80% Polyester, 20% Cotton
ROJSL	8605043402198	L	80% Polyester, 20% Cotton
ROJSXL	8605043402204	XL	80% Polyester, 20% Cotton
ROJSXXL	8605043402211	XXL	80% Polyester, 20% Cotton
ROJSXXXL	8605043406561	XXXL	80% Polyester, 20% Cotton

**WORK TROUSERS STANDARD**

260 g /m2

 80% Polyester  
20% Elastin

Reinforced



Pockets

- Purpose: Work trousers standard are ideal for painters, carpenters, potters, parquet makers, warehouse workers, etc.
- On the knees exposed to greater wear, they have pockets for inserting protectors/guards, as well as reinforcements made of 600D polyester
- The pants also have a large number of practical pockets for storing various tools and other small items

CODE	BARCODE	SIZE	MATERIAL
ROPASM	8605043402228	M	80% Polyester, 20% Elastin
ROPASL	8605043402235	L	80% Polyester, 20% Elastin
ROPASXL	8605043402242	XL	80% Polyester, 20% Elastin
ROPASXXL	8605043402259	XXL	80% Polyester, 20% Elastin
ROPASXXXL	8605043406578	XXXL	80% Polyester, 20% Elastin

**WORK BIB PANTS STANDARD**

260 g /m2

 80% Polyester  
20% Elastin

Reinforced



Pockets

- Purpose: Work bib pants are ideal for painters, carpenters, potters, parquet makers, warehouse workers, etc.
- Made of durable material which allows easy maintenance
- On the knees exposed to greater wear, they have pockets for inserting protectors/guards, as well as reinforcements made of 600D polyester
- The pants also have a large number of practical pockets for storing various tools and other small items

CODE	BARCODE	SIZE	MATERIAL
ROPKSM	8605043402266	M	80% Polyester, 20% Elastin
ROPKSL	8605043402273	L	80% Polyester, 20% Elastin
ROPKXSL	8605043402280	XL	80% Polyester, 20% Elastin
ROPKXXL	8605043402297	XXL	80% Polyester, 20% Elastin
ROPKXXXL	8605043406585	XXXL	80% Polyester, 20% Elastin

## WINTER WORK WEST



65% Polyester  
35% Cotton

- Purpose: For daily work in winter conditions, in construction, industry, workshops, warehouses, and can also be worn in free time
- Winter work vest with high collar and an extended back side
- Contains folding snaps over the zipper
- The vest is equipped with multiple different sized pockets
- Crafted from high quality fabric

CODE	BARCODE	SIZE	MATERIAL
RPZL	8605043406592	L	65% polyester,35% cotton
RPZXL	8605043406608	XL	65% polyester,35% cotton
RPZXXL	8605043406615	XXL	65% polyester,35% cotton

# PROTECTIVE EQUIPMENT



## PROTECTIVE HELMET



- Purpose: For head protection in industry
- Made from quality HDPE (high-density polyethylene)
- Made in accordance with SRPS EN397:2013

CODE	BARCODE	SIZE	COLOR
ZSB	8606007995305	Universal	White
ZSC	8606007995312	Universal	Red
ZST	8606007995329	Universal	Blue
ZSZ	8606007995299	Universal	Yellow

## SHOES FOR EPOXY FLOORS



- Purpose: For walking on self-leveling floors, epoxy and other coatings without damage
- Shoes-mounted

CODE	BARCODE	SIZE	MATERIAL
CEP	8606017659068	Universal	Polypropylene

## PROTECTIVE MASK WITH FILTER 10/1



- Purpose: For the protection of respiratory organs from dust and similar airborne particles
- With valve for easier breathing

CODE	BARCODE	SIZE	PACKAGE
ZMF	8606007992182	Universal	15 pcs

## OVERALL PROTECTIVE



- Purpose: For protection in car painting and wall painting works
- Protective overall with a hood

CODE	BARCODE	MATERIAL	COLOR
ZOXL	8606007992212	Polypropylene	White
ZOXXL	8606007992229	Polypropylene	White

## PROTECTIVE MASK



- Purpose: For the protection of respiratory organs from dust and similar airborne particles
- Simple, single-layer mask
- It does not protect against chemical fumes and harmful aerosols

CODE	BARCODE	SIZE	PACKAGE
ZM	8606007992168	Universal	50 pcs

**KNEE PADS WITH GEL**

- Purpose: Knee protection pads used for any floor tiling project
- Knee pad with soft gel
- Perforated neoprene lining for protection against moisture
- Constructed by heavy-duty 600D polyester fabric
- Elastic upper straps with fasteners for quick grip

CODE	BARCODE	SIZE	MATERIAL
KG1	8606017659259	Universal	Rubber / Canvas / Gel

**KNEE PADS-RUBBER**

- Purpose: Knee protection pads used for any floor tiling project, recommended for parquet and ceramic workers and tilers
- Improved rubber straps adjust quickly for a perfect grip every time
- The inner lining of the pillows and the knee pads in the foam absorbs shocks
- Made according to standard EN 14404: 2010.

CODE	BARCODE	SIZE	MATERIAL
K	8606007990935	Universal	Polyurethane

**KNEE PADS**

- Purpose: Knee protection pads for any floor tiling project
- Recommended for parquet and ceramic workers and tilers
- A laminated inner sponge provides extra comfort
- The uniquely designed and hard mask protects the knees from sharp points
- Made according to the standard SRPS EN 14404: 2010

CODE	BARCODE	SIZE	MATERIAL
KO	8606007990072	Universal	Polypropylene / Fabric

**EVA KNEE PAD INSERTS**

- Purpose: EVA knee pads inserts for workwear serve as knee protection during flooring work, recommended for parquet and ceramic workers and tilers
- Easy to carry and do not bother while moving and working
- They are made of EVA foam material

CODE	BARCODE	MATERIAL	DIMENSION
SKUEVA	8605043401894	EVA foam	21.5x15.5x1.5cm.



## HEARING PROTECTORS



- Purpose: Hearing protectors for noise protection
- Comfortable ear-flaps provides long lasting and uninterrupted use
- Noise reduction- 27dB
- Made in accordance with standard EN 352-1:2008

CODE	BARCODE	SIZE	MATERIAL
SZU	8606007993493	Universal	ABS

## WELDING MASK



- Purpose: Protective welding mask for welding work
- The wide field of view and the head frame enable comfortable hands-free work
- Manufactured in accordance with EN 175 2008 standard

CODE	BARCODE	SIZE	MATERIAL
ZMZN	8606007993448	Universal	Polypropylene

## ROLLING KNEE PADS



- Purpose: Rolling knee pads allow you to be mobile and protect your knees at the same time, perfect for all flooring works
- The frame is made of high-quality plastic with cushions to protect the knees during the work
- The maximum weight capacity is 130kg with five wheels for easy maneuvering
- Reduced discomfort, back and knee pain

CODE	BARCODE	DIMENSION	MATERIAL
SKT	8605043402754	50cmx25.5cmx 8.5cm	PP plastic

## REPLACEMENT GLASS FOR WELDING MASK



- Purpose: Spare replacement glass for welding mask
- Recommended for arc welding
- Dimming DIN 11

CODE	BARCODE	MATERIAL	SIZE
SMZ	8606007993486	Glass	110x90mm

**PROTECTIVE GLASSES BASIC**

- Purpose: Protective glasses for welding work and industrial use
- Wide filed of view
- Protection from small flying particles (dust, sparks)
- Manufactured in accordance with EN166:2008 standard

CODE	BARCODE	MATERIAL	COLOR
ZNBT	860607992458	Polycarbonate	Transparent
ZNBD	8606007992465	Polycarbonate	Black

**PROTECTIVE GLASSES LIGHT**

- Purpose: Protective glasses for welding work and industrial use
- Small mass frame
- Protection from small flying particles (dust, sparks)
- Manufactured in accordance with EN166:2008 standard

CODE	BARCODE	MATERIAL	COLOR
ZNLD	8606007993431	Polycarbonate	Black
ZNLT	8606007993318	Polycarbonate	Transparent
ZNLY	8606007993325	Polycarbonate	Yellow

**PROTECTIVE GLASSES WIDE**

- Purpose: Protective glasses Wide for industrial use
- Wide field of view
- Protection from small flying particles (dust, sparks)
- Manufactured in accordance with EN166:2008 standard

CODE	BARCODE	MATERIAL	COLOR
ZNWT	8606007992656	Polycarbonate	Transparent
ZNWX	8606007992717	Polycarbonate	Yellow

## PROTECTIVE GLASSES PROFESSIONAL



- Protective glasses professional for industrial use
- Wide field of view
- Protection from small flying particles (dust, sparks)
- Manufactured in accordance with EN166:2008 standard

CODE	BARCODE	MATERIAL	COLOR
ZNP	8606007992441	Polycarbonate	Transparent

## PROTECTIVE GLASSES



- Purpose: Protective glasses for welding work and industrial use
- Wide field of view
- Protection from small flying particles (dust, sparks)
- Manufactured in accordance with EN166:2008 standard

CODE	BARCODE	MATERIAL	COLOR
ZN	8606007992199	Polycarbonate	Transparent



# **GARDEN**

# PROGRAM

---

- **HOSES AND WINDERS**
- **COUPLINGS, SPRINKLERS  
AND ADAPTERS**
- **GARDEN TOOLS**

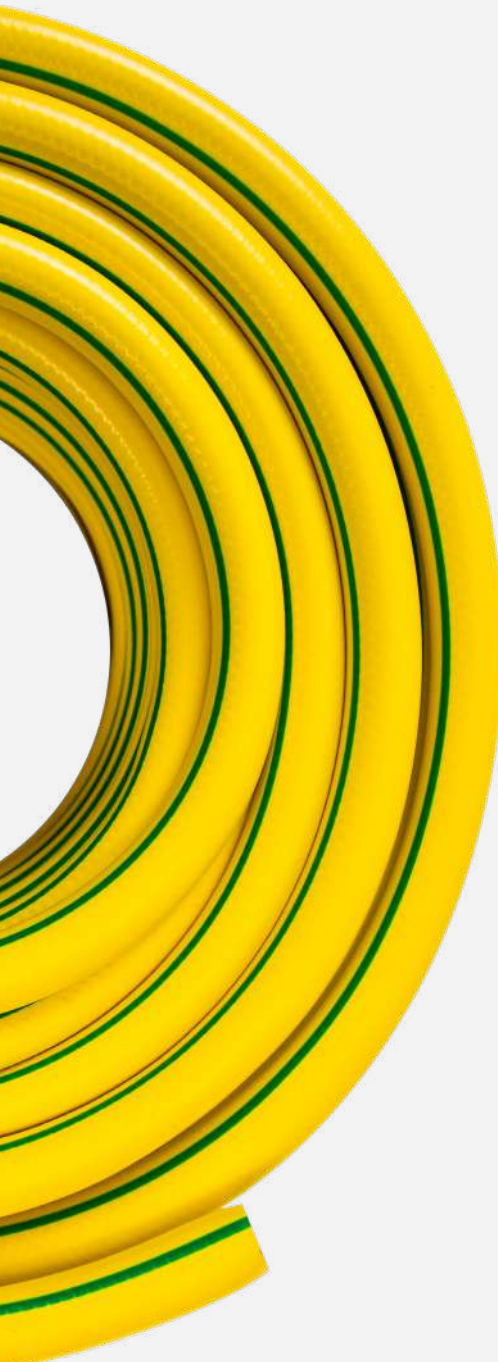

# HOSES AND WINDERS

## EXPANDABLE HOSE



- Purpose: For use in gardening
- The expandable hose is made of polyester fiber with higher pressure resistance and longer life service
- Extends 3x under the pressure and returns to original size after water flow stops
- The package contains 1" and 3/4" tap connector, tap adaptor, spray gun with 6-patterns and a 5m hose
- Work pressure up to 4bars, burst pressure 12 bars
- UV and twist resistant
- Material: inner hose latex, outer hose polyester



CODE	BARCODE	DIAMETER	LENGTH	COLOR
GBCYC15	8606017651840	Ø1/2"	15m	Red
GBCYP15	8606017651833	Ø1/2"	15m	Blue
GBCYZ15	8606017651857	Ø3/4"	15m	Green

## DRIPPING HOSE



- Purpose: For economical and precise irrigation, saves up to 70% of water by reducing evaporation, and can be used under very low pressure with a set of couplings
- Can be continued and placed in rows
- Installation: overground or underground (recommended depth 15-20 cm)
- Water consumption depending on the pressure- 1-10 lit/h, per 1m



CODE	BARCODE	DIAMETER	LENGTH
GCN1215	8606107185552	ø1/2"	15m

## GARDEN HOSE ANTI-TWIST



- Purpose: For gardening, irrigation, and drainage
- Pressure resistance up to 32 bar
- Temperature resistance from -20°C to +60°C
- The inner layer resistant to algae
- The hose is UV resistant with no cadmium and no barium
- Made of high quality and reinforced with double layer
- Extremely flexible and resistant to kinks and twists



CODE	BARCODE	DIAMETER	LENGTH
GBCAT1225	8606107185521	ø1/2"	25m

**GARDEN HOSE SOFT**

- Purpose: Garden hose soft is a flexible hose for gardening, irrigation, and drainage work
- Four-layer hose, UV- resistant, with polyester-reinforced armature mesh
- Inner layer resistant to algae
- Work pressure up to 30 bar
- Extremely flexible with a very soft surface
- Temperature resistant can be used from -10° to + 50°C
- Material: plasticized PVC



CODE	BARCODE	DIAMETER	LENGTH
GBCF1225	8606107185538	Ø1/2"	25m

**GARDEN HOSE BLUE**

- Purpose: For use in gardening, irrigation, and drainage
- Made of non-toxic PVC material
- Working pressure is maxed 3 bar

CODE	BARCODE	DIAMETER	LENGTH
GBC12P50	8606017651161	Ø1/2"	50m



## GARDEN HOSE ECONOMIC



- Garden hose economic is extremely flexible hose for gardening, irrigation and drainage
- Three-layer hose
- UV- resistant, with polyester reinforced armature mesh
- Work pressure up to 24 bar
- Inner layer resistant to algae
- Temperature resistant: from -10° to + 50°C



CODE	BARCODE	DIAMETER	LENGTH
GBCE1220	8606007999327	Ø1/2"	20m
GBCE1230	8606007999334	Ø1/2"	30m
GBCE1250	8606017657606	Ø1/2"	50m
GBCE3420	8606007999341	Ø3/4"	20m
GBCE3430	8606007999358	Ø3/4"	30m

## GARDEN HOSE PLUS



- Garden hose economic is an extremely flexible hose for gardening, irrigation, and drainage
- Three-layer hose
- UV- resistant
- With polyester reinforced armature mesh
- Inner layer resistant to algae
- Work pressure up to 40 bar
- Extremely flexible and temperature resistant
- Temperature resistant: from -10° to + 50°C
- Material: Plasticized PVC



CODE	BARCODE	DIAMETER	LENGTH
GBCP1225	8606007999365	Ø1/2"	25m
GBCP1250	8606017657613	Ø1/2"	50m
GBCP3425	8606007999372	Ø3/4"	25m

**GARDEN HOSE TRANSPARENT**

- Purpose: For gardening, irrigation and drainage
- Exceptionally flexible hose
- Working pressure: up to 2 bar
- Made of non-toxic PVC material

CODE	BARCODE	DIAMETER	LENGTH
GBC12T50	8606017651178	Ø1/2"	50m
GBC1T50	8606017653752	Ø1"	50m
GBC34T50	8606017653745	Ø3/4"	50m

**HOSE REEL 45m**

- Purpose: For hose storage, easily portable with wheels
- Capacity of 45m of 1/2" hose

CODE	BARCODE	CAPACITY	ADAPTER
GMC45	8606017654704	45m - 1/2"	Male "quick connect"

## HOSE GUIDE



- Purpose: Garden hose guide is used when watering the lawn or garden, by sticking into the ground and hosing through the rotary rollers

CODE	BARCODE	TYPE	MATERIAL
GVC	8606017654742	Puncture	ABS / Steel

## WALL MOUNTED HOSE REEL



CODE	BARCODE	MATERIAL
GMCZ	8606017654759	ABS

## PLASTIC PULSATING SPRINKLER + 3/4" TOOL ADAPTOR



- Purpose: Plastic rotating watering irrigation sprinkler for surface controlled watering irrigation
- Made of high quality ABS plastic

CODE	BARCODE	ADAPTER
GPPU	8606007998948	Male "quick connect", 3/4"

## PLASTIC BASE+PULSATING SPRINKLER + 3/4" TOOL ADAPTOR



- Purpose: For surface controlled watering irrigation
- Made of high quality ABS plastic
- It can be above-ground (an intermediate part of the irrigation system) or in-ground (the last part of the irrigation system)

CODE	BARCODE	ADAPTER
GPPB	8606007998931	Male "quick connect", 3/4"

## WATER WAND, 6-PATTERN, 28" WITH 3/4" TOOL ADAPTOR



- Purpose: For spraying surfaces with 6 operating modes and a switch to stop the flow of water
- It has 6 patterns for better watering adjustment to different workloads and surface area
- Ergonomic grip handle, coated with soft anti-skid rubber, can provides max grip even with wet hands
- Made of high quality ABS plastic

CODE	BARCODE	LENGTH	ADAPTER
GSP6	8606007998917	70cm	Male "quick connect"

## TAP ADAPTOR 1/2" & 3/4"



- Purpose: for connecting a faucet 3/4" tap or 1/2" tap to a hose 3/4" tap
- Made of high quality ABS plastic

CODE	BARCODE	ENTRANCE	EXIT
GASP34	8606017654735	Female 1/2" ili 3/4"	Male "quick connect"

## PLASTIC HOSE MENDER 1/2"



- Purpose: Plastic hose mender made for two garden hose connection or for joining two pieces of one hose obtained once it is cut at the leaking point
- Made of high quality ABS plastic

CODE	BARCODE	ENTRANCE	EXIT
GSP12	8606007999006	1/2"	1/2"

## PLASTIC HOSE QUICK CONNECTOR WITH WATER STOP 1/2"



- Purpose: For quick connection of hoses and adapters
- Automatic stop of the water flow in case of separation with the hose
- Material: ABS plastic

CODE	BARCODE	ENTRANCE	CLOSURE TYPE
GSBA12	8606007998993	Female 1/2" "quick connect"	Automatic
GSBA34	8606007998986	Female 3/4" "quick connect"	Automatic

### TAP ADAPTOR 3/4" & 1" REDUCER



- Purpose: For connecting 3/4" or 1" inlet tap and the 1/2" or 3/4" hose outlet
- Made of high quality ABS plastic

CODE	BARCODE	ENTRANCE	EXIT
GASP1	8606007999068	Female 3/4" or 1"	Male "quick connect"

### PLASTIC 2-WAY SNAP-IN COUPLING



- Purpose: Plastic garden hose coupling for garden hose and quick connector connection
- Made of high quality ABS plastic

CODE	BARCODE	EXIT
GSD	8606007999051	Male 2 way "quick connect"

### PLASTIC HOSE MENDER 3/4"



- Purpose: For connecting two 3/4" hoses
- Made of high quality ABS plastic

CODE	BARCODE	ENTRANCE	EXIT
GSP34	8606007999037	3/4"	3/4"

### PLASTIC Y SNAP-IN COUPLING



- Purpose: Plastic Y Snap-In coupling, garden hose connector with 2 or 3 male connectors

CODE	BARCODE	EXIT
GSY	8606007999044	Male "quick connect"

### PLASTIC HOSE QUICK CONNECTOR



- Purpose: 1/2" plastic hose quick connector female for quick garden hose and adapter connection
- Made of high quality ABS plastic

CODE	BARCODE	ENTRANCE	CLOSURE TYPE
GSP12	8606007999020	Female 1/2" "quick connect"	Flowing
GSP34	8606007999013	Female 3/4" "quick connect"	Flowing

### HOSE MENDER 1/2"-3/4"



- Purpose: Hose mender for easy and quick 1/2" and 3/4" hoses connection
- Made of high-quality ABS plastic

CODE	BARCODE	ENTRANCE	EXIT
GSP1234	8606017654711	1/2" or 3/4"	1/2" or 3/4"

**WO-WAY SNAP-IN COUPLING WITH SHUT-OFF VALVE 3/4"**

- Purpose: For connecting two hoses to the water supply
- Consists of the inlet 3/4" adapter with female thread and two male outlet 3/4" quickly connecting adapters with on/off valves
- It is used together with quick connectors with valves
- Made of high quality ABS plastic

CODE	BARCODE	ENTRANCE	EXIT
GADV34	8606007998962	Female 3/4"	Male 3/4"

**PLASTIC 2-WAY HOSE CONNECTOR, 3/4" WITH SHUT-OFF**

- Purpose: 3/4" plastic 2-way hose connector with shut-off valve for 2 garden hoses and water supply connection
- Consists of inlet 3/4" connector with female thread and two outlet 3/4" male threads with shut-off valves
- Made of high quality ABS plastic

CODE	BARCODE	ENTRANCE	EXIT
GSPV34	8606007998979	Female 3/4"	Male 3/4"

**SPRAY SET, 6 PIECES**

- Purpose: For spraying surfaces with 9 operating modes
- The handle is rubber-covered and ergonomically shaped
- Includes 1/2" quick coupler, aqua stop 1/2" quick coupler, 3/4" and 1" male adapters
- It has a metal protected plate for jet control

CODE	BARCODE	EXIT
GPS6	8606104807136	Male "quick connect" 3/4"

**TWIST NOZZLE SET, 5 PIECES**

- Purpose: Garden hose nozzle connector set 5pcs for lawn and garden watering
- Consists of five elements: hose nozzle, faucet adapter 3/4" and 1/2", male tap adapter with quick connector with aqua stop valve, female tap adapter with quick connector

CODE	BARCODE	EXIT
GSSM5	8606007999082	Male "quick connect"

### TRIGGER NOZZLE 9-PATTERN + 3/4" TOOL ADAPTOR



- Purpose: 9 adjustable watering patterns, can be used for watering plants, washing cars, cleaning yards and showering pets, meet all your different watering need
- Ergonomic grip trigger, coated with soft anti-skid rubber, can provides max grip even with wet hands
- Made of high-impact resistant ABS plastic body

CODE	BARCODE	EXIT
GPP9	8606007998894	Male "quick connect" 3/4"

### ADJUSTABLE 3-WAY TRIGGER NOZZLE + 3/4" TOOL ADAPTOR



- Purpose: For spraying surfaces with 3 operating modes
- The handle is rubber-covered and ergonomically shaped
- Includes 3/4" male adapter
- It has a metal protected plate for jet control

CODE	BARCODE	ENTRANCE
GPP3	8606007998900	Male "quick connect" 3/4"

### SNAP-IN TWIST NOZZLE 5"



- Purpose: For spraying, with water jet adjustment by simply turning the nozzle tip
- 13cm/5" garden hose nozzle made of high quality ABS plastic
- Adjustable head from wide cone to a strong jet

CODE	BARCODE	LENGTH	ENTRANCE
GM13	8606007999075	13cm	Male "quick connect"

### OSCILLATING SPRINKLER WITH 18 HOLES + 3/4" ADAPTOR



- Purpose: For irrigating lawns
- Oscillating sprinkler with 18 brass nozzles on a plastic housing Includes 3/4" male adapter
- The gear mechanism drives the sprinkler from 10 to 180 degrees on either side
- It covers an area of up to 35 m<sup>2</sup>

CODE	BARCODE	ENTRANCE
GPO18	8606007998924	Male "quick connect" 3/4"

# GARDEN TOOLS



## PLASTIC SHOVEL BLACK - REINFORCED PLATE



- Purpose: For clearing snow, reinforced with sheet metal
- Plastic shovel 40x40cm black sheet metal reinforced plate for havier and harder snow easy collection, made from quality PVC
- Durable on low temperatures.

CODE	BARCODE	DIMENSION	MATERIAL
LPCO	8606107688343	40x40cm	Polyethylene

## PLASTIC SHOVEL BLACK



- Purpose: For clearing snow
- Plastic shovel 40x40cm for havier and harder snow easy collection
- Made from quality PVC
- Durable on low temperatures

CODE	BARCODE	DIMENSION	MATERIAL
LPC	8606007992731	40x40cm	Polyethylene



## HEDGE SHEARS



- Purpose: For hedge cutting
- Wooden handle hedge shears for cut and trim hedge
- High quality steel blades for long life service and comfortable use

CODE	BARCODE	LENGTH	CUTTING LENGTH
MZO	8606007991390	50.4cm	18cm

## HANDLE FOR SHOVEL, WOODEN



- Purpose: For snow shovel
- Wooden handle for snow shovel 120cm, made of high quality beech wood with fine surface finish to provide better grip and comfort

CODE	BARCODE	LENGTH	MATERIAL
DLP	8606007996173	120cm	Beech tree

## TARPAULIN PROTECTIVE SHEET 2X3M



- Purpose: Tarpaulin protective sheet is a multi-purpose cover made of PE Tarpaulin, ideal for a variety of purposes in the household
- It can be used in various applications: cover boats, cars, equipment and machinery stored outside, cover painted areas, camping, etc.
- Water resistant and weatherproof
- Aluminum rings on every 1m
- Outer edges reinforced with pp rope sealed in hem for extra strength
- 80g / m2 thickness



CODE	BARCODE	DIMENSION	COLOR
CU2X3	8606106732375	2x3m	Blue
CU3X4	8606106732382	3x4m	Blue
CU3X5	8606017659945	3x5m	Blue
CU4X5	8606106732399	4x5m	Blue
CU4X6	8606017659952	4x6m	Blue
CU5X6	8606017659969	5x6m	Blue
CU5X8	8606017659976	5x8m	Blue
CU6X8	8606106732405	6x8m	Blue
CU6X10	8606017659983	6x10m	Blue

## BACKPACK FRUIT SPRAYER 12L



- Purpose: Garden back fruit sprayer for fruits and vegetables, made of high quality plastic resistant to all herbicides and insecticides
- Light and easy to use, ideal for spraying water, herbicides, pesticides, etc.
- With a high resistance pressure chamber with high capacity
- The charging ladder is large with a drip tray
- Can be adjusted for use with both the left and right hand by simply switching pump handles
- The package contains a 4 hole sprayer, shower sprayer, conical sprinkler and double conical sprinkler

CODE	BARCODE	VOLUME	MATERIAL
PZVL12	8606017651901	12 l	Polyethylene

## FRUIT SPRAYER



- Purpose: Fruit garden sprayer for fruits and vegetables
- Made of high quality plastic, resistant to all herbicides and insecticides
- Light and easy to use
- Ideal for spraying water, herbicides, pesticides etc.
- With adjustable sprinkler, ON-OFF switch with locking option

CODE	BARCODE	VOLUME	MATERIAL
PZV5	8605043407162	5 l	Polyethylene
PZV8	8606017651888	8 l	Polyethylene

## SPRAYER FOR FLOWERS 1.5L



- Purpose: Garden sprayer, made of high quality plastic
- Tank volume 1.5l
- Designed for plant and flower misting and other spray uses, herbicides or pesticides
- Ideal for household or garden use
- Lightweight and easy to use

CODE	BARCODE	VOLUME	MATERIAL
PZC1.5	8606017658566	1.5 l	Polyethylene

## TRIMMER LINE ROUND



- Purpose: For mowing and aerating lawns
- String trimmer line round is made of high quality plastic
- The length of the string line is 15m

CODE	BARCODE	DIAMETER	LENGTH
STO1615	8606017656029	Ø1.6mm	15m
STO2015	8606017656036	Ø2.0mm	15m
STO2415	8606017656043	Ø2.4mm	15m
STO2715	8606017656050	Ø2.7mm	15m
STO3015	8606017657460	Ø3.0mm	15m

## TRIMMER LINE SQUARE



- Purpose: For mowing thicker grass and weeds
- String trimmer line square is made of high quality plastic
- The length of the string line is 15m

CODE	BARCODE	DIAMETER	LENGTH
STK2415	8606017656067	2.4mm	15m
STK2715	8606017656074	2.7mm	15m
STK3015	8606017657477	3.0mm	15m

## TRIMMER HEAD TAP'N'GO M10X1.25 109mm STANDARD PLUS



### TAP'N'GO SYSTEM

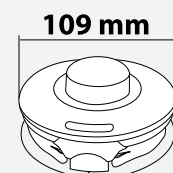
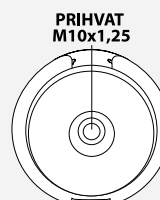
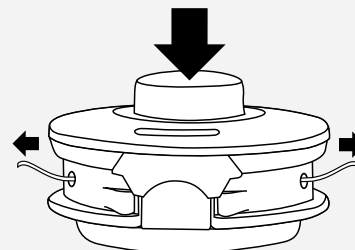

- Purpose: For trimmers on electric and petrol drive with M10x1.25 shank
- Head trimmer replacement with diameter 109 mm
- Compatible with electric and gasoline trimmer with shank M10x1.25
- Tap'n'go system allows easy and quick replacement of the worn-out string trimmer line without interrupting the trimmer operation
- The trimmer head is made of high quality plastic for a longer life service and greater durability

CODE	BARCODE	DIAMETER	TIP
TGM10X1.25SP	8606017656081	Ø109mm	M10x1.25



# HOME PROGRAM

---

- MOSQUITO NETS
- ROPES AND TIES
- SEALING STRIPES
- EXTENSION CORDS
- CLEANING EQUIPMENT





# MOSQUITO NETS

## MOSQUITO NET



- Purpose: Mosquito net for preventing entry of insects into objects
- Produced by special technology, combining glass thread and silicone mesh application
- The mesh obtained is strong enough and elastic with extended lifetime
- Resistance to mechanical and thermal loads has been increased
- Packed in rolls of 30 m, width 100 cm

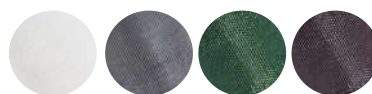

CODE	BARCODE	WIDTH	LENGTH	COLOR
MKB1	8606007995527	1m	30m	White
MKB1.2	8606007995534	1.2m	30m	White
MKB1.5	8606007995541	1.5m	30m	White
MKBR1	8606007995589	1m	30m	Brown
MKBR1.2	8606007995596	1.2m	30m	Brown
MKBR1.5	8606007995602	1.5m	30m	Brown
MKS1	8606007996470	1m	30m	Gray
MKS1.2	8606007996487	1.2m	30m	Gray
MKS1.5	8606007996494	1.5m	30m	Gray
MKZ1	8606007995558	1m	30m	Green
MKZ1.2	8606007995565	1.2m	30m	Green
MKZ1.5	8606007995572	1.5m	30m	Green

## MAGNETIC DOOR CURTAIN



- Purpose: Magnetic mosquito net for insect entry protection
- Ensures fresh airflow through mesh
- Contains narrow self-adhesive tape placed on the door frame
- Two curtain parts connected with special magnets for convenient and easy passing through after which it closes automatically
- It can be easily placed and removed for easy maintenance and seasonal use



CODE	BARCODE	WIDTH	LENGTH	COLOR
MZPIBE	8606106732122	100cm	210cm	White
MZPICR	8606104807815	100cm	210cm	Black

## SELFADHESIVE INSECT NET

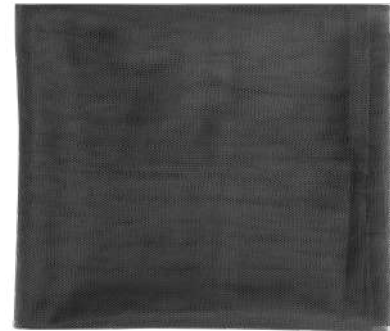

- Purpose: Self-adhesive insect net for protection from insects
- With a narrow self-adhesive tape placed on the door or window frame
- Mosquito net is easily placed on the tape
- Self-adhesive net can be easily placed and removed, for easier maintenance and seasonal use



CODE	BARCODE	WIDTH	LENGTH	COLOR
SMPIBE130	8606007999815	100cm	130cm	White
SMPIBE150	8606007999822	130cm	150cm	White
SMPIBR130	8606007999853	100cm	130cm	Brown
SMPIBR150	8606007999860	130cm	150cm	Brown
SMPICR130	8606007999839	100cm	130cm	Black
SMPICR150	8606007999846	130cm	150cm	Black
SMPISI130	8606017651703	100cm	130cm	Gray
SMPISI150	8606017651864	130cm	150cm	Gray

# ROPES AND TIES



## PLASTIC TIE WHITE



- Purpose: Plastic tie for different items binding and tying
- Made of special material Nylon 66, which makes them strong and very flexible at the same time with a lot lower degree of erosion than ordinary plastic

CODE	BARCODE	WIDTH	LENGTH	PACKAGE
VB2.5X150M	8606107263946	2.5mm	150mm	100pcs
VB3.6X200M	8606107263977	3.6mm	200mm	100pcs
VB4.8X200M	8606107387000	4.8mm	200mm	100pcs
VB4.8X300M	8606107387024	4.8mm	300mm	100pcs
VB4.8X380M	8605043407940	4.8mm	380mm	100pcs
VB4.8X500M	8606107659693	4.8mm	500mm	50pcs
VB8.0X300M	8605043407957	8.0mm	300mm	100pcs

## PLASTIC TIE BLACK



- Purpose: Plastic tie for different items binding and tying
- Made of special material Nylon 66, which makes them strong and very flexible at the same time with a lot lower degree of erosion than ordinary plastic

CODE	BARCODE	WIDTH	LENGTH	PACKAGE
VC2.5X150M	8606107263953	2.5mm	150mm	100pcs
VC3.6X200M	8606107263984	3.6mm	200mm	100pcs
VC4.8X200M	8606107387017	4.8mm	200mm	100pcs
VC4.8X300M	8606107387031	4.8mm	300mm	100pcs
VC4.8X380M	8605043407964	4.8mm	380mm	100pcs
VC4.8X500M	8606107659709	4.8mm	500mm	50pcs
VC8.0X300M	8605043407971	8.0mm	300mm	100pcs



## POLYESTER ROPE



- Purpose: Polyester rope is a universal synthetic rope for tying and tightening wide use
- Made from high quality polyester, resistant to atmospheric influences and sunlight

CODE	BARCODE	DIAMETER	LENGTH
PESK3	8605043401887	Ø3mm	200m
PESK4	8606107185996	Ø4mm	500m
PESK5	8606107263007	Ø5mm	400m
PESK6	8606107263014	Ø6mm	400m
PESK8	8606107263021	Ø8mm	200m
PESK10	8606107263038	Ø10mm	100m
PESK12	8606107263045	Ø12mm	100m
PESK14	8606107263052	Ø14mm	100m

## ROPE



- Purpose: For all tying, packaging and decoration needs
- Suitable for most users
- Made of natural hemp fiber
- Resistant, long-lasting with a quality finishing

CODE	BARCODE	THICKNESS	WEIGHT
K04200	8606007996098	0.4/2	200g
K04500	8606007996104	0.4/2	500g
K09100	8606007996111	0.9/2	100g
K09500	8606007996128	0.9/2	500g
K25100	8606007996135	2.5/2	100g
K25200	8606007996142	2.5/2	200g
K2550	8606017651536	2.5/2	50g
K25500	8606007996159	2.5/2	500g

## ROPE WITH SANITARY CERTIFICATE

- Purpose: For the needs of all tying, packaging, decorating operations; due to sanitary certification suitable for meat processing industries
- Durable, long-lasting, with a quality finish
- Sanitary rope of premium quality

CODE	BARCODE	THICKNESS	WEIGHT
K04200S	8606107779423	0.4/2	200g
K04500S	8606107779430	0.4/2	500g
K09100S	8606107779447	0.9/2	100g
K09500S	8606107779454	0.9/2	500g
K25100S	8606107779461	2.5/2	100g
K25200S	8606107779478	2.5/2	200g
K25500S	8606107779485	2.5/2	500g
K2550S	8606017651611	2.5/2	50g

# SEALING STRIPES

## SEAL STRIP E - PROFILE 6m



- Purpose: For filling cavities in doors and windows
- Stops flow of air, dust, heat, cold and noise
- Dimensions of "E" profile: 9 x 4mm
- Cavity dimensions: 1- 3.5mm

CODE	BARCODE	LENGTH	MATERIAL	COLOR
EBE6	8606007998269	2x3m	EPDM	White
EBR6	8606007998276	2x3m	EPDM	Brown

## SEAL STRIP E - PROFILE 50m

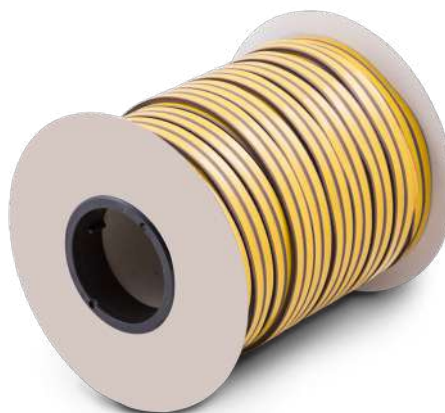

- Purpose: For filling cavities in doors and windows
- Stops flow of air, dust, heat, cold and noise
- Dimensions of "E" profile: 9 x 4mm
- Cavity dimensions: 1- 3.5mm

CODE	BARCODE	LENGTH	MATERIAL	COLOR
DTEBE	8606007996296	2x50m	EPDM	White
DTEBR	8606007996289	2x50m	EPDM	Brown

**SEAL STRIP P - PROFILE 6m**

- Purpose: For filling cavities in doors and windows
- Stops flow of air, dust, heat, cold and noise
- Dimensions of "P" profile: 9 x 5.5mm
- Cavity dimensions: 2- 5mm

CODE	BARCODE	LENGTH	MATERIAL	COLOR
PBE6	8606007998283	2x3m	EPDM	White
PBR6	8606007998290	2x3m	EPDM	Brown

**SEAL STRIP D - PROFILE 6m**

- Purpose: For filling cavities in doors and windows
- Stops flow of air, dust, heat, cold and noise
- Dimensions of "D" profile: 9 x 6mm
- Cavity dimensions: 3- 5mm

CODE	BARCODE	LENGTH	MATERIAL	COLOR
DBE6	8606007998306	2x3m	EPDM	White
DBR6	8606007998313	2x3m	EPDM	Brown

**SEAL STRIP P - PROFILE 50m**

- Purpose: For filling cavities in doors and windows
- Stops flow of air, dust, heat, cold and noise
- Dimensions of "P" profile: 9 x 5.5mm
- Cavity dimensions: 2- 5mm

CODE	BARCODE	LENGTH	MATERIAL	COLOR
DTPBE	8606007996319	2x50m	EPDM	White
DTPBR	8606007996302	2x50m	EPDM	Brown

**SEAL STRIP D - PROFILE 50m**

- Purpose: For filling cavities in doors and windows
- Stops flow of air, dust, heat, cold and noise
- Dimensions of "D" profile: 9 x 6mm
- Cavity dimensions: 3- 5mm

CODE	BARCODE	LENGTH	MATERIAL	COLOR
DTDBE	8606007996272	2x50m	EPDM	White
DTDBR	8606007996265	2x50m	EPDM	Brown

**ADHESIVE ANTI-SLIP TAPE TRANSPARENT**

- Purpose: Anti-slip, specially designed for wet, sloping and extremely slippery areas
- Mounted on slippery surfaces
- Resistant to atmospheric influences

CODE	BARCODE	WIDTH	LENGTH	COLOR
GT6T	8606104807396	25mm	5m	Transparent

**ADHESIVE ANTI-SKID TAPE**

- Purpose: Anti-slip, specially designed for wet, sloping and extremely slippery areas
- Mounted on slippery surfaces
- Resistant to atmospheric influences

CODE	BARCODE	WIDTH	LENGTH	COLOR
GT5B	8606104807372	25mm	5m	Black
GT5W	8606104807389	25mm	5m	White
GT5T	8606104807662	25mm	5m	Transparent
GT5YB	8606104807655	25mm	5m	Yellow / Black

**KITCHEN SINK STRIP IN PVC**

- Purpose: Prevents the passage of water between the wall and the sink
- Easy installation with light pressure
- No need for gluing, easy to remove

CODE	BARCODE	LENGTH	COLOR
GT14	8606104807433	130cm	White

**ADH SEAL FOR BATHTUBS SHOWER FLOORS AND WASHBASINS**

- Purpose: Prevents the penetration of water, intended for bathtubs, showers and floors in the bathroom

CODE	BARCODE	WIDTH	LENGTH
GT140	8606104807358	40mm	2,4m
GT122	8606104807341	22mm	2,4m

## ADHESIVE FOAM DRAUGHT EXCLUDER FOR DOORS AND WINDOWS



- Purpose: Prevents the penetration of water, intended for bathtubs, showers and floors in the bathroom
- Adhesive seal for bathroom

CODE	BARCODE	WIDTH	LENGTH
GT1012	8606104807402	12mm	10m

## DOOR SELF-ADHESIVE PLASTIC BRUSH SEAL STRIP



- Purpose: Reduces air flow and the passage of dust and dirt, installed at the bottom of the door
- Self-adhesive PVC molding with brush

CODE	BARCODE	LENGTH	COLOR
GT12B	8606104807419	1m	Brown
GT12P	8606104807693	1m	Bor
GT12W	8606104807426	1m	White





# EXTENSION CORDS

## RETRACTABLE CABLE REEL



- Purpose: Extended flexible cable reel 10m (conductor cross section 3x1.5mm) with four sockets and child protect system for indoor use
- With load break switch for protection
- Max. load capacity: 900W(3.9A) 2300W(10A) 230V.

 Max: 900W 250V~/3.9A  
 Max: 2300W 250V~/10A





CODE	BARCODE	SOCKETS	CABLE
EMT10	8606107263533	4	10m

## EXTENSION CABLE REEL



- Purpose: Extended flexible cable reel 25m (cross section 3x1.5mm) with four sockets and child protect system for indoor use
- Without load break switch.
- Max. load capacity: 1000W(4.35A) 3000W(13A) 230V

 Max: 1000W 250V~/4.3A  
 Max: 3000W 250V~/13A



CODE	BARCODE	SOCKETS	CABLE
EMT25	8606107387840	4	25m
EMT50	8606107387857	4	50m

## EXTENSION CABLE 3 SOCKETS



- Extended flexible cable 3 sockets (cross section 3x1.5mm)
- Three sockets and child protect system for indoor use
- Maximum load capacity: 3680W 250V 16A
- Without load break switch

CODE	BARCODE	SOCKETS	CABLE
EPK3X1.4	8606107263755	3	1.4m
EPK3X3	8606107263762	3	3m
EPK3X5	8606107263779	3	5m

## EXTENSION CABLE 5 SOCKETS



- Extended flexible cable 5 sockets (cross section 3x1.5mm)
- With five sockets and child protect system for indoor use
- Maximum load capacity: 3680W 250V 16A
- Without load break switch

CODE	BARCODE	SOCKETS	CABLE
EPK5X1.4	8606107263786	5	1.4m
EPK5X3	8606107263793	5	3m
EPK5X5	8606107263809	5	5m

EXTENSION CABLE WITH SWITCH  
3 SOCKETS

- Extended flexible cable 3 sockets (cross section 3x1.5mm)
- On/off switch and child protect system for indoor use
- Maximum Amperage 16A
- Voltage (volts) 250V
- Wattage 3680W

CODE	BARCODE	SOCKETS	CABLE
EPKP3X1.4	8606107263816	3	1.4m
EPKP3X3	8606107263823	3	3m
EPKP3X5	8606107263830	3	5m

EXTENSION CABLE WITH SWITCH  
5 SOCKETS

- Extended flexible cable 5 sockets (cross section 3x1.5mm)
- On/off switch and child protect system for indoor use
- Maximum Amperage 16A
- Voltage (volts) 250V
- Wattage 3680W

CODE	BARCODE	SOCKETS	CABLE
EPKP5x1.4	8606107263847	5	1,4m
EPKP5x3	8606107263854	5	3m
EPKP5x5	8606107263861	5	5m

### THREE AND FIVE WAY SOCKED WITH GROUND



- Purpose: For power supply, intended for users who want to replace the extension cord casing on their own
- Designed in such a way, that it is not necessary to open the casing, but only the part where the connections are located
- Connections are made by correctly arranging the phase, neutral and grounding wires to marked places
- Connect the portable socket only to a single-phase socket of the maximum specified voltage
- Max. load 16A, 250V, 3500W
- No switch

CODE	BARCODE	SOCKETS
EPP3	8606017651352	3
EPP5	8606017651369	5

### THREE AND FIVE WAY SOCKED WITH SWITCH AND GROUND



- Purpose: For power supply, intended for users who want to replace the extension cord casing on their own
- Designed in such a way, that it is not necessary to open the casing, but only the part where the connections are located
- Connections are made by correctly arranging the phase, neutral and grounding wires to marked places
- Connect the portable socket only to a single-phase socket of the maximum specified voltage
- Max. load 16A, 250V, 3500W
- With a switch

CODE	BARCODE	SOCKETS
EPP3P	8606017651628	3
EPP5P	8606017651635	5

### CONNECTING WIRES TO THE PC:

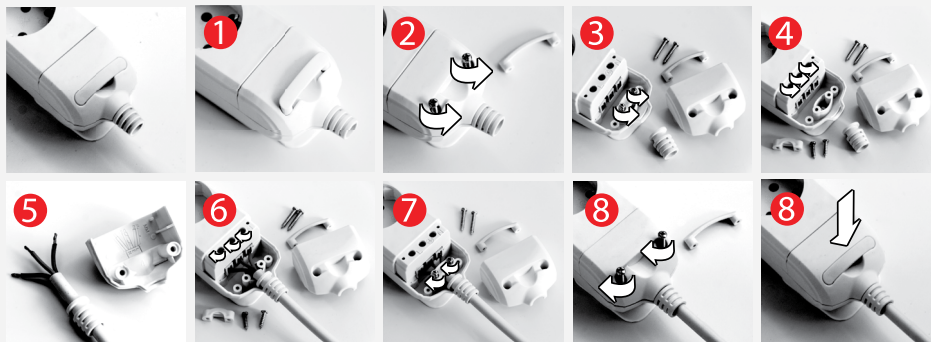

1. Remove the rubber screw protection
2. Unscrew the screws
3. Remove the protective terminal block
4. Unscrew and remove the cable fastener
5. Route the conductor through the grommet on the terminal block cover
6. Attach the unplugged conductor to the contact terminal, paying attention to the binding order (phase, ground, zero).
7. Tighten the conductor fixture and then replace the protective terminal block
8. Tighten the screws and replace the rubber guard



## EXTENSION CORD WITH SURGE PROTECTION 5 SOCKETS



Max: 3680W 16A 250V~



- Purpose: For supplying electricity from the socket to electrical appliances, indoors
- With child protection feature
- Max. load 16A, 250V, 3680W
- With a switch

CODE	BARCODE	SOCKETS	CABLE
EPKPZ5X1.4	8606017651291	5	1.4m
EPKPZ5X3	8606017651307	5	3m
EPKPZ5X5	8606017651314	5	5m

## EXTENSION CORD WITH SURGE PROTECTION 7 SOCKETS



Max: 3680W 16A 250V~



- Purpose: For supplying electricity from the socket to electrical appliances, indoors
- With child protection feature
- Max. load 16A, 250V, 3680W
- With a switch

CODE	BARCODE	SOCKETS	CABLE
EPKPZ7X1.4	8606017651321	7	1.4m
EPKPZ7X3	8606017651338	7	3m
EPKPZ7X5	8606017651345	7	5m

## SINGLE PORTABLE SOCKET



- Purpose: For use in household for electrical appliances that cannot be connected to an existing installations because of the distance, such as lawn mowers, power tools, lighting devices and other household appliances.
- Max. load 13A, 230V, 3000W
- Not intended for use in rain or wet areas

CODE	BARCODE	SOCKETS	CABLE
EJPP15	8606017659242	1	15m
EJPP20	8606017651710	1	20m
EJPP30	8606017651727	1	30m

## MAXIMUM POWER OF THE EXTENSION CABLE

Each electrical appliance must have the indicated power in watts, as this is the determinant used to calculate whether a particular appliance can be connected to the electrical outlet. Also, each extension cable must have an indication of how much current it can carry (with how many consumers it can load). If the extension cable is 3000 watts, it means that it can be connected to three consumers of 1000 watts or 30 consumers of 100 watts. Consumer forces always add up. The strength of each conductor decreases the longer the conductor is due to the resistance each material has to the flow of current, so the longer the conductor the greater the thickness of the conductor is required. The thickness of the conductors is indicated by the number of wires or wires, the thickness of the wires and their surface. All Beorol cables are 3x1.5mm<sup>2</sup> - where 3 indicates the number of wires, 1.5mm<sup>2</sup> cross-sectional area of each conductor. These dimensions are sufficient for extension cables up to 50m long.

**Max 1000W 230V~/4.3A**  
**Max 3000W 230V~/13A**



An additional "Child Protect" system can be seen on the sockets and is red. It provides protection if a foreign object is placed in the socket. If the cable is energized with this protection system, no circuit can form.

# CLEANING EQUIPMENT



## CLEANING BRUSH



- Purpose: For manual processing of surfaces and removal of small dirt
- Made of polypropylene fibers

CODE	BARCODE	MATERIAL	DIMENSION
RCD	8606007993189	Polypropylene / Wood	20x5.5cm

## SCRUBBING BRUSH WITH HANDLE



- Purpose: For manual processing of surfaces and removal of small dirt
- With wooden handle of 1.2m

CODE	BARCODE	WIDTH	BRISTLE LENGTH
RCSD	8606103238030	200mm	33mm

**FLOOR BRUSH, SYNTHETIC HAIR, 30cm**

- Purpose: Floor brush 30cm-synthetic hair manually cleaning surfaces and removing dirt

CODE	BARCODE	WIDTH	BRISTLE LENGTH
PPP30	8606103238047	30cm	45mm

**FLOOR BRUSH 30cm**

- Purpose: For manual cleaning of surfaces and removal of small dirt
- Made of polypropylene fibers

CODE	BARCODE	WIDTH	LENGTH DLAKE
PPD30	8606103238306	30cm	40mm

**STREET BROOM**

- Purpose: Road and floor stiff bristle brush for heavy duty cleaning of floors, roads, warehouses, parking lots, garage, construction site etc.
- 21mm screw thread for easy screw to broom handle

CODE	BARCODE	WIDTH	BRISTLE LENGTH
CPH40	8605043400385	400mm	85mm

**FLOOR BRUSH 60cm**

- Purpose: For manual cleaning of surfaces and removal of small dirt
- With wooden handle and thread angle
- Hair type: 100% Polypropylene

CODE	BARCODE	WIDTH	BRISTLE LENGTH
PPD60	8606103238245	600mm	40mm

## MANUAL BRUSH-NATURAL BRISTLE



- Purpose: Manual brush for manual fine dust surfaces cleaning
- Polypropylene bristle
- Handle made of beech wood.

CODE	BARCODE	LENGTH	BRISTLE LENGTH
PRD	8606103238320	390mm	44mm

## HANDLE FOR SCRUB BRUSH



- Purpose: For carpet washing brushes
- Long wooden handle is made of high quality beech wood with a good finish for easier and comfortable work

CODE	BARCODE	LENGTH	MATERIAL
DRCP	8606107185811	120cm	Wood

## PACKAGING BOX CARGO



- Purpose: Cardboard moving box cargo L for packing bulky items, clothes, transport, storage, movings, etc.
- Handles for easier carrying and pictograms for box content marking
- A class of five-ply cardboard

CODE	BARCODE	DIMENSION	LOAD CAPACITY
KZPCARGOL	8606017659549	60x38x25cm	25kg
KZPCARGOXL	8606017659556	65x35x37cm	35kg

## CAR WASH SPONGE

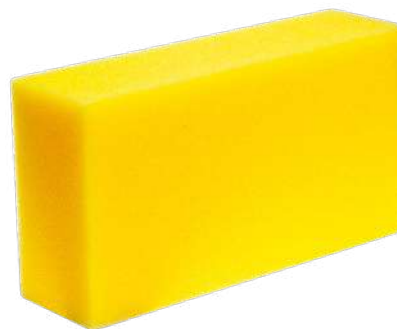

- Purpose: For removal of dirt from the car
- The sponge is made of high-density foam and provides high absorption power

CODE	BARCODE	WIDTH	MATERIAL
SPK	8605043400378	20cm	Polyethylen foam

## CELLULOSE MOP HEAD



- Purpose: For all types of floors, super absorbent
- Long lasting, absorbent, leaves no hair
- Effectively absorbs dirt and is easy to rinse

CODE	BARCODE	MATERIAL
MOPULC130	8605043400361	100% cellulose

## MOP HEAD



- Purpose: For cleaning and maintenance of various surfaces
- High liquid absorption power
- Resistance to chemical cleaners

CODE	BARCODE	MATERIAL
MOPUL140	8606017659587	PVC / Thread fibers

## MOP HEAD WITH HANDLE



- Purpose: For cleaning and maintenance of various surfaces
- High liquid absorption power
- Resistance to chemical cleaners

CODE	BARCODE	WEIGHT	MATERIAL
MOPKOM140	8606017659594	140gr	PVC / Thread fibers

**POLIPROPILEN WOVEN BAG**

- Purpose: They are widely used in industry, agriculture, trade and household
- They are accompanied with a test analysis report
- Suitable for food transfer and storage

CODE	BARCODE	MATERIAL	DIMENSION
PPVR65	8606007995763	Polypropylene	55x110cm

**SUSPENDED BAGS**

- Purpose: For all types of stores and goods

CODE	BARCODE	DIMENSION	MATERIAL	TYPE
KS22	8606007996326	22x44cm	Polyethylene	Standard
KS27	8606007996333	27x50cm	Polyethylene	Standard
KS30	8606007996340	30x58cm	Polyethylene	Standard

**GARBAGE BAGS WITH TIES**

- Purpose: For garbage, with tie

CODE	BARCODE	VOLUME	PACKAGE
KST40L	8606007996388	40l	10 pcs
KST60L	8606007996395	60l	8 pcs
KST110L	8606007996401	110l	8 pcs

**GARBAGE BAGS**

- Purpose: For garbage

CODE	BARCODE	VOLUME	PACKAGE
KS40L	8606007996357	40l	20 pcs
KS60L	8606007996364	60l	10 pcs
KS110L	8606007996371	110l	10 pcs





## CATALOGUE 2022/23

### SERBIA

Beorol d.o.o.  
Patrijarha Dimitrija 121a, 11090 Beograd  
tel: +381 (0) 11 80 42 244  
mob: +381 (0) 60 34 06 180  
e-mail: beorol@beorol.rs

### BOSNIA AND HERZEGOVINA

Beorol d.o.o. Banja Luka  
Dunavska 1c, 78000 Banja Luka  
tel: +387 (0) 51 450 292  
mob: +387 (0) 66 714 037  
e-mail: beorolbih@beorol.com

### MONTENEGRO

Beorol Montenegro d.o.o.  
Luke bb, Jelenak, 81410 Danilovgrad  
mob: +382 (0) 67 226 759  
e-mail: beorolmontenegro@beorol.com

### NORTHERN MACEDONIA

Беоорол Македонија ДООЕЛ  
Ул. 532 бр. 178 с. Марино, 1000 Скопје  
tel/fax: +389 (0) 2 615 98 90  
mob: +382 (0) 78 289 710  
e-mail: beorolmakedonija@beorol.com

### HUNGARY

Beorol HU Kft  
H-1172 Budapest, Cinkotai út 32.  
tel: +36 1 253 00 77  
mob: +36 30 559 31 75  
e-mail: beorolhungary@beorol.com

### UNITED ARAB EMIRATES

Beorol Middle East  
Dubai Investments Park 1, Dubai  
tel: +971 4 883 66 42  
mob: +971 56 432 09 64  
e-mail: beoroldubai@beorol.com

### RUSSIA

Набережная пресненская дом 12,  
Москва  
e-mail: nesavuckovic@mail.ru

### ROMANIA

Beorol Romania s.r.l.  
Strada Calea Radnei nr 288A, 310318 Arad  
e-mail: export@beorol.com,  
vukasinovic.n@beorol.rs

KATALOG20GBR



8 605043 400866

[www.beorol.com](http://www.beorol.com)

