

# Oxygen Therapy

## CLINICAL BEST PRACTICE GUIDELINE



## Acknowledgements

This College of Respiratory Therapists of Ontario (CRTO or “the College”) Clinical Best Practice Guideline (CBPG) was developed by the Professional Practice Committee (PPC) of the CRTO in consultation with Council and other committees of the College, Members at large and staff.

The PPC is a non-statutory committee comprised of Registered Respiratory Therapists (RRT) and public members with a wide range of knowledge and experience from various practice areas across Ontario. This committee was formed by the CRTO in 2010 to focus specifically on the review and development of standards of practice directly related to the practice of Respiratory Therapy in Ontario. By having a standing committee of Respiratory Therapy leaders and experts from core areas of practice, and the ability to draw on additional expertise where necessary, the CRTO aims to ensure consistency in the review and development of publications in a timely fashion. The CRTO would like to acknowledge the work of the PPC, Members at large, and staff in the development of this new CBPG.

### Professional Practice Committee Members

Paul Williams RRT – Chair (CRTO Council Academic Member)  
Renee Pageau RRT – Vice Chair (CRTO Non-Council Member)  
Carol-Ann Whalen RRT (CRTO Non-Council Member)  
Allan Cobb (CRTO Public Council Member)  
Rhonda Contant RRT (CRTO Council Member)  
Daniel Fryer RRT (CRTO Non-Council Member)  
Alean Jackman RRT (CRTO Non-Council Member)  
Lori Peppler-Beechey RRT (CRTO Non-Council Member)  
Bruno Tassonse RRT (CRTO Non-Council Member)

### Consultants

Raymond Janisse RRT Certified Hyperbaric Technologist (CHT)  
Bill Boyle, RRT (Certified Hyperbaric Technologist), MPA, CHE

### Past Professional Practice Committee Members (2010-2012)

Marisa Ammerata RRT - Vice Chair (CRTO Council member)  
Jim Ferrie (CRTO Public Council Member)  
Ally Ruzycski-Chadwick RRT (CRTO Non-Council Member)  
Sherri Horner RRT (CRTO Member at large)  
Kevin Middleton RRT (CRTO Member at large)  
Carole LeBlanc RRT – Vice Chair (CRTO Non-Council Member)  
Dave Jones RRT (CRTO Council Member)  
Tracy Bradley RRT (CRTO Council Member)  
Mark Pioro (CRTO public Council Member)

Resources and references are hyperlinked to the Internet for convenience and referenced to encourage exploration of information related to individual areas of practice and/or interests. Bolded terms are defined in the Glossary.

---

Originally Published: November 2013

# table of contents

<b>Introduction</b>	<b>5</b>
• Professional Practice Assumptions	5
• Guiding Principles	6
• Accountability	7
• Conflicts of Interest	8
<b>The Scope of this Clinical Best Practice Guideline</b>	<b>9</b>
• Evidence Based Practice	9
<b>Oxygen - A Brief Review</b>	<b>10</b>
• Fast Facts about Oxygen	10
• Overview: Types of Oxygen Delivery Systems	11
• Compressed Gas Cylinders	12
• Liquid Oxygen in Cryogenic Containers	14
• Oxygen Concentrators for Medical Use	15
• Oxygen Safety at Home	16
<b>Oxygen Therapy</b>	<b>17</b>
• Health Canada & the Food and Drug Act	17
• An overview of the Phases of Drug Action	18
• Indications for Oxygen Therapy	19
• Absolute Contraindications & Potential Adverse Effects	20
• Goals of Oxygen Therapy	21
• Hypoxia	21
• Hypoxemia	22
• The Effects of Hypoxia & Hypoxemia	23
• Drive to Breathe and Carbon Dioxide Retention	24
• How does Oxygen Therapy work?	25
• Oxygen Transport	25
• Oxhemoglobin Dissociation Curve	26
• Gas Exchange (of Oxygen)	27
• Normal Diffusion of Oxygen	28
• Pathophysiological Factors Affecting Gas Exchange	29

# table of contents

<b>Oxygen Therapy Equipment and Adjuncts</b>	<b>30</b>
• Guiding Principles	31
• Oxygen Delivery at the Patient/Client Interface	32
• Low Flow Oxygen Delivery Devices	33
• High Flow Oxygen Delivery Devices	33
• Nasal High Flow Oxygen Therapy	33
• Oxygen Therapy and Humidity	34
• Low Flow Oxygen Humidifiers	34
• High Flow Oxygen Humidifiers	34
<b>Special Considerations</b>	<b>35</b>
• Neonatal Care	35
• Hyperbaric Oxygen Therapy	36
• Physiological Effects of Hyperbaric Oxygen Therapy	37
• Major Complications of Hyperbaric Oxygen Therapy	38
• Oxygen at High Altitudes	39
<b>Assessment of Oxygen Therapy</b>	<b>40</b>
• Oximetry	40
• Pulse Oximetry	40
• Key Points to Remember	41
<b>Glossary</b>	<b>42</b>
<b>References</b>	<b>43</b>

## Introduction

### Professional Practice Assumptions

It is expected that all Respiratory Therapists (RTs) in Ontario possess the entry to practice competencies (i.e., knowledge, skills and judgment/abilities) to make sound clinical decisions regarding administration of oxygen (O<sub>2</sub>) therapy as part of their education and clinical experience. In addition, the College assumes that all Members:

- Possess a specialized body of knowledge (e.g., about oxygen therapy);
- Are committed to maintaining a high standard of professional practice through self-governance;
- Are committed to lifelong learning and the development of knowledge, skills and abilities throughout their career;
- Are committed to ongoing professional development;
- Are committed to the principle of accountability in their professional practice; and
- Are committed to practicing in an ethical manner.

In addition, Members are expected to act only within their professional scope of practice and in the best interest of their patients/clients. Please refer to the [Standards of Practice](#) and the CRTO's position statement [Scope of Practice and Maintenance of Competency](#).

The purposes of this CBPG are to:

- Provide a framework for Respiratory Therapists to make informed patient care decisions about oxygen therapy that are safe and ethical;
- Provide a framework for clinical best practices regarding oxygen therapy that are current, evidence based and linked to up-to-date resources and learning materials;
- Support Respiratory Therapists in the maintenance of competency, support ongoing professional development and quality practice; and
- Provide the public and other health care professionals with confidence that Respiratory Therapists are safe and ethical regulated health care professionals with the expertise to administer oxygen therapy that results in positive health care outcomes for the public of Ontario.

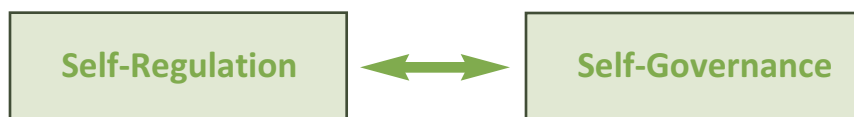



## Guiding Principles

Therapeutic oxygen should only be administered by competent healthcare providers who possess the required competencies (knowledge, skill, and judgment/abilities) to make clinical decisions regarding the administration of oxygen. The administration of substances by inhalation is a controlled act under the *Regulated Health Professions Act* (RHPA) and is authorized under the *Respiratory Therapy Act* (RTA). The practice of administering oxygen therapy clearly falls within the legislated scope of practice of Respiratory Therapy, which is:

The [Respiratory Therapy Act](#) states that the **Scope of Practice** of a Respiratory Therapist is:

*The practice of respiratory therapy is **the providing of oxygen therapy**, cardio-respiratory equipment monitoring and the assessment and treatment of cardio-respiratory and associated disorders to maintain or restore ventilation.*

Oxygen therapy is an expected competency of all Respiratory Therapists regardless of the practice setting. Respiratory Therapists work in a variety of practice settings including but not limited to:

- Acute Care (Hospitals)
- Complex Continuing Care
- Long-Term Care.
- Independent Facilities (e.g., pulmonary function testing (PFT) labs, sleep labs, ophthalmology clinics)
- Home Care
- Hyperbaric Oxygen Therapy
- Dental Anesthesia
- Independent Practice (e.g., consultants)
- Industry
- Education

## Accountability

One of the many aims of this guideline is to provide resources and tools for Respiratory Therapists who are independently administering oxygen, to mitigate the risks that may be associated with independently administering oxygen therapy in their clinical practice.

Here are some guiding principles to consider:

- Be accountable and act in the best interest of your patients/clients at all times;
- Ensure safe and ethical care;
- Act within the scope of practice of the profession, the role and scope of where you work and your individual scope of practice;
- Maintain the standards of your profession;
- Ensure that you are competent or become competent to do what you are going to do before you do it;
- Communicate with patients/clients and healthcare providers within the circle of care;
- Educate your patients/clients and healthcare providers within the circle of care; and
- Document... Document... Document!

### Did you know...

#### [Circle of Care – Sharing Personal Health Information for Health Care Purposes](#)

The term “circle of care” is not a defined term in the *Personal Health Information Protection Act, 2004* (PHIPA). It is a term commonly used to describe the ability of certain health information custodians to assume an individual’s implied consent to collect, use or disclose personal health information for the purpose of providing health care, in circumstances defined in PHIPA.

To find out more visit the Information and Privacy Commissioner of Ontario at [www.ipc.on.ca](http://www.ipc.on.ca).

## Conflict of Interest

A conflict of interest exists when you are receiving or are perceived to be receiving a benefit, from an individual or organization that could influence your professional judgment. The most common “benefit” is financial, but it is not the only kind of benefit that may be received.

It is professional misconduct to practice while in a conflict of interest.

Conflicts of interest are more likely to occur in the community or home care setting where RTs deal with sales/billing, but may also occur in hospitals when RTs are advising discharged patients about respiratory equipment or service requirements.

Respiratory Therapists must protect the trust relationship between themselves and their patients/clients. To do that, you should ensure that you do not place yourself in a position where a reasonable patient/client, or other person, might conclude that your professional expertise or judgment may be influenced by your personal interests, or that your personal interests may conflict with your duty to act in the best interests of your patient/client. It is not necessary for your judgment to actually be compromised.

Removing the conflict of interest can be achieved by disclosing to your patients/ clients (or their substitute decision maker), **orally and in writing**, that you will receive a benefit from the individual or organization **before** making any recommendation to the patient/client to purchase equipment or services from that individual or organization. In order for patients/clients to make fully informed decisions you must disclose the complete nature of your relationship with the individual or organization, e.g., that you receive financial compensation from the individual/organization for each purchase made by a patient/client. In addition, you must advise the patients/clients **orally and in writing**, that their care will not be affected if they choose to go elsewhere to purchase that equipment/service. Providing a list of alternative sources for equipment/ services is strongly recommended.

You may also wish to refer to other agencies’ policies and guidelines (e.g., Ministry of Health and Long-Term Care’s Assistive Devices Program (ADP) Conflict of Interest Policy, Veteran Affairs, etc.) and ensure that you are at all times adhering to the stricter of College, employer or third-party requirements.



## The Scope of this Clinical Best Practice Guideline (CBPG)

### Evidence-Based Practice

“Evidence-based practice is the conscientious, explicit and judicious use of current best evidence in making decisions about the care of individual patients/clients. The practice of evidence-based medicine means integrating individual clinical expertise and experience with the best available clinically relevant evidence from systematic research” (Sackett et al., 1996).

There is a vast amount of evidence-based, clinical information that is readily available on the Internet, and this information is constantly changing. This CBPG is not intended to be an all-inclusive oxygen therapy manual or textbook. Rather, this CBPG has been designed for use online and provides links to resources that can be used by RTs (and other users) to pursue their learning and professional development regarding best practices for oxygen therapy.

Specific recommendations for the delivery of oxygen via mechanical ventilation (invasive and non-invasive) and other complex respiratory care devices is beyond the scope of this CBPG.

This CBPG will not attempt to discuss the specific use of oxygen or prescribe target oxygen saturations for the treatment of different pathophysiological presentations (e.g., COPD). Alternatively, links to additional evidence-based, clinical best practice guidelines will be provided wherever possible (e.g., [Canadian Thoracic Society's COPD Guidelines](#)).

This CBPG is informed by the most current evidenced-based materials that were available at the time of publication. For example, the [British Thoracic Society's \(BTS's\) Guideline for Emergency Oxygen use in Adult Patients](#) and the [Canadian Thoracic Society's Guidelines](#). The CRTO is committed to maintaining up-to-date and accurate information to the best of its abilities and welcomes input regarding the best practices for oxygen therapy on an on-going basis.

## Oxygen - A Brief Review

Oxygen (O<sub>2</sub>) is the eighth element on the periodic table.

At **ambient temperature and pressure (ATP)**, oxygen atoms bind together, sharing electrons to form molecules of oxygen that exist as a colourless, odourless transparent and tasteless gas with the chemical symbol O<sub>2</sub>.

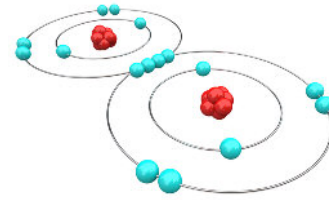

**Oxygen Molecules**

### Fast Facts about O<sub>2</sub>

- Makes up 20.9% of air by volume and 23% air by weight.
- Constitutes 50% of Earth's crust by weight (in air water and combined with other elements).
- Can combine with all other elements except other inert gases to form oxides. Oxygen is therefore characterized as an oxidizer.
- Is a non-flammable gas.
- Accelerates combustion.
- At -182.9 C (-300 F) oxygen is a pale blue liquid.
- Its critical temperature is -118.4 C (above this critical temperature oxygen can only exist as a gas regardless of the pressure).
- An oxygen enriched environment is considered to have 23% oxygen in the air and is a fire hazard.

“Oxygen sustains life and supports combustion. While there are many benefits to oxygen by inhalation, it is not without hazards and toxic effects. It is therefore important for persons who are responsible for oxygen administration to be familiar with its indications for use, potential hazards and equipment” (Kacmarek, Stoller & Heuer, 2013).

## Overview - Types of Oxygen Delivery Systems

There are three main types of oxygen delivery systems:

- Compressed gas cylinders;
- Liquid oxygen in cryogenic containers; and
- Oxygen concentrators for medical use.



Considerations for the selection of oxygen source include, but are not limited to, factors such as:

- size and weight of the device;
- storage capacity; and
- cost and the ability to fill the device.

For a good comparison of portable oxygen source and delivery devices please visit the [American Thoracic Society](#) (ATS) website.

The [Canadian Society of Respiratory Therapy](#) (CSRT) published an article in the Winter 2011 edition of the CSRT-JCTR Journal entitled: *An Overview of Oxygen Delivery Devices and Prescribing Practices* by James Stoller. This article is available at: [www.csrt.com/en/publications/pdf/CJRT/2011/Winter\\_CJRT\\_2011.pdf](http://www.csrt.com/en/publications/pdf/CJRT/2011/Winter_CJRT_2011.pdf)

### Did you know...

The manufacturing and distribution of medical oxygen in Canada is primarily regulated by Health Canada who set the standards and guidelines for the manufacturing and distribution of drugs and health products (including medical gases such as oxygen). Their mandate is to ensure medical gases are safe for human and veterinary use.

## Compressed Gas Cylinders

Oxygen is packaged and shipped as a high-pressure gas in seamless steel or aluminum cylinders constructed to Transport Canada and CSA specifications. In cylinders charged with gaseous oxygen, the pressure in the container is related both to temperature and the amount of oxygen in the container. Full high-pressure cylinders normally contain gas at 15 169 kPa (2200 psig) at 21 °C (70°F). Cylinder content can be determined by pressure, i.e., at a given temperature, when the gas pressure is reduced to half the original pressure, the cylinder will be approximately half full. The pressure of a full cylinder of oxygen is normally 2200 psig.

## **Bulk Oxygen**

Cylinders may be used various ways. For example, in a **manifold system**, large sized cylinders are linked together to supply medical oxygen to medical gas pipelines which then lead directly to the bedside in hospitals.

## **Manifold System**

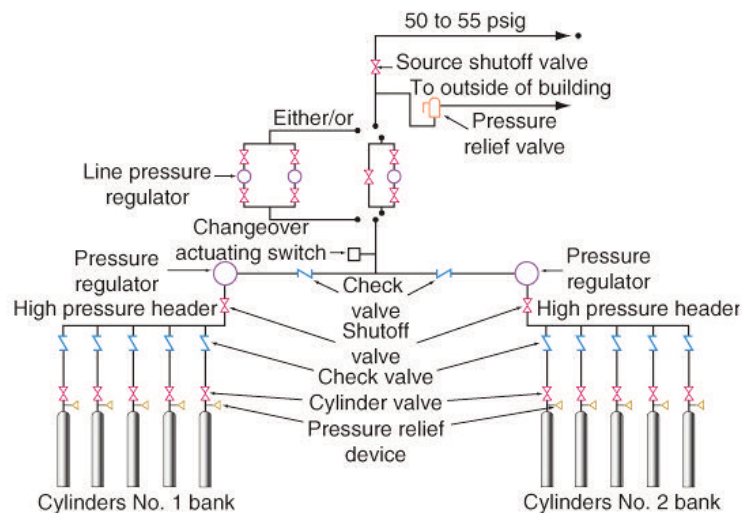

Modified from Standard for nonflammable medical gas systems, NFPA No. 56F. Copyright 1973, National Fire Protection Association, Boston, MA.

## Portable Oxygen Cylinders

Smaller sized cylinders are used as portable individual oxygen systems for short term use.

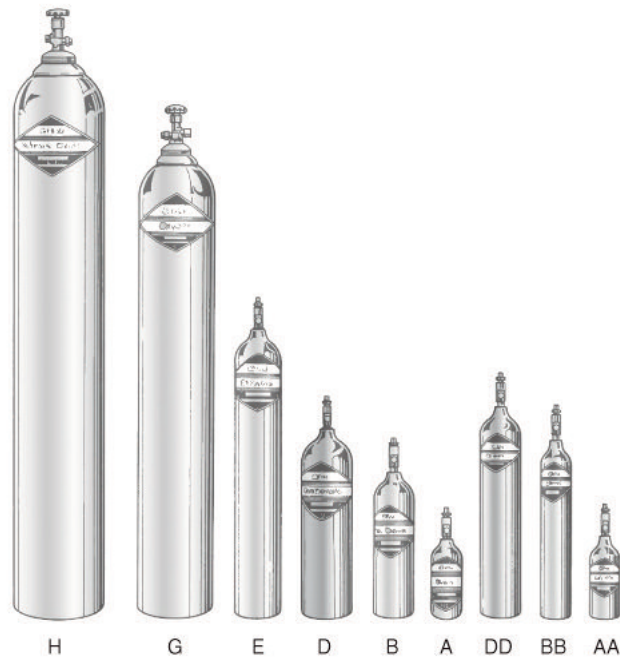

Copyright © 2013, 2009, 2003, 1999, 1995, 1990, 1982, 1977, 1973, 1969 by Mosby, an imprint of Elsevier Inc.

### Did you know...

To calculate how long a cylinder will last based on the size of the cylinder and continuous flow rate, the following formula can be used:

$$\text{Duration of Flow in minutes} = \frac{(\text{gauge pressure psi} - \text{safe residual pressure psi}) \times \text{cylinder factor}}{\text{Flow rate in liters per minute}}$$

Some examples of cylinder factors for different sized cylinders are:

- D cylinder 0.16
- E cylinder 0.28
- M cylinder 1.56



## Liquid Oxygen in Cryogenic Containers

Cryogenic containers store liquefied oxygen and vapour. Various sizes of cryogenic containers exist.

### **Bulk Liquid Oxygen systems**

Liquid oxygen can be manufactured by **fractional distillation** of air at an oxygen manufacturing plant and then delivered and stored on site to supply the healthcare facility. In this case, large stores of liquid oxygen are referred to as bulk oxygen. The oxygen is stored on site in large **cryogenic vessels** known as dewars. These dewars are regularly refilled by the oxygen gas manufacturer/supplier.

As the liquid oxygen passes through warming coils and is allowed to evaporate, the gas is delivered to a medical gas pipeline system and then directly to the bedside.

### **Portable Liquid Oxygen**

Various sizes of smaller, base-unit, cryogenic containers (also known as reservoirs) can be used in various settings such as long-term care facilities, homes, and hospital wards to fill smaller portable cryogenic liquid systems that patients can ambulate with. Portable liquid oxygen units offer continuous flow or intermittent flow of oxygen to the patient/client.

The [Canadian Standards Association](#) (CSA) offers standards and guidelines on the safety, storage and delivery of liquid oxygen.



**Oxygen Dewar**

Copyright © 2013, 2009, 2003, 1999, 1995, 1990, 1982, 1977, 1973, 1969 by Mosby, an imprint of Elsevier Inc.

## Oxygen Concentrators for Medical Use

Oxygen concentrators provide a safe source of oxygen-enriched air. They are devices which employ selective removal of nitrogen from room air to increase the concentration of oxygen in the delivered gas product. A concentrator is an electrically powered, electronically controlled device that does not store oxygen when not in operation.

### **Bulk Oxygen Supply**

Industrial sized oxygen concentrators can supply oxygen to their medical gas pipelines systems which is then delivered directly to the bedside. Concentrators use one of two main methods to separate and concentrate oxygen from the air, molecular sieves or semi-permeable membranes.

- Molecular sieves use sodium-aluminum silicate crystals and employ Pressure Swing Adsorption (PSA) or Vacuum Pressure Swing Adsorption (VPSA) technology.
- Semi-permeable membranes are thin plastic membranes that are selectively permeable to O<sub>2</sub> molecules and water vapor.

The CSA offers standards and guidelines on the safety, storage and delivery of bulk oxygen.

### **Portable Oxygen Supply**

Smaller individual concentrators can provide oxygen at a hospital bedside, in the home or on the go. They also separate oxygen from air using molecular sieves or semi-permeable membranes.

There are three types:

- Stationary concentrators;
- Concentrators that have the ability to fill portable aluminum cylinders; and
- Portable oxygen concentrators that operate using lithium batteries.

#### **Did you know...**

Battery-operated portable oxygen concentrators can function in continuous flow mode and / or pulse dose / demand mode.



**Oxygen Concentrator**

## Oxygen Safety at Home

The CSA has developed standards related to the safe storage, handling and use of portable oxygen systems in residential and healthcare facilities. This is a key resource and includes input from CRTO Members from across Ontario.

The [Canadian Centre for Occupational Health and Safety](#) also has several resources that are available to the public. You can visit the Canadian Centre for Occupational Health and Safety website and enter the search term 'oxygen' to find out more. Here are some links of interest:

- Compressed Gases Hazards  
[www.ccohs.ca/oshanswers/chemicals/compressed/compress.html](http://www.ccohs.ca/oshanswers/chemicals/compressed/compress.html)
- Storage and Handling of Compressed Gas Cylinders  
[www.ccohs.ca/oshanswers/safety\\_haz/welding/storage.html](http://www.ccohs.ca/oshanswers/safety_haz/welding/storage.html)
- Working with Compressed Gases  
[www.ccohs.ca/oshanswers/prevention/comp\\_gas.html](http://www.ccohs.ca/oshanswers/prevention/comp_gas.html)
- How Do I Work Safely with Cryogenic Liquids?  
[www.ccohs.ca/oshanswers/prevention/cryogens.html#\\_1\\_7](http://www.ccohs.ca/oshanswers/prevention/cryogens.html#_1_7)

The safety, labeling, handling and transport of medical oxygen containers is regulated by federal legislation including:

- [Transport Canada - Transportation of Dangerous Goods](#) - Oxygen is a Class 2.2, Non-flammable, Non-toxic gases.
- [Health Canada](#) – Workplace Hazardous Materials Information System ([WHMIS](#)).

Oxygen is a Class A: compressed gas.

Manufacturers of therapeutic oxygen in Canada are responsible for providing WHMIS Material Safety Data Sheets (MSDS) for oxygen and may be found on their websites.

## Oxygen Therapy

### Health Canada and the *Food and Drug Act*

According to the [Food and Drug Act](#):

- a “drug” includes any substance or mixture of substances manufactured, sold or represented for use in:
- a) the diagnosis, treatment, mitigation or prevention of a disease, in human disorder or abnormal physical state, or its symptoms, beings or animals,
  - b) restoring, correcting or modifying organic functions in human beings or animals, or
  - c) disinfection in premises in which food is manufactured, prepared or kept;

#### Did you know...

[Health Canada](#) administers the *Food and Drug Act*.

Once a drug has been authorized, Health Canada issues an eight-digit **Drug Identification Numbers (DIN)** which permits the manufacturer to market the drug in Canada.

Health Canada sets the standards and guidelines for the manufacturing of drugs and health products (including medical gases such as oxygen) to ensure they are safe for human and veterinary use.

In Canada, medical oxygen containers and systems require proper labels which include DINs.

## An Overview of the Phases of Drug Action adapted from (Rau, J.L., 2002. p. 13)

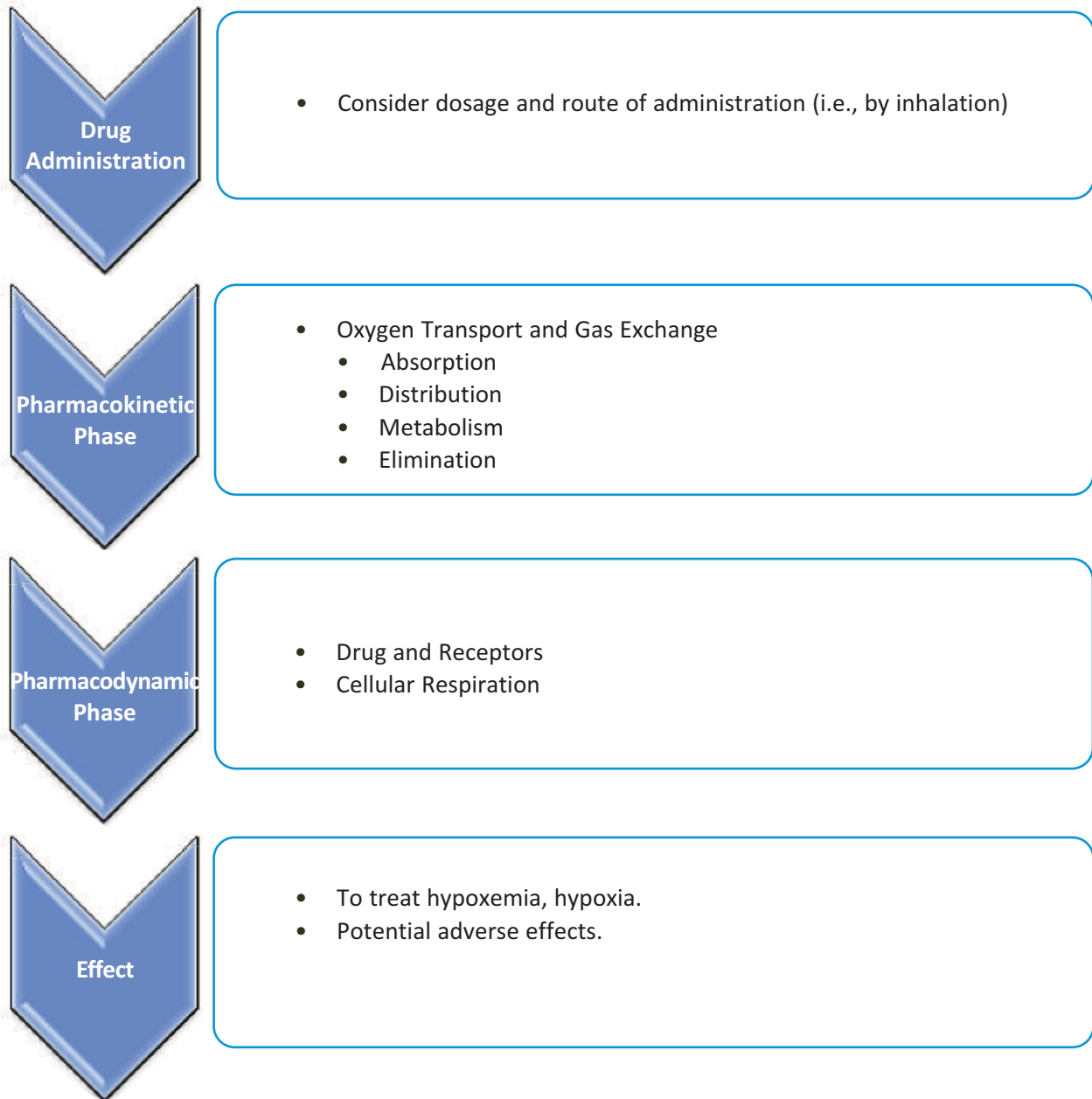



## Indications for Oxygen Therapy

- Documented hypoxemia, defined as a decreased PaO<sub>2</sub> in the blood below normal range. PaO<sub>2</sub> of < 60 torr or SaO<sub>2</sub> of < 90% in patients breathing room air, or with PaO<sub>2</sub> and/or SaO<sub>2</sub> below desirable range for specific clinical situation.
- An acute situation in which hypoxemia is suspected. Substantiation of hypoxemia is required within an appropriate period of time following initiation of therapy.
- Severe trauma.
- Short-term therapy (e.g., carbon monoxide poisoning) or surgical intervention (e.g., post-anesthesia recovery).
- Pneumothorax absorption.

### **Did you know...**

“There is no evidence to support the use of supplemental oxygen to reduce dyspnea in non-hypoxemic patients with advanced COPD” (Mariciniuk et.al, 2011).

The current BTS *Guideline for Oxygen Use in Adult Patients* (2009) is based on the premise that oxygen is a treatment for “hypoxemia, not breathlessness”. Further, the guideline states that “oxygen has not been shown to have any effect on the sensation of breathlessness in non-hypoxemic patients” (p.vi1).

## **Absolute Contraindications & Possible Adverse Effects**

### **Absolute Contraindications**

- Patient/Client does not consent to receiving the oxygen
- The use of some O<sub>2</sub> delivery devices (e.g., nasal cannulas and nasopharyngeal catheters in neonates and pediatric patients that have nasal obstructions)

### **Potential Adverse Effects**

- Oxygen toxicity
- Oxidative stress
- Depression of ventilation in a select population with chronic hypercarbia
- Retinopathy of prematurity
- Absorption atelectasis

## Goals of Oxygen Therapy

“Oxygen Therapy is usually defined as the administration of oxygen at concentrations greater than those found in ambient air” (BTS, 2011. p.vi27).

The main goal of oxygen therapy is:

“To treat or prevent hypoxemia thereby preventing tissue hypoxia which may result in tissue injury or even cell death” (BTS, 2011. p.vi27).

### Hypoxia

Hypoxia refers to a condition where the amount of oxygen available to the cells is not adequate to meet metabolic need.

#### **Did you know....**

Hypoxia can exist even though hypoxemia has been corrected with oxygen therapy?

For example:

- At the cellular level where the cells are unable to access or use the O<sub>2</sub> delivered
- At the tissue level when O<sub>2</sub> may not reach the cells due to a blocked artery

The causes of hypoxia are (BTS, 2011, p.vi14):

- Hypoxemia (e.g., at high altitudes).
- Anemic hypoxemia (e.g., reduced hematocrit or carbon monoxide poisoning).
- Stagnant hypoxemia (e.g., shock, ischemia).
- Histotoxic hypoxia/dysoxia (e.g., cyanide poisoning).

## Hypoxemia

If the partial pressure of O<sub>2</sub> (PaO<sub>2</sub>) is less than the level predicted for the individual's age, hypoxemia is said to be present.

Some of the causes of hypoxemia are:

- Low Inspired O<sub>2</sub> (e.g., at high altitude).
- Hypoventilation, V/Q mismatch (e.g., COPD).
- Anatomical Shunt (e.g., cardiac anomalies).
- Physiological Shunt (e.g., atelectasis).
- Diffusion deficit (e.g., interstitial lung disease).
- Hemoglobin deficiencies.

### **Did you know...**

In Ontario, the MOHLTC sets guidelines defining hypoxemia and the criteria for long-term use of oxygen. The criteria are:

- Each applicant's condition must be stabilized and treatment regimen optimized before long-term oxygen therapy is considered. Optimum treatment includes smoking cessation.
- Applicants must have chronic hypoxemia on room air at rest (PaO<sub>2</sub> of 55mmHg or less, or SaO<sub>2</sub> of 88% or less).
- Applicants with persistent PaO<sub>2</sub> in the range of 56 to 60 mmHg may be considered candidates for long-term oxygen therapy if any of the following medical conditions are present:
  - cor pulmonale;
  - pulmonary hypertension; or
  - persistent erythrocytosis.

Also, some applicants with a persistent PaO<sub>2</sub> in the range of 56 to 60mmHg may be candidates for long-term oxygen therapy if the following occurs:

- exercise limited hypoxemia;
- documented to improve with supplemental oxygen;
- nocturnal hypoxemia.

Retrieved from: [www.health.gov.on.ca/en](http://www.health.gov.on.ca/en)

**The Effects of Hypoxia and Hyperoxia** (O'Driscoll, 2008)

<b>Hypoxia</b>		
	<b>Effects</b>	<b>Risks</b>
Respiratory system	<ul style="list-style-type: none"> <li>- Increased ventilation</li> <li>- Pulmonary vasoconstriction</li> </ul>	<ul style="list-style-type: none"> <li>- Pulmonary hypertension</li> </ul>
Cardiovascular system	<ul style="list-style-type: none"> <li>- Coronary vasodilation</li> <li>- Decreased systemic vascular resistance (transient)</li> <li>- Increased cardiac output</li> <li>- Tachycardia</li> </ul>	<ul style="list-style-type: none"> <li>- Myocardial ischemia/infarction</li> <li>- Ischemia/infarction of other critically perfused organs</li> <li>- Hypotension</li> <li>- Arrhythmias</li> </ul>
Metabolic system	<ul style="list-style-type: none"> <li>- Increased 2,3-DPG</li> <li>- Increased CO<sub>2</sub> carriage (Haldane effect)</li> </ul>	<ul style="list-style-type: none"> <li>- Lactic acidosis</li> </ul>
Neurological system	<ul style="list-style-type: none"> <li>- Increased cerebral blood flow due to vasodilation</li> </ul>	<ul style="list-style-type: none"> <li>- Confusion</li> <li>- Delirium</li> <li>- Coma</li> </ul>
Renal system	<ul style="list-style-type: none"> <li>- Renin-angiotensin axis activation</li> <li>- Increased erythropoietin production</li> </ul>	<ul style="list-style-type: none"> <li>- Acute tubular necrosis</li> </ul>
<b>Hyperoxia</b>		
	<b>Effects</b>	<b>Risks</b>
<b>Respiratory system</b>	<ul style="list-style-type: none"> <li>- Decreased ventilation</li> </ul>	<ul style="list-style-type: none"> <li>- Worsened ventilation / perfusion matching</li> <li>- Absorption atelectasis</li> </ul>
<b>Cardiovascular system</b>		<ul style="list-style-type: none"> <li>- Myocardial ischemia (in context of decreased haematocrit)</li> <li>- Reduced cardiac output</li> <li>- Reduced coronary blood flow</li> <li>- Increased blood pressure</li> <li>- Increased reactive oxygen species</li> </ul>
<b>Metabolic system</b>	<ul style="list-style-type: none"> <li>- Decreased 2,3-DPG</li> <li>- Decreased CO<sub>2</sub> carriage (Haldane effect)</li> </ul>	<ul style="list-style-type: none"> <li>- Increased reactive oxygen species</li> </ul>
<b>Neurological system</b>	<ul style="list-style-type: none"> <li>- Decreased cerebral blood flow</li> </ul>	
<b>Renal system</b>		<ul style="list-style-type: none"> <li>- Reduced renal blood flow</li> </ul>



### **Drive to Breathe and Carbon Dioxide Retention**

The primary goal of oxygen therapy is to treat hypoxemia. However, a very small number of patients with Chronic Obstructive Pulmonary Disease (COPD) have sensitivity to higher levels of O<sub>2</sub>.

Target saturation for patients at risk of hypercapneic respiratory failure is 88-92% (BTS, 2011) unless otherwise prescribed, pending blood gas results.

If you are unsure if a patient has a sensitivity to O<sub>2</sub>, the main goal is to treat hypoxemia.

For more information on best practice guidelines for the treatment of COPD please visit the [Canadian Thoracic Society' Canadian Respiratory Guidelines for COPD](#) website.

Emphasis is always to avoid harmful hypoxemia and hypercapnia by carefully titrating O<sub>2</sub> and monitoring arterial blood gases.

#### **Did you know...**

Normal range of Carbon Dioxide (CO<sub>2</sub>) is generally accepted as 35-45 mmHg.

Normally, increased levels of CO<sub>2</sub> will stimulate ventilation. Patients with certain respiratory diseases such as COPD may have reduced sensitivity to increased levels of CO<sub>2</sub>.

Hypoxic drive refers to the patient being dependent on low levels of arterial blood oxygen (PaO<sub>2</sub>) to stimulate breathing as seen in some patients with COPD.

If too much O<sub>2</sub> is given to a patient who relies on hypoxic drive to breathe, the blood oxygen levels will rise but the CO<sub>2</sub> level will rise as well, leading to respiratory acidosis and failure.

## How Does Oxygen Therapy Work?

In order to better understand how oxygen therapy can correct hypoxemia the following section provides an overview of the physiology of oxygen transport and gas exchange.

### Oxygen Transport

Oxygen carried in the blood is reversibly bound to the hemoglobin. A very tiny amount of free oxygen gas dissolved in the plasma. Dissolved oxygen gas exerts a pressure in the vasculature that can be measured from a blood sample (e.g., an arterial blood gas (ABG)). This measurement is known as the partial pressure of oxygen in the arterial blood and is represented by the nomenclature:  $P_aO_2$ .

The majority of oxygen carried in the blood is transported bound to hemoglobin. A very small amount of oxygen gas is transported dissolved in the plasma. This dissolved  $O_2$  can be measured utilizing a small sample of arterial blood. This measurement is referred to as  $PaO_2$  and is an important indicator when assessing for hypoxia.

## Oxygen Hemoglobin Dissociation Curve

Oxygen transport can be explained and depicted by the oxygen-hemoglobin dissociation curve.

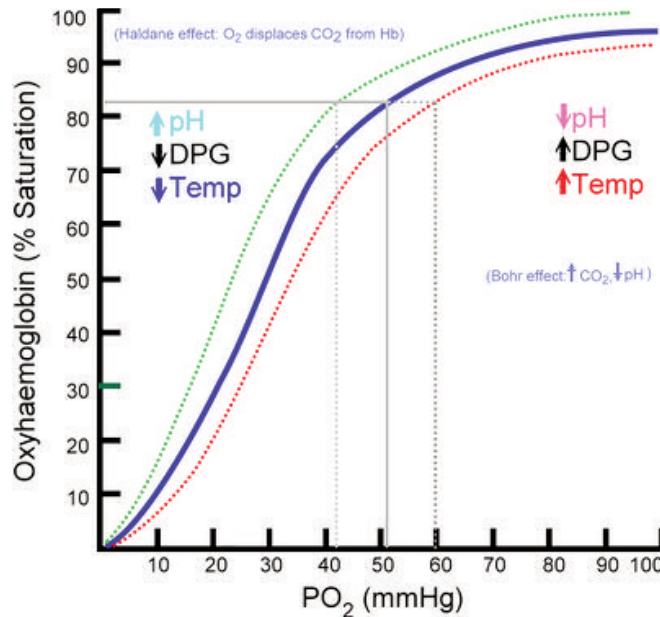

The oxyhemoglobin dissociation curve is a tool for understanding how our blood carries and releases oxygen. In the oxyhemoglobin dissociation curve, oxygen saturation (SO<sub>2</sub>) is compared to the partial pressure of oxygen in the blood (PO<sub>2</sub>), and this creates a curve that demonstrates how readily hemoglobin acquires and releases oxygen molecules into the fluid that surrounds it (oxygen-hemoglobin affinity).

Some of the factors affecting the loading and unloading of oxygen are:

- Blood pH (**Bohr effect**)
- Body temperature
- Erythrocyte concentration of certain organic phosphates (e.g., 2,3 diphosphoglycerate)
- Variation to the structure of the hemoglobin (Hb) molecules (e.g., sickle cells, methemoglobin (metHb) and fetal hemoglobin (HbF))
- Chemical combinations of Hb with other substances (e.g., carbon monoxide)

Remember, changes to any of these factors may cause the oxygen dissociation curve to shift right or left; affecting the oxygen-hemoglobin affinity.

## Gas Exchange of Oxygen

The movement of oxygen at the level of the microcirculation occurs mainly by passive diffusion. Oxygen is delivered via the respiratory tract to the alveoli and then diffuses across the alveolar-capillary membrane into the blood.

## Oxygen Cascade

The diffusion or driving pressure gradients for oxygen between the atmospheric air, alveolus, artery, and tissue capillary.

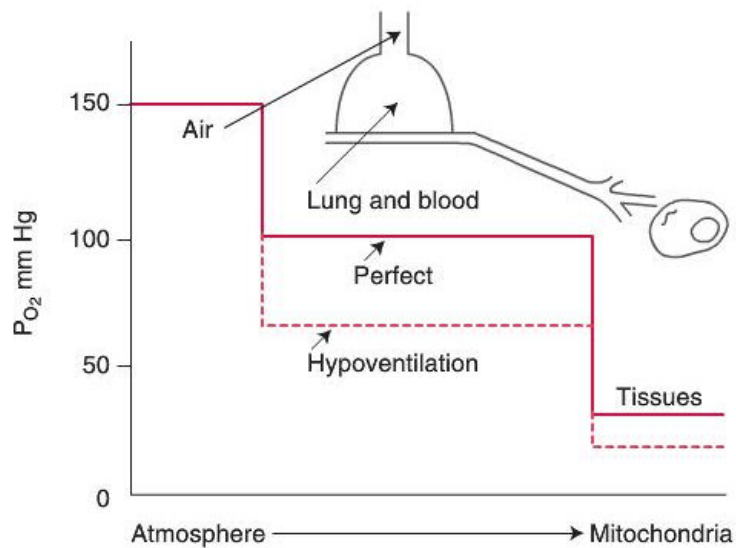

### Alveolar Air Equation

$$PAO_2 = [(PB - PH_2O) * FiO_2] - PaCO_2 / RQ$$

## Normal Diffusion of Oxygen

With regards to diffusion of oxygen in the normal lung at **Body Temperature and Pressure Saturated (BTPS)**:

- The partial pressure of oxygen in the alveolus ( $P_{A}O_2$ ) approximates 100mmHg.
- The partial pressure of oxygen in the venous blood returning to the lung ( $P_{V}O_2$ ) approximates 40mmHg, there is a pressure gradient for diffusion of oxygen into the blood of about 60 mmHg.
- Theoretically, the partial pressure in the capillary blood should rise to equal the partial pressure of oxygen in the alveolus and therefore the partial pressure of oxygen in the arterial blood ( $P_aO_2$ ) should approximate 100mmHg “the  $P_aO_2$  of healthy individuals breathing air at sea level is always approximately 5-10 mmHg less than the calculated  $P_aO_2$ . Two factors account for this difference: (1) right to left shunts in the pulmonary and cardiac circulation, and (2) regional differences in the pulmonary ventilation and blood flow” (Kacmarek, Stoller, Heuer, 2013, p. 255). Normal  $P_aO_2$  is expected to range from 90-95mmHg however, in clinical practice normoxemia in adults and children is defined as 80-100 mmHg.
- Neonates have a lower actual  $P_aO_2$  than adults and children. In neonates normoxemia is 50-80mmHg due to anatomical shunts at birth and the nature of fetal hemoglobin.

At the tissue level, oxygen diffuses from the blood ( $P_{\text{capillaries } O_2} = 40 \text{ mmHg}$ ) across the microvasculature and interstitial space into the cell ( $P_{\text{intracellular } O_2} = 5\text{mmHg}$ ) where cellular respiration take place.

The movement of gas across the alveolar-capillary membrane is best described by Fick’s first law of diffusion.

### Fick’s Law of Diffusion

$$V = \frac{A \times D (P_1 - P_2)}{T}$$

Where the factors affecting gas exchange are:

V = flow of gas (oxygen)

A = cross sectional area available for diffusion

D = diffusion coefficient

$P_1 - P_2$  = the partial pressure gradient

$P_1$  = partial pressure of oxygen in the alveolus ( $P_{A}O_2$ )

$P_2$  = partial pressure of oxygen in the blood ( $P_aO_2$ )

T = thickness of the membrane (alveolar-capillary membrane)



## Pathophysiological Factors Affecting Gas Exchange

Some of the pathophysiologic factors affecting the gas exchange of oxygen include:

- the flow of oxygen into the lungs, down to the alveoli (hypoventilation and hyperventilation);
- the flow of blood into the lungs to the pulmonary capillaries (vasoconstriction, thrombosis);
- the matching of blood flow and gas flow in the lungs;
- ventilation perfusion mismatching (pneumothorax), decreased cardiac output (MI, shock);
- the carrying content of the blood ( $\text{SaO}_2$  and  $\text{PaO}_2$ ) e.g. sickle cell anemia, carbon monoxide poisoning, hypoxemia;
- the pressure gradient for diffusion of  $\text{O}_2$  (e.g., hypoxemia);
- the thickness of the alveolar-capillary membrane (e.g., pulmonary fibrosis, pneumonia); and
- the thickness of the microvasculature/interstitial space at the tissue (e.g., necrosis).

## Oxygen Therapy Equipment and Adjuncts

The main components of an oxygen delivery system are:

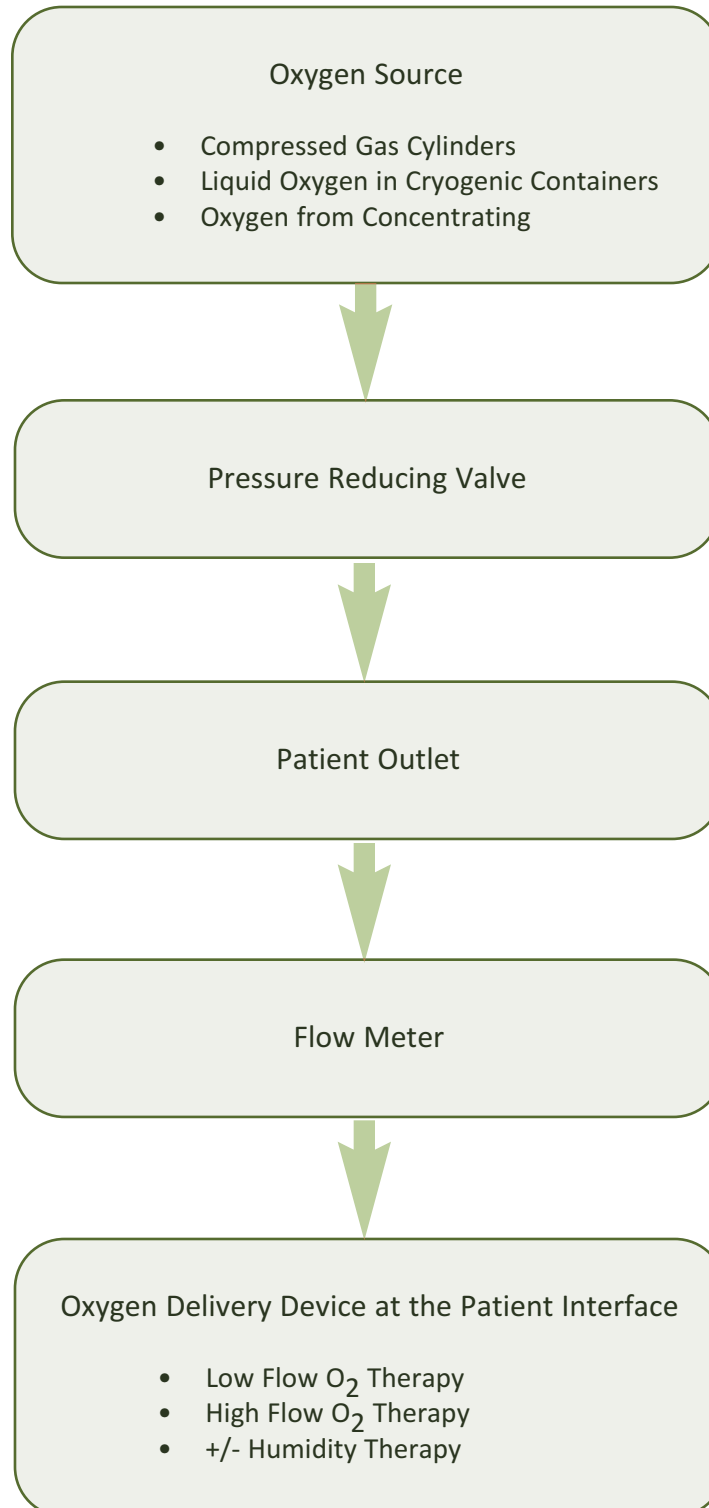

## Guiding Principles

There are many factors to consider when choosing the most appropriate oxygen source for patients/clients in their environment (e.g., from hospital to home).

For example:

- Continuous flow versus oxygen conserving devices (e.g., test patient on specific **conserving devices** to ensure the therapy meets the patient's requirements).
- Patient physiological needs (e.g., of a neonate with congenital heart disease versus a pregnant female).
- Patients physical abilities (e.g., strength to use equipment).
- Patients cognitive ability (e.g., patient/client ability to understand and use and demonstrate use).
- Environmental Considerations (e.g., site assessment for open flames in the home).
- Geographic considerations (e.g., remote patients and availability of back-up systems and supplies).

For more information please refer to ***An Overview of Oxygen Delivery Devices and Prescribing Practices*** by James Stoller available at:  
[www.csrt.com/en/publications/pdf/CJRT/2011/Winter\\_CJRT\\_2011.pdf](http://www.csrt.com/en/publications/pdf/CJRT/2011/Winter_CJRT_2011.pdf)

### Did you know...

Not all oxygen conserving devices work the same way. For example some regulators are battery-operated, while others are pneumatically powered.

## Oxygen Delivery at the Patient/Client Interface

### Low Flow Oxygen Delivery Devices

Low flow oxygen delivery devices provide a variable  $FiO_2$  depending on the patient's/client's inspiratory demands. As the inspiratory demands increase, ambient air is entrained and the  $FiO_2$  is diluted.

#### Did you know....

Low Flow Oxygen delivery devices could still deliver a high  $FiO_2$ ?

Theoretically, a reservoir mask set at 10 -15 L/min, could provide an  $FiO_2$  of 1.0 if it fit properly to a patient's face and met the patient's inspiratory flow demands on every breath.

#### Examples of low flow devices include:

- Nasal Cannula
- Nasal Catheter
- Transtracheal Catheter
- Simple Mask
- Partial Rebreather Mask
- Non-Rebreather Mask

#### Nasal Cannula

Today's nasal cannula has evolved to be the most common appliance for oxygen therapy. Permutations of the standard device include:

- models sized for neonatal and pediatric patients,
- incorporation with eye glasses,
- a single prong for sidestream sensing of exhaled carbon dioxide,
- reservoir systems (moustache and pendant) used primarily in long-term ambulatory care,
- a sensor to allow flow only on inspiratory demand (also used primarily in long-term ambulatory care),
- high-flow designs for adult and neonatal/pediatric patients.

## High Flow Oxygen Delivery Devices

High flow oxygen delivery devices will provide a fixed  $\text{FiO}_2$  (0.24 - 1.0) regardless of the patient's/client's inspiratory demands.

Some examples of high flow devices include:

- Air Entrainment Mask (Venturi);
- Air Entrainment Nebulizer;
- Nasal High Flow Oxygen Therapy;
- Mechanical Ventilators (invasive Non-invasive);
- CPAP/APAP Machines;
- Resuscitation Bags; and
- Hyperbaric Oxygen Chambers.

### Did you know...

Mouth breathing does not significantly decrease the  $\text{FiO}_2$  delivered by nasal prongs.

### Did you know...

**Nasal High Flow Oxygen Therapy (NHF)** can be an alternative to standard high-flow face mask (HFFM) oxygen therapy. It provides delivery of up to 60 L/min of heated and humidified, blended air and oxygen via wide-bore nasal cannula.



## Oxygen Therapy and Humidity

Humidity refers to the water vapour content of a gas. In a healthy individual air is delivered to the alveoli at Body Temperature and Pressure Saturated (**BTPS**). Much of the humidification of the air we inspire normally takes place via the nasal passages and upper airway. When a patient receives a supplemental medical gas it is generally cool and dry and can cause drying of the secretions and mucosa potentially leading to airway obstruction and tissue injury. A goal of humidity therapy is to minimize or eliminate the humidity deficit that may occur when a patient/client breaths a dry medical gas. Humidity therapy is therefore an integral part of oxygen therapy.

Ideally inspired gas should be humidified to 37 C and 44 mg H<sub>2</sub>O/L (Wattier & Ward, 2011. p. 265). This ensures patient comfort and promotes respiratory health by optimizing mucocilliary function and the clearance of secretions. There are several types of humidifiers that can be used with low or high flow oxygen therapy devices.

### **Clinical Signs and Symptoms of Inadequate Airway Humidification** (Cairo & Pilbeam, 2004)

- Atelectasis
- Dry, non-productive cough
- Increased airway resistance
- Increased incidence of infection
- Increased work of breathing
- Substernal pain
- Thick dehydrated secretions

### Low Flow Oxygen Humidifiers

- Molecular Humidity - bubble type humidifiers, bubble-diffuser type humidifiers used with nasal cannula.
- Humidity is not indicated at flows less than 4 L/min (Cairo & Pilbeam, 2004. p.91).
- The use of humidity is not recommended with reservoir type masks as condensates may affect the function of the mask (parts stick together) .

### High Flow Oxygen Humidifiers

- Molecular Humidity
  - Passover-type (+/- wick, +/- heater) (e.g., used to humidify trach mask systems, incubators).
- Aerosol Humidity
  - air entraining jet nebulizers (+/- baffles, +/- heaters)

## Special Considerations

### Neonatal Care

Providing oxygen therapy to the neonatal population is complex and based on each individual clinical situation. For the immediate newborn period, it is generally accepted that oxygen is provided based on the American Academy of Pediatrics' Textbook of Neonatal Resuscitation using the Canadian Adaptations from Canadian Pediatric Society.

**Resources:**

**Canadian Pediatric Society (2011).** 6<sup>th</sup> Edition NRP Guidelines.

Retrieved from: [www.cps.ca/nrp/Edition6guidelines.htm](http://www.cps.ca/nrp/Edition6guidelines.htm).

Low Flow Oxygen typically refers to oxygen delivered via nasal prongs/cannula at a flow rate 500 ml/min or less. Humidification of the oxygen is dependent on the flow rate and hospital policies. It is important to remember that it is possible to deliver high concentrations of oxygen with low flows depending on anatomic dead-space and the minute ventilation of the patient.



## Hyperbaric Oxygen Therapy (HBOT)

### Did you know...

The [Undersea and Hyperbaric Medical Society \(UHMS\)](#) is an international, non-profit organization and is generally considered a primary source of scientific information for diving and hyperbaric medicine physiology worldwide.

[Health Canada](#) refers to UHMS guidelines and the CSA sets the standards for hyperbaric therapy in Canada.

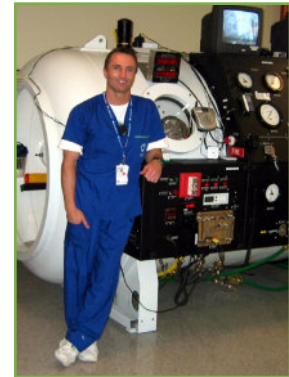

### The Basic Principles of Operation of Hyperbaric Chambers

The increased pressure inside the chamber, combined with the delivery of 100% oxygen ( $\text{FiO}_2 = 1.0$ ), drives the diffusion of oxygen into the blood plasma at up to 10 times normal concentration. Patients are monitored at all times during HBOT, often by RTs.

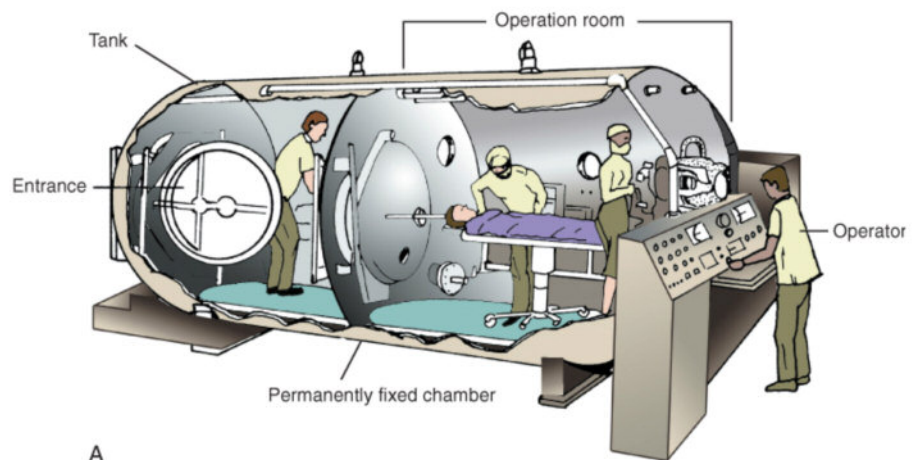

Copyright © 2013, 2009, 2003, 1999, 1995, 1990, 1982, 1977, 1973, 1969 by Mosby, an imprint of Elsevier Inc.

## Physiologic Effects of Hyperbaric Oxygen Therapy

While some of the mechanisms of action of HBOT, as they apply to healing and reversal of symptoms, are yet to be discovered, it is known that HBOT:

- greatly increases oxygen concentration in all body tissues, even with reduced or blocked blood flow;
- stimulates the growth of new blood vessels to locations with reduced circulation, improving blood flow to areas with arterial blockage;
- causes a rebound arterial dilation after HBOT, resulting in an increased blood vessel diameter greater than when therapy began, improving blood flow to compromised organs;
- stimulates an adaptive increase in superoxide dismutase (SOD), one of the body's principal, internally produced antioxidants and free radical scavengers; and
- aids the treatment of infection by enhancing white blood cell action and potentiating germ-killing antibiotics.

### Indications

The following indications are approved uses of hyperbaric oxygen therapy as defined by the [Undersea & Hyperbaric Medical Society](#) (UHMS):

1. Air or Gas Embolism
2. Carbon Monoxide Poisoning
  - Carbon Monoxide Poisoning Complicated By Cyanide Poisoning
3. Clostridial Myositis and Myonecrosis (Gas Gangrene)
4. Crush Injury, Compartment Syndrome and Other Acute Traumatic

#### Ischemias

5. Decompression Sickness
6. Arterial Insufficiencies:
  - Central Retinal Artery Occlusion
  - Enhancement of Healing In Selected Problem Wounds
7. Severe Anemia
8. Intracranial Abscess
9. Necrotizing Soft Tissue Infections
10. Osteomyelitis (Refractory)
11. Delayed Radiation Injury (Soft Tissue and Bony Necrosis)
12. Compromised Grafts and Flaps
13. Acute Thermal Burn Injury
14. Idiopathic Sudden Sensorneural Hearing Loss\*

(\*approved on October 8, 2011 by the UHMS Board of Directors)

## Potential Complications of Hyperbaric Oxygen Therapy

- Barotrauma:
  - Ear or sinus trauma
  - Tympanic membrane rupture
  - Alveolar over distension and pneumothorax
  - Gas embolism
  
- Oxygen Toxicity:
  - Central nervous system (CNS) toxic reaction (Early signs of impending CNS toxicity include twitching, sweating, pallor and restlessness. These signs usually are followed by seizures or convulsions.)
  - Pulmonary toxic reaction
  
- Other:
  - Fire
  - Sudden decompression
  - Reversible visual changes
  - Claustrophobia
  - Decreased Cardiac Output (Cairo & Pilbeam,2004)

### The Safety of Hyperbaric Chambers ([Health Canada](#))

Hyperbaric chambers are class 3 medical devices which must be licensed by Health Canada before they can be imported and sold in Canada. The Medical Devices Regulations require that the medical devices imported and sold in Canada are safe, effective, and of quality manufacture. This is achieved by a combination of a pre-market review prior to licensing, and post-market surveillance of adverse events.

Health Canada has reviewed the scientific evidence related to hyperbaric chambers. The evidence shows that chambers are effective in treating at this time 13 of the 14 conditions recognized by the Undersea and Hyperbaric Medical Society. Therefore, Health Canada has issued medical device licences for hyperbaric chambers to treat only these 13 conditions. No device licences have been issued for the use of hyperbaric chambers to treat other conditions.

#### Undersea and Hyperbaric Medical Society

<http://membership.uhms.org/?page=Indications>

#### Undersea and Hyperbaric Medical Society Canadian Chapter

[www.cc-uhms.ca/wp/](http://www.cc-uhms.ca/wp/)

#### University of Toronto Hyperbaric Medicine

(educational resource for healthcare professionals)

[www.hyperbaric.utoronto.ca/hyperbaricmedicine/index.asp](http://www.hyperbaric.utoronto.ca/hyperbaricmedicine/index.asp)



## Oxygen Therapy at High Altitudes

### Altitude Effects on the Availability of Oxygen

As altitude increases, barometric pressure decreases. Barometric pressure is the pressure that is exerted by the gases at a given point in the atmosphere, and is the sum of the partial pressures of the component gases. The composition of the atmosphere does not change with altitude, however, the barometric pressure does. As altitude increases, there is a decrease in the partial pressure exerted by each component gas. Thus, as altitude increases, the partial pressure of oxygen in the alveoli decreases. A reduced partial pressure of oxygen results in a relative hypoxia.

The following document is helpful for those planning travel by commercial airline:

#### Transport Canada – “Passengers with Medical Oxygen”

[www.tc.gc.ca/eng/civilaviation/standards/commerce-cabinsafety-tips-tips5-1368.htm#oxygen](http://www.tc.gc.ca/eng/civilaviation/standards/commerce-cabinsafety-tips-tips5-1368.htm#oxygen)

It is also helpful to consult the website of the specific airline that the patient intends to travel with for assistance in planning/arranging air travel when oxygen is required.

#### Did you know...

In the cabin of a typical commercial aircraft, the pressure exerted is equivalent to the barometric pressure at 5000 - 8000 feet above sea level. As a result, patients who require oxygen supplementation at the ground level may require increased supplementation at an increased altitude.

## Assessment of Oxygen Therapy

### Oximetry

Oximetry is the measurement of blood hemoglobin (Hb) saturations using spectrophotometry. Several types of Oximetry are used in clinical practice. The methods most commonly encountered in RT clinical practice include:

- Hemoximetry (also called CO-oximetry) – performed in arterial blood gas analysis.
- Pulse Oximetry - portable, noninvasive monitoring technique

### Pulse Oximetry

Pulse Oximetry provides estimates of arterial blood oxyhemoglobin saturation levels, but as not actual SaO<sub>2</sub> measures. Therefore, pulse oximetry readings are recorded as SpO<sub>2</sub>. Supplemental oxygen should be “prescribed” to a target blood hemoglobin saturation according to the population served and clinical presentation (Kacmarek et al, 2013.)

Pulse oximetry can be performed at rest, exercise, and during activity. The SpO<sub>2</sub> measured with the oximeter is widely used in clinical practice. Some refer to the oxygen saturation as the fifth vital sign. It is important to fully understand the appropriate applications and limitations of this technology.

Guidelines for pulse oximetry are available from the **American Association of Respiratory Care (ARRC)** at: [www.rcjournal.com/cpgs/pulsecpng.html](http://www.rcjournal.com/cpgs/pulsecpng.html)

### Key Points to Remember:

- Follow manufacturers protocol;
- Always use compatible sensors;
- Ensure correct type, size and fit of sensor;
- Confirm adequacy and accuracy of reading (validate with ABG SaO<sub>2</sub> when applicable);
- Adjust alarm according to the clinical situation;
- Apply standard precautions infection control;
- Inspect and change sensor site as needed;
- Never act on SpO<sub>2</sub> alone, reading should reflect the patient's clinical condition; and
- Avoid using pulse oximetry to monitor hyperoxia in neonates.

This CBPG was not meant to be the last resource you will need to access to answer your clinical and professional practice questions. Alternatively, we have provided you with links to other important resources that you may need to access in order to obtain required information. Websites will change and we encourage you to let us know if you are unable to access any of the websites that we have connected you to. This is a “living document” and will have to adapt as the evidence and clinical best practice guidelines change.

We encourage all CRTO Members to be active in the ongoing development of this Oxygen Therapy CBPG and to continue to advocate for safe and ethical practices in your practice environment.

## Glossary

**(ATP) Ambient Temperature and Pressure = (STP) standard temperature and pressure = 0C and 1 atmosphere**

**BTPS = Body Temperature and ambient Pressure Saturated = 37 °C, 1 atmosphere, and 44 mg H<sub>2</sub>O/L**

**Conserving Devices** - How long liquid and cylinder systems last before refilling depends on the amount of oxygen a person uses. Conserving devices extend the length of time. Oxygen systems deliver oxygen continuously during inspiration and exhalation. Conserving devices can be programmed to deliver oxygen during inspiration only, therefore reducing the amount wasted during exhalation.

**Cryogenic Vessel** - A static or mobile vacuum insulated container designed to contain liquefied gas at extremely low temperatures. Mobile vessels could also be known as "**Dewars**". Retrieved from: [www.hc-sc.gc.ca/dhp-mps/compli-conform/gmp-bpf/docs/gui\\_0031\\_tc-tm-eng.php](http://www.hc-sc.gc.ca/dhp-mps/compli-conform/gmp-bpf/docs/gui_0031_tc-tm-eng.php)

**Drug Identification Number (DIN)** - a computer-generated eight digit number assigned by Health Canada to a drug product prior to being marketed in Canada. It uniquely identifies all drug products sold in a dosage form in Canada and is located on the label of prescription and over-the-counter drug products that have been evaluated and authorized for sale in Canada. A DIN uniquely identifies the following product characteristics: manufacturer; product name; active ingredient(s); strength(s) of active ingredient(s); pharmaceutical form; route of administration. Retrieved from: [www.hc-sc.gc.ca/dhp-mps/prodpharma/activit/fs-fi/dinfs\\_fd-eng.php](http://www.hc-sc.gc.ca/dhp-mps/prodpharma/activit/fs-fi/dinfs_fd-eng.php)

**Fractional Distillation** - the process of separating the portions of a mixture by heating it and condensing the components according to their different boiling points. Retrieved from: <http://medical-dictionary.thefreedictionary.com/fractional+distillation>

**Medical gas** - (either a single gas or a mixture of gases) is a gas that requires no further processing in order to be administered, but is not in its final package (e.g., liquefied oxygen) and is known as a bulk gas. Retrieved from: [www.hc-sc.gc.ca/dhp-mps/compli-conform/gmp-bpf/docs/gui\\_0031\\_tc-tm-eng.php](http://www.hc-sc.gc.ca/dhp-mps/compli-conform/gmp-bpf/docs/gui_0031_tc-tm-eng.php)

**Manifold (rampe)** - Equipment or apparatus designed to enable one or more medical gas containers to be filled at a time. Retrieved from: [www.hc-sc.gc.ca/dhp-mps/compli-conform/gmp-bpf/docs/gui\\_0031\\_tc-tm-eng.php](http://www.hc-sc.gc.ca/dhp-mps/compli-conform/gmp-bpf/docs/gui_0031_tc-tm-eng.php)

## References

1. American Association of Respiratory Care. (2002). *AARC Guideline: Oxygen therapy for adults in the acute care facility*. *Respiratory Care*, 47(6). Retrieved from: [www.rcjournal.com/cpgs/pdf/06.02.717.pdf](http://www.rcjournal.com/cpgs/pdf/06.02.717.pdf)
2. American Association of Respiratory Care. (2007). *AARC Guideline: Oxygen therapy in the home or alternative site health care facility*, *Respiratory Care*, 52(1). Retrieved from: [www.rcjournal.com/cpgs/pdf/08.07.1063.pdf](http://www.rcjournal.com/cpgs/pdf/08.07.1063.pdf)
3. Becker, D. E., & Casabianca, A. B. (2009). *Respiratory monitoring: physiological and technical considerations*. *Anesthesia Progress*, 56(1), 14-20. doi: 10.2344/0003-3006-56.1.14.
4. Cairo, J., M. & Pilbeam, S., P., (2004) *Mosby's Respiratory Care Equipment (7th ed.)*. St. Louis, MO: Mosby.
5. Canadian Standards Association. (2006). Z305.12-06 (R2012) - *Safe Storage, Handling, and Use of Portable Oxygen Systems in Residential Buildings and Health Care Facilities*. Retrieved from: <http://shop.csa.ca/en/canada/perioperative-safety/z30512-06-r2012/invt/27004892006/>
6. Gardenshire, D. (2011). *Rau's Respiratory Care Pharmacology. (6th ed.)*. St. Louis, MO: Mosby Inc.
7. Kacmarek, R. M., Stoller, J.K. Heuer, A. J. (2013). *Egan's Fundamentals of Respiratory Care. (10th ed.)*. St. Louis, MO: Mosby.
8. Mariciniuk, D. D., Goodridge, D., Hernandez, P., Rucker, J., Balter, M., Bailey, P., Brown, C. (2011). *Managing dyspnea in patients with advanced chronic obstructive pulmonary disease: A Canadian Thoracic Society clinical practice guideline*. *Canadian Respiratory Journal*, 18(2), 69–78. Retrieved from [www.ncbi.nlm.nih.gov/pmc/articles/PMC3084418/](http://www.ncbi.nlm.nih.gov/pmc/articles/PMC3084418/)
9. O'Driscoll, B. R., Howard, L. S., & Davison, A. G. (2008). *BTS guideline for emergency oxygen use in adult patients*. *British Thoracic Society*, 36(6), vi1-68, doi: 10.1136/thx.2008.102947
10. Sackett, D., Rosenberg, W., Gray, J., Haynes, R., & Richardson, W. (1996). *Evidence-based medicine: what it is and what it isn't*. *British Medical Journal*, 312, 71-72. Retrieved from: [www.bmj.com/cgi/content/full/312/7023/71](http://www.bmj.com/cgi/content/full/312/7023/71)





College of Respiratory  
Therapists of Ontario

---

Ordre des thérapeutes  
respiratoires de l'Ontario

This Clinical Best Practice Guideline will be updated as new evidence emerges or as practice evolves. Comments on this guideline are welcome and should be addressed to:

**Manager, Quality Practice**

College of Respiratory Therapists of Ontario  
180 Dundas Street West, Suite 2103  
Toronto, Ontario  
M5G 1Z8

Tel (416) 591 7800  
Fax (416) 591-7890

Toll Free 1-800-261-0528  
Email [questions@crto.on.ca](mailto:questions@crto.on.ca)

[www.crto.on.ca](http://www.crto.on.ca)