

<p>CEMP-R Engineer Manual 1110-1-4010</p>	<p>Department of the Army U.S. Army Corps of Engineers Washington, DC 20314-1000</p>	<p>EM 1110-1-4010 1 June 1999</p>
	<p>Engineering and Design MULTI-PHASE EXTRACTION</p>	
	<p>Distribution Restriction Statement Approved for public release; distribution is unlimited.</p>	



EM 1110-1-4010

1 June 1999

US Army Corps
of Engineers®

ENGINEERING AND DESIGN

Multi-Phase Extraction

This manual is approved for public release, distribution is unlimited.

ENGINEER MANUAL

AVAILABILITY

Electronic copies of this and other U.S. Army Corps of Engineers (USACE) publications are available on the Internet at: <http://www.usace.army.mil/inet/usace-docs/>. This site is the only repository for all official USACE engineer regulations, circulars, manuals, and other documents originating from HQUSACE. Publications are provided in portable document format (PDF).

DEPARTMENT OF THE ARMY
U.S. Army Corps of Engineers
Washington, D.C. 20314-1000

EM 1110-1-4010

CEMP-R

Manual
No. 1110-1-4010

1 June 1999

Engineering and Design
MULTI-PHASE EXTRACTION

- 1. Purpose.** This Engineer Manual (EM) is intended to provide detailed guidance on all phases of remediation projects involving Multi-phase Extraction (MPE). This includes guidance on (1) the appropriate site characterization and pilot studies for MPE; (2) appropriate considerations in screening MPE for a site; (3) design of subsurface and above-ground components (excluding off gas and water treatment systems); and (4) start-up, operations and maintenance, and site closure.
- 2. Applicability.** This EM applies to all USACE commands having Civil Works and/or Military Programs hazardous, toxic, or radioactive waste (HTRW) responsibilities.
- 3. References.** References are provided in Appendix A.
- 4. Distribution Statement.** Approved for public release, distribution is unlimited.
- 5. Discussion.** MPE is natural but rapidly evolving outgrowth of both traditional ground water extraction and dewatering technology and the innovative soil vapor extraction technology. The manual focuses on the underlying physical/chemical processes (and related technology screening issues) that determine the success or failure of the technology at a site. In many cases, MPE has been misapplied because of a poor understanding of these fundamentals. Designers and decision-makers should use this manual to guide them through the early site characterization and technology screening phases of MPE projects. The design and operational guidance contained herein should be considered, to the extent applicable to a specific project, as good MPE practice by both designers and reviewers. The MPE technology is still maturing and designers are encouraged to monitor future developments using some of the resources provided in this manual.

FOR THE COMMANDER:

4 Appendices
App A - References
App B - Index
App C - Glossary
App D - Symbols

RUSSELL L. FUHRMAN
Major General, USA
Chief of Staff

Engineering and Design
MULTI-PHASE EXTRACTION

Table of Contents

Subject	Paragraph	Page
CHAPTER 1 INTRODUCTION		
Purpose	1-1	1-1
Applicability	1-2	1-1
References	1-3	1-1
Background	1-4	1-2
EM Scope	1-5	1-4
EM Organization	1-6	1-4
Resources	1-7	1-4
CHAPTER 2 TECHNOLOGY DESCRIPTION AND UNDERLYING PHYSICAL PROCESSES		
Introduction	2-1	2-1
Description of MPE Technologies and Application Strategies	2-2	2-1
General Concepts	2-3	2-4
Fundamentals of Multiphase Flow in Porous Media	2-4	2-12
Response of NAPL, Water, and Air to Vacuum	2-5	2-26
Fate Mechanisms for NAPL in the Subsurface	2-6	2-37
CHAPTER 3 SITE CHARACTERIZATION AND FEASIBILITY EVALUATIONS		
Introduction	3-1	3-1
Data Collection Requirements for Technology Screening	3-2	3-1
Site Conditions	3-3	3-1
Physical Properties	3-4	3-5
Chemical/Contaminant Analyses	3-5	3-10
Evaluation of Biological Degradation Potential	3-6	3-31
Checklist of Site Characterization Data	3-7	3-33

<u>Subject</u>	<u>Paragraph</u>	<u>Page</u>
Remedial Technology Options	3-8	3-35
Feasibility Studies for MPE	3-9	3-47
 CHAPTER 4 PILOT-SCALE TESTS		
Introduction	4-1	4-1
Pilot Testing Guidance	4-2	4-1
Field Criteria for Evaluating MPE Feasibility Based on a Pilot Test	4-3	4-26
 CHAPTER 5 DESIGN OF FULL-SCALE MPE SYSTEMS		
Introduction	5-1	5-1
MPE Design Strategy	5-2	5-2
Design Guidance - Subsurface	5-3	5-5
Modeling	5-4	5-20
Multi-Phase Extraction System Well Construction and Specifications	5-5	5-28
Piping and Above-Ground Equipment	5-6	5-37
Instrumentation and Process Controls	5-7	5-60
Electrical Requirements	5-8	5-64
Waste Stream Treatment Options	5-9	5-68
Other System Appurtenances and Design Considerations	5-10	5-70
 CHAPTER 6 DESIGN DOCUMENTATION		
Introduction	6-1	6-1
Drawings	6-3	6-1
Specifications	6-3	6-2
 CHAPTER 7 CONSTRUCTION, START-UP & GENERAL OPERATIONS AND MAINTENANCE		
Introduction	7-1	7-1
Construction Oversight	7-2	7-1
Collection of Baseline Data	7-3	7-1
Equipment Shakedown/Testing	7-4	7-5
System Start-Up	7-5	7-7
Operations, Maintenance and Monitoring	7-6	7-17

<u>Subject</u>	<u>Paragraph</u>	<u>Page</u>
CHAPTER 8 SYSTEM SHUTDOWN AND CONFIRMATION OF CLEANUP		
Introduction	8-1	8-1
Shutdown Strategy	8-2	8-1
Shutdown Guidance	8-3	8-4
CHAPTER 9 OTHER ISSUES		
Introduction	9-1	9-1
Legal and Regulatory	9-2	9-1
Patent Issues	9-3	9-1
Health and Safety	9-4	9-4
APPENDIX A. REFERENCES		
APPENDIX B. INDEX		
APPENDIX C. GLOSSARY		
APPENDIX D. SYMBOLS		

	<u>Subject</u>	<u>Page</u>
LIST OF TABLES		
TABLE	2-1 Free Product Recovery and Control Systems and Equipment	2-9
	2-2 Physical Properties of Selected Compounds	2-24
	2-3 Approximate Air Emergence Pressure and Effective Height of Capillary Fringe by Soil Textural Class	2-34
	3-1 Checklist of Site Characterization Data Needs for Technology Screening	3-4
	3-2 Soil Physical Parameters	3-6
	3-3 Ranges of Residual LNAPL Concentrations in the Unsaturated Zone	3-14
	3-4 LNAPL Physical and Compositional Analysis	3-16
	3-5 Pure Compound Solubilities at ~20°C for Selected Chlorinated Organic Solvents and Corresponding Maximum Concentration Limits (MCLs) for Drinking Water Set by USEPA	3-18
	3-6 Soil Sampling: Preservation Requirements/Recommended Analytical Methods	3-21
	3-7 Soil Gas Sampling/Analytical Methods	3-26
	3-8 Groundwater Sampling: Preservation Requirements/ Appropriate Analytical Methods	3-27
	3-9 Chemical Parameter/Purpose of Analysis	3-29
	3-10 Checklist of Site Characterization Data	3-34
	3-11 Advantages and Disadvantages of Conventional Liquid Hydrocarbon Recovery Systems	3-35
	3-12 LNAPL Pumping System Versus Recommended Operational Range	3-36
	4-1 Data Collection and Purpose of Collection During MPE Pilot Tests	4-13
	4-2 Overview of Example Sites	4-16
	4-3 Example Table (Fluid Data)	4-17
	4-4 Example Table (Air Data)	4-18
	4-5 Operating Conditions Data Summary for OU 18 Shallow Well Pilot Test	4-19
	4-6 MPE Pilot Test Site Conditions	4-27
	4-7 MPE Pilot Test Operating Conditions and Results	4-28
	4-8 Bioslurper Comparative Fuel Recovery Rates and Bioventing Feasibility Study	4-29
	5-1 Model Simulation of LNAPL Recovery by MPE: Parameters Common to Each Simulation	5-16
	5-2 Model Simulation of LNAPL Recovery by MPE: Parameters Varied	5-17

LIST OF TABLES (Continued)

	<u>Subject</u>	<u>Page</u>
5-3	Multi-Phase Flow Models	5-21
5-4	Classification of Multi-phase Flow Models	5-24
5-5	Multi-Phase Model Classifications Applicable to Specific Remedial Scenarios	5-24
5-6	Physical Properties of Common MPE Piping Materials	5-38
5-7	NEMA Enclosure Classifications	5-65
5-8	Motor Enclosures & Typical Uses	5-66
5-9	Utilization Voltages	5-67
7-1	Checklist of Baseline Data to Consider Collecting	7-2
7-2	Example Pre-Commissioning/Shakedown Checklist	7-6
7-3	Suggested Sequence of Operations During Start-up	7-9
7-4	Suggested Checklist for Monitoring an MPE System	7-10
7-5	Suggested Operational Performance Checklist	7-15
7-6	Field Troubleshooting Guide	7-20
7-7	Operational Strategy Guide	7-22
7-8	Routine MPE Equipment Maintenance Activities	7-25
7-9	Checklist of Items to Consider for Long-Term Monitoring	7-25

LIST OF FIGURES

Figure	2-1	Schematic of DPE System	2-2
	2-2	Schematic of a TPE System	2-2
	2-3	Bioslurper System	2-3
	2-4	Simplified Conceptual Model for LNAPL Release and Migration	2-4
	2-5	Distribution of Phases in the Subsurface	2-6
	2-6a	Conventional LNAPL Recovery Using Single-Pump System	2-7
	2-6b	Conventional LNAPL Recovery Using Two-Pump System	2-8
	2-7	Pneumatic Skimming Pump	2-8
	2-8	Schematic of Vacuum Effect on Perched Hydrocarbons	2-11
	2-9	Typical curves showing the relationship between capillary pressure and volumetric water content	2-16
	2-10	Capillary Pressure Head-Saturation Curves and Relative Air Permeability	2-17

LIST OF FIGURES (Continued)

	<u>Subject</u>	<u>Page</u>
2-11	a) The contact angle of a drop resting upon a plane solid surface; b) Hypothetical pore cross section with two fluids	2-25
2-12	MPE Flow Regimes	2-28
2-13	Air-Entry Pressure versus Air Emergence Pressure	2-30
2-14	Predicted Water Retention Curve and Data Points for a Silt Loam	2-31
2-15	Hypothetical scenarios that can prevail during MPE	2-33
2-16	Preferential Airflow into MPE Well from a Layered Soil	2-36
2-17	Relative Oil Mobility Versus Apparent Oil Thickness for Two Soils	2-38
3-1a	Technology Screening Matrix - Vacuum-Enhanced LNAPL (Free Product) Recovery	3-2
3-1b	Technology Screening Matrix - Vacuum-Enhanced SVE/BV	3-3
3-2	Relative vertical distribution of apparent LNAPL thickness, H_o , in a monitoring well versus true LNAPL thickness, V_o , at equilibrium	3-12
3-3	Results from Controlled Spill Experiments	3-19
3-4	Various conditions under which DNAPL may accumulate and be identifiable in a monitoring well	3-20
3-5a	VOC Sampling/Preservation Flow Chart	3-24
3-5b	VOC Sampling/Preservation Flow Chart	3-25
3-6	Trench and Drain LNAPL Recovery System	3-37
4-1	Dual-Phase Extraction Well	4-3
4-2	Two-Phase Extraction Well	4-4
4-3	Process Flow Diagram of TPE Pilot Study Equipment	4-5
4-4	Piezometric Surface Under Application of MPE	4-10
4-5	Moisture Profiles at LCAAP	4-11
4-6	Transient Vacuum Propagation	4-14
4-7	Example Field Data Collection Sheet	4-15
4-8	Example Graph (Liquid Recovery) MA Industrial Site	4-21
4-9	Example Graph (Vacuum Influence Data) Squibb Mfg. Site, PR	4-22
4-10	Example Graph (Vacuum Influence Data) LCAAP	4-23
4-11	Example Graph: Groundwater Depression During Bioslurping Pilot Test Squibb Mfg. Site, PR	4-24
4-12	Example Graph: LCAAP Area 18 Shallow Well Pilot Test Groundwater Depression	4-25

LIST OF FIGURES (Continued)

	<u>Subject</u>	<u>Page</u>
4-13	Example Graph: Fuel Recovery versus Time throughout the Bioslurper Pilot Test Performed by AFCEE at Johnston Atoll	4-30
5-1	Piping and Instrumentation Diagram of Two-Phase Extraction System	5-2
5-2	Piping and Instrumentation Diagram of a Dual-Phase Extraction System	5-3
5-3	Example vacuum distribution curves using the pseudo steady-state solution to the 1-D flow equation	5-10
5-4	Example drawdown curves using the Cooper and Jacob approximation to the Well Equation	5-11
5-5	Example of a changing capillary fringe during MPE as described by the superposition of vacuum distribution and drawdowns	5-12
5-6	LNAPL Recovery versus Time for Various Drawdowns and for Vacuum-Enhanced Recovery with Drawdown	5-14
5-7	Predicted time to 0.3 meter (1-foot) LNAPL remediation vs. applied vacuum head for various LNAPL and soil types	5-15
5-8	Predicted long-term average flow rates from a single well at various applied vacuums and a drawdown of 1 meter (3 feet)	5-18
5-9	Multi-phase Extraction Well Detail	5-29
5-10	Typical Two-Phase Extraction System Piping Manifold	5-42
5-11	a) Typical Liquid Ring Pump b) Typical Rotary Vane Pump c) Typical Ejector d) Typical Rotary Piston Pump e) Typical Rotary Lobe Blower f) Typical Regenerative Blower	5-50
5-12	Comparison of Air Flow vs. Vacuum for Various Types of Vacuum Pumps	5-51
5-13	Optimal MPE Equipment for Varying Hydraulic Conductivities	5-52
8-1	Closure Data Evaluation Decision Matrix	8-2

CHAPTER 1

INTRODUCTION

1-1. Purpose.

a. **Multi-Phase Extraction.** Multi-Phase Extraction (MPE) is a rapidly emerging, in-situ remediation technology for simultaneous extraction of vapor phase, dissolved phase and separate phase contaminants from vadose zone, capillary fringe, and saturated zone soils and groundwater. It is a modification of soil vapor extraction (SVE) and is most commonly applied in moderate permeability soils.

b. **Engineer Manual.** This Engineer Manual (EM) provides practical guidance for evaluation of the feasibility and applicability of MPE for remediation of contaminated soil and groundwater and describes design and operational considerations for MPE systems. The document is primarily intended to set USACE technical policy on the use of the technology and to help prevent incorrect MPE application or its use in inappropriate settings. By setting out technically sound design principles, it will be useful to engineers, geologists, and project managers involved with subsurface remediation. It is meant to be a companion manual to the Soil Vapor Extraction and Bioventing (EM 1110-1-4001, 30 November 1995) and the In-Situ Air Sparging (EM 1110-1-4005, 16 June 1997) EMs, which will be referenced as appropriate. Many of the aboveground design aspects of MPE and SVE are similar.

1-2. Applicability. This EM applies to all United States Army Corps of Engineers (USACE) commands having civil works and/or military programs hazardous, toxic, or radioactive waste (HTRW) responsibilities.

1-3. References.

a. This EM (Baker and Becker 1999) covers all aspects of MPE but cannot include detailed discussion of all MPE issues. Where engineering design is similar to SVE, the two related EMs referenced above will be very useful. There are other publications that summarize or give detailed insights into important aspects of MPE. An extensive list and reference details are provided in Appendix A. The following references are suggested as key supplementary sources of information on MPE:

Subject

Technology Overview

Important Physical, Biological and Chemical Parameters

Reference

Blake and Gates 1986
Kittel et al. 1994
Leeson et al. 1995
Baker 1995
Keet 1995
USEPA 1995
API 1996
USEPA 1997a

Farr et al. 1990
Lenhard and Parker 1990
Newell et al. 1995
Pankow and Cherry 1996
Hillel 1998

Subject

Reference

Pilot Testing and Design

USEPA 1996a
Parker et al. 1996
Battelle 1997
Baker and Groher 1998

Modeling

Parker 1989
Parker 1995
Parker et al. 1996
Beckett and Huntley 1998
Ruiz et al. 1997

Equipment Specification and Operation

Crane Valve Co. 1988
Hydraulic Institute 1991
Hydraulic Institute 1994
Karassik et al. 1986
Perry and Green 1984
Suthersan 1997

Evaluation of System Performance

Kittel et al. 1997
Baker and Groher 1998

b. Periodicals. Periodicals that occasionally feature articles on MPE and related technologies include:

- Ground Water (Association of Ground Water Scientists and Engineers).
- Ground Water Monitoring and Remediation (Association of Ground Water Scientists and Engineers).
- Pollution Engineering (Cahners Business Information Division of Reed Elsevier, Inc.).
- Pumps and Systems (AES Marketing, Inc.).

1-4. Background.

a. In-situ soil and groundwater remediation techniques are being relied on more and more frequently as methods that are less expensive than excavation and that do not simply move the contamination to another location. However, the limitations of many solitary in-situ technologies are becoming more apparent, especially longer-than-expected remediation times. In addition, solitary technologies may only treat one phase of the contamination when, in fact, the contamination is often spread through multiple phases and zones. For example, SVE and bioventing treat only the vadose zone and groundwater pump-and-treat removes dissolved material only from the saturated zone. Most separate (free) phase [Lighter (than water) Non-Aqueous Phase Liquid (LNAPL)] recovery systems rely on gravity alone to collect and pump the LNAPL. In contrast, MPE can extract:

- Groundwater containing dissolved constituents from the saturated zone.
- Soil moisture containing dissolved constituents from the unsaturated zone.
- LNAPL floating on the groundwater.
- Non-drainable LNAPL in soil.
- Perched or pooled Dense Non-Aqueous Phase Liquid (DNAPL), under some conditions.
- Soil gas containing volatile contaminants.

It is therefore a technology that finds its widest use in source areas.

b. In general, MPE works by applying a high vacuum (relative to SVE systems) to a well or trench that intersects the vadose zone, capillary fringe and saturated zone. Because the resulting subsurface pressure is less than atmospheric, groundwater rises and, if drawn into the well, is extracted and treated aboveground before discharge or reinjection. If liquid and gas are extracted within the same conduit (often called a suction pipe or drop tube), this form of MPE is often called "bioslurping" (when used for vacuum-enhanced LNAPL recovery), or "two-phase extraction" (TPE, often when used to address chlorinated solvents). If separate conduits for vapor and liquids are used, some call the technology "dual-phase extraction" (DPE). (These terms, "two-phase extraction" and "dual-phase extraction" more commonly refer to situations where there is no LNAPL.) LNAPL floating on the water table will also flow into the well screen and be removed. Due to the imposed vacuum, soil moisture and NAPL retained by capillary forces within the soil can, to some degree, also move to the well for collection and removal. The groundwater level may be lowered, thereby creating a larger vadose zone that can be treated by the SVE aspect of MPE. The soil gas that is extracted is, if necessary, conveyed to a vapor-phase treatment system (i.e., activated carbon, catalytic oxidation, etc.), prior to its discharge.

c. Because air movement through the unsaturated zone is induced during MPE, oxygen can stimulate the activity of indigenous aerobic microbes, thereby increasing the rate of natural aerobic biodegradation of both volatile and non-volatile hydrocarbon contamination.

d. MPE is being evaluated by several departments of the U.S. government. USEPA's Superfund Innovative Technology Evaluation (SITE) program is supporting a study of bioslurping by Battelle Memorial Institute, Columbus, OH, at a fuel tank farm. The U.S. Air Force "recommends MPE as a potentially valuable enhancement for the SVE option under the presumptive remedy for sites with volatile organic compounds (VOCs) in soil" (USEPA 1997a). In 1997, the USEPA issued "[Presumptive Remedy: Supplemental Bulletin on MPE Technology for VOCs in Soil and Groundwater](#)" (USEPA 1997a).

e. The application of MPE began the first time that either groundwater or LNAPL was extracted by a vacuum. Vacuum was applied to oil wells in the 1860s to improve LNAPL recovery from subsurface reservoirs (Lindsley 1926). One of

the first mentions of MPE as a new remediation technology appears to be by Blake and Gates (1986). At this time, MPE is utilized less often than the more established in-situ techniques such as SVE, bioventing and air sparging. The use of MPE as a deliberately applied remediation technology is expected to increase.

f. Critical aspects that govern the effectiveness of an MPE system are being researched and reported in conference proceedings and technical journals (some shown above). Innovative field techniques, such as neutron probe measurements and recoverable free phase product estimates, are refining the ability to measure the effective zone of influence (ZOI). It is anticipated that as more field data become available, the understanding of the mechanisms and processes induced by MPE will increase, as well as the ability to predict and measure its effectiveness.

g. One of the difficulties encountered with MPE is the tendency to form emulsions of LNAPL and groundwater that may need to be "broken" or separated before subsequent treatment or disposal.

1-5. EM Scope. As mentioned in paragraph 1-1b, the primary focus of this EM (Baker and Becker 1999) is to provide guidance for assessing the feasibility and applicability of MPE. The EM is also meant to assist engineering and technical staff experienced in remediation design to develop MPE design, including construction drawings and specifications. Because MPE technology is still evolving, this EM is intended to consolidate existing guidance and to stimulate the acquisition and reporting of new information that will continue to refine the technology. Although computer modeling is discussed, exhaustive coverage of analytical and numerical modeling of the processes occurring during MPE is beyond the scope of this EM. The reader should keep in mind that the use of MPE as a site remediation tool is a relatively new technology. Design and operation are highly dependent on site conditions, and designs will improve as more information becomes available and more experience is shared.

1-6. EM Organization. This EM is structured to show the progression from initial technology selection through testing, design, implementation and closure. Following this introductory chapter, Chapter 2 provides a more detailed description of MPE and its underlying physical processes. Recommendations for site characterization and feasibility evaluations are presented in Chapter 3. Strategy and guidance for pilot-scale testing are provided in Chapter 4, and full-scale design considerations are presented in Chapter 5. Chapter 6 provides guidance on preparing design documents and specifications. Issues associated with system start-up and long-term operation and maintenance are discussed in Chapter 7, and system shutdown procedures and confirmation of clean-up are introduced in Chapter 8. Chapter 9 presents other administrative issues associated with implementing MPE. Finally, Appendix A provides references cited in this document.

1-7. Resources.

a. Numerous resources are available to assist the designer in assessing the feasibility of MPE and designing an effective system. Resources include models for system design and optimization, technical journals that summarize case studies and recent technical developments, and electronic bulletin boards and databases that provide access to regulatory agency, academic, and commercial sources of information.

b. At this time, there are few computer models written specifically for MPE applications. Existing, related models, which are discussed in [paragraph 5-4](#), range from commercially available software to complex computer code requiring substantial computing ability. These models help the designer to understand what will occur relative to pressure distributions and subsurface flow when vacuums are applied. Modeling can be used to design a pilot test; optimize placement of MPE wells in a multiwell field; and estimate extracted liquid and vapor flow rates that determine the sizes of aboveground extraction and treatment equipment.

c. A table of federal bulletin boards and databases that contains information on SVE and bioventing (BV) is presented in the USACE Soil Vapor Extraction and Bioventing Engineer Manual ([EM 1110-1-4001](#)). The majority of these electronic resources also now contain some information on MPE. The following list gives a description and associated universal resource locator (URL) of several of these bulletin boards and/or databases that can be found on the World Wide Web.

- The Federal Remediation Technologies Roundtable (<http://www.frtr.gov>): Remediation Technologies Screening Matrix and Reference Guide, 3rd Edition.
- CLU-IN (<http://clu-in.org>): Hazardous Waste Clean-Up Information System provides information about innovative treatment technologies.
- REACH-IT (<http://www.epareachit.com>): Remediation and Characterization Innovative Technologies.
- TechDirect (<http://www.epa.gov/swertio1/techsub.htm>): Technology Information Service that highlights new publications and events of interest on site remediation and assessment.
- BioGroup (<http://biogroup.gzea.com>): Bioremediation Discussion Group.
- ATTIC (<http://www.epa.gov/gils/records/a00194.html>): Alternative Treatment Technology Information Center.
- Fielding Environmental Solutions (<http://aec-www.apgea.army.mil:8080/prod/usace/et/listweb.htm>): U.S. Army Environmental Center's (USAEC) Pollution Prevention and Environmental Technology Division (P2&ETD) site that provides information on recently published documents, field demonstrations of innovative technologies, and technology transfer efforts of the P2&ETD.
- GLOBALtechs (<http://www.globaltechs.com>): Online Site Remediation Technologies Directories.
- DNAPL in Groundwater Research Group (<http://civil.queensu.ca/environ/groundwater/refereed.htm>).

EM 1110-1-4010
1 Jun 99

- US Army Corps of Engineers TechInfo
(<http://www.hnd.usace.army.mil/techinfo/index.htm>): provides links to USACE publications and specifications.
- EPA Remediation Technologies Publications
(<http://www.epa.gov/swertiol/pubitech.htm>).

CHAPTER 2

TECHNOLOGY DESCRIPTION AND UNDERLYING PHYSICAL PROCESSES

2-1. Introduction. This chapter presents an overview and general description of dual-phase extraction and two-phase extraction, the latter of which includes a related technology, bioslurping. The three main strategies for applying MPE that will be discussed are: a) vacuum-enhanced recovery of NAPL, b) vacuum dewatering to enable SVE and/or BV to remove and/or treat organic contaminants via the gas phase, and c) vacuum-enhanced recovery of groundwater. This chapter also presents a review of the fundamentals of multiphase flow in porous media, and an assessment of the effectiveness and limitations of the technologies.

2-2. Description of MPE Technologies and Application Strategies.

a. Technology Definitions and Descriptions. MPE comprises a generic category of in-situ remediation technologies that simultaneously extract more than one fluid phase from wells or trenches. These phases generally include air (i.e., gaseous phase including organic vapor) and water (i.e., aqueous phase including dissolved constituents), and may include NAPL. The terminology presented by EPA (1997a), which distinguishes between dual-phase and two-phase extraction technologies, is as follows:

(1) In dual-phase extraction (DPE), soil gas and liquids are conveyed from the extraction well to the surface in separate conduits by separate pumps or blowers. A common "pipe within a pipe" configuration is depicted in Figure 2-1. It shows that a submersible pump suspended within the well casing extracts liquid, which may be NAPL and/or groundwater, and delivers it through a water extraction pipe to an aboveground treatment and disposal system. Soil gas is simultaneously extracted by applying a vacuum at the well head. The extracted gas is, in turn, conveyed to a gas-liquid separator prior to gas phase treatment. DPE is in essence a rather straightforward enhancement of SVE, with groundwater recovery being carried out within the SVE well. Other DPE configurations are also common, such as use of suction (e.g., exerted by a double-diaphragm pump at the ground surface) to remove liquids from the well, rather than a submersible pump (Blake and Gates 1986). A line-shaft turbine pump could also be employed to remove liquids from the well, provided the water table is shallow enough.

(2) In two-phase extraction (TPE), soil gas and liquid are conveyed from the extraction well to the surface within the same conduit, which has been referred to with various names including drop tube, slurp tube, stinger, lance, or suction pipe. A single vacuum source (vacuum pump or blower) is used to extract both liquid and gaseous phases. A common configuration is depicted in Figure 2-2. The suction pipe suspended within the well casing can extract a combination of NAPL and/or groundwater, and soil gas. These phases are conveyed to an aboveground gas-liquid separator. If extraction of NAPL is anticipated, an oil-water separator may be installed downstream of the gas-liquid separator.

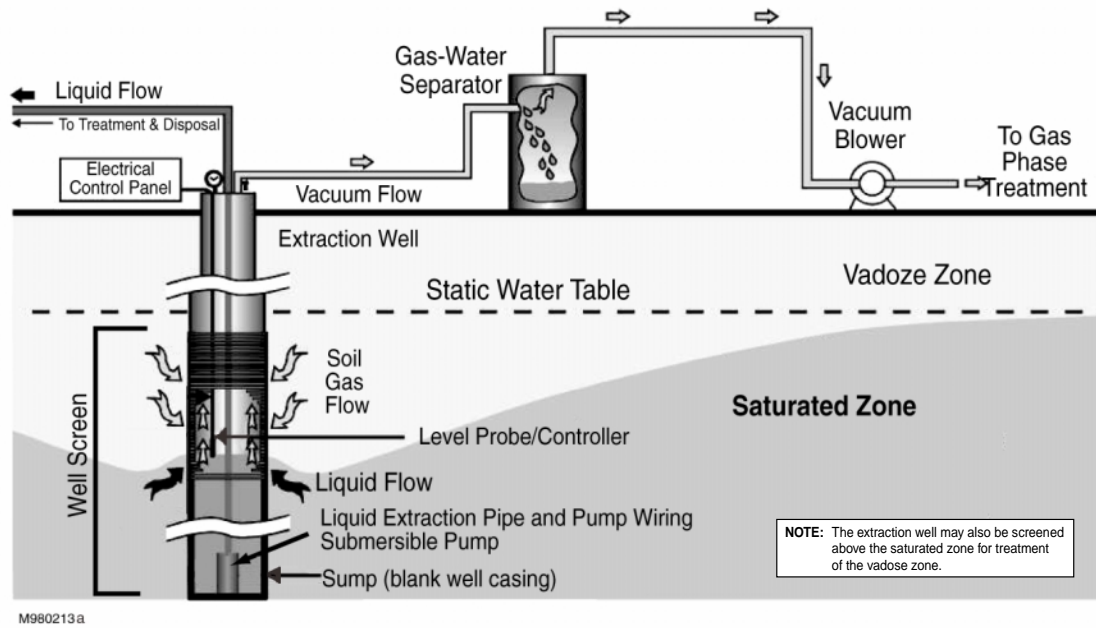

Figure 2-1. Schematic of DPE System (Low Vacuum, or High Vacuum).
 (After EPA 1997)

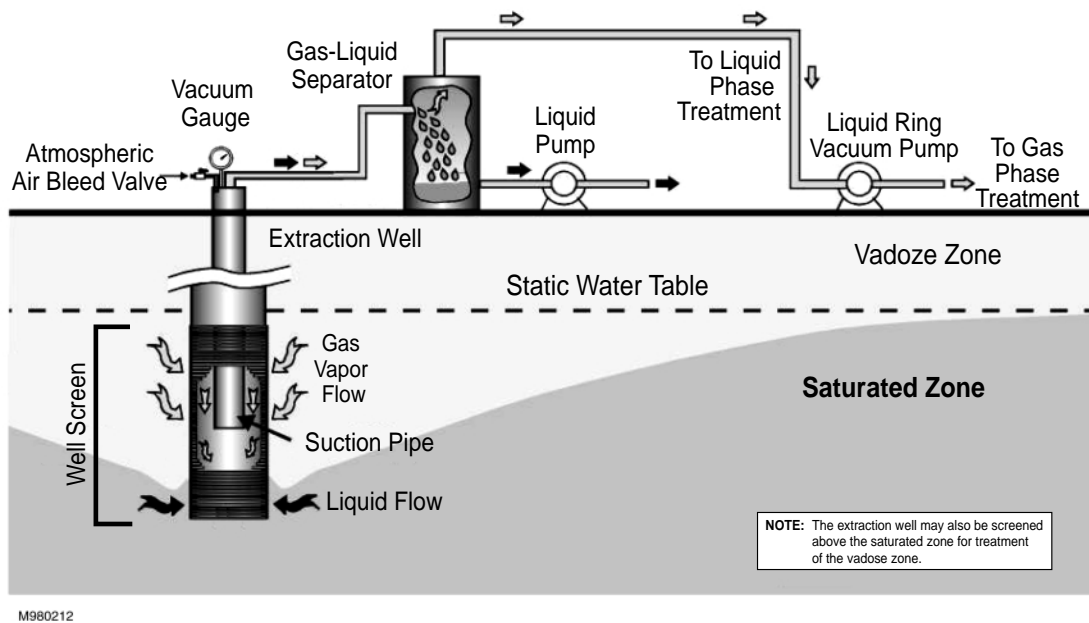

Figure 2-2. Schematic of a TPE System. After EPA 1997)

(3) Bioslurping is a form of TPE that aims to enhance the recovery of LNAPL, while also stimulating BV within the unsaturated zone (AFCEE 1994a; Kittel et al. 1994; AFCEE 1997). A bioslurper uses a suction tube positioned at the LNAPL-water interface to induce a pressure gradient causing water, LNAPL and gas to flow into the well (Figure 2-3). As with TPE, water and/or LNAPL that is drawn into the well is lifted and conveyed to a gas-liquid separator. The liquid phase is subsequently conveyed to an oil-water separator. Bioslurping systems are designed and operated in a manner that maximizes LNAPL recovery while minimizing groundwater and gas-phase recovery. Therefore, the BV aspect of bioslurping is less important than the primary objective of enhancing free-product recovery.

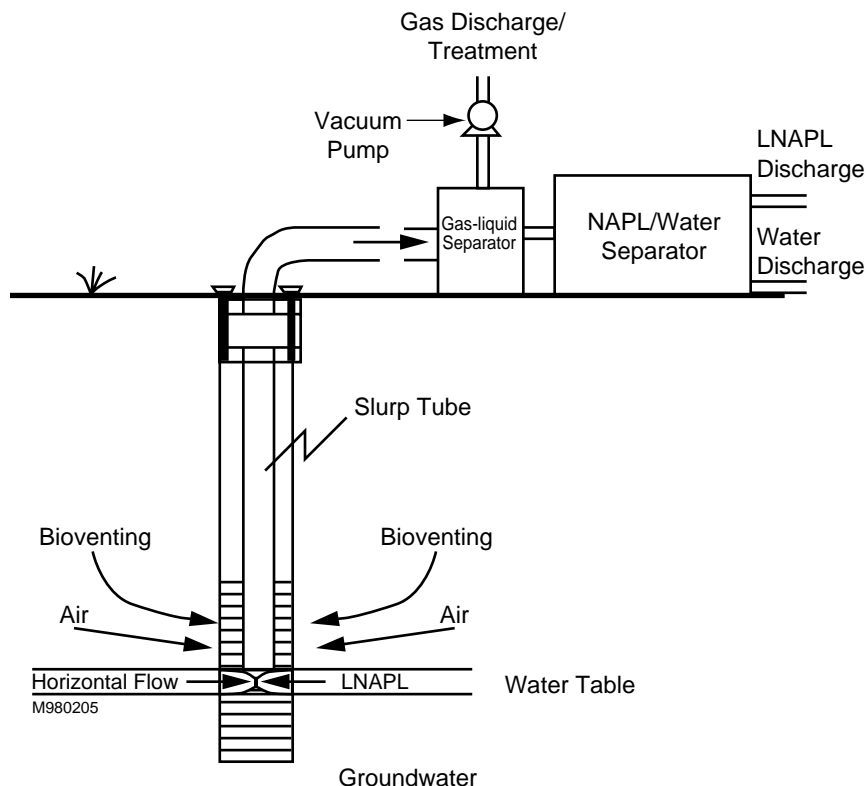

Figure 2-3. Bioslurper System. (After AFCEE 1994b)

b. MPE Application Strategies. One generally chooses MPE to enhance the extraction of one or more of the following phases:

- NAPL, to accomplish free product recovery.
- Soil gas, to accomplish mass reduction through SVE or BV in soils having low air permeabilities.
- Groundwater, to improve pump-and-treat yields. (This objective is the least common of the three.)

(1) These application strategies may be pursued separately or in combination. For example, a reason for implementing MPE may be to accomplish

contaminant mass removal from saturated zones via both gas- and liquid-phase extraction; another may be to improve mass removal from the vadose zone primarily via gas-phase extraction.

(2) One should decide at the outset which strategy is being pursued, because efforts to achieve more than one simultaneously can sometimes be at cross-purposes. For example, an extraction system designed to optimize the recovery of NAPL will probably not be optimal from the standpoint of recovering soil water to enhance SVE. Conversely, a system designed to enhance SVE will probably not do an optimal job of extracting NAPL. In the case of bioslurping, however, both NAPL extraction and BV can be conducted quite compatibly. The ramifications of these differing goals will become clear in subsequent sections.

2-3. General Concepts.

a. Introduction to NAPL and its Transport through Porous Media.

(1) Commercial, industrial and military facilities often use fuels, solvents or other organic chemicals. In the course of transporting, using or storing organic liquids, many of these facilities have experienced releases to soil and groundwater. For example, of the 2 million underground storage tanks (USTs) in the U.S., approximately 295,000, or more than 15 percent were reported to be leaking (USEPA 1993a). Following a spill or release from such storage tanks, piping, and related equipment, many organic contaminants such as those in fuels and solvents enter the soil as oily liquids (Figure 2-4). Because these compounds are not highly soluble in water, they are often present as an immiscible (non-aqueous) phase. This separate liquid phase persists when in contact with water and can serve as a long-term source of groundwater contamination. We term such a fluid a NAPL. We further distinguish between NAPL that has a density less than water (such as gasoline or fuel oil) and one that is more dense than water (e.g., a chlorinated solvent such as trichloroethene) by terming the former a light NAPL (LNAPL), and the latter a dense NAPL (DNAPL).

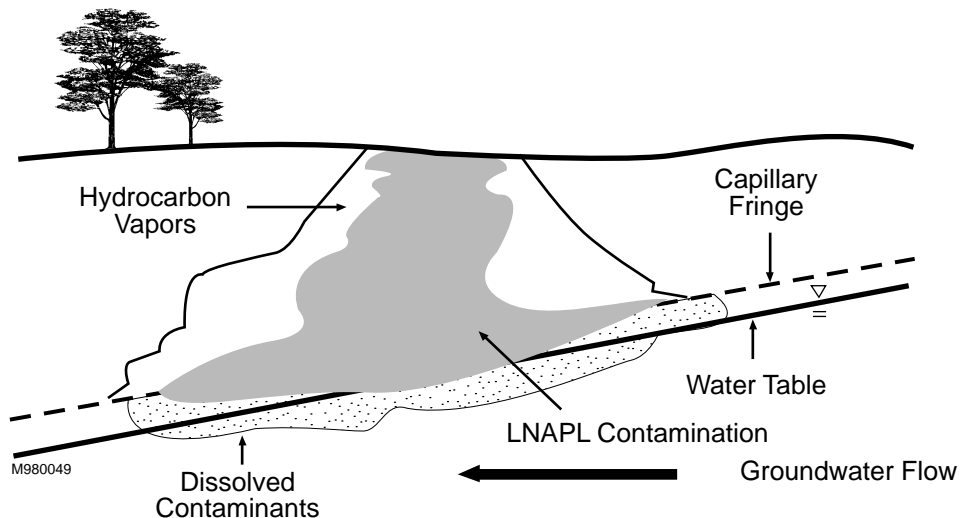

Figure 2-4. Simplified Conceptual Model for LNAPL Release and Migration. (After Newell et al. 1995)

(2) LNAPL poured into a container of water will, at equilibrium, float on the water surface; DNAPL, by contrast, will sink to the bottom of the container. The behavior of NAPL in porous media is more complex, however. When NAPL is released in unsaturated soil, it infiltrates downward under the influence of gravity, and depending on the volume of NAPL that is released, it will proceed toward the water table. As it infiltrates, a fraction of the mass will be left behind, retained by capillary forces of adhesion and cohesion, in the form of globules and ganglia occupying the soil pores and adsorbed to soil particles. This residual NAPL saturation thereby depletes the contiguous NAPL mass until it can infiltrate no further. An encounter with a low permeability layer can also impede its progress. If LNAPL arrives at the capillary fringe above the water table, its buoyancy will limit its further downward migration, but as it accumulates it will hydrostatically depress the capillary fringe and the water table to a certain extent and may move laterally as well (After Mercer and Cohen 1990). Due to its greater density, DNAPL that arrives at the capillary fringe can exert pressures in excess of pore pressures. DNAPL can penetrate the water table and proceed to displace water and infiltrate to greater depths. DNAPL too will deplete itself as it infiltrates, and its movement will be impeded by low permeability layers or bedrock fractures with small apertures. Even so, DNAPL has penetrated to significant depths beneath the water table and within fractured bedrock at many sites (Pankow and Cherry 1996).

b. Contaminant Phase Distribution. Residual or mobile NAPL residing in the subsurface, whether LNAPL or DNAPL, serves as a long-term source for contamination of groundwater (Figure 2-5). When NAPL is present at a site, it typically represents the largest fraction of the contaminant mass. For example, most of the contaminant mass in cases of LNAPL releases is in the smear zone (refer to paragraph 2-4b(2)). In addition to being present as (1) NAPL, the contaminants partition into three other principal phases, as follows. (2) Soluble components of the NAPL dissolve into infiltrating precipitation and groundwater that come into contact with it, creating an *aqueous-phase* groundwater plume (or plumes) emanating from the source zone(s). (3) Volatile components of the NAPL and of the aqueous-phase (soil pore water and groundwater) partition into the *gas phase*, which is itself capable of migrating through the unsaturated zone. (4) Contaminants in the NAPL, aqueous, or gas phases partition into the *solid phase* with which they are in contact. Solid phase sorbants include the inorganic and organic materials in the soil or aquifer, particularly clay minerals that have the greatest specific surface (surface area per unit of mass) to which contaminants can adsorb, and humic materials for which organic compounds have a high affinity. Thus the greater the clay and/or organic content of the soil and aquifer materials, the larger will be the fraction of the contaminant mass that can be adsorbed to them. The partitioning of volatile organic compounds (VOCs) among these four phases, and definitions of the pertinent partitioning coefficients (i.e., solubility, Henry's Law constant, vapor pressure and soil/water distribution coefficient) used to quantify the tendency of specific contaminants to distribute themselves among these phases are described in more detail in EM 1110-1-4001, Soil Vapor Extraction and Bioventing, Chapter 2, Contaminant Properties.

c. NAPL Recovery. If a subsurface zone containing NAPL (i.e., a source zone) is present at a site, the most efficient way to remove contaminant mass is direct extraction of the NAPL itself, if it is amenable to recovery. Furthermore, free-product recovery to remove the bulk of the floating product is generally considered a prerequisite to the application of in-situ technologies, such as BV, that require a well-aerated soil for spatially distributed microbial growth and hydrocarbon degradation (Baker 1995). The successful removal of NAPL depends greatly on the method of free-product recovery that is selected.

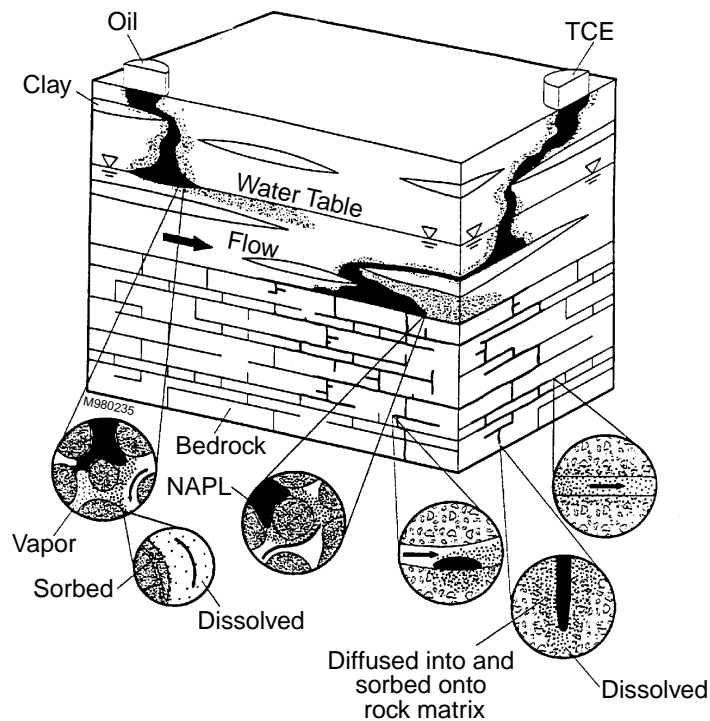

Figure 2-5. Distribution of Phases in the Subsurface. (USEPA 1995)

(1) Conventional LNAPL Recovery. Where floating product forms a continuous, free-phase layer on the water table, and especially in coarse-textured soils (e.g., sand and gravel), conventional modes of free-product recovery using submersible and skimmer pumps in wells/trenches are generally effective (API 1996; USEPA 1996). Submersible pumps generally extract NAPL and water, whereas skimmer pumps can extract LNAPL only. Submersible single- or double-pump systems (Figure 2-6a and b) extract groundwater and product and thus create a cone of depression in the water table. The resulting drawdown produces a hydraulic gradient, causing floating product to flow into the well. Because water that has been in contact with NAPL is also recovered, it must be treated prior to discharge. Skimmer systems (Figure 2-7) recover floating product only and do not usually induce a significant cone of depression. Floating filter scavenger systems, for example, can remove product down to thin layers as they track fluctuations in the water table. Although recovery rates are generally smaller, skimmer systems have the advantage that treatment of water is not required. Such systems tend to be most suitable for highly permeable formations, or where recovery rates would not be sufficient to justify operation of more costly combined water and product recovery systems. Absorbent bailers and belt skimmers also fall within this category, but are suitable only when very low rates of product recovery are acceptable. Table 2-1 presents a range of free-product recovery approaches and relative advantages and disadvantages of each. Note that pneumatic transfer of flammable liquids by air pressure (in direct contact with the liquid) is prohibited by EM 385-1-1. If pneumatically operated pumps are used, it must be ensured that the air supply is 100% isolated from free product. Most pneumatic remediation pumps sold today and/or operating today keep the motive air

separate from the pumped liquid; therefore, they do not violate this prohibition.

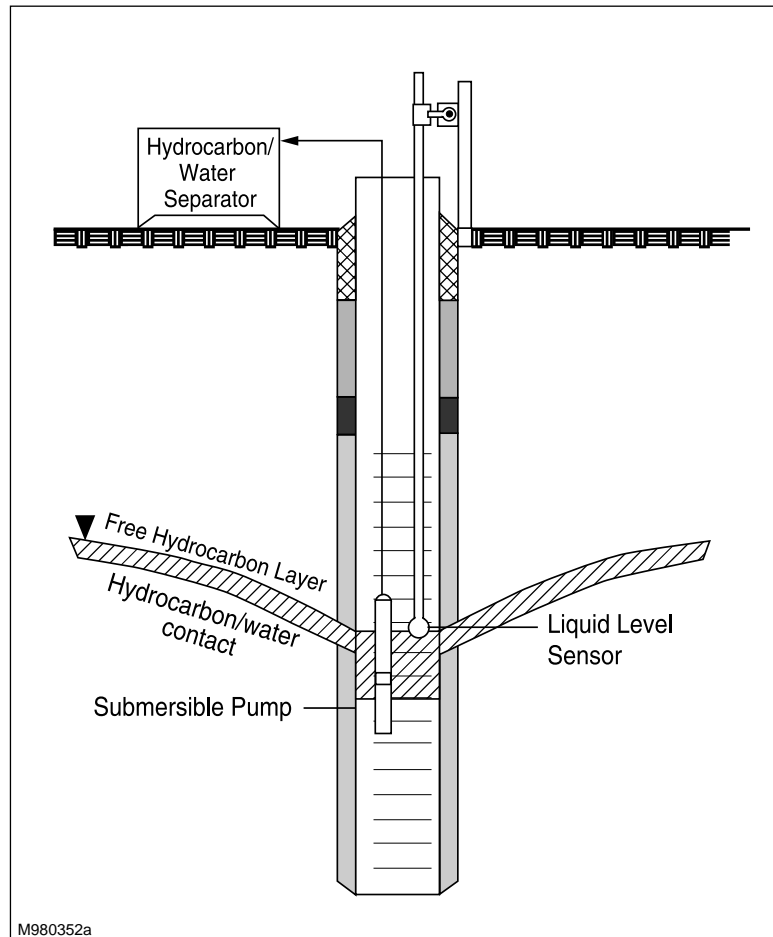

Figure 2-6a. Conventional LNAPL Recovery Using Single-Pump System. (After API 1996. Reprinted by permission of American Petroleum Institute. Copyright 1996. All rights reserved.)

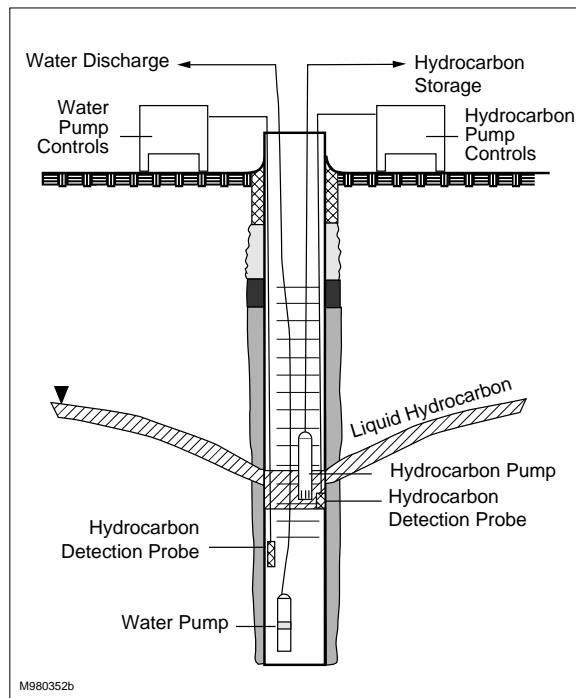

Figure 2-6b. Conventional LNAPL Recovery Using Two-Pump System.
(After API 1996. Reprinted by permission of American Petroleum Institute. Copyright 1996. All rights reserved.)

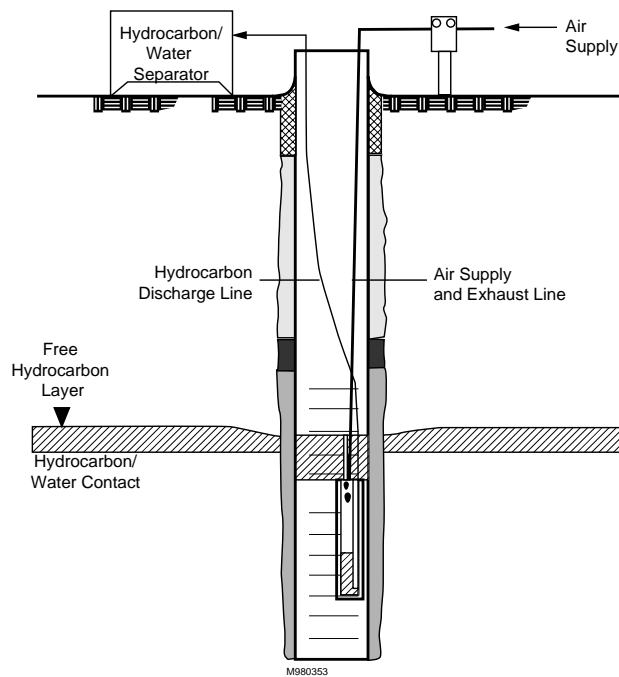

Figure 2-7. Pneumatic Skimming Pump. (After API 1996. Reprinted by permission of American Petroleum Institute. Copyright 1996. All rights reserved.)

TABLE 2-1
Free Product Recovery and Control Systems and Equipment
(After USEPA 1996a)

	Recommended Minimum Well Diameter	Recommended Minimum Value for K (cm/sec)	Relative Capital Costs	Relative Operating Costs	Relative Maintenance Costs	Potential for Product Removal	Advantages	Disadvantages
SKIMMING SYSTEMS								
• Floating								
- Large Saucer Type	36"	$>1 \times 10^{-4}$	L	L	M	M	No water pumped, skims very thin layers, moves up and down with GW	Limited radius of influence, clogging of screen, generally limited to shallow (<25 ft) applications
- Small Float Type	4"	$>1 \times 10^{-4}$	L	L	M	M		
• Floating inlet								
- Bailer/Passive	2"	$>1 \times 10^{-4}$	L	L	L	L	No water pumped, skims very thin layers, low cost	Limited radius of influence, manually adjusted, clogging, low removal rate (different for bailers and pneumatic pumps)
- Pneumatic Pump	4"	$>1 \times 10^{-4}$	L	L	L	L		
• Absorbent								
- Absorbent Bailer	2"	$>1 \times 10^{-4}$	L	L	L	L		
- Belt Skimmer	2"	$>1 \times 10^{-4}$	L	L	L	L		
SINGLE PUMP SYSTEMS								
• Diaphragm Pump	2"	$>1 \times 10^{-4}$	L	L	L	L	Low cost, low maintenance surface-mounted pumps, easy to maintain, low flows	Pumps water and product, requires o/w separator, shallow (< 20 ft)
• Centrifugal Pump	2"	$>5 \times 10^{-3}$	L	L	L	L	Low cost and maintenance	Level sensor and o/w separator required (<25 ft)
• Submersible Pump	4"	$>1 \times 10^{-2}$	M	M	L	L	No depth limitation, easy installation, removes water and product	Flow >5 gpm, o/w separator water treatment, emulsification
• Pneumatic								
- Top Filling	4"	$>1 \times 10^{-3}$	M	M	M	M	Can operate over wide range of flow rates, can pump from deep, low K aquifers	Requires air compressor system and water treatment, emulsification
- Product only	4"	$>1 \times 10^{-4}$	M	M	M	M		

TABLE 2-1
Free Product Recovery and Control Systems and Equipment
(After USEPA 1996a) (Continued)

	Recommended Minimum Well Diameter	Recommended Minimum Value for K (cm/sec)	Relative Capital Costs	Relative Operating Costs	Relative Maintenance Costs	Potential for Product Removal	Advantages	Disadvantages
DUAL PUMP SYSTEMS								
• GWP and PP with separate levels and product sensors	8"	$> 1 \times 10^{-2}$	H	H	H	H	Cone of depression induces migration of product to well, high potential product removal rates, pump GW and product potential large radius of influence	High initial cost, high maintenance; recovery wells often become clogged and inefficient, works best in clean sands and gravels, cycling the GWP on and off with level sensor not recommended approach
• GWP running steady with PP and product sensor	6"	$> 1 \times 10^{-2}$	H	H	M	H		
• GWP running steady with floating product skimming pump	6"	$> 1 \times 10^{-3}$	H	H	M	H		
DIRECT REMOVAL								
• Open Excavations or trenches	L	...	M	Good initial remedial action using vacuum truck absorbent pads, etc.	Not practical for removing product away from excavation area
• Routine skimming or bailing of wells	2"	$> 1 \times 10^{-4}$...	L	...	L	Inexpensive, works on small localized product layers	Very limited radius of influence and removal rate
VACUUM ENHANCED PUMPING								
• Drop tube suction lift	2"	$> 1 \times 10^{-5}$	M	H	L	VH	Works well with medium permeability soils, large radius of influence, increases water and product flow by 3 to 10 times; can significantly reduce site remediation time	Requires high vacuum pump or blower, usually requires thermal air treatment system and water treatment
• In-well pump augmented by vacuum on well	4"	$> 1 \times 10^{-5}$	H	H	L	VH		

- a GW = Groundwater L = Low
 GWP = Groundwater Pump M = Medium
 PP = Product Pump H = High
 K = Hydraulic Conductivity VH = Very High
 GPM = Gallons Per Minute

Approximate cost ranges based on a unit single well system including water handling and treatment:

Capital Costs:	L = \$3,000-10,000	Operating Costs:	L = \$500-1,000/mo	Maintenance Costs:	L = <10% of capital cost/yr
	M = \$10,000-25,000		M = \$1,000-3,000/mo		M = 10 to 25% of capital cost/yr
	H = >\$25,000		H = >\$3,000/mo		H = >25% of capital cost/yr

(2) Vacuum-Enhanced LNAPL Recovery. Vacuum-enhanced free-product recovery (Blake and Gates 1986; Hayes et al. 1989; API 1996) is employed, usually in medium-textured soils, to increase recovery rates of LNAPL relative to those that can be obtained using conventional means. The application of a vacuum to a recovery well increases the extraction flow rate without inducing a physical cone of depression (Blake and Gates 1986). In cases where physical drawdown is used in combination with vacuum enhancement, the effective drawdown, by superposition, is the sum of the induced vacuum (expressed in water equivalent height) and the physical drawdown (Figure 2-8). The gradient of hydraulic head that is the driving force for flow of liquid to the well is thus increased. Consequently, the volume of water extracted typically increases to an even greater extent than does the volume of LNAPL. Vacuum-enhanced recovery may also mobilize some of the LNAPL that would not otherwise be able to drain into a well because it is retained by capillary forces (Baker and Bierschenk 1995). Offsetting the increase in LNAPL removal is the necessity to treat and/or discharge a larger volume of extracted groundwater and an extracted gas stream.

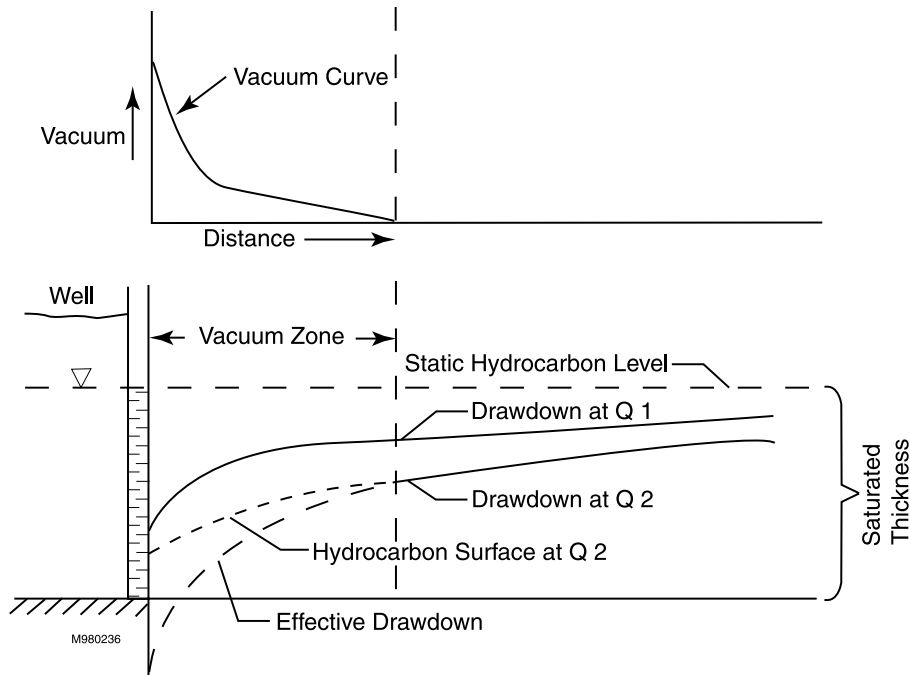

Figure 2-8. Schematic of Vacuum Effect on Perched Hydrocarbons. Q1 is extraction rate without application of vacuum; Q2 is extraction rate with application of vacuum. (Blake and Gates 1986. Reprinted by permission of National Ground Water Association. Copyright 1986. All Rights reserved.)

d. Dewatering to Enable SVE/BV.

(1) In low to moderately permeable formations that are in relatively close proximity to the capillary fringe, SVE and BV tend to have limited effectiveness, because while air can flow through air-filled passages, it cannot flow through pores in such formations that tend to be saturated with water. The process of applying a vacuum to the soil to accomplish SVE also causes the water table to rise locally, further limiting the zone through which air can flow. By removing both water and gas from the subsurface, these limitations, to some extent, can be overcome. Vacuum dewatering (Powers 1992) has had decades of use in the construction industry, where it is generally used

to remove water from medium- to fine-textured soils that would otherwise flow into excavations made below the water table. Thus it enables excavation to occur and facilitates construction of deep footings and piers. When performed in VOC-contaminated soil, vacuum dewatering permits the flow of air through some of the previously saturated soil, thereby allowing VOCs residing there to partition into the air stream (Figures 2-1 and 2-2). In addition, soluble VOCs present in the extracted groundwater are also removed (USEPA 1997a). When carried out in soils contaminated with semi-volatile organic compounds (SVOCs) that biodegrade under aerobic conditions, vacuum dewatering enhances the aeration of previously saturated soil, thus stimulating in-situ aerobic biodegradation. It can also result in an increase in the dissolved oxygen (DO) content of soil pore water, helping to further enhance aerobic biodegradation in soil that is not able to be desaturated. The potential effectiveness of this process relative to other available alternatives that do not necessarily involve extraction and treatment of groundwater, such as in-situ air sparging (IAS) and in-situ groundwater bioremediation, needs to be considered on a site-specific basis.

(2) It is important to underscore that compared to most other regions above the water table, the zone where air permeability is quite low (the capillary fringe) will transmit very little airflow during SVE or BV operation. Since in the case of LNAPL releases, this zone also tends to contain much residual LNAPL contamination (i.e., within the unsaturated portion of the smear zone), the problem of addressing the residual LNAPL is compounded unless the smear zone can be dewatered and exposed to airflow (Mickelson 1998). MPE offers a means to overcome this problem (Peargin et al. 1997).

e. Vacuum-Enhanced Pump-and-Treat. At times, particularly in moderate- to low-permeability formations, groundwater pump-and-treat extraction rates can fail to meet pre-specified hydraulic targets. A number of factors can contribute to this problem, including inadequate characterization of the hydrogeological system, failure in selecting appropriate well-screen intervals and pumps, mechanical/operational problems, well fouling, and changes in groundwater geochemistry resulting from the extraction process. If mechanical problems and limitations have been addressed, extraction rates can usually be enhanced simply by increasing the drawdown. If the physical drawdown cannot be further increased, however, e.g., because doing so would exceed the available saturated thickness, another option is to apply a vacuum gradient to the extraction well. The addition of the applied vacuum gradient to the gravitational gradient associated with physical drawdown produces an effective drawdown that can exceed the available saturated thickness, as illustrated in Figure 2-8 (Blake and Gates 1986). Consequently, the groundwater yield can be enhanced. This technique is being applied by the USACE, Philadelphia District, at the Lipari Landfill Superfund Site. DPE, rather than TPE, is the approach of choice to accomplish vacuum-enhanced pump-and-treat, because it offers a more cost-effective means of pumping groundwater.

2-4. Fundamentals of Multiphase Flow in Porous Media. An understanding of the basic concepts and physical processes involved in multiphase fluid flow is a prerequisite to making appropriate use of MPE. Much of the theory that will be presented in this section is derived from soil physics (Parker 1989; Baker 1998) and petroleum engineering (e.g., Corey 1986).

a. Constitutive Relations for Multiphase Flow and Hydrostatics.

(1) Saturation. The volume fraction of pores occupied by a given fluid is its saturation, such that water saturation, S_w , is defined as

$$S_w = \frac{V_w}{V_{pores}} \quad [2-1]$$

where V_w = volume of water, and

V_{pores} = volume of pores.

(Note that $V_{pores}/V_t = n$, where V_t = total volume of soil under consideration, and n = porosity.) Following Equation 2-1, organic liquid and air saturations, S_o and S_a , are the volume fractions of the pores occupied by NAPL and by air (or other gas), respectively. It therefore holds that for any given representative elementary volume in porous media,

$$S_w + S_o + S_a = 1 \quad [2-2]$$

Note that field and laboratory measurements are not usually expressed in terms of saturation, so appropriate conversions need to be performed. Moisture content, for example, is typically expressed as the amount, by weight or volume, of water in a soil. When given on a mass basis, moisture content, w , is the mass of water in a soil sample, M_w , divided by its oven-dry mass, M_{soil} ; or $w = M_w/M_{soil}$. When expressed on a volume basis, moisture content, θ , is the volume of water in a sample, V_w , divided by the total bulk volume of the sample, V_t ; or $\theta = V_w/V_t$. Thus from Equation 2-1 and the definition of porosity, $S_w = \theta/n$. To obtain volumetric moisture content from gravimetric moisture content, use the relation $\theta = w\rho_b/\rho_w$, where ρ_b is the bulk density (i.e., the dry weight of soil per bulk unit volume) and ρ_w is the density of the reference fluid, water.

(2) Capillary Pressure. When two or more immiscible fluids coexist in a porous medium, the pressure difference that is manifest across the fluid-fluid interface is termed the capillary pressure, P_c , defined as:

$$P_c = P_n - P_w \quad [2-3]$$

where: P_n = pressure in the nonwetting phase, and

P_w = pressure in the wetting phase.

The wetting fluid is that which has a greater affinity for the solid phase and occupies the smaller pores, while the nonwetting fluid is consigned to the larger ones and is at the higher pressure, such that the interface between them is concave toward the nonwetting phase (Brooks and Corey 1964; Parker 1989). Thus by definition, $P_n > P_w$, so P_c ordinarily must be positive. Dividing Equation 2-3 through by ρ_w and g , gravitational acceleration, we obtain an equivalent definition for capillary pressure head (or simply "capillary head"):

$$h_c = h_n - h_w \quad [2-4]$$

where: h_n = non-wetting capillary head, and

h_w = wetting capillary head.

The direction of motion of individual fluids is determined by the boundary conditions (in terms of pressure, including capillary pressure, and elevation) imposed on the individual fluids.

(3) Relationship between Saturation and Capillary Head. If the orientation of the fluid-fluid interface is not affected by gravity or adsorptive forces, then the radius of curvature of the interface, r , is related to the capillary head by Laplace's equation of capillarity:

$$r = \frac{2\sigma_c \cos \alpha}{\rho_w g h_c} \quad [2-5]$$

where: σ_c = the interfacial tension between the two fluids, and

α = the wetting angle of the liquid on the solid phase.

The air-oil, oil-water, or air-water interfacial tensions are designated σ_{ao} , σ_{ow} and σ_{aw} , respectively; the air-water interfacial tension is more commonly termed the surface tension. With a gradual reduction in the capillary head at a location in porous media, a nonwetting phase will progressively be displaced by a wetting phase, and conversely with a gradual increase in the capillary head, the wetting phase will be displaced by the nonwetting phase. Either way, the relative fluid saturations must change. For an air-NAPL-water fluid system in water-wet soil, S_w depends on the h_c value between water and NAPL phases; and the total liquid saturation, $S_t = S_w + S_o$, depends on the h_c value between the NAPL and gas phases (Lenhard and Parker 1990; Parker et al. 1996). The relationship between capillary head and saturation, $h_c(S)$, for either fluid pair is a function of the pore size distribution of the soil. Measuring the $h_c(S)$ relationship is one of the best ways to understand the pore size distribution that prevails at specific locations in the soil, and is therefore a good way of predicting how fluids will behave during remediation.

(4) Capillary Model. Rearranging the terms of Laplace's equation of capillarity (Equation 2-5), and assuming a contact angle $\alpha = 0$, the height of capillary rise in a cylindrical glass capillary tube is:

$$h_c = \frac{2\sigma}{\rho_w g r} \quad [2-6]$$

where, for an air-water system, $\sigma = \sigma_{aw}$ (Hillel 1998). This equation states that while the equilibrium height of capillary rise is related to surface tension, it is inversely related to the radius r of the capillary tube. This model can be employed to obtain a simplified representation of the effect of pore size distribution on the water content profile within unsaturated soil.

Consider a vertically oriented bundle of capillary tubes, the lower ends of which sit in a dish of water (representative of the water table). By Equation 2-6, the larger the tube radius, the smaller the height of capillary rise of water within the tubes. Likewise, the smaller the tube radius, the larger the height of capillary rise. A soil consisting entirely of pores of the same radius is like a bundle of identical capillary tubes: the lower portions of all the tubes will be filled with water, but above the height of the menisci, all of the tubes will be empty. A plot of the volumetric water content of the tubes versus height above the free water surface is thus a step function. Again rearranging terms in Equation 2-6, and substituting the equivalency $P_c = \rho_w g h_c$, we obtain:

$$P_c = \frac{2\sigma}{r} \quad [2-7]$$

This form of the capillarity equation indicates that there is a capillary pressure associated with each size pore; the larger the radius, the smaller the capillary pressure and vice versa. A soil having a range of pore sizes can be represented by a bundle of capillary tubes of various radii. The profile of volumetric water content within such a bundle of tubes indicates that as one moves upward from the free water surface, the water content of each horizontal slice across the tubes diminishes in a fashion that is *characteristic* of the pore size distribution. Plots of capillary pressure versus volumetric water content for various soil textural classes (Figure 2-9) are typically obtained from laboratory analyses (paragraphs 2-5e(3) and 3-4g(3)), and are often referred to as *soil moisture characteristic curves*. It is evident from the figure that coarse-grained soils, such as sands, become desaturated (i.e., attain a low water content) at relatively low capillary pressures (e.g., 10 to 20 cm H₂O). By contrast, fine-grained soils, such as silts and clays, retain most of their water content even at much higher capillary pressures (e.g., >500 cm H₂O). It is commonly assumed that these finer-grained soils can be readily dewatered to open their pores to airflow. A large amount of vacuum would be required, however, to overcome such strong capillary forces—more vacuum than will ordinarily propagate into the matrix blocks of a silty clay or finer-textured soil. Thus, these soil properties have a profound influence on MPE effectiveness. The difficulty of dewatering such soil in practice will be discussed in paragraph 2-5e(5) (a).

(5) Air Permeability. The ability of soils to transmit airflow (i.e. their air permeability) varies strongly as a function of both saturation and capillary pressure and differs greatly for various soil types. This is presented qualitatively in Figure 2-10. The pore size distribution of each soil in the figure is represented as a set of cylinders. It should be noted that the range of pore sizes depicted for the sand is actually wider than shown. Pores that are filled with water at a given capillary head are darkened; those that are drained of water at a given capillary head are hollow. The relative air permeability is indicated by the length of the arrows extending from the hollow cylinders. In actuality, the range of air permeabilities would be much greater than can readily be illustrated in this fashion. Note that as water saturation diminishes and air saturation increases accordingly, capillary heads increase. In the process, air permeability is initiated (except in the clay), and increases as one moves toward the upper left corner of the plot. The clay soil will not transmit air, if the clay is uniform, except via desiccation cracks under very dry conditions. The capillary pressure (or capillary head) at which air can first begin to flow through an initially saturated soil is termed the air emergence pressure, and is explained in more detail in paragraph 2-5e(3) and Figure 2-14.

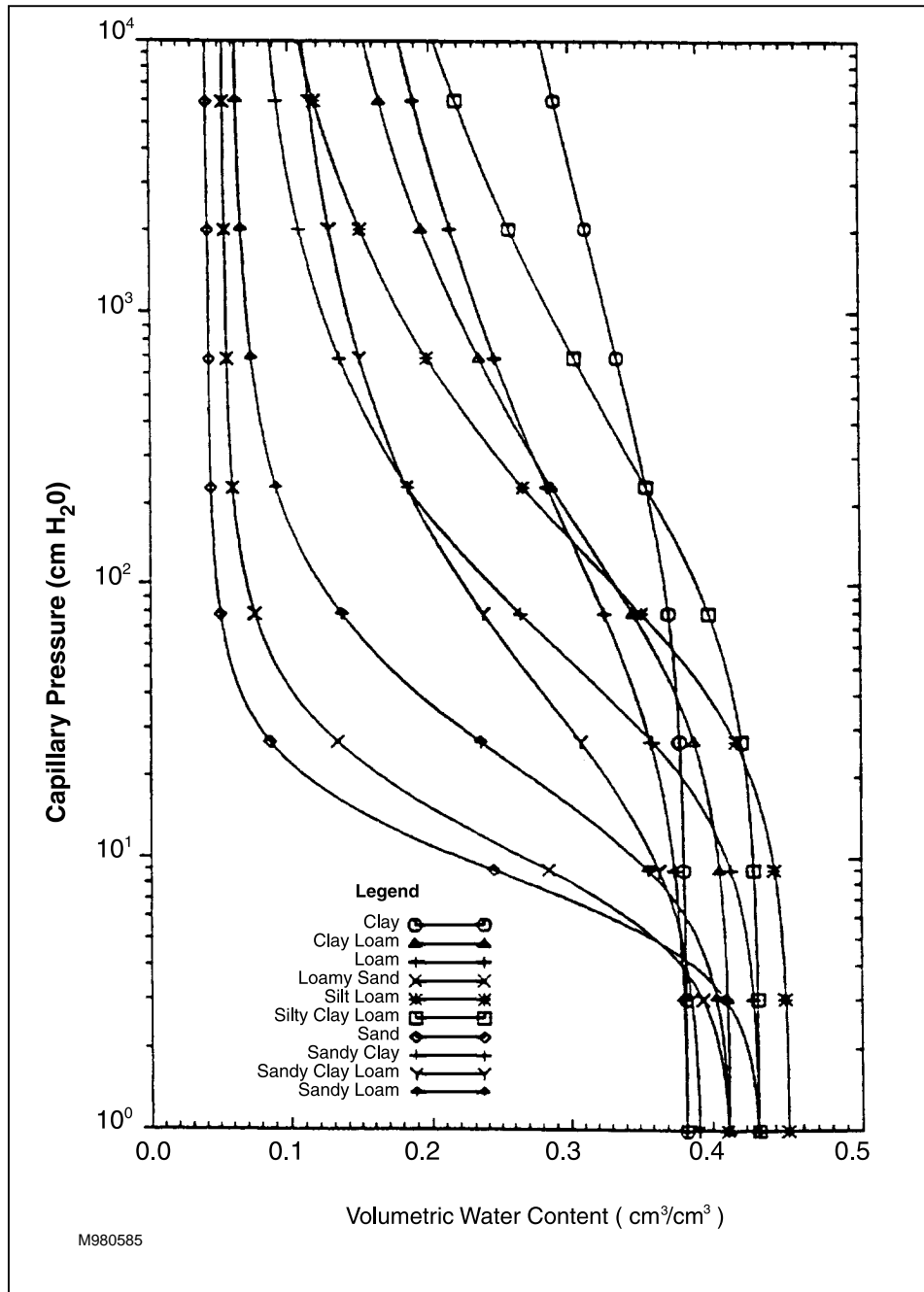

Figure 2-9. Typical curves showing the relationship between capillary pressure and volumetric water content. (USEPA 1991c)

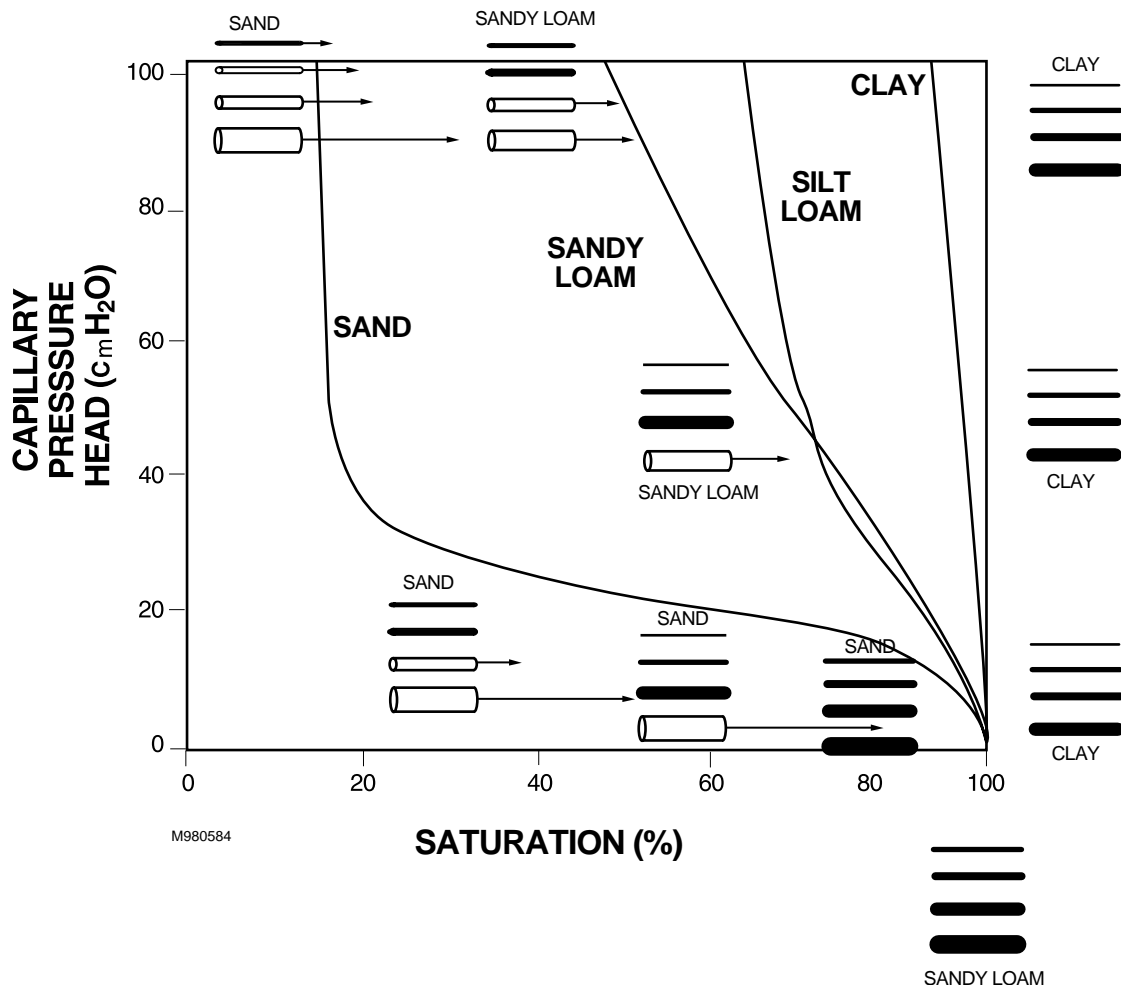

Figure 2-10. Capillary Pressure Head-Saturation Curves and Relative Air Permeability. The pore size distribution of several representative soil types is portrayed as a set of cylinders. Pores that are filled with water at a given capillary head are darkened; those that are drained of water are shown as hollow. The relative air permeability is indicated by the length of the arrows extending from the hollow cylinders. This figure is intended to provide a qualitative representation.

(6) Hysteresis. To complicate matters, the $h_c(S)$ relationship described in paragraphs 2-4a(3) and 2-4a(4) is not unique for a given soil, but exhibits hysteretic effects, i.e., it varies depending on the history of saturation changes. Somewhat higher capillary pressures are typically observed at given saturations during intervals of decreasing wetting phase saturation (drainage) than during increasing wetting phase saturation (imbibition). Although it is convenient to disregard it, hysteresis may need to be taken into consideration particularly when attempting to model the effects of rising and falling water tables on LNAPL entrapment. This is difficult to put into practice, however, due to uncertainties in saturation histories and the possible presence in the subsurface of soils that may exhibit partial hydrophobicity, with some zones being water-wet while others are oil-wet (Kool and Parker 1987; Parker and Lenhard 1987a; Lenhard et al. 1988; Lenhard and Parker 1990).

b. Movement of NAPL: Redistribution and Drainage. Let us now consider the processes by which NAPL moves through the soil.

(1) NAPL Redistribution. As NAPL enters and moves through soil, it depletes itself by leaving behind along its path an amount of NAPL equal to its residual saturation, S_{or} . (S_{or} is the NAPL saturation that remains in a soil that, having contained NAPL, is subjected to drainage until the NAPL-filled pore spaces are no longer contiguous.) If a sufficient volume of LNAPL reaches the water table, it will be affected by buoyancy forces as it accumulates there (Newell et al. 1995), and will then distribute itself within the soil above the water-saturated zone. Its transport will be governed by gradients of hydraulic head, in accordance with Darcy's law (Parker 1989). The dissolved- and gas-phase plumes that arise from NAPL are typically the forms by which the contaminants pose a potential risk to human health and the environment, but a further discussion of their fate and transport is beyond the scope of this chapter.

(2) Smear Zone. As the water table fluctuates, LNAPL will tend to be redistributed upward and downward over the vertical extent of the water table's rise and fall. The processes of NAPL entrapment and retention in the saturated zone (which occur as the water table rises) and retention in the unsaturated zone (as the water table falls) tend to increase the elevation range, termed the *smear zone*, over which $S_o \geq S_{or}$ at many, if not all locations (i.e., some locations may have $S_o \leq S_{or}$). They also tend to reduce the apparent product thickness evident in monitoring wells, particularly as the water table rises, when LNAPL entrapment tends to be greater. It is important to try to identify the smear zone early in the process of developing a conceptual model of a site. It is not recommended, however, that the range of historical water table fluctuation be used to infer the vertical limits of the smear zone. Usually, this range tends to underestimate actual smear zone thickness, since the extreme fluctuations in water table elevation are seldom measured. It should also be noted that there are occasional sites at which LNAPL was released: a) from a point, such as a pipeline or tank, located below the lowest recorded elevation of the water table; or b) from a point above the groundwater low, but under enough pressure to force it downward beneath a confining layer to depths as much as several meters below the groundwater low. In either case, the zone of LNAPL contamination would extend below what might otherwise be expected. Instead of reliance on hydrographic data, direct and indirect NAPL measurement approaches should be used. Soil sample headspace data collected during drilling, which are qualitative, have been found more useful than hydrographs in most cases. Delineation of the smear zone can be supported by various field investigation methods to be described in Chapter 3; more detailed delineation can be made by collecting continuous soil cores and subjecting them to appropriate contaminant analysis. Unless the remedial goal is defined only in terms of reducing apparent product thickness, it is the entire smear zone rather than simply the zone of floating LNAPL that deserves consideration and delineation.

(3) The Problem with the Smear Zone. As stated in [paragraph 2-3d\(2\)](#) above, the smear zone is at the same time a crucial target zone for vapor extraction-based remediation of LNAPL contamination, and a zone with no or minimal air permeability. The air permeability limitation stems from the fact that the lower reaches of the smear zone are below the water table, while the upper reaches generally coincide with the wet-season position of the capillary fringe. We define the *capillary fringe* as the zone just above the water table where the capillary pressure is less than the air entry pressure, i.e., the zone that is saturated but under a gauge pressure less than atmospheric. Pores within the capillary fringe, although above the water table, are water and/or NAPL saturated. Consequently, this zone will have an air permeability value

approaching zero, unless air is sparged from beneath, the soil is drained by lowering the water table or through vacuum dewatering, or the water is driven off by heating. The applicability of these methods is discussed in [paragraph 3-8](#).

(4) NAPL Drainage. Recovery of NAPL (either LNAPL or DNAPL) from the subsurface is often accomplished by providing wells or trenches into which it can drain, as described in [paragraph 2-3c\(1\)](#) above. Such wells or trenches are positioned below the water table somewhat, so that groundwater may be drawn down by pumping, and so that NAPL in the surrounding formation can then be recovered from the well or trench (Sale and Applegate 1997). Whether as a result of active drawdown or a seasonal decline in the water table elevation, however, LNAPL that collects at the water table in excess of S_{or} cannot drain into a well or trench pipe that is at atmospheric pressure, unless the LNAPL exists in the formation at a positive gauge pressure, i.e., a pressure greater than atmospheric. Thus, neither water nor LNAPL can drain from the capillary fringe, where they exist at negative gauge pressure, into a pipe that contains air at atmospheric pressure. Only if a vacuum were exerted on the pipe, sufficient to overcome the capillary forces holding the liquid in the soil, could the liquid begin to flow into the pipe and be recovered; we term this process vacuum-enhanced recovery rather than drainage.

c. Preferential Flow.

(1) Types of Preferential Flow. Fluids do not always infiltrate through the soil uniformly, but may show preference for certain pathways, while bypassing to a great extent adjacent regions. Preferential flow is of two general types: a) flow through recognizable morphological features such as macropores or high permeability zones, and b) unstable (i.e., fingered) flow in the absence of such features. Macropores in the context of (a) are continuous non-capillary voids such as structural cracks, decayed root channels, worm channels and burrows of larger animals (Bouma 1981; Beven 1991). To this list may be added channels created through human activities, including the coarse aggregate (e.g., gravel) often placed beneath structures, around underground storage tanks, or surrounding buried utility lines, and interconnected voids present in poorly compacted fill material. Zones of locally high permeability containing smaller capillary sized pores such as sand layers can also support a kind of morphologically related preferential flow. Fingered flow refers to the instability of immiscible displacements under certain conditions, even where there are no apparent structural channels or heterogeneity at the macroscale (Hillel 1987; Kueper and Frind 1988; Baker and Hillel 1991).

(2) Preferential Flow of NAPL. It is important to appreciate that when a substantial volume of NAPL is released within a short amount of time, it has a tendency to flow preferentially within any macropores, man-made pathways, and larger fractures within fractured bedrock that it encounters during its infiltration into heterogeneous soils. These macropores represent paths of least resistance for NAPL flow when NAPL is released under a positive gauge pressure because they are the most transmissive flow paths available. Because of macropore flow, LNAPL can infiltrate over considerable distances in the unsaturated zone within a relatively short period. Even in the absence of macropores and under conditions of slow, drip release, NAPL can infiltrate to surprising depths, as illustrated in Fig. 3-3 for a DNAPL release (Poulsen and Keuper 1992). Unlike LNAPL, DNAPL can infiltrate within the saturated zone as well. This behavior has obvious ramifications with respect to the installation of soil borings, wells and other potential conduits for DNAPL transport – care must be taken to avoid vertical spreading of the source of contamination while attempting to investigate its nature and extent and during remedial efforts.

Applicable techniques to minimize these collateral effects are presented in Chapter 3.

(3) Preferential Flow of Soil Gas. Gas is typically a nonwetting fluid relative to both NAPL and water. Therefore, it too is subject to preferential flow through macropores and other preferred pathways, especially during operation of an air-based remediation technology such as SVE, IAS, or MPE. For discussions of these effects relative to SVE, refer to EM1110-1-4001, Soil Vapor Extraction and Bioventing, and for IAS see EM1110-1-4005, In-Situ Air Sparging. Consideration of preferential flow of gas during MPE is considered in paragraph 2-5e(5)(a). In addition, most VOCs are quite heavy compared to the average molecular weight of air. Therefore, their saturated vapors can migrate preferentially within the unsaturated zone via density-driven flow (Mendoza and McAlary 1990).

d. Multiphase Flow of Water, Air, and NAPL.

(1) Fluid flow in porous media is normally laminar; that is, it occurs at velocities that are well below the threshold for turbulent flow. Under such conditions, flow may be described by Darcy's law, which underlies much of groundwater hydrogeology. Darcy's law is also applicable to gas flow, as presented in EM 1110-1-4001, Soil Vapor Extraction and Bioventing, Chapter 2, and may be further generalized to describe the movement of NAPL, water and air in porous media. The general form of Darcy's law for any phase p (for water, $p = w$; for hydrocarbon, $p = o$; and for air, $p = a$) may be written (Parker 1989; USEPA 1996; Parker et al. 1996) as:

$$q_{pi} = -\frac{k_{rp}k_{ij}}{\eta_p} \left[\left(\frac{\partial P_p}{\partial x_j} \right) + \rho_p g e_j \right] \quad [2-8]$$

where:

i, j = direction indices ($i, j = 1, 2, 3$) with repeated values indicating summation in tensor notation, x_i (or x_j) is the i th (or j th) Cartesian coordinate

q_{pi} = volumetric flux of fluid phase p in the i direction [$L^3L^{-2}T^{-1} = LT^{-1}$]

k_{rp} = relative permeability of the porous medium to phase p [-]

k_{ij} = intrinsic permeability tensor of the porous medium [L^2]

η_p = p -phase dynamic viscosity [$ML^{-1}T^{-1}$]

P_p = p -phase pressure [$ML^{-1}T^{-2}$]

ρ_p = density of phase p [ML^{-3}]

g = gravitational acceleration [LT^{-2}] and

$e_j = \partial z / \partial x_j$ is the j component of a unit gravitational vector where z is elevation (+ upward) [-].

[Symbols in square brackets are dimensions: M = mass; L = length; T = time; and - = dimensionless.] Equation 2-8 is the commonly employed form of Darcy's law in petroleum reservoir engineering. Note that the $\partial P_p / \partial x_j$ term is the pressure gradient, while the $\rho_p g e_j$ term is the gravity gradient. Together they comprise the gradient of total hydraulic head that is the driving force for flow.

(2) In groundwater hydrology, it is more common to utilize water-height equivalent heads, rather than pressures, and the equation may be written (Parker 1989; USEPA 1996b) as

$$q_{pi} = -\left(\frac{k_{rp} K_{swij}}{\eta_{rp}}\right) \left[\left(\frac{\partial h_p}{\partial x_j}\right) + \rho_{rp} e_j \right] \quad [2-9]$$

in which:

$K_{swij} = k_{ij} \rho_w g / \eta_w$, the saturated conductivity for water [LT^{-1}]

$\eta_{rp} = \eta_p / \eta_w$, the relative viscosity of phase p to that of water [-]

$h_p = P_p / g \rho_p$, the water-equivalent pressure head of phase p [L], and

$\rho_{rp} = \rho_p / \rho_w$, the specific gravity of phase p [-].

(3) The generalized Darcy's law describes the flow of water, NAPL, and air in soils when one, two, or three phases coexist within the pore space. The equation states that the flow of a fluid p through a porous medium is in response to, and in the direction of, the driving forces, which are a negative gradient of pressure head and gravity; moreover, the rate of movement is directly proportional to the relative permeability and inversely proportional to the fluid viscosity. Each phase moves with respect to the sum of its individual pressure head gradient, $\partial h_p / \partial x_j$, and gravitational head gradient, $\rho_{rp} e_j$. Since the volumetric flux of fluid phase p is the product of the total head gradient and the relative permeability, the flux can be manipulated during MPE through the application of vacuum at the well. The higher the vacuum applied, the greater the rate at which a system will produce phase p , all other things being equal. Increasing the vacuum applied may not directly result in increased NAPL recovery, however, if increasing the vacuum results in desaturation (with respect to NAPL) of a portion of the zone through which the NAPL must flow to reach the well.

(4) Relative permeability, k_{rp} , is a coefficient reflecting the ability of a fluid to move through pore spaces that are partially occupied by other fluid(s). When phase p fluid completely fills interconnected pore spaces, the relative permeability for the p phase is 1.0; and when no mobile phase p is

present (i.e., the pores containing phase p are no longer interconnected), the relative permeability for p phase is 0.0 (Parker et al. 1996). Relative permeability is thus a function of saturation, $k_{rp}(S_p)$, and as saturation in turn depends on h_c , so too does relative permeability, i.e., $k_{rp}(h_c)$. Although the exact values of these functions may not be available at a given site, the concepts presented in [paragraph 2-4a\(3\)](#) nevertheless help one to understand what phase or phases may be present at a given location in the subsurface, which has a strong bearing on the qualitative degree to which the medium will be conductive to the various phases. In addition, it is important to note that the transport coefficient in Equations 2-8 and 2-9 is the product of relative permeability and saturated hydraulic conductivity, so the order of magnitude of the K_{sw} term has as great a significance to multiphase flow as it does to single-phase flow.

(5) Assumptions Underlying Darcy's Law. One assumption underlying Equations 2-8 and 2-9 is that the flow of phase p is not directly affected by pressure gradients in other phases. Parker (1989) notes that this assumption does not always hold, since it requires that slippage zones at phase interfaces be thin in comparison to the total film thickness of the phases. This requirement will not be met in fine-grained materials and at low values of liquid saturation, but at the same time in such cases relative permeabilities would be extremely low, so associated errors would probably not be significant. This assumption also is violated when dealing with a fluid phase that is not continuous, and through which a pressure gradient is therefore not transmitted. Such a phase cannot undergo Darcian flow, although the remaining phases are still amenable to it, so long as they are continuous. A second assumption relates to the concept of intrinsic permeability and its separation of fluid-dependent and porous medium-dependent effects on fluid flow (Parker 1989). Again, in cases of fine-grained materials this assumption may not hold, because the intrinsic permeabilities of such materials can increase by orders of magnitude when they are saturated with non-polar liquids as compared with water. Finally, the equations both treat intrinsic permeability as a tensor, while relative permeability is regarded, mainly for simplicity, as a scalar. There is evidence, however, that relative permeability itself varies with direction in anisotropic porous media, with the degree of anisotropy being strongly dependent on the fluid saturation (Kueper and Frind 1991).

(6) Continuity Equations. To model a multiphase system, a continuity equation must be written for each phase. Such equations require that mass be conserved within each phase, so that within a fixed soil volume, the change of mass within a phase equals the difference between the mass entering the volume and the mass leaving the volume, plus or minus any interphase transfer that may occur. If we assume that the fluid and medium are incompressible (not mandatory assumptions but convenient ones), the fluid phase relations (Parker 1989; USEPA 1996a) are of the form:

$$n\left(\frac{\partial \rho_p S_p}{\partial t}\right) = -\left(\frac{\partial \rho_p q_{pi}}{\partial x_j}\right) + \gamma_p \quad [2-10]$$

where: n = porosity [-],

t = time [T] and

γ_p = source-sink term incorporating transfer of mass between phases [$ML^{-3}T^{-1}$].

The source-sink terms could be particularly significant during MPE because of some of the accompanying processes (e.g., volatilization of NAPL; biodegradation of hydrocarbons).

(7) Governing Equations for Multiphase Flow. Substituting Darcy's equation for q_p (Equation 2-9) into Equation 2-10 yields:

$$n\left(\frac{\partial \rho_p S_p}{\partial t}\right) = \left\{ \frac{\partial \rho_p k_{rp} K_{swij} (\eta_{rp})^{-1}}{\partial x_j} \right\} \left[\left(\frac{\partial h_p}{\partial x_j} \right) + \rho_{rp} e_j \right] + \gamma_p \quad [2-11]$$

Therefore, we arrive at the following basic set of governing equations for the flow of water, air and NAPL phases, respectively:

$$n\left(\frac{\partial \rho_w S_w}{\partial t}\right) = \left\{ \frac{\partial \rho_w k_{rw} K_{swij} (\eta_{rw})^{-1}}{\partial x_j} \right\} \left[\left(\frac{\partial h_w}{\partial x_j} \right) + \rho_{rw} e_j \right] + \gamma_w \quad [2-12a]$$

$$n\left(\frac{\partial \rho_a S_a}{\partial t}\right) = \left\{ \frac{\partial \rho_a k_{ra} K_{saij} (\eta_{ra})^{-1}}{\partial x_j} \right\} \left[\left(\frac{\partial h_a}{\partial x_j} \right) + \rho_{ra} e_j \right] + \gamma_a \quad [2-12b]$$

$$n\left(\frac{\partial \rho_o S_o}{\partial t}\right) = \left\{ \frac{\partial \rho_o k_{ro} K_{soij} (\eta_{ro})^{-1}}{\partial x_j} \right\} \left[\left(\frac{\partial h_o}{\partial x_j} \right) + \rho_{ro} e_j \right] + \gamma_o \quad [2-12c]$$

As discussed by Parker (1989), Equation 2-12 comprises a system of coupled partial differential equations because of the dependence of the saturation, permeability and capillary head terms in each equation on their respective terms in the other equations, subject to the constraint of Equation 2-2. This system of equations may be simplified if, for example, only two of the phases are present, in which case the equation for the other phase may be disregarded. Furthermore, if a gas phase is present but there is gas phase continuity throughout the unsaturated zone such that the gas phase may also be considered to be at a nearly constant atmospheric pressure, the gas phase equation may also be eliminated. This simplification would not be justified with MPE, however, during which the prevailing gas phase pressure within the zone of influence is subatmospheric.

(8) In order to model multiphase flow using these equations, the following must be specified: the porosity and intrinsic permeability of the porous medium (or the porosity plus the saturated conductivity of each phase); the density and viscosity of each phase at a reference state; and the functional relationships among fluid saturations, capillary heads, and relative permeabilities (Parker 1989). Several of these parameters are discussed in the following paragraphs. Additional discussion of the application of modeling to MPE is provided in [paragraph 5-4](#).

e. Transport Parameters.

(1) Density. Density, ρ_p is a property of the specific fluid under consideration, and varies significantly for different organic compounds (Table

2-2). Note that the compounds or products in Table 2-2 that are less dense than water (LNAPL) are benzene, o-xylene, automotive gasoline and kerosene, while those that are denser than water (DNAPL) are trichloroethene and tetrachloroethene. Note that although density varies with temperature, density will not be affected significantly by changes in temperature over the range commonly encountered in MPE (280 to 295 °K). For comparison, the density of dry air at standard temperature and pressure (STP: 273.15 °K (0 °C) and 760 mm Hg pressure) is $1.2929 \times 10^{-3} \text{ Mg m}^{-3}$ ($1.2929 \times 10^{-3} \text{ g cm}^{-3}$; $8.0699 \times 10^{-2} \text{ lb. ft}^{-3}$), while the density of water at STP is $0.99987 \text{ Mg m}^{-3}$. Standard pressure of 760 mm Hg is equivalent to 1 atmosphere 101.35 kPa, and 14.6960 lb/in² absolute (psia).

TABLE 2-2
Physical Properties of Selected Compounds*

Compound	Density (g/cm ³)	Dynamic Viscosity (cp)	Interfacial Tension (with Air) (dynes/cm)	Interfacial Tension (NAPL-Water) (dynes/cm)	Water Solubility (mg/l)	Henry's Law Constant (atm•m ³ /mol)
Water	0.998 ⁽¹⁾	1.14 ⁽¹⁾	72.0	---	---	---
Benzene	0.876	0.647	28.85	35.0	1780	5.5E-3 ⁽²⁾
o-xylene	0.880 ⁽²⁾	0.802	30.04	36.1	170	5.4E-3 ⁽²⁾
Trichloroethene	1.464	0.570	29.5	34.5	1100 ⁽²⁾	1.0E-2 ⁽²⁾
Tetrachloroethene	1.623	0.87	31.74	47.5	150	2.3E-2
Common Petroleum Products						
Automotive gasoline	0.731 ⁽³⁾	0.48	20.5 ⁽³⁾	22.9 ⁽³⁾	---	---
Kerosene	0.807 ⁽³⁾	1.73	26.8	38.6 ⁽³⁾	---	---

*Values are given at 20° C unless noted.

⁽¹⁾Value is at 15° C.

⁽²⁾Value is at 25° C.

⁽³⁾Value is at 22-24° C.

Sources: Arthur D. Little, Inc. 1987; Demond 1988; Heath et al. 1993; Huling and Weaver 1991; Newell et al. 1995; Weast 1985; Wilson et al. 1989.

(2) Viscosity. As with density, viscosity, η_b , is a property of the specific fluid under consideration, and varies significantly for different organic compounds and products (Table 2-2). Note that although viscosity varies with temperature, viscosity also will not be affected significantly by changes in temperature over the range commonly encountered in MPE (280 to 295 °K). For comparison, the viscosity of air at STP is $1.71 \times 10^{-5} \text{ newton}\cdot\text{s m}^{-2}$, which is equivalent to $1.71 \times 10^{-4} \text{ g cm}^{-1} \text{ s}^{-1}$ and 1.71×10^{-2} centipoise (cp). The viscosity of water at STP is $1.787 \times 10^{-3} \text{ newton}\cdot\text{s m}^{-2}$, which is equivalent to $1.787 \times 10^{-2} \text{ g cm}^{-1} \text{ s}^{-1}$ and 1.787 cp, while the viscosity of water at 283 °K (10 °C) is 1.307 cp.

(3) Interfacial Tension. The surface tension at the interface between two fluids is known as the interfacial tension, σ_c . Because the molecules of NAPL compounds are usually nonpolar, they interact weakly with each other in comparison with individual water molecules. As a result, they exhibit interfacial tensions with air that are much smaller than the surface tension of water. Surface tension is not strongly dependent on temperature, but varies inversely with it, with the surface tension of water against air being 75.6

dynes/cm (equivalent to 75.6 g s^{-2}) at $273 \text{ }^\circ\text{K}$ ($0 \text{ }^\circ\text{C}$), 74.22 dynes/cm at $283 \text{ }^\circ\text{K}$, and 72.75 dynes/cm at $293 \text{ }^\circ\text{K}$.

(4) Wettability. The wetting angle, α (or contact angle), is the angle that a fluid assumes at an interface with a solid surface. A simple two-phase example is that of a drop of liquid placed on a dry horizontal solid surface. The drop will spread out over the surface until it comes to rest, its interface with the solid forming a characteristic contact angle that is complementary to the angle formed by its interface with the gas. Figure 2-11a illustrates the contact angle for such a drop (after Hillel 1998, Figure 2-10). A surface would be considered to be completely wetting, with a contact angle of zero, if the drop shown in Figure 2-11a were to completely flatten out. By contrast, a surface would be considered nonwetting, with a contact angle of 180° , if the drop were to remain spherical without spreading at all. If the latter drop consisted of water, such a surface would be termed hydrophobic or water repellent. Surfaces that have been exposed to hydrocarbons or organic matter and to which a sufficient quantity of organic compounds have become sorbed can become hydrophobic and oleophilic, i.e., wetting with respect to NAPL and nonwetting with respect to water (Parker 1989). Soil that behaves in this fashion still adheres to the typical concepts presented in paragraph 2-4a(3). Since the tangent to the interface is always drawn through the wetting fluid, Equation 2-5 still holds, but the fluids simply switch roles. Figure 2-11b depicts a hypothetical pore cross-section with two liquid phases and a gas, comprising a three-phase system consisting of water, NAPL and air (USEPA 1996b). If the solid walls of the pore are wetting, as is usually the case, the inner of the two liquids will be water. If the solid were nonwetting, however, the position of the two liquids would be reversed. The behavior of NAPL in nonwetting soils is a subject of current research.

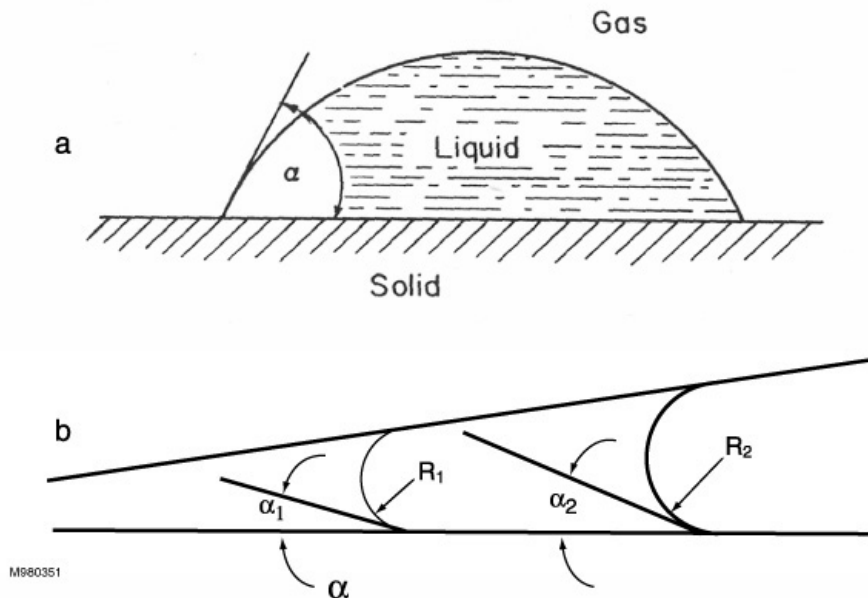

Figure 2-11. a) The contact angle of a drop resting upon a plane solid surface (Hillel 1998); b) Hypothetical pore cross section with two fluids. α is the contact angle; R is the radius of curvature. (USEPA 1996b)

2-5. Response of NAPL, Water, and Air to Vacuum.

a. Nature of the Problem. MPE works by applying a vacuum to the soil (usually via an extraction well), and by providing means for gas, water and NAPL, if present, that arrive at the well to be removed from it and handled aboveground. Its effectiveness is governed by the degree to which the process exerts its effects throughout the zone targeted for cleanup. The subsurface effects caused by application of a vacuum to the soil are not simple, however, nor are they obvious. Nor, for that matter, is the fluid flow behavior within the conveyance piping leading to the aboveground system obvious. The majority of MPE systems that have been operated have been monitored by measuring integrated parameters that can be measured aboveground, such as the flow, pressure (vacuum), temperature, and contaminant concentrations of the extracted stream(s), and the volume(s) of liquids recovered. Data have also typically been collected at monitoring wells screened over a wide (e.g., > 3 m) depth interval, including groundwater and LNAPL elevations, and at times, concentrations of contaminants (and/or other geochemical parameters) in groundwater. Less often, data have also been collected from discrete monitoring points, including pressure (vacuum) influence and O₂, CO₂, CH₄ and contaminant concentrations in soil gas; however, consistent approaches to the interpretation of such data are not available. Until recently, very little data have been published shedding light on the following questions: What portions of the subsurface are affected by MPE? Does MPE cause desaturation of soils near the extraction well? What is the zone of influence of an MPE system, and how does it correspond to the zone of influence of, for example, SVE systems? What conditions give rise to efficient modes of multiphase flow within the conveyance piping? Under what conditions does MPE work effectively? Postulated answers have, so far, often substituted where real data have been absent. One of the purposes of this EM is to provide a basis so that these questions can begin to be addressed more directly. This basis will incorporate theory, observations, and recently available data.

b. Effects at the Point of Vacuum Application. When a straw is placed below a free water surface and suction is applied, liquid flows up the straw in response to the imposed pressure gradient. Everyone who has sipped a beverage through a straw has direct experience with this process. When the liquid level drops to the bottom of the container, a combination of liquid and air is briefly drawn into the straw - a simple example of MPE. After the available liquid has been suctioned off, if suction were to continue to be applied, air alone would be drawn into the straw. Turning now to subsurface applications, this stage of the process is analogous to SVE: application of a vacuum to a well screened within the unsaturated zone will produce a flow of gas, again in response to the imposed pressure gradient. The greater the vacuum applied, the larger the imposed pressure gradient. The resulting volumetric flux of fluid is a function of the pressure gradient, diameter of the pipe, pipe roughness and associated frictional losses for the pipe and fittings, and the rate at which the subsurface porous media can yield gas. In all but the most permeable subsurface applications, the subsurface, and not the capacities of the aboveground components, limits the resulting volumetric flux.

c. Effects Within the Extraction Well During Extraction of Gas Only. To a first approximation, the magnitude of vacuum measured within an appropriately sized well (i.e., as indicated by a vacuum gauge tapped into the well head) will be the same as the vacuum exerted at all portions of the well screen above the liquid level. The groundwater elevation within a well or trench will also respond to the applied vacuum, with the height of upwelling being equal, at equilibrium, to the vacuum applied expressed as a water-height equivalent head

(Johnson et al. 1990; USEPA 1991a). Because the height of upwelling reflects a balance of forces between the applied vacuum and gravity, a submerged pressure transducer placed within the well and referenced to atmospheric pressure will register no change in head, i.e., upwelling in response to vacuum does not constitute a change in the piezometric surface. Less well appreciated is the fact that the capillary fringe (defined in [paragraph 2-4b\(3\)](#)) also will translate upward in response to the applied vacuum. This can occur to the point that previously unsaturated soil, even the soil surrounding the filter pack/well screen, can become inundated, blocking airflow to the well. The phenomenon of upwelling is discussed at greater length in [EM 1110-1-4001](#), Soil Vapor Extraction and Bioventing, Chapter 3, Site Characterization and Technology Screening, and Chapter 4, Bench- and Pilot-Scale Testing for SVE and BV. Upwelling, if uncontrolled, can result in the liquid level rising above the top of the well screen, greatly impeding or even preventing the flow of air into the well. In many applications, one of the main goals of MPE is to remove water as fast as it can enter the well, so as to enhance gas flow into the well.

d. Effects Within the Extraction Well and Piping During MPE.

(1) Extraction Well Configurations. There are several possible ways to continually remove liquid (water and/or NAPL) from a well to which a vacuum is being applied. These include: a) use of a submersible pump placed within the well to push liquid to the surface through a discharge pipe positioned inside the well casing; b) use of an aboveground vacuum pump to suction liquid out of the well through a suction pipe; and c) application to the well casing of a vacuum large enough to lift liquid to the surface. The latter is a form of well point dewatering, used in the construction industry (Powers 1992). The first two of these approaches are known as "pipe within a pipe" technologies, because the delivery tube sits inside the well casing. In either of these cases, if water is being removed as fast as it can enter the well, the water level within the well is determined by the elevation of the pump or pipe inlet. Thus, these two approaches control upwelling, leaving the well screen above the water level open to gas flow, if the formation is conducive to it. The third approach, however, essentially exacerbates upwelling, inundating the well screen with liquid lifted up within the well. If the third approach is carried out at such a rate, however, that liquid is evacuated from the well faster than it can recharge, then it too can potentially be compatible with vapor extraction. Therefore under the right circumstances, all three are potential methods of carrying out MPE. Upwelling will occur within an MPE well that is screened in part above the water table if water enters the well at a greater rate than it can be extracted from the well. This condition can occur during MPE if there is a limitation to the rate at which water can be removed from the well (relative to the rate at which it enters the well), as for example if there is insufficient airflow to lift the liquid out of the well as droplets, or insufficient suction to lift it as a solid column of water.

(2) MPE Flow Regimes. Three flow regimes have been identified to occur within TPE piping (Peargin 1997). The flow regime is believed to be governed by the hydraulic and pneumatic properties of the formation, and may be controlled largely by adjusting the drop tube depth and varying the air/water ratio (or air velocity) that one can achieve, e.g., by opening the atmospheric bleed valve and/or priming valve at the well head. Peargin (1997) has made the following observations concerning these flow regimes:

(a) Slug flow regime. At moderate air flow velocities, nearly equal ratios of air to liquid prevail, with liquid being lifted as continuous slugs moving at approximately the same velocity as the air (Figure 2-12a). The slugs

of liquid occupy the entire cross-sectional area of the piping, and line losses associated with slug flow (also termed transitional flow) are quite small.

(b) Churn flow regime. At somewhat higher airflow velocities, air/liquid ratios increase. Bullet-shaped Taylor bubbles break through the water slugs from below, with liquid then cascading downward to form new slugs (Figure 2-12b). The churning action of lifting and falling water slugs increases the drop tube line losses associated with churn flow. In addition, oscillations in drop tube and casing vacuums are typically observable.

(c) Annular flow regime. At higher airflow velocities, higher ratios of air to liquid prevail, with liquid being lifted in individual droplets and as an annular film along the inside surface of the piping (Figure 2-12c). The central cross-section of the pipe is open to airflow, and line losses associated with annular flow are relatively small. Of the three flow regimes, annular flow is the most preferable. Peargin (1997) believes that only the lowest permeability, highest operating vacuum settings justify use of a TPE drop tube as a cost-effective engineering decision rather than use of DPE.

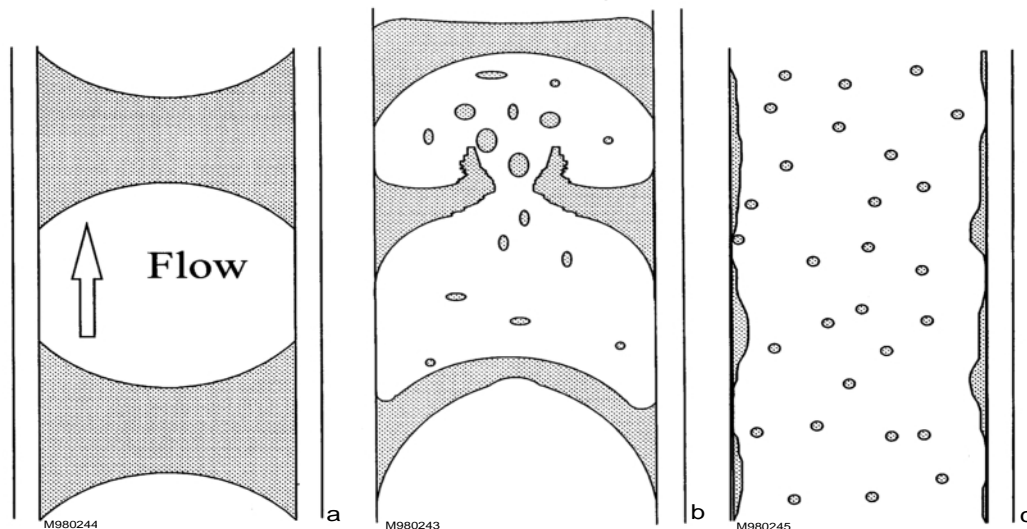

- a. Slug Flow Regime:** Gas/liquid ratio nearly equal; flow rate low. Liquid lifted as continuous slug at same velocity as gas. Slug occupies entire cross-sectional area of pipe; little line loss.
- b. Churn Flow Regime:** Gas/liquid ratio and flow velocity increase. Bullet-shaped Taylor bubbles break through water slugs from below. Liquid cascades downward to form new slug. Churning action of lifting and falling water slugs increases line loss.
- c. Annular Flow Regime:** With increasing gas/liquid ratio and flow velocity, liquid is lifted in individual droplets and as annular film. Central cross section of pipe open to airflow; little line loss.

(M980244)

Figure 2-12. MPE Flow Regimes. (Peargin 1997. Reprinted by permission of T.R. Peargin, Chevron Research and Technology Corp.)

e. Effects Adjacent to the Extraction Well/Porous Media Boundary.

(1) General Effects. Picture the case of a straw placed in a glass containing crushed ice and beverage. When the liquid level has been drawn down to the bottom of the glass, some liquid will still remain in the pores between the pieces of ice, held there by capillary forces despite the force of gravity. Continued suction will draw in a mixture of liquid and air, resulting in the

removal of some of that retained liquid. We call this process slurping. A similar effect occurs in the neighborhood of a well screen under imposition of a vacuum, with the difference that now, as liquid is removed, more liquid flows in from the formation to take its place. If liquid is being removed as fast as it is able to discharge into the well from the formation, then the vacuum will be exerted uniformly on the exposed portion of the filter pack.

(2) Upwelling. One of the effects that occurs in response to application of vacuum, as was discussed in [paragraph 2-5c](#), is upwelling of water. The position of the water table (i.e., the piezometric surface) is, by definition, the level at which water is in equilibrium with atmospheric pressure. A reduction in the pressure of the soil air in air-filled pores that are in communication with an SVE or MPE well produces a reduction of h_c and upward movement of water into those pores, provided $h_c < h_{cwb}$, the water entry capillary head. By explanation, as a wetting front within a moist, fine-textured soil layer moves into an adjacent, dryer, coarser-textured layer, the capillary head must diminish at least to the water entry value of the coarser layer before water can begin to occupy its larger pores (Miyazaki et al. 1993). The potential height of upwelling is equal to the vacuum head exerted in the air-phase at that location. For example, if 100 cm H₂O vacuum is applied to the SVE well, the level at which soil is saturated immediately below the well will be as much as a meter higher than the pre-SVE level. Note that the position of the piezometric surface as referenced to atmospheric pressure will not change during this process, unless water is extracted at a faster rate than it can recharge. Further explanation is provided in [EM1110-1-4001](#), Soil Vapor Extraction and Bioventing, Chapter 3, Bench- and Pilot-Scale Testing for SVE and BV. The following paragraphs focus on the effects of MPE on fluids in the well filter pack and adjacent soils.

(3) Soil Moisture Retention Analysis Analogy. What happens at the filter pack (and beyond it, in the formation) can best be understood by first considering the simple case of a soil sample subjected to a laboratory soil moisture retention analysis. In this case, a Tempe cell or similar device is used, in accordance with the method of Klute (1986) or ASTM D2325. The Tempe cell is a cylindrical sample holder with a porous plate against one planar boundary (Figure 2-13). A porous plate is selected that has small enough pores so that air entry will not occur through it, even under the highest suction that will be applied to the cell any time during the test. The porous plate is first presaturated with deaerated water, and a saturated soil sample is placed in contact with it. The porous plate serves, in effect, as a capillary barrier that will prevent airflow from being able to occur through the soil sample. A subatmospheric pressure, P_{sub} , is now applied to the porous plate/test cell assembly in a stepwise fashion, i.e., we make the water pressure more negative relative to the gas phase above the sample, which remains at atmospheric pressure, P_{atm} . By Equation 2-3, a reduction in the wetting pressure, P_w , results in a commensurate increase in the capillary pressure, P_c , within the sample. As P_c increases, there comes a point at which the air-water interfaces on the upper boundary of the soil sample (the boundary opposite the porous plate) achieve a radius of curvature that is smaller than the largest pore open to the atmosphere, and air enters the sample (Parker 1989). We term this point the air-entry pressure, P_a (Figure 2-13), or equivalently, the air entry capillary head, h_{cae} , defined as the lowest capillary head value that a soil can have at which air begins to displace water from the soil's largest pores. As the capillary pressure is increased further, the radius of curvature of the interface decreases further, and more air progressively enters the sample. In this manner, the wetting phase (water) will be progressively displaced from larger pores by the nonwetting phase (air), such that at each increasingly larger value of P_{sub} , an incremental fraction, n_a , of the porosity of the soil will become air-filled. As long as the h_{cae} value of the porous plate is not exceeded, this process can proceed, with water being displaced from smaller and

smaller pores until the soil sample is quite dry. The resulting set of points, $P_c(S_w)$ (Figure 2-14) describes the draining capillary pressure-saturation curve for the sample. This process of displacing water by air, through application of suction, is analogous to what occurs during MPE.

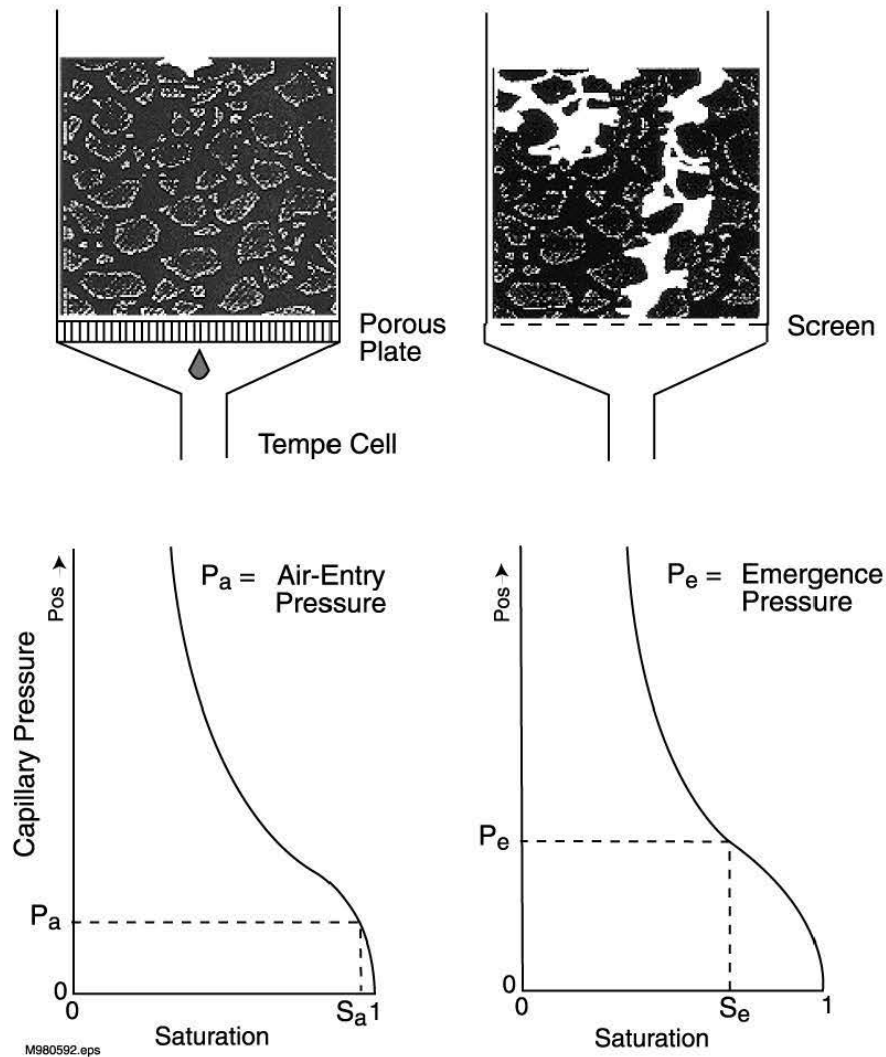

Air-entry pressure versus air emergence pressure. Tempe cell apparatus (upper left) has a porous plate that serves as a capillary barrier preventing air flow. Step-wise application of suction to the initially saturated cell across the porous plate induces gradual desaturation, yielding the soil's capillary pressure-saturation curve (lower left and right). The capillary pressure that result in the first displacement of water by air at the upper boundary of the soil sample (upper left) is the air-entry pressure, P_a . By contrast, the air emergence pressure, P_e (i.e., capillary pressure at which air is first able to emerge through a soil not bounded by a porous plate (upper right) occurs at the inflection point of a van Genuchten (1980) curve fitted to the capillary pressure-saturation data (lower right). (White et al. 1972; Baker and Groher 1998)

Figure 2-13. Air-Entry Pressure versus Air Emergence Pressure. (White et al. 1972; Baker and Groher 1998. Reprinted by permission of Battelle Press. Copyright 1998. All rights reserved.)

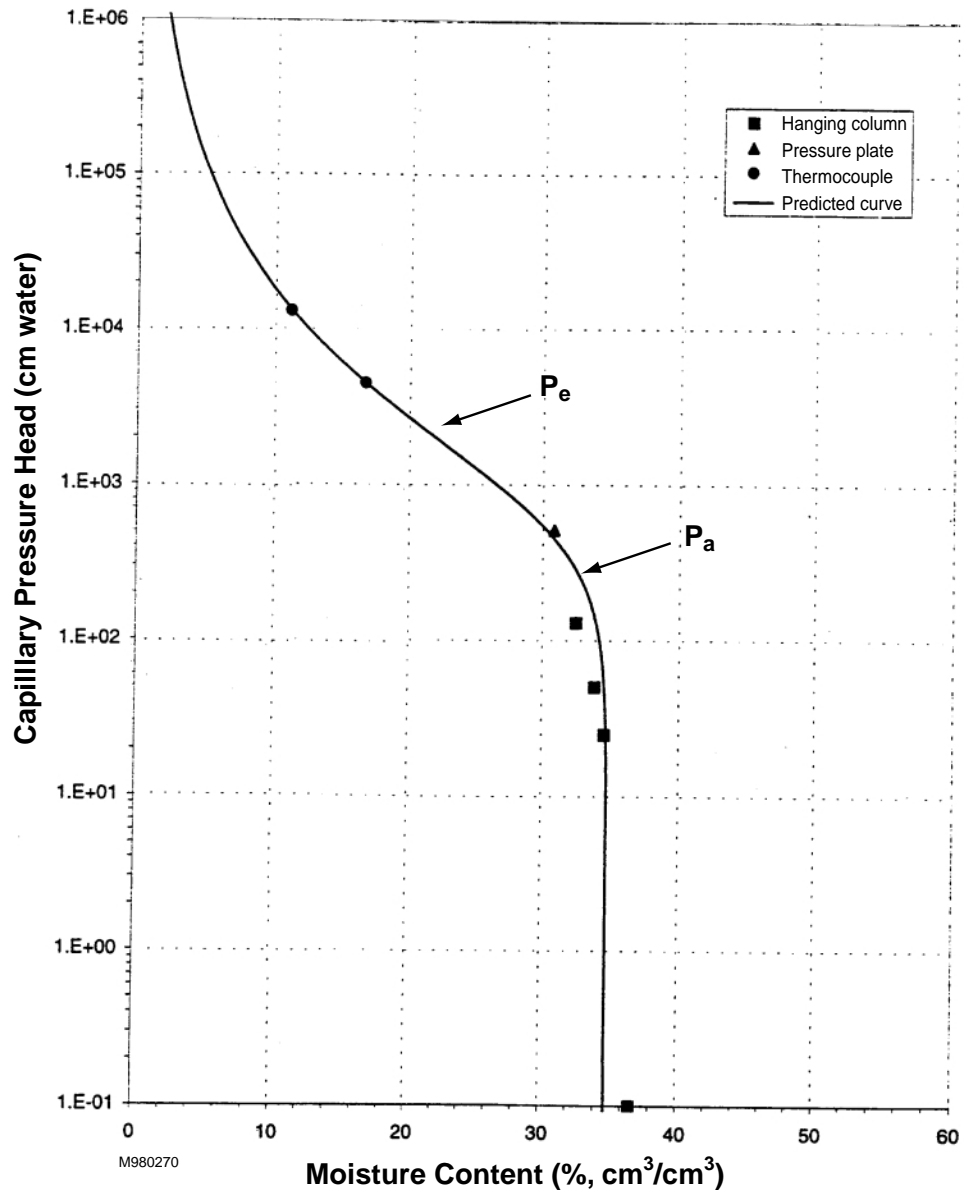

Figure 2-14. Predicted Water Retention Curve and Data Points for a Silt Loam. P_e = Air emergence pressure; P_a = Air entry pressure.

(4) Well Filter Pack. In the case of a well filter pack subjected to vacuum, as P_{sub} is applied, air is free to enter the filter pack at its value of P_a . Because of the relatively narrow particle and pore size distributions of the filter sand, and because there is no corresponding capillary barrier on the vacuum side of the soil as there was with the Tempe cell, air can displace water from most of the larger pores of the filter pack at the air emergence pressure, P_e , that is not much in excess of P_a , and the filter pack will permit air to flow readily through it. All filter pack gradations in conventional use have small enough values of P_e to be readily drained during MPE.

(5) Formations Adjacent to the Well. As vacuum propagates from the well out into the formation, a pressure gradient is established that is the driving force for fluid flow toward the well. Whether flow of NAPL, water and/or air is induced through the formation and into the well depends on a number of factors: the vacuum imposed, the saturation of each fluid and the history of saturation, the pore sizes occupied by each fluid, the associated permeabilities of the various available pathways, and the fluid properties (e.g., density, viscosity). The equilibrium vacuum experienced in the well will both be a function of vacuum imposed by the pump and the flow rate of fluids within and hence into the well. Consider two cases using the same pump: in one case, the well screen is blocked and no flow occurs, then the vacuum experienced in the well rises to its maximum value; in the case of a completely unblocked (and unimpeded) screen drawing only air into the well, the flow rate of air in the well reaches its maximum value, and the vacuum experienced/ measured in the well will be at a minimum. The behavior of the formation therefore affects the vacuum that can be applied at the well, with the effect that the vacuum experienced in the formation may change over time. In practice, maintaining a prescribed flux or pressure boundary condition cannot be selected a priori in the absence of site-specific data. To simplify what is in fact a very complex set of interactions, we shall consider: a) a uniform, homogeneous formation; then b) a layered case; and finally c) a more heterogeneous situation. If the adjacent formation is uniform and homogeneous, its behavior depends largely on its initial saturation and capillary pressure-saturation curve. Let us assume that the screen interval of the MPE well spans the water table, and that the inlet of the TPE drop tube or inlet pipe is also situated at the pre-extraction water table.

(a) Uniform, homogeneous formations.

- If the formation is quite permeable (e.g., a fine- or medium-textured sand) and has a relatively thin capillary fringe (e.g., <25 cm), imposition of a vacuum will readily pull water into the well. LNAPL also may enter the well, but only if it occupies an interconnected volume of adjacent pores. Gas may be prevented from entering the well by flooding of the inlet tube with liquid from this relatively transmissive formation. Sliding the inlet of the drop tube up above the water table can "break suction" allowing air into the tube, but in this type of formation it can be difficult to position the drop tube so as to maintain a mixture of liquid and air, because with only a slight upward repositioning of the tube, air rather than a mixture of air and liquid will be extracted. This type of setting is in general too transmissive for TPE, and may be better suited for separate vacuum extraction and liquid pumping, i.e., DPE (Peargin et al. 1997). Figure 2-15a nevertheless depicts what occurs when TPE is applied within such a setting.

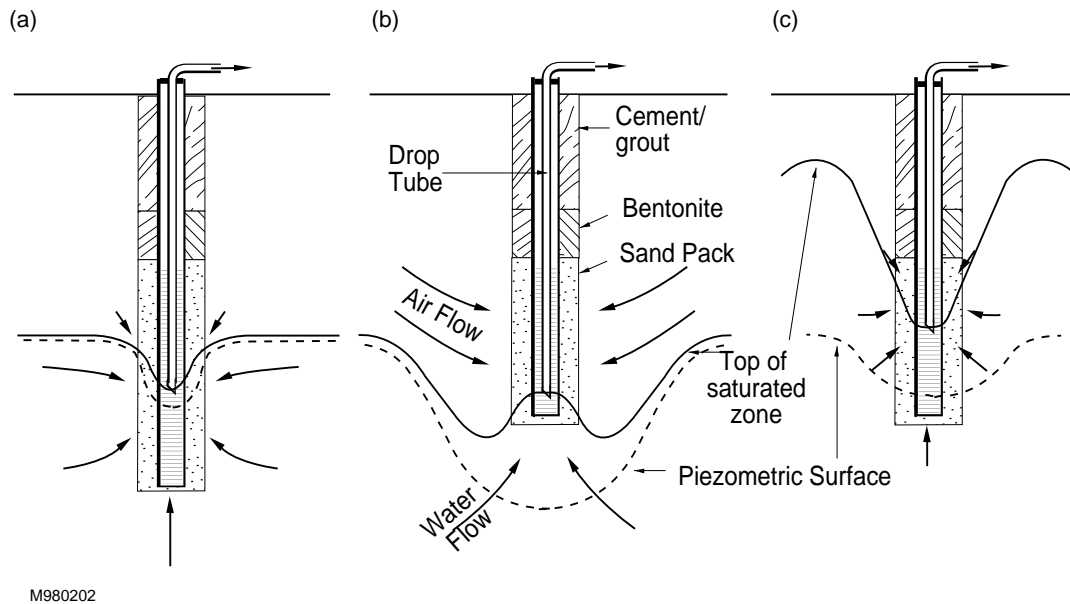

Figure 2-15. Hypothetical scenarios that can prevail during MPE. Length of arrows indicates fluid velocity; Dashed lines indicate piezometric surface; solid curve indicates top of saturated zone (top of capillary fringe within the formation). a) In high permeability settings, drop tubes can be flooded by water. b) In moderate permeability settings, a desirable ratio of gas; liquid can be extracted, leading to the desired enhancement of gas and/or liquid flow. c) In low permeability settings, it may not be possible to induce a significant amount of gas flow from the formation into the well. Only (b) is desirable. (After Baker and Groher 1998. Reprinted by permission of Battelle Press. Copyright 1998. All rights reserved.)

- If the formation is moderately permeable (e.g., a very fine sand or silt) with a capillary fringe zone of moderate thickness (e.g., 25 to 250 cm), imposition of a vacuum will likely pull a combination of liquid (water and LNAPL, if it occupies interconnected adjacent pores) and air into the well. Figure 2-15b depicts application of MPE in this type of setting, which is generally well suited to MPE. The more moderate transmissivity of this type of formation means that there will be a wider depth interval over which the inlet of the drop tube can be positioned and still result in a mixture of liquid and air being extracted. In this setting some of the vadose zone soil with which the MPE well is in contact will either already be unsaturated prior to application of vacuum, or will be able to become dewatered enough to be conductive to airflow upon application of a moderate vacuum. The vacuum that will need to be applied to begin to move air through a soil can be predicted based on capillary theory. Air will begin to flow through the soil at a capillary pressure value we again term the air emergence pressure (Stonestrom and Rubin 1989), P_e , that is somewhat greater than its P_a (air entry) value, at which air could first displace water along one boundary of the soil. By contrast, P_e , at which air is first able to flow through an initially saturated porous medium, has been found to lie near the inflection point of a van Genuchten (1980) curve fitted through a set of $P_e(S_w)$ data for that medium (White et al. 1972; Baker and Groher 1998). The difference between the two points is illustrated in Figure 2-13. Thus, we would not expect to be able to dewater a soil unless we can propagate into the soil a vacuum equal to the soil's P_e value. This explains why measurements of saturation

using neutron probes in the vicinity of MPE wells have shown that in several cases, the soil was not able to be dewatered during MPE (Baker and Groher 1998). For comparison, Table 2-3 presents approximate P_e values (and the equivalent effective capillary fringe heights) for a range of soil types, based on inflection points of the family of capillary pressure-moisture content curves illustrated in Figure 2-9. Note that each textural class encompasses a range of particle-size and pore-size distributions, and hence a range of associated capillary pressure-moisture content curves; the data are merely representative.

TABLE 2-3
Approximate Air Emergence Pressure and Effective Height of
Capillary Fringe by Soil Textural Class
(based on Figure 2-9)

Soil Textural Class (USDA)	Air Emergence Pressure (cm H ₂ O)	Ht. of Capillary Fringe (m)
Sand	10	0.1
Loamy sand	10	0.1
Sandy loam	30	0.3
Loam	40	0.4
Sandy clay loam	50	0.5
Sandy clay	100	1
Clay loam	100	1
Silt loam	200	2
Silty clay loam	500	5
Clay	>2000	>20

- Towards the lower end of the moderate permeability range, as defined in the previous paragraph, and especially in deeper applications where the depth of the water table beneath the ground surface is in excess of the suction lift of water (approximately 10 m), it may be advantageous to introduce outside air into the well initially as a way of providing enough air velocity to carry entrained liquid droplets up the well or drop tube. Such methods of priming the well with air offer ways to potentially overcome the problem of the formation not initially yielding enough airflow to sustain multiphase flow of liquid out of the well.
- Another phenomenon that occurs near a vacuum extraction well, especially in formations of moderate permeability, is redistribution of vadose-zone water (Baker and Bierschenk 1995; Baker 1995). Imposition of a vacuum gradient at an MPE or SVE well reduces the value of the nonwetting capillary pressure, P_{cn} , of air-filled pores that are in communication with the well; thereby reducing the capillary pressures, P_c (see Equation 2-3), and increasing S_w accordingly. As a result, provided that the water saturation value lies within the range: $S_{wr} < S_w(P_c) < S_w(P_{cn})$, unsaturated flow of water is initiated in the direction of the MPE well. If a sufficient

volume of moisture arrives at the well, the sharp transition to the larger pores of the sand filter pack and the well screen can constitute a capillary break, and water can "pile up" within the soil around the filter pack, as has been observed using neutron probe observations during MPE (Baker and Bierschenk 1995). It follows that the capillary pressure of the soil around the filter pack cannot fall below the P_a value for the filter pack, because at that point water would begin to seep into the sand pack; consequently, the S_w value of the soil around the filter pack will remain no higher than its $S_w(P_a)$ value (Baker 1998). This redistribution of vadose-zone liquid toward the extraction well was anticipated in theory by McWhorter (1990). Although this effect would probably not be of significance in a well-drained, permeable soil, it does manifest itself in many settings through reductions in k_a and associated dramatic head losses adjacent to SVE vents, resulting in poor vent well efficiency. This aspect is discussed in [EM 1110-1-4001](#), Soil Vapor Extraction and Bioventing, Chapter 4, Bench- and Pilot-Scale Testing for SVE and BV, Well Efficiency.

- If the formation is slowly permeable (e.g., a silty-clay or finer-textured formation) with a thick capillary fringe zone (e.g., > 250 cm), imposition of a vacuum will likely result in a limited recovery of liquid and little or no gas either (Figure 2-15c). Although a higher vacuum will impart a larger gradient and, in accordance with Equations 2-8, 2-9, 2-10 and 2-11, will increase the resulting fluid flux, the much lower permeability of this kind of formation will still largely limit the flux. In addition, airflow through the soil may not be able to be initiated due to the high value of the soil's P_e . Such low permeability settings are not likely to be conducive to MPE, unless a considerable amount of contaminant mass resides in preferential pathways that do experience fluid flow during application of the vacuum (Baker and Groher 1998). This type of setting is, however, also the kind that is most susceptible to being dominated by unwanted preferential flow, such as short-circuiting of air from the surface to the well through macropores or structural cracks (see paragraph 2-4c), with limited areal vacuum influence elsewhere. Priming will be of limited benefit in such settings.

(b) Layered soils. If the MPE well screen intersects two or more soil layers of differing pore size, airflow will be initiated first in the layer with the smallest P_e value (i.e., the path of least resistance), which we shall term Layer 1. This is because unlike the case of the soil moisture analysis (paragraph 2-5e(3)), there is no capillary barrier adjacent to the MPE well screen to prevent air from entering through some pathways and not through others. If Layer 1 can produce air or liquid at a rate commensurate with the capacity of the pump and piping at a given value of applied vacuum, other layers will not be dewatered nor produce much fluid. If Layer 1 is not very permeable, however, and cannot produce as much fluid as the pump/piping system is capable of moving, the vacuum being applied will increase, and the P_e value of another soil layer, Layer 2, will be attained, allowing that layer to begin to yield air. Once again, however, if Layers 1 and 2 can produce enough fluid to satisfy the pumping system's capacity at that value of applied vacuum, other layers will not be dewatered nor produce much fluid. This process can be visualized (Figure 2-16), and will proceed until flow through conductive layers of the formation matches the capacity of the pumping system at the applied level of vacuum. The significance of an inability to dewater other layers or entire regions of the subsurface is profound, because if zones of stagnant or limited airflow are reservoirs of contamination, the primary mechanism for mass transfer through the soil matrix becomes aqueous-phase diffusion, which is extremely slow (McWhorter 1995). Thus regardless how much air may be moving

through conductive layers or scattered permeable pathways, the course of the remediation will be diffusion-limited and protracted. On the other hand, if the objectives are simply mass removal, and if leaving a substantial fraction of the contaminant mass behind in the soil matrix can be tolerated, then MPE may still be worthwhile (Baker and Groher 1998). Deciding which is the case is an important aspect of the task of setting acceptable remedial goals.

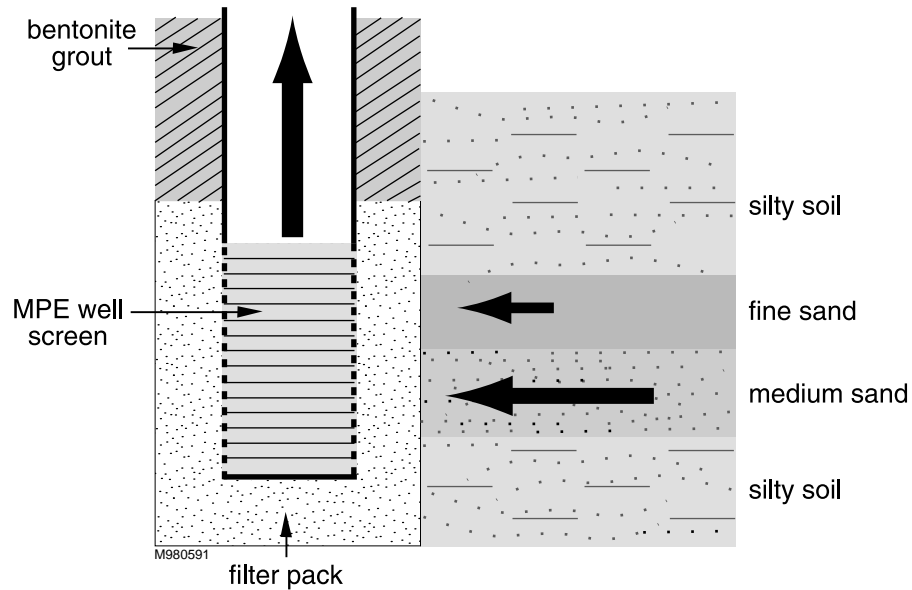

Figure 2-16. Preferential Airflow into MPE Well from a Layered Soil. Arrow sizes are proportional to airflow velocities, silty layers are not conductive to air in this case.

(c) Heterogeneous settings. If the MPE well screen is placed within a heterogeneous setting, i.e., one in which the pattern of distribution of soil types, layers or soil morphological features is not readily discerned, the response of the subsurface to application of vacuum is more difficult to characterize. Nevertheless one may expect the same sort of response as described in the preceding paragraph on layered soils, namely that flow will be predominantly along paths of least resistance. Therefore, the greatest degree of treatment will occur along preferential pathways. Whether neighboring soil (adjacent to or at a distance from conductive pathways) is treated by MPE processes depends on how great the contrast in soil properties is between the most conductive zones and less conductive zones.

f. Influence of MPE on NAPL Recovery.

(1) NAPL Saturation. If NAPL is present in the formation near an MPE well, it will flow to the well if it occupies an interconnected series of pores leading to the well. Recall that within the zone where NAPL is present, water is also present. As the wetting phase, water typically wets the soil matrix, forming a continuous phase within it (Sale and Applegate 1997). NAPL, by contrast, is typically non-wetting with respect to water, and tends to occupy the larger pore spaces. Whether or not NAPL constitutes a continuous phase within the soil depends on its saturation, S_o , and the geometry of the NAPL-filled pores. Furthermore, the transmissivity of the formation to NAPL is likewise a function of S_o , pore geometry, and the height of the continuous NAPL flow paths.

(2) Principles of NAPL Flow Path Management. As NAPL is extracted from an area within the subsurface, the NAPL saturation of that area diminishes. In the process, the height of continuous NAPL flow paths contracts, leaving behind areas of residual NAPL saturation, S_{or} , within which NAPL is immobile. Conceptually, NAPL recovery is a process of managing conditions within the NAPL flow paths to optimize NAPL flow. Quoting Sale and Applegate (1997), "the principles of flow path management dictate the importance of maintaining maximum NAPL saturations, NAPL heights, widths of NAPL flow paths, and NAPL gradients. Allowing any of these parameters to approach zero will likely limit the effectiveness of a NAPL recovery system."

(3) Effect of Vacuum on NAPL Flow Paths. Application of a vacuum during MPE will increase the head gradient driving NAPL toward the extraction well. Therefore, given a sufficiently large volume of recoverable NAPL, vacuum extraction will enhance free product recovery rates. Since MPE also inevitably enhances water recovery rates, water may displace NAPL from portions of its flow paths. Consequently, if NAPL saturations and flow paths are relatively small, application of vacuum can cause NAPL-filled pores to "snap off." Thereupon, NAPL will not be able to flow as a separate phase through those pathways again, unless the interconnections later become reestablished. These statements apply to both LNAPL and DNAPL.

(4) Recoverability. If enhanced LNAPL recovery is the objective, consideration needs to be given to evaluating the recoverability of the product. Paragraph 3-5a provides details regarding applicable methods. For example, the apparent LNAPL thickness in monitoring wells is not necessarily a good indication of the volume of recoverable product. Figure 2-17 shows the relationship between relative LNAPL transmissivity and apparent product thickness for a sandy and a silty soil (Parker et al. 1996). In cases where apparent product thickness is less than approximately 30 cm, true product thickness in the formation tends to be so small, especially in finer-textured soil, that the volume of recoverable product is negligible.

(5) LNAPL Extraction Depth. Care must also be taken to select the optimal depth of LNAPL extraction. Positioning of TPE drop tubes or DPE pump inlets so as to maintain the highest LNAPL saturation possible adjacent to the well will prolong the period before snap-off occurs. Placement of the intake device adjacent to layers of highest LNAPL transmissivity is advisable. Note that with TPE, if the drop tube is positioned above the apparent LNAPL elevation in moderate permeability soil, upwelling will occur in the soil adjacent to the well, because liquid is not being removed as fast as it redistributes upward in response to the vacuum. This upwelling in response to the application of vacuum will cause the zone of highest LNAPL saturation to translate upward along with the capillary fringe (unless a confining layer is in the way). If upwelling does occur, the optimal depth of extraction will be shallower than one would expect from pre-MPE apparent product elevations. Creating a cone of depression during MPE will not necessarily negate this effect, and can at times cause interruption of LNAPL flow paths to the well. Comparisons of LNAPL recovery obtained during sequential skimming, slurping and drawdown are provided in Table 4-8 and Figure 4-13.

2-6. Fate Mechanisms for NAPL in the Subsurface.

a. Information Sources on Fate and Properties of NAPL Constituents. A complementary discussion of fundamental fate and transport mechanisms for NAPL in the subsurface may be found in EM 1110-1-4001, Soil Vapor Extraction and Bioventing, Chapter 2. In addition, Chapter 3 lists VOCs considered amenable to SVE, and summarizes the effectiveness of SVE on general contaminant groups

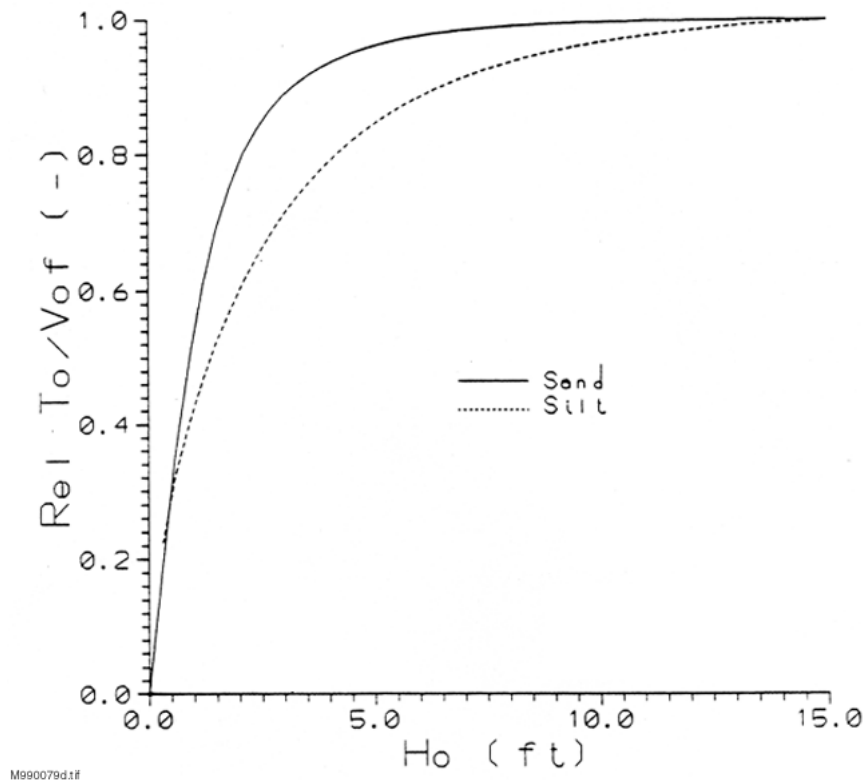

Figure 2-17. Relative Oil Mobility Versus Apparent Oil Thickness for Two Soils (EPA 1996b). To/Vof is the oil mobility factor, where To is oil specific volume. $Rel To/Vof$ is the oil mobility factor normalized by its maximum value. Ho is apparent LNAPL thickness.

for soil. These tables are also applicable to MPE. Finally, Appendix B in EM 1110-1-4001 contains useful tables of properties of common organic pollutants, including the vapor pressure, solubility, Henry's law constant, partitioning coefficient and half-life for a variety of compounds amenable to MPE.

b. Fate Mechanisms. Since MPE often addresses NAPL contamination, the following briefly reviews various NAPL fate mechanisms in soil and groundwater.

(1) Volatilization. Foremost from the standpoint of MPE is volatilization, in that a number of the compounds of potential concern in common organic liquids are VOCs that can be removed from the subsurface most readily if they can be volatilized and carried aboveground with advected air. Although some contaminants, such as acetone and ethylene glycol that are highly (or infinitely) soluble may be extracted better in the dissolved phase, most VOCs are more extractable in the gas phase, in accordance with their Henry's law constants. For that reason, obtaining a good distribution of airflow, and ensuring adequate air exchange within subsurface locations where NAPL resides, are of primary importance during MPE. The greater the surface area of NAPL exposed to volatilization, the more rapid will be the mass transfer, other factors being equal. Thus droplets of residual NAPL in a sandy vadose zone, for example, will volatilize more readily than a NAPL pool perched upon a clay lens in that same zone. Also, since various VOCs that comprise NAPL differ as to their volatility, the composition of the extracted gas will vary over the course of the remediation: higher fractions of more volatile compounds are to

be expected earlier, with less volatile compounds following later. Thus, the results of a short-term pilot study provide only an early indication of what will occur over a longer period. In addition, the concentrations of the individual VOCs present in the off-gas will very likely decline over time. As contaminant mass is removed, the concentrations remaining in the subsurface will of course decline, and the remaining composition will shift to a predominance of the less volatile compounds. Because of mass transfer limitations, it is not uncommon for these concentrations to decline asymptotically, with a substantial contaminant mass often remaining in the soil once off-gas concentrations have become asymptotic. If the contaminant concentration remaining upon reaching an asymptote is less than the remedial goal, the remediation is deemed complete. If, however, the asymptotic concentration is well above the remedial goal, it is an indication that the mass transfer has become diffusion-limited. This often occurs because mass transfer from within matrix blocks towards airflow pathways is controlled by very slow rates of aqueous-phase diffusion (McWhorter 1995; Baker et al. 1999). These effects have major ramifications for technology screening, pilot testing, design, operation, and shutdown, and will be addressed in later chapters.

(2) Dissolution. The degree to which a compound can dissolve into the aqueous phase is determined by its solubility. Since MPE involves removal of the liquid phase, contaminant mass will be removed with extracted water, but typically to a much lesser degree, over the first months or even year of an MPE remediation, than that which is extracted as vapor. Related factors strongly influencing dissolution of NAPL are the surface area of NAPL that is in contact with water, and the rate of aqueous flow through the NAPL zone. For contaminants trapped in saturated portions of the smear zone, dissolution rather than volatilization becomes the primary mass transfer mechanism, unless the water table is drawn down to expose the contaminants to air flow, or unless a related technology such as in situ air sparging (IAS) is employed in a way that ensures good contact between sparged air and aqueous or non-aqueous phase contaminants.

(3) Adsorption. Compounds in solution have a tendency to adsorb to the surfaces of soil particles or organic matter. The extent to which they do so depends on their partitioning coefficients and the specific surface and organic content of the soil or aquifer materials concerned. Organic compounds of higher molecular weight, for example, tend to have larger octanol-water partitioning coefficients, than those of lower molecular weight. In addition, the higher a soil's clay or organic matter content, the greater is its capacity to adsorb contaminants. While adsorption reactions tend towards equilibria and may be reversible, it typically takes longer for a given mass of contaminant to desorb than it took for it to adsorb, and some of the adsorbed contaminant mass can become effectively sequestered in recesses of the soil. Contaminants at such sites of sequestration may thus not be as susceptible to volatilization, dissolution or leaching, nor as bioavailable as might be indicated by an analysis of the total compound present using an aggressive extractant. Changes in subsurface geochemistry, however, can cause shifts in the equilibria, with the result that a compound thought to be unavailable can become more so at some future time.

(4) Biodegradation. Many organic contaminants are susceptible to being degraded biologically. They may be directly consumed by microorganisms that can make use of such compounds metabolically, or they may be degraded gratuitously by enzyme systems that serve some other normal metabolic purpose. The latter process, termed cometabolism, is generally not as prominent as the former. Biodegradation of many petroleum hydrocarbons occurs at much faster rates under aerobic conditions than when oxygen is limited. Thus, any process such as MPE that tends to increase airflow through the subsurface can somewhat enhance aerobic degradation of biodegradable compounds, including both amenable

EM 1110-1-4010
1 Jun 99

VOCs and SVOCs. This is one of the primary processes underlying bioslurping. By contrast, many halogenated ethenes, while not susceptible to aerobic biodegradation except under a relatively narrow set of conditions, can undergo reductive dehalogenation under suitable anaerobic conditions. In many cases, natural attenuation, particularly processes that occur biologically, will be relied upon to accomplish whatever remediation remains upon cessation of MPE activities. It is beyond the scope of this document to review the extensive background literature on the topic of biodegradation, but salient considerations will be discussed within most of the chapters that follow.

CHAPTER 3

SITE CHARACTERIZATION AND FEASIBILITY EVALUATIONS

3-1. Introduction. Prior to selecting MPE for implementation, the site characteristics and the nature and extent of contamination must be assessed to evaluate the feasibility of MPE. Data collection requirements for initial technology selection are presented at the beginning of this chapter, along with a suggested strategy for technology screening. Next, paragraphs 3-3 through 3-6 provide details on required pre-design site characterization parameters, including physical, chemical, and biological properties of site media and contaminants, and the corresponding data collection methods. Paragraph 3-7 presents a checklist of site characterization data requirements. Paragraph 3-8 describes remediation technology options. Finally, paragraph 3-9 provides guidance on performance of MPE feasibility studies.

3-2. Data Collection Requirements for Technology Screening. It is advisable to perform technology screening as early in the process as possible, preferably concurrently with site characterization activities. Early evaluation of the data needs for remedy selection (and design) may reduce the need for subsequent mobilization to the field during design. However, it is usually inappropriate to collect detailed design data before a remedial alternative has been selected. Those undertaking technology screening must have a sense of the overall remedial objectives, some knowledge of the nature and extent of contaminants at the site, and a good grasp of the range of technologies available, including their limitations. Figure 3-1a is a technology screening matrix for LNAPL (free product) recovery using MPE, and Figure 3-1b is a technology screening matrix for vacuum-enhanced SVE/BV using MPE. Table 3-1 provides a checklist of site characterization data required for use of the two screening matrices for technology selection. An example format for a Sampling and Analysis Plan (SAP) is presented in [EM 200-1-3](#).

3-3. Site Conditions.

a. Identification of Site Features. Knowledge of pertinent above- and below-ground site features is necessary in the early stages of site characterization. This is typically performed by a site visit and records research.

(1) Surficial Topography. Surface topography and surface features can provide insight on subsurface conditions such as hydraulic gradient. Surface features, such as the condition of pavement, have a direct impact on the lateral extent of MPE influence.

(2) Surface Waters. Surface waters may provide information on water table location (e.g., wetland/swamp, gaining stream) and should be considered as a potential discharge location for system effluent water under a National Pollution Discharge Elimination System (NPDES) permit.

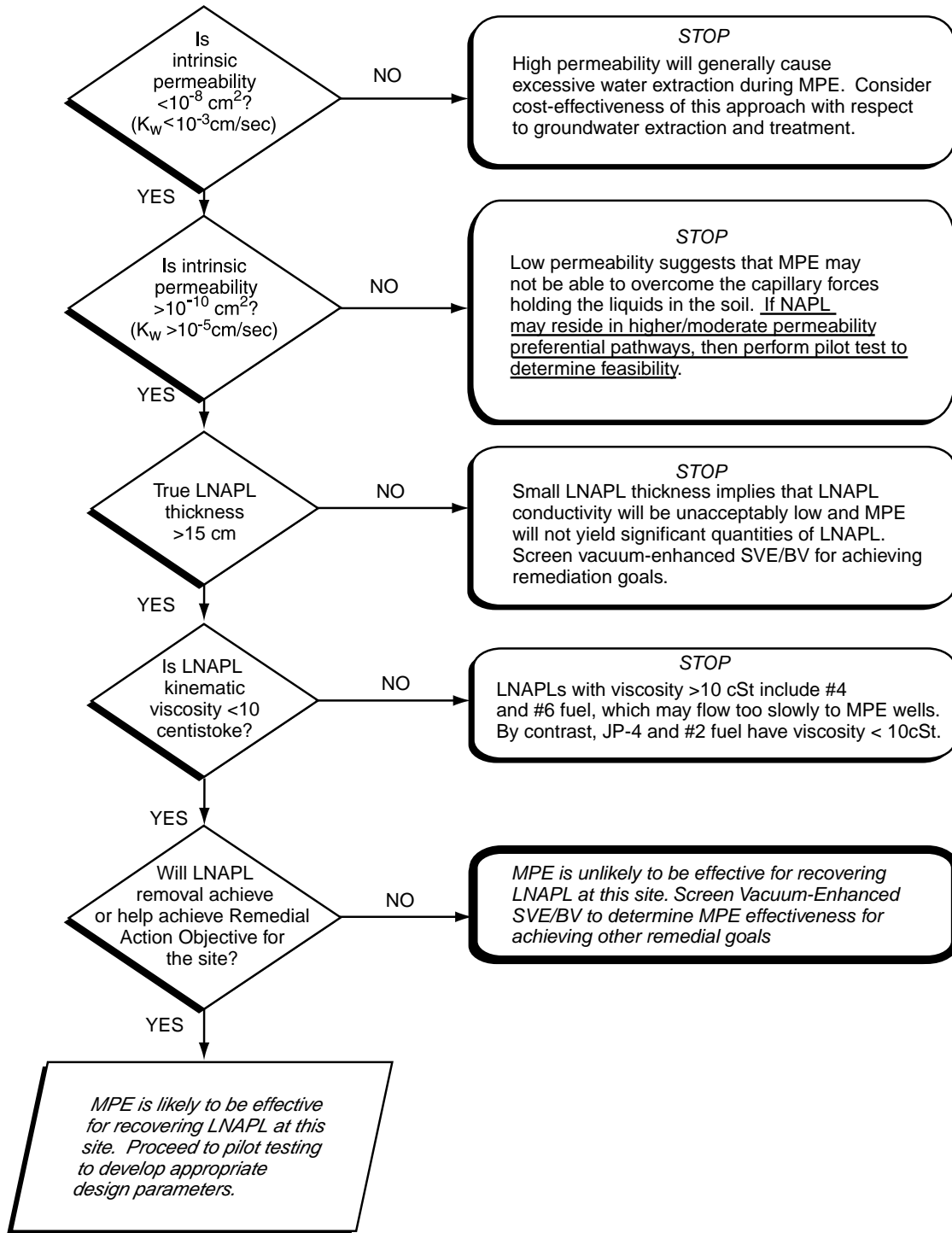

M980219

Figure 3-1a. Technology Screening Matrix - Vacuum-Enhanced LNAPL (Free Product) Recovery.

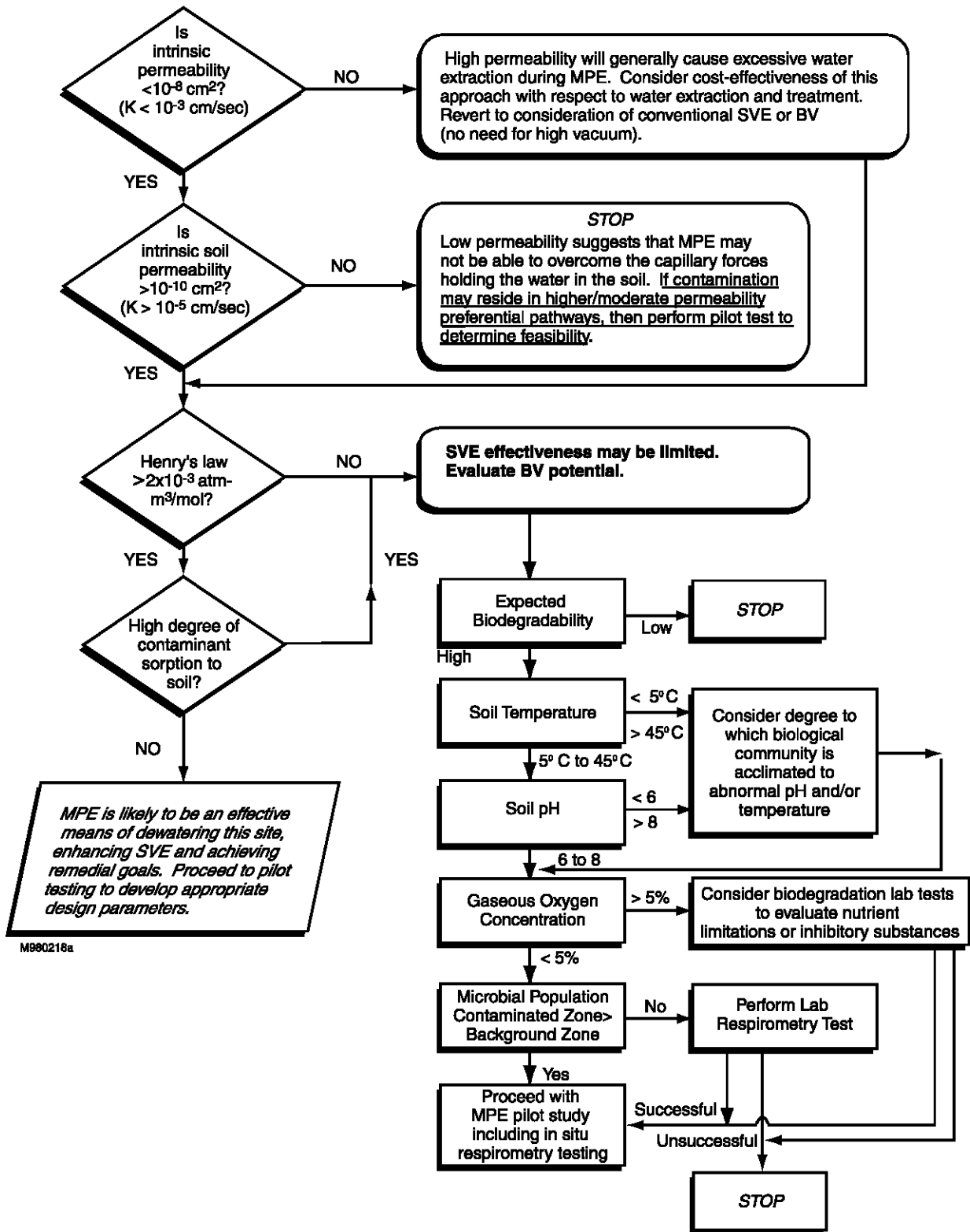

Figure 3-1b. Technology Screening Matrix - Vacuum-Enhanced SVE/BV (including vacuum dewatering).

TABLE 3-1

**Checklist of Site Characterization Data Needs
for Technology Screening**

Parameter	Source of Relevant Information (EM Paragraph No.)
Physical properties of soils: permeability, bulk density, moisture content, and capillary pressure-saturation curves	3-4 this EM; EM 1110-1-4005, Chapter 3
Stratigraphy, heterogeneity, and short-circuiting potential of formation	3-4 this EM; EM 1110-1-4005, Chapter 3
True versus apparent LNAPL thickness	3-5a(1) and 3-5a(2) this EM
NAPL viscosity, density, and interfacial tension	3-5a(7) this EM
Henry's law constants, boiling points, vapor pressures, and solubilities of contaminants, soil adsorption coefficients	EM 1110-1-4001, Chapter 2
Biodegradation potential	3-6 this EM; EM 1110-1-4005, Chapter 3
Soil/groundwater temperature	EM 1110-1-4005, Chapter 3
Soil/groundwater pH	EM 1110-1-4005, Chapter 3
Gaseous and dissolved oxygen concentration	3-5d(2)/3-5e this EM; EM 1110-1-4005, Chapter 3
Respirometry/microbial enumeration	3-6b/3-6c this EM; EM 1110-1-4005, Chapter 3

(3) Building/Basements. On-site buildings such as active facilities must be considered with respect to access restrictions and site security. Facility operating schedules may also affect operation of MPE systems (e.g., MPE system power supplied from the facility). Even at abandoned sites, existing foundations or former basements in close proximity to MPE wells can act as preferential pathways.

(4) Available Utilities. Availability of utilities must be checked in order to ensure compatibility of any equipment to be used with available power and water supply, etc. It is also important to ensure that utilities will not be subject to inadvertent disconnection by facility or security personnel.

(5) Utilities/Subsurface Interferences. Locating underground utilities must be done prior to any subsurface site work (typically by a utility locating service). On active installations, locating utilities should be coordinated with the base/facility electrician. Buried utilities may act as conduits for groundwater movement and preferential airflow pathways. As-built drawings (refer to paragraph 3-3a(9)) of buried utilities can be particularly useful, but may need to be supplemented by information obtained from experienced facility staff. Overhead obstacles such as power lines should also be identified as they may impact use of drill rigs at the site.

(6) Existing Wells. Existing monitoring wells may be useful as future MPE wells. Integrity of existing wells and suitability for MPE should be verified

prior to use (refer to paragraph 5-5d. Drinking water wells in the vicinity must be located, as system design may be required to prevent plume migration toward such wells.

(7) Unusual Features. Features such as surface soil stains which may be indicative of a former spill area; the presence of surface tanks or subsurface tanks which may be identified by aboveground vent pipes; areas of environmental stress; surface impoundments; and other potential sources of waste should be identified prior to MPE implementation.

(8) Verification of Site Boundaries. The property boundaries of the site should be identified to ensure that the remediation system will fit within the site and to identify possible off-site sources.

(9) Verification of As-Built Drawings. Pre-existing as-built drawings for the site can often be located in city or town property records and other archival locations. Caution should be exercised, however, when using these drawings because they may not be up to date. All drawings of the site furnished or obtained by others should be verified for accuracy in the field.

(10) Evaluation of Site Accessibility. Roadways to and from the site, entries onto the site, gates, and potential restrictions to site access should be identified.

b. Regulatory Context. An understanding of regulations driving remedial activities must be understood at any site. Paragraph 9-2 provides more information on regulatory issues associated with MPE.

(1) Remedial Goals. Prior to implementation of any remedial activity, appropriate goals must be set. It is imperative that measurable and achievable criteria for meeting the goals are set in the cleanup criteria and/or Record of Decision (ROD) for the site. Once these criteria are established, the design and operation of the system should focus on attaining the remedial goals. In addition, it will be far easier to demonstrate that goals have been attained if plans for monitoring and confirmatory data collection are designed with the evaluation criteria in mind. Consideration must also be given to changing conditions (e.g., subsurface dewatering, changing plume) during MPE operation. Adjustment of system operation over time (e.g., lowering of the drop tube to draw down the water table exposing more of the affected subsurface soil to the applied vacuum) may also be required to meet the remedial goals.

(2) Receptors. All potential on- and off-site receptors such as residents, workers, wetlands, or nearby drinking water wells must be identified, as protecting these receptors may be the main objective of remediation.

(3) Points of Compliance. Points of compliance may be specified during the determination of remedial goals. It may be required that contaminant concentrations be reduced to remedial goals within a certain area surrounding the site or at certain downgradient locations. These requirements must be known prior to implementation of MPE and it must be determined whether the chosen technology is capable of meeting remedial goals at the points of compliance.

3-4. Physical Properties. Physical parameters that provide necessary information when characterizing a site for MPE are described in this section. Table 3-2 summarizes these and other pertinent parameters relative to soil.

TABLE 3-2

Soil Physical Parameters

Parameter	Sample Type	Analytical Method
Air-phase permeability (core scale)	In situ or undisturbed soil sample	Various ¹
Grain size distribution	Split spoon or other soil sample	ASTM D422
Total organic carbon	Split spoon or other soil sample	Lloyd Kahn, SW-846 9060
Porosity	Undisturbed 50 to 75 mm- diameter soil sample	Calculated from dry bulk density and particle density
Dry bulk density	Undisturbed 50 to 75 mm- diameter soil sample	ASTM D2850
Moisture content (of unsaturated zone soil)	Non-destructive field measurement; grab sample; or undisturbed 50- to 75-mm-diameter soil sample	Neutron access tube measurements (Gardner 1986); ASTM D2216
Soil moisture retention (capillary pressure-saturation curve)	Undisturbed 50- to 75-mm-diameter soil sample	ASTM D2325 ¹
Stratigraphy/heterogeneity	Soil borings	Visual observation; Breckenridge et al. 1991; USEPA 1991d; ASTM D2488; EM 1110-1-4000
Depth to groundwater and range of fluctuation; hydraulic gradient and flow direction	Water table monitoring wells	Water level meter or interface gauge and surveyed well elevations; ASTM D4750 (ensure that the probe weight is inert)
Hydraulic conductivity	Field Measurement	ASTM: D4043; D4044; D4050; D4104; D4105; D4106; D5269; and D5270
Notes: ¹ USACE Soil Vapor Extraction and Bioventing Engineer Manual (EM-1110-1-4001), November 30, 1995. Table Source: USACE In-Situ Air Sparging Engineer Manual (EM-1110-1-4005), September 15, 1997.		

a. Stratigraphy. Stratigraphy within the soils exposed to MPE must be understood prior to implementation. Soil stratigraphy should be observed continuously through collection of, for example, split-spoon soil samples throughout the depth interval of the MPE well. Variations in stratigraphy can dramatically favor the lateral flow of gas in permeable zones and impede the flow of gas through less permeable zones (e.g., clay lenses), potentially leaving a large volume of soil untreated (USEPA 1995). More information on determining stratigraphy can be found in USEPA (1991a), ASTM D 2488, and EM 1110-1-4001, Soil Vapor Extraction and Bioventing, Chapter 3.

b. Grain Size Distribution. Grain size distribution data should be obtained from soil samples collected within the screened interval of the MPE well. Care must be taken to obtain representative samples for grain size analysis as this parameter is measured on a small scale. Grain size distribution data will assist in specifying the well screens. It also can aid in evaluating the permeability of the soil, which is an important consideration in MPE, as very permeable soils are typically not suitable for TPE.

c. Porosity. Porosity is an important parameter to quantify for the treatment zone. The porosity value will assist in determining the permeability of the soil and is typically a required input parameter for fate and transport models. Porosity must also be estimated in order to analyze data used to determine hydraulic conductivity (e.g., distance-drawdown data).

d. Moisture Content. Moisture content can give designers confirmation of the location of the capillary fringe when samples are obtained directly above the water table (see Table 2-3 for approximate heights of the capillary fringe for various soil types). Although moisture content in soils near the water table may change with fluctuations in water table elevation, these data (when correlated with water table elevation) can help in locating the capillary fringe and smear zone.

e. Water Table Elevation. It is important to assemble all available site data regarding water table elevation when determining the feasibility of MPE or prior to design. Consideration must be given to seasonal fluctuations in the water table elevation because seasonal rise in elevation may cause the drop tube to become submerged and/or may "dead-head" certain vacuum pumps. Seasonal water table fluctuations also affect the recoverability of LNAPL. Although 1 atmosphere (10.3 m H₂O) is theoretically the maximum vertical distance over which suction can be used to lift a continuous column of water, due to pump inefficiencies and frictional losses in piping, the maximum attainable lift is approximately 9.1 m H₂O (Powers 1992). In applications where the water table elevation is below the elevation of attainable suction lift, DPE may be implemented using a submersible pump to remove liquid from the well. Alternatively, TPE can lift water from depths of as much as approximately 40 m when a sufficient air velocity is maintained to convey liquid droplets up the drop tube.

f. Hydraulic Gradient and Flow Direction. These parameters can effect placement of wells especially if the MPE system is used to control off-site plume migration. Seasonal changes in weather, surface infiltration characteristics, and tidal effects near large surface water bodies, can have temporal effects on hydraulic gradient and flow direction.

g. Vadose and Saturated Zone Pneumatic and Hydraulic Properties. Detailed information regarding these parameters is contained within existing USACE guidance. In particular, the reader should refer to [EM 1110-1-4001](#), Soil Vapor Extraction and Bioventing, Chapter 3; and [EM 1110-1-4005](#), In-Situ Air Sparging, Chapter 3.

(1) Permeability. As is the case with all in-situ remediation technologies that rely on inducing movement of fluid to accomplish mass transfer, MPE performance depends strongly on the permeability of the soil. It is therefore essential to evaluate the permeability of the zones targeted for MPE. Chapter 2 discussed the role that intrinsic and relative permeability play in the physics of multiphase flow in the subsurface. It is often useful to measure permeability on more than one scale, i.e., at the field scale through pumping tests, slug tests, and in situ air permeability tests; as well as in the laboratory through measurement of "intact" undisturbed soil cores. A program that combines two measurement scales, for example, such as a small number of slug tests or in-situ air permeability tests, and a larger number of core-scale measurements, offers the possibility of correlating the two. The correlation can allow extrapolation of values obtained using both scales at a few locations, to other more numerous locations where data are obtained only at the core scale (Baker et al. 1995; Baker and Groher 1998). Substantial areal and vertical variations in permeability/anisotropy can significantly affect MPE effectiveness because of their potential to focus fluid flow on some regions or

zones and in certain directions, while essentially by-passing others entirely. Examples of anisotropy may be seen from the difference between field-scale and laboratory-scale measurements. Field tests (e.g., pumping tests) tend to give results that show the dominant influence of horizontal permeability, while laboratory measurements within vertically-oriented soil cores reflect only vertical permeability. For this reason, the methodology in testing permeability must be known and taken into account when analyzing these data. As discussed above, the most useful results will most likely be obtained by evaluating both field- and laboratory-scale measurements. Applicable methods for measuring and estimating permeability are described in [EM 1110-1-4001](#), Soil Vapor Extraction and Bioventing, Chapter 3 and Appendix D, and [EM 1110-1-4005](#), In-Situ Air Sparging, Chapter 3.

(2) Groundwater Yield. Experience suggests that if a TPE well will produce a groundwater yield in excess of 20 L min^{-1} ($> 5 \text{ gpm}$) at a given level of applied vacuum, too much water will be extracted and the TPE well will tend to become flooded ([paragraph 2-5e\(5\)\(a\)](#)). It is generally preferable at such locations to use DPE.

(3) Capillary Pressure-Saturation Curves. Although it has not yet become a widespread practice, it can be extremely valuable to collect capillary pressure-saturation data on "intact" undisturbed soil cores. As discussed in Chapter 2, such data can be used to:

- Determine the air emergence pressure, i.e., the negative pressure (vacuum) that will need to be applied to saturated soil to initiate airflow (Baker and Groher 1998).
- Infer the effective thickness of the capillary fringe, within which air permeability $k_a=0$.
- Provide van Genuchten (1980) α and n parameters for use in determining true versus apparent product thickness ([paragraph 3-5a\(2\)](#)).
- Provide input parameters for multiphase flow modeling.

Applicable methods are specified in [EM 1110-1-4001](#), Chapter 3, and [EM 1110-1-4005](#), Chapter 3. Note that the "inflection pressure" (P_{infl}) described in the latter publication and in Baker and Groher (1998) is the same as the "air emergence pressure" (P_e) discussed herein.

(4) Thickness of Capillary Fringe. An additional parameter of great interest in the context of MPE is the vertical distance above the water table over which the soil is saturated, with capillary pressure $0 < P_c < P_e$, termed the effective thickness of the capillary fringe. This parameter can be determined through direct measurement of soil moisture content by collection of samples and gravimetric analysis, or through in situ measurements using a neutron probe, time domain reflectometry (TDR), capacitance probes or buried resistance blocks. Alternatively, this parameter can be obtained from capillary pressure-saturation curves ([paragraph 3-4g\(3\)](#)) or estimated from grain-size distribution data (Table 2-3). Applicable methods are specified in Table 3-2 (this EM), in [EM 1110-1-4001](#), Chapter 3, and [EM 1110-1-4005](#), Chapter 3.

h. Collection of Soil/Aquifer Samples. The physical properties described above can be defined with reasonable accuracy by a variety of invasive and

remote sampling methods including analysis of soil and groundwater samples, hydraulic testing, and surface and borehole geophysics. When using these data to assemble conceptual and quantitative models of site conditions, it is important to keep in mind the levels of uncertainty associated with each measurement. While some information such as water table elevations and hydraulic gradients can usually be determined quite accurately by straightforward measurements, other properties, such as hydraulic conductivity, can be measured in many different ways and can vary widely due to typical site heterogeneity, and different scales of measurement. Wherever possible, it is best to make many measurements, comparing results from different approaches and considering the limitations of the sampling and analysis methods employed. This is generally true of all site data, which are used to form the "conceptual model" of site conditions. An effort should be made to capitalize on the interrelatedness of the data. Collection of samples discussed in this section applies to both LNAPL and DNAPL except where noted. Additional guidance can be found in EM 200-1-3, Requirements for the Preparation of Sampling and Analysis Plans.

(1) Hazards of Invasive Characterization Methods.

(a) Installing borings or monitoring wells in areas of known or suspected DNAPL releases runs the risk of intersecting residual or mobile DNAPL during drilling, and potentially carrying contamination deeper into the subsurface. Commonly known as "short-circuiting," the problem is worst in the presence of thick accumulations of potentially mobile DNAPL, and is exacerbated by low viscosity and/or high density DNAPL. Short-circuiting may occur during drilling, along the open borehole, and/or after well completion, along the sandpack. In addition to spreading contamination, short-circuiting can also create difficulty in the interpretation of analytical results. To curb these hazards, non-invasive methods (e.g., geophysics and shallow soil gas surveys) may be used. However, non-invasive measures alone generally cannot provide enough detailed information to characterize a site. Where drilling is required over less invasive measures, or where known DNAPL source areas cannot be avoided, continuous soil cores should be collected and analyzed by visual inspection and gas analysis as drilling proceeds. Visual inspection can be aided by hydrophobic dyes (e.g., Sudan IV) and/or ultraviolet light. Typically, drilling is curtailed if DNAPL is reached. During drilling, high density drilling muds and high water pressures can be used to inhibit the entry of DNAPL into the borehole. Additionally, telescopic drilling may be used, in which successively smaller drilling casings are installed as the borehole proceeds downward. Ideally, each segment of casing is terminated in an aquitard. Thus DNAPL in upper layers cannot move down through the open boring or along the sandpack into lower layers. This method is slower and more costly than conventional drilling.

(b) To minimize the chance of short-circuiting, several precautions should be taken. These are included in the discussion of the investigation options below. A more focused discussion of specific DNAPL issues is given in paragraph 3-5b.

(2) Information from Borings and Excavations.

(a) Soil borings can provide soil samples and intact cores that can be visually inspected on-site and sent to a laboratory for measurement of physical properties. Excavations (test pits or trenches) offer the added advantage of direct in-situ observation of the sidewalls. Test pits can be excavated to depths of 3 to 5 m, depending on conditions, and afford a valuable view of important features such as vertical fractures and the lateral continuity of

fine grained layers. Visual inspection and grain size analysis help define stratigraphy, which provides a framework for the subsurface data.

(b) Alternately, small diameter direct-push drilling methods, while they still must be properly abandoned after sampling is completed, can be used to reduce the risk of short-circuiting (see paragraph 3-4h(1)(a)). When these methods are combined with continuous coring, field screening and on-site real time analysis, they provide a cost-effective and relatively safe approach to collect necessary data from DNAPL source areas and at sites in general. An example of this technology, Site Characterization and Analysis Penetrometer System (SCAPS), is described in Cone Penetrometer Site Characterization Technology Task Group (1996).

(3) Collection and Analysis of Intact Cores. Normal soil sampling methods (e.g., split- spoon sampling) often disturb the sample and thus change the sample's physical properties. Therefore, collection of undisturbed intact cores is necessary for accurate laboratory analysis of these parameters. Care should be taken in the process, since the extent to which intact cores are truly "undisturbed" is a point of debate. In addition to hydraulic conductivity and porosity, mentioned above, another class of important core data includes parameters associated with fractured bedrock and clay: fracture orientation, spacing, aperture, and secondary porosity. These data are necessary for characterizing flow in fractured media. However, the hazards of drilling in DNAPL zones are intensified by drilling in bedrock. The brittle and irregular nature of fractures can lead to unpredictable mobilization of DNAPL. Therefore, it is advised that an "outside-in" approach be applied when drilling in bedrock near suspected DNAPL zones.

(4) Geophysical Methods for Hydrogeologic Characterization. Surface and borehole geophysical methods provide useful, non-invasive tools for characterization of stratigraphy and permeable pathways in the subsurface. Methods include electromagnetic (EM) conductivity, electrical resistivity, neutron thermalization, ground-penetrating radar (GPR), and high-resolution seismic surveys. These methods can provide elevation contours of stratigraphic surfaces and the water table. Although borehole electrical methods and surface GPR have been shown to map DNAPL movement and distribution in ideal settings (Brewster et al. 1992), the ability of geophysics to detect DNAPL is still not clear (Pankow and Cherry 1996). Paragraph 3-5a(6) provides information on geophysical methods for contaminant detection.

3-5. Chemical/Contaminant Analyses.

a. LNAPL.

(1) Measurement Techniques for Apparent LNAPL Thickness.

(a) The thickness of LNAPL observed floating on groundwater in a well is termed "apparent thickness," to differentiate it from the "true thickness" which exists both above and below the water table in the surrounding formation. The relationship between apparent and true thickness is discussed below in paragraph 3-5a(2).

(b) The techniques available to measure the apparent thickness of LNAPL in wells include interface probes, hydrophobic tape, hydrocarbon detection paste on steel tape, transparent bailers, and other discrete depth samplers. With

any of these methods, it is important that care be exercised to minimize disturbance of the liquid column during the measurement process. The interface probe is a device that uses optical and conductivity sensors to distinguish the air-liquid and LNAPL-water interfaces. Interface probes can be used to measure LNAPL and DNAPL thicknesses to within 0.3 to 3.0 cm (Mercer and Cohen 1990). Hydrophobic tape and hydrocarbon detection pastes show the top of the liquid level as a wet line and the LNAPL-water interface as a color change. This method is accurate to within 0.3 cm. Finally, transparent bottom-loading bailers may also be used to carry a sample to the surface for approximate measurement of LNAPL thickness. The bailer should be long enough so that its top is in air when the bottom is in water. To avoid overestimation due to LNAPL response while lowering the bailer, time should be allowed to attain hydrostatic equilibration while the bailer is lowered.

(2) Apparent Versus True LNAPL Thickness.

(a) At a site where LNAPL such as gasoline or diesel fuel is present in the subsurface, LNAPL is typically observed in wells screened across the water table and capillary fringe. All too often, however, LNAPL is viewed as occupying an oil-saturated "pancake" in the surrounding formation, the thickness of which is misconstrued as being linearly related to the thickness of the measurable LNAPL in the well. Although LNAPL reveals itself as a discrete oil lens floating on the water in a well, it does not occupy a distinct layer with a constant S_{or} floating on the top of the capillary fringe in the surrounding soil. For it to do so would violate the fundamental equations that describe the fluid pressure distributions in the porous medium and the monitoring well under conditions of static equilibrium (Farr et al. 1990). Nor is the apparent thickness, H_o (defined as the measurable thickness, at equilibrium, of the LNAPL lens in the monitoring well), equal to the true thickness, V_o (also known as the "hydrocarbon specific volume," defined as the actual hydrocarbon volume in excess of S_{or} per unit surface area of soil or aquifer) (Lenhard and Parker 1990; Newell et al. 1995). In addition, even in the absence of water table fluctuations, the upper and lower elevations of the oil lens floating in the well are not equal to the upper and lower elevations within which LNAPL is present within the soil. This elevation equivalency would hold only if the pores in the formation were all large, and the capillary forces and the S_{or} value thus infinitesimally small, as would be the case in a gravel deposit or a "delta function" soil (Figure 3-2a). Such a condition is rare in nature, and is thus not a realistic conceptualization.

(b) As we consider soils whose pore size distributions trend towards larger fractions of the smaller pore size classes, the magnitude of capillary forces increases, as does the degree to which the apparent thickness overestimates the true thickness (Lenhard and Parker 1990; Farr et al. 1990). The relative distributions of apparent versus true LNAPL thickness are represented in Figure 3-2b for a fine sand, and in Figure 3-2c for a silt loam. These USDA soil classifications would both fall roughly within the silty sand USCS classification category. (Note that an exact one-to-one correspondence between USDA and USCS soil classification categories cannot be provided.) Finally, Figure 3-2d depicts the case of a soil that exhibits a distinct h_{cne} (or P_a) value. No LNAPL will drain into a well from the soil if the LNAPL all exists at negative gage pressures such that $h_{cn} > h_{cne}$, which will be the case at $S_o < S_o(h_{cne})$; in this case, $H_o=0$ (Lenhard and Parker 1990; Farr et al. 1990). These authors present analytical methods enabling the prediction of V_o in homogeneous or stratified porous media based on the following data: a) site-specific measurements of H_o ; b) van Genuchten (1980) or Brooks and Corey (1966) $h_c(S)$ parameters, either i) fitted to moisture retention (air-water) data obtained from intact soil cores, or ii) estimated from grain size distribution data (Mishra et al. 1988; Lenhard and Parker 1990); and, c) ρ_o , σ_{ao} and σ_{ow} .

values obtained from measurements of a sample of the LNAPL or estimated from literature values.

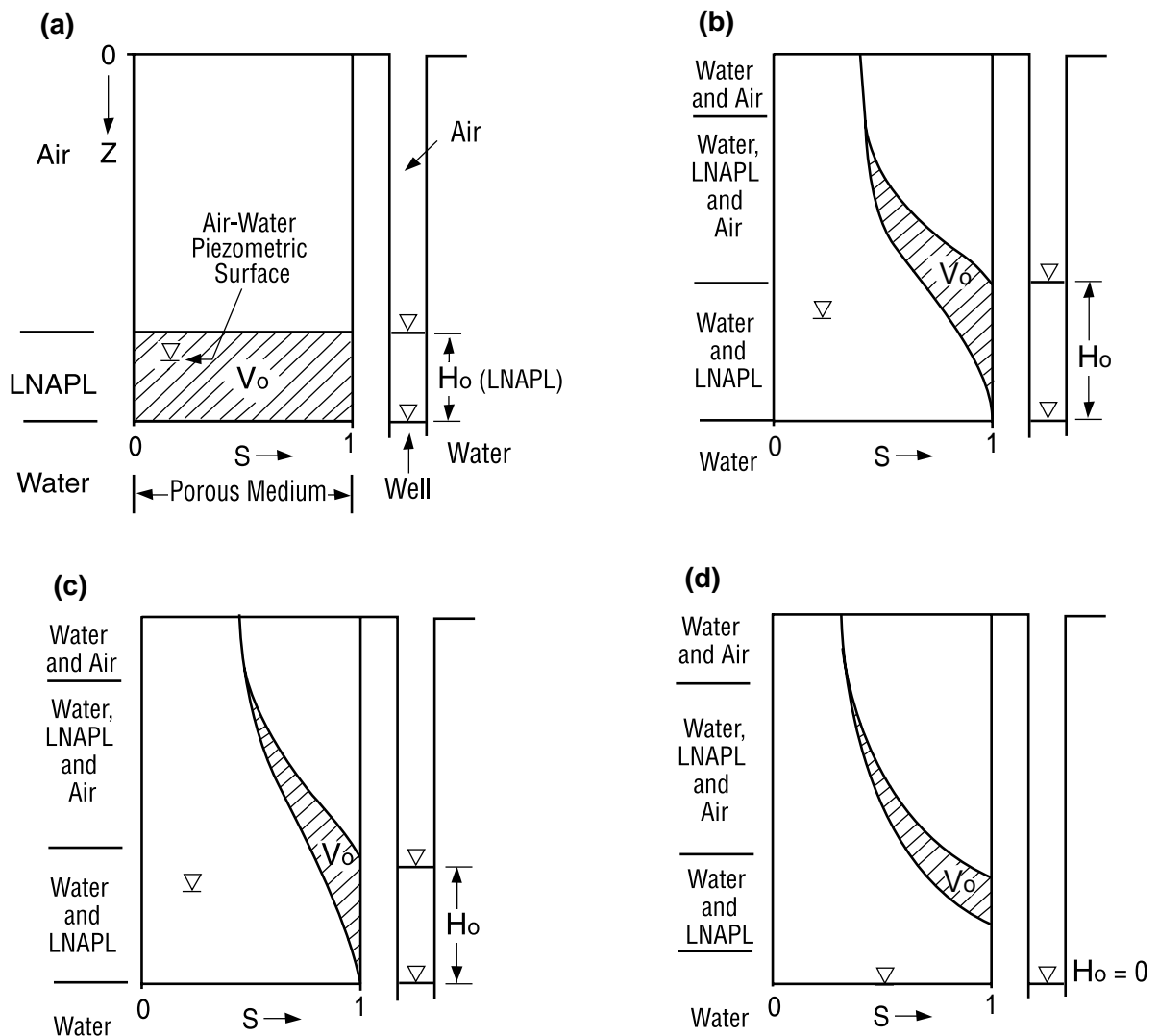

M980050

Figure 3-2. Relative vertical distribution of apparent LNAPL thickness, H_o , in a monitoring well versus true LNAPL thickness, V_o , at equilibrium, in: a) a delta function soil or clean gravel, $H_o = V_o$; b) a fine sand, $V_o \approx (0.005 \text{ to } 0.2)H_o$; c) a silt loam, $V_o \approx (0.005 \text{ to } 0.1)H_o$. V_o is typically a small fraction of H_o in soils; and d) in cases where the soil exhibits a discrete NAPL-water displacement pressure, no LNAPL will drain into the well if it at all exists at negative gage pressure. S = saturation. (After Farr et al. 1990; Lenhard and Parker 1990)

(c) Although the methods of Lenhard and Parker (1990) and Farr et al. (1990) are subject to a number of simplifying assumptions and uncertainties (Newell et al. 1995), a controlled study that compared the method of Lenhard and Parker (1990) to two more commonly applied but less physically well-founded approaches (De Pastrovich et al. 1979; Hall et al. 1984) concluded that the method of Lenhard and Parker (1990) provided the best estimate of V_o . (Wickramanayake et al. 1991).

(d) It is important to note that for typical soils, V_o is often found to range from $\ll 0.01\%$ to 10% of H_o (Lenhard and Parker 1990; Farr et al. 1990; Baker and Bierschenk 1995). Such low ratios of V_o to H_o reflect the fact that most of the finer pores within the LNAPL zone tend to retain water, not LNAPL. Thus a reliance on apparent thickness can greatly overestimate the volume of mobile LNAPL in a formation.

(3) Recharge and Baildown Tests.

(a) Baildown tests have been frequently performed to estimate the oil content of the formation and spill volumes at sites where LNAPL is found floating on groundwater in wells. Similar to slug tests, which measure hydraulic conductivity of a formation, baildown tests involve quick removal of a volume of LNAPL, and subsequent observation of the liquid responses in the well. The reduced hydraulic head caused by the withdrawal of LNAPL from the well will induce LNAPL and water from the formation to enter and recharge the well. Both the water-LNAPL and LNAPL-air surfaces are measured and recorded over time.

(b) The use of baildown tests has begun to change, since physically-based models have been developed for estimating the oil content and spill volume based on the observed LNAPL thickness in the well and soil hydraulic properties (e.g., Lenhard and Parker 1990; paragraph 3-5a(2)). However, additional soil parameters are needed to carry out the calculation. While these can be obtained from undisturbed laboratory samples, estimates of formation oil content from baildown tests alone may offer qualitatively useful information as to the recoverability of free product, since the baildown test is conducted at field scale.

(4) Estimation of Volume of Recoverable Product. Once an estimate has been made of the true versus apparent LNAPL thickness for each location at which LNAPL has been measured in monitoring wells, a computer program such as OilVol (DAEM 1997) can be employed to estimate the volume of recoverable product at the site. In addition, the results of baildown tests can be used in a qualitative manner to indicate how readily recoverable the LNAPL is, which is itself a function of the "connectedness" of LNAPL-filled pores to the extraction wells or trenches at the field-scale. It is important to establish a good baseline estimate of the volume of recoverable product, because this will serve as a basis against which the progress of the remediation can be judged. Fluctuations in water table elevation will, of course, affect the recoverability of LNAPL and thus such benchmark values must be viewed as having a measure of uncertainty associated with them.

(5) Residual LNAPL.

(a) Unless spills occur on impermeable surfaces, LNAPL spills will generally sink into the subsurface and migrate downward until they reach either a low permeability layer or the water table. The degree of penetration depends on several factors, including volume and timing of the release, liquid properties, soil properties, and soil moisture profile. As LNAPL moves, it

leaves behind a "residual saturation," which is defined as the minimum content which a liquid has to attain in order to move in a porous medium (or alternatively the threshold below which it is no longer able to move) (De Pastrovich et al. 1979). The separate-phase liquid left behind, trapped by capillary forces, exists as disconnected blobs and ganglia, which continue to act as a source of contaminants that will dissolve into water and volatilize into soil gas. Residual saturation is the primary control on the penetration depth of a spill. The amount of liquid retained depends on the following factors:

- Media pore size distribution.
- Wettability (i.e., which liquid will preferentially occupy smallest pores; typically water is the wetting liquid with respect to air and LNAPL).
- Liquid viscosity and density ratios.
- Interfacial tension.
- Hydraulic gradients.
- Hysteresis.

(b) Because of the very small scale of many of the controlling factors (e.g., pore size distribution), and the very wide range of possible site conditions, it is impossible to directly predict residual saturations for a site. However, ranges of residual saturations for various LNAPL and soil types have been derived from laboratory studies. These ranges can be used to develop screening-level estimates. Table 3-3 gives estimated ranges of residual saturation in units of liters of LNAPL per cubic meter of soil, for different types of petroleum products and soils.

TABLE 3-3
Ranges of Residual LNAPL Concentrations in the Unsaturated Zone
(American Petroleum Institute 1993)

Medium	Gasoline (L/m ³)	Middle Distillates (L/m ³)	Fuel Oils (L/m ³)
Coarse gravel	2.5	5.0	10.0
Coarse sand and gravel	4.0	8.0	16.0
Medium to coarse sand	7.5	15.0	30.0
Fine to medium sand	12.5	25.0	50.0
Silt to fine sand	20.0	40.0	80.0

(c) After LNAPL reaches a low permeability layer or, more commonly, the water table, the LNAPL will spread out in what is often visualized as a "pancake." Fluctuations in water table elevation generally cause the LNAPL to also spread vertically in a "smear zone," leaving residual LNAPL in soil pores as it rises and falls with the water table surface. Time series measurements of water table elevation changes can provide estimates of the size of the smear zone. It is important to appreciate that the notion of a "pancake" is an oversimplification. Many of the pores within the "pancake" zone will retain water that will not be displaced by LNAPL. The finer-textured the soil, the more this will be the case.

(6) Geophysical Methods for Contaminant Detection. In general, geophysics can offer helpful supporting data for shallow LNAPL detection in dry soils. The geophysical method holding most promise is ground penetrating radar (GPR). GPR may be used to map hydrocarbons in the vadose zone. A strong contrast exists between the dielectric constant of liquid hydrocarbon and water in clean sands, gravel, and clayey or loamy soils. The authors indicate that GPR is able to delineate LNAPL pools and their migration. The critical prerequisite for GPR use appears to be low soil moisture content. Electromagnetic methods may also be used to locate gross contamination by variation in conductivity (USEPA 1993c). Paragraph 3-4h(4) provides a discussion of geophysical methods for hydrogeological characterization. Additional information on geophysical methods for contaminant detection can be found in Subsurface Characterization and Monitoring Techniques - A Desk Reference Guide (USEPA 1993c).

(7) Methods of Sampling and Analysis of LNAPL.

(a) Detection and sampling of LNAPL from extraction wells can be performed using an interface probe and Teflon[®] bailers or Teflon[®] strips. The use of Teflon[®] avoids potential contamination by phthalates which can interfere with the chemical composition analyses. The interface probe is lowered into the well to determine if LNAPL is present. If LNAPL is determined to be present, a disposable Teflon[®] bailer is lowered gently into the well and a sample is collected from the upper portion of the water table. If the LNAPL is visible in the bailer, the LNAPL will be transferred to (1) a 40 mL VOC vial with a Teflon[®]-lined hard cap (without a septum) for chemical composition analyses and (2) a 500 mL glass jar for density, viscosity, and interfacial tension analyses.

(b) If the LNAPL layer is not visible in the bailer or the interface probe does not detect LNAPL, then a Teflon[®] strip is lowered into the well, allowed to pass through the surface of the liquid in the well, and then drawn up through the surface and retrieved. The Teflon[®] strip can only be utilized to determine the chemical composition of the LNAPL, not the physical parameters. The Teflon[®] strip is placed in a wide-mouth glass jar and preserved with an appropriate volume of methanol and/or methylene chloride, depending on the analytes of interest. The volume should be enough that the Teflon[®] strip is fully immersed in the solvent. Preservation of the Teflon[®] strip must be performed in the field. In general, VOC analyses require methanol preservation, and SVOC and total petroleum hydrocarbon fingerprinting analyses require methylene chloride preservation. The resulting sample extracts must be shipped to the laboratory using applicable DOT regulations, which vary depending on the total volume to be shipped. Personnel handling the methanol and/or methylene chloride solvents should take proper precautions, including the use of protective gloves and safety glasses. Personnel should work with the solvents in a well-ventilated area to avoid inhalation. Methanol should also be stored away from extreme heat or other ignition sources due to its flammability.

(c) The analytical methods associated with the physical and chemical composition parameters of LNAPL are summarized in Table 3-4.

TABLE 3-4
LNAPL Physical and Compositional Analysis

Parameter	Analytical Method
Physical Parameters	
Density	ASTM D1475
Dynamic Viscosity	ASTM D88; D4243; D87; D1795
Interfacial Tension	ASTM D971; ASTM D2285; Lyman et al. 1982
Chemical Compositional Parameters	
Volatile Organic Compounds	SW-846 3585 or 5035/8260B (EPA 1986)
Semivolatile Organic Compounds	SW-846 3580/8270C (EPA 1986)
Total Petroleum Hydrocarbons	SW-846 3580/8015B (EPA 1986)

b. DNAPL. The presence of DNAPL presents unique challenges for MPE strategies. The reader is referred to Pankow and Cherry (1996) for a helpful discussion on DNAPL behavior and assessment. DNAPL behavior, particularly in terms of lateral occurrence and thickness, is radically different from that of LNAPL. LNAPL tends to form relatively even uniform layers, aided by the uniform water surface upon which it spread. DNAPL "layers" on the other hand are typified by extremely heterogeneous distributions and unpredictable transport pathways. A small amount of DNAPL in the subsurface may be virtually impossible to locate and still lead to extensive and long-lasting dissolved plumes. An important consideration in evaluating the appropriateness of MPE strategies is the potential for significant DNAPL pool mobilization during dewatering operations. The wetting properties of DNAPL are generally such that DNAPL tends to "ball up" against water-saturated soils and spread out through air-saturated soils. DNAPL pools and blobs in a previously saturated aquifer that has been dewatered have the potential to begin spreading laterally, increasing the extent of contamination. Previously confined DNAPL can then find its way to weaknesses in an underlying confining layer and continue migrating downward to contaminate lower aquifers.

(1) Assessing the Presence of DNAPL. Paragraph 3-4h discussed DNAPL as it is associated with investigation techniques for defining physical properties in general. This section focuses on DNAPL as the object of investigation.

(a) Location of DNAPL source. Accurately locating a DNAPL source is difficult. The fact that DNAPL may exist in very fine stringers means that an extremely dense vertical and horizontal soil sampling network is generally required to find it. Minor variations in soil permeability can control DNAPL movement, shifting its location from where one might suspect it to be based on site records and other information. Furthermore, it has been shown that dissolved concentrations in wells can be quite low, even in close proximity to DNAPL pools, because of long intake screens with resulting dilution and lack of vertical delineation (Johnson and Pankow 1992).

(b) Dense vertical and horizontal profiling of groundwater plumes downgradient of suspected DNAPL source areas, combined with stratigraphic information and historical information on release locations, frequency and volumes can be used to develop effective conceptual models of DNAPL source zones (see [paragraph 3-5b\(1\)\(e\)](#)).

(c) Techniques to locate DNAPL. Initially, investigators should perform a thorough review of historical documentation, interviews, aerial photographs, and available site data. After this, the following techniques can be used in the field: observations during drilling, including visual evidence, enhanced visual evidence (ultraviolet fluorescence, hydrophobic dye), gas analyses, soil analyses, and drilling water analyses; soil gas surveys; observations of DNAPL in wells (quite rare); and geophysical methods (conditions permitting). In an experiment to test the ability to detect DNAPL, Cohen et al. (1992) demonstrated that enhanced visual evidence improved the positive identification of DNAPL from 30% (unaided visual observation) to over 80%. As mentioned in [paragraph 3-4h\(4\)](#), geophysical techniques may define hydrogeologic strata and locate likely candidate areas for DNAPL pooling, but the ability of these techniques to detect DNAPL itself is unproven. The often discontinuous presence of DNAPL in the subsurface makes it difficult even to come close enough to the DNAPL to use these techniques.

(d) Soil gas analysis of multi-component DNAPL. Soil gas sampling, generally from the upper 0.5 to 2.5 m of the soil column, may indicate the presence of DNAPL in the unsaturated zone. When analyzing gas concentrations as an indicator of DNAPL presence, it must be kept in mind that each individual component of a multi-component DNAPL, in accordance with Raoult's Law, will have a lower value than its gas concentration as estimated from its pure-phase vapor saturation. Although localized soil gas sampling can detect the presence of shallow residual DNAPL, the highly discontinuous nature of DNAPL occurrence and movement makes it likely that DNAPL will go undetected with typical gas survey sampling network spacings. Soil gas surveys can be appropriate for locating residual DNAPL provided the soil type and moisture content are considered when designing the survey. In principle, gases from SVE have the potential to reveal the presence of residual DNAPL, but this is likely to be an even less localized method than soil gas surveys.

(e) Dissolved plume delineation using monitoring wells and profiling. Although DNAPLs are referred to as "non-aqueous," their component compounds have solubilities which generally far exceed their Maximum Concentration Limits (MCLs) as set by USEPA or other regulatory agencies (see Table 3-5). Measurements of dissolved concentrations at a site can be used to infer DNAPL source areas. Because of the dangers of short-circuiting (see [paragraph 3-4h\(1\)](#)) in a suspected source area, it is advisable that investigations use an "outside-in" approach, where the emphasis is first placed on delineation of the dissolved plume, followed by investigation toward the source zone(s) (Pankow and Cherry 1996). This approach of defining the dissolved plume makes sense since it is the dissolved concentrations that generally pose the greatest risk to potential receptors. As a general rule of thumb, Newell and Ross (1991) suggest that concentrations near or above 1% of saturation (as expected based on component composition) are indicative of DNAPL. Table 3-5 shows solubility values for some pure chlorinated DNAPL compounds. Note that for a DNAPL composed of multiple chemicals, the effective aqueous solubility of a particular component can be approximated by multiplying the mole fraction of the chemical in the DNAPL by its pure phase solubility. This is analogous to Raoult's Law for vapor. The effective aqueous solubility can also be determined experimentally.

TABLE 3-5

Pure Compound Solubilities at ~20°C for Selected Chlorinated Organic Solvents and Corresponding Maximum Concentration Limits (MCLs) for Drinking Water Set by USEPA. (Pankow and Cherry 1996)

Compound	Solubility (mg/L)	MCL (mg/L)
1,2-Dichloroethane	8,690	0.005
1,1,1-Trichloroethane	720	0.2
Carbon Tetrachloride	785	0.005
Methylene Chloride	20,000	0.01 ^a
Chloroform	8,200	0.1 ^a
Tetrachloroethene	200	0.005
Trichloroethene	1,100	0.005
^a New York State Department of Environmental Conservation Guidelines for Groundwater.		

(2) Assessing Mobility of DNAPL.

(a) Sampling and analysis of DNAPL. If DNAPL is detected and a reasonable amount (usually at least 10 cm³) can be extracted from a soil sample or from a well, it is helpful to send a sample to a laboratory for compositional analysis and for liquid properties: density, viscosity, and interfacial tension. Contact angle and wettability analyses may also be performed to obtain parameters used in more detailed calculations. Laboratory procedures for measuring these parameters are given in Cohen and Mercer (1993). The sample will generally be different than any original spilled mixture due to compositional changes that occur over time. Therefore, uncertainty in the composition needs to be taken into account in calculations, particularly those involving partitioning (paragraph 2-6b(3)). DNAPL samples may be collected from the bottom of a well using a pump, bottom-loading bailer, or discrete-depth canister, the latter usually giving the best results with limited sample disturbance. Analytical methods should follow high concentration protocols for use with DNAPL-contaminated soils and waters. It can be helpful to alert the laboratory about samples suspected of containing particularly high concentrations, such as obvious DNAPL material. The discontinuous nature of DNAPL occurrence tends to result in very wide ranges of possible constituent concentrations, however, and may make it difficult to predict contamination levels in a specific sample. It may be beneficial to perform on-site analyses of the DNAPL in order to anticipate concentrations.

(b) Depth of penetration of DNAPL. The depth of penetration of DNAPL into the unsaturated and saturated zones is controlled by physical properties of the DNAPL, the nature of the release, and geologic structure. Due to the very small scale of the controlling features, it is impossible to fully characterize a site and accurately predict the penetration depth for DNAPL releases. Still, it is important to understand the factors involved. In general, the following physical DNAPL properties favor deeper penetration: high density, low interfacial tension, and low viscosity. High aquifer permeability and vertical or sub-vertical geologic structure also favor greater depths of penetration. In a famous experiment, Poulsen and Kueper (1992) released 6 liters of PCE into

the sandy Borden Aquifer under two scenarios: an instantaneous spill (over a period of 90 seconds) and a slow drip (over a period of 100 minutes). The instantaneous spill penetrated 2.0 m and the slow drip penetrated 3.2 m (Figure 3-3). In both cases, careful excavation and analysis showed movement of the red-dyed PCE was strongly controlled by bedding structure in the sand. It moved preferentially along higher permeability layers following the bedding structure. Both spills exhibited significant lateral spreading due to small-scale bedding. The results demonstrate the wide variability involved in any estimate of penetration depth.

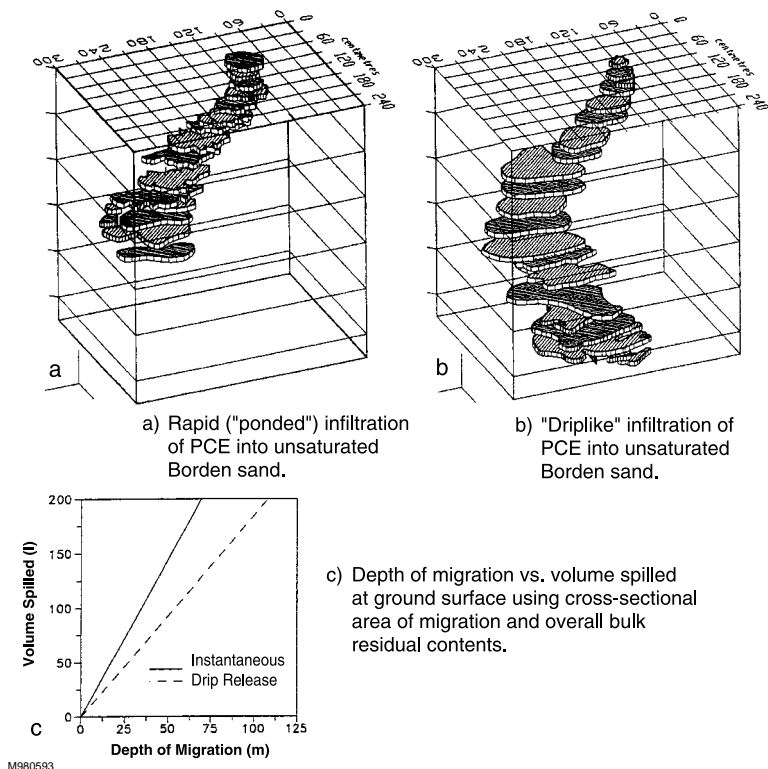

Figure 3-3. Results from Controlled Spill Experiments. (Poulson and Kueper 1992. Reprinted by permission of Environmental Science & Technology. Copyright 1992, American Chemical Society. All rights reserved.)

(c) Apparent versus true DNAPL thickness. In most cases where DNAPL is present at a site, it will probably not be found in wells. If it is found in wells, it is important to realize that the thickness found in the well will likely not reflect the true thickness in the formation. Several scenarios are possible, including those shown in Figure 3-4. As shown, entry pressures and relative differences in elevation between the screen and the DNAPL pool result in a variety of possible thicknesses in the well. Even where a well intersects a DNAPL pool, relative wetting against water and the pore properties of the well sand pack may prevent DNAPL from entering the well screen at all (Figure 3-4c). The true thickness of DNAPL will only be equal to the measured thickness in cases where the bottom of the well screen coincides exactly with the bottom of a large DNAPL pool and the pool is located in granular media in which it has displaced all of the water from the pores.

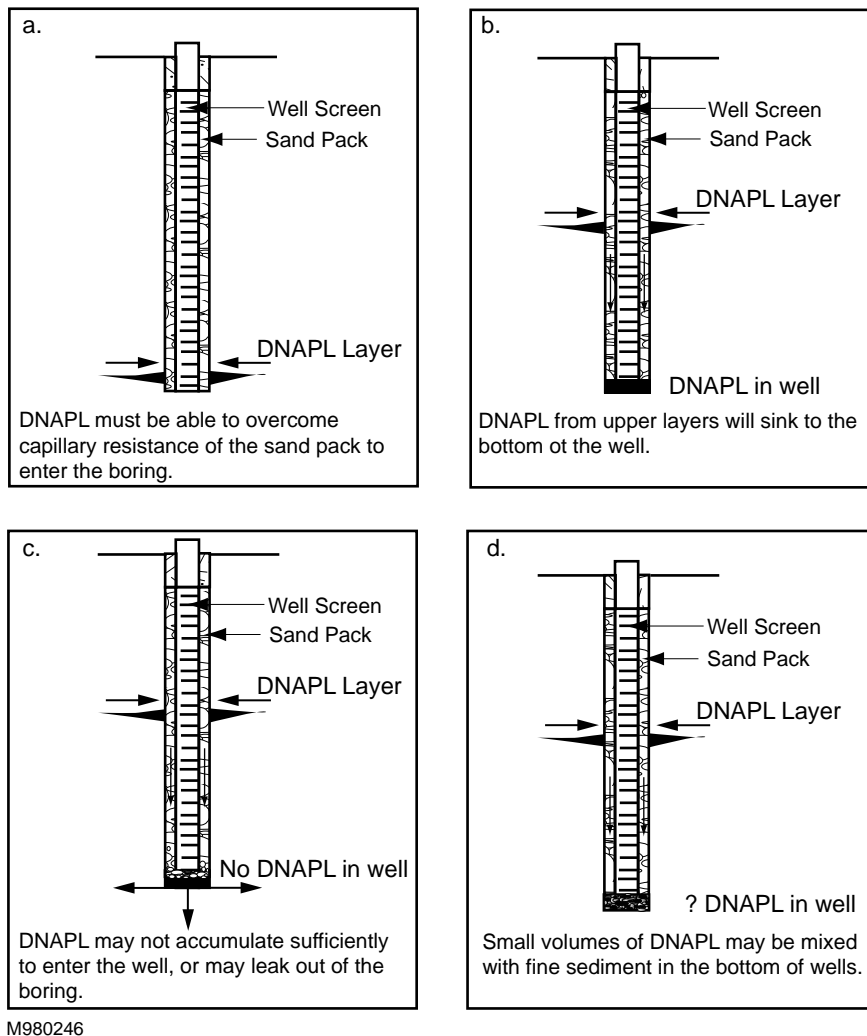

Figure 3-4. Various conditions under which DNAPL may accumulate and be identifiable in a monitoring well. (Pankow and Cherry 1996. Reprinted by permission of Waterloo Press. Copyright 1996. All rights reserved.)

(d) Importance of a confining layer during dewatering operations. DNAPL pools that have stabilized may be remobilized during dewatering operations. Changes in hydraulic gradients create pressure changes that can induce DNAPL movement. In addition, in an air-water-DNAPL setting, DNAPL will readily displace the air and directly imbibe into the dewatered portion of the formation. DNAPL will descend lower into the subsurface unless an adequate confining layer exists to impede vertical movement. It is therefore necessary to determine if a confining layer exists before dewatering.

(3) Residual DNAPL. As DNAPL migrates in a formation, residual DNAPL will generally remain in its wake, distributed as ganglia and blobs which will continue to dissolve into groundwater and vaporize into soil gas for extended periods of time. Also, DNAPL released into the subsurface will diffuse from fractures and higher permeability porous media into surrounding low permeability porous media (e.g., sedimentary rock matrix and silt and clay). Long after pool removal or other cleanup activities, the DNAPL locked in the formation pores will slowly diffuse back out into the primary groundwater flow pathways. Matrix diffusion and rate-limited mass transfer phenomena are the primary cause of the "tailing" typically observed in soil and groundwater remediation efforts and the elevated concentrations in groundwater that typically last decades or centuries (Parker et al. 1994). Downgradient containment is frequently used to address this dissolved plume. However, at some sites natural attenuation has been shown to be sufficient to alleviate risks to potential receptors.

c. Methods of Soil Sampling and Analysis.

(1) The development of sampling and analysis plans should be performed using the guidance document [EM 200-1-3](#), Requirements for the Preparation of Sampling and Analysis Plans.

(2) USEPA methods as well as USACE guidelines apply for the collection of soil samples (Table 3-6). [Paragraph 3-4h](#) should be referred to for a summary of soil sample collection methods. These methods are also discussed in [EM 1110-1-4005](#), In-Situ Air Sparging. Discussion of proposed soil sampling methods with regulators is also advisable.

TABLE 3-6

Soil Sampling: Preservation Requirements/Recommended Analytical Methods*

Chemical Parameter	Preservation	Analytical Method
Total Organic Carbon (TOC) or Fraction Organic Carbon (foc)	One 4 oz. clear glass jar; Cool, 4°C	Lloyd Kahn, SW-846 9060
Ammonia/Nitrogen ¹	One 4 oz. clear glass jar; Cool, 4°C	EPA 350.1-350.3; SM4500-NH ₃ A-H
Total Kjeldahl Nitrogen (TKN) ¹	One 4 oz. clear glass jar; Cool, 4°C	EPA 351.1-351.4; SM4500-N _{org} A-C
Nitrate/Nitrite-N ¹	One 4 oz. clear glass jar; Cool, 4°C	EPA 353.1-353.3, SM4500-N
Ortho-Phosphates ¹	One 4 oz. clear glass jar; Cool, 4°C	SM4500-P A-F
Total Phosphorus ¹	One 4 oz. clear glass jar; Cool, 4°C	EPA 365.4; SM4500-P A-F
PH	One 4 oz. clear glass jar; Cool, 4°C	SW-846 9045B, 9045C
Sulfate ¹	One 4 oz. clear glass jar; Cool, 4°C	SW-846 9035, 9036, 9038; EPA 375.1-375.4; SM4500-SO ₄ A-F
Sulfides ¹	One 4 oz. clear glass jar; Cool, 4°C	SW-846 9030A, 9031; EPA 376.1, 376.2; SM4500-S A-H
Moisture content	One 4 oz. clear glass jar; Cool, 4°C	EPA 160.1
Semivolatile Organic Compounds (SVOCs)	One 8 oz. clear glass jar; Cool, 4°C	SW-846 3540C or 3550B/8270C
Total Petroleum Hydrocarbons (TPH-extractables) ²	One 8 oz. clear glass jar; Cool, 4°C	SW-846 3540C or 3550B/8015B

TABLE 3-6 (Continued)

Chemical Parameter	Preservation	Analytical Method
Volatile Organic Compounds (VOCs) ³	Three methods: (1) Three 5g EnCore™ sampler; Cool, 4°C. (2) Two 40 mL VOA vials with 1 g sodium bisulfate and 5 mL water; add 5 g soil; Cool, 4°C. (3) One 40 mL VOA vials with 5-10 mL methanol; add 5 g soil; Cool, 4°C.	SW-846 5035 and 8260B
*Refer to appropriate state regulations for guidance.		
¹ Listed analytical methods are for aqueous samples and will need to be modified for soil samples.		
² Can be screened in the field using field screening kits (Petroflag, immunoassay kits) or via microextraction/GC-FID analysis		
³ Can be screened in the field using headspace methods along with (GC) and the appropriate detector (FID, PID, etc.)		
USEPA. Test Methods for Evaluating Solid Waste, Physical/Chemical Methods, SW-846, Third Edition including Final Update III, December 1997.		
USEPA. Methods for Chemical Analysis of Water and Wastes, EPA 600/4-79-200, March 1979.		
APHA-AWWA-WPCF. Standard Methods for the Examination of Water and Wastewater. 19th Edition, 1998.		
Kahn, L. 1988. Determination of Total Organic Carbon in Sediment. USEPA Region II, Edison, NJ.		

(3) Samples submitted for VOC analyses should be collected for low-level (acid solution preservation) and/or high-level (methanol preservation) analyses as described in SW-846 Method 5035. Other options are available for sample collection within SW-846 Method 5035 and may also be utilized for soil samples, if appropriate. Data quality objectives (DQOs [e.g. required detection limits]) may require the need for either low level or high level preservation procedures or may require preservation using both procedures, depending on the concentration ranges of VOCs in the soil samples. It may be beneficial to perform on-site analyses (e.g., using a field gas chromatograph [GC]) of the soil samples in order to determine whether the low level or high level method should be utilized. In general, low-level analyses should be utilized for VOC concentrations below 200 micrograms per kilogram ($\mu\text{g}/\text{kg}$); high level analyses should be utilized for VOC concentrations above 200 $\mu\text{g}/\text{kg}$. If any calibration ranges are exceeded during the low-level analysis, the high-level analysis also needs to be performed.

(4) The preservation procedures can be performed in the field or in the laboratory. If preservation is to be performed in the field, trained technical staff should be available due to the amount of chemicals utilized and the shipping regulations for these chemicals. In addition, the nature of the sample matrix, in cases of high carbonate content, may cause difficulty during the preservation of the samples in the acidic sodium bisulfate solution. In the event that technical staff are not available, the EnCore™ sampler (verified by the USACE Cold Regions Research and Engineering Laboratory), a disposable, volumetric, airtight sampling device (or equivalent), may be utilized for the collection of samples. A minimum of three EnCore™ samples (two for low level and one for high level analyses) should be collected per location in order to provide the laboratory with appropriate backup to accommodate the potential preservation problems or analytical problems which may occur. If quality control analyses (e.g., matrix spike/matrix spike

duplicated) are to be performed, additional EnCore™ samples will need to be collected.

(5) If samples are collected in the EnCore™ samplers, the laboratory must preserve the sample within 48 hours of sample collection and analyze the sample within 14 days of sample collection. Therefore, every attempt should be made to ship the EnCore™ sampler to the laboratory on the same day of sample collection for same day or overnight delivery. If the samples are preserved in the field, the laboratory must analyze the samples within 14 days of sample collection. Depending on the total volume of preservatives, the sodium bisulfate solution and the methanol may be U.S. Department of Transportation (DOT) Hazardous Materials and may therefore need to be shipped according to DOT shipping requirements. Depending on the project DQOs, the laboratory should perform the low-level and/or high-level preservation procedures.

(6) Solid samples also may contain high moisture content that may restrict the use of the EnCore™ sampler. If this occurs, preservation for low level and/or high level analyses (depending on DQOs) should be performed in the field.

(7) Whether the preservation occurs in the laboratory or in the field, the nature of the matrix, if high in carbonate content, may cause effervescence and thus, significant loss of VOCs, when preserved in the acidic sodium bisulfate solution. If significant effervescence occurs, the sample should be collected in an EnCore™ sampler. The laboratory should extrude the sample in water and analyze it within 48 hours of sample collection in order to minimize VOC losses.

(8) The options for sampling VOCs have been outlined above in the order that reduces VOC losses and ensures the most representative sample. Figures 3-5a and 3-5b present flow charts that summarize these options. In addition to reducing VOC losses, another objective of these flow charts is to make the sampling as simple as possible for the field team by trying to minimize the amount of chemicals utilized and/or shipped to and from the field. These flow charts should be used by both the field sampling team and the analytical laboratory.

d. Methods of Soil Gas Sampling and Analysis.

(1) The purposes of conducting soil gas surveys for MPE are similar to those discussed in [EM 1110-1-4005](#), In-Situ Air Sparging. Similarly, uses of the data collected from soil gas surveys, as well as their limitations, are discussed in [EM 1110-1-4001](#), Soil Vapor Extraction and Bioventing.

(2) Table 3-7 summarizes methods of soil gas collection. Sampling of soil gas for VOCs has been broken down into two categories, active and passive sampling. Active sampling involves driving a probe into the vadose (unsaturated) zone and drawing a vacuum to acquire a sample from the subsurface through the probe into a sample container or sorbent tube. The radius of influence will be dependent on the permeability of the soil formation. Passive sampling involves placing a sampler containing a sorbent with an affinity for the target analytes in the ground for a period of time. The target contaminants are collected by diffusion and adsorption processes.

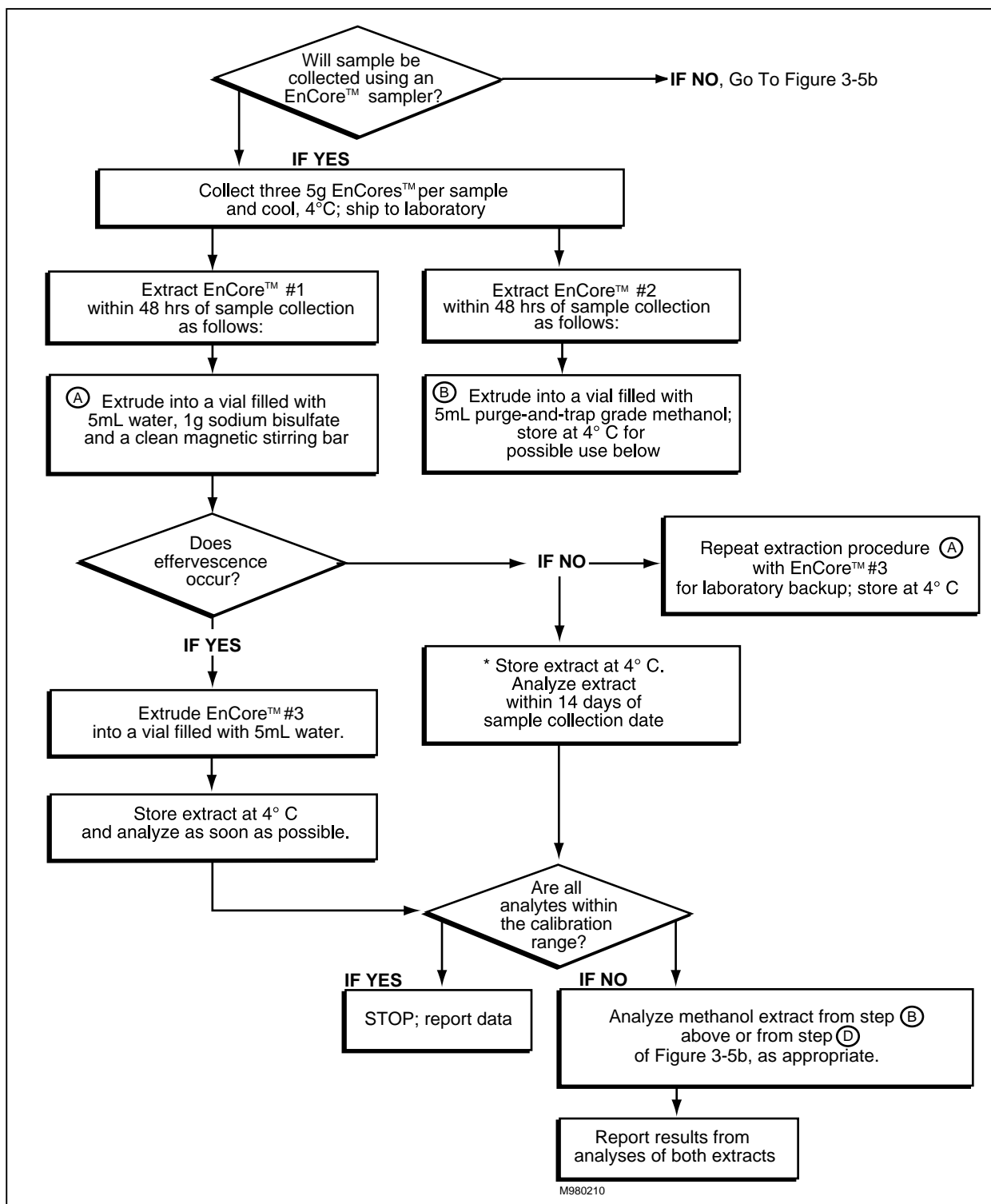

Figure 3-5a. VOC Sampling/Preservation Flow Chart. Use of EnCore™ or equivalent sampler is stipulated in Method SW846-5035.

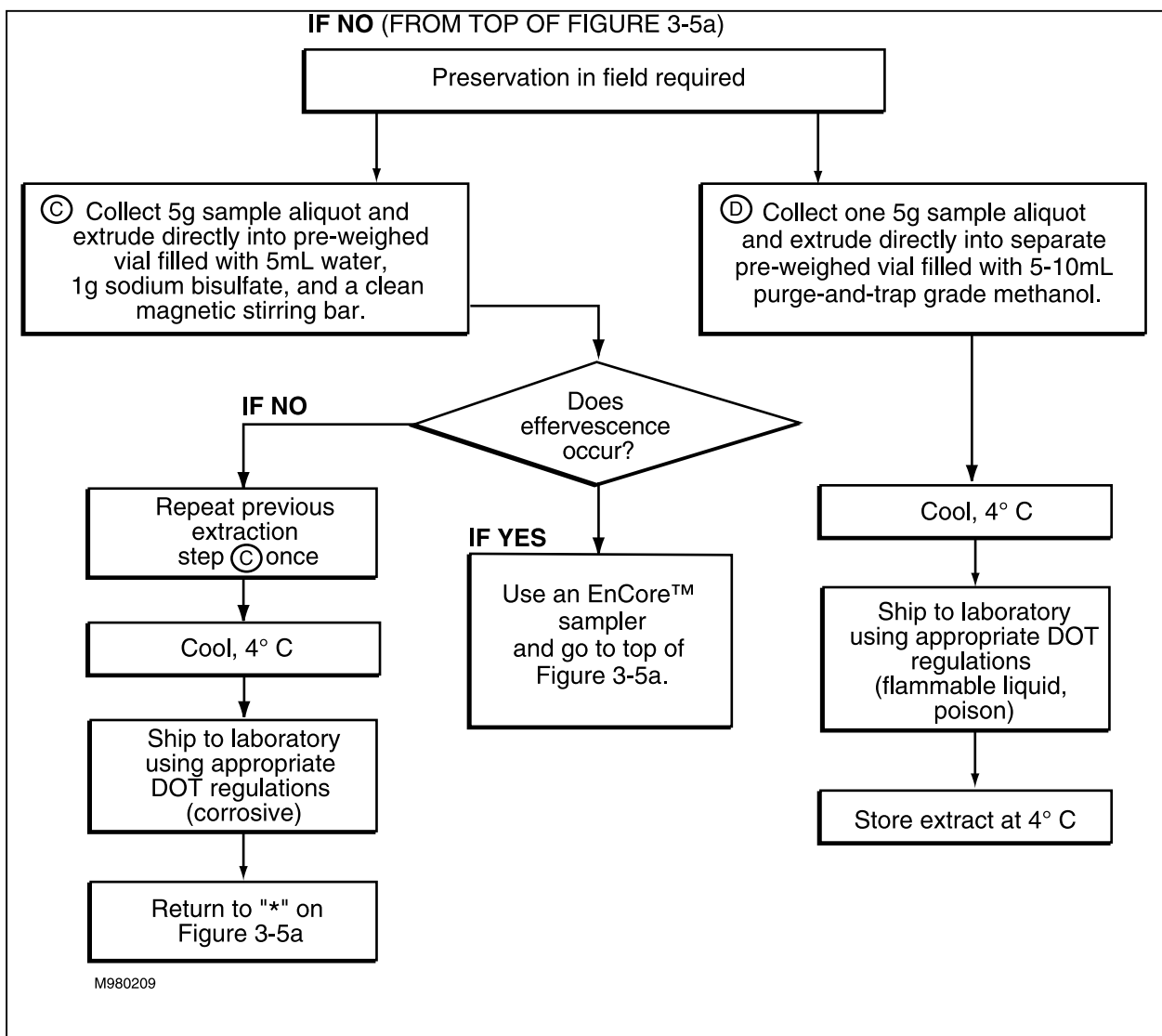

Figure 3-5b. VOC Sampling/Preservation Flow Chart. Use of EnCore™ or equivalent sampler is stipulated in Method SW846-5035.

TABLE 3-7

Soil Gas Sampling/Analytical Methods

I. VOLATILE ORGANIC COMPOUNDS (VOCs)	
A. Active Sampling	
Whole Air Collection Media Options	Sorbent Collection Media Options
Evacuated canisters Tedlar [®] bags Static-dilution glass bulbs Gas-tight syringes	Charcoal tubes Tenax [®] tubes Ambersorb [®] tubes Silica gel tubes Colorimetric detector tubes
Applicable Sampling and Analytical Method References: <ul style="list-style-type: none"> • National Institute for Occupational Safety and Health (NIOSH) 1984. <i>Manual of Analytical Methods</i>. Third Edition. February 1984. • USEPA 1987. <i>Compendium of Methods for the Determination of Toxic Compounds in Ambient Air</i>. EPA/600/4-84-041. • USEPA 1988. <i>Field Screening Methods Catalog</i>. EPA/540/2-88-015. • USEPA 1990. <i>Contract Laboratory Program - Statement of Work for Analysis of Ambient Air (Draft)</i>. • American Society for Testing and Materials (ASTM) 1993. <i>Standard Guide for Soil Gas Monitoring in the Vadose Zone</i>. ASTM D 5314-93. • 40 Code of Federal Regulations, Part 60, Method 18, 1997. • USEPA, Test Methods for Evaluating Solid Waste, Physical/Chemical Methods, SW-846, Third Edition including final Update III, December 1997. 	
B. Passive Sampling	
Sample Collection Options:	
Gore-Sorber [®] modules Emflux [®] collectors	
Analysis: solvent extraction or thermal desorption followed by GC/MS analysis or analysis by GC equipped with the appropriate detector (FID, PID, ECD, etc.)	
Applicable References: <ul style="list-style-type: none"> • Hewitt, A.D., <i>Establishing a Relationship Between Passive Soil Vapor and Grab Sample Techniques for Determining Volatile Organic Compounds</i>, US Army Corps of Engineers, September 1996. 	
II. OXYGEN, CARBON DIOXIDE, and METHANE	
Sample Collection and Analysis Options:	
In-situ collection with direct measurement using appropriate analyzer Active sampling: Tedlar [®] bags with measurement using appropriate analyzer	

(3) Active sampling can usually be accompanied by on-site analysis of air samples using GC techniques accompanied with the appropriate detector. Samples may be collected in Tedlar[®] bags, static-dilution glass bulbs, or gas-tight syringes. Colorimetric detector tubes also can be analyzed on-site. Active sampling into evacuated canisters or onto most sorbent tubes and passive

sampling usually requires more sophisticated analytical techniques (e.g., cryogenic trapping, purge-and-trap, solvent extraction, GC/mass spectrometry [GC/MS], etc.), which would not generally be appropriate for field use.

e. Methods of Groundwater Sampling and Analysis. Groundwater collection methods to be performed during the performance of MPE will be similar to those during IAS (EM 1110-1-4005). Table 3-8 summarizes container and preservation requirements for chemical analyses of groundwater samples. In addition, parameters that can be screened or analyzed in the field are flagged; field-screening options for these parameters are also listed.

TABLE 3-8
**Groundwater Sampling: Preservation Requirements/
Appropriate Analytical Methods**

Chemical Parameter	Preservation	Analytical Method
¹ Biological Oxygen Demand (BOD)	1 L polyethylene or glass bottle; Cool, 4°C	EPA 405.1; SM 5210 A-B
¹ Chemical Oxygen Demand (COD)	125 mL polyethylene or glass bottle; pH <2 with HCl or H ₂ SO ₄ ; Cool, 4°C	EPA 410.1-410.4; SM 5220 A-D
¹ Alkalinity	250 mL polyethylene or glass bottle; Cool, 4°C	EPA 310.1, 310.2; SM 2320 A-B
¹ Total Dissolved Solids (TDS)	250 mL polyethylene or glass bottle; Cool, 4°C	EPA 160.1; SM 2540C
Total Organic Carbon (TOC)	125 mL polyethylene or glass bottle; pH <2 with H ₂ SO ₄ ; Cool, 4°C	SW-846 9060; EPA 415.1, 415.2; SM 5310 A-D
¹ Iron (total and field filtered) [†]	1 L polyethylene or glass bottle; pH <2 with HNO ₃ ; Cool, 4°C	SW-846 6010B
Calcium, Magnesium, Manganese, Sodium, Potassium	1 L polyethylene or glass bottle; pH <2 with HNO ₃ ; Cool, 4°C	SW-846 6010B
¹ Ammonia-Nitrogen	500 mL polyethylene or glass bottle; pH <2 with H ₂ SO ₄ ; Cool, 4°C	EPA 350.1-350.3; SM 4500-NH ₃ A-H
Total Kjeldahl Nitrogen (TKN)	500 mL polyethylene or glass bottle; pH <2 with H ₂ SO ₄ ; Cool, 4°C	EPA 351.1-351.4; SM 4500
¹ Nitrate/Nitrite	250 mL polyethylene or glass bottle; pH <2 with H ₂ SO ₄ ; Cool, 4°C	EPA 353.1-353.3; SM 4500
¹ Sulfate	250 mL polyethylene or glass bottle; Cool, 4°C	SW-846 9035, 9036, 9038; EPA 375.1-375.4; SM 4500-SO ₄ A-F
¹ Sulfide	1 L polyethylene or glass bottle; pH >12 with NaOH; 4 drops 2N Zinc Acetate/liter; Cool, 4°C	SW-846 9030B, 9031; EPA 376.1, 376.2; SM 4500-S A-H
^{1,2} pH [†]	100 mL polyethylene or glass bottle	SW-846 9040A, 9040B; EPA 150.1, 150.2; SM 4500-H [†] A-B
² Temperature [†]	1 L polyethylene or glass bottle	EPA 170.1; SM 2550 A-B
^{1,2} Dissolved oxygen [†]	300 mL BOD bottle; 2 mL MnSO ₄ ; keep in dark	SM 4500-O A-G
	300 mL BOD bottle	EPA 360.1
	300 mL BOD bottle; 2 mL MnSO ₄ ; 2 mL alkaline iodide azide; keep in dark	EPA 360.2
² Conductivity [†]	1 L polyethylene or glass bottle; Cool, 4°C	SW-846 9050A; SM 2510 A-B
² Redox potential (ORP) [†]	100 mL polyethylene or glass bottle	SM 2580 A-B
¹ Hardness	250 mL polyethylene or glass bottle; pH <2 with HNO ₃	EPA 130.1, 130.2; SM 2340 A-C
¹ Phosphorus (total)	100 mL glass bottle; pH <2 with H ₂ SO ₄ ; Cool, 4°C	EPA 365.4

TABLE 3-8 (Continued)

Chemical Parameter	Preservation	Analytical Method
¹ Orthophosphates (filtered in field)	100 mL glass bottle; add 40 mg HgCl ₂ /liter; freeze, -10°C	SM 4500-P A-F
¹ Chlorides	125 mL polyethylene or glass bottle	SW-846 9250, 9251, 9253; EPA 325.1-325.3; SM 4500-Cl A-F
Depth to free NAPL phase	Direct push "soil boring", e.g., cone penetrometer	Laser Induced Fluorescence
³ Volatile Organic Compounds (VOCs)	Three 40 mL VOA vials; pH <2 with HCl; no headspace; Cool, 4°C	SW-846 5830B/8260B
Semivolatile Organic Compounds (SVOCs)	Two 1 L amber glass bottles; Cool, 4°C	SW-846 3510C or 3520C/8270C
⁴ Total Petroleum Hydrocarbons (TPH-extractables)	Two 1 L amber glass bottles; Cool, 4°C	SW-846 3510C or 3520C/8015B
¹ Can be determined in the field using CHEMETRIC or HACH field test kits (colorimetric or titrimetric methods); no preservative needed for field tests. ² Can be determined in the field using the appropriate field instruments (e.g. pH meter, conductance meter, etc.). ³ Can be screened in the field using headspace methods along with (GC) and the appropriate detector (FID, PID, etc.) or using the SCAPS HydroSparge VOC sensing system (see other USACE guidance). ⁴ Can be screened in the field using immunoassay test kits or via microextraction/GC-FID analysis. [†] It is strongly recommended that these parameters be analyzed in the field.		

(1) Direct-Push Methods. In unconsolidated material, it is often possible to use direct-push (also called drive point) methods. A short intake screen connected to tubing or pipe is fitted with a conical end piece and is pushed into the ground using drill rods. The short intake (typically 0.3 or 0.6 m) makes it unlikely that DNAPL will be intercepted. It is still possible that short-circuiting will occur along the sides of the piping. Direct-push methods are usually faster and cheaper than completed wells and therefore they can provide greater sampling coverage for soils loose enough to allow their installation. Groundwater samples can be taken over several discrete depth intervals along a "profiling line" to provide a detailed profile of a plume. The idea is that the profiling line is oriented to form a vertical plane of data points slicing through the dissolved plume. Although drive points are very useful, one potential difficulty is that in very fine-grained soils the small intake screens can become clogged with silt over longer periods.

f. Considerations Common to Chemical Analysis of Soil, Soil Gas, and Groundwater Samples.

(1) Recommended Analytical Methods. Table 3-9 summarizes the chemical parameters of interest and the reasons for analysis of these parameters. Additional chemical parameters may be necessary based upon project-specific contaminants or DQOs. It should be noted that samples (soil, soil gas, or groundwater) submitted for GC/MS analyses of target VOCs or SVOCs may occasionally exhibit the presence of unknown compounds. As opposed to GC analyses, the GC/MS technique allows for the potential identification of the unknown peak. This is done by performing a library search of the peak in question. The library search program compares the spectrum of the unknown peak to a library of mass spectra to find a match. Since the mass spectra in the library were produced under different instrumental conditions than the unknown peak, the identification is considered tentative and the unknown compounds are therefore referred to as Tentatively Identified Compounds (TICs). In some

instances, the spectrum of an unknown peak may yield a similar pattern to more than one compound. In this case, it is more appropriate to report the TIC as a chemical class (e.g., unknown alkane, alkyl-substituted benzene). The reported concentrations of TICs are estimated values since these compounds were not calibrated for by the laboratory. It is imperative to instruct the laboratory to identify these TICs in samples known to be contaminated early in the site characterization. Once identified, the laboratory can prepare to calibrate for these compounds for future site assessment programs, which would allow for accurate identification and quantification.

(a) Comprehensive listing of analytical methods. Methods for analysis of potential chemical parameters associated with soil, soil gas, or aqueous samples are summarized in Tables 3-7, 3-8, and 3-9.

TABLE 3-9

Chemical Parameter/Purpose of Analysis

Chemical Parameter	Purpose
BOD	to indicate the quantity of biologically oxidizable material (i.e., electron donors) present; to determine if the BOD level in extracted water will meet the discharge requirement, if applicable
COD	to indicate the quantity of chemically oxidizable material present; to assess the availability of electron donors
Alkalinity	to determine whether conditions are too acidic or alkaline to support abundant microbial populations and whether or not CO ₂ will be generated as a result of aerobic degradation
TDS	to determine salinity
TOC	to indicate ability of organic compounds to partition to the solid or aqueous phases; may be used to assess availability of electron donors
Iron (total and field filtered)	to indicate presence of either reductive or oxidative conditions and to indicate need for treatment of iron in extracted groundwater; ferrous iron may be used to assess whether ferric iron is being used as an electron acceptor
Calcium, Magnesium, Manganese, Sodium, Potassium	to determine presence of cations/anions which could precipitate in any treatment processes
Ammonia-Nitrogen	to determine nitrogen which is readily available to microorganisms
TKN	to determine total pool of organic nitrogen plus ammonia (includes less available nitrogen)
Nitrate/Nitrite	to indicate level of available nitrogen and presence of oxidative conditions; may be used to assess the availability of nitrate as an electron acceptor
Sulfate	to indicate whether subsurface conditions tend to be reductive or oxidative; may be used to assess the availability of sulfate as an electron acceptor
Sulfide	to indicate whether subsurface conditions tend to be reductive or oxidative; may be used to assess whether sulfate is being used as an electron acceptor

TABLE 3-9 (Continued)

Chemical Parameter	Purpose
pH	to determine whether conditions are too acidic or alkaline to support abundant microbial populations and whether or not CO ₂ will be generated as a result of aerobic degradation
Temperature	Important because many physical, chemical and biological properties and processes are temperature dependent.
Dissolved oxygen	to determine whether aqueous conditions tend to be aerobic or anaerobic and the extent to which these conditions vary with depth and location
Conductivity	to indicate salinity and electrolyte content
Redox potential (Eh)	to determine whether aqueous conditions tend to be aerobic or anaerobic and the extent to which they vary with depth
Hardness	to indicate alkalinity and tendency for scale formation
Phosphorus (total)	to indicate levels of all forms of phosphorus
Orthophosphates (filtered in field)	to indicate levels of readily available phosphorous
Chlorides	to determine presence of anions which may indicate dechlorination
Depth to free NAPL phase	to determine appropriateness and progress of remediation technique
VOCs (soil gas)	to estimate the initial concentration in the MPE gas emissions; to locate the soil contamination and guide the placement of MPE wells
VOCs (soil and groundwater)	to assess presence and concentration of target VOCs and associated chemicals; to determine appropriate remediation technique
SVOCs	to assess presence and concentration of target SVOCs and associated chemicals; to determine appropriate remediation technique
TPH- extractables	to assess presence and concentration of TPH and determine type of petroleum product present; to determine appropriate remediation technique

(b) Screening methods. Tables 3-7, 3-8, and 3-9 also highlight chemical parameters that can be analyzed on-site. Generalized technologies are provided for these on-site analyses.

(2) Estimation of Total Contaminant Mass.

(a) When selecting the appropriate remediation technology for the site, it is important to consider not just the concentrations of contaminant, but the total mass of contaminant present in the subsurface. Measured concentrations of dissolved contaminants have often been the focus of remedial investigations and are often the regulatory measure by which a site is deemed "clean" or "dirty." However, dissolved phase contamination may be only a small fraction of the total mass of contamination present at a given site. To achieve remediation goals, it may be necessary to remove contaminant mass that is dissolved, adsorbed onto soil, or present as a separate, non-aqueous phase.

(b) Dissolved contaminants are often in equilibrium with contaminants sorbed to the soil matrix. Removal of dissolved phase contamination via MPE may result in relatively clean water being drawn into the treatment zone and subsequently becoming contaminated by adsorbed contaminants re-equilibrating with the "new" pore water. Similarly, groundwater that comes into contact during MPE with NAPL will become contaminated. Thus it is critical to account for all of the contaminant mass and the various subsurface "compartments" where the mass may reside (adsorbed, NAPL, aqueous-phase, and gas-phase). Once the fraction of mass of contaminant residing in the various subsurface compartments is understood, then the remediation strategy can be developed.

(3) Cross-Media Correlations. The relationship of chemical compounds detected with soil analyses, and those detected by soil gas and groundwater analyses, is as discussed with respect to SVE/BV and IAS processes (EM1110-1-4001 and EM1110-1-4005).

3-6. Evaluation of Biological Degradation Potential.

a. Factors Influencing Biodegradation During MPE. One of the potentially important mechanisms for in situ treatment of contaminants during MPE is biotransformation. The paragraphs that follow discuss considerations useful in the evaluation of biodegradation and its applicability to a given site.

(1) As with all in situ remediation approaches, the potential for organic contaminant removal by microbial degradation during MPE is dependent on a variety of site specific factors, including:

(a) Amenability of contaminants to biodegradation. In general, every organic compound has an intrinsic potential for biodegradation by soil microorganisms. This potential may be governed by intrinsic parameters such as the structure of the molecule or its water solubility.

(b) Presence of microorganisms acclimated to the site contaminants. Soil may contain as many as 10^8 colony forming units (CFU) microorganisms per gram of soil, often representing a large variety of organisms. Years of exposure to environmental contaminants can influence the makeup of the microbial population, by providing a substrate or food source for a particular segment of the population. Over time, the microbial population becomes acclimated to the anthropogenically contaminated environment.

(c) Presence of toxic or inhibitory constituents (organic and inorganic). Sometimes, though not often, soil may contain compounds or elements to which the microbial population has not or can not acclimate. It is very difficult to determine *a priori* whether toxic or inhibitory constituents are present in site soil. There are no specific criteria established against which soil analytical data can be compared to identify inhibitory substances. Inhibition may be observed directly during respirometry testing or indirectly through microbial enumeration (discussed below), and the cause of the inhibition may be deduced. However, the same process that enables the microbial population to acclimate to the contaminants of concern often enables the population to acclimate to potential inhibitors.

(d) Availability of oxygen (or other electron acceptors). Microorganisms can use many environmental contaminants as substrates or electron donors, and thus transform the contaminant, often to a less toxic compound. Oxygen is a common electron acceptor for such biotransformations. The potential for biodegradation of contaminants during MPE is dependent on the ability of the MPE system to deliver oxygen proximate to the contamination. This, in turn, is

a function of the permeability of the soil. MPE will primarily affect the oxygen content of the soil gas and pore water in the vadose zone, and will have minimal affect on the saturated zone, other than possibly drawing oxygen-rich, uncontaminated groundwater toward the MPE well(s). (Some compounds, notably chlorinated ethenes, are themselves used as electron acceptors under anoxic [very low oxygen] conditions. Soil aeration by MPE will not significantly promote biodegradation of these compounds.)

(e) Other chemical environmental factors. Key factors for determining the potential of contaminant biodegradation are the availability of nutrients and suitable pH in the proximity of the contamination. There are a variety of nutrients such as nitrogen (N) and phosphorus (P), in addition to substrate/contaminant and electron acceptor (typically oxygen), that are necessary for microbial metabolism. Without these nutrients, biodegradation may not occur during MPE. Similarly, soil that has a pH that is unusually high (>11) or low (<3) may not support biodegradation during MPE. Optimal soil pH is generally in the range of about 6 to 8. It is important to note, however, that the tendency of soil microbial populations to acclimate to their environment makes it difficult to identify absolute levels of nutrients or pH that are required to support biodegradation in soil.

(2) The potential contribution of biodegradation for removal of contaminant mass during MPE is dependent on the same physical parameters as SVE (e.g., contaminant solubility, soil permeability, foc, and soil homogeneity), except the contaminants' volatility. Contaminants that are amenable to biodegradation, but not volatile enough to be extracted by MPE (e.g., naphthalene), may be removed by biodegradation promoted by MPE through soil aeration. Therefore, evaluation of biological degradation potential during MPE intended to promote biodegradation requires the same assessment of physical-chemical parameters as for MPE that is primarily intended to promote mass removal by extraction, with additional assessment of the factors described above.

(3) The contribution of biodegradation to mass removal during MPE is primarily relevant to compounds that are readily biodegradable under aerobic conditions, such as low and moderate molecular weight hydrocarbons found in petroleum fuels (e.g., gasoline, kerosene, JP-4, and diesel fuel). This is due to two factors: (1) the electron acceptor provided during MPE is oxygen which creates aerobic conditions in the treatment area; and (2) petroleum constituents are much more amenable to aerobic biodegradation than DNAPL constituents such as most chlorinated solvents. Subsurface aeration does not typically promote biodegradation of chlorinated solvents that are not amenable to biodegradation under aerobic conditions. An exception to this rule is aerobic co-metabolic biodegradation of some chlorinated ethenes. Some microorganisms, such as methanotrophs and propanotrophs (methane and propane utilizing) microorganisms, as well as toluene degraders can biodegrade compounds such as TCE, DCE, and VC in the presence of oxygen co-metabolically (i.e., using the enzymes normally used to metabolize their primary substrate). Since co-metabolism of these compounds does not provide energy for the microorganisms, suitable concentrations of primary substrate must be present (at least intermittently) to support biodegradation of the chlorinated ethenes. In the case of methanotrophic biodegradation, methane is often present in soil gas in anaerobic soil conditions. High rates of vacuum extraction often experienced during MPE may deplete the methane from the subsurface before significant contaminant biodegradation occurs. Also, by aerating the soil, the anaerobic conditions that generate methane are shut down. In contrast, when toluene is co-located with these chlorinated ethenes (e.g., when fuel and chlorinated solvents have been spilled at the same site), then aeration due to MPE may promote co-metabolic biodegradation of the chlorinated ethene(s). The rate of degradation will generally be low, but may be significant.

(4) Discussions of biological degradation potential and important microbiological and environmental factors can be found in [EM 1110-1-4001](#), Soil Vapor Extraction and Bioventing, Chapter 3, and [EM 1110-1-4005](#), In Situ Air Sparging, Chapter 3. Some key factors are discussed below.

b. **Respirometry Testing.** Site specific biodegradation potential may be evaluated by measuring respiration rates under controlled conditions (respirometry). A respiration test may entail measuring the rate of oxygen disappearance (utilization) as degradation proceeds. A biodegradation rate can then be estimated based on the uptake rate. Another variation uses the rate of evolution of carbon dioxide into the soil gas to perform a similar calculation. Both of these approaches must be evaluated with respect to abiotic sources and sinks for oxygen and carbon dioxide. In the oxygen uptake case, reduced iron may compete with microorganisms for oxygen. For carbon dioxide generation, inorganic carbonate dissolved in residual pore water and its precipitate may act as sources or sinks of carbon dioxide. Monitoring both oxygen uptake and carbon dioxide generation can help to clarify these confounding influences. Respirometry tests may be performed under laboratory conditions, but are best measured in situ, according to methods described in [EM 1110-1-4001](#) and AFCEE Principles and Practices of Bioventing (Leeson and Hincbee 1995).

c. **Microbial Enumeration Studies.**

(1) The presence of a high population density of microorganisms in contaminated soil is generally indicative of site conditions that have a relatively high biodegradation potential. However, a small population density of microorganisms does not necessarily indicate that biodegradation potential is low, but rather that existing conditions are not favorable for promoting microbial growth. If there are low microbial population densities, it is important to consider whether there are subsurface conditions limiting microbial activity that may be manipulated during remediation. For example, in soil contaminated with petroleum, the concentration of oxygen in the soil gas may be depleted (i.e., < 2%), and there may be relatively low population densities of aerobic heterotrophic (organic carbon metabolizing) microorganisms or aerobic contaminant-specific degrading microorganisms. However, upon exchanging the soil gas with ambient air containing >20% oxygen during MPE, population densities of aerobic microorganisms may increase rapidly and provide the means for biodegrading the petroleum contaminants. Similarly, soil lacking another limiting nutrient such as available nitrogen may have relatively low population densities of microorganisms but may be suitable for bioremediation if growth is stimulated through provision of this nutrient.

(2) Comparison of microbial population densities of background and contaminated zones provides additional insight into the feasibility of bioremediation. If there are significantly greater numbers of either heterotrophic or specific contaminant degraders present in the contaminated zone, then there is evidence that the microorganisms in the contaminated zone may be capable of biodegrading some (or all) of the contaminants. Again, the converse does not necessarily demonstrate that bioremediation is not feasible, but that there may be some factor inhibiting microbial growth.

d. **Bioavailability of Separate Phase Liquids.** Since microorganisms in the subsurface live in the aqueous phase (i.e., in pore water), (rather than within the NAPL), biodegradation of contaminants present in NAPL is not directly possible. The rate of biodegradation of the contaminants will generally be limited by the dissolution of the of the NAPL contaminants.

3-7. Checklist of Site Characterization Data. Table 3-10 lists data that should be obtained during site characterization for MPE or during pilot

testing. Items are prioritized so that the most necessary information is indicated by the most "+" marks. These priorities are common to most MPE sites, however, the practitioner must consider how these priorities apply to their specific site.

TABLE 3-10
Checklist of Site Characterization Data¹

Activity	Purpose	Reference
Soil Sampling +++	Determine physical and chemical soil characteristics	Paragraph 3-4 and 3-5 of this EM
Cleanup goals +++	Determine clean-up concentrations and time-frames	Paragraph 3-3 of this EM
Intrinsic permeability and air permeability of contaminated soils +++	Determine the potential rates of groundwater and soil gas recovery	Paragraph 3-4g(1) of this EM; USEPA 1995 Leeson et al. 1995
Soil structure and stratification +++	Determine how and where fluids will move within the soil matrix; identify possible permeability variations	Paragraph 3-4 of this EM USEPA 1995
Depth to groundwater +++	Difficult to apply MPE where the water table is less than 3 feet below grade. Some forms of MPE may not be possible where the water table is greater than 25 to 30 feet below grade (depending on elevation)	Paragraph 3-4e of this EM USEPA 1995 Kittel et al. 1994
Affinity of contaminants to soil +++	Contaminants with higher soil/water partitioning coefficients are harder to remove from soil	USEPA 1995; Paragraph 3-5c and 3-5e of this EM
NAPL source +++	Assess possible location(s) and estimate quantity	USEPA 1996b; Paragraphs 3-5a and 3-5b of this EM
LNAPL baildown test ++	Estimate recoverability of LNAPL in monitoring wells	Paragraph 3-5a(3) of this EM Leeson et al. 1995
In-situ respirometry test ++ ²	Evaluate in-situ microbial activity	Paragraph 3-6b of this EM Leeson et al. 1995
Volatility of constituents ++	Determine the rate and degree of contaminant vaporization; estimate initial levels of VOCs in extracted gas	USEPA 1995 EM 1110-1-4001
Moisture content of unsaturated zone ++	Moisture content reduces air permeability	Paragraph 3-4d of this EM USEPA 1995
NAPL analysis ++	Physical and chemical composition of NAPL	Paragraphs 3-5a(7) and 3-5b(2) of this EM
pH of soil and groundwater +	Determine conditions for biodegradation	Paragraphs 3-5c and 3-5e of this EM
Nutrient (e.g., nitrogen, phosphorus) concentrations in soil and groundwater +	Determine conditions for biodegradation	Paragraphs 3-5c and 3-5e of this EM
Metals concentrations in soil and groundwater +	May be toxic to microbes. Metal in groundwater must be considered for design of treatment systems.	Paragraphs 3-5c and 3-5e of this EM
¹ Importance of data for technology screening indicated by number of plusses, +++ most important. May not be important or cost-effective at sites where biodegradation is not expected to contribute significantly to mass removal. For example, sites with compounds that are not amenable to aerobic biodegradation such as PCE or heavy fuel oils; or sites where LNAPL removal is the important remedial goal.		

3-8. Remedial Technology Options. This section describes a range of MPE options and related technologies that may be considered during the technology screening process. These include single- and multi-phase non-vacuum-enhanced and vacuum-enhanced extraction technologies, as well as alternatives to these technologies (e.g., excavation) and ancillary technologies (e.g., soil fracturing) that can be used in conjunction with MPE technologies. Site-specific considerations such as soil characteristics, initial and required contaminant concentrations, and depth to groundwater will determine which technology or group of technologies will be optimal for a given situation.

a. Excavation. Excavation is a remedial option for shallow contaminated soils that may not be easily treated by in-situ methods. It is usually limited to the operating depth of the excavation equipment and to volumes of soil small enough that normal site operations are not interrupted (API 1996). The cost of excavation and disposal is often used as a baseline against which the costs of other technologies are compared. When excavation is performed, depth to groundwater is an important factor. Once excavation approaches the groundwater table, dewatering of the excavation is usually necessary and methods to keep the excavation from collapsing from infiltrating groundwater (e.g., slurry walls) may be necessary. Shoring of excavation walls may also be required in non-cohesive, more permeable soils. Excavated soil can be treated on site (e.g., treating soil piles via SVE [EM 1110-1-4001]) or disposed of off-site.

b. Conventional LNAPL Recovery. Conventional LNAPL recovery uses an electric or pneumatic pump to remove LNAPL from the surface of the water table. This is accomplished using a skimmer pump for LNAPL-only recovery, a dual pump system utilizing a submersible pump for water table depression with a skimmer pump for LNAPL removal, or a total fluids pump which removes LNAPL and water together and separates the two liquids aboveground. Conventional LNAPL recovery is best suited for sites with homogeneous, coarse-grained soils that will allow LNAPL to flow freely into a recovery well or trench. Table 3-11 lists advantages and disadvantages of various types of conventional LNAPL recovery systems, and Table 3-12 lists the most suitable method based on recovery flow rates.

TABLE 3-11

Advantages and Disadvantages of Conventional Liquid Hydrocarbon Recovery Systems

Trenches and Drains	Skimming Pump Wells	Single Pump Wells	Dual Pump Wells
Advantages			
<ul style="list-style-type: none"> • Simple operation and maintenance • Materials and equipment are available locally • Quick, cost-effective installations are possible if soil conditions are favorable • Complete plume interception 	<ul style="list-style-type: none"> • Little or no water is produced • Simple operation and maintenance • Inexpensive 	<ul style="list-style-type: none"> • Simple to operate • Inexpensive and reliable • Low operating and maintenance costs • Create capture zones 	<ul style="list-style-type: none"> • Separation of the product and water within the well • Decreased soluble components in the produced water • Allows highest degree of automation to maximize the rate of recovery • Create capture zones

TABLE 3-11 (Continued)

Trenches and Drains	Skimming Pump Wells	Single Pump Wells	Dual Pump Wells
Disadvantages			
<ul style="list-style-type: none"> The entire width of the migrating plume must be bisected unless water depression is used to capture the LNAPL plume Depth limited by soil conditions, equipment, soil disposal considerations, and cost Construction is difficult in congested areas Contaminated soil disposal 	<ul style="list-style-type: none"> Small area of influence Lack of hydraulic control 	<ul style="list-style-type: none"> Need for aboveground hydrocarbon/water separation system Tendency to emulsify the hydrocarbon and water The dissolved components in the produced groundwater are increased Creates additional smear zone in the cone of depression 	<ul style="list-style-type: none"> Higher capital, operating, and maintenance costs Initial start-up and adjustments require experienced personnel Applicability to low transmissivity formations is questionable Larger volumes of extracted water require treatment and disposal Creates additional smear zone in the cone of depression
<p>After API 1989. Reprinted by permission of American Petroleum Institute. Copyright 1989. All rights reserved.</p>			

TABLE 3-12

LNAPL Pumping System Versus Recommended Operational Range

Pump Type	Liquid Production Rate Per Well		
	Low <20 lpm (<5 gpm)	Medium 20-75 lpm (5-20 gpm)	High >75 lpm (>20 gpm)
Skimming			
Down hole	_____		
Suction lift	_____		
Vacuum-enhanced (MPE)			
Shallow	_____		
Deep	_____		
Pneumatic single pump			
Submersible	_____		
Suction lift	_____		
Electric single pump			
Submersible	_____		
Suction lift	_____		
Two-pump systems			
Submersible electric	_____		
Submersible pneumatic	_____		
Suction lift	_____		
<p>Note: lpm = liters per minute; gpm = gallons per minute After API 1989. Reprinted by permission of American Petroleum Institute. Copyright 1989. All rights reserved</p>			

(1) Trench/Drain Systems. A trench/drain system involves installation of a permeable trench to recover LNAPL. A trench is installed with very permeable backfill (e.g., gravel), and sumps or wells are installed within the trench. This allows LNAPL to flow more freely from the formation into the permeable trench, and into the sump(s). LNAPL is then recovered from the sump(s) by one of the methods discussed in 3-8b(3) and 3-8b(4). Trenches are usually installed downgradient of a LNAPL plume and may include an impermeable layer on the downgradient side of the trench to prevent LNAPL migration beyond it (API

1996). They must be excavated several feet below the lowest seasonal water table elevation (API 1996). Figure 3-6 illustrates a typical trench and drain system.

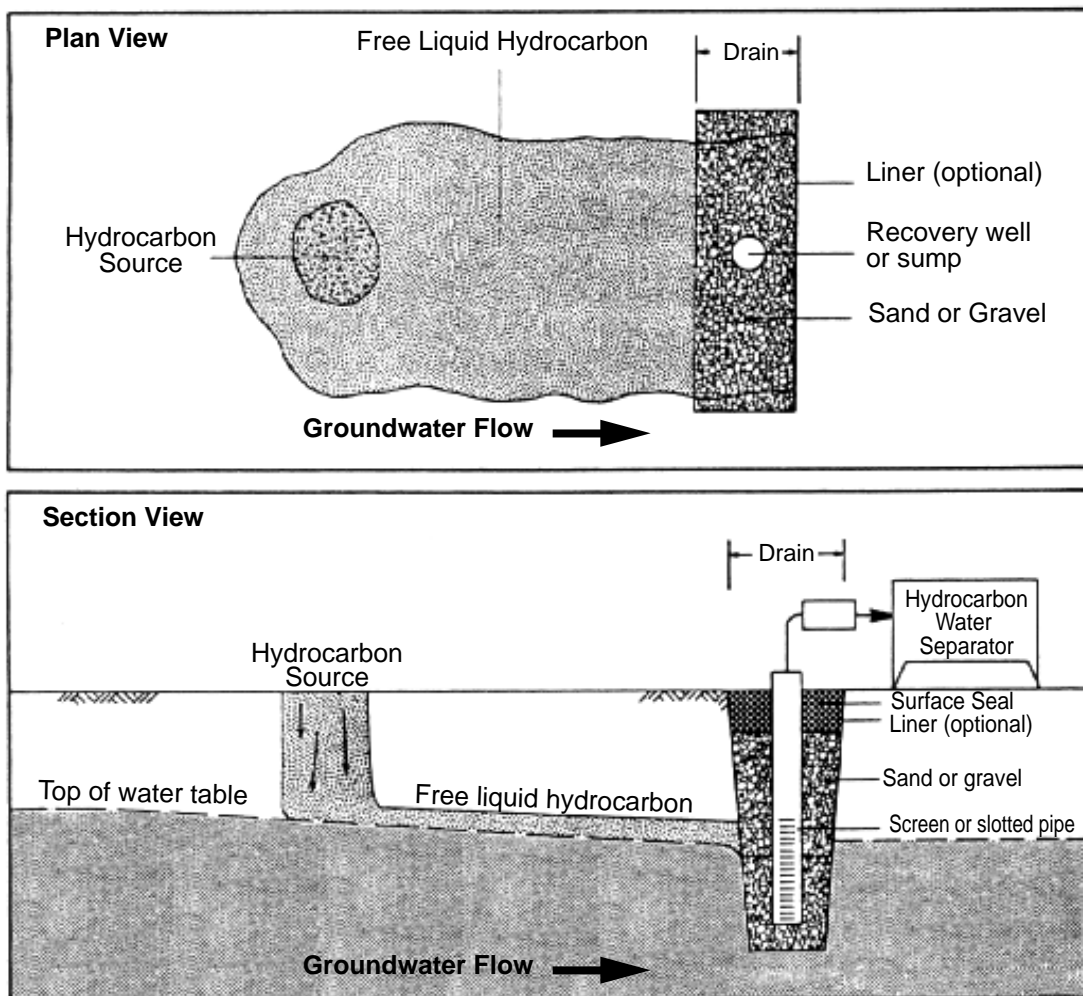

Figure 3-6. Trench and Drain LNAPL Recovery System. (API 1996. Reprinted by permission of American Petroleum Institute. Copyright 1996. All rights reserved.)

(2) Recovery Wells. Another method of LNAPL recovery is via recovery wells. Recovery wells are of large enough diameter to accommodate a LNAPL recovery pump. Wells typically do not recover LNAPL at rates as high as trench/drain systems because they do not influence as large an area. Wells do, however, offer more flexibility in design, placement, and operation than a trench and drain system (API 1996).

(3) Skimming. Skimming involves removal of LNAPL only that drains from the formation into a recovery well or trench/drain system. Skimming systems rely on passive movement of LNAPL into the product recovery system and

therefore have a very small radius of influence outside of the well or trench (Leeson et al. 1995).

(4) Drawdown. LNAPL recovery by drawdown can be performed using a single total fluids pump or separate groundwater and LNAPL recovery pumps. Single pump systems are installed below the water table and extract groundwater and LNAPL in the same stream that is then separated aboveground. Dual pump systems use a submersible water pump to lower the groundwater table and an LNAPL skimming pump to recover LNAPL that migrates into the well. Drawdown systems for LNAPL increase recovery by depressing the groundwater table, which induces a gravity gradient for LNAPL to flow into the collection system (Lesson et al. 1995). Drawdown can, however, result in entrapment of LNAPL within the cone of depression, potentially deepening the smear zone of LNAPL in the soil, which can be difficult to remediate (Leeson et al. 1995). Figure 2-6b illustrates a dual pump system for LNAPL recovery.

c. Vacuum Dewatering. Dewatering has long been a technique used in the construction industry to prevent water exfiltration from the soil into excavations and to stabilize soils to prevent excavation slopes from collapsing. Silt and clay excavations often have very unstable slopes and sidewalls (Powers 1992). Unstable silts can "act as a liquid" and destabilize the lateral loads on sheet piles, causing bracing failures (Powers 1992), particularly when subjected to aboveground compression from heavy construction equipment. Since silts and clays typically produce relatively low water flow rates when relying solely on gravity drainage, vacuum dewatering using closely spaced well points is common. Vacuum dewatering well points typically produce higher (though still low) water flow rates that can dramatically increase the stability of excavation side walls. Powers (1992) reports that this beneficial effect is observed even in sediments where the reduction in moisture content due to vacuum dewatering is small. Vacuum dewatering is typically achieved using driven well points that are sealed at the ground surface to ensure that the vacuum is transmitted to the soil. Vacuum is applied to the well points either using oil-sealed or water-sealed rotary vane or liquid ring pumps. Use of these pumps may be hampered by the limit of vacuum lift, e.g., 30 feet (9.1 m) of water. Ejector pumps (sometimes referred to as jet pumps) are commonly applied for construction dewatering at depths deeper than 28 feet (8.5 m). Powers (1992) is an excellent resource for additional information about excavation dewatering techniques and common practice.

d. Vacuum-Enhanced LNAPL Recovery. MPE has evolved as a remediation method that applies the technology pioneered for construction vacuum dewatering to enhance the recovery of LNAPL. At many sites, LNAPL present in the capillary fringe can not flow toward extraction wells due to capillary forces holding the LNAPL within soil pores (Baker and Bierschenk 1995). This phenomenon is common in fine-textured soils such as fine sands, silts and clays. By applying high vacuums at extraction wells, the capillary forces holding the LNAPL in the soil can to some degree be overcome and LNAPL can flow toward the extraction well. This technique can be implemented in two ways: MPE without drawdown of the surrounding water table (analogous to LNAPL skimming) and MPE with drawdown (analogous to LNAPL recovery using dual pumps). These techniques are discussed below.

(1) MPE Without Drawdown.

(a) MPE without drawdown is often conceived of as similar to free-product skimming with the addition of vacuum applied at the extraction well to induce LNAPL to migrate toward the well. Under these circumstances, the vacuum is typically applied at the water table surface where the LNAPL resides, and the LNAPL is induced to travel horizontally toward the MPE well. This process can

be implemented by either applying a vacuum to the top of a sealed conventional well containing a skimming pump or using a drop tube to apply the vacuum and extract the LNAPL.

(b) This common conceptualization of MPE without drawdown must be modified to account for upwelling of liquid in and around the extraction well. As described previously, application of a vacuum to an extraction well initiates a complex response of water, LNAPL, and air around the well. However, the influence of the applied vacuum in the formation outside of the immediate well area can induce LNAPL to migrate toward the well and eventually flow into the well. If a skimmer is used for product recovery and the vacuum is applied at the well head by a separate piping system, then there may not be an increase in subsurface vacuum. Because upwelling can offset the air vacuum gradient created by the extraction of air, the benefit of such a configuration is limited to overcoming the capillary pressure preventing the product from entering the filter pack.

(c) Unlike conventional LNAPL skimming, MPE without drawdown typically extracts significant quantities of water along with air and LNAPL from the subsurface. Therefore, in addition to LNAPL collection, the water and air streams must also be managed and treated.

(2) MPE with Drawdown. The use of MPE with drawdown is a means of increasing NAPL recovery. It also dewateres the zone below the water table in an area around the well, exposing residual NAPL in that zone to the air phase.

(a) MPE with drawdown is simply a vacuum-enhanced version of conventional LNAPL recovery with drawdown. When a vacuum is applied to a conventional LNAPL recovery with drawdown system, the imposed vacuum gradient provides a force in addition to the gravitational force inducing LNAPL to flow toward the extraction well. The applied vacuum induces greater water (and NAPL) flow to the well than can be achieved under typical drawdown conditions. This process can also be employed using a drop tube placed below the water table, extracting water, LNAPL, and air all through the same tube. (Using a drop tube instead of a downhole dual-pump or total fluids pumping system involves other complications regarding the dynamics of liquid and droplet flow in pipes as described in [paragraph 2-5d.](#))

(b) As in MPE without drawdown, MPE with drawdown will generate groundwater, air and LNAPL to be managed and treated aboveground. MPE with drawdown will typically result in more groundwater extraction from a given well than MPE without drawdown. However, the most commonly perceived benefit of using this technique is to dewater the soil surrounding the MPE well to expose to air discontinuous ganglia of LNAPL trapped below the water table. As the water table is drawn down, these ganglia may either drain toward the declining water table surface due to gravity and vacuum inducement, or they may volatilize and be extracted in gas that flows to the MPE well.

e. Multiphase Extraction to Enhance SVE/BV. MPE is generally accomplished using two distinct technologies. Dual-phase extraction (DPE) technology generally employs separate pumps to extract liquid and gas from a well. Two-phase extraction (TPE) extracts liquid and gas from a well using a single suction pipe or conduit. These technologies are discussed below.

(1) Dual-Phase Extraction.

(a) DPE systems typically use a submersible or pneumatic pump to extract ground water, and a low vacuum (approximately 76 to 305 mm Hg, or 3 to 12

inches Hg) or a high vacuum (approximately 457 to 660 mm Hg, or 18 to 26 inches Hg) blower to extract soil gas (USEPA 1997a; Zahiraleslamzadeh 1998). A typical DPE system is shown in Figure 3-7. DPE can be used to perform MPE either with or without drawdown. The amount of drawdown is determined by setting the intake of the pump or the level controls.

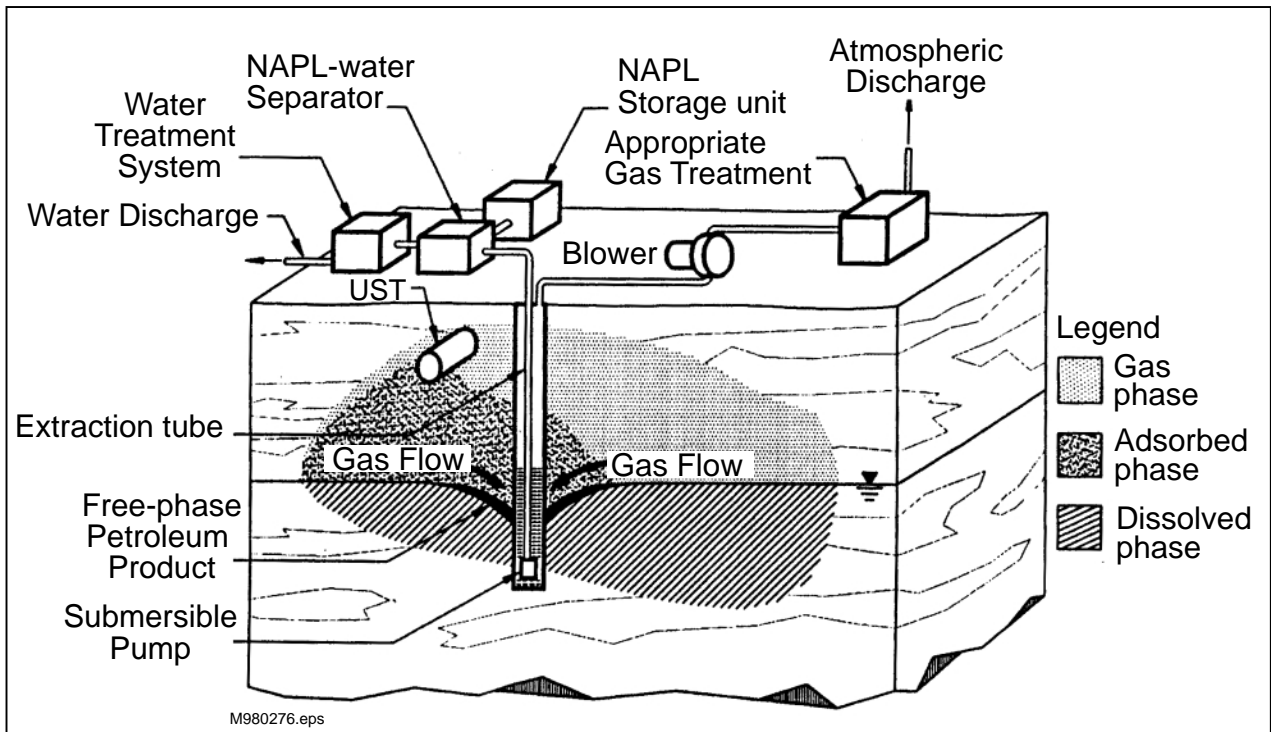

Figure 3-7. Typical Dual-Phase Extraction System. (After USEPA 1995)

(b) A key attribute of the DPE technology is that liquids and gas are withdrawn from the extraction well via separate conduits, allowing independent measurement and control of the flows of each fluid. Such independent measurement and control of the fluid flow are not readily accomplished with TPE, which can be particularly important in a multi-well system, where several wells are connected to the same blower or pump via a common manifold.

(2) Two-Phase Extraction.

(a) TPE is characterized by extraction of liquids and air from a well using a single suction pipe (Figure 3-8). TPE employs a high vacuum (approximately 457 to 660 mm Hg, or 18 to 26 inches Hg) pump to extract total fluids from an extraction well (USEPA 1997a). A suction pipe (often called a drop tube or a slurp tube) is lowered into the extraction well to a predetermined depth to accomplish MPE either with or without drawdown. MPE capital costs are reduced by using a single pumping system.

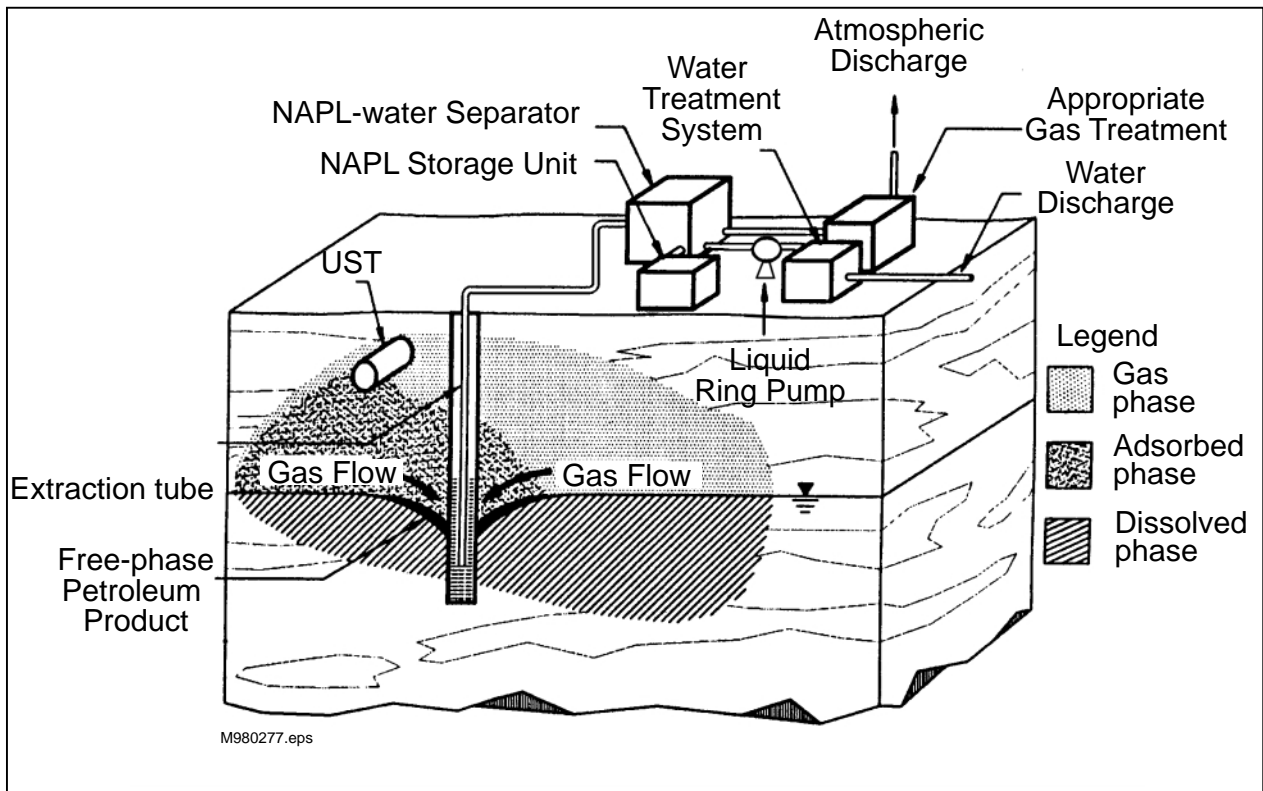

Figure 3-8. Typical Two-Phase Extraction System. (After USEPA 1995)

(b) Liquid lift via the TPE method is accomplished either by direct vacuum lift (i.e., where one inch of water vacuum raises the water level by one inch), or at depths greater than 9.1 m (the limit of suction lift of water, Powers 1992), by entraining liquid droplets in air and removing both phases together simultaneously from the well. Turbulence in the suction pipe may cause these droplets to hit the sides of the pipe. In this case, the liquid forms a layer on the inside of the pipe that is forced up the well by the velocity of the air inside the pipe. Under these conditions, the effective extraction depth can be much greater than 9.1 m (30 feet) as long as the air velocity in the pipe is sufficient to force the liquid up the pipe. There are differing opinions regarding the air velocity necessary to aspirate liquids from a well. Mickelson (1994) recommends linear air velocities in excess of 914 m/min (3,000 ft/min). AFCEE has reported velocities as low as 275 m/min (Kittel et al. 1995). A velocity of 500 m/min can be assumed for most TPE applications. It may be necessary to consider patent issues associated with TPE (see paragraph 9-3).

(3) DPE and TPE Considerations.

(a) Liquid and gas flow from extraction wells can be measured and controlled more effectively in DPE systems compared to TPE systems. Therefore, DPE provides more opportunity for developing a system in which flow rates from the MPE wells in a network can be balanced to accommodate differences in soil characteristics across the treatment area. A common problem with TPE systems is breaking suction at one or more of the wells in the network. If a single well is able to produce a high flow rate of air, then the vacuum in the entire

system can be reduced to a level that is insufficient for liquid extraction at other wells. This phenomenon is shown in Figure 3-9. As shown in this figure, there typically is little advance indication that a break in suction is about to occur. While the gas (and liquid) flows from each well are apt to differ (due to variability in subsurface properties), the vacuums being applied to each well are typically set at similar levels to balance the system. When more air enters one of the wells, which can occur if the soil is more permeable at some locations than at others (as is often the case), then the TPE system short-circuits and both the applied vacuum and flows greatly diminish at the other, non-breaking wells.

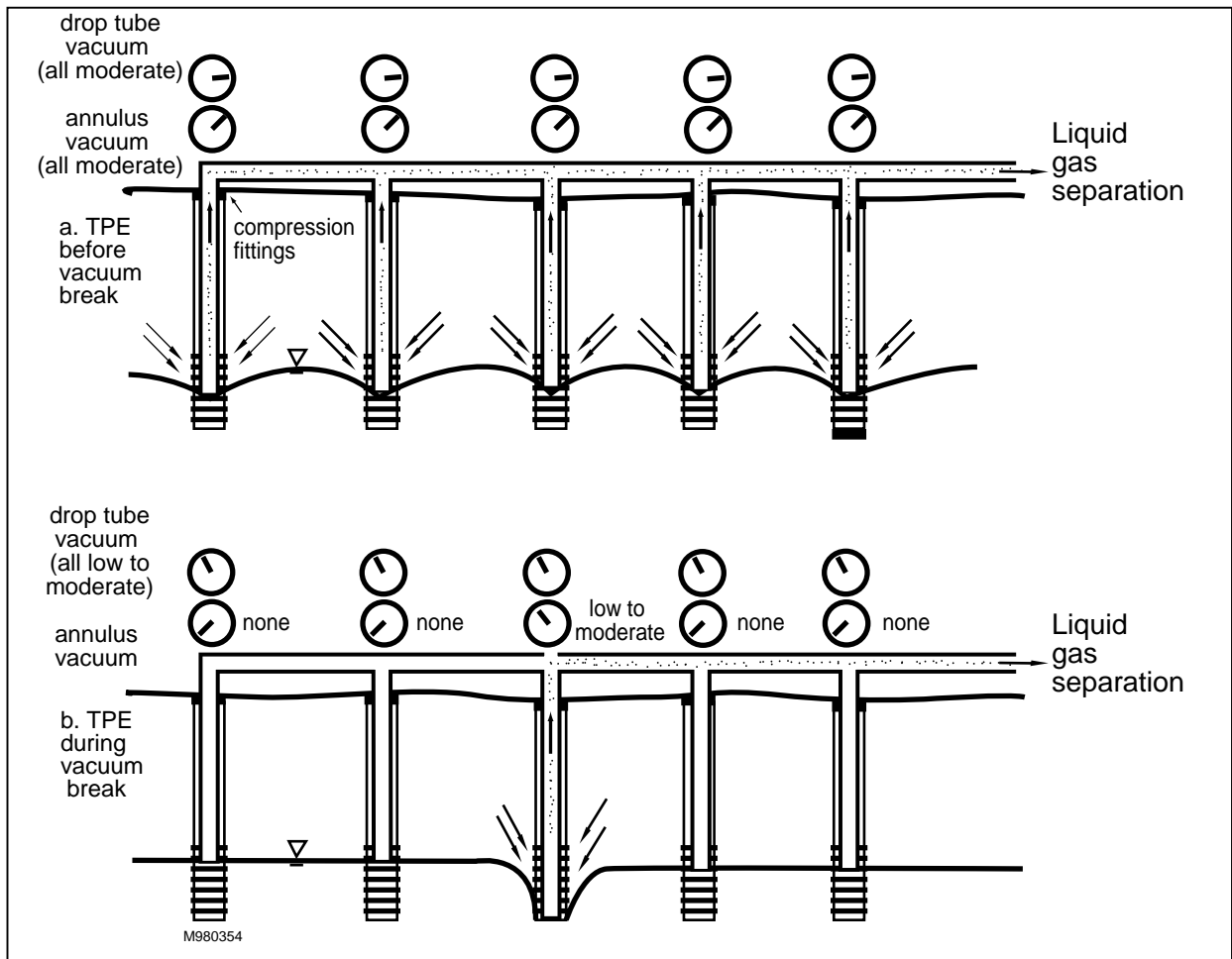

Figure 3-9. Two-Phase Extraction (a) Before and (b) During Vacuum Breaks.

(b) This effect of breaking suction is minimized or eliminated in a DPE system, since the flow rates of gas and liquid can be monitored and controlled separately. Suction break is controlled in the liquid pump with level sensors that shut down the pump when the water level approaches the intake. With DPE, monitoring of individual well gas flows permits advance warning that suction may be about to break, and allows provision of a feedback system to reduce the

flow from the problem well or wells. Thus, suction breaks are preventable, resulting in better control, less downtime, and more efficient operation for heterogeneous, multi-well sites.

(c) However, this degree of control comes at an increased capital cost for comparable DPE versus TPE systems. Liquid pumping systems in soils that require high vacuums can be quite expensive. The selection of a liquid pumping system for DPE will depend upon the depth to the water table. For depths greater than 9.1 m, submersible pumps are typically used to evacuate liquids from the extraction wells. In low permeability soils, more costly pneumatic pumps may be required.

f. Vacuum-Enhanced Groundwater Pump and Treat.

(1) Vacuum-enhanced pump and treat may be used to increase the groundwater capture zone of a pumping well beyond that which can be achieved by groundwater pumping alone. Because the discharge that can be obtained is proportional to the capture zone (that zone within the cone of depression), this method increases the rate of groundwater withdrawal from an individual well. This method thus can decrease the number of wells that are needed. The method is a type of MPE, the differentiating factor being that in this case groundwater is the target, and the aim is to withdraw as much groundwater as possible. This method is applicable in situations where transmissivity is low due to small saturated thickness and/or relatively low permeability (in the range of 10^{-3} to 10^{-5} cm/sec).

(2) As in other types of MPE, a single- or dual-pump system is used. A single-pump (TPE) system utilizes one pump to extract liquid and gas via a drop tube. This type of system is not usually a cost-effective means of enhancing groundwater recovery.

(3) A dual-pump system (DPE) uses separate liquid and gas pumps. A vacuum is applied at the well head, while a second downhole pump is used to withdraw liquids.

g. DNAPL Recovery.

(1) At some sites, the physical/chemical properties of the DNAPL combined with the release history and geologic conditions result in the formation of zones of potentially mobile DNAPL (e.g., pools). When mobile DNAPL is encountered, there are a number of methods and designs that can be employed to ensure optimal recovery efficiency. Under the most favorable conditions, direct recovery will remove between 50 and 70 percent of the DNAPL in the subsurface (Pankow and Cherry 1996). The remaining residual DNAPL will still be sufficient to serve as a significant long-term source unless it is addressed through other means.

(2) In order to properly design DNAPL recovery systems, it is important to know where the mobile DNAPL is located in the subsurface. In unconsolidated deposits, sufficient geologic information must be obtained to delineate the stratigraphy, map the extent of the DNAPL (from the "outside-in", if possible), and identify the extent and orientation of the low permeability, fine-grained deposits that may be trapping the DNAPL. These data can be obtained quickly and cheaply using direct-push drilling methods to collect continuous soil cores (paragraph 3-4h(2)). It is important to carefully screen and inspect the cores to determine the locations of the mobile DNAPL zones and the controlling stratigraphic zones. In some cases, the bedrock surface underlying the unconsolidated deposits may act as a confining layer and result in the

formation of mobile DNAPL at the bedrock-soil interface. In these situations, non-invasive geophysical methods may be used to attempt to delineate the topography of the bedrock surface and identify low points where DNAPL may be trapped.

(3) Once the mobile DNAPL zone(s) are identified, the extraction system can be designed. The screen interval of DNAPL recovery wells should correspond to the subsurface zone containing the DNAPL. At sites where several zones are encountered at different elevations, it is advisable to begin extracting from the upper-most zone first and then extracting from progressively lower zones once the upper zone(s) have ceased DNAPL production. This will maximize recovery efficiency and minimize the potential for uncontrolled mobilization.

(4) Creating a shallow sump in a less permeable stratum at the bottom of the well for the collection of the DNAPL may also be advisable. The sump will provide a convenient and efficient location for placing the intake of the DNAPL pump (Michalski et al. 1995).

(5) A total liquids approach can be used (i.e., water and DNAPL are removed from the well via one pump and then separated at the surface). This may minimize equipment costs; however, it is not the most efficient approach. As the DNAPL and water are extracted from the well, the DNAPL saturation is decreased in a zone around the well, the relative permeability of the formation with respect to DNAPL is decreased, and the DNAPL production rate decreases. Eventually, a zone of residual (non-mobile) DNAPL is created around the well and the well no longer produces DNAPL.

(6) The ideal approach is to maintain or enhance DNAPL saturation around the well in order to increase removal efficiency. DNAPL extraction can be enhanced using a dual pumping approach, where water is removed separately from the zone immediately above the mobile DNAPL (Sale and Applegate 1997). This approach results in upwelling of DNAPL in the well, and increased DNAPL saturations in the immediate vicinity of the well. A variation of this approach is to apply a vacuum to the upper of the two wells, to decrease the pressure head in the well. This has a similar effect as pumping water, in that it results in a decrease in the total head in the well (i.e., increased hydraulic gradients near the well) and increased DNAPL thicknesses, saturations, production rates, and removal efficiencies.

h. Ancillary Technologies.

(1) Soil Fracturing.

(a) Soil fracturing is a technique that may enhance the effectiveness of MPE remediation systems. The essence of this enhancement is the creation of additional high permeability pathways within otherwise low permeability strata to extend the influence of MPE wells. Soil fracturing can be accomplished either pneumatically (i.e., by injecting air at high pressure) or hydraulically (i.e., by injecting water, or a slurry of water and sand and/or gel) into the soil to create fractures or channels. Fractures are created in boreholes by injecting the air or water slurry at high pressure at intervals along the depth of the boring. A typical application may develop fractures approximately 0.5 to 1 cm wide (pneumatic) or 1 to 2 cm wide (hydraulic) at 2 foot (60 cm) intervals along the borehole. The fractures typically form horizontally away from the borehole (though they may propagate vertically as well), in a radius of 10 to 60 feet from the borehole (USEPA 1997a). The soil hydraulic fracturing often includes injection of material such as sand and gel (e.g.,

guar gum) to keep the fractures open (often described as "propped open"). In contrast, pneumatically created fractures may close somewhat over time.

(b) The new network of fractures increases the surface area of soil affected by the vacuum subsequently applied at the MPE well. In this way, soil fracturing has the potential for increasing the zone of influence of an MPE well. However, the effectiveness of soil fractures will depend upon the remediation objectives of the MPE system. Soil fracturing will increase the flow of air and liquids into MPE wells, and therefore can increase the rate of mass removal from the subsurface. If mass removal is the primary objective, then soil fracturing can be a useful enhancement. However, if a MPE system is intended to extract the contamination that resides within the low permeability soil matrix (e.g. if soil concentrations must be reduced to a specified level), diffusion limitations may still prevail even after soil fractures are developed. Murdoch (1995) and Shuring (1995) provide further information regarding the applicability and performance of soil fracturing.

(2) Air Injection. As described in Chapter 3 of [EM 1110-1-4001](#), air injection into the vadose zone is a useful enhancement of the SVE process. Air injection into the vadose zone can accomplish several purposes:

(a) It can increase the effectiveness of SVE by increasing subsurface pressure gradients, thereby increasing subsurface gas flow rates. Airflow to a SVE well is generally a function of the soil permeability and the subsurface pressure gradient. If SVE is achieved through extraction alone, then the maximum pressure gradient is between essentially atmospheric pressure and the SVE well vacuum. If air is injected at a substantial pressure, then the pressure gradient increases and airflow rates increase proportionally.

(b) In addition, air injection within a multi-well MPE wellfield can help eliminate stagnation zones that may develop where multiple MPE wells "negate" each other's influence. This effect is depicted in Chapter 5 of [EM 1110-1-4001](#).

(c) Air injection is also one of the primary methods of implementing bioventing within the vadose zone. Biodegradation of vadose zone contaminants is often oxygen-limited. Air injection is the preferred method of supplying oxygen, since this method does not require extraction and treatment of contaminated air aboveground.

(3) Air Sparging. Airsparging is a technology for remediation of in-situ soil and groundwater. It involves injection of air below the water table, which causes dissolved volatile contaminants to partition to the gas phase for subsequent extraction in the vadose zone via soil vapor extraction. Air sparging also provides oxygen to groundwater and soil, promoting aerobic biodegradation of contaminants. [EM1110-1-4005](#) In-Situ Air Sparging provides guidance on this technology.

(4) Surfactant/Cosolvent Flushing.

(a) Surfactant or cosolvent flushing is an emerging technology for increasing the effectiveness of groundwater extraction and MPE systems. The premise of this technology is that most organic NAPL is only sparingly soluble in water and therefore will persist in the subsurface for a very long time. However, chemical amendments to the groundwater can cause many types of NAPL to dissolve in the groundwater much more readily. Cosolvents such as alcohols, or surfactants such as detergents can, when added to the groundwater in high concentrations (e.g., 50% by volume in the case of cosolvents), enhance the

rate of NAPL dissolution by orders of magnitude. In this way, a MPE system that would require extraction of thousands of pore volumes to "flush" residual NAPL from the saturated zone by groundwater dissolution and extraction alone might require extraction of tens or hundreds of pore volumes of chemically amended water.

(b) Implementation of surfactant or cosolvent flushing involves installation of injection wells to introduce the chemical amendment into the contaminated zone. Groundwater is typically recirculated through the contaminated zone in an effort to achieve the widest possible dispersion of the additive throughout the contaminated area. While this technology is quite promising, it is also relatively expensive. This approach suffers from the same limitations as MPE in heterogeneous unsaturated soils; that is, the tendency of the surfactant/cosolvent laden water to preferentially flow through the highest permeability strata, which may not be where the bulk of the contaminant mass resides.

(c) Great care must be exercised when injecting surfactants or other chemicals into the subsurface. The risk of mobilizing contaminants in the absence of adequate hydraulic control is significant with these technologies. For this reason, regulators are often wary of approving remediation plans involving the injection of chemicals such as surfactants.

(d) The AATDF Technology Practices Manual for Surfactants and Cosolvents (TR-97-2, available on the internet at www.clu-in.org/PRODUCTS/AATDF/Toc.htm), produced by the DOD Advanced Applied Technology Demonstration Facility Program at Rice University, provides further information regarding evaluation and potential application of surfactant/cosolvent flushing for remediation of subsurface contamination. The report provides a basic understanding of the technologies, their applicability and limitations, and an understanding of the factors to be considered when implementing projects.

(5) Groundwater Pump-and-Treat.

(a) Groundwater pump-and-treat is the process of removing contaminated groundwater via recovery wells and pumping it to the surface for treatment. Pump and treat is primarily used as a technology for plume containment. Extracted groundwater is treated by one of several methods based on its contaminant concentration and contaminant properties. In most hazardous waste site pump-and-treat systems, groundwater is treated by air stripping (for volatile contaminants), ultraviolet oxidation, and/or carbon adsorption (for removal of additional contaminants or polishing). Pump-and-treat may be a viable option to keep contaminated groundwater from migrating off site or to enhance recovery of contaminants in the capillary fringe when operating concurrent with soil vapor extraction. As the sole remediation process, however, pump-and-treat can take a very long time to clean up a site. This is because it will only recover dissolved contaminants within the groundwater and will not remediate residual contaminant or treat the source of the contamination. MPE can be used to replace pump-and-treat, particularly at sites with low transmissivities. More information on groundwater pump-and-treat can be found in USEPA 1990, Basics of Pump-and-Treat Ground-Water Remediation Technology; NRC (1994); and other USACE guidance on groundwater extraction lessons learned.

(6) Thermal Enhancements.

(a) There are a number of methods that can be used to inject or apply heat to the subsurface to enhance MPE. Thermal enhancement is used to lower the

viscosity of NAPL, increase the vapor pressure and solubility of VOCs or SVOCs to enhance their removal, and/or increase air permeability by removing soil moisture.

(b) Steam injection may displace mobile contaminants, pushing them ahead of the condensing water vapor ("steam front") toward extraction wells, as well as vaporize residual volatile constituents. Thus, contaminants can be recovered in both the liquid and gas phases. Steam may be injected above or below the water table.

(c) Electrical energy may be applied to soil in the low frequency range used for electrical power (electromagnetic, alternating current, or resistivity heating) or in the radio frequency (RF) range. For low frequency range heating, the boiling point of water (100°C) is the highest temperature that can be achieved. RF heating can achieve higher temperatures of up to 300° or 400° C. However, RF is only about 40% efficient in producing heat from electrical energy.

(d) Thermal conduction heating, or "in-situ thermal desorption," relies on conduction rather than convection to heat subsurface soils. For shallow soil contamination, surface heater blankets may be used. For deeper soil contamination, heater wells are used. Most contaminants are destroyed in situ, while the remainder volatilize, and are removed by vacuum and treated aboveground using VOC emission control equipment.

i. Examples of Integrated Technologies. Given the nature of subsurface contamination, it is common to apply more than one technology to remediate a site. For example, it is common to have both groundwater and vadose zone contamination at the same site. MPE may be integrated with several of the ancillary technologies described above. Many of these technologies include extraction as part of the process. In medium and low permeability soils (i.e., $< 10^{-4}$ cm/sec hydraulic conductivity), extraction will best be performed using an MPE-type system. For example, extraction in a cosolvent flushing system in 10^{-4} cm/sec sands can be performed using MPE. Similarly, gases generated using high temperature thermal desorption technology, along with excess water, can be captured using MPE technology in fine-grained soils.

3-9. Feasibility Studies for MPE.

a. The Feasibility Study (FS) is a combination of the physical, chemical and biological evaluations described in the previous sections, paired with an evaluation of the potential remedial approach(es). Nine evaluation criteria are specified for feasibility studies for CERCLA sites (USEPA 1988). Similar criteria are specified for RCRA Corrective Measures Studies. In addition, many states have adopted some or all of these criteria for feasibility studies under state regulatory programs. The criteria are: 1) overall protection of human health and the environment, 2) compliance with applicable or relevant and appropriate requirements (ARARs), 3) long-term effectiveness and permanence, 4) reduction of toxicity, mobility, and volume through treatment, 5) short-term effectiveness, 6) implementability, 7) cost, 8) state acceptance, and 9) community acceptance.

b. The practitioner must consider a variety of technologies before selecting a remediation approach. Figure 3-1 provides a decision tree for evaluating the technical applicability of MPE, i.e., whether, in one of its various forms, MPE is appropriate for a given site. Use of this decision tree requires site-specific values for each of the parameters/criteria referenced in the decision tree.

c. A part of the feasibility study is an economic evaluation of the likely cost to test and implement MPE, in comparison to other technologies. Many feasibility studies recommend the technology that is likely to attain cleanup goals for the site at minimum cost. For an in situ technology such as MPE, this cost of treatment is very site-specific, and is primarily affected by the concentration and mass of extracted hydrocarbon that must be treated and site stratigraphy and permeability. Cost estimates for each of the alternatives must include treatment of all of the extracted waste streams (NAPL, water, and air). Other important cost considerations include the number of wells that are required to achieve sufficient air and liquid flow in the treatment zone; the complexity of the system, which dictates the O&M level of effort; and the projected time of treatment required.

d. An FS report is usually prepared in which potential remedial technologies are identified and evaluated against the required criteria. The FS will generally lead to a site-specific MPE pilot test if the technology still appears promising. Alternatively, pilot testing may be performed as part of the FS. Laboratory tests may also be performed, for example, laboratory column studies simulating airflow in soil may be informative (e.g., Ji et al. 1993). The use of laboratory scale testing for technology assessment should be cautiously approached as scaling and sizing issues may be left unresolved. Pilot test methods and guidance will be provided in the next chapter.

CHAPTER 4

PILOT-SCALE TESTS

4-1. Introduction. With respect to pilot-scale testing, this EM supplements and updates detailed discussions of pilot testing found in the following references: EM 1110-1-4001, Soil Vapor Extraction and Bioventing; Air Force Center for Environmental Excellence Test Plan and Technical Protocol for Bioslurping; and USEPA 600/R-96/031, UST Corrective Action Technologies: Engineering Design of Free Product Recovery Systems. These documents each provide substantial guidance related to bench- and pilot-scale testing. All MPE pilot testing should be planned and carried out in accordance with the requirements of EM 200-1-2 and 200-1-3.

4-2. Pilot Testing Guidance.

a. Objectives. The primary objectives of typical MPE pilot tests are listed as follows:

(1) Mass Removal. A pilot test can be viewed as a demonstration that MPE can accomplish removal of contaminant mass at sufficient rates to demonstrate that if carried out over a longer time period, MPE has the potential to achieve significant remediation. This objective must be considered in the context of the initial concentrations versus the remedial goals, and the length of the pilot test versus the length of the remediation. It can be expected that rates of mass removal will decline sharply over time; thus, the rate observed during the pilot test should not be expected to continue over a long period. Indeed, once the most readily-extracted fraction of the contaminant mass is removed by advection, the diffusion-limited mass transfer that ensues typically causes contaminant mass removal to taper off to an asymptotic level.

(2) Zone of Influence. A properly designed MPE pilot test will provide indications of the vadose and saturated zone response to the application of vacuum. The effective zone of influence can be discerned through monitoring a variety of data, including pressures in soil gas monitoring points, piezometric heads in monitoring wells and drive-point piezometers, moisture content via neutron probe access tubes, and tracer velocities/capture during injection of gaseous and/or liquid tracers.

(3) Subsurface Soil Properties/Parameters. MPE pilot tests provide information on the nature and variability of site-specific subsurface parameters, such as air permeability, hydraulic conductivity, soil moisture retention, and contaminant distribution.

(4) Discharge Concentrations/Design Parameters. MPE pilot testing provides designers with an indication of the initial levels of contaminants in extracted gas and liquid. These data may be used to specify treatment equipment and to prepare applications for discharge permits. It must be remembered, however, that the early concentrations seen during pilot tests are usually the highest that will be seen over a longer term remediation, unless significant desaturation is anticipated to occur over time, which may open pathways for air movement and improve mass transfer. In finer-textured, lower-permeability settings, however, substantial mass removal from desaturated regions may not be a realistic expectation (Baker and Groher 1998).

(5) Cost Estimates. MPE pilot tests can help refine cost estimates for full-scale system implementation and operation. Cost estimates based on pilot tests may, however, include extra costs not necessarily related to full-scale application (e.g., testing, analytical, ancillary equipment, inappropriately sized equipment).

b. Limitations of Pilot Studies.

(1) One cannot expect to achieve remedial goals (RGs) or to establish long-term trends in mass removal during a typical short-term MPE pilot test.

(2) One can expect to determine whether appropriate physical conditions can be established that will, over time, be conducive to achievement of RGs.

(3) Although mass removal may be included as a test objective, prior specification of a percentage removal should be avoided unless such a goal has already been established based on leaching studies, fate and transport modeling, and/or risk assessment. For example, although >90% mass removal may not be realistically achievable even within those zones targeted for MPE, leaving a certain lesser percentage of the contaminant mass in the subsurface following active remediation may still be sufficiently protective, if its potential contribution to groundwater contamination is low enough to be consistent with RGs. Quantifying the initial contaminant mass in place is usually difficult, due to sampling losses/errors and inherent spatial variability in contaminant distribution. Thus, attainment of a specified percentage mass removal can be very difficult to confirm, and may not constitute a reliable pilot test objective.

c. Preparation and Permits. Prior to performance of pilot testing, certain preparations must be made. A work plan of activities to be performed should be prepared for involved parties prior to conducting the pilot test. The work plan is vital for specifying test objectives, the range of operating conditions, and parameters to be monitored, including the locations, methods, and frequency of measurements to be taken. The work plan often is reviewed by regulatory agencies and forms the basis for the contractor scope of services. A Site Safety and Health Plan (SSHP) is required prior to conducting the work to assure safety of all on-site workers. A detailed discussion of safety is included in [paragraph 9-4](#). A schedule showing critical tasks and the various phases of the work should be included. A materials list for necessary equipment and supplies should also be prepared. Necessary permits ([paragraph 9-2b](#)), as applicable, must also be obtained for pilot system installation and discharge streams. Permitting requirements will vary depending on testing location, but may include electrical and mechanical permits for system installation, and air and water discharge permits.

d. Equipment. Most pilot systems are installed for temporary operation only. Compact equipment and treatment units that can be easily connected are extremely beneficial, especially when operating within a high traffic area with limited access and available space (e.g., gasoline station, loading dock). In some cases, however, pilot testing may represent the first phase of a staged implementation at the site. In this case, it may be desirable to oversize the equipment and equipment shelters in anticipation of future phases of the project.

(1) Extraction Wells. During pilot testing, existing monitoring wells may be used as extraction wells if they are in proper condition (e.g., well casing not cracked; well seal and well head intact) and appropriate to the task (e.g.,

sufficient diameter; and with properly positioned screen interval). Otherwise, new wells must be installed. Materials of well construction must be compatible with the contaminants present. Note, for example, that PVC is not compatible with most chlorinated solvents when they are present as pure product. PVC piping can, however be used with chlorinated solvents when dissolved in water at concentrations in the parts per million range. Many electrical submersible pumps require a minimum well diameter of 10 cm (4 in). Figures 4-1 and 4-2 show typical extraction well set-ups for DPE and TPE, respectively.

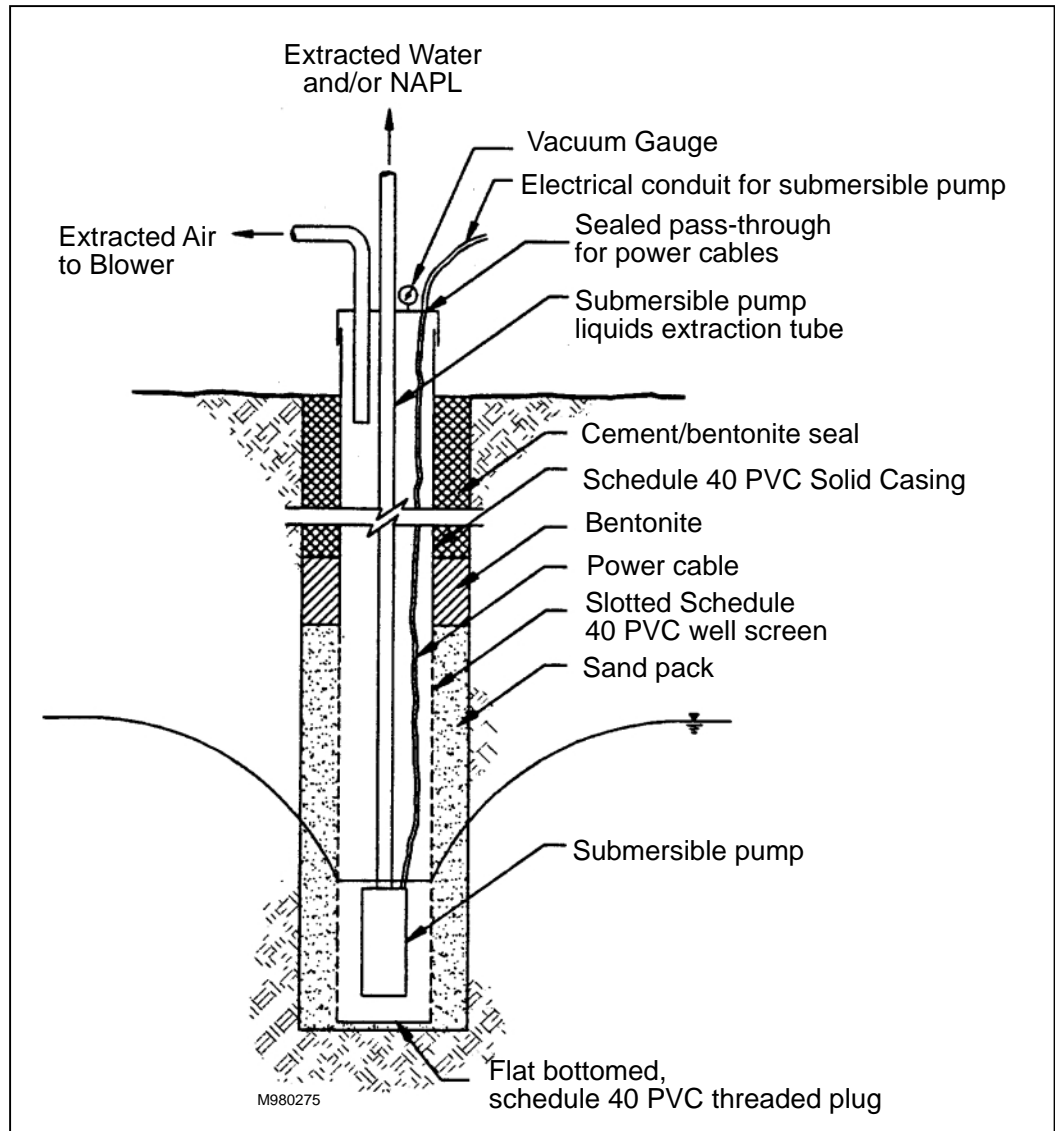

Figure 4-1. Dual-Phase Extraction Well. (After EPA 1995)

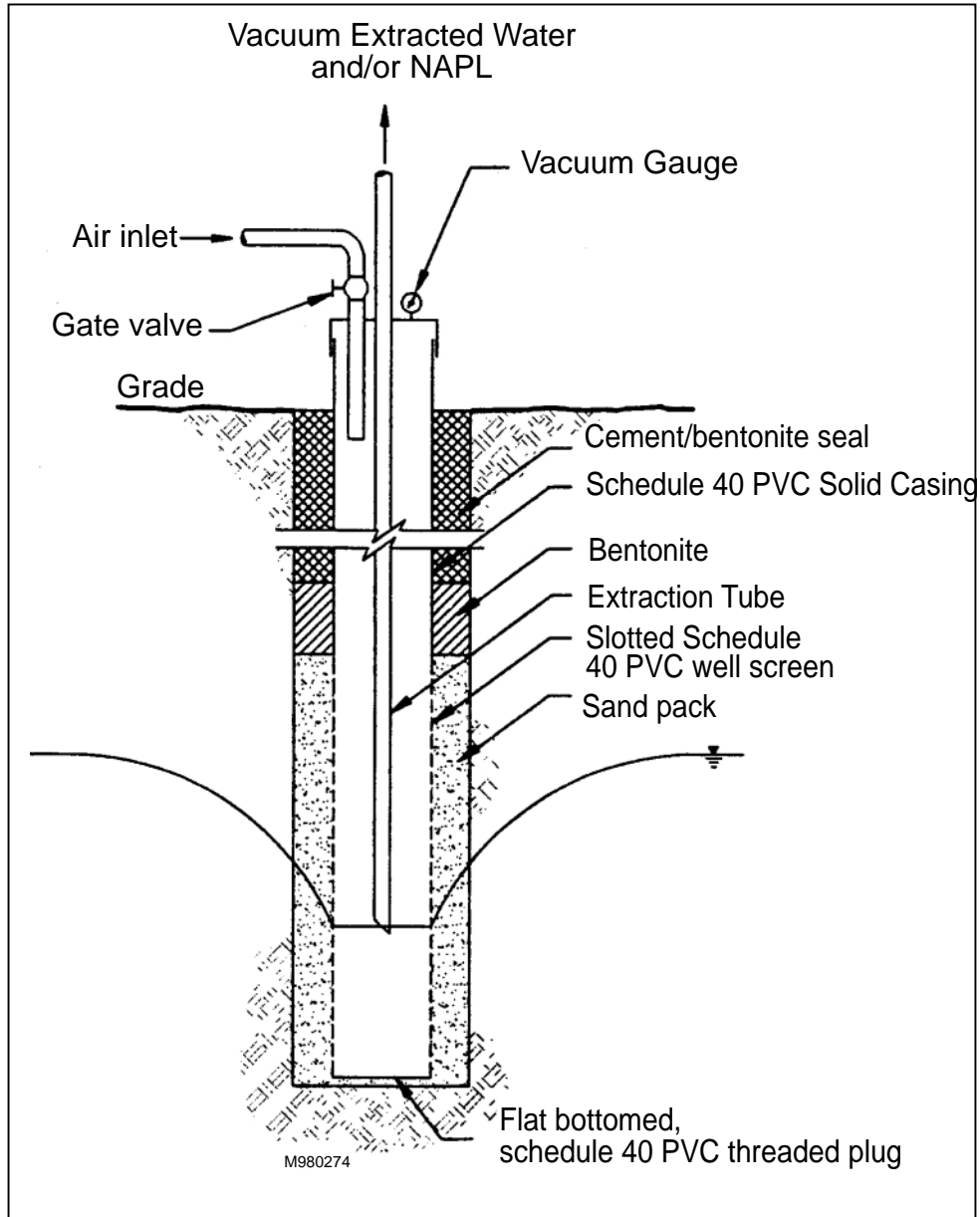

Figure 4-2. Two-Phase Extraction Well. (After EPA 1995)

(2) Mechanical System.

(a) Several mechanical systems are currently available for performing MPE pilot tests. DPE systems usually involve a submersible pump that removes water from the MPE well and an above-ground blower that removes gas from the MPE well. Liquid and gas streams extracted from the well are discharged in separate conduits to their respective treatment processes. Figure 3-7 illustrates a typical DPE system set up.

(b) TPE systems used for pilot tests are typically skid-mounted for ease of transport between sites. These systems involve a vacuum pump or blower (e.g., liquid ring pump, rotary vane pump), which draws liquid and gas through a single conduit located in the MPE well. The liquid is then separated from the gas above ground in a moisture separator that is connected to the appropriate treatment processes. Figure 3-8 and 4-3 show a typical layout and process flow diagram, respectively, for a TPE system. Example piping and instrumentation diagrams (P&IDs) can be found in Chapter 5.

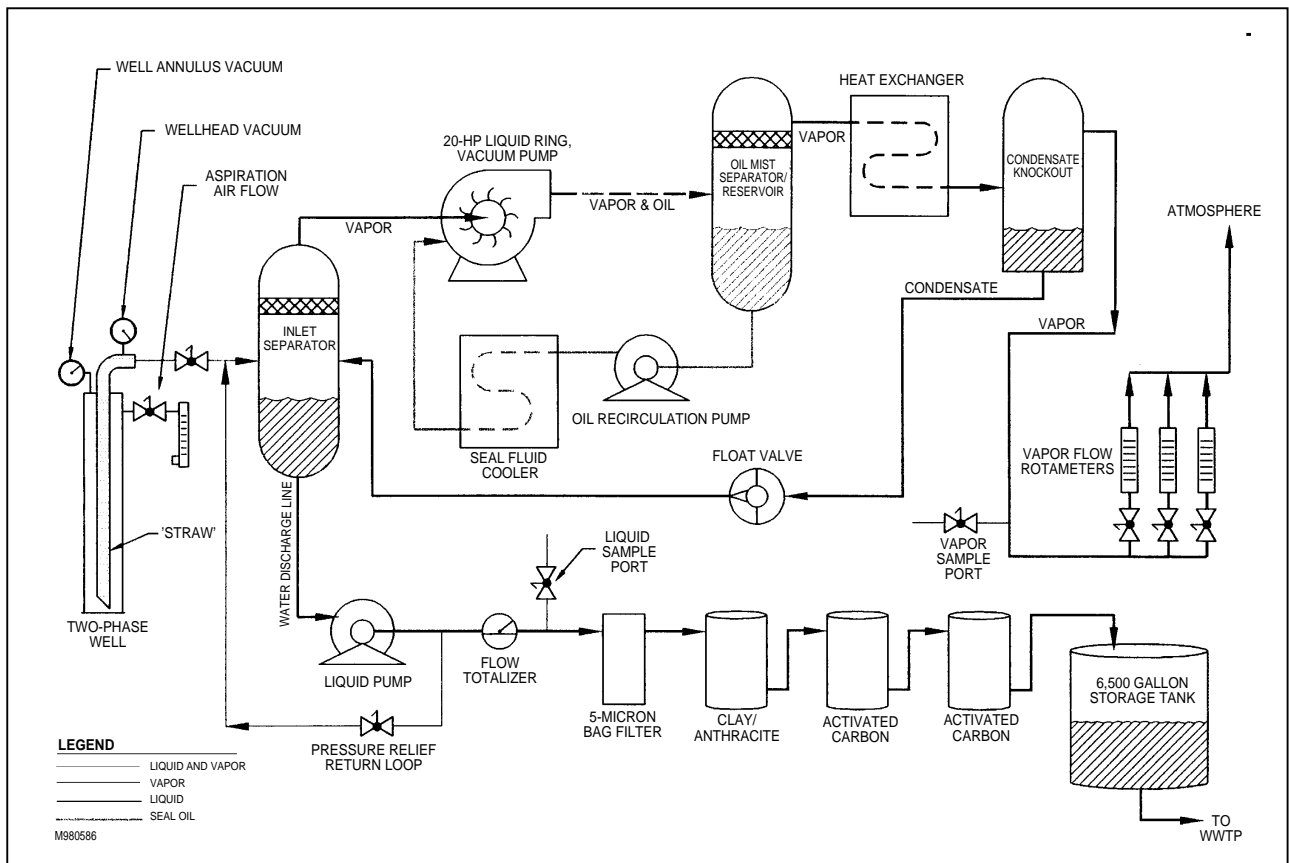

Figure 4-3. Process Flow Diagram of TPE Pilot Study Equipment (Radian International 1997)

(3) Treatment System. Depending on the contaminant of concern at the pilot study site and the duration of the pilot test, treatment for the liquid and gas streams may be required. Extracted liquid is typically routed through a NAPL/water separator, where NAPL, if present, is removed and stored in a dedicated tank. This is the case for either LNAPL or DNAPL, although separation of LNAPL is far more common. Water is pumped from the NAPL/water

separator and treated using an appropriate process (e.g., carbon adsorption) prior to discharge. Another option during a short-duration pilot test is to store extracted liquids temporarily in a tank (e.g., fractionation tank) and have the contents removed and treated off-site at the end of the test. Due to the high extraction velocity of liquid during TPE, there is a tendency for water and NAPL to form emulsions. This can have an impact on the selection of equipment used for treatment of extracted liquid, as more elaborate measures (e.g., polymer addition) may be required to separate the emulsion. Extracted gas may also require treatment depending on local air emission regulations and expected off-gas concentrations. Typically, vapor phase activated carbon or a catalytic or thermal oxidizer is used to treat extracted gas prior to its discharge to the atmosphere.

(4) Monitoring Points.

(a) Monitoring points used for measuring subsurface response to MPE must be strategically placed surrounding the MPE well. A typical configuration of monitoring points is at varying distances from the MPE well and along 90°, 120°, or 180° radials from the extraction well depending on variability of subsurface soils and budgetary constraints. This placement offers an improved likelihood of obtaining representative data points compared to installation of all points along the same radial, in which case it is possible that all may fall in a zone that is unrepresentative of the subsurface formation. Further information on placement and installation of monitoring points can be found in [EM 1110-1-4001](#), Soil Vapor Extraction and Bioventing, Chapter 4, Bench- and Pilot-Scale Testing for SVE and BV, and Peargin and Mohr (1994).

(b) MPE monitoring points are typically installed as nested pairs of piezometers, one shallow and one deep. The shallow point is used to monitor changes in vadose zone gas pressure and gas concentration (e.g., oxygen, when an objective of the remediation is to enhance aerobic biodegradation of contaminants), and the deep point is used to monitor water table elevation and LNAPL thickness changes, if applicable. Existing monitoring wells screened across the water table (i.e., in the saturated and vadose zone) can be converted to monitoring points using compression seals. Care must be taken, however, to seal the tops of all monitoring points from the atmosphere to prevent short-circuiting of air. This is typically done by installing a valve at the top of the monitoring point that is normally closed but can be opened when a measurement is taken. In addition, monitoring points having narrow (discrete) screen intervals are preferable over those with long screen intervals, because the latter are more apt to intercept preferential flow pathways and thus reflect conditions within such pathways, rather than within the soil matrix. Deep monitoring point screens, however, must, be long enough to cover expected changes in water/LNAPL levels. Monitoring points may also include neutron probe access tubes to enable monitoring of changes in liquid saturation. Monitoring strategies for MPE pilot tests are similar to those used during SVE. A discussion of SVE monitoring strategy can be found in [EM 1110-1-4001](#), Soil Vapor Extraction and Bioventing, Chapter 4.

e. Pilot Test Monitoring Methods.

(1) Above-ground Vacuum and Fluid Flow.

(a) Above-ground vacuum. Measurements for above-ground vacuum are typically taken in two places: at the MPE well head and at the inlet to the above-ground pilot system equipment (e.g., immediately upstream of the gas/liquid separator). The vacuum difference between the extraction equipment and the well head provide an indication of the pressure drop over the

conveyance piping. Vacuum measurements taken at the well head give an indication of the vacuum being applied to the vadose zone. However, the vacuum applied at the drop tube or well head may be significantly different than the inlet vacuum, because much of the vacuum applied to the drop tube or well head is lost due to the energy expended in lifting liquid from the well and due to piping friction losses. These losses can vary significantly depending on the type and size of equipment used. As an example, a low capacity vacuum pump used in a moderately permeable soil may produce a high water/air ratio. This is because a high water production is obtained from the formation, which causes the drop tube (in TPE) to be mainly filled mainly with water, causing low airflow. The resulting high line loss due to the lifting of water can cause, in turn, a low applied vacuum on the subsurface (Peargin 1998). In this case, it may be more viable to use DPE rather than TPE, since, in order to make the latter successful, a higher capacity vacuum pump that can handle the extracted water, along with producing significant airflow, may be required, increasing costs significantly. The vacuum measurement at the aboveground equipment will give data indicative of the amount of vacuum that the vacuum pump or blower must be capable of producing to achieve the desired results. However, it is typically more useful to know what the vacuum at the well head is (rather than at the pilot system), in order to determine the size of the blower/pump that will be required for full-scale operation. It should be noted that there are various ways to adjust the applied vacuum, such as opening a dilution or ambient air intake valve to adjust the applied vacuum along the blower curve, or using a variable speed drive (refer to paragraph 5-6f(8)). Variable speed drives allow more flexibility because the vacuum can be adjusted over a blower area (i.e., a set of vacuum versus flow curves that ranges over various frequencies of operation) rather than just along a single vacuum versus flow curve.

(b) Above-ground gas flow rate during TPE. Measurement of the extracted gas flow rate is performed using appropriate measuring devices during TPE. Measurement of gas velocity is typically performed using a Pitot tube, hot-wire anemometer, venturi meter, or other appropriate device positioned downstream of the point where liquid is removed from the extracted gas stream. Measurement of the flow of dilution or bleed-in air must also be made in order to calculate subsurface airflow and, depending on where measurements are taken, the mass of contaminant removed (paragraph 4-2e(3)). Due to the high vacuum applied to the gas stream (or high pressure and possibly temperature if flow measurements are taken on the positive side of the blower), gas flow or velocity measurements must be corrected to standard temperature and pressure conditions in order to make data comparisons. Measurements can also be corrected for relative humidity. However, this is generally not necessary because flow corrected for humidity is usually within one percent of the uncorrected value.

(c) Above-ground liquid flow rate during TPE. Measurement of extracted liquid flow is performed by measuring the volume of liquid that is discharged from the gas-liquid separator over a given time interval (e.g., recording the flow rate of water pumped from the separator). It should be noted that the above listed methods of measuring gas and liquid flow are applicable after the multi-phase streams from individual TPE wells are combined into a single multi-phase stream, and later separated into the component single-phase streams. During TPE, it is not practical to measure flow of gas and liquid from individual wells, due to the impossibility of isolating these two streams within the same conduit. It can be of value, however, to make qualitative observations of the relative proportion of gas versus liquid flow in a transparent section of the lateral from each well.

(d) Above-ground fluid flow during DPE. During DPE, measurements should be taken from both individual wells and from the combined gas and liquid streams emanating from multiple wells. This is possible because liquid and air

are extracted in separate conduits. Again, when gas flow measurements are made, the dilution airflow must also be measured, and measurements must be adjusted to standard conditions.

(2) LNAPL Recovery.

(a) Instantaneous LNAPL recovery rates are difficult to measure because most sites do not produce a large enough volume of NAPL. Total accumulated LNAPL volumes can be measured easily depending on the type of pilot system used. In a typical system, LNAPL drains from the LNAPL/water separator into a storage tank. LNAPL volume can be measured from this storage tank with a sight glass or by recording the total volume of LNAPL each time the product storage tank is pumped. The volume of LNAPL recovered should be measured at least daily during pilot tests.

(b) In cases where emulsions form from the high velocity created by the pump, especially in diesel fuel applications, NAPL volumes can be estimated based on the concentration of the NAPL present in the emulsion (Keet 1995).

(3) Contaminant Mass Removal. Contaminant mass removal is calculated by multiplying the flow rate of gas or liquid extracted from the subsurface by the corresponding contaminant concentration in the gas or liquid stream. Whenever possible, measurements of gas contaminant concentrations should be taken from the same location (i.e., same side of the vacuum pump) as the flow measurement, although mass calculations can still be made if gas flow rates are corrected for dilution factors and standard conditions. Samples of both gas and liquid should be obtained (if possible) from their associated stream prior to contact with pilot test equipment. This will prevent cross-contamination from residue remaining within the equipment from previous pilot tests. This can be especially difficult in the case of the liquid stream, because the water and NAPL remain in a combined stream until after the NAPL/water separator. In this case, the separator should be properly decontaminated, or the sample should be taken from the MPE well.

(4) Vacuum Influence (Unsaturated Zone).

(a) Vacuum influence within the unsaturated zone can be monitored using soil gas probes connected to differential pressure gauges, which measure the difference between the pressure applied to the gauge and atmospheric pressure (i.e., they read "gauge" pressure). These readings, along with knowledge of the effective air permeability, are often the principal indication of the zone of influence (ZOI) surrounding an MPE well. Explanations of why ZOI, defined as the zone of effective air exchange, is preferable to reliance on the radius of pressure influence are given in EM 1110-1-4001, Soil Vapor Extraction and Bioventing, Chapters 4 and 5. The procedure used to calculate the flow velocity between monitoring points and the pilot test extraction well is given in Soil Vapor Extraction and Bioventing EM 1110-1-4001, Chapter 4. This velocity can then be used to estimate travel time (EM 1110-1-4001). The designer must determine, based on the site and cleanup objectives, what a reasonable travel time will be in order to meet these objectives. In the case where several wells are used for extraction during MPE pilot tests, modeling may be required in order to make a determination of the zone of influence.

(b) Changes in soil gas pressure in the vadose zone can also result from barometric pressure changes. Rising or falling barometric pressure caused by the passage of weather systems, for example, should be noted and considered in the interpretation of minor changes in subsurface vacuum. Barometric pressure

can be measured using a portable instrument, or a record of local data can usually be readily obtained from a nearby meteorological station.

(c) Installation of soil gas monitoring points in silty-clay and clayey soils using direct push technology may have a tendency to result in smearing of the soil that is in contact with the probe. When sealed in this way, the soil can appear to be less transmissive than it actually is. Soil gas monitoring points installed with drill rigs can sometimes have faulty (i.e., leaky) well seals, whereby the soil can appear to be more transmissive than it actually is. A brief round of pressure testing of each monitoring point, regardless of method of installation, is recommended before the pilot test (to ensure its integrity and ability to transmit an adequate amount of airflow) and again after the pilot test (to determine whether desiccation cracks have changed its integrity). Pressure testing of this type is described in Peargin and Mohr (1994). Example results obtained from pressure testing of 6 shallow piezometers installed to depths of approximately 3 feet (1 m) bgs at the Lake City Army Ammunition Plant (LCAAP) indicated that three of the piezometers showed high air permeability with applied pressure dissipating into the formation in 8 seconds or less. Two of the piezometers showed low air permeability with pressure remaining in the piezometer after 60 seconds. One piezometer appeared to be clogged, with pressure of 60 kPa (9 psi) versus initial pressure of 68 kPa (10 psi) remaining in the probe after 460 seconds (Radian International 1997).

(d) Measurements of vacuum influence, coupled with measurements of applied vacuum and airflow at the MPE well, can be used with an appropriate solution to calculate the effective air permeability at the prevailing moisture content of the soil. For guidance on performance of such tests, see EM 1110-1-4001, Appendix D.

(5) Drawdown and Upwelling.

(a) The response of the water table to MPE is an important indication of the influence of MPE on the saturated zone. Drawdown is monitored by placement of pressure transducers at fixed depths in monitoring wells screened across the water table. Drawdown is the hydrostatic head measured at such transducers prior to MPE, less that measured during MPE.

(b) Measurements of drawdown, coupled with measurements of liquid flow, applied vacuum, and elevation head at the pump inlet, can be used with an appropriate analytical solution to estimate the transmissivity of that portion of the formation that is intersected by the well screen.

(c) Note that drawdown measurements indicate the position of the piezometric surface; they do not necessarily suggest that the soil above that surface is unsaturated or dewatered. Liquid saturation in the soil above the water table is governed by the capillary pressure that results from the vacuum being applied to the soil, relative to its capillary pressure-saturation relationship. Any pressure device used to monitor the degree of upwelling in the vicinity of an MPE well must be zeroed to the vacuum in the soil gas rather than to atmospheric pressure at the ground surface (In Situ, Inc. 1993; EM 1110-1-4001, Soil Vapor Extraction and Bioventing, Chapter 4). Refer to paragraphs 2-5e and 4-2e(4). By contrast, the vacuum applied to the subsurface does not affect the piezometric surface, because any additional head of water above the pressure transducer (resulting from upwelling) is reduced by the vacuum being experienced above the water table. In vacuum as in non-vacuum applications, the piezometric head at any point below the water table is, by definition, simply the difference between the pressure side of a differential

transducer positioned at that point and atmospheric pressure. Figure 4-4 displays the piezometric surface in a two-phase and dual-phase extraction well where MPE is applied. Note that the gauge pressure, P_w , observed at the pressure measurement point is the height of the water column above the measurement point, less any applied vacuum experienced above the water. The gauge pressure at any point in the formation is zero (i.e., the pressure is in equilibrium with atmospheric pressure) if, and only if, the height of the water column above that point is equal and opposite to the vacuum being experienced in the vadose zone above the water. This set of points is the piezometric surface.

(6) Monitoring Saturation.

(a) It is highly useful to monitor soil moisture content (or liquid saturation) during MPE pilot tests, and thereby be able to better understand the degree to which the technology is able to dewater the soil and enhance airflow. Although soil samples could be collected for gravimetric determination of moisture content, implementation of a repeatable, non-destructive technique such as neutron thermalization is strongly recommended for this purpose. Its use in this respect is referenced in EM 1110-1-4005, Chapters 3 and 4.

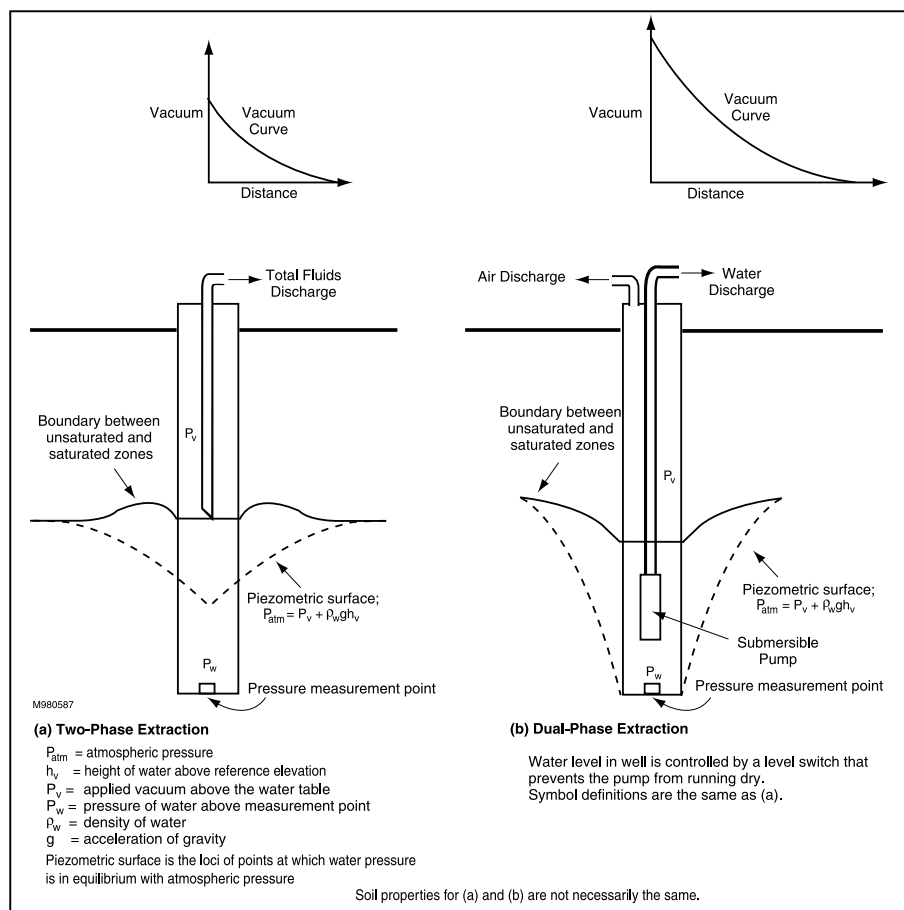
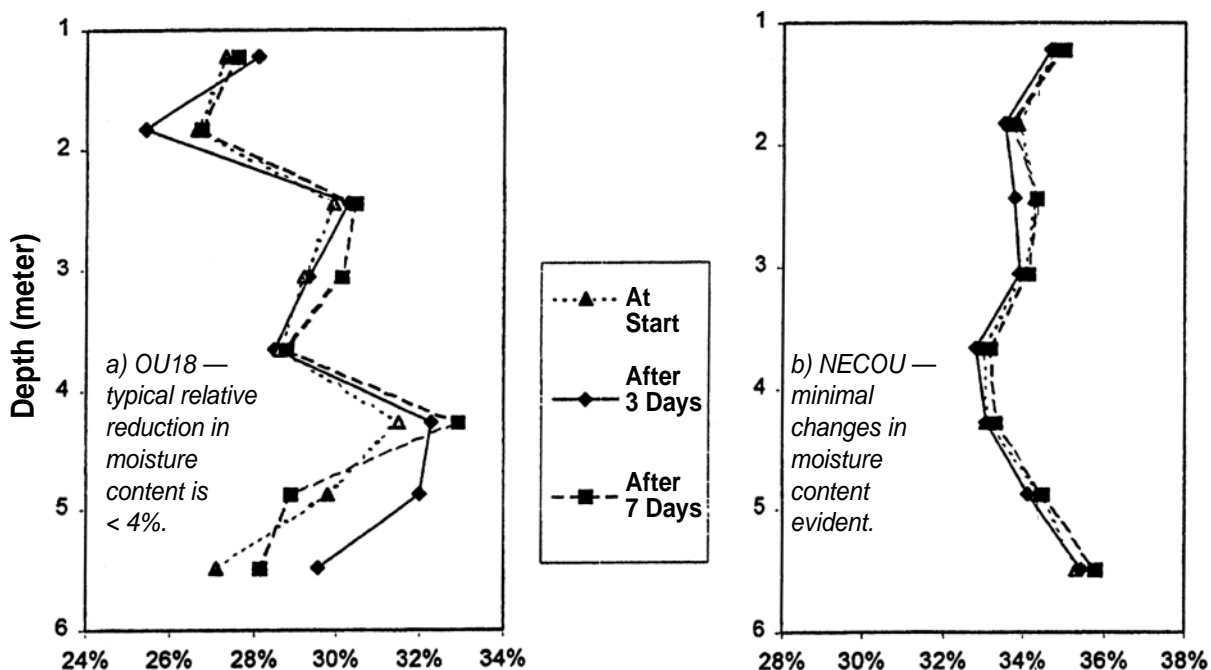

Figure 4-4. Piezometric Surface Under Application of MPE. (See paragraph 5-2e(5))

(b) Installation of neutron probe access tubes extending to the elevation of the bottom of the MPE well screen, at several locations within each pilot test area, plus at one or two locations beyond the expected ZOI of the pilot tests, enables soil moisture content to be profiled prior to and several times during an MPE pilot test. The neutron probe detects liquid content over a volume that extends approximately 20 to 50 cm (8 to 20 inches) out into the formation beyond the radius of the access tube itself. Thus the device measures the in-situ liquids content and indicates where the capillary fringe is located and where airflow is possible. Where both water and NAPL are present, since both are hydrogen-rich, they are indistinguishable by the device, which is sensitive to hydrogen content. Nevertheless, it does provide an accurate measure of total liquids content (i.e., saturation), and by subtraction from the initial, pre-MPE liquids content (which we may presume is fully saturated below the capillary fringe), indicates the air-filled porosity caused by MPE. Figure 4-5 presents saturation data obtained for two MPE pilot tests conducted at separate operable units at LCAAP (Radian International 1997; Baker and Groher 1998). Other techniques such as time domain reflectometry (TDR) can also be used to determine changes in soil moisture content (Clayton et al. 1995).



M980355

Figure 4-5. Moisture Profiles at LCAAP a) 4 ft (1.2 m) from the OU18 MPE well, and b) 5 ft (1.5 m) from the NECOU MPE well. (Radian International 1997; Baker and Groher 1998. Reprinted by permission of Battelle Press. Copyright 1998. All rights reserved.)

(c) Care should be taken, during installation of the neutron probe access tubes, to avoid changing the density and thus the moisture-holding characteristics of the soil within the zone that will be sensed by the neutron probe. Either increases (due to compaction resulting from driving a probe) or decreases (resulting, for example, from collapsing the formation against the tube) are undesirable and should be avoided to the extent possible. A recommended technique appropriate for fine-textured, non-stony soils is to use drill casing (preferably 2-inch diameter) to pre-bore a hole the same diameter as the access tube via drive and wash methods, after which the carbon steel access tube can be pushed directly into the boring.

(d) Soils targeted for MPE are typically medium and/or fine in texture. It may not be possible to desaturate such soils to a substantial extent. Recent research, including results from several USACE pilot tests, indicates that silty-clay and clay soils will resist undergoing any significant desaturation during MPE (Baker and Groher 1998).

(e) Capillary pressure-saturation curve measurements can be used both to estimate the ability of MPE to desaturate soil and to help explain the results of MPE pilot tests (Baker and Groher 1998). It is recommended that a representative number of intact soil cores be collected during the installation of the MPE wells, neutron access tubes, and/or adjacent monitoring points at depths representative of zones that are targeted for dewatering. Bulk density (ASTM 2850) and grain size distribution (ASTM D422) should be determined for each core as quality assurance measures. Capillary pressure-saturation curves provide an indication as to what level of vacuum, at equilibrium, needs to be exerted within the formation to reduce the water saturation to a desired degree. It may not be feasible to exert a high enough vacuum on fine-textured soils, because capillary forces tend to hold water in such soils so tenaciously. However, if pilot test data shows that the soils can be dewatered to some degree, these data can be used to evaluate the feasibility of dewatering over an expanded area during full-scale remediation. In addition, such data, if collected more widely from other locations within the site, can provide a way to extrapolate the results from pilot test locations to additional prospective MPE locations.

(7) Use of Tracers. Tracer gas tests employ gases not naturally occurring in unconsolidated sediment, such as sulfur hexafluoride or helium, to indicate rates of subsurface gas flow. Ideally, the selected tracer gas closely approximates the aggregate physical and chemical characteristics of the major compounds present in air, such as their solubility and density (molecular weight). During an MPE pilot test, tracer gas may be injected at one or more soil gas monitoring points. Equipment required is described in EM 1110-1-4005, Chapter 4. In the case of MPE, samples would be collected downstream of the gas-liquid separator at a location where airflow, temperature, and vacuum are also being monitored. The resulting record of tracer concentration as a function of time can be interpreted to indicate the spatial distribution and velocity of subsurface airflow resulting from MPE, and can indicate whether or not preferential flow is dominating subsurface airflow.

f. Reports.

(1) In order to develop a useful report for use during full-scale design, appropriate data must be collected in the field. It is important to consider the main objectives of the MPE application in order to ensure collection of the proper field parameters. Based on whether the main objective of MPE is to

enhance NAPL recovery, SVE or BV, or groundwater recovery, there are different parameters the pilot system operator should be observing. These parameters will also vary depending on whether a two-phase or dual-phase mode MPE operation is being employed. Table 4-1 displays required parameters to obtain during TPE and DPE applications based on which of the three main objectives the operation is based on (i.e., enhance NAPL recovery, SVE/BV, or groundwater recovery).

TABLE 4-1

Data Collection and Purpose of Collection During MPE Pilot Tests

Parameter	Goal	Two-Phase Extraction			Dual-Phase Extraction			Uses/Comments
		LNAPL Recovery	SVE/BV	GW Recovery	LNAPL Recovery	SVE/BV	GW Recovery	
Gas phase mass removal			X			X		Increase at higher applied vacuum is favorable
Extracted LNAPL/water ratio		X			X			Observe ratios at different applied vacuum settings
Groundwater extraction rate		(X)	(X)	X	(X)	(X)	X	Increase at higher applied vacuum is favorable
Drop tube depth setting		X	X	X				Observe change in recovery rates at varying depths
Water table elevation changes		X		X	X		X	Indication of zone of pumping influence. Depression may increase gravity gradient for LNAPL flow to well.
Vadose zone pressure changes			X			X		Gives an indication of the zone of influence
Groundwater mass removal		X		X	X		X	Increase may indicate pumping from source area
O ₂ , CO ₂ , CH ₄ in soil gas			X			X		Indication of biological activity in bioslurping applications

X = Required parameter
(X) = Optional parameter

(2) The data displayed in Table 4-1 are used to determine essential design parameters such as air permeability, hydraulic conductivity, and changes in saturation over time. Air permeability, along with zone of influence within the vadose zone (an especially useful parameter in cases of SVE enhancement) can be estimated as described in EM 1110-1-4001, Soil Vapor Extraction and Bioventing, Chapter 4 and Appendix D. Hydraulic conductivity is usually measured through standard hydraulic testing (e.g., pumping test, recovery test, slug test, etc.), although it may be possible to utilize data collected during an MPE pilot test to estimate hydraulic conductivity. In the enhanced-SVE MPE pilot test example that is presented later in this chapter (from Radian International 1997) the authors chose to employ, for that purpose, a mathematical solution for analysis of recovery test data. They adopted the assumption that any vacuum that existed in the formation during the MPE pilot test would dissipate quickly upon cessation of vacuum, and that they could therefore ignore any lingering vacuum effects and fit a hydraulic model to the distance-drawdown recovery data. Peargin and Mohr (1994) indicate it may take several months for vacuum to propagate into low permeability soil, much longer than the duration of a typical pilot test. This is illustrated on Figure 4-6.

One should nevertheless evaluate whether such an assumption is appropriate on a site-by-site basis.

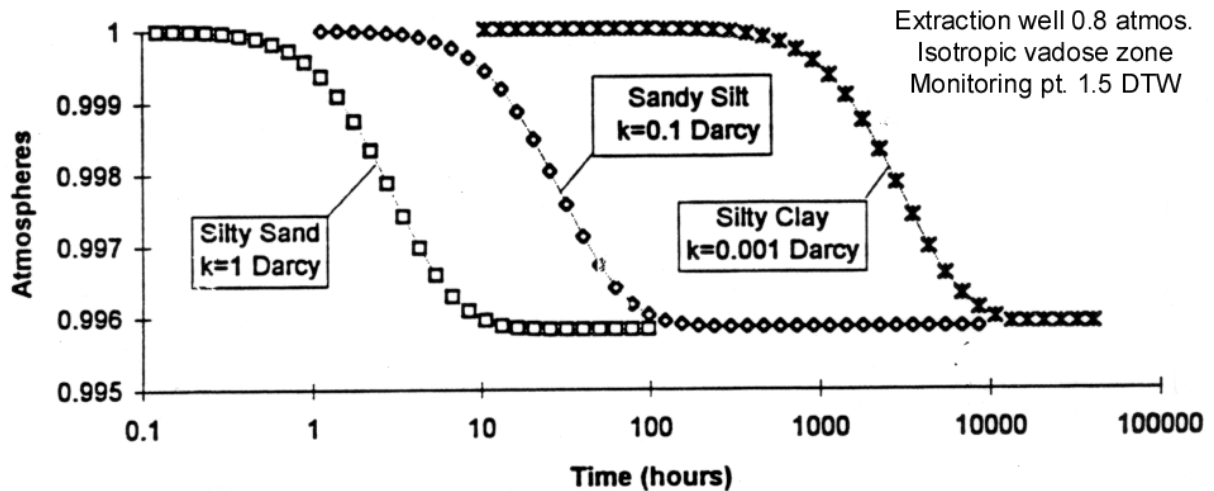

Figure 4-6. Transient Vacuum Propagation. (Peargin and Mohr 1994. Reprinted by permission of National Ground Water Association. Copyright 1994. All rights reserved.)
(DTW = depth to water table)

(3) Figure 4-7 is an example of a typical field data collection sheet for a bioslurping/MPE pilot test. Typical data collected include: recovered LNAPL volume, recovered air and water flow rate and contaminant concentrations (for calculation of mass removal), vacuum influence over distance from the extraction well, LNAPL thickness and groundwater elevation changes, and vadose zone oxygen and carbon dioxide concentrations (for indications of biological activity). Data collected from the field are typically tabulated in a spreadsheet program. Tables and graphs are then generated from the data to assist in evaluation of the effectiveness of the pilot study.

(4) Pilot study reports should include a summary of testing objectives and procedures, a summary and discussion of results, feasibility determination, and considerations for full-scale system design.

(5) Example tables and graphs from two separate pilot study reports are included as Tables 4-3 through 4-5 and Figures 4-8 through 4-12. Table 4-2 gives an overview of pertinent site information used in the example tables to give the reader a better understanding of the data presented and lists the tables and figures in this EM that display the pilot test results. The sites are a former industrial facility in Massachusetts and an Operable Unit (OU18) at Lake City Army Ammunition Plant (LCAAP) in Missouri.

BIOSLURPING/MPE TEST MONITORING SHEET

Facility Name _____ Location _____

Collector Name(s): _____

Conditions: _____

Date: _____ Start Time: _____ End Time : _____

Vacuum Applied to System : _____

Depth of Drop Tube: _____

AMBIENT AIR INTAKE Flow : _____ Temperature : _____

TOTAL FLOW Flow: _____ Temperature : _____

GROUNDWATER TOTALIZER READING: _____ gallons

VOLUME OF LNAPL RECOVERED: _____

CUMULATIVE VOLUME OF LNAPL RECOVERED: _____

PZ-1 Depth to Water: _____ Free Product: _____
 Shallow: O2: _____ CO2: _____ Pressure : _____
 Deep: O2: _____ CO2: _____ Pressure : _____

PZ-2 Depth to Water: _____ Free Product: _____
 Shallow: O2: _____ CO2: _____ Pressure : _____
 Deep: O2: _____ CO2: _____ Pressure : _____

PZ-3 Depth to Water: _____ Free Product: _____
 Shallow: O2: _____ CO2: _____ Pressure : _____
 Deep: O2: _____ CO2: _____ Pressure : _____

PZ-4 Depth to Water: _____ Free Product: _____
 Shallow: O2: _____ CO2: _____ Pressure : _____
 Deep: O2: _____ CO2: _____ Pressure : _____

PZ-5 Depth to Water: _____ Free Product: _____
 Shallow: O2: _____ CO2: _____ Pressure : _____
 Deep: O2: _____ CO2: _____ Pressure : _____

“Background” Monitoring Well Pressure : _____

Blower Influent PID: _____ Carbon Midfluent PID: _____ Off-gas PID: _____

Comments/Observations: _____

M980283.eps

Figure 4-7. Example Field Data Collection Sheet.

TABLE 4-2
Overview of Example Sites

Parameter	Industrial Site (MA)	LCAAP OU18 (MO)
Primary Contaminants	TPH (mineral and heat transfer oil)	TCE, PCE, MIBK, toluene
Soil Type	Fill: boulders and cobbles, till, and bedrock	Alluvium: silty clay
Depth to Water Table (m bgs)	4.0	1.5
Extraction Well Screen Interval (m)	1.5 to 4.5	2.4 to 5.5
Extraction Well Diameter (cm)	10	10
Table/Figure Description	Corresponding Table/Figure Number	Corresponding Table/Figure Number
Operating Conditions Summary	Tables 4-3 and 4-4	Table 4-5
Cumulative Liquid Recovery	Figure 4-8	NA
Vacuum Influence at Monitoring Points	Figure 4-9 ^a	Figure 4-10
Groundwater Elevation Changes	Figure 4-11 ^a	Figure 4-12
Notes: NA = not applicable Information from MA industrial site from ENSR Corp. 1997 Information from LCAAP, MO site from Radian International 1997 ^a Vacuum influence and water level data from these figures taken from ENSR Corp. 1996 from the Squibb Mfg. Site, PR (data on this site are presented in Tables 4-6 and 4-7).		

TABLE 4-3

Example Table (Fluid Data)

MA Industrial Site

Bioslurping/MPE Test: Groundwater/LNAPL Recovery Data

Source: ENSR Corporation 1997

Date	Time	Elapsed Time (hrs)	Applied Vacuum (inches Hg)	Total Fluids Extracted (gal)†	Extracted Emulsion			Free Phase LNAPL (gal)	Total LNAPL Recovered (emulsion + free phase) gal
					Flow Rate (gpm)	as LNAPL (gal)	as Water (gal)		
11/21/96	10:50	0.00	6.0	0.00	—	0.000	0.00	—	0.00
11/21/96	11:20	0.50	6.0	30.50	1.02	0.050	30.45	—	0.05
11/21/96	11:50	1.00	6.0	69.20	1.29	0.064	38.64	—	0.11
11/21/96	12:40	1.83	6.0	95.10	0.52	0.043	25.86	—	0.16
11/21/96	13:30	2.67	6.0	151.50	1.13	0.093	56.31	—	0.25
11/21/96	13:35	2.75	12.0	157.30	1.16	0.010	5.79	—	0.26
11/21/96	14:05	3.25	12.0	181.70	0.81	0.040	24.36	—	0.30
11/21/96	14:35	3.75	12.0	209.20	0.92	0.045	27.45	—	0.34
11/21/96	15:05	4.25	12.0	236.30	0.90	0.045	27.06	—	0.39
11/21/96	15:25	4.58	12.7	245.30	0.45	0.015	8.99	—	0.40
11/21/96	15:45	4.92	12.0	263.20	0.89	0.029	17.87	—	0.43
11/21/96	16:15	5.42	9.0	290.48	0.90	0.044	26.86	0.38	0.85
11/22/96	8:30	9.67	*	525.08	*	0.386	234.21	*	1.24
11/22/96	11:40	9.67	9.0	528.93	—	0.006	3.59	0.25	1.50
11/22/96	12:10	10.17	9.0	572.93	1.47	0.072	43.93	—	1.57
11/22/96	12:40	10.67	9.0	608.93	1.20	0.059	35.94	—	1.63
11/22/96	13:10	11.17	9.0	633.03	0.80	0.040	24.06	—	1.67
11/22/96	13:40	11.67	9.0	653.93	0.70	0.034	20.87	—	1.70
11/22/96	14:00	12.00	9.0	669.85	0.74	0.024	14.78	1.13	2.85
11/22/96	14:45	12.75	12.0	702.65	0.73	0.054	32.75	—	2.90
11/22/96	16:00	14.00	12.0	758.55	0.75	0.092	55.81	—	3.00
11/23/96	8:45	30.75	11.0	1315.15	0.55	0.916	555.18	0.50	4.41
11/24/96	10:20	56.33	10.9	2023.95	0.46	1.167	707.63	—	5.58
11/25/96	7:35	77.58	9.9	2535.58	0.41	0.843	510.76	0.03	6.45
11/25/96	10:50	80.83	10.7	2608.68	0.37	0.120	72.98	—	6.57
11/26/96	8:50	102.83	15‡	3186.38	0.44	0.952	576.75	0.13	7.64
11/26/96	10:05	104.08	shutdown	3305.68	1.59	0.196	119.10	0.38	8.22
Total volume recovered (gal):				3305.68	—	5.44	3297.96	2.78	8.22

Notes:

*System down due to high tank condition in oil/water separator at approximately 20:30 on 11/21/96. The system was restarted on 11/22/96 at 11:40.

†Based on totalizer readings. Evidence from emptying the fractionation tank indicates that totalizer may have been incorrect.

‡Increased applied vacuum on 11/26 believed to be caused by a rise in water table from rain and snow.

TABLE 4-4
Example Table (Air Data)

MA Industrial Site
Bioslurping/MPE Test: Air Flow/VOC Data
Source: ENSR Corporation 1997

Date	Time	Elapsed Time (hrs)	Applied Vacuum (inches Hg)	Depth of Slurp Tube (ft)	Ambient Air Intake (scfm)	Total Flow (scfm)	Flow from MW-25 (scfm)†	Blower Effluent FID Reading (ppmV)
11/21/96	10:50	0.00	6.0	12.7	44.4	53.7	9.3	—
11/21/96	11:20	0.50	6.0	12.7	39.8	52.8	13.0	—
11/21/96	11:50	1.00	6.0	12.7	38.1	53.1	14.9	3068
11/21/96	12:40	1.83	6.0	12.7	35.2	54.3	19.1	6157
11/21/96	13:30	2.67	6.0	12.7	35.2	54.0	18.8	6803
11/21/96	13:35	2.75	12.0	12.7	4.1	34.2	30.1	—
11/21/96	14:05	3.25	12.0	12.7	4.0	35.6	31.5	15880
11/21/96	14:35	3.75	12.0	12.7	4.0	35.8	31.8	14545
11/21/96	15:05	4.25	12.0	12.7	4.0	35.0	31.0	17759
11/21/96	15:25	4.58	12.7	12.7	0.0	31.0	31.0	—
11/21/96	15:45	4.92	12.0	12.7	0.0	31.8	31.8	14372
11/21/96	16:15	5.42	9.0	12.7	0.0	41.3	41.3	10121
11/21/96	20:30	9.67	*	*	*	*	*	*
11/22/96	11:40	9.67	9.0	12.8	—	—	—	—
11/22/96	12:10	10.17	9.0	12.8	32.0	47.0	15.0	2911
11/22/96	12:40	10.67	9.0	12.8	27.7	47.6	19.9	4510
11/22/96	13:10	11.17	9.0	12.8	26.8	48.7	21.9	4397
11/22/96	13:40	11.67	9.0	12.8	26.8	50.4	23.6	4493
11/22/96	14:00	12.00	9.0	12.6	26.8	50.4	23.6	—
11/22/96	14:45	12.75	12.0	12.6	4.0	39.0	35.0	—
11/22/96	16:00	14.00	12.0	12.6	0.0	36.6	36.6	9637
11/23/96	8:45	30.75	11.0	12.6	0.0	36.7	36.7	3193
11/24/96	10:20	56.33	10.9	12.6	0.0	40.2	40.2	3263
11/25/96	7:35	77.58	9.9	12.6	0.0	42.8	42.8	2940
11/25/96	10:50	80.83	10.7	14.3	0.0	39.6	39.6	3616
11/26/96	8:50	102.83	15‡	14.3	0.0	37.0	37.0	6017
11/26/96	10:05	104.08	shutdown	—	—	—	—	—

Notes: * System down due to high tank condition in oil/ water separator at approximately 20:30 on 11/21/96. The system was restarted on 11/22/96 at 11:40.

†Based on average groundwater extraction flow rates,

‡Increased applied vacuum on 11/26 believed to be caused by a rise in water table from rain and snow.

TABLE 4-5
Operating Conditions Data Summary for OU 18 Shallow Well Pilot Test (LCAPP).
(Radian International 1997)

Actual Schedule			Pump Inlet Data		Wellhead Data				Exhaust Vapor		Cumulative	Vapor
Day	Time	Total Hours	Temp (°F)	Vacuum (in. Hg)	Straw Vacuum	Casing Vacuum	Annulus Vacuum	Aspiration Air Flow Rate	Temp (°F)	Pressure (psi)	Liquid Flow (gal)	Flow Rate (cfm)
10/31/96	1550	0	36	0	0 ^a	0	0	0	84	0	0	20
10/31/96	1615	0.25	40	22.5	14 ^a	13.5	13.5	9	100	05	92.5	37
10/31/96	1700	1	40	24.2	14 ^a	14.9	14.7	9	110	0.5	195.1	16
10/31/96	1800	2	40	23.8	13.75 ^a	15.25	15	9.5	107	0.5	363.1	24
10/31/96	1900	3	40	24.5	14 ^a	15.25	15	9.5	105	0.5	498.8	26
10/31/96	2000	4	40	23.5	13.5 ^a	15.5	15.2	9.5	102	0.5	647.6	26
10/31/96	2200	6	40	23.5	14 ^a	15.5	15.5	9.5	107	0.5	896.4	28
10/31/96	2400	8	40	23.5	14 ^a	15.7	15.5	9.5	110	0.5	1,094.5	28
10/31/96	400	12	40	23	13.2 ^a	15.5	15.2	9.5	105	0.5	1,503.7	26
10/31/96	1000	18	40	23.7	14 ^a	15.4	15	9	114	0.5	2,057.9	34
10/31/96	1600	24	40	23	13.5 ^a	14.9	14.5	9	113	0.75	3,041.3	37
10/31/96	2200	30	40	24	17 ^a	19	18.5	0	110	0.5	4,485.6	23
11/1/96	400	36	40	23.5	16.2 ^a	18.9	18.2	0	110	0.5	8,742.6 ^c	24
11/1/96	1000	42	40	24	16.2 ^a	18	17.2	0	112	0.5	9,853	25
11/1/96	1600	48	40	24.5	16.5 ^a	17.5	17	0	112	0.7	10,544.9	30
11/1/96	2200	54	40	22.5	14.5 ^a	16	15.5	0	110	0.75	10,899.2	35
11/2/96	400	60	40	22	13 ^a	15	15.2	0	107	0.75	11,195.5	35
11/2/96	1000	66	40	22.5	14 ^a	15.7	15	0	110	0.5	11,481.3	35
11/2/96	1600	72	40	23.7	18.5	15.6	N/A ^b	0	113	0.75	11,767.2	38
11/2/96	2200	78	40	21	17	14.5	14	0	119	1	12,025.2	42
11/3/96	400	84	40	21.2	17.5	14.7	14.2	0	113	1	12,275.2	41
11/3/96	1000	90	40	23	17.5	14.5	14.2	0	112	0.9	12,525.6	42
11/3/96	1600	96	40	21.2	14.5	10	10	0	125	0.8	12,762.2	56
11/3/96	2200	102	40	20.5	13.5	9.5	9	0	120	1	12,993	61
11/4/96	400	108	40	20	12.5	8.75	8.5	0	115	1	13,269.4	62
11/4/96	1000	114	40	20.5	N/A ^c	10.5	10	0	109	1	14,076	53
11/4/96	1600	120	40	22	16.5	13	12	0	115	0.5	13,825.2	39
11/4/96	2200	126	40	23	17	13.5	13	0	116	0.5	14,215.8	38

TABLE 4-5 (Continued)

Actual Schedule			Pump Inlet Data		Wellhead Data				Exhaust Vapor		Cumulative Liquid Flow (gal)	Vapor Flow Rate (cfm)
Day	Time	Total Hours	Temp (°F)	Vacuum (in. Hg)	Straw Vacuum	Casing Vacuum	Annulus Vacuum	Aspiration Air Flow Rate	Temp (°F)	Pressure (psi)		
11/5/96	400	132	40	22.5	16.5	13.5	13	0	112	0.5	14,652.4	37
11/5/96	1000	138	40	23.5	16	13.2	13	0	117	0.5	15,080.9	37
11/5/96	1600	144	40	23.5	16	13	12.9	0	118	0.5	15,461.1	39
11/5/96	2200	150	40	23	16	13	12.5	0	120	0.5	15,848.6	39
11/6/96	400	156	40	23.5	15.5	12.9	12.3	0	120	0.5	16,174.4	40
11/6/96	1000	162	40	24.2	15.2	12.5	12	0	122	0.5	16,311.3	40
11/5/96	Post-test (final)		NA	Na	Na	NA	NA	NA	NA	NA	16,322.5	NA

Notes:

^aVacuum gauge partially plugged. New gauge installed on 2 November 1996.

^bReading not taken

^cThis large increase in flow was due to excess recirculating of water through flow meter and back to inlet separator. Recirculation system was re-piped to address this problem. Flow rates during this interval were adjusted to reflect average of prior flow rates and subsequent flow rates.

- cfm = cubic feet per minute
- gal = gallon
- in. Hg = inches in mercury
- psi = pounds per square inch
- NA = Not applicable
- N/A = Not available

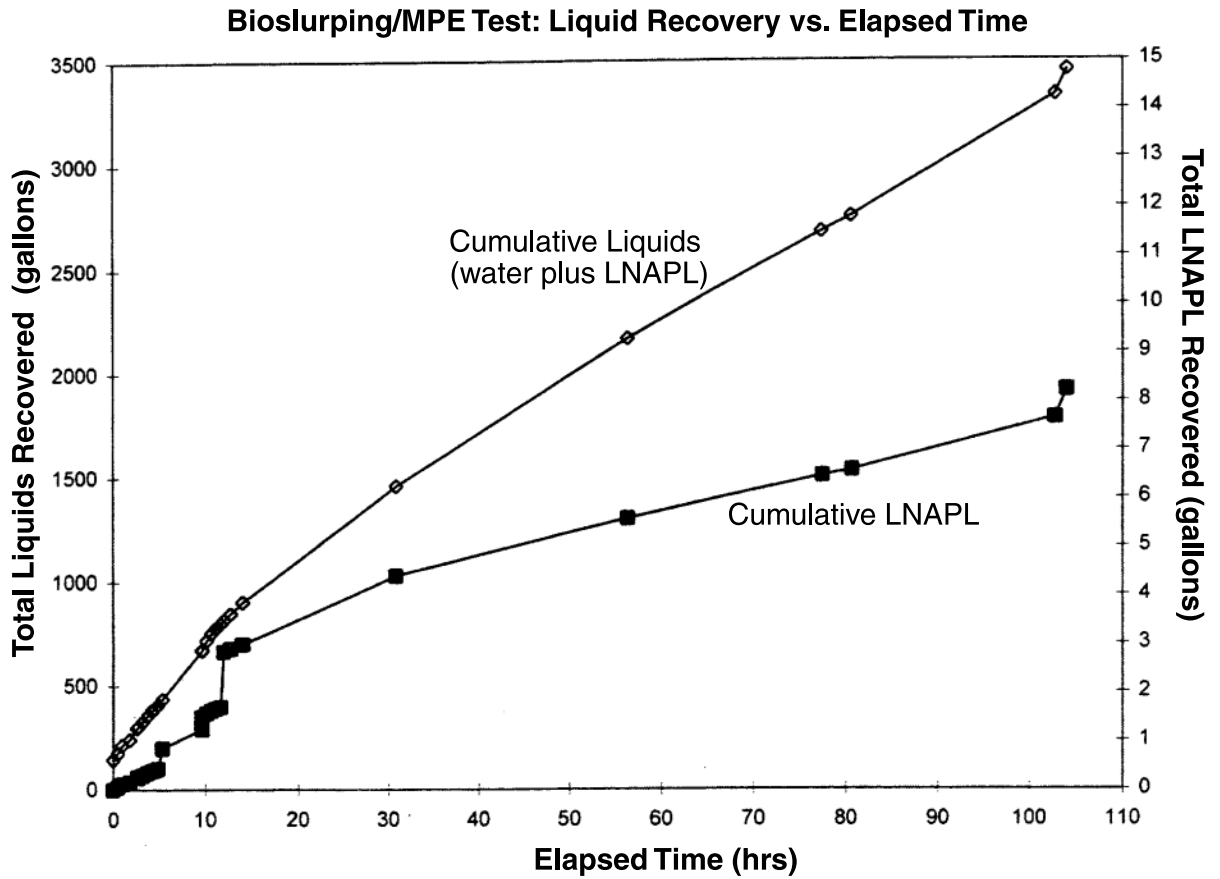

NOTE: Operational parameters associated with this figure are included in Table 4-3.

M980280

Figure 4-8. Example Graph (Liquid Recovery) MA Industrial Site. (ENSR Corp. 1997)

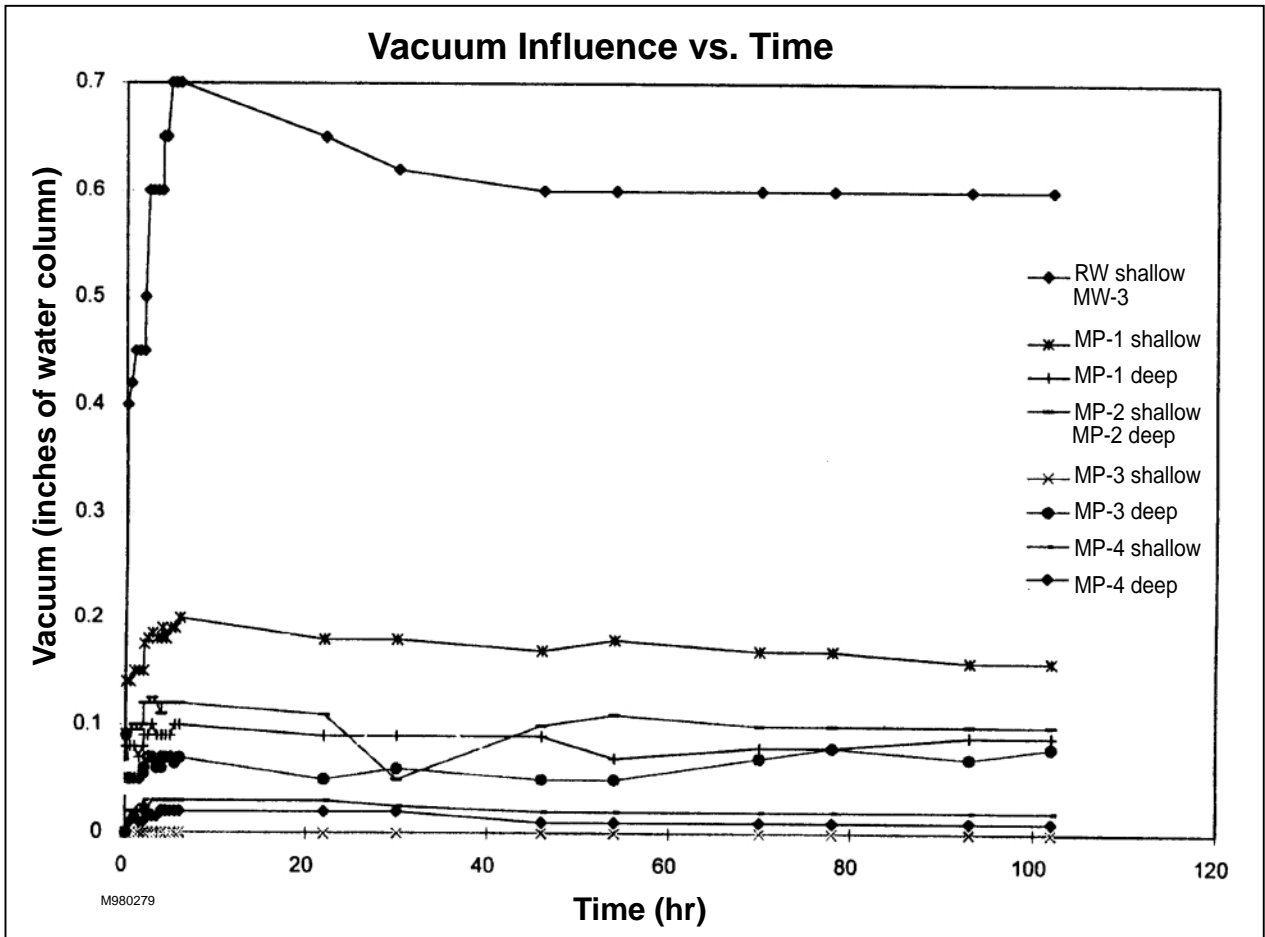

Figure 4-9. Example Graph (Vacuum Influence Data) Squibb Mfg. Site, PR. (ENSR Corp. 1996)

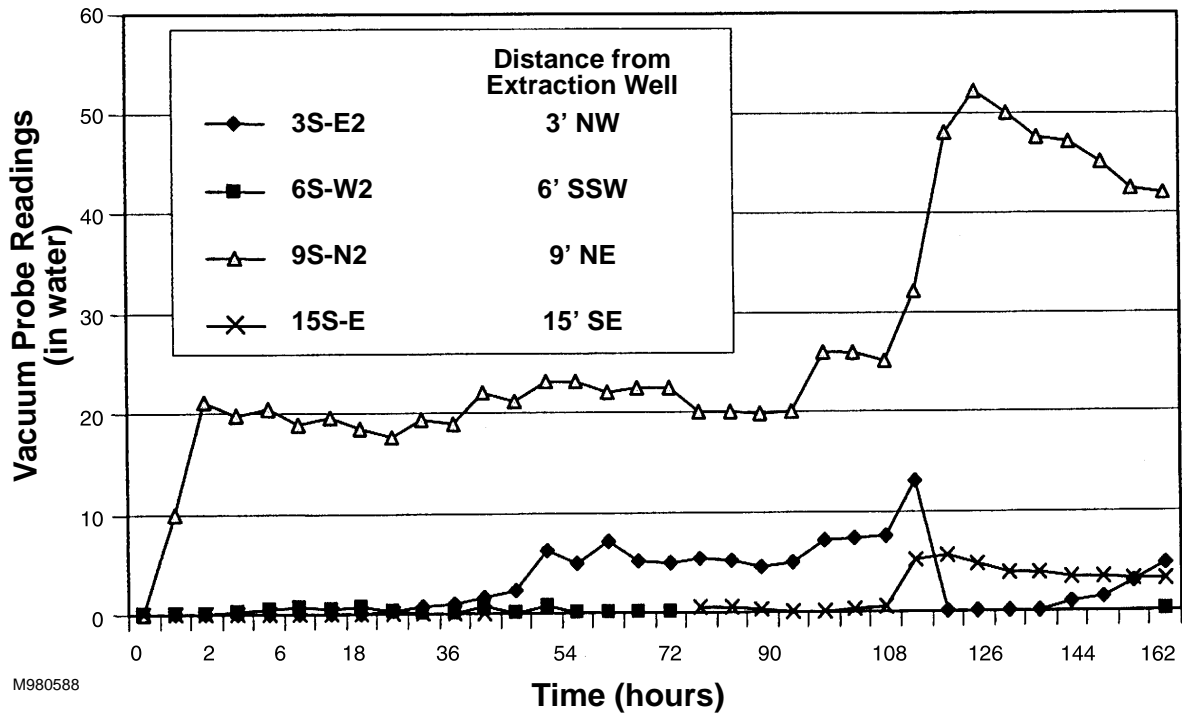

Figure 4-10. Example Graph (Vacuum Influence Data) LCAAP. (Radian International 1997)

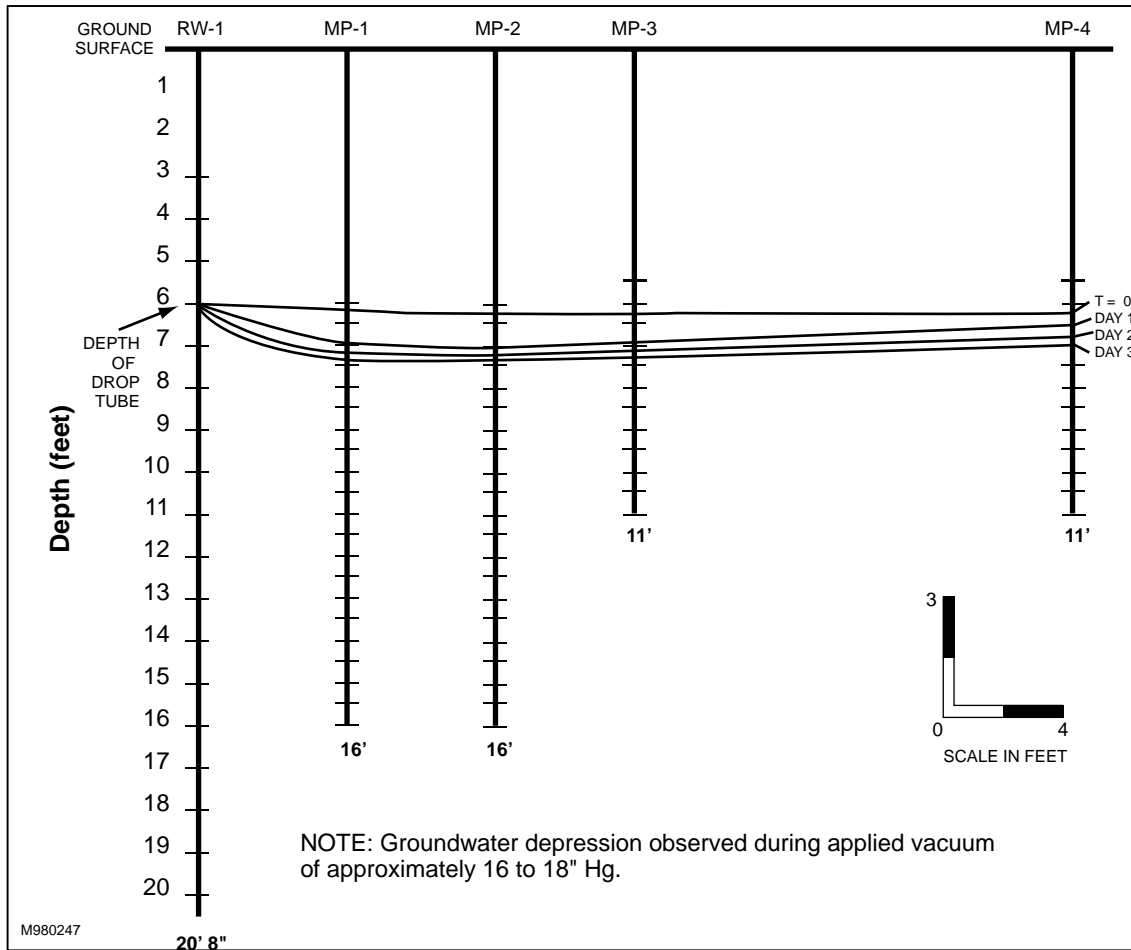

Figure 4-11. Example Graph: Groundwater Depression During Bioslurping Pilot Test Squibb Mfg. Site, PR. (ENSR Corp. 1996)

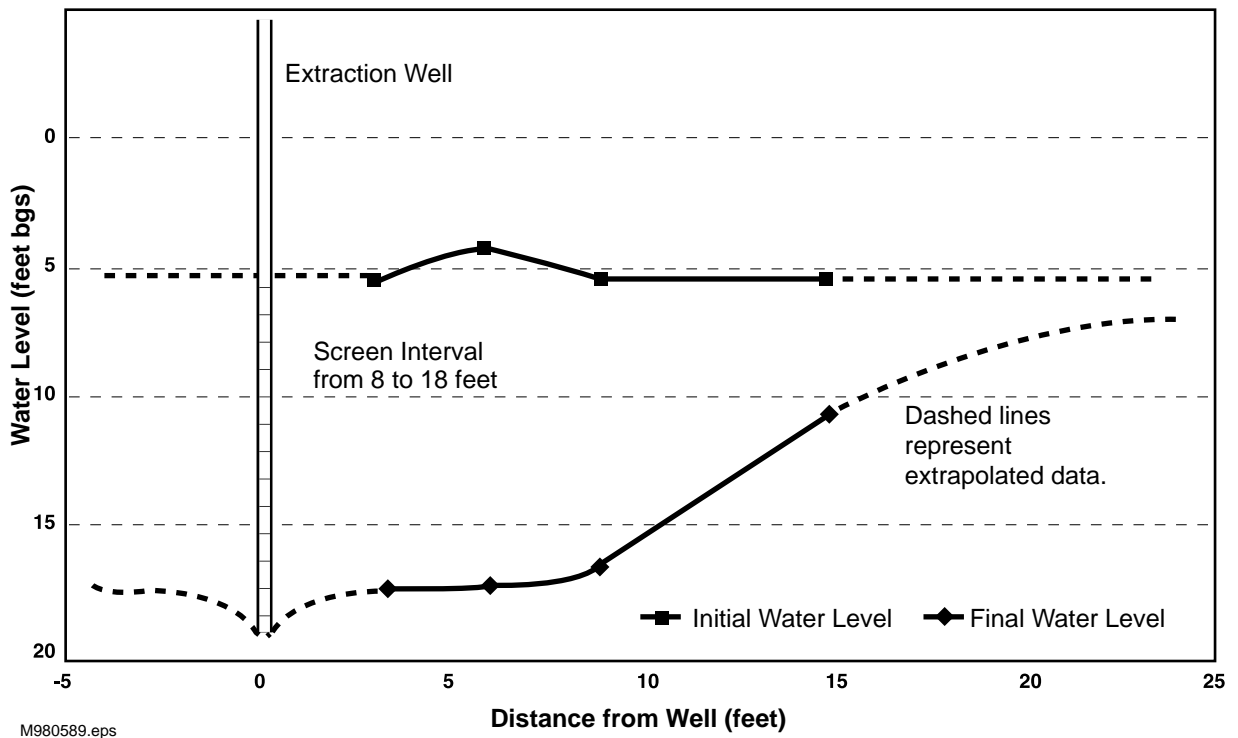

Figure 4-12. Example Graph: LCAAP Area 18 Shallow Well Pilot Test Groundwater Depression. (Radian International 1997)

(6) Further examples of key reporting parameters are summarized in Tables 4-6 and 4-7 (from Baker and Groher 1998; Radian International 1997; and FWEC 1997). These tables provide a comparison of data obtained from MPE pilot tests performed at chlorinated solvent contaminated sites. Additional studies have been performed by the Air Force Center for Environmental Excellence (AFCEE) at a number of MPE sites. Table 4-8 (Kittel et al. 1995) shows product recovery results at 10 AFCEE sites along with radius of influence and biodegradation rate data. Figure 4-13 (Kittel et al. 1995) shows product recovery versus time for an MPE pilot test performed by AFCEE.

4-3. Field Criteria for Evaluating MPE Feasibility Based on a Pilot Test.

There is not a specific set of criteria by which to measure the success of an MPE pilot test, nor is there a single criterion that is "make-or-break"; rather there are various important lines of evidence that must together be weighed to reach an appropriate judgment as to the success of the pilot test.

a. If the purpose of MPE is to enhance NAPL recovery, the rate of NAPL recovery should be compared to that observed during conventional recovery without application of vacuum. AFCEE (1997) discusses how this technique can be utilized for determining the effectiveness of bioslurping based on a pilot test.

b. If the purpose of MPE is to enhance vapor extraction, the contaminant mass recovered in the gas phase should be compared to that recovered in the liquid phase. If the former exceeds the latter during the pilot test, it would be an indication that the technology is functioning as intended. In addition, gas phase mass recovered using SVE alone should be compared to that recovered using MPE. Table 4-7 (from Baker and Groher 1998) provides information on VOC mass extracted in the gas and liquid phases for several pilot tests. As the data indicate, all sites showed significantly more mass extracted in the gas phase compared to the liquid phase. In TPE applications, it should be noted that off-gas concentrations at sites containing contaminants that are more volatile may increase due to VOC partitioning from the liquid to gas phase. In these cases, an increase in gas phase mass removal may not be indicative of an improvement in TPE system performance. There remains the distinct possibility that at some point during the actual remediation, the contaminant mass recovered in the gas phase may decline and become less than that recovered in the liquid phase. Such a change would signal a loss in efficiency.

c. Determining Whether the Vacuum Influence within the Subsurface is Well Distributed as Indicated by Monitoring Point Data.

TABLE 4-6

MPE Pilot Test Site Conditions
(Baker and Groher 1998. Reprinted by permission of Battelle Press.
Copyright 1998. All rights reserved)

SITE	Primary Contaminants	Soil Type	Depth to Water Table ft (m) bgs	Extraction Well Screen Interval ft (m) bgs	Hydraulic Conductivity (cm/sec)
Squibb Mfg. Co. Site, Humacao, PR	Dichloromethane (MeCl ₂), MIBK, xylenes	fill: clay	0.5 (0.15)	3 to 20 (0.9 to 6.1)	1 x 10 ⁻⁶ (a) 5 x 10 ⁻⁴ (b)
Confidential Site, S. CA	1,2-DCA, TCE, VC	silty sand, silty clay	20 (6.1)	20 to 30 (6.1 to 9.1)	3 x 10 ⁻⁷ (c) 4 x 10 ⁻⁵ (d)
LCAAP OU18, Lake City, MO	TCE, PCE, MIBK, toluene	alluvium: silty clay	5 (1.5)	8 to 18 (2.4 to 5.5)	9 x 10 ⁻⁶ (e) 2 x 10 ⁻⁴ (f)
LCAAP NECOU, Lake City, MO	TCE, PCE, toluene	residual colluvium: silty clay	7 (2.1)	5 to 26 (1.5 to 7.9)	2 x 10 ⁻⁷ (g) 3 x 10 ⁻⁵ (f)
Silresim Superfund Site, Lowell, MA	1,1,1-TCA, TCE, 1,1-DCE, Freon 113, MeCl ₂ , ethylbenzene, benzene, styrene	lacustrine : silts and sandy silts	5 (1.5)	11 to 32 (3.4 to 9.8)	4 x 10 ⁻⁵ to 1 x 10 ⁻³
Laboratory determinations on: (a) 1; (c) undetermined number; (e) 8; and (g) 5 intact soil cores (mean is reported where applicable). Field determinations based on: (b) Mean of slug tests; (d) Numeric flow model calibrated to MPE test; (f) Modified pumping test conducted during MPE.					

TABLE 4-7

**MPE Pilot Test Operating Conditions and Results
(Baker and Groher 1998. Reprinted by permission of Battelle Press.
Copyright 1998. All rights reserved.)**

SITE	Test Length (hr)	Applied Vacuum in. Hg (kPa)	SVE Rate scfm (std. m³ per min)	GWE Rate gpm (L/min)	VOC Mass Extracted as vapor as liquid	Test Designer/Operator
Squibb Mfg. Co. Site, Humacao, PR	128 ⁽¹⁾	6-19 (20-64)	18 (0.5)	0.38 (1.4)	<u>5 kg</u> < 1 kg	ENSR Corp.
Confidential Site, S. CA	160	4-8 (14-28)	25 (0.7)	0.07 (0.3)	<u>1,360 kg</u> 900 kg	ENSR Corp.
LCAAP OU18, Lake City, MO	162	9-16 (31-54)	35 (1.0)	0.85 (3.2)	<u>379 kg</u> 17 kg	Radian Int. LLC
LCAAP NECOU, Lake City, MO	162	16-24 (54-81)	2.4 (0.07)	0.15 (0.6)	<u>70 kg</u> 0.5 kg	Radian Int. LLC
Silresim Superfund Site, Lowell, MA	64 ⁽²⁾	7-25 (24-85)	2 (0.06)	0.8 (3.0)	<u>12 kg</u> U	Foster Wheeler Env. Corp.
<p>(1) Data are representative of MPE with drawdown phase of test (128 hr); bioslurping (i.e., MPE without drawdown) had first been conducted for 102 hr. (2) Data are representative of MPE with drawdown portion of test, conducted for 64 hr. High vacuum SVE had first been conducted for 72 hr. Following MPE, SVE with dewatering using submersible pumps was conducted for 456 hr. (U) indicates undetermined.</p>						

TABLE 4-8

Bioslurper Comparative Fuel Recovery Rates and Bioventing Feasibility Study
(Kittel et al. 1995. Reprinted by permission of National Ground Water Association.
Copyright 1995. All rights reserved.)

Base Location	Site ID	Average Fuel Recovery (gal/day)				Soil Gas Radius of Influence (ft)	Biodegradation Rate (mg/kg/day)
		2-Day Skimmer Test	4-day Bioslurper Test	1-Day Skimmer Test	2-Day Drawdown Test		
Bolling AFB, D.C.	Bldg. 18	16.9	59.8	8.2	31.2	45	NA
Bolling AFB, D.C.	Bldg. 41	0.86	1.14	NA	0.13	47	12.9 to 15.3
Andrews AFB, MA	Bldg. 1845	8.7	78.5	0.7	NA	250	21 to 7.5
Wright-Patterson AFB, OH	Well P6-2	4.0	4.65	NA	2.46	10.0	1.3 to 3.2
Travis AFB, CA	JFSA-1	0.0	3.85	0.0	3.76	55.3	61 to 82
Robins AFB, GA	UST 70/72	10.85	47.5	4.96	11.5	56	1.8-3.3
Robins AFB, GA	SS010	1.41	3.22	NA	0.36	76	6.9-10.7
Kaneohe MCBH, HI	POL Tank Farm	0.0	2.39	0.05	0.0	23	60 to 122
Hickam AFB, HI	Area H	34.5	90.9 ¹	NA	408.5	NA ¹	5.1 to 21
Johnston Atoll DNA	Tank 41	29.8	56	3.6	9.5	15.0	3.9 to 8.0

NA Test not performed.

¹ Extraction well screen extended to the ground surface causing short-circuiting.

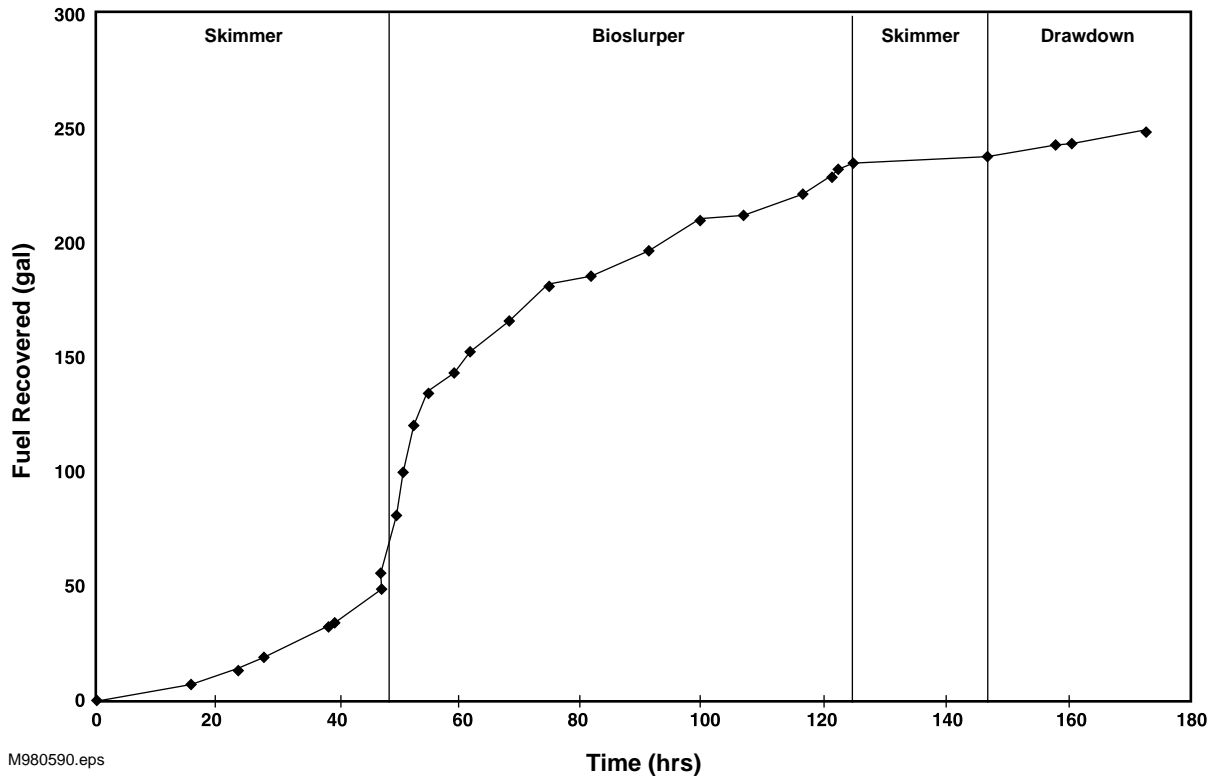

M980590.eps

Figure 4-13. Example Graph: Fuel Recovery versus Time throughout the Bioslurper Pilot Test Performed by AFCEE at Johnston Atoll, Well JA-4. The four phases of the test are in accordance with the AFCEE Bioslurping Protocol. (Kittel et al. 1995. Reprinted by permission of National Ground Water Association. Copyright 1995. All rights reserved.)

d. Determining the Zone of Effective Air Exchange. Note that the conventional radius of influence (EM 1110-1-4001, Chapter 4) tends to overestimate the zone of effective air exchange because at the outer limits of the capture zone (i.e., where some arbitrarily small vacuum level may be detectable), the travel time to the MPE well will be unacceptably long. However, if the purpose of the applied vacuum is not to promote airflow in the vadose zone, but rather to enhance the total gradient driving water and/or product into the well, then a pressure radius of influence approach may be valid. The zone of effective air exchange, by comparison, is much smaller (Johnson and Ettinger 1994). If a goal of MPE is to promote bioventing, examination of oxygen distribution using subsurface monitoring points will yield an indication of the zone of influence.

e. Preferential flow may be present if any of the following conditions exist: 1) there is much more influence observed at one or two depths or directions relative to the MPE well than others; 2) there is more influence observed at a distant monitoring point than at closer points; or 3) there is no influence at a significant number of monitoring points that were pre-tested and determined not to be clogged. Preferential flow of air is not regarded as favorable for MPE unless such flow pathways contain a substantial contaminant mass (Baker and Groher 1998). If short-circuiting of air has been observed at the surface such as at the base of a well riser, it may be necessary to repair a surface seal or install a new MPE well. (Foams, such as shaving foam, can be used to detect such leaks; the foam collapses if air leakage under vacuum is occurring).

f. The efficiency of the extraction well, based on a comparison of the applied vacuum with that measured within an annular monitoring point (as described in EM 1110-1-4001, Chapter 4), must be identified in order to determine whether the well can be used for MPE and whether the pilot test produced unfavorable results due to an inefficient well.

g. On the basis of neutron probe measurements, the degree to which the soil was able to be dewatered or desaturated should be determined. If saturation values remain high within zones targeted for MPE, gas-phase mass transfer will tend to be very inefficient and mass transfer will have to occur mostly within the liquid phase. If NAPL recovery is a goal of the remediation, maintaining high NAPL saturations in extracted liquids should be pursued. If NAPL recovery is not a goal, however, the resulting predominantly liquid-phase mass transfer process will suffer from the same limitations that are common to pump-and-treat.

h. If inducement of subsurface airflow is an objective, the induced vacuums should be compared with the capillary pressure-saturation curves obtained from representative, intact soil cores. Specifically, it should be determined whether the air emergence pressure (paragraph 2-5e(5) (a) based on the soil cores was achieved at the various soil gas monitoring points during MPE.

i. The behavior of the free water surface should be measured within monitoring wells in order to determine if MPE controlled upwelling as intended, and to determine whether the extent of the groundwater zone of influence was satisfactory.

j. If the equipment did not operate as expected during the pilot test, operating malfunctions or problems may indicate design problems. Formation of emulsions that prove difficult to break can render vacuum-enhanced NAPL recovery problematic.

k. Calculations should be made as to what fraction of the estimated contaminant mass within the zone of effective air exchange was extracted during the pilot test. Although one should not expect a high mass removal over the short period of the pilot test (unless the goal is NAPL recovery and the NAPL plume is relatively small), it may be useful to estimate this fraction and judge how promising the technology is from the result.

l. Hydraulic parameters of the subsurface (e.g., hydraulic conductivity) and NAPL permeability estimates are important to obtain during pilot tests (see [paragraph 4-2\(f\)\(2\)](#)).

m. If the pilot test had to be conducted for a longer period than originally intended due to specific reasons, they may suggest potential limitations to the applicability of MPE to the site.

CHAPTER 5

DESIGN OF FULL-SCALE MPE SYSTEMS

5-1. Introduction.

a. As with conventional SVE systems, the main objective in designing an MPE system is to achieve the greatest removal of contaminant mass in the most efficient and timely manner. To accomplish this objective, the design team must understand the nature of the contamination (e.g., composition and physical and chemical characteristics) and the soil characteristics (e.g., permeability and water table elevation). A good understanding of the site allows the designer to determine the rate-limiting step(s) for contaminant removal and thus the areas in which to focus the design effort. Collection of the data necessary to make these determinations is described in Chapter 3.

b. The process of designing an MPE system is similar to that of an SVE system. The subsurface design is based on pilot test results (always required) and the extrapolation of these results to air and liquid flows in the entire treatment zone. Pilot testing is crucial to proper design and the pilot test can function as the first phase of construction at the site. Long-term operation of the pilot testing system may give useful information for the design of additional parts of the system. Subsurface design consists of establishing a network of wells, their screened intervals and construction details, and appropriate subsurface monitoring locations.

c. The aboveground design is based on the flow rates associated with the subsurface design. Aboveground equipment design generally begins with development of a process flow diagram (PFD) identifying mass flows, selection of major equipment, development of system operation and control philosophy, and preparation of a preliminary piping and instrumentation diagram (P&ID) and site layout.

d. A complete MPE system design includes, at a minimum:

- A site layout plan showing locations of MPE wells, monitoring points, aboveground equipment, and buried utilities.
- Specifications and design analysis.
- A PFD that describes the entire system, including material and energy balances, tanks, pumps, blowers, wells, conveyance piping, valves, flow rates, temperatures, pressures, and composition of each "stream."
- A P&ID identifying equipment and components that determine the operation of the system, system controls, interlocks, and automatic shutdown logic.
- A piping drawing displaying the locations of conveyance piping and construction details.
- Well construction drawings, including well head design.

- A system control logic diagram that can be used to design and build a system control panel.
- Requirements for a system enclosure and foundations for system components including storage tanks and treatment equipment.
- An operation, maintenance and monitoring plan.

e. The elements noted above form the basis for a conceptual design. Prior to completion, more detail will be required and the design will need to proceed through a series of reviews and iterations.

5-2. MPE Design Strategy.

a. General Considerations.

(1) A typical MPE system is somewhat similar to an SVE system. A typical MPE system consists of extraction wells, conveyance piping from each well to a vacuum pump, gas/liquid separator, NAPL/water separator, transfer pump, controls, and gas and/or water treatment equipment. The piping to wells may be in trenches or aboveground in regions where there is little potential of frost. In colder regions, piping should only be installed aboveground if heat tape and insulation are applied for freeze protection. An additional requirement for aboveground installation is adequate site security. Figures 5-1 and 5-2 show examples of P&IDs describing TPE and DPE systems, respectively.

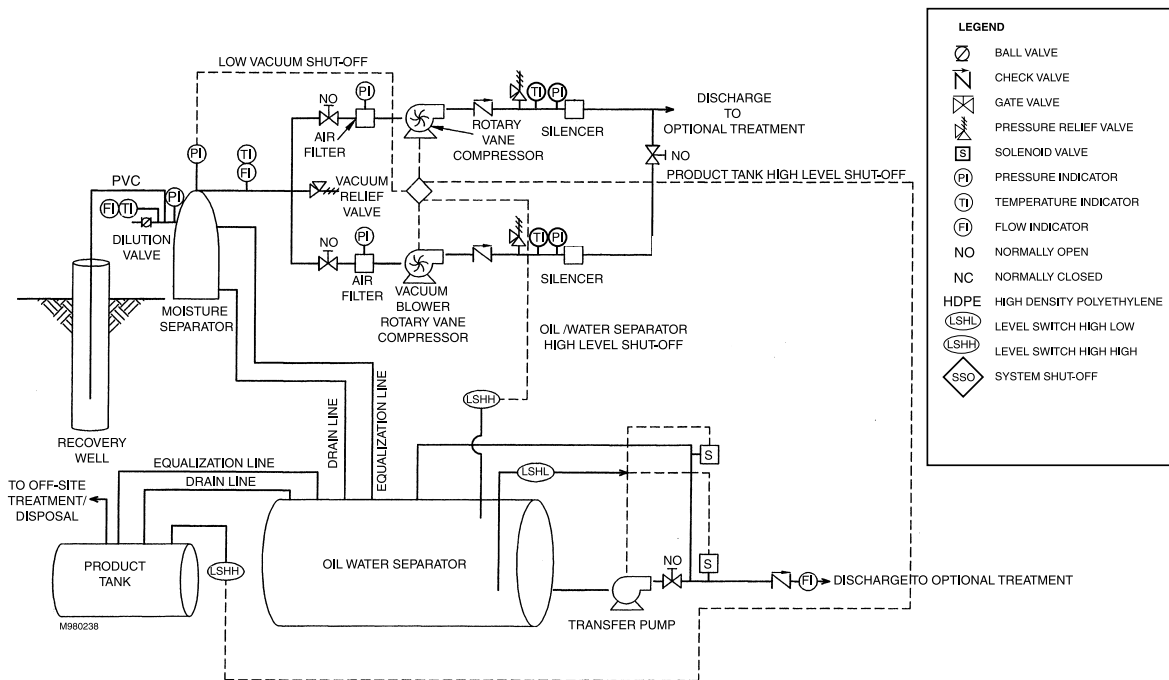

Figure 5-1. Piping and Instrumentation Diagram of Two-Phase Extraction System.

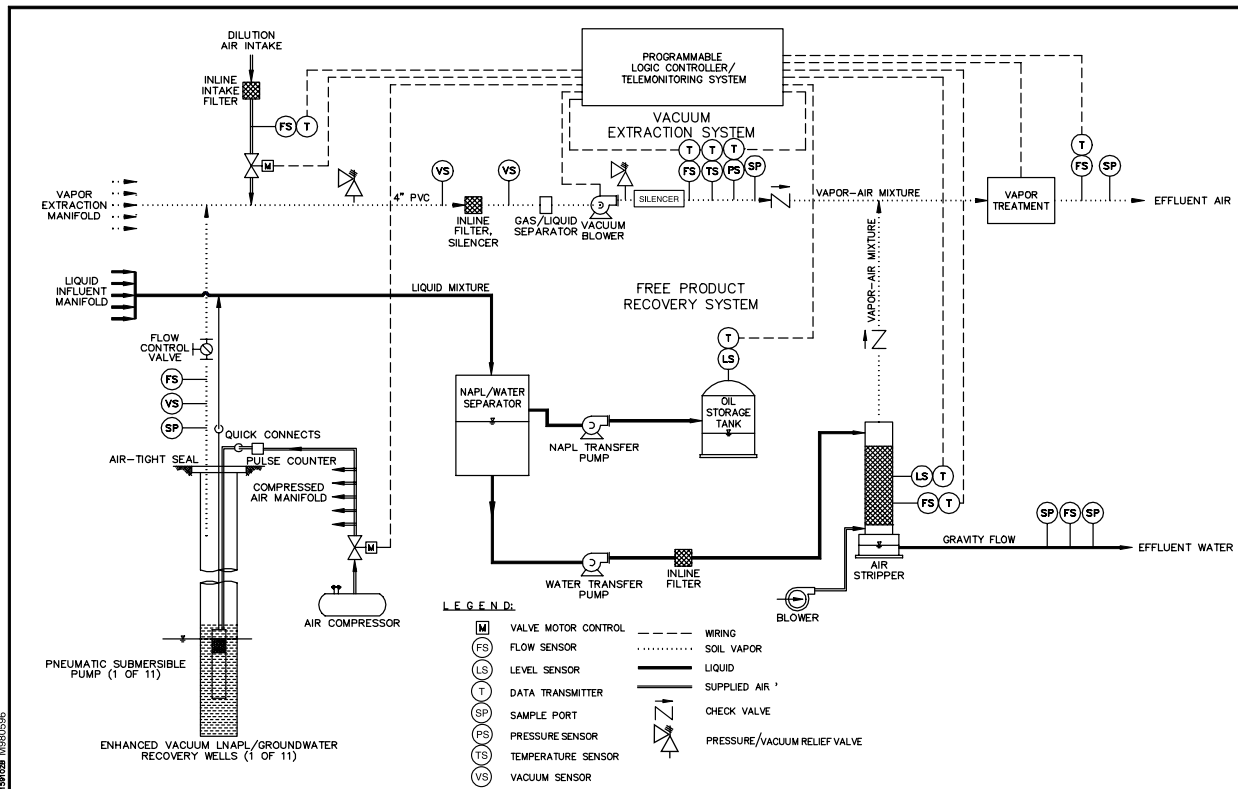

Figure 5-2. Piping and Instrumentation Diagram of a Dual-Phase Extraction System.

(2) To do a thorough and proper job of designing an effective full-scale MPE system, a comprehensive multi-disciplinary design team must first be assembled. This design team may include:

- Environmental/chemical/mechanical engineer.
- Electrical engineer.
- Geologist/geotechnical engineer/hydrogeologist.
- Chemist/geochemist.
- Cost engineer.
- Civil/structural engineer.
- Architect.
- Soil scientist/soil physicist.

- Regulatory specialist.
- Health and safety specialist.

(3) Interaction among these disciplines is critical for appropriate design development. As with other in-situ remediation approaches, it is very important that designers of above-ground components and subsurface components work together throughout the design process. Similarly, a proper design must incorporate sufficient above-ground and subsurface monitoring components to provide the feedback necessary to modify system operating parameters during normal operation and maintenance.

b. Remedial Objectives. The ultimate objective of an MPE system is to achieve the remediation goals in a cost-effective and timely fashion. However, as discussed in paragraphs 2-2b and 3-8d to 3-8f, MPE can be implemented in a variety of ways, depending on whether the goal of remediation is to address soil, groundwater, or NAPL. For example, a remediation system that is intended to remove perched water, and then subsequently remove contaminant mass through SVE will require a different system design than a remediation system that is intended to remove LNAPL to a specified thickness.

c. Subsurface Strategy.

(1) Two main MPE approaches are MPE with drawdown (i.e., dewatering) and MPE without drawdown. As a basis for the design strategy for either of these approaches, the subsurface designers must:

(a) Understand subsurface flow characteristics of gas, water, and NAPL, potential preferential flow pathways, soil permeability, and NAPL physical characteristics.

(b) Develop a conceptual model for mass removal, that is, determine the treatment mechanisms and the extent to which the system is to remove mass via the gas phase, dissolved phase, as NAPL, and through biodegradation.

(c) Optional: use flow models to predict liquid and gas flow throughout the treatment area and from MPE wells to:

- Ensure adequate well coverage in the treatment area.
- Allow specification the sizes and capacities of pumps and above-ground treatment equipment.

(2) In many ways, MPE subsurface design is very similar to SVE subsurface design, as described in EM 1110-1-4001, Chapter 5. The most critical design parameter is permeability. This parameter governs the flow rates of gas and liquids to MPE wells and therefore determines the number of wells that will be required to achieve remedial goals, as well as the capacity required for above-ground components. Soil heterogeneity also affects the number and placement of wells to be used in an MPE system. The designer should try to anticipate locations of flow short-circuiting and minimize their impact by positioning well screen intervals away from these locations.

(3) Notable differences between MPE systems with and without drawdown include: changes in the gas and liquid pathways to the well as desaturation proceeds, and different requirements for aboveground water treatment and disposal.

(a) Initially, the screen interval that is exposed to unsaturated soil will be relatively small. As MPE desaturates the surrounding saturated soil, additional air pathways will open, some of which may be more permeable than the initial pathways. Airflow patterns and extraction rates will thus change over time, along with concomitant changes in water and NAPL pathways and flow rates. The subsurface designer may use well packers or multi-level or nested wells to attempt to control the depths from which extraction is occurring. Changing flow paths and rates will also affect above-ground design.

(b) Requirements for aboveground water treatment and disposal. An MPE system that does not draw down the surrounding water table may not extract significant volumes of water. Cost-effective options for managing and treating small quantities of water may entail containment and subsequent off-site disposal or batch treatment through activated carbon. MPE with drawdown will most likely require more elaborate and costly water treatment processes.

d. Pneumatic Considerations.

(1) Pneumatic considerations for MPE are very similar to those for SVE as described in [EM 1110-1-4001](#), Chapter 5. The primary differences in these considerations arise from the need to extract multiple phases from the subsurface. When this is accomplished using DPE (i.e., separate pumping for liquid and air phase), the air-phase pneumatic considerations are the same as for SVE, though typically the applied vacuums are significantly higher in the former case. Pneumatic considerations for TPE are complicated by the presence of multiple phases within a single pipe from the extraction well to the air-liquid separator. As discussed in Chapter 2, the flow of liquid up the extraction tube within a TPE well takes several forms. Each of these forms will engender different vacuum/pressure losses. However, once the air-liquid stream arrives in the conveyance piping to the air-liquid separator, liquid in excess of entrained droplets generally flows along the bottom of the conveyance pipe, with minimal effect on the air flow. In most TPE applications, the liquid discharge is small compared to the air discharge, and liquid does not occupy a significant amount of the cross-sectional area of the pipe. Therefore, provided piping runs are relatively short, pneumatic considerations for MPE are not substantially different from those for SVE. If the liquid flow through the conveyance piping is expected to be significant (e.g., when TPE is applied in moderate to high permeability soil) then the pipe size should be increased accordingly (or DPE should be considered as a more appropriate alternative).

(2) One pneumatic consideration that is unique to TPE is the drop tube size. As described in Chapter 3, entrainment of liquid droplets in a gas stream and subsequent extraction from a well requires linear gas velocities in excess of 275 m/min. The designer should choose a design velocity of 500 m/min or greater. The drop tube diameter will depend upon this velocity and the extracted airflow rate achievable in a given well. A 2.5 cm (1-inch) drop tube will require at least 0.25 m³/min gas flow to provide the requisite linear velocity up the drop tube.

5-3. Design Guidance - Subsurface. This section discusses the considerations necessary for appropriate extraction well and wellfield design. Different applications of MPE (e.g., MPE to enhance SVE vs. MPE to enhance free-product

recovery (FPR)) have different goals and thus require different design approaches. However, all MPE applications have a common set of important design parameters. The common design parameters that will be developed during the subsurface design include:

- Applied vacuum - The designer must select a target vacuum to apply in the MPE wells that will best suit the remediation objectives. The desired applied vacuum and associated fluid extraction rates dictate the type and size of the aboveground vacuum generator.
- Fluid extraction rates - The designer must determine the desired and/or expected extraction rates of each fluid (gas, water, NAPL). For some applications, the designer sets the extraction rate as a design parameter (e.g., airflow rate to achieve a desired pore volume exchange rate [PVER]). In other circumstances, the design parameter for the extraction of one fluid will generate a collateral fluid stream that requires aboveground management. For example, by imposing a vacuum to enhance the recovery rate of NAPL, an extracted gas stream is generated that must be managed and treated above ground.
- Well spacing within a well field - The designer must determine a well field configuration that will achieve the extraction rate(s) necessary to meet the remediation objectives. Well spacing has substantial impact on the cost of the MPE system.
- Well screen placement - In all cases, the factors that affect selection of well screen length and depth include the depth to contamination and the thickness of the contaminated zone. The designer must also consider the effects that will arise (e.g., short-circuiting) from changes in permeability due to stratification of the soil within the contaminated zone.

Each of the different MPE applications has specific design criteria that are associated with the different goals of these applications. Development of these design criteria for each MPE application is described in the following sections.

a. MPE with Drawdown to Enhance SVE/Bioventing.

(1) For the case of MPE with drawdown (i.e., lowering of the water table), where the primary remediation objective is to remove mass by venting or bioventing, it is critical to reduce saturation in the soil within the treatment zone to allow gas to flow through it. This is accomplished by drawing down the water table in the conventional sense, i.e., by gravity drainage. Vacuum applied to the extraction well increases gravity drainage of liquid by increasing the groundwater flow rate to the well. However, the applied vacuum impedes liquid drainage by lowering the air pressure in the capillary zone and causing the groundwater to "upwell". The vacuum applied at the MPE well should be as high as required to achieve the groundwater flow rates necessary to reduce saturation in the surrounding soil, but not so high as to overwhelm the drawdown caused by groundwater depression. In addition, in medium- and fine-textured soils, it will be necessary to achieve a distribution of vacuums in the surrounding soil that is able of overcoming the capillary pressures exerted by the soil. That is, the MPE wellfield must propagate enough vacuum in the remediation area to drain soils that will often have moderate to high air-entry capillary pressures. Paragraphs 2-4a(3) and 3-4g(3)

discuss the relationship between capillary pressure and saturation. It is important for the designer to realize that, within the lower permeability range (i.e., 10^{-4} to 10^{-5} cm/s), it may be very difficult to achieve the requisite vacuum in the formation with a reasonable number of wells.

(2) An exception to this guideline is the case where there are conduits within the soil that have higher permeability and lower capillary pressures to overcome. The presence of such conduits may only be observable during pilot testing or through a substantial number of soil cores collected from the treatment area.

(3) Achievable MPE gas and liquid extraction rates are primarily a function of the permeability and the applied well vacuum. The effective intrinsic permeability of the soil will be governed by the nature of preferential flow paths encountered by a well. Baker and Groher (1998) reported that permeabilities obtained at the laboratory scale are typically two orders-of-magnitude less than at the field scale. This may be an indication of the importance of preferential flow paths at the field scale. It may also be explained by the fact that lab permeability tests measure the vertical hydraulic conductivity, while field measurements reflect a combination of vertical and horizontal hydraulic conductivity values. MPE design rates for air and liquid extraction are dependent on the objectives of the system. As described in paragraph 5-2c, the air and liquid flow rates will change during operation of the MPE system. It is necessary to design for the highest air extraction rate expected (extraction rate expected after pores are opened/desaturated). Similarly, it is necessary to design for the highest water flow rate expected, typically the water flow rate achieved at system startup. It may be beneficial to use modular rental treatment units that allow the flexibility to handle initially higher flow rates and concentrations.

(4) When applying MPE for dewatering and enhancing SVE, the designer, within the constraints of the permeability limitations, will set the groundwater extraction rate. The ratio of extracted air to water can be adjusted by changing the elevation of the drop tube. Throughout the implementation of an MPE system, the water table (actually the top of the capillary fringe) acts as a no-flow boundary for vacuum-enhanced SVE. It may be desirable to lower the water table slowly so that vacuum-enhanced SVE can be performed in a given stratum without "exposing" potentially higher permeability soil layers and thus promoting preferential flow through them. It is also desirable to minimize capital expense for water treatment equipment; therefore, it may be prudent to lower the water table slowly to integrate the water flow rate over time and maintain a more even flow rate. Ultimately, to lower the water table, the water extraction rate must exceed the "recharge" rate. In the saturated zone, this is the true recharge rate. Within the capillary fringe (which may be several meters thick), this will be a total of the rate at which water "wicks" upward from the water table plus the rate of infiltration.

(5) One method for selecting design vacuums, well spacings and fluid extraction rates is to use an MPE model (to select an appropriate model, see paragraph 5-4). Based on information available from site investigation and pilot test data, an MPE model can be used to:

1. Predict airflow rates and determine the maximum vacuum to be applied based upon the PVER that is desirable for the site, thus determining the required well spacing and blower type and size. Typical PVERs range from 300 to 1,000 exchanges per year. For this application of MPE (vacuum dewatering to enhance SVE), it is desirable to use a PVER of at least 1,000 to account for the lower air-filled porosity of the "dewatered" soil. The MPE model can be used to estimate the air

velocities around a well or within a well field. The vacuum applied to the well(s) must be sufficient to achieve air velocities of 0.001 cm/sec throughout the treatment area (Dom Diguilio, verbal communication 1998).

2. Estimate groundwater extraction rates necessary to expose the treatment zone. In effect, the model must predict the groundwater extraction rates necessary to dewater the treatment zone and maintain the new capillary fringe at the bottom of the treatment zone. These predicted extraction rates will encompass both the maximum extraction rates (typically encountered when initiating dewatering) and the "steady-state" extraction rates. These data can then be used to determine groundwater treatment system design.
3. Evaluate various well configurations to obtain the optimum number and location of vacuum-enhanced extraction wells.
4. Estimate the concentration and mass of contaminant to be removed from the subsurface over time in both liquid and gaseous form.

(6) If an MPE model is not readily available to the designer, then another method, based on approximate solutions of one-dimensional radial flow to the MPE well can be used to select a design vacuum, approximate well spacing, and groundwater extraction rates. In this method, the designer (with assistance from a hydrogeologist) should estimate these design parameters for a single well. This will entail:

1. Calculation of an air extraction rate that will achieve the desired PVER. This will allow the designer to determine the zone of influence for the extraction well (note that the equations presented are only valid for confined conditions). This extraction rate is discussed in detail in [Engineer Manual 1110-1-4001](#), Soil Vapor Extraction and Bioventing, Chapter 5, Design of Full-Scale SVE and BV Systems. An equation that can be used to estimate the extraction rate from a single well is:

$$Q_v^* = \frac{\pi r^2 b n_a}{t_{xc}} \quad [5-1]$$

where:

Q_v^* = volumetric flow rate at atmospheric pressure [$L^3 T^{-1}$]

r = radius of treatment zone [L]

b = vadose zone thickness [L]

n_a = air-filled porosity of the soil [$L^3 L^{-3}$]

t_{xc} = the time required for one pore volume exchange (1/PVER) [T]

2. Next the pressure distribution resulting from applying a vacuum to the extraction well must be estimated. For a given vacuum, the pressure (vacuum) distribution can be estimated using the pseudo-steady solution to the one-dimensional flow equation (described in detail in [Engineer Manual 1110-1-4001](#), Chapter 2, subsection on Fundamentals of Vapor Flow in Porous Media).

$$P_2 - P_1 = \frac{Q_v \mu}{4 \pi b k_a} \left(\ln \frac{r_2}{r_1} \right) \quad [5-2]$$

where:

- r_1 and r_2 = radial distances from the well [L]
 P_1 and P_2 = the pressures at r_1 and r_2 , respectively [$\text{ML}^{-2} \text{T}^{-2}$]
 Q_v = volumetric flow rate estimated above [$\text{L}^3 \text{T}^{-1}$]
 μ = dynamic air viscosity, $\sim 1.83 \times 10^{-5} \text{ N} \cdot \text{s}/\text{m}^2$ [$\text{ML}^{-1} \text{T}^{-1}$]
 b = thickness of the zone of air flow [L]
 k_a = air permeability [L^2]

Analyses based on the above equation assume a 100% efficient extraction well. Note that per [EM 1110-1-4001](#), the Chapter 4 discussion on vent well efficiency, one should incorporate flow loss due to borehole smearing that is not accounted for in this equation. Figure 5-3 shows vacuum distributions estimated using this equation for three homogeneous, isotropic soils with intrinsic permeabilities of 10^{-8} , 10^{-9} , and 10^{-10} cm^2 , bracketing the range of soil conditions suitable for MPE. Each vacuum distribution was developed assuming that P_1 observed directly adjacent to the well is equal to the vacuum applied to the well. A different applied vacuum is presented for each soil type in order to achieve vacuum greater than zero at the edge of the treatment zone (set at 5.5 m for each example). It is interesting to note, that Equation 5-2 estimates negative vacuums (i.e., positive pressure) beyond 0.7 m using the Q_v estimated using Equation 5-1, indicating that the soil is too impermeable to treat to 5.5 m, even applying a vacuum of 684 mm Hg. Caution should be taken when using these equations as they may produce negative vacuum values. Estimates of negative vacuum should be interpreted as zero vacuum. These estimates can be made iteratively to determine a consistent applied vacuum, air extraction rate and treatment zone radius. In this analysis, wellhead vacuum will be higher than the values used due to well efficiency.

3. Once the airflow rate, design vacuum, and treatment zone radius are estimated, the groundwater extraction rate necessary to dewater the treatment zone can be estimated using a Cooper and Jacob (1946) modification of the Theis solution to the well equation. This solution is presented in Equation 5-3.

$$h - h_o = \frac{2.3Q_w}{4\pi T} \log \frac{2.25T t}{r^2 S_y} \quad [5-3]$$

where:

r = the radial distance to the well [L]

$h_o - h$ = the drawdown at distance r from the well [L]

Q_w = extracted water flow rate [L³ T⁻¹]

T = transmissivity of the saturated zone [L³ T⁻¹] = $K \times b$

K = hydraulic conductivity [L T⁻¹]

t = pumping time [T]

S_y = specific yield of the saturated zone [-]

This modification of the Theis equation is only valid when the Boltzmann variable, $u = (r^2 \cdot S_y) / (4 \cdot T \cdot t)$ is less than 0.01.

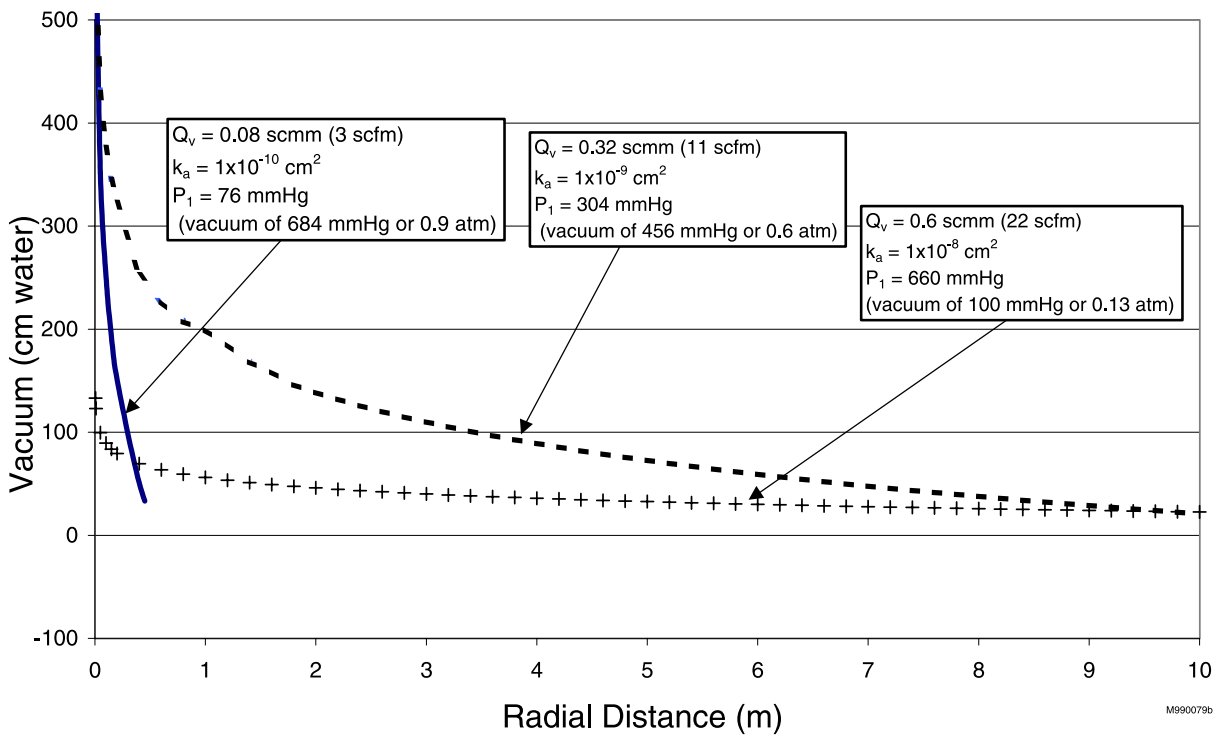

Figure 5-3. Example vacuum distribution curves using the pseudo steady-state solution to the 1-D flow equation.

Figure 5-4 shows typical drawdown curves estimated using this equation for the same three homogeneous, isotropic soils discussed above. The hydraulic conductivities of these soils are 10^{-3} , 10^{-4} , and 10^{-5} cm/sec, bracketing the range of soil conditions suitable for MPE. Each drawdown curve was developed for a given pumping time (35, 69, and 69 days, respectively). The saturated thickness, b , is 20 m and the specific yield, S_y , is 0.1 for each case. The curve for the low permeability, 10^{-5} cm/sec, soil appears somewhat different than the other two curves, indicating that 69 days is not sufficient to reach "steady state" in this soil.

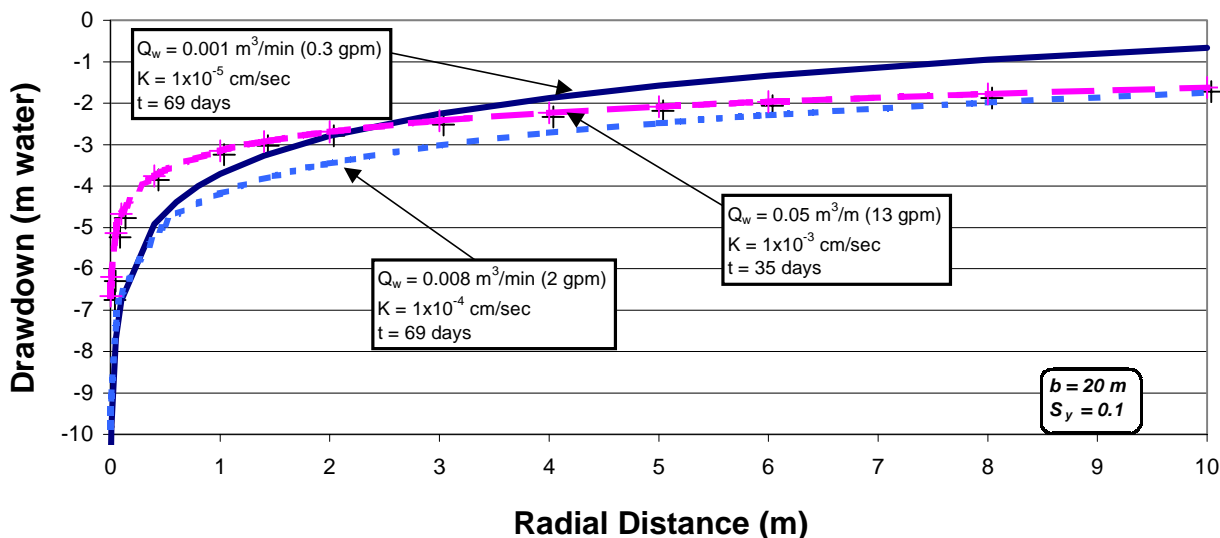

Figure 5-4. Example drawdown curves using the Cooper and Jacob approximation to the Well Equation.

4. The zone of desaturation (i.e. the lowered top of the capillary fringe) around the MPE well can then be estimated by superimposing the vacuum distribution and drawdown curves, as shown in Figure 5-5a, b, and c. This figure shows the results of this superposition for the three example soils in which a hypothetical treatment zone of 1 meter was desired (e.g., corresponding to a 1 meter smear zone). In each of these examples, a combination of applied vacuums and predicted drawdowns produces a desaturation zone greater than 1 meter at a reasonable distance from the well. It is important to note that, though this criterion is met for all the soils, the vacuum distribution for the lowest permeability soil, $k_a=10^{-10}$ cm², indicates that the enhanced SVE/bioventing zone would be limited to very close to the well, thus in low permeability settings, close well spacing may be necessary to achieve the desired flow rates.

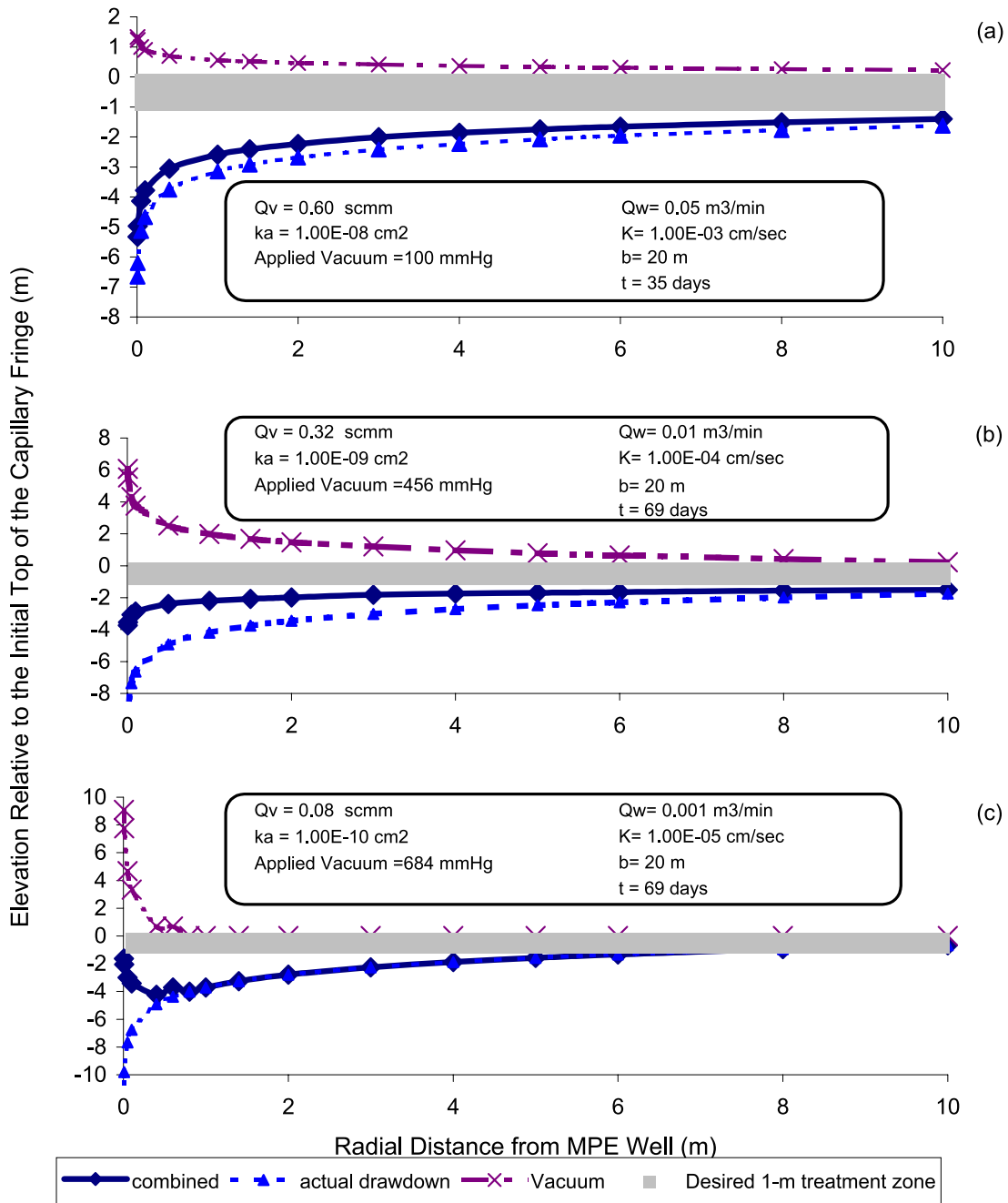

Figure 5-5. Example of a changing capillary fringe during MPE as described by the superposition of vacuum distribution and drawdowns curves for a) moderate; b) low; and c) very low permeability soils. For each, the predicted dewatered zone is >1m thick within 6m of the well; however, for c), SVE is limited to ~1m from the well.

b. MPE with Limited Drawdown to Recover LNAPL.

(1) For the case of MPE with limited drawdown, the vacuum applied at an MPE well must be sufficient to overcome the capillary forces of the surrounding soil so as to "encourage" LNAPL flow toward the well. Again, the wellfield design must create a vacuum distribution within the treatment zone such that the capillary forces holding the NAPL within the soil pores are overcome. However, it is important not to induce too high a vacuum near a well that may cause the LNAPL to flow faster than it can be "replenished" by other LNAPL within the interconnected NAPL-filled pores. "Snap-off" of the interconnected LNAPL-filled pores may occur and water may be induced to flow into the resulting void space. Under these conditions, a well may become "isolated" from the surrounding LNAPL-filled pores (Barker et al. 1997). The LNAPL interconnections may re-establish slowly after snap-off occurs. The appropriate design vacuum can only be determined based on pilot testing results, or developed over time during system operation based on careful monitoring. As described above, the optimum design vacuum for MPE for LNAPL recovery will also be dependent on the extent to which there are conduits within the soil that have higher permeability and lower capillary pressures to overcome. This may only be observable during pilot testing or through a substantial number of soil cores collected from the treatment area.

(2) MPE systems that are intended primarily as vacuum-enhanced LNAPL recovery systems will typically be designed to manage as little water as possible. Therefore, the groundwater extraction rate for such systems will be low, typically less than 7.5 liter/min (2 gpm) per well. The rate of groundwater extraction will be a function of the vacuum applied to the well and the actual drawdown imposed by setting the water pumping inlet at some depth below the water table. LNAPL extraction rates for such systems must be based on the same considerations described for design vacuum, i.e., extraction rates must be low enough to prevent snap-off.

(3) Well spacing is primarily determined by the vacuum and/or flow distribution that is desired throughout the treatment area. For the case where the objective of the MPE system is to remove mass through vacuum-enhanced free product recovery, the spacing of wells within an MPE well network should be based on pilot test results and subsurface flow modeling using a multiphase flow model. At the outset of a typical MPE project, screening level models such as, OILVOL, SPILLCAD, and BIOVENTING^{PLUS} can be used to answer questions such as:

- How much LNAPL is present?
- About how many (order-of-magnitude number of) wells will be needed for a MPE system?
- Approximately what concentrations of contaminants are expected in the extracted gas and water and therefore what type of treatment system should be contemplated?

(4) If a multi-phase flow model is unavailable, then the designer may use prior experience, designs for similar projects, published modeling results, or published MPE results as guides for order-of-magnitude estimates of MPE design parameters. For example, Figure 5-6 presents published computer simulated LNAPL recovery rates over time in SM soil that initially had 3 m (10 feet) of LNAPL. The SM soil was a sandy loam containing approximately 9% clay and 26% silt, with the remainder fine- to very-coarse-grained sand (Beckett and Huntley

1998). These simulations were performed for LNAPL recovery with groundwater drawdowns set at 0.76, 1.5, 2.3, and 4.6 m (2.5, 5, 7.5, and 15 feet). A fifth simulation was performed with a vacuum applied to the 2.3-m (7.5-foot) drawdown case. These data can be used as guidance for estimating LNAPL recovery rates under similar conditions.

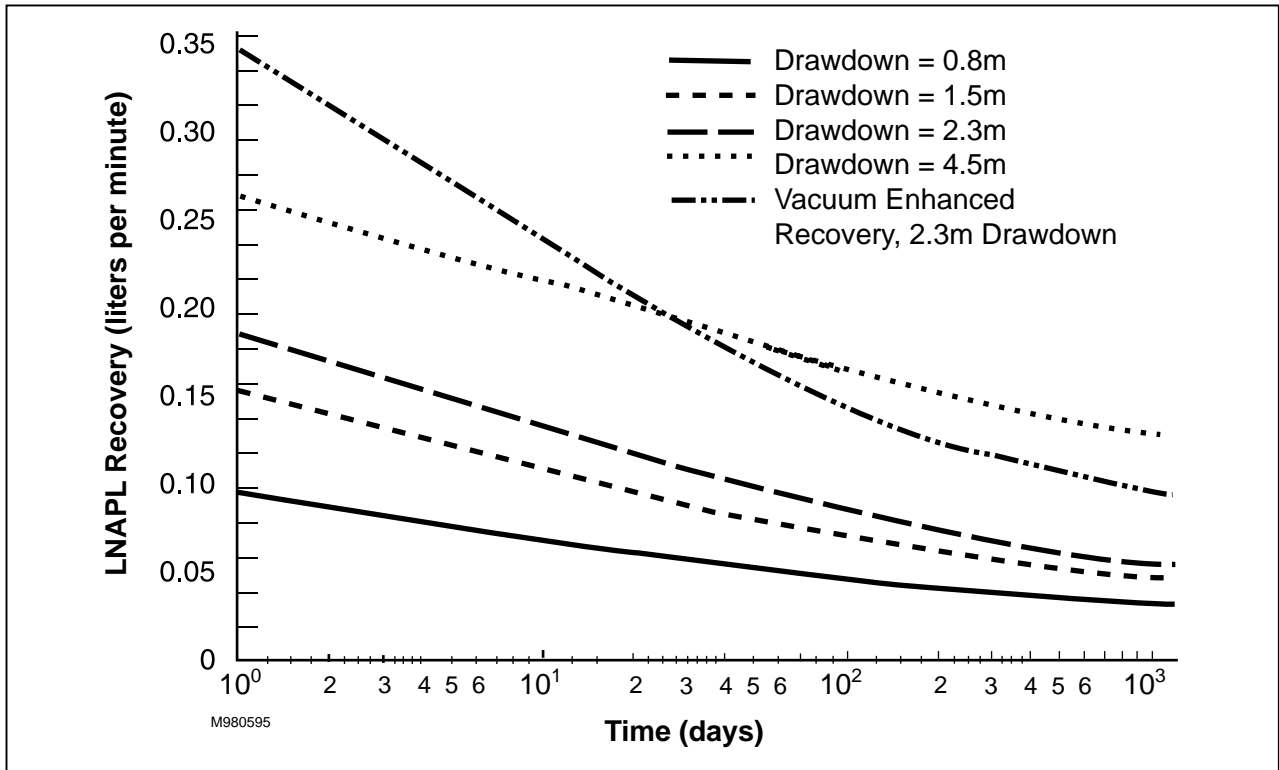

Figure 5-6. LNAPL Recovery versus Time for Various Drawdowns and for Vacuum-Enhanced Recovery with Drawdown. (After Beckett and Huntley 1998. Reprinted by permission of Environmental Science & Technology. Copyright 1998, American Chemical Society. All rights reserved.)

(5) Figures 5-7a and 5-7b present some example model simulations of MPE for NAPL recovery under a variety of scenarios. The figures illustrate remediation times for different pairs of soil. The simulations are for a hypothetical site with 1.5 m (5 feet) of LNAPL (apparent thickness) and were performed to aid estimation of the number of wells and vacuums required to recover LNAPL at this site. The model estimates the period of time required to recover the LNAPL from within a cylinder of a given radius of a well, assuming no additional LNAPL could flow into the cylinder from beyond it. In effect, this estimates the performance of one well in a multi-well field. If the time to recover the LNAPL seems reasonable to the designer for his/her site, then the total number of wells can be estimated by determining the number of wells necessary to cover the site, applying a suitable overlap or safety factor. Each of the simulations had a set of common conditions, as described in Table 5-1.

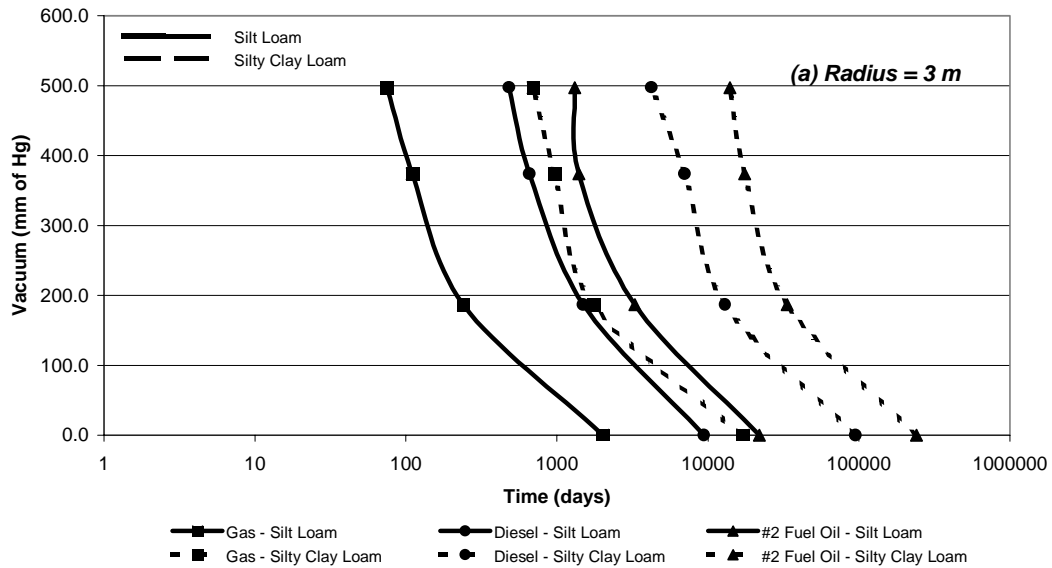

Figure 5-7a. Predicted time to 0.3 meter (1-foot) LNAPL remediation vs. applied vacuum head for various LNAPL and soil types defined by a 1.5 meter (5-foot) apparent thickness LNAPL plume with (a) 3.0 meter (10-foot) radius; and (b) 6.1 meter (20 foot) radius

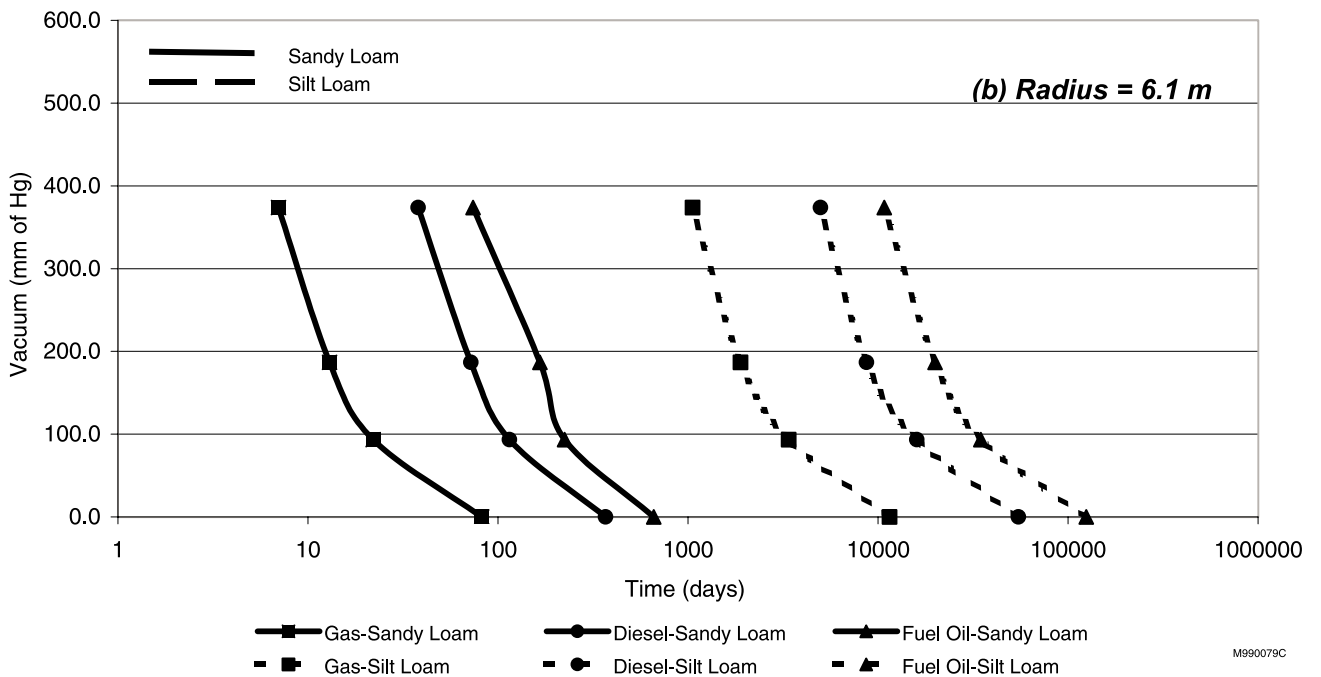

Figure 5-7b

TABLE 5-1

Model* Simulation of LNAPL Recovery by MPE: Parameters Common to Each Simulation

Parameter	Value
LNAPL thickness	1.5 m (5 ft)
Vadose zone thickness	4.5 m (15 ft)
Saturated zone thickness	15 m (50 ft)
Porosity	35%
Specific storage	0.2%
Unsaturated zone residual LNAPL	2.5%
Saturated zone residual LNAPL	7.5%
Drawdown in well	1 m (3 ft)
*TIMES (Trihydro 1997)	

(6) Parameters that were varied in the example model simulations were soil type, applied vacuum, NAPL type, and recovery radius (see Table 5-2). For example, 12 LNAPL recovery simulations were performed for a 6.1-m radius from an MPE well placed in loamy sand, one for each LNAPL type (gasoline, diesel fuel and #2 fuel), applying four different vacuums to the recovery well (0, 93, 187, and 374 mm Hg, or 0, 50, 100, and 200 inches H₂O). Similarly, 12 simulations were performed for recovery from a 6.1-m radius to an MPE well placed in silt loam; 12 simulations of recovery from a 3-m radius in silt loam; and 12 simulations of recovery from a 3-m radius in silty clay loam. The results of these simulations are presented in Figure 5-7a and 5-7b. Each simulation was run until the LNAPL thickness present in the specified radius from the well (3 or 6.1m) drained to less than 0.3m (1 foot) of apparent thickness. (As described in Chapter 2 and displayed in Figure 2-17, NAPL conductivity diminishes dramatically as NAPL thickness drops to below 1 ft (0.3 m). This changing NAPL conductivity must be accounted for on a site-specific basis.) These figures can be used as guides for screening the feasibility of applying MPE at similar sites. For example, if a site has a 30 m by 30 m area with 2 m of diesel fuel in loamy sand, then the remediation designer can expect that a grid of 3 by 3 MPE wells spaced approximately 10 m apart with a vacuum of 100 mm Hg applied to the wells can expect to remove most of the LNAPL in less than one year. This is probably a reasonable remediation scenario, though the designer may want to perform a more rigorous design using MPE flow models. For the same scenario at a site with silt loam, then the designer should expect to need approximately 25 MPE wells (a grid of 5 by 5 spaced 6 m apart), with a much higher vacuum (e.g., 400 mm Hg) to remove the LNAPL within several years. Figure 5-8 presents average groundwater extraction rates that can be expected under the various LNAPL recovery scenarios presented in Figures 5-7 a and b. By examining the flow rate associated with a pumping scenario, the designer can evaluate likely groundwater treatment requirements. For the first example above, the designer can expect around 100 m³/day of water per well to manage and treat. In the second example, the designer can expect less than 10 m³/day of water per well. By using these figures as screening guides the designer can determine:

TABLE 5-2

Model* Simulation of LNAPL Recovery by MPE: Parameters Varied

Soil Parameters		Soil Type		
		Loamy Sand	Silt Loam	Silty Clay Loam
Hydraulic Conductivity (cm/sec)		4.06E-03	1.27E-04	1.98E-05
Air Conductivity (cm/sec)		2.77E-04	8.66E-06	1.35E-06
van Genuchten (alpha)		3.8	0.67	0.37
van Genuchten (n)		2.4	1.7	1.9
Applied Vacuums for "Drained Radius" (mmHg)	3 m (10 ft)		0	0
			187	187
			374	374
			497	497
	6.1 m (20 ft)	0	0	
		93	93	
		187	187	
		374	374	
NAPL Parameters		Type of NAPL		
		Gasoline	Diesel	#2 Fuel Oil
Air-NAPL Scaling Parameters		3.3	2.8	2.8
NAPL-Water Scaling Parameters		1.4	1.4	1.4
NAPL/Water Density Ratio		0.73	0.83	0.87
NAPL/Water viscosity Ratio		0.62	2.7	5.3
*TIMES (Trihydro 1997)				

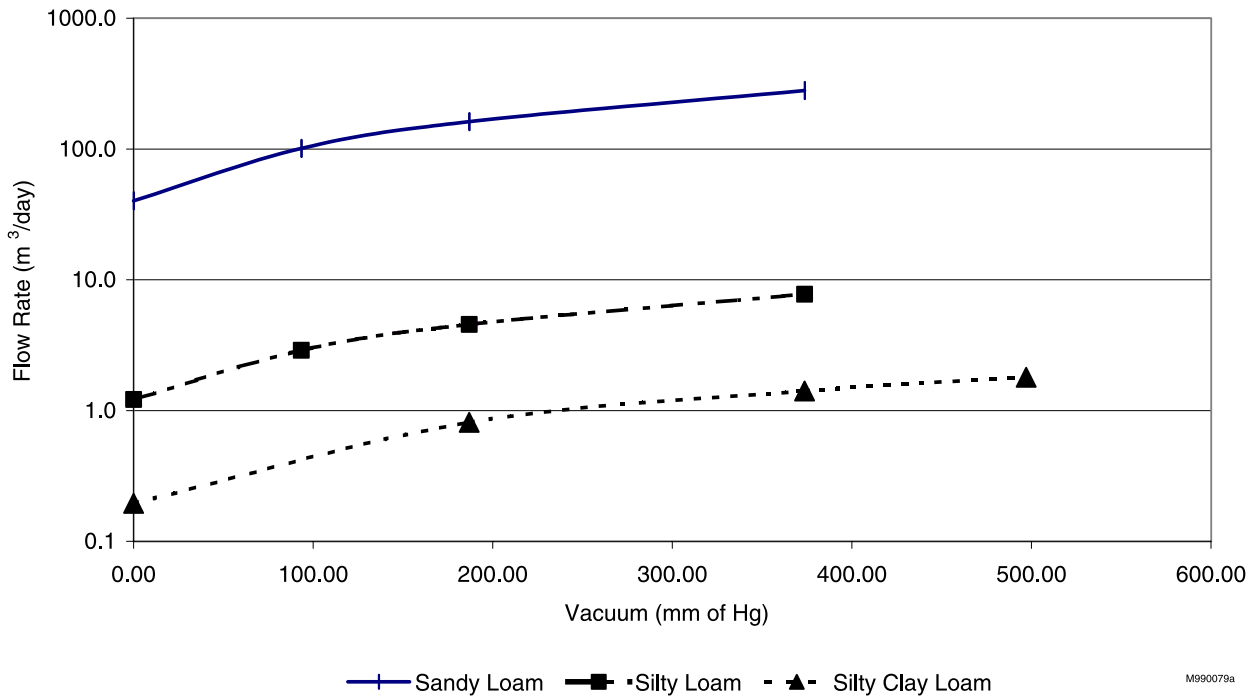

Figure 5-8. Predicted long-term average flow rates from a single well at various applied vacuums and a drawdown of 1 meter (3 feet).

- Whether to proceed in considering MPE as an applicable remediation approach for a specific site.
- Whether more rigorous modeling is desirable (i.e., cost-effective) to develop a site-specific subsurface design.
- The aboveground equipment that will likely be required for the site.

(7) After screening MPE by pilot testing, and preliminary design calculations, more sophisticated computer models can be used to establish the critical design parameters. The model is calibrated to pilot test results by iteratively running the model and making adjustments of parameters within reasonable ranges, beginning with those parameters having the most uncertainty. After achieving calibration to within acceptable criteria, the model is ready to simulate various configurations of extraction point locations and flow rates, zeroing in on an efficient system design that fulfills design criteria, e.g., sufficient contaminant removal within an acceptable time frame. A sensitivity analysis is then performed in which parameters are varied within plausible ranges to determine the effects on predicted flow rates and pressure distributions. The model is used to:

- Estimate water flow rates for the groundwater treatment system design.
- Estimate airflow rate and determine the maximum vacuum to be applied, thus determining the required blower size.

- Evaluate various well configurations to obtain the optimum number and location of vacuum-enhanced extraction wells.
- Estimate the number of pore volumes of air that will be flushed through the system during a given length of time.
- Estimate the mass of contaminant to be removed from the subsurface over time.

c. Vacuum-Enhanced Groundwater Extraction.

(1) As described in [paragraph 2-3e](#), it is sometimes desirable to increase groundwater withdrawal rates by applying a vacuum to an extraction well. The goal for such a system is to enhance the rate of pumping and treating contaminated groundwater compared to conventional pumping systems. The approach toward design of a vacuum-enhanced groundwater extraction system is similar to that for a system designed to accomplish MPE with drawdown to enhance SVE/Bioventing ([paragraph 5-3a](#)). The important differences for vacuum-enhanced groundwater extraction are:

- There is no requirement for pore-volume exchange, therefore the zone of influence for an extraction well is not dependent on a PVER.
- The system design does not have to ensure that a specific degree of dewatering is achieved.
- The vacuums and drawdowns applied to each extraction well will generally be optimized to achieve the optimal groundwater extraction rates while minimizing soil gas extraction rates.

However, as with other MPE approaches, it will be necessary to: select a well network that yields sufficient groundwater flow to achieve the remediation goals; estimate groundwater and soil gas extraction rates for the design of aboveground fluid pumping and treatment equipment; and determine extraction fluid flows to properly size conveyance piping.

(2) As with the previous MPE approaches, the designer can develop a design using simple solutions to the one-dimensional flow equations or by using more sophisticated multi-phase flow models, as described in [paragraph 5-3a](#).

d. Well Screen Length and Depth.

(1) A cluster of different depth MPE wells should be considered in situations where there are notable stratigraphic layers or discontinuities that might cause preferential flow to the extraction well. For example, if there is a 3-m thick contaminated zone that requires remediation, with a discernible difference in permeability between the top 1.5 m and the lower 1.5 m, then it may be desirable to use two wells with 1.5-m screen intervals to extract from the two zones separately. In this way, it may be possible to extract from the lower permeability strata without all of the air or water flowing through the more permeable zone. Caution should be used in cases of low permeability layers as extraction wells screened in such layers may have minimal effect.

(2) The likelihood of experiencing preferential flow increases as the length of the well screen increases. As a rule, MPE well screen intervals should be configured to expose no more than 3 m of screen during extraction. The well screen should extend some distance below the depth of the smear zone and be open to enough of the water-bearing zone to allow development of an adequate cone of depression if groundwater table depression is desired to enhance LNAPL recovery. The well screen must extend into the vadose zone over an adequate interval to allow airflow into the well and to initially draw air from above the capillary fringe. The well screen interval in the vadose zone should not be so large that unwanted air is induced to flow into the well from above the target remediation zone.

(3) For DPE systems that use submersible pumps to extract liquids entering the well, there is a second important factor in determining well depth and screen interval. The DPE well must include a sump that will both accommodate the body of the pump (typically at least 60 cm long below the water level) and the amount of net positive suction head necessary to prevent cavitation in the pump. Net positive suction head (NPSH) is discussed in detail in [paragraph 5-6i](#).

5-4. Modeling. Numerical modeling is an important part of the design, development, and operation of MPE systems by allowing simulation of conditions in the subsurface around the system for different system configurations and for system evaluation. Models vary from simple, order-of-magnitude tools for estimating quantities such as the volume of oil present, to more complex models simulating various well and pressure configurations and their impact on system radius of influence and performance. The models discussed here are intended to simulate flow and transport processes over scales of meters to tens-of-meters; as such they are generally not appropriate for simulating details of multiphase flow occurring within the extraction wells themselves.

a. Currently Available Models. Numerous mathematical models have been developed and computer codes written to simulate subsurface liquid pressure distributions, airflow, transport of water and gas, and extraction. The discussion in this manual is limited to those models which have been developed for more than a specific project, are maintained as practical programs for remedial design, and are usable on IBM-compatible personal computers. Table 5-3 presents an overview of these multi-phase flow models.

Model Name	Model Type and Use	Developer	Computer Requirements	Input Parameters / Assumptions	Output Parameters	Ease of use
ARMOS	2D FE free-phase hydrocarbon migration and recovery	Environmental Systems and Technologies, Inc.	80486 or higher with 8 MB RAM, 10MB free disk space, DOS 3.3 or higher or MS Windows, math coprocessor, VGA graphic adapter and monitor, MS compatible mouse, not compatible with some AST computers or Macintosh computers	Mesh discretization data, water & oil pressure distribution, boundary conditions, soil hydraulic properties, species concentrations, dispersivities, mass transfer rate coefficient between oil and water, distribution coefficient, bulk density, diffusion coefficient, biodegradation parameters	Distribution of fluid pressure with time, distribution of fluid saturation with time, fluid velocity distribution with time, fluid pumping/injection rates and volume vs. time, distribution of concentration, mass dissolved in water or air vs. time, mass remaining in NAPL phase vs. time, mass adsorbed on the solid phase vs. time	moderate
BIOVENTING ^{PLUS}	Windows 95 based program for air injection and extraction remediation design	Environmental Systems & Technologies, Inc.	Intel 80486 based computer, math coprocessor, 8 MB RAM, 12 MB free hard disk space, VGA graphics, Windows 95. A copy of SPILLCAD (standard version) is included with purchase from IGWMC	Airflow model requires ground surface parameters to calculate leakage across it and the mass balance model considers multiphase, multicomponent partitioning and requires appropriate parameters.	Air flow rate and pressure radius of influence, composition and mass recovery vs. number of wells, time to meet cleanup criteria, total cost vs. number of wells.	easy
HSSM	Hydrocarbon Spill Screening Model for LNAPL's in soils, capillary fringe, and ground water (analytical model)	USEPA	Intel 8086 or higher microprocessor, at least 640 KB (low) RAM (preferably 1 MB RAM to run MS Windows in enhanced mode), DOS 5.1 or higher, hard disk with at least 2 MB free disk space, EGA/VGA graphics, MS Windows 3.0 or later, and Microsoft compatible mouse	Includes a soil property regression utility for estimating soil hydraulic properties and a utility for calculating the NAPL/water partition coefficient based on Raoult's law.	Saturation profiles, NAPL lens contaminant mass balance, receptor concentration histories.	moderate
MOTRANS	Finite element LNAPL/DNAPL/water/air flow in cross-sections through saturated/unsaturated zone	Environmental Systems & Technologies, Inc.	IBM PC 386/486 with 8 Mb extended memory, math coprocessor, VGA graphics; SURFER/GRAPHER is required to view or print	NAPL viscosity, porosity, hydraulic conductivity, air-water capillary pressure, water/NAPL surface tension ratio, NAPL characteristics	System pressure, saturations, velocities, concentrations in each phase, total phase volume and total component mass	difficult
RITZ	Regulatory and Investigative Treatment Zone Model. Screening level model for transport of oily waste in soils (analytical model)	USEPA	Intel 80i86 based computer, 640 KB RAM, about 1 MB free disk space, DOS 2.0 or higher, CGA graphics, math coprocessor recommended	Assumes oily waste is uniformly mixed in the plow zone, soil properties are uniform and water flow is steady. Degradation is described as a first-order process. Requires hydraulic conductivity and a water retention curve parameter.	Estimates of the movement and fate of hazardous chemicals during land treatment of oily wastes and evaluates fate of residual oil from leaks and spills.	easy
SPILLCAD	Oil spill volume estimation and remedial design evaluation	Environmental Systems & Technologies, Inc.	Intel 80486 based computer with math coprocessor, 8 MB RAM, about 10MB free disk space, DOS 3.3 or higher, or Microsoft Windows 3.1, VGA graphics	Monitoring well fluid level data and soil sampling data, soil concentration data, soil TPH data, domain geometry, soil hydraulic parameters.	Free product volume, and soil product thickness. Volumes of soil above a threshold, estimates of total mass of a species and estimates of residual hydrocarbon volume, capture zone analysis, estimates of recoverable product from recovery wells, compute water and oil streamlines for steady state water pumping/recharge, determinations of well placement and operation for control of free product or dissolved plumes, estimates of asymptotic recoverable and residual product for different recovery systems	easy

Multi-Phase Flow Models

TABLE 5-3

TABLE 5-3

Multi-Phase Flow Models (continued)

Model Name	Model Type and Use	Developer	Computer Requirements	Input Parameters / Assumptions	Output Parameters	Ease of use
SWANFLOW	3D FD research code for simulating flow of water and a NAPL in saturated/unsaturated systems	GeoTrans, Inc.	Intel 80386/80486 based computer, 4 MB RAM, hard drive with about 3 MB free disk space, DOS 3.0 or higher, math coprocessor	Pressure gradients in the gas phase (air) are assumed negligible, water and NAPL viscosity and density are pressure independent, relative permeability and capillary pressure are functions of water saturations, air saturation if a function of NAPL pressure	Flow, pressure and concentration variations through the model domain	very difficult
VLEACH	1D finite difference model for hydrocarbon leaching in soils	CH2M Hill and Dynamac Corp.	Intel 80i86 based computer, 640 KB conventional RAM, DOS 2.0 or higher, CGA graphics	One-dimensional, can simulate leaching in distinct polygons during each run; polygons may differ in soil properties, recharge rate, depth to water, or initial conditions; assumes a homogeneous soil with uniform, steady-state downward water flow; dispersion is neglected and there is no in-situ segregation or production	Groundwater impact as a function of time and soil concentration profiles (text files)	moderate
MARS 2D/3D	Multi-Phase (Water and Oil) Areal Remediation Simulator	Draper Aden Environmental Modeling	Windows 3.x/95/NT and 4 MB RAM. With Transport requires Windows95/NT and 16 MB RAM	Mesh discretization data, water & oil pressure distribution, boundary conditions, soil hydraulic properties, species concentrations, dispersivities, mass transfer rate coefficient between oil and water, distribution coefficient, bulk density, diffusion coefficient, biodegradation parameters	Distribution of fluid pressure with time, distribution of fluid saturation with time, fluid velocity distribution with time, fluid pumping/injection rates and volume vs. time, distribution of concentration, mass dissolved in water vs. time, mass remaining in NAPL phase vs. time, mass adsorbed on the solid phase vs. time	difficult
MOFAT for Windows	Multiphase (Water, Oil, Gas) Flow and Multicomponent Transport	Draper Aden Environmental Modeling	Windows 3.x/95/NT and 8 MB RAM	Mesh discretization data, water & oil pressure distribution, boundary conditions, soil hydraulic properties (may be estimated using DAEM's SOILPARA), species concentrations, dispersivities, mass transfer rate coefficient between oil and water, distribution coefficient, bulk density, diffusion coefficient, biodegradation parameters	Distribution of fluid pressure with time, distribution of fluid saturation with time, fluid velocity distribution with time, fluid pumping/injection rates and volume vs. time, distribution of concentration, mass dissolved in water or air vs. time, mass remaining in NAPL phase vs. time, mass adsorbed on the solid phase vs. time	difficult
MOVER	Multiphase (Water, Oil, Gas) Areal Flow with Vacuum Enhanced Recovery	Draper Aden Environmental Modeling	Windows 3.x/95/NT and 8 MB RAM	Mesh discretization data, water and oil pressure distributions, specified head and flux boundaries, source/sink boundary: soil hydraulic properties include van Genuchten parameters, hydraulic conductivity distribution and porosity	Distributions of fluid pressure and saturation with time, fluid velocity distribution with time, pumping/injection rates and volume with time, output can be used to simulate multicomponent aqueous phase transport using BIOF&T 2D/3D	difficult

Model Name	Model Type and Use	Developer	Computer Requirements	Input Parameters / Assumptions	Output Parameters	Ease of use
BioSVE	Incorporates soil vapor extraction, vacuum enhanced recovery and biodegradation into one screening model	Draper Aden Environmental Modeling	Windows 3.x/95/NT and 4 MB RAM	Air pumping rate, total mass of the spill, maximum simulation time, time increment parameters, soil air temperature, venting efficiency, bio efficiency, volume of contaminated soil, soil bulk density, fraction of organic matter in the soil, free product recovery parameters, species properties including: molecular weight, vapor pressure, mass fraction, boiling point, aqueous solubility, and Kow (oil-water partition coefficient)	Species mass in water, oil, gas, and solid phases versus cleanup time, total species mass versus cleanup time, total contaminant mass versus cleanup time	moderate
BIOSLURP	Areal finite-element model to simulate three-phase (water, oil, and gas) flow and multicomponent transport in ground water in the unsaturated zone gas phase	Draper Aden Environmental Modeling	Windows 3.x/95/NT and 8 MB RAM	Initial fluid pressures, species concentration distribution, and free oil volume are estimated internally from monitoring well data	Distribution of fluid pressure, distribution of fluid saturation, fluid velocity distribution, distribution of concentration	moderate
AIRFLOW/SVE	A radial-symmetric model for simulating soil vapor flow and multi-component vapor transport in the unsaturated zone	Waterloo Hydrogeologic Software	IBM PC 386/486 with minimum of 4 Mb RAM, EGA or VGA display, and a math coprocessor	Permeability, initial pressures, gas characteristics, temperature	Soil pressure distribution, total system flow	easy
TIMES 2.0	Visual and interactive groundwater modeling system that integrates numerical groundwater models with data visualization	TriHydro Corporation	Windows95/NT and 16 MB RAM	Mesh discretization data, water & oil pressure distribution, boundary conditions, soil hydraulic properties, species concentrations, dispersivities, mass transfer rate coefficient between oil and water, distribution coefficient, bulk density, diffusion coefficient, biodegradation parameters	Distribution of fluid pressure with time, distribution of fluid saturation with time, fluid velocity distribution with time, fluid pumping/injection rates and volume vs. time, distribution of concentration, mass dissolved in water or air vs. time, mass remaining in NAPL phase vs. time, mass adsorbed on the solid phase vs. time	moderate
OILVOL	Estimates the free hydrocarbon volume in a soil and computes the volume of residual NAPL in the saturated and unsaturated zones	Draper Aden Environmental Modeling	Windows 3.x/95/NT and 4 MB RAM	Depth to air-oil and oil-water interfaces measured in monitoring wells, van Genuchten soil moisture retention parameters (can be estimated with SOILPARA), and fluid properties	Free product (true product) volume, and residual oil volume after skimming	easy
SOILPARA	Estimates hydraulic parameters in the van Genuchten constitutive model (Brooks-Corey parameters can be estimated from these) for variably saturated soils	Draper Aden Environmental Modeling	Windows 3.x/95/NT and 4 MB RAM	Retention data and/or conductivity or diffusivity data (K or D vs. soil water content/pressure), or soil texture (percentage sand/silt/clay, or USDA-recommended typical parameter values for various texture classes	Hydraulic parameters in the van Genuchten constitutive model (Brooks-Corey parameters can be estimated from these)	easy
MAGNAS	2-D and 3-D finite element transport of water, NAPL, and air through porous media; can simulate the flow of air as a fully active phase	HydroGeologic Inc. 1165 Hernadon Parkway, Suite 900, Hernadon, VA 22079 703/478-5186	IBM PC/AT compatible computer, DOS	Heterogeneous and anisotropic media properties, capillary pressures and permeability	Breakthrough curves of concentration vs. time, flow and transport mass balances	difficult

Multi-Phase Flow Models (continued)

TABLE 5-3

b. Criteria for Model Selection. While a large number of MPE model codes have been written, those which are generally available can be classified into four main groups (Table 5-4) in terms of generality and complexity. Use of the simplest appropriate model for a given design objective will save time and budget (Table 5-5). A more complex and general model can be used in simpler situations, but typically at the cost of a steeper learning curve and greater difficulty in setup and calibration. More complex models may require a more detailed site characterization to obtain the input parameters necessary. Some complex models require input parameters that are typically not determined in a site investigation.

TABLE 5-4

Classification of Multi-phase Flow Models

Model Class	Phases in Model ¹	Spatial Dimension	Flow	Aqueous Transport	Vapor Transport	Bio	Ease of Use	Representative Model Codes
A	Water, Oil	2D Areal	Yes	No	No	No	High	ARMOS, MARS ²
B	Water, Oil, Air	2D Areal	Yes	TIMES only	No	No	High	TIMES, MOVER, ARMOS/AIR
C	Water, Oil, Air	2D Areal	Yes	Yes	Yes	Yes	Mode - rate	BIOSLURP, BIOVENTING
D	Water, Oil, Air	2D planar, 2D vertical, 3D	Yes	Yes	Yes	No	Low	MOFAT, MOTRANS, MAGNAS, T2VOC

¹ Phases explicitly determined in each cell, i.e. 2-phase (oil, water) models only account for a static, uniform vapor phase with no applied vacuum effects.

² MARS can be linked to the 2D/3D aqueous transport model BIOF&T to add aqueous transport and biodegradation reactions capabilities

TABLE 5-5

Multi-Phase Model Classifications Applicable to Specific Remedial Scenarios

Pumping Scenarios	Remediation / Design Objectives [†]					
	Determine Area of Pumping Well Influence	Optimize De-watered Zone Volume	Optimize Product Recovery	Optimize Mass Removal	Optimize Contaminant Concentration Reduction	Simulate Smear Zone Development
Groundwater Recovery	A	A	A	B ²	A ¹ , C	D
Product Skimming	A	A	A	B ²	A ¹ , C	D
Total Liquid Recovery (Oil + Water)	A	A	A	B ²	A ¹ , C	D
Multi-phase (TPE or DPE) Recovery (Oil + Water + Air) (e.g. Slurping)	B ²	B ²	B ²	B ²	C	D

TABLE 5-5

Multi-Phase Model Classifications Applicable to Specific Remedial Scenarios (Continued)

Pumping Scenarios	Remediation / Design Objectives [†]					
	Determine Area of Pumping Well Influence	Optimize De-watered Zone Volume	Optimize Product Recovery	Optimize Mass Removal	Optimize Contaminant Concentration Reduction	Simulate Smear Zone Development
Vacuum-enhanced Groundwater Recovery	B ²	B ²	B ²	B ²	C	D
Vacuum-enhanced Product Skimming	B ²	B ²	B ²	B ²	C	D
Vacuum-enhanced Total Liquid Recovery	B ²	B ²	B ²	B ²	C	D
Vacuum-enhanced Soil Vapor Extraction	B ²	B ²	B ²	B ²	C	D
[†] Model Classes A, B, C and D refer to Table 5-4. ¹ Inclusion of aqueous contaminant transport +/- biodegradation would require use of MARS + BIOF&T ² Class C models would generally be easier to apply here, unless peculiarities in the vertical profile or significant departures from sharp oil-water and oil-air interfaces require a class D (true 3D or vertical radial 2D) model.						

(1) The first group of models simulates the two-dimensional areal flow of an oil phase and a water phase. Air is not considered explicitly, so that variations in air pressure from such mechanisms as vacuum enhancement cannot be calculated at the same time as variations in pressure in co-existing NAPL and water. These simpler models also do not generally include transport of dissolved or vaporized contaminants, but are relatively simple and fast to calibrate and run. The next step up in complexity adds explicit calculation of an air phase to those of NAPL and water. This is necessary to fully consider the effects of vacuum enhancement, where air pressure must vary from a vacuum extraction well towards its surroundings. This class of models still consists of 2D areal models in which the properties of each phase are integrated vertically from one sharp inter-phase boundary to another. While sharp oil-air or oil-water boundaries, for example, are not realistic in detail, this assumption can be a reasonable simplification in many cases and greatly improves model performance. This class of models may or may not include aqueous transport of contaminants along with multi-phase flow. In the third class of models, the previous areal 3-phase models are augmented with a number of species transport and reaction options, including aqueous and vapor-phase transport as well as biodegradation reactions from simple first-order decay to higher-order decay rates. These options can be important when total reduction in contaminant concentrations needs to be simulated, rather than just radius of MPE influence or extraction rate of product.

(2) When the assumption of sharp inter-phase boundaries made by the areal models is inappropriate, a fourth class of models is necessary in which 2D cross-sectional (assuming radial symmetry) or fully 3D model domains are possible. While such models allow for mixed-phase model zones and other vertical heterogeneities to be accurately simulated, the model codes are

generally more difficult to calibrate and run. Fully 3D multi-phase model codes are generally considered not to be of practical use on personal computers for more than a quite limited model domain (e.g. 3 to 9 m).

c. Methodology for Model Development.

(1) Once the objectives of an MPE model have been specified, the appropriate modeling tool can be selected and a model developed. A screening level tool to estimate LNAPL volumes or order-of-magnitude well and flow information can be used quickly with gross generalizations about the site.

(2) More refined multiphase models are generally finite element, two-dimensional models that assume vertical homogeneity within each phase. These models employ complex numerical methods, thus requiring the skills of experienced modelers.

(3) At a minimum, the same kinds of data must be known or assumed about an area as would be required for a groundwater flow model. Groundwater modeling is discussed in detail in Anderson and Woessner (1992). When modeling more than one phase, however, additional information must be known or estimated:

- The ratio of the density of LNAPL to the density of water.
- The ratio of the viscosity of LNAPL to the viscosity of water.
- The LNAPL-water scaling parameter (USEPA 1996b).
- The LNAPL-air scaling parameter (USEPA 1996b).
- The extent and thickness of the LNAPL plume.

(4) If the objectives of the model warrant modeling of dissolved transport then the solubilities of the separate phase components in water must also be known.

(5) The designer of an MPE system is encouraged to make use of airflow in addition to water flow modeling. Several models on the market include air as a third phase in the multiphase model. This is especially important for MPE systems as the changes in air pressure that result from application of a vacuum affect the water and LNAPL heads in the vicinity of the extraction wells. The information required to handle the air phase in most models includes:

- The horizontal and vertical air conductivity.
- The applied vacuum.

(6) Air (also termed pneumatic) conductivity may be calculated from hydraulic conductivity by first calculating the intrinsic soil permeability (a soil parameter independent of fluid that can be calculated from hydraulic conductivity using the density and viscosity of water). The air conductivity can then be calculated by using the same equation relating permeability to conductivity but substituting in the density and viscosity of air. Moisture content must also be considered in determining air conductivity.

(7) If a groundwater model is selected because it is on hand and because users are familiar with it, it may be possible to apply it to model airflow as the primary phase. If the maximum pressure difference between any two points in the flow field is less than approximately 0.2 atmospheres, the differential equations developed to model groundwater flow provide good approximations to gas transport. Vapor extraction and MPE systems generally operate under pressure differences in the formation on the order of 0.2 atmospheres or less. Even at differences of 0.5 atmospheres, the error may only be on the order of 10 percent. Analytical and numerical groundwater flow models can therefore be used to model vapor and gas transport if the proper set of input variables is defined (Massmann 1989). The conceptualization of airflow, however, is significantly different than it is for water flow in a numerical model, and care must be taken to ensure that parameter values and boundary conditions are appropriate.

(8) When developing a model with the primary phase being air, the lower boundary of the model domain is assumed the same as the water/oil potentiometric surface. The model is generally set up to be a semi-confined system, with the upper boundary of the model set to be a head-dependent flow boundary. The conductance of that boundary is equal to the vertical air conductivity of the surface seal divided by the thickness of that seal (often 5 cm of pavement). The head associated with the upper boundary must be specified to be significantly higher than the elevation of that boundary to ensure the model cells do not "go dry." The vertical and horizontal conductivities in the model must be equal to the air rather than the hydraulic conductivities. The extraction wells may be simulated with constant head cells where head is specified to be equal to the head at the bottom of the unsaturated zone model, minus the vacuum pressure. A model set up in this fashion may be used to predict air pressure and flow rates through the model domain.

(9) Numerical models may also be applied to simulating the behavior of DNAPL, either as a single contiguous phase or as one of multiple phases in a multiphase model. This may be practical where DNAPL forms a thick continuous blanket over a relatively uniform confining surface. Success in modeling DNAPL is rare, however, because DNAPL rarely behaves as a single saturated contiguous phase (paragraph 3-5b). DNAPL is more likely to move through the subsurface as a complex discontinuous system of stringers, pools, and residual patches whose mobility is controlled by soil heterogeneities at a scale far below that considered by applicable multiphase models.

d. Use of Models to Evaluate System Performance. Numerical models are clearly useful in the design of MPE systems, by validating a set of assumptions and parameter estimations used in the system design and testing process. Following system startup and during system operation, there are certain system parameters such as well pressures and extraction rates that no longer need to be simulated but can be measured directly. Much of the subsurface domain undergoing remediation will nonetheless remain a black box whose characteristics cannot practically be monitored in detail. For example, the true distribution of remaining product or of soil permeability between extraction wells may be difficult or impossible to determine but clearly can have dramatic significance for future system performance.

(1) It can be of great value during system operation to continue using a model that had already been set up and calibrated for system design and testing. By maintaining a dynamic calibration of the model to current system monitoring data, it is often possible to understand the causes of presently observed trends in system performance as well as to anticipate future ones such as decreases in mass recovery rates. Other uses for a dynamically calibrated model include predicting the effects of unanticipated events such as system

shutdowns, evaluating the effects of system refinements, and updating estimates of time to cleanup.

(2) One way to look at such a numerical model is as an operating representation of the site conceptual model that is the basis for MPE system design. An on-going comparison between model behavior and actual system behavior may be the quickest way of detecting when assumptions underlying MPE system behavior, such as airflow paths or product viscosity, may no longer be valid. A good indication of this may be when certain model parameters are frequently changed to maintain dynamic model calibration. If this occurs, the model then becomes a ready-to-use tool for investigating whether modifications to the site conceptual model are warranted and how best to modify system operation in response. The model codes listed in Table 5-3 are grouped here into four broad classifications according to the phases they explicitly consider, the number of spatial dimensions, and what types of contaminant transport/reaction are considered. Table 5-5 presents multi-phase model classifications applicable to specific remedial scenarios. For each combination of pumping scenario and remediation / design objective, the model class with the minimum required complexity is indicated.

5-5. Multi-Phase Extraction System Well Construction and Specifications.

a. Introduction. This section provides guidance on design and specification of proper well/trench construction for multi-phase fluid extraction and system monitoring. This guidance is not comprehensive and must be adapted as necessary for site-specific conditions and objectives. Specific requirements for design of soil vapor extraction wells are provided in EM 1110-1-4001, Soil Vapor Extraction and Bioventing. Detailed guidance on monitoring well construction is provided in EM 1110-1-4000, Monitor Well Design, Installation, and Documentation at Hazardous and/or Toxic Waste Sites. Guide specifications for well construction are available through the U.S. Army Corps of Engineers Guide Specification (CEGS) system, including CEGS 02671 Wells for Monitoring Ground Water and CEGS 02670 Water Wells. These can be modified for typical multi-phase fluid recovery applications.

b. Applicable Standards. The guide specifications reference the appropriate industry standards for materials and testing procedures. The designer should assure that these references are appropriate for specific projects. The designer must assure that appropriate state and local well construction regulations are referenced in the specifications.

c. Contractor Qualifications. Competent professionals, drillers, and installers are required for successful installation of wells and trenches. Minimum criteria for these personnel must be identified in the specification.

(1) Well Installation. The level of experience of the contractor's well driller and hydrogeologist (or engineer) directing the well installation should be specified. It may be necessary to specify state registration or certification where required.

(2) Horizontal Well/Trench Installer Qualifications. There may be special requirements for the operators of the trenching machine or horizontal drilling rig, such as a minimum number of months or years experience. A registered or licensed driller may be necessary.

d. Multi-phase Fluid Recovery Well Design. Multi-phase fluid recovery wells are intended to capture any combination of groundwater, free product, and air. This section provides a checklist of topics to be covered in design and specification for such wells. Typical requirements are discussed under each topic. The typical construction of vertical multi-phase extraction wells is illustrated in Figure 5-9.

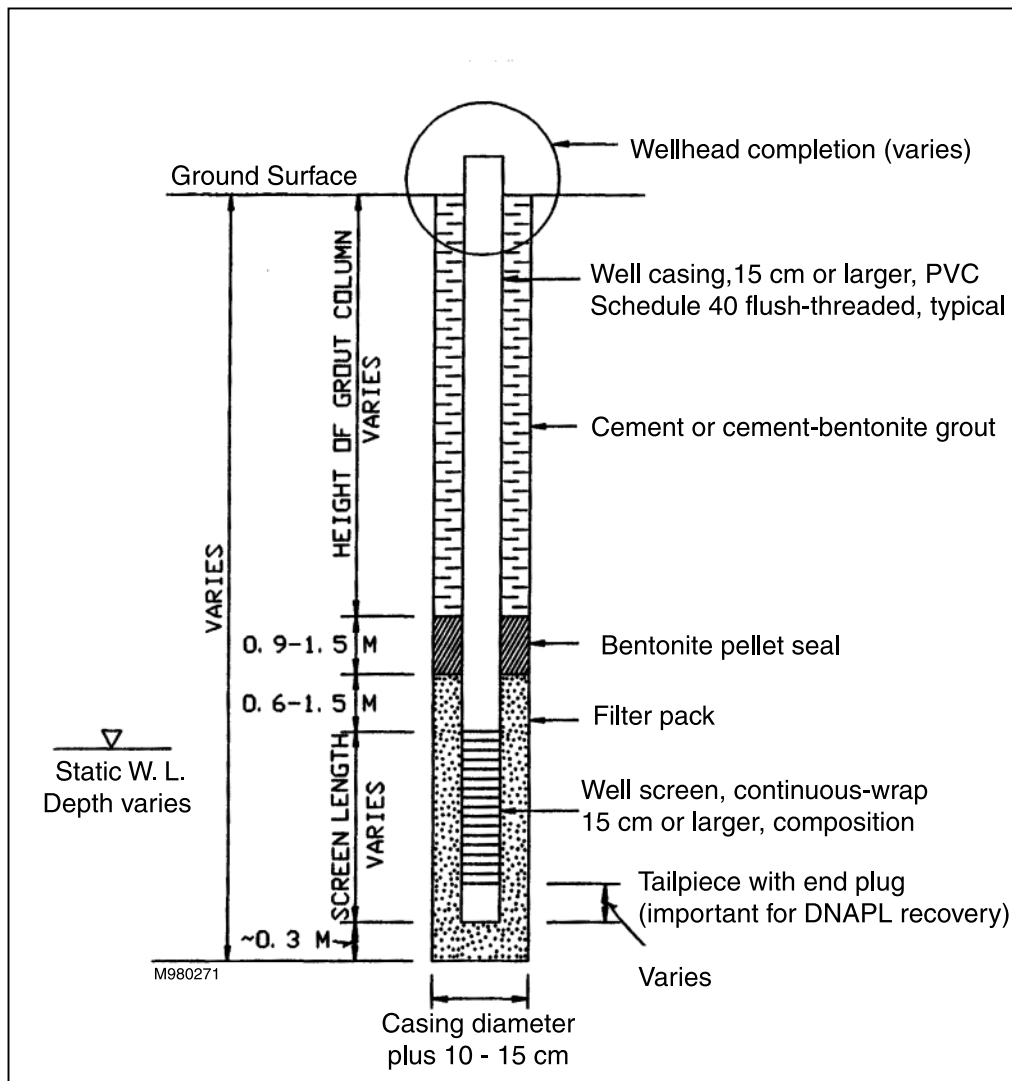

Figure 5-9. Multi-phase Extraction Well Detail.

(1) Materials. The materials used for multi-phase fluid recovery wells will generally depend on site conditions and project objectives. Composition of the materials will depend on the subsurface geochemistry including the natural constituents and contaminants.

(a) Casing. For many applications, schedule 40 PVC well casing is adequate. A reference to ASTM D 1785, Standard Specification for Polyvinyl Chloride (PVC) Plastic Pipe, Schedule 40, 80, 120 or ASTM F 480, Standard Specification for Thermoplastic Water Well Casing Pipe and Couplings Made in Standard Dimension Ratio (SDR), is appropriate. If high levels of liquid organics are to be encountered by the casing, the compatibility of the casing material with the fluids must be considered. Require stainless steel (generally schedule 5S or 10S, type 304) if PVC will be degraded by the product. A reference to ASTM A 312, Standard Specification for Seamless and Welded Austenitic Stainless Steel Pipe, is recommended. Alternatively, PVC may be preferred in an environment that is highly corrosive to metals. The well can be a "hybrid" of PVC casing and stainless steel screen. PVC casing exposed to sunlight should be protected or treated to withstand ultraviolet radiation without becoming brittle. Casing diameter is generally dependent on pump space requirements. Dual-phase pumps usually require a minimum of 15 cm (6 in) inside diameter; larger pipe diameters allow easier pump installation. If only groundwater and air are to be removed, groundwater pumps as small as 5 cm (2 in) in diameter capable of pumping 0.04 m³/min (10 gpm) are available. Wells in which small diameter groundwater recovery pumps or drop tubes are installed should be at least 10 cm (4 in) in diameter to provide higher well efficiency. Generally, 15 cm (6 in) diameter or larger wells are recommended. The specifications should require casing with flush-threaded joints and o-ring seals. A well sump, 0.6 to 3 m (2-10 ft) long and constructed of the same casing materials, should be incorporated in wells designed for DNAPL recovery. It should be noted however, that regulatory agencies may not approve of installation of a sump in a DNAPL recovery well where drilling into an aquitard that is preventing DNAPL from migrating further vertically is required. In such a case, it may be possible to modify submersible pumps to make them bottom-loading, enabling DNAPL recovery in a well without a sump.

(b) Screen. Well screen is usually PVC, but as noted above, other materials may be more appropriate. The use of continuous-wrap "v-wire" screen is strongly recommended. Screen slot size is designed based on the formation material and filter pack gradation according to methods outlined in Driscoll (1986) or similar reference. Different slot sizes can be used in different portions of the screened interval if the producing formation varies in soil gradation. The screen slot-size selection for the portion of the well likely to be placed above the typical location of the capillary fringe can be selected based on guidance given in EM 1110-1-4001, Soil Vapor Extraction and Bioventing. If the gradations of the producing formation have not been determined during design, the contractor should obtain samples during drilling. Require the contractor to run gradations according to an appropriate method (e.g., ASTM D 422 Standard Method for Particle-Size Analysis of Soils) and size the screen slot (and filter pack, discussed below) accordingly. Screens with flush-threaded joints and o-ring seals are preferred.

(c) Filter pack. The requirements for filter pack for this application are generally more critical than for SVE wells because the filter pack plays a more significant role in reducing entrainment of fine sands, silts, and clays in the produced fluid. As described above, the filter pack gradation should be chosen based on the gradation of the producing formation. Design should follow methods outlined in Driscoll (1986) or similar reference. If only groundwater and air are to be recovered, require the chosen filter pack to have a uniformity coefficient of 2.5 or less. A less uniform filter pack may be appropriate if non-wetting fluids, such as hydrocarbons, are to be recovered or

in those cases involving fine grained, low-yield soils, where the formation may yield significant amounts of fine material through a uniform filter pack. In this case, a uniformity coefficient greater than 2.5 may be specified; however, the uniformity coefficient must not exceed the uniformity coefficient of the typical formation. Require rounded to subrounded siliceous particles, free from organic matter and calcareous or elongated particles. If free product recovery is of primary concern, a special filter pack that includes hydrophobic materials, such as ground high density polyethylene (HDPE) or polytetrafluoroethylene (PTFE, Teflon[®]), may improve the early rates of product (LNAPL and DNAPL) recovery (Hampton et al. 1993). In certain (relatively rare) circumstances, a well can be designed that does not include filter pack, but develops a natural filter pack. Thorough well development can selectively remove fines from the native formation material and leave coarser native sands and gravel around the well as a natural pack.

(d) Seal and grout. A well seal is necessary to prevent entry of grout into the filter pack and well screen. Unamended sodium bentonite, as pellets, granules, or a high-solids bentonite grout, is normally specified for the seal material. The use of bentonite chips is not acceptable for most applications. Since most applications will involve the extraction of groundwater and either floating product or soil gas, the well seal will be above the water table and pellets or granules must be hydrated with clean water added to the annulus. A cement grout is normally required above the bentonite well seal. The mixture of the grout should be specified and is normally one 43-kg (94-lb) bag of cement, (optionally with up to 2.3 kg (5 lb) of bentonite powder to further resist cracking), with less than 0.03 m³ (8 gal) of clean water. Reference ASTM Standard C150, Standard Specification for Portland Cement, as appropriate. In the event that the seal will be placed below the water table, the use of bentonite pellets is preferred.

(e) End caps and centralizers. Flush-threaded end caps, consistent with the casing and screen in size and material, should be specified. Centralizers center the well in the borehole and must be a size appropriate for the casing and borehole. Select centralizers made of material that will not lead to galvanic corrosion of the casing. For DNAPL recovery wells, a funnel-shaped "basket" can be placed outside the bottom of the well screen at the base of the filter pack that directs product flowing downward within the filter pack into the well (Niemeyer et al. 1993).

(2) Installation.

(a) Test holes. Careful design of the filter pack, screen slot size, and screen location needs to be based on site-specific conditions. It may be necessary for the contractor to drill test holes at the proposed well locations to obtain boring logs and samples for gradation analyses.

(b) Drilling methods. There are many methods for drilling. Drilling methods can be proposed by the contractor or specified. Avoid mud-based drilling fluids if possible because of the difficulty in developing the zone containing floating product. The use of water-based fluids can also impede product recovery because the water can displace the hydrocarbon near the well and disrupt continuous hydrocarbon flow pathways. Auger, air-rotary, dual-wall air casing-hammer, rotosonic, or cable tool drilling may be acceptable, depending on site conditions. Choose drilling methods that minimize smearing of fines on the air- or product-bearing interval. Require that all equipment be decontaminated and disinfected before drilling at each location.

(c) Soil sampling and logging. Sampling of soils encountered during drilling increases understanding of the subsurface and allows better decisions to be made about well construction, including screen placement. Require sampling of soils at regular intervals, at least every 1.5 m (5 ft); sometimes, continuous sampling is appropriate. Samples should be obtained by appropriate method such as split spoon sampler or thin-walled tube according to ASTM D1586, Standard Method for Penetration test and Split-Barrel Sampling of Soils, or D1587, Thin-Walled Tube Sampling of Soils, respectively. Consider sample volume requirements when specifying the sampling method. Require that sampling for chemical and physical analyses be done according to an approved sampling and analysis plan. Strongly recommend a drilling log be prepared by a geologist or geotechnical engineer. Materials encountered should be described according to a standard such as ASTM D2488, Standard Practice for Description and Identification of Soil (Visual-Manual Procedure). Geophysical logging may be appropriate for borings that extend into the water table. Electrical and gamma ray logs can help identify coarser materials for screen placement and can supplement or reduce soil sampling. This can reduce the time needed to drill and sample the hole. Refer to [EM 1110-1-1802](#), Geophysical Exploration for Engineering and Environmental Investigations, for further information on geophysical logging.

(d) Borehole diameter and depth. Specify the dimensions of the borehole for well installation. The diameter must be approximately 10 to 15 cm (4 to 6 in) greater than the diameter of the casing and screen to allow placement of the filter pack. If the well is to be naturally developed, a smaller borehole diameter is acceptable. Note that in fine-grained formations, natural development is problematic. The depth of the borehole should be based on the screen depth. The borehole should only extend to a foot below the projected bottom of the screen (or DNAPL sump, if part of the well design, paragraphs [3-8g\(4\)](#) and [5-5d\(1\)\(a\)](#)).

(e) Screen and casing placement. Casing and screen must be cleaned and decontaminated before placement. Disinfection of materials may also be desirable. Screen and casing should be joined by flush-threaded joints and suspended in the center of the borehole. To maintain plumbness and alignment, the string should not be allowed to rest on the bottom of the hole. Centralizers should be placed on the casing at regular intervals if the depth of the well exceeds some minimum value such as 6 m (20 feet).

(f) Filter pack placement. The specification should require the filter pack to be placed using a decontaminated tremie pipe. Since much, if not most, of the filter pack is placed below the water table, the tremie pipe should be kept within 0.6 to 3.0 m (2 to 5 feet) of the surface of the placed filter pack. This prevents the pack material from bridging or segregating by size while falling through the water column. Measure the level of the pack material following placement. Approximately 0.3 m (1 ft) of filter pack should be placed in the borehole below the bottom of the screen to act as a cushion for the screen and casing. Filter pack material should extend 0.6 to 3.0 m (2 to 5 feet) above the top of screen to allow for settlement so native material will not collapse around the screen. Gentle agitation of the water within the well during or after filter pack placement can help ensure full settlement before grouting. Store and handle the pack material carefully to avoid contamination from undesirable materials.

(g) Seal and grout placement. The grouting of the well is critical to preventing vertical migration of contaminants along the wellbore and short circuiting due to air leakage from the ground surface if vacuum is applied. Normally 0.9 to 1.5 m (3 to 5 ft) of a bentonite well seal are placed above the filter pack. If the well seal is to be placed above the water table, the specification should include a requirement for hydrating the bentonite before

placement of the grout. The specification should require the addition of a volume of distilled or potable water for every 15-cm (6-inch) lift of bentonite pellets or granules. The bentonite should hydrate for at least three to four hours before placing the grout. This can be avoided by specifying the use of a bentonite high-solids grout as the seal. Place the high-solids bentonite grout by tremie pipe. Cement grout should also be pumped into annular space via a side-discharge tremie pipe and the pipe should be kept submerged in the grout during grout placement. If the grout is to be placed to a depth of less than 4.6 m (15 ft), the grout may be poured into place directly from the surface. If the well seal is to be placed below the water table, allow the bentonite pellets to hydrate in place for three to four hours before grouting the well. Fine sand can be placed above the bentonite pellets to further prevent grout intrusion.

(h) Surface completion. The extraction of multiple phases from a single well will require specification of a suitable wellhead. Provisions may be needed in the wellhead for multiple discharge pipes, electrical leads, compressed air or vacuum lines, control leads, and sampling ports. Compression grommets with rubber or viton seals that squeeze around electrical conduit, drop tubes, etc. when the compression fitting is tightened are used to seal the well penetrations. If finished above grade, the well may require suitable protection, such as a small wellhouse and bollards, to avoid damage to the well and equipment from vandalism, traffic, etc. A well vault may be required.

(i) Well development. Well development is critical to the ultimate performance of the well. A careful specification of the acceptable development methods and development criteria is strongly recommended. Require the water-bearing interval of the well be developed by surging and bailing using a suitably sized surge block or jetting at appropriate water velocities. The development of the water-bearing zone should continue until the well is producing clear water with less than 2 to 5 ppm by weight sand and/or other suspended solids. A turbidity criterion defined as less than 5 Nephelometric Turbidity Units (NTUs) determined by a nephelometric turbidity measurement method can be used. Such criteria may not be appropriate or feasible in fine-grained formations. Establishing some required level of effort (e.g., development time) may be an acceptable option in those cases. Sometimes, the use of dispersing agents such as phosphates can help develop wells by breaking down clay smears on the borehole walls. The regulatory authorities may need to approve dispersing agents or other additives such as acids. Note that jetting or other development techniques that use water can dramatically affect product recovery by disrupting floating hydrocarbon flow pathways. Do not use jetting (or surging) in the product-bearing zone. The use of surfactants in development of the product-bearing zone may also improve product recovery by reducing pore-scale NAPL/water interfacial tension barriers to product flow. In rare cases, and only with regulatory agency approval, introduction of previously recovered product into the well may improve product recovery by increasing product saturation in the filter pack and surrounding formation. Development is conducted after placement of the filter pack and before or after grouting the well. Development before the grouting of the well will ensure that the filter pack is fully settled before grout placement, thus assuring no voids would be created; however, the potential exists for cross-contamination while the well annulus is open above the pack. Normally, conduct development after grouting.

(j) Disinfection. In some cases, biological encrustation has caused severe degradation of performance of extraction wells. Contaminated sites often provide ample food for microorganisms that can plug well screens. Disinfection of the drilling tools and the well itself can help prevent or slow these problems. Disinfection can be done by various means (refer to Driscoll 1986; AWWA A100, Section A1-A10), including creating a specified concentration

of a strong oxidizing agent, such as sodium hypochlorite, in the well. Consider the chemical ramifications of any additives. Consult with the project chemist to evaluate possible dangerous or undesirable reactions that may occur between the groundwater constituents and the disinfecting reagents.

(k) Surveys. Establish the horizontal coordinates of the well by survey. Survey the elevation of the top of the casing to provide accurate groundwater elevations. The accuracy of the surveys depends on the project needs, but generally is to the nearest 0.3m (1.0 ft) for the horizontal coordinates and the nearest 0.003 m (0.01 ft) for elevation.

(3) Permits. Identify the well and construction permits needed from local agencies. These are usually obtained by the contractor. Utility clearances are also typically required.

e. Soil Gas/Vacuum Monitoring Points and Monitoring Wells. Refer to [EM 1110-1-4001](#) for guidance on the design and construction of soil gas/vacuum monitoring points. Refer to [EM 1110-1-4000](#) for guidance on the design and construction of groundwater monitoring wells.

f. Horizontal Wells. Horizontal wells or drains can be used for multi-phase recovery provided adequate steps are taken to assure proper depth. Horizontal wells can be used for the simultaneous recovery of water and product if the well can be installed near the NAPL/water interface. The well acts as a drain for both product and water. Provided the liquids can be removed at an adequate rate to result in open-channel flow in the well, air could also be extracted at the same time. Horizontal wells can be used to recover product under structures (provided adequate steps are taken to avoid damage to foundations) or as an alternative to trenches if the creation of contaminated trench spoil is problematic. Depth control is critical for multi-phase extraction. Poor depth control can cause inconsistent product, air, or water production due to high and low spots in the screened interval. Refer to USEPA (1994) and other USACE guidance on horizontal wells for additional design and installation information.

(1) Materials. Differences between horizontal and vertical applications are discussed below.

(a) Casing. Although PVC casing is commonly used, flexible or rigid polyethylene pipe may be more efficient for certain placement methods. Reference appropriate ASTM standards for PVC pipe or ASTM D3350 for polyethylene plastics pipe and fittings materials. The casing can be joined by threaded coupling or thermowelds, as appropriate for the material. Pipe sizes of 50 to 200 mm (2 to 8 inches) are typically used. Larger diameters than typically used in vertical wells may be required because of the potentially larger flow rates and better recovery of multiple phases. Larger pipe sizes allow easier access for development, surveys, and maintenance.

(b) Screen. Avoid using drainpipe wrapped with geotextile or other filter-like material because of the potential for fine material to plug the openings. Perforated piping is more difficult to develop and rehabilitate than continuous slot screen. Prepacked well continuous-slot screens have been successfully used in recovery applications. Prepacked screens are really two screens enclosing preselected filter pack material. The use of prepacked screen can overcome the difficulties of installing filter pack within a horizontal well. Stainless steel prepacked well screen is typically used instead of PVC because its greater strength allows it to withstand the stresses of placement. There are porous materials, including porous sintered

polyethylene, that have also been used very successfully as screen and filter pack in horizontal wells.

(c) Bedding material/filter pack. If a filter pack is to be placed around the horizontal well screen, it should be sized according to the formation, as it is for vertical wells. Filter pack is difficult to place uniformly in horizontal wells.

(d) Development. Horizontal wells are more difficult to develop than vertical wells. Jetting has been most commonly used. As discussed for vertical recovery wells, jetting should not be used in the product-bearing zone. If the horizontal well is to be used for LNAPL recovery, any development should be done before the product is drawn to the level of the well. Development of a DNAPL recovery trench is problematic. Best results may be obtained without any development.

(2) Installation. Installation methods vary significantly depending on drilling method. Refer to EPA (1994) for additional information. The use of bentonite-based drilling fluids is discouraged. Degradable additives, such as guar-based products are preferred.

g. Recovery trench. Recovery trenches can be used effectively at sites with shallow product and groundwater. The placement of a recovery trench can be accomplished by several methods including normal excavation or trenching machines (which excavate and place pipe and filter pack in one pass).

(1) Materials. Materials specified for recovery trench construction are often similar to those specified for horizontal wells. Different materials may be needed if specialized trenching methods or machines are used. Differences between trench and vertical/horizontal well applications are discussed below.

(a) Casing. Although PVC casing is commonly used, flexible or rigid polyethylene pipe may be more efficient for certain excavation methods such as trenching machines. The pipe must resist the crushing pressures of the backfill and compaction equipment.

(b) Screen. Screen can consist of slotted pipe, continuous slot screen, or porous material.

(c) Bedding material/filter pack. The guidance for specifying filter pack in vertical multi-phase extraction wells may be applied for trenches, but somewhat coarser material may be needed for a secure bedding and cover for the pipe and screen. Coarse material (uniform coarse sand and gravel) also provides a high hydraulic conductivity during pumping.

(d) Backfill material. Native material may be used as backfill above the filter pack in an excavated recovery trench. Coarse filter pack material may extend into the unsaturated zone especially if there are seasonal variations in the water table.

(e) Geotextile. A geotextile may be needed to separate the filter pack from native material or clay backfill in an excavated trench.

(f) Marking tape and locator strips. Specify a locator strip specifically manufactured for marking underground utilities. This tape is made of colored

polyethylene backed with foil or containing embedded wire that allows others to locate the trench at later dates.

(2) Installation. Installation methods vary significantly depending on excavation method.

(a) Excavation methods. Methods used to install recovery trenches include many standard earth-excavating equipment (e.g., backhoe) and trenching machines. Given this wide variety, it may be desirable to specify only the pipe, screen, pack materials, and an ultimate pipe alignment and depth. This would allow the contractor the option to propose what might be the most cost-effective method; however, the trenching technique used by the contractor must provide an adequate filter placement around the collector pipe and avoid to the extent possible smearing of fines along the trench wall in any product bearing zone. Dewatering or shoring will be required in most cases. Dewatering generates contaminated water that requires storage or treatment. Shoring with trench boxes or sheet piles, for example, maintains wall stability while bedding material and piping is placed. Compliance with Occupation Safety and Health Administration and USACE safety requirements is mandatory.

(b) Soil sampling and logging. If open excavation techniques are used, a graphical log of the materials encountered in the trench should be prepared, including the description of the materials according to ASTM D2488.

(c) Trench dimensions. The trench dimension should be wide enough to allow preparation of the bottom of the trench and placement of the pipe. Normally, the trench width is limited to the pipe diameter plus 600 mm. If the material to be trenched is contaminated, a smaller trench reduces the volume of material to be disposed or treated as waste. The trench depth must exceed the depth of the bottom of the mobile NAPL if product recovery is a goal. A deep trench may be useful for providing more certain capture of a dissolved plume, though it may increase water yield for product recovery. If the recovery of soil gas is desired, the filter pack must extend some height above the projected water levels, but should not extend to depths less than 1 to 1.5 m (3 to 5 ft) below the surface if no surface cover is provided. Trench length is selected based on the objective of the system. If the trench is meant to capture a migrating plume of NAPL and groundwater, the trench width should span the width of the plume. If the trench is designed to capture an area of NAPL, the trench length must be adequate to assure that all product flow lines extend to the trench. Modeling may be required. Excessive trench length may make operational modification difficult. For example, if the plume shrinks during operation, a long trench extending well past the limits of the plume may recover undesirable volumes of clean water.

(d) Trench bottom preparation and pipe placement. The bottoms of the excavated trenches must be prepared before placement of pipe and screen. Unstable materials should be removed. A bedding layer of filter pack material approximately 100 mm thick should be placed before pipe and screen placement. The trench bedding must be leveled to the required grade to provide uniform bearing for the pipe and to assure somewhat uniform hydrostatic head along its length. Pipe depth must consider the objectives of the system. If both air and liquid recovery is desired, two pipes set at different depths, one shallow (in vadose zone) and one deep (at depth of desired groundwater or product depth), may be appropriate. Place pipe near the depth of maximum hydrocarbon saturation for product recovery with minimal water production. Pipe should be placed no more than a few feet below the product smear zone for simultaneous groundwater and LNAPL recovery. The pipe and screen should be placed in a way that prevents entrapment of filter pack or native material inside the pipe. The joining of sections of the pipe and screen must be done in a manner

consistent with the material and manufacturer's recommendations. A clean out or access port for the pipe should be provided to allow for later surveys and maintenance of the screen and casing.

(e) Filter pack placement. Compaction of the filter pack material should not be done within 150 mm to 300 mm of the pipe and screen. Some trenching machines place the pipe and filter pack material as it progresses. In these cases, it is important to verify that the machine is placing adequate filter pack around the screen.

(f) Backfilling and compaction. The remainder of an excavated trench is backfilled with the appropriate material. Placement of a geotextile between the filter pack and backfill may be appropriate if there is a significant difference in grain size between the two materials. Backfill above the filter material should be placed in 150- to 200-mm lifts and compacted to approximately 90 percent optimum standard density, determined by ASTM D 698, if cohesive materials are used. Compaction should not occur closer than 0.3 m (1 ft) above the pipe. A locator strip should be placed within 0.5 meter of the surface.

5-6. Piping and Above-Ground Equipment. Selection of piping and system hardware will depend on site and contaminant specific factors. Configuration of the various extraction and treatment system components will depend on whether the MPE system is simultaneously extracting total fluids (air, NAPL and water) with a common intake line or whether the system is recovering air and liquids separately. Designers of above-ground piping and components must coordinate with designers of underground portions of the MPE system to ensure compatibility in materials and flow capacity.

a. Piping.

(1) It is important to select piping materials of appropriate size and materials of construction to allow proper and efficient operation of the MPE system. Undersized piping system components could lead to inefficient operation of the MPE system or damage to the system blowers/pumps, while oversized components may add unnecessary capital costs and result in inefficient operating conditions. Selection of piping materials that are incompatible with the recovered fluids or the system operating parameters may result in failure of the piping system, while improper or unnecessary specification of exotic or expensive piping materials will add an unwarranted burden to the system capital cost.

(2) Piping for an MPE system generally includes one or more intake (suction) lines, influent manifold(s), interconnecting piping between the phase separation and treatment system components, sampling lines, recovered NAPL transfer lines, and pressurized discharge lines. Certain types of MPE pumps will have oil or water seal circulation lines. Natural gas, propane or diesel fuel lines may also be required for thermal off-gas treatment systems (e.g., catalytic or thermal oxidizers, internal combustion engines, etc.). MPE piping systems may employ polyvinyl chloride (PVC), coated black (carbon) steel, stainless steel or copper pipe, as appropriate for the intended use. In addition, flexible reinforced hose (PVC, HDPE, rubber, etc.) or flexible tubing (HDPE) may also be used to incorporate a degree of flexibility into the system.

(3) Refer to [CEGS-02500](#) (Pipelines, Liquid Process Piping) and [CEGS-02150](#) (Piping, Off-Gas) for specific guidance on process piping requirements. EM [1110-1-4008](#) on Liquid Process Piping is also available to supplement CEGS-

02500. Refer to the process piping [EM 1110-1-4008](#) and the applicable CECS sections when designing or installing process piping.

(4) The following major issues must be considered when designing an MPE piping system: pneumatics and/or hydraulics, pressure/vacuum limitations, temperature limitations, material compatibility and mechanical constraints. When metallic components are used, corrosion of some type may occur. USACE policy requires that all underground ferrous piping be cathodically protected. In addition, corrosion may occur when dissimilar metals are immersed in a conductive medium. Use of dielectric bushings to prevent corrosion should be used when dissimilar metals are joined together (e.g., copper tubing connecting to a steel pipe or tank). Additional information may be found in [EM 1110-1-4008](#), Liquid Process Piping. Table 5-6 provides a summary of the physical property limitations of the various types of piping materials typically used in MPE systems. These considerations are discussed in the following paragraphs.

TABLE 5-6

Physical Properties of Common MPE Piping Materials

Material	Max. Pressure ¹ PSI	Max. Temp. °C (°F)	Chemical Resistance ²			
			Non-Halogenated VOCs ³	Halogenated VOCs ⁴	Oils	Acids ⁵
Sch. 80 PVC	400 ⁶	60 (140)	Good-poor	Poor	Excellent	Good to excellent
Sch. 40 Galv. Steel	2500		Good-poor	Good	Good	Fair to poor
Sch. 40 Coated Steel	2500		Fair	Excellent	Good	Poor
Sch. 40 Type 304 S.S.		204 (400)	Excellent	Good	Excellent	Fair to poor
Type K Copper Tubing	450	Varies	Good-poor	Excellent	Good	Poor
Reinforced PVC Hose	Varies, typ. <200	27-93 (80-200)	Good to poor	Poor	Excellent	Good
HDPE Tubing	55-140		Good to poor	Poor	Poor	Good to fair

Notes:

- 1) Max. Pressure rating for 50 mm (2 in.) diameter pipe at approx. 38°C (100°F). If operating temperature is over 38°C (100°F), working pressure must be de-rated. Maximum allowable pressure will vary for pipe sizes other than 50 mm (2 in.)
- 2) This table is intended as a general guideline for various classes of contaminants. Always consult with the manufacturer to determine chemical compatibility with site-specific contaminant suite.
- 3) e.g., pure benzene, toluene.
- 4) e.g., pure trichloroethylene.
- 5) e.g., sulfuric acid. Different acids will have different chemical compatibility.
- 6) PVC pipe manufacturers do not typically recommend their products for use in above-ground air/gas, pressure/vacuum applications. Pressure rating is for water service.

Source:

Pressure, Vacuum, Temperature Limits:

F.W. Webb Company. 1995. General Catalog. Wallace Press. Hillside, IL.

Chemical Compatibility Data:

Omega Engineering, Inc. 1995. Flow and Level Handbook. Omega Engineering, Inc. Stamford, CT. pp. Z46-Z57.

(5) Pneumatics and/or Hydraulics.

(a) The piping system (intake and discharge) components must be sized to accommodate the design flow without excessive frictional losses. Frictional loss calculations for liquids flowing through piping typically use the Darcy-Weisbach equation:

$$h_f = f (L/D) (v^2/2g) \quad [5-4]$$

where:

h_f = friction loss

f = friction factor (dimensionless)

L = Length of pipe

D = inside diameter of pipe

v = average fluid velocity

g = gravitational constant (9.8 m/s², 32.2 ft/sec²)

(b) The friction factor is a dimensionless number that has been determined experimentally, and is based on the pipe's interior roughness and the Reynolds number. The Reynolds number is a function of the fluid velocity, pipe diameter and fluid viscosity. From this, it can be seen that friction loss (or head loss as it is often termed) is related to the volumetric flow rate and fluid viscosity (which is a function of temperature), as well as the pipe material, diameter, and length. Any one or a combination of these items can be manipulated to maintain frictional losses through the piping system within acceptable limits. A detailed discussion of pneumatic analysis for determining head loss through extraction system piping is presented in [EM-1110-1-4001](#), Chapter 5, and as such will not be discussed here. In addition, most elementary fluid mechanics texts (e.g., Gerhart and Gross 1985) or engineering handbooks (Perry and Green 1984; Marks 1987; Ingersoll-Rand 1987) provide detailed discussions on this subject.

(c) In addition to the Darcy-Weisbach equation, many empirical formulas have been developed for evaluating frictional losses under turbulent flow conditions. Turbulent flow is believed to be common in MPE applications, especially in TPE where fluid is moving at high velocities through a small diameter drop tube. Turbulent flow is a function of the Reynolds number, which indicates flow is turbulent at values greater than approximately 4,000 (Munson et al. 1990). The Reynolds number is proportional to fluid density, velocity, and pipe diameter and will therefore increase as any of these values increase. The Hazen and Williams formula is a commonly used empirical solution for determining frictional losses through pipes, with inputs of length, diameter, flow rate and the Hazen and Williams friction factor (C), which is based on the material type and condition of the pipe. The Hazen and Williams "C" factor is different than the Darcy-Weisbach "f" factor. As engineering handbooks (Ingersoll Rand 1988; Crane 1988) provide a discussion of this method of friction loss calculation, it is not discussed in detail here; however, the designer should note that this empirical formula was developed for water at 15°C (60°F). Significant variation in results can occur at different temperatures.

(d) Many handbooks present the concept of "equivalent lengths" for fittings, where the friction loss through a fitting (e.g., elbow, tee, valve, etc.) is represented as an equivalent length of straight pipe of the same nominal diameter as the fitting. Various nomographs have been developed to speed the friction loss calculation procedure (Crane 1988; Driscoll 1986). In addition to these nomographs, several suppliers offer computer programs to calculate piping system friction losses and to aid in optimizing pipe size (e.g., Crane 1997; Costello 1996).

(6) Pressure/Vacuum Limitations. Pressure and vacuum limitations of the various types of piping typically used in MPE systems vary, depending upon the material of construction and the method used to join pipe sections and fittings (i.e., threaded, flanged, or glued). The type of joint specified and the care with which the joint is installed in the field should be given careful consideration to minimize air leakage into (or out of) the MPE system under operating conditions. Where polyvinyl chloride (PVC) pipe is used, PVC pipe joints depend on internal pressure forcing the seal into the joint (for larger diameter PVC pipe where compression joints are required). Thermoplastic piping or tubing (e.g., PVC, high-density polyethylene [HDPE], etc.) is typically limited to lower positive pressure applications than metallic piping systems. Reinforced flexible hose or tubing may be used on the intake (suction) side of the vacuum blower provided that the hose or tubing is rated for the maximum applied vacuum anticipated for the MPE system. Thermoplastic pipe or flexible tubing may not be suitable for high vacuum applications (>88 kPa [>26" Hg] vacuum). Consult with the manufacturer to determine pressure and vacuum ratings for the type of pipe or tubing proposed for use. Remember that the manufacturer's specified vacuum or pressure rating may change with fluid temperature. In some cases, testing performed by manufacturers may not reach the pressure or vacuum limits required for a particular MPE system. In these cases, additional research and/or testing should be performed in order to ensure proper material specification.

(7) Temperature Limitations. The temperatures typically encountered in MPE system operation generally do not significantly affect metallic piping components. However, it is often desirable to use thermoplastic piping or flexible hoses to join certain components of an MPE system to reduce piping costs, to allow flexibility for system adjustments (e.g., raising/lowering the drop tube), or to facilitate treatment component change out. Thermoplastic piping or tubing (PVC, HDPE, etc) may weaken or melt at elevated temperatures. It is not uncommon to encounter temperatures in excess of 93 °C (200 °F) in the vapor exhaust stream of a MPE blower. Typical Schedule 40 PVC can deform or melt at temperatures in excess of approximately 60 °C (140 °F), and it is therefore not applicable for use in locations where the temperature is expected to approach or exceed this value. To be conservative, a temperature lower than the typical manufacturer rating of approximately 43 °C (110 °F) is a reasonable limit to avoid deformation. In many cases, a segment of metallic pipe can be utilized at the blower exhaust to radiate heat to the atmosphere, after which PVC, CPVC, or other thermoplastic materials can be used to complete the remainder of the plumbing through the treatment train. Insulate or cover piping sections and employ appropriate warning signs to protect workers from pipes carrying high temperature (>38 °C [>100 °F]) fluids, and also to prevent condensation and freezing in above grade pipelines. Thermal expansion and contraction of plastic pipe exposed to ambient conditions weakens and occasionally destroys the joints. Refer to Plastic Pipe Institute publications AW-132 TR-22 Thermal Expansion and Contraction of Plastic Pipe and AW-129 TR-18 Weatherability of Thermoplastic Pipe for more information.

(8) Material Compatibility. Careful consideration must be given to the materials of construction employed in MPE piping systems that will be in contact with contaminated fluid streams. In many cases, PVC piping will

suffice; however, there are circumstances where PVC is not appropriate. For example, chlorinated solvents when present as pure product will degrade PVC, however in most MPE applications where chlorinated hydrocarbons are present in the ppb to ppm range, PVC piping should suffice. Contact with NAPL or high dissolved concentrations may cause some plastic or rubber materials to degrade, become brittle, or crack, resulting in a mechanical failure and a potential release to the environment. Consult the manufacturer's chemical compatibility chart before specifying pipe materials, particularly in cases where NAPL or high dissolved concentrations are present.

(9) Mechanical Constraints. Piping for an MPE system must be supported and protected from damage. The cyclic action of vacuum application and suction breaking that can be encountered in an operating TPE system results in an effect somewhat similar to a water-hammer, which can damage improperly restrained or unsupported pipes. Pipe supports should conform to MSS SP-58, MSS-SP-69 and MSS-SP-89.

b. Design and Installation of MPE Manifold.

(1) The intake manifold system connects the extraction wells to common header pipe(s) and combines the extracted fluids into a common flow network for phase separation and subsequent treatment. In the case of DPE (separate pumps for liquid and vapor recovery), the liquid and gaseous phases are withdrawn from the extraction well within separate conduits. Separate manifolds may be constructed for liquid and air streams. A typical MPE intake manifold will consist of some or all of the following components:

- Pressure/vacuum indicators.
- Temperature indicators.
- Flow control valves.
- Flow meters (air and/or water for DPE applications).
- Sample ports.
- Ambient air (dilution) inlet valve(s).
- Check valves.
- Solenoid valves or motorized valves (optional - to allow automated cycling between wells).

Vacuum applied to the subsurface and/or flow extracted from the wells may be regulated using a dilution valve (ambient air bleed-in valve) or by a variable speed drive on the vacuum pump. The variable speed drive is a more efficient means of regulating vacuum and flow.

(2) A typical MPE manifold layout is depicted in Figure 5-10. Manifolds may be constructed of PVC, HDPE, galvanized steel, or where required, stainless steel. MPE designers and installers should install segments of transparent PVC pipe or hose on the intake side of multi-phase vacuum blowers for TPE

applications (transparent pipe is normally needed for DPE). This will facilitate observation of the fluids being produced by the MPE wells and may provide useful information on the nature of the multi-phase flow into the system (i.e., slug flow, annular flow, etc.), to aid in optimizing performance.

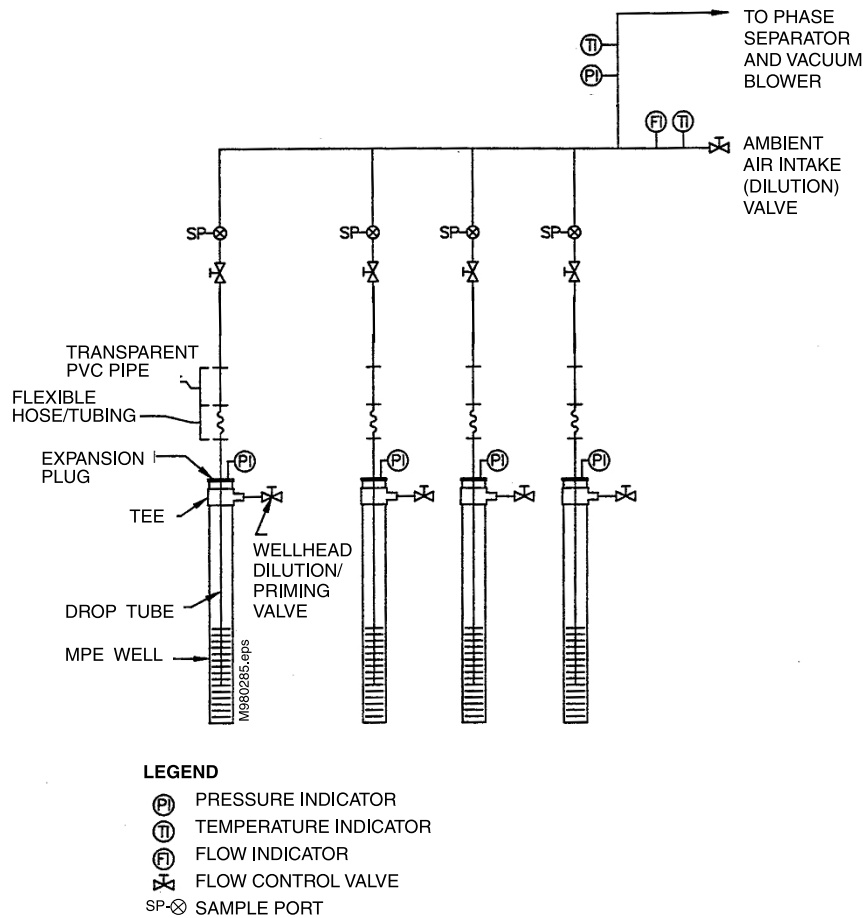

Figure 5-10. Typical Two-Phase Extraction System Piping Manifold.

(3) The MPE manifold must be designed to allow monitoring and control of individual MPE wells. This will allow the operator to observe the effectiveness of individual MPE wells and balance flows among multiple MPE wells. Control of individual wells will also allow the operator to cycle among MPE wells to vary subsurface air and water flow pathways, and to focus remediation efforts on the most contaminated areas as the remediation progresses. Preferential flow pathways may exist in the subsurface prior to the start of MPE as described in Chapter 2, or may develop as the soil moisture content is reduced during MPE operation. Varying subsurface air and water flow pathways by cycling individual MPE wells, or groups of MPE wells, on and off will change the subsurface hydraulic gradients, thus varying the flow pathways within the treatment area.

(4) Manifold piping may be located either above or below ground. For extended operating periods it is generally best to install manifold piping below ground in shallow utility trenches to protect the piping from mechanical damage, freezing and vandalism. Piping located below ground should be constructed of, or coated with, non-corroding materials, or should be mechanically protected from corrosion (e.g., cathodically). In some cases, MPE piping may be installed with as little as two feet of cover if adequate slope is provided to allow liquids to drain from the pipe. However, in colder climates, especially in cases where liquid is moving as creep flow or as droplets, frost/ice scale will build up on the pipe interior and reduce the available flow area, which will eventually cause a blockage in the pipe. If pipe is installed above the local frost line, frost heaving may damage the pipe or weaken underground joints. Where installation of MPE piping below frost depth is not feasible, the lines should be heat-traced and insulated to avoid the damage discussed above.

(5) The manifold can be installed at a central location (e.g., inside the treatment enclosure). This is convenient in that the flow/pressure/temperature monitoring, flow control devices and sample ports can be located in an easily accessible location; however, constructing the manifold in this fashion requires running separate lines to each extraction well to achieve control of the individual wells. This method, although slightly more costly to install, provides the best means for balancing flows during system operation. An alternative is to place the monitoring and control devices in the well vaults and connect the lines from the individual wells to one or more common header pipe(s), which extend back to the vacuum pump in the treatment enclosure. To monitor or adjust flows and pressures, the operator must travel between wells making incremental adjustments at each location, and checking the effect at the other wells. This small installation cost savings is likely to be far outweighed by labor costs incurred during system operation.

(6) The working pressure (not burst pressure) of the manifold piping should be able to withstand the maximum anticipated (worst-case) system pressure (USEPA 1996a, Appendix B).

(7) If an underground manifold is constructed of plastic pipe, a metallic locator strip or similar material should be installed in the trench along with the manifold piping to allow magnetic location of the buried manifold at a later date. As an added safety measure, caution tape or other marking material should be placed in the trench above the pipe bedding materials, to indicate the presence of buried lines.

c. Piping and Valves.

(1) Extraction piping for MPE systems may include a single multi-fluid (air, NAPL, water) intake line or may consist of separate fluid intake lines for air and liquids, depending on what variation of MPE is employed at the site. Piping and valves used in MPE installations should be selected and installed in accordance with [CEGS 02500](#) Pipelines, Liquid Process Piping and [CEGS 02150](#), Piping, Off-Gas.

(2) Valves are used to regulate flow in the MPE system, or in the case of closed valves, to isolate portions of the MPE system. Valves should be assigned unique identification numbers during the design phase and should be labeled with corresponding identification markers during installation to facilitate operation and maintenance of the MPE system.

(3) A number of different types of valves may be used to control or shut off flow in MPE systems. A list of the valve types and a brief discussion of the nature and function of these valves is provided below. A more detailed discussion of these various valves can be found in many sources, including [EM 1110-1-4001](#) Soil Vapor Extraction and Bioventing (Chapter 5), EPA/600/R-96/042 (USEPA 1996a, Appendix B) or in Perry's Handbook (Perry and Green 1984, Sec. 6). Be aware that MPE systems frequently extract some silt with the recovered liquid stream. This may cause valves to become clogged and require frequent cleaning. Care should be taken to design piping systems that enable easy valve removal if silt clogging is a potential problem.

- Gate valves - Used for on/off service. A wedge shaped gate is moved up (for open position) or down (for closed position where the gate is seated) to allow or stop fluid flow. This valve is designed to minimize pressure drop in the open position.
- Globe (and angle) valves - Used for on/off service and clean throttling applications, this valve controls flow with a convex plug lowered onto a horizontal seat. Raising the plug off the seat allows for fluids to flow through.
- Ball valves - Used primarily for on/off control and some throttling applications, the ball valve uses a rotating ball with a hole through the center to control flow.
- Butterfly valves - Used for on/off and throttling applications, the butterfly valve controls flow with a rotating disk or vane. This valve has relatively low friction loss in the fully open position.
- Diaphragm valves - This multi-turn valve is used to control flow in clean and dirty services. The diaphragm valve controls flow with a flexible diaphragm attached to a compressor and valve stem.
- Needle valves - This multi-turn valve is used for precise flow control applications in clean services, typically on small diameter piping. Needle valves have relatively high frictional losses in the fully open position.

- Plug valves - Used for on/off service and throttling applications. Flow is controlled by a plug with a hole in the center that rotates to align with the flow path.
- Foot valves with strainer - Foot valves are located at the bottom of the suction line of a surface-mounted jet pump. The valve functions similar to a check valve to keep water in the down-well pipe or hose and contains a strainer or screen around its inlet to keep solids from clogging the valve.

(4) Check valves (swing, lift, flapper, and spring check types) should also be incorporated into the intake (immediately upstream of the air/moisture separator) and discharge piping (immediately downstream of the transfer pump that empties the water reservoir of the oil/water separator) of the MPE system to prevent back flow.

d. Condensate Controls and Fluid Separation. Successful operation of an MPE system requires good separation of the recovered contaminant phases to minimize treatment costs (e.g., due to carbon fouling and/or excessive carbon consumption) and to ensure compliance with discharge permit limits. In the case of a dual pump system, liquid (water and/or NAPL) and air are extracted from the well separately. Water and NAPL, if present, may require separation at the surface if a "total fluids" (water and NAPL) pump is employed to recover liquid from the DPE well. However, for other MPE applications, multi-phase fluids (air, NAPL, water) are all extracted simultaneously through a single intake tube and must be separated at the ground surface. The following paragraphs discuss various fluid separation techniques applicable to MPE.

(1) Gas-Liquid Separation. Typical MPE systems employ inertial gas-liquid separators equipped with water level controls/sensors similar to the moisture knockouts used in SVE systems. Because the gas-liquid separators are typically installed between the vacuum pump and the extraction well, the gas-liquid separator tank must be designed to withstand the maximum vacuum that the extraction blower is capable of producing. A brief description of inertial separators is presented in [EM 1110-1-4001 Soil Vapor Extraction and Bioventing](#). A more detailed discussion of centrifugal separation, as well as other gas-liquid separation mechanisms, is presented in Perry's Handbook (Perry and Green 1984). Recovered liquids are typically pumped from the gas-liquid separator to the water treatment system, which may include a NAPL-water separator. If NAPL is present, the transfer pump should be selected to minimize shearing and turbulence of the pumped liquids and thereby prevent formation of oil-water emulsions.

(a) One design approach utilizes a transfer pump with a high suction-head capacity (i.e., low net positive suction head required [$NPSH_R$]). Positive displacement pumps, such as progressing cavity, diaphragm, or double diaphragm pumps, are often used in this application. It should be noted that air-operated double diaphragm pumps may require a large volume of high-pressure air to pump against the vacuum applied to the gas-liquid separator. This approach is relatively simple, is based on components that are readily available, and is particularly good for applications where NAPL is expected, since positive-displacement pumps typically do not tend to increase emulsification.

(b) An alternate approach utilizes a low suction-head transfer pump (e.g., centrifugal pump), coupled with a vacuum-relief device (e.g., vacuum-relief valve or solenoid valves) to allow the transfer pump to evacuate the accumulated liquids from the gas-liquid separator. This approach is also relatively simple; however, there are several disadvantages. Periodic vacuum

relief in the phase separator allows ambient air to enter the phase separator. This has the effect of reducing the overall mass removal efficiency from the subsurface (due to discontinuous application of vacuum) and also dilutes the influent concentration to the gas treatment device, which will reduce its treatment efficiency. Also, centrifugal pumps tend to increase formation of emulsions due to the turbulent shearing action that occurs in the volute (impeller chamber).

(c) Another design approach employs multiple gas/liquid separation vessels equipped with level controls that operate under vacuum (refer to Figure 5-1). In this approach, small-diameter tubing connects the headspace of each vessel to that of the other vessels so as to equalize the pressure (vacuum) differences among the vessels. The liquids are then able to flow by gravity between the vessels. In practice, the gas/liquid separator would be located above the other vessels, so that liquids (water and NAPL) separated in it can drain by gravity to a NAPL-water separator. The NAPL-water separator may be a simple decanter for small NAPL volumes or a coalescing-type oil-water separator (see [paragraph 5-6d\(2\)](#) where greater NAPL recovery is expected. Recovered NAPL flows over a weir and drains by gravity to a NAPL storage tank. Accumulated water may be pumped from the NAPL-water separator using either a high-suction head transfer pump or a low suction-head transfer pump and vacuum relief device, as described in the preceding two paragraphs. Manual or automatic isolation valves can be used to allow accumulated NAPL to be pumped from the NAPL storage tank. This approach is somewhat more complex than the previously described approaches since multiple vessels are involved and NAPL-water separation is accomplished under vacuum. An advantage is that the recovered NAPL-water mixture does not have to pass through a pump, reducing the chance for additional emulsification to occur.

(d) A novel approach for multi-phase separation under vacuum combines gas/NAPL/water separation in one vessel (Rentschler 1998). This approach uses an inertial gas-liquid-solid separation tank coupled with a coalescing plate oil-water separator on the intake (negative pressure) side of the vacuum pump. Extracted fluids enter the phase separator tank through a tangential inlet, which forces liquids and entrained or suspended solids to the outer wall of the tank where they eventually settle to the bottom of the first chamber. Extracted vapors are drawn off the top of the phase separation tank by a dry vacuum pump. Liquids (NAPL, water, and condensed water vapor from the air stream) flow over a weir into a stilling chamber where a coalescing plate pack separates LNAPL and water. A pressure (vacuum) equalization line connects the multi-phase separator to a NAPL storage tank, allowing separated NAPL to flow over an adjustable weir and drain by gravity to the NAPL storage tank. Water flows under and over a set of weirs to exit the coalescing chamber. Level sensors in the final chamber control the water transfer pump. A high-suction head transfer pump is preferred for this application since water seals and weirs separate the headspace of the second and third chambers from the first (air/liquid separation) chamber.

(2) LNAPL-Water Separation.

(a) LNAPL-water separators most commonly used in MPE systems are coalescing plate or tube oil-water separators. These types of separators are readily available from a number of vendors, are relatively inexpensive and require little maintenance. Coalescing plate or tube LNAPL-water separators are sized to allow laminar flow conditions to develop based on the design water feed rate. The LNAPL-water mixture flows through a section of corrugated or chevron-shaped plates or vertical tubes, under laminar flow conditions. Small entrained LNAPL particles agglomerate to larger particles and droplets, and rise vertically through the coalescing media. The greater the difference in the specific gravity of the two liquids (LNAPL and water), the more rapid and

effective the separation will be (USEPA 1996). Recovered LNAPL is retained in a chamber over the coalescing media, where it can be skimmed off and transferred to a storage tank. Most oil-water separators of this type can effectively remove non-emulsified oil to concentrations below 10 mg/l (USEPA 1996). Effluent water then flows through a series of baffles and typically discharges from the separator by gravity. A pump chamber can be incorporated into the separator or a pressurization tank/pump can follow the separator if additional water treatment is required. NAPL-water separation chambers must be vented to a safe location. Oil/water separators should be sized based on anticipated maximum fluid recovery rates. The separators should also have sufficient sediment and oil storage capacity based on site-specific information such as expected product recovery and the presence of fine sediments within the extracted liquid stream.

(b) Liquid-liquid centrifuges can be used to separate fluids of different specific gravities. Membrane separators (e.g., hydrophobic or hydrophilic membranes) can be used to separate water and hydrocarbons. Distillation can also be used to separate liquids of different boiling points and specific gravity. However, these devices are usually not warranted for LNAPL-water separation applications in MPE systems due to the added capital cost, complexity and maintenance requirements.

(c) Additional guidance on the selection and design of oil-water separators can be found in other USACE guidance on oil/water separators.

(3) Emulsions.

(a) Emulsions are stable dispersions of one liquid in another and are generally characterized by droplet diameters of 1 μm or less (Perry and Green 1984). Emulsions may be characterized as oil-in-water (i.e., organic droplets in an aqueous medium) and water-in-oil (i.e., water droplets dispersed in a continuous organic liquid phase).

(b) Emulsions may be mechanically separated using porous or fibrous solid coalescing media, centrifugal extractors, separating membranes (e.g., hydrophobic or hydrophilic membranes), or by using high-voltage electric fields to separate electrically conductive liquids from non-conductive liquids. Perry's Handbook (Perry and Green 1984) provides a detailed discussion on liquid-liquid separation techniques. Organically activated clays have also proven to be effective in capturing oil-water emulsions to prevent fouling of activated carbon or other treatment equipment. These clays can be used as a pre-filter prior to secondary treatment equipment. Organically activated clays are especially useful in removal of heavier oils and can remove 50% of their weight in oil (Alther 1997).

(c) Numerous commercially available emulsion-breaking reagents are also available. A bench or pilot scale test should be conducted to determine the most appropriate and effective emulsion-breaking chemical for site-specific conditions. Some of these reagents may require pH adjustment or heating of the emulsion to enhance their effectiveness.

(4) DNAPL-Water Separation.

(a) DNAPL-water coalescing plate or tube separators work on the same principle as LNAPL-water separators. Coalescing plate or tube separators take advantage of the difference in specific gravity between the DNAPL and water, allowing DNAPL to separate under laminar flow conditions. DNAPL and water can

be separated using a similar type of coalescing media to that used in LNAPL coalescers, although the DNAPL withdrawal outlet must obviously be on the bottom of the separator tank. More viscous DNAPLs (e.g., creosote, coal tar) may require addition of chemicals to enhance DNAPL flow through this type of device.

(b) As with LNAPL-water separation, other mechanical separation means are available for DNAPL separation, although their use is typically not warranted in MPE systems due to the added cost and complexity of the additional equipment. For operating facilities with organic solvent contamination (e.g., TCE, PCE) where a source of steam is readily available, condensation separation may be a feasible alternative.

e. Electrostatic Charge Considerations. Build-up of electrostatic charges results from the contact and separation that occurs as non-polar liquids (e.g., gasoline, jet fuel) flow through a pipe. Static charge generation increases as fluid velocities and pipe lengths increase (Curran 1997).

(1) Electrostatic Charge in Tanks and Piping Systems. Static charges in underground steel and fiberglass tanks are readily dissipated through the adjacent soil matrix. Aboveground steel and fiberglass tanks (including drums) can develop a static charge between the fluid and the tank wall (or metallic fitting in non-metallic tanks) during filling. Maintaining electrical continuity between the tank and the fill line will help prevent static accumulation and discharge. Grounding and/or bonding may also be required to prevent static discharge. Because plastic containers are not conductive, electrical continuity can not be maintained between a plastic tank and a metallic fill tube. Therefore, the use of plastic piping and containers for transport and accumulation of recovered NAPL should be avoided.

(2) Ignition of Electrostatic Charge. Once a means of generating a static charge exists, it can be a source of ignition if the following three conditions are met (Curran 1997):

- A static charge accumulates that can produce an incendiary spark.
- There is a spark gap (arc).
- There is an ignitable vapor-air mixture within the spark gap.

Thus, by the third condition, the vapor concentration must be between the lower explosive limit (LEL) and upper explosive limit (UEL) for the specific flammable liquid, assuming oxygen is present at 20% by volume. If there is a concern about the vapor concentration in the NAPL storage tank or within the treatment enclosure, LEL sensors can be deployed to detect excessive flammable vapor concentrations and shut down the recovery system at a pre-set vapor concentration (i.e., 10% to 20% of LEL). JP-4, for example, requires added precautions in handling, as its vapors above free product are naturally within their explosive range. JP-4 grade jet fuel forms explosive vapors in the vapor space of storage tanks in the range of -23 °C to 27 °C (-10 °F to 80 °F). These are temperatures usually encountered in storage and handling of fuels. In addition, jet fuel is more subject to buildup of static charges than gasoline products (Department of the Air Force 1981).

(3) Electrostatic Charges in MPE Applications. In many MPE system applications, NAPL is not being recovered or discharged to a tank at a

significantly high velocity or piped over a very large distance, so build-up of significant electrostatic charges is generally not a problem. However, in some cases, where NAPL is pumped at a relatively high velocity or travels over a long distance, design measures must be incorporated to reduce the risk of static discharge. Grounding and/or bonding of NAPL accumulation tanks and conveyance piping may be required to prevent static discharge. Nitrogen purging or blanketing of the headspace of a tank or container can be used to eliminate the third condition (ignitable air-vapor mixture within the spark gap) discussed above, thus preventing accumulation and ignition of flammable vapors (Ebdat 1996; Curran 1997).

(4) Consult NFPA 77, Static Electricity, for further guidance on preventing build-up or discharge of electrostatic charges. Although preventing the development of potentially explosive conditions is preferred, the designer should incorporate explosion isolation and containment measures (i.e., explosion-proof vessels), explosion suppression, and/or venting measures into the design in cases where there is a high potential for explosive conditions to develop (Chatrathi and Siwek 1996). Suppression is preferred to venting, as the release of flammable vapors to the environment may be problematic. Also, release of exploding vapors may represent a risk to personnel and/or equipment in the vicinity of the relief vent. Additional guidance on explosion suppression and prevention is available in NFPA 68, Guide for Venting Deflagrations and NFPA 69, Explosion Prevention Systems. In addition, designers should review and comply with NFPA 30, Flammable and Combustible Liquids Code, when flammable liquids are expected to be present.

f. Blowers, Pumps and Motors. There is a multitude of available vacuum producing devices that can be employed in an MPE design. A wealth of information on operating principles, capabilities, design and selection of vacuum pumps has been produced throughout the chemical and food processing industries where vacuum pumps are widely used. Selection of the most appropriate vacuum producer depends mainly on the vacuum and flow requirements of the specific application; however, other site-specific factors may influence selection of the vacuum device. These factors may include, but are not limited to: hydraulic conductivity and air permeability of the soil, number and configuration of MPE wells, power availability, cooling/seal water availability, waste stream treatment/disposal costs, remoteness of site, and the skill level of on-site maintenance personnel. The following paragraphs present a summary of commonly available vacuum pumps for MPE applications. Figure 5-11 presents a graphical description of the various types of vacuum pumps and Figure 5-12 presents a comparison of the typical operating flow and vacuum ranges for these various types of vacuum pumps. Figure 5-13 presents a comparison of optimal MPE equipment (vacuum generators and pumps) for various hydraulic conductivity ranges. These ranges are approximate and selection of the MPE pump for a specific site will depend on the factors discussed in the preceding paragraph, as well as the anticipated duration of the MPE remediation and the capital and maintenance cost associated with the pump(s). More information on blowers and pumps applicable to MPE can be found in [CEGS 11215 Fans/Blowers/Pumps; Off-Gas](#).

(1) Liquid Ring Pumps. Liquid ring pumps are the most commonly used vacuum pumps reported in the literature for MPE applications (AFCEE 1997; Hansen, et al. 1994; Suthersan 1997). Liquid ring pumps can transfer both liquids and gases through the pump casing. A rotating impeller, offset from the center of the pump casing, generates centrifugal force to drive liquid within the pump casing to the outer wall of the casing. The liquid forms a seal layer conforming to the interior shape of the pump body. The eccentric impeller causes gases trapped between the rotating vanes and the seal liquid to be compressed and forced in toward a central discharge port. Seal liquid is typically water or oil. Water-sealed liquid ring pumps may use once-through

municipal water, recirculated water, or if there is a sufficient volume, groundwater, to provide seal liquid for the pump.

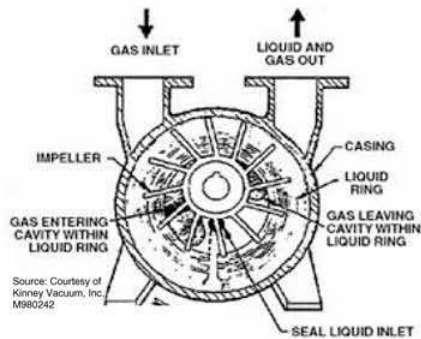

FIGURE 5-5(a): Typical Liquid Ring Pump

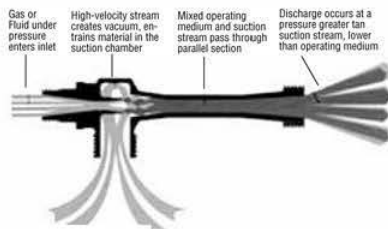

FIGURE 5-5(c): Typical Ejector

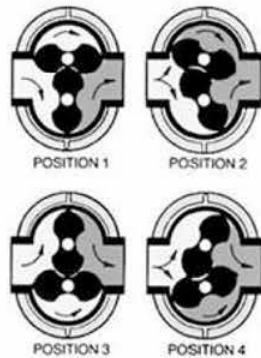

FIGURE 5-5(e): Typical Rotary Lobe Blower

M980241a.eps

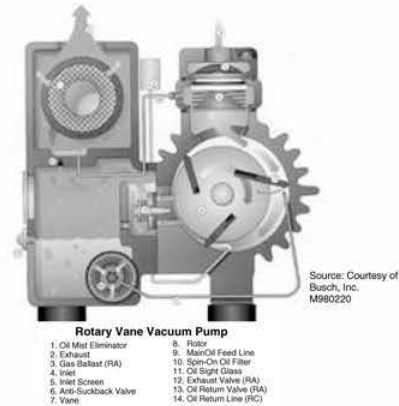

FIGURE 5-5(b): Typical Rotary Vane Pump



FIGURE 5-5(d): Typical Rotary Piston Pump

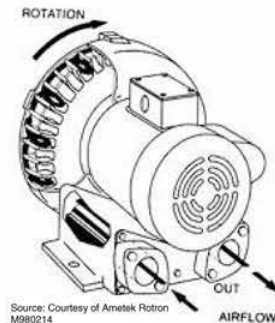

FIGURE 5-5(f): Typical Regenerative Blower

Figure 5-11. a) Typical Liquid Ring Pump b) Typical Rotary Vane Pump c) Typical Ejector d) Typical Rotary Piston Pump e) Typical Rotary Lobe Blower f) Typical Regenerative Blower. Reprinted by permission of: a) Tuthill Corporation, Kinney Vacuum Division, b) and d) Busch, Inc., c) John C. Ernst Co., Inc. e) Roots Division, Dresser Equipment Group, Inc., a Halliburton Company, f) Ametek Rotron.

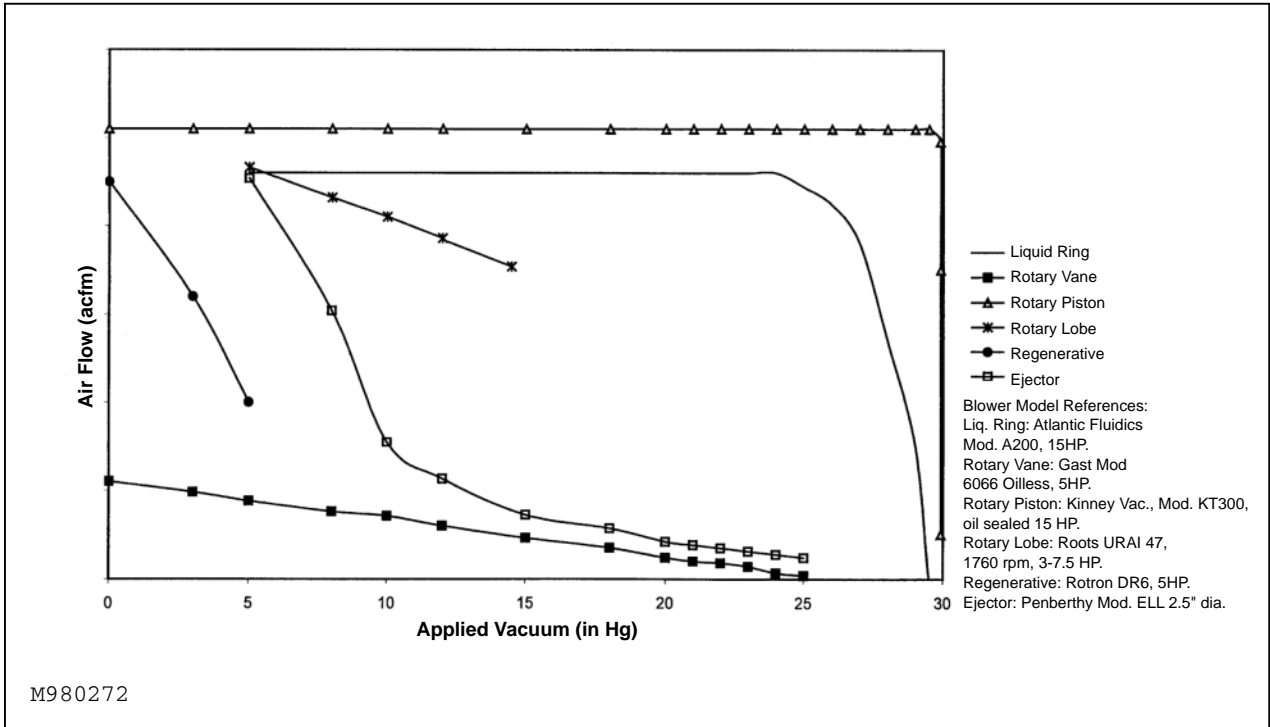

Figure 5-12. Comparison of Air Flow vs. Vacuum for Various Types of Vacuum Pumps.

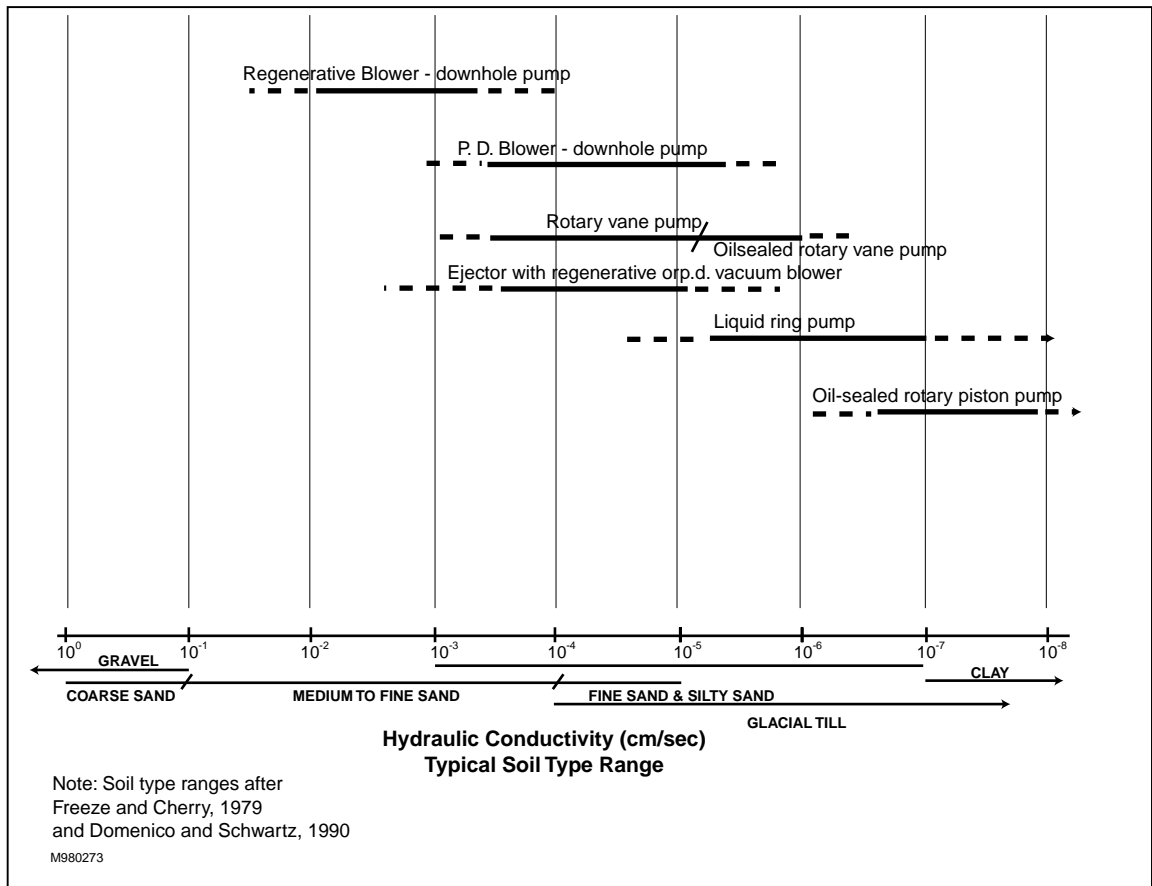

Figure 5-13. Optimal MPE Equipment for Varying Hydraulic Conductivities. (After Peargin 1998. Reprinted by permission of T.R. Peargin, Chevron Research and Technology Corp.) (Refer also to Figures 3-1a and 3-1b)

(a) Extracted groundwater is generally not preferred for the seal liquid due to the presence of inorganic impurities that tend to increase scaling on the vanes, and the often insufficient/irregular groundwater recovery rate at low-permeability sites. Due to the heat generated during compression of the extracted gas, pumping systems that used a closed-loop seal liquid system must be equipped with a heat exchanger to cool the seal liquid. Oil-sealed liquid ring pump systems, although generally more expensive than water-sealed pumps, may be preferred for remote sites since the units are essentially self-contained, typically including an oil reservoir, oil heat exchanger, and an oil mist filter and coalescer on the vapor discharge line from the pump. Vacuum in excess of 98 kPa (29 in Hg, gauge vacuum) can be generated by water sealed liquid ring pumps, while vacuum to 101 kPa (29.9 in Hg, gauge vacuum) can be generated by oil-sealed liquid ring pumps. As shown in Figure 5-12, liquid ring pumps have relatively flat performance curves over the majority of their operating range. A main disadvantage of using liquid ring pumps is that if NAPL is extracted, emulsions tend to form due to the high velocity of the extracted NAPL and groundwater, which may necessitate additional treatment to separate the emulsion (unless NAPL and groundwater is separated upstream of the pump).

(2) Rotary Vane Pumps. Rotary vane pumps are positive displacement pumps with sliding (or spring loaded) flat vanes mounted in an eccentric rotor. As the rotor turns, the vanes are flung outward against the casing wall trapping gases between the vanes, and providing a seal between the intake and exhaust ports of the blower. The offset position of the rotor within the pump housing causes compression and subsequent expansion of the compressed gases, resulting in a vacuum at the intake port of the blower. Rotary vane pumps are available in oil sealed or oil-less models, in a wide range of flow capacities. Oil-sealed rotary vane pumps are typically capable of generating vacuums up to 98 kPa (29 in Hg, gauge vacuum), while oil-less pumps are generally limited to vacuum below 85 kPa (25 in Hg, gauge vacuum). Oil-sealed rotary vane pumps are typically equipped with an oil reservoir, oil filter, air-oil heat exchanger, and an oil-mist or coalescing filter on the vapor discharge. Larger rotary vane pumps with spring loaded vanes may require special tools and skilled mechanics to perform repairs; however, smaller pumps typically use centrifugal force to fling the vanes outward and can generally be repaired in the field.

(3) Ejectors (Eductors).

(a) Ejectors are perhaps the simplest of vacuum pumps because they have no moving parts. An ejector is essentially a specially designed nozzle consisting of three sections, a pressure nozzle, a siphon body, and a discharge diffuser. Pressurized gas or liquid (e.g., for MPE applications, water or steam) used as the motive force, is injected through the pressure nozzle. The reduced diameter of the nozzle throat increases the velocity of the motive fluid and creates a suction within the chamber around the nozzle throat. The pumped fluid is drawn into the nozzle by the suction created in the chamber, and then both the motive fluid and the pumped fluid are discharged through the diffuser as a single mixed stream. Ejectors are available in a wide range of sizes and can be combined into multi-stage units for higher vacuum requirements. Vacuum and flow limitations of ejectors depend on the number of stages, the nature (water or steam) and pressure of the motive fluid, and discharge pressure. Single stage liquid-powered ejectors can typically produce 68 to 74 kPa (20 to 22 in Hg, gauge vacuum), while multiple stage steam jet ejectors frequently used in high vacuum processing can develop significantly greater vacuum. Steam jet ejectors have a low capital cost; however, they are very energy intensive to operate. It is not likely that an MPE application would require the use of a steam jet ejector but if a steam source is readily available this type of vacuum generator may be worth some consideration. Ejectors can also be

combined with liquid ring pumps or rotary lobe blowers to increase the airflow and/or vacuum capacity of the MPE pumping system.

(b) A patented system (see [paragraph 9-3\(e\)](#)) employing water-powered ejectors has been used to extract groundwater from low permeability formations. Water from a holding tank is circulated at high pressure through a manifold of small ejectors piped in parallel. The resulting vacuum generated at the ejectors is used to draw groundwater (and to a lesser extent, soil gas) from several extraction wells simultaneously. The extracted groundwater enters the holding tank and is circulated through the system. Level switches in the circulation tank maintain the water level within specified limits. Excess water from the holding tank is discharged to the treatment system. An advantage of this type of arrangement is that if one extraction well breaks suction (i.e., the water level drops below the intake tube), the other wells will not lose vacuum because each ejector operates independently. Each ejector will continue to apply vacuum to its well as long as water is pumped through the manifold.

(c) There are other methods of employing ejectors for vacuum applications. Motive water for the ejector can be from a municipal supply (although this will likely require a booster pump to increase the water pressure), from a sump well in a groundwater recovery trench, or from any other source. Motive water can be recirculated, or treated and discharged. High pressure steam, typically 690 kPa (100 psi) gauge pressure or more, if available on site, will allow development of higher vacuums.

(4) Rotary Piston Pump. Rotary piston pumps are essentially positive displacement oil-sealed compressors, and are typically available in single- or two-stage models. As the piston rotates, vapors are drawn into the pump, compressed and discharged to a treatment device or the atmosphere. Vacuum is generated during the pump intake cycle as the piston withdraws into the cylinder. The mechanical operation of the rotary piston pump is similar to an internal combustion engine. These pumps can develop vacuums in excess of 98 kPa (29 in Hg, gauge vacuum), at low to moderate flow rates (0.28 to 14m³/min [10 to 500 cfm]). Because these types of vacuum pumps operate in an oil bath, condensation within the pump chamber can create problems and cause reduced vacuum capacity. Volatile compounds may also condense under the high pressure of the compression cycle. As such, this type of vacuum pump is not recommended for most MPE applications.

(5) Rotary Lobe Vacuum Blowers. Rotary lobe vacuum blowers are positive displacement blowers that use two interlocking rotors to trap and compress gases. The rotors are synchronized by external gears and turn in opposite directions (Ryans and Croll 1981). Although the external gears operate in an oil bath, the process air chamber is typically dry (i.e., free of oil). This type of blower can be used in MPE applications requiring moderate vacuums (up to 51 kPa [15 in Hg], gauge vacuum) and high gas flow rates. They may be applicable for use in conjunction with submersible pumps in DPE systems employed at sites with moderate to high permeability soils.

(6) Regenerative Vacuum Blower. Regenerative blowers use a multi-stage impeller to create a pressure (vacuum) differential through use of centrifugal force. Air drawn in between rotating vanes is thrust outward toward the impeller casing, then turned back to another section of the rotating impeller (Soil Vapor Extraction and Bioventing [EM 1110-1-4001](#)). Regenerative vacuum blowers generally do not produce a sufficiently high vacuum for use in MPE applications. However, regenerative blowers may provide an economical solution when used in conjunction with submersible pumps in DPE systems, or for sites

where less than 34 kPa (10 in Hg), gauge vacuum (CEGS 11215) and relatively high air flow rates are required to meet MPE design requirements.

(7) Liquid-only Pumps for Use in Dual-Phase Extraction Systems. Liquid-only pumps for DPE may be either electric or pneumatically operated submersible pumps, or surface-mounted diaphragm pumps, jet pumps, or vertical turbine pumps equipped with appropriate down-well level controls. Liquid pumps should be sized to handle the anticipated groundwater yield that will be generated by the water table drawdown created by the water pump plus the additional groundwater yield induced by the application of vacuum to the extraction well head. Consideration must be given during design and construction of the well head seal to allow water and gas transfer lines plus submersible pump control lines, to pass through the well head while maintaining a vacuum-tight seal. Refer to CEGS 11211 and 11212 for guidance on liquid-only pumps.

(8) Variable Speed Drives. Although variable speed drives (VSDs) are not pumps, their use in controlling pump motor speed can be valuable in MPE use. VSDs allow simple adjustment of motor speed to achieve the optimal applied vacuum and flow rate. This is especially useful for pilot test operations where vacuum is often applied in stepped increments. These drives allow adjustment of applied vacuum without the need for dilution or bleed-in air valves. Bleed-in air may still be required, however, in order to obtain the necessary velocity to lift fluids from the well in TPE operation. Some VSDs can be configured with a feedback control loop to maintain constant pressure (vacuum) or flow operation. See also paragraph 5-6(h)(2).

g. Selecting Vacuum Pump Sizes.

(1) In order to properly size a vacuum pump, or any pump in general, the designer should determine the flow the pump is expected to see approximately 80% of the time, the minimum anticipated flow rate and the maximum expected flow rate. The pump should be sized to operate as near as possible to the Best Efficiency Point (BEP) on the pump curve for the flow rate that is expected 80% of the time, while still having the capacity to operate at the maximum and minimum anticipated flow rates without causing damage to the pump (Monroe 1996). Since site conditions or operating configuration of the MPE system may change over time, the vacuum blower(s) selected for the system should be able to operate efficiently over the anticipated range of operating conditions.

(2) When sizing a pump, the designer must define the flow and vacuum requirements at the extraction well(s). This should be established through pilot testing during preliminary design. Then, starting from the most remote well on the line, work through the piping manifold summing flows and frictional losses associated with piping, valves, and fittings to determine the flow and vacuum requirement at the blower. Remember to include losses through manufacturer-supplied items on the blower skid (filters, mufflers, knockouts, etc.), or alternately, specify the flow and vacuum required at the suction point of manufacturer-supplied skid-mounted vacuum pumping system. Include a reasonable factor of safety (typically 10 to 25 percent; however, the exact determination is site specific and may depend on the degree of confidence in design values) to allow for future expansion, vacuum leakage, or unforeseen system losses. Include also the backpressure on the discharge side of the blower associated with off-gas treatment equipment, as this may reduce the available vacuum the pump can apply to the wells. Keep in mind that it may be beneficial to split the extraction flow between two or more smaller blowers rather than one large blower. Duplex pumps may be used at remote locations where system redundancy is desirable due to lag time for parts and maintenance. Also, if there are excessive discharge pressure requirements, which may require over-sizing the vacuum pump, consider instead employing a booster blower on the

discharge side of the vacuum system to provide the required discharge pressure. The operating point of the blower/pump is determined by developing a system head curve based on pilot test data and laying it over the pump curve. An example of this step can be found in [EM 1110-1-4001](#), Soil Vapor Extraction and Bioventing, Chapter 4, Bench- and Pilot-Scale Testing for SVE and BV.

(3) A brief example of vacuum pump sizing procedures for MPE applications is provided in this paragraph. A detailed numerical example is presented in [EM 1110-1-4001](#), Soil Vapor Extraction and Bioventing, Chapter 5, SVE and BV Design Strategy. Evaluating head losses through the extraction pipe network is an iterative process in which the designer must adjust the system piping configuration to ensure that the pressure at each node (junction point) will balance. The designer must also be aware that air is a compressible fluid, and as such the actual volumetric flow rate (acmm or acfm) must be used when calculating frictional (velocity) losses through the piping system. Also, designers must note that the actual volumetric flow rate will increase on the discharge side of the vacuum pump as a result of the temperature rise induced by the blower during the vacuum (compression) cycle. These calculations can be done by hand or using readily available computer software (e.g., ABZ, Inc. 1998). The effect of discharge losses due to off-gas treatment equipment must be included in the calculations before a blower can be properly sized, since backpressure on the positive-pressure side of a vacuum generator may significantly affect the vacuum pump performance.

(a) Assume that a system curve (vacuum versus flow) and appropriate regression coefficients have been developed for the pilot test data. Assume also that the pilot test results indicate the following requirements for a full-scale MPE system:

- Three parallel lines of four MPE wells each, connected to a common junction point, then piped to the vacuum pump.
- The desired extraction vacuum (design value) at the wells is 54.2 kPa (16" Hg, gauge vacuum).
- The desired extraction flow (design value) is 0.33 scmm (11.8 scfm) per well, for a total air extraction flow rate of 4.0 scmm (141 scfm).
- Line losses through the subsurface piping, header and manifold will add approximately 10.7 kPa (3.2 in Hg, gauge vacuum).
- The air/liquid separator and particulate filter will add an additional 1.3 kPa (0.4 in Hg, gauge vacuum) loss on the vacuum side of the pump at the anticipated operating flow.
- Vacuum pump discharge restrictions will be approximately 10.3 kPa (1.5 psi or 3.1 in Hg, gauge pressure) at the anticipated operating flow.
- Up to 2.3 L/min (0.6 gpm) of water may be extracted with the vapor stream.

(b) With these data in hand, the designer may now select a vacuum pump to fit the specific situation. From the specified design requirements, the vacuum

pump must be capable of delivering 4.0 scmm (141 scfm). Summing vacuum requirements (well vacuum plus losses), a minimum inlet vacuum of 66.2 kPa (19.6 in Hg) is desired. The discharge pressure requirement is 10.3 kPa (3.1 in Hg). Sum the suction and pressure losses for a total of 76.5 kPa (22.7 in Hg), and add a 15% factor of safety to get a total of 88 kPa (26 in Hg) as the normal operating requirement. Head losses should also be calculated for the anticipated minimum and maximum operating flows in a similar fashion, to develop the system curve for the normal, minimum and maximum operating conditions. Search manufacturers' literature (vacuum versus flow curves) to find a vacuum pump that will operate near its optimum efficiency for the anticipated operating conditions. The system curve should be overlaid on manufacturer-supplied pump curves when determining the best vacuum pump for a specific application. Based on these data, i.e., a flow of 4 scmm (141 scfm) and total head requirement of 88 kPa (26 in Hg), a liquid ring pump or oil-sealed rotary vane pump are likely vacuum pump candidates (see Figure 5-12). Designers should also consider vacuum pump noise when determining the most appropriate pump for a given situation. In general, operating a pump or blower at a point away from its optimum efficiency will result in more noise, and operating at a higher speed (RPM) will also result in greater noise.

h. Selecting Motor Size.

(1) Once a range of vacuums and flow rates has been determined, designers frequently consult vendor-supplied performance curves to determine the required motor horsepower. An alternate method of calculating the motor power requirement for vacuum blowers based on mass flow rate, head loss and efficiency is provided in Chapter 5 of [EM-1110-1-4001](#). For liquid pumps, the power requirement can be estimated by the following equations (Perry and Green 1984):

$$\begin{aligned} \text{Power (kilowatts)} = & \quad [\text{total dynamic head (m)}] \\ & \quad \times [\text{pump capacity (m}^3/\text{hr)}] \\ & \quad \times [\text{density kg/m}^3] \\ & \quad \times \text{efficiency} \\ & \quad \div 3.670 \times 10^5 \end{aligned} \quad [5-5]$$

or, in customary English units,

$$\begin{aligned} \text{Power (horsepower)} = & \quad [\text{total dynamic head (ft)}] \\ & \quad \times [\text{pump capacity (gpm)}] \\ & \quad \times [\text{sp. gravity}] \\ & \quad \times \text{efficiency} \\ & \quad \div 3.96 \times 10^3 \end{aligned} \quad [5-6]$$

(2) In some cases it may be advantageous to employ a VSD instead of a throttling device (e.g., valve, flow restrictor) to regulate vacuum pump output. VSDs (paragraph 5-6(f)(8)) are the most efficient method of varying both flow and pressure in vacuum systems ([CEGS 11215](#)). Several types of VSDs are available. Mechanical gear VSDs use a handwheel to change the effective diameter of opposing drive wheels, and thus vary the rotational speed of the output drive shaft; however, these types of VSDs require manual adjustment to vary motor speed (Perry and Green 1984). In most MPE systems, electrical or electronic VSDs are more appropriate. These devices control alternating current (a.c.) motor speed by varying frequency and voltage, and can be configured to automatically and continuously vary motor speed in response to changing system vacuum and flow demands in real-time. In larger systems, the

potential cost savings afforded by automatically adjusting the load on the motor in response to vacuum and flow fluctuations may provide substantial cost savings (Revelt 1996.) However, not all motors are suitable for use with VSDs. Consult with the manufacturer to determine whether a VSD-compatible motor is available for the specific application.

i. Net Positive Suction Head Considerations for Liquid Pumps in MPE Applications. The following paragraphs provide an overview of net positive suction head (NPSH) considerations. Additional information on NPSH can be found in chapter 3 of [TM 5-813-9](#).

(1) When selecting a pump, one must determine the required capacity of the pump and the total dynamic head (TDH) required by the specific application. TDH is equal to the total discharge head, h_d , minus the total suction head, h_s . The suction head, h_s , has a positive value when the free surface of the liquid being pumped is above the pump impeller centerline (i.e., a flooded suction condition), and has a negative value when the liquid level is below the pump centerline (a suction "lift" condition). The head equivalent to the vacuum applied above the free surface of the liquid must also be overcome when selecting a pump. Static and friction losses must be included in the calculation of h_d and h_s . Calculation of these values is discussed in paragraph 5-6a(5).

(2) Cavitation in a pump occurs when the pressure of the liquid being pumped is reduced below the vapor pressure of that liquid (at the system operating temperature). This occurs in a pump impeller as the velocity of the liquid is increased, resulting in a corresponding reduction in pressure. Gases within the liquid vaporize, forming bubbles. These gas bubbles are transported to zones of higher pressure by the rotating impeller where they collapse instantaneously and with great force. Cavitation is often observed as noise and vibration and should be avoided, as it can result in excess wear or erosion of pump internals and dramatically shorten the operating life of a pump. Cavitation can also greatly reduce the pump's efficiency resulting in insufficient throughput.

(3) The Net Positive Suction Head Required ($NPSH_R$) is the minimum suction condition required to prevent pump cavitation, and is equal to the total suction head of liquid (absolute) determined at the first stage impeller datum, minus the vapor pressure of the liquid (in head of liquid pumped), required to prevent more than 3% loss in total head from the first stage of the pump at a specific capacity (Hydraulic Institute, 1994). NPSH is generally expressed in terms of a height of a column of liquid (mm Hg, ft of water). Manufacturers typically plot $NPSH_R$ data for a given pump operating a certain speed and capacity on the pump's characteristic performance curve. $NPSH_R$ for centrifugal pumps typically ranges between 22 mm Hg (1 ft H₂O) for a high-quality progressing cavity pump, to 224 mm Hg (10 ft H₂O) for low-end flooded suction centrifugal pumps. $NPSH_R$ can be greatly influenced by flow rate.

(4) The Net Positive Suction Head Available ($NPSH_A$) depends on the system layout and, to prevent cavitation, must always be greater (by some margin of safety) than the $NPSH_R$ for the intended operating range of the pump. $NPSH_A$ is calculated according to the following equation (Driscoll 1986):

$$NPSH_A = h_a + h_s - h_{vp} - h_f \quad [5-7]$$

where

h_a = absolute pressure on the free surface of the pumped liquid, in meters or feet of liquid. This will be equal to atmospheric pressure if the liquid is in an open tank or well, or can be less than atmospheric if the liquid is in a well or tank under vacuum.

h_s = static height (in meters or feet) of liquid surface above (positive value) or below (negative value) the centerline of the pump intake.

h_{vp} = absolute vapor pressure of the liquid at the pumping temperature, in meters or feet of liquid. In mixtures such as gasoline or NAPL/water systems, this value should be determined by the bubble point method (Karassick, et al. 1986)

h_f = suction line losses (in meters or feet of liquid) including entrance losses and friction losses due to pipe, fittings, and valves.

(5) In an MPE application, the $NPSH_A$ of a pump can be thought of according to the following expression, which is similar to the equation presented above.

$$NPSH_A = (\text{absolute atmospheric pressure}) - (\text{lift} + \text{line losses}) - (\text{vacuum in well or tank}) - (\text{vapor pressure of liquid}) \quad [5-8]$$

In other words, the limiting factor for a pump drawing liquid from a well or vessel under vacuum in an MPE application is:

$$(\text{lift} + \text{line losses} + \text{vacuum in well}) = (\text{absolute atmospheric pressure}) - NPSH_A - (\text{vapor pressure}) \quad [5-9]$$

(6) As can be seen from the preceding expression, a dual-pump MPE system comprised of a surface-mounted liquid pump for liquid removal and vacuum blower for vapor extraction, is limited to shallow water table applications. In this configuration, the sum of lift, line losses and vacuum can not exceed the difference between absolute atmospheric pressure and the sum of the liquid's vapor pressure and the $NPSH_A$. Therefore, a pump with a lower $NPSH_A$ will allow for either greater suction lift or will be capable of overcoming a stronger applied vacuum.

(7) If a submersible liquid pump is used in conjunction with a vacuum blower for MPE, the $NPSH_A$ only limits pumping when the vacuum in the well exceeds approximately 609 to 635 mm Hg (24 to 25 in Hg). There is no limitation by depth to water (lift) because the submersible pump operates in a flooded condition. Manufacturer's specifications on $NPSH_A$ are typically not available for submersible pumps since this application is relatively rare. One can safely assume a submersible pump to have an $NPSH_R$ of approximately 112.1 mm Hg (5 ft H_2O).

(8) Another common MPE application where $NPSH_A$ must be considered is in the case of a pump used to transfer fluids from a tank under vacuum such as transfer pump on a phase separator on the intake side of a dry vacuum blower. The transfer pump $NPSH_A$ must be sufficiently low as to allow the pump to overcome the vacuum in the tank without cavitating. Frequently in this

application, a pump with a very low $NPSH_R$, such as a progressing cavity pump or a multi-stage centrifugal pump is required.

(9) Consideration must be given to prolonged application of vacuum to the volute (pump impeller chamber) of a liquid transfer pump. Pumps with low $NPSH_R$ may allow air leakage into the volute when the liquid pump is not operating. This may occur when an operating MPE system recovers very little water in the phase separator over the course of several hours, such that the liquid transfer pump does not cycle on for an extended period. Air leaked into the volute may result in the pump losing its prime and not being able to develop sufficient suction to overcome the vacuum applied to the phase separator tank by the vacuum pump. Installing a flapper check valve or solenoid valve between the vacuum source and the transfer pump intake may alleviate this problem; however, the valve will reduce the $NPSH_A$ due to the increase in frictional loss associated with the valve.

5-7. Instrumentation and Process Controls. The designer must carefully consider instrumentation and control requirements of the MPE system. A guide specification for process instrumentation and control is currently under development. Designers should refer to this guide specification to determine minimum standards during the preliminary process control design stage. A good instrumentation and control system design will assure that the individual components are coordinated and operate effectively. Presented in the following paragraphs are the typical types of instrumentation and controls normally included in an MPE system, a discussion on the degree of automation for MPE systems, and a list of minimum instrumentation and control requirements.

a. Instrumentation.

(1) Designers may specify various types of instrumentation to monitor desired system operating parameters, including flow, vacuum/pressure, level, temperature, etc. Other specialty sensors that may be required for certain MPE applications may include combustible gas indicators, organic vapor analyzers, and process gas chromatographs. Direct reading instruments and gauges are preferred to provide the on-site operator with easily obtainable information. The anticipated level, and range of levels, expected for the parameter that will be measured should govern the accuracy and scale of measuring devices. If the instrument is properly sized for the application, then an unusually high degree of accuracy should be unnecessary. Electrical or electronic sensors and switches used in hazardous areas must be designed for use in these areas. See paragraph 5-8d for a discussion of hazard classification. Note that all instrumentation that may be in contact with potentially explosive conditions should be intrinsically safe. Most of the instrumentation discussed in the following paragraphs can be obtained from manufacturers with adjustable set point switches, dry contacts, low voltage DC output, or 4-20 mA signal output that can be integrated with a central control panel or PLC for automated control or monitoring purposes.

(2) Multi-phase fluid flow measurement with a single instrument is possible; however, the instrumentation required is relatively large and expensive and is not realistically applicable to MPE projects. Flow rates of the individual phases (gas, water and NAPL) must be monitored separately (i.e., measure gas flow after the phase separator, water flow at the treatment system effluent and NAPL recovery at the inlet to the holding tank). If it is critical that gas and/or liquid flow rate from the individual wells be determined, individual phase separators may be provided for each extraction well; however, this is expensive and typically not warranted. In DPE applications, each well must have the capability to measure flow of extracted air and water. It is, however, important to measure dilution air flow rate at

the individual extraction wells and/or at the extraction blower, as this air flow must be subtracted from the total air flow rate to determine the actual flow contribution, and hence contaminant mass removal, from the subsurface.

(3) Airflow (or velocity) may be measured using rotameters, orifice meters, turbine flow meters, pitot tubes, or hot-wire anemometers. The process air flows through rotameters, orifice meters, and turbine meters, while pitot tubes and anemometers are typically placed in the flow path to measure airflow rate. As a result, pitot tubes and anemometers (which have relatively low pressure drops across them) can be either fixed or portable devices. Since pitot tubes and anemometers have portable capability, a single device can be used to measure multiple wells. Between the two, pitot tubes are generally less expensive as they contain only the appropriate piping connections to measure static and total pressure (where the difference between the two is given as the velocity head using a differential pressure gauge). Rotameters consist of a float mounted inside a tapered cylinder, which is marked with a calibrated scale. The fluid flows through annular space between the float and the cylinder wall. The higher the fluid flow/velocity, the greater the annular opening required to allow passage of the flow, and thus the higher the float will be lifted within the cylinder. Rotameters provide simple direct flow measurement, although they have a poor turndown ratio if flows are at the lower end of the scale and often result in higher pressure drop than some of the other types of meters. Orifice meters measure the pressure drop across an orifice (reduced diameter section) installed in the airflow path to determine air velocity or flow in through a pipe. Turbine flow meters typically consist of a paddlewheel sensor that is turned by the flowing air stream. The rate of revolution of the paddlewheel is converted to flow rate. Pitot tubes and differential pressure gauges can be used to measure air velocity in a pipe. Specially calibrated gauges (i.e., for a specific size pipe) are available to allow direct reading of flow rate based on differential pressure. Pitot tubes and anemometers are both sensitive to the position of the measurement device in the pipe and to moisture or liquid droplets in the air stream. Hot wire anemometers measure temperature change across a resistive element to determine air velocity. Anemometer readouts are typically provided with selectable scale ranges to provide good turndown ratio over a wide range of air velocity (flow) conditions. The best method of airflow measurement depends on the configuration of the system, location of the desired flow measurement, etc., and therefore should be selected based on the specific application. Note that the airflow measurement device should typically be located within a straight run of piping, at least 5 pipe diameters upstream and 10 pipe diameters downstream of the nearest flow interference or piping direction change.

(4) Water flow can be measured using pressure type meters similar to those used for air measurement such as orifice meters, nozzle meters, or venturi meters (Munson et al. 1990). More commonly in MPE applications, volume flow meters such as rotameters, turbine flow meters, paddle wheel, or magnetic flow meters are used. Rotameters are used to measure flow rate in a pipe. Disadvantages of rotameters include high pressure drop across the meter and potential for clogging since the float in the rotameter acts as a collection point for any suspended solids within the water stream. Turbine flow meters are used to measure flow rate or total flow (using a totalizing meter). These meters provide a wide range of flow at relatively low cost. Paddle wheel flow meters can measure flow rate or total flow. These meters provide very low pressure drop but are generally more expensive. Both turbine and paddle wheel meters can be used for remote flow sensing. Magnetic flow meters also provide very low pressure drop. These meters are also very useful for water streams where suspended solids may be present, as they are not easily fouled. Fouling may occur from precipitated metals or bacterial growth (biofouling), which can cause significant errors in flow meter accuracy. Magnetic flow meters are, however, the most expensive of those discussed here. In applications where gravity flow of water in a pipe exists, open channel flow meters that measure

partial flow in pipe are required. The volume flow meters discussed above apply only to full-flow applications.

(5) Typically it is desirable to measure vacuum applied at the individual well heads, at intermediate points in the system (i.e., at header/manifold joints), at the vacuum blower, and at the dilution air inlet. This vacuum measurement will give the operator an idea of how well balanced the vacuum/pressure is at various locations throughout the system. Vacuum or pressure sensors are available in many varieties, including manometers, diaphragm sensors, and Bourdon tube sensors. Manometers may be U-shaped or inclined, and are typically used for obtaining precise differential pressure measurements. These devices are not frequently used in field MPE applications, but field portable manometers are available. Diaphragm sensors measure the motion of a rubber or metallic diaphragm, and use a mechanical, electrical, magnetic or optical mechanism to convert this physical motion to a pressure/vacuum reading on a calibrated gauge. The widely used Magnahelic gauges manufactured by Dwyer Instruments (Michigan City, IN) are diaphragm sensors. Bourdon tube pressure gauges typically consist of a semi-circular piece of metallic tubing, fixed in position at one end, while the other end is allowed to flex or move in response to varying pressure. Bourdon tube indicating mechanisms, as with diaphragm sensors, may be mechanical, electrical, magnetic or optical. Many common dial-indicator pressure gauges use Bourdon tube sensors.

(6) Level sensors may be simple sight glasses, or may include float sensors, conductivity sensors, optical sensors, radio-frequency sensors, or proximity sensors. Typically used float sensors may be lever arms with floats, or float balls of a specific gravity that allows them to rise and fall with changes in the level of the liquid being measured. Conductivity sensors typically consist of a ground probe and one or more additional probes to detect the presence of a conductive liquid (i.e., water). Optical and radio frequency level sensors typically use an emitter and receiver to determine the position of a liquid surface relative to the position of the sensor. Proximity sensors are non-contact sensors that typically use capacitance to detect the presence or absence of a conductive liquid. Proximity sensors can be mounted on the outside of a tank to detect the level of a liquid within that tank. More information on level sensors can be found in [TM 5-813-9](#), Chapter 3.

(7) Temperature sensors may be bi-metal thermometers, thermocouples, or infrared temperature sensors. Bi-metal thermometers typically consist of a coil comprised of two dissimilar metals with different thermal expansion properties. Bi-metal thermometers are typically used in MPE system applications. The differential expansion or contraction of the two metals is mechanically or electrically converted to a temperature reading on a calibrated scale. Thermocouples are calibrated bi-metallic elements that employ a small voltage across the dissimilar metals at the measuring end. Voltage changes as a known function of temperature. Infrared temperature sensors use a calibrated infrared detector to determine the temperature of a process stream.

(8) In certain applications it may be desired to continuously monitor for potentially explosive conditions (i.e., on the intake of a thermal or catalytic oxidizer, or within the atmosphere of a hazardous area) using a combustible gas indicator (CGI). CGIs may be used for continuous or periodic monitoring for explosive conditions; however, they may not be necessary if explosion-proof control wiring is used. It may also be desirable to continuously record influent and/or effluent vapor concentrations using a dedicated organic vapor analyzer (photoionization detector [PID], flame ionization detector [FID], etc.) or a process gas chromatograph (GC). PIDs and FIDs will record total hydrocarbons, while the GC will differentiate between individual hydrocarbon species. PIDs are the easiest to operate, requiring no external fuel or

standards; however, some compounds may not be detected or may have poor response factors. FIDs determine total hydrocarbon concentration through combustion of the sample stream, and therefore require a fuel source. Bottled hydrogen is typically used. PIDs and FIDs require regular (e.g. daily) calibration. GCs required trained chemists to prepare calibration standards and interpret results.

b. Process Controls. A description of process control design elements for a typical soil vapor extraction/bioventing system is presented in EM 1110-1-4001, Chapter 5. These same basic minimum design elements are required for an adequate and complete MPE system design. A full MPE system design should include the elements discussed in Chapter 6, Design Documentation. As discussed in Chapter 6, a full MPE design should also include a Process Flow Diagram. The process flow diagram should show the flow pathways through the extraction and treatment system for the various fluid phases, and provide mass balances and flow rates for each phase throughout the extraction and treatment system.

(1) Control Needs. In a typical MPE system, the following systems typically require control:

(a) Flow rate: Monitoring and controlling fluid (gas, water, NAPL) extraction rate is important to assess the progress and optimize the performance of the remedial activity. Contaminant concentration and extraction rate over time can be used to estimate mass removal of the MPE system. In multi-well systems, flow from the various extraction wells must be balanced or adjusted to maintain optimum mass removal and areal influence. Control of flow from individual wells is typically done with manual control valves located at the wellhead.

(b) Vacuum/pressure: Vacuum application can be controlled through the use of dilution (air inlet) valves positioned either at the extraction well head or at the extraction blower, or by adjusting the frequency of the VSD, if used. Vacuum and pressure relief valves should be installed at appropriate locations to protect blowers, pumps, tanks and other vessels from excessive vacuum or pressure, as applicable.

(c) Liquid level: MPE systems must be equipped with liquid level controls to operate transfer pumps and prevent tank over fills. Level sensors, switches and alarms should be installed at appropriate locations to control filling and discharging of tanks and vessels, and to activate an alarm in the event of a high-level condition.

(d) Temperature: The temperature of exhaust gases and lubricating or sealing fluids should be controlled to prevent operation of the MPE system outside allowable limits. Operation at excessively high temperatures may result in damage to blower or pump motors or and/or seals. Temperature of off-gas control equipment (e.g., carbon adsorbers, oxidizers) must be controlled to allow operation within a safe and efficient range.

(2) Degree of Automation.

(a) The degree of automation required for an MPE system is dependent on the size and complexity of the system, the remoteness of the system location, and upon owner or regulatory agency specified monitoring and control requirements. In general, process controls may be either local (i.e., control elements are mounted adjacent to equipment being controlled), central (i.e.,

control elements are mounted at a central control panel or operator station), or remote (i.e., system controls are accessed via modems or radio telemetry).

(b) Designers must recognize that there are capital and maintenance costs associated with automating system controls and should be selective as to which process items are specified for automated control. For active sites with readily available technicians to monitor process conditions and respond to potential problems, minimal automation is required. By contrast, at unattended remote sites, it may be desirable to employ a state-of-the-art supervisory control and data acquisition (SCADA) system to monitor system progress and alert operations personnel in the event of an alarm condition. SCADA systems typically comprise a programmable logic controller (PLC) with various instrumented inputs and outputs. Software specially configured to each site can provide the user with a graphical interface to observe a digital "picture" of the system operation in real time. SCADA systems can be used to monitor, adjust and record system flow, vacuum/pressure, and liquid levels, alternate operation of extraction wells, record influent and effluent concentrations for determining mass removal and verifying permit compliance, and initiate proper system shutdown procedures and notify maintenance personnel in response to an alarm condition. Installation of a full SCADA system, including the PLC, the SCADA software and customized program, plus purchasing, installing and maintaining all of the required monitoring instruments can add a significant cost to a project. Adequate consideration must be given to the availability of maintenance personnel, potential system failure conditions, and the risk associated with the various types of potential failures in comparison with the costs and benefits of employing a complete SCADA system. In most cases, a centralized control panel equipped with either a remote annunciator (light or horn) or telemetry capability to signal an alarm condition will be sufficient.

5-8. Electrical Requirements. All electrical equipment and wiring must comply with NFPA-70, the National Electrical Code (NEC), and applicable local codes and standards. [EM-1110-1-4001](#), Chapter 5, provides a discussion of electrical systems planning, including: identification of applicable codes and standards, determining hazard area classification, electrical conduits, motor selection, heat tracing, and fire protection.

a. External Protection. Electrical conduits, enclosures and motors should be selected with the anticipated operating conditions in mind. At a minimum, designers should consider the potential for dirt and dust accumulation, water (drips, mist or spray as applicable), contact with corrosive liquids or vapors, and the hazard classification in which the item will be located. The National Electrical Manufacturer's Association (NEMA) has established standards for manufacture of enclosures to protect electrical equipment from various environmental hazards. Table 5-7 provides a description of the various NEMA enclosure numbers and their designated usage. Conduits should be specified to be resistant to external corrosion from moisture and/or exposure to acids or caustics including vapors, if neutralizing/scrubbing waste from a process treating chlorinated hydrocarbon contaminated water (e.g., air stripping) is used. Corrosion protection for electrical conduits should at a minimum include external galvanizing for metallic conduit, and if warranted may include PVC coating of metallic conduit. Where allowed by the NEC, PVC or ABS conduit may be used. For highly corrosive environments, fiberglass reinforced plastic (FRP) enclosures may be required to protect electrical devices. In highly corrosive environments, stainless steel hardware (nuts, bolts, pipe hangers, clamps, etc.) should also be specified. Protection of system operators from electricity and mechanical equipment must also be considered. Guards and shields around motors, belts and other moving parts should be installed in accordance with manufacturer specifications. Piping exposed to extreme temperatures should be insulated and labeled. Health and safety procedures

(e.g., lock-out/tag-out) must be followed (see paragraph 9.4) to ensure protection from electrical equipment.

TABLE 5-7

NEMA Enclosure Classifications (Ametek Rotron 1998)

NEMA Type 1 - General Purpose - Indoor	Type 6 - Submersible, Watertight, Dusttight and Sleet Resistant-Indoor and Outdoor
Type 2 - Dripproof - Indoor	Type 7 - Class I, Group A, B, C or D Hazardous Locations; Air-break Equipment-Indoor
Type 3 - Dusttight, Raintight and Sleet (Ice) Resistant - Outdoor	Type 8 - Class I, Group A, B, C or D Hazardous Locations; Oil-immersed Equipment - Indoor
Type 3R - Rainproof and Sleet (Ice) Resistant - Outdoor	Type 9 - Class II, Group E, F or G Hazardous Locations; Air-break Equipment - Indoor
Type 3S - Dusttight, Raintight and Sleet (Ice) Proof - Outdoor	Type 10 -Bureau of Mines
Type 4 - Watertight and Dusttight - Indoor	Type 11 -Corrosion Resistant and Dripproof; Oil-immersed - Indoor
Type 4X - Watertight, Dusttight and Corrosion Resistant - Indoor	Type 12 -Industrial Use, Dusttight and Driptight - Indoor
Type 5 - Superseded by Type 12 for Control Apparatus	Type 13 -Oiltight and Dusttight - Indoor

b. Motors.

(1) Motor enclosures have been developed to protect motors from a variety of environmental hazards typically encountered. Table 5-8 presents a summary of available motor enclosures and their intended use. Commonly used motor types in MPE applications are open drip-proof (ODP), totally enclosed fan cooled (TEFC) and explosion proof (XP). Unless otherwise required based on expected environmental conditions, ODP motors should be specified. ODP motor enclosures essentially protect the motor from dripping liquids or solids. TEFC motors incorporate a sealed (but not airtight) housing with an integral shaft-mounted fan to blow cooling air across the motor frame. TEFC motors are typically used when the motor may be located in a dusty or dirty environment. XP motors are

totally enclosed motors whose casing and conduit box are designed to withstand and contain an explosion, and prevent the surrounding atmosphere from igniting due to an explosion occurring within the casing.

TABLE 5-8

Motor Enclosures & Typical Uses (Revelt 1996)

A PRIMER ON MOTOR ENCLOSURES
A broad range of electric-motor enclosures is available. Enclosures can most easily be visualized in terms of descriptions of motors that employ them. The descriptions given here present the enclosures that are most widely used.
An Open Motor is one having ventilating openings that permit passage of external cooling air over and around the windings
A Drip-proof Motor is an open motor in which the ventilating openings are so constructed that drops of liquid or solids falling on the machine at any angle not greater than 15 deg from the vertical cannot enter the machine
A Guarded Motor is an open motor in which all ventilating openings are limited to specified size and shape to prevent insertion of fingers or rods, so as to avoid accidental contact with rotating or electrical parts
A Splash-proof Motor is an open motor in which the ventilating openings are so constructed that drops of liquid or solid particles falling on the machine or coming toward the machine in a straight line at any angle not greater than 100 deg from the vertical cannot enter the machine
A Totally Enclosed Motor is a motor so enclosed as to prevent the free exchange of air between the inside and outside of the case, but without being airtight
A Totally Enclosed Nonventilated (TENV) Motor is a totally enclosed motor that is not equipped for cooling by means external to the enclosing parts
A Totally Enclosed Fan-Cooled (TEFC) Motor is a totally enclosed motor with a shaft-mounted fan to blow cooling air across the external frame. It is a popular motor for use in dusty, dirty, and corrosive atmospheres
A Totally Enclosed Blower-Cooled (TEBC) Motor is a totally enclosed motor equipped with an independently powered fan to blow cooling air across the external frame. A TEBC motor is commonly used in constant-torque, variable-speed applications
An Encapsulated Motor is an open motor in which the windings are covered with a heavy coating of material to protect them from moisture, dirt, abrasion, and other difficult environments. Some encapsulated motors have only the coil noses coated. In others, the encapsulation material impregnates the windings even in the coil slots. With this complete protection, the motor can often be used in applications that call for totally enclosed motors
An Explosion-proof Motor is a totally enclosed motor designed and built to withstand an explosion of dust, gas or vapor within it, and to prevent ignition of dust, gas or vapor surrounding the machine by sparks, flashes or explosions that may occur within the machine casing
It is strongly recommended that all personnel involved with motors be familiar with, and adhere to, NEMA Standard MG2, "Safety Standard for Construction and Guide for Selection, Installation and Use of Electric Motors and Generators."

(2) Unless otherwise specified, motors and electrical equipment should be designed to operate on standard utilization voltages presented in Table 5-9.

TABLE 5-9

Utilization Voltages (EM 1110-1-4001)

Service	Utilization Voltage	System Nominal Voltage
Motors below 1/2 HP	115 v, 1-Phase, 60 Hz 208 v, 1-phase, 60 Hz	120 v 240 v
Motors below 1/2 HP to 200 HP	460 v, 3-Phase, 60 Hz 230 v, 3-Phase, 60 Hz 200 v, 3-Phase, 60 Hz	480 v 240 v 208 v
Lighting	115/200 v, 3-phase, 60 Hz, 4-wire 460 v, 3-phase, 60 Hz, 3-wire 460/265 v, 3-phase, 60 Hz, 4-wire	120/208 v 480 v 480/277 v
Noncritical instruments; power and control; telephone equipment	115 v, 1-phase, 60 Hz	120 v
Telecommunication equipment	48 v DC	-
Shutdown systems, alarms, instrumentation	24 v DC with battery backup	-
Critical loads that do not permit interrupt	120 v, 1-phase, 60 Hz	-
Switchgear control	125 v DC	-
Heat tracing	265/460 v, 3-phase, 60 Hz 115 v, 1-phase, 60 Hz	277/480 v 120 v

c. System Voltage. Typically, single-phase power is used for motors less than ½ horsepower (Fuchs 1992; EM 1110-1-4001). Three phase 208/120V or 240/120V power should be used for motors over ½ horsepower when system loading is less than approximately 75 KVA. For loading in excess of 75 KVA, three phase 480/277V power should be used. The reason for this is mainly economics. Operating motors at higher amperages results in increased capital cost for branch circuit and motor protection equipment, and significantly higher operating electrical costs. To determine system KVA load, multiply the operating (nameplate) amperage by the utilization voltage (start with the lower available utilization voltage). Sum the KVA loads for all equipment, including lighting and heaters. If total system load exceeds 75 KVA at the lower utilization voltage (e.g., 208/120), recalculate the KVA load for a 480/277-volt system.

d. Hazardous (Classified) Locations (NEC Article 500).

(1) Locations where flammable or potentially flammable vapor concentrations or combustible dust may accumulate may be classified as hazardous locations under NEC Article 500. EM 1110-1-4001, Chapter 5 presents general guidance on determining the hazard classification of an area. Additional guidance on classification of hazardous areas may be found in NFPA 497, Class I Hazardous Locations for Electrical Installations in Chemical Plants, and in API RP500A, Classification of Locations for Electrical Installations in Petroleum Facilities classified as Class I Division 1 and Division 2.

(2) Class I, Division 1 and 2, and Class II, Division 1 and 2, atmospheres may be encountered at MPE sites. Class I areas are areas where flammable gases or vapors may be present in potentially explosive quantities. Class II areas are areas where combustible dust is present in potentially explosive quantities. In general, Division 1 locations are areas where a potentially explosive concentration or quantity exists under normal operating or maintenance conditions, while Division 2 locations are those locations where potentially explosive conditions would typically only exist in the event of some failure (i.e., rupture or equipment breakdown). Refer to the NEC and other applicable codes for specific direction on classification of hazardous areas. Designers must use reasonable care and discretion when classifying areas as hazardous, as considerable additional expense will be required for electrical equipment installed in classified areas.

(3) Wherever possible, designers should strive to limit the amount of equipment, sensors and controls that must be located in hazardous areas. Where practicable, equipment such as control panels and motor starters should be located in unclassified areas. As an alternate to using (XP) enclosures for control panels in hazardous locations, NEC article 500-2(a)(3) allows the use of purged and pressurized enclosures in hazardous areas. This method is typically significantly less costly than installing XP enclosures. For additional guidance on the use of purged and pressurized enclosures, designers are referred to NFPA 496, Standard for Purged and Pressurized Enclosures for Electrical Equipment. In addition, intrinsically safe sensors and controls may be substituted for XP sensors located in hazardous areas, in accordance with NFPA Article 500-2(a)(4), and in accordance with ANSI/UL 913-1988, Intrinsically Safe Apparatus and Associated Apparatus for Use in Class I, Class II and III, Division 1, Hazardous Locations. Designers must note that intrinsically safe sensors require the use of intrinsically safe relays, and that intrinsically safe wiring must be physically separated from non-intrinsically safe wiring.

e. Electric Service. If the MPE site is on a Military Reservation, the electric utility is normally owned and operated by the Government. The design agent will design any connections or extensions. If Government-owned electric supply is not available, the local utility company will provide services, usually up to the transformer secondary, and at times the service entrance conductors to the site. It is the designer's responsibility to clarify what service the local utility will provide and what services will be the construction contractor's responsibility. Local utility connection charges can be expensive (around \$30,000/mile of three-phase line) and may take several weeks or more to schedule with the utility. Designers should verify power availability, cost, and time for electrical services at the earliest possible opportunity.

5-9. Waste Stream Treatment Options. Off-gas treatment and wastewater treatment will be discussed briefly in this section. A complete discussion of the design of emission control or wastewater treatment devices is beyond the scope of this manual. Other existing USACE guidance documents are available to assist with the evaluation and design of waste treatment devices. Designers should consult the Federal Remediation Technologies Roundtable (FRTR) Remediation Technologies Screening Matrix and Reference Guide (Van Deuren et al. 1997) for use in conducting preliminary screening of available treatment alternatives. This guidance is available in print form through NTIS or via the Internet at <http://www.frtr.gov>. Preliminary treatment system capital and operating costs from other government remediation cost data source documents are incorporated into the Screening Matrix Guide to allow the designer to make a preliminary estimate of waste treatment costs. In addition, the USACE has developed several guidance documents to assist designers with establishing requirements for waste treatment equipment, including:

- [CEGS-11225](#) (Oct. 1995, Feb 1997) Downflow Liquid Activated Carbon Adsorption Units.
- [CEGS-11226](#) (DRAFT In Progress) Vapor Phase Activated Carbon Adsorption Units.
- [CEGS-11301](#) (November 1991, July 1997) Air Stripping Systems.
- [CEGS-11377](#) (July 1997) Advanced Oxidation Processes.
- [EP 1110-1-21](#) (1997) Air Pathway Analysis and Design of HTRW Remedial Action Projects.

a. Off-gas. Off-gas contaminant mass loading in MPE applications is typically high due to several factors: 1) MPE technologies are often used at sites where NAPL is present; 2) the high vacuums may volatilize many low-vapor pressure contaminants; 3) turbulence in a TPE drop tube tends to cause it to act as an in-pipe air stripper, transferring volatile contaminant mass to the vapor phase; and, 4) dewatering or desaturating of the capillary fringe during MPE may expose adsorbed contaminants to airflow for subsequent collection by the MPE system. The [FRTR](#) provides a summary description of a number of commonly used off-gas treatment technologies. The off-gas treatment technologies discussed in the [FRTR](#) include: thermal oxidation, catalytic oxidation, condensation, carbon adsorption, resin adsorption, biofiltration, internal combustion engines, and flares. Additional information can also be found in Principles and Practice of Bioventing, Volume II, Appendix D - Off-Gas Treatment Options (Leeson and Hinchee 1995). Applicable concentration range, capacity range, removal efficiency, secondary waste streams, advantages and limitations of each technology are presented in tabular form in [EM 1110-1-4001](#).

b. Groundwater.

(1) If contaminant concentrations in the extracted groundwater are low enough it may be possible to discharge the extracted groundwater directly to the local POTW or to a NPDES discharge point; however, this is rarely the case, and treatment of the extracted groundwater is generally required. Once the phase separation has been completed, groundwater treatment in MPE applications is similar to other remedial technologies that require treatment of recovered groundwater. Selection of the groundwater treatment alternative will depend on the groundwater flow rate, contaminant type and concentration, discharge permit limits, presence of other constituents in the water (e.g., iron, manganese, calcium), secondary waste stream generation, and capital and operating costs.

(2) Typical groundwater treatment methods for organic compounds include:

- Air stripping.
- Liquid-phase carbon adsorption.
- Advanced oxidation processes .
- Ex-situ bioreactors.

- Resin adsorption.

(3) These groundwater treatment technologies have all been applied as full-scale treatment technologies at government and private sites. Designers should consult the [FRTR](#) Remediation Technologies Screening Matrix and Reference Guide (Van Deuren et al. 1997) for information necessary to perform a preliminary screening-level evaluation of the applicability of these various technologies. Once inapplicable technologies have been screened out, the designer should contact water treatment technology vendors to discuss the design basis and establish preliminary component sizing, estimated removal efficiencies, and estimate capital and O&M costs.

c. NAPL. Recovered NAPL is typically stored in a tank and manifested off site as a hazardous waste. If the recovered NAPL is sufficiently pure, free of sediment, and has a sufficiently high heating value, it may be possible to use the recovered NAPL as supplemental fuel for a thermal vapor-phase treatment device (i.e., catalytic oxidation, thermal oxidation, internal combustion engine or flare). This approach will eliminate one waste stream from the project and will reduce treatment costs for another waste stream. Use of this approach is very site specific but should be considered in appropriate cases. Another option may be to send the recovered NAPL to an off-site recycler.

d. Emulsions. Oil-water emulsions may occur during simultaneous extraction or transfer of groundwater and NAPL. The presence of emulsified oil in liquid effluent will typically result in a violation of discharge permit limits for total oil and grease, and/or for total toxic organics. Refer to [paragraph 5-6d\(3\)](#) for a discussion on methods of breaking or treating oil-water emulsions.

5-10. Other System Appurtenances and Design Considerations.

- a. Buildings or Enclosures.

(1) Typically, MPE systems are housed in an existing building, in a shed, or in a trailer. Enclosures housing MPE equipment should be equipped with adequate electrical power, heating, lighting and ventilation. The selected enclosure may serve several purposes, such as: 1) protect the MPE equipment from sunlight, precipitation and/or freezing, 2) reduce the chances of damage due to vandalism, and 3) reduce external noise pollution.

(2) Although the enclosure must be sturdy enough to withstand wind and snow loads, designers should be frugal when designing the MPE enclosure. Equipment should be laid out to utilize interior space efficiently without being so cluttered as to make maintenance activities difficult. For sites where a portion of the MPE system enclosure will be classified as a hazardous area, it is often desirable to install a barrier wall to separate the classified and unclassified areas. Designers should strive to include engineering controls (e.g., negative pressure air handling, ventilation, and locating fugitive emission sources outside of enclosed spaces) to prevent the need to have continuous monitoring for explosive conditions. Service panels, control panels, disconnect switches, and other components can be located in the unclassified area to reduce the amount of electrical equipment within the classified area. As an alternative, service panels, control panels and disconnects can be mounted on the exterior of the building. Electrical components mounted outside should be covered with a roof and secured to prevent damage or vandalism.

b. Surface Covers. Surface covers or impermeable caps are used to reduce infiltration and to prevent or reduce short-circuiting of airflow. Surface caps may be constructed of asphalt or concrete, or may be a synthetic material such as high-density polyethylene (HDPE) or low-density polyethylene (LDPE). Existing pavement may require the application of an asphalt sealer to reduce air leakage. It should be noted that existing pavement is not considered an adequate seal if it was installed with a base course. Refer to EM1110-1-4001, Chapter 5, for additional information on use and effectiveness of surface covers.

c. Barrier Walls.

(1) Barrier walls may be used to contain NAPL migration. Barrier walls may be constructed of soil-bentonite (S-B) slurry, steel (or plastic) sheet piles, pressure-injected grout curtains or a synthetic material (e.g., HDPE). USACE guidance indicates that S-B slurry cut-off walls have replaced the use of traditional cutoff barriers such as steel sheet piles or grout curtains at hazardous waste sites. Slurry wall barriers are constructed by excavating a relatively narrow vertical trench, typically 0.6 to 1.5 m (2 to 5 ft) wide, through a pervious soil stratum to an underlying impervious layer. The trench is filled with a bentonite-water slurry during excavation to stabilize the trench walls, - allowing excavation to continue through the slurry, to the desired depth. Once the desired depth has been reached, the slurry trench is backfilled with a soil/bentonite/water mixture designed to provide a low-permeability barrier wall (10^{-7} to 10^{-8} cm/sec). Designers should consult guide specification [CEGS 02444](#), Soil-Bentonite Slurry Trench for HTRW Projects, and other USACE reference documents if considering use of an S-B cut-off wall. Installation of sheet pile barrier walls may be performed using conventional impact or vibratory pile driving techniques. Installation of a synthetic barrier may be accomplished by conventional cut and cover excavation techniques, or the designer may opt to consider a one-pass trenching method to install a vertical HDPE barrier. The type of barrier wall should be selected based on the specific installation configuration, required installation depth, contaminant type, and installation cost.

(2) Designers must consider the potential for groundwater to mound up behind a barrier wall and, either over-top the barrier wall or flow around the limits of the barrier wall. Therefore, barrier walls should, at a minimum, incorporate water level monitoring piezometers on either side of the barrier. Because groundwater and NAPL will build up behind (upgradient of) the barrier, it is generally beneficial to install groundwater recovery wells/trenches, MPE and/or SVE on the hydraulically upgradient side of the barrier. If a barrier wall is contemplated to contain DNAPL migration, the designer must carefully consider whether potential detrimental effects could result during construction of the barrier that could mobilize the DNAPL or allow DNAPL to migrate to previously uncontaminated sub-strata. Refer to other USACE guidance for additional information on design requirements and considerations for construction of vertical barrier walls.

d. Freeze Protection. Heat tape is typically used to provide freeze protection for exposed piping. Heat tape is rated in power output per unit distance (e.g., watts per foot). Calculate the estimated heat loss based on the type of piping, and the expected temperature difference between the process water and the outside air. It is generally best to use a self-regulating heat tape as opposed to a constant wattage heat tape to prevent the heat tape from overheating. If heat tape is to be used in a classified area (e.g., inside a well vault where NAPL is present), consult the manufacturer regarding their procedures for approving the use of their product in a classified location. Many manufacturers will require a design review and use of XP termination kit accessories before approving the use of their product in a classified location.

Heat tape should always be covered with insulation to retain the heat, otherwise the heat input will be dissipated in the surrounding soil or atmosphere. Insulation should be suitable for wet conditions (e.g., closed cell foam) since water may condense on the outside of the piping and because outside piping may be exposed to precipitation. For long-term MPE projects, exposed insulation should be coated or covered to prevent photo-degradation. More information on insulation can be found in [CEGS 15080](#), Thermal Insulation for Mechanical Systems.

e. Alarms. Other appurtenances such as audible alarms and warning lights may also be included as part of a MPE system. Alarms and warning lights may be located within the treatment system enclosure to alert on-site operators or located outside of the building in order to notify outside sources (e.g., facility personnel not associated with the MPE system) that the system is in alarm condition. MPE systems may also be equipped with remote alarm notification that will call the system operator via an autodialer should the system go into alarm condition.

CHAPTER 6
DESIGN DOCUMENTATION

6-1. Introduction.

a. Design and construction documentation must comply with ER 1110-345-700, Design Analyses, Drawings, and Specifications. Complete design packages must include a thorough and complete design analysis that documents all design issues, assumptions, critical parameters and special site-specific considerations. Additional information may also be required by state and/or federal agencies for design submittals.

b. The design analysis must include a complete narrative description as well as supporting calculations including the material balances and modeling assumptions and results. This information is required to be submitted as part of the design package; however, it is not required to be included as part of the construction bid package issued to contractors.

c. This chapter will discuss typical drawings and specification sections normally included in a MPE design package; however, site specific requirements will vary and actual needs may differ from those shown below.

6-2. Drawings. Typical drawings required for MPE design may include some or all of the following:

- Site location.
- Legend and general notes.
- Site plan and profiles.
- Well construction and surface cover details.
- Exterior details.
- Piping and equipment layout.
- P&ID with control logic identified.
- Piping sections.
- Piping plans.
- Piping profiles.
- Piping details.

- Pitless adapter details.
- Pump setting details.
- Interior details.
- Foundation plan & structural details (where required).
- Power plan.
- Power/control plan including control panel layout and sequence of control.
- Electrical details/wiring diagram including legend and standard symbols.
- Lighting, power and one-line electrical diagrams.
- Schedule of valves (valve ID #, size, type, material of construction).

6-3. Specifications. Typical specification sections that may be utilized in MPE designs are listed below. Where applicable, the CEGS section number is presented. Specifications shown ending in XXX are either currently under development by USACE or may need to be developed by the designer to meet project specific needs. The designer should always check [TECHINFO](#) for the most recent versions of all guide specifications and the addition of new ones. TECHINFO can be reached through the Home Page of the U.S. Army Engineering Support Center, Huntsville.

a. Typical Specification Sections

(1) Work Plans.

01240	Cost and Performance Report
01270	Measurement and Payment
01320	Project Schedule
01330	Submittal Procedures
01351	Safety, Health and Emergency Response
01410	Environmental Protection
01450	Chemical Data Quality Control

01451 Contractor Quality Control
01XXX Special Items
01XXX System Startup, Operation, and Maintenance Plans

(2) Site Work.

02120 Transportation and Disposal of Hazardous Materials
02150 Piping; Off-Gas
02220 Demolition
02230 Clearing and Grubbing
02260 Soil-Bentonite Slurry Trench for HTRW Projects
02300 Earthwork
02316 Excavation, Trenching, and Backfilling for Utilities Systems
02500 Pipelines, Liquid Process Piping
02521 Multi-Phase Extraction Wells
02522 Ground-water Monitoring Wells
02699 Valve Manholes and Piping and Equipment in Valve Manholes
02741 Bituminous Paving for Roads, Streets and Open Storage Areas
02754 Concrete Pavement for Small Projects
02975 Sealing of Cracks in Bituminous Pavements

(3) Extraction and Treatment System Specifications.

11211 Pumps: Water, Centrifugal
11212 Pumps: Water, Vertical Turbine
11215 Fans/Blowers/Pumps; Off-Gas
11220 Precipitation/Coagulation/Flocculation Water Treatment

EM 1110-1-4010
1 Jun 99

11225	Downflow Liquid Activated Carbon Adsorption Units
11226	Vapor Phase Activated Carbon Adsorption Units
11242	Chemical Feed Systems
11301	Air Stripping Systems
11377	Advanced Oxidation Processes (AOP)
11378	Thermal (Catalytic) Oxidation Systems
11393	Filtration System
11500	Air Pollution Control
11XXX	Vapor Phase Resin Adsorber
11XXX	Package MPE System
11XXX	Multi-Phase Separator or NAPL-Water Separator
13121	Metal Building Systems (Minor Requirements)
13405	Process Control
15400	Plumbing, General Purpose
16370	Electrical Distribution System, Aerial
16375	Electrical Distribution System, Underground
16415	Electrical Work, Interior
16475	Coordinated Power System Protection

CHAPTER 7

CONSTRUCTION, START-UP & GENERAL OPERATIONS AND MAINTENANCE

7-1. Introduction.

a. This chapter provides guidance on: 1) collecting baseline data for future evaluation of MPE performance; 2) testing the equipment (i.e., shakedown); 3) operating the MPE system during start-up; 4) monitoring MPE (the equipment and the subsurface conditions) during start-up and over the long-term; and 5) operating and maintaining the MPE system over the long-term.

b. Some of the guidance on operations and maintenance (O&M) is taken from [EM 1110-1-4001](#), SVE and Bioventing. Additional O&M activities that are required for MPE but not SVE/BV include:

- Preventing leaks in system piping that is subjected to much higher vacuums.
- Adjusting the system to optimize free-phase product removal.
- Operating oil/water or DNAPL/water separators.
- Treating contaminated groundwater that is extracted.
- Adjusting the placement of drop tubes or submersible pumps to desired depths (e.g., in some cases, sequential lowering of the water table may be beneficial in that SVE can be performed in certain strata without dewatering potentially higher permeability soil layers and thereby promoting preferential airflow).

7-2. Construction Oversight. The construction of an MPE system consists of well installation, piping and wiring installation, and placement of pumps, blowers, or vacuum pumps and accessories. The construction of an MPE system is comparable to the installation of soil vapor and groundwater extraction systems. [EP 415-1-261](#), Volume 5, Chapters 2 and 6, contain specific information on construction of groundwater and soil vapor extraction systems, respectively, that can be applied directly to oversight of installation of the various components of MPE systems. In particular, the guidance contained in those chapters is applicable to the installation of extraction wells, piping, and aboveground equipment.

7-3. Collection of Baseline Data.

a. General.

(1) Information on subsurface conditions must be updated just prior to implementation of MPE to provide a baseline against which the future effects of MPE can be compared and evaluated. Although much of the necessary characterization data may have already been developed during earlier site investigations, it should be confirmed that all necessary information has been collected and that baseline information is current. Collection of baseline

data is very important because once MPE has begun, baseline conditions cannot be determined accurately.

(2) An efficient way to ensure that the necessary baseline data are collected is to produce a checklist of parameters to be measured, including measurement locations and methodology. Table 7-1 lists the parameters that typically should be considered for measurement, and the following paragraphs explain some of the rationale behind their inclusion. Table 3-10 provides additional information about many of these parameters). The specific measurement locations (see 7-3(e)(3)) for each parameter must be selected so variations in subsurface conditions can be determined.

TABLE 7-1

**Checklist of Baseline Data to Consider Collecting
(This assumes site characterization has been completed.)**

Soil characteristics	
	Variation in contaminant concentrations (laterally and with depth)
Soil gas pressures in:	
	Vadose zone monitoring points
	Groundwater monitoring wells
Barometric pressure	
Groundwater elevations in:	
	Phreatic zone (shallow) wells
	Deep wells (for determination of vertical hydraulic gradients)
Soil gas concentrations measured in:	
	MPE wells
	Vadose zone monitoring points
	Groundwater monitoring wells
Biological activity parameters (if biodegradation is a remedial component)	
	Respiratory parameters (e.g., O ₂ , CO ₂ , CH ₄)
	Nutrient concentrations (e.g., nitrogen, phosphorus)
	Plate counts of total heterotrophs and/or specific types of degraders (e.g., hydrocarbon degraders)
Groundwater quality (e.g., oxidation/reduction potential, pH, conductivity, temperature, concentrations of: contaminants, dissolved oxygen, dissolved hydrogen, iron, manganese, nitrate, sulfate, chloride, hardness, alkalinity, anions and cations) in:	
	MPE wells
	Groundwater monitoring wells
NAPL (if present)	
	Viscosity, density, composition and type (e.g., of petroleum product); tendency to form emulsions
	Area of plume and thicknesses across site
	Depth of smear zone
Estimate of total mass of contaminants and distribution among all phases and zones	

b. Soil Vacuum/Pressure Head Distribution. At most sites, especially those with shallow water tables, the static soil gas pressure in the soils to be remediated should be equal to or very similar to atmospheric pressure, or the differences should be small compared to the vacuum to be applied. Still, this should be confirmed by measuring baseline vadose zone pressures. Also, changes in atmospheric pressure when weather fronts pass through the area can

cause small pressure differences between the subsurface and the atmosphere. Therefore, soil gas pressure should be monitored in several wells over at least a few hours to establish the baseline variations that can be expected. This will become important when evaluating whether pressure changes observed during remedial operations are due to weather conditions or the application of a vacuum.

c. Soil Characteristics. Chapter 3 discusses the rationale and methodology for collecting data relative to the following soil characteristics:

- Stratigraphy.
- Permeability of different soil layers (this can be estimated from data collected during pumping tests in the saturated zone or SVE pilot tests in the vadose zone, and/or by laboratory triaxial cell permeability measurements of soil samples).
- Porosity (air- and water-filled) in different soil layers.
- Soil moisture content in different layers (can be measured or calculated from the above porosity data).
- Fraction organic content (foc) in different soil layers (for estimating the amount of adsorbed contamination).
- Spatial variation in the above soil properties site-wide.

d. Piezometric Head Distribution, NAPL Thickness.

(1) Application of a vacuum to SVE or MPE wells will cause upwelling within the extraction well if liquid is not removed. Even with liquid removal, upwelling may occur in the area around the extraction well where pressures are sub-atmospheric. Therefore baseline static groundwater levels must be measured in the MPE system area. It is also very important to accurately measure baseline LNAPL thicknesses in the extraction well(s) and in surrounding monitoring wells containing LNAPL. The true LNAPL thickness (see paragraph 3-5a(2)) should be estimated from the apparent LNAPL thickness. True DNAPL thicknesses should also be estimated, if possible.

(2) If deeper or nested groundwater monitoring wells exist, the piezometric heads should be measured in order to calculate vertical hydraulic gradients.

e. Chemical Data Requirements. If recent data are not sufficient, then additional baseline chemical data should be collected prior to start-up. For most chemical parameters, data should not be more than a month or two old. Concentrations of contaminants in the groundwater, soil, and soil gas, and free product composition will change during remediation as the more volatile components are removed and more biodegradable compounds are consumed. Therefore, it is important to have a good understanding of pre-remediation (baseline) concentrations against which to compare future concentrations. These changes will also affect efficiencies, costs, and sometimes methods of treatment. A Sampling and Analysis Plan (SAP) should be prepared that

specifies how, what and where to sample, and how samples will be analyzed. The SAP should also include protocols for sample transportation and chain of custody procedures. The quality objectives and other quality assurance and control procedures that are appropriate or required for the site must also be included in the SAP. For these requirements, the designer should follow [EM-200-1-3](#), Environmental Quality - Requirements for the Preparation of Sampling and Analysis Plans. This document provides guidelines for implementing any SAP in a way that will produce data of the necessary quality, accuracy, representativeness, etc. The following sections discuss some of the key aspects of SAPs.

(1) Contaminants to be Measured.

(a) The contaminants to be measured in the extracted groundwater and soil gas should have been identified during previous investigation phases. The parameter list should be reviewed for completeness and should include:

- Contaminants that exceed a clean-up standard and must be remediated.
- Other compounds that can affect treatment or whose change in concentrations will help the evaluation of the remediation progress. For example, observing different rates of decrease in concentrations of various volatile contaminants (including compounds that do not require remediation) can help evaluate the rate of progress of MPE. Similarly, changes in concentrations of compounds of differing biodegradabilities, and the production of biodegradation breakdown products, can assist the evaluation of the degree of biodegradation that is occurring. Other constituents may be oxidized or adsorbed along with the target compounds.
- Specific contaminants to be measured in each medium will depend on the contaminant characteristics. For example, only VOCs need to be measured in the soil gas and only soluble components of the NAPL need be measured in the groundwater. Soil samples should generally be analyzed for VOCs, SVOCs and petroleum hydrocarbons. For NAPL, quantifying the major constituents is usually sufficient (and it is usually difficult to quantify lesser constituents because of interferences from the major constituents).

(b) In addition to the need to determine mass balances and removal rates, additional parameters need to be measured to enable evaluation of other aspects of MPE remediation. Physical, biological and chemical parameters that may affect treatment or may be important for evaluating bioventing and natural attenuation are included in Table 7-1.

(2) Health and Safety considerations. Health and Safety issues are to be addressed in a Site Safety and Health Plan (SSHP). Many of the specific issues that relate to MPE sites are related to volatile and flammable gasoline and other petroleum compounds. Therefore, combustible gas indicators should be employed to ensure that explosive mixtures do not collect in enclosed areas. Other volatile or hazardous compounds (such as toxic chlorinated compounds) may be present, representing a potential exposure hazard to workers. The SSHP should therefore specify the use of appropriate field instruments (e.g., PIDs or FIDs in the case of volatile compounds) to evaluate concentrations of these compounds.

(3) Quantity of Samples. The number of baseline samples must be sufficient to characterize variations across the site and provide representative data. EM 200-1-3 and Breckenridge (1991) provide guidance for selecting the number of samples to collect. Geostatistical methods can effectively be used to estimate average concentrations in various areas (blocks) and can provide measures of the uncertainties in those estimates. Refer to other USACE guidance on geostatistics. However, such a rigorous effort is not usually necessary for remediation design purposes since very high and very low concentrations will be averaged out in the gas and liquid waste streams. What is important to gather from the sampling results is some certainty that the chosen design basis concentration(s) are not much different than the average concentrations in the area to be remediated. If the design concentration turns out to have been overestimated, the remediation system may be oversized and therefore more expensive than necessary. If the design concentration turns out to have been underestimated, the treatment system will not be able to handle the flow or mass loading.

(a) Sufficient data should also be gathered such that the initial contaminant mass in the various phases (free phase, adsorbed, dissolved) can be estimated so that mass removed during MPE can be compared to that originally present.

(4) Field Sampling and Analytical Measurement Methods.

(a) The field sampling methodology (including sampling equipment, sample containers, preservatives, holding times, equipment decontamination procedures, etc.) should be detailed in the Field Sampling Plan (FSP) section of the SAP. EM 200-1-3 should be used for guidance. Examples of appropriate analytical methods are listed in Tables 3-7 and 3-8 of this EM.

(b) Similarly, screening and analytical methods to be used (in-situ, on-site or laboratory) should be specified in the SAP. Specific field instruments (i.e., dissolved oxygen meters, field test kits, portable VOC detectors, etc.), calibration procedures, and proper use should also be described.

(5) Quality Assurance/Quality Control procedures will be chosen with the help of Appendix H of EM-200-1-3 and will be contained in the Quality Assurance Project Plan (QAPP) section of the SAP.

(a) Since the FSP and QAPP of a SAP will likely also be appropriate for the start-up phase as well as long-term monitoring and closure, it may be advantageous to prepare a single SAP to guide monitoring for the entire remediation program. The locations and numbers of samples will vary with the different phases of work. Also, the degree of required QA/QC will vary depending on the phase of remediation (i.e., specifications for O&M monitoring may be less rigorous than those for baseline or closure monitoring).

7-4. Equipment Shakedown/Testing.

a. Before actually beginning the remediation effort, all aboveground equipment and piping should be inspected and tested. An extensive shakedown checklist is included as Table 7-2. Manufacturers' specifications should be included on this checklist so that performance can be easily checked. Out-of-compliance conditions should be corrected prior to start-up of the entire system.

TABLE 7-2

Example Pre-Commissioning/Shakedown Checklist

Checklist Item		Approved by	Date
Subsurface			
	Wells installed and developed as specified		
	Well head covers in good repair and clearly marked		
	Determine/record specific capacity of wells		
	Drop tube (s) and well heads assembled correctly		
	Vadose zone monitoring points installed, developed and pressure tested		
	Trenches, seals and horizontal wells installed per specifications		
	Trenches for subsurface piping installed per specifications		
Piping installation			
	Piping complete (aboveground and subsurface)		
	Piping flushed and pressure/vacuum tested		
	Silencers, strainers and filters installed in correct direction		
	Control and check valves installed and operation verified		
	Valves accessible (easy to reach/manipulate)		
	Piping leak tested (insulation/heat tape, if required, will be installed later after system has been started up)		
	Piping clearly labeled and valves tagged		
Pumps and blowers			
	Foundation, trailer, or shed complete according to specifications and inspected by building inspector (if required)		
	Vibration dampers installed, heavy equipment bolted in place		
	Motor and blower coupling alignments are level and true		
	Pipe supports installed/tested		
	Pumps and seals intact (no leaks)		
	Centrifugal pumps primed as needed or plumbed to self-prime		
	Belts properly tensioned, guards in place		
Electrical/controls/instrumentation			
	Grounding installed/checked		
	Lighting/HVAC and thermostats functional		
	Lockouts/covers/panels in place		
	Pressure/vacuum transducers functioning and calibrated		
	Temperature and pressure gauges installed or portable gauge connections provided		
	Blower and pump rotation verified		
	High and low fluid level sensors operating		
	Disconnects in sight of unit being controlled		
	PLC, controls/alarms, remote monitoring system and interlocks functional and calibrated		
	Power connected to on-line monitoring instruments		
	Final approval received from electrical inspector		

TABLE 7-2

Example Pre-Commissioning/Shakedown Checklist (Continued)

Checklist Item		Approved by	Date
Other			
	Operators have been trained (with respect to Health & Safety and equipment operation)		
	Groundwater treatment system operating (hydraulically) and groundwater discharge (sewer, NPDES, re-injection) arranged		
	Flame arrestor on vapor oxidizer installed correctly		
	Vapor treatment system functional		
	Liquid ring fluid make-up system functional		
	Oil/seals/recirculation system (for oil-cooled blowers) functional, and lubricating oil filled		
	Treatment enclosure ventilation functional		
	Control panel purge system (if required) functional		

b. After the operator has confirmed that all engineered systems meet specifications, the operator will recommend to the project manager that operation begin. The site Health & Safety officer must also be in agreement that all safety devices are operable and that site personnel have, and are trained to use, the appropriate personal protective equipment as required by the SSHP.

7-5. System Start-Up. System start-up refers to the actual initial period of extracting, separating, and treating fluids and measuring the response at surface and subsurface measuring points. This period may last hours, days, or weeks, depending on the complexity of the system, the conditions encountered, and the time to reach steady-state operating conditions.

a. Operations.

(1) This section presents an overall strategy for the start-up of an MPE remediation system, including monitoring the initial response in the subsurface and making the necessary adjustments to begin meeting the operational and remedial objectives. As with all paragraphs in this chapter, the designer preparing the O&M manual must decide which of the suggestions included here (or not included here but relevant to the site-specific remediation system) are appropriate given site-specific conditions, remedial objectives, and remedial equipment. The designer must also decide what constitutes the start-up phase since there is likely to be a specific contract in place to bring the system from installation to normal, long-term operations. The intent should be made clear in the start-up contract. The best way to specify what is expected from the contractor in the start-up phase is to list the performance criteria that must be met before the start-up phase contract is considered complete. Examples of performance criteria are: 48 (or more) hours of continuous operation of all equipment, reaching steady-state flow or pressure conditions; completion of a specified number of cycles of pumping based on water level switches; or completion of all start-up data collection. There may be unexpected problems during the start-up phase, especially if the start-up contractor was not the installation contractor. The contract should thus also specify the conditions or situations that are understood to be out of scope,

and which aspects of a second or third start-up are within scope and which are out of scope.

(2) The designer must state the specific intent and objectives of the start-up phase of system operation. In general, the intent of the start-up phase is to bring all systems, above and below ground, into normal operation (although concentrations and flows may continue to change). The objective of the start-up phase of MPE (and of SVE as well) entails more than simply the mechanical start-up of aboveground equipment. It is also a very important phase in the remediation, because often the highest rates of contaminant removal occur during this initial operating period. Start-up monitoring data can be tabulated and displayed graphically to determine trends in the subsurface response to the MPE system.

(3) The principal objective of many MPE projects is to maximize NAPL removal. However, in cases where MPE is used to augment SVE, the principal objective could be to depress the water table surface and remove enough water to facilitate vapor extraction within the enlarged vadose zone. In this case, greater groundwater extraction rates may be desired to consistently reduce the water table over the entire remedial area. Another example for which greater groundwater extraction rates may be desirable is vacuum-enhanced groundwater extraction systems. Depending on the amount of NAPL at a site and how recoverable the NAPL is, the relative amount of contaminant mass removed during a MPE remediation via either soil gas or groundwater may be less or greater than via NAPL. Initially, if recoverable NAPL is present at the site, most contaminant mass removal is usually in the form of NAPL. But as NAPL recovery rates decline, relatively more may be removed via soil gas and groundwater. The amount of contaminant mass removed per time via soil gas is usually greater than via groundwater, at least initially when soil gas concentrations are high. If soil gas concentrations decrease but groundwater concentrations decrease more slowly, contaminant mass removal via groundwater may eventually become predominant.

(4) A periodic or preventative maintenance plan is typically not included in the start-up plan because the start-up period is typically too short to require scheduled maintenance. Regular or scheduled maintenance items are covered in [paragraph 7-6](#). However, some components may require adjustment during start-up, so manufacturers' specifications and a troubleshooting guide should be included in the start-up plan. For very complicated equipment such as a catalytic or thermal oxidizer, it may be very beneficial to have the equipment supplier or representative on-site during initial start-up activities.

(5) The start-up plan should be prepared and implemented sequentially, to allow comparison of the observations and measurements with the design criteria. This will ensure that the plan is implemented systematically and safely. This sequence is especially important because flammable liquids and explosive vapors may be present.

(6) Table 7-3 is a sequential list of operations that is likely to be followed during an MPE system start-up. In addition to developing such an operations list to follow during start-up, a checklist of the expected ranges in flows, pressures, etc. should be prepared to accompany the monitoring schedule discussed in [paragraph 7-5b](#). If measured conditions vary significantly from the expected range, the reason(s) must be investigated, and explained or corrected. If the reason for the variance cannot be determined or remedied, the system may need to be shut down until corrections can be made.

TABLE 7-3

Suggested Sequence of Operations During Start-up

Check that all planned baseline measurements have been collected (see Table 7-1)	
Calibrate all dedicated and portable instruments	
Pressure test vadose zone monitoring points (they should slowly lose an applied pressure - no loss indicates clogging, fast loss indicates leak)	
Set fluid extraction drop tubes or submersible pumps to selected depths	
Ensure that liquid/air seals are tight at top of MPE wells	
Start groundwater pumping if separate groundwater pump is used (record flow rate and water levels)	
Confirm operation of level control sensors for pump operation	
Turn on vapor treatment system	
Open bleed/dilution valves and all valves controlling flow through vapor extraction/treatment system (extraction wells vapor valves closed)	
Turn on power for liquid transfer pump	
Start vacuum blower	
Open valves from extraction wells completely	
Slowly decrease flow through dilution air valve(s)	
Monitor and record:	
	Extraction well vacuum and vacuum at vacuum pump
	Gas and dilution air flow rates
	Groundwater drawdown
	Groundwater flow rates
	NAPL accumulation rate in tanks, NAPL/water separator
	Blower and pump cycles (programmable logic control should record on and off times)
	Fluid levels in extraction wells (not necessary if levels are controlled by drop tubes or level controls)
	Fluid levels in holding tanks
	Catalytic oxidizer catalyst temperature (if applicable)
Measure gas influent and effluent concentrations with PID or FID	
Monitor pressure changes in nearby vadose zone monitoring wells	
Check for emulsion formation in NAPL/water separator	
Adjust drop tube depths (TPE) or pump intake depths (DPE) to maximize free-phase product removal	
Adjust vacuum at the blower and valves on the extraction wells to optimize operation in accordance with operating strategy	
Leak test lines again at design vacuum	
Check instrument calibration at end of each day (or more frequently if required by SAP)	
Collect vapor samples for laboratory analysis if specified in SAP	
Collect influent and effluent compliance samples as required by permits/regulations	
Insulate/heat trace piping, after startup	

b. MPE Monitoring During Start-Up: Parameters, Methods and Frequency. During MPE start-up, measurements of both the aboveground equipment parameters and below-ground conditions must be performed. Some of these measurements must be real-time or almost real-time since adjustments in the operating conditions will frequently be required.

(1) During the design phase, one cannot precisely predict the required applied vacuum to extract groundwater, NAPL or soil gas from the soil. Therefore, the applied vacuum is typically increased gradually while monitoring

the resulting fluid flows and the resulting pressure effects in the soil formation surrounding the extraction wells or trenches. With a regenerative blower, this is usually done by beginning start-up with a dilution valve open that allows ambient air as well as soil gas to be taken in by the vacuum blower, thereby reducing the vacuum applied to the soil. (The blower exhaust could be recycled instead of bleeding in ambient air, but the potential of excessive temperature increases must first be evaluated before trying this.) The dilution valve is then gradually closed to generate increasing vacuum in the subsurface. The vacuum applied to the extraction well can also be varied through the use of a constricting valve on the inlet side of the vacuum blower. While this is an efficient control method for centrifugal blowers, it is energy inefficient to employ regenerative blowers in this way. Other methods of varying the applied vacuum include using variable speed motors or changing the pulleys and sheaves between the motor and the blower.

(2) A comprehensive monitoring plan is required in order to effectively evaluate subsurface response to MPE. The following sections discuss the types of measurements to be made and the rationale for each so that the O&M Plan author can develop an appropriate monitoring plan. Most of the same parameters must be measured during both the start-up and long-term operating phases of a MPE remediation. Therefore, it will usually be efficient to prepare an overall monitoring plan and simply specify the slightly different parameters and different monitoring frequencies during start-up and long-term monitoring. To help guide the preparation of a monitoring plan (for both phases), Table 7-4 notes monitoring parameters, including those that are not critical to measure during start-up. Long-term monitoring is discussed in paragraph 7-6c. The sampling and analyses aspects of the monitoring plan will follow the procedures specified for the SAP discussed in paragraph 7-3e. The following paragraphs discuss the rationale behind the more important monitoring issues.

TABLE 7-4

Suggested Checklist for Monitoring an MPE System

<u>Physical and Mechanical Parameters (in approximate descending order of importance)</u>
Vacuum in extraction wells and monitoring wells and ambient barometric pressure
Vacuum blower inlet vacuum
Vacuum at each flow measurement point
Vacuum blower outlet pressure
Groundwater drawdown in extraction wells
Volume of groundwater removed
Individual well head fluid velocities
Blower inlet flow rate
Treated effluent flow rate
Bleed/dilution air flow rate
Temperature at blower discharge
Temperature at each flow measurement point
Temperature of treated effluent
NAPL thickness in extraction wells and monitoring wells
NAPL accumulation rates
Appearance of flow regime in transparent portions of piping
Volume of condensate
Blower amperage meter readings
Run time of blowers or pumps
Soil moisture content changes (not critical during start-up)
Groundwater elevations near extraction wells
Degree of upwelling observed

TABLE 7-4

Suggested Checklist for Monitoring an MPE System (Continued)

Relative humidity of gas to be treated if by activated carbon (not critical during start-up)
Ambient temperature (not critical during start-up) Atmospheric pressure (not critical during start-up) Gas temperature at extraction wellhead (not critical during start-up) Noise level (as required)
<u>Chemical Parameters</u> Vapor contaminant concentrations at blower inlet and/or outlet Contaminant concentrations in treated effluent (gas and/or water) Contaminant concentrations at treatment midpoint (if using activated carbon vessels in series) Contaminant concentrations in extracted groundwater (not so critical during start-up) Gas contaminant concentrations in individual MPE extraction wells Gas contaminant concentrations in vadose zone monitoring points (not so critical during start-up) Compositional changes in NAPL (not critical during start-up)
<u>Biological Parameters (if biodegradation is an important remedial process)</u> Dissolved and gas phase oxygen concentrations (not critical during start-up) Gas phase carbon dioxide concentrations(not critical during start-up) Nutrient concentrations, e.g., nitrogen and phosphorus (not critical during start-up) pH (not critical during start-up) Oxidation/reduction potential (not critical during start-up) Microbial plate counts (not critical during start-up)

(a) Vacuum/pressure. Vacuum or pressure should be monitored in gauges installed throughout the MPE system whenever significant changes are expected (e.g., across the blower, the fluid separator, particulate filter). The vacuum at the well(s) is the most important factor to monitor and relate to evidence of the beginning of flow of fluids (air, groundwater, free-phase product). Increases in the resulting flow and changes in soil vacuum at soil gas monitoring points [installed around the extraction well(s)] over time are also important as they indicate when steady-state conditions are being approached. As reported by Johnson et al. (1990) and Peargin and Mohr (1994), the time to reach steady state can range from several hours to several days or much more, depending on soil permeability. The frequency of vacuum/pressure measurements can then be reduced over time as the magnitude of changes in measured values decline and steady-state conditions are approached. If many points need to be monitored and if initial changes are expected to be significant, it may be worthwhile to use electronic data loggers. If data loggers are used, the monitoring plan should include the calibration and operating procedures for the equipment. An accuracy of 0.2 mm Hg (0.1 inches water) column is usually sufficient, especially for the higher applied vacuums associated with MPE. Different strategies and monitoring may be appropriate for horizontal MPE systems where the vacuum is applied through horizontal piping and screens installed in trenches and the overlying soil must be of low permeability. In horizontal (trench) MPE systems, the applied vacuum should be checked at different locations along the horizontal screen, because the vacuum is not likely to be uniform throughout. Important measurements include vacuum in vadose zone monitoring points in order to evaluate the zones of influence and to confirm that the upper trench seals meet the design criteria.

(b) Fluid head distribution. Applying a vacuum to the well will cause the zone of saturation to upwell (rise) in the recovery well upon application of vacuum. However, in MPE, there is typically a drop tube or separate pump to remove groundwater and/or free phase product. Hence, this upwelling does not present the same problems encountered with SVE/BV systems of raising the top of the zone of saturation. Measuring the actual changes in the top of the saturated zone in the formation and/or in the extraction well may be desirable, but can only be accomplished if appropriate pressure transducers have been installed (see [paragraph 4-2e\(5\)\(c\)](#)). It would also be possible to install sensors to detect the thickness of NAPL in a MPE well during extraction but it is rarely done. Water and NAPL levels in nearby monitoring wells might also change due to the applied vacuum. If significant soil vacuums are noted during monitoring, the elevation of the top of the saturated zone should also be measured in the vadose zone monitoring points (if they intercept the water table), in such a way as to prevent air from leaking into the monitoring points. In a DPE trench system, water levels in the trench must be monitored to confirm that LNAPL or groundwater is indeed above the level of the horizontal pipe so that extraction can take place.

(c) Fluid flow. To measure the efficacy of the MPE system, the flows of extracted gas, water, and NAPL must be measured. [Paragraphs 5-7a\(3\)](#) and [5-7a\(4\)](#) discuss the various flow measurement devices available and note that fluid flows must be measured after the fluids have been separated. While these issues will have been considered during the design of the instrumentation and control system, they are also discussed here as a very important aspect of proper O&M.

- Gas velocities are typically measured with pitot tubes, rotameters or hot wire anemometers. The flow through a vacuum blower can also be estimated based on the inlet vacuum, outlet pressure and the manufacturer's blower curve. In DPE, the extracted gas flow from each well is typically measured using a pitot tube or hot-wire anemometer placed in the riser or in the conduit from the well to the manifold. With TPE (e.g., bioslurping), if flow from multiple wells are manifolded together before phase separation, it will not be possible to measure the soil gas flow from each well when both liquids and soil gas are being extracted. Only the total airflow to or from the vacuum blower will be measurable in this case.
- It is also very important to measure the flow of any dilution air so that the airflow from the subsurface can be calculated as the difference between the entire airflow being treated and the dilution airflow.
- Sufficient pipe length must be provided to reduce turbulence upstream and downstream of the measurement location. Attaining less turbulent flow conditions may also be aided by installing stabilizing fins, but this is usually not necessary (there is usually sufficient room in a MPE system to provide the required straight length of pipe). Airflow should be measured frequently during start-up, perhaps every 10 to 15 minutes during the first several hours and then hourly for the first several days to monitor the natural variation in flows. Measurement of the airflow from individual wells allows one to adjust the flow or vacuum to meet a particular operating strategy (e.g., equal flows, equal applied vacuum, equal mass removals).

- Gas flow rates should be reported in both scmm (flow at standard temperature and pressure) and acmm (flow at the actual temperature and pressure), and the temperature and pressure should also be recorded. (Scmm data are useful for comparing flows in standard units, while acmm data are required for calculating mass removal rates.) Corrections to standard temperature and pressure can be significant during high vacuum MPE. For example, the algorithm used by most hot wire anemometers (which actually measure fluid mass flow) report the velocity as if the air is at standard temperature and pressure. When calculating velocities from pitot tube data, both the differential pressure and absolute pressure must be known and used to calculate the velocity and flow (in accordance with manufacturers' instructions). Even the flow readings from rotameters must be adjusted depending on the absolute pressure and whether the rotameter is calibrated for a certain pressure (usually atmospheric) at the inlet or the outlet. Temperature corrections to flow measurements are generally small and are often ignored since the overall accuracy of flow measurement is ordinarily only about plus or minus 5 percent.
 - When designing the instrumentation system, the designer and operator must choose the correct pipe diameter for the velocity measurement device to be used. For example, an operator who later wants to use a pitot tube instead of the hot-wire anemometer (or vice versa) may discover that the pipe diameter is not appropriate.
 - Groundwater recovery rates may be measured with the use of flow rate meters or totalizing flow meters or by measuring accumulation in a holding tank over time, after separation from NAPL. Initial flow rates will be very important for evaluating conditions in the recovery well(s) and should also be monitored frequently, perhaps hourly on the first day. After separation, NAPL flow can generally be measured in a manner similar to that for groundwater. However, flow meters for NAPL measurement must be calibrated to the specific gravity of the NAPL.
- (d) VOC concentrations in extracted gas.
- In almost all cases, the mass of contaminant being removed in the gas phase will need to be measured during start-up (when significant changes often occur). The removal efficiency of the gas treatment system must also usually be monitored. Thus, influent and effluent VOC concentrations should be measured frequently enough to observe changes. The precision, accuracy and quantification requirements are specified in the SAP and will depend, in part, on the chosen sampling and analytical methods. Sampling and analysis may employ: FIDs, PIDs, on-site GCs, combustible gas indicators, detector tubes (i.e., Draeger®), gas (Tedlar®) bags followed by laboratory GC or GC/MS analysis, activated carbon adsorption tubes followed by laboratory GC or GC/MS analysis, or summa canisters followed by laboratory GC or GC/MS analysis. Paragraph 3-5d provides guidance on selecting the most appropriate methodology.
 - The specific analytical methods, holding times, QA/QC requirements, etc., for VOC monitoring in gas should be included in the SAP described in paragraph 7-3e, but they may be different than those chosen for other purposes such as determining of the extent of

contamination or demonstrating that remedial goals have been achieved. Effluent air sampling frequency is often specified in discharge permits.

- Methods for evaluating the VOC mass removal data are discussed in [paragraph 7-5c\(2\)](#).

(e) Groundwater quality.

- During the relatively short start-up period, groundwater contaminant concentrations in monitoring wells are not likely to change sufficiently to warrant any sampling or analysis.
- The quality of the extracted groundwater may change over time and therefore monitoring of contaminant concentrations is necessary for calculating mass removal of dissolved contaminants. If a groundwater treatment system is part of the MPE system, the SAP will address details of monitoring contaminant concentrations in the influent and effluent. Often, a discharge permit will specify monitoring frequencies and maximum discharge flow rates and concentrations.

(f) Other measurements. Performing the following supplemental measurements should also be considered for additional information that will help in evaluating MPE system operations:

- A volt meter (at a minimum) or an amperage meter (recommended) can be used to determine whether a motor is overheating or is functioning properly.
- Ambient atmospheric pressure should be monitored if it is important to distinguish small changes in vadose zone pressure from changes in ambient atmospheric pressure.
- If vapors are to be treated by vapor-phase carbon, the temperature and humidity may need to be controlled for optimum adsorption efficiency and to minimize costs (i.e., significantly lower adsorption capacity occurs when the relative humidity (RH) is greater than 50 percent). Therefore, the RH in the exhaust of the vacuum blower system should be measured. Alternatively, the RH in the exhaust can be estimated by assuming that the incoming air is at 100% RH at the temperature of the subsurface and then calculating the RH at the higher temperature in the blower exhaust.
- The temperature rise through the blower should be compared to the manufacturer's specifications for an indication of whether the blower is operating properly.
- Differential temperature through a catalyst (where applicable) can indicate the approximate level of VOC contamination in the gas extracted from the subsurface.

- Monitoring the level detectors in liquid/gas separators, water/NAPL separators, and holding tanks is important for the proper operation of, and troubleshooting of, the MPE system.

(g) **Steady-State Conditions.** Once steady-state operating conditions appear to have been reached, at least three sets of measurements of groundwater elevations, vadose zone vacuums, and gas and liquid flow rates should be collected at least one day apart (or more in the case of low permeability soils) to confirm the achievement of steady-state conditions. The start-up phase can then be considered technically complete. Long-term operational and monitoring guidance from this point forward is described in [paragraph 7-6](#). For contractual purposes, there should be more specific criteria for the start-up contractor to fulfill before this phase is considered complete and payment is approved. These criteria should be reasonable but give an incentive to the contractor to complete the start-up efficiently and expediently, For example, it could be required that the entire system operate for a specified number of hours or days and at some minimum flowrate without attendance for start-up to be considered complete.

c. **Start-up Report.**

(1) A start-up report should be prepared to report the data and observations developed during baseline monitoring, equipment shake-down and start-up. This information will be very important in evaluating the likelihood of success of the remediation, the expected time to reach remedial goals, long-term O&M costs, and potential quantities of contamination to be removed via gas and liquid phases. Many of the procedures to be specified in the long-term O&M plan described in [paragraph 7-6](#) will be based on the start-up results.

(2) A suggested format for the report would be to present the data by activity (baseline monitoring, equipment shakedown, instrument calibration, and startup) and chronologically within data categories (vacuum levels, flow rates, NAPL volumes, vapor concentrations, groundwater elevations, etc.). The following topics should be included at a minimum:

- Statement of objectives of the start-up phase of the remediation.
- Baseline information collected (as listed in Table 7-1 as well as data collected during earlier investigation phases that may be relevant for describing initial conditions), including field measurements and laboratory data.
- Results of equipment performance checks (as listed in Table 7-2 and Table 7-5).

TABLE 7-5

Suggested Operational Performance Checklist

	Checklist Item	Checked by	Date
Subsurface hydrogeology/soil conditions			
	Water level upwelling within expected ranges		
	Monitoring point chemical data within expected ranges		

TABLE 7-5

Suggested Operational Performance Checklist (Continued)

	Checklist Item	Checked by	Date
	Monitoring point pressures within expected ranges for zone of influence		
	Well specific capacity within expected ranges		
Piping, valves, and instrumentation			
	No leaks in piping or extraction well connections/fittings		
	All valves operate freely and correctly		
	Flow meters in good working order and properly calibrated		
	Expansion joints sufficient to take up movements due to temperature changes		
	Pressure relief valves operate at set pressures		
Pumps and blowers			
	Start and stop of all control mechanisms functioning		
	Operating conditions match pump curve specifications		
	Current draw and voltage balance match specifications for all phases		
	Support systems (sufficient make-up water for liquid ring systems, fuel for catalytic combustion systems) operate within specifications		
	No excessive temperature rises		
	No excessive vibration/noise		
Treatment systems			
	Air and water treatment system performance meets discharge requirements (i.e., maximum concentration, minimum percent removal)		
	Pressure/vacuum transducers maintain calibration		
	NAPL not escaping NAPL separator		
	Mass removal rates follow expected trends		

- Calibration records for instrumentation used on-site.
- Start-up operating procedures that were used.
- Times that pumps and blowers were started.
- Total elapsed time that pumps and blowers were operated.
- Times that various valves were opened and closed.
- Dates and times that the system was shut down (either purposefully or inadvertently).
- Pressure and vacuum measurements taken at blowers and other aboveground equipment.

- Lessons learned, i.e., a documentation of issues and difficulties encountered during the project.
- Pressure and vacuum measurements in recovery wells (before and after balancing flows if multiple wells are present) and in vadose zone monitoring points.
- Flow rates and total cumulative volumes of extracted gas, water and NAPL.
- Dilution air flow rates.
- Flow rates from individual wells should be tabulated if possible. In TPE (e.g., bioslurping) systems, it may not be possible to monitor individual well liquid and gas flow rates. Since NAPL is usually collected separately for disposal, its volume is usually known. At a minimum, the appearance of the flow regime within transparent portions of piping should be recorded.
- Samples collected and analytical results obtained for influent and effluent groundwater and gas.
- Calculations of contaminant mass recovered in water and gas streams, both total and on a well-by-well basis, if possible. [EM 1110-1-4001](#), Chapter 7 ("air emission calculation"), describes in detail how to perform such calculations. Basically, the extraction rate (mass/time) = Q (volume/time) \times C (mass/volume). However, concentrations in soil gas are most typically reported on a ppmv (volume/volume) basis. Conversion to a mass/volume (usually grams/m³) value is based on the molecular weight of the contaminant and the air temperature. For weathered gasoline sites, USEPA (1989) suggests using a molecular weight of 177. More accurate determinations are possible if gas concentrations of individual contaminants are known.
- Corrective actions or changes in design required due to construction conditions, design error or omission, or field observations during construction and start-up.
- Recommendations for adjustments to accommodate seasonal variations.
- Variation in actual versus anticipated operating conditions.

7-6. Operations, Maintenance and Monitoring. Every remediation system should have a site-specific, equipment-specific, comprehensive Operations and Maintenance manual. [EM 1110-1-4001](#), Chapter 8, discusses O&M manuals and presents a typical manual outline. An O&M manual for a MPE system would have similar contents. The paragraphs that follow present guidance on specifying the appropriate long-term (e.g., after the start-up period) O&M procedures as well as monitoring required for fine-tuning operation and evaluating remediation progress. Some of the monitoring activities are the same or similar to those performed during start-up discussed in paragraph 7-5.

a. Operation Strategy. Based on the chosen remediation strategy and objectives, a site- and equipment-specific O&M plan can be prepared. It is very important that the design basis and remedial strategy be considered in preparing this plan and that the system designers be involved in plan preparation.

(1) Subsurface Operations.

(a) The primary parameters that the operator can control to manipulate the subsurface during MPE, and strategies to consider, are discussed in the following paragraphs:

- The vacuum applied to the MPE well affects liquid and/or gas extraction rates, the extent to which vacuum dewatering and NAPL removal occurs in the formation, and to what distance it occurs from the extraction well.
- The position of the drop tube (for TPE systems) affects the amount of upwelling experienced adjacent to the MPE well and the liquid and gas extraction rates from the MPE well. Initially, the drop tube may be placed just at the liquid surface to remove mostly soil gas, thereby helping to dewater the soil. The drop tube can be lowered and raised to determine the optimal position for recovering LNAPL. With deep groundwater (>~25 feet), it is the flow of gas into the drop tube that entrains the liquid and carries it upwards. If the vadose zone soils have such low permeability that there is insufficient gas velocity to entrain liquids, it can be helpful to "prime" the system, e.g., have a separate tube deliver air to the liquid surface to convey the entrained liquids out of the well.
- For horizontal (trench) MPE systems, since the horizontal pipe cannot be lowered or raised, changes in the depth at which gas or liquid extraction is performed must be made by: choosing a different level pipe (if multiple level horizontal pipes with individual risers have been installed in the trench), or by varying the level of the drop tube or submersible pump in the trench sump (if multiple level horizontal pipes all discharge into sumps at the ends of the trenches).
- For recovery of shallow DNAPL (less than about 8 meters below surface) a drop tube placed into the water column to where the DNAPL has accumulated can be used. If the DNAPL is deeper, a submersible pump may be required. Experience has shown that centrifugal submersible pumps will often produce emulsions of water and NAPL. Therefore, unless a pilot test has shown that it is unlikely that emulsions will be created, positive displacement pumps (usually pneumatic) should be used instead. As the depth of DNAPL varies, the depth of the pump intake will need to be raised or lowered.
- Water pump intake depth and pumping rate (for DPE systems) affect the depth of the water table that is maintained in the vicinity of the MPE well. They also affect the extent of "dewatered" or unsaturated soil available for air flow to the MPE well.

- The depth interval over which vacuum is applied (in the case of nested or multi-level MPE wells) enables the operator to minimize the effects of soil heterogeneity and thus preferential flow pathways.

(b) The following secondary operational activities and their possible effects are discussed in more detail in [EM 1110-1-4001](#), Chapter 8:

- Transition from high flow extraction to low flow bioventing after significant contaminant mass is no longer being removed.
- Pulsed extraction from the wells.
- Cycling the applied vacuum among different extraction wells.
- Injecting air into some of the wells to enhance pressure gradients driving fluids toward extraction wells.

(2) Aboveground Operations. The O&M plan for aboveground treatment components must meet the goal of effectively extracting and treating fluids before discharge for the least cost of power, labor, and materials. To do this, consideration should be given to the following:

- Developing a training program for operators and adhering to a policy of using only these trained operators.
- Not running groundwater through the NAPL/water separator after NAPL flow has ceased. Additional groundwater may actually become more contaminated by being placed in contact with residual NAPL in the separator.
- Switching from thermal or catalytic oxidation to activated carbon adsorption when vapor concentrations decrease to a level where the cost for supplemental fuel for the oxidizer exceeds costs for carbon replacement and disposal or regeneration.
- Proper storage, removal and disposal of collected NAPL.
- Periodic re-evaluation of whether 1) systems to prevent or sense the release of explosive vapors are adequate, 2) grounding and bonding to prevent static electricity discharge is sound, and 3) automatic shutdown systems are still functioning and appropriate.
- Deciding if and when to utilize an automatic or remote interface control (higher capital cost and lower O&M costs) versus manual control (lower initial costs and higher labor O&M costs).
- For vacuum truck MPE systems (Ueland et al. 1998), the schedule for pump-out times must be set based on criteria (e.g., length of time for LNAPL to drain toward extraction wells) that can be monitored and revised as appropriate. A vacuum truck MPE system is an

alternative where capital and initial costs are minimized by not providing a fixed aboveground extraction system. Rather, a vacuum truck periodically visits the site and extracts liquids from the extraction wells/trenches for subsequent off-site disposal.

b. Troubleshooting. Two types of troubleshooting will be necessary for successful implementation of the O&M plan: 1) troubleshooting the mechanical and control systems, and 2) troubleshooting the subsurface extraction processes.

(1) Mechanical and Control Systems. Table 7-6 lists specific problems, what to consider in diagnosing the problem and suggested solutions. In addition to the items listed in Table 7-6:

TABLE 7-6

Field Troubleshooting Guide

Problems/Symptoms	Possible Reasons/Considerations	Potential Solutions
High pressure drop in air stripper, activated carbon canisters, or piping	Excessive bacterial growth and/or iron precipitation clogging surfaces Hardness deposition, or large material lodged in piping, valves, etc.	Physically clean top layer of carbon in openable drum, and clean piping Acid-clean air stripper packing Add water treatment chemicals to hold minerals in solution
Excessive noise from motors/blowers	Operating out-of-range Needs lubrication	Lubricate. Check if vacuums/pressure is too great
Freezing of water lines and/or the moisture in gas lines, especially at low spots, are reducing or preventing flow	Typical in cold climates. Low points in the gas lines may collect moisture that is never carried further into the moisture separator	Heat taping and/or insulating may be necessary Add traps with drain valves at low points to regularly remove condensate
Lower groundwater flow rates at same head	Well screen filter pack becoming clogged	Develop or redevelop well Clean or treat well
High vacuum or low vacuum alarms sound	Vent lines blocked, vent lines leaking	Measure vacuums in the lines to locate blockages or leaks; repair
Motor shutdown on thermal overload	Loss of power in one leg, undersized wire, blower pump working too hard	Check recent vacuum/pressure values Have electrician check systems
High water alarm, but no liquid in moisture separator	Float stuck, float/transducer malfunctioning	Release float if possible Remove and test transducers
Water and/or NAPL level detectors become covered with bacterial growth, preventing their proper operation.	This occurs frequently and usually cannot be stopped if the contaminants are biodegradable	Periodic detector performance evaluation and preventive maintenance program

TABLE 7-6

Field Troubleshooting Guide (Continued)

Problems/Symptoms	Possible Reasons/Considerations	Potential Solutions
Excessively high vacuum blower exhaust temperatures	Flow constrictions Blower malfunction	Check for piping blockage, open dilution valves, open SVE valves Verify that blower is operating within design specifications, if so a heat exchanger or other design modification may be necessary
Motors shut down, will not reset or restart	Fuse or circuit breaker blown	Shut off main circuit breakers, check individual fuses
Chattering in water level- controlled pumps	Time between high and low levels is too short; control logic is faulty	Increase delay; change control logic
Pump motor operating but not pumping water	Loss of prime with centrifugal pumps Air in suction line (i.e., vapor lock) Intake or intake strainer clogged Pneumatic pump not receiving air	Redesign system to guarantee flooded suction Compressor down or unable to keep up with compressed air demand Clean pump intake Install air relief valve
NAPL in water only tanks	Piping leaks, baffles improperly installed Too much NAPL in NAPL/water separator	Repair leaks, reinstall baffles, select properly sized separator
Water bubbles in air flow meter (rotameter)	Liquid/air separator not working properly Liquid not being pumped out of separator fast enough	Re-evaluate liquid/air separator design, increase liquid pumping rate Purge meter, or wait for water to evaporate before using again
Air pockets in water flow meter	Liquid/air separator not working properly Leaks in vacuum piping or fittings	Install an air bleed-off valve at a high point in the system before the water flowmeter Re-evaluate liquid/air separator design; Purge meter
Cover influent concentrations and/or higher flow rates than expected	Short-circuiting, leaks in vacuum piping or fittings	Check for leaks in surface cover and piping/fittings

- Check valves between the vacuum pump and extraction wells are important for preventing backflow, but they can become stuck in the open position after a period of time.

- Vacuum pump bearings or seals may wear out. Comparing the operational data with manufacturers' specifications after some months of operation may indicate such problems before they turn into more expensive repairs (see [paragraph 7-6d](#)).
- If liquid ring vacuum pumps are used, there are additional components that can wear out. These must be considered in formulating a preventive maintenance program and schedule.
- The control system will be made of many transducers, switches, interlocks, motor starters, etc., each of which could cause the entire control system to malfunction. It is important to insist that a complete as-built wiring and instrumentation diagram be provided by the equipment vendor so that electronic troubleshooting can be done readily by anyone capable of reading the wiring diagrams.

(2) Subsurface System Troubleshooting.

(a) Since MPE is an in-situ technology that manipulates conditions within the subsurface (which cannot be observed directly), problems often arise that make the remediation objective difficult to attain. Table 7-7 is a troubleshooting guide addressing some of the problems commonly encountered with the subsurface components of MPE systems.

TABLE 7-7
Operational Strategy Guide

Example Problems	Considerations	Potential Solutions
The zone of influence of the vacuum extraction system is not as predicted and may be insufficient for remediation	The soil may be less permeable than believed There may be preferential flow pathways	Apply greater vacuum Install additional wells Check wells for silt clogging Check for preferential pathways, including borehole short-circuiting Install less permeable surface cover
Vacuum levels are spatially very variable	There may be preferential flow pathways	Same as above
VOC concentrations in gas have been reduced in some but not all wells	Treatment may be completed in some, but not all, areas of the site due to heterogeneities	Reduce flows or take some wells offline Check for ongoing sources of contamination
Free-phase product now absent but groundwater VOC concentrations remain high	Large amounts of sorbed contaminant is present beneath the water table	More aggressive MPE to dewater the saturated soil, if feasible, or removal of mass by SVE and/or air sparging

TABLE 7-7

Operational Strategy Guide (Continued)

Example Problems	Considerations	Potential Solutions
No more free product, low concentrations of VOCs extracted during operation, but high concentrations reappear when system is shut off	Diffusion limitations, preferential flow, soils too moist, fluid flow rates higher than necessary	Pulse SVE/bioventing Thermal enhancement Excavation of "hot spots" and ex-situ soil treatment Reduce flow rates
Continued high levels of less volatile components in the soil	This is likely to occur with a contaminant mixture with a large range of volatility	Concentrate on bioventing if remaining target contaminants are biodegradable
Decreasing air flow rates, increasing vacuum levels	Soil has become too moist Wells are clogged	Surface cover to limit infiltration Increase dewatering Clean/treat wells
A decline in vapor concentrations has made thermal/catalytic oxidation uneconomic	Tailing off of the concentrations with time is a common occurrence	Evaluate whether treatment is still necessary. Change to activated carbon or biofilters. Possibly reduce airflow rates
Groundwater concentrations very low in some wells	Area is remediated	Consider closure for this area and/or well abandonment
Freezing of water lines and/or the moisture in vapor lines, especially at low spots, reduces or prevents flow	Typical in cold climates. Low points in the vapor extraction line may collect moisture that is never carried further into the moisture separator	Heat taping and/or insulating may be necessary. Traps with drain valves should be added at low points to regularly remove condensate
Poor catalytic oxidizer efficiency	Lack of sufficient oxygen for combustion in the soil gas Unexpected chemicals in the subsurface that poison the catalyst	Bleed air in with dilution valve or allow ambient air to enter MPE well through a priming tube Replace catalyst
In bioslurping, fluids not extracted with soil gas	Soil is too tight or too moist to permit enough soil gas to be extracted at a rate than can entrain fluids Drop tube is positioned too high or too low	Install a priming tube that delivers air to the well screen initially; airflow will then need to be reduced as soil dewateres and more soil gas flows Lower drop tube; raise drop tube, or reduce diameter of drop tube
Filters prior to vacuum blower become clogged, leading to excess pressure head losses. Material breaks through, potentially damaging blower	Filter needs to be changed Filter type was not properly chosen or sized	Change filter Try a different filter type, institute a preventive program of changing filter regularly

TABLE 7-7
Operational Strategy Guide (Continued)

Example Problems	Considerations	Potential Solutions
NAPL and water do not separate in NAPL/water separator	Emulsion has formed	For single pump systems, change pump type (e.g., centrifugal to bladder) Change to a dual-pump system that pumps free phase separately
Stable emulsion persists in the NAPL/water separator	Not unusual	Break emulsion chemically or physically in batches Dispose of as emulsion
Large vacuum losses between pump and well	Compare to design friction pressure losses	Increase pipe diameters, check for clogging Check for pipe leaks Check for water in pipes
Groundwater extraction rates decrease but site is not adequately dewatered	Extraction wells could be clogged	Redevelop extraction wells
Much less NAPL recovered than was expected	NAPL is not very recoverable; much less NAPL may be present than initially estimated; snap-off	Increase or reduce vacuum Change over to bioventing and/or air sparging
Unexpectedly high vapor concentrations at or near explosive levels	VOC component in NAPL is high; methane may be present that was not detectable with PID	Dilute intake air, use internal combustion engine system Alter system to be explosion-proof

(b) Evaluating unexpected monitoring results, solving system problems and making the necessary operational changes will likely change one's understanding of the subsurface, thereby requiring the original conceptual model of site conditions to be updated. Therefore, the O&M plan must be flexible and allow for creative solutions. Continual coordination between those responsible for O&M and system designers is essential.

c. Monitoring.

(1) Monitoring Strategy.

(a) Like the monitoring plan developed as part of the start-up procedures, the long-term O&M plan should specify parameters, locations, methods and frequencies for monitoring. The strategy should be to collect data frequently enough to ensure that trends are detectable, with decreasing monitoring frequency as conditions appear to reach steady-state (to minimize costs).

(b) Table 7-8 lists the MPE equipment maintenance activities to consider including in the long-term O&M plan. Table 7-9 is a checklist of monitoring topics to consider in the future after operating and monitoring data have been collected for a period of time. EM 1110-1-4001, Chapter 8, presents an overview of the parameters to monitor. Another reference is the Air Force's

Long Term Monitoring Optimization Guide, August 1997 (available off the internet at www.afcee.af.mil). Principal monitoring parameters are discussed below.

TABLE 7-8

Routine MPE Equipment Maintenance Activities

Periodically drain the water that has accumulated at low spots in the header lines
Check for leaks in water and NAPL lines
Perform pressure tests of pneumatic lines
Check operation of remote monitoring system and all transducers and level detectors
Check volume of seal water in liquid ring vacuum pumps.
Calibrate gas concentration monitoring instruments by collecting gas samples for GC analysis.
Recycle or dispose of collected NAPL according to plan and regulations
Approximately every 500 hours, regrease blower assembly per manufacturer's instructions
Based on operating hours and manufacturer's instructions, regrease bearings and change any oil
Periodically check and clean particulate filters on intake points or change when pressure drop becomes too great

TABLE 7-9

Checklist of Items to Consider for Long-Term Monitoring

Field Sampling
<ul style="list-style-type: none"> • Are sampling pumps, bailers, and other non-disposable sampling equipment properly maintained? • Are field sampling crews adequately trained in proper sampling procedures (what are their qualifications)? What costs are incurred for disposal of purged groundwater? • Would there be a cost/time benefit to using low-flow sampling techniques? • Can cost savings be achieved through the increased use of dedicated equipment?
Sampling Program Strategy
<ul style="list-style-type: none"> • Is there a comprehensive Sampling and Analysis Plan (SAP) for long-term environmental monitoring at the site? What are the objectives of the environmental monitoring program (in addition to monitoring the operation of the MPE remediation system)? • Monitor the extent of the plume? • Monitoring for plume migration to exposure points or sensitive receptors? • Evaluate plume remediation? • Does the SAP agree with the Record of Decision (ROD) or comparable document in its prescription for a sampling program? • Has the data quality objective (DQO) approach prescribed by USEPA (EPA 540-R-93-071) and/or EM 200-1-2 been used to develop the SAP? Based on discussions with the owner and operator, is it appropriate to evaluate/reconsider the DQOs?

TABLE 7-9

Checklist of Items to Consider for Long-Term Monitoring (Continued)

<ul style="list-style-type: none">• Does the Record of Decision (ROD) or comparable document prescribe a sampling program?• Are there "decision rules" in the ROD or comparable document that allow one to determine when to stop the monitoring program or to eliminate a well from the program? If not, can changes to the environmental monitoring program be considered in consultation with stakeholders?
<p>Analytical Program Strategy</p> <ul style="list-style-type: none">• Evaluate every well included in the current monitoring program relative to plume location, hydrogeological units, monitoring objectives, concentration history (plots of concentration versus time), mass removal versus time, and well construction (is it properly constructed to provide reliable data? Can it act as a contaminant pathway between hydrogeological units/aquifers?)• Can the well be eliminated from the program because it is redundant, unreliable, or outside the area of current interest? (Note that any well determined to be unnecessary must be properly decommissioned in accordance with state regulations. The costs for this must be considered in any economic evaluation of potential program changes.)• Are additional wells needed to properly meet monitoring objectives? (Note that in some cases there may be existing wells, not currently part of the current program, that may serve the purpose.)• Evaluate the sampling frequency for each well and analyte in the program.<ul style="list-style-type: none">• Can the monitoring frequency be reduced?• Do wells require more frequent monitoring to be protective of receptors?• Evaluate the sampling frequency in light of the estimated rate of plume migration, proximity to receptors, past contaminant concentrations changes, and the frequency of operational changes in the remediation. (Refer to section 3.1.4 of the Long-Term Monitoring Optimization Guide [AFCEE 1997]).• Evaluate the analytical program for each well and analyte in the monitoring program. Can laboratory analysis be replaced with less expensive field methods (in conjunction with confirmatory laboratory analyses)?• Can the current analytical methods be replaced with less expensive analyses and still meet the data quality objectives?<ul style="list-style-type: none">• Can the analyte list be shortened to focus on the known contaminants of concern? For example, can a Target Analyte List be replaced with a list of indicator compounds?• Can off-site analysis be replaced with less expensive on-site analysis?• Can a less expensive (but still USACE validated) laboratory be found to do the analysis?• Is the level of quality control/quality assurance (QC/QA) appropriate?• Are the data appropriately validated?• Were there any major failures in data acquisition and reporting?• Were proper corrective actions prescribed for such events?• Were corrective actions implemented to correct data failures?• Are additional corrective actions needed?

TABLE 7-9

Checklist of Items to Consider for Long-Term Monitoring (Continued)

- Evaluate data management practices.
 - Are sampling results entered into an electronic data retrieval system (e.g., GIS, IRPIMS, etc.)?
 - Are monitoring data available in a form that enhances usability (provides for graphical presentation of time histories, contour maps, reports in format expected by regulators, etc.)?
 - Are data archived in a reliable manner?
- Cost Evaluation - a chemist and a cost engineer should evaluate the potential cost savings (or additional costs if the current monitoring program is not adequate) of the potential changes and document this in the evaluation report.

(2) Subsurface Vacuum/Pressure/Head Distribution. One of the most important conditions to understand is the zone of influence around an extraction point or trench. If the entire target zone is not influenced, more extraction points may need to be installed. Gas pressure/vacuum should be monitored at different depths and distances from the extraction wells. EM 1110-1-4001, Chapter 8, presents guidance on how to choose appropriate long-term pressure/vacuum/head monitoring equipment, as well as the frequency and locations (horizontal and vertical placement) for measurement.

(3) Water, Gas and NAPL Flow.

(a) The volumes of the extracted fluids must be measured. The most appropriate methods (discussed in more detail earlier) are a totalizing flow meter for groundwater; pitot tube, hot wire anemometer or rotameter for gas; and thickness (or volume) of NAPL in the NAPL/water separator or holding tank.

(b) Pumps, blowers, oxidizers or other electrically operated devices should be equipped with hour meters so that on and off periods can be tracked. Total volumes can then be calculated from the average flows and on-time.

(4) Sampling and Analysis Plan.

(a) The number and location of samples collected as part of the long-term monitoring plan will be specified in the FSP portion of the SAP. Analyses of contaminants in the vadose zone, extracted soil vapor, extracted groundwater and the groundwater plume will be specified in the QAPP section of the SAP. The procedures will probably be the same as those developed under the guidelines of [paragraph 7-5](#) for the start-up plan. In most cases, the earlier prepared SAP can be updated and revised based on the data collected during start-up. The frequency of sampling will depend on permit requirements, the magnitude or rate of change of influent concentrations and the progress of remediation. The SAP must address not only in-situ remedial progress, but also the removal efficiency of any water or gas treatment processes. These data will enable the contaminant mass removed via water and gas to be calculated (see [paragraph 7-5c\(2\)](#) of this EM and Chapter 7 of [EM 1110-1-4001](#) for guidance on calculations).

(b) To minimize analytical costs, consideration should be given to analyzing only a few carefully selected indicator compounds instead of all

contaminants, if feasible. Analysis of recovered NAPL should be performed at least quarterly, or possibly more often depending on the rate of change of its composition.

(c) Additional monitoring parameters may include:

- Changes in soil moisture content within the depth that the vacuum is being applied. This may be accomplished through the use of neutron probes (for the saturated zone and capillary fringe), time domain reflectometry, or electrical resistivity tomography. For more information about these tools, see the In-situ Air Sparging EM (1110-1-4005), Chapter 4.
- Biological factors (vadose zone methane, oxygen and carbon dioxide, and nutrient concentrations, and/or bacterial enumeration).
- Confirmatory soil sampling should be performed (see paragraph 8.2) after other monitoring data indicate that cleanup goals have been met, or that mass removal via MPE has decreased to the point that continued operation of the MPE system is no longer justified.

d. Maintenance.

(1) Aboveground System Maintenance. Table 7-8 lists some of the routine and non-routine maintenance tasks that may need to be performed on the aboveground equipment. A similar list with a schedule must be prepared based on the specific equipment in use at the site.

(2) Extraction Wells. Over time, extraction wells may become clogged or leak, diminishing the ability to extract fluids. Consult with the project chemist, hydrogeologist and/or microbiologist for guidance on how to evaluate and solve such problems. Very serious problems may require installation of new extraction wells. Additional information can be found in other USACE guidance on well maintenance.

e. System Operating Schedule. An operating schedule must be developed that is specific to the particular MPE system and subsurface conditions, as well as the rate of mass removal at the time. Items that may require periodic attention include:

- Continuous or pulsed (intermittent) extraction for optimizing contaminant removal rates versus cost of operation.
- Flow rate adjustments for optimizing contaminant removal rates.
- Adjusting the depth of the drop tube or liquid pump intake for extracting maximum NAPL and minimal groundwater (unless enhanced pump-and-treat is the objective).
- Adjusting the depth of liquid level indicators as needed for groundwater versus NAPL extraction.

- Carbon (vapor phase and/or aqueous phase) regeneration or replacement to meet emission permit requirements.
- Disposal of collected NAPL at a frequency that complies with hazardous waste storage requirements.

f. System Modifications. After several months of operation and monitoring data have been collected and evaluated, it may become clear that the installed MPE system needs significant modification to optimally remediate the site. Modifications may include:

- Additional extraction wells.
- Installation of a less permeable surface cover.
- Cessation of liquid removal if NAPL is absent and groundwater quality is not significantly contaminated.
- Reduced vacuum to support bioventing instead of MPE. Related issues are also discussed in Table 7-7.

Any changes made to the system should be clearly documented (see following section).

g. Recordkeeping. A data management system is crucial for evaluating the operation and remedial progress of a MPE system. Data on groundwater elevations, water and gas concentrations, flows, NAPL thicknesses, applied vacuums, NAPL recovery volumes, gas pressures, operating times, etc. that are collected (manually or electronically via a telemonitoring system) must be organized, evaluated and archived. Sampling and analytical data will have Chains of Custody as specified in the SAP. For a small project, simple worksheets (e.g., Excel, Lotus) may suffice, while for a larger project, a more versatile database (e.g., Access, dBase) may be desirable. Maintenance logbooks must be kept on site that note the time and date of site visits and contain a summary of any important observations that were made and tasks that were performed. Ideally, a section of the computer database would be used to record these maintenance activities. There would then be a backup to the site logbook and a convenient means of accessing the site activities log without needing to check the dedicated site logbook. When properly managed, the aggregate data collected during site remediation can be used not only for site-specific purposes but also for overall technology assessment purposes. In 1995, all agencies of the Federal Remediation Technologies Roundtable endorsed standardized collection and reporting of remediation performance and costs (USEPA 1995).

h. Operating and Maintenance Contracting Approaches.

(1) Operation, maintenance and monitoring costs are typically a major component of the overall remediation project cost. Developing a sound contracting strategy for this phase of the MPE remediation project is critical to controlling the total project budget. Capital costs frequently comprise only a small portion of the overall project cost, while the majority of the costs are generally expended during the operating phase of the project. Costs are typically incurred for: electricity and/or natural gas, operator labor,

groundwater sampling labor, laboratory analyses, remediation waste disposal, reporting, and project management. Contracting officers should consider viewing MPE projects as service contracts rather than construction contracts in cases where this phase of the project is expected to comprise the majority of the total project cost.

(2) Contracts should be written flexibly enough so that the remediation contractor has the option to use portable (trailer/skid mounted) or modular remediation equipment. In this way, if MPE is expected to take place for a relatively period of short time, the contractor can reuse the equipment elsewhere, thereby reducing costs. An example of this approach would be to use a rented thermal or catalytic oxidizer for off-gas treatment. The capital cost of an oxidizer will frequently exceed that of the remainder of the MPE system hardware; however, influent vapor concentrations may only justify the use of this component for the initial period of operation (e.g., several months). In this case, a rental or lease-purchase arrangement for the oxidizer will likely reduce overall project costs.

(3) Designers writing O&M specification requirements should also carefully consider the best strategy for service contract payment. The objective is create a contract that motivates the system operator to operate the system at maximum efficiency as well as determine modifications that can improve efficiencies and reduce O&M costs. Several possible O&M contracting and payment strategies are listed below:

- Simple time and materials.
- Cost plus fixed fee.
- Operation time (system up-time, but with the contractor estimating and including repair time labor).
- Contaminant mass removal or other performance criteria.
- Lump sum.
- Use of an independent consultant to manage the operator and the operation, providing the consultant incentives (e.g., a bonus equal to a percentage of any O&M savings that the consultant can generate by operating the system more efficiently).

(4) There are advantages and disadvantages to each of these payment strategies. Time and materials has been the traditional method of payment for remediation system O&M. Payment for up-time provides the contractor with added incentive to minimize MPE system downtime; however, the contracting officer and project manager must ensure that efficiency (i.e., mass removal rate) is also maximized to the extent practicable such that payment is for effective operation of the MPE system. The contractor should factor repair costs into the amount bid for up-time operating hours. Payment based on contaminant mass removal may pose some risks in that disputes may arise over issues such as: methods of calculating the actual amount of contaminant mass removed, underestimation of the mass initially in the subsurface resulting in unexpected operating costs, and items such as equipment repair and/or replacement, which may not be easy to correlate with contaminant mass removal. Is it also likely that no contractor will be willing to be paid on a mass removal basis if they

were not involved in the design. In a lump sum contract, the contractor assumes the risk to complete the O&M for a fixed sum; this option may be attractive to both a contractor who is willing to assume the risk in return for potentially higher profit and a contracting officer seeking to cap project costs at a specific limit. Selection of the most appropriate payment strategy by the contracting officer and project manager should be based on site-specific circumstances and input from technical staff (e.g., hydrogeologists and process engineers) and construction representatives.

CHAPTER 8

SYSTEM SHUTDOWN AND CONFIRMATION OF CLEANUP

8-1. Introduction.

a. System shutdown is typically performed when regulatory goals are reached, when the rate of mass removal is deemed not high enough to justify continued operation, or when monitoring indicates asymptotic levels of contaminants in extracted air and groundwater. It is imperative that each project has a clear closure strategy with set goals. Some closure strategies may involve transition from MPE into other remediation technologies such as natural attenuation. In other cases, closure may closely follow shutdown of the MPE system. System shutdown involves two main components: closure sampling and analysis, which may need to be conducted during more than one event over an extended period of time, and MPE mechanical system shutdown, disassembly and decommissioning. Decommissioning of an MPE system may also require decontamination of equipment.

b. Sampling associated with site closure is performed on media associated with remediation clean-up goals. For example, if the remedial goal involves reduction of NAPL thicknesses to a certain level in monitoring wells (a common goal in several states), NAPL thicknesses would be gauged over time to ensure that this thickness remains below the remedial goal. Similarly, if reduction in groundwater contaminant concentration is the goal of MPE, sampling will occur following shutdown over an extended period to ensure concentrations remain below specified limits and that rebound does not occur.

8-2. Shutdown Strategy.

a. Prior to start-up of an MPE system, a shutdown strategy must be developed. Cleanup goals (e.g., Maximum Contaminant Levels [MCLs], or product thickness less than 0.01-inches) for the contaminant(s) of concern should be negotiated prior to initiating design of the MPE system. Risk-based cleanup goals should be used whenever possible.

b. Shutdown strategy should then be developed on the basis of established cleanup criteria. During system operation, modifications to site closure objectives may be made as remediation proceeds. If the MPE system has been operating continuously for one or more years, and it does not appear that it will be possible to achieve cleanup goals in a reasonable time frame, then it may be necessary to re-evaluate cleanup goals.

c. A strategy for system shutdown should include cleanup levels, sample schedules and methods, and a closure decision matrix. Figure 8-1 is an example of a decision matrix used to evaluate closure data.

d. System shutdown may be determined by direct sampling of the contaminated media. Groundwater samples should be taken from selected monitoring wells identified to be indicative of site conditions. Groundwater samples obtained from monitoring wells should be taken a minimum of 2 to 3 months following shutdown. Soil samples should be obtained using methods that have been described in a work plan that has been reviewed by technical staff and regulatory representatives. Typically, best results are obtained when samples are obtained using methods resulting in the least disturbance to the sample, as discussed in [paragraph 3-4h](#).

e. Three possible outcomes from a closure and analysis program, which depend on regulatory, cost, and technical constraints, are as follows:

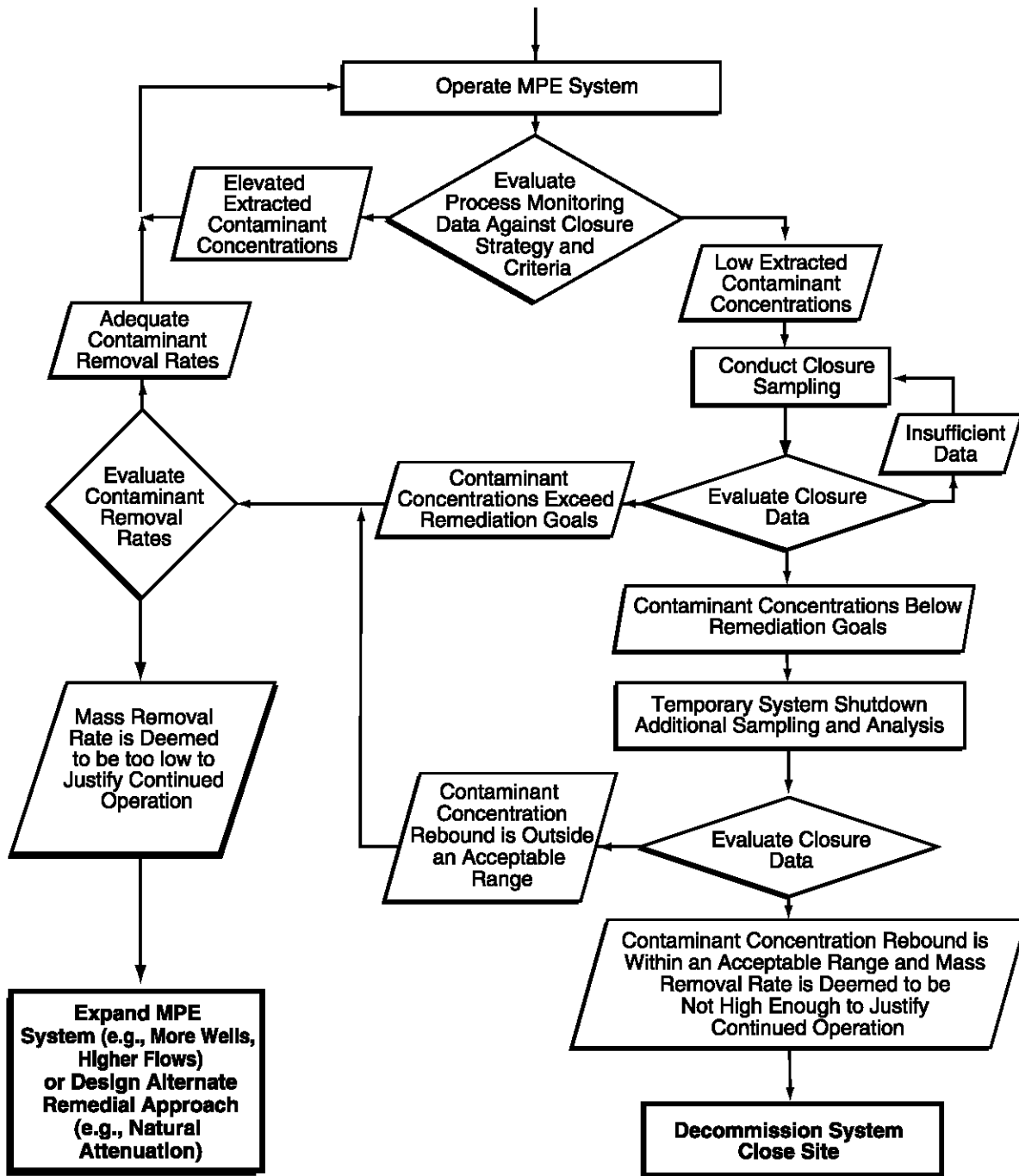

M980211

Figure 8-1. Closure Data Evaluation Decision Matrix.

- Contaminant concentrations are and remain below applicable standards;
- Contaminant concentrations are below applicable standards; however, concentrations rebound following system shutdown;
- Contaminant concentrations are above applicable standards, yet the concentrations of contaminants in the extracted air/water have fallen to asymptotic levels.

If extracted concentrations are low, a reduction in the extraction rates should be tried to see whether contaminant concentrations may increase, thereby increasing the efficiency of treatment processes.

f. As an aid to designers and regulators in developing mutually beneficial shutdown criteria, two MPE site examples of closure criteria/strategy are provided.

(1) The first example is the Lake City Army Ammunition Plant (LCAAP), a CERCLA site in Lake City, MO at which MPE was selected for remediation of TCE in low permeability soils (discussed in Chapter 4). The Record of Decision for the site stated the following: "Semiannual technical reviews will accommodate the development of appropriate criteria for measuring system performance and shutting down the system. MPE system performance data will be made available to the Federal Facility Agreement (FFA) parties for evaluation at a minimum of six months after the system begins operation. Criteria will include, but not be limited to, evaluation of mass recovery rates, cost-effectiveness, and reduction of soil contamination levels. System operation will be determined based on the evaluation of these criteria. As full-scale performance data is collected, information on physical limitations of the site and the benefits of this mass removal system will be better developed and used to determine continued operation of the system. System enhancements (e.g., soil fracturing or horizontal well installation) will be evaluated prior to system shutdown. Termination of the system will occur only with the approval of the FFA parties." Given this language, there was difficulty in negotiating shutdown criteria, and little information was available to assist the parties (Army, consultants, and regulators) in developing good shutdown criteria. (Clif Rope, personal communication).

(2) The second example of closure criteria/strategy is a site remediation project that incorporated DPE with steam flooding and biotransformation to enhance removal of chlorinated hydrocarbons from low permeability soil. Portions of the site from which DNAPL had been extracted at the beginning of the remediation could be closed after application of the integrated technology (Smith et al. 1998). As new areas containing DNAPL were encountered during system operation and monitoring, the system was expanded to treat them. The closure approach was therefore phased, in order to allow shutdown of those portions of the remediation system at which cleanup goals had been achieved. This phased approach allowed closure (based on risk assessment and natural attenuation calculations) of two areas at the site, for which a "no further remediation" letter from the Illinois Environmental Protection Agency was received. The remainder of the contaminated zone continued to undergo active remediation until closure goals were met.

8-3. Shutdown Guidance.

a. Routine monitoring of system performance and routine sampling provide the best indication of an MPE system nearing shutdown. Particular trends and observations indicate that the remediation is nearing its end. These include:

- Reduction in NAPL recovery, reduction in system off-gas contaminant concentrations, reduction of LNAPL thickness in observation wells, and reduction in recovered groundwater contaminant concentrations. These methods provide a simple and quick way of monitoring performance as they provide real-time estimates (if laboratory analysis is not required) of system performance. Disadvantages of these methods include the potential for measurement error, and the necessity of taking into consideration subsurface changes that may influence measured results. For example, although LNAPL had been evident in observation wells during periods of low water table at a site, it may become trapped and therefore may not be evident in the same wells during periods of high water table. A longer monitoring period (of at least a year) would be required to ensure that it does not reappear in the wells.
- Reduced CO₂ or increased O₂ in the extracted off-gas when bioremediation parameters are being tracked. These methods can again provide real-time results; however, if ambient dilution air is used by the MPE system, this must be accounted for in the readings, as the diluted off-gas will not give a direct indication of subsurface conditions. In this case, it may be more desirable to obtain readings from observation wells or soil gas monitoring points.
- Reduced contaminant concentrations in routinely collected groundwater and periodically collected soil samples. These parameters typically give the best results as to how well the MPE system is remediating the subsurface. They are often the parameters used by regulators in determining clean-up goals. Collection of groundwater and subsurface soil samples is, however, labor intensive and entails laboratory costs that typically make these efforts too costly to perform more than once per quarter (or, in the case of soil sampling, much less frequently).

b. Following confirmatory sampling, shutdown of subsurface and aboveground equipment is performed. ASTM D 5299 provides general requirements for well decommissioning, but note that well decommissioning procedures typically vary depending on state requirements. Shutdown of aboveground equipment will typically include decontamination of equipment that will be re-used, and its subsequent removal from the site. If an item of equipment is expected to be stored for a period prior to its next use, it should be stored properly according to the manufacturer's instructions.

CHAPTER 9

OTHER ISSUES

9-1. Introduction. There are many considerations for MPE other than the technical aspects of the technology. These administrative items include legal and regulatory issues, patent issues, and safety issues. These issues are described in more detail below.

9-2. Legal and Regulatory.

a. State and federal regulatory requirements should be identified by the designer prior to operation of an MPE system. Regulations for different design processes will vary from site to site depending upon various regulations. Many states require that well permits be obtained, and that a licensed driller be used. In some cases, a licensed pump installer may even be required. Most states have regulations limiting air emissions from remediation systems, which will govern the method and extent of off-gas treatment required. Treated water disposal may also require permitting, especially when discharging to a sewer system or surface water. Such permit requirements may be set forth by local sewer commissions or by the National Pollution Discharge Elimination System (NPDES).

b. Permits or regulations may also apply when installing wells for use with MPE systems. Regulations for handling of investigation-derived wastes generated during site characterization are included under federal regulations promulgated by the Resource Conservation and Recovery Act (RCRA).

c. It is important to recognize that regulations vary among site locations and that working closely with the appropriate regulatory agency or agencies is the best way to ensure compliance with applicable regulations.

9-3. Patent Issues.

a. There are several patents that have been issued relative to technologies discussed in this EM. Readers are advised to consider the ramifications of these patents on their site activities. A first step toward this end is facilitated by a review of the summary of MPE and related patents that follows. If closer scrutiny is required, a copy of the patent can be obtained promptly from the U.S. Patent office (1) by mail for a minimal charge by calling (703) 305-4350, or (2) by visiting the patent server world-wide web site at <http://www.patents.ibm.com>. **Contact Office of Counsel for further guidance on addressing this issue.** The following list of patents with associated summary descriptions is not intended to represent a complete patent search. It is organized from a search of patents that most closely resemble technologies discussed in this EM. The Xerox® patents are discussed first and in considerably more detail since many TPE applications will either narrowly miss infringing on the patents or may require appropriate licensing for use of the technology. Note that the validity of any of the described patents has not been determined. The United States has authority to make use of any patented item or process in the course of any project, and cannot be refused use or enjoined from use of any patented item or process. Under the procedures of Title 28 United States Code 1498, a federal agency may be required to pay reasonable compensation for the use of any patented item or process. This is normally done by negotiation or determination of a reasonable fee to obtain the right to use the patented item or process under a license agreement.

Government contract clauses are prescribed for use in various types of contracts, which may require the contractor to obtain any applicable licenses, and may in some cases require the contractor to indemnify the government in the event of a claim for compensation from a patent or license holder. The Office of Counsel should be notified in the event of any questions or disputes related to patents.

b. Xerox Corporation. Process for Two Phase Vacuum Extraction of Soil Contaminants (# 5,050,676). This process uses one vacuum source to extract liquid and gases from a well as a single stream. The abstract below defines the process.

"A process for two phase vacuum extraction of contaminants from the ground involves vacuum withdrawal of liquid and gaseous phases as a common stream, separation of the liquid and gaseous phases, and subsequent treatment of the separated liquid and gases to produce clean effluents. Two phase vacuum extraction employs a single vacuum generating device to remove contaminants in both the liquid stream and soil gases through a single well casing." (U.S. Patent # 5,050,676)

c. Xerox Corporation. Process and Apparatus for Groundwater Extraction Using a High Vacuum Process (#5,172,764). This process utilizes a vacuum extraction pipe within the well (i.e., a drop tube) by which extract liquid and vapor. Gas is introduced to the well riser through a pipe exposed to the atmosphere. The abstract below defines the process.

"Disclosed is a process for removing contaminants from a contaminated area of the ground having a vadose zone and a water table which comprises providing a borehole in the contaminated area; placing in the borehole a perforated riser pipe inside of which is situated a vacuum extraction pipe with an opening situated near, at, or at any point below the water table within the perforated riser pipe, while introducing a gas into the riser pipe, applying a vacuum to the vacuum extraction pipe to draw gases and liquid from the soil into the perforated riser pipe and from the riser pipe into the vacuum extraction pipe and transport both the gases and the liquid to the surface as a common stream; forming from the common stream is a stream which is primarily gaseous; and separately treating the separated liquid and gas streams. Also disclosed is an apparatus for carrying out this process." (U.S. Patent #5,172,764)

d. Dames & Moore.

(1) Priming Methods for Vacuum Extraction Wells (#5,076,360). This process utilizes a priming tube that introduces atmospheric air near the bottom of the drop tube. The drop tube extracts both liquid and vapor in a common stream. The abstract below defines the process.

"Methods and apparatus for vacuum extraction of contaminants from the ground which, in a preferred embodiment, involves vacuum withdrawal of liquid and gaseous phases as a common stream, separation of the liquid and gaseous phases, and subsequent treatment of the separated liquid and gases to produce clean effluent. A primed vacuum extraction employs a single vacuum generating device to remove contaminants in both the liquid stream and soil gases through a single well casing utilizing a priming tube which introduces air or other gas to the liquid collected at the bottom of a well. The present invention permits vacuum extraction of both liquids and gases from the subsurface by way of wells having a

liquid layer which is more than thirty feet below the soil surface or in which a screened interval of the extraction pipe is entirely below the liquid surface." (U.S. Patent #5,076,360)

(2) This patent differs from both Xerox patents in that: (1) The extracted vapor is atmospheric and is not pulled entirely from the soil gas; and (2) The priming tube is inserted near the bottom of the extraction tube and not just into the top of the well casing.

e. R.E. Wright Environmental, Inc. Multiple Well Jet Pump Apparatus (#5,555,934). This process utilizes venturi jet pumps on each extraction well to create a vacuum and extract liquid and air from the subsurface. The abstract below defines the process.

"The apparatus is a pumping system for multiple wells which uses a single circulating pump and two or more venturi jet pumps, at least one jet pump for each well. The circulating pump furnishes feed water to the several jet pumps, with the vacuum line of each jet pump installed into a different feed well. Automatic level control within the well is furnished because when the liquid level falls, the jet pump vacuum line within the low level well draws air, and there is no effect on the pumping action of the jet pumps of other wells. Thus, if the level of liquid in a well drops, that pump simply pumps air and will resume pumping the liquid when the liquid once again covers the well pipe intake." (U.S. Patent #5,555,934)

f. Texaco, Inc. Multi-Phase Flow and Separator (#5,149,344). This apparatus separates a stream of multi-phase fluid into discrete components. The abstract below defines the process.

"A multi-phase separating apparatus for fluid containing a gaseous component. The apparatus includes a first tank which receives a stream of the multi-phase fluid which is to be resolved into discrete components. A second or separating tank positioned at a lower elevation than the first tank, receives a stream of substantially gas-free liquid. Said gas-free multi-liquid stream is conducted through a valved conduit. The latter includes a buoyant element which is displaceable by liquid in the lower tank, to form a barrier to avoid backflow or oscillatory fluid response of said liquid. Liquid accumulated in the lower tank thus maintains said tank in a substantially full condition. Liquid monitors in the separating tank monitor liquid levels and control outflow from the unit." (U.S. Patent #5,149,344)

This relates to MPE because separation methods of the extracted liquid and vapor stream may be similar to this patent.

g. BCM Engineers, Inc. Bootstrapping Process Optimization for Two Phase Vacuum Extraction Systems (#5,586,836). This process describes a system to separate the liquid and gas from a vacuum extraction system stream. The separated water is then recirculated and re-used as described in the abstract below.

"A system for receiving an effluent stream of liquids and gases from a vacuum extraction system is disclosed. The system uses the water separated from the effluent stream by a knock-out pot to cool recirculating water, provide seal water and/or providing make up water to a liquid ring vacuum pump that provides the suction for vacuum

extraction. In a preferred embodiment, a heat exchanger uses cool water from a knock-out pot to condense vapors and uses the warm water exiting the liquid ring vacuum pump to reheat the vapor stream, raising its temperature and thus lowering its relative humidity, resulting in more efficient contaminant removal by vapor treatment systems. The knock-out pot also preferably includes a free contaminant recovery system that collects and transfers liquid contaminants that separate from the water collected in the knock-out pot due to a difference between the contaminant density and the density of water. The contaminants thus collect as free product either floating on top of the water or sinking to the bottom of the knock-out pot." (U.S. Patent # 5,586,836)

9-4. Health and Safety. In order to analyze safety and health issues associated with MPE, the user of this EM should refer to safety and health hazard analyses of similar or related technologies as presented in the Remediation Technologies Screening Matrix and Reference Guide published by the Federal Remediation Technologies Roundtable, and available at <http://www.frtr.gov/matrix2/>. The generic physical, chemical, radiological, and biological hazards and controls identified in Sec. 4.41 Dual Phase Extraction, Chapter 10-2 of the Screening Matrix should be considered a baseline from which a unique project specific hazard analysis is developed. The project-specific hazard analysis should address all phases of MPE development, including predesign investigation, design, construction, and operation and maintenance. All hazards identified in all phases of MPE development, must be addressed in complying with applicable federal regulations, e.g., OSHA, NFPA, and USACE regulations including ER 385-1-92. Appendix B of ER 385-1-92 must be followed when drafting the related safety and health design documents, including any investigative Site Safety and Health Plans, Health and Safety Design Analyses, and the Safety, Health and Emergency Response contract specifications for MPE construction, based on CEGS 01551. Safety and risk assessment guidance for remediation systems involving contaminated air streams can be found in EP 1110-1-21.

APPENDIX A

REFERENCES

A-1. Required Publications.

Department of the Army

TM 5-813-9	Water Supply Pumping Stations
ER 385-1-92	Safety and Occupational Health Document Requirements for Hazardous, Toxic, and Radioactive Waste (HTRW) and Ordinance and Explosives
ER 1110-345-700	Design Analyses, Drawings, and Specifications
EP 1110-1-21	Air Pathway Analysis and Design of HTRW Remedial Action Projects
EM-200-1-2	Technical Project Planning (TPP) Process
EM-200-1-3	Requirements for the Preparation of Sampling and Analysis Plans
EM 385-1-1	Safety and Health Requirements Manual
EM 1110-1-1802	Geophysical Exploration for Engineering and Environmental Investigations
EM 1110-1-4000	Monitoring Well Design, Installation, and Documentation at Hazardous, Toxic, and Radioactive Waste Sites Engineer Manual
EM 1110-1-4001	Soil Vapor Extraction and Bioventing Engineer Manual
EM 1110-1-4005	In Situ Air Sparging Engineering Manual
EM 1110-1-4006	Removal of Underground Storage Tanks (USTs) Engineer Manual
EM 1110-1-4008	Liquid Process Piping Engineer Manual
EP 415-1-261	Quality Assurance Representative's Guide - Ground Water Extraction, Ground Water Treatment, Landfills, Soils Vapor Extraction, Slurry Walls and Solidification/Stabilization, VOL 5
EP 1110-1-21	Air Pathway Analysis for the Design of HTRW Remedial Action Projects

EM 1110-1-4010
1 Jun 99

ER 385-1-92 Safety and Occupational Health Document Requirements for Hazardous, Toxic and Radioactive Waste (HTRW) and Ordinance and Explosive Waste (OEW) Activities

CEGS 02150 Corps of Engineers Guide Specification - Piping, Off Gas

CEGS 02500 Corps of Engineers Guide Specification - Pipelines, Liquid Process Piping

CEGS 02521 Corps of Engineers Guide Specification - Multiphase Extraction Wells

CEGS 02522 Corps of Engineers Guide Specification - Ground-Water Monitoring Wells

CEGS 11215 Corps of Engineers Guide Specification - Fans/Blowers/Pumps; Off-Gas

CEGS 11225 Corps of Engineers Guide Specification - Downflow Liquid Activated Carbon Adsorption Units

CEGS 11226 Corps of Engineers Guide Specification - Vapor Phase Activated Carbon Adsorption Units

CEGS 11301 Corps of Engineers Guide Specification - Air Stripping Systems

CEGS 11377 Corps of Engineers Guide Specification - Advanced Oxidation Processes

Department of the Air Force

AFCEE 1997 Air Force Center for Environmental Excellence. 1997. Test Plan and Technical Protocol for Bioslurping. Battelle Press, Columbus, OH.

Department of
the Air Force
1981 Maintenance of Petroleum Systems. AF Manual 85-16.

Manufacturers Standardization Society of the Valve and Fittings Industry (MSS)

MSS SP-58 Pipe Hangars and Supports - Materials, Design and Manufacture

MSS SP-69 Pipe Hangars and Supports - Selection and Application

MSS SP-89 Pipe Hangars and Supports - Fabrication and Installation Practices

National Fire Protection Association (NFPA)

30 Flammable and Combustible Liquids Code

- 68 Guide for Venting Deflagrations
- 69 Explosion Prevention Systems
- 70 National Electric Code
- 77 Static Electricity
- 496 Standard for Purged and Pressurized Enclosures and Electrical Equipment
- 497 Class I Hazardous Locations for Electrical Installations in Chemical Plants

U.S. Environmental Protection Agency (USEPA)

- USEPA 1986 Test Methods for Evaluation Solid Waste, Physical/Chemical Methods. SW-846, 3rd ed., with updates July 1992 and September 1994.
- USEPA 1995 How to Evaluate Alternative Cleanup Technologies for Underground Storage Tank Sites. EPA 510-B-95-007.
- USEPA 1996a Assessing UST Corrective Action Technologies: In Situ SVE-Based Systems for Free Product Recovery and Residual Hydrocarbon Removal. EPA 600-R-96-042.
- USEPA 1997a Presumptive Remedy: Supplemental Bulletin Multi-Phase Extraction (MPE) Technology for VOCs in Soil and Groundwater. EPA 540-F-97-004.

American Society for Testing and Materials (ASTM)

- A312 Seamless and Welded Austenitic Stainless Steel Pipes
- C150 Specifications for Portland Cement
- D87 Melting Point of Petroleum Wax (Cooling Curve)
- D88 Saybolt Viscosity
- D422 Methods for Particle-Size Analysis of Soils
- D698 Test Method for Laboratory Compaction Characteristics of Soils Using Standard Effort
- D971 Interfacial Tension of Oil Against Water by the Ring Method
- D1475 Density of Paint, Varnish, Lacquer, and Related Products

EM 1110-1-4010
1 Jun 99

- D1586 Standard Method for Penetration Test and Split-Barrel Sampling of Soils
- D1587 Thin-Walled Tube Sampling of Soils
- D1785 Specifications for Poly (Vinyl Chloride) (PVC) Plastic Pipe, Schedule 40, 80, and 120
- D1795 Intrinsic Viscosity of Cellulose
- D2216 Standard Test Method for Laboratory Determination of Water (Moisture) Content of Soil and Rock
- D2241 Specifications for Poly (Vinyl Chloride) (PVC) Pressure-Rated Pipe (SDR-Series)
- D2285 Interfacial Tension of Electrical Insulating Oils of Petroleum Origin Against Water by the Drop Weight Method
- D2325 Test Method for Capillary-Moisture Relationships for Coarse- and Medium-Textured Soils by Porous-Plate Apparatus
- D2487 Classification of Soils for Engineering Purposes
- D2488 Practice for Description and Identification of Soils (Visual-Manual Procedure)
- D2850 Unconsolidated, Undrained Compressive Strength of Cohesive Soils in Triaxial Compression
- D3350 Polyethylene Plastics Pipe and Fittings Materials
- D4043 Selection of Aquifer-Test Method in Determining of Hydraulic Properties in Well Techniques
- D4044 (Field Procedure) for Instantaneous Change in Head (Slug) Tests for Determining Hydraulic Properties of Aquifers
- D4050 (Field Procedure) for Withdrawal and Injection Well Tests for Determining Hydraulic Properties of Aquifer Systems
- D4104 (Analytical Procedure) for Determining Transmissivity of Nonleaky Confined Aquifers by Overdamped Well Response to Instantaneous Change in Head (Slug Tests)
- D4105 (Analytical Procedure) for Determining Transmissivity and Storage Coefficient of Nonleaky Confined Aquifers by the Modified Theis Nonequilibrium Method
- D4106 (Analytical Procedure) for Determining Transmissivity and Storage Coefficient of Nonleaky Confined Aquifers by the Theis Nonequilibrium Method

- D4243 Measurement of Average Viscometric Degree of Polymerization of New and Aged Electrical Papers and Boards
- D4750 Determining Subsurface Liquid Levels in a Borehole of Monitoring Well (Observation Well)
- D5092 Practice for Design and Installation of Ground Water Monitoring Wells in Aquifers
- D5269 Determining Transmissivity of Nonleaky Confined Aquifers by the Theis Recovery Method
- D5270 Determining Transmissivity and Storage Coefficient of Bounded, Nonleaky, Confined Aquifers
- D5299 Decommissioning of Ground Water Wells, Vadose Zone Monitoring Devices, Boreholes, and Other Devices for Environmental Activities
- D5314 Soil Gas Monitoring in the Vadose Zone
- F480 Thermoplastic Well Casing Pipe/Couplings Made in Standard Dimension Ratios (SDR) Schedule 40/80, specifications.

National Sanitation Foundation

Standard 14 . Plastics, Piping Components and Related Materials

American National Standards Institute (ANSI)

- EP400.1 Magnetic oxide EP-cores and associated parts for use in inductors and transformers - Dimensions
- UL 913-1988 Intrinsically Safe Apparatus and Associated Apparatus for Use in Class I, II, and III, Division I, Hazardous Locations

American Water Works Association (AWWA)

AWWA A100 Water Wells

Other

- API 1989 American Petroleum Institute. 1989. A Guide to the Assessment and Remediation of Underground Petroleum Releases. API Publication #1628. Second Edition. Washington, D.C.
- API 1996 American Petroleum Institute. 1996. A Guide to the Assessment and Remediation of Underground Petroleum Releases. Third Edition. API Publication #1628. Washington, D.C.

- Baker 1995 Baker, R. S. 1995. One-, two-, and three-phase flow during free product recovery. pp. 349-359. In: Hinchee, R.E., Kittel, J.A. and Reisinger, H.J. (Eds.) Applied Bioremediation of Petroleum Hydrocarbons. Battelle Press, Columbus, OH.
- Baker and Groher 1998 Baker, R.S. and Groher, D.M. 1998. Does multiphase extraction require soil desaturation to remediate chlorinated sites? pp. 175-180. In: Wickramanayake, G.B., and Hinchee, R.B. (Eds.) Physical, Chemical and Thermal Technologies: Remediation of Chlorinated and Recalcitrant Compounds. Battelle Press, Columbus, OH.
- Battelle 1997 Battelle. 1997. U.S. Air Force Center for Environmental Excellence Test Plan and Technical Protocol for Bioslurping. Battelle Press, Columbus, OH.
- Beckett and Huntley 1998 Beckett, G. D., and Huntley, D. 1998. Soil Properties and Design Factors Influencing Free-Phase Hydrocarbon Cleanup. ES&T. 32(2):287-293
- Blake and Gates 1986 Blake, S. B. and Gates, M. M. 1986. Vacuum Enhanced Hydrocarbon Recovery: A Case Study. pp. 709-721. Proceedings: Petroleum Hydrocarbons and Organic Chemicals in Groundwater - Prevention, Detection, and Restoration. Houston, TX. November 12-14, 1986. NWWA/API, Dublin, OH.
- Crane Valve Co. 1988 Crane Valve Company. 1988. Flow of Fluids Through Valves, Fittings, and Pipes. Technical Paper #410. Crane Valve Company, Long Beach, CA
- Farr et al. 1990 Farr, A.M., Houghtalen, R.J., and McWhorter, D.B. 1990. Volume Estimation of Light Nonaqueous Phase Liquids in Porous Media. Ground Water. 28(1):48-56.
- Hillel 1998 Hillel, D. Environmental Soil Physics. Academic Press, San Diego, CA
- Hydraulic Institute 1991 Hydraulic Institute. 1991. Engineering Data Book. Parsippany, NJ.
- Hydraulic Institute 1994 Hydraulic Institute. 1994. Pump Standards. Parsippany, NJ.
- Karassick et al. 1986 Karassick, I.J., Krutzsch, W.C., Fraser, W.H., and Messina, J.P. 1986. Pump Handbook, 2nd Edition. McGraw Hill Book Company. New York, NY.
- Keet 1995 Keet, B.A. 1995. Bioslurping State of the Art. pp. 329-344. In: Hinchee, R.E., Kittel, J.A. and Reisinger, H.J. (Eds.) Applied Bioremediation of Petroleum Hydrocarbons. Battelle Press, Columbus, OH.

- Kittel et al. 1994
Kittel, Jeffrey A., Hinchee, Robert E.,
Hoepfel, Ron, and Miller, Ross 1994.
Bioslurping - Vacuum-Enhanced Free-Product
Recovery Coupled with Bioventing: A Case
Study. Proc. Petroleum Hydrocarbons and
Organic Chemicals in Groundwater: Protection,
Detection, and Remediation Conf. Houston,
TX. November, 1994.
- Kittel et al. 1995
Kittel, J.A., Leeson, Andrea, Hinchee, R.E.,
Miller, R.E., and Haas, P.E. 1995. Results of
a Multi-Site Field Treatability Test for
Bioslurping: A Comparison of LNAPL Rates
Using Vacuum-Enhanced Recovery (Bioslurping),
Passive Skimming, and Pump Drawdown Recovery
Techniques. Proc. Petroleum Hydrocarbons and
Organic Chemicals in Groundwater: Prevention,
Detection, and Remediation Conference and
Exposition. Nov. 29-Dec. 1, 1995. Houston,
TX. pp. 305-321.
- Leeson et al. 1995
Leeson, A., J.A. Kittel, R.E. Hinchee, R.N.
Miller, P.E. Haas, and R.E. Hoepfel. 1995.
Test Plan and Technical Protocol for
Bioslurping. pp. 335-347. In: Hinchee, R.E.,
Kittel, J.A. and Reisinger, H.J. (Eds.)
Applied Bioremediation of Petroleum
Hydrocarbons. Battelle Press, Columbus, OH.
- Lenhard and Parker 1990
Lenhard, R.J., and Parker, J.C. 1990.
Estimation of Free Hydrocarbon Volume from
Fluid Levels in Monitoring Wells. Ground
Water. 28(1):57-67.
- Newell et al. 1995
Newell, C.J., Acree, S.D., Ross, R.R., and
Huling, S.G. 1995. Light Nonaqueous Phase
Liquids. Ground Water Issue. EPA 540-S-95
500. Office of Solid Waste and Emergency
Response, Washington, DC.
- Pankow and Cherry 1996
Pankow, J.F., and Cherry, J.A. 1996. Dense
Chlorinated Solvents and other DNAPLs in
Groundwater. Waterloo Press, Portland, OR.
- Parker 1989
Parker, J.C. 1989. Multiphase Flow and
Transport in Porous Media. Reviews of
Geophysics. 27(3):311-328.
- Parker 1995
Parker, J. 1995. Bioslurping Enhances Free
Product Recovery. Soils and Groundwater
Cleanup. October:53-56.
- Parker et al. 1996
Parker, J.C., Waddill, D.W., and Johnson,
J.A. 1996. UST Corrective Action
Technologies: Engineering Design of Free
Product Recovery Systems. EPA 600-R-96-031.
National Risk Management Research Laboratory,
Office of Research and Development,
Cincinnati, OH.
- Perry and Green 1984
Perry, R.H. and Green, D.W. 1984. Perry's
Chemical Engineers' Handbook, 6th Ed. McGraw
Hill Publishing Co., Inc., New York, NY.

EM 1110-1-4010
1 Jun 99

- Ruiz et al. 1997 Ruiz, C.E., Zakikhani, M., McGrath, C.J., Deliman, R.N., Howington, S., Evans, R.A., and Tracy, E.T. 1997. Documentation on Limitations and Applicabilities of the Use of Off-the-Shelf Groundwater Models in Site Cleanup. Technical Report IRRP-97-4. U.S. Army Corps of Engineers Waterways Experiment Station, Vicksburg, MS. August, 1997
- Suthersan 1997 Suthersan, S. 1997. Remediation Engineering, Design Concepts. Lewis Publishers, CRC Press, Inc., Boca Raton, FL.

A-2. Related Publications.

- ABZ, Inc. 1997. The Crane Companion (Ver. 3.0). Chantilly, VA.
- Air Force Center for Environmental Excellence. 1994a. Bioventing Performance and Cost Summary. Brooks Air Force Base, Texas. 14 pp.
- Air Force Center for Environmental Excellence. 1994b. Technology Profile: Vacuum-Mediated LNAPL Free Product Recovery/Bioremediation(Bioslurper). Issue 1. March, 1994.
- Air Force Center for Environmental Excellence. 1997. Long Term Monitoring Optimization Guide. August, 1997.
- Alther, G.R. 1998. The Missing Link: Organoclay Systems Extend the Life of Activated Carbon and Membrane-Based Polishing Systems by Reducing or Eliminating Organic Fouling. Industrial Wastewater. 6(1):27-30.
- Alther, G.R. and McCallion, J. 1997. Preventing Resin Fouling with Clay Prepolish. Chemical Processing. April.
- American Petroleum Institute (API). 1997. Classification of Locations for Electrical Installations in Petroleum Facilities Classified as Class I, Division 1 and Division 2, Second Edition. RP500.
- American Petroleum Institute (API). 1995. In Situ Air Sparging: Evaluation of Petroleum Industry Sites and Considerations for Applicability, Design and Operation. API Publication 4609. Washington, DC.
- American Petroleum Institute (API). 1993. Guide for Assessing and Remediating Petroleum Hydrocarbons in Soils. First Edition. API Publication 1629. Washington, DC
- American Public Health Administration, American Water Works Association, and Water Pollution Control Federation. 1998. Standard Methods for the Examination of Water and Wastewater. 19th Edition.
- Ametek Rotron. Environmental/Chemical Processing Product Guide, Saugerties, NY.

- Anderson, M.P. and Woessner, W.W. 1992. Applied Groundwater Modeling: Simulation of Flow and Advective Transport. Academic Press, San Diego, CA.
- Anderson, M.R., Johnson, R.L., and Pankow, J.F. 1992. Dissolution of Dense Chlorinated Solvents into Groundwater 3: Modeling Contaminant Plumes from Fingers and Pools of Solvent. Environmental Science & Technology. 26(5):901-907.
- Arthur, D. Little, Inc. 1987. The Installation Restoration Program Toxicology Guide, Volume 1. Section 2:1-16.
- Baker, R.S. and Becker, D.J. 1999. Introducing USACE's Multi-Phase Extraction Engineer Manual. In Alleman, B. and Leeson, A. In Situ Bioremediation of Petroleum Hydrocarbon and Other Organic Compounds. Battelle Press, Columbus, OH. pp. 155-160.
- Baker, R.S. 1998. Applications of Soil Physics to Remediation of Hazardous Waste Sites. pp. 677-690. In: D. Hillel (Ed.) Environmental Soil Physics. Academic Press, San Diego, CA.
- Baker, R.S. and Hillel, D. 1991. Observations of Fingering Behavior During Infiltration into Layered Soils. In Gish, T.J. and Shirmohammadi, A. (Eds.) Proceedings of the National Symposium on Preferential Flow. Chicago, IL, Dec. 16-17, 1991. American Society of Agricultural Engineers, St. Joseph, MI. pp. 87-99.
- Baker, R.S. and Bierschenk, J. 1995. Vacuum Enhanced Recovery of Water and NAPL: Concept and Field Test. Journal of Soil Contamination. 4(1):57-76.
- Baker, R.S., Vinegar, H.J., Stegemeier, G.L. 1998. Use of In Situ Thermal Conduction Heating to Enhance Soil Vapor Extraction. In: Kostecki, P.T., and Calabrese, E.J. (eds.) Proc. 14th Annual Conference on Contaminated Soils. University of Massachusetts, Amherst, MA.
- Baker, R.S., Hayes, M.E., and Frisbie, S.H. 1995. Evidence of Preferential Vapor Flow During In Situ Air Sparging. pp. 63-73. In: Hinchee, R.E., Miller, R.N., and Johnson, P.C. (eds.) In Situ Aeration: Air Sparging, Bioventing, and Related Remediation Processes. Battelle Press, Columbus, OH.
- Barker, C.C., Bruell, C.J., and Baker, R.S. 1997. The Selective Recovery of Nonaqueous Phase Liquids (NAPLs) From Groundwater Using Oleophilic Suction Lysimetry. pp. 219-230. In P.T. Kostecki, E.J. Calabrese, and M. Bonazountas (eds.) Contaminated Soils, Vol. 2. Amherst Scientific Publishers, Amherst, MA.
- Beven, K. 1991. Modeling Preferential Flow: An Uncertain Future? In Gish, T.J. and A. Shirmohammadi (eds.) Proceedings of the National Symposium on Preferential Flow, Chicago, IL, Dec. 16-17, 1991. American Society of Agricultural Engineers, St. Joseph, MI. pp. 1-11.
- Bouma, J. 1981. Soil Morphology and Preferential Flow Along Macropores. Agric. Water Management, 3:235-250.

EM 1110-1-4010
1 Jun 99

- Breckenridge, R.P., Williams, J.R., and Keck, J.F. 1991. Characterizing Soils for Hazardous Waste Site Assessments. Ground Water Issue, EPA/540/4-91/003, Office of Research and Development, Office of Solid Waste and Emergency Response.
- Brewster, M.L., Annan, A.P., Greenhouse, J.P., Schneider, G.W., and Redman, J.D. 1992. Geophysical Detection of DNAPLs: Field Experiments. In: Proc. International Association of Hydrogeologists Conference. Hamilton, Ontario. May 1992. pp. 176-194.
- Brooks, R.H. and Corey, A.T. 1964. Hydraulic Properties of Porous Media Affecting Fluid Flow. Hydrology Papers No. 3. Colorado State University, Ft. Collins, CO. 29 pp.
- Busch, Inc. General Product Line Brochure. Virginia Beach, VA.
- Chatrathi, K. and Siwek, R. 1996. Use Suppression Systems to Mitigate Explosions. Chemical Engineering Progress. Vol. 92, No. 3. March. pp. 22-31.
- Clayton, W.S., Brown, R.A., and Bass, D.H. 1995. Air sparging and bioremediation: The case for in situ mixing. In: Hinchee, R.E., Miller, R.N., and Johnson, P.C. (eds.) In Situ Aeration: Air Sparging, Bioventing, and Related Remediation Processes. Battelle Press, Columbus, OH. pp. 75-85.
- Cohen, R.M. and Mercer, J.W. 1993. DNAPL Site Evaluation. CRC Press, Boca Raton, FL. 314 pp.
- Cohen, R.M., Bryda, A.P., Shaw, S.T., and Spalding, C.P. 1992. Evaluation of Visual Methods to Detect NAPL in Soil and Water. Groundwater Monitoring Review. 12(4):132-141.
- Cone Penetrometer Site Characterization Technology Task Group. 1996. An Expedited Site Characterization Technology: Site Characterization and Analysis Penetrometer System, Laser-Induced Fluorescence (SCAPS-LIF).
- Corey, A.T. 1986. Mechanics of Immiscible Fluids in Porous Media. Water Resources Publications, Littleton, CO.
- Costello, R.C. 1996. Pipe Flow: A Pressure Drop Calculator. Chemical Engineering. Vol. 103, No. 8. August. pp. 22-31.
- Cooper, H.H. and Jacob, C.E. 1946. A Generalized Graphical Method for Evaluating Formation Constants and Summarizing Well Field History. Trans. Am. Geophys. Union. 27:526-534.
- Crane Valve Company, Inc. 1988. Flow of Fluids through Valves, Fittings, and Pipe. TP-410. Crane Valve Company. King of Prussia, PA.
- Curran, S.D. 1997. Static Electricity in Fuel Handling Facilities. Petroleum Equipment and Technology. Vol. 2, No. 5. September/October. pp. 54-60.

- Demond, A.H. 1988. Capillarity in Two-Phase Liquid Flow of Organic Contaminants in Groundwater. Ph.D. Diss., Dept. of Civil Eng., Stanford University, Menlo Park, CA.
- Department of the Air Force. Manual 86-16. Maintenance of Petroleum Systems.
- De Pastrovich, T.L., Baradat, Y., Barthel, R., Chiarelli, A., and Fussell, D.R. 1979. Protection of Ground Water From Oil Pollution. CONCAWE, The Hague, 61 pp.
- DiGiulio, D. 1998. Personal Communication. Robert S. Kerr Environmental Research Laboratory, USEPA. Ada, Oklahoma.
- Domenico, P.A. and Schwartz, F.W. 1990. Physical and Chemical Hydrogeology. John Wiley & Sons. New York, NY.
- Driscoll, F.G. 1986. Groundwater and Wells, (2nd Edition) Johnson Filtration Systems, Inc. St. Paul, MN. 1089 pp.
- Ebdat, V. 1996. Electrostatic Hazards in the Chemical Processing Industry. Chemical Engineering. Vol. 103, No. 7. September. pp. 141-144.
- ENSR Corp. 1996. Phase II Pre-Design Report for the Former Tank Farm Area. Prepared for Squibb Manufacturing, Inc. by ENSR, Acton, MA.
- ENSR Corp. 1997. Final Report for Bioremediation Treatability Study for Confidential Industrial Client. Prepared by ENSR, Acton, MA.
- Ernst, John C. Co., Dover, NJ.
- Foster Wheeler Environmental Corporation. 1997. Soil Vapor Extraction Pilot Test Report - Silresim Superfund Site, Lowell, Massachusetts. March. Prepared for USACE, New England District, Concord, MA.
- Freeze, R.A. and Cherry, J.A. 1979. Groundwater. Prentice-Hall, Englewood Cliffs, NJ.
- Fuchs, S.J. 1992. Complete Building Equipment Maintenance Desk Book, (2nd Edition) Prentice Hall, Inc. Paramus, NJ. p.147.
- Gardner, W.H. 1986. Water Content. pp. 493-544. In A. Klute (ed.) Methods of Soil Analysis, Part 1. Physical and Mineralogical Methods Agronomy Monograph No. 9 (2nd Edition). American Society of Agronomy. Soil Science Society of America, Madison, WI.
- Gerhart, P.M. and Gross, R.J. 1985. Fundamentals of Fluid Mechanics. Addison-Wessley Publishing Co., Inc., Reading, MA.
- Hall, R.A., Blake, S.B., and Champlin, Jr., S.C. 1984. Determination of Hydrocarbon Thicknesses in Sediments Using Borehole Data. pp. 300-304. In Proc. Fourth Natl. Symp. on Aquifer Restoration and Ground Water Monitoring. Natl. Ground Water Assoc., Dublin, OH.

EM 1110-1-4010
1 Jun 99

- Hampton, D.R., Barrett, T.R., Nayyar, H.S., and O'Connell, T.P. 1993. Hydrophobic Gravel Packs for Product Monitoring and Recovery Wells. In: Proceedings of the Seventh National Outdoor Action Conference, Las Vegas, NV, May 25-27, 1993. pp. 581-595.
- Hansen, M.A., Flavin, M.D., Fam, S.A. 1994. Vapor Extraction/Vacuum-Enhanced Groundwater Recovery: A High-Vacuum Approach. 49th Purdue Industrial Waste Conference Proceedings. Lewis Publishers. Chelsea, MI. pp. 127-134.
- Hayes, D., Henry, E.C., and Testa, S.M. 1989. A Practical Approach to Shallow Petroleum Hydrocarbon Recovery. Ground Water Monitoring Review. Winter:180-185.
- Heath, J.S., Koblis, K., Sager, S.L., and Day, C. 1993. Risk Assessment for Total Petroleum Hydrocarbons. In: Calabrese, E.J. and Kostecki, P.T. (eds.) Hydrocarbon Contaminated Soils - Volume III. Lewis Publishers, Chelsea, MI. pp. 267-301.
- Hewitt, A.D. 1996. Establishing a Relationship Between Passive Soil Vapor and Grab Sample Techniques for Determining Volatile Organic Compounds. U.S. Army Corps of Engineers. September 1996.
- Hillel, D. 1987. Unstable Flow in Layered Soils: A Review. Hydrological Processes. 1:143-147.
- Hinchee, R.E., Ong, S.K., Miller, R.N., Downey, D.C., and Frandt, R. 1992. Test Plan and Technical Protocols for a Field Treatability Test for Bioventing. U.S. Air Force Center for Environmental Excellence (AFCEE), Brooks Air Force Base, Texas. 78 pp.
- Hoepfel, R.E., Kittel, J.A., Goetz, F.E., Hinchee, R.E., and Abbott, J.E. 1995. Bioslurping Technology Applications at Naval Middle Distillate Fuel Remediation Sites. pp. 389-400. In: Hinchee, R.E., Kittel, J.A. and Reisinger, H.J. (Eds.) Applied Bioremediation of Petroleum Hydrocarbons. Battelle Press, Columbus, OH.
- Huling, S.G., and Weaver, J.W. 1991. Dense Nonaqueous Phase Liquids. Ground Water Issue, EPA/540/4-91-002. U.S. Environmental Protection Agency, Office of Research and Development, Office of Solid Waste and Emergency Response.
- In-Situ, Inc. 1993. Technical Notes - Monitoring Water Levels and/or Air Pressure During Vacuum-Enhanced Extraction. In-Situ, Inc., Laramie, WY.
- Ingersoll Rand Company. 1987. Woodcliff Lake, NJ.
- Ingersoll Rand Company. 1988. Cameron Hydraulic Data, 17th Edition. C.C. Heald (ed.) Ingersoll Rand Company, Woodcliff Lake, NJ.
- Ji, W., Dahmani, A., Ahlfeld, D.P., Lin, J.D., and Hill III, E. 1993. Laboratory Study of Air Sparging: Air flow Visualization. Groundwater Monitoring and Remediation. 13(4):115-126.

- John C. Ernst Co., Inc. Catalog 96. Dover, NJ.
- Johnson, P.C. and Ettinger, R.A. 1994. Considerations for the Design of In Situ Vapor Extraction Systems: Radius of Influence vs. Zone of Remediation. Ground Water Monitoring Review. Summer: 123-128.
- Johnson, R.L. and Pankow, J.F. 1992. Dissolution of Dense Chlorinated Solvents into Groundwater. 2. Source Functions for Pools of Solvents. Environmental Science & Technology. 26:896-901.
- Johnson, P.C., Stanley, C.C., Kemblowski, M.W., Byers, D.L., and Colthart, J.D. 1990. A Practical Approach to the Design, Operation, and Monitoring of In Situ Soil-Venting Systems. Ground Water Monitoring Review. 10(2):159-78.
- Kahn, L. 1988. Determination of Total Organic Carbon in Sediment. USEPA Region II, Monitoring Management Branch. Edison, NJ.
- Katyal, A. 1998. Personal Communication. Draper Aden Environmental Modeling, Inc. Blacksburg, VA.
- Klute, 1986. Water Retention: Laboratory Methods. In: Klute, A. (ed.). Methods of Soil Analysis, Part 1 - Physical and Mineralogical Methods. Agronomy Monograph No. 9 (2nd Edition), American Society of Agronomy, Soil Science Society of America, Madison, WI. pp. 635-62.
- Kool, J.B. and Parker, J.C. 1987. Development and Evaluation of Closed-Form Expressions for Hysteretic Soil Hydraulic Properties. Water Resour. Res. 23:105-114.
- Kueper, B.H., and Frind, E.O. 1988. An Overview of Immiscible Fingering in Porous Media. J. Contam. Hydrol. 2:95-110.
- Kueper, B.H., and Frind, E.O. 1991. Two-Phase Flow in Heterogeneous Porous Media, 1. Model Development. Water Resour. Res. 27(6):1049-1057.
- Leeson, A., and Hinchee, R.E. 1995. Principles and Practices of Bioventing. Vols. I and II. Prepared by Battelle Memorial Institute, Columbus, OH for Environics Directorate, Armstrong Laboratory, Tyndall AFB, FL; National Risk Management Research Laboratory, USEPA, Cincinnati, OH; and, US Air Force Center for Environmental Excellence, Technology Transfer Division, Brooks AFB, TX.
- Lenhard, R.J., Dane, J.H., Parker, J.C. and Kaluarchchi, J.J. 1988. Measurement and Simulation of One-Dimensional Transient Three-Phase Flow for Monotonic Liquid Drainage. Water Resource. Res. 24:853-863.
- Lindsley, B.E. 1926. Use and Limitations of Vacuum in the Recovery of Oil. Petroleum Development and Technology. American Institute of Mining and Metallurgical Engineering. pp. 158-176.
- Lyman, W.J., Reehl, W.R., and Rosenblatt, D.H. 1982. Handbook of Chemical Property Estimation Methods. McGraw-Hill, New York.

EM 1110-1-4010
1 Jun 99

- Marks, L.S. 1987. Marks' Standard Handbook for Mechanical Engineers, 9th Edition
Avallone, E.A. and Baumeister, T., eds. McGraw-Hill Book Company, New
York, NY.
- Massmann, J.W., 1989. Applying Groundwater Flow Models in Vapor
Extraction System Design. Journal of Environmental Engineering,
V.115, No. 1. pp. 129-149.
- McWhorter, D.B. 1990. Unsteady Radial Flow of Gas in the Vadose Zone.
Journal of Contaminant Hydrology. 5:297-314.
- McWhorter, D.B. and Sunada, D.K. 1990. Exact Integral Solutions for Two-Phase
Flow. Water Resources Research. 26(3):399-413.
- McWhorter, D.B. 1995. Relevant Processes Concerning Hydrocarbon Contamination
in Low Permeability Soils. In: T. Walden (ed.) Petroleum Contaminated
Low Permeability Soil: Hydrocarbon Distribution Processes, Exposure
Pathways and In Situ Remediation Technologies. API Pub. No. 4631.
American Petroleum Institute, Washington, DC. pp. A-1-A-34.
- Mendoza, C.A. and McAlary, T.A. 1990. Modeling of Ground-water Contamination
Caused by Organic Solvent Vapors. Groundwater. 28(2):199-206.
- Mercer, J.W. and Cohen, R.M. 1990. A Review of Immiscible Fluids in the
Subsurface: Properties, Models, Characterization, and Remediation.
Journal of Contaminant Hydrology. 6:107-163.
- Michalski, A., Metlitz, M.N., and Whitman, I.L. 1995. A Field Study of Enhanced
Recovery of DNAPL Pooled Below the Water Table. Ground Water Monitoring
Review. Winter: 90-100.
- Mickelson, G. 1994. Vacuum-Enhanced Recovery. Designing Air-Based In Situ Soil
and Groundwater Remediation Systems. Univ. of Wisconsin-Madison
Extension, College of Engineering. Dec. 12-14, 1994 Short Course,
Madison, WI.
- Mishra, S., Parker, J.C., and Singhal, N. 1989. Estimation of Soil Hydraulic
Properties and Their Uncertainty From Particle Size Distribution Data.
J. Hydrol. 108:1-18.
- Monroe, P.C. 1996. Pump Installation: Penny Pinch at Your Own Risk. Chemical
Engineering. Vol.103, No. 3. March. pp. 88-91.
- Munson, B.R., Young, D.F, and Okiishi, T.H. 1990. Fundamentals of Fluid
Mechanics. John Wiley & Sons, New York.
- Murdoch, L. 1995. Hydraulic and Impulse Fracturing for Low Permeability Soils.
pp. E-1-E-37. In: Walden, T., (Ed.) Petroleum Contaminated Low
Permeability Soil: Hydrocarbon Distribution Processes, Exposure Pathways,
and In Situ Remediation Technologies. API Pub. No. 4631, Washington, DC,
American Petroleum Institute.

- National Institute for Occupational Safety and Health (NIOSH). 1984. Manual of Analytical Methods. Third Edition. February 1984.
- Newell, C. and Ross, R.R. 1991. Estimating Potential for Occurrence of DNAPL at Superfund Sites. Quick Reference Guide Sheet. U.S. EPA, 9355,4-07FS, Washington, D.C.
- Niemeyer, R.A., Palmer, M.A., and Hargis, D.R. 1993. Extraction Well Design for DNAPL Recovery. Proceeding of the Seventh National Outdoor Action Conference, Las Vegas, NV. May 25-27, 1993. National Ground Water Assoc. pp. 193-206.
- NRC. 1994. Alternatives for Groundwater Cleanup. National Research Council, National Academy of Sciences, Washington, DC. 281pp.
- Omega Engineering, Inc. 1995. Flow and Level Handbook. Omega Engineering, Inc. Stamford, CT. pp. Z46-Z57.
- Parker, J.C. and Lenhard, R.J. 1987a. A Model for Hysteretic Constitutive Relations Governing Multiphase Flow. 1. Saturation-Pressure Relations. Water Resour. Res. 23:2187-2196.
- Parker, J.C., Lenhard, R.J. and Kuppusamy, T. 1987b. A Parametric Model for Constitutive Properties Governing Multi-Phase Flow in Porous Media. Water Resources Research. V. 23 pp. 618-624.
- Parker, J.C., Zhu, J.L., Johnson, T.G., Kremesec, V.J., and Hockman, E.L. 1994. Modeling Free Product Migration and Recovery at Hydrocarbon Spill Sites. Ground Water. 32(1):119-128.
- Peargin, T.R., Ireland, E.A. and Stephenson, A.A. 1997. Air-Based Remediation Systems Targeting the Smear Zone. Proc. Petroleum Hydrocarbons and Organic Chemicals in Ground Water. Houston, TX. NGWA/API, Dublin, OH.
- Peargin, T.R. and Mohr, D.H. 1994. Field criteria for SVE pilot tests to evaluate data quality and estimate remediation feasibility. Proc. Petroleum Hydrocarbons and Organic Chemicals in Groundwater. Houston, TX. Nov. 2-4. NGWA/API, Dublin, OH. 14 pp.
- Peargin, T.R. 1997. Personal Communication. Chevron Research and Technology Corp., Richmond, CA.
- Peargin, T.R. 1998. Personal Communication. Chevron Research and Technology Corp., Richmond, CA.
- Perry, R.H. and Green, D.W. 1984. Perry's Chemical Engineers' Handbook, 6th Edition. McGraw Hill Publishing Co., Inc. New York, NY.
- Plastic Pipe Institute. 1974. AW-132, TR-21. Thermal Expansion and Contraction of Plastic Pipe.

EM 1110-1-4010
1 Jun 99

- Plastic Pipe Institute. 1973. AW-129, TR-18. Weatherability of Thermoplastic Pipe.
- Poulson, M.M., and Keuper, B.H. 1992. A Field Experiment to Study the Behavior of Tetrachloroethylene in Unsaturated Porous Media. Environmental Science & Technology. 26(5):889-895.
- Powers, J.P. 1992. Construction Dewatering. John Wiley & Sons, New York. pp. 492.
- Radian International, LLC. 1997. Summary Report, Pilot Study: Two-Phase Vacuum Extraction, Lake City Army Ammunition Plant, Lake City, Missouri - Volume I. Prepared for USACE, Kansas City District by Radian International, LLC.
- Rentschler, D. 1998. Personal Communication. ENSR Corporation, Acton, MA.
- Revelt, J. 1996. Don't Take Electric Motors for Granted. Chemical Engineering. V.103, No. 8. August. pp. 84-88.
- Roots Division, Dresser Equipment Group, Inc., a Halliburton Company, West Bend, IN.
- Ryans, J.L. and Croll, S. 1981. Selecting Vacuum Systems. Chemical Engineering. December 14. pp. 72-90.
- Sale, T. and Applegate, D. 1997. Mobile NAPL Recovery: Conceptual, Field, and Mathematical Considerations. Ground Water. 35(3):418-426.
- Schuring, J.R. 1995. Pneumatic Fracturing for Low Permeability Soils. pp. F-1-F-26. In: Walden, T., (Ed.) Petroleum Contaminated Low Permeability Soil: Hydrocarbon Distribution Processes, Exposure Pathways, and In Situ Remediation Technologies. API Pub. No. 4631, Washington, DC, American Petroleum Institute.
- Smith, G., Adams, T.V., and Jurka, V. 1998. Closing a DNAPL Site Through Source Removal and Natural Attenuation. pp. 97-102. In: Wickramanayake, G.B., and Hinchee, R.B. (Eds.) Physical, Chemical and Thermal Technologies: Remediation of Chlorinated and Recalcitrant Compounds. Battelle Press, Columbus, OH.
- Stonestrom, D.A. and Rubin, J. 1989. Air Permeability and Trapped-Air Content in Two Soils. Water Resour. Res. 25:1959-1969.
- TriHydro Integrated Models for Environmental Solutions (TIMES). 1997. TRIHYDRO Corporation, Laramie, WY.
- Tuthill Corporation, Kinney Vacuum Division. 1995. Product Bulletin Form No. 1137. Canton, MA.

- Ueland, S., Fagan, B., and Curry, K. 1998. Use of High Vacuum Extraction for Low-Cost, Maintenance Approach to No. 6 Oil Recovery. In: Kostecki, P.T., and Calabrese, E.J. (eds.) Proc. 14th Annual Conference on Contaminated Soils. University of Massachusetts, Amherst, MA.
- USEPA. 1975. Manual of Water Well Construction Practices. EPA/570/9-75/001.
- USEPA. 1979. Methods for Chemical Analysis of Water and Wastes. EPA/600/4-79-200.
- USEPA. 1987. Compendium of Methods for the Determination of Toxic Compounds in Ambient Air. EPA/600/4-84/041.
- USEPA. 1988a. Field Screening Methods Catalog. EPA/540/2-88/015.
- USEPA 1988b. Guidance for Conducting Remedial Investigations and Feasibility Studies Under CERCLA. EPA/540/G-89/004.
- USEPA. 1989. Estimating Air Emissions from Petroleum UST Cleanups. Office of Underground Storage Tanks. Washington, D.C.
- USEPA. 1990a. Contract Laboratory Program - Statement of Work for Analysis of Ambient Air (Draft).
- USEPA. 1990b. Basics of Pump-and-Treat Ground-Water Remediation Technology. (pg 3-28).
- USEPA. 1991a. Soil Vapor Extraction Technology Reference Handbook. EPA/540/2-91/003. Prepared by: Pederson, T.A. and Curtis, J.T. of Camp Dresser & McKee, Inc. Office of Research and Development.
- USEPA. 1991b. Description and Sampling of Contaminated Soils, A Field Pocket Guide. EPA/625/12-91/002. Center for Environmental Research Information, Cincinnati, OH.
- USEPA. 1991c. Seminar Publication: Site Characterization for Subsurface Remediation. EPA/625/4-91/026.
- USEPA. 1991d. Sampler's Guide to the Contract Laboratory Program. EPA/540/8-90/006.
- USEPA. 1993a. Cleaning Up the Nation's Waste Sites: Markets and Technology Trends. EPA//542/F-93/003. Fact and Order Sheet Form. Office of Solid Waste and Emergency Response, Washington, DC.
- USEPA. 1993b. Guidance for Evaluating the Technical Impracticability of Ground-Water Restoration. Directive 9234.2-25.
- USEPA. 1993c. Subsurface Characterization and Monitoring Techniques--A Desk Reference Guide. EPA/625/R-93/003a.

EM 1110-1-4010
1 Jun 99

- USEPA. 1994. Manual, Alternate Methods for Fluid Delivery and Recovery, EPA/625/R-94/003. September, 1994.
- USEPA. 1995. Guide to Documenting Cost and Performance for Remediation Projects. EPA-542-B-95-002.
- USEPA. 1996b. UST Corrective Action Technologies: Engineering Design of Free Product Recovery Systems. EPA/600/R-96/031.
- USEPA. 1997b. Design Guidelines for Conventional Pump-and-Treat Systems. EPA/540/S-97/504.
- USEPA 1997c Test Methods for Evaluating Solid Waste, Physical/Chemical Methods. SW-8946, Third Edition including final Update III, December 1997.
- Van Deuren, J., Wang, Z., and Ledbetter, J. 1997. SFIM-AEC-CR-97053 Remediation Technologies Screening Matrix and Guide, 3rd Edition.
- Van Genuchten, M.T. 1980. A Closed-Form Equation for Predicting the Hydraulic Conductivity of Unsaturated Soils. Soil Science Society of American Journal. 44:892-8.
- Weast, R.C. 1985. CRC Handbook of Chemistry and Physics. 65th Edition. R.C. Weast (ed.) CRC Press, Inc., Boca Raton, FL.
- White, N.F., Sunada, D.K., Duke, H.R., and Corey, A.T. 1972. Boundary Effects in Desaturation of Porous Media. Soil Science. 113(1):7-12.
- Wickramanayake, G.B., Gupta, N., Hinchee, R.E., and Nielsen, B.J. 1991. Free Petroleum Hydrocarbon Volume Estimates from Monitoring Well Data. J. Environ. Eng. 117(5);686-691.
- Wilson, J.L., Conrad, S.H., Mason, W.R., Peplinski, W. and Hagan, D. 1989. Laboratory Investigation of Residual Liquid Organics from Spills, Leaks, and the Disposal of Hazardous Wastes in Groundwater. EPA/600/6-90/004.
- Zahiraeslamzadeh, Z.M., Bensch, J.C., and Cutler, W.G. 1998. Enhanced Soil Vapor Extraction for Source Area Remediation using Dual Phase Extraction with Pneumatic Fracturing. In: Kostecki, P.T., and Calabrese, E.J. (eds.) Proc. 14th Annual Conference on Contaminated Soils. University of Massachusetts, Amherst, MA.
- Zhu, J.L., Parker, J.C., Katyal, A.K., Kremesec, V.J., Hockman, E.L., and Gallagher, M.N. 1991. Effects of Delays in Recovery System Startup on Product Recovery at Hydrocarbon Spill Sites. In: Proc. Conference on Hydrocarbons in Groundwater. NWWA.

APPENDIX B

INDEX

Activated carbonSee Carbon Adsorption

Adsorption2-39, 5-69, 6-4

Advection4-1

Air

- emission calculation7-17
- extraction 5-7, 5-8, 5-9, 5-56
- injection3-45
- moisture separator See separator, moisture
- permeability 2-15, 2-17, 2-33, 3-4, 3-6, 3-34, 5-4, 5-9
- saturation See saturation, air
- sparging 1-1, 2-20, 3-45

Air saturationSee saturation, air

Airflow

- blocking of 2-27, 2-29, 2-33, 2-35
- in laboratory testing3-48
- in layered soils 2-35, 2-36
- in SVE3-45
- initiation of 3-8, 4-31. See also Priming
- measurement 4-7, 4-8, 4-9, 5-61, 7-12
- modeling See Modeling
- preferential See Preferential flow
- rates 3-45, 5-5, 5-7, 5-9, 5-18, 7-9, 7-12
- related to biodegradation2-39
- required to lift liquid 2-27, 2-28, 2-34, 3-41

Air-liquid separatorSee Separator, gas-liquid

Anemometer4-7, 7-12, 7-13, 7-27

Anisotropy2-22, 3-7

BacteriaSee Microorganisms

Barometric pressure4-8

Biodegradation

- aerobic 1-3, 2-12, 2-40, 3-32, 3-45, 4-6
- applicability of 3-31, 3-32, 3-33, 3-45
- description of2-39
- factors influencing 3-31, 3-32, 3-33, 3-34
- modeling See Modeling
- monitoring 3-33, 7-2, 7-4, 7-11
- potential 3-4, 3-31, 3-32, 3-33
- rates 3-33, 4-26

Biofiltration5-69

Bioslurping See also Two-phase extraction

- applicability of 3-2, 7-23
- description 1-3, 2-3, 2-4
- monitoring 4-13, 4-14
- performance 4-29, 4-30
- pilot testing 4-1, 4-17, 4-18, 4-24, 4-26
- processes of 2-37, 7-12, 7-17

Bioventing	
background	1-2, 1-4, 1-5, 2-5, 2-20
factors influencing	7-4. See also Biodegradation
feasibility	3-3, 4-29, 4-31
implementation	3-45, 5-6, 5-19, 7-19, 7-23, 7-24, 7-29
modeling	See Modeling
zone of influence	4-8, 5-11
Blower	
area	See Variable speed drive
associated piping	5-37, 5-40, 5-41
curve	4-7, 7-12
design	5-49, 5-57
liquid ring pump	5-49, 5-50
maintenance	7-25
maximum lift	5-59
monitoring performance	4-7, 7-16, 7-27
protection	5-65, 7-23. See also Filter, particulate
regenerative	5-50, 5-54
rotary lobe	5-50, 5-54
rotary piston pump	5-50, 5-54
rotary vane pump	5-50, 5-53
selection/sizing	4-7, 5-7, 5-18, 5-55, 5-56
shakedown	7-6
start-up	7-9, 7-10
temperature	5-40, 5-63, 7-14
troubleshooting	7-20, 7-23
use in DPE	2-1, 3-39, 3-40, 4-5
use in TPE	2-1, 4-5
Boiling point	3-4, 3-47, 5-47
Boring log	3-6, 5-31
Bulk density	2-13, 3-4, 3-6, 4-12
Bulletin Board Systems	1-4, 1-5
Capillary	
barrier	2-29, 2-35
break	2-35
forces	1-3, 2-5, 2-15, 3-11, 5-13
fringe	2-5, 2-18, 2-33, 2-34, 3-8, 4-11, 5-12, 5-30
model	2-14
pressure (head)	2-13, 2-16, 2-23, 2-33, 4-9
pressure-saturation curve	2-17, 2-32, 2-34, 3-4, 3-6, 3-8, 4-12
pressure-saturation relationship	2-14, 4-9, 5-7
rise	2-14, 2-15
Carbon adsorption	
aqueous treatment	3-46, 4-6, 5-5, 5-47, 5-69, 6-4
operation	7-11, 7-20, 7-23
use in sampling devices	7-13
vapor treatment	4-6, 5-69, 6-4, 7-19
Carbon dioxide	3-26, 3-33, 4-14, 7-11, 7-28
Catalytic oxidation	
operation	7-19, 7-23
selection	5-69, 5-70
CERCLA	3-47, 8-3
Closure	1-4, 7-5, 7-23, 8-1, 8-2, 8-3
Commissioning Checklist	See Pre-Commissioning Checklist

Condensate	
control/separation	5-45, 7-20, 7-23
monitoring	7-10
Contaminant	
concentration	3-18, 4-2, 7-14, 8-3
removal	1-2, 1-3, 3-31, 3-46, 3-47, 7-15
short-circuiting	3-9
Contamination	
cross-	4-8, 5-33
extent	1-2, 2-5, 2-12, 2-18, 2-19, 3-1, 3-16, 3-30, 3-32, 5-6, 7-14
locating by geophysical methods	3-15
Contract Issues	7-7, 7-15, 7-29, 7-30, 7-31, 9-2, 9-4
Cost	
capital	3-40, 3-43, 3-44, 5-6, 5-37, 5-47, 5-48, 5-49, 5-53, 5-64, 5-67, 5-68, 5-69, 7-19, 7-20, 7-29, 7-30
documenting	7-29
estimating	3-35, 3-47, 3-48, 4-2, 5-70
operating	3-35, 5-64, 5-67, 5-68, 5-69, 7-15, 7-19, 7-27, 7-28, 7-29, 7-30, 8-4
Cover	See Surface cover
Darcy's Law	2-18, 2-20, 2-21, 2-22, 2-23
Darcy-Weisbach equation	5-39
Data	
acquisition	3-1, 3-4, 3-33, 3-34, 4-13, 4-19, 4-28, 5-64, 7-1, 7-2, 7-3, 7-26
analysis	2-26, 3-8, 4-12, 4-17, 4-18, 4-22, 4-23, 5-56, 7-3, 7-13, 7-27, 8-2
collection sheet	4-14
loggers	7-11
management	5-68, 7-4, 7-8, 7-15, 7-27, 7-29
quality control/objectives	3-22, 6-2, 7-5, 7-25, 7-26
validation	7-26
Database	1-4, 1-5, 7-29
Decontamination	7-5, 8-1, 8-4
Density	
air	2-24, 4-12
bulk	See Bulk density
fluid	2-13, 2-23, 2-24, 3-4, 3-14, 3-16, 5-26, 5-39, 7-2, 9-4
particle	3-6
water	2-24
Desiccation	2-15, 4-9
Design	
parameters	4-13
Diffusion	
-limited mass transfer	2-35, 2-36, 2-39, 3-21, 3-45, 4-1, 7-23
Dissolution	2-39, 3-33, 3-46

Drop tube	2-1, 2-27, 2-28, 2-32, 2-33, 2-34, 3-7, 3-40, 4-13, 5-5, 5-30, 5-39, 7-1, 7-9, 7-18, 7-23, 7-28, 9-2
Dual-phase extraction	
background/description	1-3, 2-1, 3-39
data collection	4-13
liquid-only pump use	5-55
typical system layout	3-40
well	4-10
Electrical systems	
area classification	5-60, 5-67
electrostatic charge considerations	5-48
requirements	5-64
Electron acceptors	3-29, 3-31, 3-32
Excavation	3-35
Explosion hazard	5-49, 5-62, 5-65, 5-66, 7-24
Filter	
bio-	See Biofiltration
particulate	5-55, 7-11, 7-23
Fire protection	5-64
Fracturing	
hydraulic	3-44
pneumatic	3-44
Friction loss	5-39, 5-40
across valves	5-44
in piping	5-56
Gradient	
gravitational	2-21, 3-38, 4-13
hydraulic	2-6, 3-6, 3-7
pressure	2-3, 2-21, 2-26, 7-19
Granular activated carbon	See Carbon adsorption
Groundwater	
contamination	2-4, 2-5, 5-69, 7-3, 7-14
elevation	2-26, 3-6, 3-34, 4-16, 7-3
hydrology	2-21
pump-and-treat	1-2, 2-3, 3-43, 3-46
sampling	3-9, 3-27, 8-1
treatment methods	5-69
yield	3-8, 5-13
Half-life	See Biodegradation rates
Hazen and Williams formula	5-39
Head loss	
description	5-39
determining	5-39
Health and Safety	5-64, 7-4, 9-4
Heating (in-situ)	3-47
Henry's Law	2-5, 2-24, 2-38, 3-4
Heterogeneity	2-19, 3-4, 3-6, 3-9, 5-4, 7-19
Humidity	See Relative humidity

Hydraulic conductivity	2-22, 3-7, 3-8, 3-10, 4-13, 4-27, 4-32, 5-7, 5-10, 5-17, 5-26, 5-49, 5-52
In situ respirometry	
method	3-33
use in monitoring	3-4, 3-33, 3-34
Incompressible flow assumption	2-22
Injection	
air	See Air: injection
steam	3-47
surfactant	3-46
Instrumentation	5-60, 5-67, 7-6, 7-13
Laminar flow	2-20
Liquid ring pump	See Blower
Manifold	5-41, 5-42, 5-43
Manometer	5-62
Microorganism	
biotransformation	3-31
co-metabolic degradation	3-32
enumeration studies	3-33
nutrient needs	3-29
population	3-31, 3-33
Modeling	
airflow	5-26, 5-27
contaminant transport	3-7, 5-26
DNAPL	5-27
fundamentals	2-20, 5-20
groundwater	5-26, 5-27
LNAPL recovery	5-16, 5-17
use in design	1-5, 5-13, 5-18
use in evaluating system performance	5-27
Models	
classification of	5-24, 5-25
development of	5-26
numerical	5-27
selection criteria	5-24
summary of available software	5-21
Modifications	7-29
Moisture content	See Saturation, water
Mole fraction	3-17
Monitoring	4-6, 5-43, 5-60, 7-10, 7-11, 7-17, 7-24, 7-25, 7-26, 7-27, 7-28, 8-4
Monitoring points	4-6, 4-9, 5-34, 7-2, 7-9
Nitrogen	3-21, 3-27, 3-29, 3-32, 3-34, 7-2

Non-aqueous phase liquids (NAPL)	
dense non-aqueous phase liquids (DNAPL)	2-24, 3-16, 3-20, 5-27
emulsions	5-70
light non-aqueous phase liquids (LNAPL)	2-4, 2-24, 3-10
movement	2-18, 2-20
recovery	2-3, 2-5, 2-7, 2-8, 3-2, 3-35, 3-36, 3-37, 3-38, 4-8, 5-15
saturation	See Saturation, NAPL
spatial distribution	2-5, 2-37
storage	5-70, 7-19
-water separation	5-45, 5-46, 5-47
Nutrients	3-32, 3-33, 3-34, 7-2, 7-28
Octanol-water partitioning coefficient	2-39
Off-gas treatment	
implications for design	5-55, 5-56
operation	5-63
selection	5-69
Oil-water separator	See Separator, NAPL-water
Operation and maintenance	
monitoring	7-10, 7-11
performance	7-15
start-up	7-9
strategy	7-18, 7-22, 7-23, 7-24
troubleshooting	7-20
Organic vapor analyzer	5-62
Organically activated clay	5-47
Oxygen	
dissolved	3-27, 3-30
monitoring/sampling	3-26, 4-13, 7-28
supplying	3-45
uptake	3-33
Particulate filter	See Filters
Partitioning	
air-NAPL	2-5
air-soil	2-12
air-water	3-45
coefficients	2-39
octanol-water	2-5
soil-NAPL	2-5
soil-water	2-5, 3-34
Patent issues	9-1
Permeability	
air	See Air permeability
intrinsic	2-20, 2-22, 3-34
relationship to hydraulic conductivity	2-22
relative	2-20, 2-21
Permitting	4-1, 4-2, 5-34, 9-1
pH	3-4, 3-21, 3-30, 3-32, 3-34, 5-47, 7-2
Phosphorus	3-21, 3-27, 3-30, 3-32, 3-34, 7-2
Piezometer	See Monitoring points
Piezometric surface	2-29, 4-10

Pilot test	
evaluation	4-26
limitations	4-2
monitoring	4-6
objectives	4-1
reports	See Reports
Piping	5-37
Pitot tube	See Aiflow measurement
Plate count	See Microorganisms, enumeration
Pneumatic analysis	5-39
Pore volume	
exchange rate	5-6, 5-8
selection of exchange rate	3-46, 5-19
Pore water	2-5, 2-12, 3-31, 3-32, 3-33
Porosity	
air filled	2-29, 5-7, 5-8
use in determining moisture content	2-13
Potential	
biodegradation	See Biodegradation, potential
redox	3-27, 3-30, 7-2, 7-11
Pre-Commissioning Checklist	7-6, 7-7
Preferential flow	2-19, 4-31, 5-4, 5-7, 5-20, 7-19, 7-22.
See also Short-circuiting	
Pressure	
absolute	5-59
air emergence	2-15, 2-30, 2-31, 2-34, 3-8
air entry	2-29, 2-30, 2-31
atmospheric	2-19, 2-29, 4-10
barometric	See Barometric pressure
capillary	See Capillary pressure (head)
control devices	5-63
distribution	7-2, 7-27
drop across valves	See Friction loss
gauge	2-19, 4-8, 5-61, 5-62
gradient	See Gradient, pressure
head	2-21
inflection	See Pressure, air emergence
limitations on piping	5-40
loss in piping	See Friction loss
monitoring in the subsurface	7-11
standard	2-24, 4-7, 7-13
testing of monitoring points	4-9
vapor	See Vapor pressure
wetting	2-29
Pressure-saturation	See Capillary pressure-saturation
Presumptive remedies	1-3
Priming	2-34, 2-35, 7-23, 9-2
Process controls	5-60, 5-63
Product	See Non-aqueous phase liquids (NAPL)

Project team	5-3
Pulsed extraction	7-19, 7-28
Pump curve	See Blower curve
Quality assurance	7-5, 7-26
See also Sampling and Analysis Plan	
Quality assurance requirements	See Data
Radius of influence	
radius of pressure influence	4-8
zone of effective air exchange	4-8, 4-31
Raoult's Law	3-17
Rebound	8-1, 8-3
Recordkeeping	7-29
References	1-1, 1-4
Regenerative blower	See Blower
Regulatory issues	3-5, 8-1, 9-1
Relative humidity	4-7, 7-11, 9-4
Remedy selection	3-1
Reports	
design	6-1
feasibility study	3-48
pilot test	4-12
start-up	7-15
Residual NAPL saturation	2-18, 3-14
Resource Conservation and Recovery Act (RCRA)	3-47, 9-1
Respirometry	See In situ respirometry
Rotary lobe blower	See Blower
Rotary vane pump	See Blower
Safety	See Health and Safety
Sampling	
air	3-26, 7-14
closure	8-1
DNAPL	3-18
field methods	7-5, 7-25
groundwater	See Groundwater sampling
in long-term monitoring	7-25
intact soil cores	3-10
LNAPL	3-15
soil	3-8, 3-21, 3-34, 5-32, 5-36
soil gas	3-23, 3-26, 7-13
VOC decision tree	3-24, 3-25
Sampling and Analysis Plan	3-1, 3-21, 7-3, 7-25, 7-27
Saturated zone	2-4, 2-33, 3-7

Saturation	
air	2-13, 2-15
monitoring	4-10
NAPL	2-5, 2-12, 2-18, 2-36, 3-44
residual	3-14
vapor	3-17
water	2-12, 2-15, 2-34
Semi-volatile organic compounds (SVOC)	2-12, 3-21, 3-30, 3-47, 7-4
Separator	
gas-liquid	2-1, 4-5, 5-45
NAPL-water	2-1, 4-5, 5-46, 5-47, 7-1, 7-9
Short-circuiting	4-31, 5-71. See also Preferential flow
Shutdown	
guidance	8-4
strategy	8-1
Site characterization	3-1, 3-4, 3-34
Slurp tube	See Drop Tube
Soil	
cores	2-18, 3-8, 3-10
moisture	See Saturation, water
porosity	See Porosity
probes	See Monitoring points
properties	3-4, 3-6, 3-34, 4-1, 5-17, 7-3
sampling	See Sampling, soil
texture	2-6, 2-12, 2-15
Soil gas survey	3-23
Soil vapor extraction	
background	1-1
combining with groundwater extraction/NAPL recovery	3-46
Engineer Manual	1-5
wells	5-28
Solubility	
approximation of	3-17
of various compounds	2-24, 3-18
Solvent	1-3, 2-4, 3-15, 3-18, 4-3, 5-41
Start-up	
checklist	7-6, 7-7, 7-9
monitoring	7-9
objectives	7-8
overview	7-7
report	See Reports, start-up
strategy	7-7
Stratigraphy	3-6, 7-3
Structural considerations	6-2
Substrate	3-31, 3-32
Suction	2-26, 3-7, 5-53, 5-59. See also Capillary pressure
Suction tube	See Drop tube
Superfund	See CERCLA
Superposition, principle of	2-11, 5-12

Surface cover	5-36, 5-71, 6-1, 7-22, 7-23, 7-29
Tanks	5-2, 5-63
Technology screening	2-39, 3-1, 3-2, 3-3, 3-4
Temperature	
effects on chemical properties	2-24
instrumentation	5-62, 7-6
limitations	3-2, 3-3, 5-40, 5-63
measurement of	3-27, 3-30, 4-12, 5-39, 7-10
operating	5-38, 5-58
standard	2-24, 4-7, 7-13
Tension	See Capillary pressure
Texture	See Soil, texture
Thermal oxidation	
operation	7-8
selection	5-69, 5-70
Tracer gas	4-12
Trench/drain systems	3-36, 3-37
Trenches	5-28, 5-35, 7-6, 7-18
Troubleshooting	See Operation and maintenance, troubleshooting
Two-phase extraction	See also Bioslurping
background/description	1-3, 2-1, 3-40
data collection	4-7
limitations of	2-32, 3-2, 3-3, 3-6, 3-7, 3-8, 4-6, 5-41
typical system layout	2-2
Unsaturated zone	1-3, 2-5, 2-18, 3-14, 4-8
Upwelling	
causes of	2-27
concept	2-26, 2-27, 2-29, 4-10
measurement of	4-9, 4-10
of DNAPL	3-44
Vacuum	2-11, 2-26, 2-37, 4-6, 4-8, 5-40, 5-63, 7-2, 7-11, 7-27
Vacuum pump	See Blower
Vadose zone	See Unsaturated zone
Valves	
ball	5-44
butterfly	5-44
diaphragm	5-44
foot	5-45
gate	5-44
globe	5-44
needle	5-44
plug	5-45
Vapor concentration	
measurement	5-60, 5-62
trends	2-39, 5-48, 7-19, 7-23
Vapor pressure	2-38, 3-4, 3-47, 5-58, 5-59
Variable speed drive	5-55
Viscosity	2-21, 2-24, 3-14, 3-16, 7-2

Volatile organic compounds (VOC)	
gaseous phase	2-20, 7-13
liquid phase	2-5
methods of analysis	3-22
partitioning	2-5, 4-26
residual phase	2-5
Volatilization	2-38
Water saturation	See Saturation, water
Water table	See Groundwater level
Wells	
design	5-29
filter pack	2-32, 5-30, 5-32, 7-20
horizontal	5-28, 5-34
installation	5-28, 5-31
maintenance	7-20, 7-23, 7-28
screen placement	5-30, 5-32
Wetting phase	2-13, 2-14, 2-17, 2-29, 2-36
Work Plan	4-2, 6-2, 8-1

APPENDIX C

GLOSSARY

AFCEE	U.S. Air Force Center for Environmental Excellence
API	American Petroleum Institute
ASTM	American Society for Testing and Materials
ATTIC	Alternative Treatment Technology Information Center
BEP	Best Efficiency Point
BOD	Biological Oxygen Demand
BV	Bioventing
CEGS	USACE Guide Specifications
CERCLA	Comprehensive Environmental Response, Compensation, and Liability Act
CFU	Colony Forming Unit
CGI	Combustible Gas Indicator
CLU-IN	Hazardous Waste Clean-Up Information System
COD	Chemical Oxygen Demand
DCE	Dichloroethylene, Dichloroethene
DNAPL	Dense Non-Aqueous Phase Liquid
DOT	U.S. Department of Transportation
DPE	Dual-Phase Extraction
DQO	Data Quality Objective
EM	Engineer Manual
FFA	Federal Facility Agreement
FID	Flame Ionization Detector
FOA	Field Operating Activities
foc	Fraction of Organic Carbon
FOIA	Freedom of Information Act
FPR	Free Product Recovery
FRP	Fiberglass Reinforced Plastic
FRTR	Federal Remediation Technologies Roundtable
FS	Feasibility Study
FSP	Field Sampling Plan
GC	Gas Chromatograph
GPR	Ground Penetrating Radar
HDPE	High Density Polyethylene
IAS	In-Situ Air Sparging
LDPE	Low Density Polyethylene

GLOSSARY (Continued)

LEL	Lower Explosive Limit
LNAPL	Light Non-Aqueous Phase Liquid
MCL	Maximum Concentration Limit
MPE	Multi-Phase Extraction
MS	Mass Spectrometry
MSC	Major Subordinate Commands
NAPL	Non-Aqueous Phase Liquid
NEC	National Electric Code
NEMA	National Electrical Manufacturer's Association
NFPA	National Fire Protection Association
NIOSH	National Institute for Occupational Safety and Health
NPSH	Net Positive Suction Head
NPSH _A	Net Positive Suction Head Available
NPSH _R	Net Positive Suction Head Required
NTU	Nephelometric Turbidity Unit
O&M	Operation and Maintenance
ODP	Open Drip Proof
ORP	Oxygen Reduction Potential
P&ID	Piping and Instrumentation Diagram
PCE	Tetrachloroethylene, Tetrachloroethene, Perchloroethylene, Perchloroethene
PFD	Process Flow Diagram
PID	Photo Ionization Detector
PLC	Programmable Logic Controller
PTFE	Polytetrafluoroethylene, Teflon [®]
PVC	Polyvinyl Chloride
PVER	Pore Volume Exchange Rate
QA/QC	Quality Assurance/Quality Control
QAPP	Quality Assurance Project Plan
RCRA	Resource Conservation and Recovery Act
RF	Radio Frequency
RG	Remedial Goal
RH	Relative Humidity
ROD	Record of Decision
SAP	Sampling and Analysis Plan

GLOSSARY (Continued)

SCADA	Supervisory Control and Data Acquisition
SCAPS	Site Characterization and Analysis Penetrometer System
SITE	Superfund Innovative Technology Evaluation
SSHP	Site Safety and Health Plan
STP	Standard Temperature and Pressure
SVE	Soil Vapor Extraction
SVOC	Semi-Volatile Organic Compound
TCE	Trichloroethylene, Trichloroethene
TDH	Total Dynamic Head
TDR	Time Domain Reflectometry
TDS	Total Dissolved Solids
TEBC	Totally Enclosed Blower Cooled
TEFC	Totally Enclosed Fan Cooled
TENV	Totally Enclosed Nonventilated
TIC	Tentatively Identified Compounds
TKN	Total Kjeldahl Nitrogen
TOC	Total Organic Carbon
TPE	Two-Phase Extraction
TPH	Total Petroleum Hydrocarbons
UEL	Upper Explosive Limit
URL	Universal Resource Locator
USACE	United States Army Corps of Engineers
USEPA	United States Environmental Protection Agency
UST	Underground Storage Tank
VC	Vinyl Chloride
VISITT	Vendor Information System for Innovative Treatment Technologies
VOC	Volatile Organic Compound
VSD	Variable Speed Drive
XP	Explosion Proof
ZOI	Zone of Influence

APPENDIX D

SYMBOLS

b	Thickness of Soil Layer
C	Hazen and Williams Friction Factor
D	Diameter
e	Unit Gravitational Vector
E_h	Redox Potential
f	Darcy-Weisbach Friction Factor
g	Gravitational Acceleration
h_a	Absolute Pressure on the Surface of the Pumped Liquid
h_c	Capillary Head
$h_c(S)$	Capillary Head/Saturation Relationship
h_{cae}	Air-Entry Capillary Head
h_f	Friction Loss
h_n	Non-Wetting Capillary Head
H_o	Apparent LNAPL Thickness
h_p	Water-Equivalent Pressure Head
h_s	Static Height of Liquid Above/Below Pump Intake
h_{vp}	Absolute Vapor Pressure of Liquid
h_w	Wetting Capillary Head
K	Hydraulic Conductivity
k	Intrinsic Permeability
k_a	Air Permeability
k_r	Relative Permeability
K_{sw}	Saturated Hydraulic Conductivity of Water
L	Length
M	Mass
M_{soil}	Mass of Soil
M_w	Mass of Water
n	Porosity
n_a	Air Filled Soil Porosity
P_a	Air-Entry Pressure
P_{atm}	Atmospheric Pressure
P_c	Capillary Pressure
P_e	Air Emergence Pressure
P_{infl}	Inflection Pressure
P_n	Non-Wetting Phase Pressure

SYMBOLS (Continued)

P_{sub}	Subatmospheric Pressure
P_w	Wetting Phase Pressure
Q	Volumetric Flow Rate
q_p	Volumetric Flux of Fluid Phase P
Q_v^*	Volumetric Flow Rate at Atmospheric Pressure
Q_w	Water Flow Rate
r	Radius
Rel. T_o/V_{of}	Normalized Oil Mobility Factor
S_a	Air Saturation
S_o	Organic Liquid Saturation
S_{or}	Residual Organic Liquid Saturation
S_w	Water Saturation
S_y	Specific Yield
t	Time
T	Transmissivity
t_{xc}	Time Required for One Pore Volume Exchange
v	Velocity
V_o	True LNAPL Thickness
V_{pores}	Volume of Pores
V_t	Total Volume of Soil
V_w	Volume of Water
w	Moisture Content
α	Wetting Angle
γ_p	Source-Sink Term of Mass Transfer
η	Dynamic Viscosity
η_r	Relative Viscosity
θ	Moisture Content
ρ	Density
ρ_b	Bulk Density
ρ_r	Specific Gravity
ρ_w	Density of Water
σ_{ao}	Air-Oil Interfacial Tension
σ_{aw}	Air-Water Interfacial Tension
σ_c	Interfacial Tension
σ_{ow}	Oil-Water Interfacial Tension