

Lawrence Berkeley National Laboratory

Lawrence Berkeley National Laboratory

Title

PROCEEDINGS OF THE SYMPOSIUM COMMEMORATING THE 25th ANNIVERSARY OF ELEMENTS 99 AND 100

Permalink

<https://escholarship.org/uc/item/92g2p7cd>

Author

Authors, Various

Publication Date

1979-04-01

Peer reviewed

LBL-7701 c.2
UC-34C
CONF-780134

PROCEEDINGS

SYMPOSIUM COMMEMORATING THE 25th ANNIVERSARY OF ELEMENTS 99 AND 100

January 23, 1978
at Lawrence Berkeley Laboratory

RECEIVED
LAWRENCE
BERKELEY LABORATORY

JUL 30 1979

LIBRARY AND
DOCUMENTS SECTION

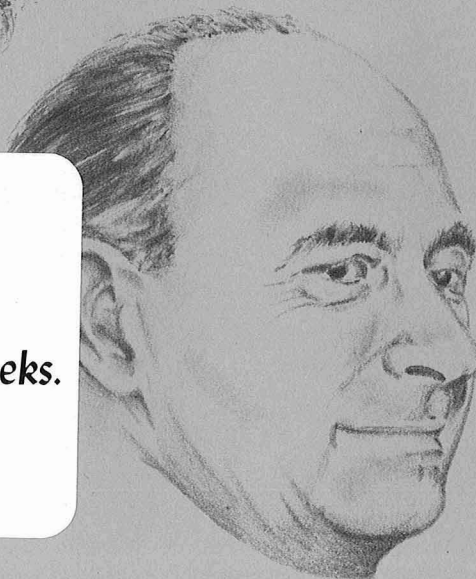
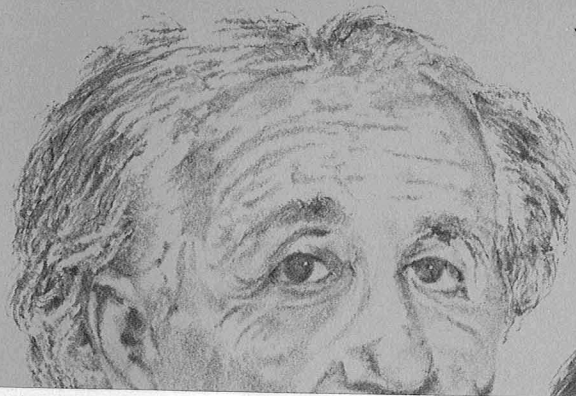

TWO-WEEK LOAN COPY

*This is a Library Circulating Copy
which may be borrowed for two weeks.
For a personal retention copy, call
Tech. Info. Division, Ext. 6782*

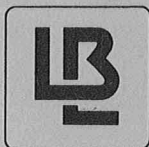

Lawrence
Berkeley
Laboratory
University of California, Berkeley

Prepared for the U.S. Department of Energy under Contract W-7405-ENG-48.

LBL-7701 c.2

Lawrence Berkeley Laboratory Library
University of California, Berkeley

**Proceedings of the
SYMPOSIUM COMMEMORATING
the 25th ANNIVERSARY of
ELEMENTS 99 and 100 held
January 23, 1978 at
Lawrence Berkeley Laboratory**

April 1979

Scientific Editor
Glenn T. Seaborg

Technical Editor
Catherine Webb

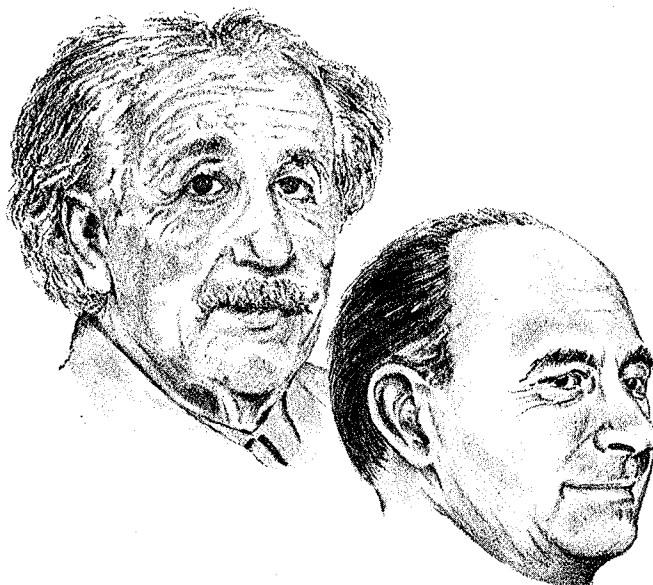

Dedicated to

*Albert Einstein
and
Enrico Fermi*

CONTENTS

Preface	v
Introductory Remarks	
<i>Glenn T. Seaborg, Lawrence Berkeley Laboratory</i>	1
Reminiscences	
<i>Sherman M. Fried, Argonne National Laboratory</i>	4
<i>Paul R. Fields, Argonne National Laboratory</i>	5
<i>Albert Ghiorso, Lawrence Berkeley Laboratory</i>	7
<i>Gary H. Higgins, Lawrence Livermore Laboratory</i>	9
<i>Roderick W. Spence, Los Alamos Scientific Laboratory</i>	11
Nuclear Properties of Einsteinium and Fermium	
<i>John R. Huizenga, University of Rochester</i>	17
Fission Properties of Einsteinium and Fermium	
<i>Darleane C. Hoffman, Los Alamos Scientific Laboratory</i>	27
Production of Einsteinium and Fermium in Reactors	
<i>Donald E. Ferguson, Oak Ridge National Laboratory</i>	35
Production of Einsteinium and Fermium in Nuclear Explosions	
<i>Richard W. Hoff, Lawrence Berkeley Laboratory</i>	39
Chemical Properties of Einsteinium	
<i>E. Kenneth Hulet, Lawrence Livermore Laboratory</i>	51
<i>Joseph R. Peterson, Oak Ridge National Laboratory</i>	55
Chemistry of Fermium, Element 100	
<i>Norman M. Edelstein, Lawrence Berkeley Laboratory</i>	65
Free Ion Spectroscopy of Einsteinium and Comments on Fermium	
<i>John G. Conway, Lawrence Berkeley Laboratory</i>	69
Crystal and Solution Spectroscopy of Einsteinium	
<i>William T. Carnall, Argonne National Laboratory</i>	73

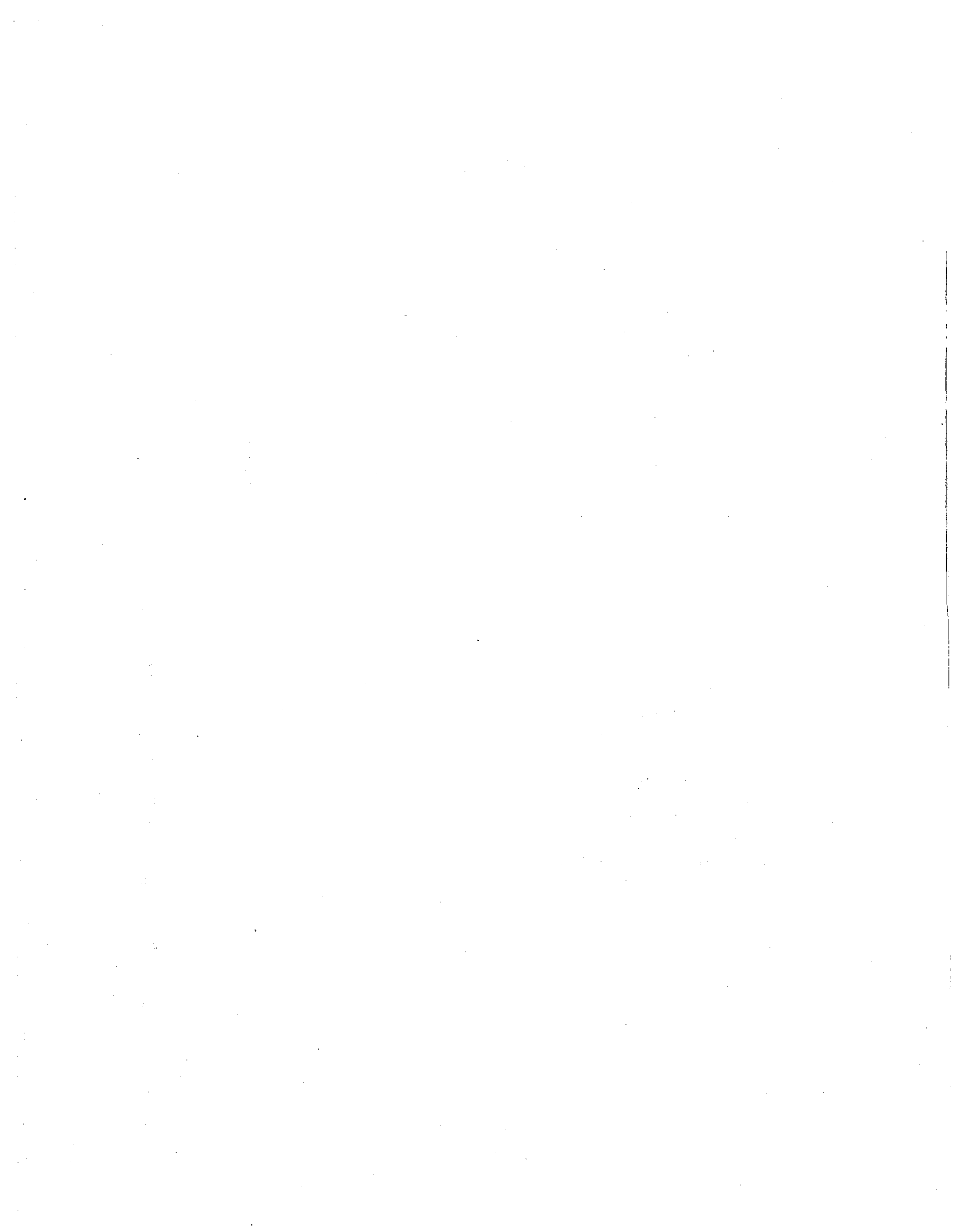

Preface

This volume includes the talks given on January 23, 1978, at a symposium in Berkeley on the occasion of the celebration of the 25th anniversary of the discovery of einsteinium and fermium. Talks were given at this symposium by representatives of the groups from the three laboratories (Lawrence Berkeley Laboratory, Argonne National Laboratory, and Los Alamos Scientific Laboratory) that parti-

cipated in the discovery of these elements and by a number of people who have made significant contributions in the intervening years to the investigation of their nuclear and chemical properties. The papers are being published here, without editing, in the form in which they were submitted by the authors.

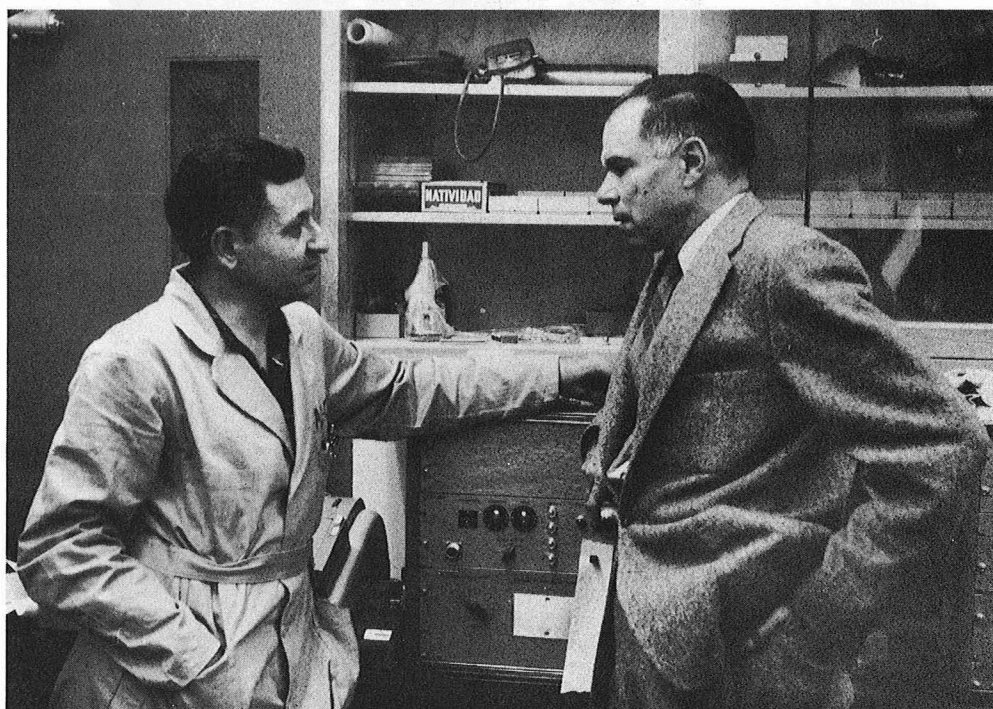

Albert Ghiorso and Glenn T. Seaborg as they were when elements 99 and 100 were discovered.

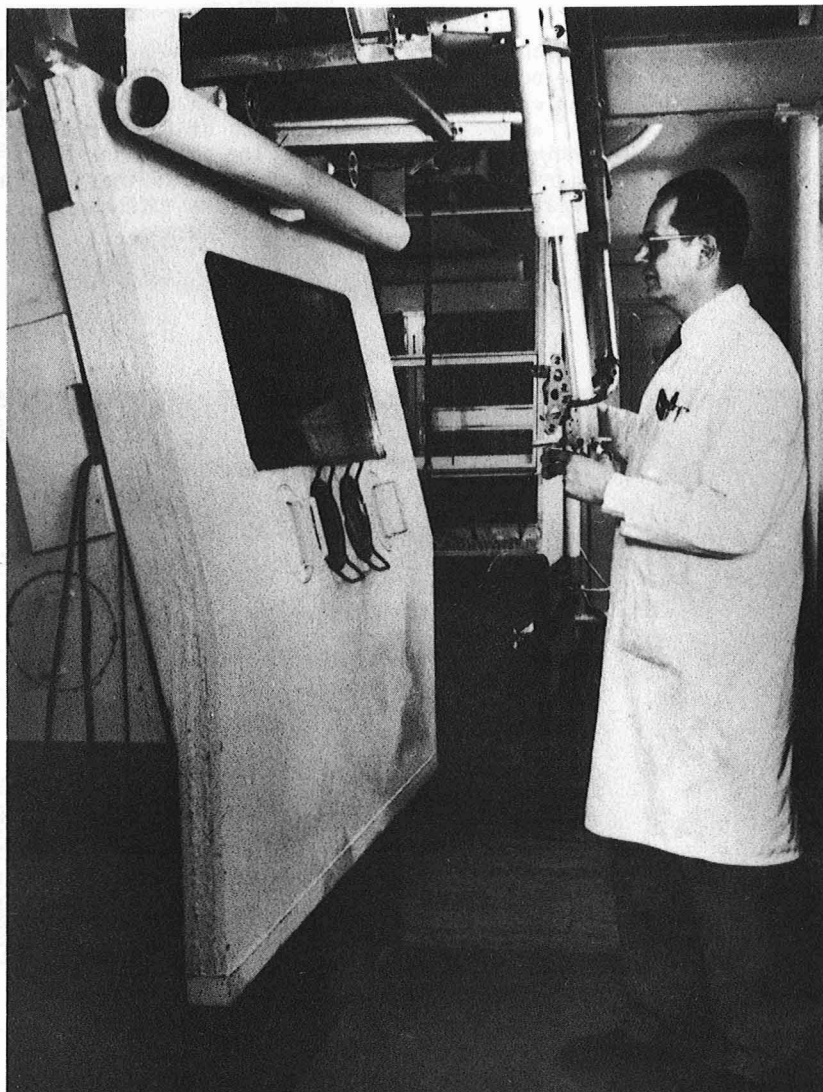

Paul Fields operating remote handling devices like those used in the isolation of einsteinium and fermium.

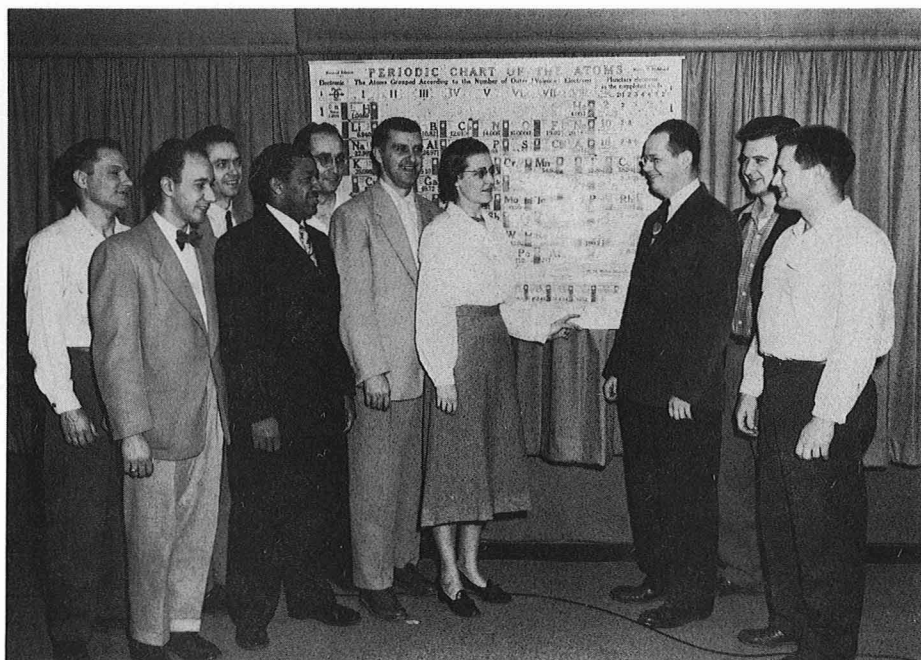

Chemists who worked on elements 99 and 100 at Argonne National Laboratory. Left to right are: Lawrence B. Magnusson, Arnold M. Friedman, Charles M. Stevens, Philip A. Sellers, Herbert Diamond, John R. Huizenga, Gray Pyle, Paul R. Fields, Joseph F. Mech, and Martin H. Studier.



Charles Browne and Rod Spence in the early 1950's.



Co-discoverers of elements 99 and 100 at symposium commemorating the 25th anniversary of their discovery held at Lawrence Berkeley Laboratory, January 23, 1978. Front row: Louise Smith, Sherman Fried, Gary Higgins. Back row: Al Ghiorso, Rod Spence, Glenn Seaborg, Paul Fields and John Huizenga.

Introductory Remarks

Dr. Glenn T. Seaborg

I think we might get started. I hope those of you from the East and the Midwest, where the weather hasn't been so great recently, appreciate the fine weather we brought out for you to commemorate this occasion.

I think it's appropriate to observe or celebrate the 25th anniversary of a scientific event as important as the discovery of two chemical elements. It also gives us the opportunity to bring together old friends, and serves the purpose, also, I believe, of contributing at least a little bit to the historical record.

The discoveries of many of the transuranium elements were the result of careful preliminary planning, taking into account experimental techniques, predictions of chemical and nuclear properties, and the availability of starting material. Elements 99 and 100 were, however, unexpectedly discovered in the debris from the first thermonuclear explosion, the "Mike" shot,

which was staged in the Pacific on November 1, 1952. The discoveries occurred only because chemical identifications were made routinely in connection with these tests in order to establish certain properties, efficiencies, etc., of the explosion. Accordingly, debris for this purpose was collected on filters attached to airplanes which flew through the explosion area. Later, in order to obtain more source material, it was necessary to process many hundreds of pounds of coral from one of the neighboring atolls.

We have a number of the discoverers here today from the three laboratories involved and a number of others, who are experts on these elements, to talk to us.

Initial investigation of the debris by groups at Argonne National Laboratory in Chicago and at the Los Alamos Scientific Laboratory of the University of California in New Mexico resulted in the discovery of heavy isotopes such as plutonium-244

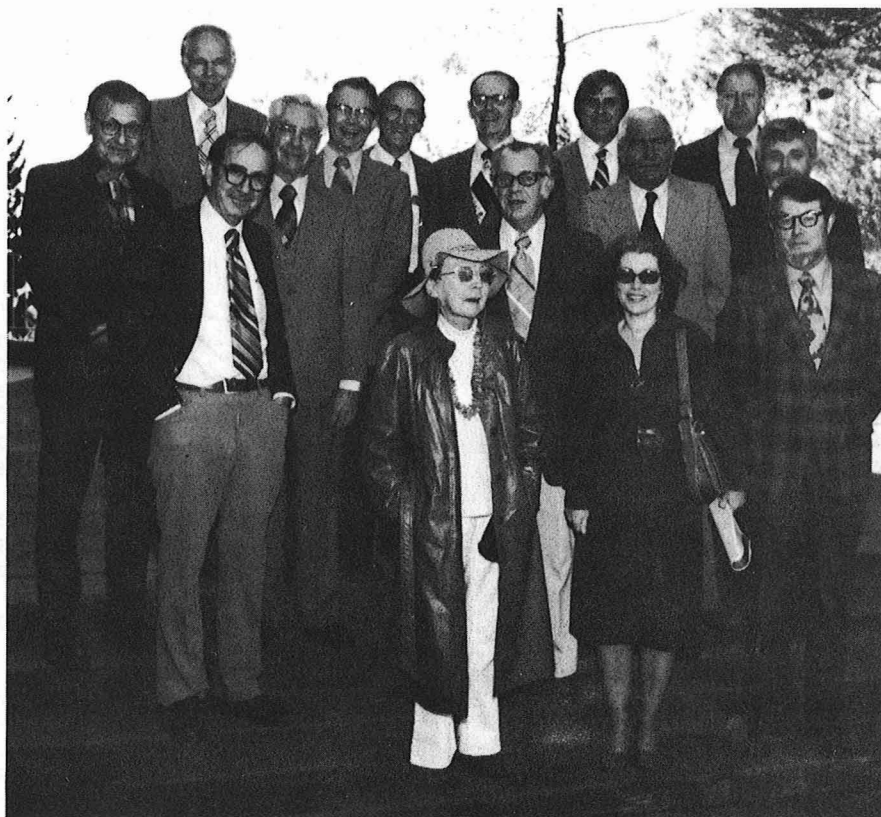

Participants in 25th anniversary symposium for the discovery of elements 99 and 100.

First row, L-R: Louise Smith, Darleane Hoffman, Kenneth Hulet.

Second row: Sherman Fried, Gary Higgins.

Third row: Al Ghiorso, Rod Spence, Don Ferguson, Norman Edelstein.

Fourth row: Glenn Seaborg, Bill Carnall, John Conway, Paul Fields, John Huizenga, Dick Hoff.

and plutonium-246. At that time plutonium-243 was the heaviest plutonium isotope known. The presence of these previously unknown heavy isotopes in such high yield pointed to the successive capture of many neutrons by the uranium in the device. This resulted in the production of very heavy uranium isotopes which underwent many successive beta particle decays, due to their high ratio of neutrons to protons, to form very heavy isotopes of the transuranium elements.

The group at the University of California Radiation Laboratory at Berkeley began a search for transcalifornium isotopes in the debris immediately upon receipt of a copy of a telegram dated December 2, 1952. The telegram, from Ralph Carlisle Smith of Los Alamos Scientific Laboratory, was sent to James G. Beckerly at the U.S. Atomic Energy Commission, Washington, D.C. to warn about the secret nature of certain data concerning the Mike explosion as follows:

"At the request of Los Alamos, a sample of Mike shot has been analyzed and found to contain plutonium two four four. Other heavy element unique isotopes are also present in the samples. This information indicates an especially high neutron flux, which reveals something of nature of device detonated. Samples of the bomb debris have been made available to Argonne, Livermore, and AFOAT-1 organizations. Therefore, Bradbury, Kellogg, Graves and I recommend that you advise all organizations including the Joint Task Forces that all Analyses of the debris be considered part of the Ivy Report Series and be graded secret restricted data. Furthermore advise all concerned that the existence of plutonium two four four is considered secret restricted data at this time in order to avoid an injudicious announcement by organizations which might acquire samples."

Now we're going to have a number of people reminisce about the sequence of events. On receipt of that telegram, the group here began to look for the possibility of transcalifornium elements being produced and, using the ion exchange technique, they were able to show that a transcalifornium isotope was produced. Then a little later still another transcalifornium isotope, due to still another element, was identified. But without going into details, it may be pointed out that such experiments involving the groups at the three laboratories led to the positive identification of elements 99 and 100. I won't stop to give you details about the isotopes.

The large group of scientists who contributed to the discovery of these elements includes A. Ghiorso, S.G. Thompson, G.H. Higgins, and myself at the Radiation Laboratory and Department of Chemistry at the University of California; M.H. Studier, P.R. Fields, S.M. Fried, H. Diamond, J.F. Meck, G.L. Pile, J.R. Huizenga, A. Hirsch, and W.M. Manning at the Argonne National Laboratory; and C.I. Browne, H.L. Smith, and R.W. Spence of the Los Alamos Scientific Laboratory.

These researchers suggested the name einsteinium for element 99 in honor of the great physicist, Albert Einstein, and for element 100 the name fermium in honor of the father of the nuclear age, Enrico Fermi. The investigators also suggested the

symbols E for einsteinium and Fm for fermium, but the Commission on Nomenclature of Inorganic Chemistry of the International Union of Pure and Applied Chemistry which, of course, has the ultimate responsibility for such things, didn't accept the proposed symbol for einsteinium and instead suggested the symbol Es, and that is the symbol today.

Before the removal of the secret label from this information and the subsequent announcement of the original discovery experiments could be accomplished, isotopes of elements 99 and 100 were produced by other more conventional methods. That is, they were produced by successive neutron capture interspersed with beta decays as a result of intensive slow neutron irradiation of plutonium in the high flux Materials Testing Reactor in Idaho. This work was published first before the declassification of the work involved in the discovery experiments utilizing the Mike explosion. It wasn't until 1961 that sufficient einsteinium had been produced through intensive slow neutron irradiation of plutonium-239 in the MTR to permit separation of the macroscopic and weighable amount, and that was done by Cunningham, Wallman, Phillips, and Gatti working at Berkeley.

In my notes I have material on the isotopes of einsteinium and fermium that are known, but I'll skip over that. I imagine John will go into some of that, and I will just conclude by saying a little bit about the naming of these elements.

Elements 99 and 100 were the first of the transuranium elements to be named by the direct system of honoring eminent scientists. (There had been namings before that that honored scientists, but it was due to a more indirect system.) This is the system that has been used for naming all of the subsequent transuranium elements. I believe Albert Ghiorso can be credited with leading his coworkers into this method of naming. His first move in that direction was a letter he wrote to Mrs. Enrico Fermi on April 26, 1955, from which I quote as follows, "I thought you might like to know that we are planning to name element 100 in honor of Enrico... It was my fortune and privilege to know your husband in the days of the Metallurgical Laboratory project, and I can say from personal contact that science has lost a very warm-hearted human being as well as its greatest physicist." Enrico had died just five months before this.

We considered many other possibilities for elements 99 and 100 before making the final decision for the names. The name centurium for element 100 was suggested to us by many people and this, of course, was an obvious contender. The possibility of naming element 99 or 100 after one of the laboratories was very seriously considered. It would have been natural to honor in this manner the Los Alamos Scientific Laboratory, which was responsible for staging the Mike explosion. In reviewing the notes covering one of my phone conversations with Rod Spence, I find we discussed such possibilities as losalium, losalamium, losalamosium, and alamosium, and in recognition of the acronym "LASL," the names laslium, laslucium, ucladium, the latter two in recognition of the role of UC (University of California) in operating the Los Alamos Scientific

Laboratory. Another possibility, of course, was argonmium after the Argonne National Laboratory. Berkeley had already been honored as the namesake for element 97. I believe that the fellows from the Argonne National Laboratory considered at one time the name phoenicium for element 99. We received one interesting letter suggesting arconium in honor of Arco, Idaho, for element 100. This correspondent pointed out that its lanthanide homologue, erbium, was also named after a town, Ytterby, Sweden. This suggestion was made after the publication of the research in which element 100 had been synthesized by neutron bombardment in the MTR at Arco, and before it was revealed that it had been synthesized earlier in the Mike explosion. He also suggested that element 99 could be named after a location because its lanthanide homologue, holmium, derives its name from Stockholm; he suggested, therefore, that element 99 might be named ucalium, anlum, or losalium, after the University of California, ANL or Los Alamos. It is clear that the manner in which erbium and holmium were given their names gave us the license to name elements 99 and 100 after a place had we chosen to do so.

The name and symbol athenium, Am, for element 99, and centurium, Ct, for element 100 appeared mysteriously in the literature in the early 1950's. It appears that this was an indirect result of a talk by Louis Alvarez at a conference at Oxford, England, in 1950, in which he outlined the future possibility for synthesizing these elements by certain nuclear reactions. This was misinterpreted as an announcement of discovery by the press and

even reached some scientific journals. A consequence of this, apparently, was somehow the suggestion of the names athenium and centurium which had either a Spanish or a French source, and these names appeared in the Soviet literature for a while in the early 1950's. Soon after our letter to the editor in The Physical Review, announcing the discovery of elements 99 and 100, another correspondent wrote as follows: "I stated very plainly, in diagram text and nomenclatural, a new atomic theory which named element 99 ninetynineum, symbol Nn, and element 100 centinium, symbol Ct. This is my creative knowledge, and I value and honor each atom ninetynineum, 99, and centinium, 100, a million dollars each."

The announcement of the names einsteinium and fermium was first made at the Geneva International Conference on the Peaceful Use of Atomic Energy just as the Letter to the Editor "New Elements Einsteinium and Fermium, Atomic Numbers 99 and 100" was appearing in the August 1, 1955 issue of The Physical Review. Today, following some further reminiscences by Sherman M. Fried, Paul R. Fields, Albert Ghiorso, Gary Higgins, Roderick W. Spence, and we had originally planned to have Charlie Browne with us but I have just learned that he has a case of the flu and isn't going to be able to make it, we will hear much about the research that has been performed on einsteinium and fermium during their lifetimes of a quarter of a century. We will hear about the elements' nuclear, fission, spectroscopic and chemical properties, and their production in large quantities.

Introduction of Sherman M. Fried

Dr. Seaborg

Now I turn to the introduction of the first reminiscer. These introductions are all going to be very short. Dr. Sherman Fried, who was a member of the discovery team at the Argonne National Laboratory in 1952-53, is here to reminisce with us today. He received his B.S. degree in 1938, and his Ph.D. in chemistry in 1942 from the University of Chicago. He did war work at Northwestern University from 1942 to 1943. On October 16, 1943, exactly that date, he joined my Chemistry section at the Metallurgical Laboratory, where he

immediately became involved in his first project - the production of plutonium metal and the measurement of its density, leading to some very exciting results, that I'm sure Sherman recalls. He continued his work at the Argonne National Laboratory. He came to work at Berkeley Radiation Laboratory for a while, from 1959 to 1966, and after that he returned to Argonne where he has been ever since. Sherm is a pioneer in the preparation of compounds of neptunium, americium, protactinium, and actinium, as well as plutonium.

Reminiscences

Sherman M. Fried

Glenn was right when he said that the discovery of these elements was accidental. I have always felt that we fell with our nose in the butter. We had no idea, naturally, when we started this work. We were interested in large samples of ^{237}U , which we understood would occur in the bomb debris from the device, so we arranged with Los Alamos to make a mass spectrometric examination of the heavy element fraction in return for an early sample of it. True to their word, one fine first Tuesday in November 1952 a plane arrived at Glenview Naval Air Station, and that evening Mrs. Pyle and I drove out and got this small cask of material. We listened to the Democratic debacle on the way back; Stevenson was running against Eisenhower at that time, and we listened to the elections. Anyway, we got the sample and right away worked it up to obtain ^{237}U . It was an extremely odd sample. We set aside a sample for the mass spectrometric examination to see how much ^{235}U and all the rest was in there, and also how much ^{237}U . A smaller sample was obtained for fission counting. In those days we thought, in a very naive way, that ^{237}U might have a very large neutron cross section, a fission cross section, and we were going to examine this. That was our main interest. But just for the heck of it, we began to examine the plutonium fraction, and in the first shot out of the box we found 20 or 25% of plutonium-240 and 2% of plutonium-241. These were incredible, incredible concentrations. That afternoon Tony Turkevich called up and said, "Say, look at these things you've got. You better look for plutonium-244."

And, sure enough, we looked at the mass spectrometric result, and there it was. The question then came up, what is the radiation of plutonium-244? That is easy to determine. We purified the plutonium and looked, and sure enough, there was beta activity in the plutonium fraction. That beta activity gave rise to and added to another beta activity which was in the americium fraction. And it had a 25-minute half-life, which pegged it immediately as ^{244}Am , as everybody knew. This meant that the plutonium-244 was a beta emitter, and we were feeling pretty good about that. But Marty Studier said, "Well, if you're so smart and if it's really a beta emitter, where's the curium-244?" (which would result from the decay of the americium). When we looked, it wasn't there. We were feeling pretty sorry for ourselves, let me tell you. I was pretty sure that we did know how to purify plutonium from fission products. But one thing and another, we finally worked out that it was plutonium and that, indeed, it had to be plutonium-246, which we verified. Once having shown it was plutonium-246, it began to dawn on us that, my God, uranium has captured eight neutrons and we still, three weeks later, have enough stuff to see plutonium-246 easily. The way was open. We knew we needed to work our way up the ladder. Unfortunately, ion exchange columns were relatively crude in those days. Today it would be a simple thing to do, knowing the objective. In those days the results were pretty ambiguous. However, we started something that we are celebrating today.

Introduction of Paul R. Fields

Dr. Seaborg

The next speaker is Paul Fields. Paul is the director of the Chemistry Division at the Argonne National Laboratory, which was the successor to the Metallurgical Laboratory. He obtained his B.S. degree from the University of Chicago in 1941, and worked for TVA in Alabama before he joined us at the Met Lab. Paul worked in my section at the Metallurgical Laboratory, and the reason I know all these dates is, as some of you may know, I've been doing some research in writing the history of those exciting days of Chemistry Section C-1 at the Metallurgical Laboratory. On this basis I know that Paul began to work there on September 10, 1943. He worked first on the adsorption method of separating and isolating plutonium, and after that he worked in what we called the recovery group. In

the summer of 1945, or a little earlier, he was transferred along with a number of others to the Mound Laboratory of the Monsanto Company in Dayton, Ohio to work on plutonium. He later worked for about a year with the Standard Oil Company, and then returned home to the Argonne National Laboratory where he has been ever since. In 1970 he received the American Chemical Society Award for Nuclear Applications in Chemistry. He has a very distinguished research record doing work on the nuclear and chemical properties of the actinide elements, on nuclear structure and nuclear reactions in general. In particular, he has worked on the nuclear properties of the heaviest trans-uranium elements.

Reminiscences

Paul R. Fields

Actually, I think the idea of having this symposium commemorating the 25th anniversary of the discovery of elements 99 and 100 probably arose during the one we had previously, the 25th anniversary for berkelium and californium. I suggested, perhaps, that there was another anniversary coming up soon and Glenn, of course, took the initiative and arranged this meeting, so here we are. Generally these are rather pleasant reminiscing sessions, and it's nice to see all our old colleagues from the good old days, and I'm happy to see another reunion.

This meeting certainly takes us back to some very pleasant memories, and some really fantastic years. Those were years of really hard work and rewarding research. If I remember, Sherm and I and Arnie Friedman and others must have put in 16 hours a day, seven days a week for about two years. In a way we're glad because everything worked out fine, but we really didn't get any rest, because then the napkin ring program started and we just kept on going.

As you heard from Sherman, most of the real introduction to the work on einsteinium and fermium really came from him and Gray Pyle and others who were working on the thermonuclear debris from the Mike device for diagnostic purposes. This really led us to a whole storehouse of information for heavy element chemists. When they found ^{246}Pu and ^{246}Am , we first realized what an enormous flux had been developed in the Mike explosion. For this reason we began a concentrated effort to look not only for the heavier elements, but also to try to outline the mass yield curves so that we could see what nuclides had been built up during the explosion.

We had two fortunate circumstances working in our favor. One, of course, was the sensitive mass spectrometers that Mark Ingram and his group had built which really helped us outline the mass yield curve, particularly in the plutonium through curium region. Of course, in those days many of the isotopes of these elements just weren't known, so all we could do was guess at the nuclear and chemical properties. Glenn Seaborg's group had done pretty well in projecting nuclear properties but there still were uncertainties. So we couldn't use radiochemical techniques, and the mass spectrometer work really helped us outline the mass yields. The other fortunate circumstance was the fact that the Berkeley group had previously worked out the ion-exchange technique, I guess primarily by Stan Thompson, Ken Street, and Dick Diamond. This played a key role in being able to separate the actinides from fission products, minor impurities, and separating the actinides from each other. The techniques were well suited for the small amounts of radioactivity that we had in those days. We had about a fission per minute on that first filter paper that Fried mentioned. At that time it was considered to be a very small amount of activity, but compared to how new elements are found now, one atom at a time, you could say we really had a potful of activity in those days.

Just prior to the detonation of the Mike device on November 1, 1952, we had already initiated a program to try to make the very heavy elements by irradiating plutonium samples in the Materials Testing Reactor. That was the first high flux reactor built in Arco, Idaho, and this was a joint program between Berkeley and Argonne and the Arco people. The MTR was run by Phillips Petroleum Company. There were about 50 samples in the

reactor at that time, but they had just been irradiated for rather a short time, and we weren't going to pull a sample for perhaps another year. But the main effect for us, of course, was that we were geared up to work up those samples. When the Mike device went off, therefore, we were all prepared. When Fried and Pyle (and also Henry Selig, I believe) showed that ^{246}Pu and ^{246}Am were present, the rest of the heavy element chemists got excited, and Marty Studier, Herb Diamond and I joined Fried and Pyle in working up the samples.

The best sample was, of course, a filter paper that one of the planes had collected flying through the cloud. When we dissolved that sample there was about a fission per minute. We knew we had a fairly good source, but we felt an obligation to collect the data for the weapons diagnostic tests, so we split up into two groups, as I remember, one looking at the uranium, plutonium and neptunium, and the rest of us looking for the heavier elements. We used standard techniques: lanthanum fluoride, to get rid of the inorganic impurities, then the Dowex 50-HCl column, and finally citrate columns to separate the actinides from each other. We were able to separate the 6.6-MeV alpha activity from spontaneous fission, and were able to show that element 99 was responsible for this activity. We identified all the various isotopes and the different fractions. We noticed the 6.6-MeV alpha activity growing back, as I recall, into the 98 fraction. It's pretty vague now, 25 years later, and I think at Argonne the notebooks are probably still classified. This is all pure memory, but I remember we had some difficulty unfolding the situation of the growth and decay of the 6.6-MeV alpha activity where it was growing and where it was decaying, but finally that got straightened out. The Berkeley group, of course, were experts in running citrate columns, but the citrate column we ran in December of 1952 was the first one we had ever tried. We must have had beginner's luck, it worked very fine for us. Those of you who remember citrate columns know that they were extremely sensitive functions of pH, citric acid being a tribasic acid. If you didn't do your chemistry right, if you didn't have the rare earths in there to predict where things would fall, the heavy elements could show up almost anywhere.

I recall the mad scramble to try to get bigger samples. We wanted to get a better delineation of the nuclear properties of these elements. There was little enough as it was, and we wanted to follow some of the half-lives better. We got something like 500 pounds of coral that condensed and fell on one of the neighboring islands, where it had been bulldozed up and shipped back to us. Rather than work up the whole 500 pounds, Peppard and Mason worked up about 50 pounds on a trial basis. They used solvent extraction. There was plenty of calcium in the coral, so that was the salting-out agent. They gave Sherm, Marty, and me the actinide fraction, which we separated further. We must have spent nearly a year working day and night trying to get quantities of elements 98, 99, and 100. Whenever we were supposed to get bigger samples, it took so long to work them up that the decay of the 99 and 100 overbalanced the greater amounts originally there. Therefore we were working furiously and losing ground all the time;

we never did get a sample as good as that first filter paper, which probably took us about 30 minutes to dissolve.

But we were really under intense pressure to find out all we could about the nuclides we had discovered there. We found two isotopes of einsteinium. We found ^{253}Es , which we recognized first, and later the ^{255}Es by inference because the 7.1-MeV fermium was found and was supported by an einsteinium parent. Of fermium, I guess, there was just the one isotope, ^{255}Fm . Several years later, when we worked up samples from the Materials Testing Program, the first isotope of fermium we found was ^{254}Fm , but there are different build-up paths. I guess some of the later speakers are going to talk about the difference of building up isotopes in reactors versus bomb debris.

It's interesting how the whole series of events took place that led us to do this work. Sherm mentioned some of them. As he said, we really had no idea we were going to begin working for new elements. Sherm and Gray Pyle started the work, and I guess it was Tony Turkavich who alerted us to the fact that there must have been a pretty good neutron flux because there were large amounts of some of the neutron-rich plutonium isotopes. If Studier hadn't bugged Sherman about the whereabouts of the ^{244}Cm from the ^{244}Pu decay, maybe we wouldn't have proceeded beyond that. Then we began to make predictions on what ^{246}Am and ^{246}Cm might be like and our best guess approximated what Sherman was looking at. Actually getting ready for the Materials Testing Program made us aware of how sensitive the build-up of heavy elements was to neutron flux. It's easy to see that if you're depending on the 15th-order capture product, it's going to go to the 15th power of the flux, but that has to sink into your consciousness for a while before you really realize it. And so, it was like pieces of a jigsaw puzzle falling into place, and you just have to have the perseverance not to give up.

Glenn mentioned some of the names that were proposed. I know Argonne suggested the name Phoenicium for element 99. This suggestion came from remembering the Egyptian myth about the bird, Phoenix, that lived out in the Arabian desert for about 500 years, and then consumed itself in flames and was reborn from the ashes. We figured uranium went up in smoke and new elements came out of the debris, so maybe it wasn't a bad analogy. I guess centurium occurred to a lot of people for element 100, but the first indication I had that centurium might not be such a good idea was when Glenn called me to say that someone had just translated a Red Chinese analytical text that was using centurium and quoting a Russian source for the name. Hence we all decided it would be best to name the new elements after some eminent scientists, and the idea of honoring Fermi certainly seemed good. If I remember, Rod Spence came up with einsteinium for element 99, in honor of Einstein. The names were really very appropriate. These were two outstanding scientists who really started the whole atomic energy program.

That whole period, from 1952 to about 1956, really was an exciting time. All kinds of things

were taking place, the single particle and collective models were developing, new ideas were being proposed on fission, and new separations techniques were developing for the heavy elements. In addition, for the first time it was possible to

get reasonable quantities of these elements to do the chemistry we'd never been able to do before. Therefore, I'm just glad I had a chance to participate in this work in an exciting era.

Introduction of Albert Ghiorso

Dr. Seaborg

The next reminiscer is Albert Ghiorso. Albert graduated from the University of California at Berkeley with a B.S. in electrical engineering in 1937. During the following years he worked for a company, the Cyclotron Specialties Company, in Moraga that at that time supplied us with a good deal of our geiger counter equipment. It was in that connection that I first met Albert. Then after I had gone to the Metallurgical Laboratory in the spring of 1942, I received a letter from Al asking me if I would be willing to recommend him for some kind of a job in the Navy. (I don't know if you've heard me tell this story before, but I think it's so good it bears repeating.) My wife, Helen, who had worked at the laboratory here as Ernest Lawrence's secretary, was a very good friend of Al's wife, Wilma, who was working here

in the laboratory as Donald Cooksey's secretary. When the letter came Helen told me, "You hire this guy!" He worked for me during the four years or so that we were at the Metallurgical Laboratory and participated, as you know, in the discovery of americium and curium (elements 95 and 96). He then returned with a group of us to the Radiation Laboratory at Berkeley in the spring of 1946, where he has been ever since. Al was awarded an honorary Doctor of Science Degree from Gustavus Adolphus College in 1966, and he was a recipient of the ACS Award for Nuclear Applications in Chemistry in 1973. He is the co-discoverer of the transuranium elements with the atomic numbers 95 through 106. A very short statement of a very distinguished career.

Reminiscences

Albert Ghiorso

While listening to the speakers it occurred to me that there is one person who has not been mentioned yet -- Stan Thompson. Stan, as you will see from my remarks, played a central and vital role in the Berkeley work on the discoveries of elements 99 and 100 and it is too bad that we cannot hear his reminiscences also. For this meeting I have refreshed my memory by spending several days perusing Glenn's copious "Mike" file, an exhausting undertaking in itself, and my account is based partly on that file.

Twenty-five years is a very long time, however, and I wish now that I had kept a detailed diary of the events involved the discovery of elements 99 and 100. It was a very exciting period for me with many things happening in a few short weeks. I have been involved in searches for a lot of new elements, but none of the other hunts has had quite the drama of this one. Let me tell you something of the story of how we came to be involved in it.

On December 4, 1952, Glenn Seaborg received a teletype from James Beckerley, the Director of Office of Classification in Washington. It read:

Radiochemical data on recent Eniwetok test indicates presence of some unique heavy element isotopes such as ^{244}Pu . We do not want to release any information on the properties of these isotopes, even their existence, at this time even though information is declassifiable under guide. Accordingly, you are requested to withhold publication of any information on the existence and properties of isotopes present in debris samples and consider such information as secret, restricted data. This prohibition applies even when information is disassociated from test. Please inform those in laboratory who might have access to these data.

When Glenn showed the teletype to Stan Thompson and me, we were puzzled and began speculating as to what had happened and what we might do about it. Stan had been bombarding ^{239}Pu in the MTR for a long time, and periodically searches had been made with our mass spectrograph for ^{244}Pu , which we expected to be made by successive neutron captures. Now suddenly we were told that it had been produced

at one fell swoop in a nuclear explosion! Since we were not connected in any way with the bomb tests, we had no way of finding out what had happened, or when.

By the next morning, however, I had come up with a really wild idea and I got together with Stan and tried it out on him. First, I assumed that the curve of the yield at each mass number could be represented by a straight line on a semi-log plot, as shown in Fig 1. To get the slope of the line, I

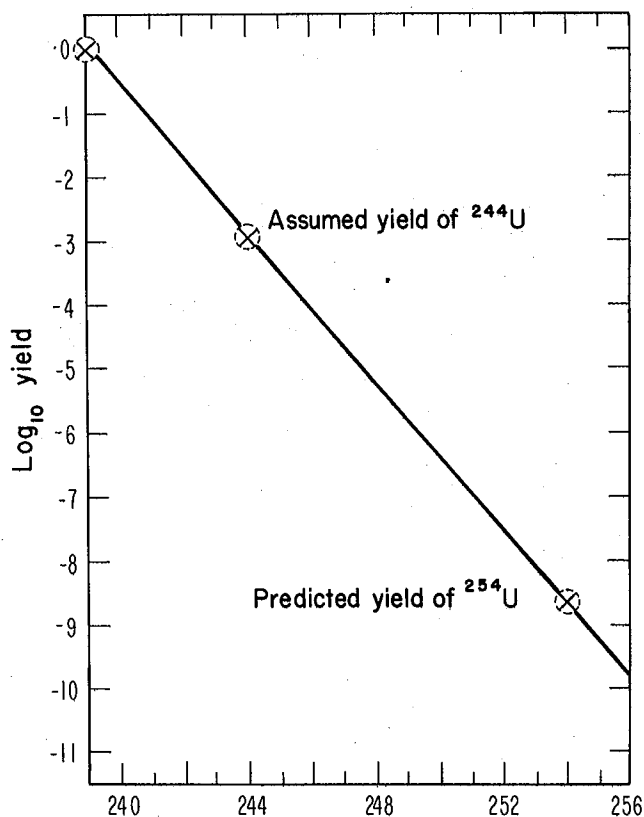

Fig. 1. Curve predicting yield for ^{254}U .

assumed that the starting material was ^{238}U and that the relative yield of ^{244}U (which of course would beta-decay to ^{244}Pu) was 10^{-3} . I felt that this number was the lowest yield that could be seen in the plutonium fraction with certainty on the mass spectographs of that time. Extrapolating this line to the mass ^{254}U (ten neutrons heavier), which I assumed would beta-decay all the way up to element 100, indicated a yield of roughly 10^{-8} or 10^{-9} . For some reason, which I don't recall now, I assumed that the bomb fraction of 10^{14} atoms was obtainable. This meant that we might get approximately a count per minute of alpha activity from ^{254}Fm if it had a half-life of about a month.

It didn't take much persuasion to convince Stan that the possibility was real, although pretty far fetched, and that we should do something about it. When we approached Glenn and Iz Perlman about the idea, they quite logically thought it was too fantastic to be taken seriously.

Stan and I were too brash to be deterred, however. The Livermore Laboratory was in the process of being set up at this time, with Ken Street heading up their Nuclear Chemistry Department. Ken had worked with us on the discovery of elements 97 and 98 just a couple of years before, and Stan had no difficulty in enlisting his cooperation. It turned out that they had received one of the filter papers that had been flown through the mushroom cloud from the Mike explosion, and they were willing to let us have half of it.

With the helpful advice of Bill Crane, who had also just transferred from Stan's group to Ken's, Stan and Gary Higgins separated out a transplutonium fraction a few days later when they received their half of the filter paper. Two days after their round-the-clock efforts had started, I was analyzing the samples from the citrate cation elution column with the same alpha grid chamber that we had used to find elements 97 and 98. To our great amazement, there was about a count per minute of a 6.6-MeV alpha particle activity, which we had never seen before, and it eluted just ahead of the Cf fraction. We concentrated all our efforts on this early fraction, of course, and found that spontaneous fissions were also being emitted by it. I remember going to some trouble to prove that they were fissions, since up to that time this mode of decay was extremely rare. We immediately jumped to the conclusion that we had found ^{254}Fm , since we expected that only an even

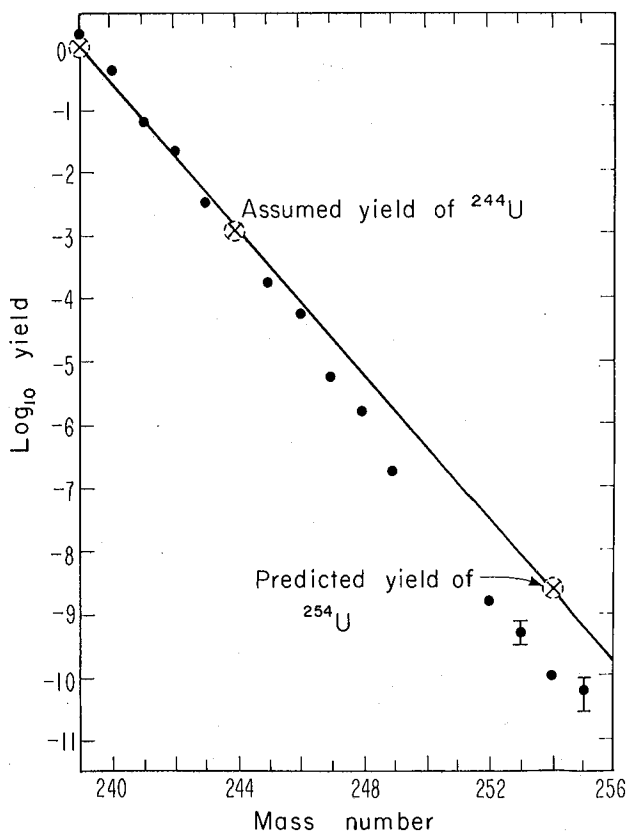

Fig. 2. Comparison of yield curve for ^{254}U (...) and predicted curve(—).

Z element would have an appreciable spontaneous-fission branching decay. We brushed aside, for the moment, the chemical evidence that the elution position for the so-called element 100 activity was too close to that of californium. What a wild scenario this was! Everything had turned out as hoped for -- or had it?

The next step was to procure more material, and this was done by using a filter paper which had gone to Tracerlab, a private company also engaged in weapons tests diagnostics. This time we made some 1.5-day ^{246}Cf at the 60" Cyclotron, and added this to solution so that we could be absolutely certain of the element assignments. Two more separations of the 6.6-MeV alpha activity were made, and on December 19-20, 1952 it was shown to be due to element 99, not 100, since it eluted like its homolog, holmium, rather than erbium. The spontaneous fissions were found to be coming from the californium fraction, (due mostly to ^{254}Cf , as it turned out later), the few in the 99 fraction of the first separation being due to small amounts of Cf breakthrough of the cation column. Accordingly, we changed our assignment of the activity to ^{253}Es . It was subsequently shown to have a half-life of about 20 days.

But where was element 100? In the next couple of weeks more filter material was obtained and we

examined the 99 and trans-99 fractions even more closely. After we had reported our earlier work to them, the Los Alamos group told us of possibly seeing a few 7.1-MeV alpha particles of unknown Z, as well as the 6.6-MeV activity. On January 15-16, 1953, the 7.1-MeV alphas showed up again, this time at Berkeley. The activity eluted just ahead of the ^{253}Es activity but decayed with a half-life of about a day. How could this activity still be around when the explosion had occurred two months previously? It was kept alive by a relatively long-lived ^{255}Es (40-day half-life) and we were able to show this by finding a 7.1-MeV activity also in the 99 fraction. This firm identification of element 100 was made only about a month after we had received our first filter paper.

How close was the original guess about the yield curve? The superimposed transparency (Fig. 2) shows a remarkable similarity. Fantastic is the only word for it, and this once again illustrates the famous Ghiorso uncertainty principle. This principle, as I have elucidated for many years, goes like this: If there are enough uncertain errors while making the first measurement of a particular property, then one is likely to arrive at the correct answer! Certainly all of these conditions were fulfilled in this case.

Introduction of Gary H. Higgins

Dr. Seaborg

Al might have mentioned that that first identification on January 15 and 16 was done with 200 atoms, I think that's what it calculates.

Gary Higgins is our next speaker. He has come back to Berkeley to recall with us some experiences of the discovery of elements 99 and 100. He received his A.B. degree in 1949 at Macalester College in Minnesota and his Ph.D. degree with me here at the University of California at Berkeley in 1952. He was employed by the California Research and De-

velopment Corporation in 1952 and joined the Lawrence Radiation Laboratory in Livermore in 1953. His early work centered in the area of radiochemistry and nuclear properties of americium and curium isotopes. More recently his work has included application of nuclear explosives to peaceful purposes and geochemistry of the earth's mantle and crust. Gary received the Engineering Man of the Year Award in 1964 and was awarded an honorary Doctor of Science degree from Macalester College in 1968.

Reminiscences

Gary H. Higgins

I think my memory is a little worse than most people's concerning this whole thing, although I do have several recollections I want to share with you. I'm glad Al mentioned Stan. The thing I recall most is the tremendous excitement that we shared and the discussions about the credibility of our prediction curves. I was too young then, just a

little over 25 years old, to not be quite an optimist. I was absolutely sure it was right; there was no good reason for my certainty, but it just made sense. Wouldn't it be fun if it were true? Stan used to say, "It isn't worth doing if it isn't fun." That was his favorite expression. I think we worked 30 hours straight on the first filter

paper when it came. It arrived in the afternoon, not late, about 4:00 p.m. We had put together a flow sheet for dissolving a filter paper. Of course, Rod could have told us how to do it, but we didn't have time to wait to find out so we figured that sulphuric acid and nitric acid would work fine to dissolve cellulose, and away we went with pots of black, fuming organic material. In fact, for that whole 30 hours I mainly remember waiting for things to boil to dryness. It seemed an endless procedure. Of course, the procedure that had been worked out at Los Alamos, which we found out about later, was a perchloric-nitric method. This goes much more rapidly than the sulphuric-nitrate, sometimes even too rapidly, as we found out after we got more material. We received the coral, I guess it was in January sometime, and dissolved it a piece at a time. That is, we used lab procedures rather than those you should use when you have 500 pounds of material to dissolve, and did the dissolving with some contrived equipment out in a little building behind Building 5. This building, which I guess isn't there anymore, we dubbed "the ore house" while we were working on the coral.

Coral is a very difficult material to deal with. This coral had a bit of organic material in it (there was some wood in it as well as different kinds of vegetation of various ages) and other material that didn't smell very good by the time we'd received it. Therefore, we decided that nothing would be better than pickling it, and used acetic acid and dilute hydrochloric to try to do the first part of the dissolution. Coral also has a lot of phosphate in it, enough so that when you get down to the bitter end there's a residue that always seems to have all of the activity in it. As I recall, one night we had concentrated the barrel of coral into a two-liter beaker and were fuming it down with perchloric acid (we'd learned about perchloric acid by then) and nitric to destroy all its organic residue. Of course, we didn't have enough air to see anything, and the beaker was just a mass of white fumes. We were not sure when it went dry, but we obviously had enough calcium perchlorate for it to blow up when it went dry. It was about nine in the morning by then. We looked at the whole thing with a great deal of chagrin. I remember we had both been sitting on stools holding cups of coffee waiting for it to go dry when it went off. It didn't break the beaker, but all the radioactivity, including the heavy elements, was now scattered on the walls of the hood and on a blotter paper that we'd put down on the floor of the hood. Stan looked at it and said, "Well, if it isn't fun it isn't worth doing." So we folded

all the paper, including the sticky tape that we'd used to peel the stuff off the wall of the hood, back into the beaker and started over. It wasn't until late afternoon that it was dissolved.

I think I will mention one more thing, namely, that I was rather lucky to have been involved in all this. I was a little surprised that it was so easy to discover a new element. Stan, Al, and Glenn, of course, had worked for years on 97 and 98, and I'd just then started to work on the americium curium problem in some detail, working with Ken Street. When I first got in as a graduate student, Ken told me, "Why don't you try running a citrate column at high temperature, and see if we can't get the kinetics better so the peaks would be sharper?" Before that, cold columns used to take 12 to 20 hours to run because you had to flow them so slowly. By the time the heavy elements eluted, anything with a short half-life was gone. So, being brash and not knowing any better, I did a bunch of distribution-coefficient experiments at high temperature (87°, which is where trichloroethylene boils). I made a constant boiling bath with trichloroethylene, being too brash to realize that it's pretty hazardous. Anyway, it worked, so we built jacketed columns. I think it was Bill Crane who suggested using trichloroethylene condensation to maintain a constant temperature, and that was very useful in doing my thesis work. In the meanwhile, though, I had gotten a calibrated system, that is, a given kind of resin, because no two batches quite performed the same in those days. When we eluted rare earths they eluted not only in the same inverse order, but the irregularities in the elution pattern were reproduced between 95, 96, 97, and 98, so that perhaps we could predict where 99 and 100 would occur by just putting in a proportionality constant. I think Glenn probably has a copy of the prediction curve that we had for this particular column. I know I had it in my notes, and I think I sent it in last year. It's around someplace anyway. That's the only thing that remains of that period because (and I think everyone has already mentioned this) we were all very excited, and we didn't stop to write things down in detail in our notebooks. We had slips of paper, I remember. As the column eluted we had a heat lamp fixed so that when it turned to the next position the little planchets that the drops fell on would dry, and Al would be standing with his forceps waiting to run for the counter. It literally was that kind of thing, day in and day out. A tremendous excitement, I think, is what I share most in my memory. Thank you very much.

Introduction of Roderick W. Spence

Dr. Seaborg

This all took place in Building 5, which is still standing on the hill. However I must say I don't remember being as skeptical as Al says I was, but he's probably right. I'm glad that both Al and Gary mentioned Stan Thompson. I guess you all know he was my lifelong friend. We met when we were thirteen years old, freshmen in high school, and he was just like a brother to me. He had the most amazing chemical intuition of any chemist I've ever known. Over and beyond understanding he just seemed to know what to do next. You all know his contribution at the Metallurgical Laboratory where he conceived the phosphate process that went into operation so successfully for the isolation of plutonium at Hanford, a process that wasn't supposed to work. It just worked.

The next speaker is Roderick Spence who was a member of the Los Alamos discovery team in this period, 1952 to 1953. He was born in Scotland and earned his A.B. degree at Huron College in 1933 and his Ph.D. degree at the University of Illinois in 1939. During the years 1939 through 1942 he was an associate chemist in the College of Pharmacy at the University of Illinois. We were colleagues at the Metallurgical Laboratory in 1942 and 1943. As Rod will recall, I'm sure, we both lived on Woodlawn Avenue, south of the Midway on the same side of the street. We used to walk across that windy alley of the Midway together to get to the Met Lab, which was on the University of Chicago campus. Rod began working at the Los Alamos Scientific Laboratory in 1944 and has been there ever since.

Reminiscences

Roderick W. Spence

I can't help thinking that in a couple of ways the discovery of elements 99 and 100 had a political background, although one doesn't normally think about that. You may know, however, that the very existence of the Mike device was preceded by a long political discussion about whether or not the work should ever take place. If I'm not mistaken (there are people from Argonne who may be able to correct me), the reason we sent samples to them so quickly to do a mass spectrometer analysis (which we couldn't do) was that there was a rumor that somebody at Argonne had lost 30 ml of uranium-235, or something like that. I believe that Charlie Stevens was brought in to further Mark Inghram's work, and he set up a very fine mass spectrometer lab. I think that was the way it came about; we sent samples directly to Argonne so they could get them very quickly.

I wonder if I could take you back a little bit to the device that produced these heavy elements. My first slide (Fig. 1) shows the same things that are on the wall, but I thought maybe if I told you a little bit about it, it would help when you took a look at them. Imagine that you are standing on the Island of Elugelab in the Eniwetok Atoll. You would be standing just a little bit away from the bomb tower itself, looking down a long instrumentation tunnel to a little dot in the distance, which is just an instrumentation bunker. (You will see later that the place where you would be standing no longer exists.) The next slide (Fig. 2) shows the tower. If you just turned around on your heels from the last slide and looked the other way, this is what you would see. That's not snow, it's sand. You see that long cylindrical device standing on end? That is the Mike device. I'd never seen this

picture before a few days ago. I'm sure it was declassified especially for this meeting. There's nothing much you can see. You will observe an awful lot of auxiliary equipment. It took a lot of such junk, and other associated cryogenic equipment, to get this device in operating order.

A little closer view is seen in the next slide (Fig. 3). This again is the device which generated elements 99 and 100. It is a big long thing, again with a lot of associated junk. You may remember, this was in November 1952. We had spent the previous year out in the Pacific on Greenhouse. Two of those shots were also experimental thermonuclear tests, but they were not really H-bombs. This was an honest-to-God H-bomb. This is the picture (Fig. 4) taken some miles away from the Mike explosion. (I'm sorry, I can't tell you how many minutes after the explosion it was taken.) One gets various estimates of magnitude of both the stem and the cloud. At a later time this cloud was supposed to be 300 miles in diameter and the stem about 30, but that obviously was later. The next picture (Fig. 5) was probably taken from the photographic airplane I was in. We weren't supposed to get any closer than 300 miles, but I think we fudged and got about 75 miles away.

I want to show you once more the chain of islands before the explosion. This slide (Fig. 6) was shot facing the house where the gadget is located. I think this is probably Engebi, the island I was on. The islands all have names, but I can't remember them all. They also had other names, more familiar to people in New Mexico, one of the islands was called San Ildefonso for example. Notice, just for reference, that little



Fig. 1. Looking away from the Mike Device. Engebi Island, Eniwetok Atoll.

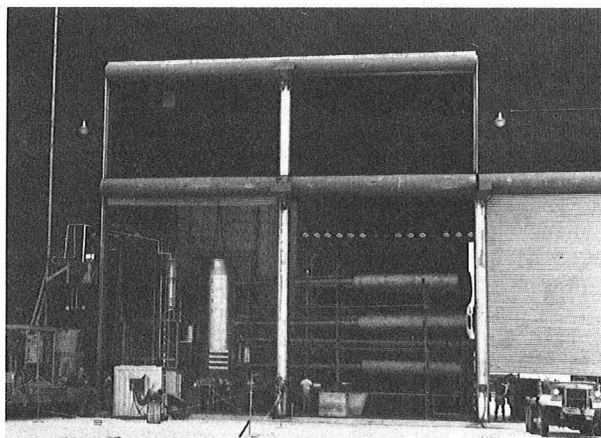

Fig. 2. The Ivy Mike Device on Elugelab.

spit going out there, and the shape of that island there. Just beyond that is Elugelab. In this next slide (Fig. 7), taken after the explosion, there's that little spit again. This is the island, but you see Elugelab is gone. There's a sand reef there.

You have heard a lot about later coral samples, they were done at the instigation of Glenn. Glenn called me up and said, "Wouldn't it be possible to find some more debris in the coral sand that's piled up in the crater?" I said, "I should think so," so I called up Harry Allen, our supply and

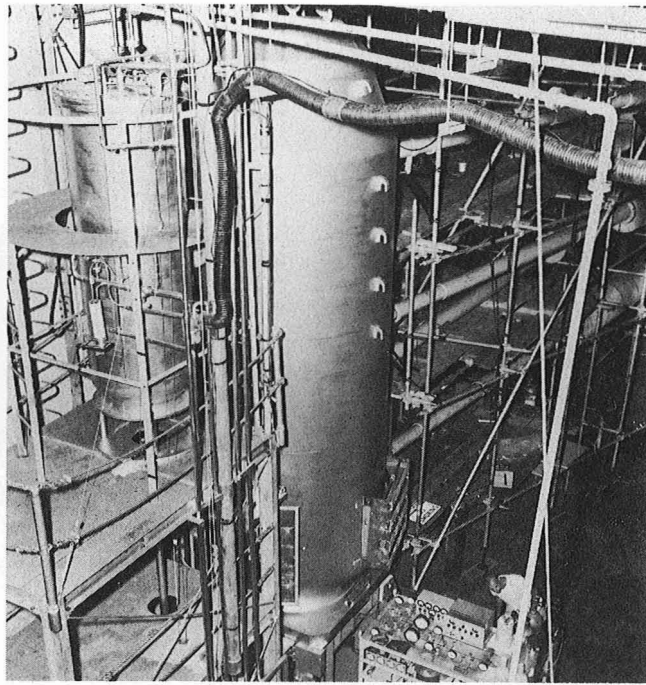

Fig. 3. Close up view of the Mike Device.

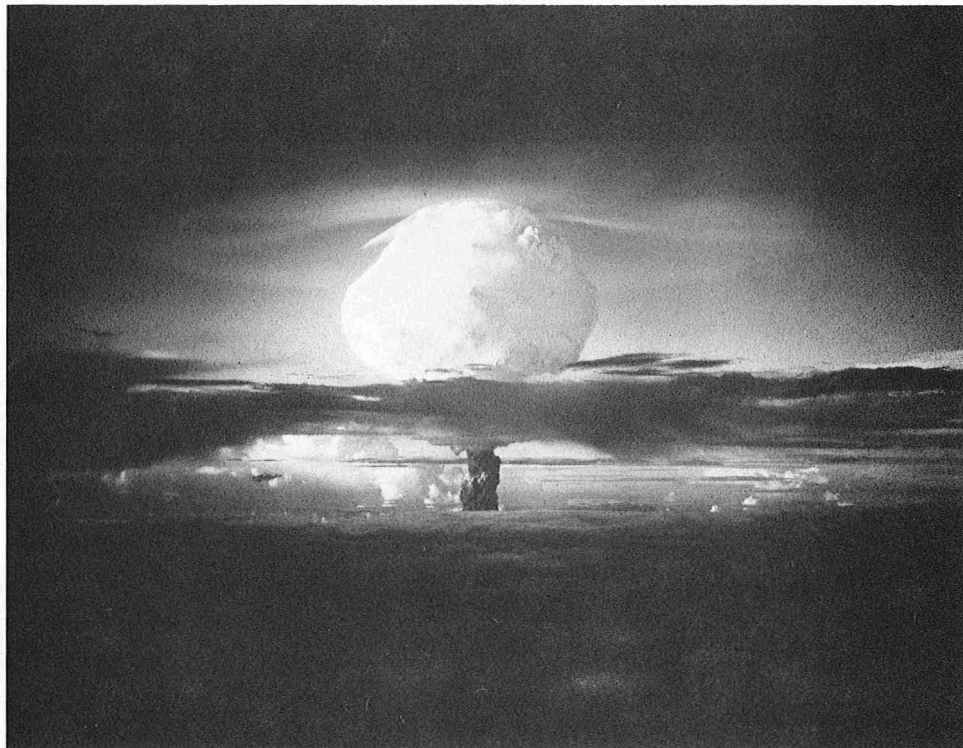

Fig. 4. A view of the Mike explosion.

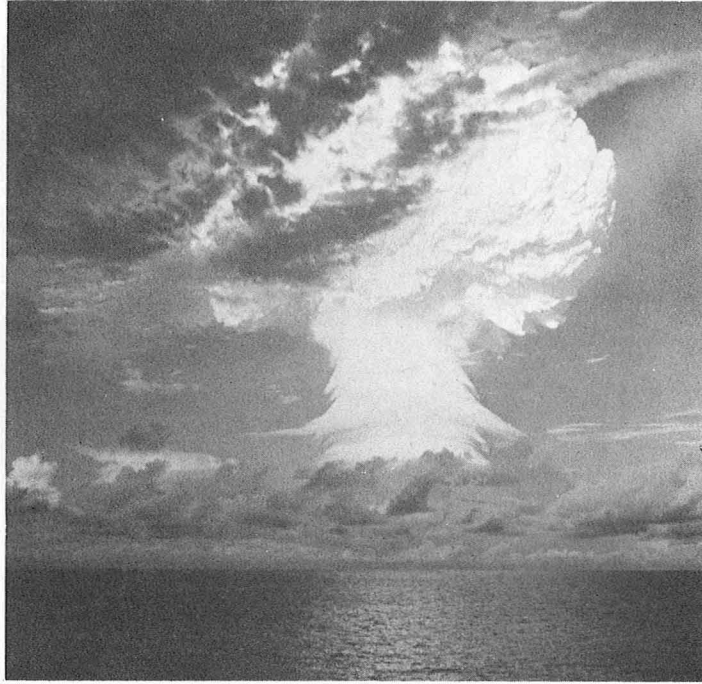

Fig. 5. A view of the Mike explosion.



Fig. 6. Before the Mike explosion. Elugelab and the Mike Device, top center.



Fig. 7. After the Mike explosion. Elugelab has gone.

property man, who arranged matters with the joint task force out there. They really put out a big effort and got 800 pounds of coral, recovered almost exclusively from the area close by. I can't tell you now, I used to remember, how many hundreds of thousands of tons, or millions of tons, I guess, of coral went into the air, but it was a very large amount.

I lived on Kwajelein, and I did want to say a little bit about the sampling operation. You've heard a lot about the samples that we got. Our primary way of getting samples in those days was to send manned aircraft through the cloud. We didn't have the foggiest idea of what the magnitude of the explosion would be. Usually we based our planes on the island of Eniwetok itself, which had a short runway. We used F86's, as I remember, and it was decided to base them on Kwajelein so they'd be safe in case of a tidal wave. People were a little bit worried about tidal waves. Unfortunately, the range of these fighter planes is not very large. They were equipped with the usual sample-collection devices. So a very elaborate system, under the direction of Hal Plank (who was in charge of the sample collection for Los Alamos) and the Air Force, was set up in which the fighter planes took off from Kwajelein, rendezvoused with tanker refueling planes over the island, and then went on to collect their samples. In theory it sounded pretty good, but in practice it turned out to be horrendous. For whatever reason, the fighter planes had a terrible time rendezvousing with the tankers. We were lucky, in retrospect, to collect

as many samples as we did. Most of the samples that you are seeing did come from the penetrations of the aircraft, but there was some cost. In fact, this was the only operation in all the aircraft sampling of all the shots we ever did that cost the life of a pilot. These samples cost the life of First Lieutenant Jimmy Robinson, who waited too long before he went home, tried to land on Eniwetok, and ditched about a mile short of the runway.

Good samples were collected, fortunately. Gary mentioned dissolving the samples. We had our problems, too, when we got our paper home. We started dissolving the samples with our usual technique and they caught on fire. I don't know whether it was the fact that there was a lot of calcium oxide or calcium hydroxide produced from the calcium carbonate, or organic matter reacting with acid, but they gave us fits. I still remember we had a terrible time dissolving those samples, before we sent them on to other people. The only other thing I can remember about was an incident with George Cowan. George was not staying at Kwajelein like we were, he was staying on board a carrier. His wife, Helen, who some of you remember from the Met Lab days, Helen Dunham, had given him instructions to get some vermicelli spaghetti. He knew that he didn't have time on the way back because he was taking a sample directly back from Eniwetok to home, so he purchased the vermicelli earlier and he carried it around with him. Apparently he and Herb Greir were in the same plane in the catapult takeoff from the carrier. During the take-off the vermicelli stuck out right

under Herb Greir's chin. George got it home, all right, intact.

Our primary job, of course, was to determine the yield and efficiency of the gadget as well as we could. Naturally, as a team we measured plutonium. Ed Moore, who was the analyst for plutonium, reported that he was having a pretty hard time decontaminating the fission products. He had never had that problem before, but he tried all kinds of things, particularly with the help of Charles Browne (who unfortunately can't be here--he probably remembers much more than I do) and Helen Louise Smith. It was decided that there was something going on, all right, and we started investigating on our own when we could (we were busy with other things) to discover what in the world we had run in to. And I think we concluded independently that it must be plutonium-246, although we were in touch with the Argonne people. We had done very little research on the heavy elements, although we did separate transplutonic fractions. We didn't have an alpha pulse analyzer of our own, but Bob Penneman did in another section of the lab. We took samples there and one day we did run across the 7.1-Mev alpha activity; I think we promptly communicated that fact to both the other laboratories. We were not in any position to identify the Z because we couldn't do it with the fine resolution necessary in those days.

I might just say that the coral gave us trouble for months, and I'll tell you why. We were supposed to get the fission yield of this gadget, and we kept getting the wrong answer. We would strive and strive. Our normal way of getting the fraction of the total bomb debris was to analyze for uranium. We knew that there was uranium in coral, everybody knew that. We'd gotten samples of the coral from the various islands in the Eniwetok Atoll, as a matter of fact, not just Elugelab, and found a pretty good value for uranium content in coral. We were pretty dumb. It never occurred to us that the uranium content of coral might vary

with the depth, but in fact it varies a lot with the depth, so much so that we were off by just about a factor of 2. The only reason we really rectified our mistake was that somebody, for a reason that I don't remember, had taken corings of the islands. Therefore, we became aware of the depth factor, got a hold of some coral, ran uranium analyses on it to check and, sure enough, that was the answer. It took some months before that fact became apparent.

Finally, I would like to comment on the naming of the elements. I don't believe that I was the one to say anything about the name einsteinium. I think I heard it from other people. My only real recollection is that Glenn proposed variations on alamosium. The one who turned that down flat was Norris Bradbury, the Director of the Laboratory. I can still remember that. He just said no, he didn't want it to have that kind of a name. That was the real reason, I'm sure, that it was dropped besides the difficulty of pronouncing it. But Glenn always said "Don't worry about that, you'll get used to it." I did make a phone call about the time when things were still kind of crazy. I called up Glenn and said, "Look, why don't we all compromise on the names." Los Alamos was not involved. By that time I think Al's idea of naming elements after people had taken hold, but there was still some talk. I said, "Why don't you name 99 after Einstein and 100 after Fermi, and that would make everybody happy?" I said this because, Glenn, I knew you didn't like centurium. And you said "That sounds like a good idea." My guess is that you thought of it earlier. Anyway, you said, "I want to check with Al and Stan and the other people." You called back and said yes. Then I called Winston Manning and he seemed agreeable and said he'd have to check with all the other people. When he called back he said "Yeah, that sounds pretty good." I believe, but I could be wrong, that that is finally how they decided to name elements 99 and 100.

Introduction of John R. Huizenga Dr. Seaborg

The next speaker is John Huizenga who is the first of our guests today who will speak on the research which has been done on einsteinium and fermium. I'm sure he will include a little history. He received his A.B. degree at Calvin College in Grand Rapids, Michigan in 1944 and his Ph.D. degree at the University of Illinois in 1949. From 1944 to 1946 he was a member of the Manhattan Wartime Project in Oak Ridge. He worked at the Argonne National Laboratory from 1949 to 1967. In 1967 he joined the faculty at the University of Rochester as a professor of chemistry and physics, a position that he holds today. John was honored with the AEC's Ernest O. Lawrence Memorial Award in 1966. I had the honor of participating in awarding that to him. He received the American Chemical Society's Award for Nuclear Applications in Chemistry in 1975. He served as chairman of the Division of Nuclear Chem-

istry and Technology of the American Chemical Society in 1972, and as chairman of the NAS NRC Committee of Nuclear Science since 1974. He was elected to the National Academy of Sciences in 1976. John's publication list includes a book he co-authored with Bob Vandenbosch entitled Nuclear Fission which was published in 1973 as well as numerous scientific publications. These publications cover the fields of radiochemistry, nuclear fission, nuclear properties and systematics of heavy elements, nuclear level density, pressure dependence of electron capture decay constants, nuclear reaction mechanisms with light and heavy projectiles including strongly damped collision processes, and muon-induced reactions. John is speaking today on nuclear properties of einsteinium and fermium.

Nuclear Properties of Einsteinium and Fermium

John R. Huizenga

A quarter century has slipped away and the exciting experiments which culminated in the discovery of elements einsteinium and fermium are history. In the April 6, 1976 issue of Chemical and Engineering News (Vol. 54, No. 15, pp. 91-92), the discovery of einsteinium and fermium was listed among the great discoveries of the last 100 years. Some of you no doubt have seen this list in the two-page Crest toothpaste ad.

In many respects my research experience during the early fifties was similar to that enjoyed over the last four years doing very heavy-ion experiments. The availability of energetic heavy-ion beams opened up a new field of research which is rich in many different types of phenomena. Likewise, the availability of intense sources of neutrons in the early fifties triggered a new wave of interest and activity in transuranic research. Over a relatively short period, two new elements and a very large number of heavy nuclei were discovered and their properties characterized.

Many of these newly discovered nuclei have measurable spontaneous fission branching ratios and as a result much new information about the systematics of this process was obtained during the early fifties. The charged liquid-drop model of the nucleus predicts nuclear instability for the condition

$$E_C = 2 E_S \quad (1)$$

where E_C and E_S are the Coulomb and surface energies of a nucleus, respectively. The quantities E_C and E_S are given by

$$E_C = 3(Ze)^2/5R = k_C Z^2/A^{1/3} \quad (2)$$

$$E_S = 4\pi R^2\gamma = k_S A^{2/3} \quad (3)$$

where γ is the nuclear surface tension ($\approx 1 \text{ MeV fm}^{-2}$). The limiting value of the atomic number, Z_{LIMIT} , according to Eq. (1) is

$$Z_{\text{LIMIT}}^2 = 2(k_S/k_C) A_{\text{LIMIT}} \quad (4)$$

Under the additional assumption that $A_{\text{LIMIT}} \approx 2.5 Z_{\text{LIMIT}}$, the value of Z_{LIMIT} is

$$Z_{\text{LIMIT}} \approx 5 (k_S/k_C) \quad (5)$$

Hence, the upper bound to the periodic table is dependent upon the ratio of two fundamental coupling constants, the strong or nuclear coupling constant divided by the electromagnetic coupling constant. The ratio of (k_S/k_C) is known to be about 20. Therefore, the periodic table in our universe has approximately 100 elements rather than, for example, two or 10,000 elements.

We know now that this upper bound to the periodic table at element 100 can be increased slightly due to nuclear shells. Nuclear stability depends on a very delicate balance between the Coulombic and nuclear forces. Although the value of each of these quantities is of the order of hundreds of MeV, the fission barriers for heavy nuclei are only a few MeV, as illustrated in Fig. 1. Hence, a one or two MeV nuclear shell effect can play a significant role in nuclear stability, even though the Coulomb and surface energies are very large.

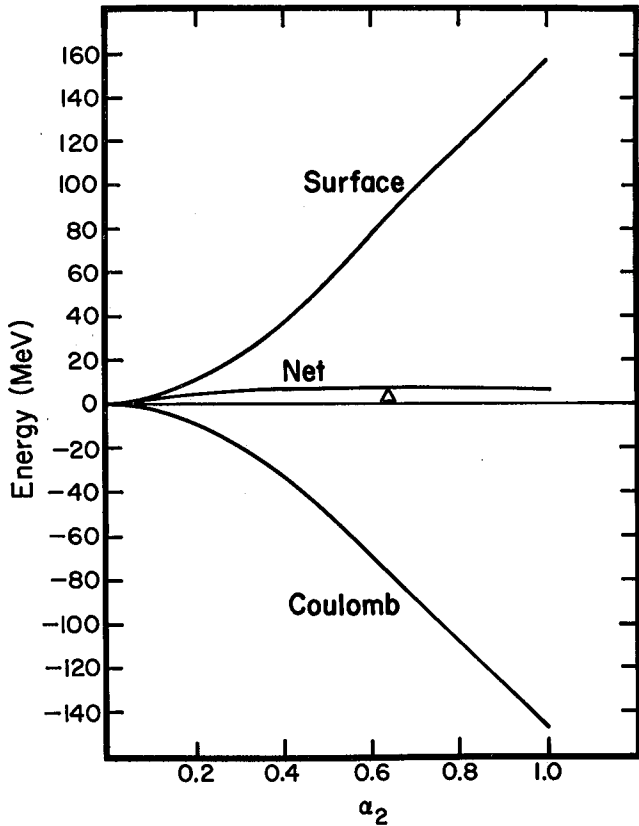

Fig. 1. Surface, Coulomb and net deformation energies (in MeV) shown as a function of α for a cut through the potential energy surface corresponding to $dE/d\alpha_n = 0$. All the coefficients higher than α_n are zero. The triangle indicates the position of the saddle point. The fissility parameter is $x = 0.76$ in this example, corresponding approximately to ^{252}Cf . From Ref. 1.

The November, 1952 thermonuclear device (Mike) produced an enormous neutron flux. In the resulting debris, two new elements 99 and 100, einsteinium and fermium, were discovered. In addition to these two elements, many new isotopes of plutonium, americium, curium, berkelium, and californium were found and their properties characterized. The concept of an enormous flux of neutrons for an extremely short period of time was new in terms of human achievement, although it was soon realized that a direct analogue existed in supernova explosions. The production of einsteinium and fermium required up to 17th order neutron capture on ^{238}U . These neutron reactions on uranium isotopes and their subsequent beta decay are illustrated in Fig. 2. One observes from the figure that the beta decay chain ends at the first beta-stable nuclide. Hence, the first isotopes of element 99 and 100 produced in such a device are $A = 253$ and 255 , respectively.

Early analyses of the "Mike" debris showed the presence of new isotopes of plutonium, ^{244}Pu and ^{246}Pu . These results provided evidence that uranium had been subjected to a very high instan-

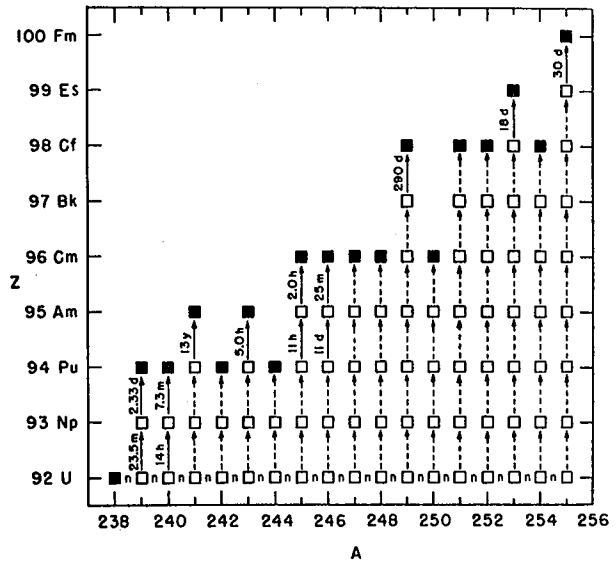
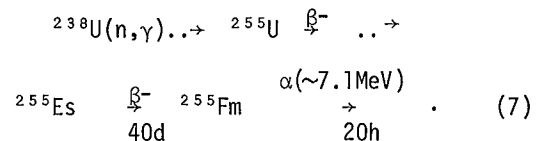
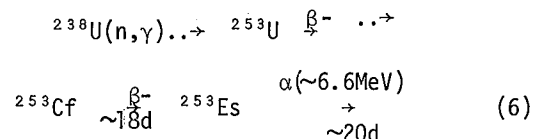

Fig. 2. Production of uranium isotopes in the November, 1952 "Mike" thermonuclear device, and their decay to beta stable nuclei. \square beta unstable nuclide. \blacksquare beta stable nuclide. From Ref. 2.

taneous neutron flux in the "Mike" device and served as a catalyst to search for isotopes of transcalifornium elements. The outcome of this search is history and the occasion of this meeting.

The discovery of einsteinium and fermium took place in an era when chemical confirmation was not only possible, but a requirement for confirmation of a new element. The use of cation-exchange resins for separation of lanthanide and actinide elements was already a well established technique. An example of an early elution curve for an actinide fraction from the "Mike" debris is shown in Fig. 3. This separation of activities was effected using the cation-exchange resin Dowex-50 and elution at 87°C with an ammonium citrate solution. Such experiments established the atomic number of the 6.6- and 7.1-MeV alpha-particle activities as due to elements 99 and 100 (See Ref. 3). As illustrated in Fig. 2, the production paths of these elements are as follows:



One of the striking properties of the californium fractions from the "Mike" debris was the decay curve for the spontaneous fission activity. This

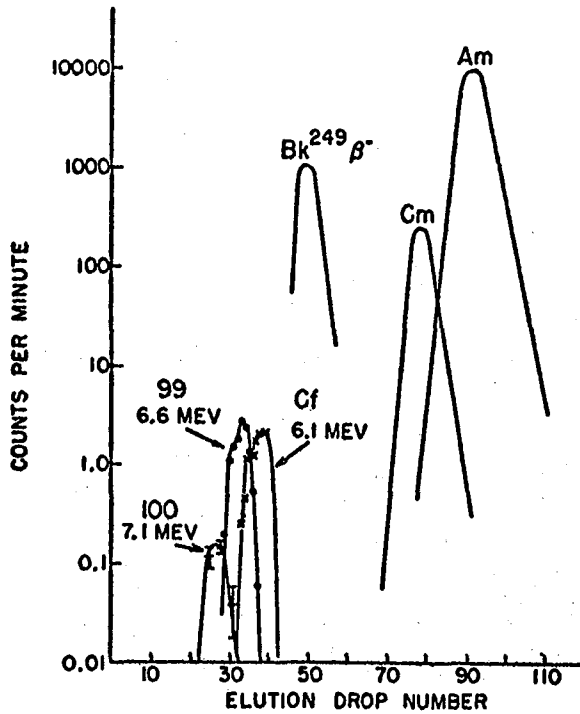

Fig. 3. Elution of elements einsteinium (99) and fermium (100) relative to other actinide elements with a citrate eluant. From Ref. 3.

~ 55 day activity was assigned to ²⁵⁴Cf and this discovery touched off a series of important astrophysical speculations (for example, it was suggested⁴ that the exponential decay of light curves of Type I supernovae is due to the spontaneous decay of ²⁵⁴Cf). The analogy between "Mike" and supernovae was convincingly made by the above authors with important implications to the advancement of astrophysics.

The relative yield curve² for the production of the heavy uranium isotopes is shown in Fig. 4. Several suggestions have been made in attempts to understand the relatively large yields of the heaviest isotopes. One of these postulates assumes the existence of zones and gradients of neutron concentration within the "Mike" device. One such fit⁵ to the data of Fig. 4 assumes that a central

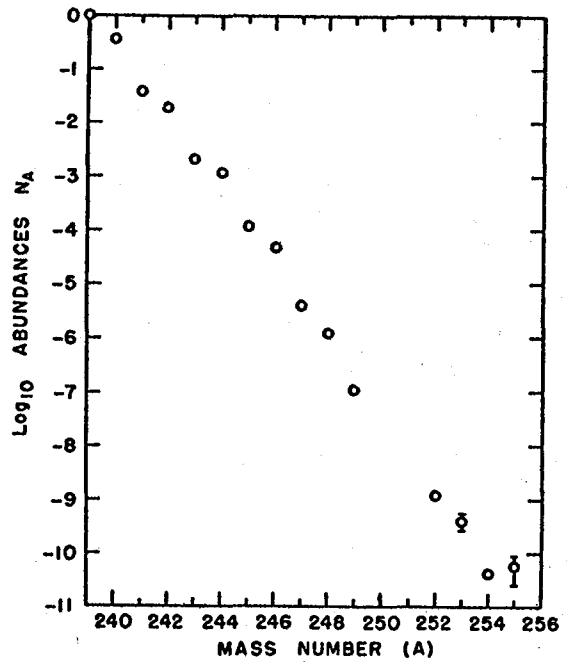

Fig. 4. The log₁₀ of the abundances (N_A) of the various nuclides with mass numbers at the time of detonation of "Mike". From Ref. 2.

zone (comprising 0.01% of the device) received an integrated flux of 4.81×10^{24} neutrons while the remainder of the device received 1.21×10^{24} neutrons in a time period of a few nanoseconds.

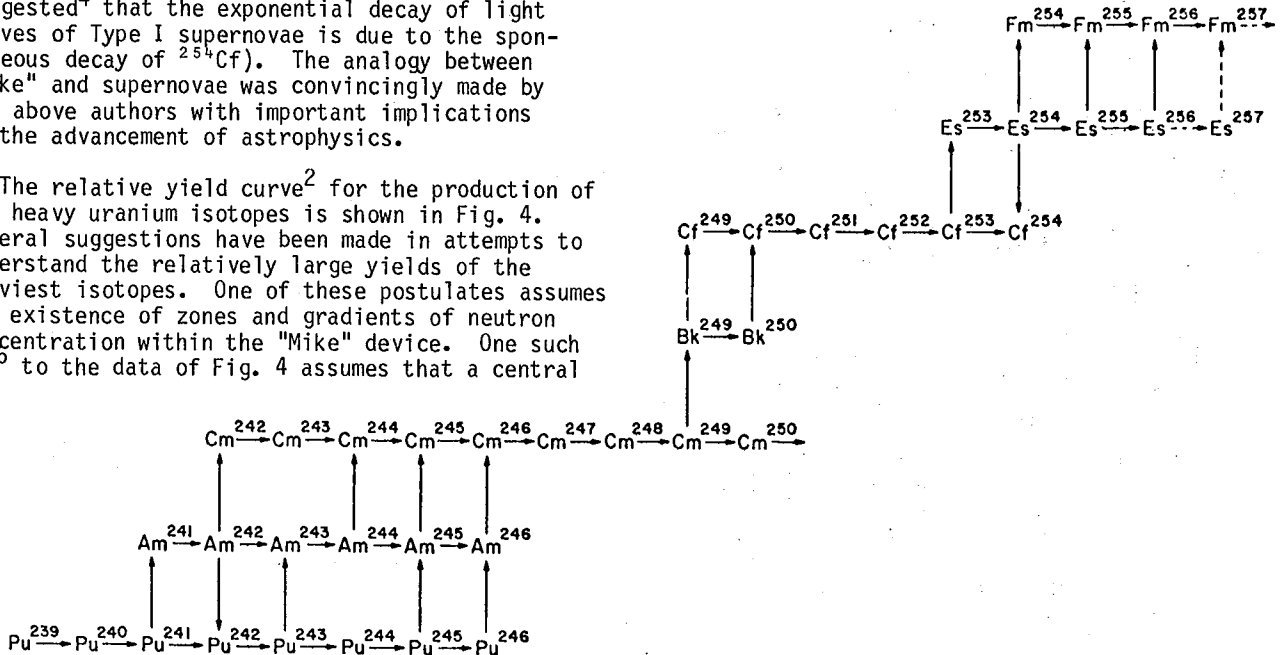

Fig. 5. The sequence of nuclides produced in a high-flux reactor neutron irradiation of a ²³⁹Pu target. The horizontal arrows represent neutron capture, vertical arrows up represent β⁻ decay, and vertical arrows down represent electron capture decay.

A short time after the Mike device, many heavy nuclides, including elements einsteinium and fermium, produced by intense neutron radiation of plutonium in the Material Testing Reactor (MTR), were isolated and studied.⁶⁻⁹ The path for production of heavy nuclides in a reactor, where the neutron flux is much more modest but continues for a long period of time (for these experiments, of the order of a year), is illustrated in Fig. 5. Now the path for production of heavy nuclides proceeds up the beta stability valley and the element number is increased at the first beta unstable isotope. Hence, the nuclide ^{253}Es is formed by beta decay of ^{253}Cf [in a reactor the

beta decay of ^{253}Cf is much more probable than neutron capture, $^{253}\text{Cf}(n,\gamma)$]. From similar arguments, the isotope of fermium with mass 254 was produced by the reactions



The results of a sequential four-day irradiation of an einsteinium fraction (with Cf impurity) produced the results shown in Figs. 6 to 8. The separation of elements 98, 99, and 100 with a Dowex-50 cation citrate column is shown in Fig. 6. The peak of the new 7.2-MeV alpha activity of element 100 eluted from the cation column on drop 61, while the peaks of elements 99 and 98 eluted on drops 69-70 and 78, respectively. The 7.2-MeV alpha-emitting isotope (^{254}Fm) of element 100 decayed with a 3.3 ± 0.2 hr half-life (see Fig. 7) measured both by total and spontaneous fission activity. In addition, the 7.2-MeV alpha activity was observed to grow into the purified element 99 fraction with a 37 ± 1 hr half-life (see Fig. 8). The spontaneous fission activity followed a similar growth-decay curve. Figure 6 shows the element 99 activity after element 100 had grown into equilibrium and accounts for the spontaneous fission activity.

Neutron buildup in stars (e.g. novae) by a process analogous to that in reactors is called

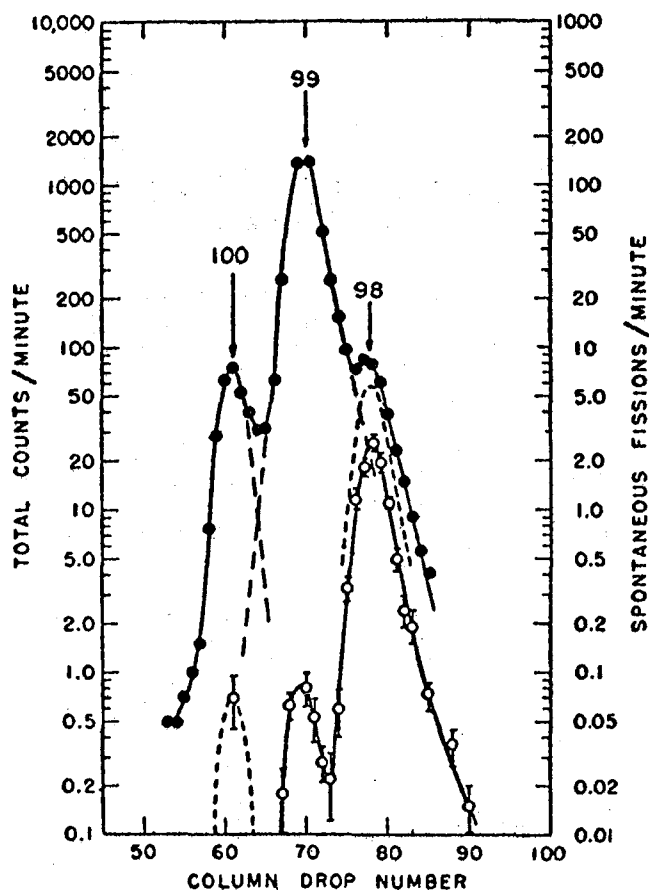

Fig. 6. The solid points represent the total counts/minute (alphas plus spontaneous fissions) from each drop at the time of removal from the cation column. The dashed curves outline the individual element separations as determined by alpha-pulse analysis and spontaneous fission measurements. The open circles represent the spontaneous fission activity as a function of drop number. The value at drop 61 is a result of a spontaneous fission activity measurement immediately after column elution. The other spontaneous fission measurements were made more than 12 hours after column elution, and therefore isotope $^{254}\text{100}$ was in approximate equilibrium with its element-99 parent causing the spontaneous fissions on the element-99 drops. From Ref. 9.

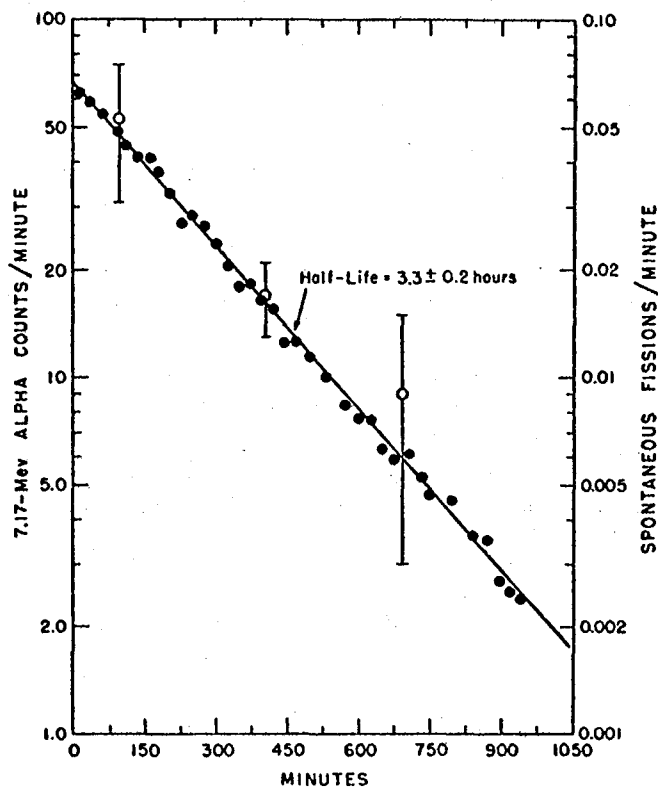

Fig. 7. Decay of the element-100 fraction. The solid points represent the 7.17-MeV alpha counts/minute of drop 60 as a function of the time in minutes. The open circles represent the spontaneous fission activity of drop 61 as a function of time. From Ref. 9.

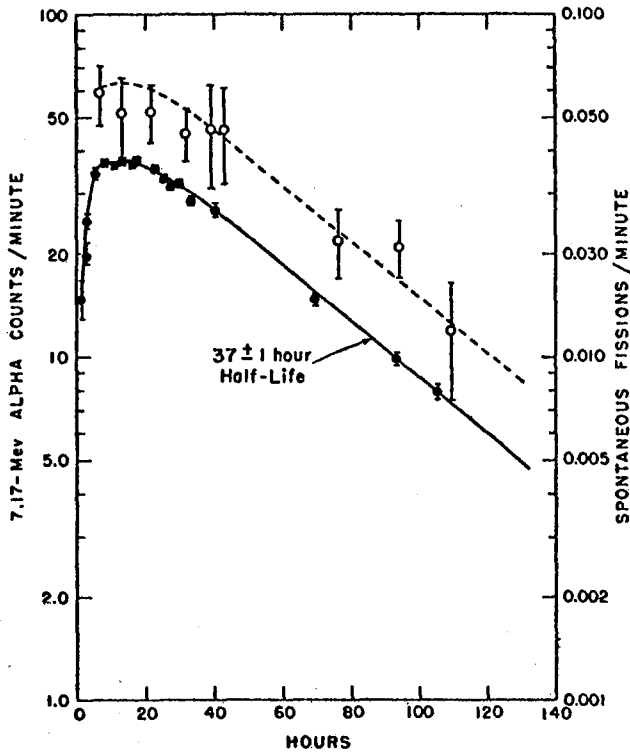

Fig. 8. Growth and decay of element-100 isotope in an initially separated element-99 fraction. The solid circles represent the 7.17-MeV alpha activity on drop 71 as a function of time. The open circles represent the spontaneous fission activity on drop 68 as a function of time. The dashed line is a parallel displacement of the solid line. From Ref. 9.

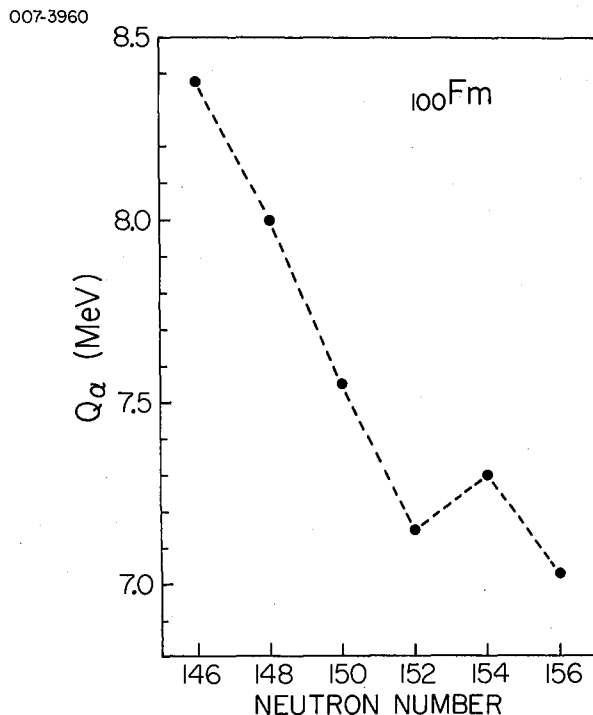

Fig. 9. Energy for α decay, Q_α , versus neutron number for the even-even Fm isotopes.

the s-process (slow) in contrast to the r-process (rapid) in supernovae.

As can be seen from Figs. 2 and 5, neutron irradiation of heavy elements of either the rapid or slow variety leads only to the heavier mass isotopes of einsteinium and fermium. Present day values of the nuclear properties of these isotopes are listed in Tables 1 and 2. Neutron cross sections of some of the heavier isotopes of Es and Fm are listed in Table 3.

The known isotopes of Es with $A \leq 252$ and Fm with $A \leq 253$ have been produced by various charged-particle reactions including heavy ions. The nuclear properties of these nuclides are summarized also in Tables 1 and 2. The reactions employed to produce some of the lighter Es and Fm isotopes are as follows: $^{249}\text{Bk}(\alpha, 4n)^{249}\text{Es}$ (See Ref. 10), $^{249}\text{Bk}(\alpha, 2n)^{251}\text{Es}$ (See Ref. 10), $^{238}\text{U}(^{14}\text{N}, 6n)^{246}\text{Es}$ (See Ref. 11), $^{249}\text{Cf}(\alpha, 3n)^{250}\text{Fm}$ (See Ref. 11), and $^{238}\text{U}(^{16}\text{O}, 6n)^{248}\text{Fm}$ (See Ref. 11).

In Fig. 9 the Q value for α decay of the even-even Fm isotopes is plotted versus the neutron number. One observes an irregularity in this plot at ^{252}Fm due to a neutron shell at $N = 152$.

Historically, the first isotope of fermium which was shown to have spontaneous fission activity was ^{254}Fm . The spontaneous fission half-lives of the

007-3959

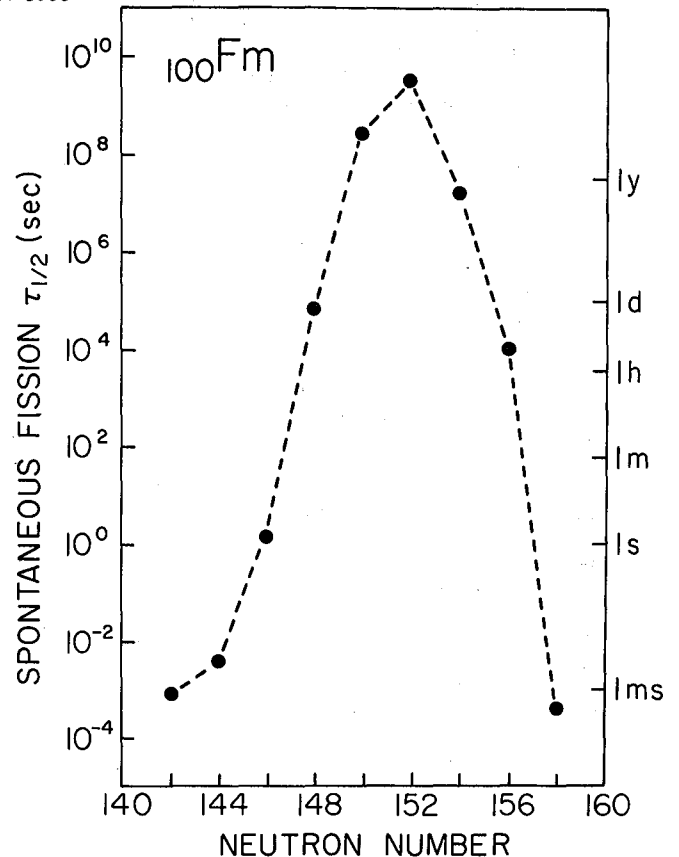

Fig. 10. Spontaneous fission half-life versus neutron number for the even-even Fm isotopes.

Table 1. Nuclear Properties of einsteinium isotopes (main decay mode, total half-life, energy in MeV of the main alpha particle group, percent α branch, percent spontaneous fission branch and ground-state nuclear spin).

Nuclide	Main decay mode	$t_{1/2}$	Main α energy MeV	% α branch	% SF branch	g.s. spin	Ref.
^{243}Es	EC	21s	7.89	$\geq 30\%$			(a)
^{244}Es	EC	37s	7.57	4%			(b)
^{245}Es	EC	1.33m	7.73	40%			(a)
^{246}Es	EC	7.7m	7.35	9.9%			(b)
^{247}Es	EC	4.8m	7.32	7%			(a)
^{248}Es	EC	27m	6.87	0.25%			(b)
^{249}Es	EC	1.70h	6.77	0.9%		(7/2+)[633 \uparrow]	(c)
^{250}Es	EC	8.6h				(6+)	(b)
^{250m}Es	EC	2.1h				(1 $^-$)	(b)
^{251}Es	EC	33h	6.49	0.5%		3/2 $^-$ [521 \uparrow]	(c)
^{252}Es	EC	471d	6.632	78%		(5 $^-$)	(b)
^{253}Es	α	20.47d	6.63	$\sim 100\%$	$8.7 \times 10^{-6}\%$	7/2 $^+$ [633 \uparrow]	(c)
^{254}Es	α	275.7d		100%	$< 3 \times 10^{-6}\%$	(7 $^+$)	(b)
^{254m}Es	β^-	39.3h	6.38	0.33%	$< 0.045\%$	2(+)	(b)
^{255}Es	β^-	39.8d	6.300	8%	$4.1 \times 10^{-3}\%$	(7/2 $^+$)[633 \uparrow]	(c)
^{256}Es	β^-	28m					(b)

(a) Nuclear Data Sheets 19 103 (1976)

(b) Nuclear Data Sheets 17 391 (1976)

(c) Nuclear Data Sheets 18 389 (1976)

Table 2. Nuclear properties of fermium isotopes (main decay mode, total half-life, energy in MeV of the main alpha particle group, percent α branch, percent spontaneous fission branch and ground-state nuclear spin).

Nuclide	Main decay mode	$t_{1/2}$	Main α energy MeV	% α branch	% SF branch	g.s. spin	Ref.
^{242}Fm	SF	0.8ms				0 $^+$	(d)
^{244}Fm	SF	3.7ms		1%	99%	0 $^+$	(a)
^{245}Fm	EC	4.2s	8.15	$> 0\%$			(b)
^{246}Fm	α	1.1s	8.240	92%	8%	0 $^+$	(a)
^{247}Fm	α	35s	7.87	$> 50\%$			(b)
^{248}Fm	α	36s	7.870	$> 99\%$	0.05%	0 $^+$	(a)
^{249}Fm	EC	2.6m	7.53	25%		(7/2 $^+$)[624 \uparrow]	(c)
^{250}Fm	α	30m	7.430	$> 90\%$	$6 \times 10^{-4}\%$	0 $^+$	(a)
^{250m}Fm	IT	1.8s					(a)
^{251}Fm	EC	5.3h	6.9	1.9%		(9/2 $^-$)[734 \uparrow]	(c)
^{252}Fm	α	25.4h	7.040	99.998%	$2.5 \times 10^{-3}\%$	0 $^+$	(a)
^{253}Fm	EC	3.00d	6.943	12%		1/2 $^+$ [620 \uparrow]	(c)
^{254}Fm	α	3.24h	7.189	99.94%	$5.9 \times 10^{-2}\%$	0 $^+$	(a)
^{255}Fm	α	20.07h	7.022	$\approx 100\%$	$2.4 \times 10^{-5}\%$	7/2 $^+$ [613 \uparrow]	(c)
^{256}Fm	SF	2.63h	6.915	8.1%	91.9%	0 $^+$	(a)
^{257}Fm	α	100.5d	6.519	99.8%	0.21%	(9/2 $^+$)[615 \uparrow]	(c)
^{258}Fm	SF	0.38ms				0 $^+$	(a)
^{259}Fm	SF	1.5s					(c)

(a) Nuclear Data Sheets 17 391 (1976)

(b) Nuclear Data Sheets 19 143 (1976)

(c) Nuclear Data Sheets 18 389 (1976)

(d) G.M. Ter-Akopyan et al., Nucl. Phys. A255 509 (1977)

Table 3. Neutron cross sections of some einsteinium and fermium isotopes (2200 m/s cross section in barns)^(a).

Nuclide	Capture	Fission
^{253}Es	345	0
^{254}Es	20	3060
^{254m}Es	1.26	1840
^{255}Es	60	0
^{254}Fm	76	0
^{255}Fm	26	100
^{256}Fm	45	0
^{257}Fm	10	5500

(a) L.J. King, J.E. Bigelow and E.D. Collins, ORNL-5216 (1976).

The above neutron cross sections were used to compute transmutations in HFIR target irradiations.

fermium isotopes are shown in Fig. 10. The even-even isotopes show a remarkable Gaussian-like curve when the logarithm of the half-life is plotted as a function of the neutron number. The odd-isotope ^{255}Fm has a hindrance factor of about four orders of magnitude.

An approximately linear trend of the spontaneous fission half-life as a function of the fissility parameter x is obtained¹ if one makes a correction of the ground state masses from a smooth liquid drop model reference surface. A nucleus with less than average stability in its ground state is found to have a shorter half-life than that given by the overall trend with Z^2/A . Each MeV of extra ground state instability is found to correspond to approximately 10^5 times shorter lifetime. Hence, if one plots $\log t_{1/2} + 5\delta m$ versus the fissibility parameter x , a rather dramatic correlation is obtained (Fig. 11). Both the systematic deviation in half-lives of the heavier isotopes for a given element and the anomalously short half-lives for nuclides with $N > 152$ are attributed to instabilities in the ground state masses associated with their shell structure.

Spontaneous fission half-lives are known for two einsteinium isotopes, ^{253}Es and ^{255}Es (see Table 1). These isotopes display the characteristic hindrance factor for odd nuclei.

The actinide elements have served as a rich source of data to test models of single-particle and collective energy levels. The theoretical predictions for single-particle energy levels of protons (Fig. 12) and neutrons (Fig. 13) by Sven Gosta Nilsson are an important signpost and guide to all experimenters in this field. The predictions drawn from Fig. 12 is that the 99th proton of Es is expected to occupy the 7/2 $^+$ [633 \uparrow] level in its ground state with the 3/2 $^-$ [521 \uparrow] level

occupied but lying very close in energy. The ground state of ^{253}Es is known to be $7/2^+[633\uparrow]$, and it is likely that ^{249}Es and ^{255}Es have the same assignment.¹² In ^{251}Es (152 neutrons), the ground state is $3/2^-[521\uparrow]$, with the $7/2^+[633\uparrow]$ configuration lying 8 keV above the ground state.¹³ It is very interesting that ^{249}Bk (152 neutrons) is also an exception for the ground state spin of isotopes with 97 protons. The ground state of ^{249}Bk is $7/2^+[633\uparrow]$ with the $3/2^-[521\uparrow]$ configuration lying 9 keV above the ground state.¹² For some reason, the isotopes of Bk and Es with 152 neutrons have the two orbitals reversed relative to the other isotopes of the element.

Information about the ground state orbitals of Es and Fm isotopes is deduced from α - and β -decay spectroscopy. This is illustrated by the alpha decay of ^{253}Es and ^{255}Fm in Figs. 14 and 15, respectively. In the case of ^{253}Es , the main group populates the ground state of ^{249}Bk and establishes the fact that the ground states of ^{253}Es and ^{249}Bk have the same orbital assignment. One also observes the near degeneracy of the $7/2^+[633\uparrow]$ and $3/2^-[521\uparrow]$ proton orbitals.

The main α -group in the decay of ^{255}Fm is to an excited level in ^{251}Cf at 93.4 keV. One observes α -decay to several different neutron orbitals in the vicinity of the 152 closed-neutron shell marked in Fig. 13. Favored α -decays are those decays in

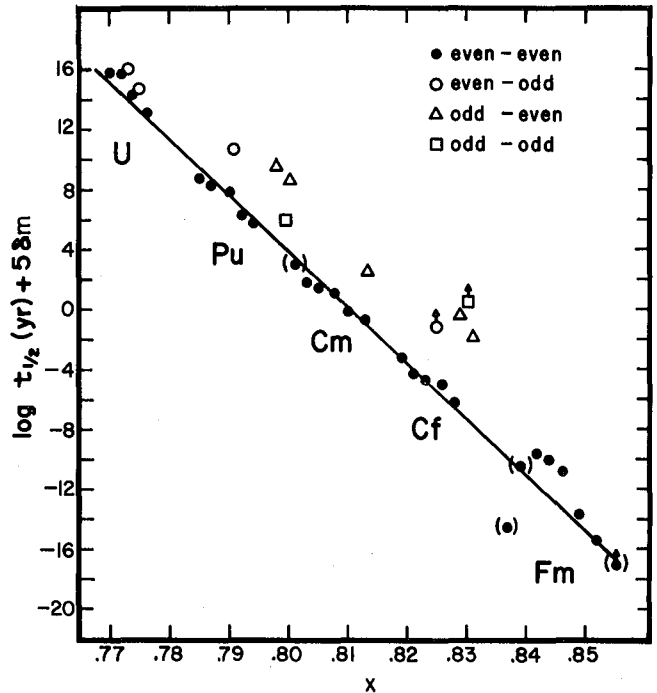

Fig. 11. Spontaneous fission half-lives corrected according to the method of Swiatecki. The ordinate is $\log \tau_{1/2} (\text{yr}) + k\delta m$ where $k = 5$ and δm is in MeV. The abscissa is the fissility parameter appropriate to the Myers-Swiatecki mass formula. ●, even-even; ○, even-odd; △, odd-even; □, odd-odd. From Ref. 1.

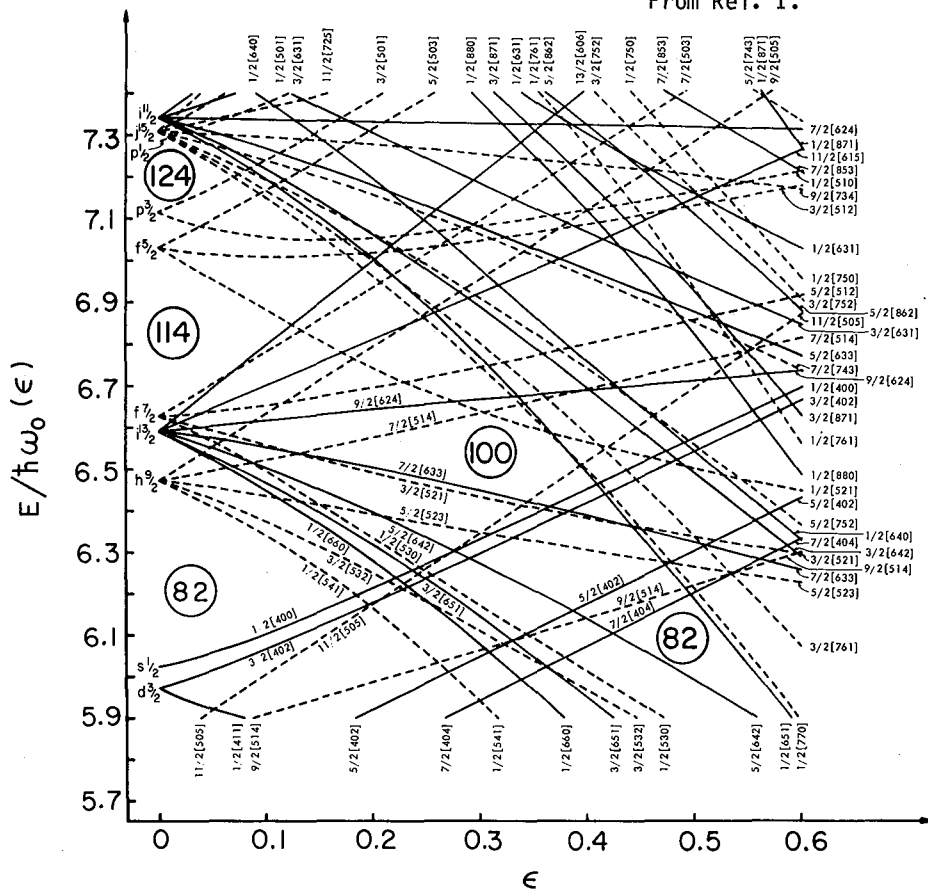

Fig. 12. Nilsson diagram for odd-proton levels.

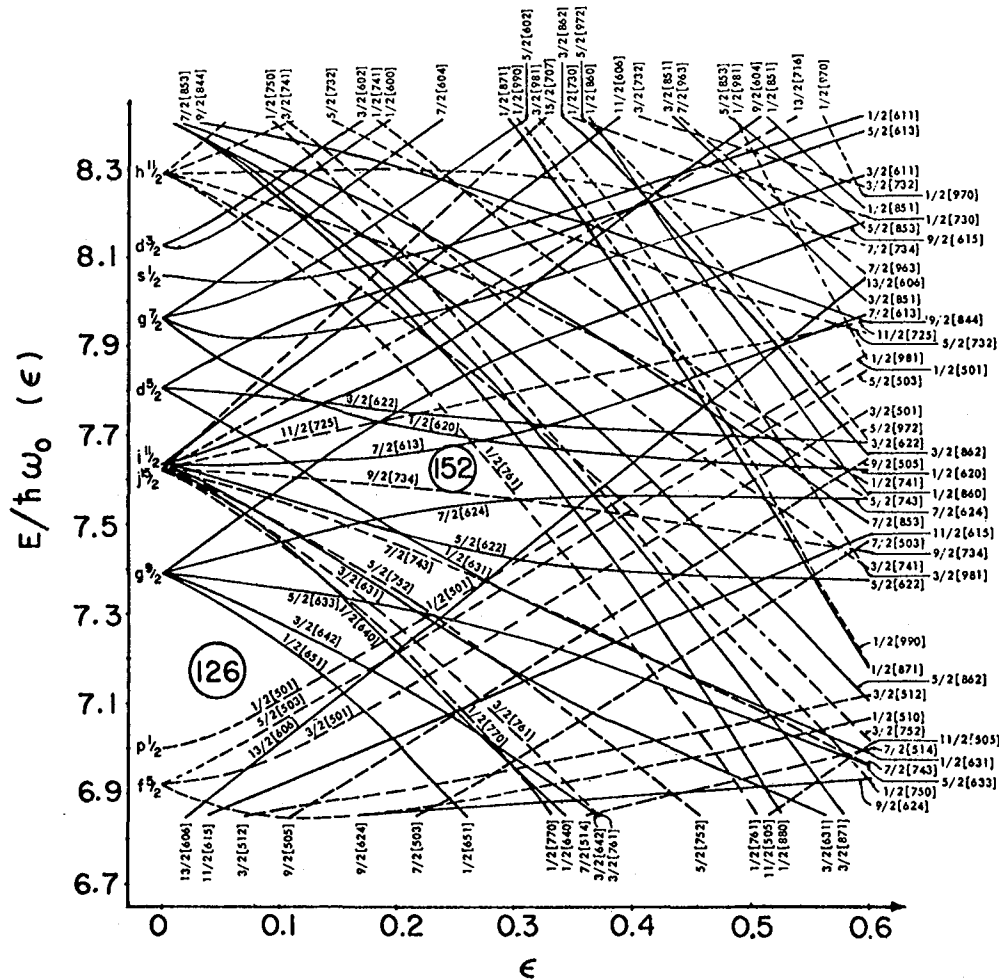

Fig. 13. Nilsson diagram for odd-neutron levels.

which the quantum numbers of the odd-nucleon are the same for parent and daughter. The nuclei ^{253}Es and ^{255}Fm , both spin $7/2$ nuclei, are ideal cases for applying theoretical calculations¹⁵ because the α -decay to a large number of excited states have been well studied experimentally.

Nuclei of ^{253}Es have been oriented at low temperatures in a neodymium ethylsulfate lattice. Alpha-particle emission from deformed (prolate) nuclei is expected to be larger from the poles than from the equator. This enhanced polar emission, first predicted by Hill and Wheeler, has been verified for several odd-A actinide nuclei including ^{253}Es . From the temperature dependent α -particle angular distribution, Soinski et al.¹⁶ determined a nuclear magnetic moment for ^{253}Es of $|\mu| = (2.7 \pm 1.3)\mu_N$.

A considerable amount of information about the single-particle and collective levels of actinide nuclei has been obtained by nuclear reaction spectroscopy. Although such data are rather sparse for Es and Fm isotopes, as you might well imagine, the Argonne group has studied the $^{250}\text{Cf}(\alpha, t)^{251}\text{Es}$ reaction.¹³ This is a spectacular accomplishment for a highly radioactive target like ^{250}Cf . The

spectrum of outgoing tritons produced in this reaction was measured with the Argonne Enge split-pole magnetic spectrograph and is shown in Fig. 16. The spectrum was interpreted in terms of the following single-proton orbitals: $3/2^- [521^+]$, $7/2^- [633^+]$, $1/2^- [521^+]$, $7/2^- [514^+]$ and $9/2^+ [624^+]$. The energies of these proton orbitals are shown in Fig. 17. All of these orbitals can be identified in Fig. 12 near the subshell of $Z = 100$.

One of the interesting features of the spectrum shown in Fig. 16 is the confirmation of the position of the $1/2^- [521^+]$ proton orbital. The excitation energy of this orbital in the actinides is of crucial importance in assessing the possible stability of superheavy elements with nuclear charge $Z \approx 114$. The degree of stability of these elements with respect to fission arises from the shell effects associated with large gaps in the single-particle spectra. At $Z = 114$, the stability is partly due to the $f_{7/2} - f_{5/2}$ splitting. The energy of $1/2^- [521^+]$ orbital in the single-particle spectrum is rather sensitive to the position of the $f_{5/2}$ orbital in the spherical potential as can be seen in Fig. 12. The position of the spherical $f_{7/2}$ orbital is largely fixed by the known energy of the deformed $3/2^- [521^+]$ orbital. Calculations

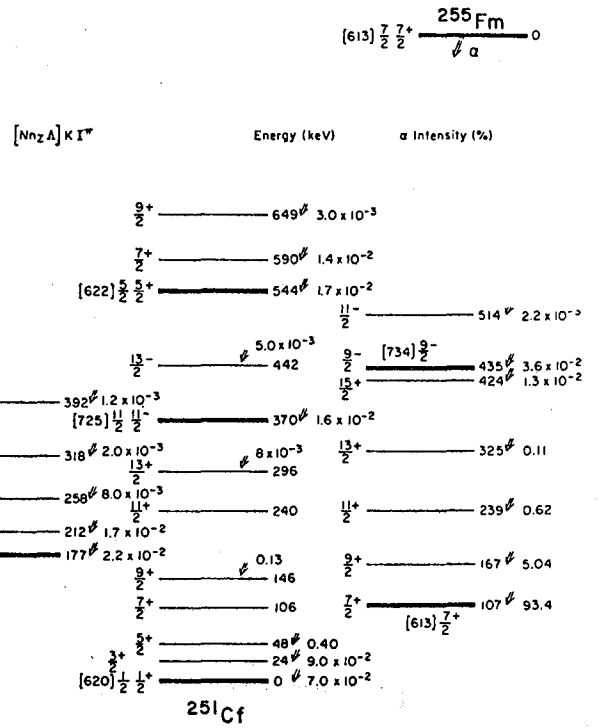
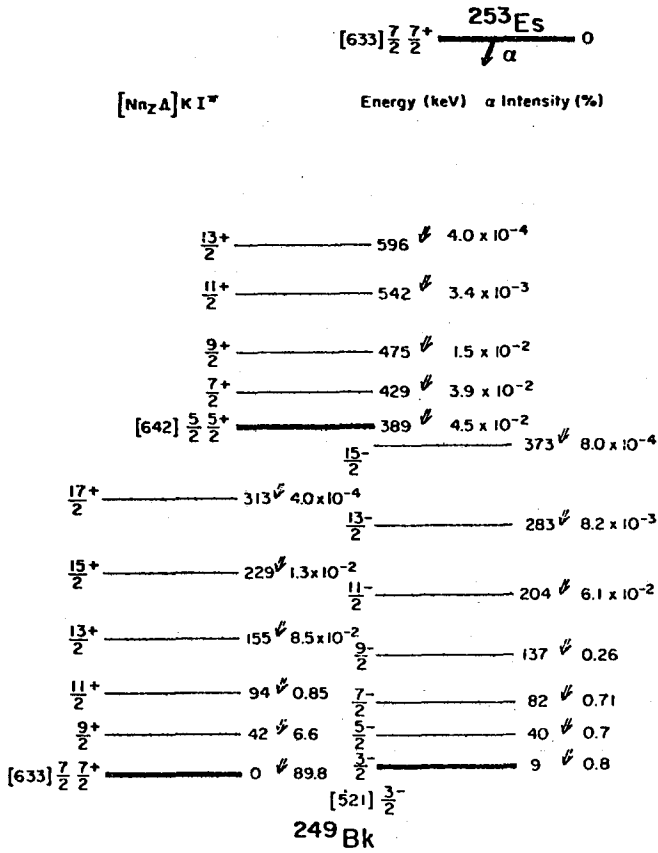

Fig. 14. Alpha-decay scheme of ^{253}Es . From Ref. 14.

Fig. 15. Alpha-decay scheme of ^{255}Fm . From Ref. 14.

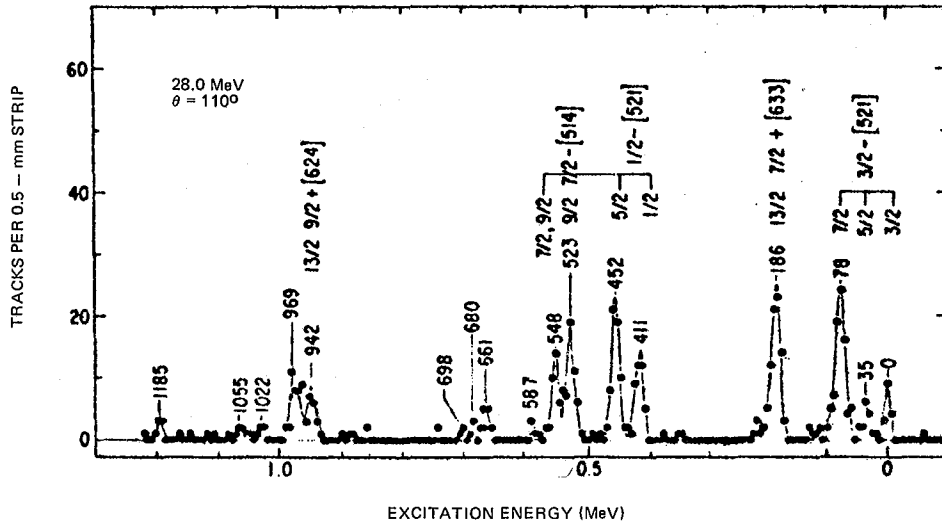

Fig. 16. The triton spectrum from the $^{250}\text{Cf}(\alpha, t)^{251}\text{Es}$ reaction. From Ref. 13.

of the proton energy levels for the spherical nucleus ^{214}X give a $f_{7/2} - f_{5/2}$ splitting of approximately 1.5 MeV and a proton shell correction at $Z = 114$ of about -2.8 MeV.

Information about the fission probability (and fission barriers) of einsteinium isotopes as a

function of excitation energy has been obtained from reaction studies.¹⁷ The $^{249}\text{Cf}(^3\text{He}, t)^{249}\text{Es}$, $^{249}\text{Cf}(^3\text{He}, d)^{250}\text{Es}$, $^{250}\text{Cf}(^3\text{He}, t)^{250}\text{Es}$ and $^{250}\text{Cf}(^3\text{He}, d)^{251}\text{Es}$ reactions have been used to produce compound nuclei with a well-defined mass and charge at a measured excitation energy. The number of observed fissions per detected light

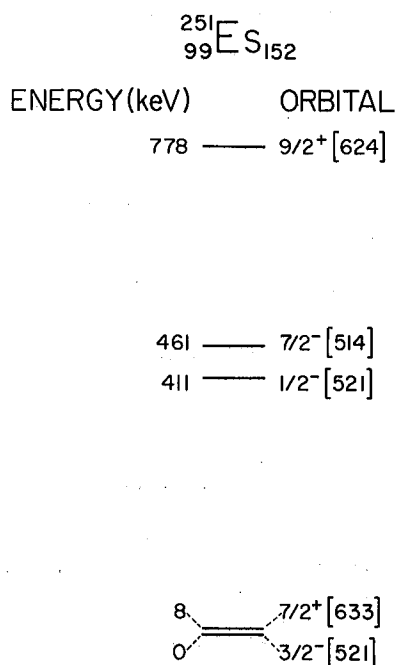

Fig. 17. Single proton levels of ${}^{251}\text{Es}$.
Constructed from data in Ref. 13.

particle (t or d) then determines the fission probability at a known excitation energy. Odd-A isotopes of Es (and also Bk) exhibit a strong dip in the fission probability above the neutron binding energy, followed by a gradual increase with increasing excitation energy. This trend cannot at present be reproduced with statistical model calculations.

REFERENCES

1. R. Vandenbosch and J.R. Huizenga, Nuclear Fission, Academic Press, Inc. (1973).
2. H. Diamond et al., Phys. Rev. 119, 2000 (1960).
3. A. Ghiorso et al., Phys. Rev. 99, 1048 (1955).
4. Baade et al., Astron. Soc. Pacific 68, 296 (1956); Burbidge et al., Phys. Rev. 103, 1145 (1956).
5. J.J. Devaney, A.G. Petschek and M.T. Menzel, Los Alamos Scientific Laboratory Report LAMS-2226, 1958 (unpublished).
6. S.G. Thompson et al., Phys. Rev. 93, 908 (1954).
7. B.G. Harvey et al., Phys. Rev. 93, 1129 (1954).
8. M.H. Studier et al., Phys. Rev. 93, 1428 (1954).
9. P.R. Fields et al., Phys. Rev. 94, 209 (1954).
10. B.G. Harvey et al., Phys. Rev. 104, 1315 (1956).
11. E.K. Hyde, I. Perlman and G.T. Seaborg, Nuclear Properties of Heavy Elements (Prentice-Hall, Inc., 1964) Vol. II.
12. Nuclear Data Sheets 18, 389 (1976).
13. I. Ahmad et al., Phys. Rev. Letts. 39, 12 (1977).
14. I. Ahmad et al., Nucl. Phys. A 239, 1 (1975).
15. A.J. Soinski et al., Nucl. Phys. A 291, 386 (1977).
16. A.J. Soinski et al., Phys. Rev. C 2, 2379 (1970).
17. A. Gavron et al., Phys. Rev. C 15, 2238 (1977).

Introduction of Darleane C. Hoffman

Dr. Seaborg

I hate to see that comment about supernovae go by the board. Of course this would mean also that the Chinese would have a claim to the discovery of californium because they found the first supernova in the year 1054. I hadn't seen that little piece in Chemical Engineering News listing the discovery of 99 and 100 as one of the important discoveries in the last century.

The last speaker in this morning's program is one of the world's leading investigators of nuclear fission. Darleane Hoffman received her B.S. degree in 1948 and her Ph.D. degree in 1951 at Iowa State College. From 1951 to 1952 she was a member of the Materials Chemistry Division and worked on the aircraft nuclear propulsion project at the Oak Ridge National Laboratory. (I had a lot to do with eliminating that project when I first came to the AEC. In 1961 I was one of those who convinced President

Kennedy that the project was not worth continuing. I don't know why it lasted as long as it did, it just seemed obvious that this was not a good use for nuclear energy.) The following year she moved to the Los Alamos Scientific Laboratory and has been there ever since. In 1971 she was appointed an associate group leader of the radiochemistry group. In 1976 Darleane was awarded the John Dustin Clark medal by the New Mexico section of the American Chemical Society. She has played a central role in elucidating the trend towards symmetric spontaneous fission of fermium isotopes. Darleane has many important discoveries to her credit, including the discovery of the presence in nature of the long-lived plutonium isotope, plutonium-244, which we've heard so much about today. Darleane is speaking today on fission properties of einsteinium and fermium isotopes.

Fission Properties of Einsteinium and Fermium

Darleane C. Hoffman

Since the discovery of einsteinium and fermium in the Mike debris in the form of isotopes ^{253}Es , ^{255}Es , and ^{255}Fm , some two dozen more isotopes of these elements have been identified, many of which spontaneously fission. Studies of the spontaneous fission (SF) decay properties, particularly of the fermium isotopes, have been especially fascinating to me. Most of my remarks will be concerned with the fission properties of the fermium isotopes, primarily because so much more is known about them than about the SF of the einsteinium isotopes, and because a dramatic change in SF properties has been found to occur with increasing mass of the fermium isotopes. A dramatic increase in total kinetic energy (TKE) release and a change in the mass division from predominantly asymmetric to predominantly symmetric has been found to occur between ^{256}Fm and ^{258}Fm , with ^{257}Fm apparently being in a "transition" region.

Relatively little is known concerning the SF of the einsteinium isotopes, probably primarily because the half-lives for SF of the isotopes known so far are very long (10^3 to 10^7 years) compared to those for alpha decay, and it has been difficult to obtain sufficiently strong sources for study because of the extremely high alpha decay rates. Isotopes for which measurements of the kinetic energy release and mass distributions have been made^{1,2} so far include ^{253}Es (SF) and ^{254}Es (n,f), i.e., excited ^{255}Es ($^{255}\text{Es}^*$). The properties are similar to those of the lower Z actinides although the peak-to-valley ratio is somewhat lower and the TKE release is somewhat higher for $^{255}\text{Es}^*$ than

expected, but this may be due to the effect of the extra excitation energy resulting from neutron capture. Studies of the heavier einsteinium isotopes, although difficult, should be pursued for comparison with the fermium isotopes having the same number of neutrons in order to try to ascertain the effect of having one less proton. Such investigations of the kinetic-energy and mass distributions as a function of excitation energy can be done for prompt fission of ^{255}Es ($N = 156$) via the ^{254}Es (d,p) reaction, and of ^{256}Es ($N = 157$) via the ^{255}Es (t,p) reaction using direct reaction techniques. We believe this can be done at the LASL Tandem Van de Graaff Facility using an isotope-separated ^{254}Es target. We hope to perform such experiments this spring in collaboration with coworkers from LLL. Prompt fission of ^{255}Fm and ^{256}Fm via the (^3He ,d) and (^3He ,p) reactions will also be investigated for comparison using the same target and techniques.

I would now like to turn my attention to the systematics of the low-energy fission of the fermium isotopes, and consider the half-lives, mass division, kinetic-energy release, and accompanying prompt neutron emission.

The SF half-lives for the even-even fermium isotopes show a maximum of about 100 years at the $N = 152$ subshell with the half-lives decreasing very rapidly for either higher or lower neutron numbers. Based on the half-life of 125 years for SF of ^{257}Fm , it was at first estimated that ^{259}Fm might have an SF half-life of about a month.

However, it was not detected in debris from several underground nuclear tests in which it should have been produced,^{3,8} and limits of less than 5 hours or greater than 7.5 years were placed on its half-life. With the discovery in 1971 by Hulet and coworkers⁴ that the half-life of ^{258}Fm was only 380 microseconds, it appeared that a "disaster" in SF half-lives had occurred in the fermium isotopes after $N = 157$. The half-life of ^{259}Fm might easily then be much less than the 5 hour limit we had set earlier. If the reduction in half-life between ^{257}Fm and ^{259}Fm was the same as that of 4×10^{-8} between ^{256}Fm and ^{258}Fm , a half-life of 2 to 3 minutes could be estimated for ^{257}Fm . However, calculations of Randrup et al.⁵ indicated that disappearance of the second fission barrier at ^{258}Fm could account for its very short half-life. Thus ^{258}Fm and ^{259}Fm might have about the same half-life except for the special hindrance⁶ associated with the odd neutron and ^{259}Fm might have a half-life of only a few tenths of a second. Finally, Weber, Wilhelmy, and I at LASL, in cooperation with Hulet, Loughheed, Landrum, and Wild from LLL, succeeded in 1975, after several attempts, in producing⁷ ^{259}Fm and measuring its half-life as 1.5 seconds. This is the most neutron-rich nuclide so far identified and although its half-life is perhaps not as short as the most pessimistic estimates, neither is it long enough to indicate a reversal of the "disaster". Chances for producing still more neutron-rich fermium isotopes appear very remote at the present, even if their half-lives were sufficiently long for measurement.

As early as 1963, Brandt et al.¹ reported double-kinetic energy measurements of the SF of ^{254}Fm which showed properties not unlike those of the lower Z actinides. The mass division was still strongly asymmetric and the TKE release was not anomalously high, being roughly consistent with a linear extrapolation of TKE values for other actinides as a function of $Z^2/A^{1/3}$. However, even though it was commonly believed that all low energy fission, i.e., SF and thermal neutron-induced fission, always resulted in mass distributions which were strongly asymmetric, exhibiting the familiar double-humped mass distribution, some of us continued to speculate that the more neutron-rich fermium isotopes might show an increased yield of symmetric mass division as the fragment configurations could more closely approach the stable, doubly magic ^{132}Sn core. Closed-shell effects usually become prominent only within a few nucleons of shell closure and, therefore, the effect might not show up at ^{254}Fm , but might become apparent at ^{257}Fm . Although ^{257}Fm was not identified in the Mike debris, sources for study of its 0.2% SF branch were later obtained from debris from subsequent nuclear tests conducted underground at the NTS, as well as from the AEC transplutonium production program at the high-flux isotopes reactor (HFIR) at Oak Ridge. (In fact, the largest source of ^{257}Fm ever obtained was isolated at LLL from the Hutch debris.⁹) Initial double-kinetic energy measurements were performed on a source of ^{257}Fm of only 0.8 Sf/min obtained from Hutch debris and on a 2.7 Sf/min source from the HFIR. Measurements on both types of sources showed greatly enhanced yields for symmetric mass division and an increase in TKE release--these results were reported⁹ in 1970 and 1971, not without some

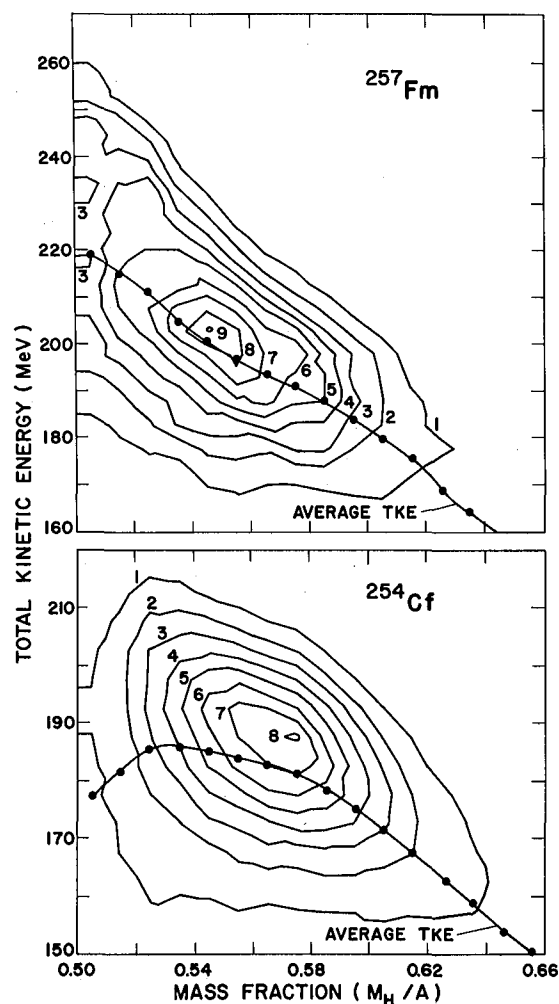

Fig. 1. Contour diagrams showing pre-neutron emission total kinetic energy distributions for ^{257}Fm and ^{254}Cf as a function of mass fraction. The contours are lines of relative numbers of events, based on data groupings 5 MeV \times 0.01 units of mass fraction. From Ref. 9.

trepidation! A monotonic increase in TKE with approach to symmetry was also observed, in contrast to the measurements for ^{252}Cf , ^{254}Cf , and lower Z actinides which show a decrease, as illustrated in Fig. 1. The high TKE release at symmetry was attributed to the sphericity of the fragment which would give rise to a larger TKE because of increased Coulomb repulsion. However, the variance of the TKE was also very large, indicating that some of the symmetric fragments were still ellipsoidal in shape, and that ^{257}Fm might be in a "transition" region where the fragments were still "soft" toward deformation. The mass distribution shown in Fig. 2 was obtained, but as is illustrated, the yields at symmetry were extremely sensitive to the neutron-emission function which was used in correcting the data. Since the TKE at symmetry, for some of the fragments, approached the total energy available from fission, we felt that neutron emission must be very low at symmetry and that this

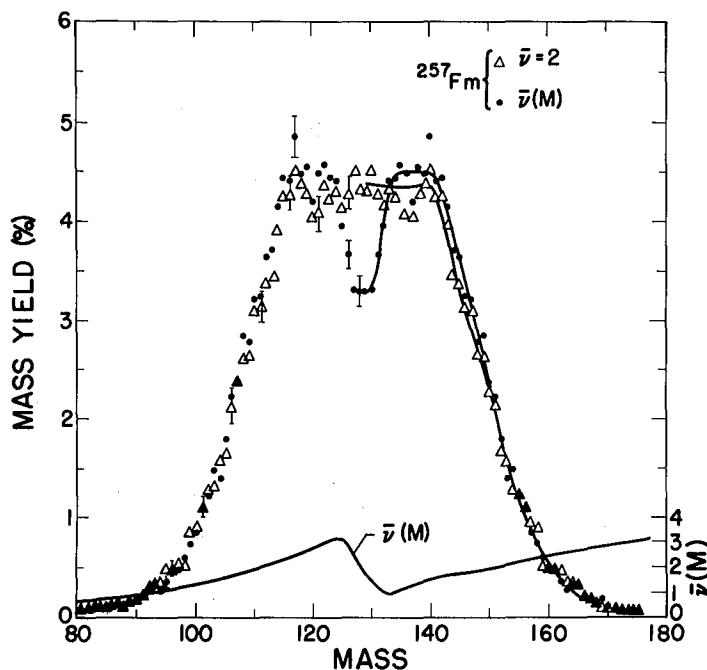

Fig. 2. Pre-neutron-emission mass-yield curve for ^{257}Fm from Ref. 9.

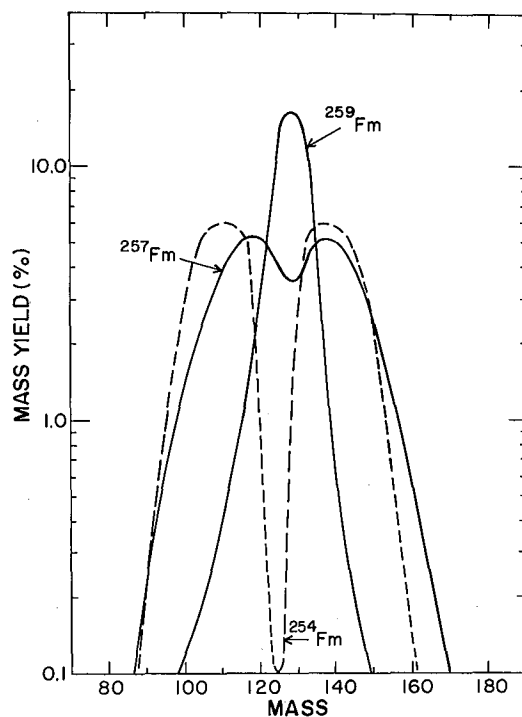

Fig. 4. Normalized mass-yield distributions for SF of ^{254}Fm (RC, Ref. 2), ^{257}Fm (SS, Ref. 9), and ^{259}Fm (SS, Ref. 7).

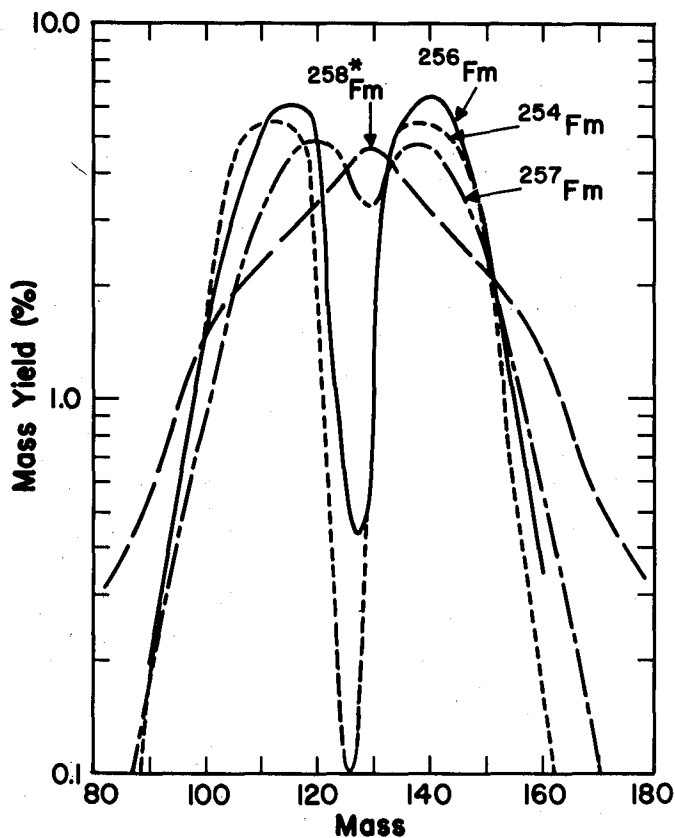

Fig. 3. Normalized mass-yield distributions for SF of ^{254}Fm (RC, Ref. 2), ^{256}Fm (RC, Ref. 13), ^{257}Fm (SS, Ref. 9), and for $^{258}\text{Fm}^*$ (SS, Ref. 10).

was a point that deserved experimental investigation. About the same time, thermal neutron-induced fission of ^{257}Fm was measured by John et al.¹⁰ and a still more symmetric, but very broad mass distribution with the most probable mass split being symmetric, was obtained. These observations indicated that there might indeed be something "new" in low energy fission as Glenn Seaborg had put it at the 1970 Houston meeting, and considerable interest was generated in additional measurements of the fermium isotopes. Kinetic-energy and radiochemical measurements were made for a number of fermium isotopes.^{2, 11-16} The results, which are shown in Fig. 3, indicated a clear trend toward more symmetric mass distributions and higher TKE's with increasing mass of the fermium isotopes. Our recent measurements of the SF of ^{258}Fm (to be published) and ^{259}Fm (See Ref. 7) performed at LASL in collaboration with Hulet et al. from LLL, show that the most probable mass division for both isotopes is narrowly symmetric with a very high TKE release, consistent with the trends exhibited for the higher fermium isotopes, but exhibiting a much greater change. The mass-yield curves shown in Figs. 4 and 5 show this effect.

Differences in mass distributions between SF and thermal neutron-induced fission caused by the excitation energy of about 6 MeV resulting from the neutron-binding energy can be seen by comparing the mass distributions for ^{256}Fm (SF) with $^{256}\text{Fm}^*$ and ^{258}Fm (SF) with $^{258}\text{Fm}^*$ shown in Figs. 6 and 7 (See Refs. 17, 10). The mass distribution for $^{256}\text{Fm}^*$ shows increased yields for symmetric mass splits and a slightly higher TKE than for SF of ^{256}Fm . In the case of $^{258}\text{Fm}^*$, the effect is just the opposite

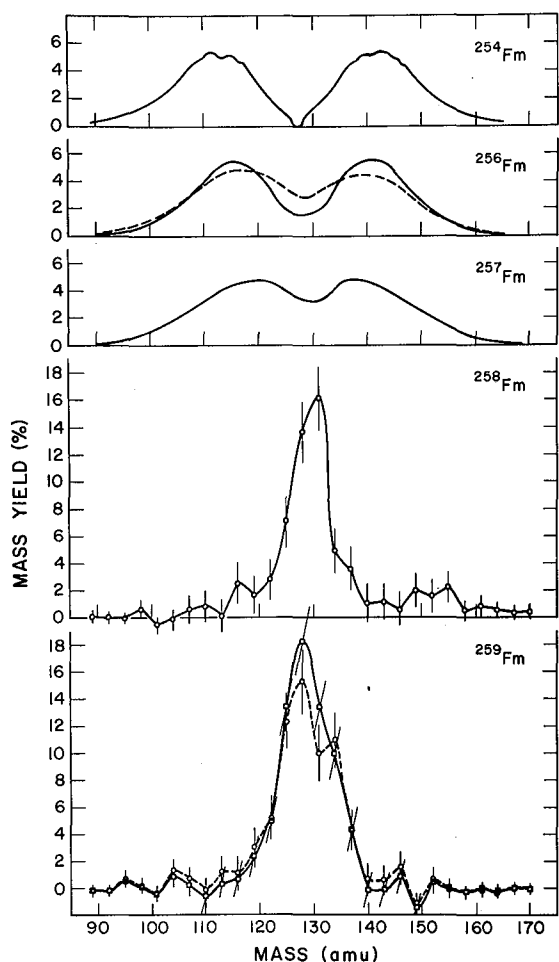

Fig. 5. Mass distributions for SF of fermium isotopes.

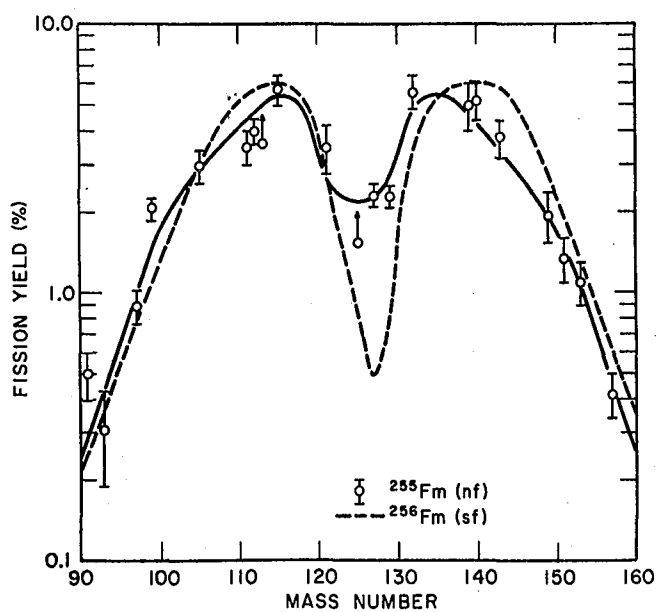

Fig. 6. Mass-yield curves for $^{256}\text{Fm}(\text{SF})$ and $^{256}\text{Fm}^*$ from Ref. 15.

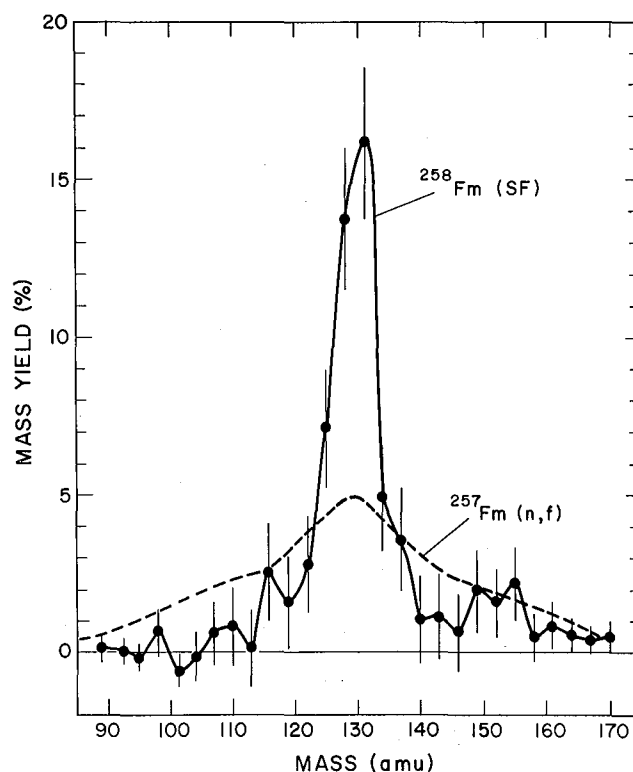

Fig. 7. Provisional mass distributions for $^{258}\text{Fm}(\text{SF})$ and $^{257}\text{Fm}^*$ from Fig. 10.

--the mass distribution is less sharply symmetric and the TKE has been reported¹⁰ to be only 183 MeV compared to the most probable value of 238 MeV we have measured for $^{258}\text{Fm}(\text{SF})$. Perhaps these apparently conflicting results can be explained on the basis of fragment shell effects which tend to be washed out by the extra excitation energy in the case of neutron-induced fission. In the case of ^{256}Fm and higher actinides, the fragment shell effects may tend to stabilize asymmetric mass division while in ^{258}Fm they stabilize symmetric mass division. Thus the extra excitation energy, by outweighing the shell effect, makes the distribution more symmetric in the one case, and broader and more symmetric in the other. Alternatively, the abrupt change in SF properties at ^{258}Fm may be explained in terms of the potential energy surface of the fissioning nucleus. The potential energy surface being sampled during fission may be very shallow between the symmetric and asymmetric mass components. In $^{256}\text{Fm}(\text{SF})$, the potential energy minimum would be associated with a configuration giving asymmetric mass division, and the addition of energy would allow a broader sampling of the surface which would permit some fission via symmetric mass division with a higher TKE. In $^{258}\text{Fm}(\text{SF})$, the potential energy minimum would be presumed to be associated with symmetric mass division, and addition of energy to the system would allow the fissioning nucleus to sample mass asymmetric components of the potential energy surface which would also result in lower TKE release.

Table 1. Properties of low energy fission of the fermium isotopes.

Nuclide	P/V ^a	TKE ^b (MeV)		$\bar{\nu}_T^d$	$\sigma_{\bar{\nu}_T}^2$
		exp.	calc. ^c		
²⁵⁴ Fm	≈ 60 (RC)	192	198.7	3.95 ± 0.19	1.49 ± 0.20
²⁵⁶ Fm	12 (RC)	197.9	198.2	3.70 ± 0.18	1.82 ± 0.08
²⁵⁶ Fm	2.5 (RC)	195.5#	198.2	---	---
²⁵⁷ Fm	≈ 1.5 (SS)	197.6	197.9	3.77 ± 0.02	2.49 ± 0.06
²⁵⁸ Fm*	Broad, Symm. (SS, RC)	---	197.6	---	---
²⁵⁸ Fm	Narrow, Symm. (SS)	238#	197.6	---	---
²⁵⁹ Fm	Narrowly Symmetric (SS)	243#	197.4	---	---

- a Peak-to-valley ratios for the mass distributions from either radiochemical (RC) or solid-state detector (SS) measurements.
- b Average values for pre-neutron total kinetic energy except for those designated by # which are most probable values obtained from a Gaussian fit to the peak region. (All corrected to TKE = 186.1 MeV for ²⁵²Cf.)
- c Calculated from the linear relationship, $\overline{TKE} = 0.13323Z^2/A^{1/3} - 11.64$ obtained by Unik et al. (Ref. 2) from best fit to data for SF and thermal neutron-induced fission of nuclides from ²³⁰Th to ²⁵⁶Fm.
- d Relative to $\bar{\nu}_T = 3.735$ for ²⁵²Cf.

The measured and calculated values for the \overline{TKE} for low energy fission of the fermium isotopes and peak-to-valley ratios for the mass distributions are summarized in Table 1. The calculated values of \overline{TKE} , based primarily on liquid-drop considerations,^{2,18} i.e. that the kinetic energy release is a linear function of $Z^2/A^{1/3}$, show a slight decrease with increasing A for a given Z, while the measured values for fermium show a slight increase between mass 254, 256, and 257 and a precipitous increase for 258 and 259. (See Fig. 8)

A plot of average neutron emission, $\bar{\nu}_T$, as a function of A is shown in Fig. 9, and in general is seen to increase more or less linearly. However, as the total kinetic energy release increases and approaches the Q value for fission as in the fermium isotopes, the excitation energies of the fragments, and hence neutron and/or gamma emission must of necessity decrease rather than continue to increase as shown in Fig. 9. From the data given in Table 1, it can be seen that $\bar{\nu}_T$ does indeed decrease as the TKE increases between ²⁵⁴Fm and ²⁵⁶Fm and ²⁵⁷Fm. The variance for neutron emission also goes up markedly between ²⁵⁶Fm and ²⁵⁷Fm, reflecting the large variance observed for the TKE for ²⁵⁷Fm. Studies of neutron emission of SF of ²⁵⁷Fm and of ²⁵²Cf showed^{19,20} that for fission events with TKE greater than 240 MeV (about 5% of the total fissions), $\bar{\nu}_T$ was only 0.9 for ²⁵⁷Fm while for ²⁵²Cf it was still 2.2 for the 3% of the fissions having the highest TKE's. Some of our recent measurements²¹ of neutron multiplicities (Fig. 10) also illustrate this point. The mass distribution for fission events from ²⁵⁷Fm having

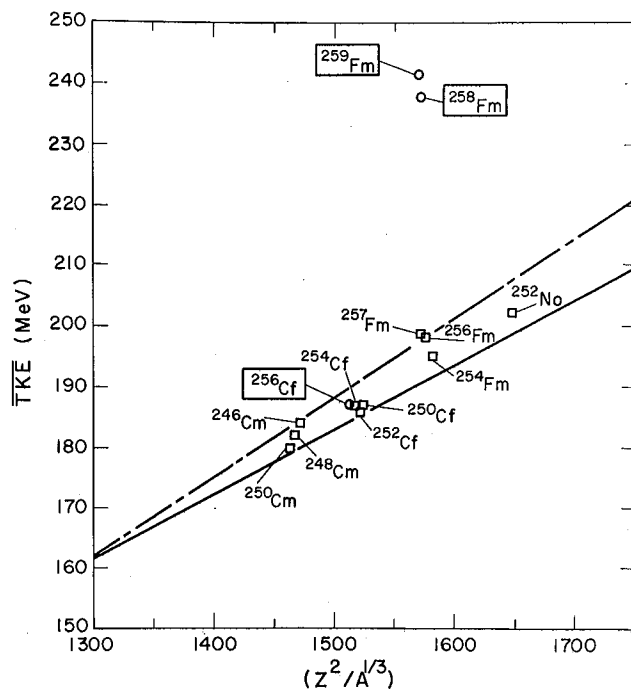

Fig. 8. Systematics for the average TKE release for SF of curium through nobelium isotopes. The solid line represents the systematic trend of Viola¹⁸ and the dashed line is from the analysis of Unik et al.²

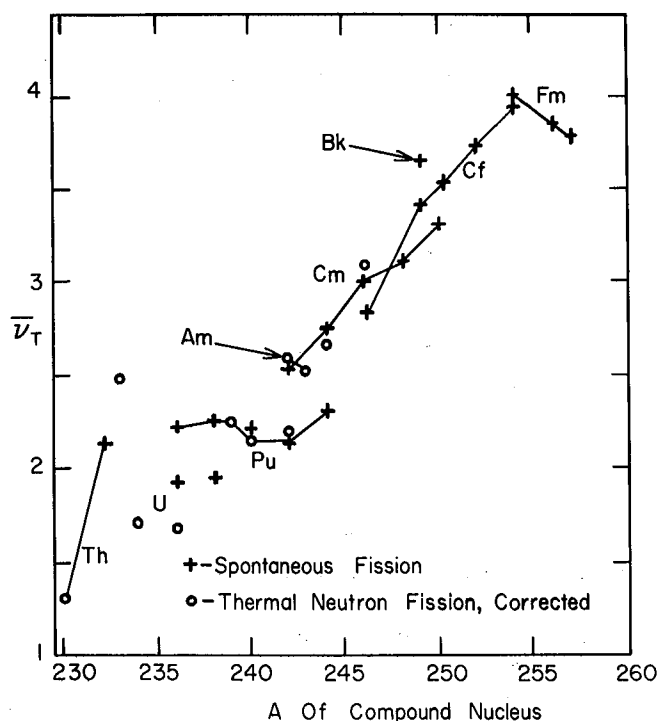

Fig. 9. Experimental values of $\bar{\nu}_T$ as a function of A of the compound nucleus. Data for SF are shown by (+). All measurements of $\bar{\nu}_T$ for (n, f) are corrected to zero excitation energy and are shown by (o). (Figure from Ref. 11.)

TKE greater than 235 MeV is shown in Fig. 11. It is narrowly symmetric with a FWHM of about 7 mass units and $\bar{\nu}_T$ is only about 1 for these events. Similarly, neutron emission for SF of ^{258}Fm and ^{259}Fm would also be expected to be extremely low since their most probable values of TKE are about 240 MeV and approach the total energy of about 250 MeV estimated to be available from fission.

In summary then, I have tried to show that the low energy fission of the fermium isotopes is a microcosm of the fission process, exhibiting a wide range of half-lives, mass and kinetic-energy distributions and varying neutron emission. The trends in the fermium isotopes toward higher yields for symmetric mass division, higher total kinetic energies, and reduced neutron emission as the mass of the fermium isotopes is increased, are consistent with the simple postulate that the closer the fragments resulting from symmetric mass division are to the doubly magic $Z = 50, N = 82$ configuration, the more highly favored symmetric fission becomes. The fragments become more spherical which results in increased kinetic energy, decreased neutron emission, and probably decreased gamma emission. The variances for the mass, kinetic-energy, and neutron distributions appear to be largest in the "transition" nucleus ^{257}Fm where symmetric mass division apparently can result in fragment shapes ranging from rather deformed to nearly spherical as evidenced by the observation of symmetric mass division with both very high and very low TKE's. However, at ^{258}Fm and ^{259}Fm where symmetric mass division results in fragments with 79 or 80 neutrons, they are close enough to the 82-neutron

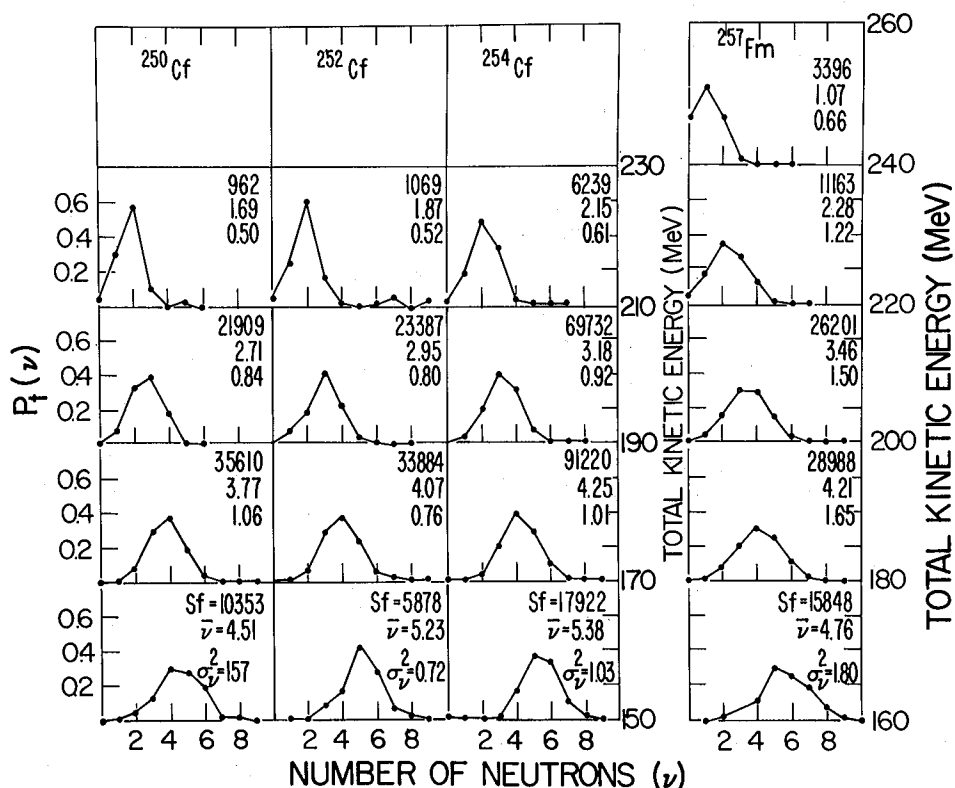

Fig. 10. Multiplicity distributions for ^{250}Cf , ^{252}Cf , ^{254}Cf , and ^{257}Fm from Ref. 21.

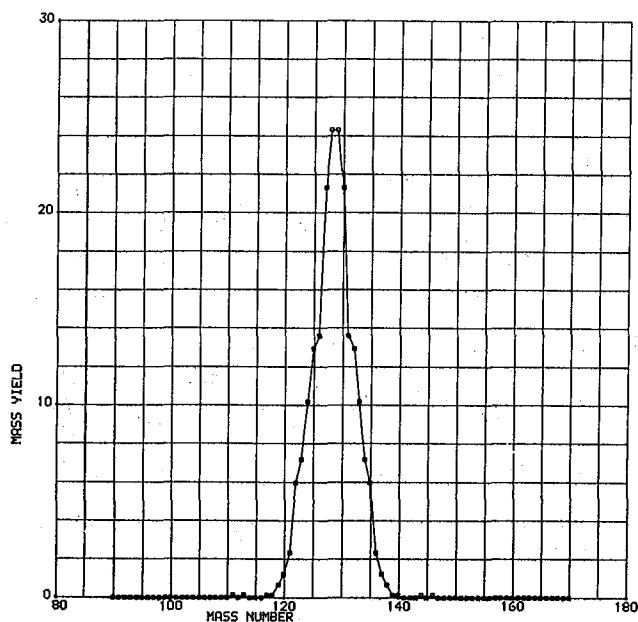

Fig. 11. Mass distribution for fission events from ^{257}Fm having pre-neutron TKE greater than 235 MeV, from Ref. 19.

shell so that most of them are quite spherical, resulting in the observed highly symmetric mass distributions, very high TKE's, low excitation energies, and presumably low neutron emission. If fermium isotopes up to mass 264 could be observed, one might speculate that nearly all symmetric mass division, with the TKE approaching that available from the fission process, might result. We have measured the SF properties for the even californium isotopes from $N = 152$ to $N = 158$ and see no such abrupt change or trend in fission properties as observed for the fermium isotopes. It will be interesting to see whether the einsteinium isotopes with Z between californium and fermium show SF properties similar to the fermium isotopes or not.

I think it is important to try to correlate the SF properties of these nuclides with the theoretical predictions. Mustafa²² has calculated potential energy surfaces for fission of the fermium isotopes which are consistent with our observations. His calculations indicate a preference for asymmetric mass division for $^{256}\text{Fm}(\text{SF})$ and symmetric mass division for $^{258}\text{Fm}(\text{SF})$. The calculated potential energy region is rather flat in both cases and would be qualitatively consistent with the effects observed experimentally with the addition of excitation energy to the system via thermal neutron-induced fission. P. Möller has suggested that the neutron-deficient fermium ($A < 244$) may also show symmetric fission and this should be investigated.

Wilkins, Steinberg, and Chasman²³ also predict a rapid change from asymmetric to symmetric mass division in the vicinity of ^{258}Fm . Their calculations imply a symmetric division consisting of one spherical and one elongated fragment, resulting in a lower TKE release than for two spherical fragments. A TKE of about 225 MeV would be predicted

while our data give a most probable value of 238 MeV for ^{258}Fm and show substantial yields for fission splits with still higher TKE. Thus, our results suggest somewhat more compact, spherical shapes for the fragments at scission and/or a larger amount of pre-scission kinetic energy than do their predictions. Their calculated mass distribution is triple-peaked while our results for $^{258}\text{Fm}(\text{SF})$ show little, if any, of this effect. However, the experimentally observed effects must be extremely sensitive to small changes in the potential energy surfaces and may be outside the accuracy which can reasonably be expected even from realistic static calculations. Ultimately, dynamic calculations, incorporating both the potential energy surface of the fissioning nucleus and the shell effects in the fragments, will probably be required in order to completely explain the phenomena associated with the fission process.

REFERENCES

1. R. Brandt, S.G. Thompson, R.C. Gatti, and L. Phillips, *Phys. Rev.* **131**, 2617 (1963).
2. J.P. Unik, J.E. Gindler, L.E. Glendenin, K.F. Flynn, A. Gorski, and R.K. Sjoblom, in *Proceedings of the Third International Atomic Energy Agency Symposium on the Physics and Chemistry of Fission*, Rochester, NY, 1973 (International Atomic Energy Agency, Vienna, 1974) Vol. II, p. 19.
3. D.C. Hoffman, *Arkiv Fys.*, **36**, 533 (1966).
4. E.K. Hulet, J.F. Wild, R.W. Lougheed, J.E. Evans, B.J. Qualheim, M. Nurmia, and A. Ghiorso, *Phys. Rev. Lett.* **26**, 523 (1971).
5. J. Randrup, S.E. Larson, P. Möller, S.G. Nilsson, K. Pomorski, and A. Sobiczewski, *Phys. Rev. C*, **13**, 229 (1976).
6. J. Randrup, C.F. Tsang, P. Möller, S.G. Nilsson, and S.E. Larson, *Nucl. Phys. A* **217**, 221 (1973).
7. D.C. Hoffman, J. Weber, J.B. Wilhelmy, E.K. Hulet, R.W. Lougheed, J.H. Landrum, and J.F. Wild in *Transplutonium 1975, Proceedings of the 4th International Transplutonium Element Symposium* (North Holland, Amsterdam, 1976) p. 363; *Proceedings of the 3rd International Conference on Nuclei Far From Stability*, Cargese, Corsica (CERN, Geneva, 1976) p. 558.
8. R.W. Hoff and E.K. Hulet, American Nuclear Society-U.S. Atomic Energy Commission Report No. CONF-700101, **2**, 1283 (1970).
9. J.P. Balagna, G.P. Ford, D.C. Hoffman, and J.D. Knight, *159th Natl. ACS Meeting, Houston, Feb. 23-27, 1970*; *Phys. Rev. Lett.* **26**, 145 (1971).
10. W. John, E.K. Hulet, R.W. Lougheed, and J.J. Wesolowski, *Phys. Rev. Lett.* **27**, 45 (1971).
11. D.C. Hoffman and M.M. Hoffman, *Ann. Rev. Nucl. Sci.* **24**, 151 (1974).

12. R.M. Harbour, K.W. Mac Murdo, D.E. Troutner, and M.V. Hoehn, *Phys. Rev. C* 8, 1488 (1973).
13. K.F. Flynn, E.P. Horwitz, C.A.A. Bloomquist, R.F. Barnes, R.K. Sjoblom, P.R. Fields, and L.E. Glendenin, *Phys. Rev. C* 5, 1725 (1972).
14. R. C. Ragaini, E.K. Hulet, R.W. Lougheed, and J.F. Wild, *Phys. Rev. C* 9, 399 (1974).
15. K.F. Flynn, J.E. Gindler, R.K. Sjoblom, and L.E. Glendenin, *Phys. Rev. C* 11, 1676 (1975).
16. K.F. Flynn, J.E. Gindler, and L.E. Glendenin, *Phys. Rev. C* 12, 1478 (1975).
17. J.E. Gindler, K.F. Flynn, L.E. Glendenin, and R.K. Sjoblom, *Phys. Rev. C* 16, 1483 (1977).
18. V. Viola, *Nucl. Data* 1, 391 (1966).
19. D.C. Hoffman, 167th Natl. ACS Meeting, Los Angeles, California, March 31-April 5, 1974, NUCL-15; LAUR-73-1683.
20. J.P. Balagna, J.A. Farrell, G.P. Ford, A. Hemmendinger, D.C. Hoffman, L.R. Veese, and J.B. Wilhelmy, in Proceedings of the Third International Atomic Energy Agency Symposium on the Physics and Chemistry of Fission, Rochester, NY, 1973 (International Atomic Energy Agency, Vienna, 1974) Vol. II, p. 191.
21. D.C. Hoffman, G.P. Ford, J.P. Balagna, and L.R. Veese, Conference on Interactions of Heavy Ions with Nuclei and Synthesis of New Elements, Dubna, USSR, December 13-16, 1977.
22. M.G. Mustafa, *Phys. Rev. C* 11, 1059 (1975).
23. B.D. Wilkins, E.P. Steinberg, and R.R. Chasman, *Phys. Rev. C* 14, 1832 (1976).

Introduction of Donald E. Ferguson Dr. Seaborg

Our first speaker this afternoon is Donald E. Ferguson. He's presently the director of the Chemical Technology Division at the Oak Ridge National Laboratory. He received his B.S. degree in 1944 at the Tennessee Technical University and was awarded his masters degree in 1946 at the Uni-

versity of Tennessee. He joined Oak Ridge National Laboratory after graduation and has remained there for the past 31 years. Don will present a talk on the production of einsteinium and fermium in reactors.

Production of Einsteinium and Fermium in Reactors Donald E. Ferguson

This paper will be presented in two parts. The first part will provide a historical background for the production of elements 99 and 100 in nuclear reactors, while the second will consist of a survey of the current technology used for producing these elements. In 1975, John Crandall¹ reviewed the history of the production of the heavier transuranium elements; therefore, I will only summarize and update his paper.

The production of einsteinium and fermium in reactors is accomplished by the successive capture of neutrons on a source material, as illustrated in Fig. 1. This figure traces only the primary path of the neutron capture sequence. Twenty years ago we would have started this chain at plutonium or americium, the two heaviest elements available in quantity at that time. Now, we begin it with ^{248}Cm to correspond with what currently takes place in the production program, since the feed material to the High Flux Isotope Reactor (HFIR) today is rich in ^{248}Cm .

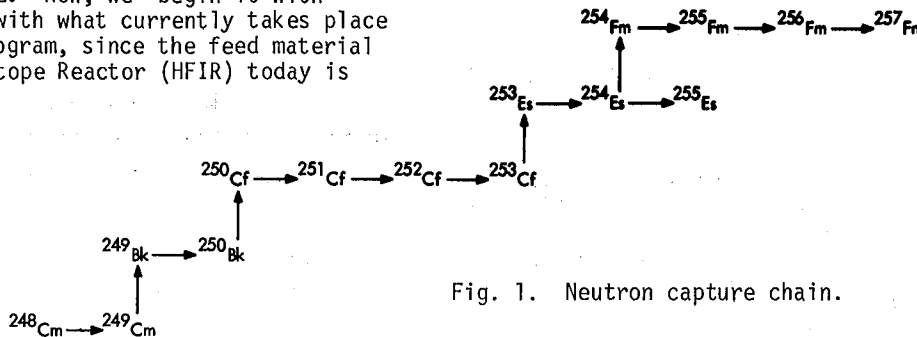

Fig. 1. Neutron capture chain.

The overall scheme that was adopted in the late 1950s for the production of research quantities of the heavy transplutonium elements is shown in

The chronology of the transplutonium processing program is detailed in Fig. 3. Small amounts of plutonium and americium were irradiated in the MTR in the early 1950s to produce transplutonium elements for use in research and chemical process

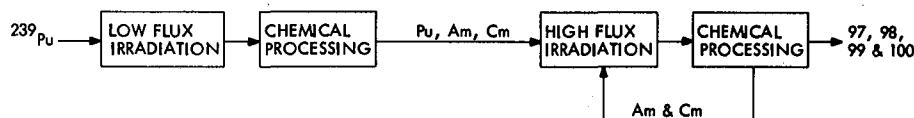

Fig. 2. Production scheme for elements 99 and 100.

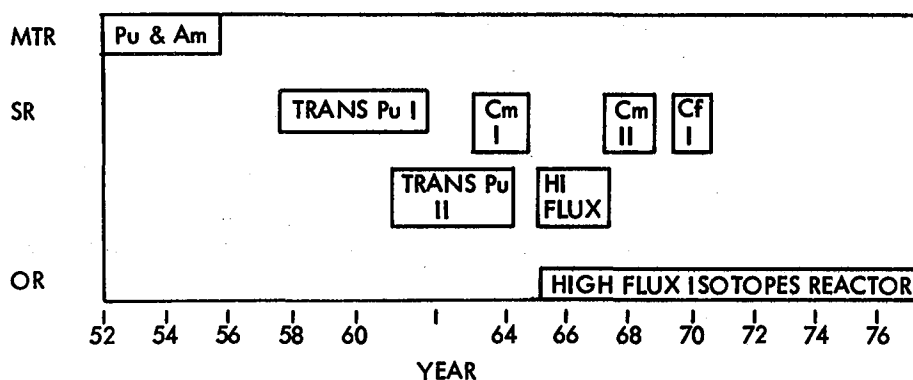

Fig. 3. Reactor irradiations.

development. The first 10 kg of ^{239}Pu was inserted in a Savannah River reactor in 1957, and this irradiation campaign was labeled TRANS Pu I. A similar irradiation was initiated four years later. While small amounts of elements 99 and 100 were produced in these irradiations, it was not possible to recover them because of the long cooling period required prior to processing at Savannah River.

These irradiations were followed by two ^{239}Pu irradiations to produce curium for isotopic heat sources and to demonstrate that a Savannah River reactor could be operated at a very high flux, greater than 5×10^{15} neutrons/cm 2 ·sec. All of these irradiations produced future feed for the HFIR, which was completed in 1965 in Oak Ridge.

When the HFIR and a small transplutonium processing plant (TRU) were started up in the mid-1960s, we were on our way to obtaining significant research quantities of elements 99 and 100. In certain respects, the HFIR has been the most successful research reactor ever built. For example, it has operated at full power 95% of the time for 11 years except for two periods of maintenance.

You will note a fifth irradiation campaign at Savannah River, designated as Cf I. In this campaign, large quantities of plutonium, americium, and curium were irradiated to produce gram quantities of californium. While it was not possible to recover einsteinium and fermium from the irradiated material because of the necessary long cooling period, a supply of curium was produced that was rich in the 248 isotope. This curium has served as an excellent feed for HFIR.

Typical results of an irradiation cycle in HFIR and a processing campaign in TRU are illustrated in Tables 1 and 2. Table 1 gives the isotopic composition of the americium-curium feed before and after the irradiation. Note that the curium is rich in the 246 and 248 isotopes, which significantly enhances its value for producing the heavier elements. Table 2 lists the products of the campaign, including the isotopic composition of the recovered californium. As an aside, I might mention that tens of milligrams of very pure ^{248}Cm are being produced each year at TRU by the decay of

Table 1. Campaign 53.

	INPUT	OUTPUT
	(g)	(g)
AMERICIUM-243	4.7	<0.1
CURIUM	113.0	54.8
	(%)	(%)
^{244}Cm	57.66	33.91
^{245}Cm	0.777	0.348
^{246}Cm	36.40	55.75
^{247}Cm	1.053	1.550
^{248}Cm	4.11	8.44

Table 2. Campaign 53 products.

	INPUT	OUTPUT
		(mg)
BERKELIUM-249	-	52.8
CALIFORNIUM-252	-	361
		(%)
^{250}Cf		7.58
^{251}Cf		2.10
^{252}Cf		88.73
^{253}Cf		1.53
^{254}Cf		0.06
		(μg)
EINSTEINIUM-253		2745
		(pg, est.)
FERMIUM-257		0.7

Table 3. Production of elements 99-100 in TRU-HFIR.

NUCLIDE	FISCAL YEARS						
	1967-70	1971-73	1974	1975	1976	1977	1978
^{253}Es , μg	481	3210	2170	3750	1700	2620	1960
^{257}Fm , μg	0.26	2.8	1.5	1.6	0.54	1.1	0.7

stored californium. The californium solution is "milked" periodically to obtain the curium daughter.

The production of elements 99 and 100 has now reached a steady state. The production totals since 1967 are given in Table 3. You should note that the values listed for 1978 are for only one-half of the year.

Finally, I will show you the effective cross sections for the heavier transplutonium elements in HFIR (Table 4). We call them the Melton Valley, Anderson County, Tennessee cross sections. They differ only slightly from those published in 1965 for the isotopes up through ^{252}Cf , but, of course we have made significant refinement in the heavier isotope regions.

In the second part of this paper, I will review the technology presently being used in TRU² to isolate the heavy elements from irradiated HFIR tar-

gets. This technology is based on someone's realization that, instead of purifying all of the curium each time, a portion of it could be recycled to the next campaign through the use of an ingenious batch solvent-extraction contactor.

When TRU was started up, a continuous solvent-extraction process, called Tramex, was used to separate the transplutonium elements from fission products and other impurities. The operational steps in this process recovered all the curium for reuse. We have since replaced the continuous solvent extraction with a batch extraction carried out in the equipment shown schematically in Fig. 4. This

Table 4. HFIR-Effective cross sections, in barns.

Nuclide	σ_c	σ_f
^{248}Cm	9.26	0
^{249}Bk	1267	0
^{250}Cf	2055	0
^{251}Cf	2454	3361
^{252}Cf	18.4	31.2
^{253}Cf	10.6	1090
^{253}Es	289	0
$^{254\text{m}}\text{Es}$	1.1	1540
^{254}Fm	64	0
^{255}Fm	22	840
^{256}Fm	38	0
^{257}Fm	8	4600

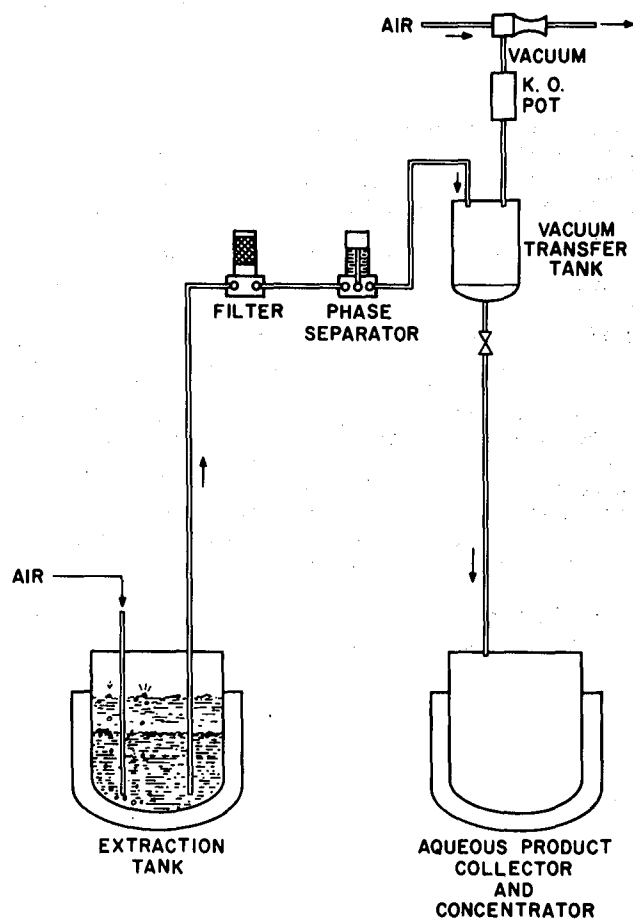

Fig. 4. Batch solvent-extraction equipment.

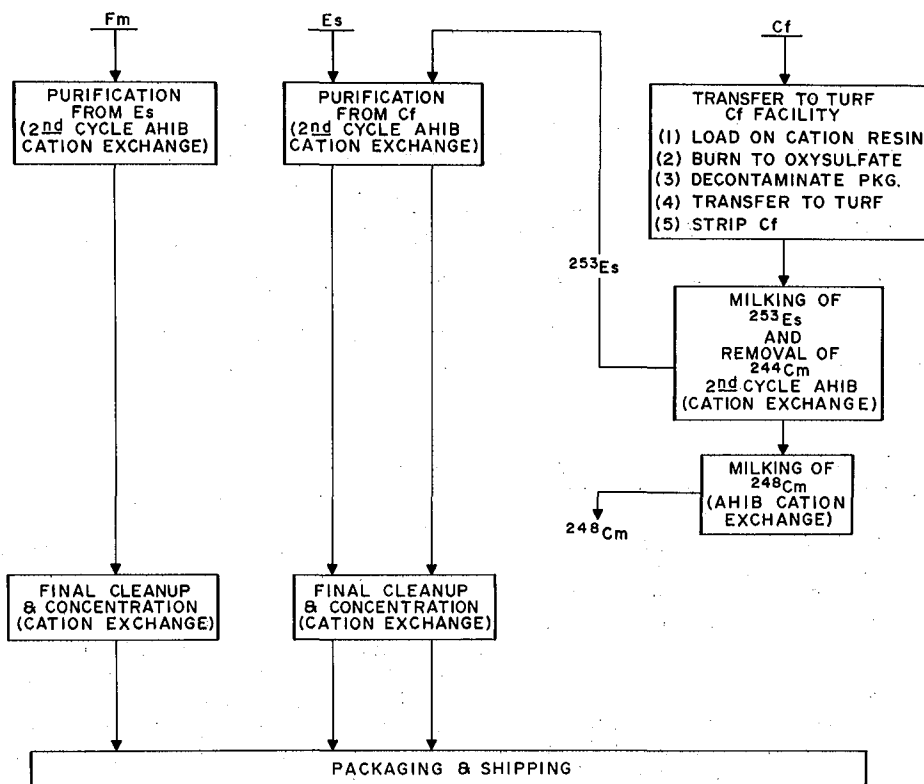

Fig. 5. Sequence of steps used in purifying the fermium, einsteinium, and californium fractions.

consists of a tank equipped to mix the phases and separate them. Thus, we extract the transplutonium elements and strip them from the solvent in a series of batch contacts. The product is further processed by LiCl anion exchange to remove residual impurities and separate 95% of the curium from the transcurium elements. The californium fraction is then transferred to another facility, and the californium, einsteinium, and fermium are separated by high-pressure ion exchange, as shown in Fig. 5.

I have not described all of the process details, instead I've simply pointed out how the process is different than that used a decade ago. As stated earlier, partially purified curium (about 25%) is stored and recycled to the next campaign. This permits a great simplification of what originally was a very complicated process.

In closing, I would like to pay tribute to two ORNL chemists who were instrumental in developing

the technology to routinely produce elements 99 and 100. These chemists, now deceased, are A. ("Chet") Chetham-Strode, Jr., and Russel D. ("Russ") Baybarz. Chet taught us what engineers could and could not do with the transplutonium elements, and Russ was instrumental in developing all the chemical processes we have used to date.

REFERENCES

1. J. L. Crandall, in Proceedings of the Symposium Commemorating the 25th Anniversary of Elements 97 and 98 held on January 20, 1975, (Lawrence Berkeley Laboratory, 1976) Report LBL-4366.
2. E. D. Collins and J. E. Bigelow, "Chemical Process Engineering in the Transuranium Processing Plant," Proc. 24th Conf. Remote Syst. Technol., p. 130 (1976).

Introduction of Richard W. Hoff

Dr. Seaborg

I'd say that the AEC was pretty far-sighted in the 1960's to support this program.

Our second contributor this afternoon, who will speak about einsteinium and fermium research, and I guess methods of production, is Richard Hoff. He received his B.A. degree in 1950 at the University of Minnesota and his Ph.D. in 1954 with me here at

the University of California at Berkeley's Radiation Lab. He joined the staff at the Lawrence Livermore Laboratory as a research chemist in 1953 and is presently the Associate Division Leader of the Nuclear Chemistry Division at the laboratory. His research interests include nuclear spectroscopy in the actinide elements, alpha decay, and neutron-capture gamma measurements.

Production of Einsteinium and Fermium in Nuclear Explosions

Richard W. Hoff

HISTORICAL BACKGROUND

Earlier papers in this symposium conveyed the excitement associated with the discovery of Es and Fm in debris from the Mike Event¹ (November 1952). It was with a similar feeling of excitement that teams of radiochemists from Lawrence Livermore Laboratory and Los Alamos Scientific Laboratory prepared to search for even heavier elements and new short-lived nuclides in the debris from large thermonuclear explosions scheduled for testing in 1954. A laboratory was set up on the island of Enewetak to facilitate the search for short-lived species.

When testing began in March 1954, samples of particulate debris were collected on filter papers immediately after each explosion by airplanes flown through the radioactive cloud. These samples were delivered as quickly as possible to radiochemical laboratories at Enewetak and in the United States for extraction of the heavy actinides. Throughout the study of the products from the megaton-range thermonuclear devices exploded in 1954 and 1956, we were disappointed to find that the yields of heavy nuclides were considerably lower than those from the Mike explosion. At that time, the heaviest species detected were the ²⁵⁵Es - ²⁵⁵Fm pair, nuclides already discovered in the Mike debris. No evidence was found for the existence of elements heavier than Fm.

In the meantime, reactor production of Es and Fm was begun in 1952. Plutonium samples (napkin rings) were inserted into the highest reactor neutron flux available at the Materials Testing Reactor in Idaho. These irradiations resulted in the production of submicrogram amounts of Es and Fm, which were used for research studies in the period 1953-1960.

UNDERGROUND TESTS

Once again during the 1960s, when nuclear weapons testing was being conducted underground at the

Nevada Test Site, attention was focused on production of very heavy elements in nuclear explosions. The AEC decided to design and test nuclear explosive devices that would produce heavy isotopes. This is accomplished by incorporating a ²³⁸U target into the device so that it is exposed to an extremely intense neutron flux. In these devices, the neutrons are generated by the thermonuclear reaction $D+T+n \rightarrow ^4\text{He}$. The ²³⁸U target undergoes multiple neutron capture reactions while being exposed to a total fluence of approximately 10^{25} n/cm². This capture reaction phase is completed in less than a microsecond, before appreciable beta decay can occur. After the neutron capture phase, nuclides in each mass chain decay by beta emission, which continues until a beta-stable product is reached. These beta-stable products, or possibly a longer-lived beta emitter close to beta stability, are detected when the debris is examined; they provide evidence for the multistep process already described.

Although this method of heavy element production is effective, isolation of products is difficult. The nuclear device inevitably produces large amounts of energy, and in the process of dissipating this explosive energy by melting and vaporizing rock, the reaction products are dispersed in an appreciable quantity of molten rock. In order to recover the heavy nuclides, it is necessary to drill down to a zone close to the initial device (which was typically 300 - 600 m below the surface of the Nevada desert) to obtain samples of the debris. Following recovery, the actinides are separated and purified.

The effort to design heavy-element producing devices was quite successful. A series of experiments were conducted, culminating in the most productive tests, Cyclamen² and Hutch³, which were detonated in 1966 and 1969 respectively. Some of the experiments in this series are listed in Table 1. The exposure, or time-integrated neutron flux to which the target material was subjected, is a measure of how many multiple neutron capture

Table 1. Underground nuclear explosions that have produced high neutron exposures.

Event name	Lab	Date	Exposure ^a	Target
Par	LLL	10/64	11	^{238}U
Barbel	LASL	10/64	11	^{238}U
Tweed	LLL	5/65	12	$^{242}\text{Pu} + ^{237}\text{Np}$
Cyclamen	LASL	5/66	18	$^{238}\text{U} + ^{243}\text{Am}$
Kankakee	LLL	6/66	12	^{238}U
Vulcan	LLL	6/66	12	^{238}U
Hutch	LLL	7/69	40	$^{238}\text{U} + ^{232}\text{Th}$

^aEquivalent 20 keV-time-integrated neutron flux (moles neutrons/cm²).

reactions occurred. A value for this exposure was derived by fitting the observed mass-yield curve for a given device to relative yields calculated using a consistent set of capture cross sections for the uranium isotopes, masses 238 to 257. The high neutron exposure achieved in the Cyclamen and Hutch events led to greatly increased production of heavy products. The greatest success was obtained with ^{238}U targets. Various other heavy nuclides were tried as target materials, but did not provide any significant improvement over ^{238}U . For example, the target in the Tweed Event was mostly ^{242}Pu with a smaller amount of ^{237}Np . Although the device performed almost identically to the Par device, where an all- ^{238}U target was used, the yields of heavier products from Tweed were sub-

stantially less. This effect was apparently due to greater fission losses in the first few members of the Pu capture chain. In the Cyclamen Event, a small amount of ^{243}Am was added to a ^{238}U target, but without effect. The observed yields of heavy nuclides could be explained as arising solely from capture in ^{238}U .

The production of heavy nuclides in the Cyclamen and Hutch Events is plotted in Fig. 1 in terms of total atoms produced during the nuclear explosion. Yields were measured experimentally for masses up to 255 and 257; no heavier species were identified. The lines in Fig. 1 connect points for calculated yields, which represent best fits to the experimental data. An odd-even fluctuation of these

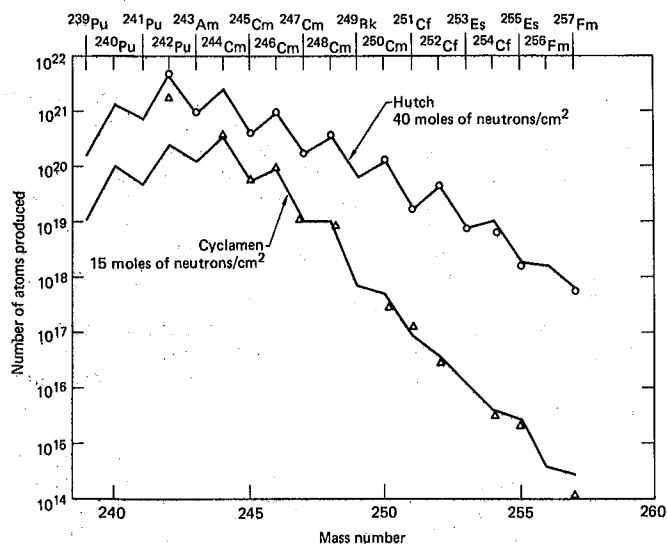

Fig. 1. Mass yield curves in the Hutch and Cyclamen nuclear explosions. The solid lines are the result of calculational fits.

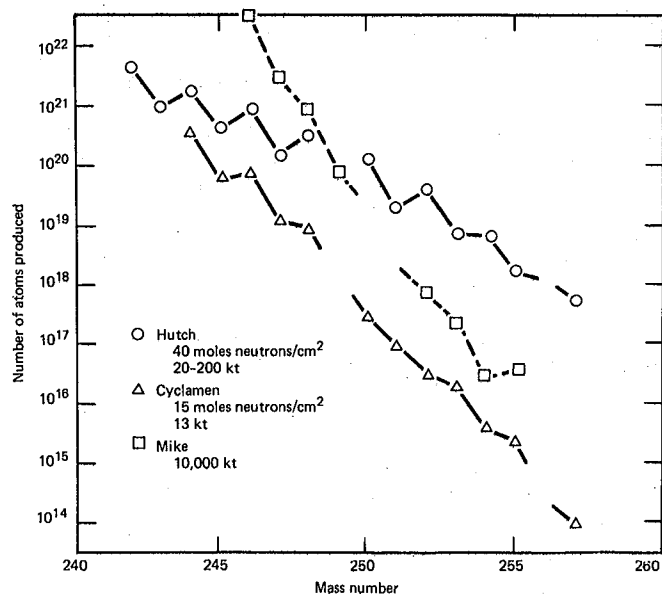

Fig. 2. Mass yield curves for the Hutch, Cyclamen, and Mike nuclear explosions.

yields is evident; in the uranium isotope capture chain, the odd-mass members have larger cross sections for neutron capture and, hence, exhibit lower yields than for the even-mass neighboring isotopes. If one assumes a smooth trend in capture cross sections for heavier members of the capture chain, then predictions can be made for the yields of heavier, unobserved species beyond $A = 257$.

A direct comparison of production yields for the Hutch, Cyclamen, and Mike⁴ events is shown in Fig. 2. A striking feature of this comparison is that a greater quantity of nuclides with mass > 250 was produced in the Hutch event than in the Mike explosion, in spite of the much larger explosive yield for Mike. For Cyclamen, the production of heavy nuclides was also very impressive when one considers that the yields of products with $A = 250$ to 257 in Cyclamen are only one order of magnitude lower than for Mike, while the total explosive yield was nearly three orders of magnitude lower.

SAMPLE RECOVERY

An important part of detecting new short-lived nuclides produced in these explosions is the time required for the sample recovery. In underground

experiments, it usually takes several days after the explosion for the first samples to become available for chemical purification and counting. Since the capture products are distributed in the vaporized rock and must be recovered from 300 - 600 m below the surface, only a small fraction of the total production is recovered for experimentation. The Cyclamen Event was an exception in that samples were recovered extremely rapidly; debris samples were in the laboratories within 24 hours after the event. Thus, experimenters were able to make sensitive tests for the existence of heavy nuclides such as ^{259}Md and ^{261}Md , which are probably quite short-lived.

To further emphasize the effects of explosive yield in dispersing the products of a nuclear explosion a view of the cloud produced following the Mike explosion is given in Fig. 3. Figure 4 shows a large hole in the atoll reef, perhaps 1000 m in diameter, produced by the explosion. After it was discovered that the airborne debris contained significant amounts of heavy nuclides, including the new elements Es and Fm, efforts were made to collect device debris and coral that had fallen to surface of islands in the atoll chain near the original site of the event.

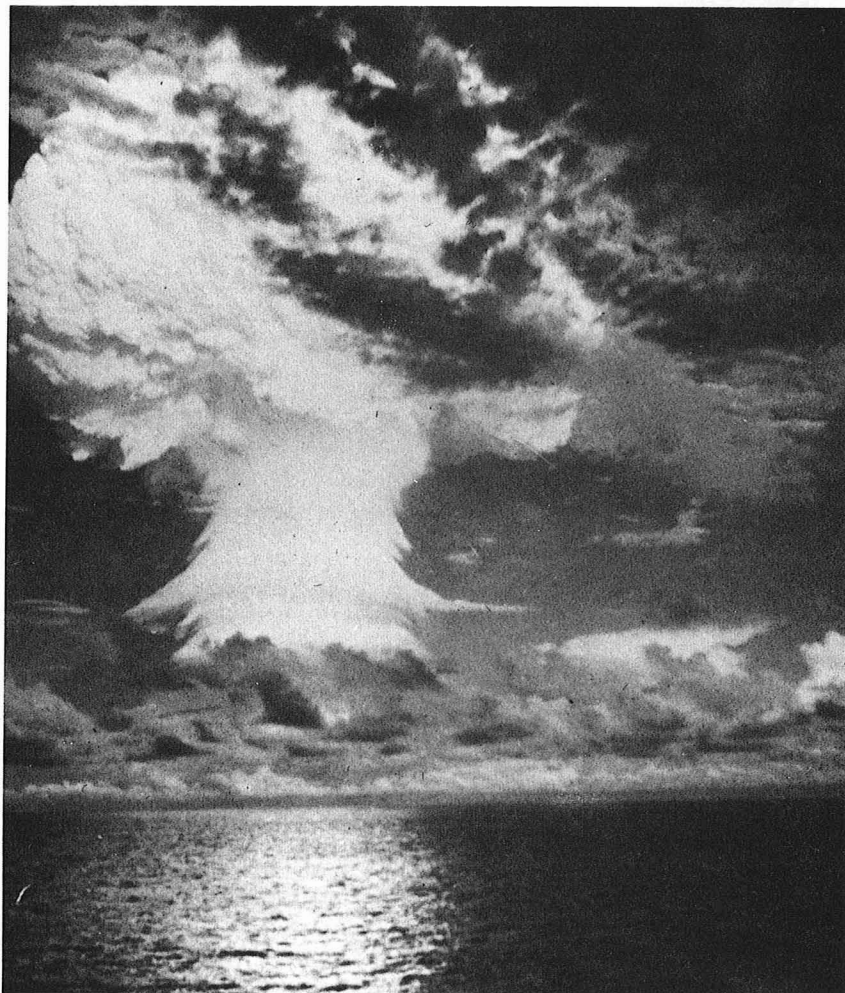

Fig. 3. Mushroom cloud produced by the Mike explosion, Enewetak, November 1952.



Fig. 4. Crater in the Enewetak atoll reef produced by the Mike explosion; the Mike Crater is the large hole in the upper part of the picture.

The Hutch surface crater, shown in Fig. 5, is another manifestation of the energy generated during the explosion. This device was exploded 600 m below the surface of the ground at the Nevada Test Site. An underground explosion first produces a spherical cavity filled with vaporized rock. Sometime following the explosion, usually within minutes to hours, the roof of the spherical cavity falls in. This collapse continues until it reaches the surface and produces a crater. The drill rigs that were used to recover samples from the Hutch Event are seen in Fig. 5 located away from the crater edge. A slant drilling technique was used to reach the debris zone directly below the crater.

Having reviewed why sample recovery can be rather difficult, we can compare data for fractions of the device recovered from the Mike and Hutch Events (Table 2). The initial efforts to sample Hutch debris were very effective; a 100-g rock sample, typical of the sample size processed at each of four laboratories, contained approximately an 8×10^{-10} fraction of the total Hutch debris. In comparison, early samples from the Mike explosion (aircraft filters) contained only a 4×10^{-14} fraction of that device. These recovery fractions, when combined with the mass yield data of Fig. 2, show that a much larger sample of heavy nuclides (1.3×10^{10} atoms with $A = 253-255$ before decay)

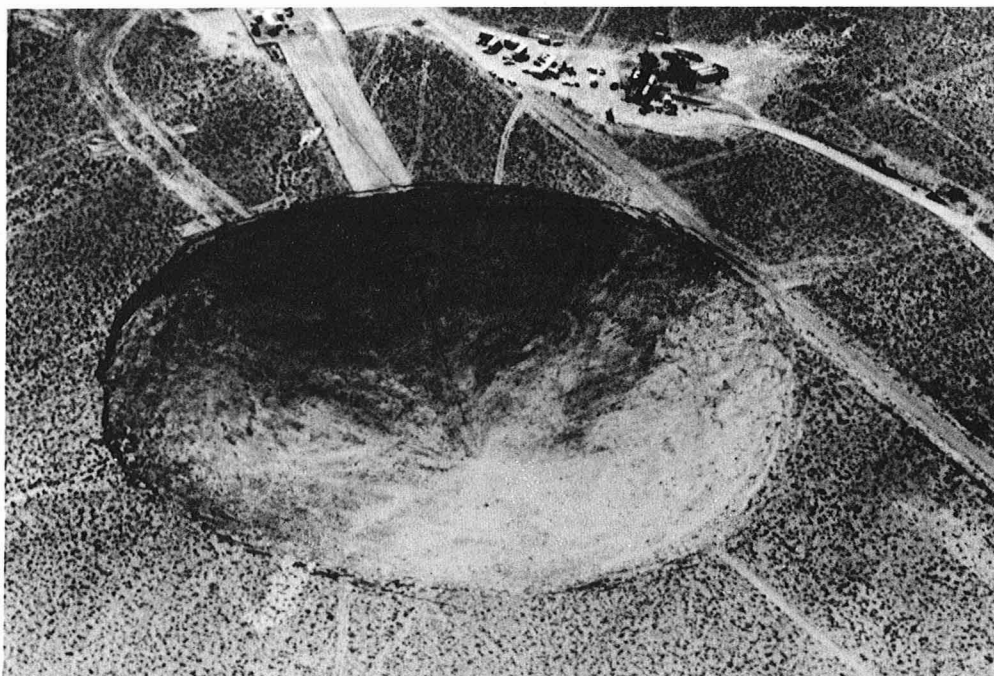

Fig. 5. Surface crater at the Nevada Test Site produced by the Hutch explosion, July 1969.

was available for laboratory study 7 days after the Hutch explosion than was available from the early sampling of Mike debris.

After the heavy nuclide content of the initial samples from each event was demonstrated in the laboratory, efforts were made to recover addi-

tional samples. Chemical processing of nearly a ton of coral samples containing Mike debris resulted in the isolation of 1×10^{-12} of the device, a significant improvement in total atoms of heavy nuclides available for experimentation. The larger scale recovery of samples (Phase II recovery) from the Hutch device was completed 60 days after the

Table 2. Comparison of sample recoveries for the Mike Event (a 10 000 kt atmospheric explosion) and the Hutch Event (an underground explosion in the range 20-200 kt).

Sample description	Fraction of total device
Mike Event	
Initial samples - aircraft filters	4×10^{-14}
Later coral samples	100×10^{-14}
Hutch Event	
Phase I samples - $T_0 + 7$ days	
Total recovery - 10kg rock	30×10^{-9}
Most concentrated sample - 0.4 kg rock	3×10^{-9}
Phase II samples - $T_0 + 60$ days	
Total recovery - 500 kg rock	$< 120 \times 10^{-9}$

explosion and resulted in the recovery of 500 kg of rock. However, the concentration of debris in this 500 kg was disappointingly low; the total fraction of the device debris in this batch was less than 4 times greater than was present in the initial recovery of 10 kg of rock. Thus, it was not judged worthwhile to process the rock from the Phase II recovery. The low concentration of device debris could be explained by the intrusion of water after the first samplings. Although the Hutch device was detonated below the water table, the extreme heat of the explosion drove the water away from the zone where debris was sampled. A few weeks after the explosion, water flowed back into the region and a normal water table was reestablished. Thus the Phase II recovery operations, which employed a new sampling technique involving under-reaming of the existing hole and collection of the material in a bucket below the reamer, were ineffective, apparently because the operation was performed under water. Developmental tests of this new recovery technique had been performed in a dry hole.

RAPID SAMPLE RECOVERY

A new rapid sample recovery technique was tried in the Anacostia and Kennebec Events⁵ in order to avoid the lengthy delays associated with drilling to 300-m depths. In each case, the sampling system consisted of a 25-cm-diameter vertical pipe that lead from near the nuclear device to four large holding tanks on the surface. The 230-m vertical section of pipe was filled with water containing a 50 wt% starch suspension to provide thixotropic properties to the fluid. The force of the explosion drove some device debris into this pipe. Debris entrained in the fluid mixture was carried to the surface where all of the fluid was collected in the holding tanks. The tanks were examined after the radioactivity had decayed. Between 10 and 40 kg of rock and device debris were found in the Anacostia tanks, while 360 kg of rock and device debris were collected in the Kennebec tanks. Analyses showed that the Pu concentrations in these rock samples were 25-33% of those found in the samples recovered by drilling. Thus, we see that these systems delivered experimentally useful quantities of device debris to the surface immediately following an explosion. In fact, the quantities of rock are comparable to those recovered in the initial Hutch drillback. Further development would be required to devise a system to separate rock and device debris from the large quantity of water-starch suspension and to manipulate the debris samples at early times when radioactivity is extremely high. Nevertheless, these demonstrations of a rapid sample-recovery technique are considered an important development with regard to the ultimate usefulness of heavy-element production by means of thermonuclear explosions.

ODD-EVEN YIELD VARIATION

We have already seen that a typical mass-yield curve exhibits an odd-even variation of the total atoms versus mass number. This phenomenon was observed in the data from the Mike Event, as well as in more recent events. A new feature, observed first in the 1960s, was that the odd-even effect

reversed somewhere in the vicinity of $A = 250$. Below $A = 250$, yields of the even-mass products are relatively higher than their odd-mass neighbors. Beyond $A = 250$, the effect is reversed. This behavior can be seen in the data for Cyclamen (Fig. 2) and for the Barbel Event⁶ (Fig. 6). In

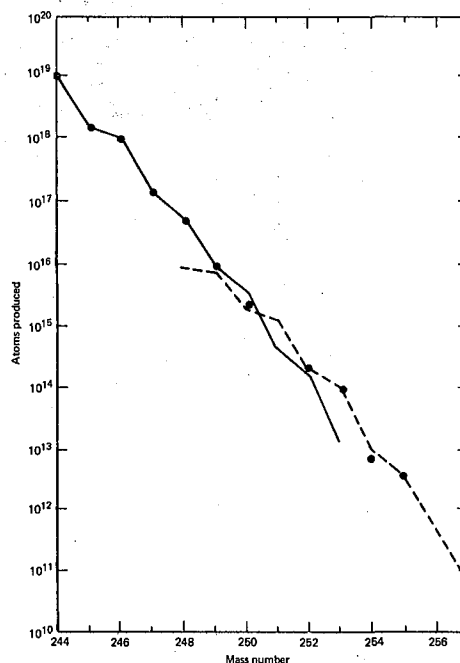

Fig. 6. Mass yield curve from the Barbel nuclear explosion. Experimental data are shown as solid circles. Calculated yields from the ^{238}U capture chain are shown as a solid line; calculated yields from the ^{238}Pa capture chain are shown as a dashed line.

order to explain this observation, Fields and Diamond⁷ suggested that the heaviest products are produced in a capture chain with odd Z , e.g., Pa or Np, while the lighter masses are produced in the uranium capture chain. When multiple captures occur in an odd- Z element, the yields are reversed because the cross sections for capture by even-mass nuclides (which are nuclides with both an odd proton and an odd neutron) are larger than for their odd-mass neighbors. This explanation has been tested quantitatively by Ingley⁸ and by Bell⁹ and provides good agreement with the experimental data. In Fig. 6, one can see that the relative linearity of the experimental yield curve is due to the superposition of two curves, both somewhat concave downward, with the heaviest products being derived from capture in the Pa isotopes. Although no Pa existed in the original target, conversion of the target through $^{238}\text{U}(n,p)^{238}\text{Pa}$ reactions provides the starting material for the Pa capture chain. Two variables in the fitting procedure are the amount of ^{238}U surviving fast-neutron fission ($N/N_0 = 0.95 \times 10^{-2}$) and the conversion of ^{238}U to ^{238}Pa ($N/N_0 = 1.6 \times 10^{-2}$).

A set of calculated cross sections for neutron-rich uranium isotopes are available from the work of Truran and Cameron¹⁰. These cross sections are estimated from statistical model calculations and are normalized to the measured ^{238}U capture cross section (0.6 b) at 20 keV. Ingley⁸ has fitted the mass-yield data from six underground nuclear explosions to produce a set of averaged experimental capture cross sections, which are compared with the calculated values of Cameron and Truran in Fig. 7. One can see the agreement with the calculated values is quite good. We also note that the lowest cross section occurs for ^{244}U , which presumably can be ascribed to the shell effect at 152 neutrons. For calculations of capture in a Pa chain shown in Fig. 6, Ingley⁸ used a set of cross sections calculated by Truran¹⁰.

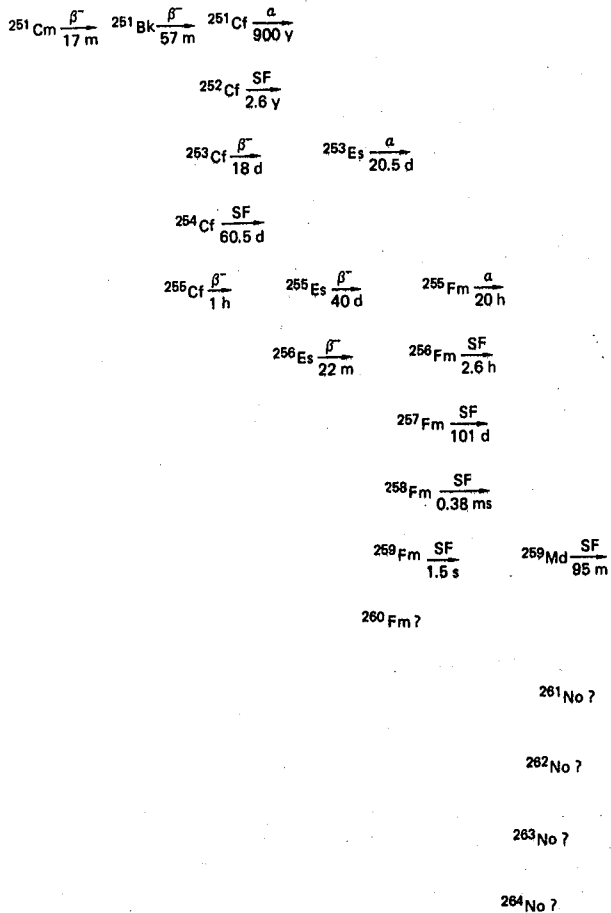

Fig. 8. Beta decay chains for $A = 251$ to $A = 264$.

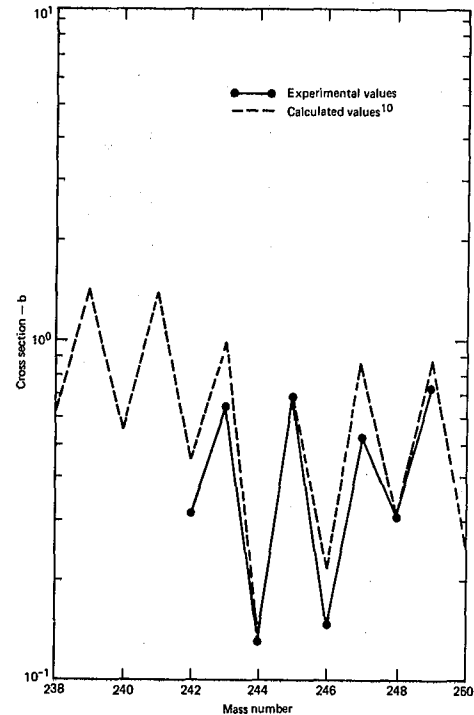

Fig. 7. Uranium isotopes cross sections for 20-keV neutrons. The experimental values are an average from fitting data from the Anacosta, Par, Barbel, Kankakee, Vulcan, and Cyclamen Events.

Although extrapolation of the production curves for Cyclamen and Hutch suggest that detectable amounts of nuclides with $A > 257$ were produced, the radiochemistry teams could find no evidence for new nuclides beyond ^{257}Fm . We show some of the beta decay chains in Fig. 8, where the last nuclide listed is beta stable and is usually the nuclide that was measured quantitatively in these experiments. In the search for new species, the best chance for detection might have been in the mass chains 259 and 261, each of which would be expected to produce a detectable isotope of mendelevium. These odd-mass chains would be depleted less by spontaneous fission. From the Cyclamen experiment the following limits were set for ^{259}Md :

$$t_{1/2}(\text{SF}) < 5 \text{ h or } > 15 \text{ y}$$

$$t_{1/2}(\alpha) > 30 \text{ y,}$$

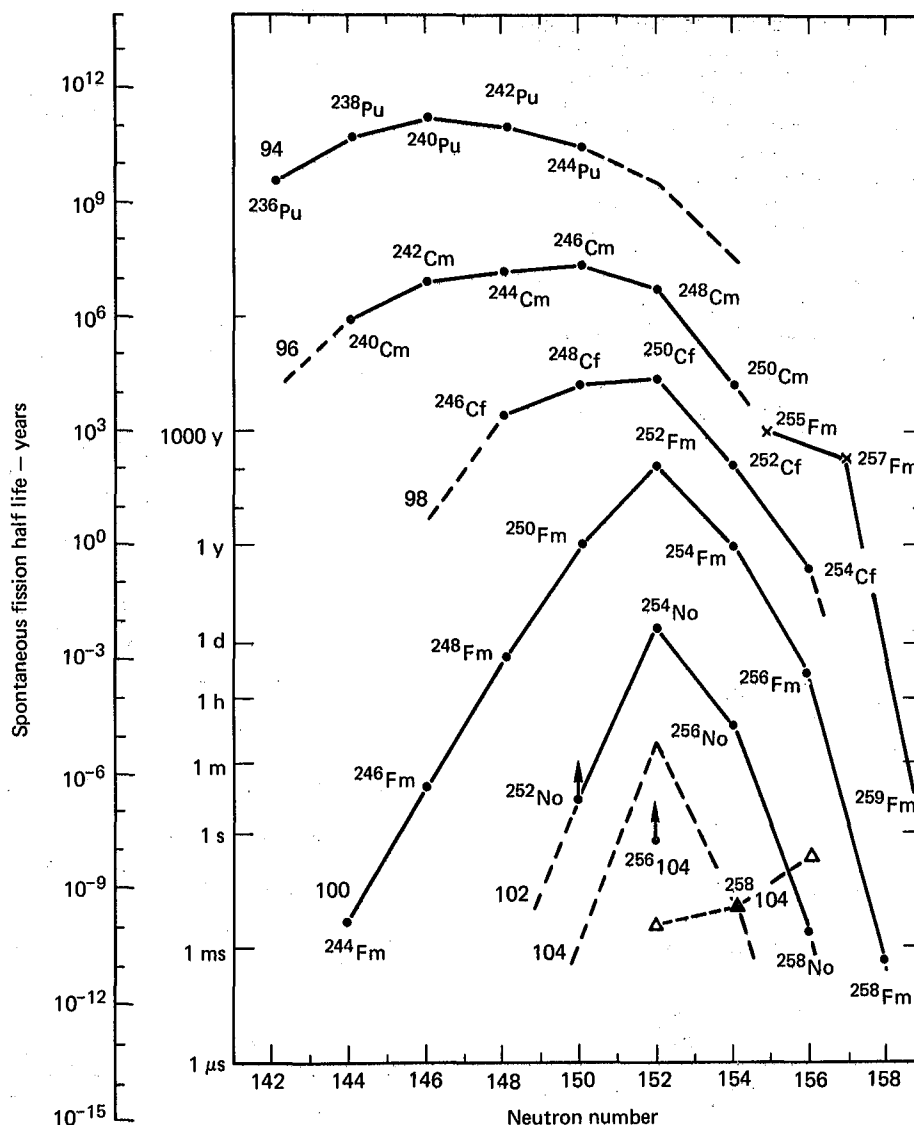

Fig. 9. Systematics of spontaneous fission half-lives.

and the corresponding limits for ^{259}Fm were:

$$t_{1/2}(\text{SF}) < 5.5 \text{ h or } > 7.5 \text{ y}$$

$$t_{1/2}(\alpha) > 30 \text{ y.}^2$$

From the Hutch experiments, the limits for ^{259}Md were:

$$t_{1/2}(\text{SF}) < 12 \text{ h or } > 1.25 \times 10^4 \text{ y}$$

$$t_{1/2}(\alpha) > 1.25 \times 10^4 \text{ y}$$

and the corresponding limits for ^{259}fm were:

$$t_{1/2}(\text{SF}) < 12 \text{ h}$$

$$t_{1/2}(\alpha) > 250 \text{ y.}^3$$

In related experimental work, the nobelium, lawrencium, and element-104 fractions were examined for evidence (SF or alpha activity) of the presence of nuclides with $A \geq 261$. Again, no evidence for new species was found by any of four teams working at separate laboratories. Since that time, Hulet and coworkers¹¹ have used an accelerator to produce ^{259}fm and ^{259}Md by charged particle reactions. They demonstrated experimentally that these nuclides have extremely short half-lives for spontaneous fission (See Fig. 8). The nuclides ^{259}Fm and ^{259}Md are the most neutron-rich species that have been detected to date. Their extremely short half-lives are part of a trend toward rapid spontaneous-fission that is shown graphically in Fig. 9. We see that the trend to short half-lives is quite extreme at $N = 158, 159$; beyond this point, we do not know if this effect changes and if spontaneous fission half-lives become long enough to

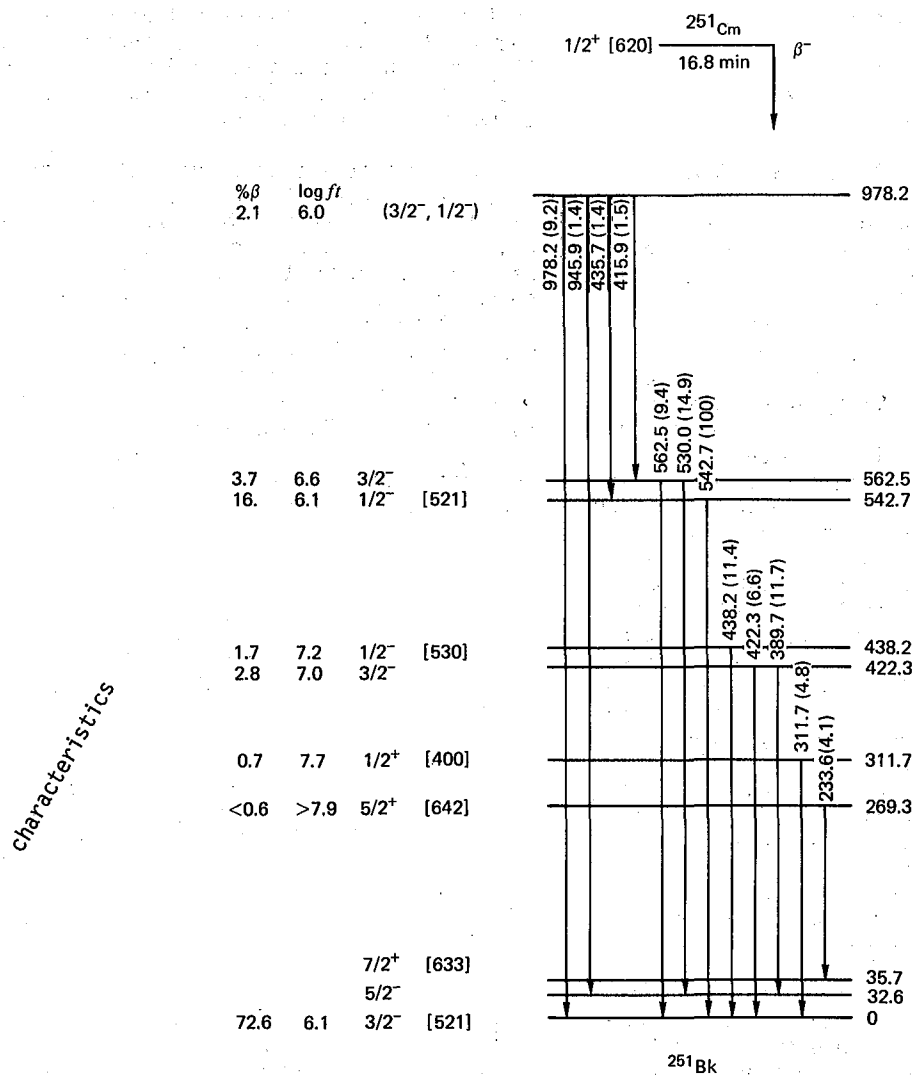

Fig. 10. Beta decay scheme of ^{251}Cm , a nuclide that was produced by irradiating a sample of Hutch curium with neutrons.

permit experimental detection of superheavy elements. There is one indication that the trend reverses, namely, the experimental results for isotopes of element 104 reported by Flerov and co-workers¹² and plotted as triangles in Fig. 9.

RESEARCH USING HUTCH-PRODUCED ^{257}Fm and ^{250}Cm .

Although no new nuclides or new elements were detected in these underground experiments, significant amounts of certain rare and heavy nuclides were produced in the explosion. Recovery of 10 kg of debris-rich rock and its subsequent processing provided larger amounts of ^{257}Fm and ^{250}Cm for the experimentation than had been available in the past.¹³ The Hutch detonation produced 6×10^{17} atoms of ^{257}Fm , of which 6×10^9 atoms were recovered. This ^{257}Fm was used in a series of significant experiments by Hulet and co-workers^{14,15} to discover an unexpectedly symmetric mode of fission accompanied by high kinetic energy release in

the thermal-neutron induced fission of ^{257}Fm , to discover a new isotope, ^{258}Fm , which has a very short half-life for spontaneous fission (0.38 ms), and to determine more precise values for the decay characteristics and thermal fission cross section of ^{257}Fm .

Another rare isotope, ^{250}Cm , was also recovered from the Hutch debris. There was enough ^{250}Cm available to do neutron capture irradiations, which led to the production of a new isotope, 17-min ^{251}Cm . Sufficient data were obtained in the study by Loughed, et al.¹⁶ to produce a detailed level scheme of ^{251}Bk as shown in Fig. 10. The abundance of ^{250}Cm in the Hutch curium was 6.7 at. %. This high ^{250}Cm content is a significant feature of the Hutch curium fraction. Reactor production of heavy curium isotopes does not produce appreciable amounts of ^{250}Cm because its production depends upon competition between beta decay

and neutron capture of 64-min ^{249}Cm , which has a thermal neutron capture cross section of 2.8^{D} . Even at the flux level of the HFIR (5×10^{15} n/cm 2 -s), only 0.02% of the ^{249}Cm atoms undergo capture and are converted to ^{250}Cm .

FUTURE DIRECTIONS FOR HEAVY-ELEMENT SYNTHESIS

As a final topic, I wish to discuss the possible future exploitation of synthesis in nuclear explosions. If one considers the problem of generating increased neutron fluxes in order to produce and detect nuclides beyond $N = 158$, a number of questions arise. For example: Where does the region of catastrophic rapid spontaneous fission, which dominates nuclear stability around $N = 157$, end? The shell model of the nucleus suggests that heavier nuclei will be stabilized because of the presence of closed shells in heavier regions, just as subshells occur at $Z = 100$ and $N = 152$ and major shell closings occur at $Z = 82$, $N = 126$. The current belief with respect to superheavy elements is that stabilization will occur near nucleon numbers, $Z = 114$ and $N = 184$. As a result, nuclides in this region might be long-lived enough to permit detection. However, at this time, theoretical predictions of spontaneous lifetimes for nuclides in the region $Z > 100$ and $N > 158$ are uncertain to several orders of magnitude. The Hutch and Cyclamen experiments provided opportunities to detect nuclides at heavier masses than 258; it appears that there was sufficient production of nuclides up to mass 263 to permit detection of their characteristic radiations within the limits stated. Our inability to detect new species in the mass range $A = 258$ -263 was apparently due to the very short spontaneous fission half-lives for these nuclides.

The multiple-capture production path to superheavy nuclei requires extremely high neutron fluxes; it is a completely different approach than methods involving heavy-ion bombardment where one attempts to force rather massive projectiles to at least partially fuse with heavy target atoms. While the products from almost any heavy-ion reaction tend to be neutron deficient, our technique involves the absorption of many neutrons by a $Z = 91$ or 92 nucleus before any other reactions can occur. The relatively beta-stable product nuclei are approached from the direction of extreme neutron richness. Success depends upon how many very heavy atoms can be produced in the multiple neutron-capture reactions, and how well these atoms survive during beta decay to a beta-stable product.

Another question is: Can samples be recovered rapidly and can new species in these samples be detected at short times following a nuclear explosion? We have already referred to experiments that demonstrated the feasibility of rapidly recovering samples that represent fractions of the device that are comparable to those recovered by drill-back techniques. Meldner, et al.¹⁷ discussed the use of neutron counters to detect events with high neutron multiplicity ($\bar{\nu} > 5$) that are characteristic of the spontaneous fission of nuclei with $A > 258$. They conclude it would be feasible to record 10^3 events from the spontaneous fission of a mass-265 species in a device fraction of only 1×10^{-12} if the lifetime of this species is > 30 s. Other assumptions in their calculations are that one can

design and field a thermonuclear device that subjects a ^{238}U target to a time-integrated neutron flux of about twice that obtained in the Hutch Event and that the resultant production of mass-265 atoms will be 10^{16} atoms.

It is possible that a successful effort to produce heavier elements may require a combination of high flux multiple neutron capture (to produce a heavy, neutron-rich target material) and charged-particle bombardment with heavy ions. A proposed search for superheavy elements developed by Hulet, et al.¹⁸ begins with the production of a large quantity of ^{250}Cm in a Hutch-like nuclear explosion in a natural salt formation. This nuclide would serve as target material for ^{238}U -ion bombardments. For a good experimental program, one needs about $100 \mu\text{g}$ (2.4×10^{17} atoms) of target material. If the device is exploded in a natural salt formation, the recovery of sufficient ^{250}Cm appears feasible.

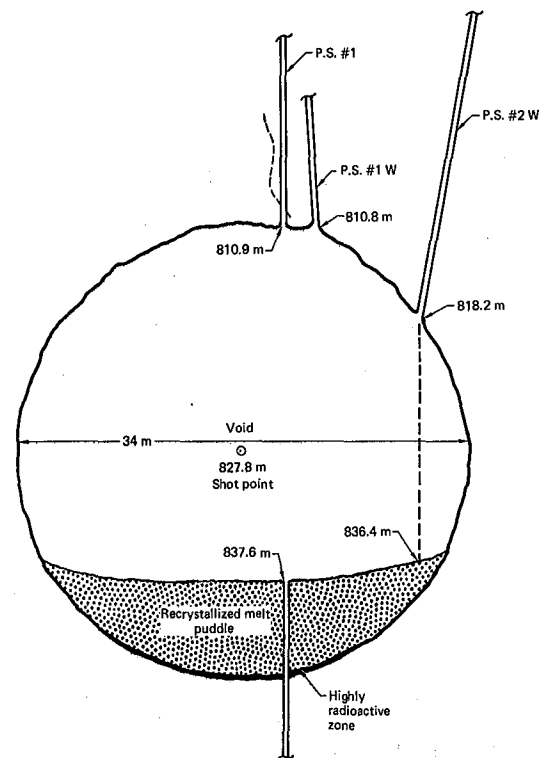

Fig. 11. Schematic drawing of the cavity produced in molten salt by the Salmon explosion, detonated in October 1964 in Mississippi.

There have been two nuclear explosions in the U.S. in natural salt formation; these were the Salmon (1964) and Gnome (1961) Events. In Fig. 11, we see a schematic drawing of the cavity created by the Salmon explosion, in which a 5.3-kt device was detonated at a depth of 828 m. The energy released by the explosion melted and vaporized the surroundings, 90% NaCl , with the formation of a spherical cavity. As cooling progressed, molten salt on the walls of the cavity formed a puddle containing about 5400 metric tons of material at

the bottom. As the puddle cooled, certain oxide and silicate minerals began to precipitate at temperatures of the order of 2000°C. Various radioactive elements that are somewhat refractory, for example, the actinides and the rare earths, were concentrated in the insoluble fraction, which was subsequently found to be principally $\text{Ca}_2\text{Al}_{0.6}\text{Fe}_{1.4}\text{O}_5$ and $\beta\text{-Ca}_2\text{SiO}_4$. These oxide-silicate minerals settled to the bottom of the molten salt puddle to form a highly radioactive zone of material whose specific activity was approximately 100 times that of the NaCl. Thus, most of the refractory device debris is contained in a shallow (1-m thick) lens consisting of about 50 metric tons of oxides.

Hulet, et al.¹⁸ propose that following explosion of a Hutch-like device in a natural salt formation, and after the rather slow cooling of the molten salt and eventual solidification (perhaps requiring as much as 18 months), the actinide-rich ore be mined. Between 50 and 100 tons of this material would be chemically processed to yield perhaps as much as 250- to 500- μg ^{250}Cm . This very rare isotope would then serve as target material for heavy-ion bombardments with ^{238}U , and other projectiles, in order to test this promising approach to the production of superheavy elements.

REFERENCES

1. A. Ghiorso, M. H. Studier, C. I. Browne, et al., *Phys. Rev.* **99**, 1048 (1955).
2. D. C. Hoffman, *Arkiv for Fysik* **36**, 533 (1966); Los Alamos Radiochemistry Group, USAEC Report LA-DC 8103 (Revised) (1966).
3. S. F. Eccles and E. K. Hulet, Lawrence Livermore Report UCRL-50767, October 1969; S. F. Eccles, in Proceedings of the ANS Topical Meeting, Engineering with Nuclear Explosives, Las Vegas, NA, January 14 - 16, 1970, p. 1269; R. W. Hoff and E. K. Hulet, *ibid*, p. 1283.
4. H. Diamond, A. Ghiorso, C. I. Browne, et al., *Phys.*, *Rev.* **119**, 2000 (1960).
5. J. D. Brady, "Evaluation of the Prompt Sample Systems Used for the Anacostia and Kennebec Experiments", Lawrence Livermore Report UCRL-50441, March 1968.
6. Los Alamos Radiochemistry Group, *Phys. Rev. Letters* **14**, 962 (1965).
7. P. R. Fields and H. Diamond, private communication, December 1964.
8. J. S. Ingley, *Nucl. Phys. A* **124**, 130 (1969).
9. G. I. Bell, *Phys. Rev.* **158**, 1127 (1967); G. I. Bell, *Phys. Rev. B* **139**, 1207 (1965); G. I. Bell, *Rev. Mod. Phys.* **39**, 59 (1967).
10. J. W. Truran, C. J. Hansen, A. G. W. Cameron, and A. Gilbert, *Can. J. Phys.* **44**, 151 (1966).
11. E. K. Hulet, et al, D. C. Hoffman, et al., in Proceedings of the International School-Seminar on Reactions of Heavy Ions with Nuclei and Synthesis of New Elements, Dubna, U.S.S.R., Sept. 23-Oct 4, 1975; J. F. Wild, E. K. Hulet, R. W. Lougheed, J. H. Landrum, J. M. Nitschke, R. F. D. Lundquist, and A. Ghiorso, *Am. Chem. Soc. Nat. Meeting, Anaheim, CA, March 12-17, 1978*.
12. V. A. Druin, et al., *Yad. Fiz.* **24**, 254 (1976); G. M. Ter-Akopyan, et al., *Nucl. Phys. A* **255**, 509 (1975); Y. T. Oganessian et al., *Nucl. Phys. A* **239**, 353 (1975).
13. R. Quong and J. R. McNabb, Lawrence Livermore Report UCRL-50499, October 1968; R. Quong and J. O. Cowles, Lawrence Livermore Report UCRL-50847, April 1970.
14. E. K. Hulet, J. F. Wild, R. W. Lougheed, J. E. Evans, B. J. Qualheim, M. Nurmia, and A. Ghiorso, *Phys. Rev. Letters* **26**, 523 (1971).
15. W. John, E. K. Hulet, R. W. Lougheed, J. J. Wesolowski, *Phys. Rev. Letters* **27**, 45 (1971); J. F. Wild, E. K. Hulet, and R. W. Lougheed, *J. Inorg. Nucl. Chem.* **35**, 1063 (1973).
16. R. W. Lougheed, J. F. Wild, E. K. Hulet, R. W. Hoff, and J. H. Landrum, *J. Inorg. Nucl. Chem.* (to be published, 1978).
17. H. W. Meldner, G. A. Cowan, J. R. Nix, and R. W. Stoughton, *Phys. Rev. C* **13**, 182 (1976).
18. E. K. Hulet, S. F. Eccles, and R. A. Heckman, private communication, November 1973.

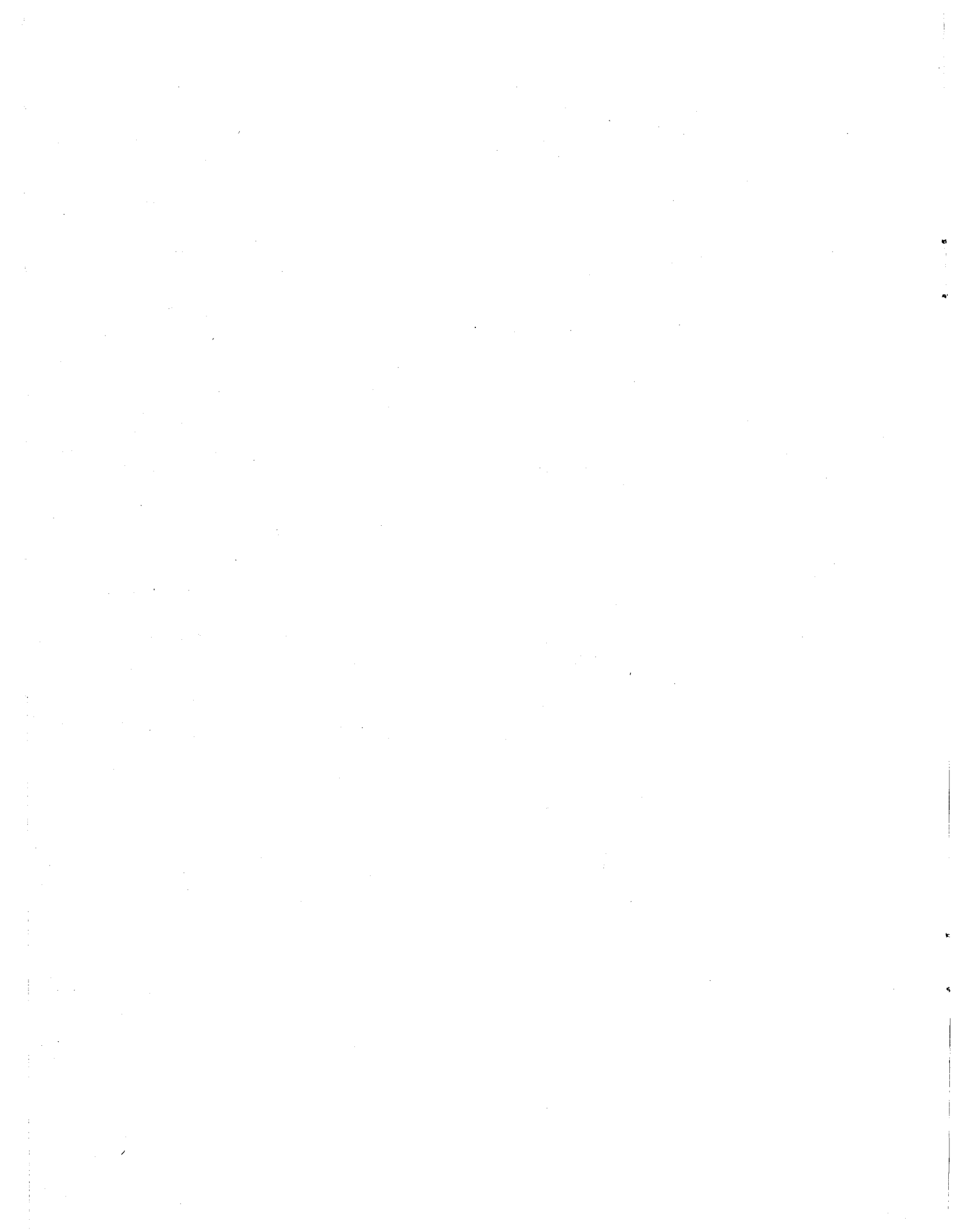

Introduction of E. Kenneth Hulet Dr. Seaborg

The next two scientists, who will discuss the chemical properties of einsteinium, are Ken Hulet and Joe Peterson. Ken Hulet will talk first. He received his B.S. degree in chemistry at Stanford University in 1949. He came to Berkeley and completed his graduate work here in 1953 in the Nuclear Chemistry Division of the Radiation Laboratory. He received his Ph.D. under my direction, but he worked independently for the most part with help from Stan Thomson, in his Ph.D. program. He then joined the staff at the Lawrence Livermore Labora-

tory in nuclear chemistry where he has done work in many areas, including a great deal of work in actinide chemistry and the nuclear properties of the actinide elements. Since 1966 he has held the position of group leader on heavy elements in the nuclear and radiochemistry section. Recently he played a key role in the synthesis and identification of the latest transuranium element, element 106. Ken will be the first of the two, then, to discuss the chemical properties of einsteinium.

Chemical Properties of Einsteinium: Part I E. Kenneth Hulet

Joe Peterson and I have divided the discussion into the fields of actinide chemistry we each thought we knew best; therefore, I am talking about the ionic and solution chemistry, and Joe will talk about the absorption spectrum of the solid state chemistry of einsteinium.

I wanted to make several remarks about the early history of the chemistry of einsteinium. The opportunity to study einsteinium was largely dependent on the amounts available. In the very first few years after the discovery of this element in the Mike explosion, very little of it was being made except in the few napkin-ring irradiations. These irradiations only yielded a few thousands of counts a minute, not the micrograms or fractions of a microgram that were necessary to study the chemistry in detail. I've made a graph (Fig. 1) similar to

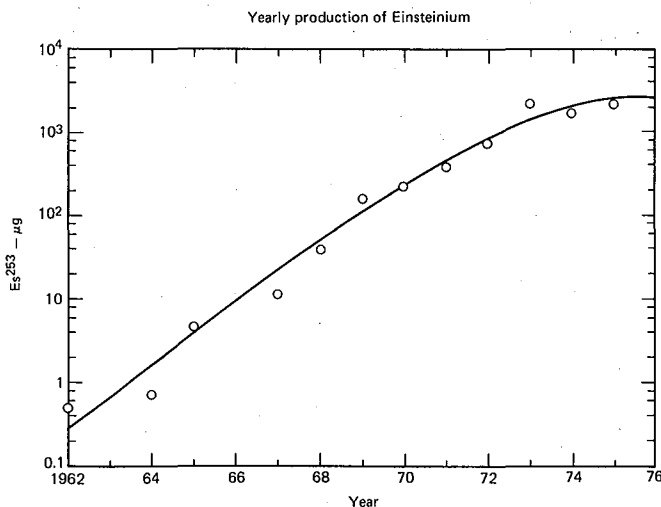

Fig. 1. Yearly production of einsteinium.

one that Don Ferguson showed earlier. Some of the earliest productions of einsteinium are included, and as you can see it wasn't until 1961 that the first fractions of a microgram became available, and this was recovered in Berkeley. Later Burris Cunningham used some of this material to study the magnetic susceptibility of Es. However, by 1962 we had recovered approximately half a microgram at Livermore and Earl Worden and Ralph Gutmacher used a fraction of this to measure the absorption and emission spectra. A total of seven lines were observed in the initial spectra after subtracting a background due to the carrier element, lanthanum. In about 1964, we again recovered approximately a half to one microgram of einsteinium and several experiments were repeated. Berkeley was also carrying out processing in this period under Sherman Fried and later Robert Latimer. It wasn't until 1968 that enough einsteinium had been produced to allow more detailed studies to be made. At that time, we made several discharge lamps containing Es, and Earl Worden found over 400 lines that were due to einsteinium. All of these investigations used einsteinium-253 because this is the major isotope produced in nuclear reactors. About 1969 the TRU facility began to produce larger quantities so we stopped our production program and focused our effort toward research. You can see from Fig. 1 that Es production is now on the order of several milligrams a year, and that production is leveling out because of the limited capacity of the HFIR reactor.

I wanted to say just a few words about the chemical separation methods we employed in the early hot-cell operations at Livermore. They were nearly identical to the present-day chemistry being used in the TRU facility. We employed lithium chloride anion-exchange to separate heavy actinides from lanthanide fission products. The original capsules from the MTR (and later the Savannah River Reactor) were dissolved in a NaOH-NaNO₃ solution. The only

difference between the chemistry then and now is that in the earlier period we removed the berkelium at an early stage in the separations.

Other than production, there have been additional problems in the study of einsteinium. With the 20-d einsteinium-253, einsteinium can be studied only for a short period of time before it is half berkelium-249, and eventually californium-249 grows into the samples from the decay of $^{320}\text{d } ^{249}\text{Bk}$. Therefore, in a freshly purified sample, there are literally just a few days to study the properties of pure einsteinium. After that, corrections are required for the berkelium accumulating in the samples.

The second problem with studying berkelium is the very large heat output from α -decay. In solution, radiolysis seriously disturbs the absorption spectra because the hydrogen peroxide being formed absorbs very strongly in the ultra-violet wavelengths. The amount of heat is enormous -- it's 3500 kilocalories per mole or more than 100 electron volts per molecule. In solid phases the structure is totally disrupted so that samples require annealing and reannealing during the study of their recrystallographic properties. In studying the optical absorption in crystalline samples, a strong and often overpowering background arises because of the formation of color centers.

As for separations, very little can be said because the methods used for all trivalent actinides have not changed much over the years. The separations of einsteinium from californium is extremely poor, but separations from fermium are quite good. As shown in Fig. 2, the α -hydroxyisobutyric acid

	Es separations	
	Extraction Chromatograph HDEHP	Ion Exchange HIBUT
Es/cf	1.02	0.70
Fm/Es	2.20	
Md/Es	9.7	

Fig. 2. Es separations.

(HIBUT) separation is clearly the better of the two complexants indicated for separating einsteinium from californium. The separation factor for einsteinium and fermium is not listed for HIBUT, but it is about 0.5. When we compare the elution sequence using HIBUT with that using di(2-ethylhexyl) phosphoric acid (HDEHP), we note an inversion with respect to atomic number. The sequence is monotonic with increasing Z with di(2-ethylhexyl)-phosphoric acid, and is the reverse case for the α -hydroxyisobutyric acid.

Studies of the complex-ion chemistry of einsteinium have been made in conjunction with measurements of stability constants of the other trivalent actinides. A summary of the known stability constants for Es complexes are shown in Fig. 3. The only

Stability Constants of Es^{3+} Complexes	
Outer Sphere	
Es Cl^{2+}	$\log \beta_1 = -0.18$
Inner Sphere	
Es OH^{2+}	$\log t_1 = -5.05$
Es SO_4^+	$\beta_1 = -2.19$
Es $(\text{SO}_4)_2^-$	$\beta_2 = -4.3$
Es $(\text{SO}_4)_3^{3-}$	$\beta_3 = -4.93$
Es $\text{H}(\text{Cit})^{2-}$	$\beta_1 = 10.6$
Es $(\text{Cit})_2^{3-}$	$\beta_1 = 12.1$
Es (α -But)	$\beta_1 = 4.29$
Es (tartaric)	$\beta_1 = 5.86$
Es (Malic)	$\beta_1 = 7.06$
Es (DETPA)	$\beta_1 = 22.62$
Es (DCHTA)	$\beta_1 = 12.10$

Fig. 3. Stability constants of Es^{3+} complexes.

outer-sphere complex that has been measured is the monochloride. In this case, the waters of hydration are located between the chloride and einsteinium atoms. On the other hand, the inner-sphere complex anion is inside the hydration sphere and electrostatically bonded to the metal ion. The inorganic anions generally yield small and similar stability constants, while the organic chelates that form ring structures with the metal ion provide much stronger complexes. If we consider the amino acids, we find that the stability constants become very high. The diethylenetriaminepentacetic acid is a cyclo ring compound of an amino acid.

One of the best investigations of complexation is a study of thiocyanates complexing of the trivalent actinides by Harmon and Peterson. These results are shown in Fig. 4. The first and third stability constants are quite large and increase with atomic number, e.g., while the second stability constant rapidly falls-off with increasing Z. The third stability constant, while similar to that of the first, exhibits a sharp increase just beyond the half-filled 5f electron shell. This is related to the tetrad effect observed with many complexing agents and extractants. These results can be applied to interpreting the separations using anion-exchange of thiocyanate complexes of actinides and lanthanides. This method is occasionally used to separate the two series of elements because of the greater complex strength of the actinides compared to the lanthanides. From Fig. 4, one can estimate that a large portion of the actinide ions exist as complexes in $1 \text{ M } \text{NH}_4\text{SCN}$.

The divalent oxidation state of einsteinium is of major importance and a number of experiments have been carried out on the divalent state since 1967. The first of these was by J. Maly and it

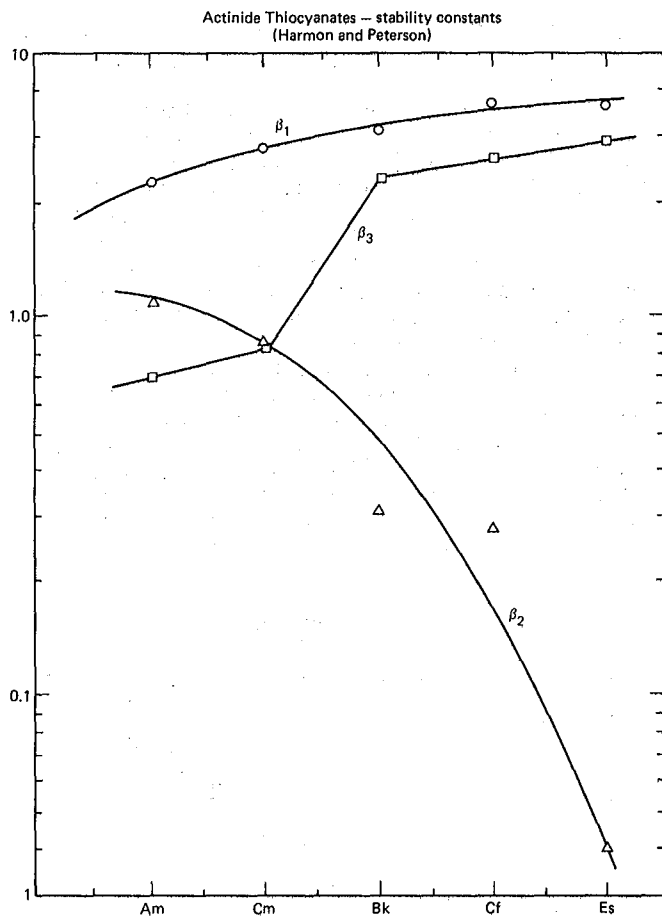

Fig. 4. Actinide thiocyanates -- stability constants (Harmon and Peterson).

concerned the reduction and amalgamation of einsteinium and californium. (He also worked with fermium and mendelevium.) In the early 1970's, Nikolji Mikheev and his colleagues in the Soviet laboratories identified a divalent oxidation state by precipitation experiments after they had reduced Es (III) to Es (II) with SmCl_2 . They also attempted to estimate the oxidation potential (II \rightarrow III) by determining the extent of reduction when YbCl_2 was employed as a reductant. Their results tended toward an oxidation potential close to that of Sm (II \rightarrow III) or roughly 1.55 V. In recent years, David and Samhoun performed radiopolarography in order to estimate electrode potentials for the reduction of Es. In our research, evidence for Es (II) was obtained when tracer quantities were reduced with SmCl_2 in ethanol solutions. Thus, we view the divalent state as confirmed but the oxidation potential should be regarded as uncertain.

Interpretations of the data obtained from amalgamation experiments, such as those of J. Maly, have continued to be very questionable. In these experiments, lanthanide and actinide ions, that had been complexed by citric acid, were reduced to the metallic state by contact with Li(Hg) amalgams. Although virtually all lanthanides and actinides can be reduced, as determined by their presence in the amalgam, their rates of amalgamation vary over

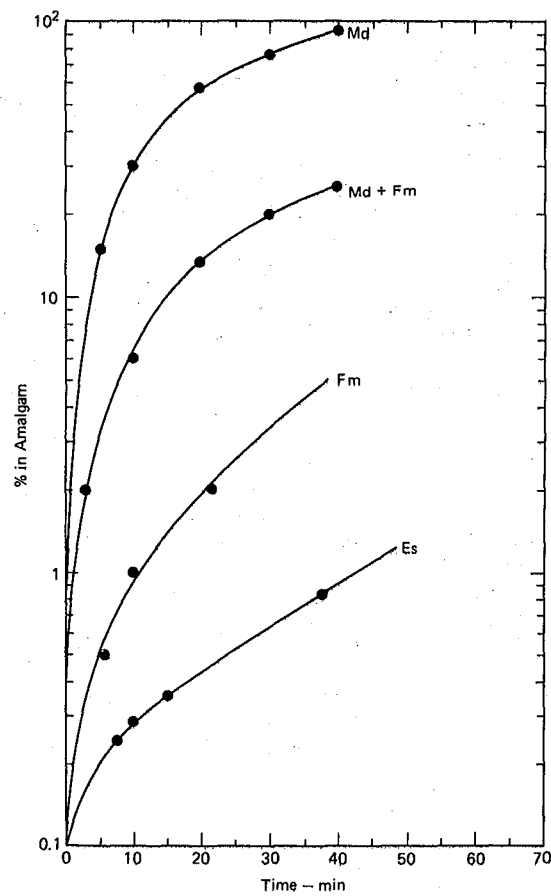

Fig. 5. Amalgamation rates (J. Maly).

a range of $\sim 10^5$. Because the most rapid rates of amalgamation were associated with Eu and Yb in the lanthanides, it was assumed that a quasi-stable, dipositive state was responsible for the enhanced rates. The actinides, from Es to Md, also showed relatively rapid rates which increased with atomic number (Fig. 5). Maly and then Nugent claimed this as evidence for a dipositive oxidation state in these elements. As I shall explain shortly, the amalgamation rates by themselves will not support such a conclusion.

L. Nugent attempted to place the amalgamation rates into two classes. The first class consisted of elements that are only slowly extracted and where reduction through an intermediate divalent state is very unlikely. Class 2 contained those elements known to be divalent and rapidly extracted by the amalgam. This classification procedure is quite arbitrary because, within each class, there is a broad range of amalgamation rates and the rates between classes have some overlap. The most telling argument against using amalgamation rates as an indicator of divalency is that lanthanum, actinium, uranium, and plutonium are rapidly extracted by these amalgams, and yet, we know these elements do not form stable divalent oxidation states. The amalgamation rates of La and Ac are comparable to those of Sm, Fm, and Md; hence, the correlation with divalency is unjustified.

Radiopolarography, as applied to einsteinium and other actinides, is another area in which there has been divergences of opinion with regard to interpreting the measurements. After examining the disagreements over the chemical potentials derived from the data, I became concerned about the methods of converting measured amalgamation potentials to standard potentials. In radiopolarography, a half-wave curve is obtained by determining the amount of tracer element extracted into the mercury falling from a dropping-mercury cathode held at fixed potentials. A series of measurements, each at different potential, is required to construct a half-wave polarogram. Several half-waves may appear and this has led to uncertainty in the assignment of the waves to specific reduction couples and/or other causes. As an example, F. David measured half-wave amalgamation potentials for a series of trivalent actinides and lanthanides and assigned the first half-wave of each polarogram to the III + 0 couple. On the other hand, L. J. Nugent believed these same half-waves represented II + 0 reductions and arrived at a new interpretation based on his systematics of amalgamation rates (Class 1 or Class 2 elements). The results of these divergent interpretations, as shown in Fig. 6, gave drastically different values for several of the standard II + III oxidation potential calculated from the polarograms. Another disturbing result, also noted in Fig. 6, is an inversion in slope, dE/dZ , for the 0 + II potential.

$E^\circ (\text{An}^{2+} \rightarrow \text{An}^{3+} + e^-)$						
	Ac	Am	Cm	Cf	Es	Fm
(David)	1.6	1.5	1.5	1.4	—	0.8
(Nugent)	4.9	2.3	4.4	1.6	1.3	1.0

$E^\circ (\text{An}^\circ \rightarrow \text{An}^{2+} + 2e^-)$	
(David)	$dE^\circ/dZ < 0$ (neg.)
(Nugent)	$dE^\circ/dZ > 0$ (pos.)

Fig. 6. Different values for half-wave amalgamation potentials.

These earlier problems seem to have been resolved after K. Samhoun and F. David recently remeasured the half-wave potentials for Am, Cm, Bk, Cf, Es, and Fm. With improved techniques and a better accounting of diffusion rates, they eliminated the inconsistencies in their previous measurements and interpretations. They observed a single half-wave, generally representing only the III + 0 reduction potential. For Fm, they presented evidence (absence of a large shift in the reduction potential in a complexing media of citric acid) that the reduction couple measured was the II + 0. A further result coming from this new data is that Nugent's earlier analysis of the radiopolarographic data largely fell apart because his classification

method placed Cf and Es in Class 2 whereas the new data showed they should be Class 1 (III + 0).

Although the measured half-wave potentials are quite accurate ($\pm 5\text{mV}$), larger and perhaps major uncertainties are encountered when standard electrode potentials are derived from the half-wave potentials. The measured half-wave potentials contain an energy of amalgamation, ΔE , that can be estimated only from the amalgamation energies derived for comparable elements. The amalgamation potential for many elements has been obtained by taking the difference between the measured half-wave and standard electrode potentials. An unknown amalgamation potential is then estimated by interpolation within an intra-series group of similar elements. A linear correlation with the atomic radii is indicated by most of the elements within a Periodic series, but not always. An example taken from Nugent's analysis is shown in Fig. 7. His interpolated values for Cf, Es, and

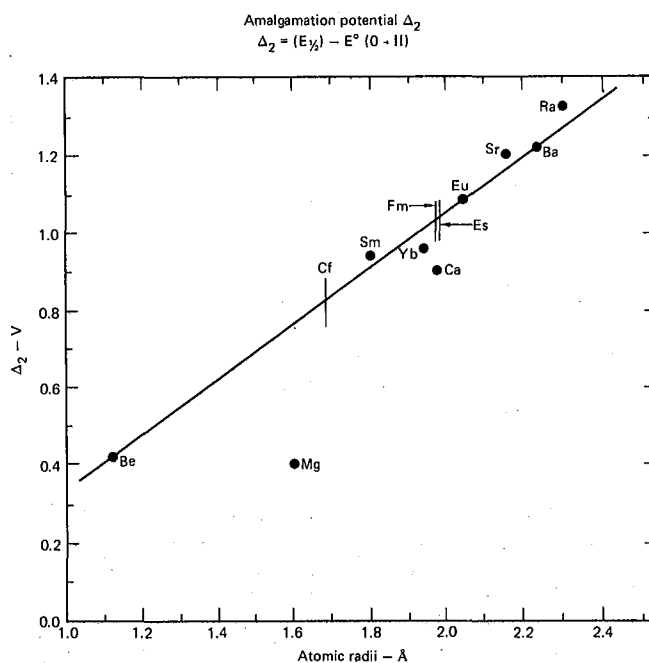

Fig. 7. Amalgamation potential Δ_2 .

Fm are shown as vertical lines, but only the Fm amalgamation potential should have been comparable in this correlation to the other divalent species. The point for Mg is so distant from the correlation line, that we should be suspicious of either the correlations or of the Mg data.

The amalgamation potentials derived for the actinides and lanthanides reduced to the metals from the III oxidation state are about half of those reduced from the II state. The correlations of (III + 0) amalgamation potentials with the atomic radii of the metals are much poorer than for (II + 0) correlations shown in Fig. 7. The actinides and lanthanides fall on two separate but

parallel lines; however, the uranium and lanthanum points are well separated from either line.

In sum, one should be cautious in using radiopolarographic potentials for making quantitative judgments about the stability of the divalent

oxidation state in the actinides. The amalgamation potential represents a large correction in obtaining standard electrode potentials from the half-wave measurements and a reliable estimation of these corrections cannot be guaranteed because of the poor theoretical understanding of their basis.

Introduction of Joseph R. Peterson

Dr. Seaborg

Joseph Peterson will also discuss the chemistry of einsteinium. Joe Peterson is 35 years old and I've known him for about 35 years. He was born about six days AFWP (six days after the first weighing of plutonium). That would make it September 16, 1942. Helen and I met him after his family had moved to Chicago early in 1943, where his father began to work at the Met Lab. He received his A.B. degree in chemistry from Swarthmore College in 1964 and his Ph.D. in 1967 in chemistry here at the University of California in the Nuclear Chemistry Division, working with Burris Cunningham. This was approximately 30 years after his father received

his Ph.D. degree here; he was a graduate student at about the same time I was. After receiving his Ph.D., Joe became a faculty member at the University of Tennessee where he continues to hold an Associate Professor of Chemistry position in Knoxville, with connections to the Oak Ridge National Laboratory. During the academic year 1969-70 Joe was a NATO Post-Doctoral Fellow in Science at the University of Liege in Belgium. His work has been concentrated in the areas of systematic and basic chemistry of heavy transuranium elements. Joe will speak on the chemical properties of einsteinium.

Chemical Properties of Einsteinium: Part II

Joseph R. Peterson

We heard this morning from the reminiscers about staying up all night to wait for precipitates to dissolve or wait for solutions to evaporate to dryness. I have, I suppose I can say now, fond memories of staying up all night with my Ph.D. research director Professor Burris Cunningham when we began to make the first solution absorption spectroscopic measurements of einsteinium twelve years ago. We had been developing techniques for such measurements on the few-microgram scale as part of my thesis research on berkelium, and when the einsteinium became available, it was obvious to try it. We carried out the first einsteinium experiment on January 24, 1966 (exactly twelve years ago tomorrow!) with only 500 nanograms of Es-253. Listening to Ken just a few minutes ago, I thought how dedicated one must be to tackle a study of the chemistry of einsteinium when one considers the inherent problems of very rapid decay and the limited quantities available for study. The key number that expresses this rapid decay is 3.3% berkelium ingrowth per day. So in just two days you have less than 95% pure einsteinium samples -- hence we were staying up all night to do these experiments as rapidly as possible.

The ingenious capabilities of Burris really came to the fore in the development of our so-called light-pipe, microabsorption cell, shown diagrammatically in Fig. 1. An overview of an actual cell is shown in Fig. 2. A photomicrograph of the light-pipe area, where the droplet of einsteinium solution was placed, is presented as Fig. 3. Loading the cell with the einsteinium solution was no trivial task, and that's part of the role I played. An indication of how this task was accomplished is depicted in Fig. 4. We are looking down into a flat-topped, gloved box where the cell could be loaded under conditions of radioactivity containment and good visibility (with the aid of a microscope). The microabsorption cell was protected from contamination through handling by a plastic cover over each half so that the Es-loaded cell would be free of external contamination for placement into the Cary Model 14 Recording Spectrophotometer. Einsteinium, in about one microliter of HCl solution, was drawn into the quartz capillary pipet (held in the micromanipulator), expelled to form a droplet hanging on the outside of the capillary tip, allowed to evaporate to a volume of about 60 nanoliters, and transferred to

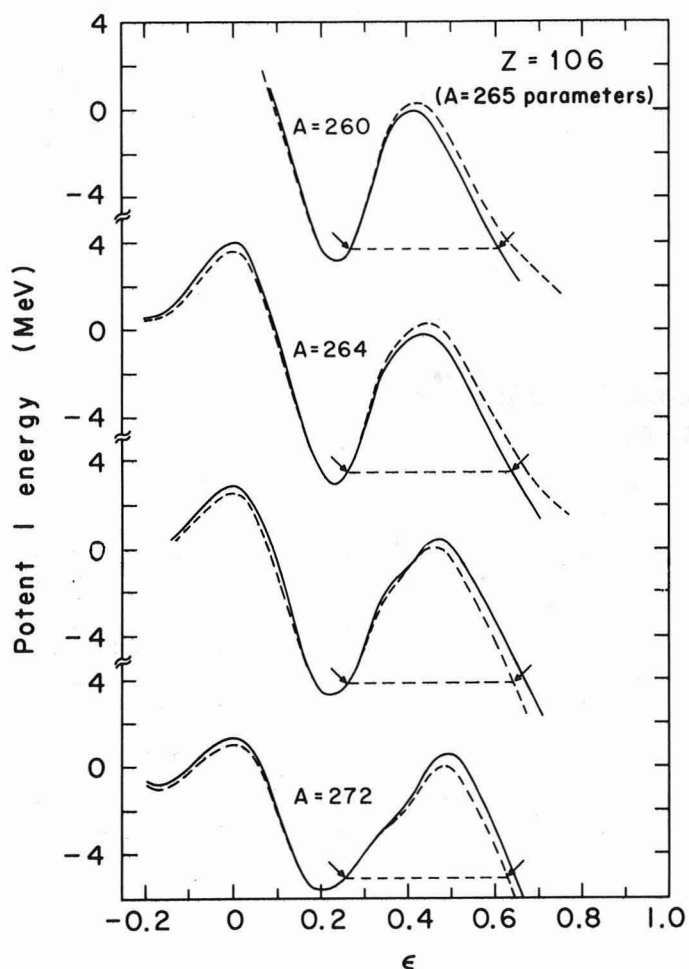

Fig. 1. Diagram of a light-pipe, microabsorption cell.

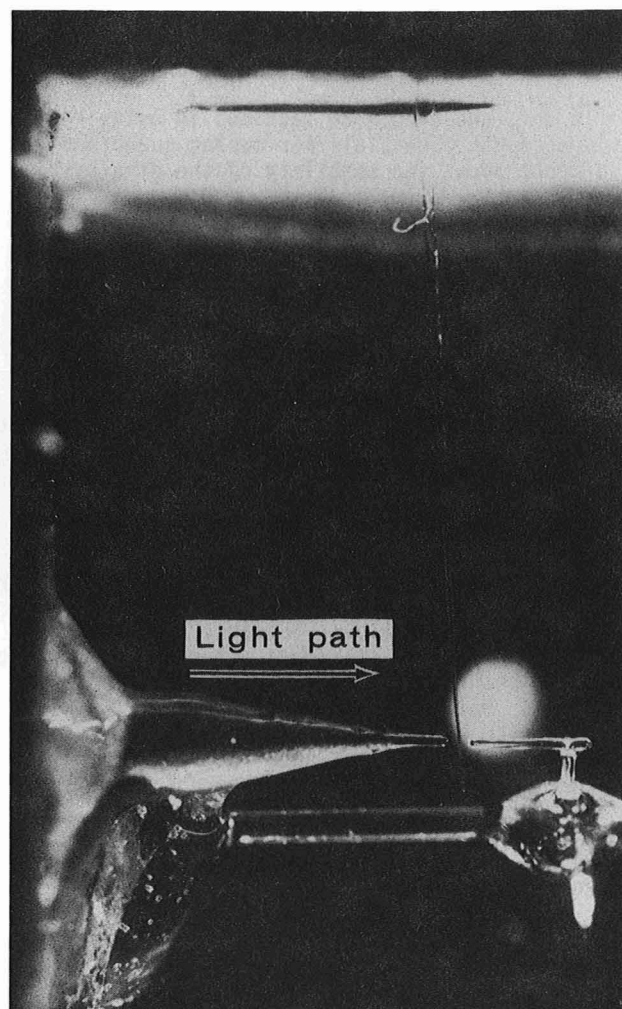

Fig. 3. Photomicrograph of the light-pipe area of a microabsorption cell.

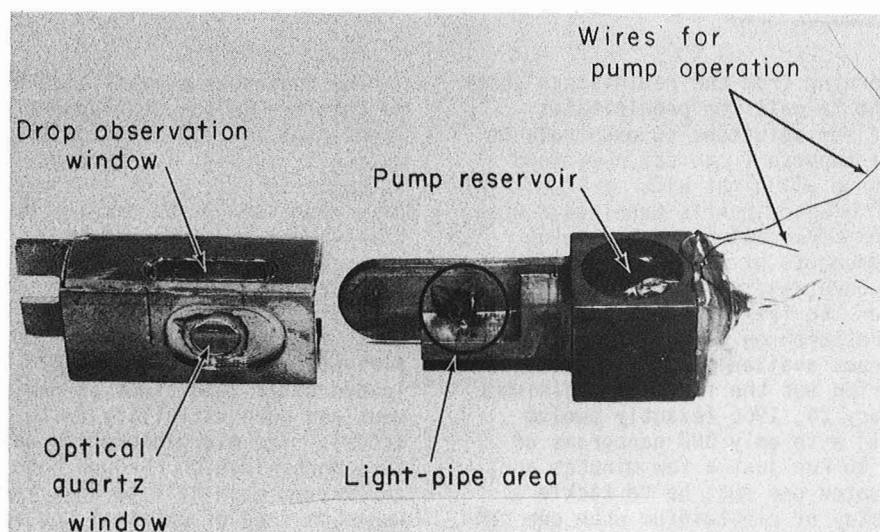

Fig. 2. Photograph of a light-pipe, microabsorption cell.

the gap between the light pipes. The one micro-liter droplet of einsteinium solution was actively bubbling and frothing until it evaporated to some

critical volume, when it suddenly became very quiet and well behaved. We presumed that this behavior was caused by the tremendous energy dissipated from

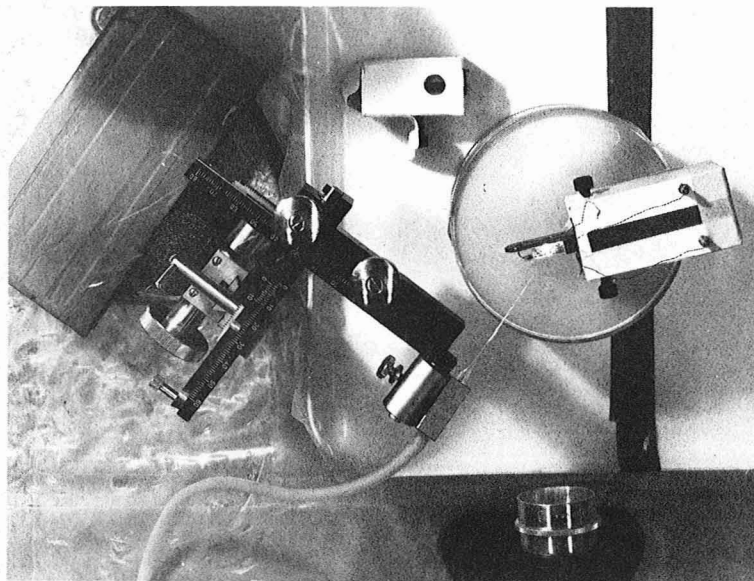

Fig. 4. Photograph of microabsorption cell loading operation.

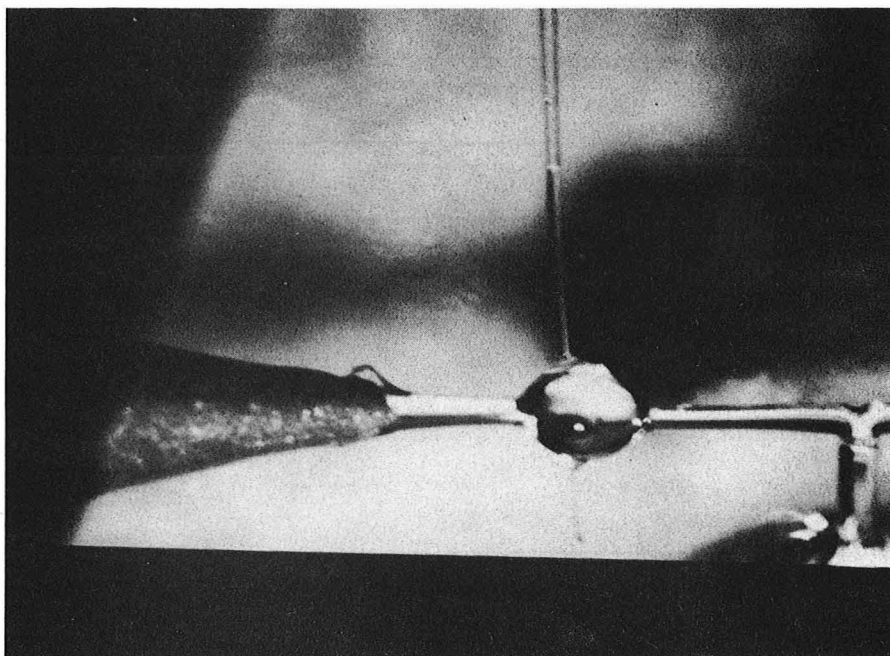

Fig. 5. Photomicrograph of light-pipe gap loaded with $\sim 60 \mu\text{l}$ of solution.

einsteinium decay ($3600 \text{ kcal/mole}\cdot\text{min}$) that initially was deposited into the droplet of solution and then, at some definite surface/volume ratio, was dissipated primarily outside of the solution. I recall the anxiety which accompanied each loading operation; we hoped that the purified einsteinium would not drop off the pipet during

the violent frothing stage or during the actual transfer to the light-pipe gap. In Fig. 5 we see the $\sim 60 \mu\text{l}$ droplet of solution across the light pipes (the tube perpendicular to the light pipes is the nozzle through which additional HCl could be introduced as the droplet of solution evaporated; see Fig. 1. Figure 6 shows the $\sim 1.5\text{-nl}$ limit-

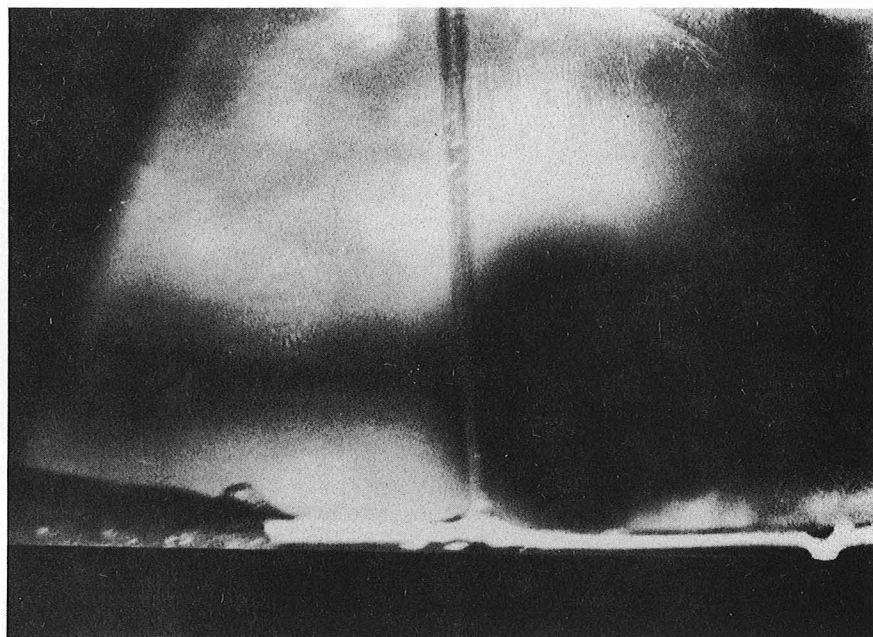

Fig. 6. Photomicrograph of light-pipe area with limiting volume of solution (≈ 1.5 nl) across gap.

Table 1. Absorption peaks of Es^{3+} in 3-6 M HCL solution.

Peak Position (\AA)	Remarks
3625 ± 25	
3760 ± 30	Prominent
4230 ± 30	Most prominent
4960 ± 30	Prominent
5296 ± 20	
5625 ± 30	
6050 ± 50	Very broad, weak

ing volume of solution between the light pipes. With $1 \mu\text{g}$ of Es^{3+} this corresponds to a 3-M solution! Further details of the light-pipe, micro-absorption cell and its use are available elsewhere.¹⁻³

The initial report¹ of this work, based on two sets of experiments, identified the seven Es^{3+} absorption peaks listed in Table 1. In August 1968 about $7.5 \mu\text{g}$ of einsteinium became available for additional spectroscopic measurements, so I returned to Berkeley from Oak Ridge to participate with Burris, Dennis Fukita, and Tom Parsons in another set of experiments. The quality and quantity

of data obtained from these experiments were sufficient to report³ the solution absorption spectrum of Es^{3+} shown in Fig. 7. The result was rather remarkable, I thought, considering the difficulty of the experiment.

Burris Cunningham was also interested in preparing simple compounds of einsteinium, so attempts were made to employ the then-standard Cunningham-Wallman technique, i.e., using a single bead of ion-exchange resin to sorb the Es^{3+} from solution, followed by calcination in air to the oxide, and examination by x-ray powder diffraction. Unfortunately this technique was not suitable for ein-

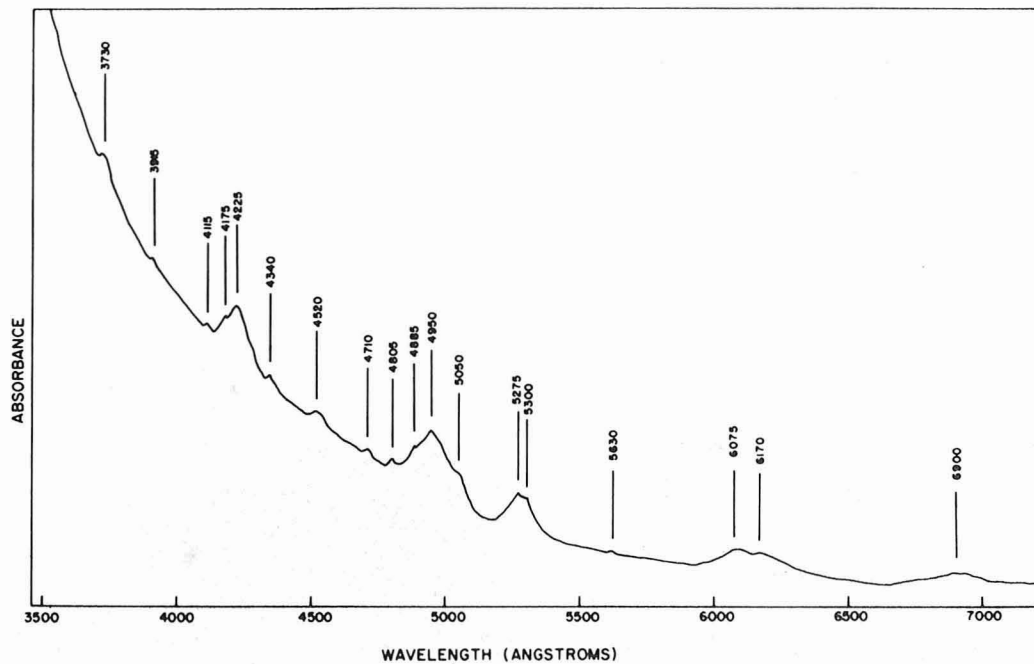

Fig. 7. Solution absorption spectrum of Es^{3+} .

steinium because it failed to saturate the exchange sites in the resin bead. With only a 10 to 20% loading of the exchange sites, the calcination step produced very small, fragile flakes of oxide which could not be easily manipulated.

Small pieces of highly purified, porous charcoal were then employed instead of resin beads, and the

first attempt to prepare an oxide of einsteinium was carried out in the following way. The einsteinium eluted from the final clean-up column was evaporated to $\sim 1\text{-}\mu\text{l}$ volume. A 0.18-mm cube of charcoal was added, and the solution evaporated to dryness during continuous centrifugation. The Es^{3+} -loaded charcoal was transferred to a quartz capillary where it was treated with oxygen at 600°C

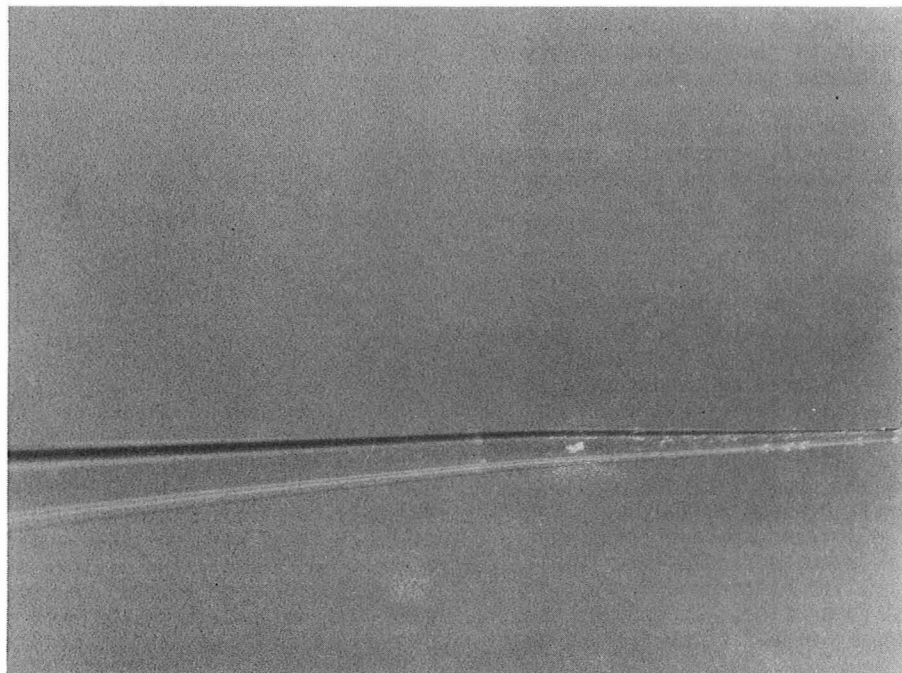

Fig. 8. Photomicrograph of a sample of einsteinium oxide on the wall of a quartz tube.

Table 2. First einsteinium compounds characterized by diffraction methods.

Compound	Reference	Structure Type	Lines Observed	Diffraction
EsCl ₃	[4]	Hexagonal	19	x-ray
EsOCl	[4]	Tetragonal	13	x-ray
Es ₂ O ₃	[5]	Body-centered Cubic	69	Electron

to convert the carbon to CO₂, leaving white einsteinium oxide as a solid residue. A photomicrograph of one of these initial samples is presented as Fig. 8. No x-ray diffraction data could be obtained from the oxide samples, so there was no proof that an einsteinium oxide had indeed been formed.

Table 2 summarizes the first einsteinium compounds which were characterized by diffraction methods. Once again the initial success came from Burris Cunningham's laboratory.⁴ Dennis Fujita treated the oxide samples prepared as described above with anhydrous HCl(g) to yield EsCl₃ then with a HCl/H₂O gas mixture to produce EsOCl. In each case the product was sealed in a reduced atmosphere of the reactant gas. Burris's reasoning was that if the tremendous decay energy was completely destroying the crystal structure, perhaps a steady state condition could be reached if one provided a continual resynthesis atmosphere. Dennis found that by heating the sealed capillary to about 430°C in the x-ray camera during the x-ray exposure, he could obtain some diffraction lines, whereas without heating he obtained none. Thus, it appeared that the annealing provided sufficient energy for the generation of enough crystallinity in the sample to obtain some diffraction data.

The other approach that had been discussed for the analysis by diffraction of einsteinium compounds was based on our observation that the behavior of a droplet of solution containing einsteinium changed abruptly as it evaporated. Apparently at some critical surface/volume ratio, the bulk of the decay energy is dissipated outside the sample itself. This approach was used by Dick Haire and Rus Baybarz at Oak Ridge in identifying and characterizing Es₂O₃ by electron diffraction methods.⁵ The Es₂O₃ samples were prepared by evaporating an einsteinium nitrate solution to dryness and then calcining the material up to 1000°C. In Fig. 9 are shown typical electron diffraction patterns for isostructural Gd₂O₃ (9A) and Es₂O₃ (9B) and an electron micrograph of an Es₂O₃ sample (9C) depicting the 100500 Å particles. These workers found that the Es₂O₃ particles were quite stable with time, some providing good quality electron diffraction patterns over several days' time. It appears that the small-particle-to-minimize-lattice-disruption theory holds.

More recently our group at ORNL has obtained limited x-ray powder diffraction data from EsBr₃⁶

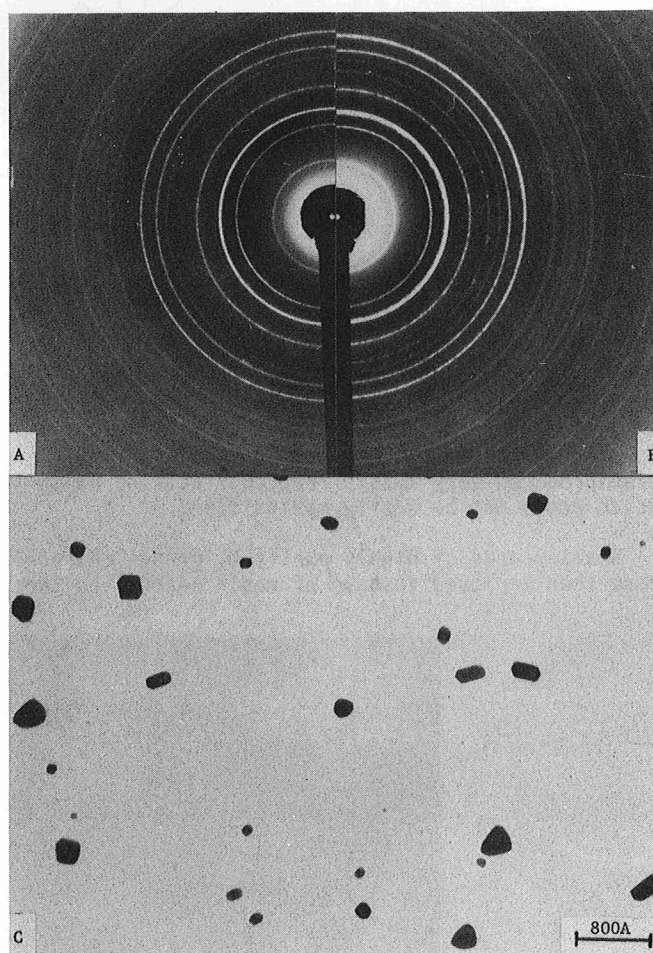

Fig. 9. Electron diffraction patterns of (A) Gd₂O₃ and (B) Es₂O₃ and (C) an electron micrograph of Es₂O₃ particles.

and EsI₃⁷ at ambient temperature. In each case, 15 to 20 lines were obtained and found to be sufficient to identify the crystal structure type. Before touching on some of our recent efforts, however, let me go back to the work of the real pioneer of chemical studies of einsteinium in the bulk phase and mention Burris' attempt to make einsteinium metal.⁸ In 1970 he and Tom Parsons reduced a 1-μg EsF₃ sample with metallic lithium in the apparatus shown diagrammatically in Fig. 10.

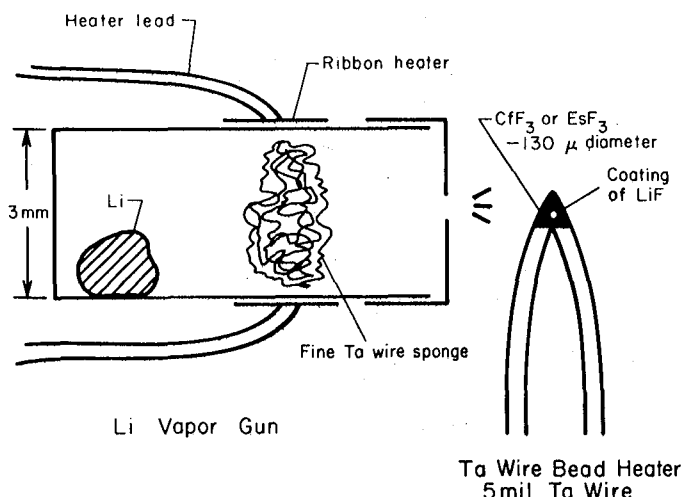

Fig. 10. Diagram of the apparatus used for the preparation of Es metal by Li metal reduction.

The minimal heat capacity of the system was necessary because of the high volatility of metallic Es. The Li was first distilled *in vacuo* onto the unheated EsF_3 sample. Then the temperature of the Li-coated trifluoride was raised quickly to about 800°C to promote the reaction $\text{EsF}_3 + 3\text{Li} \rightarrow \text{Es} + 3\text{LiF}$. The product was examined by x-ray powder diffraction, yielding four lines which could be indexed on the basis of a face-centered cubic (fcc) structure with $a_0 = 5.40 \text{ \AA}$.⁸ They pointed out that this parameter indicates that the average number of electrons per atom which participate in bonding in Es metal is substantially below three.

More recently Dick Haire and Rus Baybarz at Oak Ridge used an electron microscope to examine deposits of elemental einsteinium prepared by lanthanum metal reduction of einsteinium oxide.⁹ This technique takes advantage of the high volatility of einsteinium metal and is illustrated in Fig. 11. The einsteinium metal was distilled from a $\text{La-Es}_2\text{O}_3$ mixture ($\text{Es}_2\text{O}_3 + \text{La} \rightarrow \text{Es} + \text{La}_2\text{O}_3$) and was condensed on an electron microscopy grid, where it was examined both by electron diffraction and microscopy. From analysis of a number of samples, a composite diffraction pattern was obtained which was derived from a fcc structure with $a_0 = 5.75 \text{ \AA}$. They concluded that einsteinium is a divalent metal. In fact, their lattice parameter is the same one I reported¹⁰ for the high-temperature form of californium metal, which I endeavored to show is divalent; so I can say that the evidence strongly suggests that einsteinium is also a divalent metal. An added bonus of the Haire and Baybarz work was the measurement of the melting point of the metal. This was accomplished by observing the metal deposits while they were being heated in the electron microscope. The temperature at which the individual particles coalesce or form a puddle was taken to be the melting point. Metals of known melting points were used to establish a calibration curve. This so-called "puddling effect" is illustrated in Fig. 12 for (A) thin and (B) thick deposits of californium metal. Thusly, the melting point of elemental einsteinium was determined to be $860 \pm 30^\circ\text{C}$.

My last topic is the complementary x-ray diffraction and absorption spectrophotometric studies that we've been doing for the past two or three years at the Oak Ridge National Laboratory. After considerable frustration with attempts to obtain x-ray powder diffraction data from einsteinium

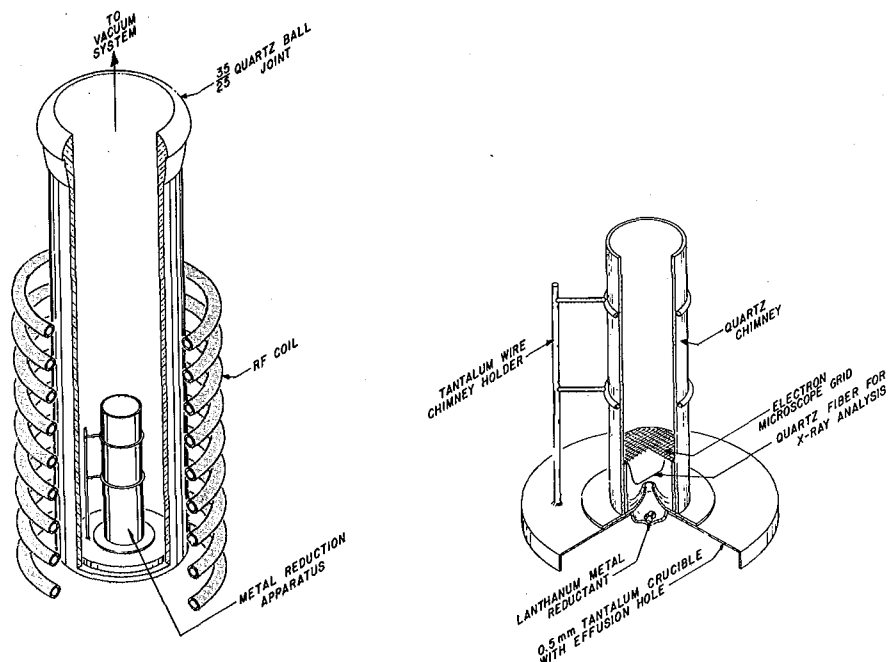

Fig. 11. Diagram of apparatus used for the preparation of Es metal by La Metal reduction.

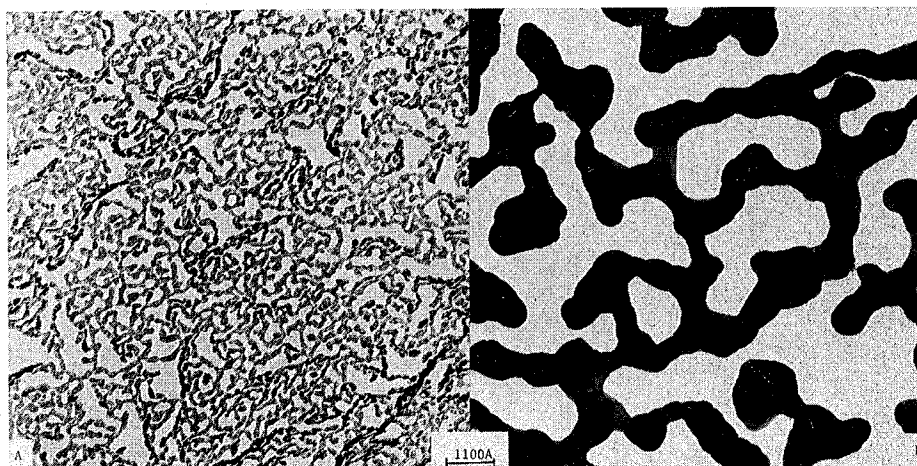

Fig. 12. (A) Thin and (B) thick deposits of Cf metal after melting--"the puddling effect."

compounds in order to characterize them, we developed a way to analyze the einsteinium samples spectrophotometrically.¹¹ However, we also found out that spectrophotometry is a much more sensitive analytical technique than is x-ray powder diffraction, and this meant that we had to characterize spectrally the corresponding compounds of berkelium and californium which rapidly grow into any einsteinium compound. We've concentrated on the halide and oxyhalide compounds. I've summarized the structural data known for the transcurium element trihalides in Fig. 13. Concerning the einsteinium trihalides, we spoke earlier about Fujita's work⁴ which established the UCl_3 -type hexagonal structure for $EsCl_3$ at $430^\circ C$, and about our x-ray work at Oak Ridge on $EsBr_3$ ⁶ and EsI_3 . We have characterized spectrally all of these compounds, with the exception of BkF_3 and CfF_3 . On the basis of our spectrophotometric analysis, we suggest that $EsCl_3$ also exhibits dimorphism.

TRANSCURIUM ELEMENT TRIHALIDE STRUCTURES

	Bk	Cf	Es
F	LaF_3 -trig (9) YF_3 -ortho (8)	LaF_3 -trig (9) YF_3 -ortho (8)	?
Cl	$PuBr_3$ -ortho (8) UCl_3 -hex (9)	$PuBr_3$ -ortho (8) UCl_3 -hex (9)	UCl_3 -hex (9)
Br	$AlCl_3$ -mono (6) $PuBr_3$ -ortho (8)	$AlCl_3$ -mono (6) $FeCl_3$ -rhombo (6)	$AlCl_3$ -mono (6)
I	BiI_3 -hex (6)	BiI_3 -hex (6)	BiI_3 -hex (6)

Fig. 13. Transcurium element trihalide structures (metal atom coordination number is given in parenthesis).

Let's add to these compounds, then, the ones of einsteinium that have been characterized only

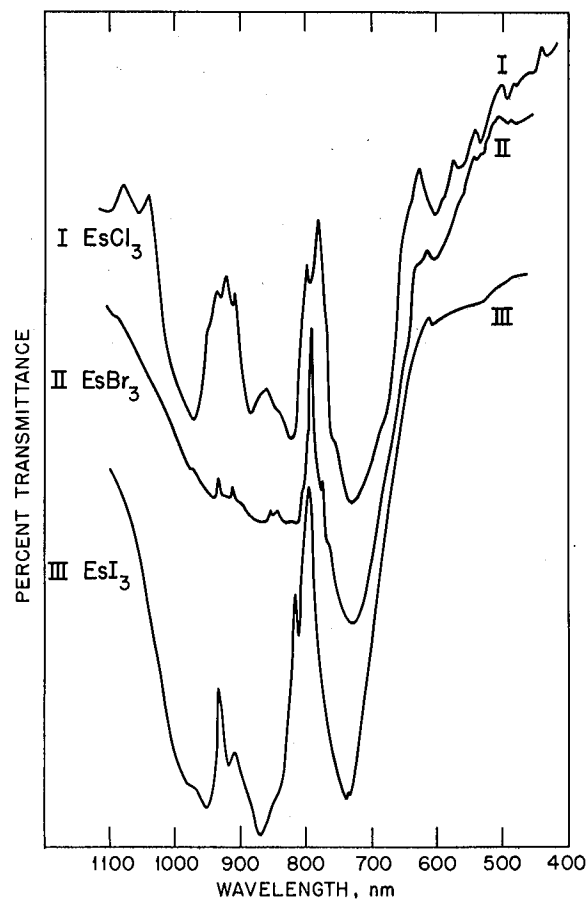

Fig. 14. Absorption spectra (raw data) of three einsteinium trihalides.

by absorption spectrophotometry: EsF_3 , $EsOBr$, $EsOI$, $EsCl_2$, $EsBr_2$, and EsI_2 . Just recently we extended our halide studies to include fluorides, and we have prepared and characterized spectrally

EsF_3 . Because of difficulties which arose in our initial attempts to prepare einsteinium dihalides, we found it necessary to know the spectral properties of all the oxyhalides. Of greater significance, however, is our positive identification of divalent einsteinium in the solid state by the preparation of EsCl_2 (Ref. 12), EsBr_2 , and EsI_2 . Let me mention once again that our characterization of these compounds has been strictly by absorption spectrophotometry. Also I want to acknowledge my co-workers in these studies: Bob Fellows, a postdoc from Greg Choppin's group at Florida State, and Jack Young and Dick Haire, both of the Oak Ridge National Laboratory staff.

I'll finish up by showing you examples of the types of spectrophotometric data we obtain from einsteinium samples. In Fig. 14 are reproduced, for ease of comparison, the raw spectral data from EsCl_3 , EsBr_3 , and EsI_3 . I say raw data because our microscope-spectrophotometer is a single-beam

device, and this is the way the initial spectra look to us on the output chart paper. The sample absorption spectrum is obtained by subtracting a background (no sample) spectrum from this. The response curve of the detector has the "U" shape evident in these spectra. As the halide gets heavier, one notes the expected shift of the intense Es(III) absorption peak to higher wavelengths (in the vicinity of 800 nm).

A spectral comparison of the di- and trivalent states of einsteinium in a host matrix of LaCl_3 is shown in Fig. 15. These are refined data, those where the background subtraction has been made. I don't have the time to go into detail, but it will suffice to say that such dilution experiments were carried out when we thought our difficulty in preparing dihalides of einsteinium was due to the high level of radiation associated with bulk einsteinium samples. The characteristic absorption peaks for Es(II) appear here at about 900 and 540 nm.

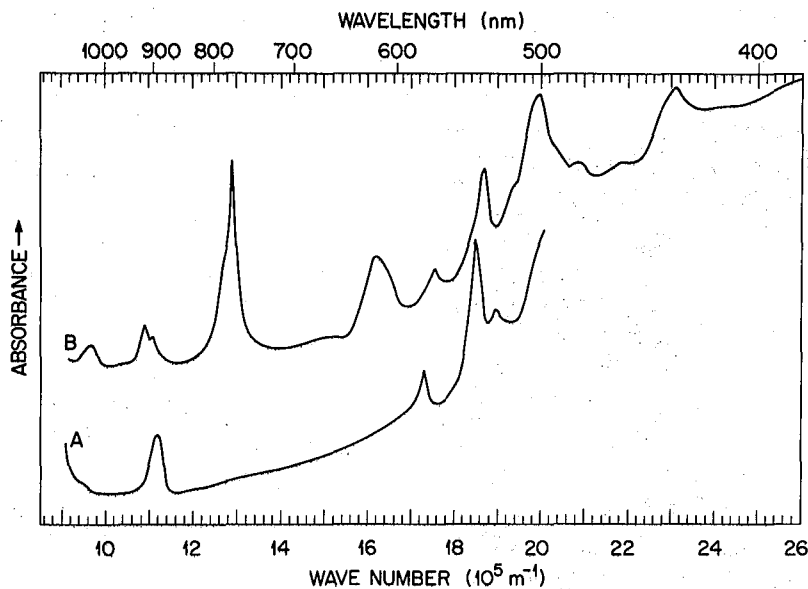

Fig. 15. Absorption spectra of (A) Es^{2+} in LaCl_3 and (B) Es^{3+} in LaCl_3 .

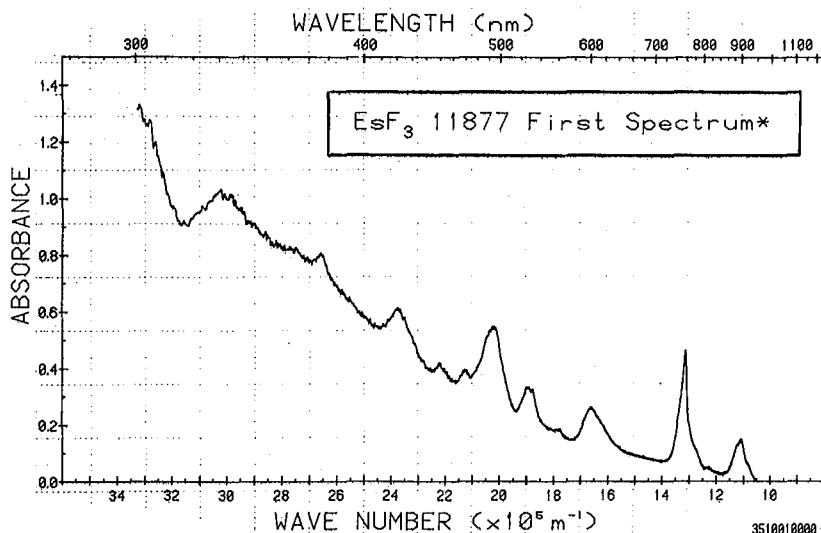

Fig. 16. First absorption spectrum of EsF_3 .

In Fig. 16 is reproduced the first absorption spectrum recorded for EsF₃ on November 8 of last year. The very prominent Es(III) absorption peak here at 760 nm continues the trend pointed out in Fig. 14. We've come a long way from our initial recording of these f-f transitions in Es³⁺ (aq) (Fig. 7) to the quality and resolution of the spectra obtained currently from the solid compounds!

Finally, I'll just mention that we have also characterized Es(II) and Es(III) by self-luminescence.^{7,13} In Fig. 17 we are seeing EsI₃ by transmitted light.

The chemistry of element 99, einsteinium, has been characterized to some degree in three oxidation states: the zero, or metallic state; the two state; and the three state. The elemental state is the least well-characterized of these, and additional work will certainly be carried out to study einsteinium metal. I hope that by the time this group meets again for the celebration of the 25th anniversary of the discovery of element 101, mendelevium, a fourth oxidation state of einsteinium will have been discovered -- Es(IV)!

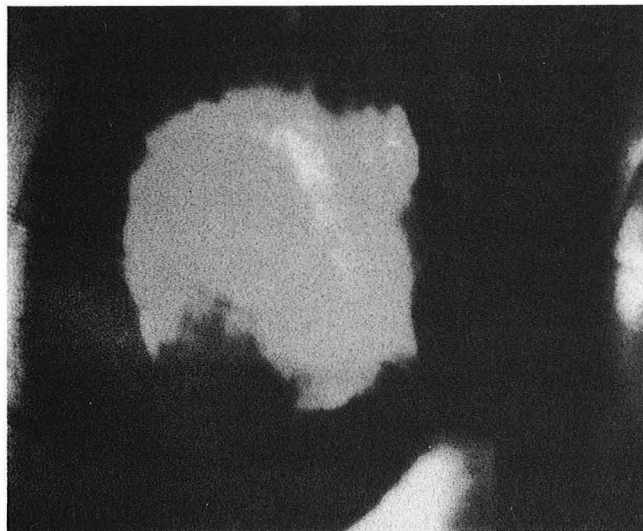

Fig. 17. EsI₃ by transmitted light.

REFERENCES

1. B. B. Cunningham, J. R. Peterson, R. D. Baybarz, and T. C. Parsons, *Inorg. Nucl. Chem. Letters* **3**, 519 (1967).
2. J. R. Peterson (Ph.D. Thesis), University of California Lawrence Radiation Laboratory Report UCRL-17875 (October 1967).
3. D. K. Fujita, B. B. Cunningham, T. C. Parsons, and J. R. Peterson, *Inorg. Nucl. Chem. Letters* **5**, 245 (1969).
4. D. K. Fujita, B. B. Cunningham, and T. C. Parsons, *Inorg. Nucl. Chem. Letters* **5**, 307 (1969).
5. R. G. Haire and R. D. Baybarz, *J. Inorg. Nucl. Chem.* **35**, 489 (1973).
6. R. L. Fellows, J. R. Peterson, M. Noé, J. P. Young, and R. G. Haire, *Inorg. Nucl. Chem. Letters* **11**, 737 (1975).
7. R. L. Fellows, J. P. Young, and R. G. Haire in J. R. Peterson et al., *Ann. Progr. Rept., U.S. Energy Research and Development Administration Document No. ORO-4447-048* (1976-1977), p. 5.
8. B. B. Cunningham and T. C. Parsons in *Nuclear Chemistry Annual Report 1970*, Lawrence Radiation Laboratory, U.S. Atomic Energy Commission Document Number UCRL-20426 (1971), p. 239.
9. R. G. Haire and R. D. Baybarz in *Chemical Technology Division Annual Progress Report*, Oak Ridge National Laboratory, U.S. Atomic Energy Commission Document Number ORNL-4883 (1973), p. 43.
10. M. Noé and J. R. Peterson, *Transplutonium Elements 1975*, W. Müller and R. Lindner, Eds. (North-Holland Publishing Co., Amsterdam, 1976), p. 69.
11. J. P. Young, R. G. Haire, R. L. Fellows, and J. R. Peterson, *J. Radioanal. Chem.* **43**, 477 (1978).
12. R. L. Fellows, J. R. Peterson, J. P. Young, and R. G. Haire, *The Rare Earths in Modern Science and Technology*, G. J. McCarthy and J. J. Rhyne, Eds. (Plenum Press, New York, 1978), p. 493.
13. J. P. Young, R. G. Haire, R. L. Fellows, M. Noé, and J. R. Peterson, *Transplutonium Elements 1975*, W. Müller and R. Lindner, Eds. (North-Holland Publishing Co., Amsterdam, 1976), p. 227.

Introduction of Norman M. Edelstein *Dr. Seaborg*

The next speaker is Norman Edelstein. He graduated from the University of Illinois at Urbana in 1957 and did his Ph.D. work here at Berkeley in the Department of Chemistry where he received his degree in 1962. In 1964 he joined the staff at the Lawrence Radiation Laboratory (that's what it was called in those days) and worked with Burris Cunningham until Burris's untimely death in 1971. Norm has continued his work here at the laboratory

and is presently the group leader of lanthanide and actinide chemistry in the Materials and Molecular Research Division. He has established himself as one of the leading authorities in the field of magnetic measurements in the actinide elements, and will speak to us today about the chemical properties of fermium, describing, of course, work done entirely on the tracer chemical scale.

Chemistry of Fermium, Element 100

Norman M. Edelstein

The reports on Fm Chemistry are limited because this element can only be produced in tracer quantities. Early work on Fm included co-precipitation studies and ion-exchange studies whose main purpose was to make possible the separation of this element from other trivalent actinide ions.¹ Figure 1 shows a typical result: the behavior of Fm^{3+} in solution follows the expected pattern,² with the elution of the tripositive actinides from Dowex 50 with ammonium lactate showing that Fm comes off first followed by the lower Z actinides. This behavior parallels that found in the lanthanide series, as shown in the bottom half of the figure. In the 1954 paper on "Chemical Properties of Elements 99 and 100", Thompson, Harvey, Choppin and Seaborg summarized their findings by the statement "They (Elements 99 and 100) are chemically very similar to their actinide predecessors, differing in the manner to be expected for ions of somewhat smaller radius".

A number of groups² have measured the stability constants of Fm^{3+} with a variety of ligands by ion exchange or solvent extraction techniques. These values are listed in Table 1. These data on Fm^{3+} follow the trends in the actinide series mentioned previously.

In 1967, Maly³ demonstrated that Cf, Es, and Fm were preferentially extracted in Na amalgam compared with the lower Z actinides. This behavior was similar to that observed previously for the lanthanide ions which had the relatively stable dipositive ions Sm, Eu, and Yb. These experiments suggested the heavier actinides could have somewhat stable +2 states.

Bouissières and his coworkers⁴ demonstrated the volatility of Fm metal by irradiating a uranium target with ^{16}O ions. After bombardment the target was heated in high vacuum to slightly above the melting point of uranium. Their data are shown in Fig. 2. The yield of Fm and Cf as a function of time followed first-order kinetics in the temperature range 1140 C to 1310 C. There was no difference in the rate of volatilization of Cf and

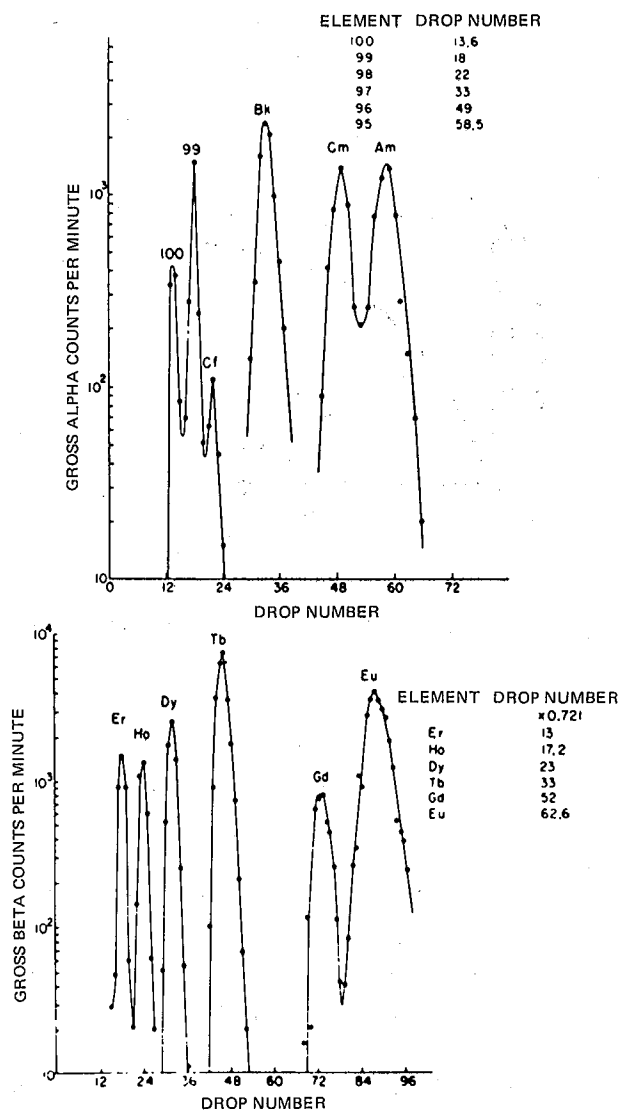

Fig. 1. Elution of Fm from Dowex 50 with ammonium lactate. (Taken from Reference 1.)

Table 1. Stability constants of various Fm complexes.

Complex	Log β_1	Method	Reference
Fm(OH) ²⁺	-3.8 ± .2	Solv. ext.	2a
Fm EDTA ⁻	19.22	Ion exch.	2c
Fm DACTA ⁻	19.49 - 19.56	Ion exch.	2c
Fm DTPA ²⁻	22.6 - 22.7	Ion exch.	2c
Fm(lactate) ₃	6.36 ± .06 ^α	Solv. ext.	2b
Fm(lactate) ₃	6.27 ± .09 ^α	Ion exch.	2b

α) Log β_3

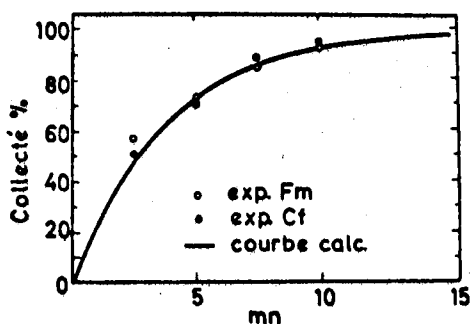

Fig. 2. Yield of Fm and Cf after heating of target.

Fm. The energy of activation of the process was estimated to be 20 kcal/mole for the two elements.

Nugent and coworkers⁵ estimated the $Fm^{2+} \rightleftharpoons Fm^{3+}$ potential in 1969 on the basis of Jorgenson's spin-pairing theory, electron transfer bands of trivalent actinide ions, and empirical correlations. In a series of experiments over a period of eight years or so, Mikheev and his colleagues⁶ in Moscow were able to determine ranges for this couple on the basis of the use of various reducing agents and the co-crystallization of the divalent Fm in SmCl or later in SrCl₂. The Russian results are shown in Table 2. Their most recent value for the $Fm^{3+} \rightleftharpoons Fm^{2+} + e^-$ couple is $-1.15 \pm .02$ V vs NHE.

The teams David and Hussonnois and Samhoun and David have investigated the radiopolarographic behavior of aqueous Fm. In this method a potential is imposed at the dropping Hg electrode and, if the radioisotope is reduced to the metallic state, the radioactive metal is amalgamated. Thus, by count-

Table 2. Results of co-crystallization experiments.

Reducing Systems	Precipitates	$E^0_{Fm^{2+}/Fm^{3+}}$	Reference
Eu ²⁺ /Eu ³⁺ , Yb ²⁺ /Yb ³⁺ , Sm ²⁺ /Sm ³⁺	SmCl ₂ , EuCl ₂	-(.43 - 1.15)	6a 1972
Yb ²⁺ /Yb ³⁺ , U ³⁺ /U ⁴⁺	SrCl ₂	-(.64 - 1.15)V	6b 1975
Yb ²⁺ /Yb ³⁺	SrCl ₂	-(1.15 ± .02)V	6c 1977

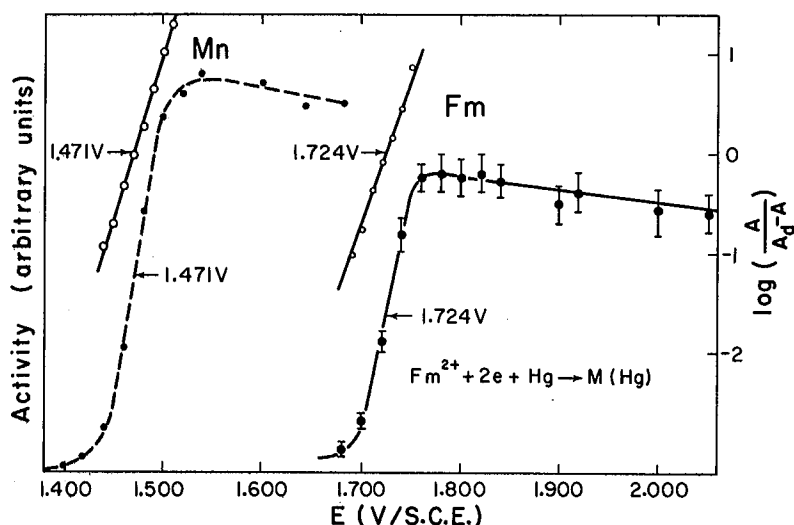
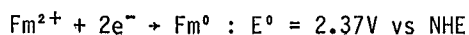

Fig. 3. Radiopolarographic results for Fm in aqueous solution.

ing the activity in each Hg drop as the applied potential is varied, a plot of activity vs potential should parallel the well-known current-potential curves.

The estimated values for the ionic radius and metallic radius of Fm, as calculated by Samhoun and David are shown in Fig. 3.

There is an ambiguity here as to whether the measurement represents the reduction of the trivalent ion or of the divalent ion to the metal. From the previously determined Fm^{3+}/Fm^{2+} potential, it appears the measurement of Samhoun and David is of the Fm^{2+}/Fm^0 potential. By redetermining the potential in the presence of a complexing agent they confirmed the $Fm^{2+} + Fm^0$ mechanism. They obtained the following value for the couple



after correcting for the amalgamated energy.

Finally, the values for the metallic radius of Fm, and the ionic radii of Fm^{2+} and Fm^{3+} have been estimated. These values are shown in Table 3.

Table 3. Estimated values for the ionic radius and metallic radius of Fm.

Ion	Radius(\AA)	Reference
Fm	1.97(2)	5b
Fm^{2+}	1.1	6c
Fm^{3+}	.92	7b

REFERENCES

1. S. G. Thompson, B. G. Harvey, G. R. Choppin, and G. T. Seaborg, *J. Amer. Chem. Soc.* **76**, 6229 (1954).
2. a) M. Hussonnois, S. Hubert, L. Aubin, R. Guillaumont, and G. Boussières, *Radiochem. Radioanal. Letters* **10**, 231 (1972);
b) V. A. Ermakov and I. Stary, *Soviet Radiochemistry* **9**, 195 (1967);
c) B. F. Myasoedov, L. I. Guseva, and I. A. Lebedev, "Analytical Chemistry of the Transplutonium Elements", Nauka, Moscow, 1972.
3. J. Maly, *Inorg. Nucl. Chem. Letters* **3**, 373 (1967).
4. J. Merinis, Y. Legoux, and G. Boussières, *Radiochem. Radioanal. Letters* **13**, 221 (1973).
5. a) L. J. Nugent, R. D. Baybarz, and J. L. Burnett, *J. Phys. Chem.* **73**, 1177 (1969);
b) L. J. Nugent, *J. Inorg. Nucl. Chem.* **37**, 1767 (1975).
6. a) N. B. Mikheev, V. I. Spitsyn, A. N. Kamenskaya, B. A. Gvozdev, V. A. Druin, I. A. Rumer, R. A. Dyachkova, N. A. Rosenkevitch, and L. N. Auerman, *Inorg. Nucl. Chem. Letters* **8**, 929 (1972);
b) N. A. Rozenkevitch, N. B. Mikheev, I. A. Rumer, L. N. Auerman, B. A. Gvozdev, and A. N. Kamenskaya, *Soviet Radiochemistry* **17**, 429 (1975);
c) N. B. Mikheev, V. I. Spitsyn, A. N. Kamenskaya, N. A. Konvalova, I. A. Rumer, L. N. Auerman, and A. M. Podorozhnyi, *Inorg. Nucl. Chem. Letters* **13**, 651 (1977).
7. a) F. David and M. Hussonnois, *Radiochem. Radioanal. Letters* **11**, 1 (1972);
b) K. Samhoun and F. David, *Transplutonium Elements*, W. Müller and R. Lindner, Eds., (North-Holland, Amsterdam, 1976), p. 297.

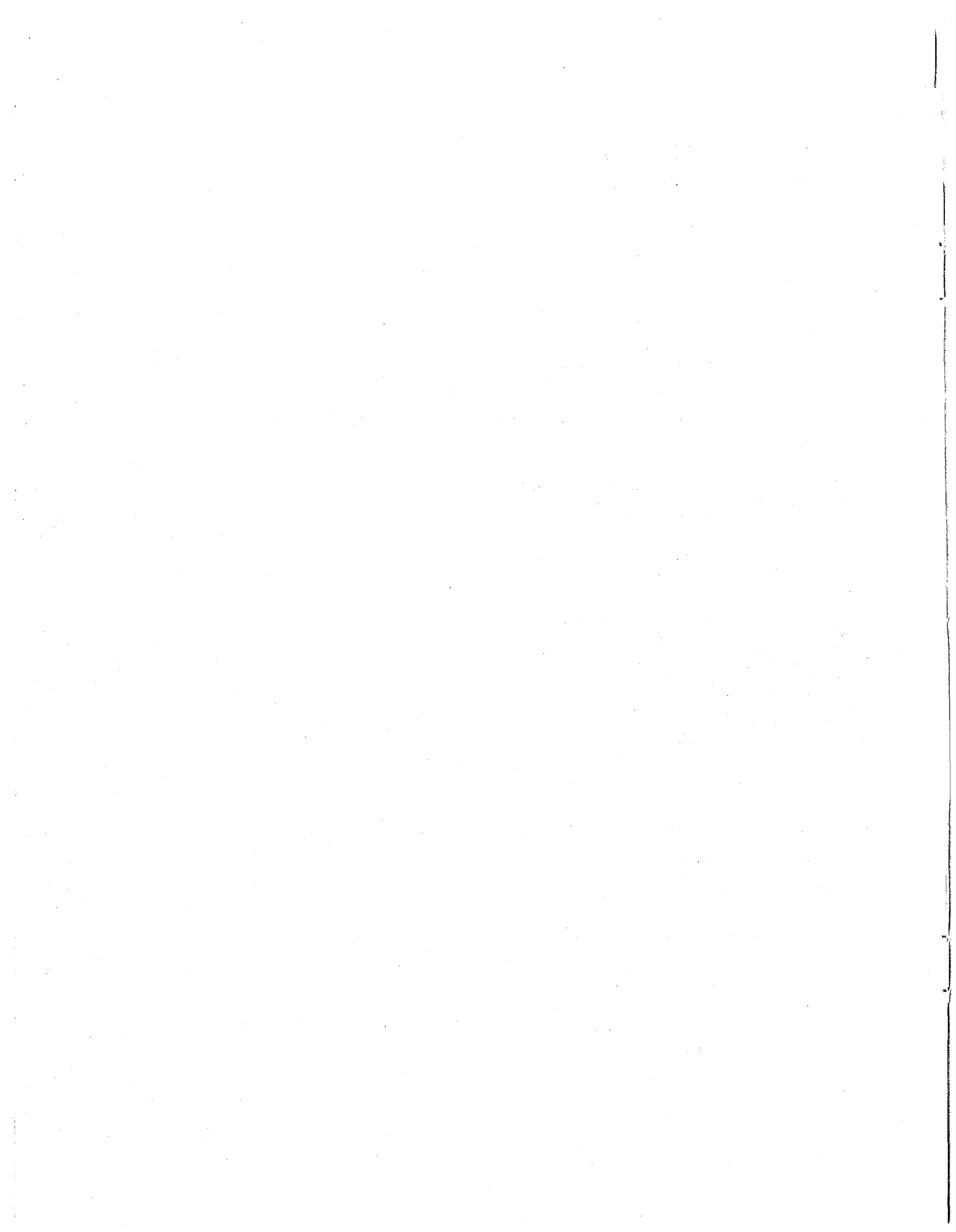

Introduction of John G. Conway

Dr. Seaborg

The next contribution will be made by John Conway. John obtained a B.S. degree from the University of Pittsburgh in 1944. He spent a short amount of time at Los Alamos Laboratory, then joined the staff at the Lawrence Radiation Laboratory in 1947 where he's been ever since. He is currently

the group leader in the optical spectroscopy group. John's investigations lie in the areas of spectroscopy, chemical analysis, absorption and emission of transuranium elements, and the spectra of higher ionized atoms.

Free Ion Spectroscopy of Einsteinium and Comments on Fermium

John G. Conway

I plan to present the spectroscopy of einsteinium and add the other relevant atomic data to give an understanding of the status of that element. Then I will give some information on the ongoing work on einsteinium. I will finish with comments on fermium.

The first observation of the spectral lines of einsteinium was made in the spring of 1967 by Gutmacher, Evans, and Hulet.¹ They recorded two spectra, using 100 ng each, under low resolution in a graphite spark and observed 9 lines. They also proved to be prophets, for in the very last sentence they say, "The measurement and interpretation of that spectrum is likely to be a prolonged and difficult task."

The second observation was made a few months later by Worden, Gutmacher, Loughheed, Evans, and Conway,² using a 0.6 μg of GdI_3 as a carrier. This sample was prepared in a quartz lamp and run as an electrodeless discharge. The spectra were run at high resolution, but because of difficulties the lamp only lasted 10 minutes. However, six lines were still photographed, and it was possible to determine from the hyperfine structure the nuclear spin and thus confirm the values of $7/2$.

Two years later the experiment was repeated.³ This time everything worked well. A sample of 0.8 μg of Es and 100 μg GdI_3 lasted as long as we wanted, over 3 hours, and then was returned for recovery and use in other experiments. Fifty-three lines were observed, 23 of which showed well-resolved hyperfine structure. Using these new data and the spark lines of 1967, it was possible to establish the ground state of the +1 ion of Es and determine the interval to the first excited state. The nuclear spin was again confirmed and a nuclear moment was calculated.

About 2 years later an 11- μg sample of Es and 100 μg of YI_3 as carrier were used to prepare an electrodeless lamp.⁴ This time we observed 290 lines and were able to establish the ground state of the neutral Es and several excited configurations. We were also able to measure the quadrupole.

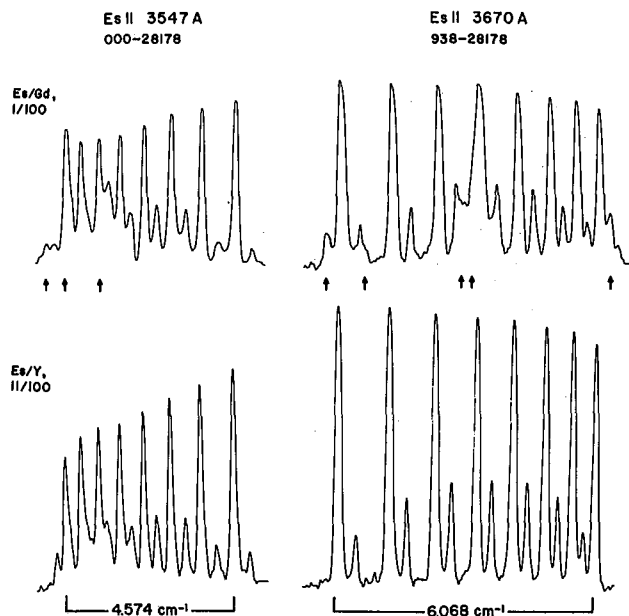

Fig. 1. Densitometer tracing of two Es lines. The upper lines were done with 1 μg of Es and 100- μg GdI_3 . The arrows indicate where Gd atomic emission lines appear. The lower traces are shown 11- μg Es and 100 μg YI_3 .

Figure 1 is a densitometer tracing of two Es^{+1} lines which have wide, hyperfine structure. The upper tracings are for the 0.8- μg Es with 100 μg GdI_3 . The arrows point to the Gd atomic emission lines which overlap the Es structure. The lower traces are for the 11- μg Es and 100 μg of YI_3 . In this example, there happens to be no Y emission lines to interfere with the structure. If you think that Y carrier is a complete solution to this type of problem, I should point out that in the red region of the spectrum above 6000 \AA there is a very intense band system which completely covers all other features. The region below 6000 \AA Y has less emission lines and is better than Gd.

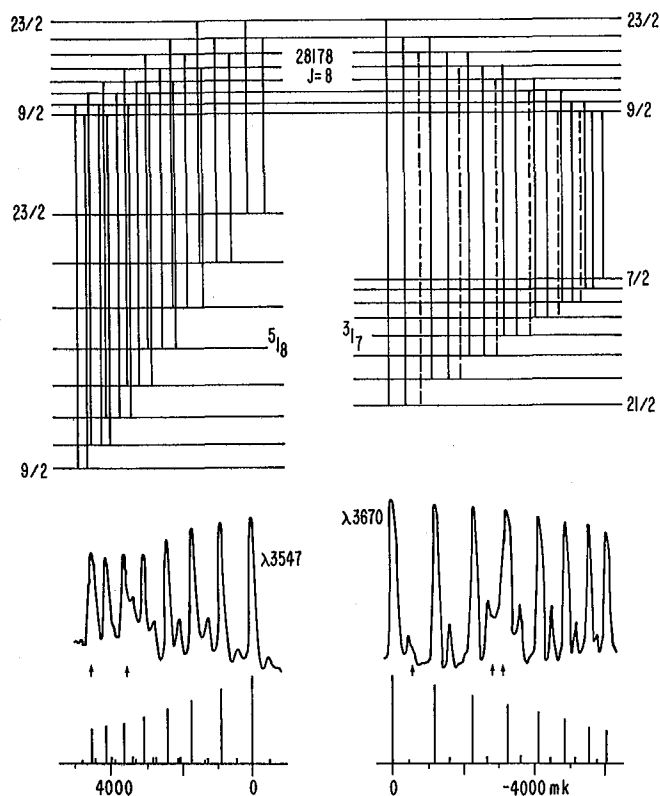

Fig. 2. The upper portion shows energy level diagrams for the two Es lines at 3547 and 3670 Å. The lower portion repeats the traces from Fig. 1.

Figure 2 repeats the tracings of the same two lines of the Es/Gd spectrum. Above the tracings are the energy level diagrams for these two transitions. The $5I_6$ is the ground state. The interval between the two low levels is 938.66 cm^{-1} . The numbers on the sides of the diagrams are the F quantum numbers.

In April of 1975 a collaborative effort between Argonne National Laboratory, Lawrence Livermore Laboratory and Lawrence Berkeley Laboratory⁵ resulted in a complete set of plates taken on the Argonne 30-foot spectrograph. These experiments produced plates suitable for accurate wavelength measurements between 2400 and 10000 Å and a set of Zeeman effect plates covering the same wavelength range. The experiments used the Es four times with purification between runs. Typically we prepared an electrodeless discharge lamp that had between 50 and 75 μg of Es (no carrier), and the lamp would last ten or more hours before failure. The radioactivity of such a sample was 4.5 R at a distance of 2 in. from the surface of the lamp. The plates are being measured at Argonne, and to date the region from 2370-3966 Å and the region from 6600 to 8765 Å have been completed. In the region of overlap with the 1973 experiment, they are measuring about 100 times more lines. It is expected that the line list will contain about 20000 entries.

Figure 3 is a computer-generated densitometer trace of a small portion between 3573 and 3633 Å. There is a great variety, from very sharp lines to wide hyperfine structure with blending and interferences.

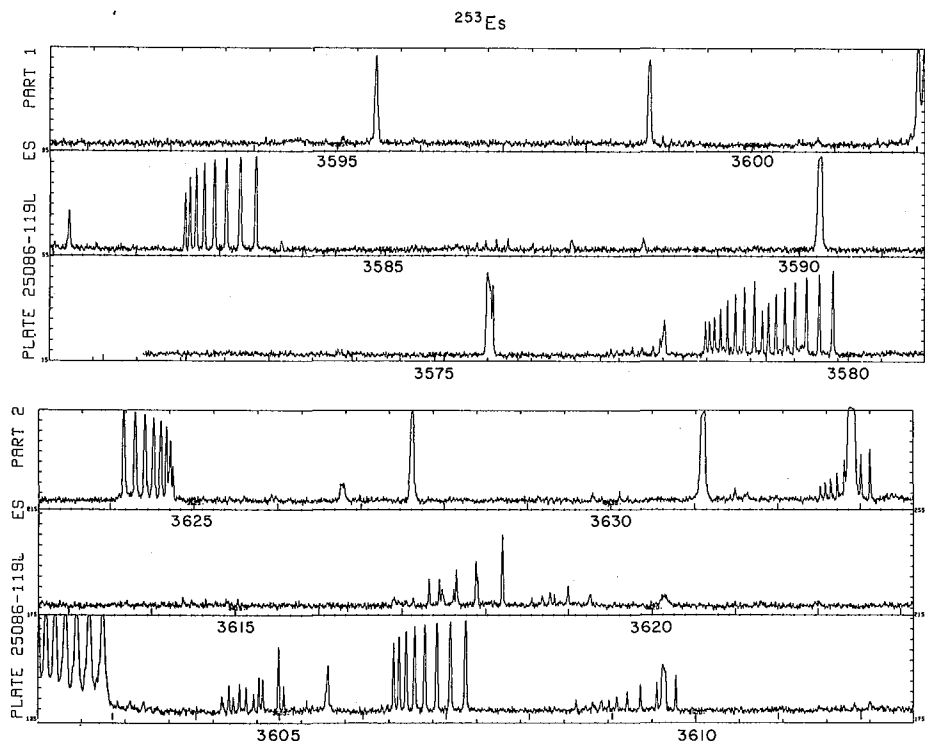

Fig. 3. Computer-generated densitometer traces of the Es spectrum between 3573 and 3633 Å taken on the ANL 30-foot spectrograph.

Figure 4 is the energy level diagram of Es I showing four known configurations.

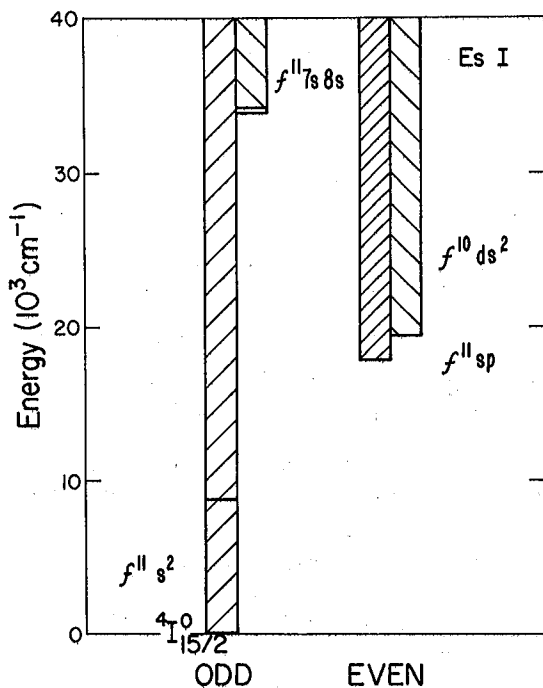

Fig. 4. Energy level diagram of Es I showing the position of the lowest level of the four known configurations.

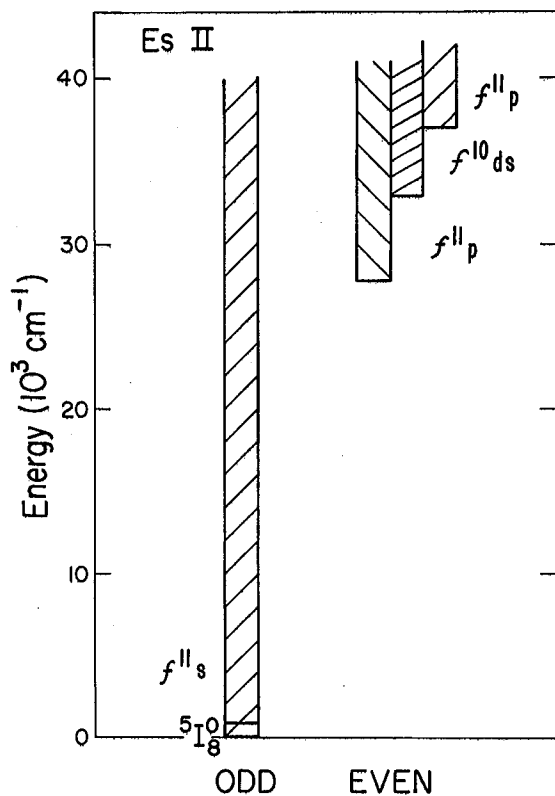

Fig. 5. Energy level diagram of Es II.

Figure 5 is a similar energy level diagram for Es II showing only one odd configuration (only two levels of that are known) and the three even configurations.

Other measurements have been made to obtain atomic parameters. The electron paramagnetic resonance by Edelstein of Es^{2+} in CaF_2 (Ref. 6) has produced a nuclear moment. Goodman, Diamond, and Stanton⁷ have performed atomic-beam magnetic resonance experiments on both ^{253}Es and ^{254m}Es and have obtained very accurate values for the nuclear moment, quadrupole moment, and g value of the ground state of the neutral atom.

Table I is a summary of the best known values for einsteinium.

Table I. Summary of the atomic properties of einsteinium.

EINSTEINIUM			
NEUTRAL ATOM	GROUND STATE	$4f_{15/2}^0$	$5f^{11} 7s^2$
	g_j	1.185138(5)	
	IONIZATION POTENTIAL	6.4 eV	
FIRST ION	GROUND STATE	$5f_8^0$	$5f^{11} 7s$
	^{253}Es	^{254m}Es	
NUCLEAR SPIN, $I =$	7/2	2	
NUCLEAR MOMENT, $\mu_I =$	4.10(7) μ_N	2.90(7) μ_N	
QUADRUPOLE MOMENT, $Q =$	6.9(8) b	3.8(5) b	

Recently, Rajnak and Shore⁸ have calculated the ionization potential and give a value of 6.4 eV. This is the same value given by J. Sugar.⁹

And now to comment on fermium. To date there have been no spectroscopic observations and no electron paramagnetic-resonance observations. There have been atomic beam magnetic resonance experiments by Goodman, Diamond, Stanton, and Fred¹⁰ at the Argonne National Laboratory. They needed a good prediction of the g value, since the search region for resonance would be limited due to the short lifetime of Fm. By assuming the ground state and predicting the atomic parameters, they were able to calculate a g value. Then they searched in a limited range and found a resonance which gives a g value of $g_j = 1.16042(14)$, which is in close agreement with their calculation (1.16059). Thus they were able to say that the ground state of the neutral fermium atom is the 3H_6 level of the $5f^{12} 7s^2$ configuration.

Figure 6 reflects the meager data known for fermium. An ionization potential of 6.5 eV is estimated by Rajnak and Shore.⁸

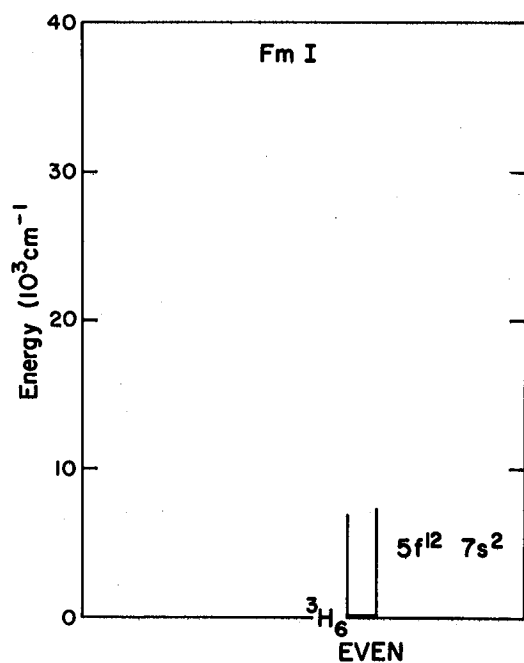

Fig. 6. Energy level diagram of Fm I. The only information given is the ground state of the $5f^{12}7s^2$ configuration.

REFERENCES

1. R.G. Gutmacher, J.E. Evans, and E.K. Hulet, *J. Opt. Soc. Am.* 57, 1389 (1967).
2. E.F. Worden, R.G. Gutmacher, R.W. Lougheed, J.E. Evans, and J.G. Conway, *J. Opt. Soc. Am.* 58, 998 (1968).
3. E.F. Worden, R.G. Gutmacher, R.W. Lougheed, J.G. Conway, and R.J. Mehlhorn, *J. Opt. Soc. Am.* 60, 1297 (1970).
4. E.F. Worden, R.W. Lougheed, R.G. Gutmacher, and J.G. Conway, *J. Opt. Soc. Am.* 57, 1389 (1967).
5. From Argonne National Laboratory, W.T. Carnall, H.M. Crosswhite, M. Fred, R. Sjoblon. From Lawrence Livermore Laboratory, E.F. Worden, and from Lawrence Berkeley Laboratory, J.G. Conway.
6. N. Edelstein, *J. Chem. Phys.* 54, 2488 (1971).
7. L.S. Goodman, H. Diamond, and H.E. Stanton, *Phys. Rev. A* 11, 499 (1975).
8. K. Rajnak and B.W. Shore, *J. Opt. Soc. Am.* 68, 360 (1978). Lawrence Livermore Laboratory Rept. UCRL 80059.
9. J. Sugar, *J. Chem. Phys.* 60, 4103 (1974).
10. L.S. Goodman, H. Diamond, H.E. Stanton, and M.S. Fred, *Phys. Rev. A* 4, 473 (1971).

Introduction of William T. Carnall

Dr. Seaborg

The last speaker of today's symposium is William Carnall. He received his B.S. degree in chemistry at Colorado State University in 1950 and completed his Ph.D. work with John Willard at the University of Wisconsin in 1954. Bill joined the Argonne

National Laboratory in 1954 where he currently is a member of a heavy elements group. His interests are in the chemistry and spectroscopy of the actinide elements.

Crystal and Solution Spectroscopy of Einsteinium

William T. Carnall

In a sense it is symbolic that papers on free-ion and condensed phase spectroscopy were chosen as the concluding work to be presented in this symposium. Einsteinium is probably the last element in the periodic table that will be available in sufficient quantity to permit the use of classical methods of spectroscopy to explore energy level structure.¹ Indeed, in both current and past attempts to observe absorption bands in solutions and crystals, the experimentalists have been pushing the use of classical methods and standard equipment to the limit in order to obtain interpretable results. This was certainly true of the first observation of the spectrum of Es^{3+} in solution.²

An innovative method of condensing the analyzing beam of a standard spectrophotometer on a microsphere of liquid made it possible for Cunningham and coworkers to obtain the first evidence of absorption bands characteristic of Es^{3+} , as shown in Fig. 1. The date was 24 January 1966, almost 12 years ago to the day. The date has additional significance to a number of us, because this was precisely the period during which investigators from LBL, LLL, and ANL were conducting a collaborative experiment to measure the spectrum of $^{252}\text{Cf}^{3+}$ in neighboring laboratories.³ I remember that at the time, Burris dropped by to check our progress, and showed me one of the condensing lenses used in the Es^{3+} experiments. As I recall, he ground those by hand. The first experiments with Es^{3+} were subsequently followed by a more extensive investigation⁴ which resulted in the trace shown at the bottom of Fig. 1.

Gutmacher, Worden, and Conway observed lines in the self-luminescence spectrum of $\text{Es}^{3+}:\text{GdI}_3$ in 1967 during the course of preparing samples for their emission spectra studies.⁵ This was, then, the first spectroscopic investigation of Es^{3+} in crystals. No interpretation was possible at the time because too few details of the electronic structure were known.

As soon as absorption bands of Es^{3+} had been observed, the effort was made to fit their energies into predicted energy level structure

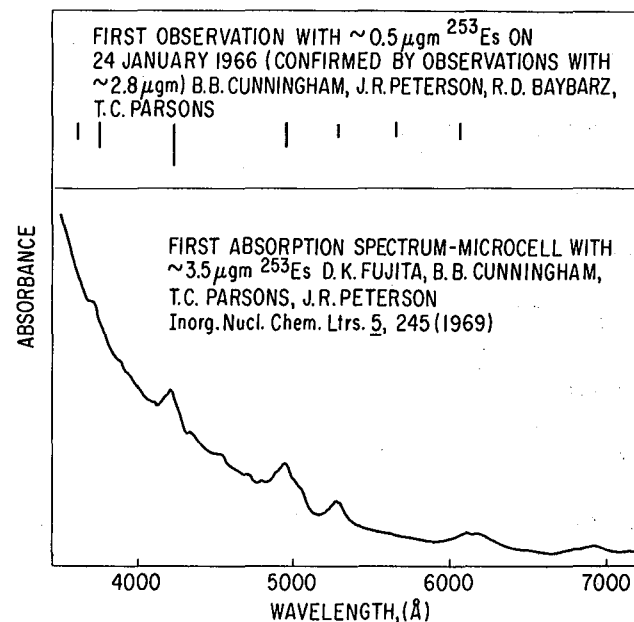

Fig. 1. The solution absorption spectrum of Es^{3+} . (Ref. 2,4)

schemes. Paul Fields and I did what we could with the data and theory at hand when we made our first predictions in late 1965.⁶ The problem, which is illustrated by the diagram shown in Fig. 2, lay in the fact that relatively small changes in the energy level parameters of the theory could change the predicted ordering of several of the lower-lying states. A predicted energy level scheme results from the intersection of a particular ordinate with the various predicted abscissa. Couple this with the fact that we were making assumptions about the spectra of Np^{3+} , Pu^{3+} , and Am^{3+} and extrapolating from there to Es^{3+} , and it is not too surprising that the estimates were wrong in important respects. As it turned out, the first $J = 5$ state is lower in energy than the first $J = 7$ state contrary to what we projected at the time.

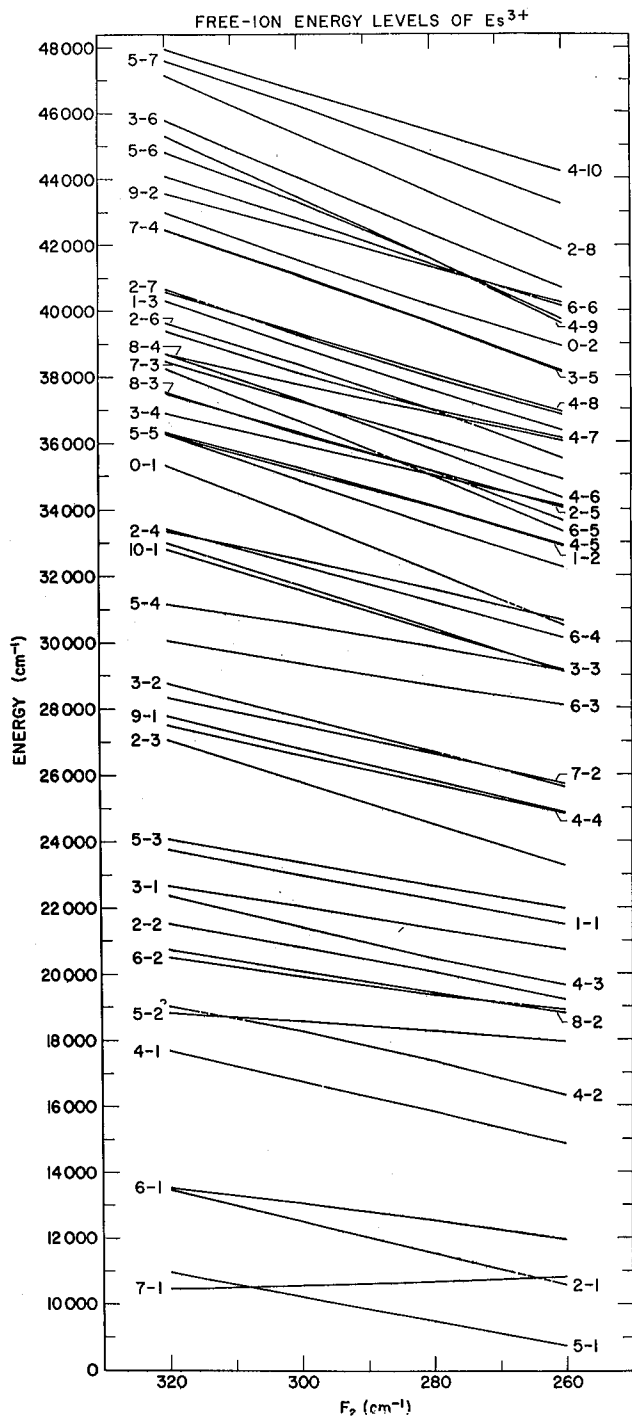

Fig. 2. Computed free-ion energy level scheme for Es^{3+} as a function of the electrostatic interaction parameter F_2 . (ref. 11)

Among the important experimental details required in just the first stage of improving the analysis was the relative energies of the first excited states. Of particular interest was the energy of the first excited state. The group at ORNL addressed this problem in some very creative fluorescence experiments.^{7,8} As described in a

L.J. NUGENT, R.D. BAYBARZ
G.K. WERNER, H.A. FRIEDMAN
OAK RIDGE NATIONAL LAB (1970)

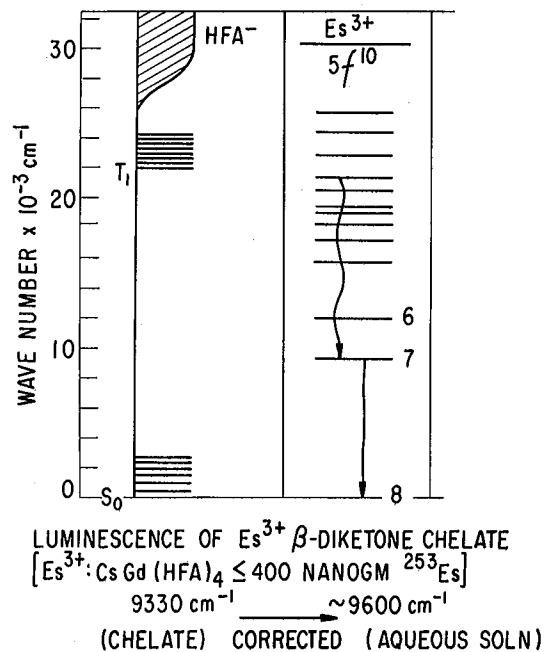

Fig. 3. Schematic representation of the excitation of fluorescence in Es^{3+} - β -diketone chelate. (Ref. 7,8)

1970 paper by Nugent, Baybarz, Wener, and Friedman⁸ (Fig. 3), they excited fluorescence in an Es^{3+} -containing β -diketone chelate and detected emission near the limits of the spectral range which they could investigate with their equipment. Correcting to aqueous solution, they assigned a $J = 7$ state at 9600 cm^{-1} . The assignment was based solely on our incorrect prediction. They would have been happy with $J = 5$.

The period 1969-1970 was also important for the report by Edelstein and coworkers⁹ at LBL of detecting Es^{2+} in CaF by ESR methods. A self-luminescence spectrum of the sample was also published. In addition there was the deduction of II-III oxidation potentials for the actinides by Nugent and coworkers.¹⁰ The intense charge transfer band observed in the spectrum of EsBr provided an important benchmark in this work.

The next development in our understanding of electronic structure in Es^{3+} took place at ANL. The group was finally successful in getting a sizeable sample of ^{253}Es away from the nuclear types long enough to make measurements of the solution absorption spectrum on a more macroscopic scale than had previously been attempted.¹¹ Along with some increased intensity in the absorption bands compared to previous work, a new band was detected near 11000 cm^{-1} (Fig. 4). These data, along with those of Nugent and coworkers at ORNL, provided the basis for a significant improvement in the theoretical interpretation. It became

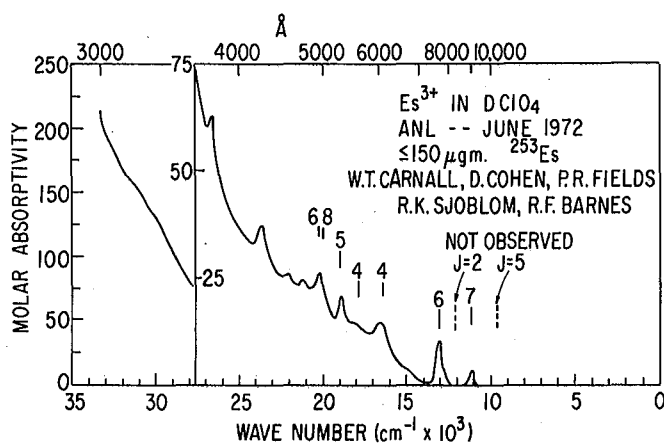
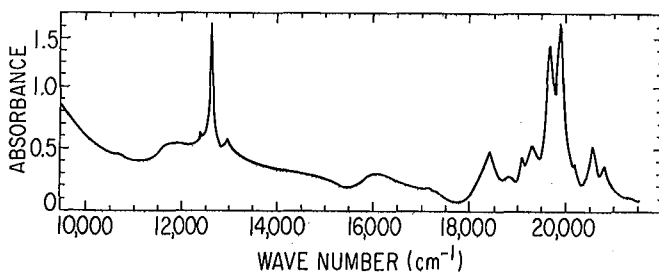

Fig. 4. The solution absorption spectrum of Es^{3+} . (Ref. 11)

possible at this point to introduce transition intensity as a guide to energy level assignment. Thus it was possible to avoid the semi-qualitative approach of matching calculated level energies with estimated band positions.¹² We measured the areas of the absorption band envelopes normalized to unit concentration and compared these intensities to those predicted by the Judd-Ofelt theory before making the energy level assignments. The pattern that emerged was consistent with all measurements made to date, and corresponded to the level structure yielded in Fig. 2 by constructing a vertical line at $F_2 = 288 \text{ cm}^{-1}$.

In about 1974, the ORNL group began using a microscope spectrophotometer system in conjunction with experiments in which compounds of Es were being synthesized and characterized. They succeeded in obtaining very clear absorption spectra of small samples such as that shown for EsBr_3 (Ref. 13) in Fig. 5. These spectra were the first taken in absorption in the solid phase, and the bands observed were consistent with those reported in solution. More recently, Fellows, Peterson, Young,

J.P. YOUNG AND R.G. HAIRE ORNL
R.L. FELLOWS, M. NOÉ, J.R. PETERSON, UNIV. OF TENNESSEE



THE ABSORPTION SPECTRUM OF EsBr_3
AFTER ANNEALING AT 400°C

Fig. 5. Absorption spectrum of EsBr_3 . (Ref. 13)

and Haire reported distinct changes in the spectrum of EsCl_3 reduced with H_2 at $\geq 575^\circ\text{C}$.¹⁴ This, of course, is consistent with the formation of E^{2+} .

In order to make further progress in the analysis of electronic structure in Es^{3+} , it was essential to be able to observe spectra recorded at low temperature, preferably at 4°K . Such measurements make possible a considerable simplification in the interpretation because all transitions arise from the lowest energy crystal field state. We could anticipate severe problems associated with the attempt to obtain such data from absorption measurements because of the radiation effects that tend to rapidly reduce transmission and the complexity due to the increasing presence of Bk^{3+} and Cf^{3+} over the time required for measurement.

At this point, Hessler, Caird and the group at ANL turned to laser-excited fluorescence spectroscopy. We were beginning to develop a major facility with a variety of laser based capabilities in 1975, and many of the techniques that were being used proved to be well suited to the Es^{3+} problem. They provided the discrimination necessary to isolate Es^{3+} signals from those of its decay

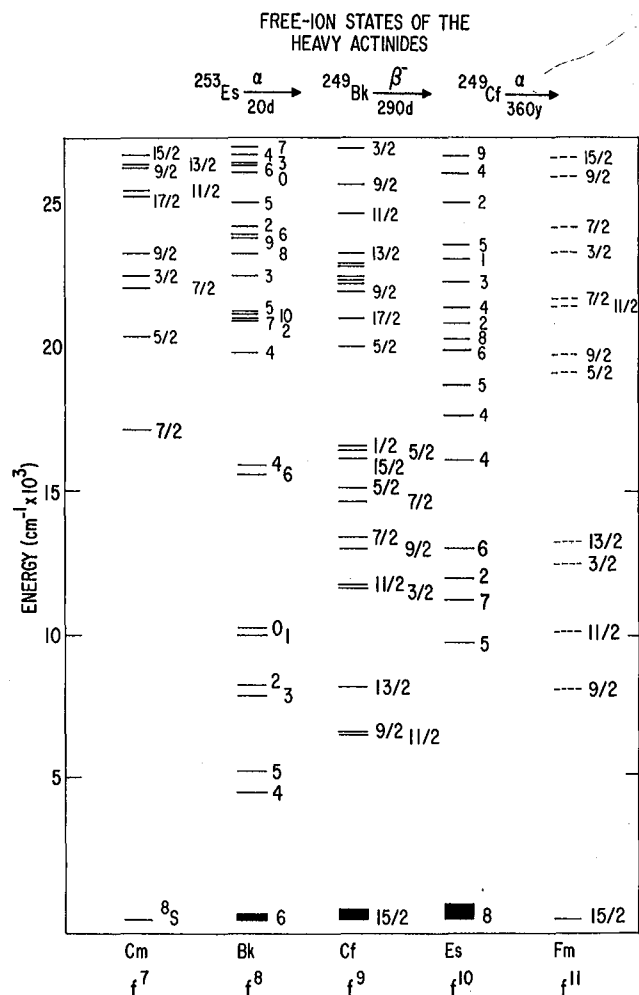

Fig. 6. Computed free-ion states of Cm^{3+} , Bk^{3+} , Cf^{3+} , Es^{3+} , and Fm^{3+} . (Ref. 15)

products. The predictions of the energy level structures of Bk^{3+} , Cf^{3+} , and Es^{3+} in $LaCl_3$ were also being improved during this period, based on a rapidly developing experimental base.¹⁵

We began by growing single crystals of $LaCl_3$ doped with Es^{3+} . This provides an environment of well established symmetry and minimizes interaction between Es^{3+} ions. The close proximity of Es^{3+} ions has the effect of broadening the observed spectral lines. The high resolution of a N_2 -pumped dye laser made it possible to scan the visible-near infrared region and selectively excite many of the Es^{3+} states even though Bk^{3+} and Cf^{3+} states were in close proximity, as indicated in Fig. 6. The resulting fluorescence was monitored, and this can be done very sensitively. In this type of measurement most of the absorption and reemission occurs at the surface of the sample, so, the fact that the sample may become opaque to transmission, is not limiting. Further discrimination between levels characteristic of Es^{3+} and those of impurities became essential. It was provided by the measurement of fluorescence lifetimes coincidentally with monitoring the energies of the fluorescing states.¹⁶

The lifetimes of the observed fluorescence transitions are very characteristic, as indicated in Fig. 7. By appropriate electronic gating of the signals, one can detect the very weak fluorescence of Es^{3+} in the presence of very

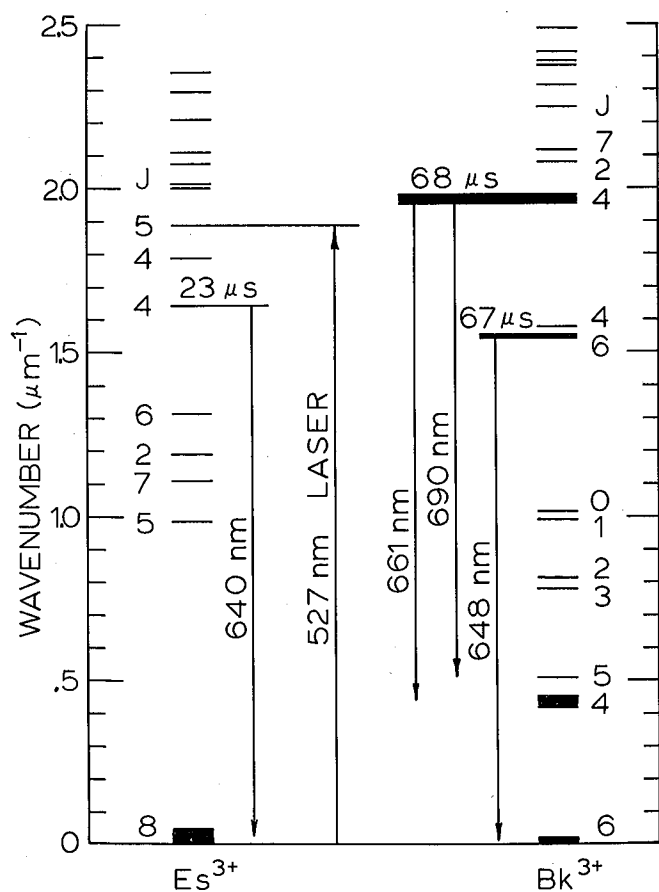

Fig. 7. Relative life-times of some fluorescing states in $Es^{3+}:LaCl_3$ and $Bk^{3+}:LaCl_3$.

strong signals from Bk^{3+} and Cf^{3+} . Since there was independent evidence for the relative energies of lower-lying excited levels in Es^{3+} , Bk^{3+} , and Cf^{3+} ,¹⁷ it was possible to obtain excitation spectra as well as fluorescence spectra.

In excitation spectra, the fluorescence of a well established state characteristic of Es^{3+} , for example the $J = 4$ state near 16500 cm^{-1} , is monitored, while scanning a limited range of higher energies with the dye laser. In the absence of large ($> 600\text{-}700 \text{ cm}^{-1}$) energy gaps, these states rapidly relax by non-radiative processes to the fluorescing $J = 4$ state following excitation. The signal is detected only when the pump energy is tuned to the energy of a higher-lying crystal field state of Es^{3+} . Excitation of Bk^{3+} or Cf^{3+} states will result in fluorescence at other energies.¹⁸

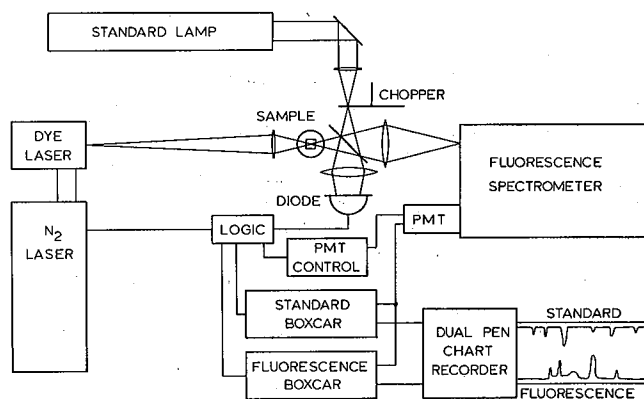

Fig. 8. Block diagram of experimental equipment used in monitoring the excitation and fluorescence spectrum of Es^{3+} . (Ref. 18)

The block diagram in Fig. 8 shows the experimental arrangement. A 1-meter monochromator was used in the experiments to date, but the inherent resolution of the system exceeded by far the reproducibility of the wavelength drive. It was consequently necessary to introduce a diode trigger circuit so that the photomultiplier could be time-shared to record standard and sample spectra continuously.¹⁸ The data from a typical recording is reproduced in Fig. 9. The only disadvantage to the method is that nature gives up her secrets very slowly.

The results given in Fig. 10 constitute a current status report on the spectrum of $Es^{3+}:LaCl_3$. This represents the type of data desired for the whole spectral range. The confirmation that will result when fluorescence from several different excited states decay to a single lower state is needed to accurately establish the details of the crystal-field splitting. In addition to the energies of levels, it is necessary to assign crystal field quantum numbers. These can be deduced if the polarization of the fluorescing transitions is known.

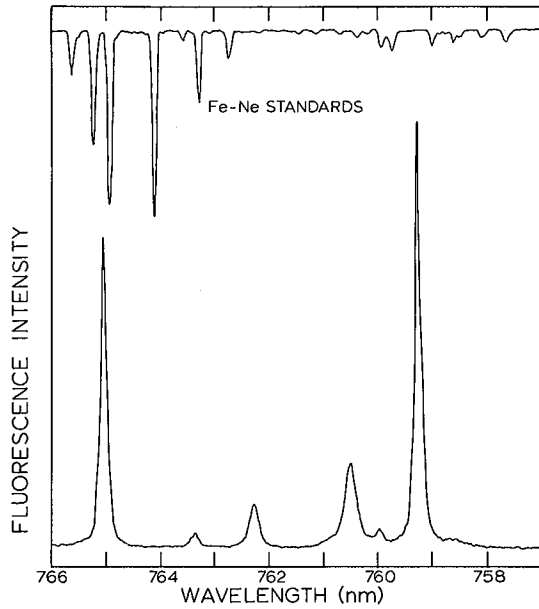

Fig. 9. Absorption spectrum of $\text{Es}^{3+}:\text{LaCl}_3$ at 77°K with simultaneous recording of Fe-Ne wavelength standard spectrum.

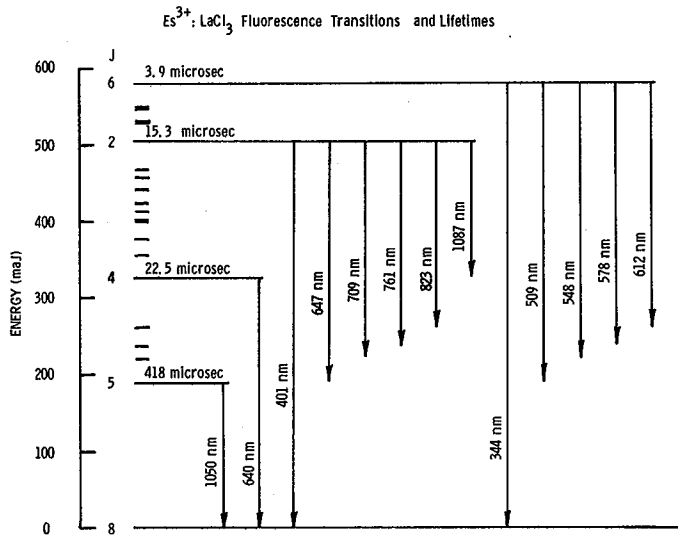

Fig. 10. Fluorescence transitions and life-times for $\text{Es}^{3+}:\text{LaCl}_3$.

The selective excitation and fluorescence lifetime monitoring techniques discriminated against impurities such as Bk^{3+} and Cf^{3+} . However, traces of Pr^{3+} were also detected in every crystal even though the highest available purity La_2O_3 was used to produce the LaCl_3 . Not all impurities are unwelcome. The observed polarization of the Pr^{3+} lines revealed the orientation of the crystal host and thus provided the basis for assigning the polarization of the Es^{3+} lines.

Based on all of the experimental evidence obtained to date, it was possible to construct the complete ground state splitting diagram for $\text{Es}^{3+}:\text{LaCl}_3$, shown in Fig. 11. For comparison, the computed counterpart, which is still based on energy level parameters extrapolated from the analysis of lighter actinide energy level schemes, is in quite good agreement. There is no question but that it will be possible to develop as complete an analysis of the energy level scheme for Es^{3+} as will be available for any of the lighter members of the series, but the experiments are laborious and time consuming. Those primarily responsible for this work at ANL include J.P. Hessler, J.A. Caird, F. Wagner, Jr., R.K. Sjolom, and H. Crosswhite.

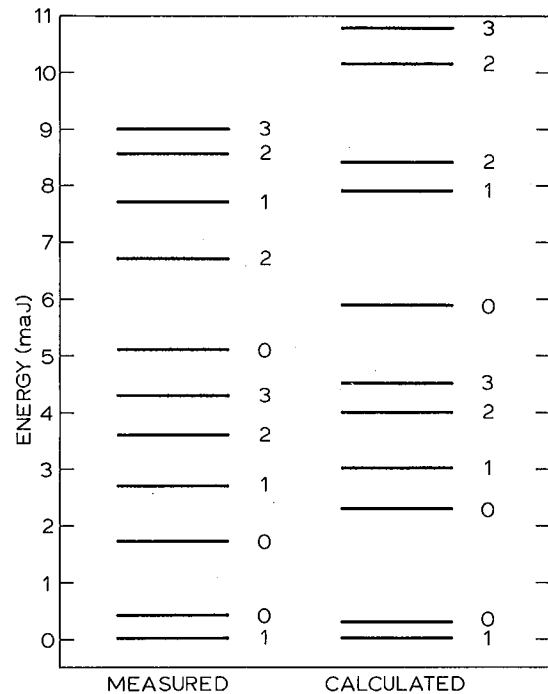

Fig. 11. Observed and computed ground state splitting in $\text{Es}^{3+}:\text{LaCl}_3$.

One of the advantages of the techniques we have been discussing is that they are well suited to very small samples. No attempt has been made to grow "mini"-crystals because to date it hasn't been necessary. We estimate that a few nanograms of Es^3 could be detected with relative ease, and this encourages at least the consideration of spectroscopic work with Fm^{3+} where the picogram scale is indicated.¹

In addition to a tentative energy level scheme for Fm^{3+} as shown in Fig. 6, some guidance with respect to potentially prominent fluorescing lines is desirable. Actually we are able to make predictions of fluorescence branching ratios and radiative lifetimes since it has already been shown that several of the heavier actinides are amenable to an extensive intensity analysis. The theoretical model that provides the basis for computing intensities in good agreement with experiment can be

FLUORESCENCE BRANCHING RATIO CALCULATIONS
FOR $\text{Fm}^{3+}:\text{LaCl}_3$

Initial State	Final State	Initial Energy (cm ⁻¹)	Final Energy (cm ⁻¹)	β_R	Excited State Lifetime msec
$^4\text{F}_{9/2}$	$^4\text{I}_{15/2}$	8288	418	1.0	0.850
$^2\text{H}_{11/2}$	$^4\text{I}_{9/2}$	9958	8288	.004	0.853
	$^4\text{I}_{15/2}$		418	.996	
$^2\text{P}_{3/2}$	$^2\text{H}_{11/2}$	12282	9958	.14	0.843
	$^4\text{I}_{9/2}$		8288	.01	
	$^4\text{I}_{15/2}$		418	.85	
$^4\text{I}_{13/2}$	$^2\text{P}_{3/2}$	13382	12282	~0	0.143
	$^2\text{H}_{11/2}$		9958	.02	
	$^4\text{F}_{9/2}$		8288	.01	
	$^4\text{I}_{15/2}$		418	.97	
$^4\text{F}_{5/2}$	$^4\text{I}_{13/2}$	18776	13382	.05	0.190
	$^2\text{P}_{3/2}$		12282	.02	
	$^2\text{H}_{11/2}$		9958	.17	
	$^4\text{F}_{9/2}$		8288	.05	
	$^4\text{I}_{13/2}$		418	.71	

Fig. 12. Fluorescence life-time and branching ratio calculation for $\text{Fm}^{3+}:\text{LaCl}_3$.

used to predict the purely radiative relaxation characteristics of excited states. Typical results for Fm^{3+} are indicated in Fig. 12. For each excited state one can compute a total radiative lifetime and a branching ratio to each lower-energy state. Such a calculation maps the flow of energy in the system assuming that non-radiative processes are not rate controlling. A particularly interesting possibility for monitoring characteristic fluorescence in Fm^{3+} is associated with the $^4\text{F}_{5/2}$ state predicted to lie near 18000 cm⁻¹. With a large energy gap to the next lower-lying state, the probability of rapid non-radiative decay is greatly diminished so the observed lifetime may be expected to approach the radiative limit. In addition, there is strong coupling to the ground state, so detectable fluorescence at ~18000 cm⁻¹ would be predicted.

Experimentally, the problem would be to minimize the volume of the sample. It is probably not even necessary to separate from other actinide impurities; that can be accomplished by electronic discrimination. What is needed is to perform similar experiments with Es^{3+} to determine where the real problems lie and realistically appraise the chances of success in detecting Fm^{3+} .

I said at the beginning of this paper that the spectroscopy of Es required pushing the use of classical methods toward the limit. When you think about it, Burris Cunningham, Sherman Fried and all of their fellow micro chemists were faced with a similar type of problem as they began work on the Plutonium Project. They developed what to many were radical methods, and showed that they could productively work with the material available to

them. In a sense, we have a similar challenge put to us today; to develop new, more sensitive methods of electronic structure analysis! Such methods will not only allow us to scale down from the microgram level, but will permit an increasingly detailed examination of the nature of the ionic environment which is fundamental to all chemical behavior.

The developments of the last 25 years in Es and Fm chemistry and spectroscopy are prologue. There are challenging new frontiers both today and for the future.

FOOTNOTES AND REFERENCES

1. At present a maximum of ~0.5-picogram ^{257}Fm is produced and separated at one time by the ORNL HFIR-TRU facility. This quantity is insufficient for classical spectroscopic sources. However, as pointed out by R.W. Hoff, as much as 1- μg ^{257}Fm might be recovered at one time in a suitably designed nuclear explosion. The latter quantity would, of course, suffice for a classical spectroscopic experiment.
2. B.B. Cunningham, J.R. Peterson, R.D. Baybarz, T.C. Parsons, *Inorg. Nucl. Chem. Ltrs.* **3**, 519 (1967).
3. W.T. Carnall in *Proc. Sympos. Commemorating the 25th Anniversary of Elements 97 and 98* (Lawrence Berkeley Laboratory, University of California, 1976) Report LBL-4366.
4. D.K. Fujita, B.B. Cunningham, T.C. Parsons, J.R. Peterson, *Inorg. Nucl. Chem. Ltrs.* **5**, 245 (1969).
5. R.G. Gutmacher, E.F. Worden, J.G. Conway, in *Atomic Spectroscopy Symposium, N.B.S., Gaithersburg, MD, Sept., 1967*, *Abst. of Papers*, p. 9.
6. W.T. Carnall and P.R. Fields, *Adv. Chem. Ser.* **71**, 86 (1967).
7. L.J. Nugent, J.L. Burnett, R.D. Baybarz, G.K. Werner, S.P. Tanner, J.R. Tarrant, O.L. Keller, *J. Phys. Chem.* **73**, 1540 (1969).
8. L.J. Nugent, R.D. Baybarz, G.K. Werner, H.A. Friedman, *Chem. Phys. Ltrs.* **7**, 179 (1970).
9. N. Edelstein, J.G. Conway, D. Fujita, W. Kolbe, R. McLaughlin, *J. Chem. Phys.* **52**, 6425 (1970).
10. L.J. Nugent, R.D. Baybarz, J.L. Burnett, J. Phys. Chem. **73**, 1177 (1969).
11. W.T. Carnall, D. Cohen, P.R. Fields, R.K. Sjoblom, R.F. Barnes, *J. Chem. Phys.* **59**, 1785 (1973).
12. L.P. Varga, R.D. Baybarz, M.J. Reisfeld, J.B. Mann, *J. Inorg. Nucl. Chem.* **35**, 2303 (1973).

13. J.P. Young, R.G. Haire, R.L. Fellows, M. Noé, J.R. Peterson, in Proc. 4th Intern. Transplutonium Elements Conf., Baden-Baden, W. Germany, 13 Sept. 1975.
14. R.L. Fellows, J.R. Peterson, J.P. Young, R.G. Haire, in Absts. 13th R.E. Conf., Oglebay Park, W. VA 1977.
15. W.T. Carnall, H.M. Crosswhite, H. Crosswhite, J.P. Hessler, C. Aderhold, J.A. Caird, A. Paszek, F. Wagner, Jr., in Proc. 2nd Int. Conf. on the Electronic Structure of the Actinides, Wroclaw, Poland, Sept. 1976 (Ossolineum Press, 1977).
16. J.A. Caird, J.P. Hessler, A.P. Paszek, W.T. Carnall, H.M. Crosswhite, H. Crosswhite, H. Diamond, C.W. Williams, in Abst. of Papers, Am. Phys. Soc. Mtg. Stanford, Calif. 20 Dec. 1976.
17. W.T. Carnall, H.M. Crosswhite, H. Crosswhite, J.P. Hessler, J.A. Caird, C. Aderhold, A. Paszek, R.K. Sjoblom, in Abst. of Papers, 173rd A.C.S. Mtg., New Orleans, LA 1977.
18. Jan P. Hessler, J.A. Caird, W.T. Carnall, F. Wagner, Jr., C.W. Williams, in Abst. of Papers, 13th R.E. Conference, Oglebay Park, W. VA 1977.

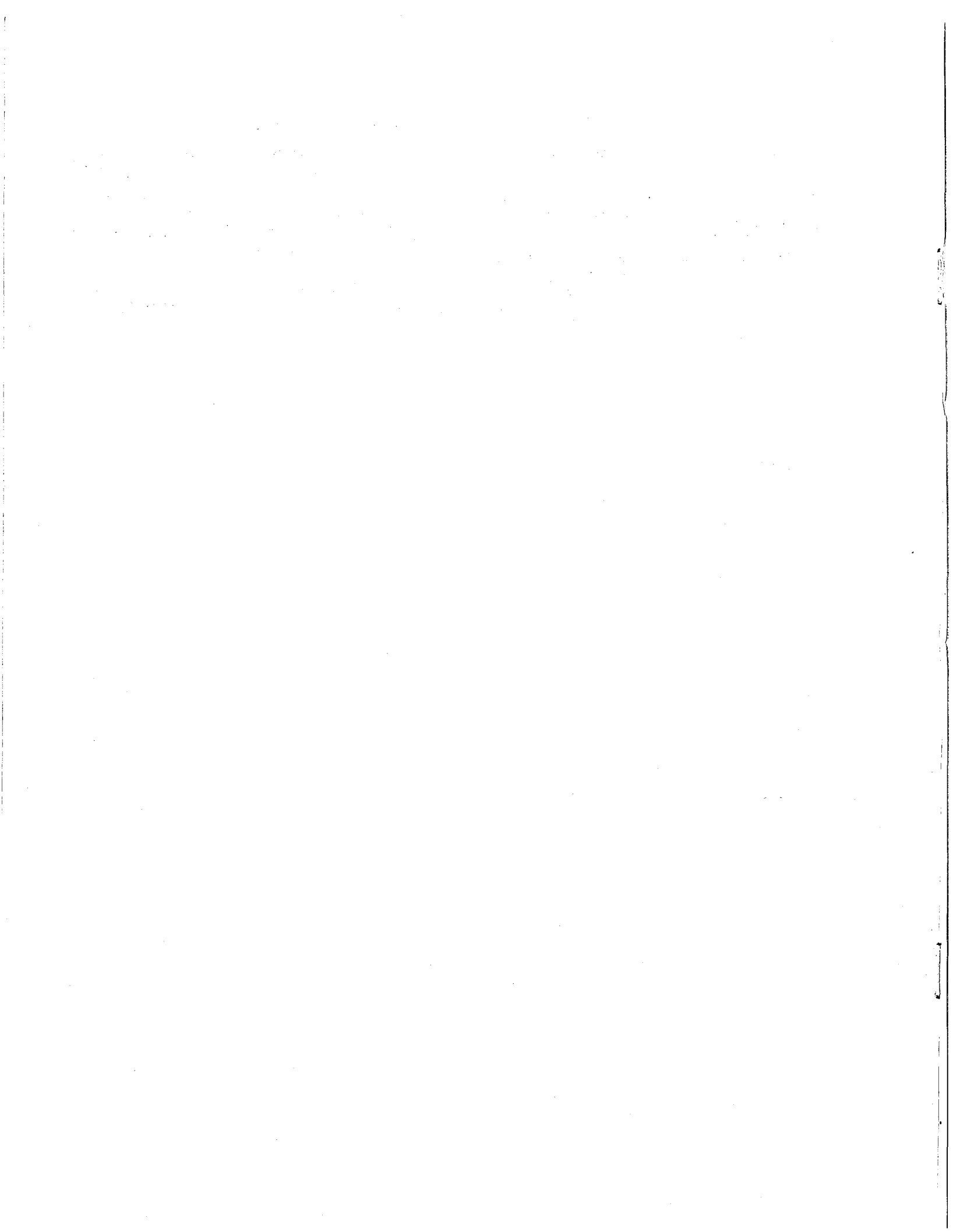

This report was done with support from the Department of Energy. Any conclusions or opinions expressed in this report represent solely those of the author(s) and not necessarily those of The Regents of the University of California, the Lawrence Berkeley Laboratory or the Department of Energy.

Reference to a company or product name does not imply approval or recommendation of the product by the University of California or the U.S. Department of Energy to the exclusion of others that may be suitable.

TECHNICAL INFORMATION DEPARTMENT
LAWRENCE BERKELEY LABORATORY
UNIVERSITY OF CALIFORNIA
BERKELEY, CALIFORNIA 94720