

Advanced Florida Building Code

FLOORING

by Jim Caron

Design Arts Seminars, Inc.

PO BOX 20369

Tallahassee FL 32316

info@designarts.net

www.designarts.net

1.800.264.9605





Table of Contents

2010 FLORIDA BUILDING CODE – BUILDING

Chapter 6 - Types of Construction

602 Construction Classification

602.4.2 Floor Framing

Chapter 8 - Interior Finishes

804.1 General. Interior Floor Finish

804.2 Classification

804.3 Testing and identification

804.4 Interior Floor Finish Requirements

Chapter 10 - Means of Egress

1003 General Means of Egress

1003.4 Floor Surface

Chapter 12 - Interior Environment

1207 Sound Transmission

1207.2 Airborne Sound.

1207.2.1 Masonry

1207.3 Structure-borne sound.

2010 FLORIDA BUILDING CODE - RESIDENTIAL

Chapter 3 - Building Planning

R311 Means of Egress

R311.1 Means of Egress

Chapter 5 - Floors

R501 General

R502 Wood Floor Framing

2010 FLORIDA BUILDING CODE – EXISTING BUILDING

Chapter 6 - Alterations—Level 1

613 Residential Swimming Pools and Spas

613.1 Existing Pool And Spa Components and Systems

2012 FLORIDA ACCESSIBILITY CODE

Chapter 3 – Building Blocks

302 Floor or Ground Surfaces

302.1 General

302.3 Openings

Chapter 5 – General Site and Building Elements

500 General

502.4 Floor or Ground Surfaces

Chapter 8 – Special Rooms, Spaces and Elements

802 Wheelchair Spaces



Learning Objectives

- Be acutely aware of Florida Building Code requirements as they relate to flooring.
- Have an understanding of the extent to which design professionals and the construction industry must research all aspects of the Florida Building Code in order to assure the safety of their clients and adhere to the law.
- Know exactly which provisions of the Florida Building Code address flooring design and construction.

2010 Florida Building Code Building

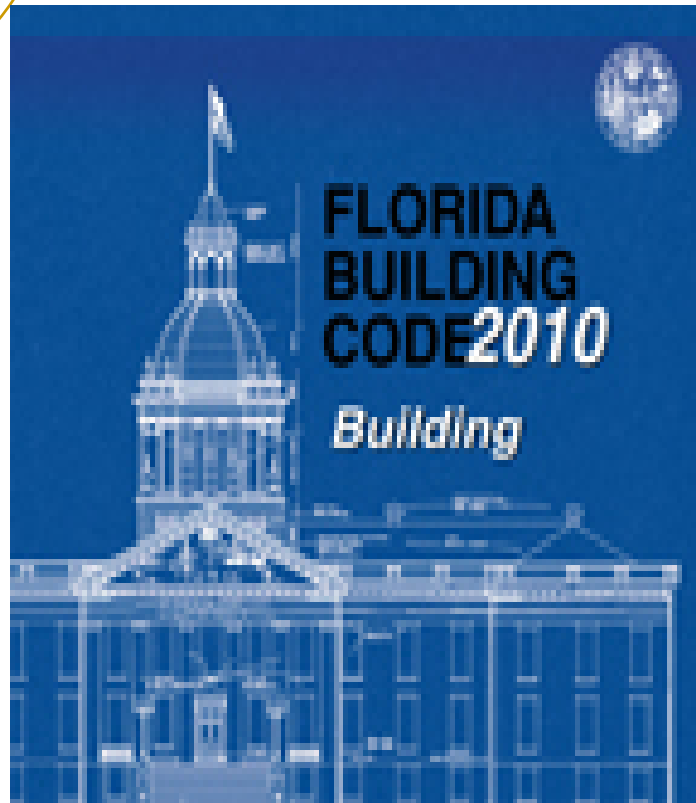

2010 Florida Building Code **Building**

- [Chapter 6 - Types of Construction](#)
 - 602.4.2 Floor Framing
- [Chapter 8 - Interior Finishes](#)
 - 804.4 Interior Floor Finish Requirements
 - 804.1 General. Interior Floor Finish
 - 804.2 Classification
 - 804.3 Testing and identification
- [Chapter 10 - Means of Egress](#)
 - 1003.4 Floor Surface
- [Chapter 12 - Interior Environment](#)
 - Section 1207 Sound Transmission
 - 1207.2 Airborne Sound.
 - 1207.2.1 Masonry
 - 1207.3 Structure-borne sound.

Chapter 6 - Types of Construction

602.4.2 Floor Framing of Heavy Timber Construction

- 602.4.2 Floor Framing. Wood beams and girders shall be of sawn or glued-laminated timber and shall be not less than 6 inches (152 mm) nominal in width and not less than 10 inches (254mm) nominal in depth. Framed sawn or glued-laminated timber arches, which spring from the floor line and support floor loads, shall be not less than 8 inches (203 mm) nominal in any dimension. Framed timber trusses supporting Floor loads shall have members of not less than 8 inches (203 mm) nominal in any dimension.

Chapter 8 - Interior Finishes

804.1 General. Interior Floor Finish

- 804.1 General. Interior Floor finish and floor covering materials shall comply with Sections 804.2 through 804.4.1

Tile and Stone often preferred in high-rise condos

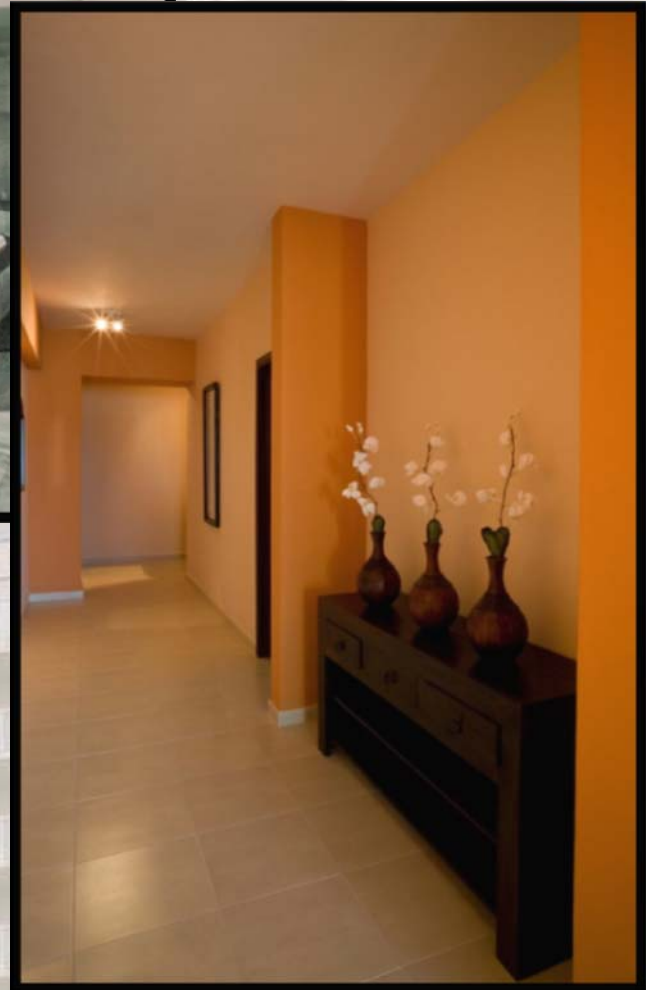

Chapter 8 - Interior Finishes

804.2 Classification

- 804.2 Classification. Interior Floor finish and floor covering materials required by section 804.4.1 to be of Class I or II materials shall be classified in accordance with NFPA 253. The Classification referred to herein Corresponds to the Classifications referred to herein determined by NFPA 253 as Follows: Class I, 0.45 watts/cm² or greater.

Chapter 8 - Interior Finishes

804.3 Testing and identification

- 804.3 Testing and identification. Interior floor finish and floor covering materials shall be tested by an agency in accordance with NFPA 253 and identified by a hang tag or other suitable method so as to identify the manufacturer or supplier and style, and shall indicate the interior floor finish or floor covering classification according to Section 804.2. Carpet-type floor covering shall be tested as proposed for use, including underlayment. Test reports confirming the information provided in the Manufacturer's product identification shall be furnished to the building official upon request.

Chapter 10 - Means of Egress

1003.4 Floor Surface

- 1003.4 Floor Surface. Walking surfaces of the means of egress shall have a slip resistant surface and be securely attached.

Chapter 12 - Interior Environment

Section 1207 Sound Transmission

- 1207.2 Air-borne Sound. Walls, partitions and floor/ceiling assemblies separating dwelling units from each other or from public or service areas shall have a sound transmission class (STC) of not less than 50 (45 in field tested) for air-borne noise when tested in accordance with ASTM E 90. Penetrations or openings in construction assemblies for piping; electrical devices; recessed cabinets; bathtubs; soffits; or heating, ventilating or exhaust ducts shall be sealed, lined, insulated or otherwise treated to maintain the required ratings. This requirement shall not apply to dwelling unit entrance doors; however, such doors shall be tight fitting to the frame and sill.

Impact Floor-to-Floor noise

Low concern



High concern



Chapter 12 - Interior Environment

Section 1207 Sound Transmission

Identifying, measuring and controlling unwanted noise

Acoustical Testing

- Types of noise
 - Provide additional insight
 - Review current methods
 - What do and don't they measure
 - Identify things that can affect results
-
- Examples of typical floor/ceilings assemblies
 - Determining requirements
 - Sound Reduction Products
 - Commonly used products
 - Selection
 - Green considerations

Chapter 12 - Interior Environment

Section 1207 Sound Transmission

Two types of noise

STC = Airborne
Noise

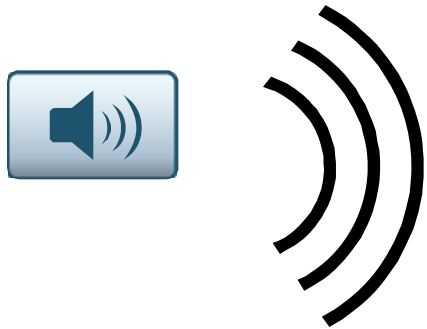

IIC = Impact
Noise



Chapter 12 - Interior Environment

Section 1207 Sound Transmission

Codes & Minimum Value Required

Code	Min. IIC	Code	Min. IIC
BOCA	IIC 45	California	IIC 50 FIIC 45
ICBO	IIC 45 FIIC 45	HUD/FHA	IIC 52
International Building Code	IIC 50 FIIC 45	Natl Assn of Home Build	IIC 55 to 60
Florida BC	IIC 50 FIIC 45	Condo Association	IIC 45 to 50

Chapter 12 - Interior Environment

Section 1207 Sound Transmission

Installation

- Proper installation is critical.
 - Isolate floor
 - Flanking noise
- Shallow cavity - use acoustical sealant
- For deeper cavities - compressible backer rod

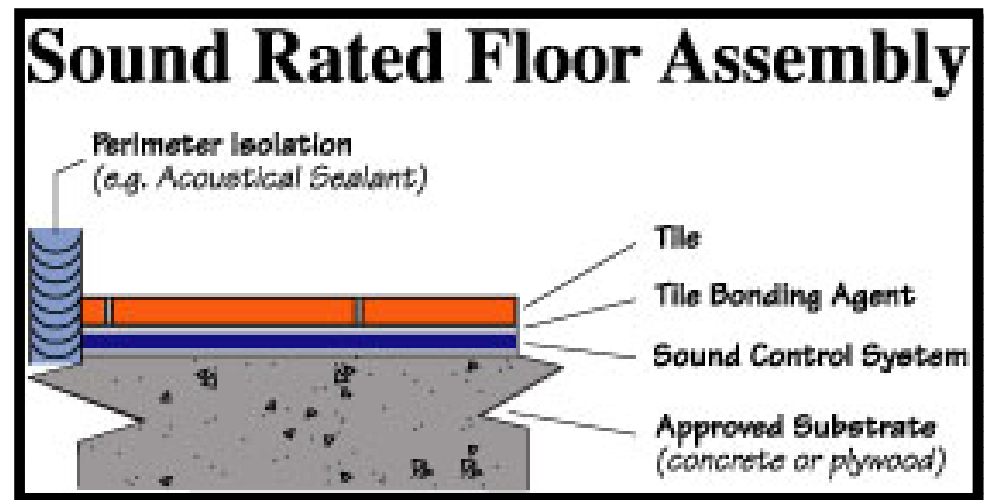

Chapter 12 - Interior Environment

1207.2 Air-borne Sound Standard for Sound Rated Floors

TCNA committee proposed a standard for bonded, sound reduction membranes includes:

- Acoustical performance
 - ASTM E492
 - ASTM E2179
- Crack isolation
 - ASTM C627

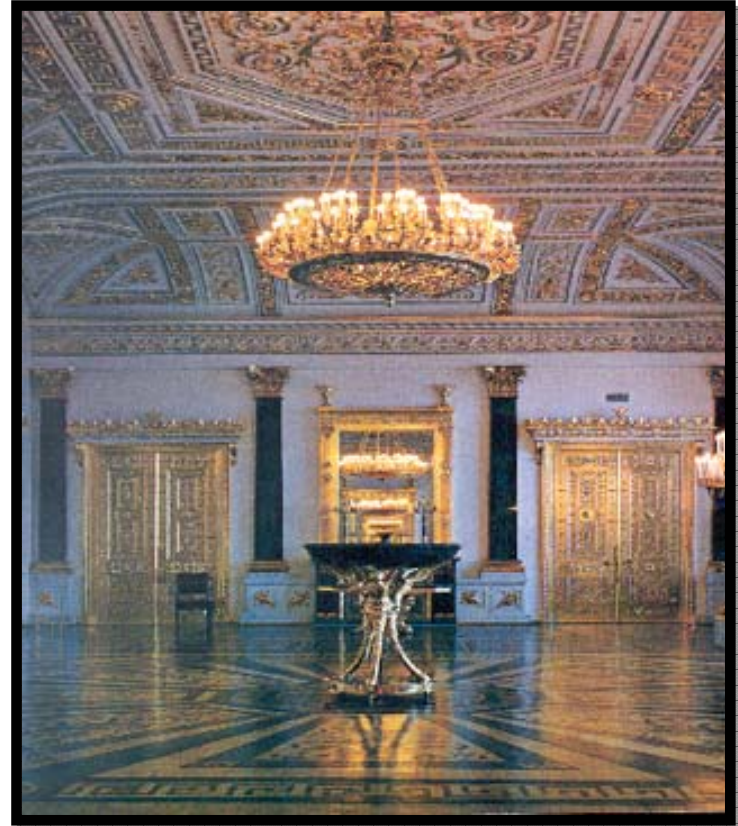

A Tile Floor Must Be Isolated from the Wall as well as the Floor.

**Elastic Sealant Under Trim
Perimeter Isolation Board and
Elastic Sealant at Floor Edge**

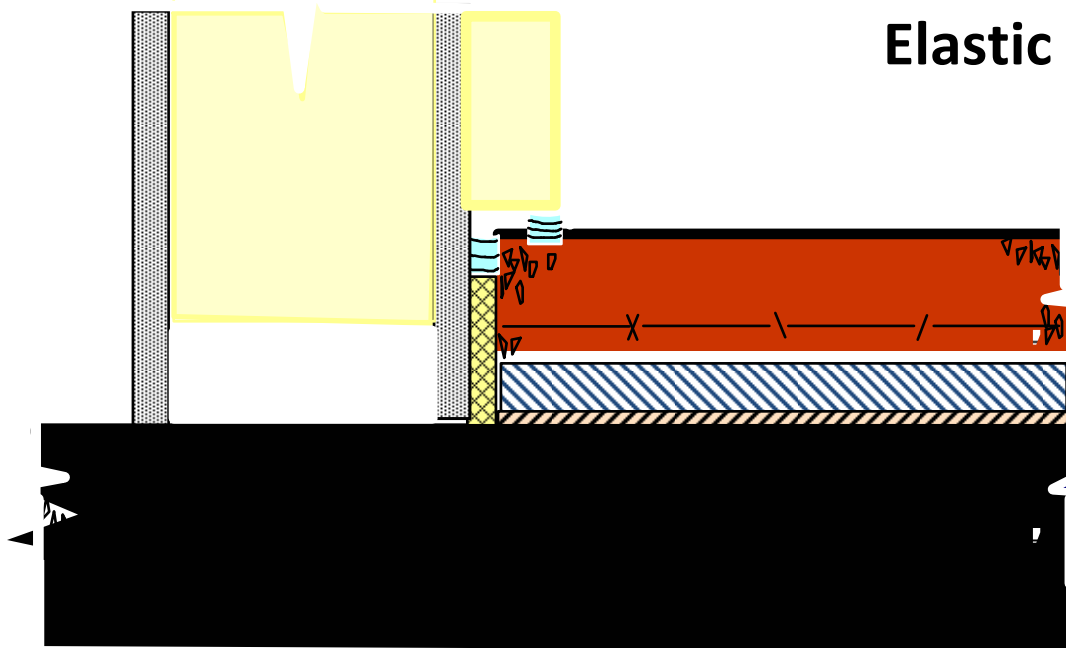

Tile

Concrete Deck

IIC Class - Concrete Construction 1 of 4

1207.2 Air-borne Sound.

Impact Insulation Class Concrete Construction

Section Sketch

Assembly

IIC



4" Concrete Substrate

24



6" Concrete Substrate

28

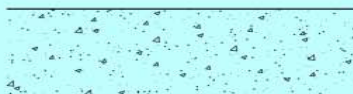

8" Concrete Substrate

32

IIC Class - Concrete Construction 2 of 4

1207.2 Air-borne Sound.

Impact Insulation Class Concrete Construction

Section Sketch

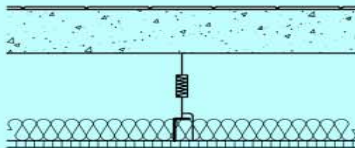

Assembly

Tile Floor
Thin Acoustic Underlayment
(1/4" or less)
Concrete Substrate

Tile Floor
Concrete Substrate
Spring Isolation Hangars
Batt Insulation
Gypsum Board Ceiling

Tile Floor
Thick Acoustic Underlayment
Concrete Substrate

IIC

45



45 to 50:
Building Code Min.



50

53

IIC Class - Concrete Construction 3 of 4

1207.2 Air-borne Sound.

Impact Insulation Class Concrete Construction

Section Sketch

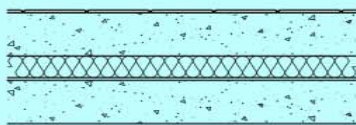
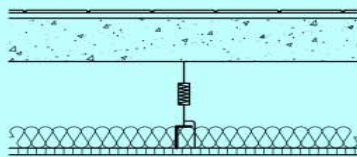
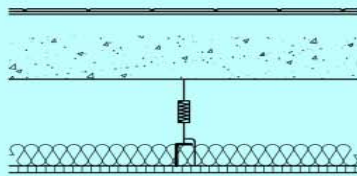

Assembly

Tile Floor
Thin Acoustic Underlayment
(1/4" or less)
Concrete Substrate
Spring Isolation Hangars
Batt Insulation
Gypsum Board Ceiling

Tile Floor
Thick Acoustic Underlayment
Concrete Substrate
Spring Isolation Hangars
Batt Insulation
Gypsum Board Ceiling

Tile Floor
Floating Concrete Floor
Acoustic Underlayment
Structural Concrete Substrate

IIC

56

64

67

IIC Class - Concrete Construction 4 of 4

1207.2 Air-borne Sound.

Impact Insulation Class Concrete Construction

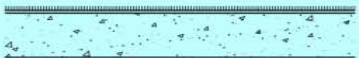
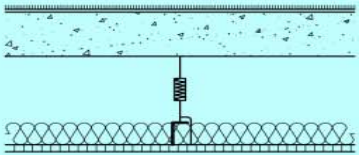
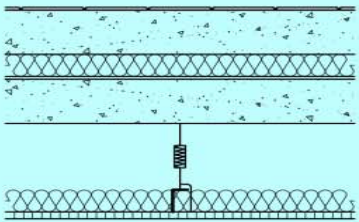
<u>Section Sketch</u>	<u>Assembly</u>	<u>IIC</u>
	Carpet on Pad Concrete Substrate	70
	Carpet on Pad Concrete Substrate Spring Isolation Hangars Batt Insulation Gypsum Board Ceiling	73
	Tile Floor Floating Concrete Floor Acoustic Underlayment Structural Concrete Substrate Spring Isolation Hangars Batt Insulation Gypsum Board Ceiling	76

IIC Class - Wood Joist Construction 1 of 3

1207.2 Air-borne Sound.

Impact Insulation Class Wood Joist Construction

Section Sketch

Assembly

IIC

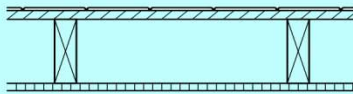

Tile Floor
Joists
Gypsum Ceiling

33



Tile Floor
Joists
Resilient Channel
Gypsum Ceiling

39

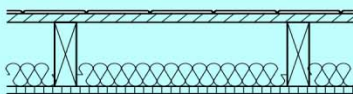

Tile Floor
Joists
Batt Insulation in the Cavity
Gypsum Ceiling

42

IIC Class - Wood Joist Construction 2 of 3

1207.2 Air-borne Sound.

Impact Insulation Class Wood Joist Construction

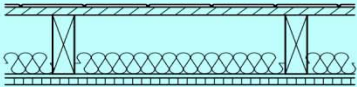
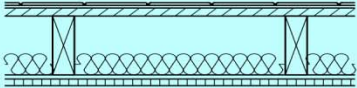
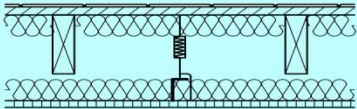
<u>Section Sketch</u>	<u>Assembly</u>	<u>IIC</u>
	Tile Floor Joists Batt Insulation in the Cavity Resilient Channel Gypsum Ceiling	44
	Tile Floor Thin Underlayment Subfloor Joists Batt Insulation in the Cavity Resilient Channel Gypsum Ceiling	50
	Tile Floor Joists Batt Insulation in the Cavity Spring Isolators Gypsum Ceiling	52

IIC Class - Wood Joist Construction 3 of 3

1207.2 Air-borne Sound.

Impact Insulation Class Wood Joist Construction

Section Sketch

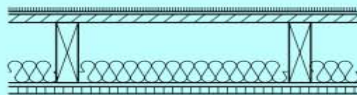
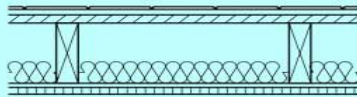

Assembly

Tile Floor
Thick Underlayment
Subfloor
Joists
Batt Insulation in the Cavity
Resilient Channel
Gypsum Ceiling

Carpet on Pad
Joists
Batt Insulation in the Cavity
Resilient Channel
Gypsum Ceiling

IIC

55

66

Selection of Sound Reduction Membranes

1207.2 Air-borne Sound.

Define your requirements:

- What is the IIC of your starting assembly?
- What IIC value do you want (or need) Type of flooring that will be used?
- Other things that your installation will need
 - Waterproofing
 - Crack isolation

Sound Reduction products

1207.2 Air-borne Sound.

Types

- Bonded
- Examples
 - Sheet membranes
 - Cork
 - Fabric/fiber sheets
 - Recycled rubber sheets
 - Become substrate
 - Should not contribute to cracking
 - ASTM C627
 - Some provide crack isolation & waterproofing
- Features
 - Generally, faster, easier to install
 - Modest increase in floor height

Sound Reduction products (cont.)

1207.2 Air-borne Sound.

Types - continued

- Floated (installed under a mortar bed or CBU)
 - Fiber/filament
 - Phenolic honeycomb sheets
- Features
 - Generally, higher IIC values
 - Greater elevation to floor height
 - More complex installation

Chapter 12 - Interior Environment

Section 1207.2.1 Sound Transmission

- 1207.2.1 Masonry. The sound transmission of class of concrete masonry and clay masonry assemblies shall be calculated in accordance with TMS 0302 or determined through testing in accordance with ASTM E 90.

Recent trends - Things that affect sound transmission: 1207.2 Air-borne Sound

Resilience, mass, air space

- Sound reduction membranes
- Ceilings (insulation, isolation, multiple layers)
- Concrete substrates (types, mix and thickness)
- Wood joist floor/ceiling assemblies

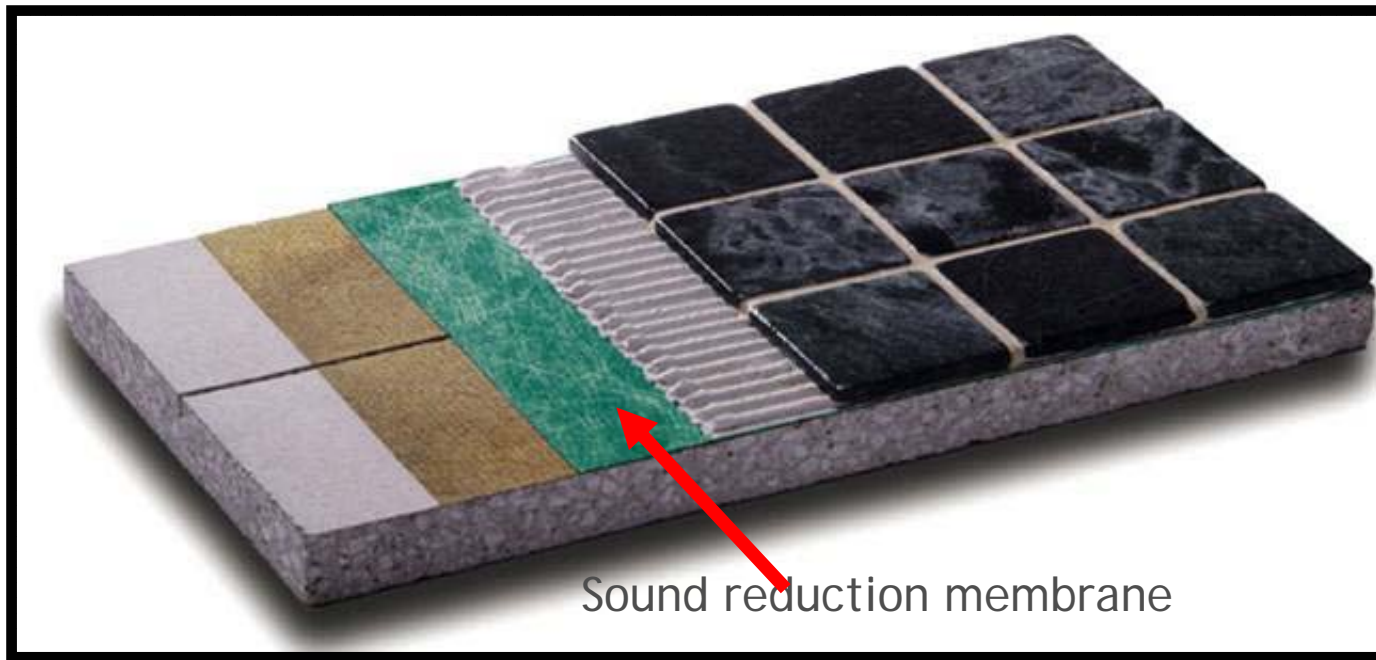

Testing STC: 1207.2 Air-borne Sound

Sound Transmission Class (STC)

- Single-number rating derived from laboratory measurement of sound transmission loss (ASTM E90).
- Describes the sound insulating properties of a floor/ceiling assembly in the 100-4000 Hz frequency range
- FBC and UBC Requirement for is 50
- Higher values indicate less noise

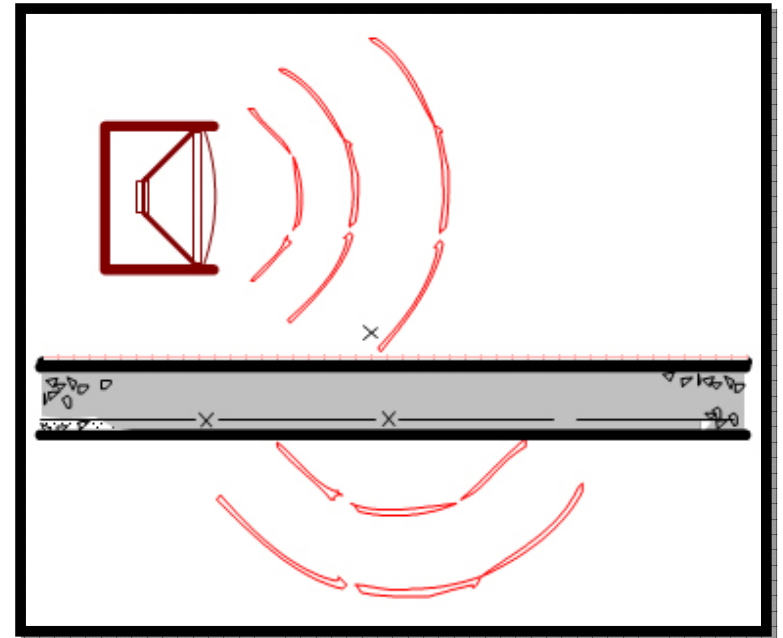

Chapter 12 - Interior Environment
Section 1207.3 Sound Transmission

- 1207.3 Structure-borne sound. Floor/ceiling assemblies between dwelling units or between a dwelling unit and a public or service area within the structure shall have an impact insulation class (IIC) rating of not less than 50 (45 if field tested) when tested in accordance with ASTM E 492.

Testing IIC: 1207.2 Air-borne Sound

Impact Insulation Class (IIC)

- Single-number rating that describes the insulating properties of a floor/ceiling assembly for impact (footfall) noise.
- FBC and UBC requirements:
 - IIC = 50
 - FIIC = 45
- Higher numbers = better performance.
- Logarithmic scale

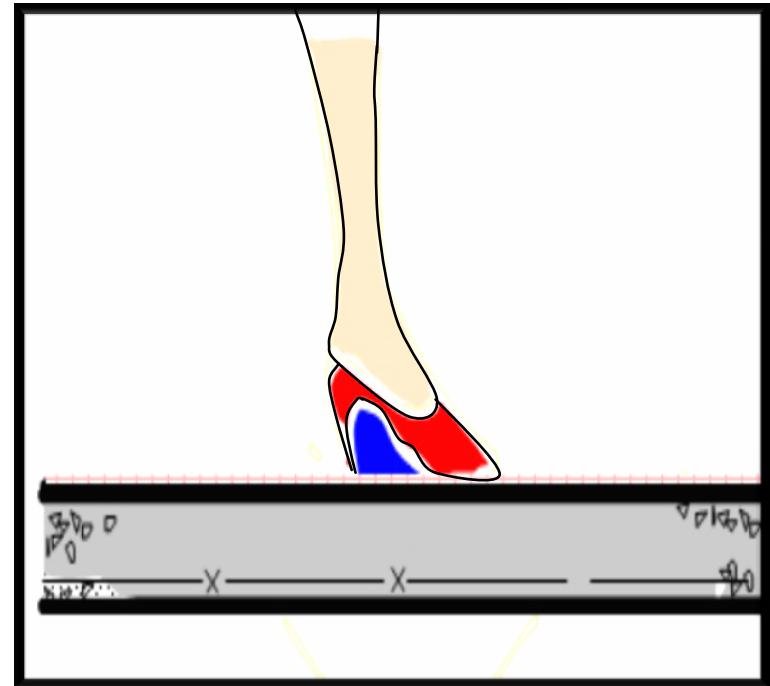

Testing: 1207.2 Air-borne Sound

- Impact Noise Rating (INR) - replaced by IIC
- INR of 0 = IIC of 51
- Higher numbers indicate better performance.

ASTM E2179 introduced in 2003

“The Standard Test Method for Laboratory Measurement of the Effectiveness of Floor Coverings in Reducing Impact Sound Transmission Through Concrete Floors” .

- Test IIC of bare, concrete substrate
- Then add sound reduction membrane and flooring surface and test IIC.
- Results for both are compared at each of 21 frequencies and a change (or delta) is calculated.
- Can provide an estimate of the IIC rating for a specific sound reduction membrane and flooring surface

Increase in IIC

1207.2 Air-borne Sound.

Some acousticians say an increase in IIC of
10 =

- 90% decrease in the sound pressure level
- And you hear approximately 50% less noise

Chapter 12 - Interior Environment

Section 1207.3 Sound Transmission

Sound Room video



2010 Florida Building Code Residential

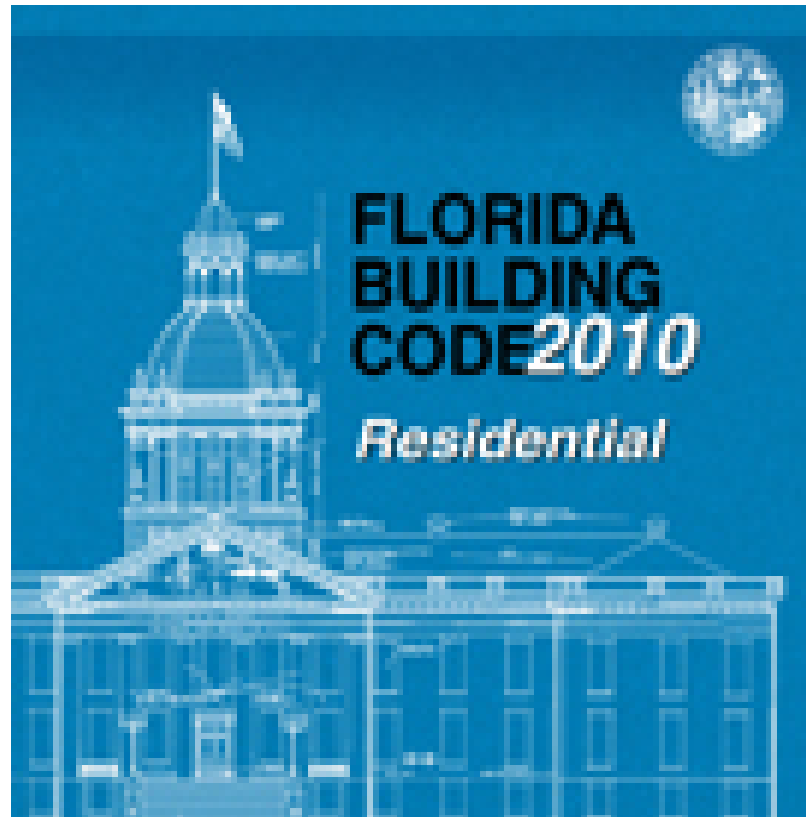

2010 Florida Building Code Residential

- Chapter 3 - Building Planning
 - R311.1 Mean of Egress
- Chapter 5 - Floors
 - R501 General
 - R502 Wood Floor Framing

Chapter 3 - Building Planning

R311 Mean of Egress

- Ramps (R311.8)
 - Maximum slope (R311.8.1)
 - 1:12 ratio – 1 inch of rise for every 12 inches of run
 - Landing required at top and bottom (R311.8.2)
 - Handrail required one side if exceeds 1:12 slope (R311.8.3)
 - Height 34 - 38 inches (R311.8.3.1)
 - Grip size same as size of stair rail (R311.8.3.2)
 - Continuous for length of ramp (R311.8.3.3)
- Guard rails required for porches, balconies, raised floors 30" above floor or ground (R312.1)
 - Guard rails must not be less than 36 inches in height (312.2)

Chapter 3 - Building Planning

R311.1 Mean of Egress

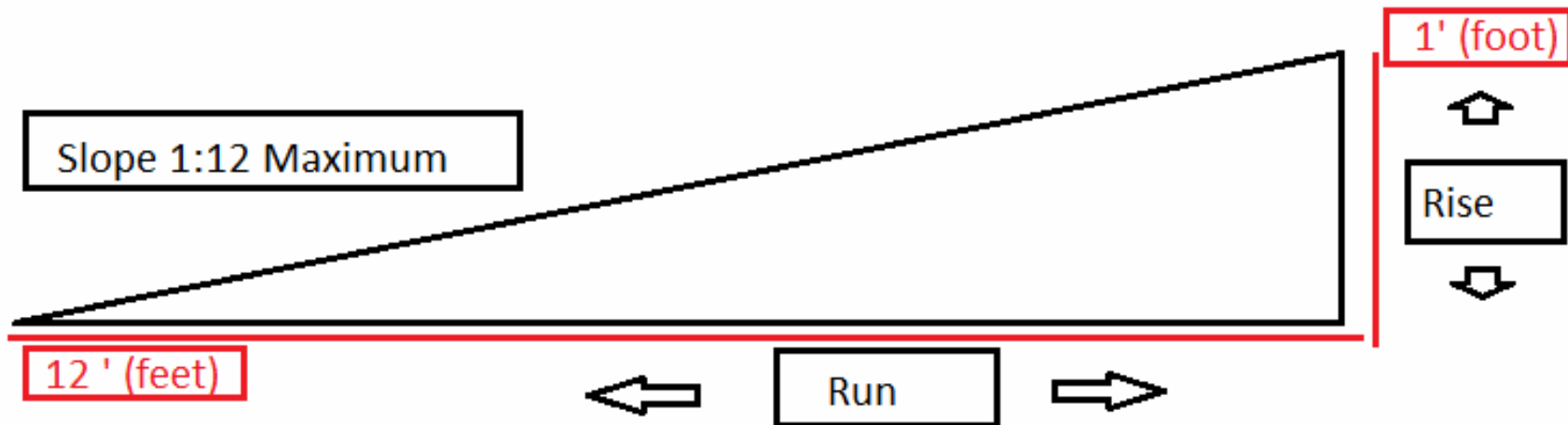

Ramps (R311.8)
Maximum slope (R311.8.1)

Slope Calculations

$$\text{Slope} = \text{Rise}/\text{Run}$$

$$\text{Rise} = \text{Slope} \times \text{Run}$$

$$\text{Run} = \text{Rise}/\text{Slope}$$

Chapter 5 - Floors

R501 General

- Section R501 Regulates design and construction of all floors
 - Includes attic spaces that house mechanical/plumbing
 - Exception
 - housing in High Velocity Wind Zone must comply with Chapter R44
- R501.2 Floor construction must be capable of distributing loads
- Concrete slab-on-ground
 - Minimum 3.5 inches thick per R506.1
 - Required comprehensive strength of concrete is regulated by Section R402.2

Chapter 5 - Floors

R502 Wood floor framing

- R502.1.5 limits drilling and notching in wood floor members (girders, floor joists)
 - See figure R502.1.5

Figure R502.1..5
Cutting, Notching and Drilling

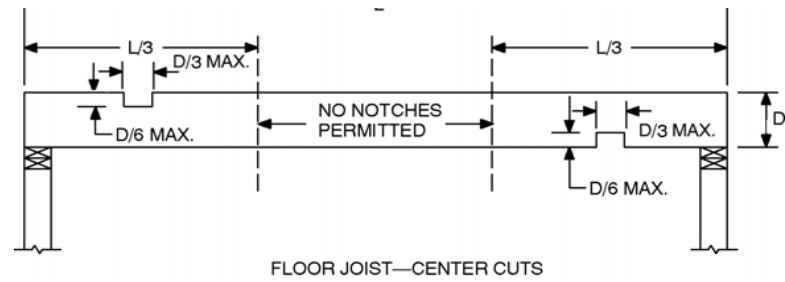

FLOOR JOIST—CENTER CUTS

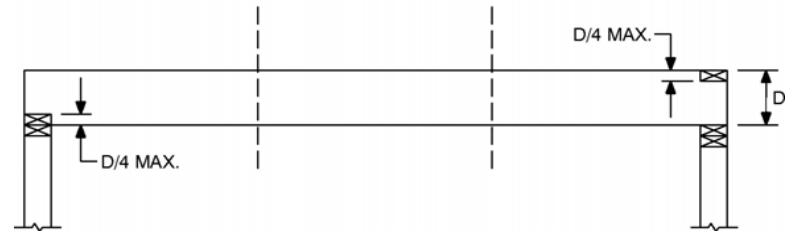

FLOOR JOIST—END CUTS

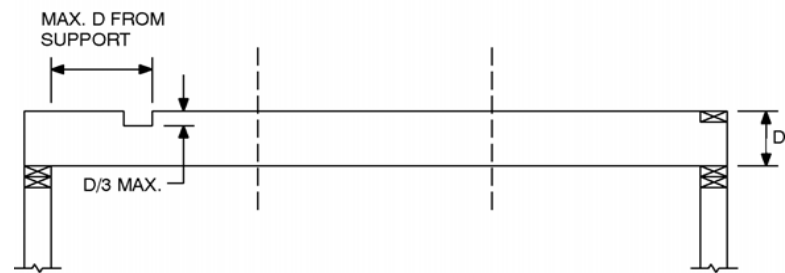

RAFTER/CEILING JOISTS (R802.7.1)

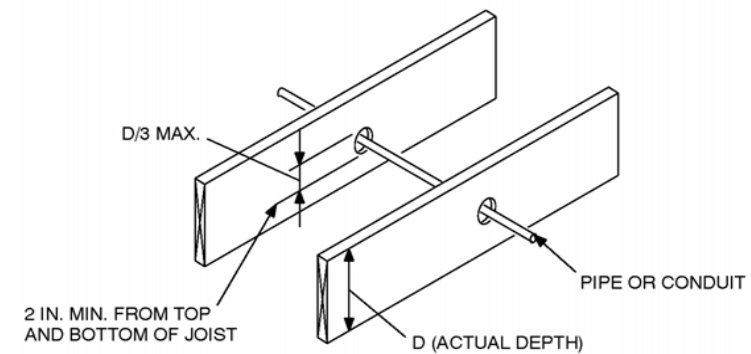

For SI: 1 inch = 25.4 mm

2010 Florida Building Code Existing Building

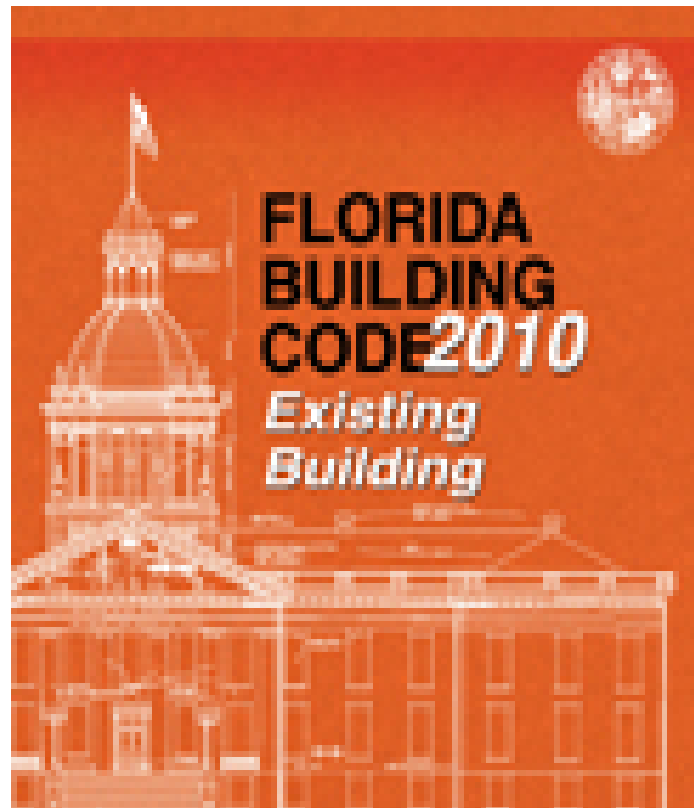

2010 Florida Building Code **Existing Building**

- **Chapter 6 - Alterations—Level 1**

- 613.1 Existing Pool And Spa Components and Systems

Chapter 6 - Alterations—Level 1

613.1 Existing Pool And Spa Components and Systems

- 613.1 Existing Pool and Spa Components and Systems. A pool or spa component or system undergoing alteration shall comply with section R4101 of the Florida Building Code, Residential.

Exceptions: A level one alteration, as described in section 403, shall not require compliance with section R4101.17 of the Florida Building Code, Residential.

The following alterations shall not require compliance with Section R4101 of the Florida Building Code, Residential:

1. Installation of pavers or coatings to an existing pool or spa deck.



Adoquin: *Outside in Moderate Temperature Areas of the Country – Southern California, Texas & Florida*



Australian Sandstone: *Random, Flagstone*

2012 Florida Accessibility Code

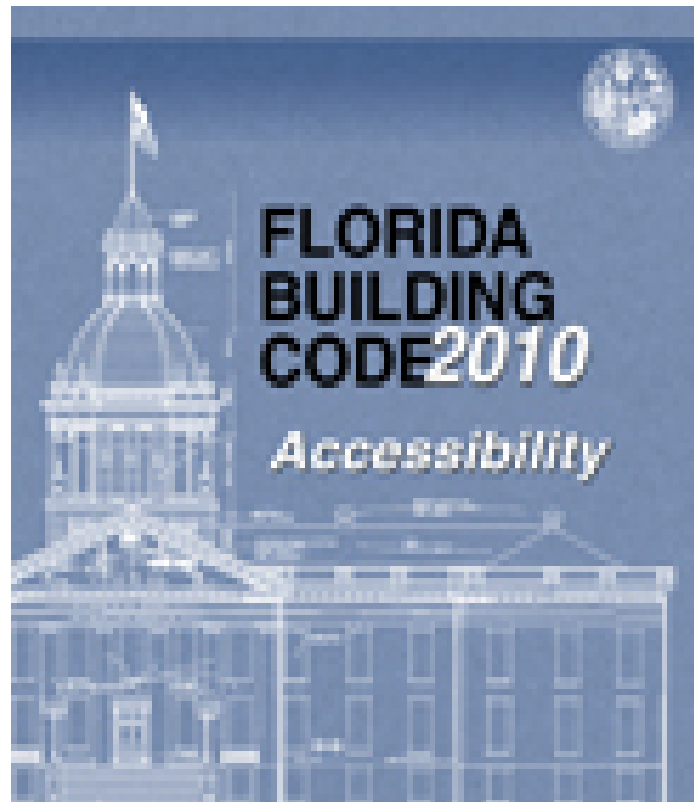

2012 Florida Accessibility Code

- **302 FLOOR OR GROUND SURFACES**
General
 - 302.1 General
 - 302.3 Openings
- **Advisory 502.4 Floor or Ground Surfaces**
- **802 WHEELCHAIR SPACES**

2012 Florida Accessibility Code

302 FLOOR OR GROUND SURFACES

- **302.1 General.** Floor and ground surfaces shall be stable, firm, and slip resistant and shall comply with 302
- **EXCEPTIONS:**
- **1.** Within animal containment areas, floor and ground surfaces shall not be required to be stable, firm, and slip resistant.
- **2.** Areas of sport activity shall not be required to comply with 302.

Retail



Laboratories



Hospitals



Restaurants



2012 Florida Accessibility Code

Advisory 302.1 General

- **A stable surface is one that remains unchanged by contaminants or applied force, so that when the contaminant or force is removed, the surface returns to its original condition. A firm surface resists deformation by either indentations or particles moving on its surface. A slip-resistant surface provides sufficient frictional counterforce to the forces exerted in walking to permit safe ambulation.**

2012 Florida Accessibility Code

302.3 Openings

- **302.3 Openings. Openings in floor or ground surfaces shall not allow passage of a sphere more than**
- 1/2 inch (13 mm) diameter except as allowed in 407.4.3, 409.4.3, 410.4, 810.5.3 and 810.10.
- Elongated openings shall be placed so that the long dimension is perpendicular to the dominant direction of travel.

2012 Florida Accessibility Code

Advisory 502.4 Floor or Ground Surfaces

- Access aisles are required to be nearly level in all directions to provide a surface for wheelchair transfer to and from vehicles. The exception:
- allows sufficient slope for drainage. Built-up curb ramps are not permitted to project into access
- aisles and parking spaces because they would create slopes greater than 1:48.

2012 Florida Accessibility Code

802 WHEELCHAIR SPACES, COMPANION SEATS, AND DESIGNATED AISLE SEATS

802.1 Wheelchair Spaces. Wheelchair spaces shall comply with 802.1.

802.1.1 Floor or Ground Surface. The floor or ground surface of wheelchair spaces shall comply with 302. Changes in level are not permitted.

EXCEPTION: Slopes not steeper than 1:48 shall be permitted.

802.1.2 Width. A single wheelchair space shall be 36 inches (915 mm) wide minimum. Where two adjacent wheelchair spaces are provided, each wheelchair space shall be 33 inches (840 mm) wide minimum.

Questions?

Websites of interest:

<http://www.floridabuilding.org>.

http://www.ecodes.biz/ecodes_support/Free_Resources/2010Florida/2010Florida_main.html