

***Consolidation Plan for Facilities and Areas in Okinawa***

***April 2013***

# ***Table of Contents***

## **Section 1 - Introduction**

I. Overview	1
II. Notes	3

## **Section 2 - Land Returns**

### **III. Areas Eligible for Immediate Return Upon Completion of Necessary Procedures**

1. West Futenma Housing area of Camp Zukeran (Camp Foster)	4
2. The north access road of Makiminato Service Area (Camp Kinser)	5
3. Area near Gate 5 on Makiminato Service Area (Camp Kinser)	6
4. A portion of the warehouse area of the Facilities and Engineering Compound in Camp Zukeran (Camp Foster)	7

### **IV. Areas Eligible for Return Once the Replacement Facilities in Okinawa are Provided**

1. Camp Kuwae (Camp Lester)	8
2. Camp Zukeran (Camp Foster)	
a. Lower Plaza Housing area	10
b. A part of Kishaba Housing area	11
c. The Industrial Corridor	12
3. Elements of Makiminato Service Area (Camp Kinser), including the preponderance of the storage area	14
4. Naha Port	16
5. Army Petroleum, Oil, and Lubricant Depot Kuwae Tank Farm No. 1	17
6. Marine Corps Air Station (MCAS) Futenma	19

### **V. Areas Eligible for Return as USMC Forces Relocate from Okinawa to Locations Outside of Japan**

1. Additional elements of Camp Zukeran (Camp Foster)	21
2. The remainder of Makiminato Service Area (Camp Kinser)	22

## **Section 3 - Progress Since the April 27, 2012 SCC Joint Statement**

### **VI. Areas of Additional Land Returns**

1. Shirahi River area, Camp Zukeran (Camp Foster)	24
2. Area south of the Industrial Corridor, Camp Zukeran (Camp Foster)	25

### **Appendix A:**

List of Estimated Timelines for the Return of Facilities and Areas	27
--	----

## **Section 1 - Introduction**

### ***I. Overview***

The realignment, including consolidation, of U.S. forces within Okinawa is a significant effort by the U.S. and Japanese Governments which recognize the importance of enhancing Japanese and U.S. public support for the security alliance, which contributes to a sustainable presence of U.S. forces at facilities and areas in Japan as stated in the October 29, 2005 document of the Security Consultative Committee (SCC) entitled "U.S.-Japan Alliance: Transformation and Realignment for the Future".

When implemented, the realignment will ensure a life-of-the-Alliance presence for U.S. forces in Japan as stated in the May 1, 2006 document of the SCC entitled "United States-Japan Roadmap for Realignment Implementation" (Realignment Roadmap) and will maintain deterrence and mitigate the impact of U.S. forces on local communities.

In order to realize the realignment, the U.S. and Japanese Governments have developed and will implement this consolidation plan. This consolidation plan, including sequencing steps, was jointly developed for facilities and areas remaining in Okinawa.

The U.S. and Japanese Governments reaffirm their commitment to the steady implementation of the realignment.

The U.S. Government (USG) remains committed to return lands on Okinawa as designated U.S. Marine Corps forces relocate from Okinawa, and as facilities become available for units and other tenant activities relocating to locations on Okinawa.

The Government of Japan (GOJ) noted its responsibility to relocate all functions and capabilities that are resident in U.S. facilities designated for return, and that are required by U.S. forces remaining in Okinawa, including the housing necessary to support the remaining U.S. Marine Corps units, in coordination with the USG.

In the April 27, 2012 SCC Joint Statement, the U.S. and Japanese Governments confirmed that the total or partial return of the six facilities and areas designated in the Realignment Roadmap remains unchanged and that the land of aforementioned facilities and areas utilized by U.S. forces are eligible for return in three categories, as follows:

- 1) Areas eligible for immediate return upon completion of necessary procedures;
- 2) Areas eligible for return once the replacement facilities in Okinawa are provided; and,
- 3) Areas eligible for return as U.S. Marine Corps forces relocate from Okinawa to locations outside of Japan.

## ***I. Overview (continued)***

This consolidation plan was developed reflecting the precepts that regular training and exercise, as well as the availability of facilities and areas for these purposes, are essential to ensure the readiness, employability, and interoperability of U.S. forces, and that adequate capacity of U.S. facilities and areas is necessary, and the capacity above typical daily peacetime usage levels plays a critical and strategic role in meeting contingency requirements. This capacity can provide an indispensable and critical capability toward meeting local emergency needs such as in disaster relief and consequence management situations.

In addition, in the April 27, 2012 SCC Joint Statement, it was noted that the effort to develop this consolidation plan should consider the possible impact of the joint and shared use of facilities located on Okinawa and that joint and shared use of facilities was a key objective of the Realignment Roadmap. The U.S. and Japanese Governments confirmed that joint and shared use by Japan Self-Defense Forces will continue to be discussed at a variety of fora, including the Joint/Shared Use Working Group, which was established in December 2010. The discussion at this working group will be reflected in master planning for facilities and areas remaining in Okinawa to implement this consolidation plan.

Timelines for completing the implementation of this consolidation plan are event-driven. Recognizing the strong desires of Okinawa residents, this consolidation plan is to be implemented as soon as possible while ensuring operational capability, including training capability, throughout the process. The U.S. and Japanese Governments agree that no further significant changes will be required for the foreseeable future. The USG will implement this consolidation plan subject to the Agreement under Article VI of the Treaty of Mutual Cooperation and Security between Japan and the United States of America, Regarding Facilities and Areas and the Status of United States Armed Forces in Japan (SOFA), including continuing to observe the needs for facilities and areas for the purposes of SOFA. Timelines for the return of facilities and areas in Appendix A of this consolidation plan will be updated by the U.S. and Japanese Governments and publicly released every three years.

## II. Notes

1. The area for return outlined in the maps and the size of area identified in “Area for return” show those currently agreed between the U.S. and Japanese Governments, and the precise dimensions are subject to minor adjustments based on the result of measurement surveys, etc. to be conducted in the future.
2. “Major facilities to relocate” shows the major buildings that require relocation as well as other necessary measures, such as ensuring use of utilities, which will be required due to land returns. Additional functions requiring relocation will be identified during the master planning process.
3. The timelines and dates shown in this consolidation plan are best-case estimates for when specific facilities and areas can be returned, following the completion of necessary steps and procedures by the U.S. and Japanese Governments. These timelines are subject to delay, depending on such elements as progress of the GOJ’s efforts to prepare relocation sites on Okinawa and progress of the USG’s efforts to relocate USMC forces to locations outside of Japan.
4. “Return/relocation sequence” for each facility shows the major procedures necessary for land returns from JFY2013 onward. Linkages between the return/relocation sequence of other facilities are not necessarily considered. The relocation of functions to Camp Zukeran (Camp Foster), Camp Hansen, Camp Courtney and Camp Schwab may need to be implemented after the units currently located in the subject areas relocate to locations outside of Japan. They are also subject to further coordination depending on the progress of relocation.
5. Cultural Asset Surveys (CAS), Environmental Impact Assessment (EIA), etc. are identified in the return/relocation sequence where implementation is expected. Therefore, even if the return/relocation sequence does not show CAS, etc., it may be required to conduct CAS, etc. depending on the result of site survey to be conducted in the future, which may cause delay in the approximate timing for return.
6. “Relocating to” shows the currently planned areas where major facilities will be relocated and is subject to change during the master planning process, which will be implemented by the USG.



Abbreviations: MP (Master Plan)  
JC (Joint Committee)  
BCP (Basic Criteria Package)

\* The number below each sequence in ( ) shows the minimum period required to implement the process.

## Section 2 - Land Returns

### III. Areas Eligible for Immediate Return Upon Completion of Necessary Procedures

#### 1. West Futenma Housing area of Camp Zukeran (Camp Foster)

- i. Area for return
  - Area for return is approximately 52 ha.
- ii. Timing for return
  - Can be returned upon completion of necessary procedures for return in JFY2014 or later. (Reference sequence of return steps below)

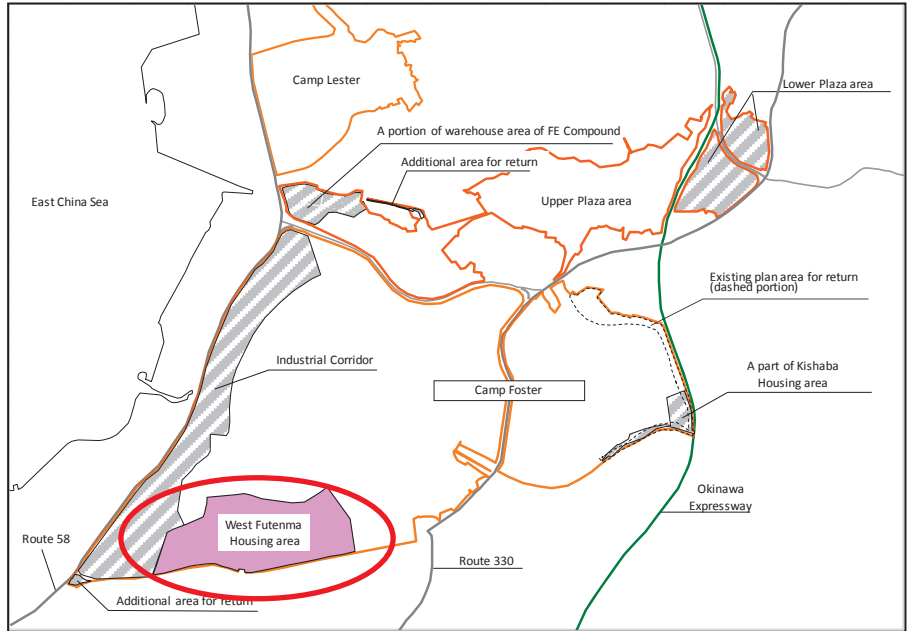

Major facilities to relocate	Relocating to	Return sequence
—	—	<div style="display: flex; justify-content: space-around; align-items: center;"> <div style="border: 1px solid black; padding: 2px;">Survey</div> <div style="border: 1px solid black; padding: 2px;">JC Agreement</div> <div style="border: 1px solid black; padding: 2px;">Fence/Utilities</div> <div style="border: 1px solid black; padding: 2px;">Admin procedures</div> <div style="border: 1px solid black; padding: 2px;">Return</div> </div> <p style="text-align: center; margin-top: 5px;"> <span style="margin-right: 40px;">(0.5)</span> <span style="margin-right: 40px;">(1)</span> <span>(0.5)</span> </p>

**III. Areas Eligible for Immediate Return Upon Completion of Necessary Procedures**

2. The north access road of Makiminato Service Area (Camp Kinser)

- i. Area for return
  - Area for return is approximately 1 ha.
- ii. Timing for return
  - Can be returned upon completion of necessary procedures in JFY2013 or later. (Reference sequence of return steps below)



Major facilities to relocate	Relocating to	Return sequence
—	—	<div style="display: flex; align-items: center; justify-content: center; gap: 10px;"> <div style="border: 1px solid black; padding: 2px 5px;">Survey</div> <div style="border: 1px solid black; padding: 2px 5px;">JC Agreement</div> <div style="border: 1px solid black; padding: 2px 5px;">Admin procedures</div> <div style="border: 1px solid black; padding: 2px 5px;">Return</div> </div> <p style="text-align: center; margin-top: 5px;">(0.5)                      (0.5)</p>

**III. Areas Eligible for Immediate Return Upon Completion of Necessary Procedures**

**3. Area near Gate 5 on Makiminato Service Area (Camp Kinser)**

- i. Area for return
  - Area for return is approximately 2 ha.
  
- ii. Timing for return
  - Can be returned upon completion of necessary procedures for return in JFY2014 or later. (Reference sequence of return steps below)

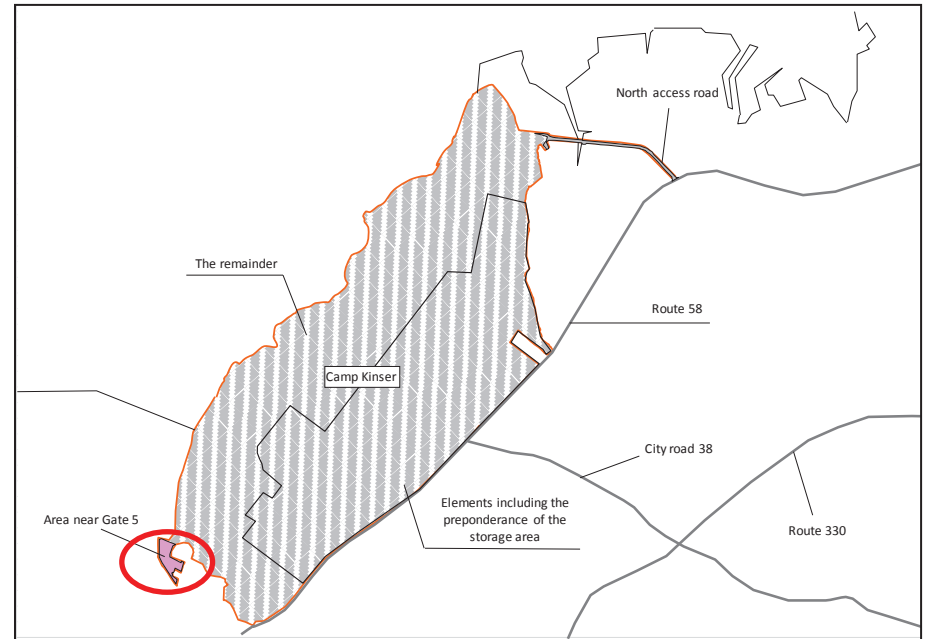

Major facilities to relocate	Relocating to	Return sequence
—	—	<div style="display: flex; align-items: center; justify-content: center; gap: 10px;"> <div style="border: 1px solid black; padding: 2px;">Survey</div> <div style="border: 1px solid black; padding: 2px;">JC Agreement</div> <div style="border: 1px solid black; padding: 2px;">Fence</div> <div style="border: 1px solid black; padding: 2px;">Admin procedures</div> <div style="border: 1px solid black; padding: 2px;">Return</div> </div> <p style="text-align: center;">(0.5)                      (0.5)                      (0.5)</p>



**III. Areas Eligible for Immediate Return Upon Completion of Necessary Procedures**

**4. A portion of the warehouse area of the Facilities and Engineering Compound in Camp Zukeran (Camp Foster)**

- i. Area for return
  - Area for return is approximately 10 ha.

Note: The Shirahi River area was not agreed to be returned at the time of the April 27, 2012 SCC Joint Statement. However, it will be an additional area of land return based on the request of the local community.

- ii. Conditions for return
  - The MCCS complex including administrative offices, maintenance shops, storage buildings, etc. will be relocated to Camp Hansen.

- iii. Timing for return
  - Can be returned upon completion of conditions and necessary procedures for return in JFY2019 or later. (Reference sequence of return steps below)

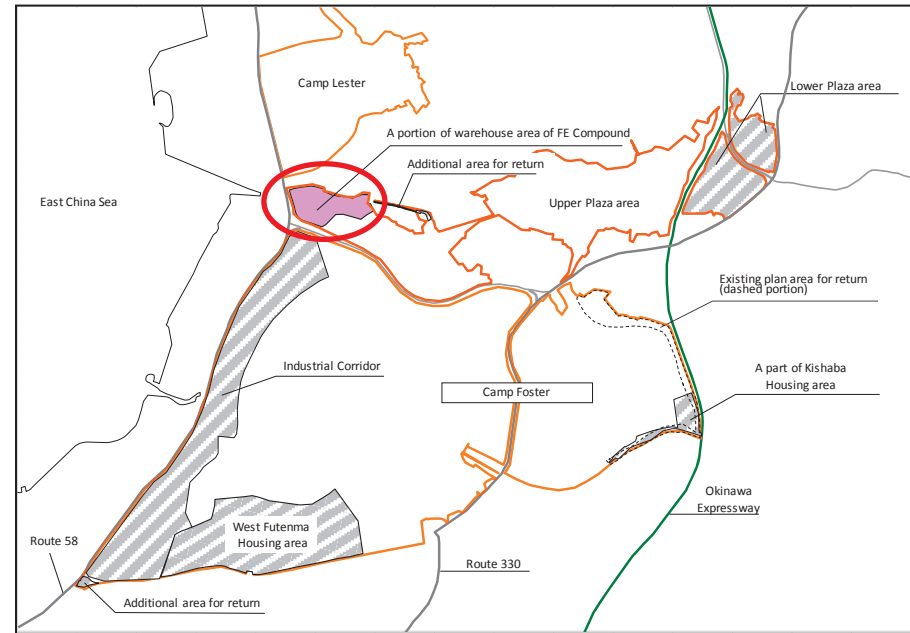

Major facilities to relocate	Relocating to	Return sequence
MCCS complex	Camp Hansen	<div style="display: flex; align-items: center; gap: 10px;"> <div style="border: 1px dashed black; padding: 2px;">Identify relocation site</div> <div style="border: 1px solid black; padding: 2px;">JC Agreement</div> <div style="border: 1px dashed black; padding: 2px;">BCP</div> <div style="border: 1px solid black; padding: 2px;">Survey, Design</div> <div style="border: 1px solid black; padding: 2px;">Construction</div> <div style="border: 1px solid black; padding: 2px;">Admin procedures</div> <div style="border: 1px dashed black; padding: 2px;">Relocation</div> <div style="border: 1px solid black; padding: 2px;">Return</div> </div> <p style="margin-top: 5px;"> <span style="margin-right: 100px;">(1)</span> <span style="margin-right: 100px;">(1)</span> <span style="margin-right: 100px;">(2)</span> <span style="margin-right: 100px;">(2)</span> <span style="margin-right: 100px;">(0.5)</span> </p>

#### IV. Areas Eligible for Return Once the Replacement Facilities in Okinawa are Provided

##### 1. Camp Kuwae (Camp Lester)

- i. Area for return
  - Area for total return is approximately 68 ha.
- ii. Conditions for return
  - Naval Hospital and middle school will be relocated to Camp Zukeran (Camp Foster).
  - Family housing (375 units) will be relocated to Camp Zukeran (Camp Foster) under Okinawa Housing Consolidation (OHC).

Note: OHC plan under Special Action Committee on Okinawa (SACO) was reevaluated and based on the post-Defense Posture Review Initiatives (DPRI) family housing requirement on Okinawa, approximately 910 family housing units, including the replacement of units to be demolished at the construction areas, will be constructed in addition to the 56 units which have already been agreed to.

- iii. Timing for return
  - Can be returned upon completion of conditions and necessary procedures for return in JFY2025 or later. (Reference sequence of relocation steps on next page)

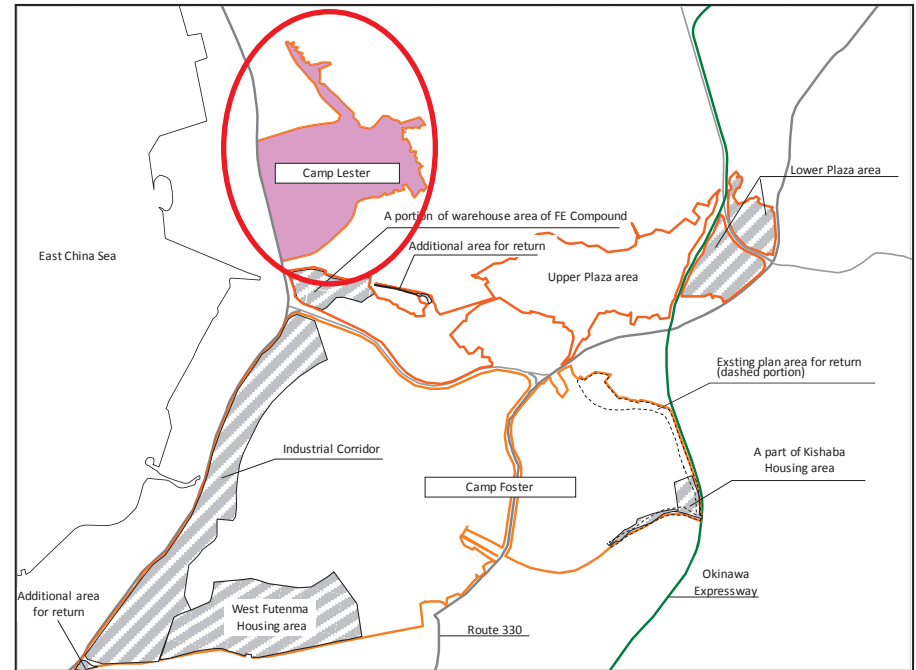

**IV. Areas Eligible for Return Once the Replacement Facilities in Okinawa are Provided**

**1. Camp Kuwae (Camp Lester)**

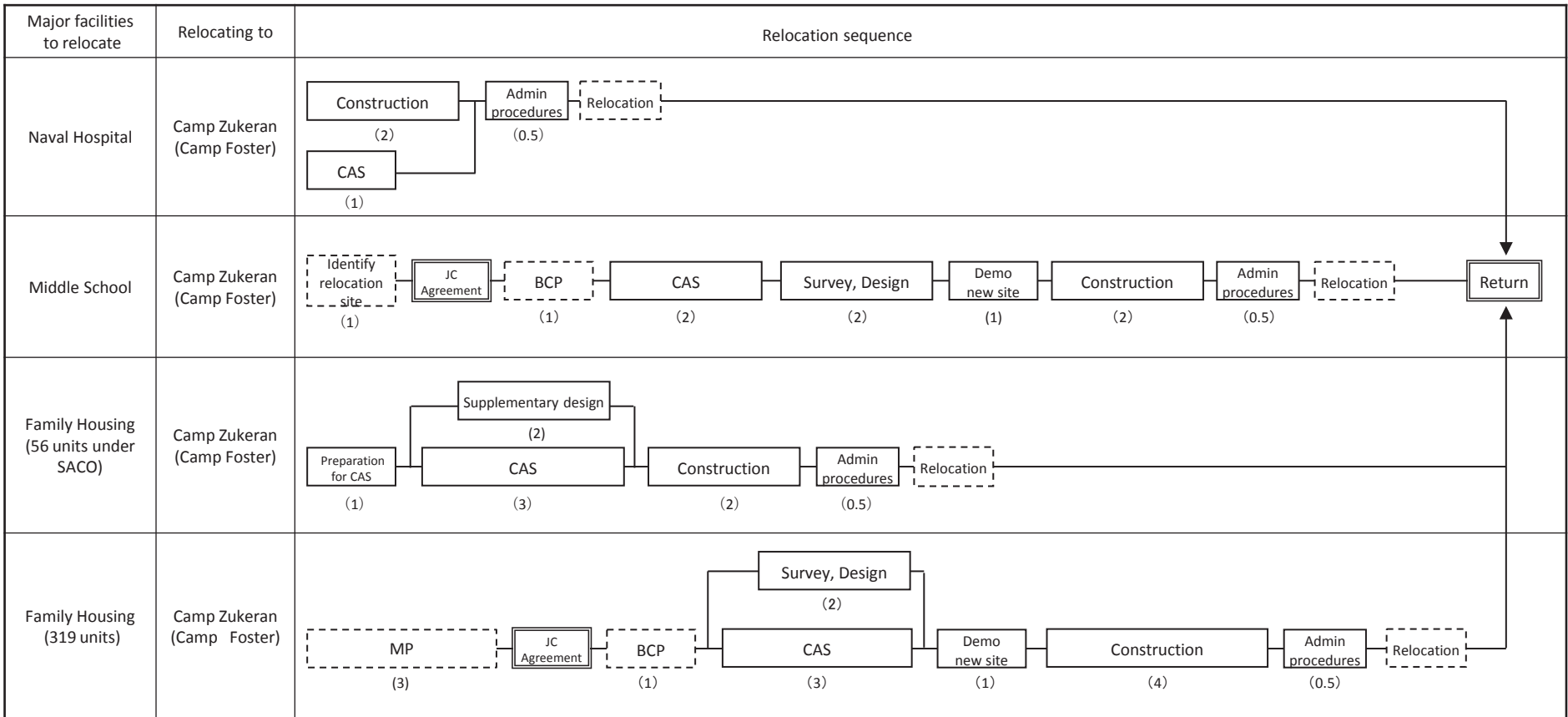

Note 1 : Naval Hospital and family housing (56 units under SACO) are based on the existing plan and have already been agreed to at JC.

2 : MP is for Camp Hansen, Camp Courtney, Camp Foster, etc.

3 : For relocation of family housing (319 units and 56 units under SACO), duration of survey and design is subject to adjustment depending on the result of CAS.

4 : 3 years for development of MP assumes current manpower. Additional manpower may accelerate MP development.

**IV. Areas Eligible for Return Once the Replacement Facilities in Okinawa are Provided**

**2. Camp Zukeran (Camp Foster)**

**a. Lower Plaza Housing area**

- i. Area for return
  - Area for return is approximately 23 ha.
- ii. Conditions for return
  - Family housing (102 units) will be relocated within Camp Zukeran (Camp Foster) under OHC.

Note: OHC plan under SACO was reevaluated and based on the post-DPRI family housing requirement on Okinawa, approximately 910 family housing units, including the replacement of units to be demolished at the construction areas, will be constructed in addition to the 56 units which have already been agreed to.

- iii. Timing for return
  - Can be returned upon completion of conditions and necessary procedures for return in JFY2024 or later. (Reference sequence of relocation steps below)

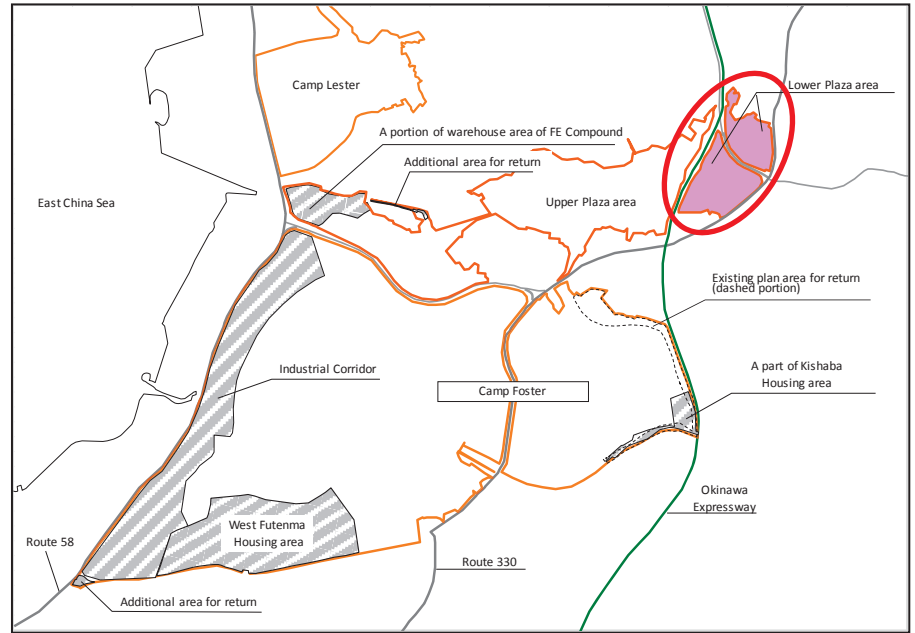

Major facilities to relocate	Relocating to	Relocation sequence
Family Housing (102 units)	Camp Zukeran (Camp Foster)	<div style="display: flex; align-items: center; gap: 10px;"> <div style="border: 1px dashed black; padding: 5px; text-align: center;">MP (3)</div> <div style="border: 1px solid black; padding: 5px; text-align: center;">JC Agreement</div> <div style="border: 1px dashed black; padding: 5px; text-align: center;">BCP (1)</div> <div style="border: 1px solid black; padding: 5px; text-align: center;">CAS (2)</div> <div style="border: 1px solid black; padding: 5px; text-align: center;">Survey, Design (2)</div> <div style="border: 1px solid black; padding: 5px; text-align: center;">Demo new site (1)</div> <div style="border: 1px solid black; padding: 5px; text-align: center;">Construction (2)</div> <div style="border: 1px solid black; padding: 5px; text-align: center;">Admin procedures (0.5)</div> <div style="border: 1px dashed black; padding: 5px; text-align: center;">Relocation</div> <div style="border: 1px solid black; padding: 5px; text-align: center;">Return</div> </div>

Note 1: MP is for Camp Hansen, Camp Courtney, Camp Foster, etc.  
 Note 2: 3 years for development of MP assumes current manpower. Additional manpower may accelerate MP development.

**IV. Areas Eligible for Return Once the Replacement Facilities in Okinawa are Provided**

**2. Camp Zukeran (Camp Foster)**

**b. A part of Kishaba Housing area**

**i. Area for return**

- Area for return is approximately 5 ha.

Note 1: The area for return has been modified from the area agreed to in the SACO Final Report (dashed portion) based on the request of the local community.

2: OHC plan under SACO was reevaluated and based on the post-DPRI family housing requirement on Okinawa, approximately 910 family housing units, including the replacement of units to be demolished at the construction areas, will be constructed in addition to the 56 units which have already been agreed to.

**ii. Conditions for return**

- Family housing (32 units) will be relocated within Camp Zukeran (Camp Foster) under OHC.

**iii. Timing for return**

- Can be returned upon completion of conditions and necessary procedures for return in JFY2024 or later. (Reference sequence of relocation steps below)

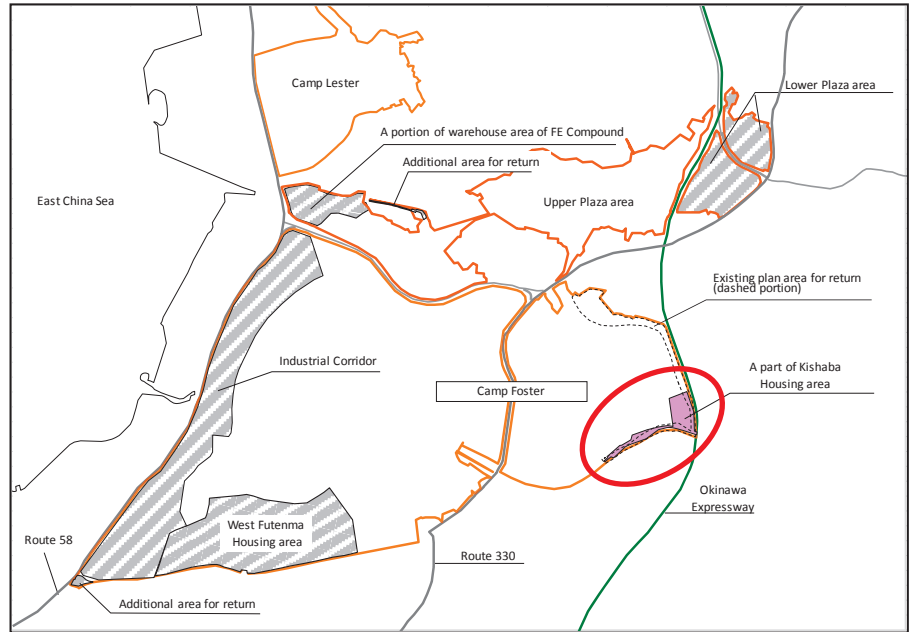

Major facilities to relocate	Relocating to	Relocation sequence
Family Housing (32 units)	Camp Zukeran (Camp Foster)	<div style="display: flex; align-items: center; gap: 10px;"> <div style="border: 1px dashed black; padding: 5px; text-align: center;">MP (3)</div> <div style="border: 1px solid black; padding: 5px; text-align: center;">JC Agreement</div> <div style="border: 1px dashed black; padding: 5px; text-align: center;">BCP (1)</div> <div style="border: 1px solid black; padding: 5px; text-align: center;">CAS (2)</div> <div style="border: 1px solid black; padding: 5px; text-align: center;">Survey, Design (2)</div> <div style="border: 1px solid black; padding: 5px; text-align: center;">Demo new site (1)</div> <div style="border: 1px solid black; padding: 5px; text-align: center;">Construction (2)</div> <div style="border: 1px solid black; padding: 5px; text-align: center;">Admin procedures (0.5)</div> <div style="border: 1px dashed black; padding: 5px; text-align: center;">Relocation</div> <div style="border: 1px solid black; padding: 5px; text-align: center;">Return</div> </div>

Note 1: MP is for Camp Hansen, Camp Courtney, Camp Foster, etc.

2: 3 years for development of MP assumes current manpower. Additional manpower may accelerate MP development.

#### **IV. Areas Eligible for Return Once the Replacement Facilities in Okinawa are Provided**

### 2. Camp Zukeran (Camp Foster)

#### c. The Industrial Corridor

##### i. Area for return

- Area for return is approximately 62 ha.

##### ii. Conditions for return

- Army warehouse will be relocated to Torii Communication Station.
- School bus service related facilities will be relocated to the Chibana area of the Kadena Ammunition Storage Area.
- Marine Corps transportation related facilities, etc. will be relocated to Camp Hansen.
- Recycling Center, buildings, etc. will be relocated to Camp Hansen.
- Community support facilities, etc. will be relocated within Camp Zukeran (Camp Foster).
- Marine Corps wing support related facilities will be relocated to Camp Schwab.
- Marine Corps communications related facilities will be relocated to Camp Courtney.
- Marine Corps logistics support units will be relocated to locations outside of Japan.

##### iii. Timing for return

- Can be returned upon completion of conditions and necessary procedures for return in JFY2024 or later. (Reference sequence of relocation steps on next page)

Note: Efforts will be made to return the south end of the Industrial Corridor at the earliest possible date by considering a phased return.

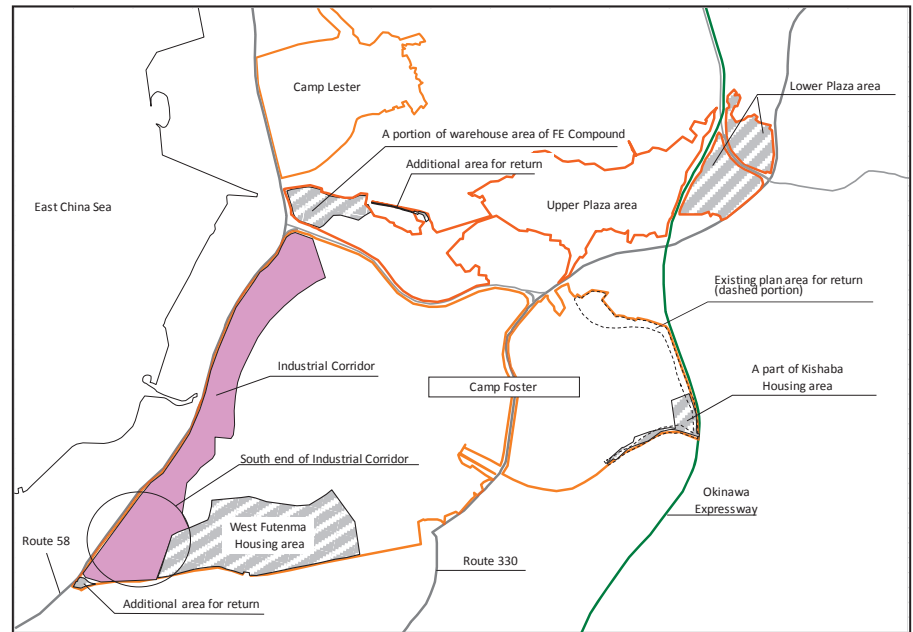

**IV. Areas Eligible for Return Once the Replacement Facilities in Okinawa are Provided**

2. Camp Zukeran (Camp Foster)

(c) The Industrial Corridor

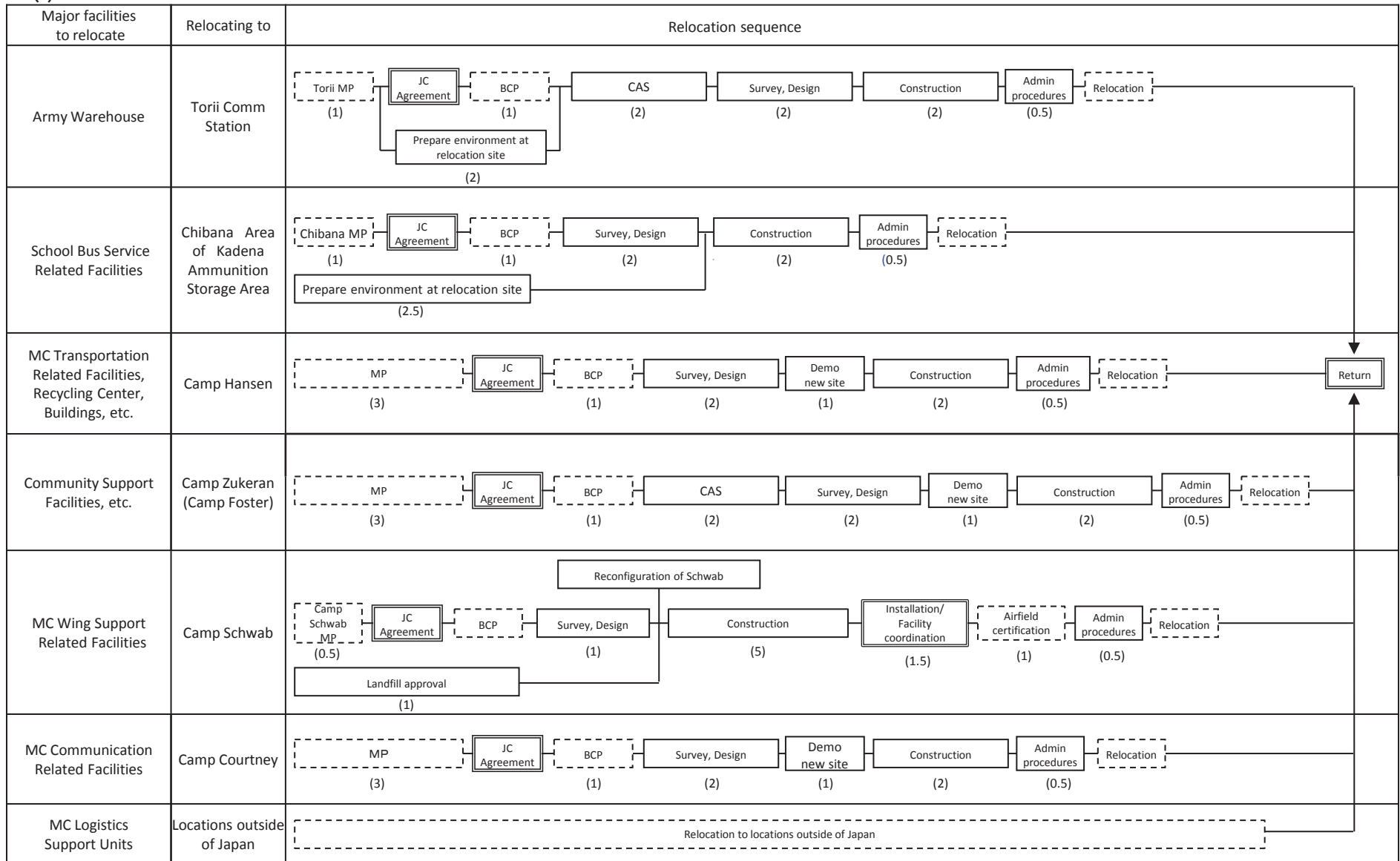

Note 1: Part of the logistics support units in this area are scheduled to be relocated to locations outside of Japan. Efforts will be made to minimize the impact of the relocation on the approximate timing for return. However, the relocation sequence is subject to change depending on the progress of relocation.

2: MP is for Camp Hansen, Camp Courtney, Camp Foster, etc.

3: 3 years for development of MP assumes current manpower. Additional manpower may accelerate MP development.

**IV. Areas Eligible for Return Once the Replacement Facilities in Okinawa are Provided**

**3. Elements of Makiminato Service Area (Camp Kinser), including the preponderance of the storage area**

- i. Area for return
  - Area for return is approximately 129 ha.
  
- ii. Conditions for return
  - Army warehouse will be relocated to Torii Communication Station.
  - DoD support agency facilities will be relocated to the Chibana Area of the Kadena Ammunition Storage Area.
  - Marine Corps warehouses, shops, etc. will be relocated to Camp Hansen.
  - Marine Corps postal center, etc. will be relocated to Camp Zukeran (Camp Foster).
  
- iii. Timing for return
  - Can be returned upon completion of conditions and necessary procedures for return in JFY2025 or later. (Reference sequence of relocation steps on next page)

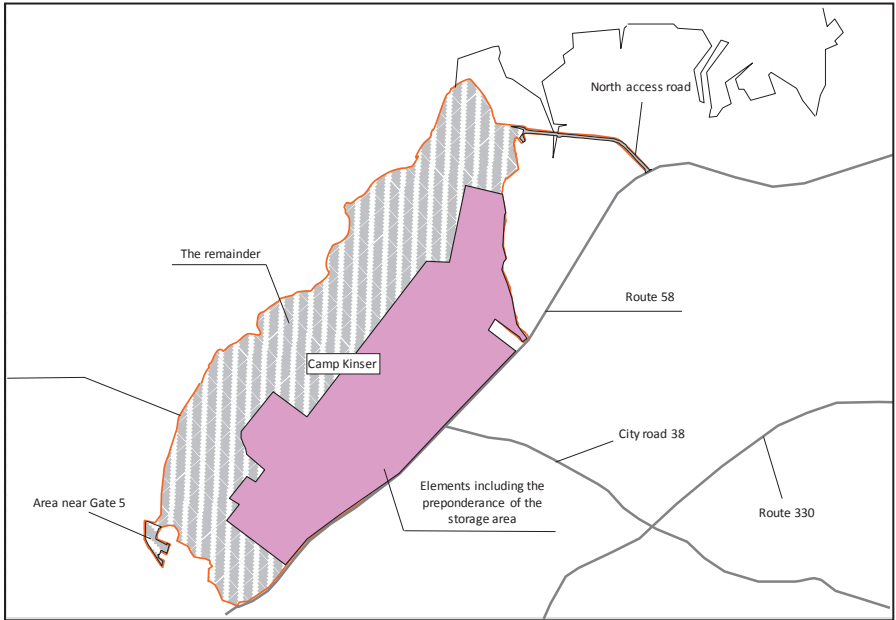



**IV. Areas Eligible for Return Once the Replacement Facilities in Okinawa are Provided**

3. Elements of Makiminato Service Area (Camp Kinser), including the preponderance of the storage area

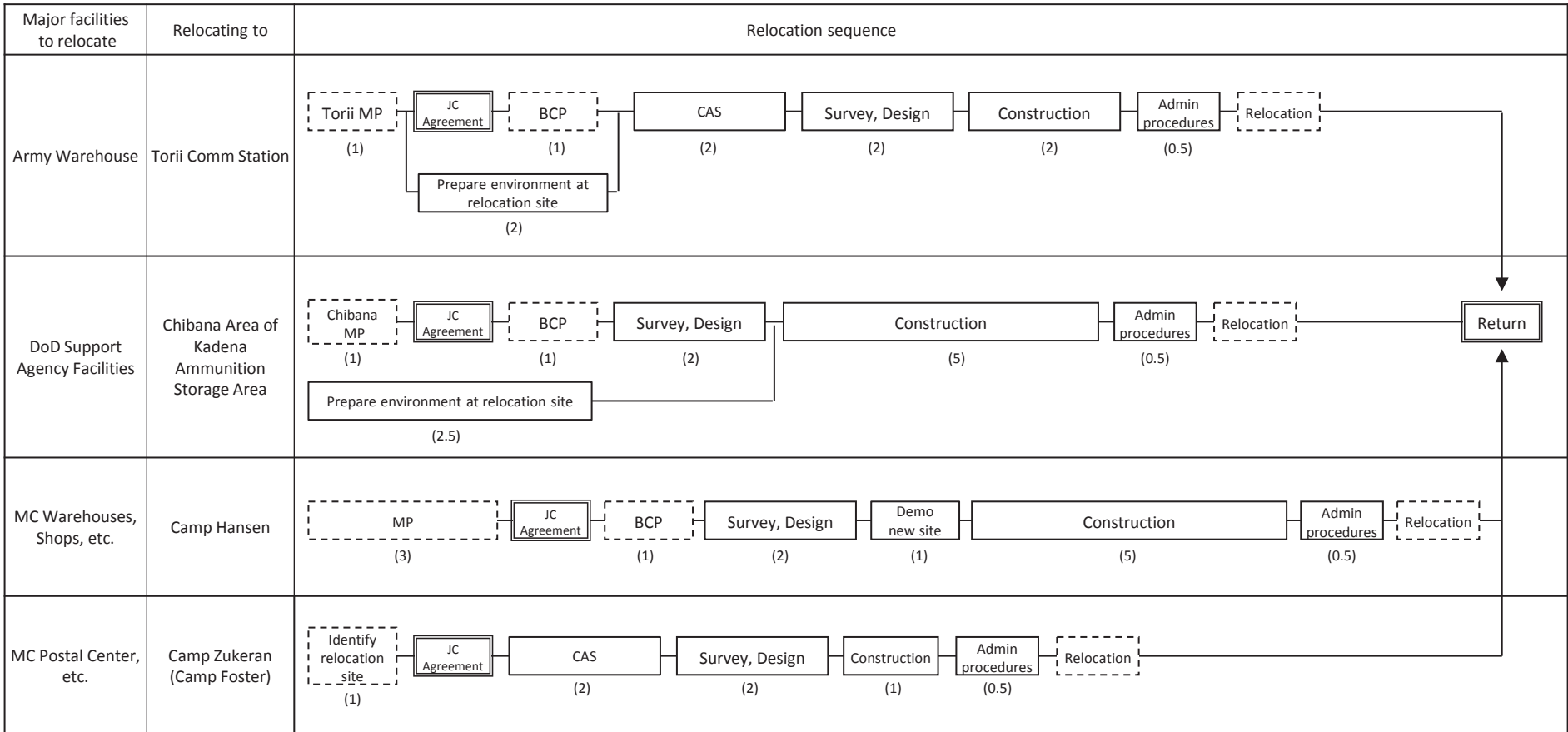

Note 1 : MP is for Camp Hansen, Camp Courtney, Camp Foster, etc.  
 2 : 3 years for development of MP assumes current manpower. Additional manpower may accelerate MP development.

**IV. Areas Eligible for Return Once the Replacement Facilities in Okinawa are Provided**

**4. Naha Port**

- i. Area for return
  - Area for total return is approximately 56 ha.
- ii. Conditions for return
  - Functions of Naha Port will be relocated to the replacement facility (approximately 49ha), including additional staging area, which is to be constructed at Urasoe Pier area.
- iii. Timing for return
  - Can be returned upon completion of conditions and necessary procedures for return in JFY2028 or later. (Reference sequence of relocation steps below)

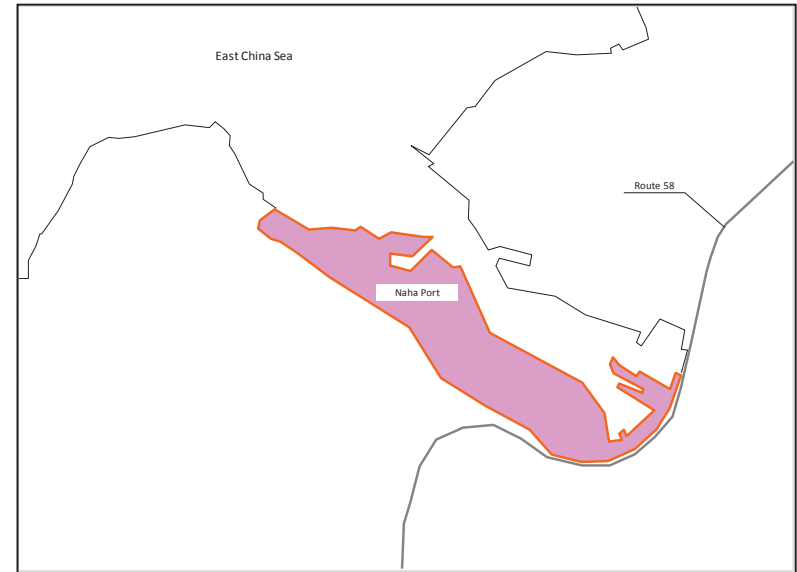

Major facilities to relocate	Relocating to	Relocation sequence
Naha Port Functions	Naha Port replacement facility (Urasoe Pier area)	<pre>           graph LR             A["Naha Port Repl. Facility MP (1)"] -.-&gt; B["BCP (1)"]             B --&gt; C["Survey, Design (2)"]             C --&gt; D["Construction (9)"]             D --&gt; E["Admin procedures (0.5)"]             E -.-&gt; F["Relocation"]             F --&gt; G["Return"]                          H["EIA (5)"] --&gt; C             I["Landfill approval (1)"] --&gt; C           </pre> <p>The flowchart illustrates the relocation sequence. It starts with the 'Naha Port Repl. Facility MP (1)' (dashed box), leading to 'BCP (1)'. From 'BCP (1)', the process moves to 'Survey, Design (2)'. This step is supported by 'EIA (5)' and 'Landfill approval (1)'. The main sequence then proceeds to 'Construction (9)', followed by 'Admin procedures (0.5)'. A dashed box labeled 'Relocation' encompasses the 'Admin procedures (0.5)' and 'Return' steps, indicating the final stage of the process.</p>

**IV. Areas Eligible for Return Once the Replacement Facilities in Okinawa are Provided**

**5. Army Petroleum, Oil, and Lubricant Depot Kuwae Tank Farm No. 1**

i. Area for return

- Area for total return is approximately 16 ha.

ii. Conditions for return

- Facilities/Functions supporting operations at MCAS Futenma will be relocated to Camp Schwab.
- Facilities/Functions supporting operations at Kadena Air Base will be relocated to Army POL Depot Chimu-wan Tank Farm No. 2.
- Administrative building and vehicle fuel points will be relocated to Army POL Depot Kuwae Tank Farm No. 2.

iii. Timing for return

- Can be returned upon completion of conditions and necessary procedures for return in JFY2022 or later. (Reference sequence of relocation steps on next page)

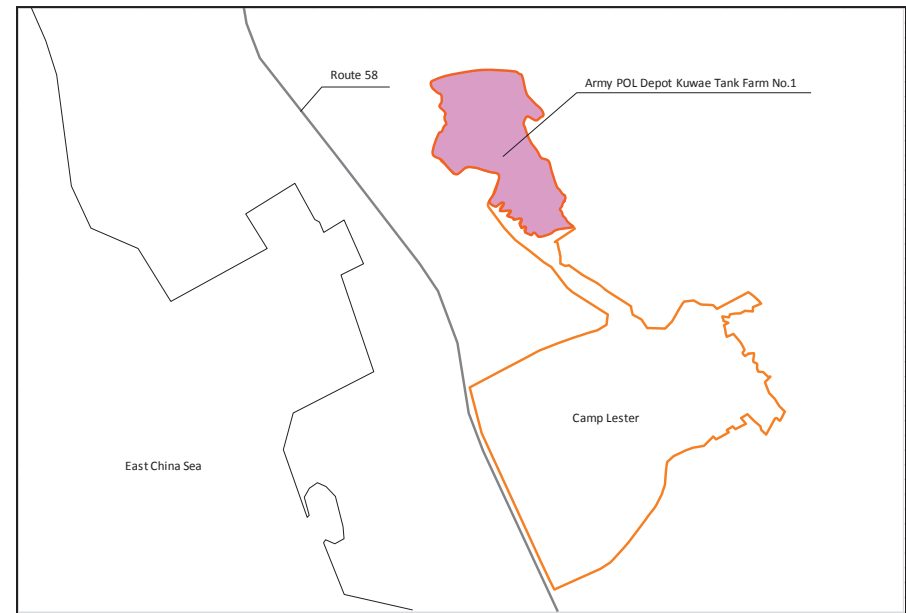

**IV. Areas Eligible for Return Once the Replacement Facilities in Okinawa are Provided**

5. Army Petroleum, Oil, and Lubricant Depot Kuwae Tank Farm No.1

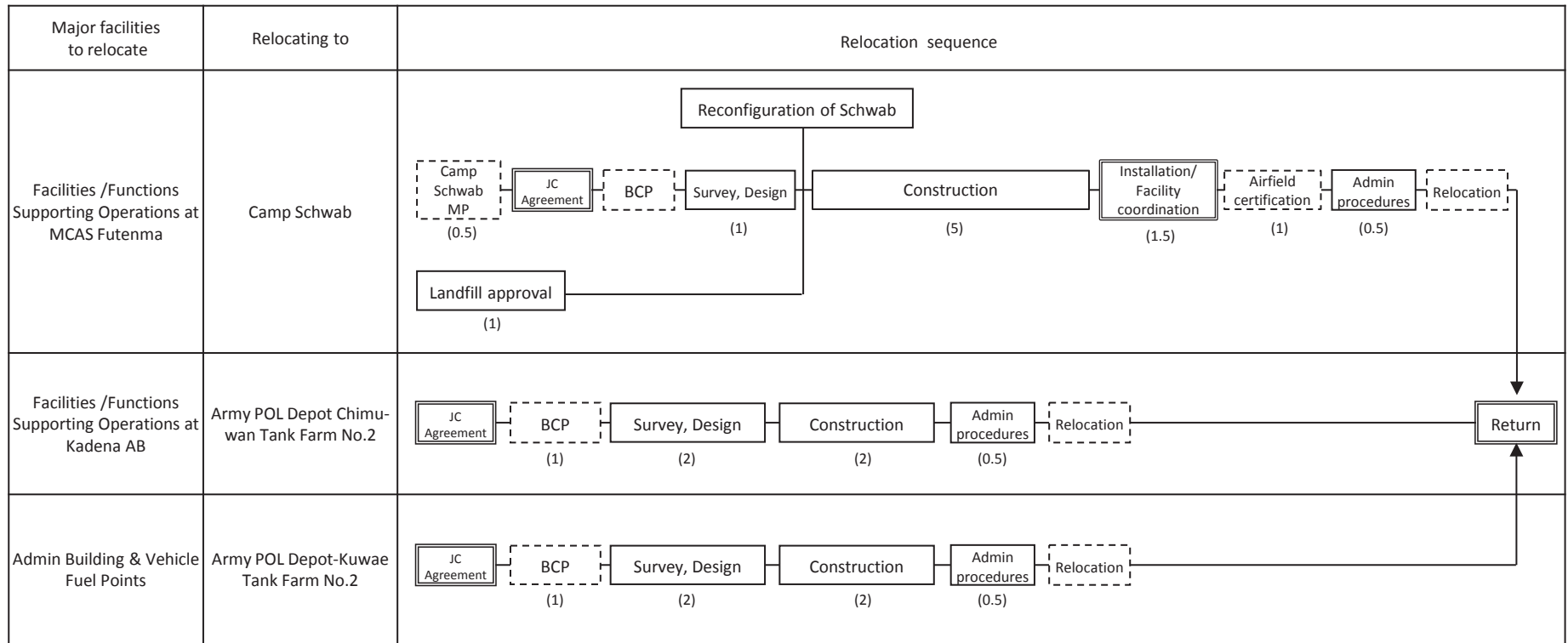

**IV. Areas Eligible for Return Once the Replacement  
Facilities in Okinawa are Provided**

**6. Marine Corps Air Station (MCAS) Futenma**

i. Area for return

- Area for total return is approximately 481 ha.

ii. Conditions for return

- Marine Corps airfield related facilities, etc. will be relocated to Camp Schwab.
- Marine Corps aviation unit and command function, and related facilities will be relocated to Camp Schwab.
- Facility improvements for contingency use of JASDF Nyutabaru Air Base and Tsuiki Air Base related to the replacement of MCAS Futenma capabilities will be implemented as necessary.
- Improved contingency use of civilian facilities for long runway operations that cannot be replicated at the FRF.
- Avoid creation of traffic congestion and related irritants that might otherwise detract from the quality of life of local residents.
- Necessary adjustments will be made to adjacent water surface areas.
- The facility is fully operationally capable.
- The KC-130 squadron will be based at MCAS Iwakuni.

iii. Timing for return

- Can be returned upon completion of conditions and necessary procedures for return in JFY2022 or later. (Reference sequence of relocation steps on next page)

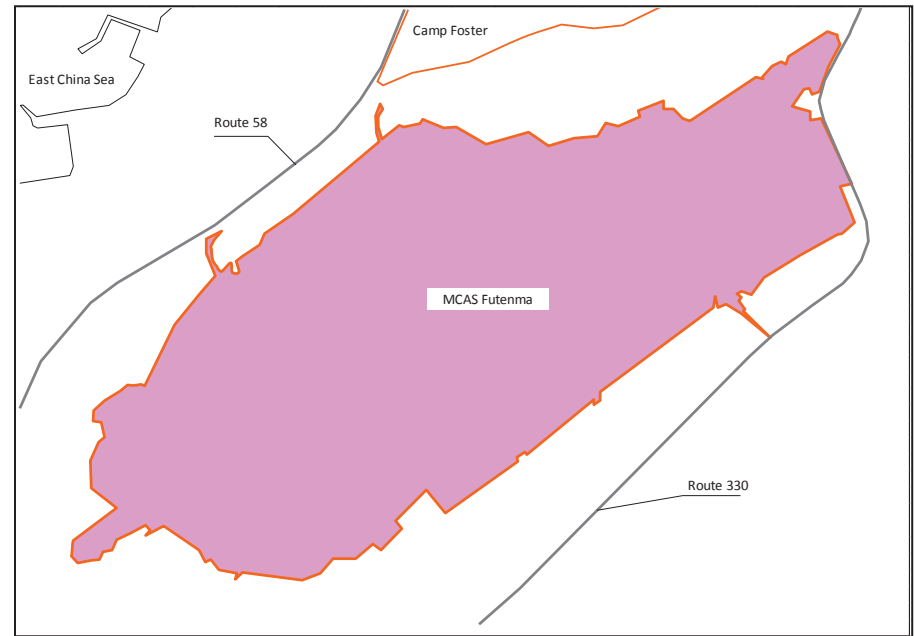

**IV. Areas Eligible for Return Once the Replacement Facilities in Okinawa are Provided**

**6. Marine Corps Air Station (MCAS) Futenma**

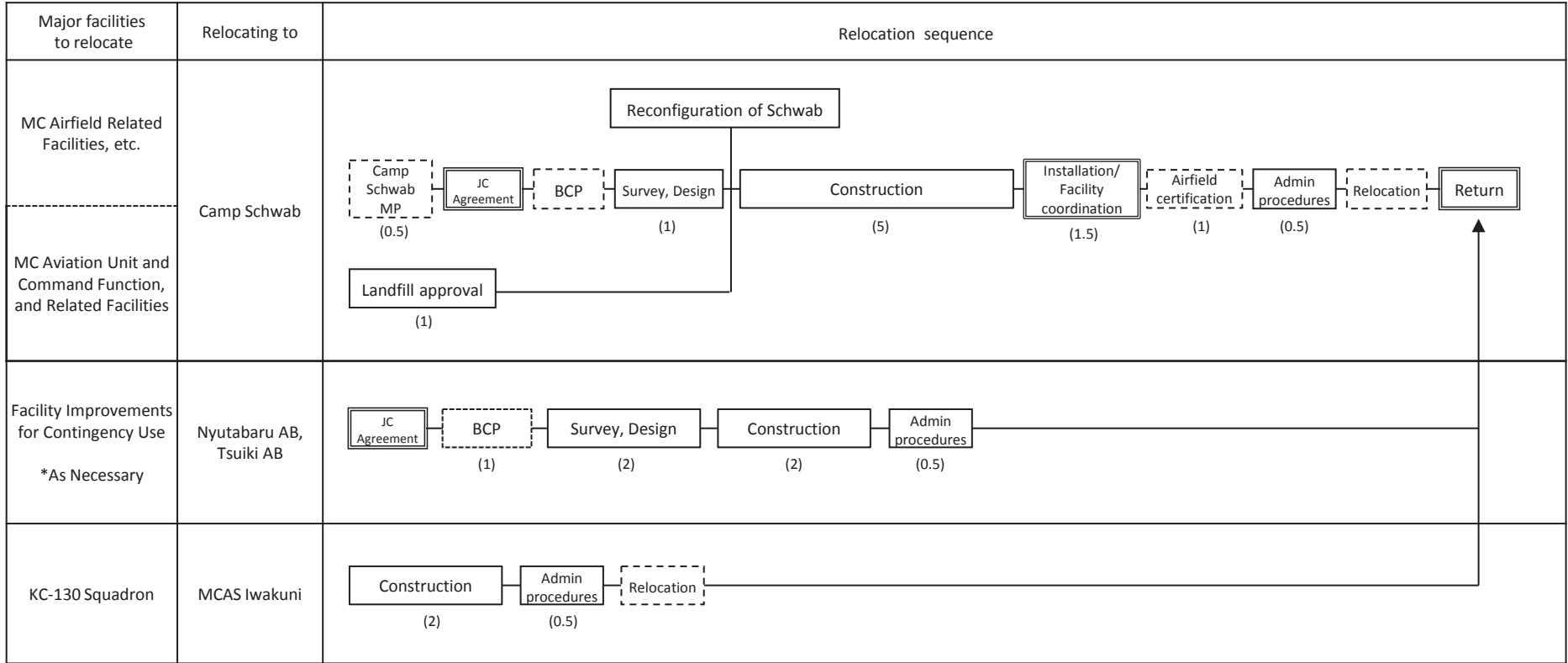

## V. Areas Eligible for Return as USMC Forces Relocate from Okinawa to Locations Outside of Japan

### 1. Additional elements of Camp Zukeran

The priority in master planning will be to ensure Camp Zukeran (Camp Foster) remains an effective and efficient base under the Treaty of Mutual Cooperation and Security between the United States of America and Japan. In order to reduce the impact of U.S. forces on local communities, the U.S. and Japanese Governments have developed this consolidation plan, including sequencing of relocation steps, with a particular focus on determining the end-state of Camp Zukeran (Camp Foster). This effort considered the land usage at Camp Zukeran (Camp Foster) required by the revised Marine Corps unit composition. The possible impact of the joint and shared use of facilities on Okinawa affects the effort.

In the April 27, 2012 SCC Joint Statement, it is stated that remaining facilities and infrastructure at Camp Zukeran (Camp Foster) are to be consolidated to the extent possible and that additional elements of Camp Zukeran (Camp Foster) are eligible for return as U.S. Marine Corps forces relocate from Okinawa to locations outside of Japan. In the course of developing this consolidation plan, the U.S. and Japanese Governments have identified and agreed to additional elements on Camp Zukeran (Camp Foster) for return, which are outlined in Subsection VI of this consolidation plan. During the course of master planning for facilities and areas remaining in Okinawa, the area adjacent to the Industrial Corridor will be studied to identify whether additional returns might be possible. The USG remains committed to return facilities and areas on Camp Zukeran (Camp Foster) that are found to be no longer needed for the purpose of SOFA after the publication of this consolidation plan in accordance with existing SOFA obligations.

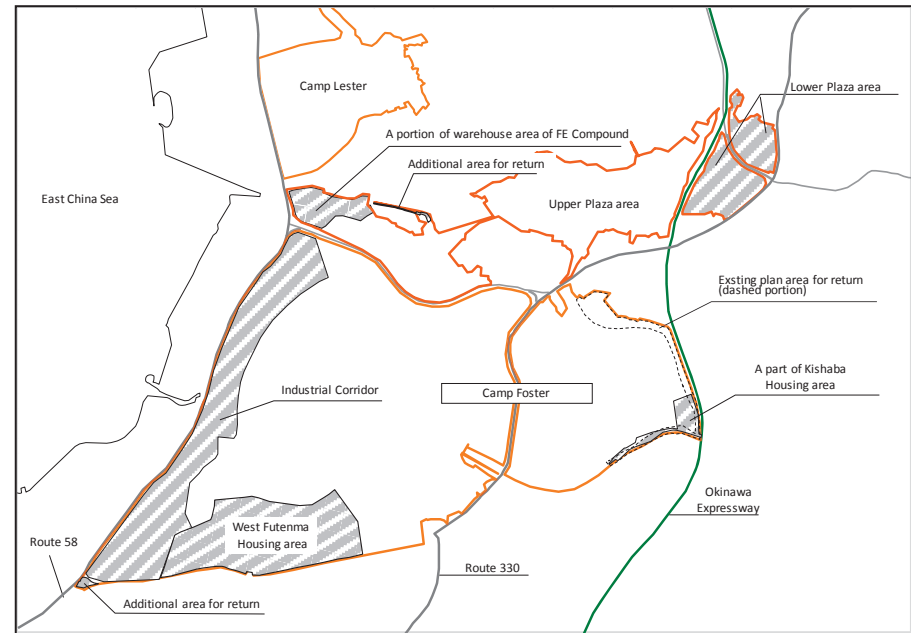

***V. Areas Eligible for Return as USMC Forces Relocate  
from Okinawa to Locations Outside of Japan***

**2. The remainder of Makiminato Service Area (Camp Kinser)**

- i. Area for return
  - Area for total return is approximately 142 ha.
- ii. Conditions for return
  - Marine Corps administrative buildings, etc. will be relocated to Camp Zukeran (Camp Foster).
  - American Forces Network (AFN) transmission facility will be relocated to Camp Courtney.
  - Functions supporting units relocating to locations outside of Japan will be deactivated.
- iii. Timing for return
  - Can be returned upon completion of conditions and necessary procedures for return and after USMC forces are relocated to locations outside of Japan in JFY2024 or later. (Reference sequence of relocation steps on next page)

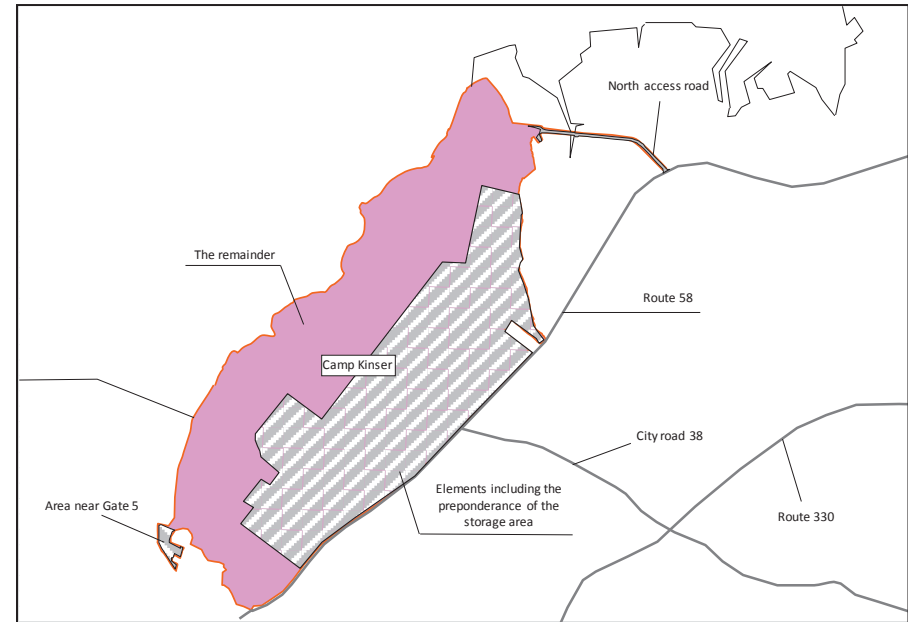



**V. Areas Eligible for Return as USMC Forces Relocate  
from Okinawa to Locations Outside of Japan**

2. The remainder of Makiminato Service Area (Camp Kinser)

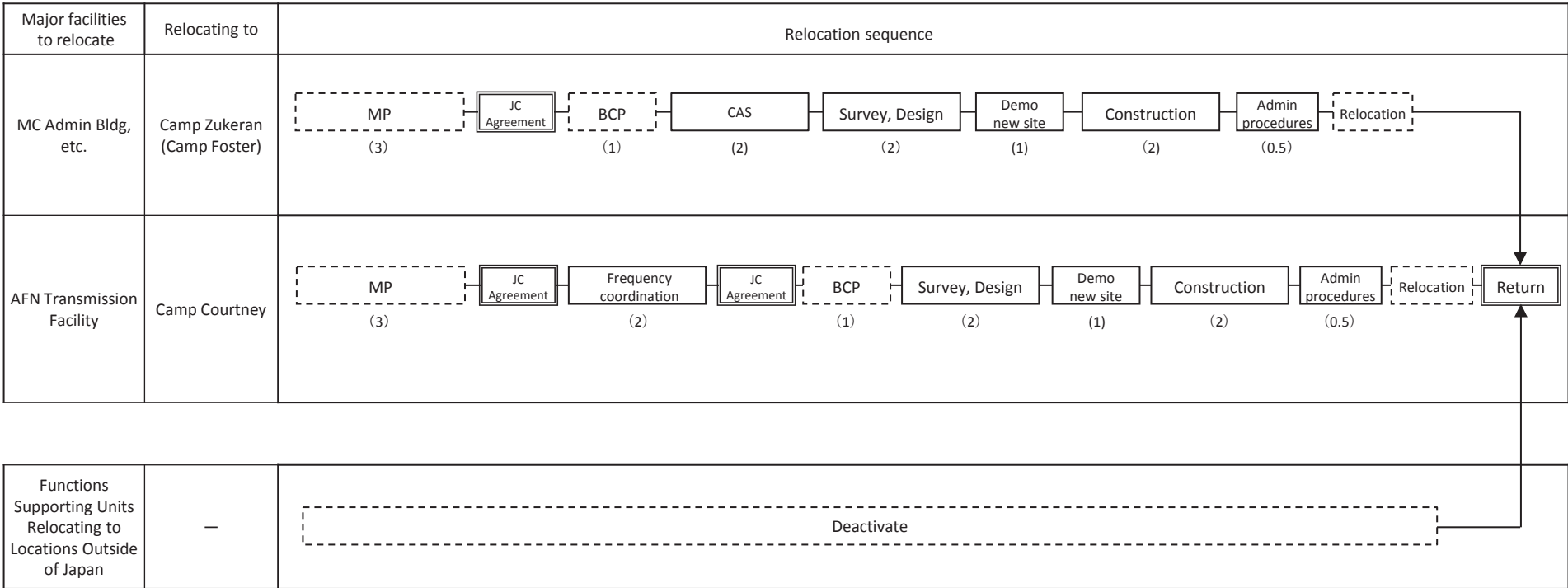

Note 1: Plans for USMC relocation to locations outside of Japan have not yet been determined. The relocation sequence is subject to change depending on the progress of relocation.  
 2: MP is for Camp Hansen, Camp Courtney, Camp Foster, etc.  
 3: 3 years for development of MP assumes current manpower. Additional manpower may accelerate MP development.

**Section 3 - Progress Since the April 27, 2012 SCC Joint Statement**

**VI. Areas of Additional Land Returns**

**1. Shirahi River area, Camp Zukeran (Camp Foster)**

i. Area for return

- Area for return is approximately 0.4 ha.

Note: The Shirahi River area was not agreed to be returned at the time of the April 27, 2012 SCC Joint Statement. However, it will be an additional area of land return based on the request of the local community.

ii. Conditions for return

- The MCCS complex including administrative offices, maintenance shops, storage buildings, etc. located at the portion of the warehouse area of the FE Compound will be relocated to Camp Hansen.

iii. Timing for return

- Can be returned upon completion of conditions and necessary procedures for return in JFY2019 or later. (Reference sequence of return steps below)

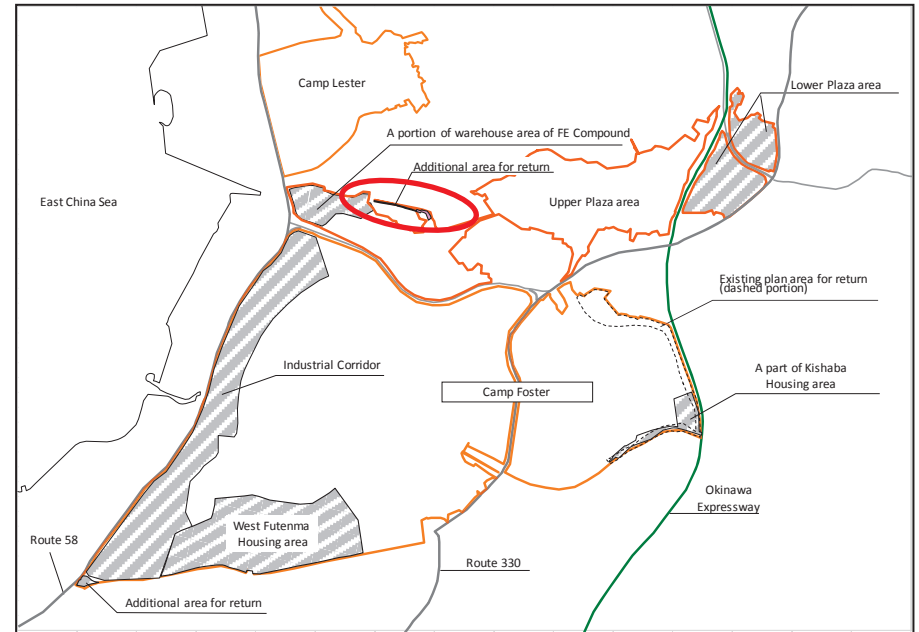

Major facilities to relocate	Relocating to	Return sequence
MCCS Complex	Camp Hansen	<div style="display: flex; align-items: center; gap: 10px;"> <div style="border: 1px dashed black; padding: 2px;">Identify relocation site</div> <div style="border: 1px solid black; padding: 2px;">JC Agreement</div> <div style="border: 1px dashed black; padding: 2px;">BCP</div> <div style="border: 1px solid black; padding: 2px;">Survey, Design</div> <div style="border: 1px solid black; padding: 2px;">Construction</div> <div style="border: 1px solid black; padding: 2px;">Admin procedures</div> <div style="border: 1px dashed black; padding: 2px;">Relocation</div> <div style="border: 1px solid black; padding: 2px;">Return</div> </div> <p style="margin-top: 5px;"> <span style="margin-right: 100px;">(1)</span> <span style="margin-right: 100px;">(1)</span> <span style="margin-right: 100px;">(2)</span> <span style="margin-right: 100px;">(2)</span> <span style="margin-right: 100px;">(0.5)</span> </p>

## VI. Areas of Additional Land Returns

### 2. Area south of the Industrial Corridor, Camp Zukeran (Camp Foster)

#### i. Area for return

- Area for return is approximately 0.5 ha.

Note: The area south of the industrial corridor was not agreed to be returned at the time of the April 27, 2012 SCC Joint Statement. However, it will be an additional area of land return.

#### ii. Conditions for return

The following located in the Industrial Corridor will be relocated:

- Army warehouse will be relocated to Torii Communication Station.
- School bus service related facilities will be relocated to the Chibana area of the Kadena Ammunition Storage Area.
- Marine Corps transportation related facilities, etc. will be relocated to Camp Hansen.
- Recycling Center, buildings, etc. will be relocated to Camp Hansen.
- Community support facilities, etc. will be relocated within Camp Zukeran (Camp Foster).
- Marine Corps wing support related facilities will be relocated to Camp Schwab.
- Marine Corps communications related facilities will be relocated to Camp Courtney.
- Marine Corps logistics support units will be relocated to locations outside of Japan.

#### iii. Timing for return

- Can be returned upon completion of conditions and necessary procedures for return in JFY2024 or later. (Reference sequence of relocation steps on next page)

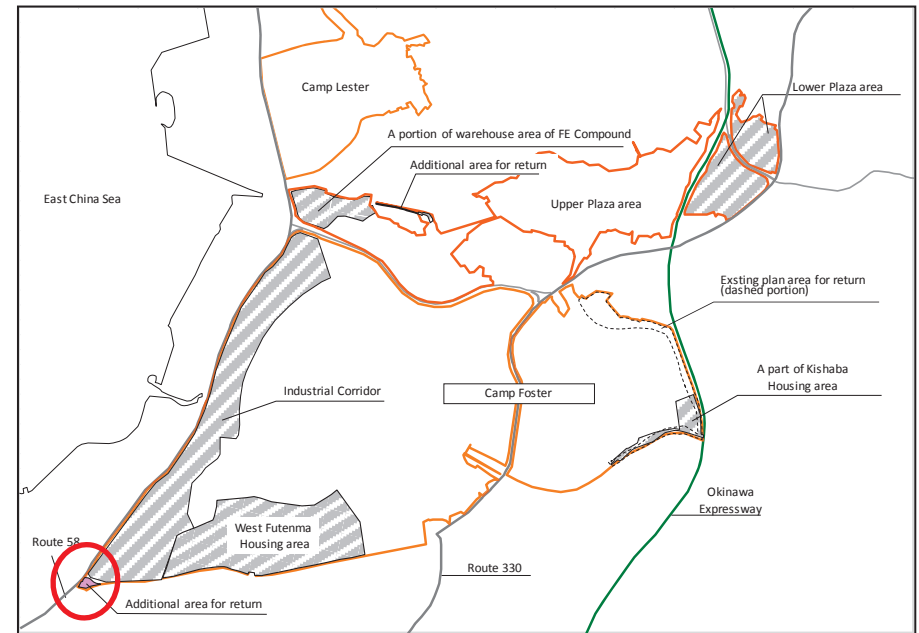

## VI. Areas of Additional Land Returns

### 2. Area south of the Industrial Corridor, Camp Zukeran (Camp Foster)

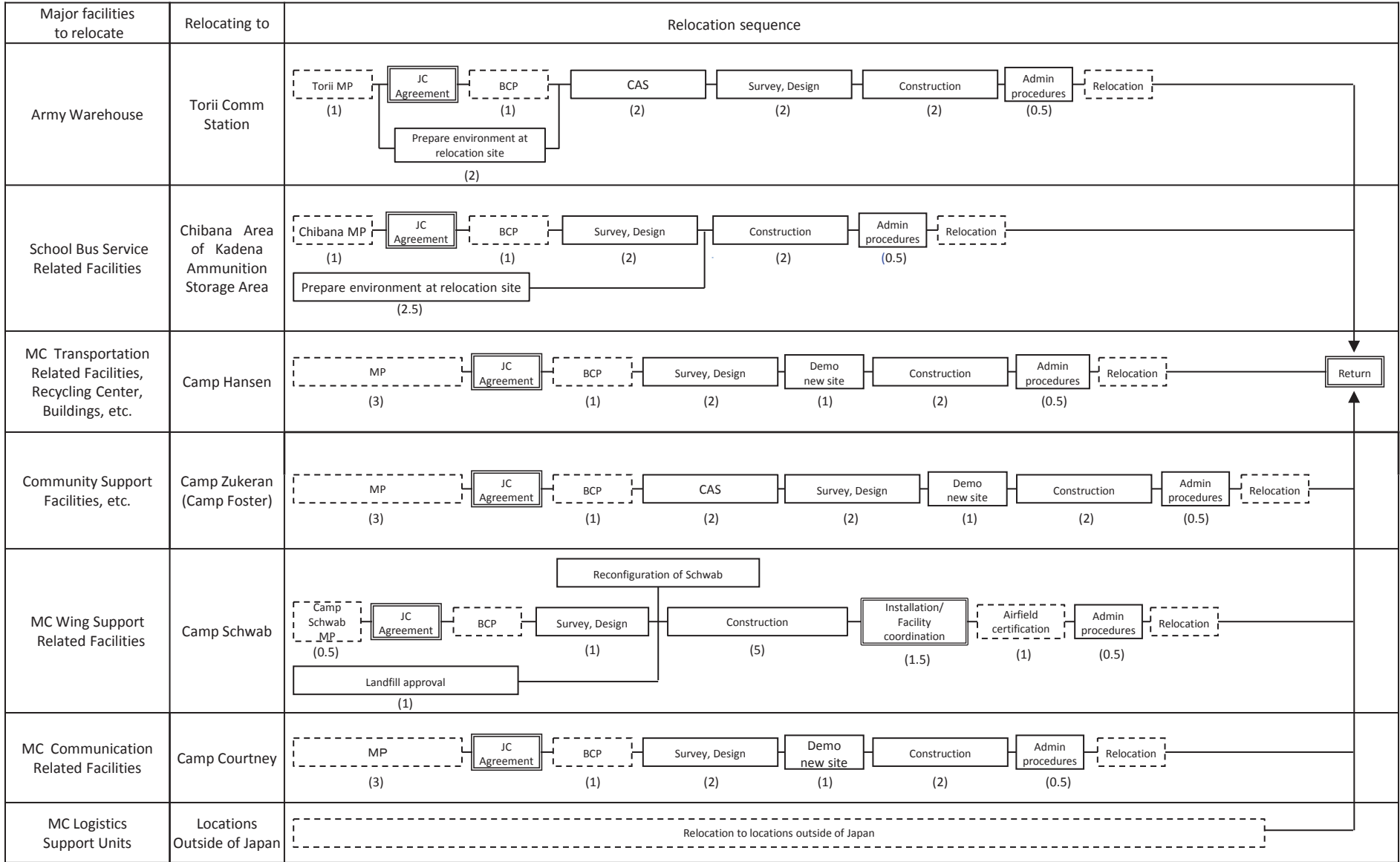

Note 1: Part of the logistics support units in this area are scheduled to be relocated to locations outside of Japan. Efforts will be made to minimize the impact of the relocation on the approximate timing for return. However, the relocation sequence is subject to change depending on the progress of relocation.

2: MP is for Camp Hansen, Camp Courtney, Camp Foster, etc.

3: 3 years for development of MP assumes current manpower. Additional manpower may accelerate MP development.

**Appendix A: List of Estimated Timelines for the Return of Facilities and Areas**

<b>Areas Eligible for Immediate Return Upon Completion of Necessary Procedures</b>	
West Futenma Housing area of Camp Zukeran (Camp Foster)	JFY2014 or later
The north access road of Makiminato Service Area (Camp Kinser)	JFY2013 or later
Area near Gate 5 on Makiminato Service Area (Camp Kinser)	JFY2014 or later
A portion of the warehouse area of the Facilities and Engineering Compound in Camp Zukeran (Camp Foster)	JFY2019 or later <sup>1</sup>
<b>Areas Eligible for Return Once the Replacement Facilities in Okinawa are Provided</b>	
Camp Kuwae (Camp Lester)	JFY2025 or later
Lower Plaza Housing area, Camp Zukeran (Camp Foster)	JFY2024 or later
A part of Kishaba Housing area, Camp Zukeran (Camp Foster)	JFY2024 or later
The Industrial Corridor, Camp Zukeran (Camp Foster)	JFY2024 or later <sup>2,3</sup>
Elements of Makiminato Service Area (Camp Kinser), including the preponderance of the storage area	JFY2025 or later
Naha Port	JFY2028 or later
Army Petroleum, Oil, and Lubricant Depot Kuwae Tank Farm No. 1	JFY2022 or later
Marine Corps Air Station (MCAS) Futenma	JFY2022 or later
<b>Areas Eligible for Return as USMC Forces Relocate from Okinawa to Locations Outside of Japan</b>	
Additional elements of Camp Zukeran (Camp Foster)	-
The remainder of Makiminato Service Area (Camp Kinser)	JFY2024 or later <sup>4</sup>

1: Shirahi River area can be returned at the same timing.

2: Part of the logistics support units in this area are scheduled to be relocated to locations outside of Japan. Efforts will be made to minimize the impact of the relocation on the approximate timing for return. However, the relocation sequence is subject to change depending on the progress of relocation.

3: Area south of the Industrial Corridor (Camp Foster) can be returned at the same timing.

4: Plans for USMC relocation to locations outside of Japan have not yet been determined. The relocation sequence is subject to change depending on the progress of relocation.