



PDHonline Course G125 (1 PDH)

Understanding Firewall Basics

Instructor: Matthew Stuart, PE

2020

PDH Online | PDH Center

5272 Meadow Estates Drive
Fairfax, VA 22030-6658
Phone: 703-988-0088
www.PDHonline.com

An Approved Continuing Education Provider

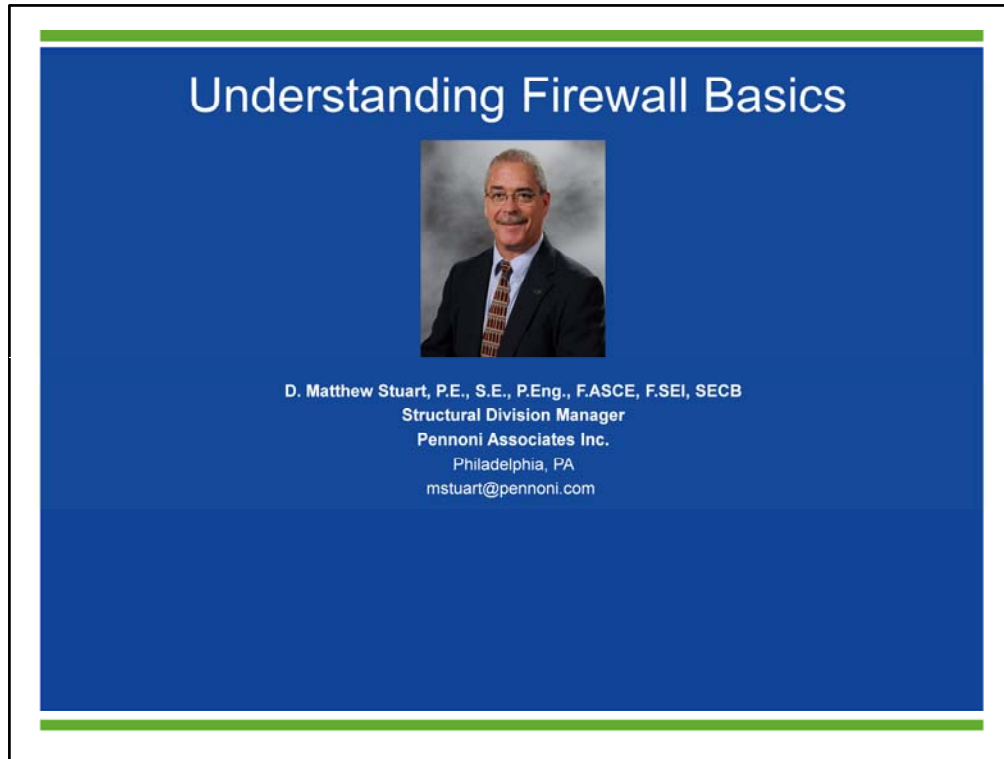

This presentation includes a discussion of firewall construction.

The material presented in this webinar concentrates on the requirements of insurance underwriters, or property protection services, such as Factory Mutual (or FM) and Global Asset Protection Services (or GAPS). This is because the firewall requirements of companies such as FM and GAPS provide guidance with constructability issues and structural engineering design aspects of firewalls that are not always available in the building codes or standards.

In addition, it has also been my experience that typically for new building design, firewall requirements mandated by the building codes and standards are specified by the Architect-of-Record, while firewall requirements mandated by the insurance underwriters (such as FM and GAPS) have to be understood by the Structural-Engineer-of-Record because of a lack of experience of the Architect.

In my opinion, insurance underwriter requirements can also be more stringent than the building codes and standards because the insurers are interested in protecting as much of the physical building as possible from fire damage in order to lower their risk of having to absorb repair and reconstruction costs resulting from a fire, in addition to protecting the occupants.

This presentation includes relevant sections of Chapter 7, *"Fire and Smoke Protection Features"*, of the 2012 IBC so the material presented is also applicable to the requirements of this same governing building code.

In addition, specific references to the 2015 NFPA standard titled *"NFPA 221 Standard for High Challenge Fire Walls, Fire Walls, and Fire Barrier Walls"* are included in the presentation. This NFPA standard is referenced in both FM Data Sheets and GAPS Guidelines, and the 2012 IBC. NFPA 221 was initially published in 1994 as the *"Standard for Fire Walls and Fire Barrier Walls"*.

It is also interesting to note that many of the requirements listed in NFPA 221 are sourced from FM, while the 2012 IBC in turn refers to NFPA 221. So many of the building blocks of the 2012 IBC concerning firewalls start with FM as the foundation and progress up through the NFPA 221.

Firewall Definition: A fire-resistant structure that restricts the spread of fire and allows the collapse of the building on either side of the wall without allowing the collapse of the wall.



Source: Manitoba Masonry Contractor's Association

2

So that's start by defining what a firewall is:

A firewall is a fire-resistant structure which restricts the spread of fire and extends continuously from the foundation to or through the roof with sufficient structural stability under fire conditions to allow the collapse of the existing construction on either side of the wall to occur without allowing the collapse of the wall.

So basically a firewall creates separate independent buildings. In fact Section A.3.3.14.6 of the NFPA 221 allows for the portions of the structure subdivided by a firewall to be considered separate buildings.

The requirement that a firewall cannot collapse during fire conditions is also documented in Section 706.2 of the 2012 IBC.

However, for Double Firewall construction (that we will discuss in more detail later), which is also allowed by the 2012 IBC via reference to the NFPA 221, a fire that occurs on one side of a double firewall can cause the collapse of the wall on the same side as the fire, but the remaining wall on the side opposite of the fire must remain standing.

Firewalls are required in order to:

1. Contain fires and subsequently limit property damage.
2. Protect the building occupants.



Source: ACP Concrete Ltd

3

Firewalls are necessary for two primary reasons, which are:

1. To contain fires and subsequently limit property damage, and...
2. Protect the building occupants.

Fire resistance rated construction (in other words the time in minutes or hours that materials or assemblies, like a firewall, have withstood a fire exposure as determined by tests) is a passive form of protection that provides resistance to the advance of a fire, as opposed to active fire protection systems such as automatic sprinkler systems, which actively attempt to suppress a fire.

Restriction of fire growth, or passive protection, has been a key part of building codes ever since public officials first started to address how to protect building occupants and the public from the danger of uncontrolled fires and conflagrations of urban areas.

This slide illustrates an interlocking system of prestressed, precast wall panels used at a Tied Firewall, which is a type of firewall that we will talk about in more detail later.



Source: Concord Construction Company

4

This slide illustrates another type of precast concrete firewall that is temporarily braced during construction.

NFPA 221

Chapter 3: Definitions

3.3.5 Fire Protection Rating: The designation indicating the duration of the fire test exposure to which an opening protective assembly was exposed.

3.3.6 Fire Resistant Rating: The time in minutes or hours that materials or assemblies have withstood a fire exposure as determined by tests, or methods based on tests, prescribed by this standard.

5

Fire Resistance Rated construction, which I mentioned a minute ago as a part of the definition of a firewall, should not be confused with Fire Protection Rating.

Fire Protection Rating is the designation indicating the duration of the fire test exposure to which an opening protective assembly was exposed.

The definition of both of these terms is provided in Chapter 3 of NFPA 221.

GROUP	FIRE-RESISTANCE RATING (hours)
A, B, E, H-4, I, R-1, R-2, U	3
F-1, H-3 ^b , H-5, M, S-1	3
H-1, H-2	4
F-2, S-2, R-3, R-4	2

2012 IBC
Table 706.4
Firewall Fire Resistance Ratings

6

Information about the required fire resistance rating of firewalls for various occupancies can be found in the 2012 IBC and the NFPA 221.

For example, Table 706.4 of the 2012 IBC lists the required fire resistance rating in hours for the different Use Groups defined in Chapter 3 of the same Code.

These ratings range from 2 hours for Storage facilities (Group S) and Factories (Group F) to 4 hours for High Hazard facilities (Group H). In addition, Tables 721 in the 2012 IBC lists minimum fire resistance, in hours, of various structural components.

Section 706.4 of the 2012 IBC requires that if two adjoining buildings have different occupancies then the rating of the firewall must comply with the more restrictive of the two.

Fire ratings of construction assemblies can also be found in the Underwriters Laboratory (or UL) Fire Resistance Directory, PCI Manual 124-1, ACI 216.1, NCMA TEK 07-01C, and the Gypsum Associations Fire Resistance Design Manual.

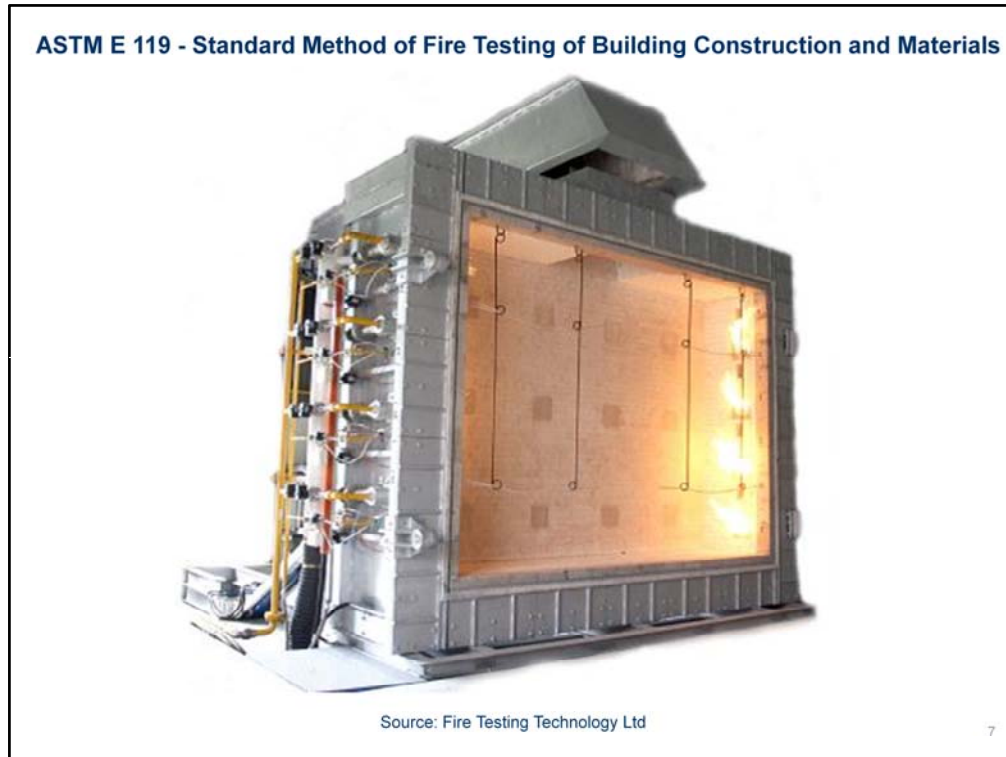

Firewalls should be designed and built with materials that have met the requirements of ASTM E 119 (*Standard Method of Fire Testing of Building Construction and Materials*). ASTM E 119 specifies fire-endurance tests, which include placing a sample of a firewall in a furnace and heating it to a certain temperature for a specified length of time. Data collected during the test includes the length of time for which the wall remains structurally intact and the ability of the wall to limit the amount of heat passing through it. Similar testing requirements are also provided by Underwriters Laboratory, UL Standard 263.

In addition, as mentioned before, the fire rating and resistance of a number of different materials including gypsum board is provided by the 2012 IBC, Underwriters Laboratory, PCI, ACI, NCMA and the Gypsum Association.

This slide illustrates one of the many different testing apparatuses, in this case a Fire Resistance Test Furnace, used to determine ASTM E 119 and UL 263 test results.

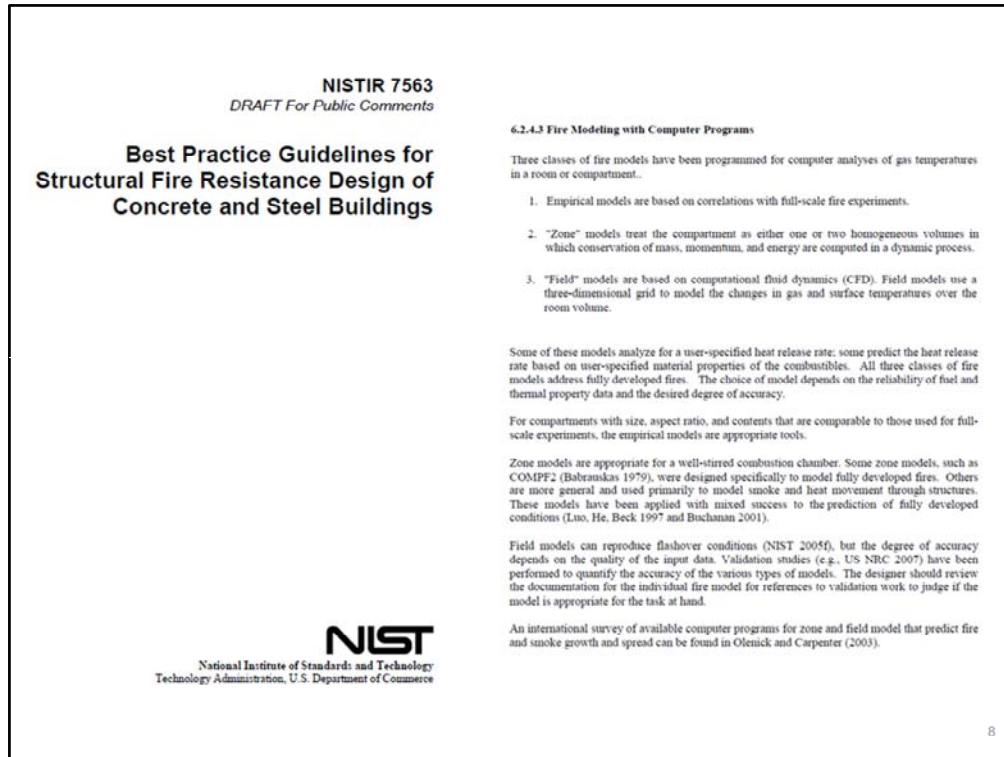

NFPA 221 Section 4.3.2 also allows for analytical methods of determining the fire resistant rating of structural elements and assemblies.

When calculations are used to establish the fire resistance rating of structural elements or assemblies, they have to be performed in accordance with ASCE/SFPE 29. However, when calculations are used to establish the fire resistance rating of concrete or masonry elements or assemblies, the provisions of ACI 216.1/TMS 0216.1 (*Code Requirements for Determining Fire Resistance of Concrete and Masonry Construction Assemblies*) have to be complied with.

The evaluation of existing building and firewall construction, which can be a relatively straight forward process with concrete structures where the fire rating can be determined based on the rebar cover and material properties of the concrete, can be a more challenging under taking when virtually no historical data is available for the building construction. For this type of situation it is possible to construct computer models that can very accurately determine the fire rating of any given type of construction. This approach of determining the fire rating of a structure is recognized by the NIST, which is illustrated on this slide, and has been readily accepted by most Fire and Building Code Officials because the computer modeling has been verified by actual tests conducted at nationally recognized testing labs. The computer modeling should be performed by a licensed Fire Engineer.

Another good source of information on fire ratings of archaic construction materials and assemblies is Resource A of the IEBC.

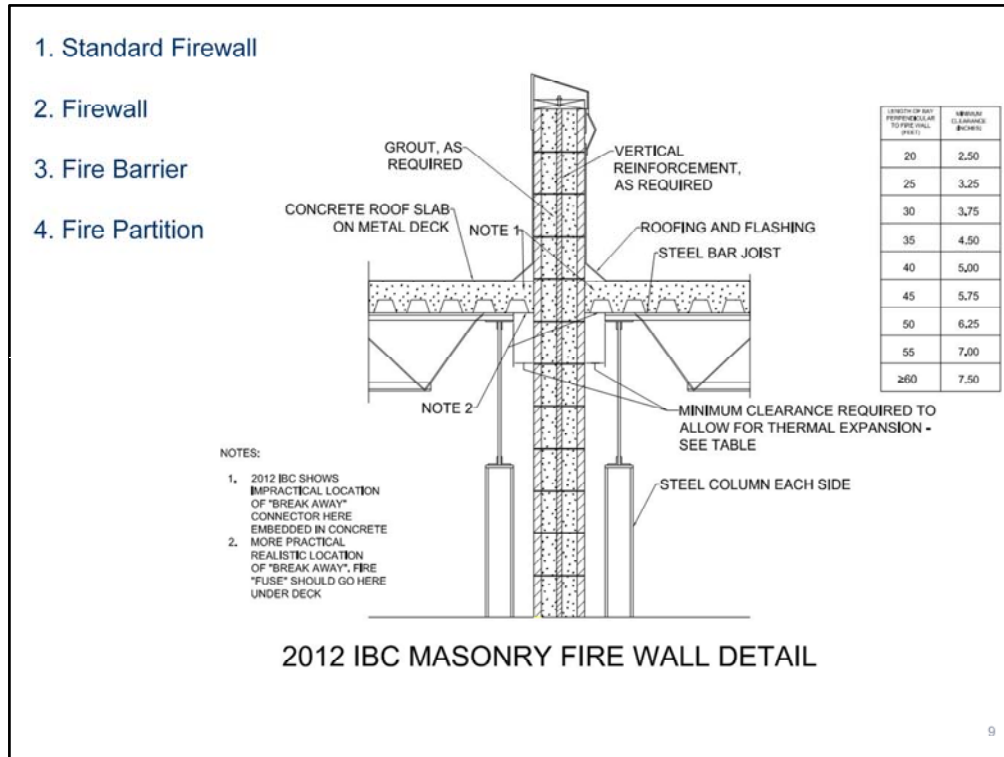

For this presentation, four types of walls will be defined, which include:

1. Standard Firewalls
2. Firewalls
3. Fire Barriers, and..
4. Fire Partitions

All of the above walls, with the exception of Standard Firewall, are defined by the 2012 IBC.

The types of firewalls are differentiated by their construction and by their rated ability to resist a fire. So in other words a firewall is categorized primarily by how long it is able to withstand a fire.

NFPA 221 only defines Firewalls and Fire Barrier Walls, but as of 2006 it also included a definition for High Challenge Firewalls, or HC Firewalls. HC Firewalls are equivalent to Maximum Foreseeable Loss (or MFL) Firewalls defined by FM. HC and MFL Firewalls are beyond the scope of this presentation; however, I will be mentioning aspects of this type of construction because it is referenced by the NFPA 221 as a part of the requirements of firewall construction in general.

MFL Firewalls are designed to stop the spread of an uncontrolled fire when there is an impairment of the facilities fire protection equipment and manual firefighting is limited or delayed. A HC Firewall is used to subdivide a building with high fire challenge occupancies.

GAPS Guidelines also provide definitions for Firewalls, Fire Barriers and Fire Partitions.

This slide includes an illustration of Figure 706.2(1) of the 2012 IBC of a Masonry Firewall. We will discuss the table of clearances provided along with this detail later in Slide 29 however, for now I wanted to point out the areas of the detail referenced but not shown for:

Note 1, which references a "break-away" connector embedded in the concrete roof slab that is shown in the 2012 IBC figure that would not function properly during a fire protected from the heat by the concrete slab encasement.

Note 2 points to more appropriate locations for a "break-away" or heat sensitive connector beneath the concrete slab where it would be exposed to the heat of a fire. There are commercially available break-away connectors available from manufacturers such as the Fero Corporation.

I will also share another type of break-away connector I have had good success with later in Slide 41.



A firewall is designed to remain freestanding even if the adjacent structure collapses. To withstand the expansion of the adjacent structure that occurs due to the heat generated by a fire, firewalls are usually thicker than walls that are intended to act as fire stops only. If a firewall is of considerable height and length, buttresses or pilasters may also be required in order to provide adequate lateral stability.

Some firewalls, which border areas containing explosive materials, must also be designed to resist the lateral pressures that can result from the explosion of these types of materials. Blast resisting walls require specialized engineered designs and are beyond the scope of this webinar.

This slide illustrates a Double Firewall consisting of an existing CMU firewall on the left and an adjacent newly constructed precast concrete firewall on the right.

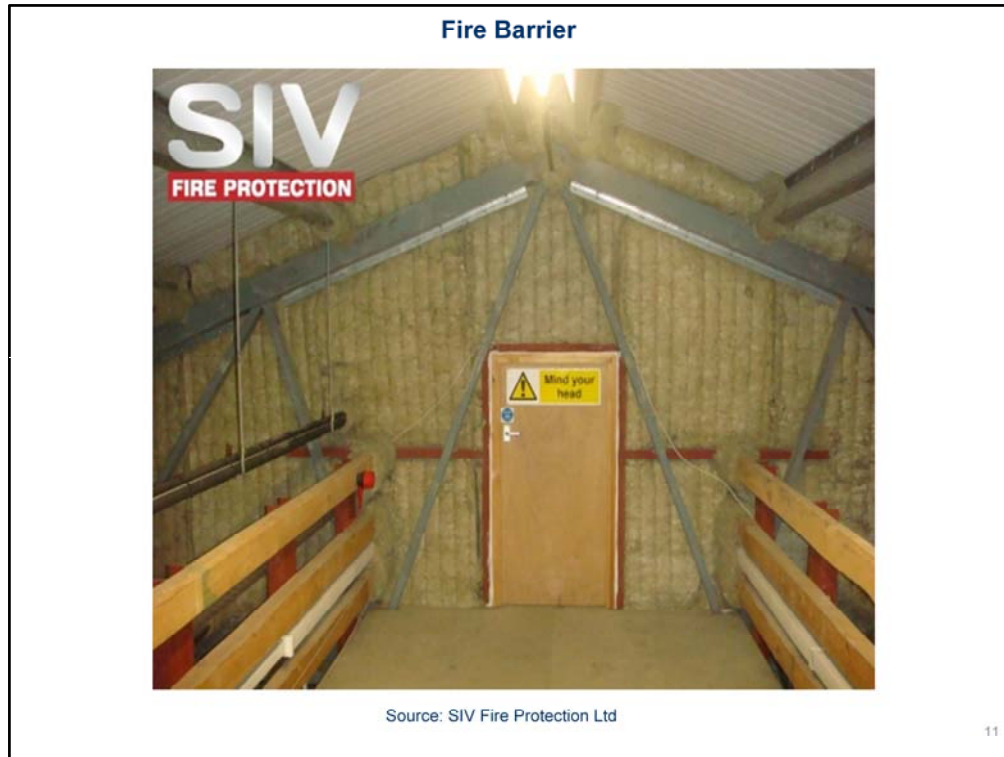

Fire barriers and fire partitions can be used to sub-divide portions of the building contained by a firewall. These types of walls can be attached to or supported by the adjacent structure. However, these lower rated walls must also be built according to designs established by nationally recognized testing laboratories such as UL and in accordance with the 2012 IBC.

We will discuss fire barriers and fire partitions in more detail later in this presentation, but for now I wanted to mention them to highlight the difference between fire barriers and partitions and firewalls.

Firewall Design Factors:

1. Stability under applied design loadings.
2. Other forces affecting the wall.
3. Effects of the thermal expansion on the adjacent structural steel or the wall itself.
4. Non-Loadbearing.
5. Minimum uniform horizontal pressure of 5 PSF.

12

Firewalls, as noted in Slide 8, are typically built to standards established by recognized testing laboratories; however, these designs only establish the fire rating (in other words how long a wall can withstand a fire). There are other factors that should be taken into account when designing a firewall, some of which are listed on this slide. We will discuss these same design factors plus some other ones later in the presentation.

1. Stability under applied design loadings, which can include superimposed dead loads such as heavy equipment or piping suspended from the wall and lateral loads such as wind and earthquake forces acting on the wall.

2. Other forces affecting the wall include the collapse of an adjacent roof structure or adjoining buildings, building contents (such as elevated vessels or racks), and as previously mentioned, explosion of the building contents (such as pressure vessels or flammable materials).

Section 4.6 of NFPA 221, for instance, requires that firewalls that are subject to impact damage from moving vehicles (which can occur in storage and distribution warehouses) must be protected from damage for a height not less than 5-feet above the finished floor level.

3. Effects of the thermal expansion of the adjacent structural steel or the wall itself. The impact of this factor depends on the length of the framing and the height of the steel columns, while the effects of the wall itself depend upon the construction material, height and width of the wall.

In addition, NFPA 221 Section A.4.7 requires that expansion joints in a firewall must be protected with the use of steel cover plates or other suitable means of protection.

4. Be designed as non-loadbearing; however, the structural framing within a tied firewall can be loadbearing but the wall itself must not carry any gravity loads other than its own weight.

5. Be designed for a minimum interior uniform out-of-plane or horizontal pressure of 5 PSF perpendicular to the wall.

GAPS Guideline GAP 2.2.1 also includes minimum design criteria for masonry mortar.

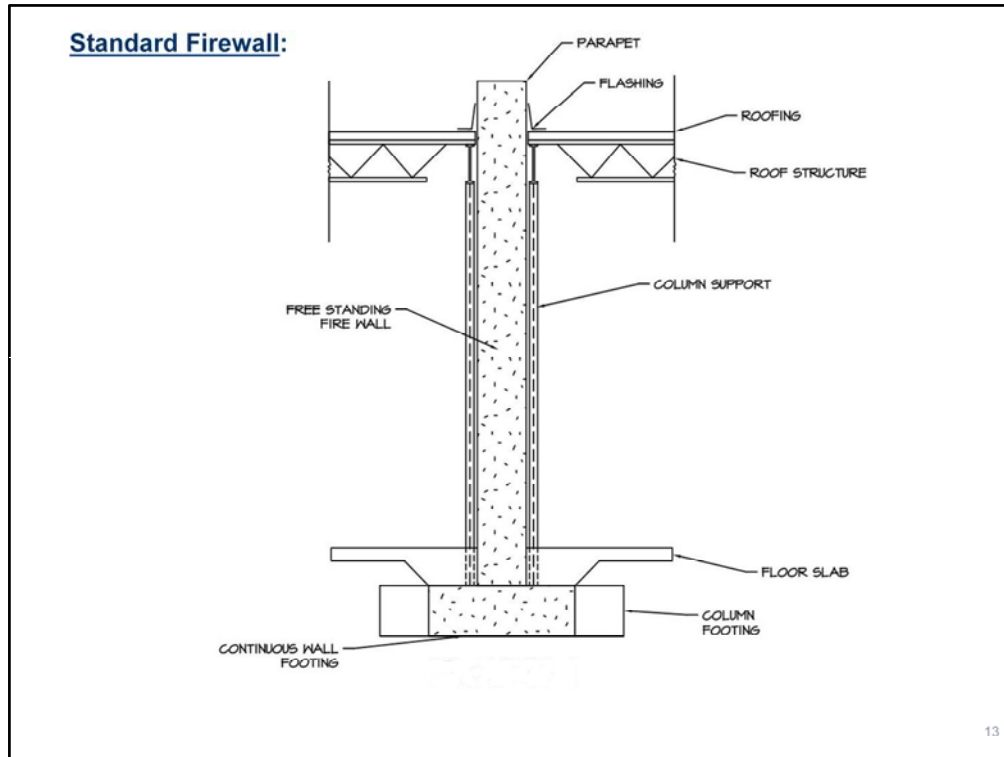

A Standard Firewall, as illustrated on this slide and as defined by GAPS, is a freestanding masonry or concrete wall with no openings.

It can be designed to have as much as a 4-hour fire-resistance rating. If a Standard Firewall is designated as a FM MFL Firewall it must also be designed to contain a fire within the area of origin, even after other firefighting efforts, such as sprinklers have failed.

Although not referred to as a Standard Firewall in the 2012 IBC, there are requirements in the same Code that certain firewalls not have openings. This includes Party Walls that are described in Section 706.1.1.

Party Walls are firewalls that occur on an interior lot line or exterior property line that is used by adjoining buildings. A Party Firewall cannot have any openings in it.

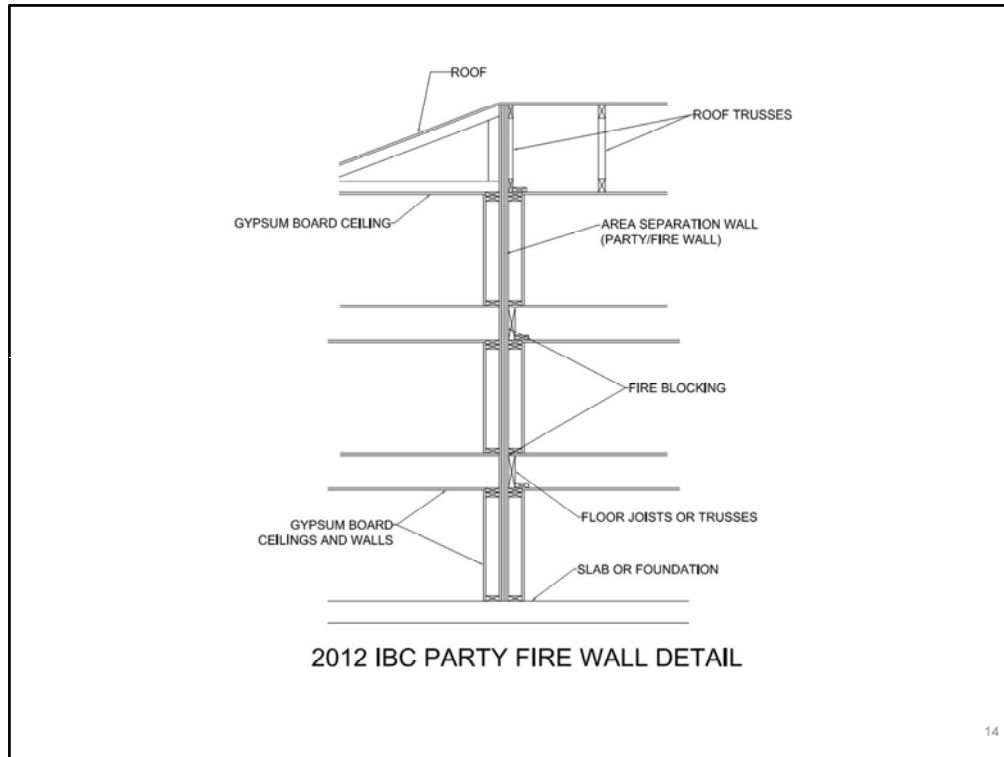

The Gypsum Association's Fire Resistance Design Manual contains construction details for party walls, which have been accepted by IBC as firewalls.

An illustration of a gypsum board fire wall is provided on this slide and can also be found in Figure 706.2(2) of the 2012 IBC.

Firewalls:

1. Withstand damage from stored items or the adjacent structure.
2. Resist damage that can be caused by a fire.
3. Extend from exterior wall to exterior wall.
4. Extend vertically and continuously through all stories of the building and through the roof.
5. Have expansion or control joints.

15

In addition to providing the minimum fire resistance rating, a Firewall must also:

- 1. Be designed to withstand damage from the fall, collapse or expansion of stored items or the adjacent structure.**
- 2. Resist fracture, penetration and fragmentation that can be caused by a fire.**
- 3. Extend from exterior wall to exterior wall, or from one firewall to another. The requirement for horizontal continuity varies between the 2012 IBC, NFPA 221 and insurance underwriter guidelines, so before you design a firewall you need to be sure you are using the correct governing code, standard or guideline.**
- 4. Extend vertically and continuously through all stories of the building and through the roof to form a parapet over the highest point in the roof, or of any structure within a specified distance of the firewall. The requirement for vertical continuity also varies between the 2012 IBC, NFPA 221 and insurance underwriter guidelines.**
- 5. Have expansion or control joints, which helps prevent the wall from buckling when rising temperatures from a fire cause the wall to expand.**

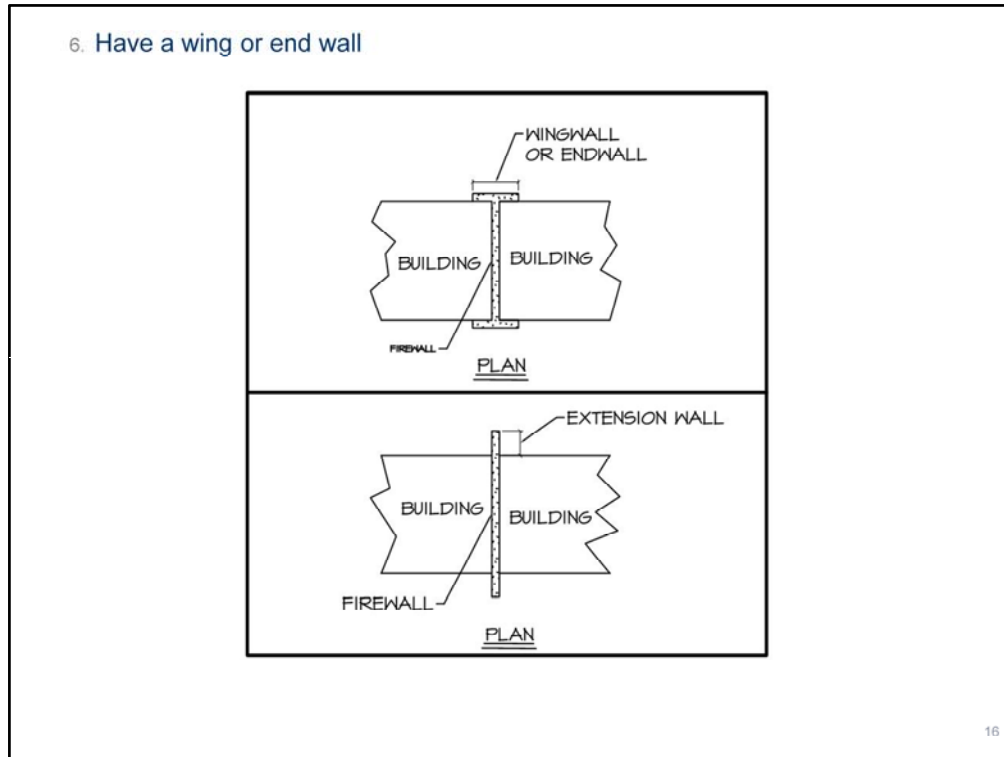

...and finally, a Firewall must:

6. Have a wing wall of a specified minimum length, an end wall of a specified minimum length or an extension wall as needed.

End walls or wing walls are masonry or concrete structures that have no openings, that prevent a fire from passing around or through the adjacent firewalls. These same walls are joined perpendicularly to the ends of the firewall, forming part of the building's exterior walls as illustrated in this slide.

The minimum specified dimensions of wing, end or extension walls varies between the 2012 IBC, NFPA 221 and insurance underwriter guidelines.

NFPA 221 provides diagrams of different examples of this condition in Figures 5.16.2.1 (a) & (b) and 5.16.2.3, which are illustrated in the next two slides.

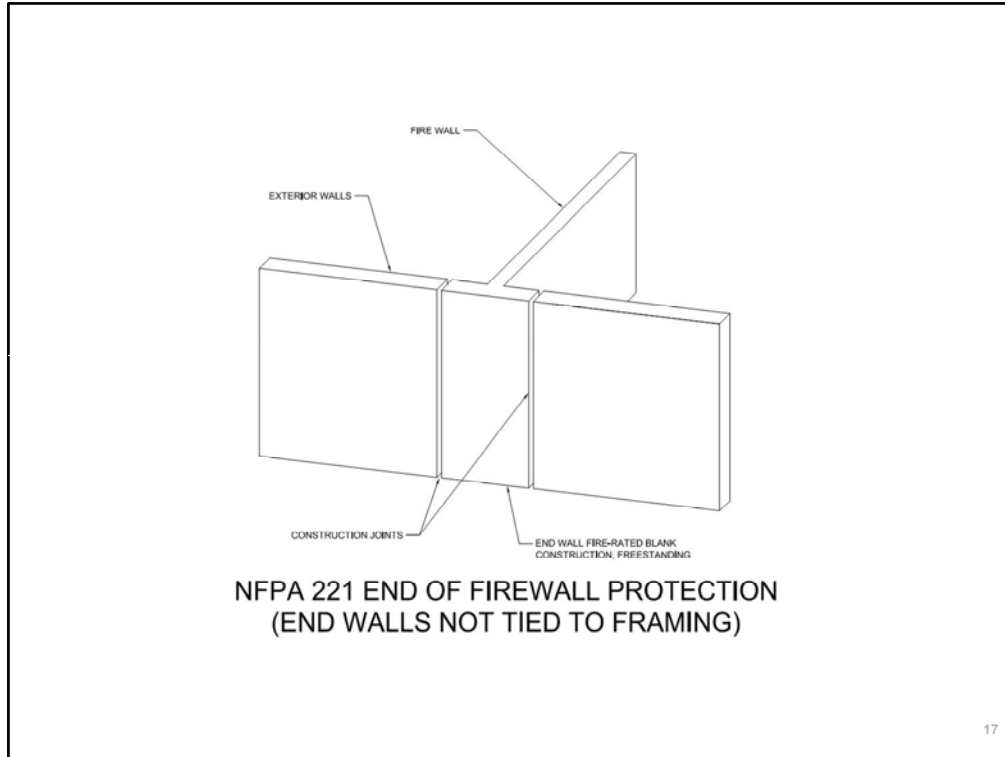

This is Figure 5.16.2.1 (b)

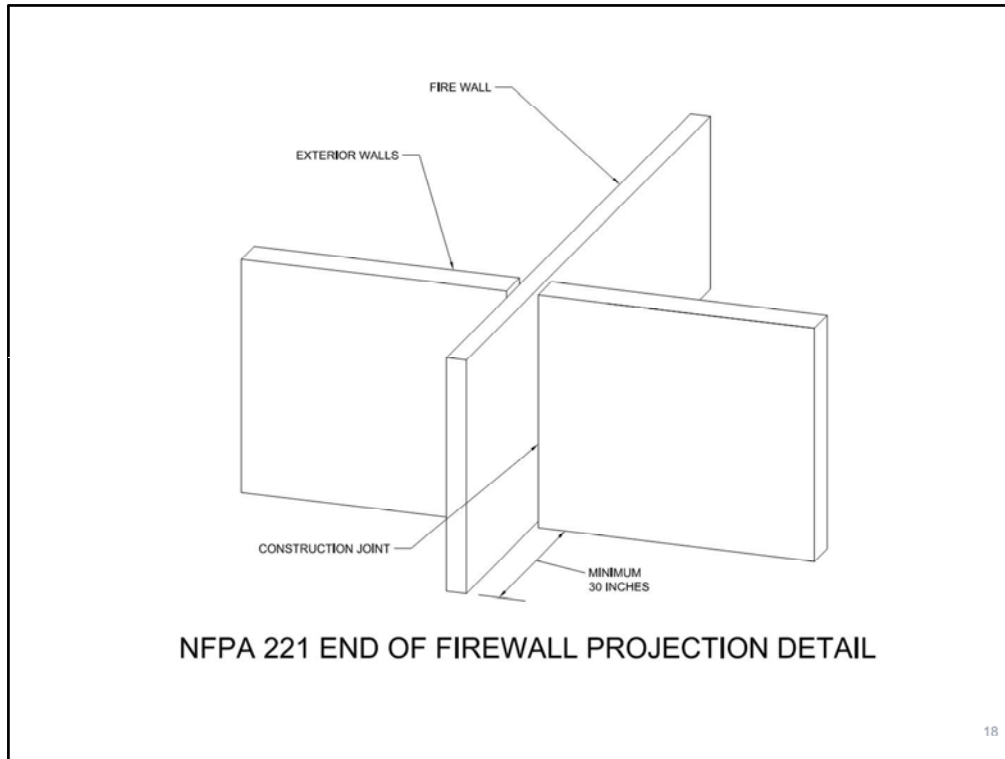

...and 5.16.2.3

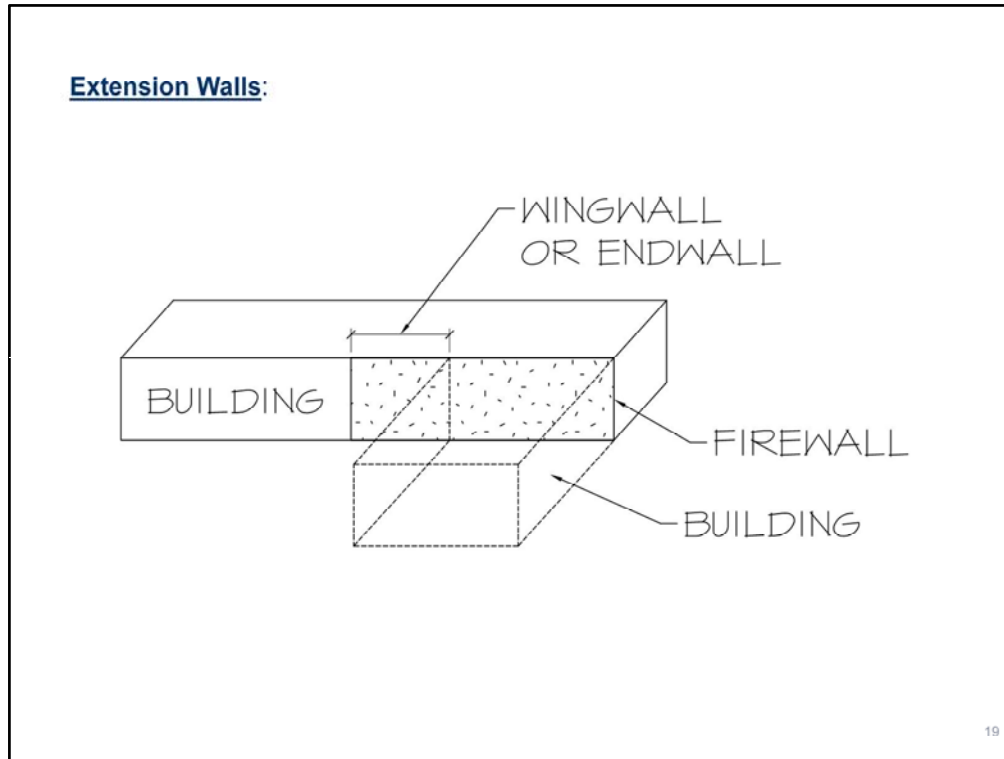

Where two buildings meet perpendicularly to form an L-shape (as illustrated on this slide), the 2012 IBC, NFPA 221 and insurance underwriter guidelines require that an end wall that forms an extension of the interior firewall must be provided beyond the inside corner of the L shape. It should be constructed of masonry, concrete or other fire-rated material. These types of extension walls essentially substitute for end walls or wing walls. A wall extension must project in line with the firewall a minimum distance beyond the building's exterior walls.

The 2012 IBC provides diagrams of different examples of this condition in Figures 706.5.1 (1), (2) and (3), while the NFPA 221 provides a diagram of different examples of this condition in Figure 5.16.3.1

Horizontal Continuity:

Section 706.5 of 2012 IBC

Firewalls shall be continuous from exterior wall to exterior wall and extend a minimum of 18-inches beyond the exterior face of the exterior walls unless the exterior wall has a fire rating of at least 1-hour for a distance of 4-feet on both sides of the intersection with the firewall.

Section 706.5.2 of 2012 IBC

Firewalls shall extend to the outer edge of horizontal projecting elements such as balconies, roof overhangs, canopies, marquees, etc., that are within 4-feet of the firewall.

20

Per the 2012 IBC firewalls shall be continuous from exterior wall to exterior wall and extend a minimum of 18-inches beyond the exterior face of the exterior walls unless the exterior wall has a fire rating of at least 1-hour for a distance of 4-feet on both sides of the intersection with the firewall.

In addition, there are other exceptions listed from this same section that pertain to non-combustible exterior sheathing.

Section 706.5.2 states that firewalls shall extend to the outer edge of horizontal projecting elements such as balconies, roof overhangs, canopies, marquees, and other similar building projections, that are within 4-feet of the firewall.

Vertical Continuity of Firewalls: Section 706.6 of 2012 IBC

1. Stepped buildings in accordance with Section 706.6.1.
2. Two-hour fire-resistance-rated walls shall be permitted to terminate at the underside of the roof sheathing, deck or slab, provided:
 - 2.1. The lower roof assembly within 4 feet of the wall has not less than a 1-hour fire-resistance rating and the entire length and span of supporting elements for the rated roof assembly has a fire-resistance rating of not less than 1 hour.
 - 2.2. Openings in the roof shall not be located within 4 feet of the fire wall.
 - 2.3. Each building shall be provided with not less than a Class B roof covering.
3. Walls shall be permitted to terminate at the under-side of noncombustible roof sheathing, deck or slabs where both buildings are provided with not less than a Class B roof covering. Openings in the roof shall not be located within 4 feet of the fire wall.

21

Section 706.6 of the 2012 IBC specifies vertical continuity requirements for firewalls, which also lists a number of exceptions as shown on this slide, including Stepped Buildings in accordance with Section 706.6.1.

Stepped Buildings: Section 706.6.1 of 2012 IBC

Where a firewall serves as an exterior wall for a building that separates adjacent buildings having different roof levels, the wall shall terminate at a point not less than 30 inches above the lower roof level, provided the exterior wall for a height of 15 feet above the lower roof is not less than 1-hour fire-resistant rated construction from both sides with openings protected by fire assemblies having a fire protection rating of not less than 3/4-hour.

22

Section 706.6.1 basically states that when the exterior wall for a height of 15 feet above the lower roof is not less than 1-hour fire-resistant rated construction from both sides with openings protected by fire assemblies having a fire protection rating of not less than 3/4-hour, the firewall can terminate 30-inches above the lower roof

There are also exceptions for this Section listed in the Code.

4. In buildings of Type III, IV and V construction, walls shall be permitted to terminate at the underside of combustible roof sheathing or decks, provided:
 - 4.1. There are no openings in the roof within 4 feet of the fire wall.
 - 4.2. The roof is covered with a minimum Class B roof covering.
 - 4.3. The roof sheathing or deck is constructed of fire-retardant-treated wood for a distance of 4 feet on both sides of the wall or the roof is protected with $\frac{5}{8}$ -inch Type X gypsum board directly beneath the underside of the roof sheathing or deck, supported by a minimum of 2-inch nominal ledgers attached to the sides of the roof framing members for a minimum distance of 4 feet on both sides of the fire wall.
5. In buildings designed in accordance with Section 510.2, fire walls located above the 3-hour horizontal assembly required by Section 510.2, Item 1 shall be permitted to extend from the top of this horizontal assembly.
6. Buildings with sloped roofs in accordance with Section 706.6.2.

23

Other exceptions to vertical continuity requirements of firewalls are listed in Section 706.6 that include non-combustible roof sheathing and other similar construction requirements.

Other than the exceptions, vertical continuity of a firewall is required from the foundation to a point at least 30-inches above both adjacent roofs.

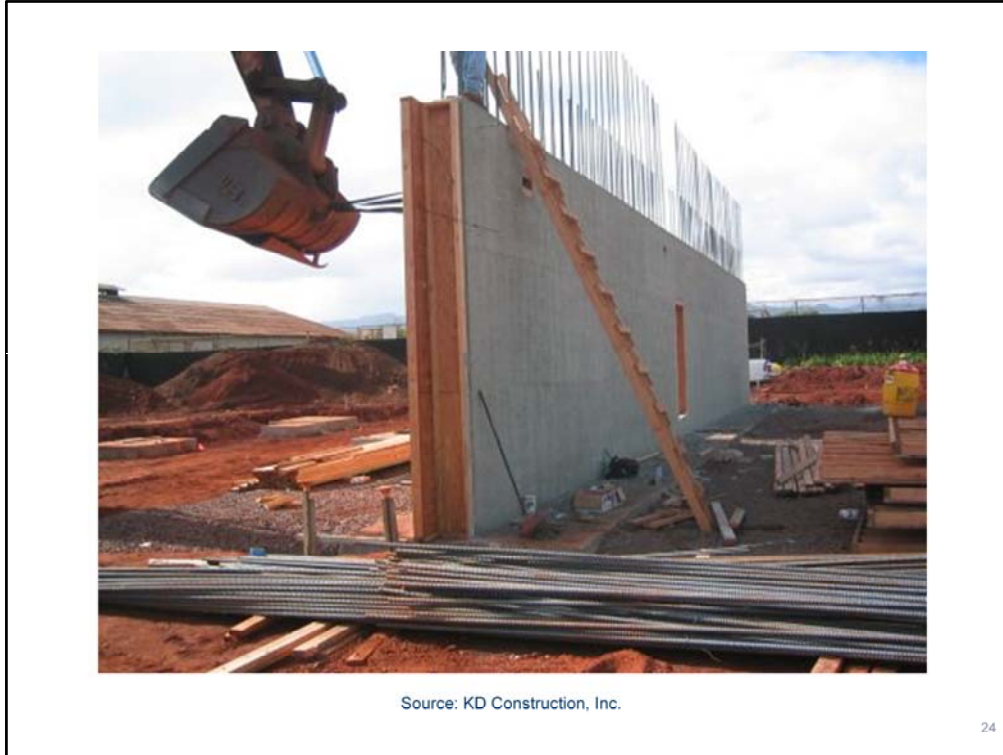

A Firewall is similar to a Standard Firewall, but has protected openings and can have up to a 3 or 4-hour fire-resistance rating. This classification also includes tied walls and double one-way walls, which will be discussed later.

Section 717.5.1 of the 2012 IBC states that firewalls can create separate buildings within a structure. These multiple buildings may be on a single lot, or in the case of zero lot line construction, the firewall may be located on the lot line. In the case where the fire wall separates different buildings on different lots, the code does not permit openings per Sections 706.1.1 and 706.11 as was mentioned earlier. In such instances, no penetrations are permitted. Where the firewall is not located on a lot line, the wall is permitted to have penetrations provided the opening is protected per the requirements of the Code.

This slide shows a cast-in-place concrete firewall under construction.

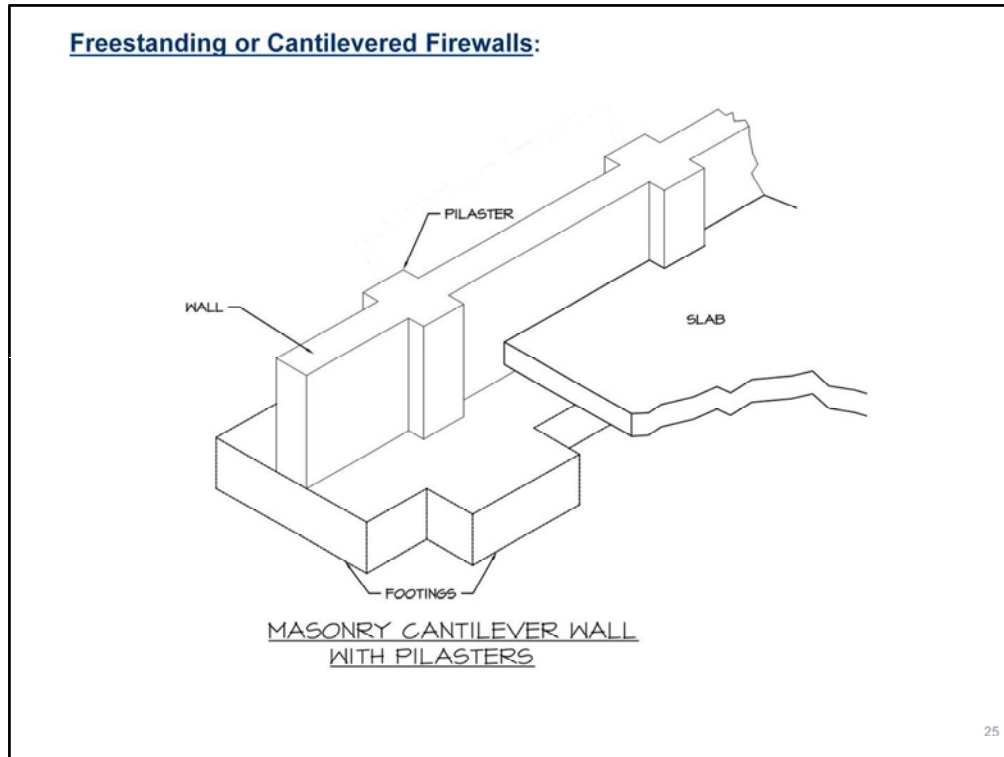

There are several types of Firewalls as defined by the 2012 IBC, NFPA 221 and insurance underwriters guidelines, which include Freestanding or Cantilevered Firewalls.

This type of firewall has no ties to the building other than flashing at the roof as required to prevent moisture intrusion into the building. This type of firewall can be constructed of brick, concrete, precast or concrete masonry units and is usually located at a building expansion joint. A freestanding firewall must be designed to independently resist forces such as expansion caused by temperature differences on either side of the wall or collapse of the building components or contents.

Typically a freestanding wall is strengthened with internal reinforcement, or pilasters may be used to provide the required strength (as illustrated in this slide). Proper horizontal clearance between the wall and the structural framework must also be maintained in order to allow for the deflection of the wall and expansion of the adjacent steel or concrete framing.

The 2012 IBC does not provide guidance for the structural design of this type of wall other than to mention that it is a legitimate form of firewall construction. More detailed information about the design of freestanding firewalls can be found in NFPA 221, GAPS Guideline GAP 2.2.1, and FM Data Sheet 1-22 on MFL firewalls.

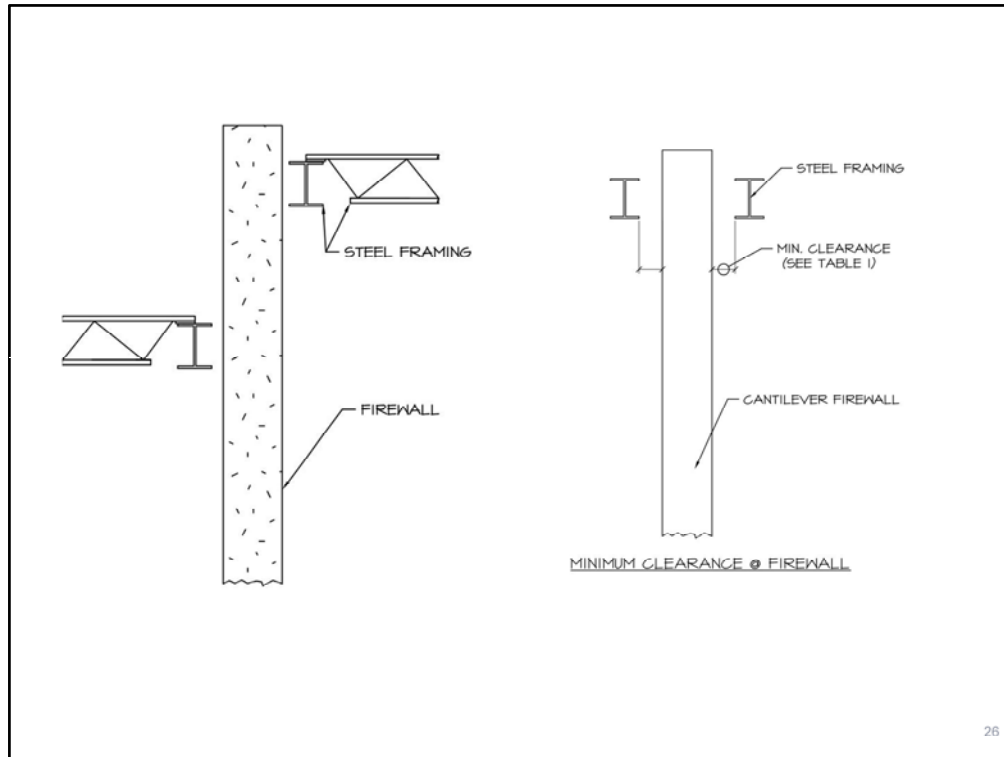

Steel framing on the fire side of a cantilevered firewall will expand and may cause failure of the wall particularly when the steel framing on each side of the wall does not line up horizontally or vertically as illustrated on the left side in this slide.

Adequate clearance between the wall and the framing on both sides is therefore needed to allow for the steel on the fireside to reach the point of maximum expansion without exerting any lateral force on the firewall as shown on the right side of this slide.

The referenced minimum clearance Table 1 will be provided in Slide 29.

The clearance requirements are mandated by insurance underwriters, and referenced directly by NFPA 221 and the 2012 IBC.

Freestanding Cantilevered Firewall Recommendations:

1. Design for a minimum uniform lateral load of 5 PSF from either side.
2. Cantilever walls should be securely fixed to their foundation.
3. Cantilever walls are not recommended in seismic areas.

27

Recommendations for the design and detailing of cantilevered freestanding firewalls includes:

1. The wall should be designed for a minimum uniform lateral load of 5 PSF from either side to assure lateral stability. This magnitude of load corresponds to the code minimum internal lateral pressure for any type of wall. We will discuss this requirement further in Slide 32.
2. Cantilever walls should be securely fixed to their foundation to resist the overturning moment induced by lateral loads. This may be accomplished by designing the footing to resist all of the overturning forces; however, I have also designed cantilever walls that were tied into the slab on grade with horizontal dowels, which in conjunction with a continuous footing below, served as a force couple resistance to the overturning moment in order to minimize the footing size.
3. Cantilever walls are not recommended in seismic areas; however, if they are required, they should be designed to resist all anticipated earthquake forces.

4. Provide clearance between the wall and the steel framing.

Table 1
Recommended Clearance Between Structural Steel and Firewall

Length of Bay Perpendicular to the Firewall	Minimum Clearance Between Wall and Steel
20'-0"	2½ inches
25'-0"	3¼ inches
30'-0"	3¾ inches
35'-0"	4½ inches
40'-0"	5 inches
45'-0"	5¾ inches
50'-0"	6¼ inches
55'-0"	7 inches
60'-0" or greater	7½ inches

28

...and...

4. To prevent damage during initial steel expansion, clearance as indicated in Table 1 should be provided between the wall and the framing on each side of the cantilever wall.

The recommendations provided in Table 1 are based on FM requirements for MFL Firewalls, and explicitly referenced by NFPA 221 in Table A.5.7, and copied by the 2012 IBC in Figure 706.2 (1), which was illustrated in Slide 10.

The clearance is based on an average of 800 degrees Fahrenheit in the two adjacent bays on the fire side of the wall.

NFPA 221 also recommends that adequate clearance be provided between stored materials that may swell due to absorption of moisture from sprinklers or other fire fighting measures. In addition the clearance values in Table A.5.7 apply to Double HC Firewalls.

It is also interesting to note that FM Data Sheet 1-22, which pertains to MFL Firewalls and is referenced by NFPA 221, allows for only a ¼-inch clearance when the structural framing is aligned vertically and horizontally on both sides of the Firewall. Neither the 2012 IBC or NFPA 221 make this same distinction, but it is interesting to also note that Figure 706.2 (1) in the 2012 IBC, which was illustrated in Slide 10, shows a concrete roof diaphragm in contact with both sides of the firewall that essentially negates the minimum clearance called for between the steel framing and the firewall.

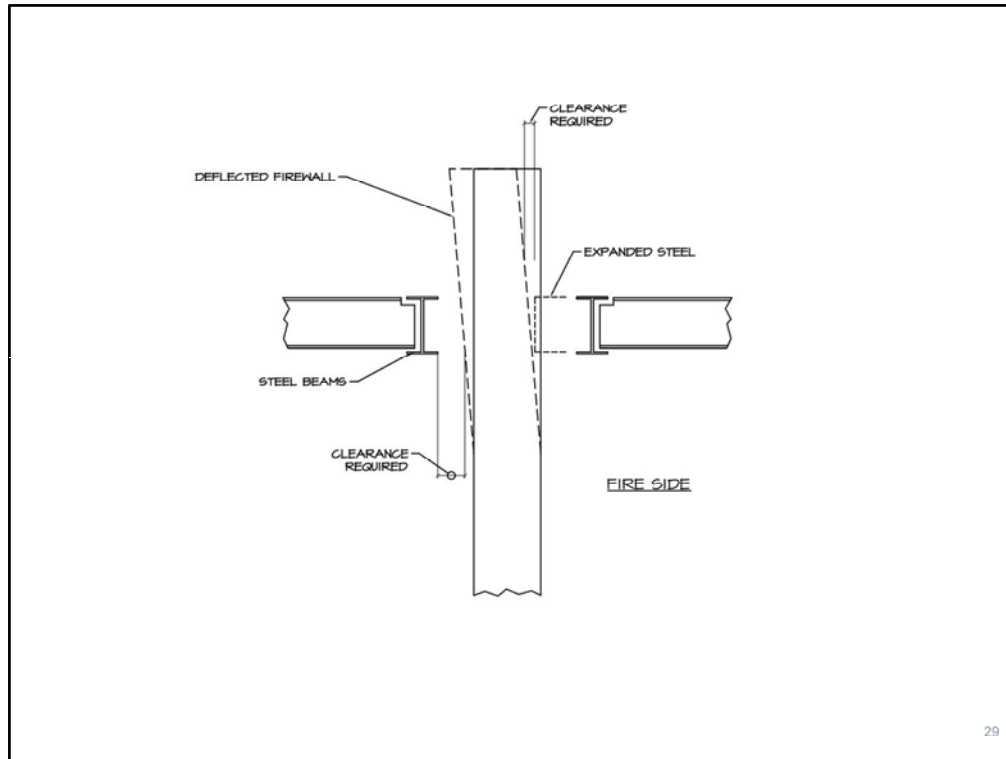

Per FM, for walls higher than 40'-0", the maximum $\frac{3}{4}$ -inch clearance space mentioned in the previous slide from FM Data Sheet 1-22 should be increased $\frac{1}{4}$ " for every additional 10'-0" of wall height as illustrated in this slide. For masonry wall construction, a bond beam should be installed in the second course below the bottom of the primary steel and all cores of concrete block above should be filled with grout.

For a CMU firewall in which the primary steel is parallel to the firewall all cores above the bond beam to the top of the wall should be grouted along the entire length of the wall. However, when the adjacent primary steel is perpendicular to the wall the grouted cores above the continuous bond beam only have to extend 16 inches on each side of the columns.

In all cases the vertical wall reinforcing and related grouted cells in a CMU firewall should be continuous through the bond beam and extend to the top of the wall.

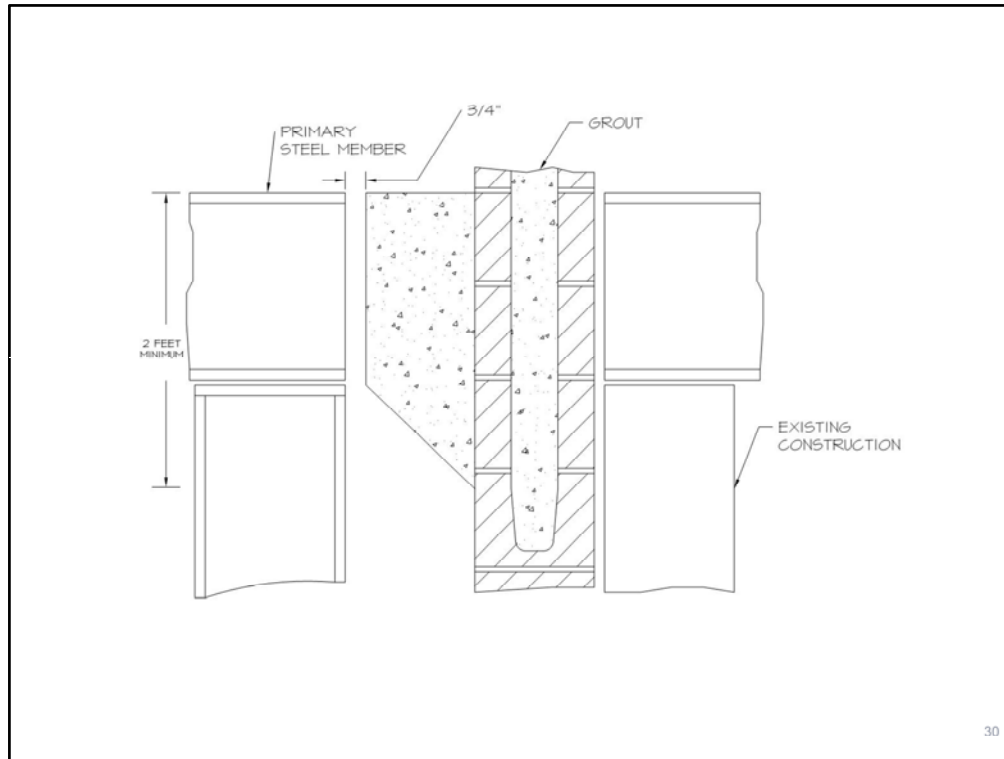

For existing structures, FM Date Sheet 1-22 for MFL firewalls allows the use of solid masonry or concrete pilaster or corbel to be constructed between the wall and structural steel as illustrated on this slide when the minimum clearances required by Table 1 are not provided.

The purpose of the corbel is to protect the main body of the firewall from damage associated with movement or distortion of the adjacent steel framing due to the heat from a fire, thus eliminating the need for providing minimum clearance between the wall and the framing.

If clearance is required as a part of a normal building expansion, a space that satisfies the expansion joint requirements should be maintained between the column and the pilaster or corbel.

Per FM, the pilaster or corbel should be at least 2'-0" high at the face of the existing wall and a layer of building paper should be placed over the new structural steel to prevent bonding to the corbel during construction.

Freestanding Cantilevered Firewall Recommendations (Continued):

5. Tilt-up or precast concrete construction foundation connections.
6. Temporary exterior firewalls.

31

So continuing with additional recommendations for freestanding walls we also have:

5. If tilt-up or precast concrete construction is used for a cantilever wall design, particular attention should be paid to the connection to the footing to ensure that the foundation can adequately resist the overturning moment of the wall. We also discussed options for this condition in Recommendation #2 on Slide 28.

6. If the firewall is built for a future addition and must therefore function initially as an exterior wall, then the wall must be designed to resist exterior component and cladding pressures. Typically for this situation the wall is temporarily connected to the building frame until the future building is constructed and the same connections are then removed when the new construction occurs. The other option of course is to design the wall as self-supporting for exterior conditions, but this typically requires the introduction of large pilasters or buttresses.

It should also be noted that when an interior firewall is exposed to an exterior condition after the collapse of an adjacent protective structure as the result of a fire, the wall only has to be designed to resist 10 PSF of horizontal wind pressure. This is because until the collapsed structure is replaced the exterior exposure of the firewall can be considered as a temporary construction condition, which per OSHA only amounts to a 10 PSF wind load. Similar logic is also used in the tilt-up industry for temporary bracing loads, which are based on a 5-year mean recurrence wind load cycle.

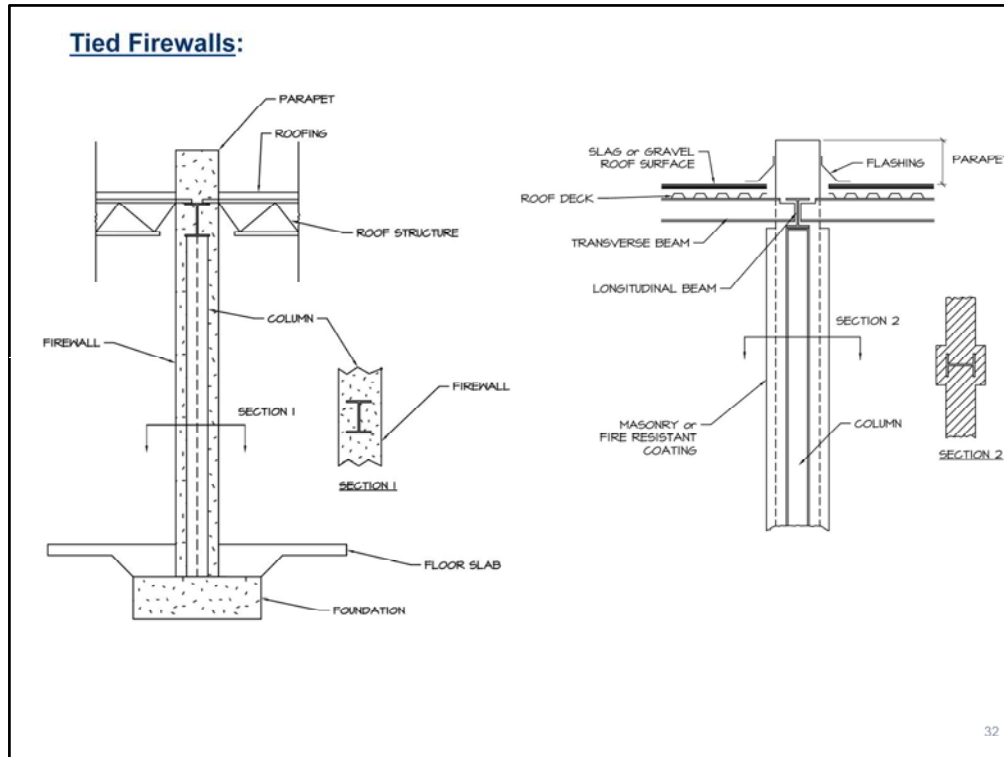

A Tied Firewall consists of masonry or other rated construction materials that either encases or is tied to the structural framing as illustrated in this slide. These types of walls are integral with and therefore supported by the structural framework. To ensure the stability of the wall, the adjacent structural framing on either side of the wall must be designed to resist the forces caused by the structure collapsing on the opposite fire-exposed side.

The 2012 IBC does not provide guidance for the structural design of this type of wall other than to mention that it is a legitimate form of firewall construction. Tied firewalls are discussed in Section 6.4 of the NFPA 221, and described in detail in the GAPS Guideline GAP.2.2.1 and FM Data Sheet 1-23.

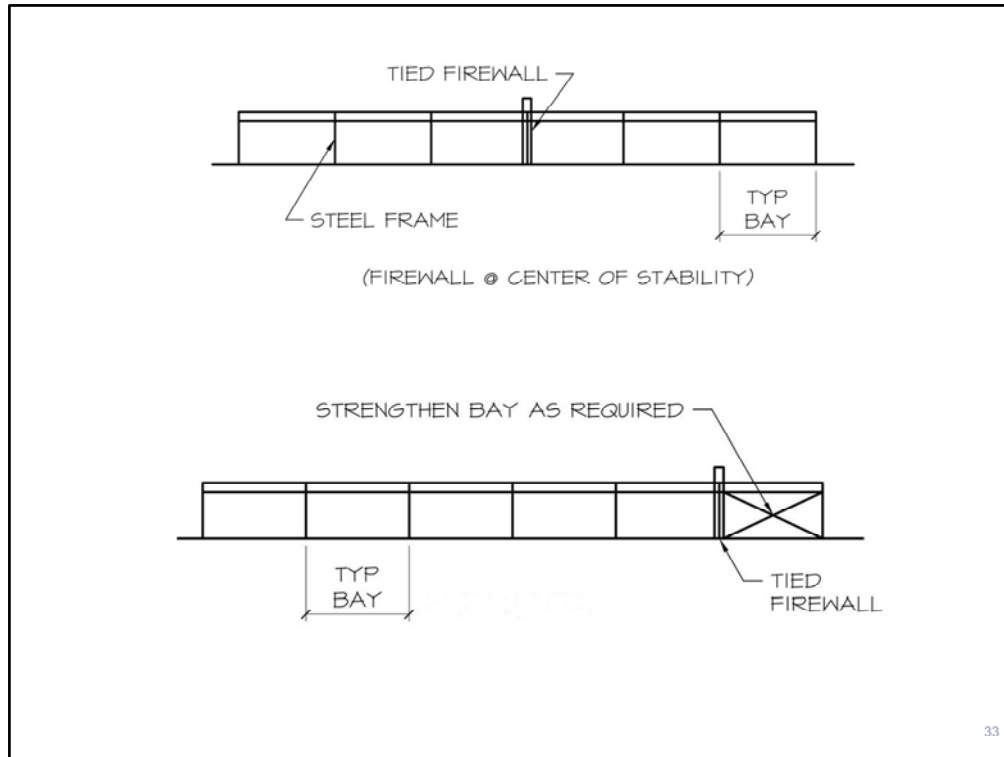

To remain stable, the pull of the collapsing steel on the fire side of the wall must be resisted by the strength of the undamaged steel on the other side of the wall. Since the fire can occur on either side of the wall, the wall preferably should be located at the center of lateral resistance of the building frame or in other words the area of the building in which the steel framing on either side has equal lateral resistance as illustrated on the top of this slide. If the firewall cannot be located in the middle of the building then strengthening of the smaller remaining portion of the building as shown on the bottom of this slide may be required.

Tied Firewall Recommendations:

1. A tied wall should follow a column line to take advantage of the vertical strength of the column and to minimize twisting forces on the wall.
2. The steel framing on each side of a tied firewall should be at the same elevation and in line horizontally.

34

Recommendations for the design and detailing of Tied Firewalls as required by insurance underwriters include:

1. A tied wall should follow a column line to take advantage of the vertical strength of the column and to minimize twisting forces on the wall. The steel columns and framing in line with the wall should have a fire resistance equal to the wall. For situations where the wall is constructed between columns on a double-column line, the column and beams parallel to the wall immediately on each side should be rated to a fire resistance equal to the wall to prevent the steel from buckling and fracturing the wall.

2. The steel framing on each side of a tied firewall should be at the same elevation and in line horizontally.

These same recommendations can also be found in Sections 6.4.1 and 6.4.2 of NFPA 221

3. Horizontal Force

$$H = \frac{wBL^2}{8S}$$

where:

H = horizontal pull pier tie (lbs)

w = dead load plus 25 percent of the live load of the roof
(lb/ft²)

B = distance between ties (ft)

L = span of the structural member running perpendicular to
the wall (ft)

S = sag in(ft) that can be assumed as:

= 0.07L for open web trusses

= 0.09L for solid beams

= 0.06L for wood trusses

35

As indicated in Slide 34, when the steel frames on either side of the wall are not of equivalent strength provisions must be made so that the lateral resistance of the frame on either side of the wall is sufficient to resist the horizontal component of the force resulting from collapsing steel on the opposite side. The horizontal force may be computed by using Formula A.5.4 provided in this slide from NFPA 221.

$$H = (wBL^2)/(8S)$$

Where:

H = Horizontal pull in pounds

w = Dead load of the structure, plus 25% of the roof live load, pounds per square foot

B = the distance between each tie in feet

L = Span of the structure in feet of the immediately adjacent perpendicular span.

S = Sag in feet may be assumed as: 0.07L for open-web steel joists or trusses, 0.09L for solid-web steel beams, and 0.06L for wood trusses.

4. Where the wall is constructed between columns on a double column line, the ties should be designed based on the formula in Slide 35.

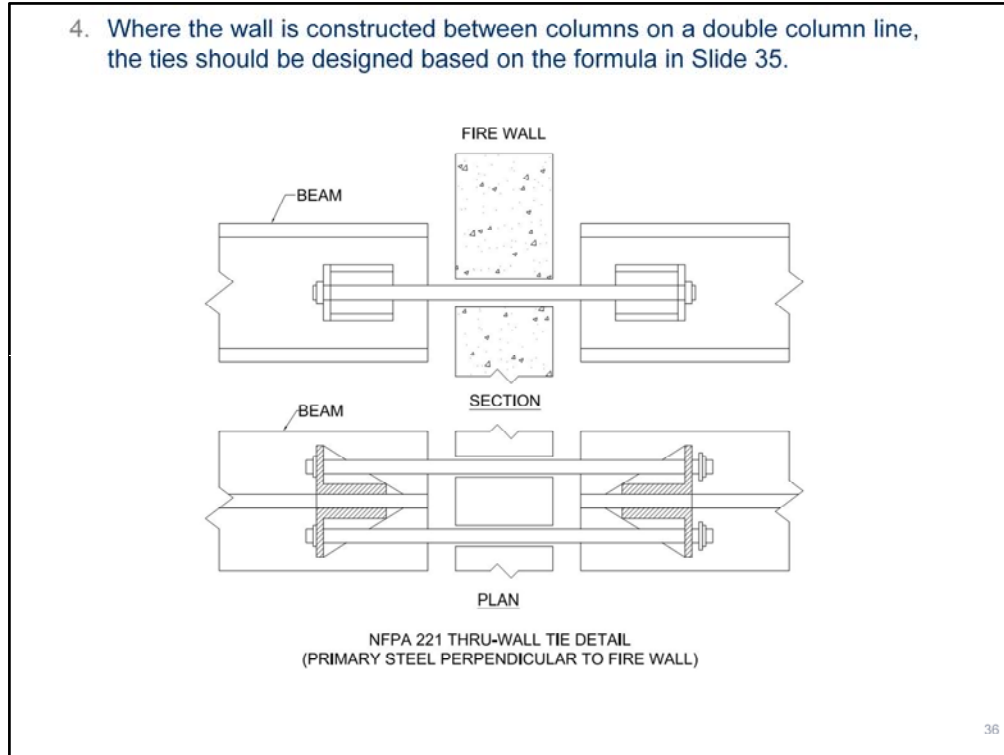

The fourth recommendation for tied firewalls deals with walls constructed between columns on a double column line. In this case the ties should be designed based on the formula in Slide 36 using an allowable tensile stress of not more than $0.3 F_y$ and an allowable shear stress of $0.2 F_y$ per FM Data Sheet 1-22.

Two tie rods per column should be used to reduce torsion as illustrated on this slide when the primary steel is perpendicular to the wall. The ties should be connected to the steel framing at the column locations. The column is not shown in this illustration for clarity, but is required.

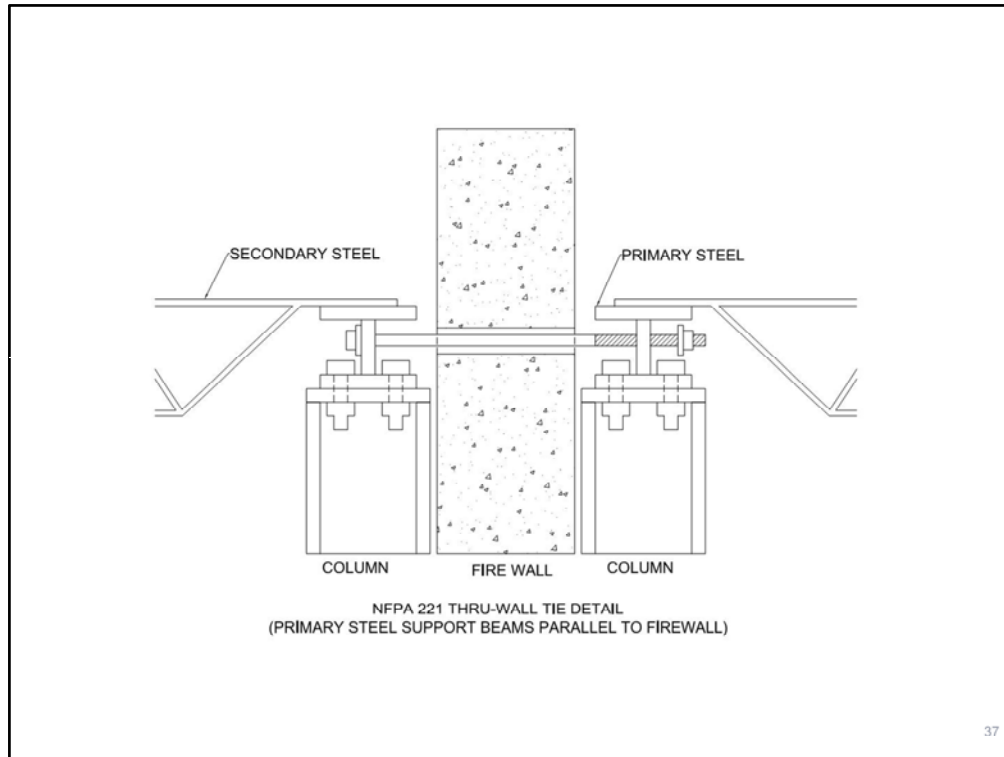

When the primary steel is parallel to the wall it may be necessary to install ties more often than every column line as illustrated in this slide.

Nuts for through-wall ties should be backed off slightly (up to $\frac{3}{4}$ inch) for walls up to 40'-0" high with an additional $\frac{1}{4}$ inch added for every additional 10'-0" of wall height to allow for normal building movement as recommended by FM.

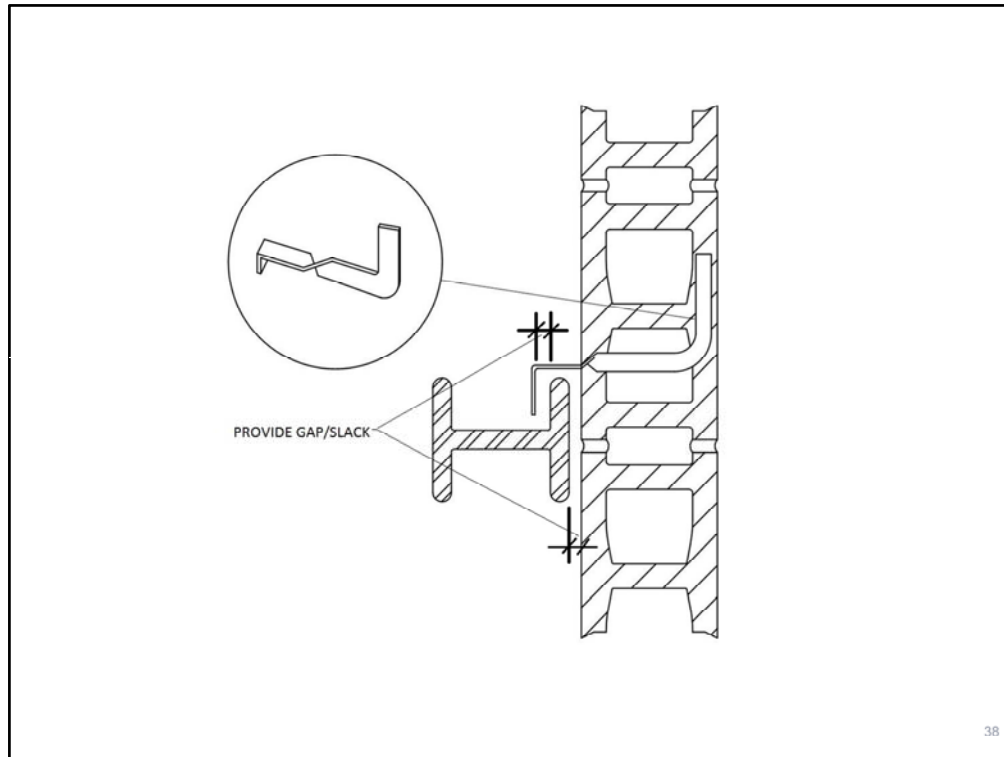

While through wall connections should be used to make steel framework continuous across the wall, flexible masonry anchors should be provided to brace the wall laterally. Enough slack, as illustrated by the gap between the wall and the column and the connector and the column, should be provided in order to prevent the collapsing steel from pulling on the wall before there is resistance from the steel on the unexposed side of the wall.

5. Tied firewall clearance should be provided between the wall and the steel framing on each side of the wall. As an alternative it is acceptable to construct solid masonry or concrete pilasters or corbels between the wall and structural steel similar to that recommended for freestanding firewalls.

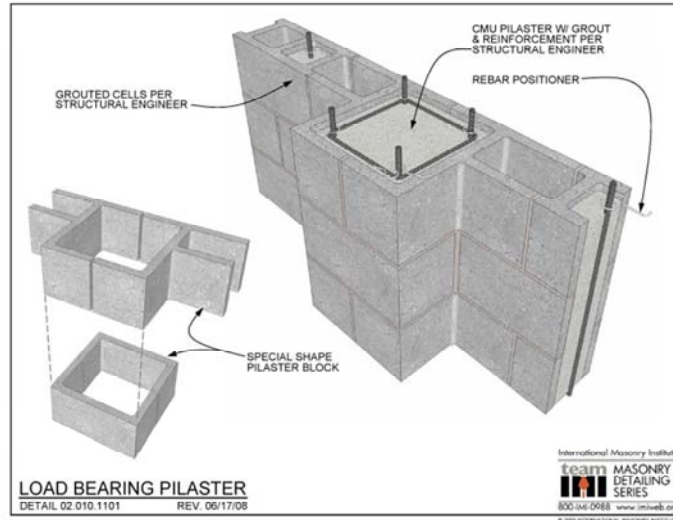

Source: International Masonry Institute

39

The fifth recommendation for tied firewalls as required to prevent damage during the initial steel expansion at a double-column line, involves clearance, which should be provided between the wall and the steel framing on each side of the wall per Table 1 on Slide 29.

As an alternative it is acceptable to construct solid masonry or concrete pilasters similar to that shown in this slide, or corbels between the wall and structural steel similar to that recommended for freestanding firewalls.

6. In the case of single-column line tied walls, the framing on the unexposed side of the wall must resist steel expansion on the fire side.

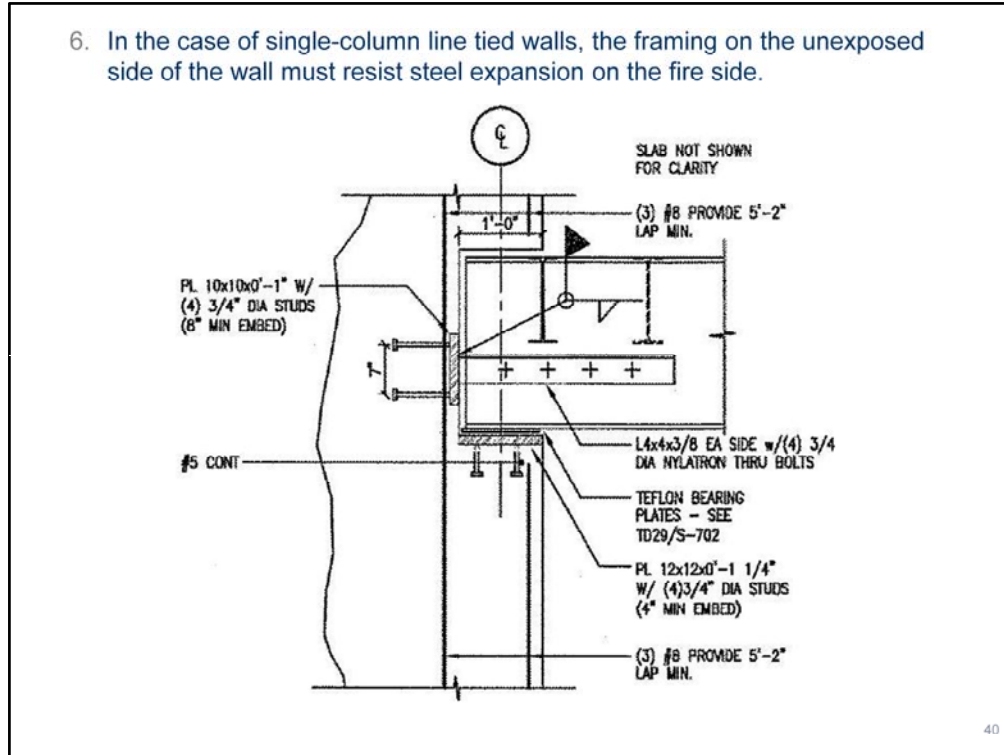

In the case of single-column line tied walls, the framing on the unexposed side of the wall must resist steel expansion on the fire side. However, the connection of the wall to the columns should allow some flexibility as the building frame on the unexposed side will deflect laterally as a result of the pull from the sagging steel on the fire side. This can be accomplished by using flexible masonry anchors as was illustrated on Slide 39, or using concrete blocks that are loosely keyed into the re-entrant space of the column. In either case, if sprayed-on fireproofing is used, the entire column should be sprayed before the wall is constructed.

The detail provided on this slide shows a method of avoiding the problem of pull-over forces via a special fusible connector that involves Nylatron bolts. Nylatron is a composite plastic & nylon material that has a melting point of approximately 490° F. Structural steel begins to distort at approximately 900° to 1,000°.

Use screen pointer to identify Nylatron bolts

Although it may appear that the detail on this slide will only function properly as a fusible link if the fire and resulting heat occur directly beneath the Nylatron bolts, I have been able to successfully get approval of this and other similar details from Building Officials and Fire Marshalls at a number of different municipalities across the U.S.

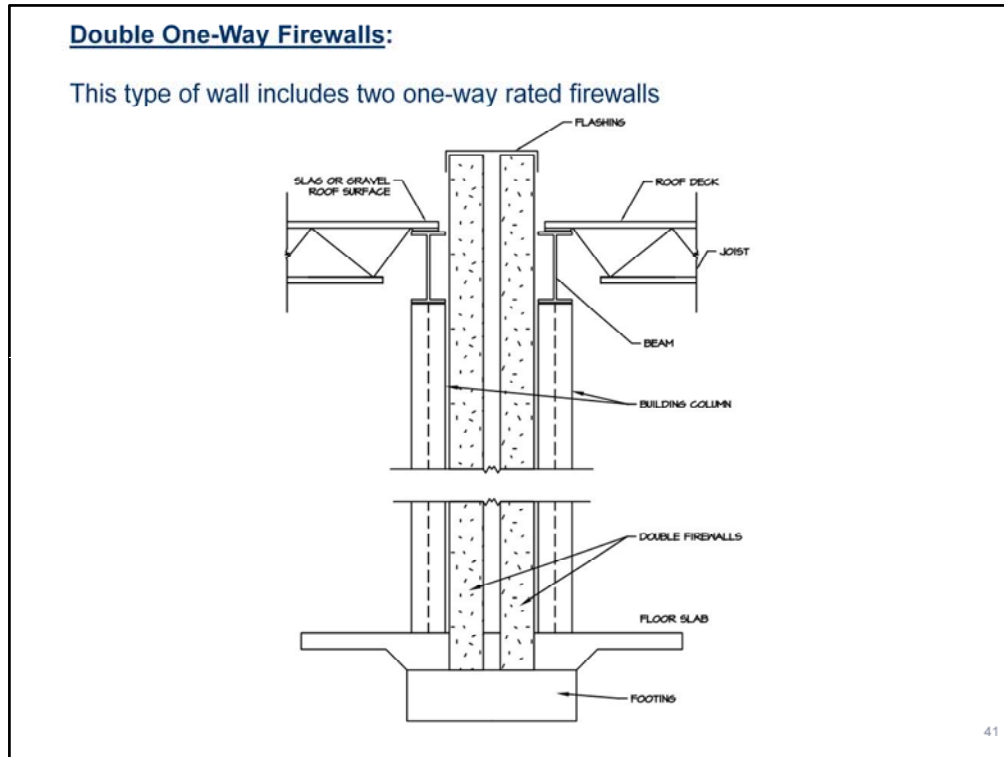

Double One-Way Firewalls involve two one-way rated firewalls as illustrated on this slide, which have exposed structural framing on one side. The one-way walls are placed back-to-back, with a minimum separation between them. Each wall must have a minimum fire resistance rating of 3-hours. Double firewalls are most commonly built when a firewall is required to separate an existing structure from a new building as illustrated in Slide 11. In such a situation it is possible to upgrade a wall secured to an existing building frame to the required fire-resistance rating. This is accomplished by constructing a new rated firewall next to it and securing it to the new building frame. If a fire destroys one wall, the wall supported by the other side should remain standing.

Double Firewalls, per the 2012 IBC, must be constructed in accordance with NFPA 221.

Double One-Way Firewall Recommendations:

1. Each wall should have a 3-hour fire resistance rating.
2. Provide building paper to prevent bonding between the masonry walls.
3. Anchor each wall to its respective steel framework.

42

Recommendations for the design and detailing of double one-way firewalls provided by insurance underwriters guidelines include:

- 1. Each of the two wall elements should have a 3-hour fire resistance rating.**
- 2. If significant separation to prevent bonding of masonry walls is lacking, a layer of building paper or other suitable material should be used between the walls during construction.**
- 3. Each wall should be anchored to its respective steel framework at each framed level. In addition, there should be no connections other than the roof flashing between the walls. Particular attention should also be paid to details at openings in the walls and at the roof flashing between the walls.**

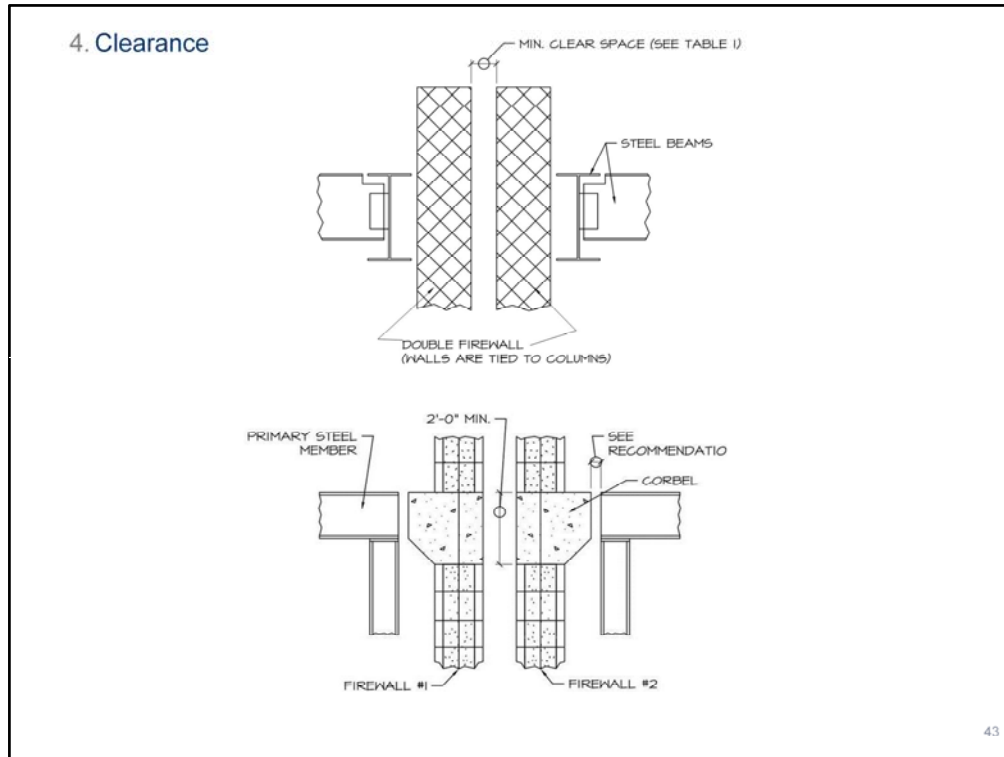

4. To prevent damage to the remaining wall during initial steel expansion resulting from the extreme heat of a fire, clearance per Table 1 on Slide 29 should be provided between the walls as illustrated at the top of this slide. As an alternative, when the steel framing lines up horizontally and vertically on both sides of the walls, it is acceptable to construct solid masonry or concrete pilasters or corbels between the wall and structural steel as shown on the bottom of this slide, similar to that recommended for freestanding firewalls for existing construction.

Fire Resistance Rating of Each Wall (hours)	Equivalent Single Wall Fire Resistance Rating (hours)
3	4
2	3
1	2

**NFPA 221
Table 4.5
Fire Resistance Ratings for Double Firewalls**

44

NFPA 221 Section 4.5 states that where either wall of a double wall is laterally supported by a building frame with a fire resistance rating less than that required for the wall, double wall assemblies shall be considered to have a combined assembly fire resistance rating as specified in Table 4.5.

Fire Barriers:

Fire Barriers typically have lower fire-resistance ratings than firewalls.

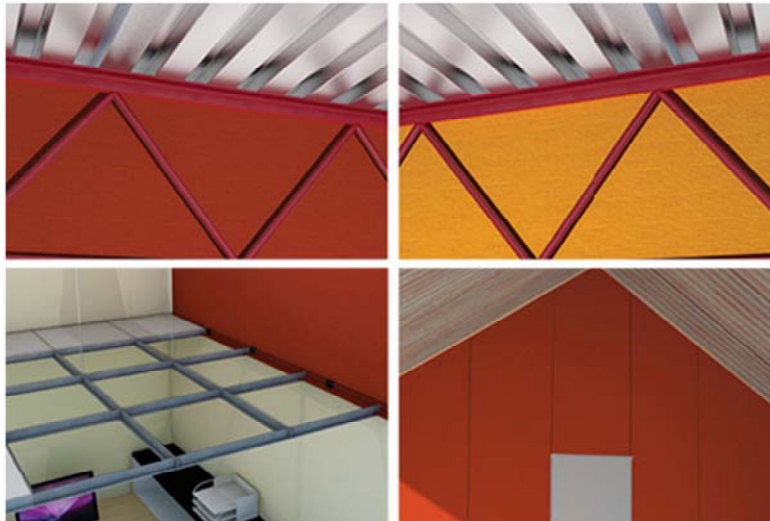

Source: Envirograf

45

Fire Barriers, which are covered in Section 707 of the 2012 IBC, and Chapter 7 of the NFPA 221, typically have lower fire-resistance ratings than firewalls, however, fire barriers must also be designed and constructed according to specifications established by nationally recognized laboratories. Fire barriers are typically used to subdivide floors and can be attached to or supported by structural members.

Fire barriers are typically rated for 2 to 3-hour fire-resistance; however, Table 707.3.10 of the 2012 IBC that will be presented on the next slide, requires a 4-hour fire rating for Occupancy Groups H-1 and H-2.

Fire barriers are typically non-load-bearing walls that extend from the floor-to-floor or floor-to-roof, including concealed and interstitial spaces like ceiling plenums. All supporting structures, such as roofs, columns or floors, should be noncombustible or fire resistant to a rating not less than that of the fire barriers they support.

Occupancy Group	Fire Resistance Rating (hours)
H-1, H-2	4
F-1, H-3, S-1	3
A, B, E, F-2, H-4, H-5, I, M, R, S-2	2
U	1

**2012 IBC
Table 7067.3.10
Fire Barrier Assemblies
Fire Resistance Ratings**

46

...and here is Table 707.3.10 of the 2012 IBC, which also allows for just a 1-hour fire-resistance for fire barriers in Occupancy Group U



Fire barriers do not require parapets or end walls, and are generally not freestanding. Fire barriers restrict the initial flow of heat within the area of origin and thereby help to limit the actuation of sprinklers outside the fire zone. Fire barriers also help to provide the building occupants with sufficient time to evacuate to adjacent safe areas. Fire barriers are most effective when heat and smoke vents are provided and sprinklers are operable.

A fire barrier also helps to supplement the sprinkler system. For example, a sprinkler system might be adequate for the area it protects, however, during a fire one or two sprinkler heads might malfunction due to lack of maintenance or a mechanical problem. In such a situation, the fire barrier helps to contain the fire in the absence of a fully functioning sprinkler system.

If there is a possibility of an intense fire on either side of a barrier, a double or freestanding barrier can be constructed between a building's structural columns.



Source: Firewise Supplies Ltd

48

If there is a possibility of an intense fire on either side of a barrier, a double or freestanding barrier can be constructed between a building's structural columns. A double barrier is similar to a double one-way firewall, but instead is comprised of two, one-way fire barriers rather than two fire walls. A one-way fire barrier is the simplest form of a fire barrier. It is designed to withstand a fire on one side only. It is effective for separating an area whose contents will generate relatively little heat during a fire from a higher-hazard area. This type of fire barrier is tied into the building's structural framing on the low-hazard side of the wall.

A one-way fire barrier should be a non-loadbearing wall and be installed in line with a row of the building's structural columns.



Source: SSA Techno Construction Pvt. Ltd.

49

A one-way fire barrier should be a non-loadbearing wall and be installed in line with a row of the building's structural columns and have through-barrier ties to the building frame on both sides of the wall. Constructing a fire barrier to follow a line of structural columns allows it to benefit from the columns' vertical strength. All columns and structural framing parallel to and within 1'-0" of the barrier should have a fire-resistance rating not less than that of the fire barrier.

Where two buildings are joined with a barrier, each side of the building must be designed to provide stability. In other words, the structural steel must be constructed to support all loads in the presence of a fire or absence of the structure on the opposite side of the wall.

707.5 Continuity. Fire barriers shall extend from the top of the foundation or floor/ceiling assembly below to the under-side of the floor or roof sheathing, slab or deck above and shall be securely attached thereto. Such fire barriers shall be continuous through concealed space, such as the space above a suspended ceiling. Joints and voids at intersections shall comply with Sections 707.8 and 707.9.

50

Section 707.5 of the 2012 IBC specifies continuity requirements for Fire Barriers, which requires fire barriers to extend from the top of the foundation or floor/ceiling assembly below to the under-side of the floor or roof sheathing, slab or deck above and be securely attached to this same structural elements. Fire barriers shall be continuous through concealed space, such as the space above a suspended ceiling. Joints and voids at intersections shall comply with Sections 707.8 and 707.9 of the 2012 IBC.

Fire Partitions:

Fire partitions subdivide areas within a building and can be attached to and supported by adjacent structural members.



Source: Warrington Certification Ltd

51

Fire partitions, which are covered in Section 708 of the 2012 IBC, subdivide areas within a building and can be attached to and supported by adjacent structural members. Fire partitions extend to the fire-resistant rated ceiling only and are constructed of less fire-resistive materials than fire barriers. However, they must also be built according to specifications certified by nationally recognized testing laboratories.

The terms barrier and partition are generally used interchangeably in the industry. However, there is a difference between the two structures. Fire partitions typically only have a 1 to 2-hour fire-resistance rating and can be terminated at the ceiling. In all other respects, they are in general similar to fire barriers.

708.1 General. The following wall assemblies shall comply with this section.

1. Walls separating *dwelling units* in the same building as required by Section 420.2.
2. Walls separating *sleeping units* in the same building as required by Section 420.2.
3. Walls separating tenant spaces in *covered and open mall buildings* as required by Section 402.4.2.1.
4. Corridor walls as required by Section 1018.1.
5. Elevator lobby separation as required by Section 713.14.1.

52

Section 708.1 of the 2012 IBC specifies the wall assembly types associated with fire partitions, which are listed on this slide and include dwellings and sleeping units, covered malls, corridor walls and elevator lobby walls.

708.4 Continuity. Fire partitions shall extend from the top of the foundation or floor/ceiling assembly below to the under-side of the floor or roof sheathing, slab or deck above or to the fire-resistance-rated floor/ceiling or roof/ceiling assembly above, and shall be securely attached thereto. In combustible construction where the fire partitions are not required to be continuous to the sheathing, deck or slab, the space between the ceiling and the sheathing, deck or slab above shall be fire-blocked or draft-stopped in accordance with Sections 718.2 and 718.3 at the partition line. The supporting construction shall be protected to afford the required fire-resistance rating of the wall supported, except for walls separating tenant spaces in covered and open mall buildings, walls separating dwelling units, walls separating sleeping units and corridor walls, in buildings of Type IIB, IIIB and VB construction.

53

Section 708.4 of the 2012 IBC specifies continuity requirements for Fire Partitions, which states that fire partitions must extend from the top of the foundation or floor/ceiling assembly to the underside of the floor or roof decking, or fire-resistance rated ceiling above. However, the space between the ceiling and the sheathing, deck or slab above shall be fire-blocked or draft-stopped in accordance with Sections 718.2 and 718.3 at the partition line.

Protection at Openings:

The biggest cause of firewall failure is unprotected or improperly protected openings at doorways, conveyors and other similar penetrations.



Source: NIST

54

The biggest cause of firewall failure is unprotected or improperly protected openings at doorways, conveyors and other similar penetrations. These types of openings in firewalls have resulted in the spread of some of the most destructive industrial fires in history. To maintain the integrity of a wall and to keep fires from spreading, the number and size of openings in a firewall should be minimized. In general, the total width of openings should not exceed more than 25% of the length of a firewall at each story, and should be constructed with the proper protection.

706.8 Openings. Each opening through a firewall shall be protected in accordance with Section 716.5 and shall not exceed 156 square feet. The aggregate width of openings at any floor level shall not exceed 25 percent of the length of the wall.

Exceptions:

1. Openings are not permitted in party walls constructed in accordance with Section 706.1.1.
2. Openings shall not be limited to 156 square feet where both buildings are equipped throughout with an automatic sprinkler system installed in accordance with Section 903.3.1.1.

55

Section 706.8 of the 2012 IBC also limits the size of opening in firewalls to 156 SF, which can be increased if automatic sprinkler systems are in use on both sides of the firewall.

In addition, as indicated before, openings are not allowed in party walls.

All openings in firewalls and fire barriers should be protected with equipment listed by the national testing laboratories.



Source: J.W. Murdoch & Sons

56

All openings in Firewalls, Fire Barriers and Fire Partitions should be protected with equipment listed by a national testing laboratory such as Underwriters Laboratories (UL). Examples of the proper types of components in a firewall opening include automatic fire doors, shutters or dampers, deluge sprinkler systems and fire-stop assemblies. Components of an opening should have a fire-resistance rating equal to or greater than the walls in which they are installed. Manually operated doors, windows, shutters or water curtains on the other hand are not acceptable means of protecting openings in firewalls or fire barriers.

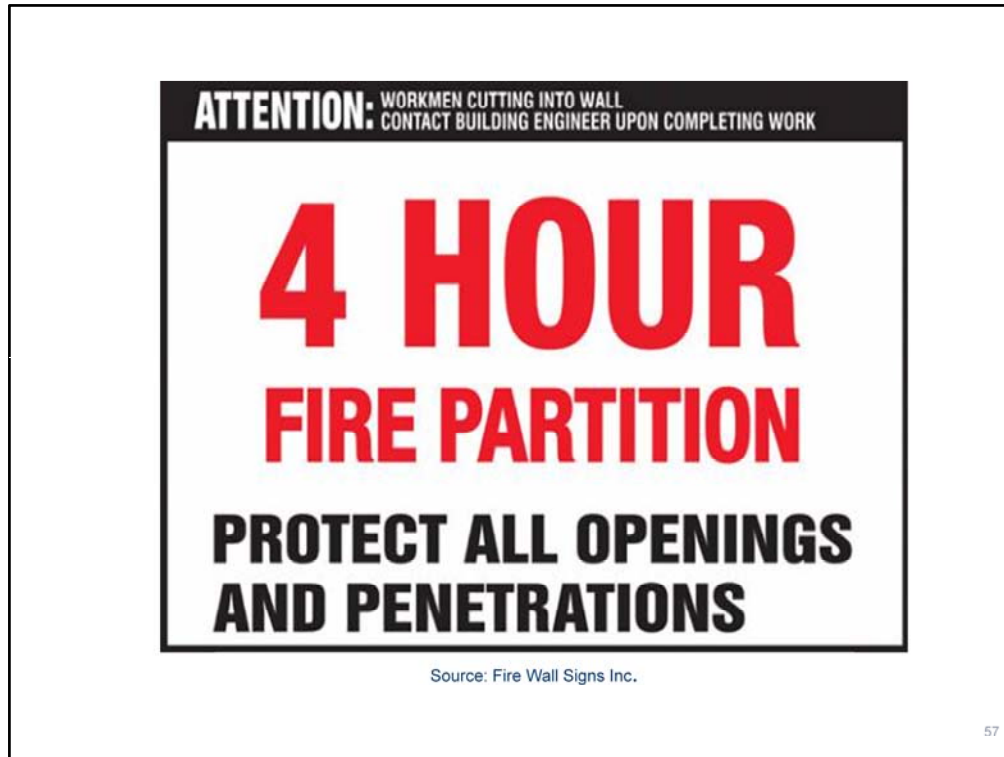

Per the 2012 IBC, Section 703.7, Firewalls, Fire Barriers and Fire Partitions with protected openings have to also be permanently identified with signs. The identification has to be:

- Located in accessible concealed floor, ceiling or attic spaces, and...
- Located within 15-feet of the ends of the wall and at intervals not exceeding 30-feet measured horizontally.

The purpose of the signage is to notify workers and inspectors that any new openings or penetrations must be protected per the requirements of the Code.

This slide includes an illustration of a Fire Partition sign.

Fire door assemblies should be listed by a nationally recognized laboratory.



Source: ACME Doorway Technical Services

58

Fire door assemblies should be listed by a nationally recognized laboratory. The listing should be based on tests performed in accordance with ASTM E152, UL10B or NFPA 252. These tests involve placing a sample of a fire door in a furnace and rating its endurance.

Traditionally, the limiting size on openings in fire -resistance-rated walls has been based on the maximum sizes identified in the fire door listings. The previous size limitation was 120 square feet due to the limitations of such listings. The 2012 IBC now allows for a maximum permitted size of an opening to be 156 square feet, based upon the current listing limitations of steel fire doors.

Fire doors should be simple, direct acting, and reliable. When selecting a design, be sure the product complies with the following:

1. Self-releasing features are incorporated into the design.
2. Sprinkler discharge will not impede operation of any fusible link on the fire door.
3. Conveyor belt objects will not prevent the fire door from closing.

59

Fire doors should be simple, direct acting, and reliable. When selecting a design, be sure the product complies with the following:

- 1. Self-releasing features are incorporated into the design of the track, chain supports and other components.**
- 2. Sprinkler discharge will not impede operation of any fusible link on the fire door. Typically a fusible link, which consists of two pieces of metal soldered together, is installed on a fire door, holding the door open. When the ambient temperature in the area reaches a certain level, the solder melts allowing the door to close. We will discuss closing mechanisms in more detail on Slide 64.**
- 3. If a conveyor belt carries objects through an opening protected by a fire door, counterweights, springs and other components must be designed with enough strength to push the materials on the conveyor belt out of the way, allowing the fire door to close**

Per the NFPA, fire doors are rated at 4, 3, 1½ and 1-hours, as well as 45, 30 and 20 minutes.



60

Per the NFPA; fire doors are rated at 4, 3, 1½ and 1-hours, as well as 45, 30 and 20 minutes. Fire doors are also rated at levels that indicate the maximum temperature that can be transmitted to the unexposed side after 30 minutes. Three levels of temperatures are typically provided for this type of rating and include; up to 250, 450 and 650 degrees Fahrenheit.

The lower the temperature rating, the more protection the door provides, since it conveys less heat than a door with a higher temperature rating. For example, a fire door with a temperature transfer level higher than 250 degrees Fahrenheit may allow sufficient heat from one side to pass through enabling the ignition of combustible materials located on the other side of the door.

- Types of fire doors include; swinging, horizontally sliding, vertically sliding and rolling.
- Rolling doors are overhead metal doors that unroll downward to close.
- Booklets are available from the testing laboratories, which provide recommendations of specific hardware to be used with different types of doors.
- Fire doors used for egress must be designed and installed in accordance with the requirements of the NFPA Life Safety Code.

61

Types of fire doors include; swinging, horizontally sliding, vertically sliding and rolling. Rolling doors are overhead metal doors that unroll downward to close. A door should be chosen depending upon how it will be used and what operational clearances it will require. Door hardware is a critical part of the fire door. A door that does not operate properly in an emergency is as useless as no door at all.

Information is available from the testing laboratories, which provides recommendations of specific hardware to be used with different types of doors. The hardware should be installed according to manufacturers' specifications.

Fire doors used for egress must be designed and installed in accordance with the requirements of the NFPA. Single-personnel doors (i.e., doors that allow only one person at a time to pass) should not be larger than 3'-0" x 7'-0". Fire resistant glass is allowed in ½-hour rated fire doors. Fire doors should be provided in all openings in firewalls, fire barriers and fire partitions. Protective devices such as bumpers, guards or bollards should be installed to prevent vehicular traffic from damaging the doors and their mechanisms and extend at least 60-inches above the finished floor level.

716.5 Fire door and shutter assemblies. Approved fire door and fire shutter assemblies shall be constructed of any material or assembly of component materials that conforms to the test requirements of Section 716.5.1, 716.5.2 or 716.5.3 and the fire protection rating indicated in Table 716.5. Fire door frames with transom lights, sidelights or both shall be permitted in accordance with Section 716.5.6. Fire door assemblies and shutters shall be installed in accordance with the provisions of this section and NFPA 80.

Exceptions:

1. Labeled protective assemblies that conform to the requirements of this section or UL 10A, UL 14B and UL 14C for tin-clad fire door assemblies.
2. Floor fire door assemblies in accordance with Section 711.8.

62

Section 716.5 of the 2012 specifies fire door and shutter assembly requirements and the applicable exceptions, which are listed on this slide.

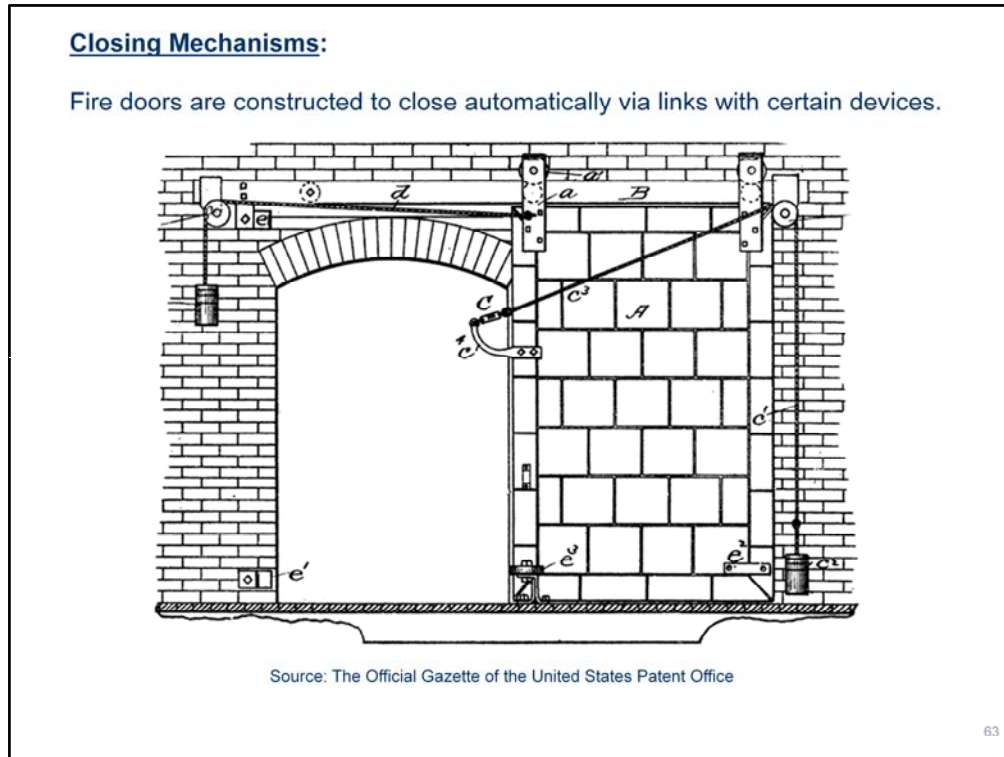

Fire doors are constructed to close automatically via links with certain devices. The most common such device is the heat-sensitive fusible link. A fusible link is installed over a door opening and at the ceiling on both sides of the wall. When activated, the link releases a latch, which in turn releases the door or the counterweights that trigger the operation of the door.

Another device is the fire detector. Fire detectors are located on each side of the wall, either over the opening or at the ceiling. When activated the detector releases the door or a set of weights that triggers the operation of the door.

A third device is a fire-suppression system. This can be a sprinkler system, water-flow alarm, carbon dioxide system or foam system. When the system is activated, it automatically releases the fire door.

This slide illustrates a very early version of an automatic closing system.

716.5.9 Door closing. Fire doors shall be self or automatic closing in accordance with this section. Self-closing chute intake doors shall not fail in a "door open" position in the event of a closer failure.

Exceptions:

1. Fire doors located in common walls separating sleeping units in Group R-1 shall be permitted with-out automatic or self-closing devices.
2. The elevator car doors and the associated hoistway enclosure doors at the floor level designated for recall in accordance with Section 3003.2 shall be permitted to remain open during Phase I emergency recall operation.

716.5.9.1 Latch required. Unless otherwise specifically per-mitted, single fire doors and both leaves of pairs of side-hinged swinging fire doors shall be provided with an active latch bolt that will secure the door when it is closed.

716.5.9.2 Automatic-closing fire door assemblies. Auto-matic-closing fire door assemblies shall be self-closing in accordance with NFPA 80.

64

Section 715.5.9 of the 2012 IBC specifies fire door closing requirements and the applicable exceptions, which are listed on this slide.

This slide also includes the subsequent sections that deal with latches and automatic closing assemblies.

Through Wall Penetration Protection:

In firewalls, fire barriers and fire partitions, "through wall penetrations" allow passage of cables, ducts, pipes and conduits.

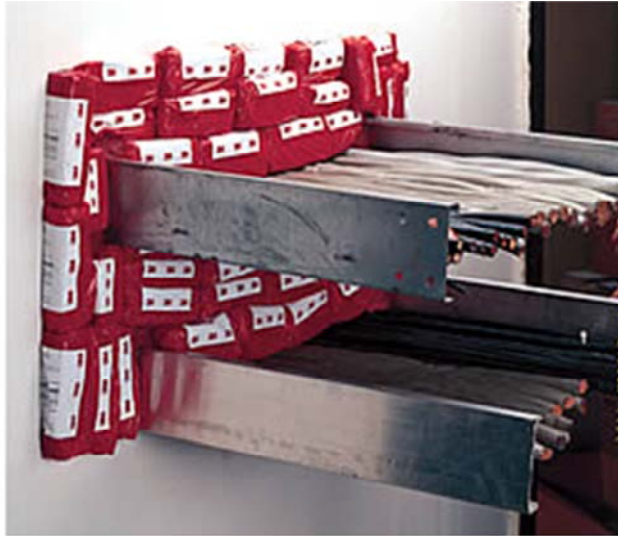

Source: Fire Protection Supplies

65

In firewalls, fire barriers and fire partitions, "through wall penetrations" that allow passage of cables, ducts, pipes and conduits also present problems. These types of openings should be sealed with noncombustible material having a fire-resistance rating equal to that of the wall.

If an opening is no longer required, it should be permanently sealed.

It is also necessary to include through wall penetrations when calculating if the total width of all openings in a firewall is within the 25% limitation required by Section 706.8 of the 2012 IBC.

- Ducts should be made of noncombustible materials and be constructed with automatically activated fire dampers where they pass through firewalls, fire barriers and fire partitions
- A fire damper is a mechanism, placed in a duct that closes off the duct when the temperature reaches a certain level. Improperly designed ducts can cause problems.

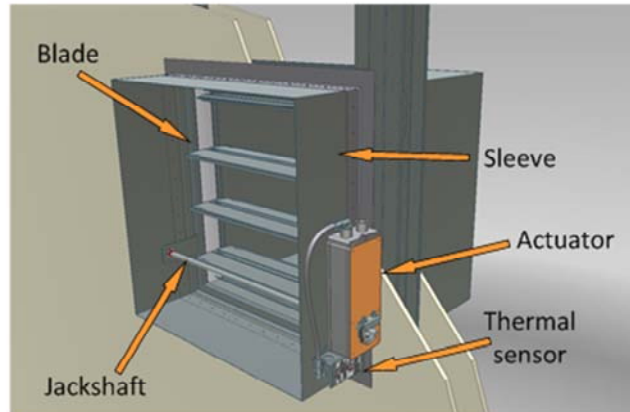

Source: Belimo Air Controls (USA) Inc.
Courtesy of Ruskin Company

66

Ducts that penetrate a firewall should be made of noncombustible materials and be constructed with automatically activated fire dampers where they pass through a firewall, fire barrier or fire partition. A fire damper is a mechanism, placed in a duct that closes off the duct when the temperature reaches a certain level.

Per NFPA 221 Section 4.4.2.1, fire dampers are required to be designed and tested in accordance with UL 555 (Standard for Safety of Fire Dampers) and shall have a minimum fire protection rating as specified in Table 4.4.2.1

Improperly designed ducts can cause problems. For example, during a fire, the structure can collapse, exerting pressure on a duct. If the duct is not designed to break free from the firewall, it can exert excessive pressure on the wall, enlarging the penetration and thereby allowing the fire to breach the wall. To avoid this scenario ducts, piping conduits and cable trays if possible should be installed around a wall.

This slide illustrates a combination fire and smoke damper.

Summary:

Ratings of Standard Firewalls, Firewalls, Barriers and Partitions		
Type of Construction	Rating	Configuration
Standard Firewall	4-hour minimum with no openings.	Parapet extends above the roof with wing walls, end walls or extensions.
Firewall	3 to 4-hour with protected openings.	Parapet extends above the roof with wing walls, end walls or extensions.
Fire Barrier	2 to 3-hour with protected openings.	Wall extends from floor to beneath roof or floor deck above.
Fire Partition	1 to 2-hour with protected openings.	Wall extends from floor to ceiling.

67

So in summary, there are four types of walls that help mitigate the spread of fires and protect building occupants. These walls include standard firewalls, firewalls, fire barriers and fire partitions. A standard firewall must provide a minimum fire resistance rating of 4-hours and cannot include openings. A firewall can include openings and must provide a minimum fire resistance rating of either 3 or 4-hours. Fire barriers and fire partitions typically provide a minimum of 2 to 3-hours and 1 to 2-hours of fire resistance rating, respectively.

In addition, openings in firewalls must also be constructed to satisfy the same minimum fire resistance rating as the wall in which they are located. Wall penetrations likewise must also provide a fire rating equal to or greater than the effected wall. Closing mechanisms for both protected wall openings and penetrations must be carefully scrutinized in order to ensure that the equipment intended to prevent the breach of the firewall at the opening or penetration functions properly.

Related Links:

For additional technical information related to this webinar, please visit the following websites or web pages:

NFPA Codes and Standards:

<http://www.nfpa.org/>

Underwriters Laboratories:

<http://www.ul.com/global/eng/pages/>

FM Global:

<https://www.fmglobal.com/>

68

For additional technical information related to this webinar, you can visit the following websites.