



MATH WITHOUT WORDS

Purely Visual Puzzles to Confound and Delight



James Tanton



A FEW BRIEF INFORMAL WORDS(!!)

MATH WITHOUT WORDS is a collection of 75 immediately accessible, but deeply mathematical, puzzles all designed to offer true joy in thinking mathematically in creative, innovative and surprising ways. Not a single word is written. These puzzles are universal: they transcend the barriers of language and culture, literally, and are thereby accessible to all people on this globe. Moreover, the puzzles themselves speak to a universal truth of mathematics.

Many of these puzzles are hard and they are not intended to be solved in one sitting. (And sometimes the bulk of the challenge is figuring out what is being asked!) The idea is to sit with a puzzle or two over a number of days and wait for a moment of inspiration or insight to arrive. That is the true mathematical experience. Mathematicians call such flashes of understanding *aha moments* and recognize that they cannot be called upon within minutes, or even hours, or even days. (Mathematicians don't believe that timed tests reflect the mathematical experience.) Moments of insight will come on their own accord and there is nothing to be done but let them take their time. There is never need for a rush in doing true mathematics!

For this reason each puzzle should be mulled upon for quite some while. This book is designed to carry interest for many weeks, not just hours. Perhaps pull out a particular puzzle page and hang it as a poster on the wall. Let it become part of your subconscious. It's surprising how fruitful indirect mulling can be!

Some puzzles are relatively easy to answer, while others are quite deep. Some connect to current research problems in mathematics. Any relevant insight garnered with a particular puzzle should be deemed a success, even if it does not solve the challenge completely. (But for those that are looking for confirmation or guidance with any particular puzzle, brief answers appear at the back of the book.)

Mathematics can be compelling and frustrating, enlightening and humbling, but most of all it should forever be joyful. So on that note ... Enjoy!



MATH WITHOUT WORDS: 1

A large rectangular frame containing several geometric puzzles. At the top left is a grey maze with a black dot and a white dot. To its right is a grey curved shape with a black dot and a white dot. Further right is a grey complex maze with a black dot and a white dot. Below these are three small dots: a black dot, a white dot, and a black dot. In the center is a square maze with a black dot and a white dot. At the bottom is a large, complex white maze with a black dot and a white dot.

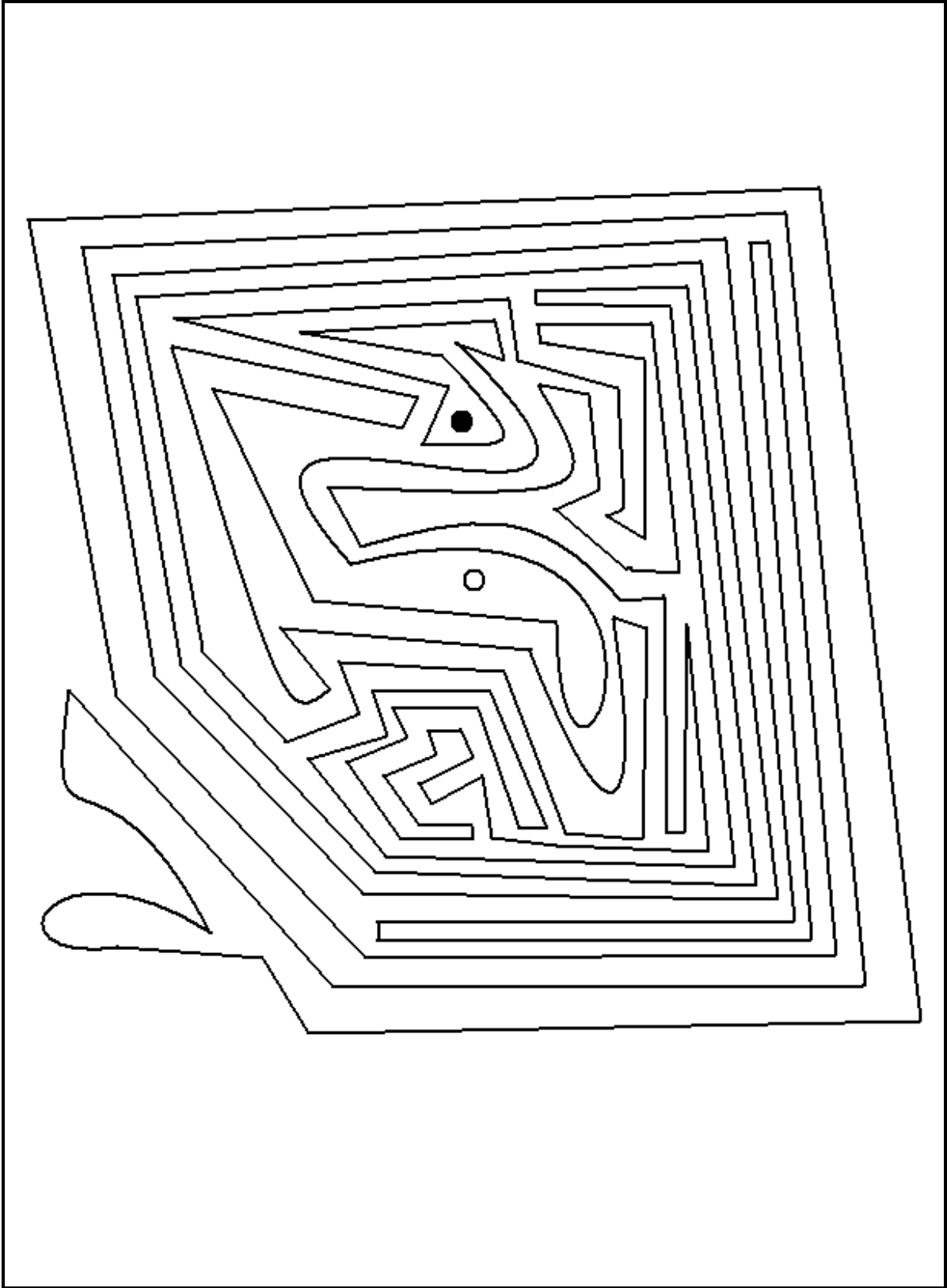



MATH WITHOUT WORDS: 2

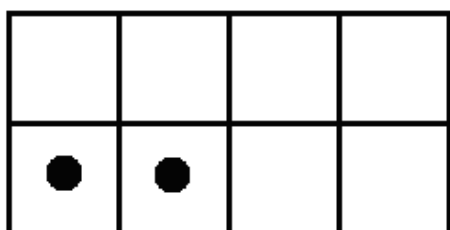
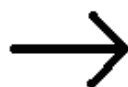
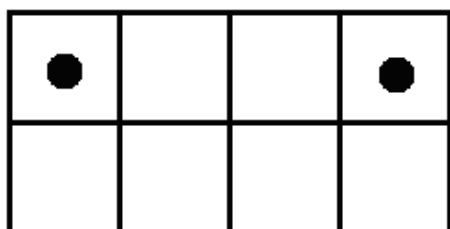
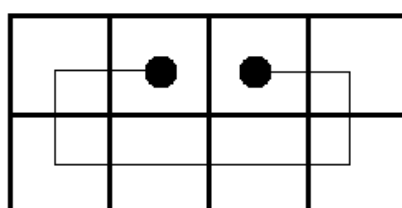
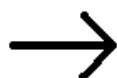
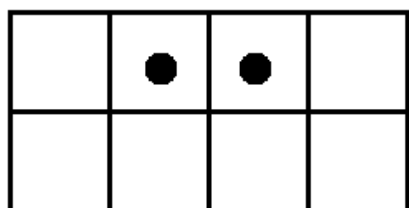
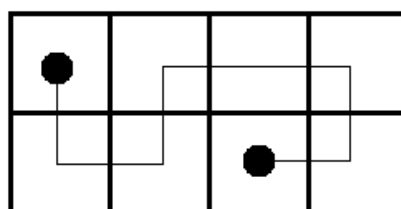
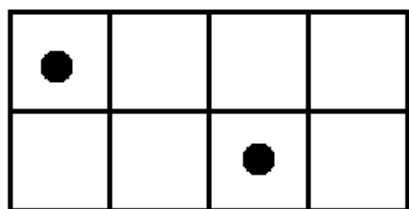

| | | | |
|--|---|--|---|
| | ● | | ● |
| | | | |

| | | |
|---|--|---|
| ● | | |
| | | |
| | | ● |

| | | |
|--|--|---|
| | | ● |
| | | |
| | | ● |

| | | |
|---|---|--|
| | | |
| | ● | |
| ● | | |

| | | |
|---|--|--|
| ● | | |
| ● | | |
| | | |



MATH WITHOUT WORDS: 3

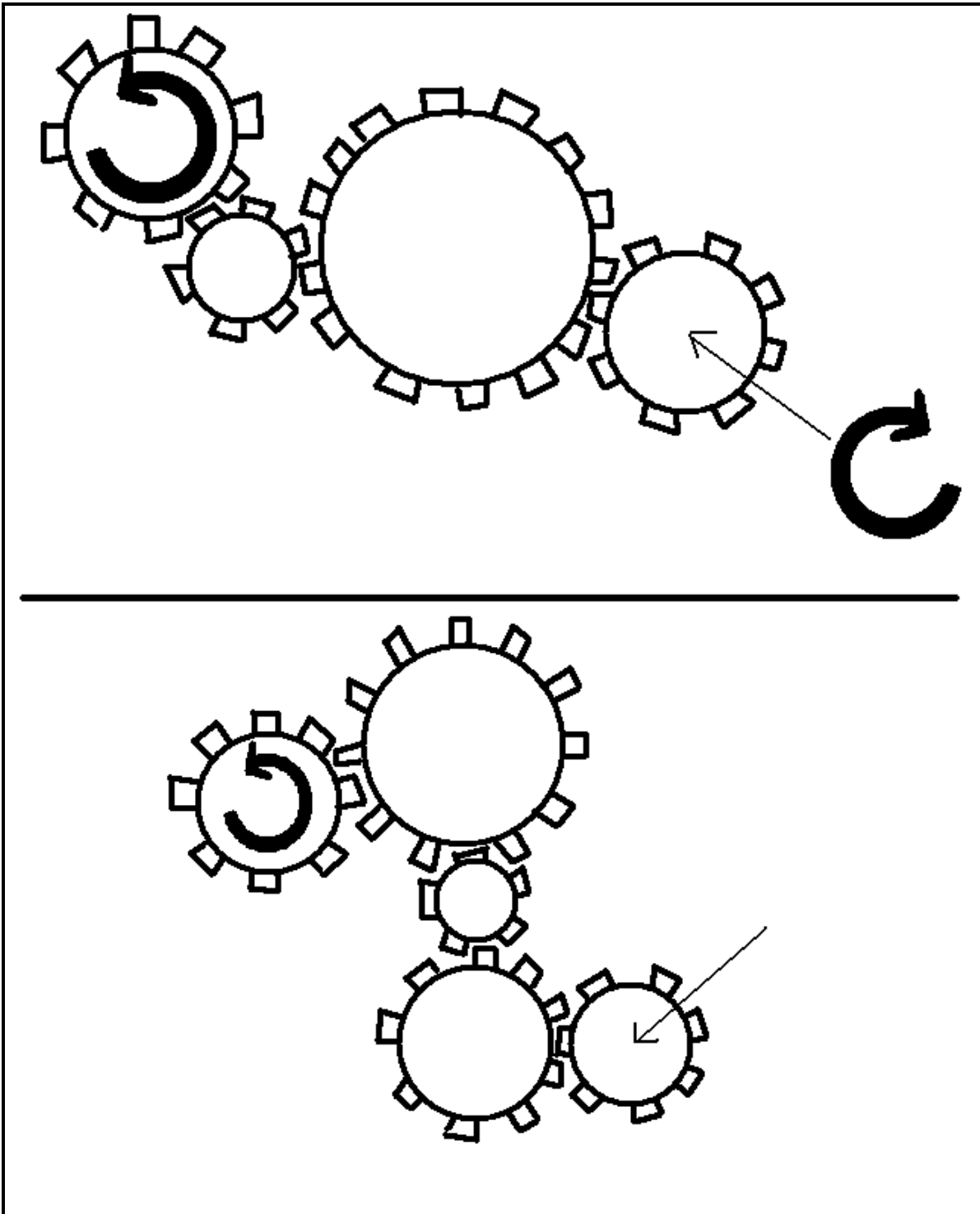

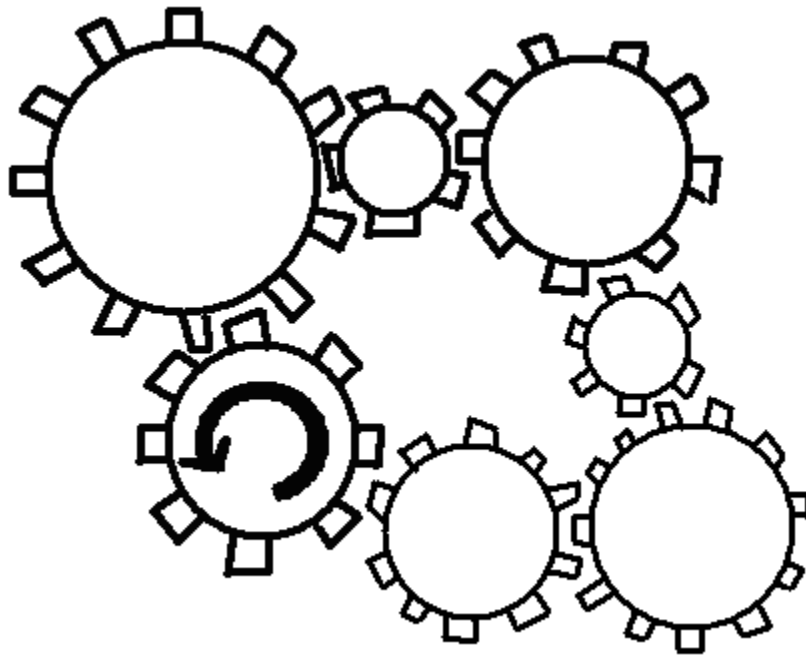



★ MATH WITHOUT WORDS: 4

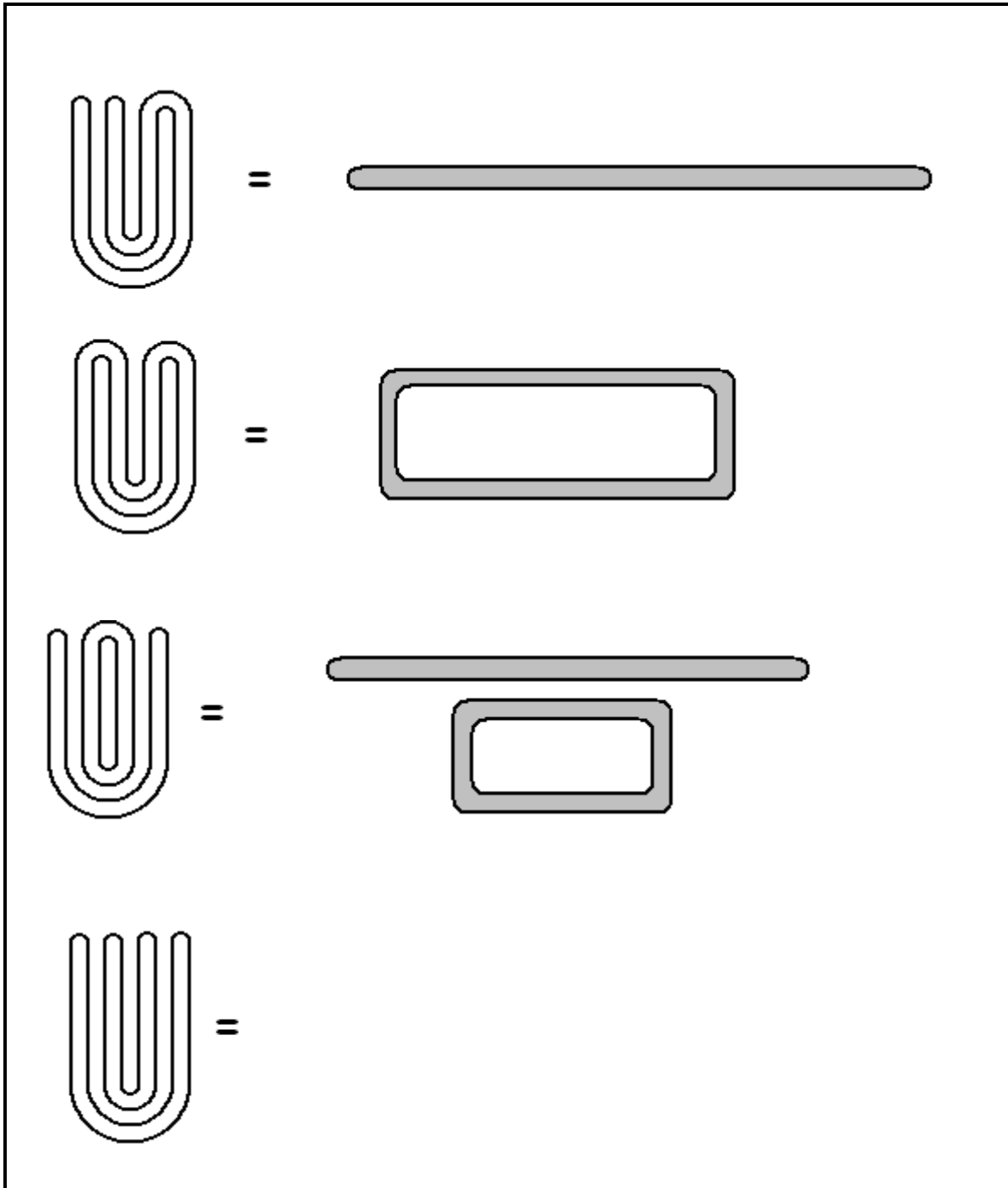

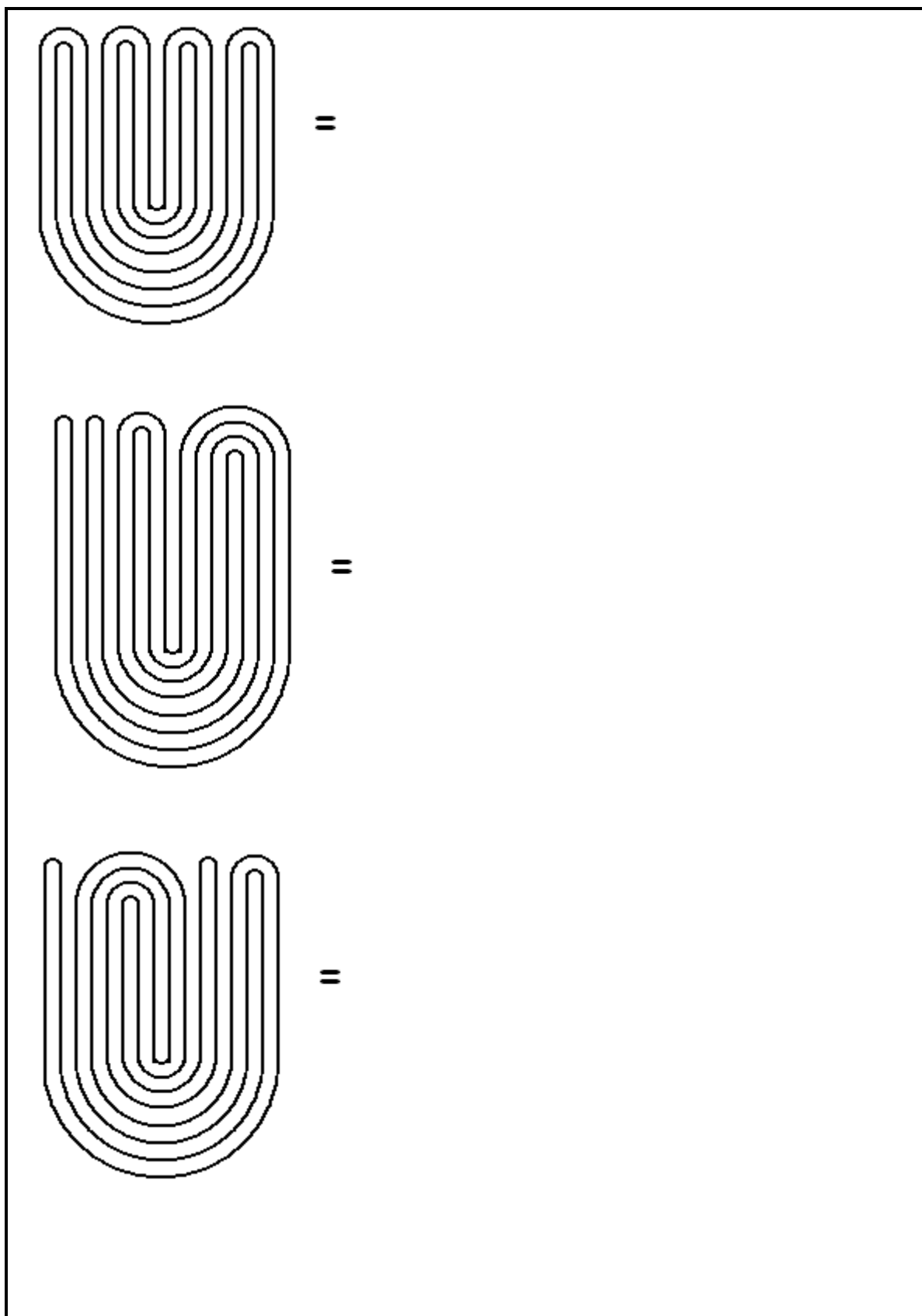

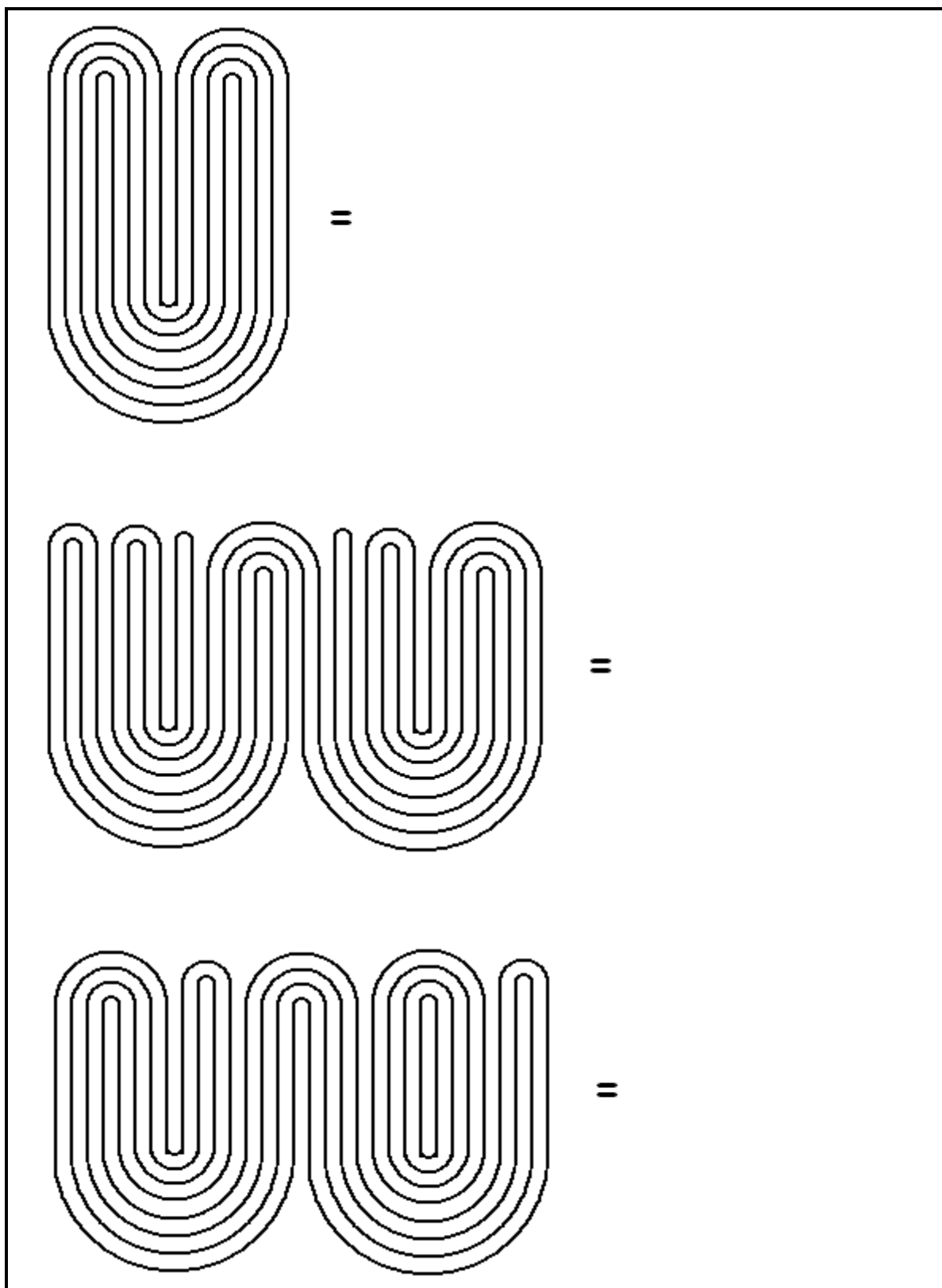



MATH WITHOUT WORDS: 5

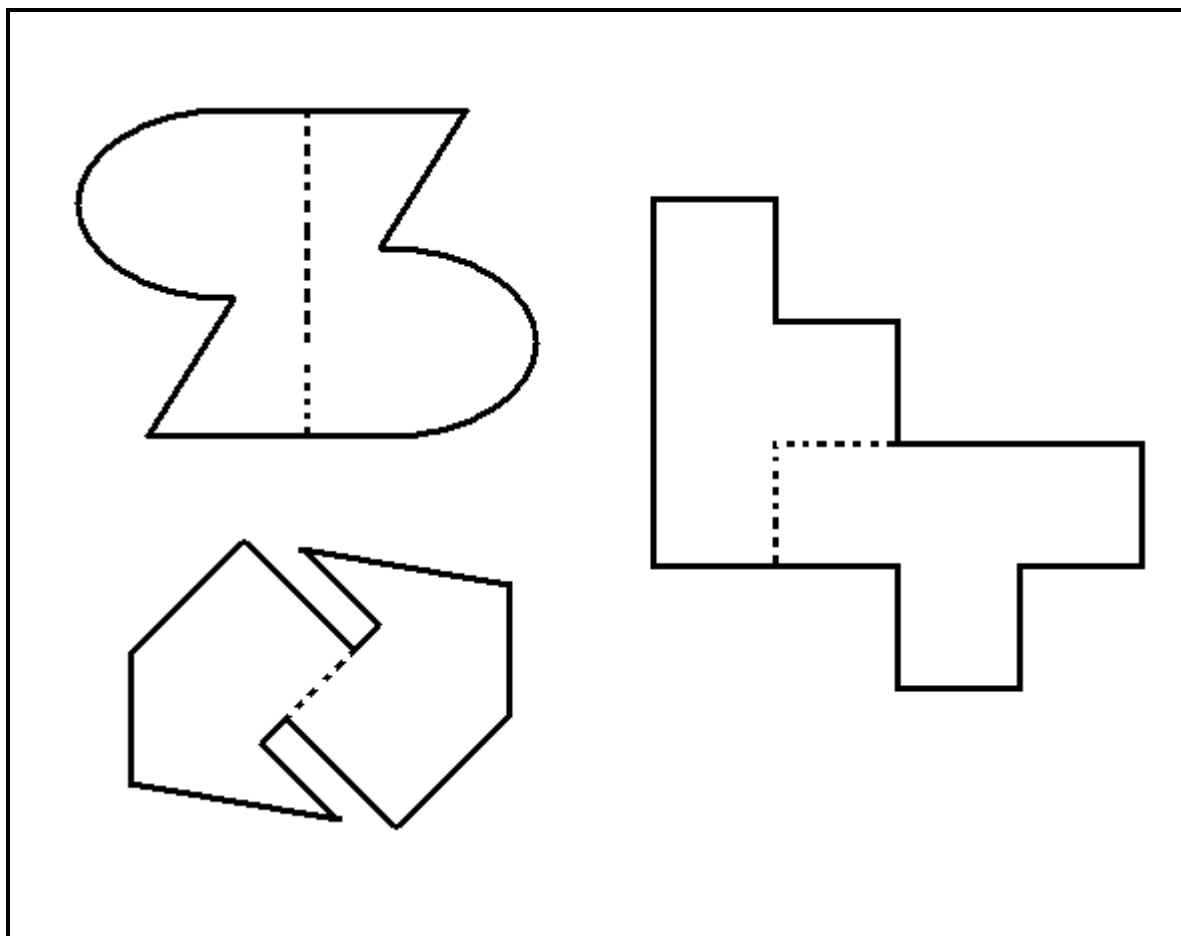

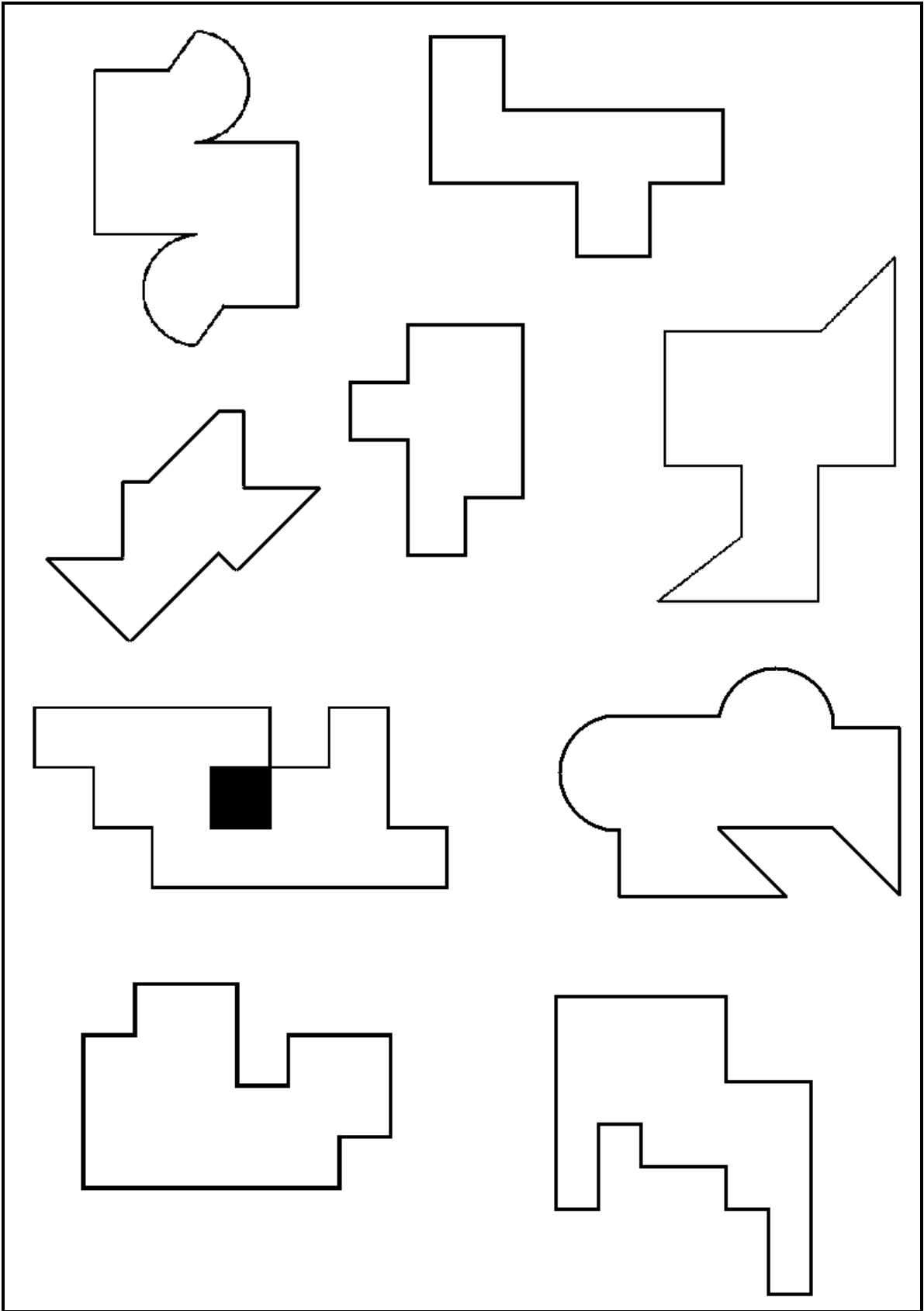



MATH WITHOUT WORDS: 6

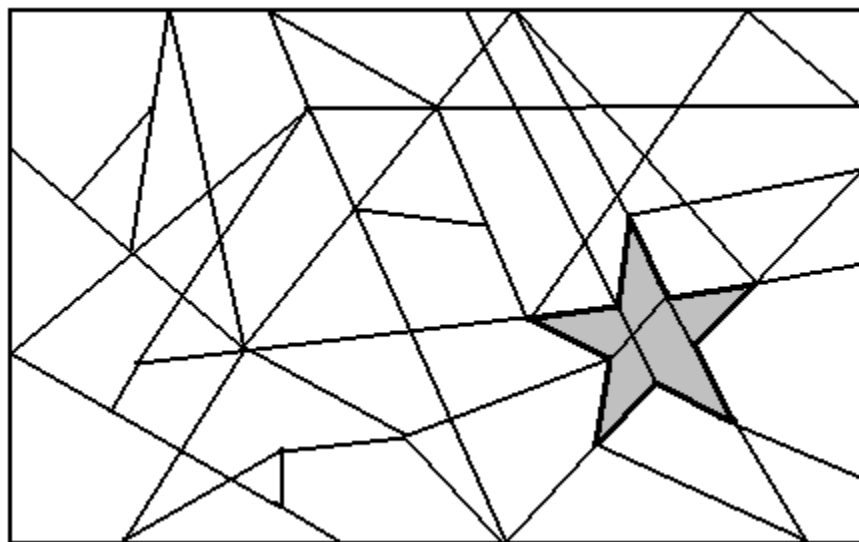

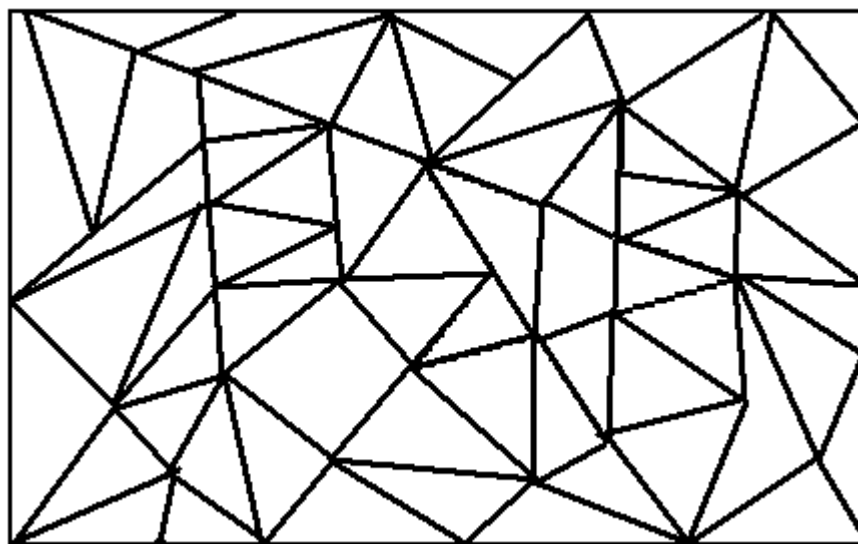
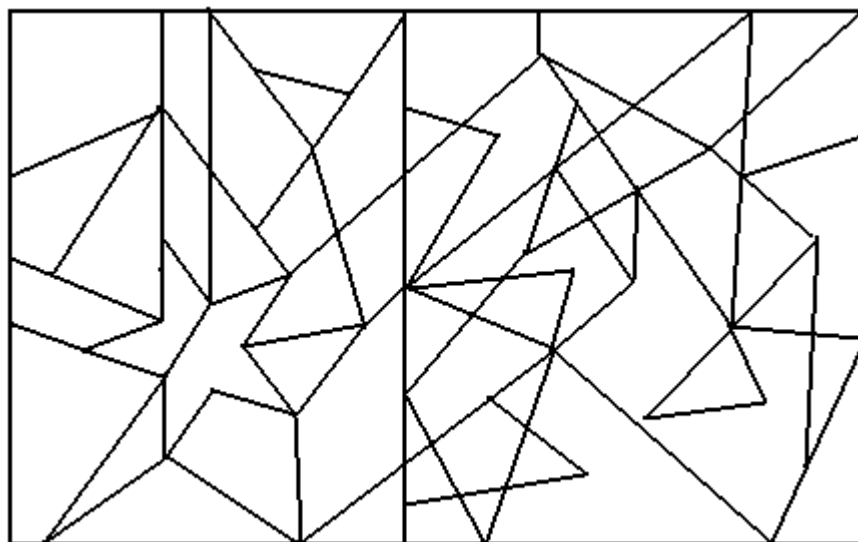

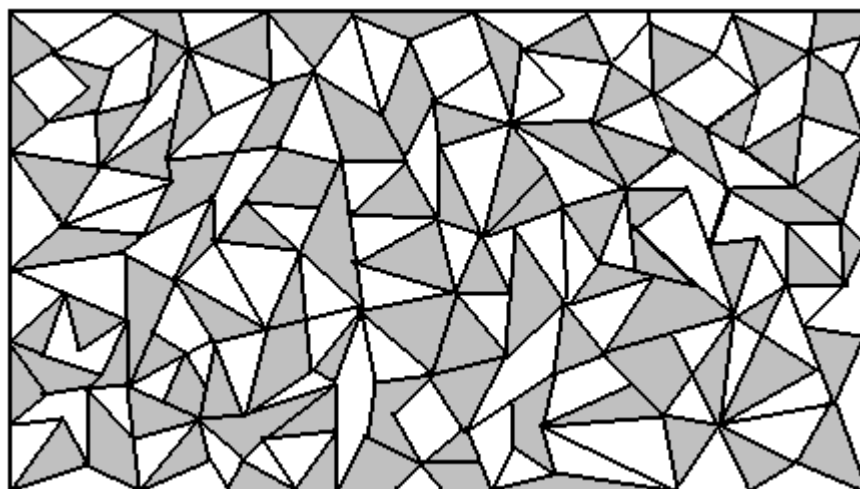
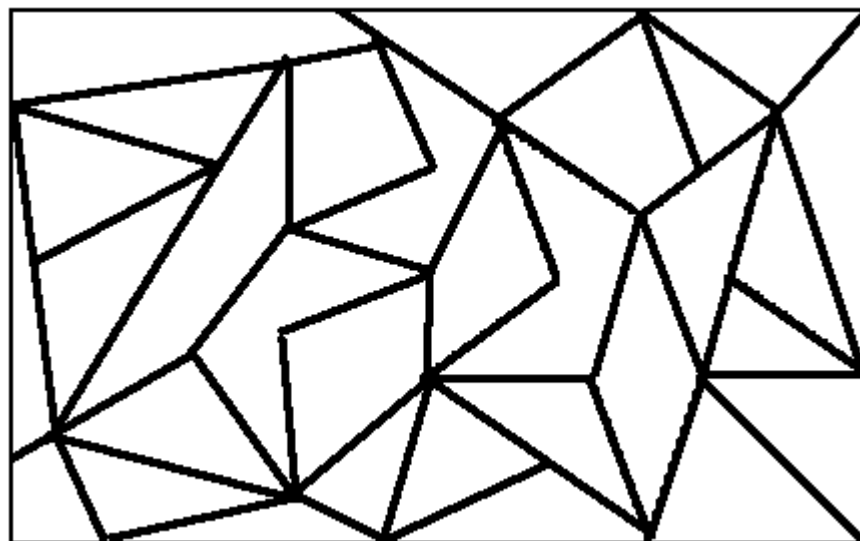



MATH WITHOUT WORDS: 7

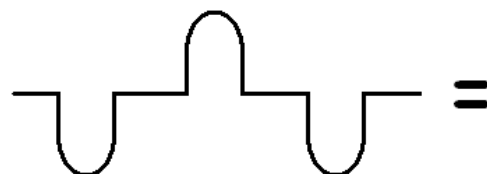
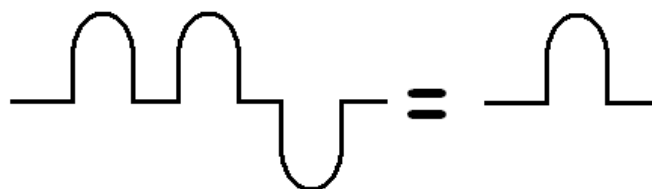
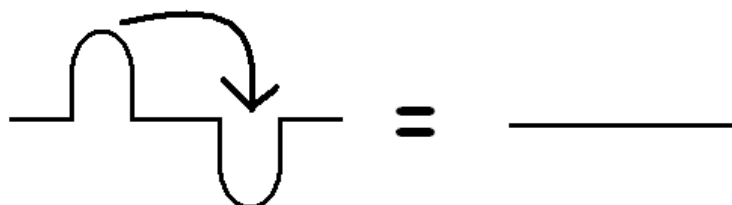

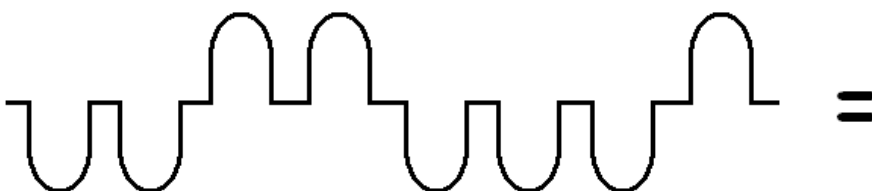
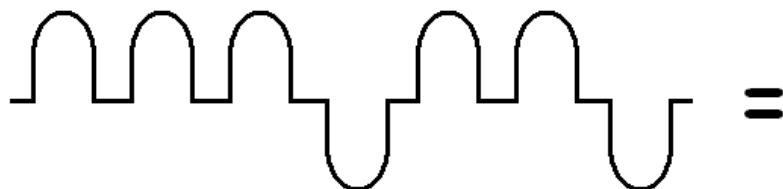
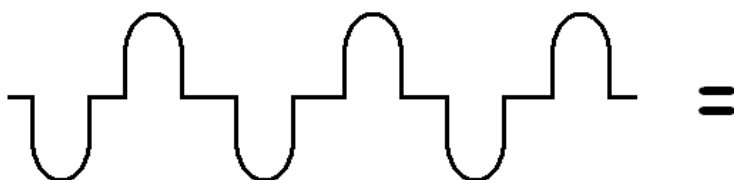
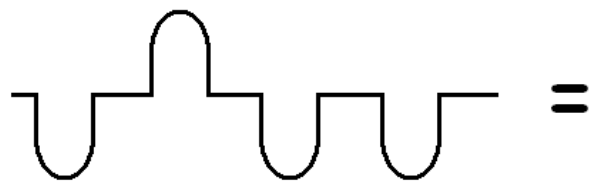



MATH WITHOUT WORDS: 8

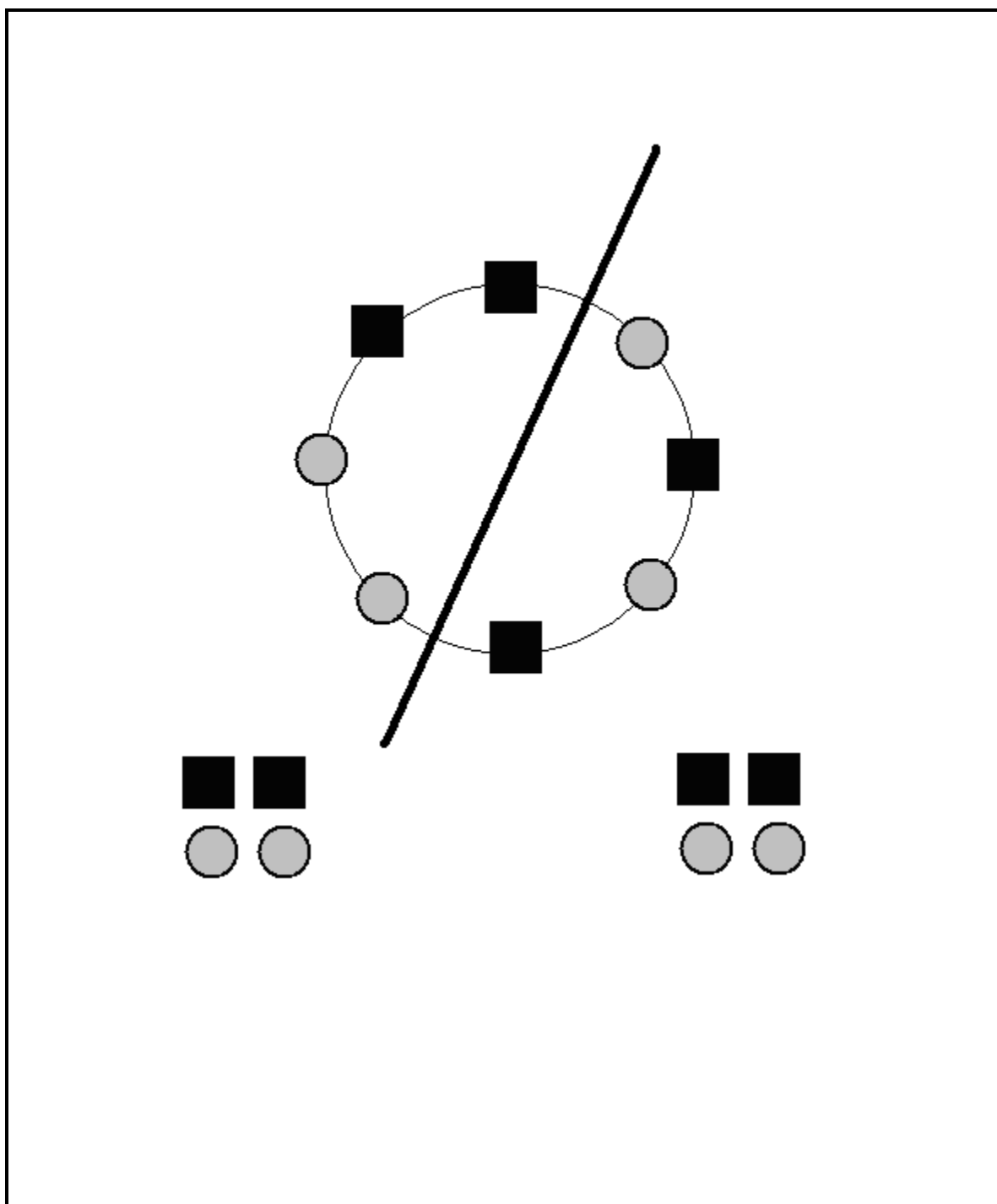

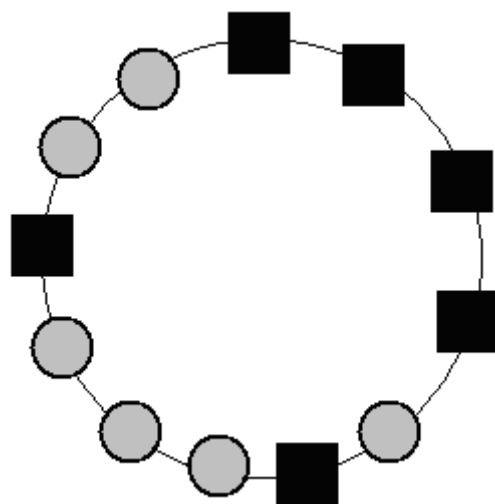
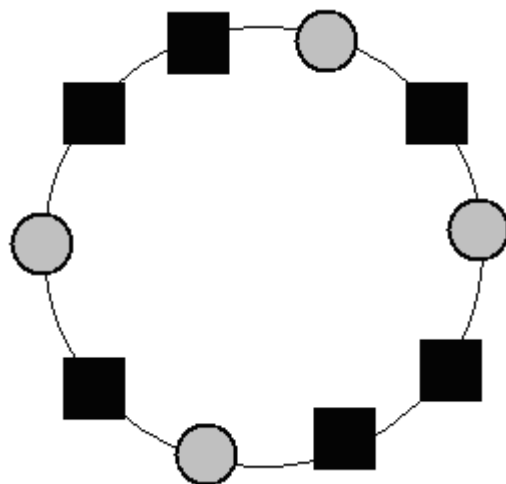

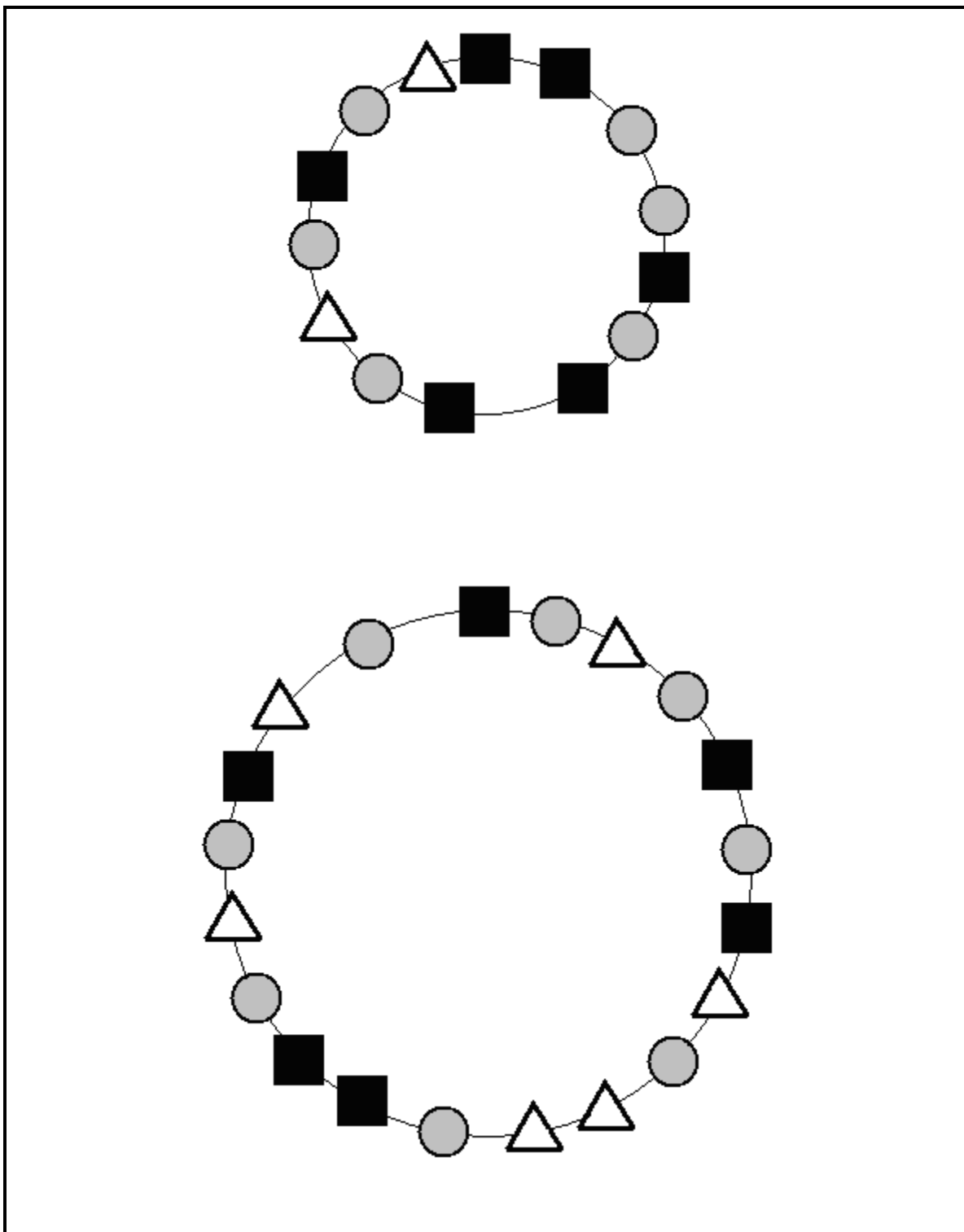



MATH WITHOUT WORDS: 9

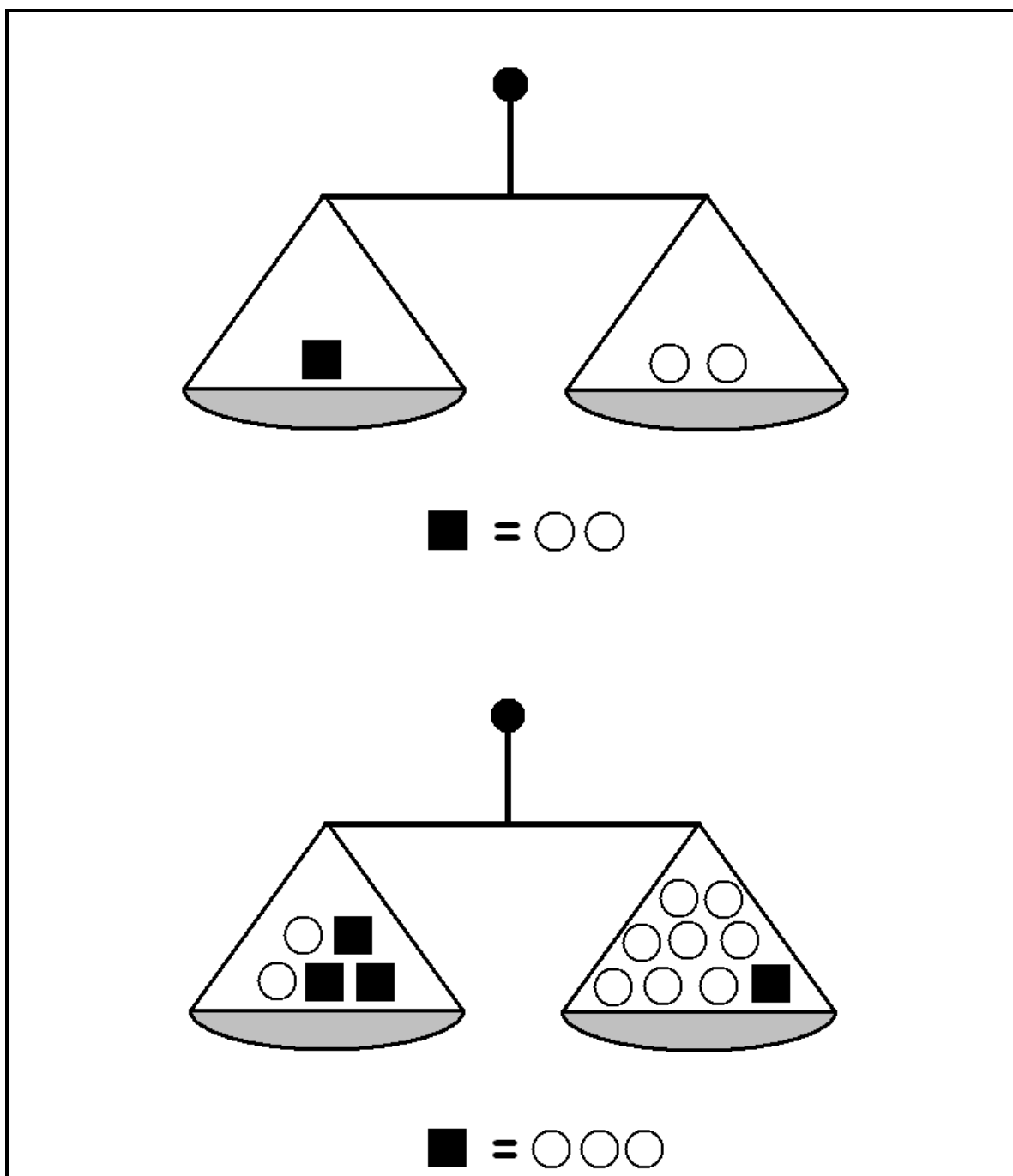

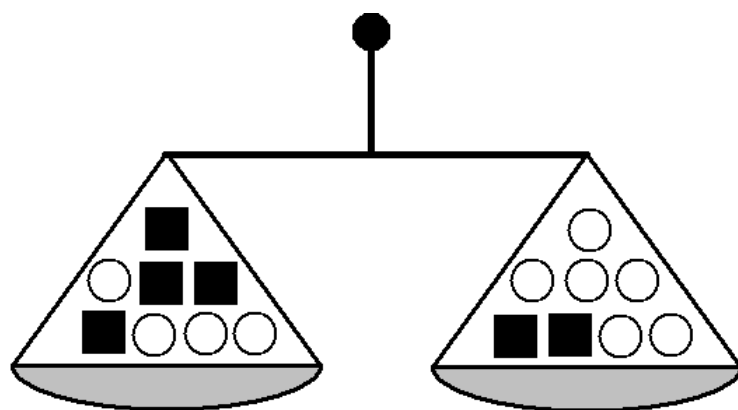

$$\blacksquare =$$

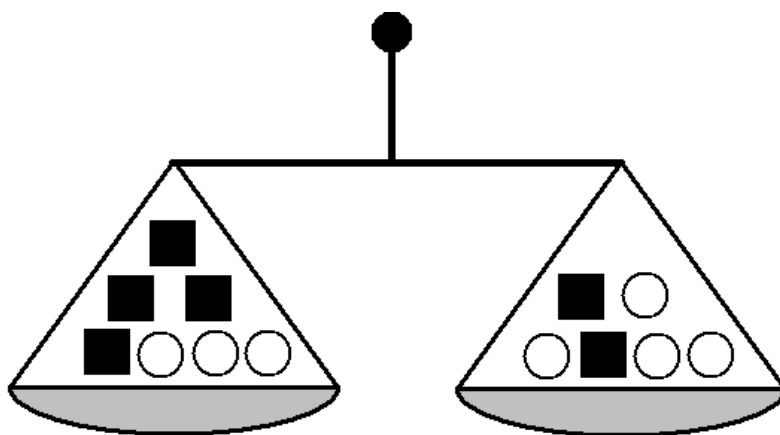

$$\blacksquare =$$

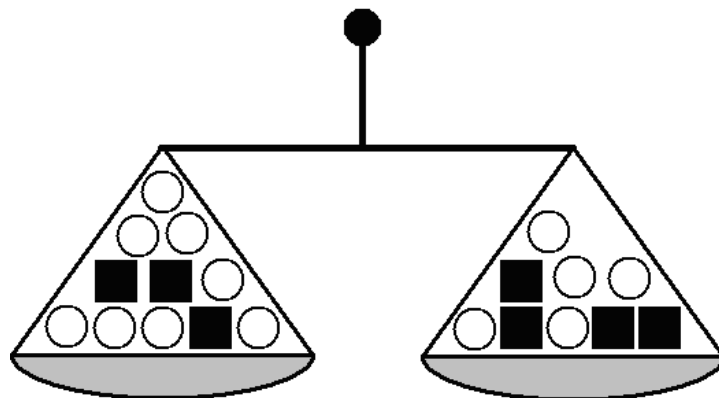

$$\blacksquare = \bigcirc$$

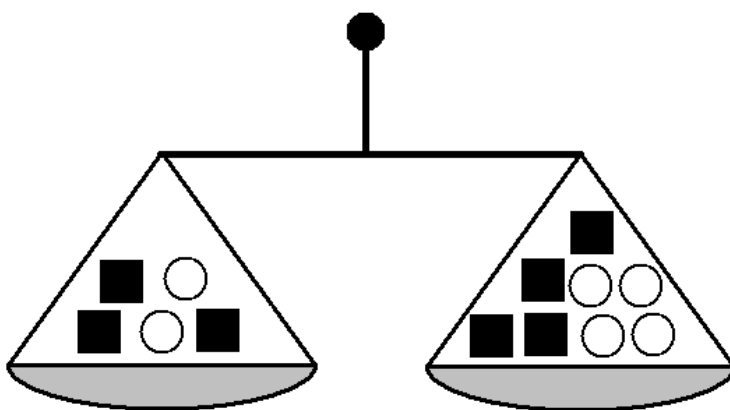

$$\blacksquare = \bigcirc$$



MATH WITHOUT WORDS: 10

| | | | | |
|---|---|--|--|----------|
|  | | | | |
| ○ | → | ○ ● | | 2 |
| | | | | |
| ○○ | → | ●○ ○● ○○ | | 3 |
| | | | | |
| ○○○ | → | ○○● ●○○ ●○○ ○●○ ○○○ | | 5 |
| | | | | |
| ○○○○ | → | ○○○● ○○●○ ○●○○ ●○○○ ●○●○ ●○○● ○●○● ○○○○ | | 8 |

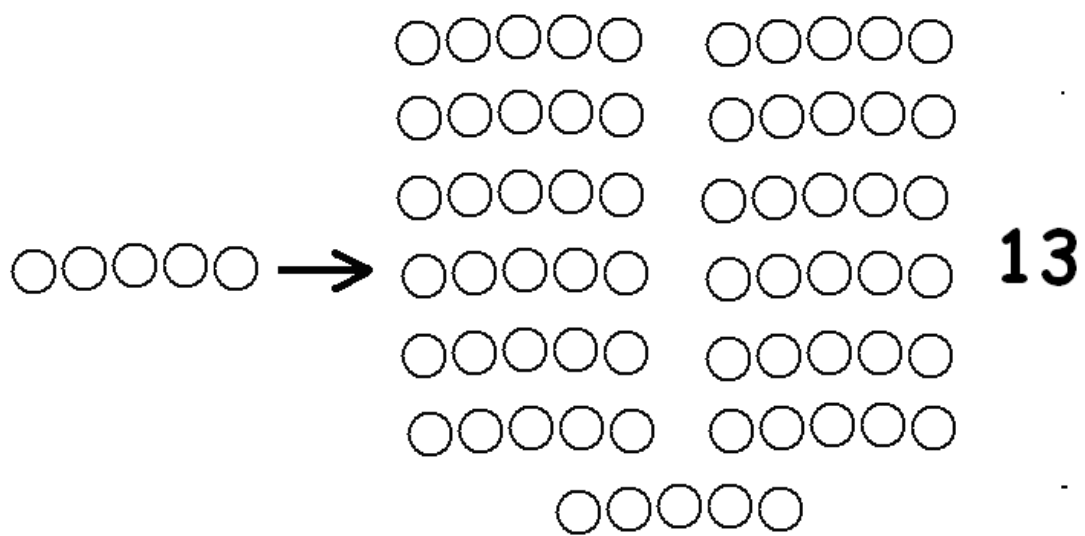



MATH WITHOUT WORDS: 11

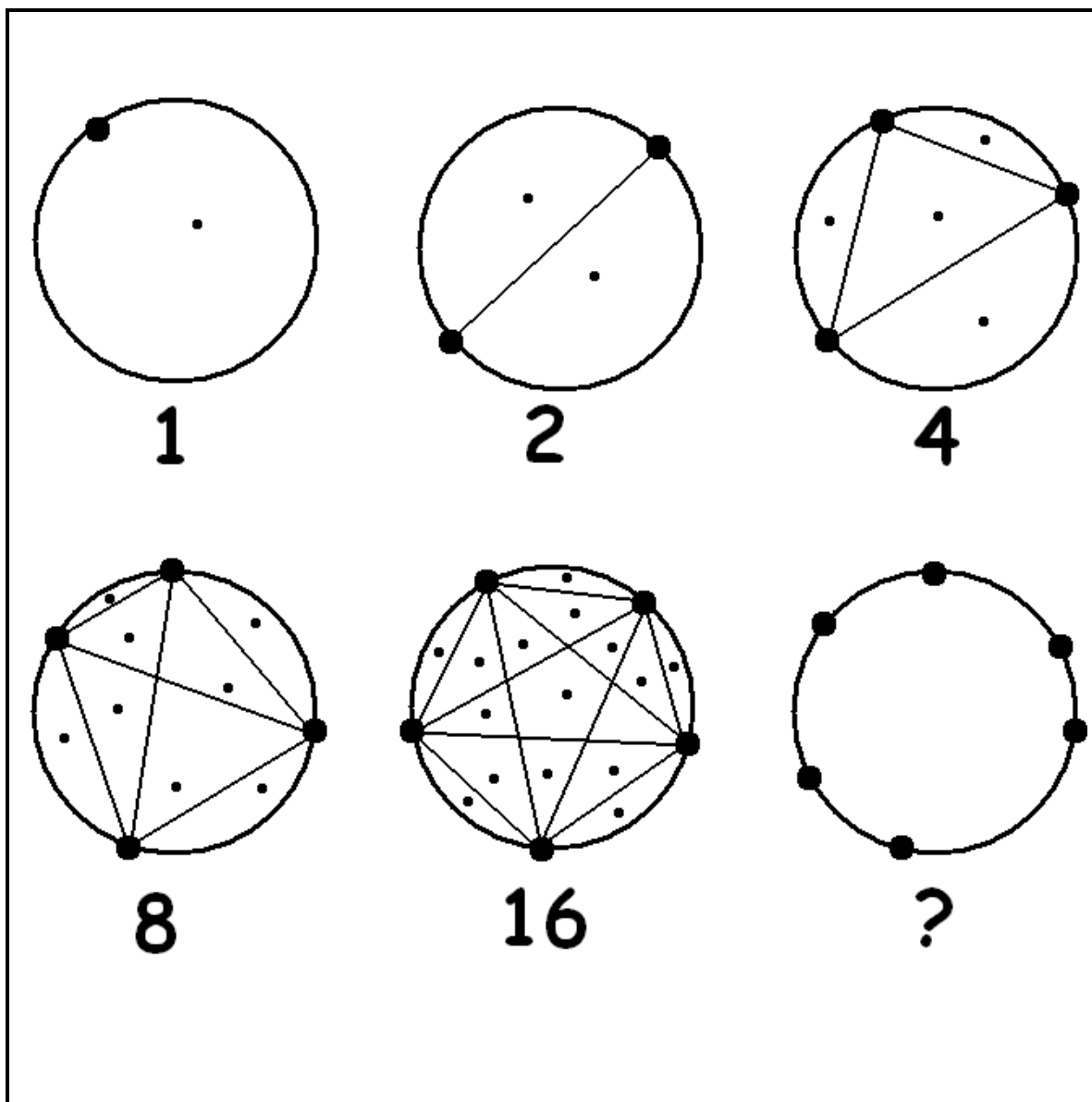



MATH WITHOUT WORDS: 12

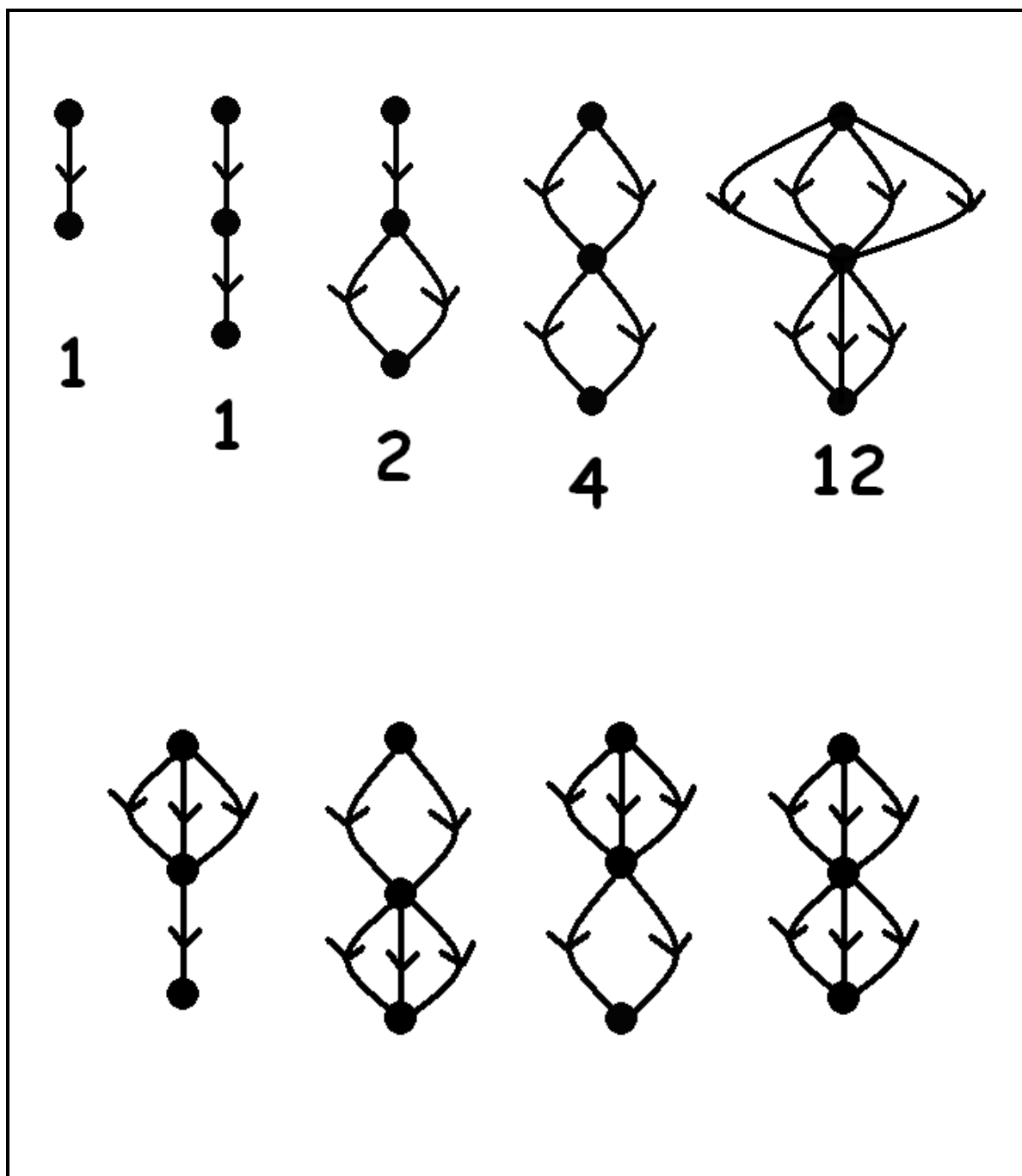

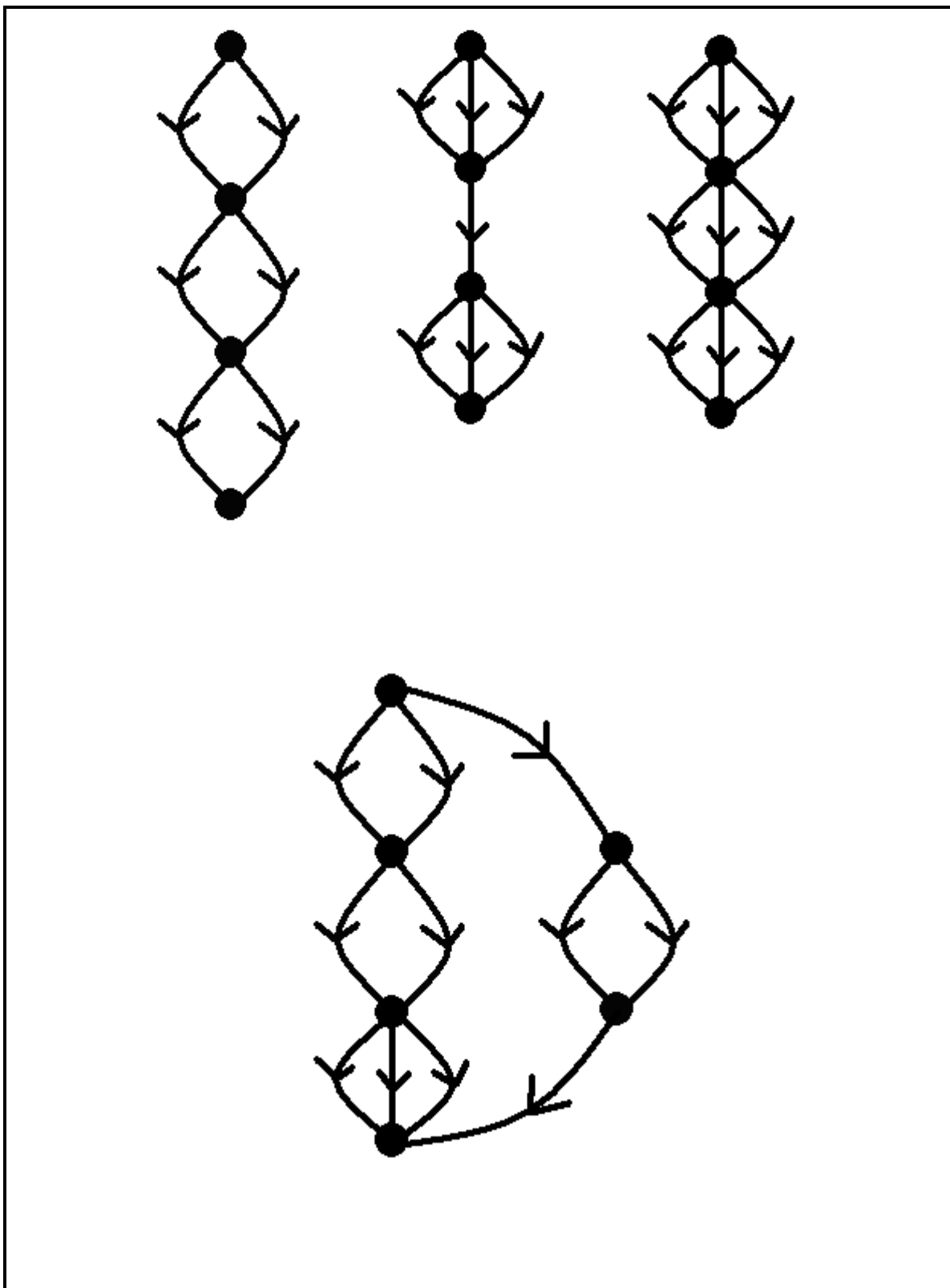



MATH WITHOUT WORDS: 13

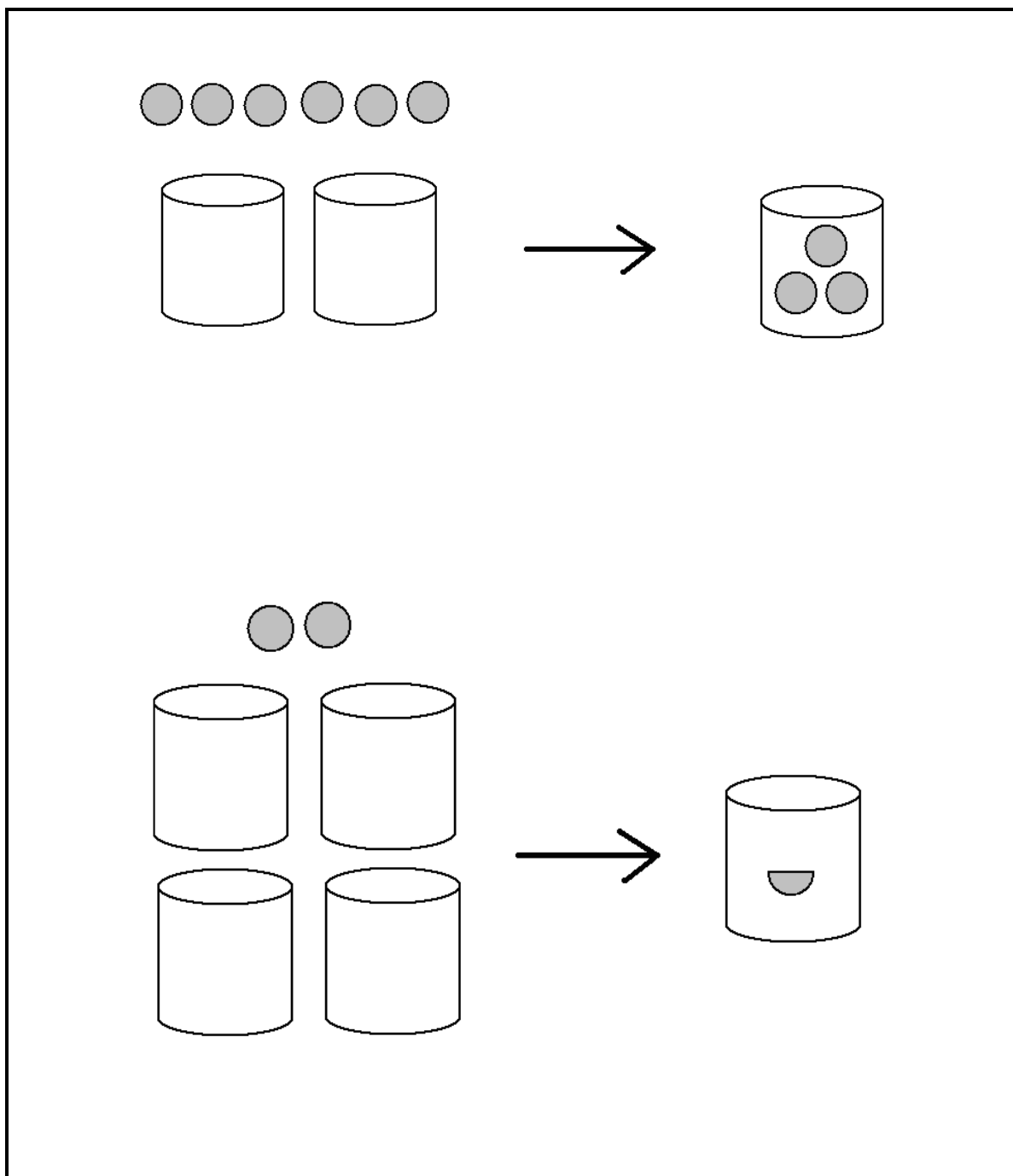

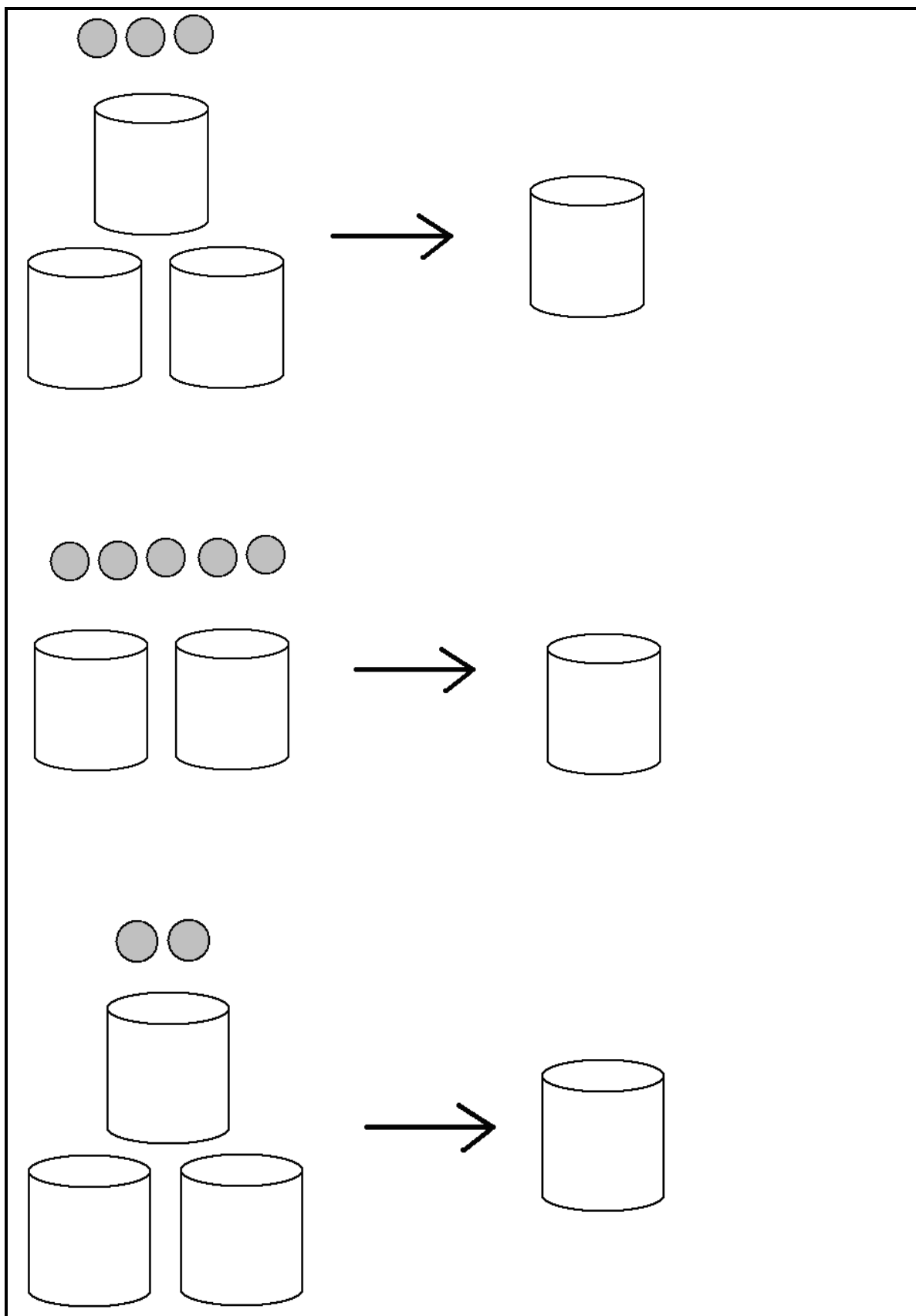

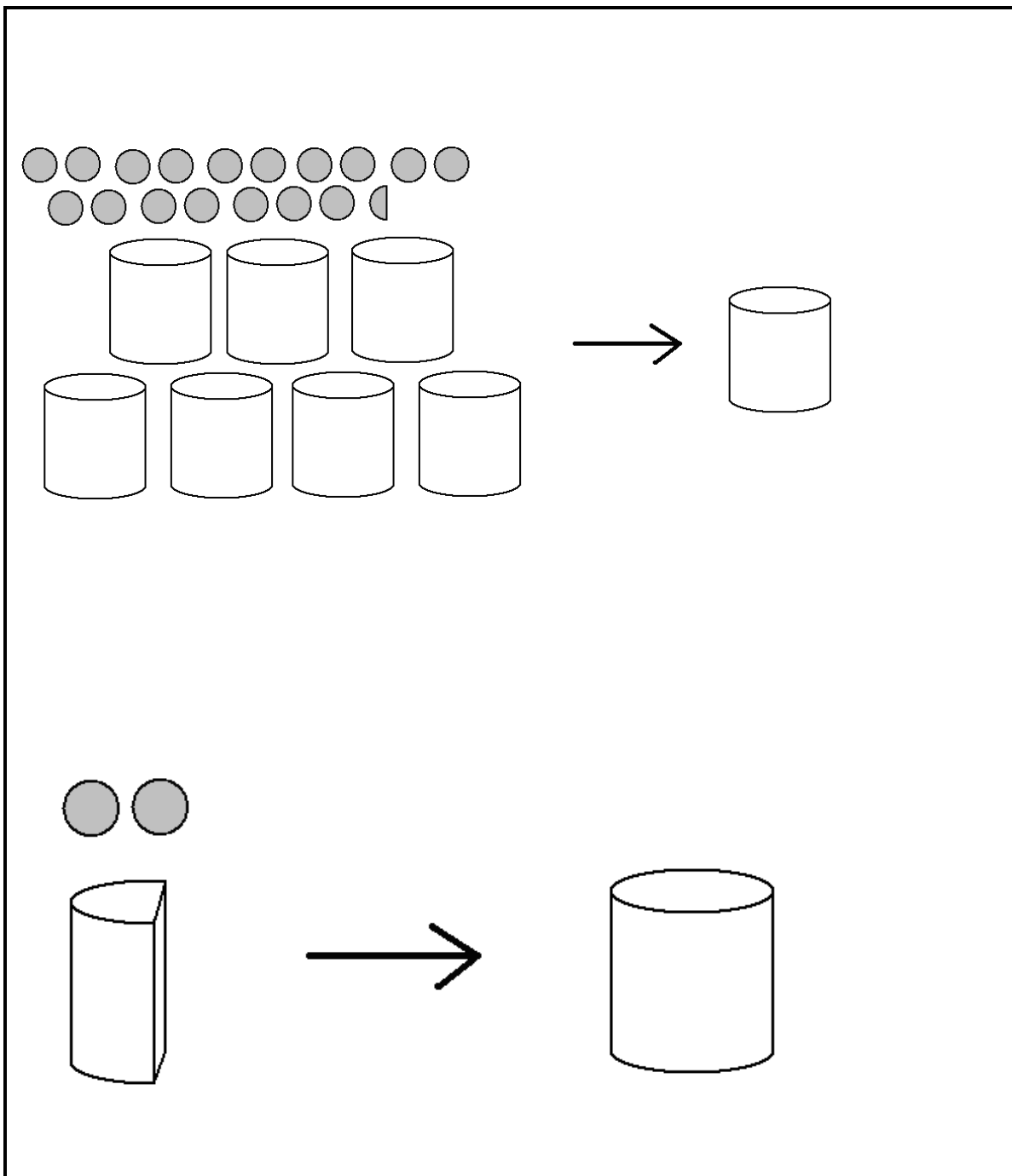



MATH WITHOUT WORDS: 14

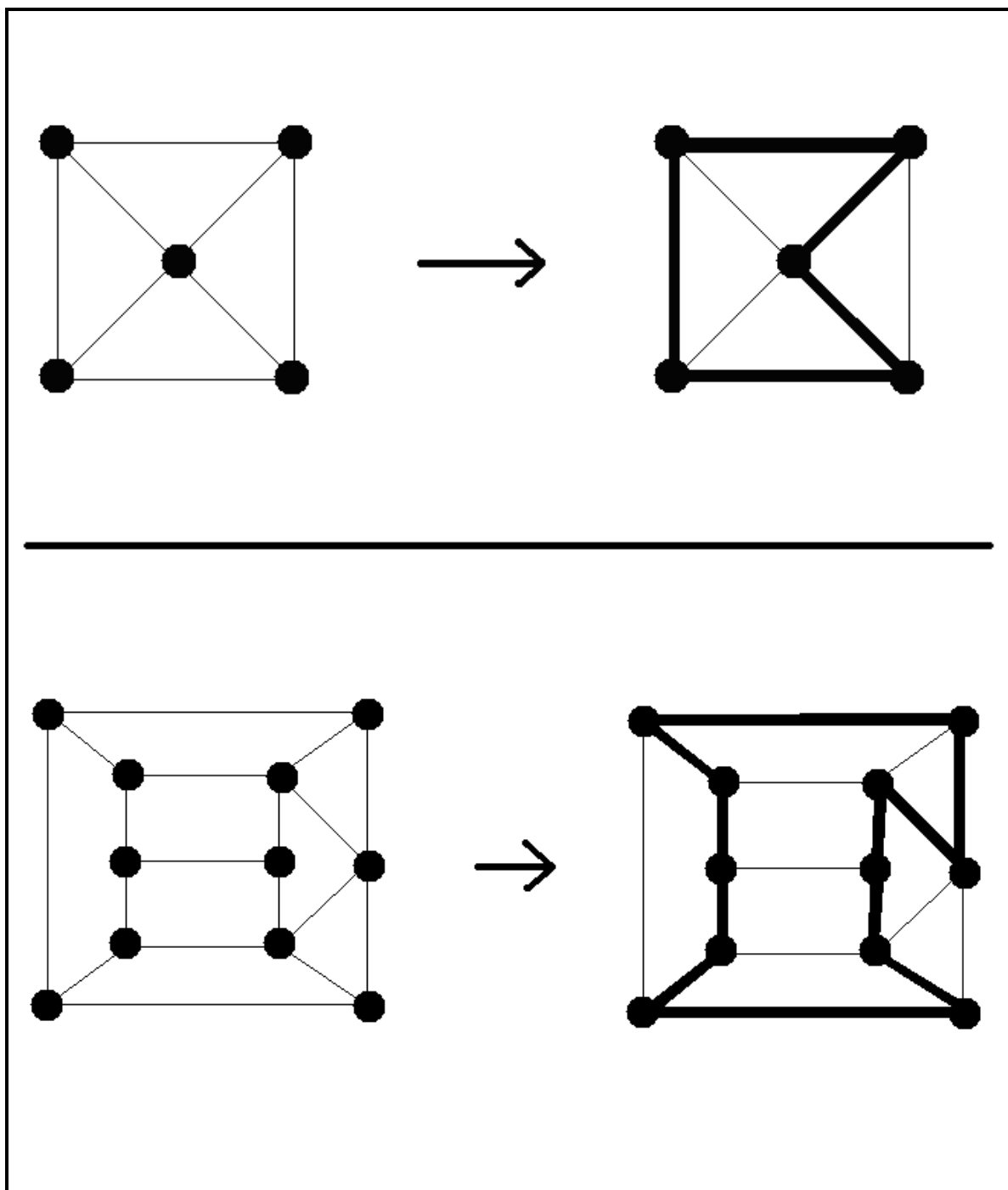

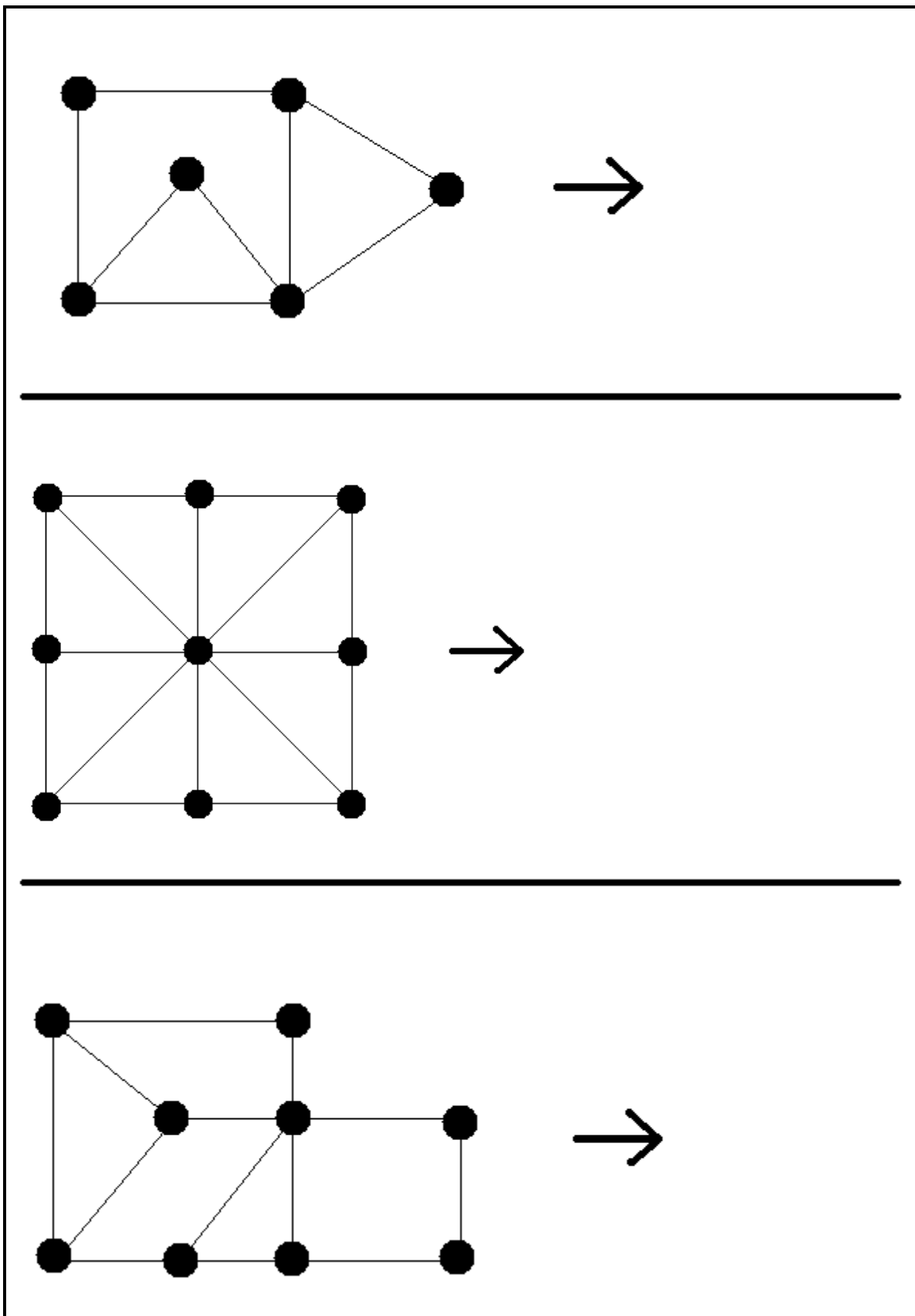

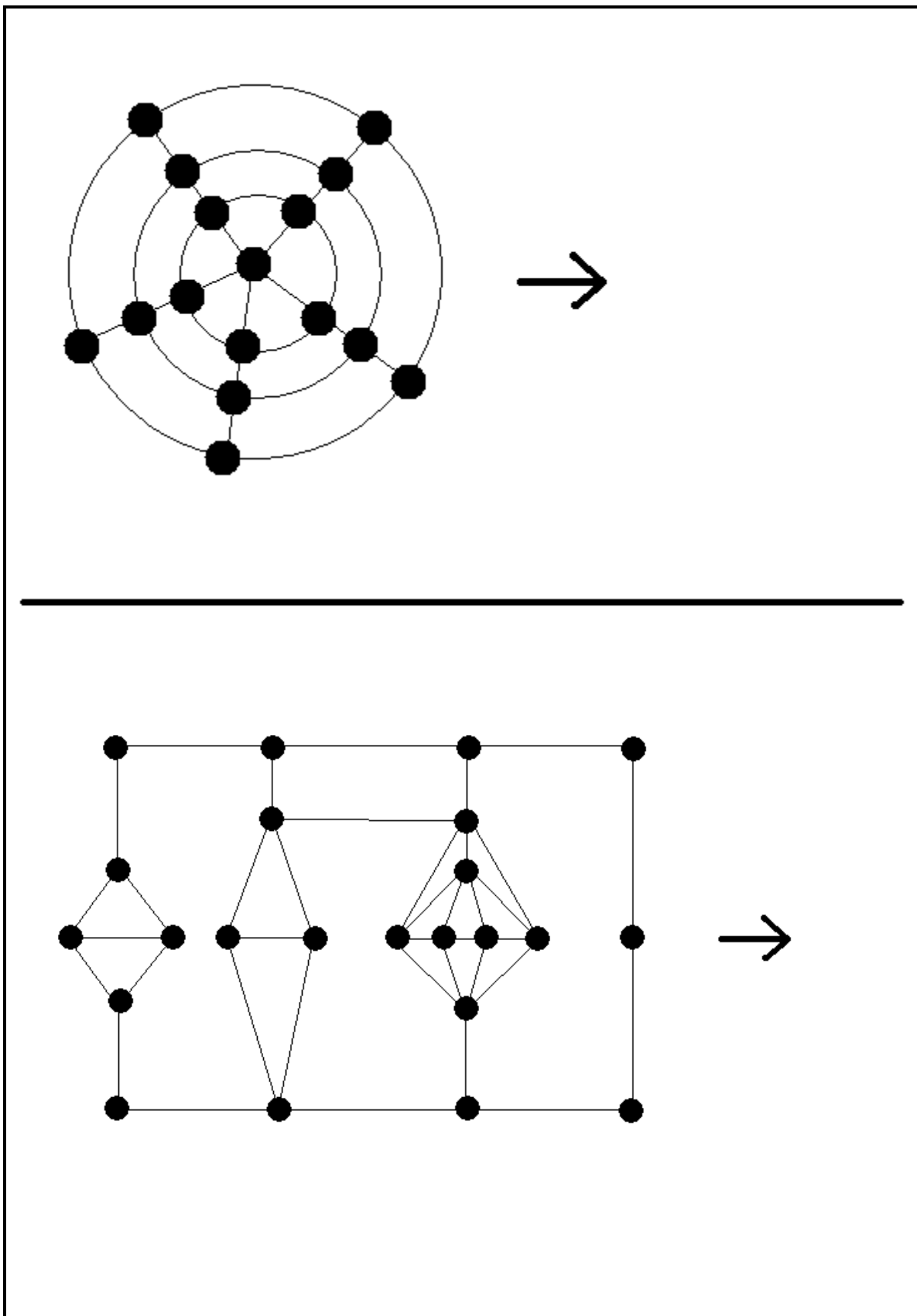

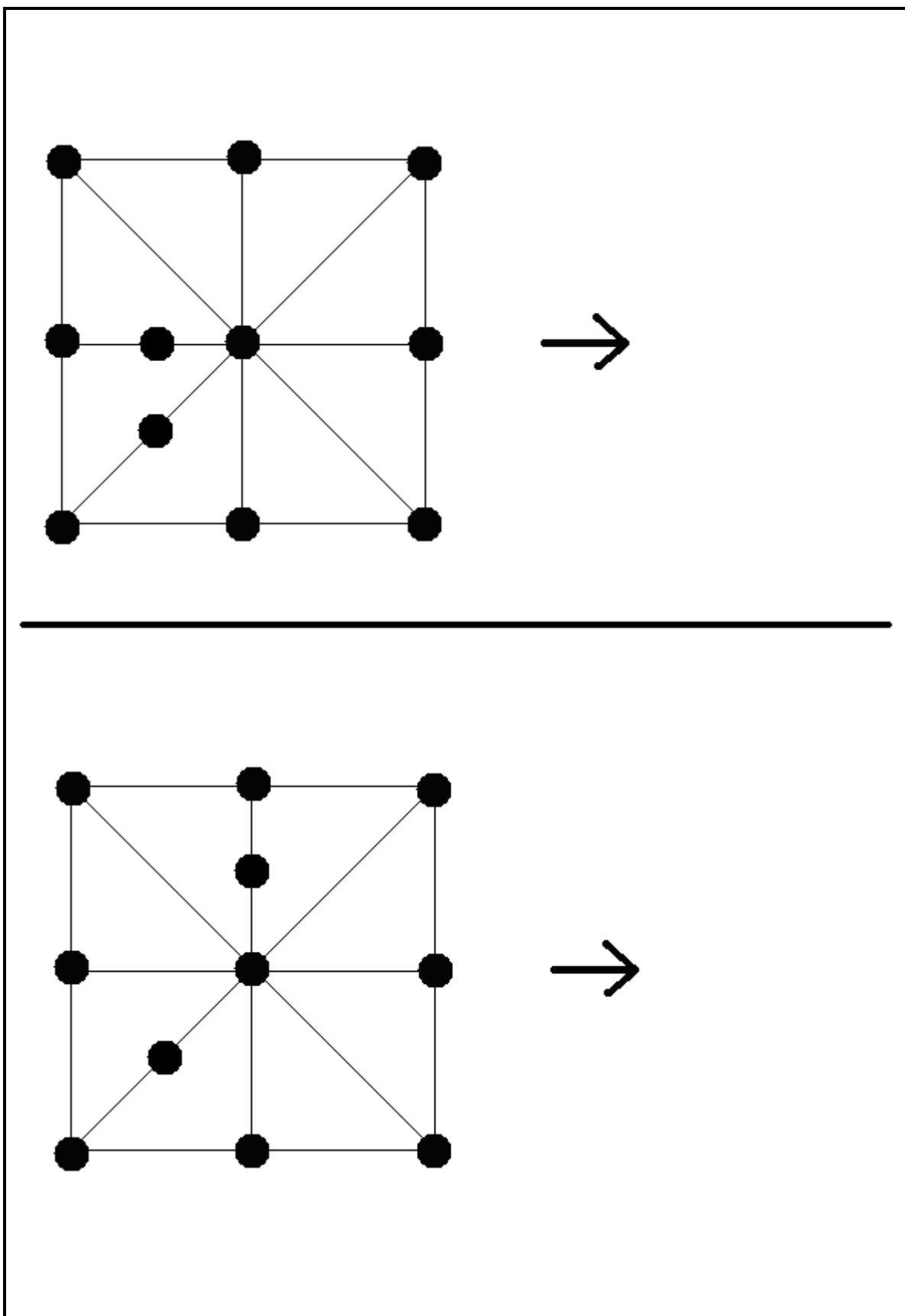

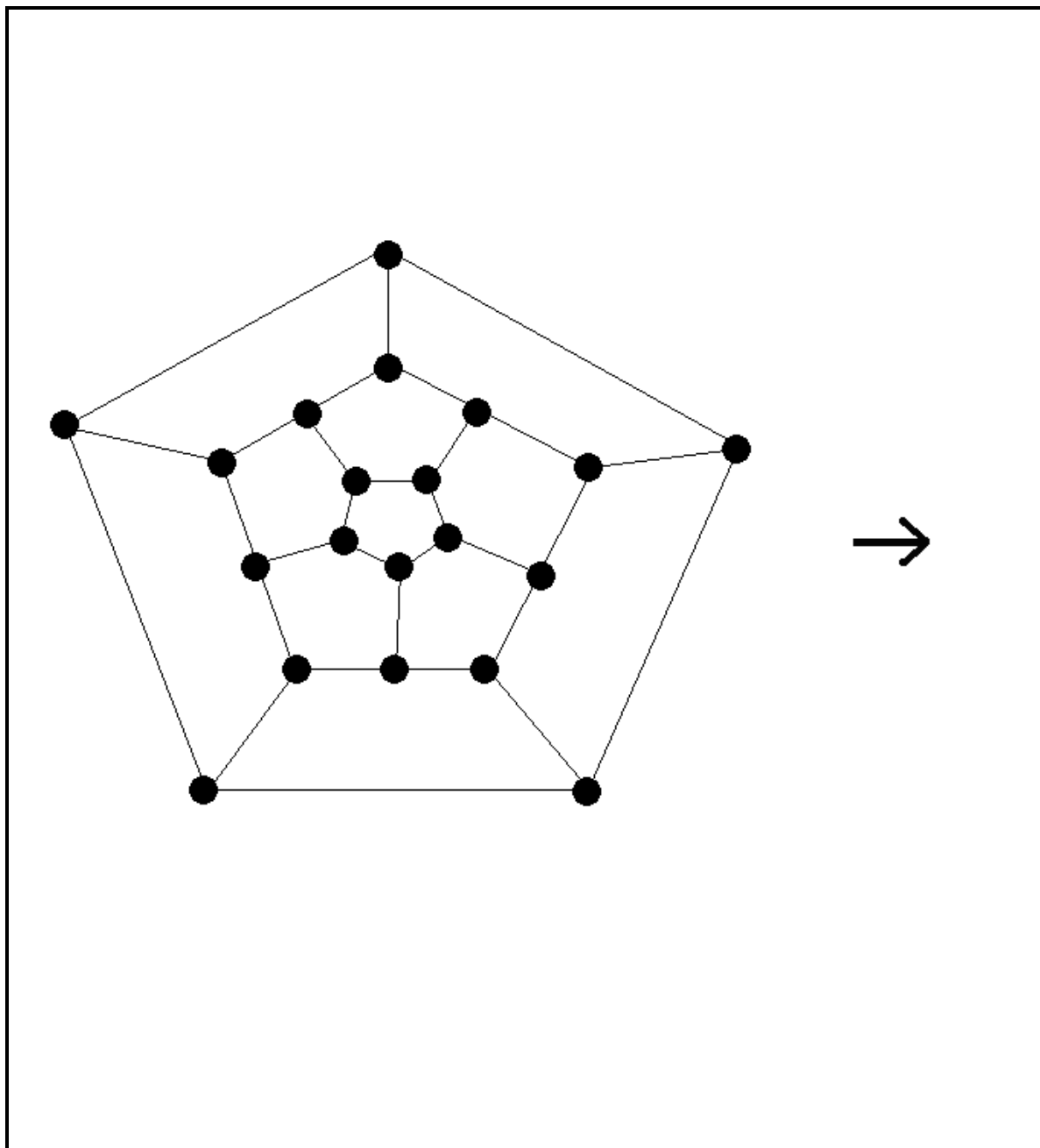



MATH WITHOUT WORDS: 15

15 dots → 15 dots in boxes (3 rows of 5) → 3

15 dots → 15 dots in boxes (1 row of 15, 2 rows of 5) → 2

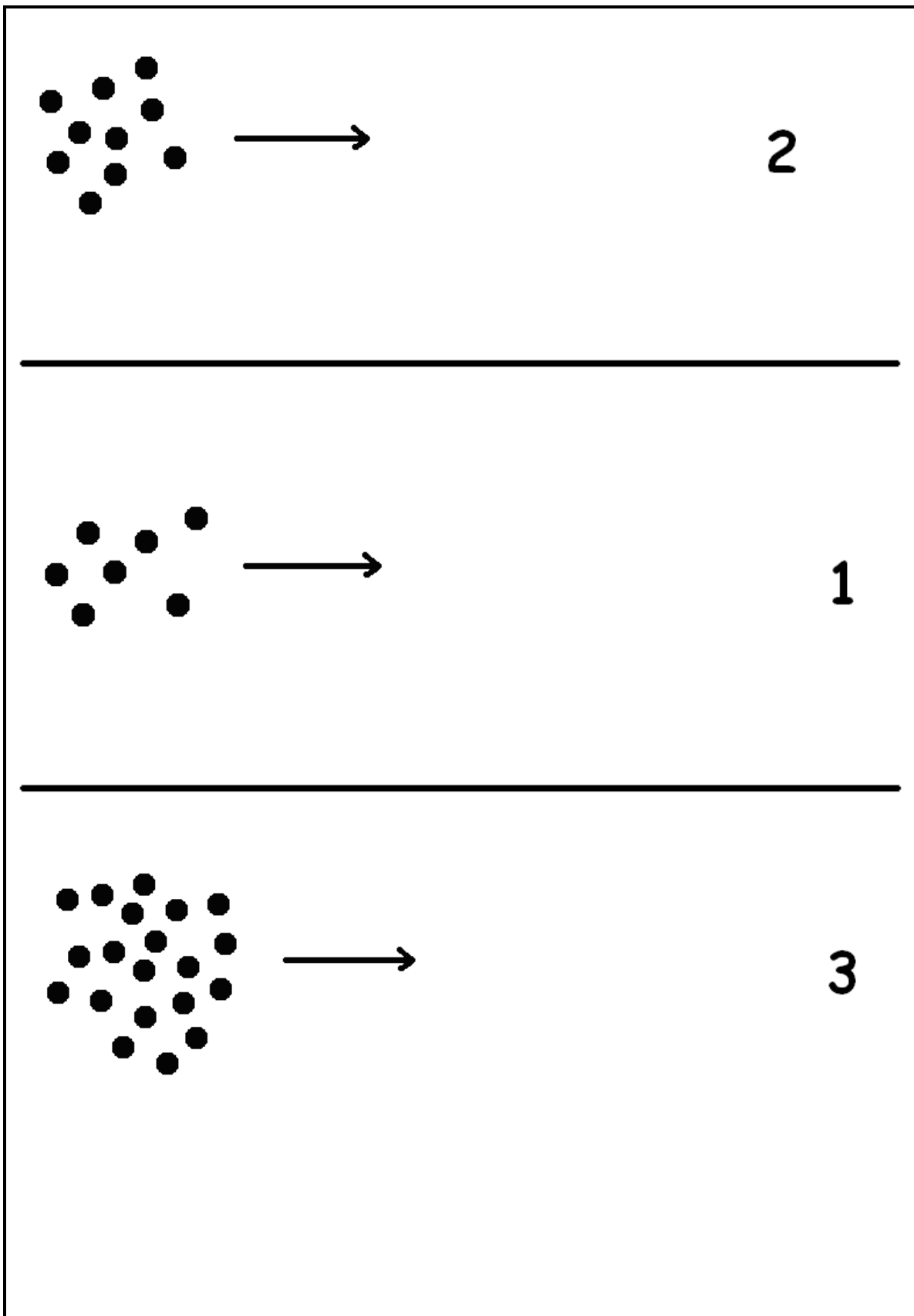

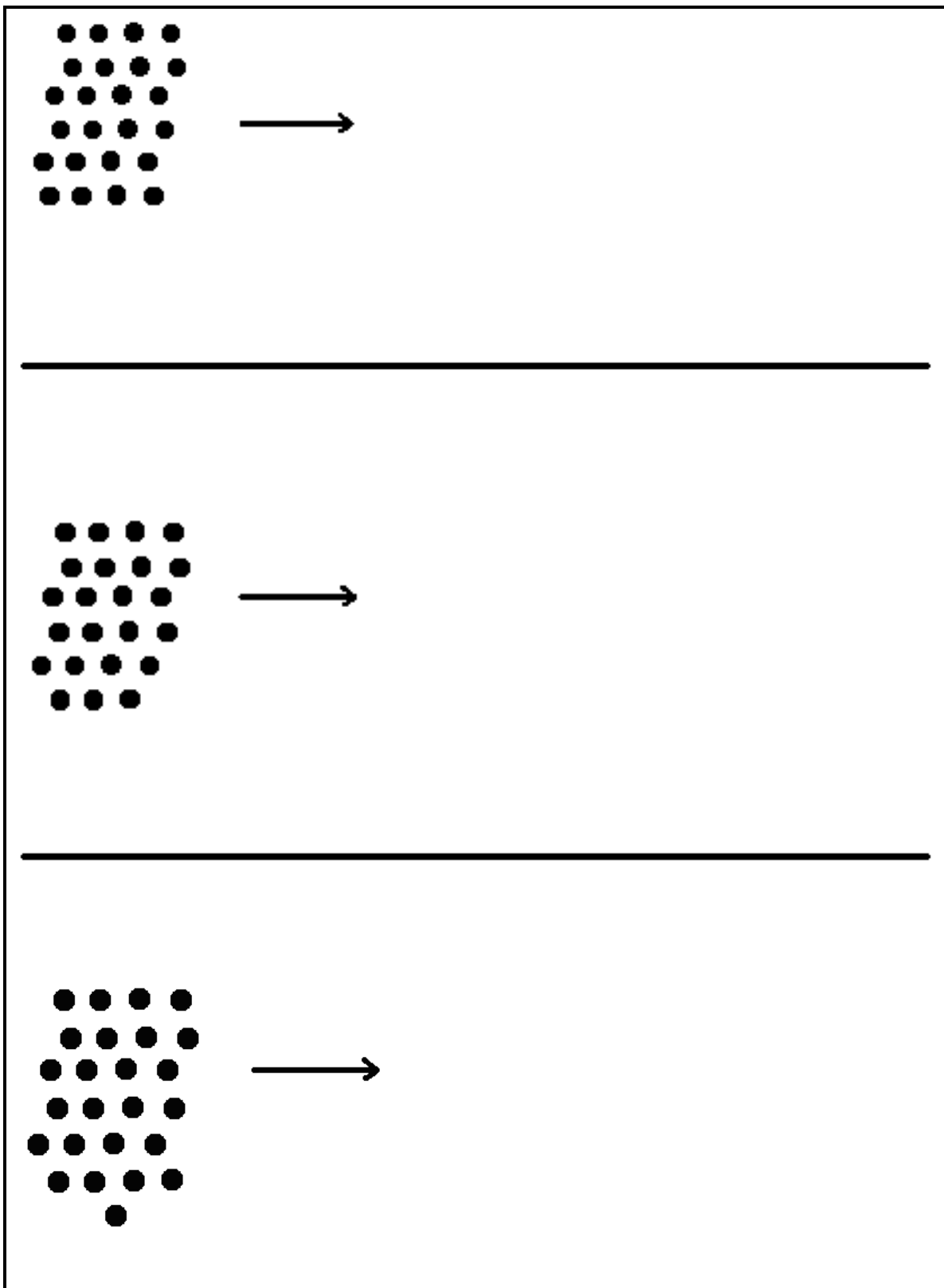



MATH WITHOUT WORDS: 16

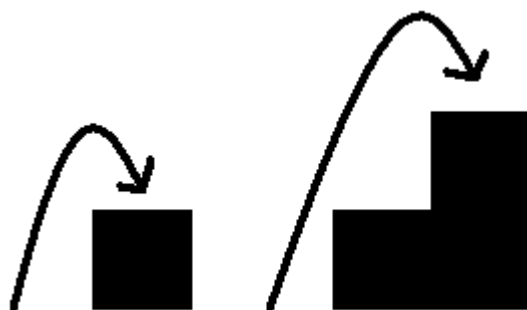

1

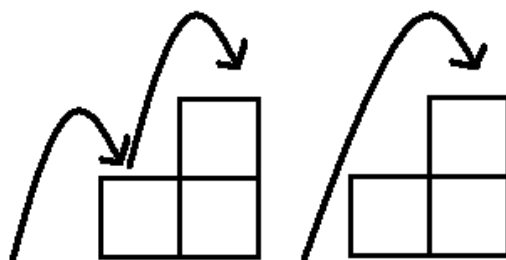

2

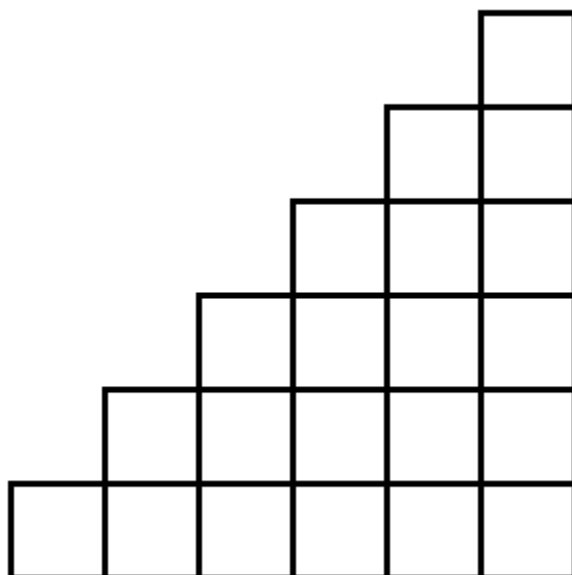
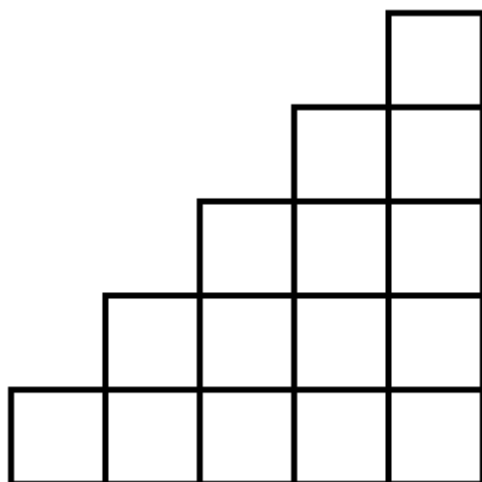



MATH WITHOUT WORDS: 17

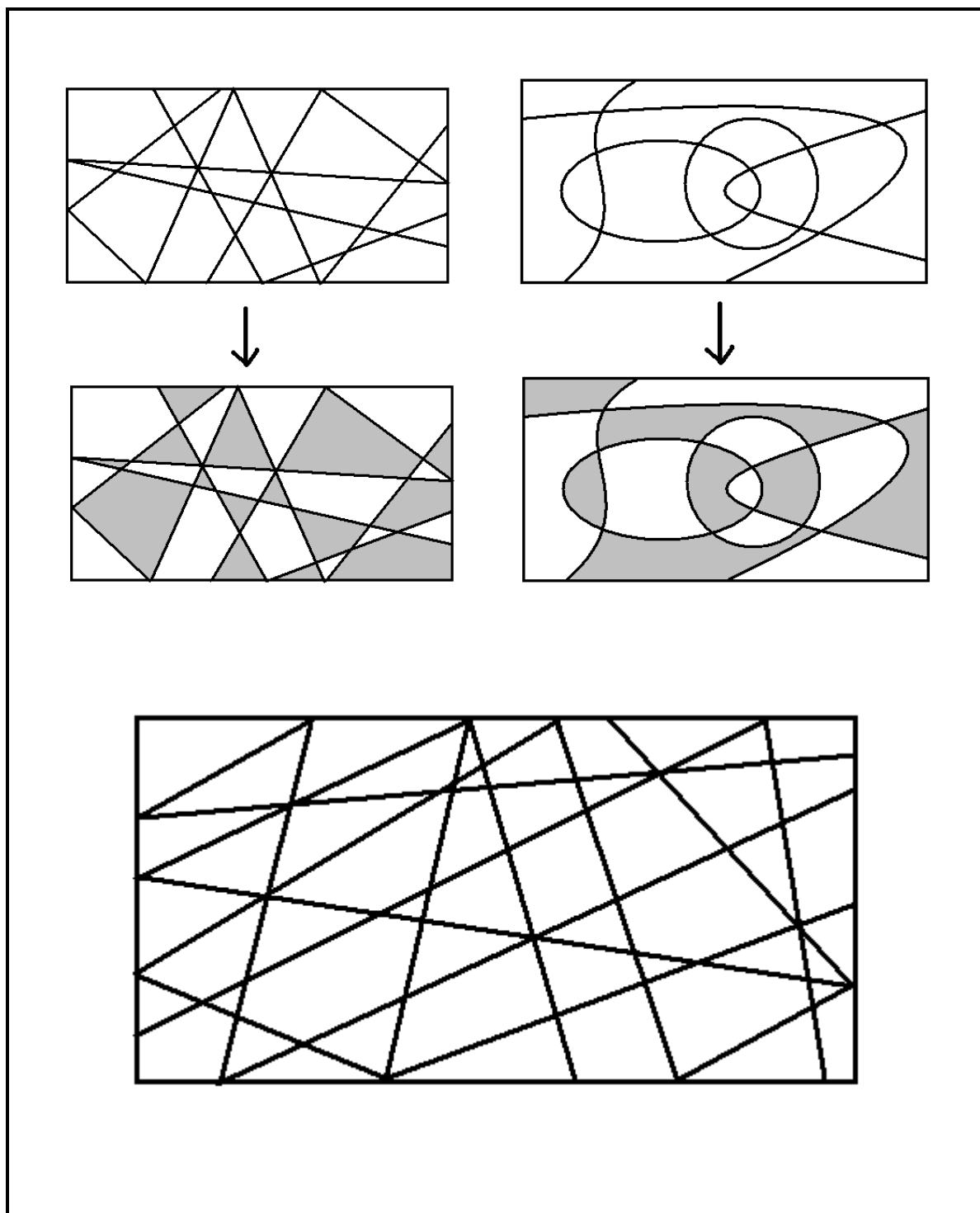

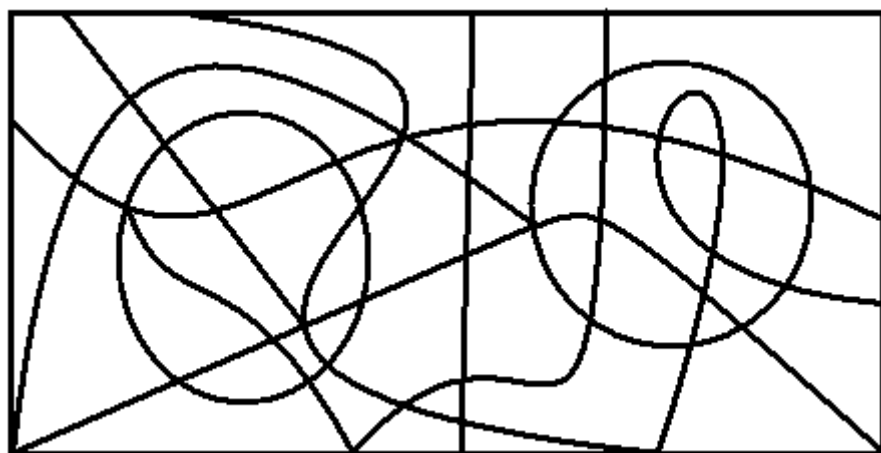
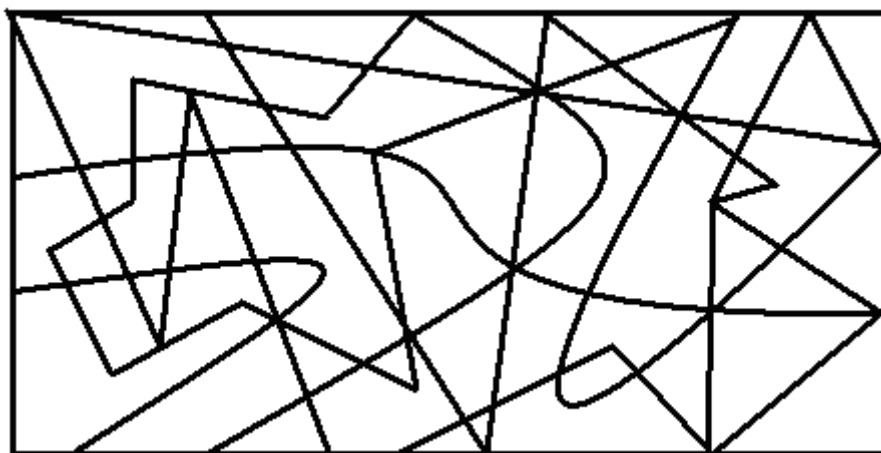



MATH WITHOUT WORDS: 18

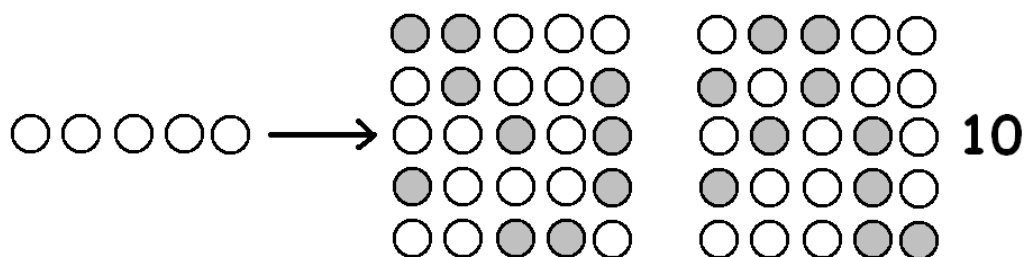
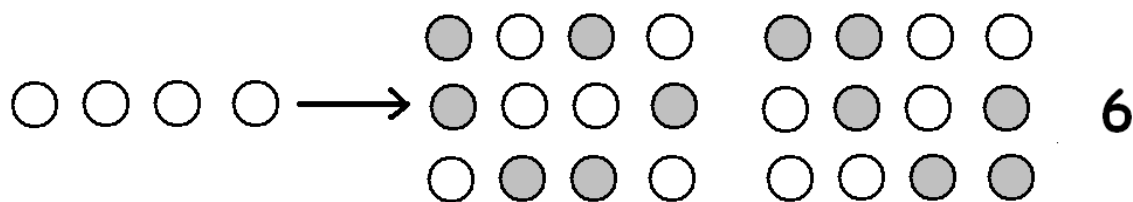
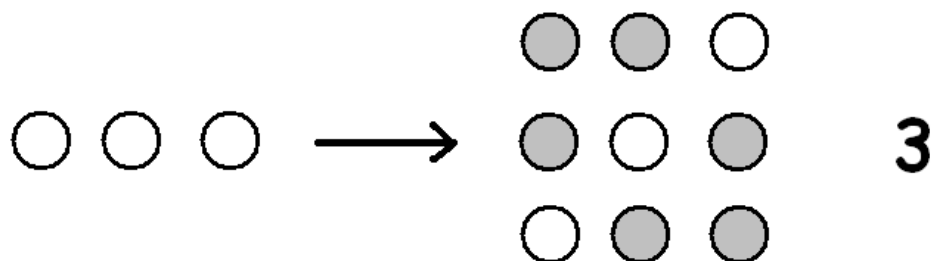

○ ○ ○ ○ ○ ○ ○ →

15

○ ○ ○ ○ ○ ○ ○ ○ →

21

○ ○ ○ ○ ○ ○ ○ ○ ○ →



MATH WITHOUT WORDS: 19

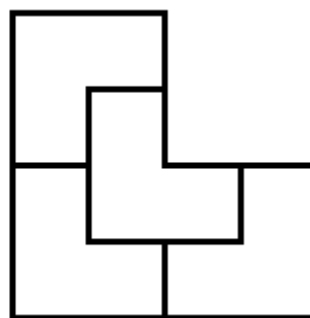
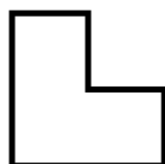
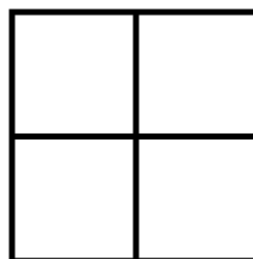
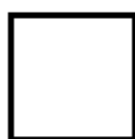
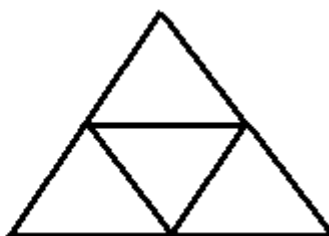

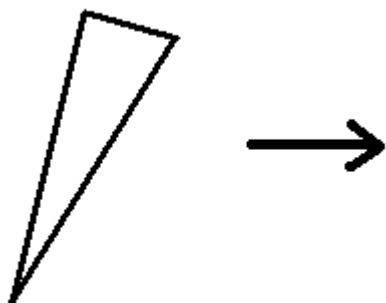
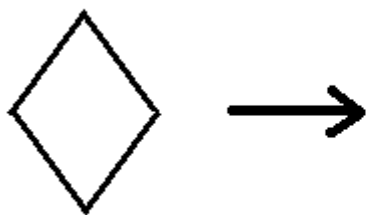



MATH WITHOUT WORDS: 20

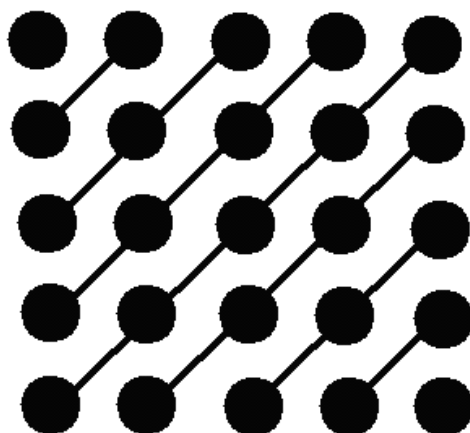

$$1+2+3+4+5+4+3+2+1$$

$$= 25$$

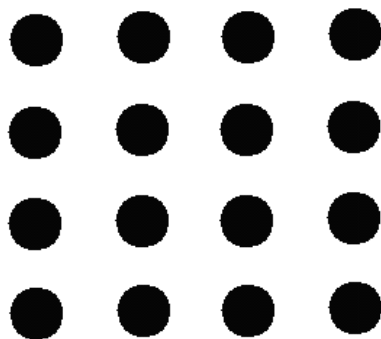

$$1+2+3+4+3+2+1$$

$$= 16$$

$$1+2+3+2+1$$

$$= \underline{\quad}$$

$$1+2+3+4+5+6+5+4+3+2+1$$

$$= \underline{\quad}$$

$$1+2+3+4+5+6+7+6+5+4+3+2+1$$

$$= \underline{\quad}$$

$$1+2+3+\dots+99+100+99+\dots+3+2+1$$

$$= \underline{\quad}$$



MATH WITHOUT WORDS: 21

1 3 5 7

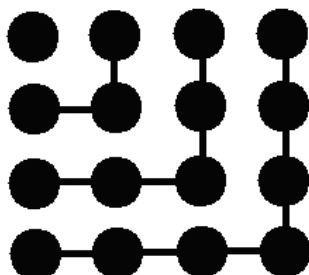

1 3 5 7 9

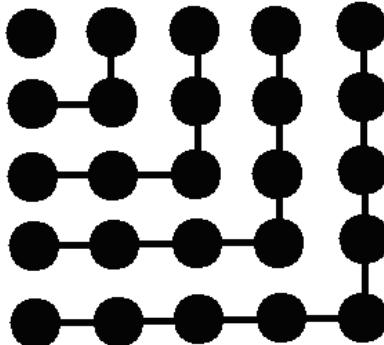

1 3 5

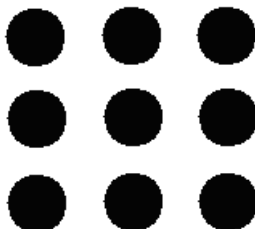

1 3 5 7 9 11

1 3 5 7 9 11 13 15 17 19

2 4 6 8 10 12 14 16 18 20



MATH WITHOUT WORDS: 22

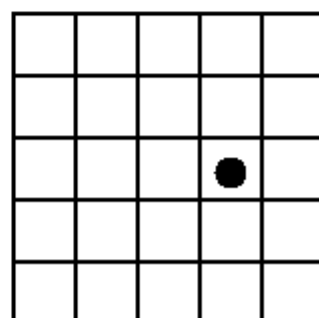
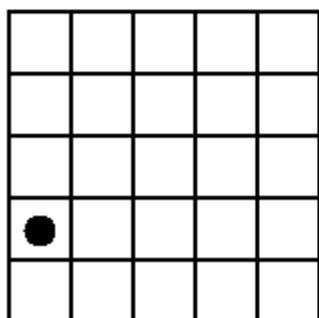
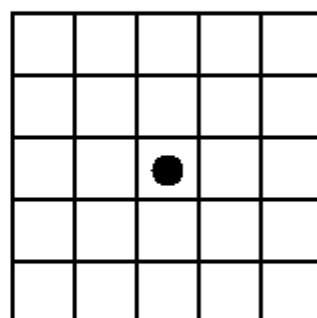
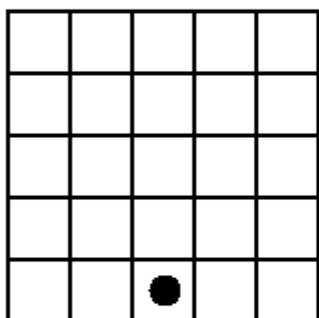
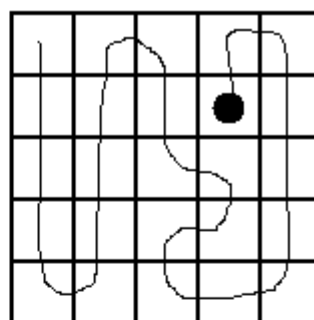
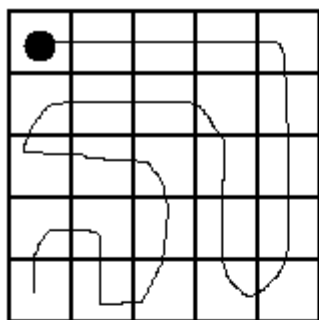



MATH WITHOUT WORDS: 23

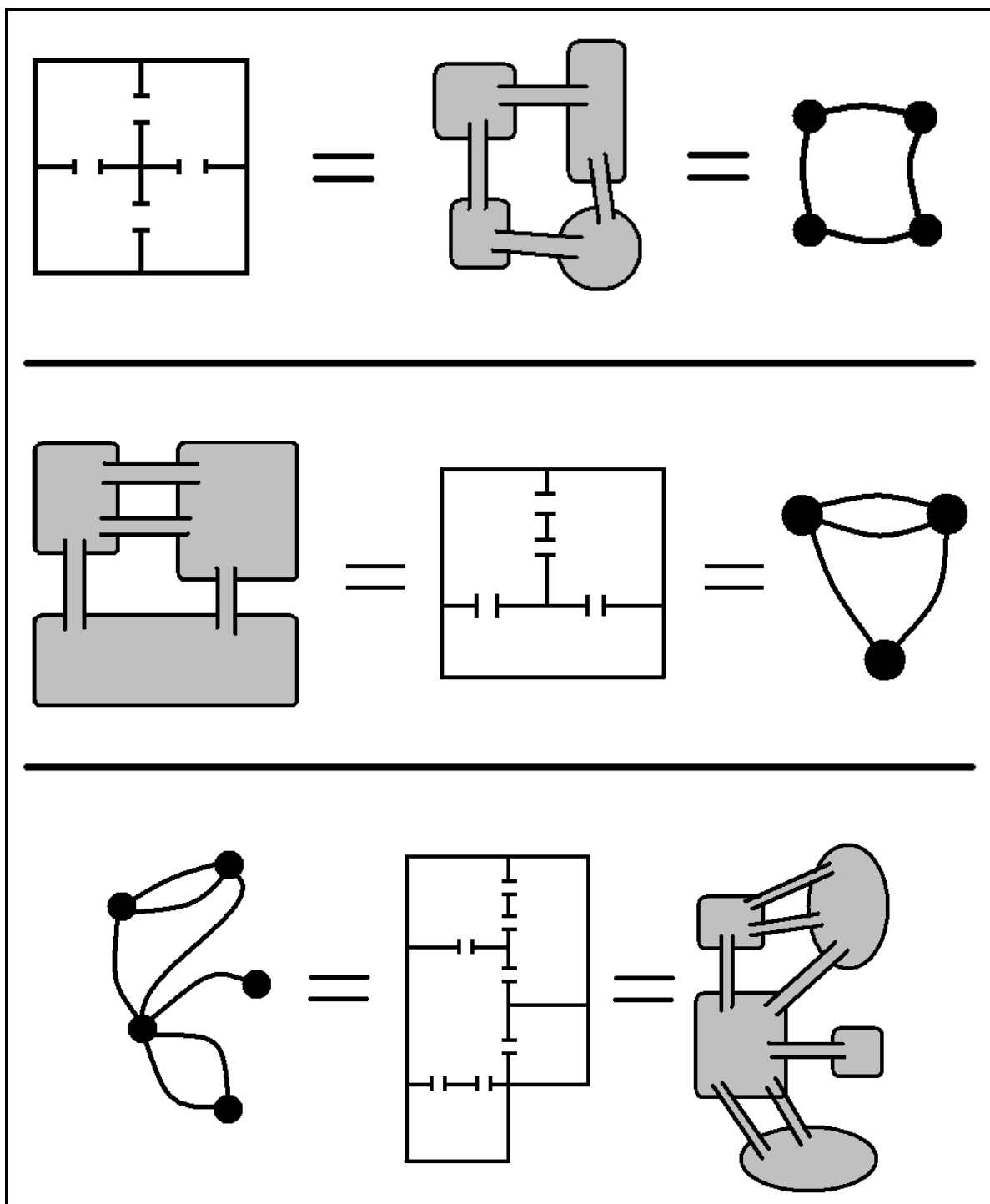

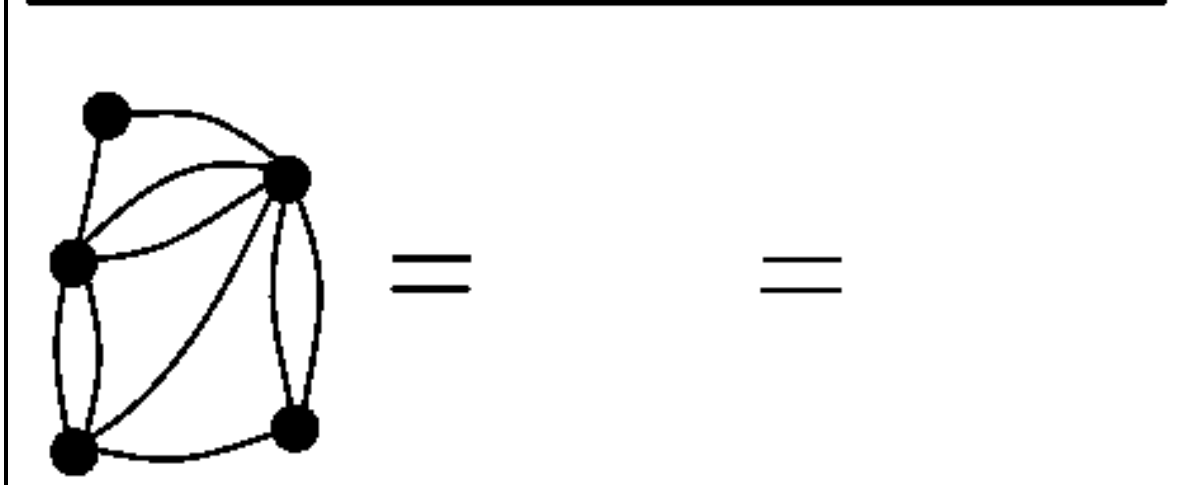
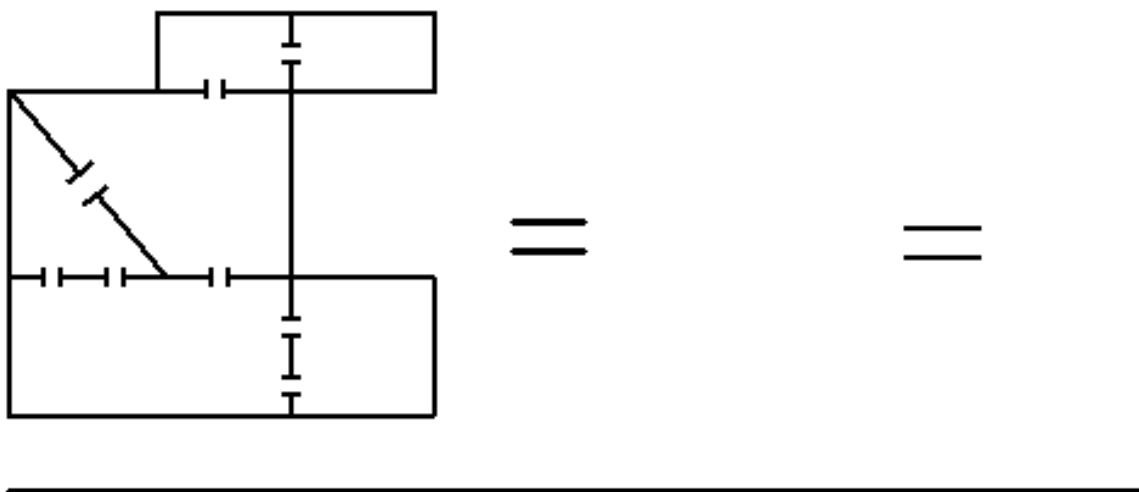
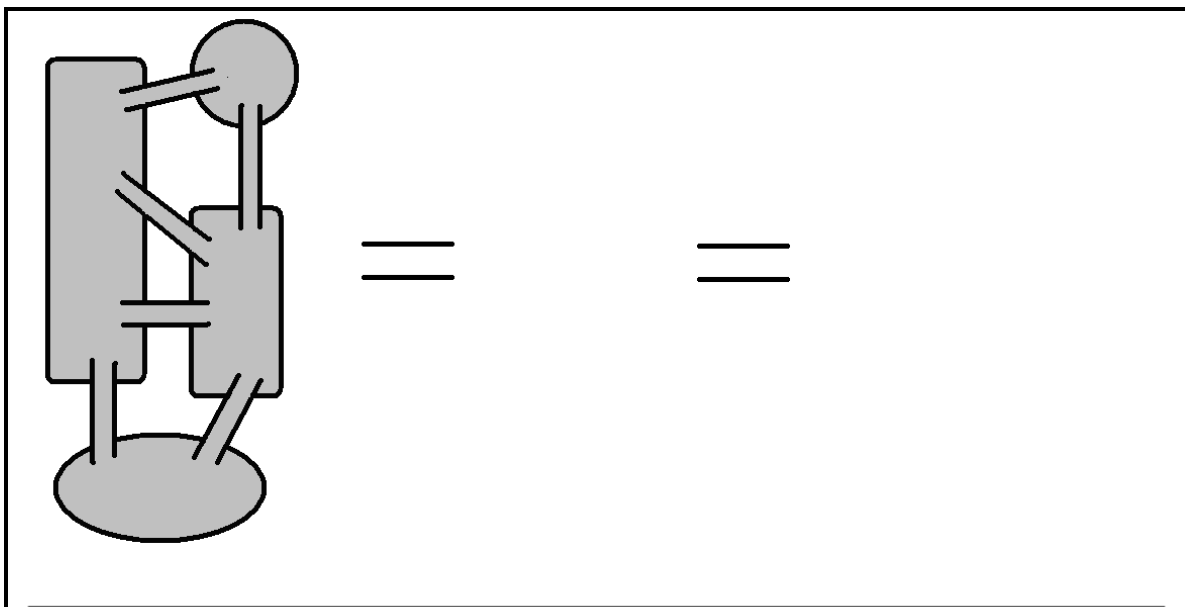

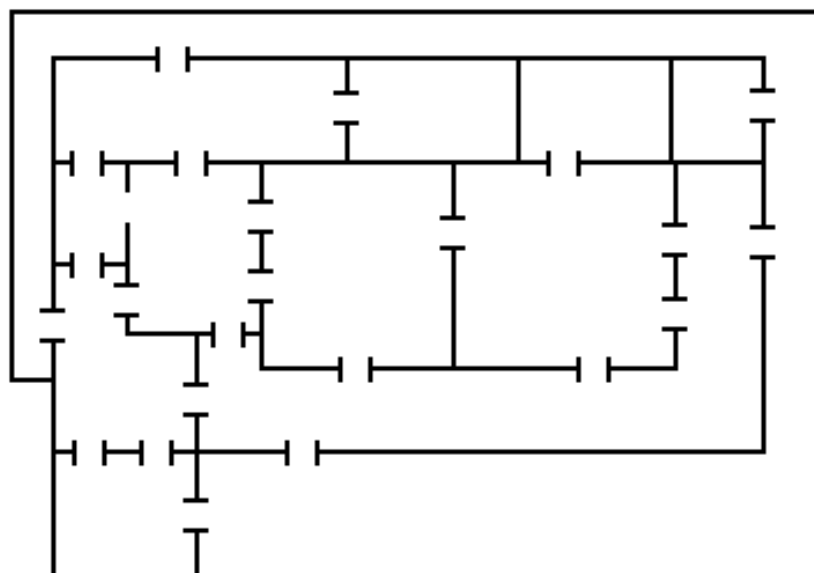
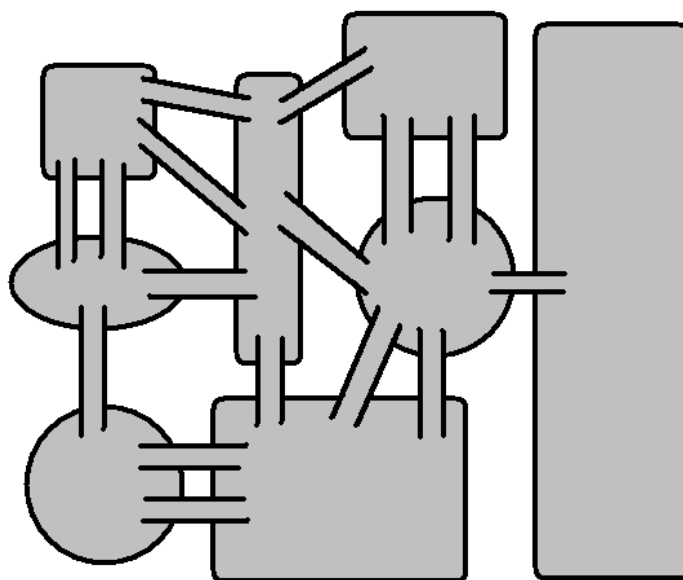

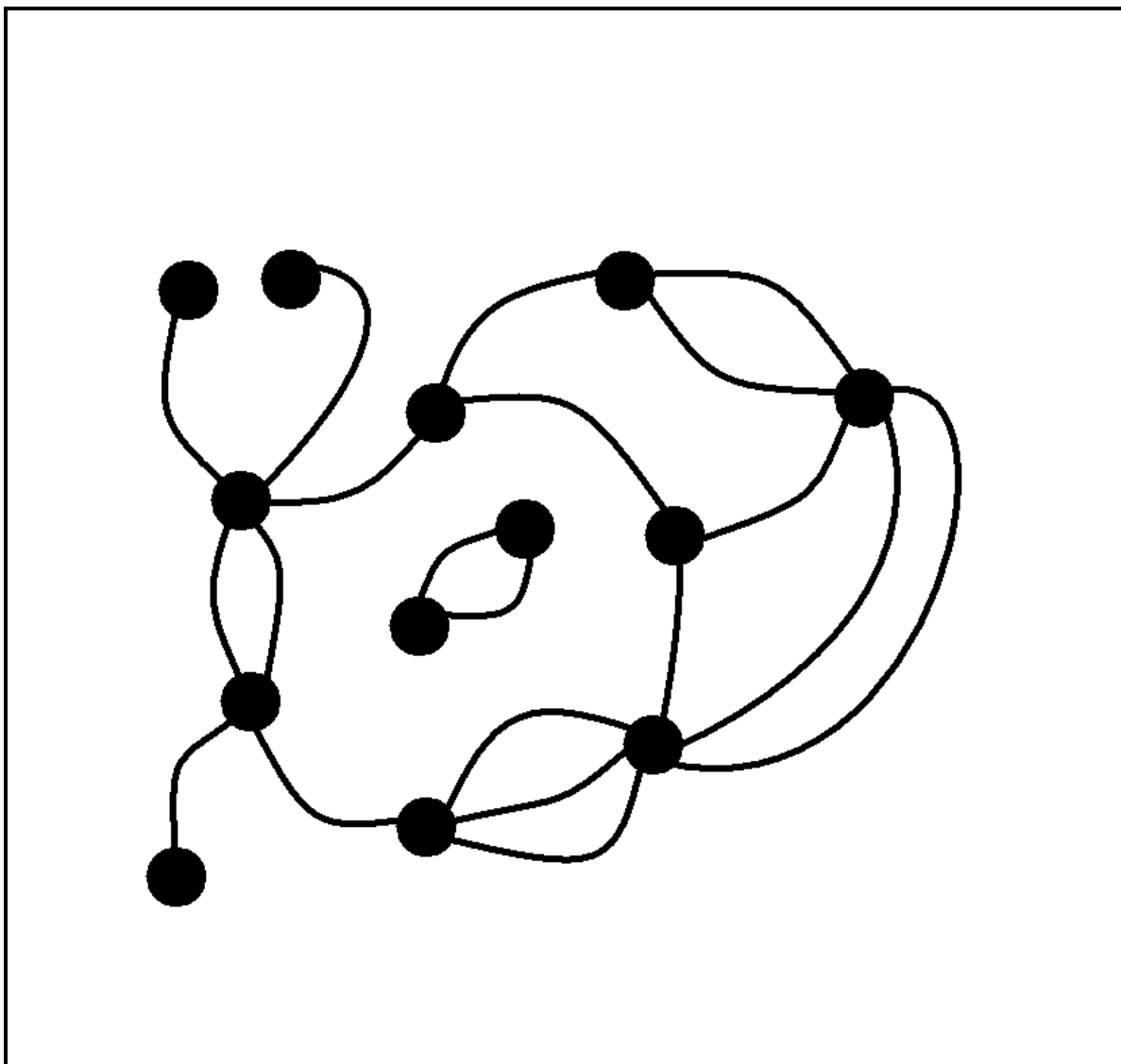



MATH WITHOUT WORDS: 24

This section contains several math puzzles:

- Top Left:** A legend showing a solid black dot followed by a horizontal line with six 'x' marks. Below it is a maze with a path of 'x' marks starting from a solid dot and ending at an open circle.
- Top Middle:** A legend showing an open circle followed by a horizontal line with one 'x' mark. Below it is a maze with a path of 'x' marks starting from an open circle and ending at a solid dot.
- Top Right:** A legend showing a solid black dot followed by a horizontal line with four 'x' marks. Below it is a complex maze with a path of 'x' marks starting from a solid dot and ending at an open circle.
- Bottom Center:** A large square maze with a path of 'x' marks starting from a solid dot at the top and ending at an open circle at the bottom.

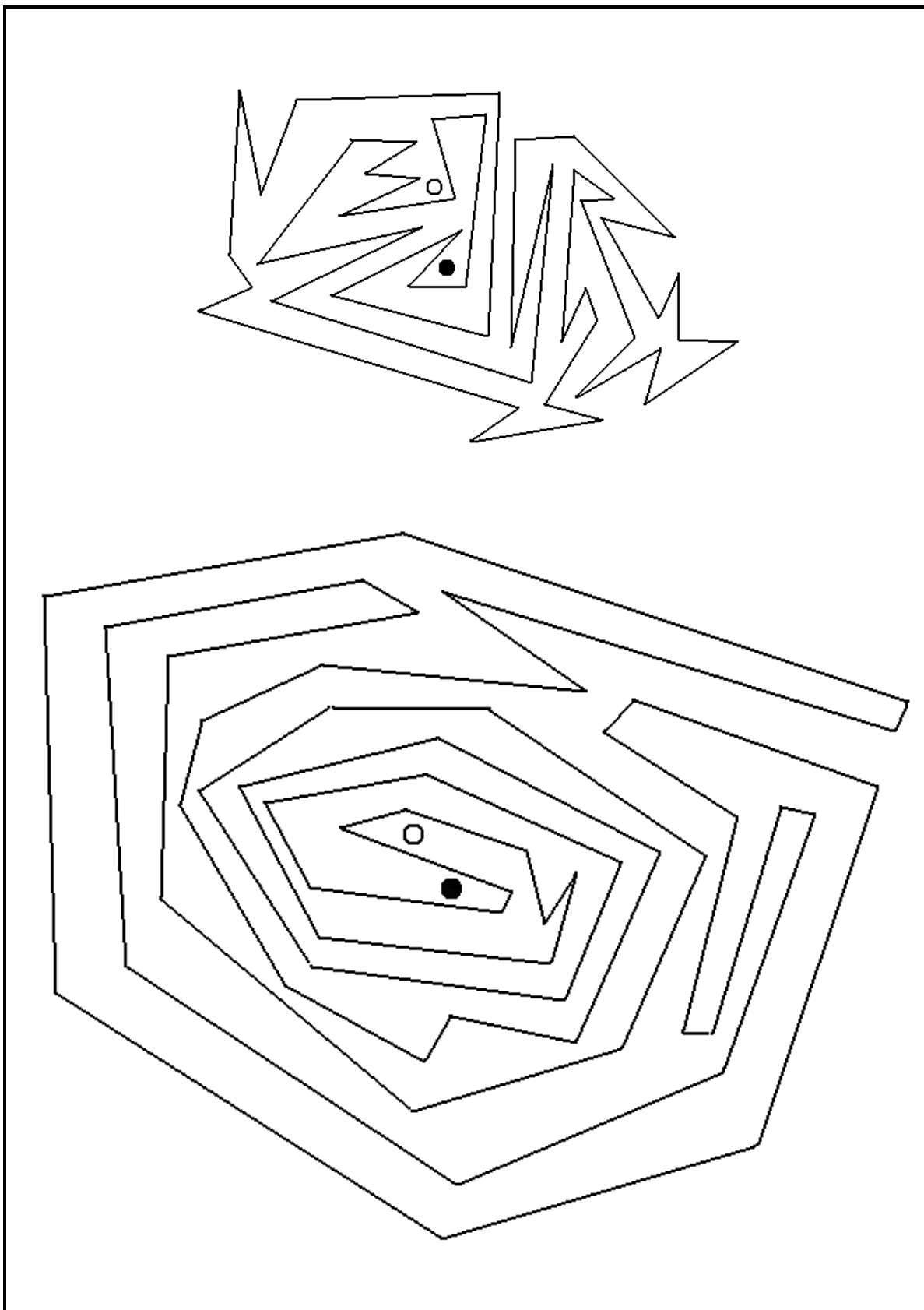

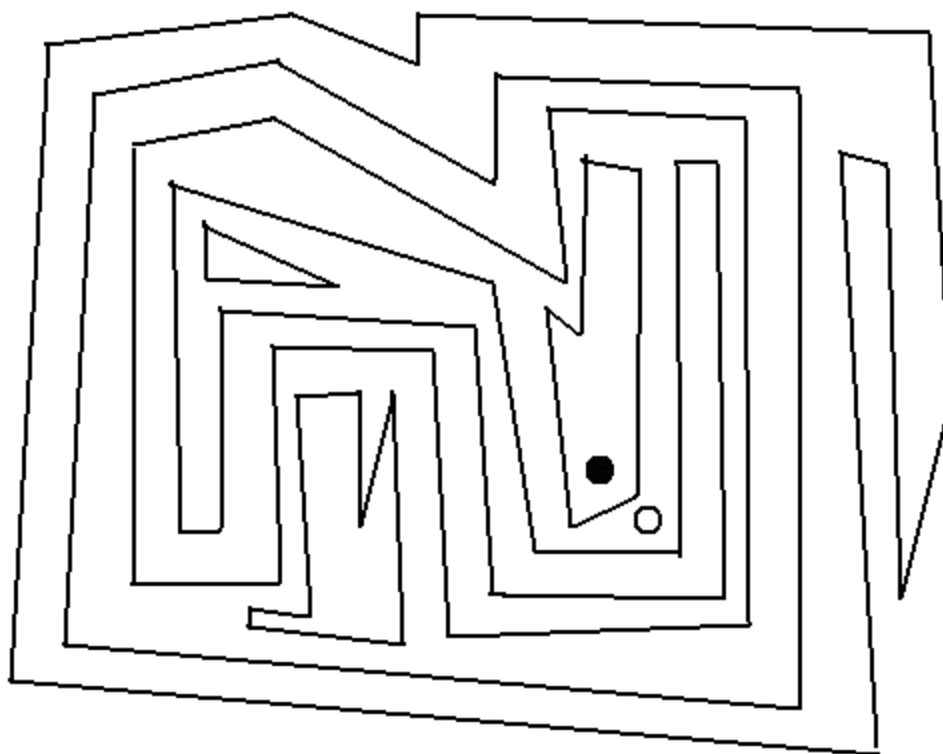
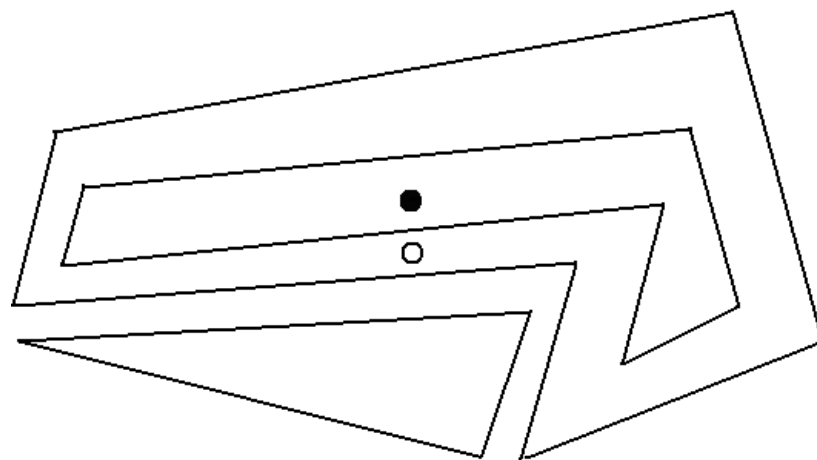

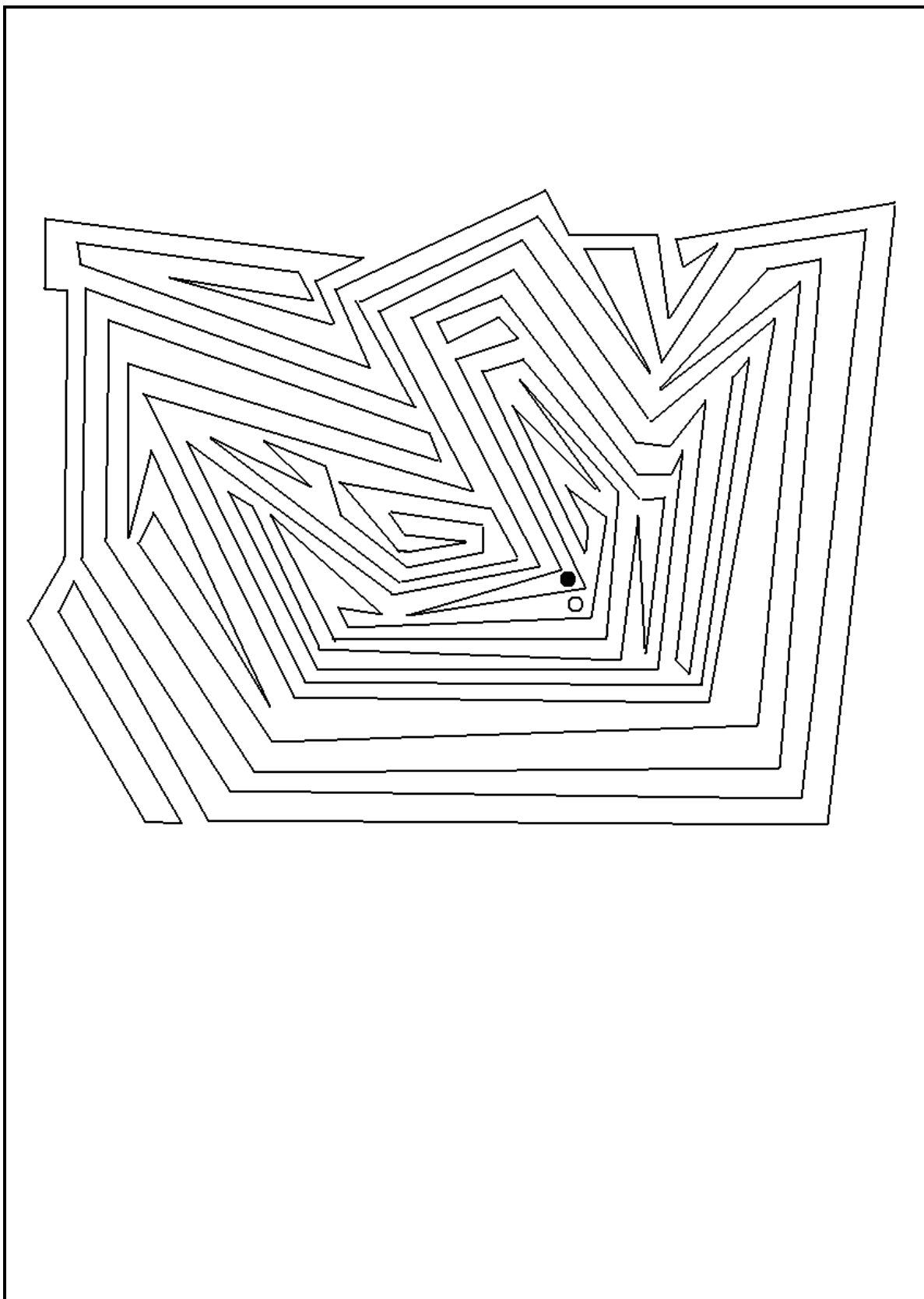



MATH WITHOUT WORDS: 25

| | |
|--|---|
| | |
| | 1 |
| | |
| | 1 |
| | |
| | 1 |
| | |
| | 2 |
| | |
| | 2 |

● ● ● ● ● ● ● → ● ● ● | ● ● | ● ● 3

● ● ● ● ● ● ● ● → 4

● ● ● ● ● ● ● ● ● → 5

● ● ● ● ● ● ● ● ● ● →

● ● ● ● ● ● ● ● ● ● ● →



MATH WITHOUT WORDS: 26

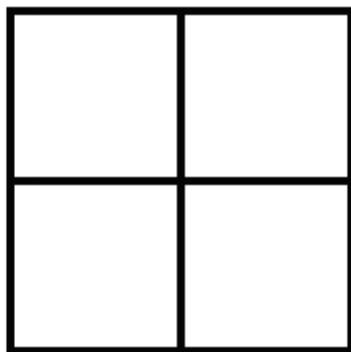

$$\square = 4 \quad \square\square = 2$$

$$\begin{array}{|c|} \hline \square \\ \hline \square \\ \hline \end{array} = 2 \quad \begin{array}{|c|c|} \hline \square & \square \\ \hline \square & \square \\ \hline \end{array} = 1$$

$$\square + \begin{array}{|c|} \hline \square \\ \hline \square \\ \hline \end{array} + \square\square + \begin{array}{|c|c|} \hline \square & \square \\ \hline \square & \square \\ \hline \end{array} = 9$$

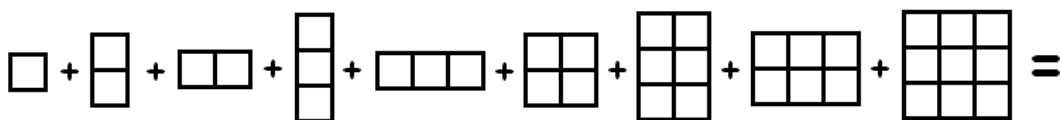
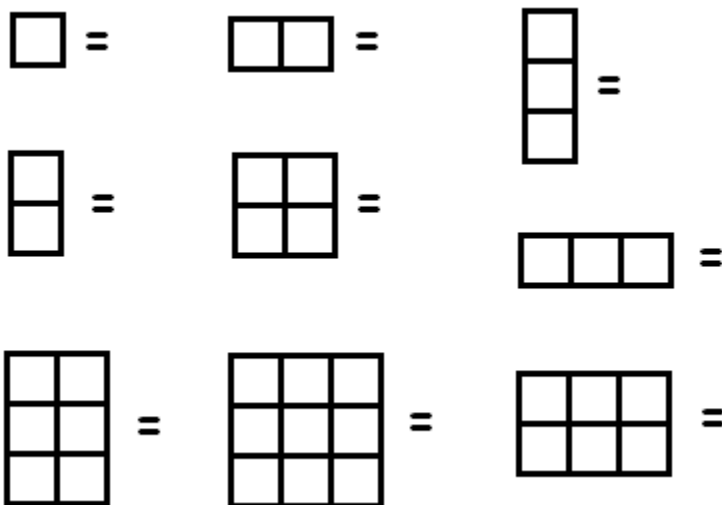
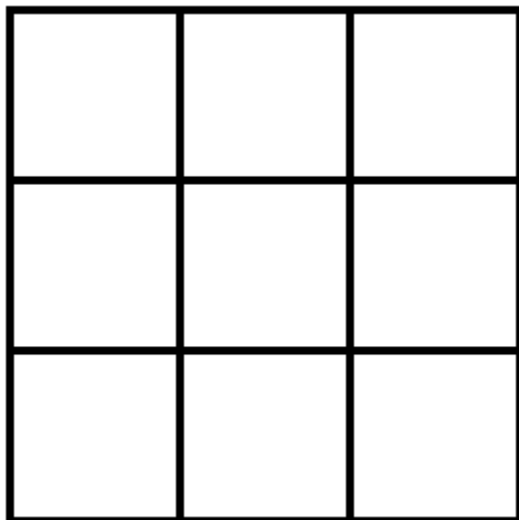

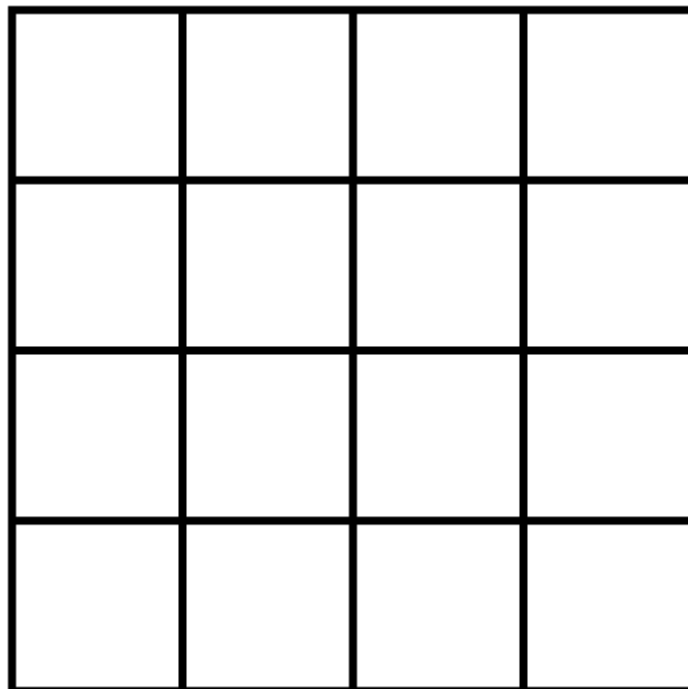









MATH WITHOUT WORDS: 27

| | | | |
|--|---|--|---|
| | → | | 1 |
| | | | |
| | → | | 2 |
| | | | |
| | → | | 3 |
| | | | |
| | → | | 5 |
| | | | |
| | → | | 8 |



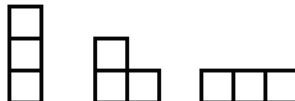

MATH WITHOUT WORDS: 28

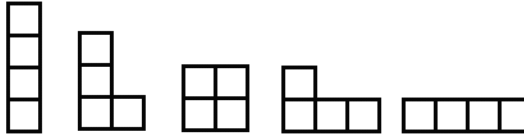
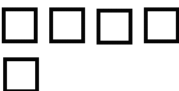
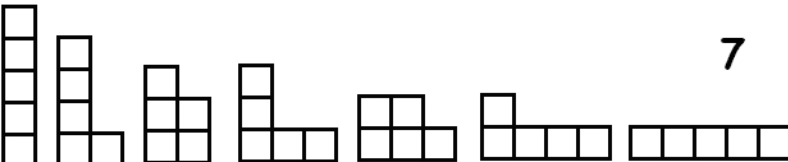
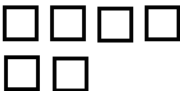
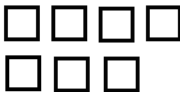
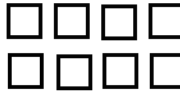
| | | | |
|---|-------------------|---|---|
|  | \longrightarrow |  | 1 |
|  | \longrightarrow |  | 2 |
|  | \longrightarrow |  | 3 |
|  | \longrightarrow |  | 5 |
|  | \longrightarrow |  | 7 |
|  | \longrightarrow | | |
|  | \longrightarrow | | |
|  | \longrightarrow | | |



MATH WITHOUT WORDS: 29

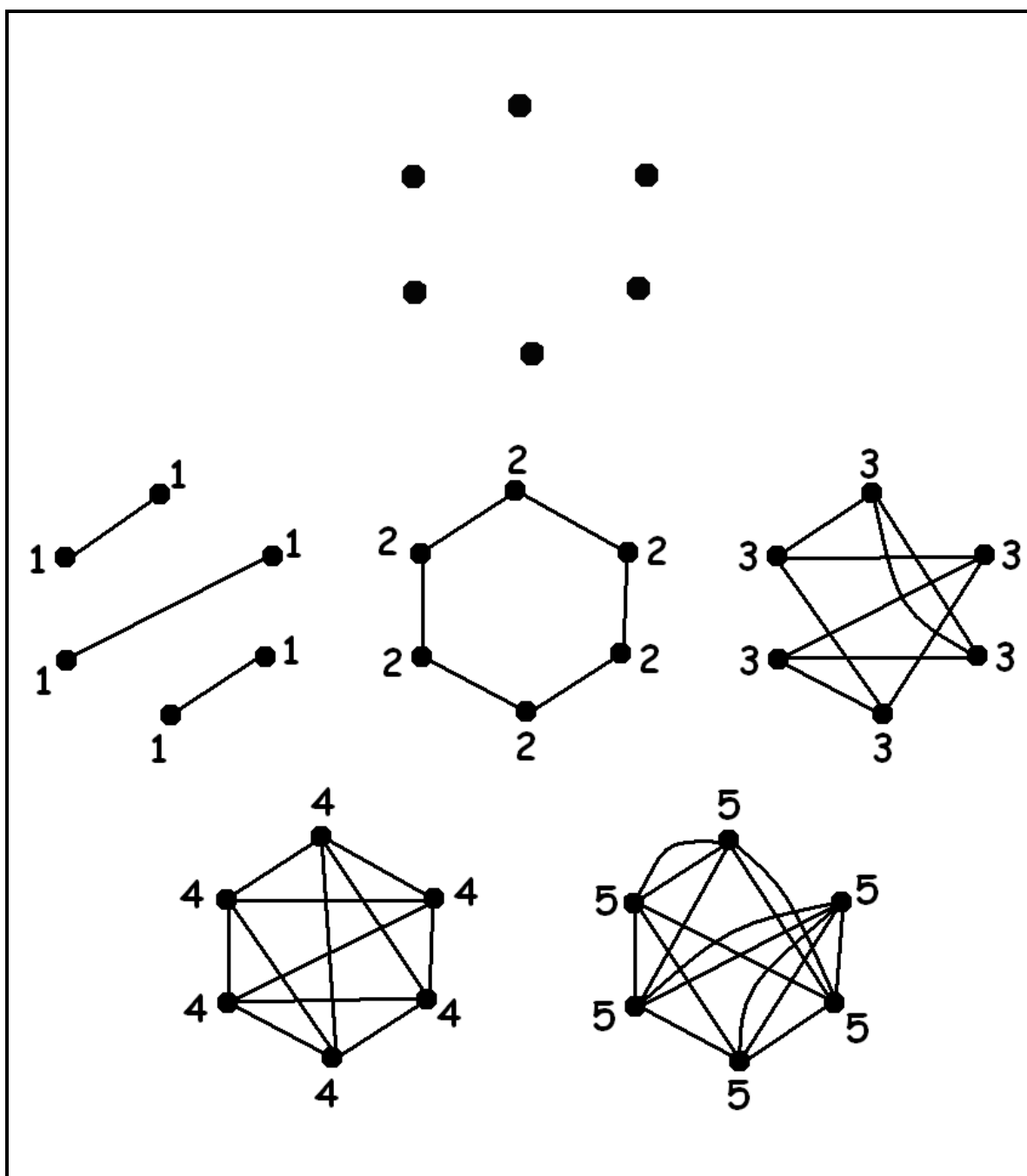

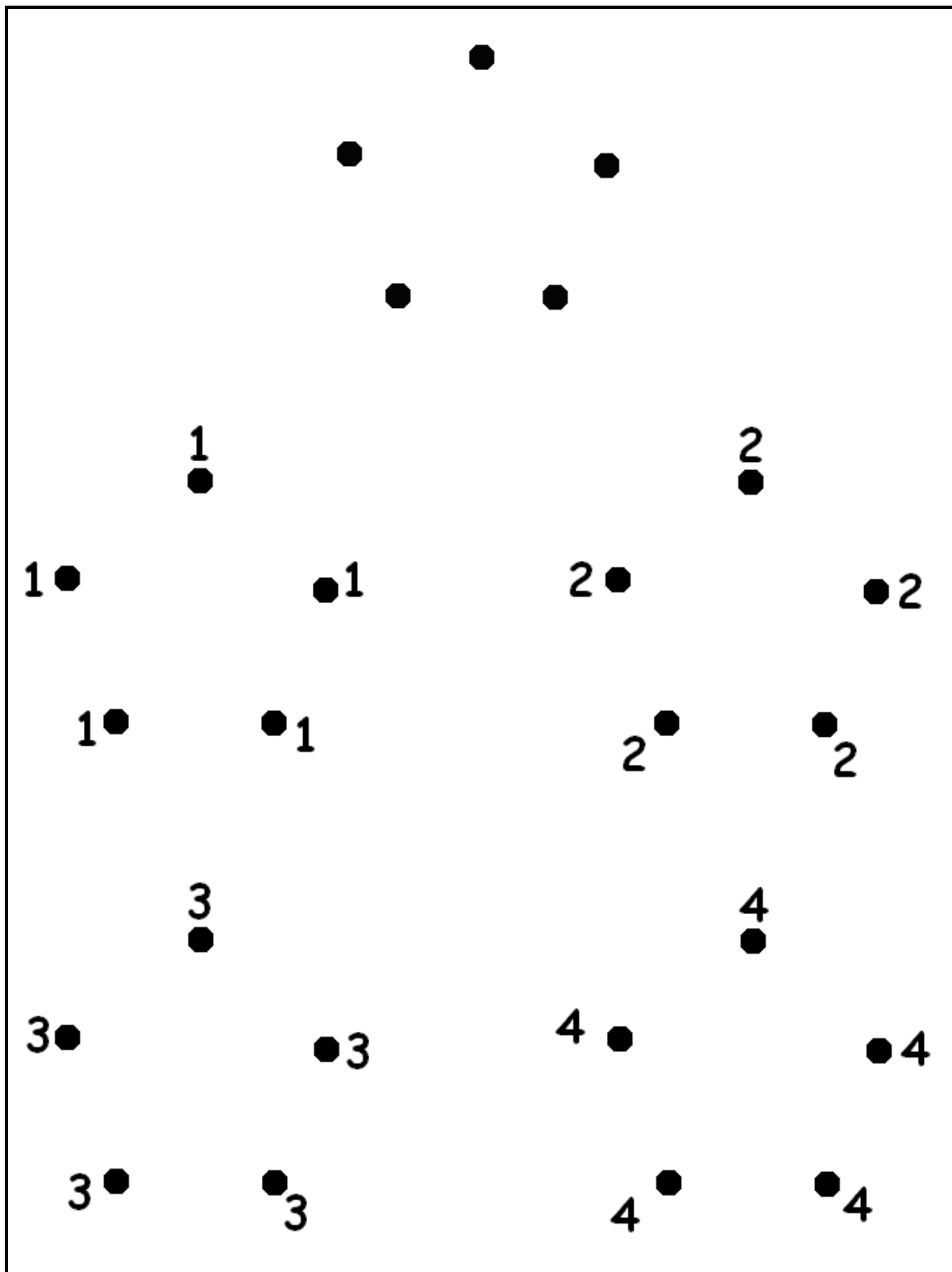

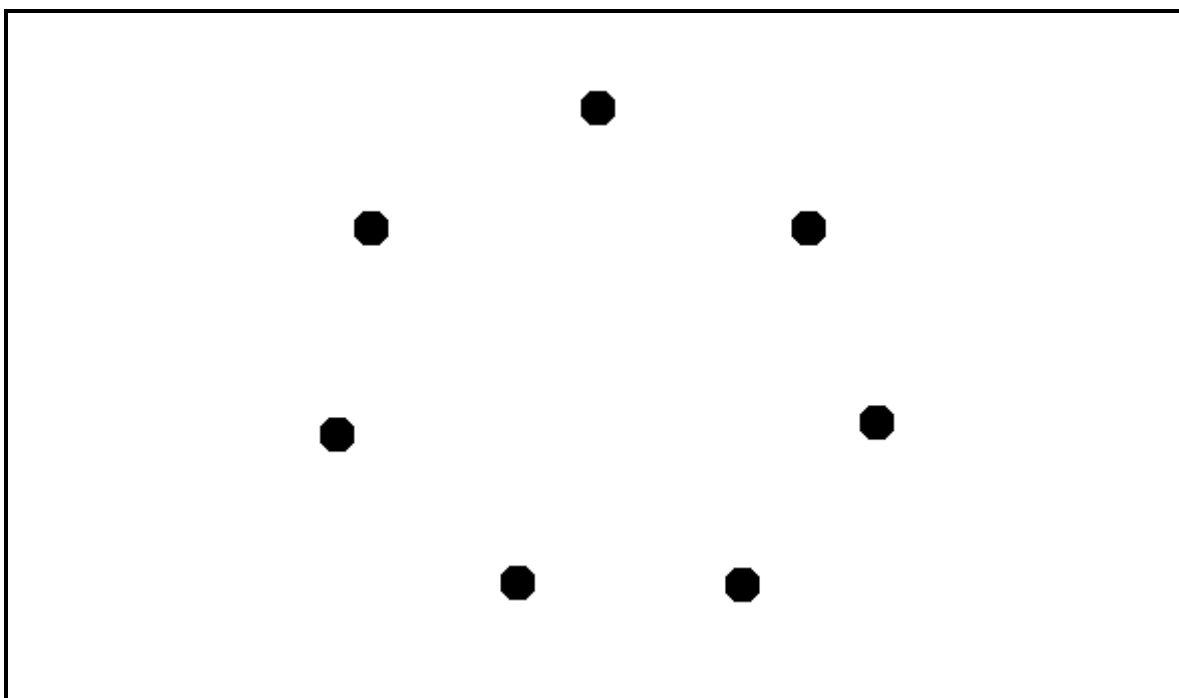
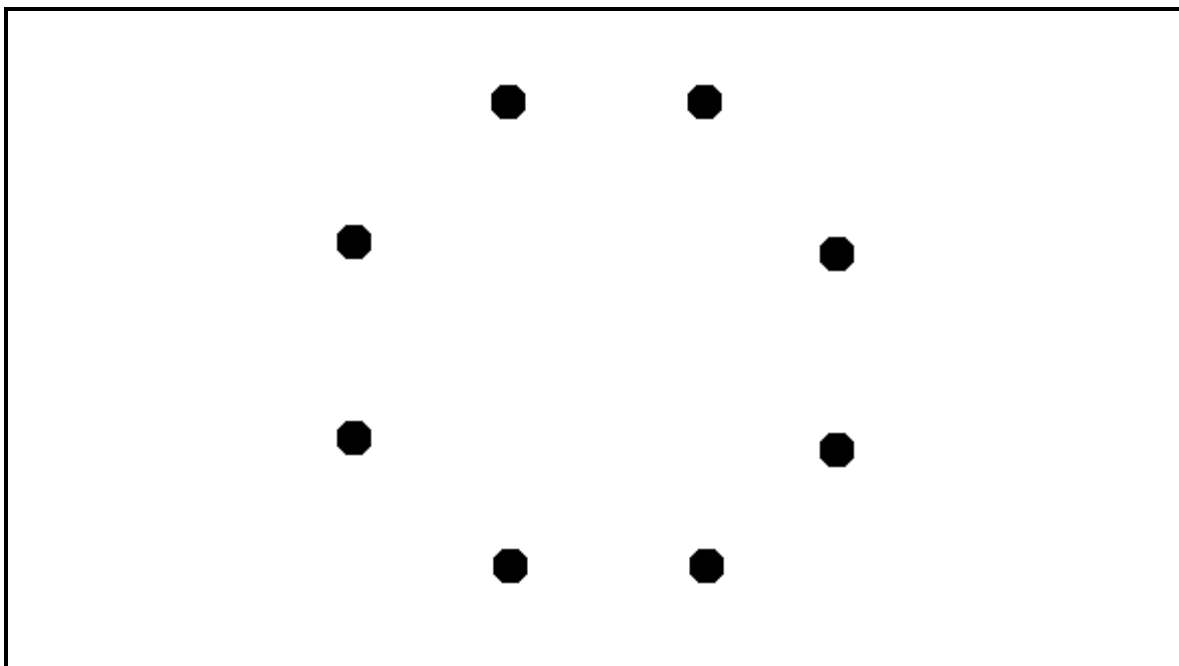



MATH WITHOUT WORDS: 30

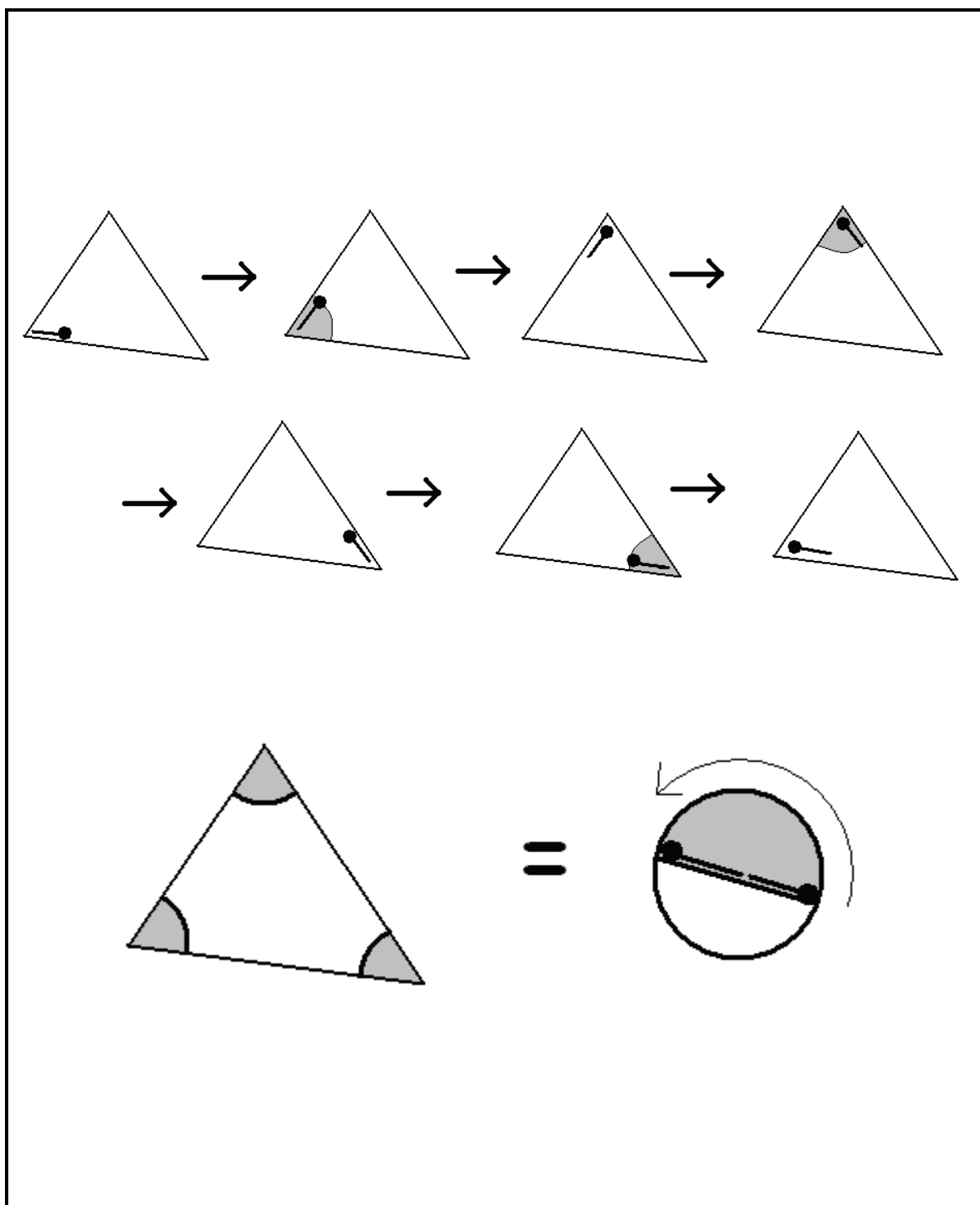

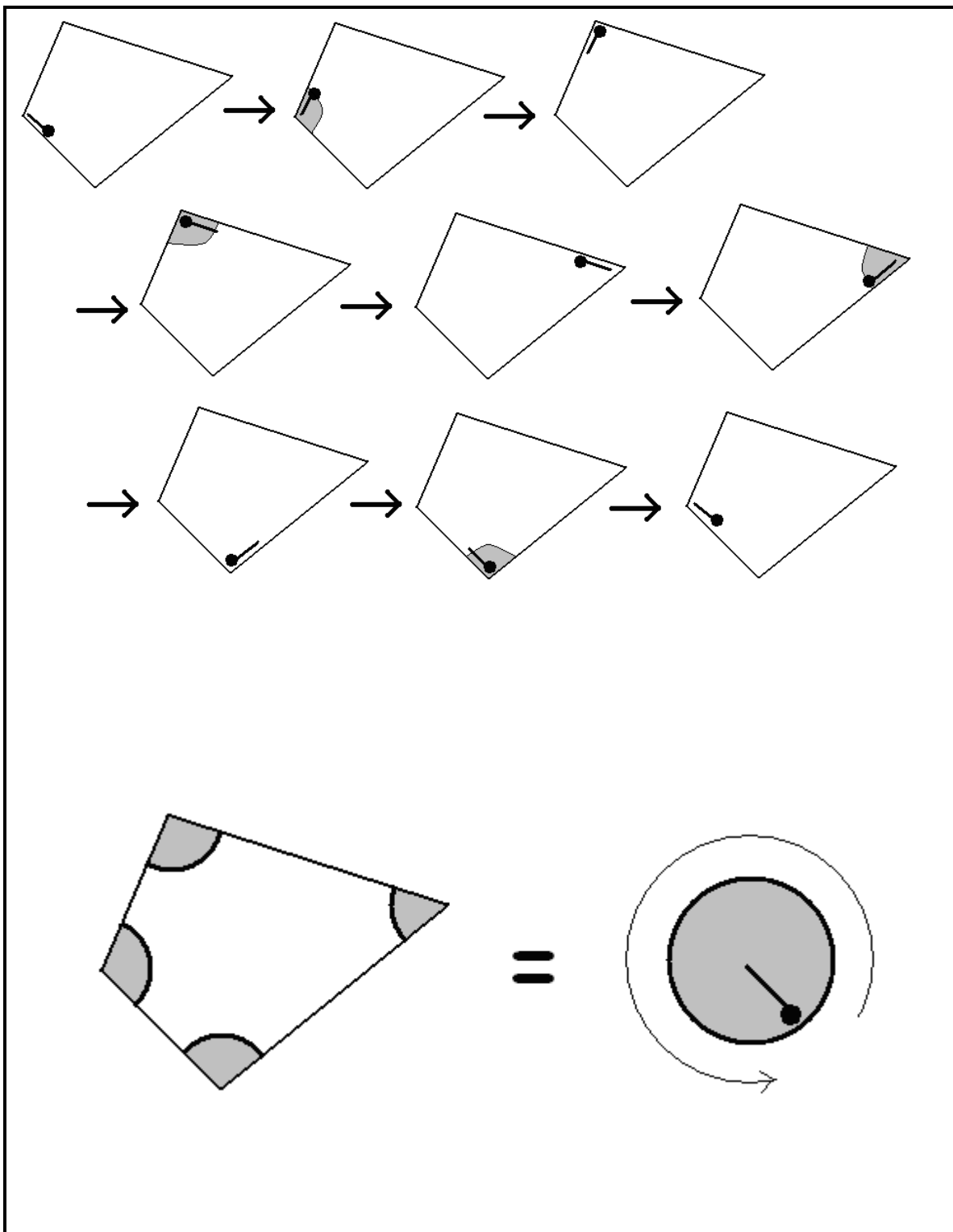

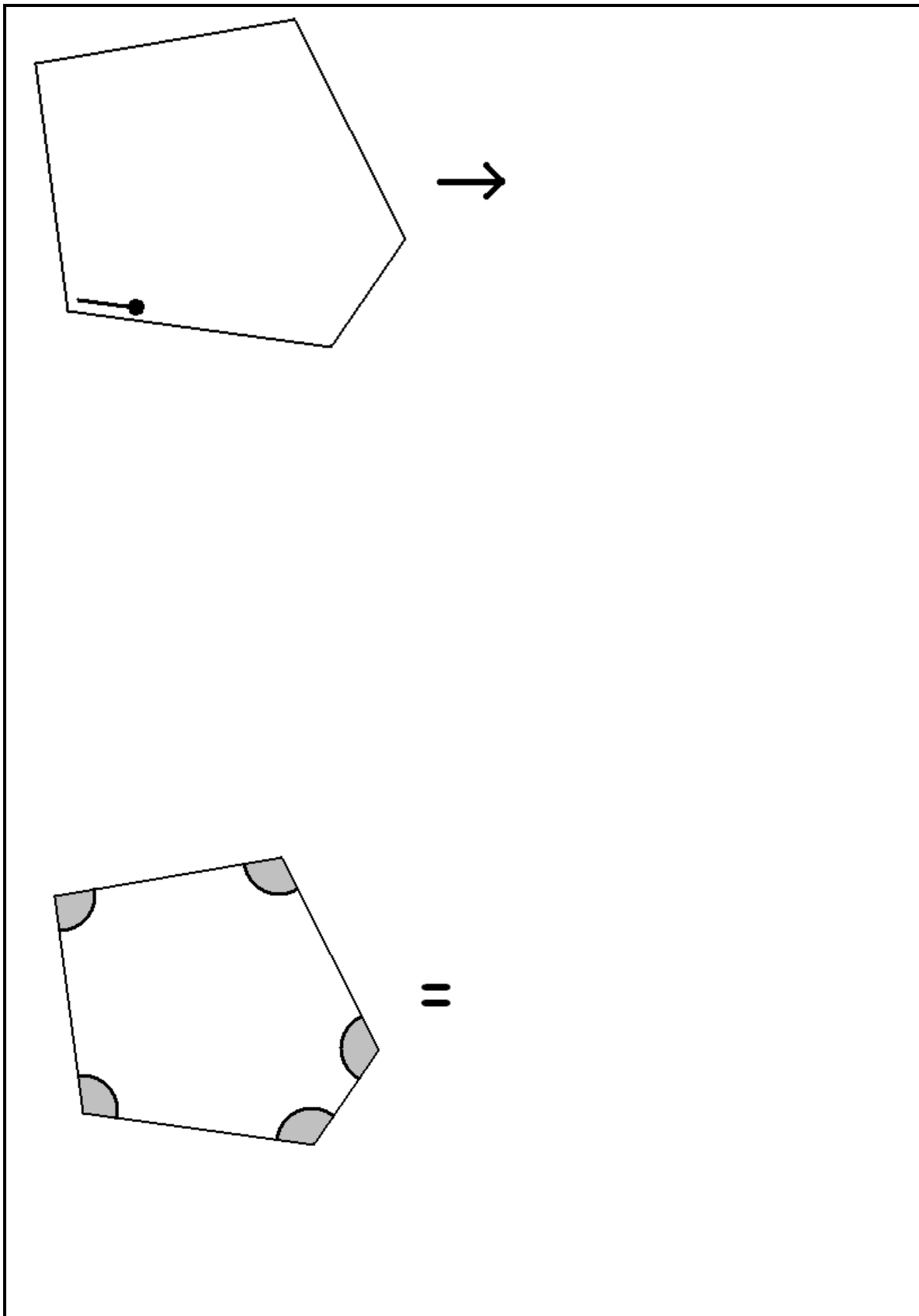

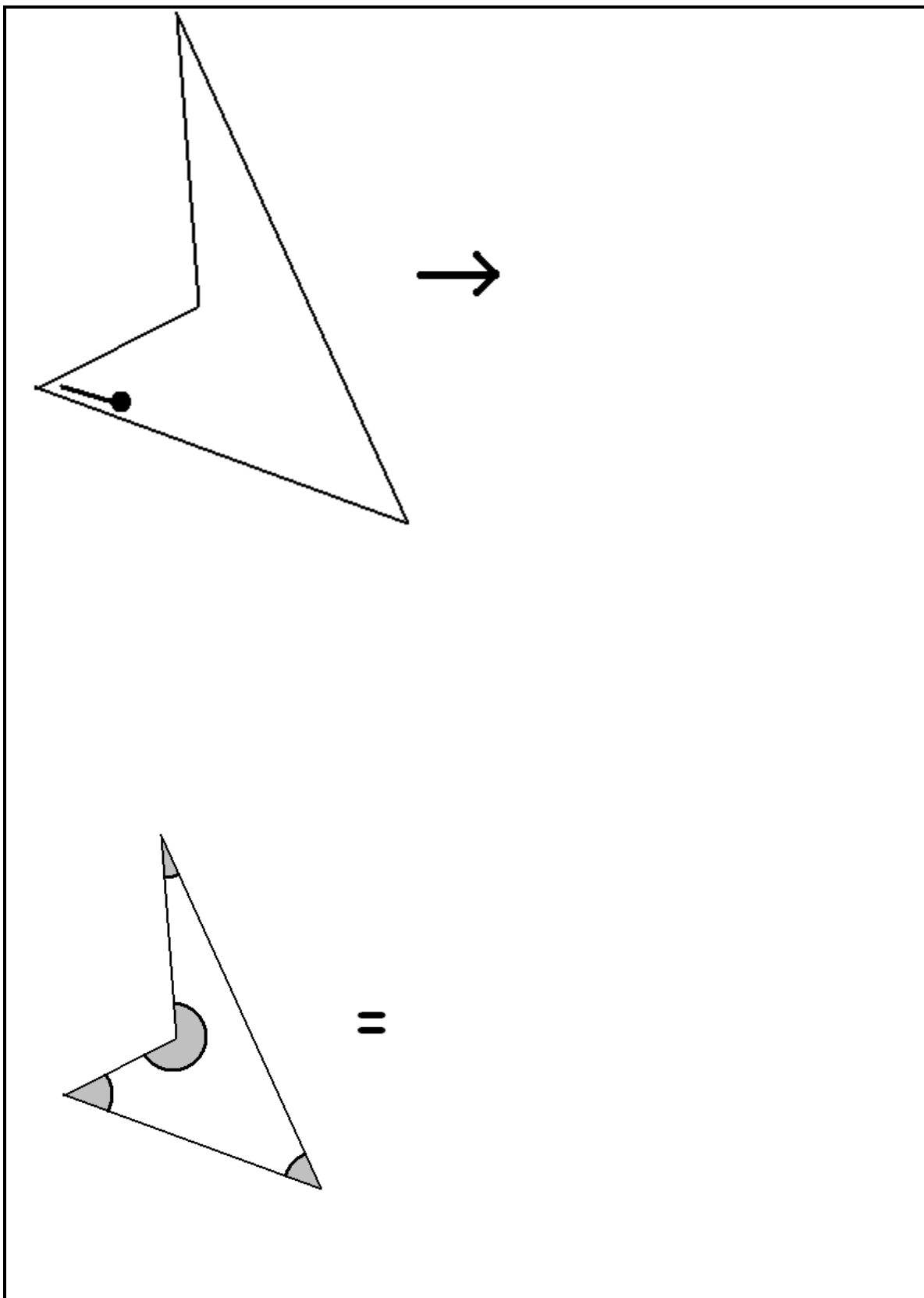

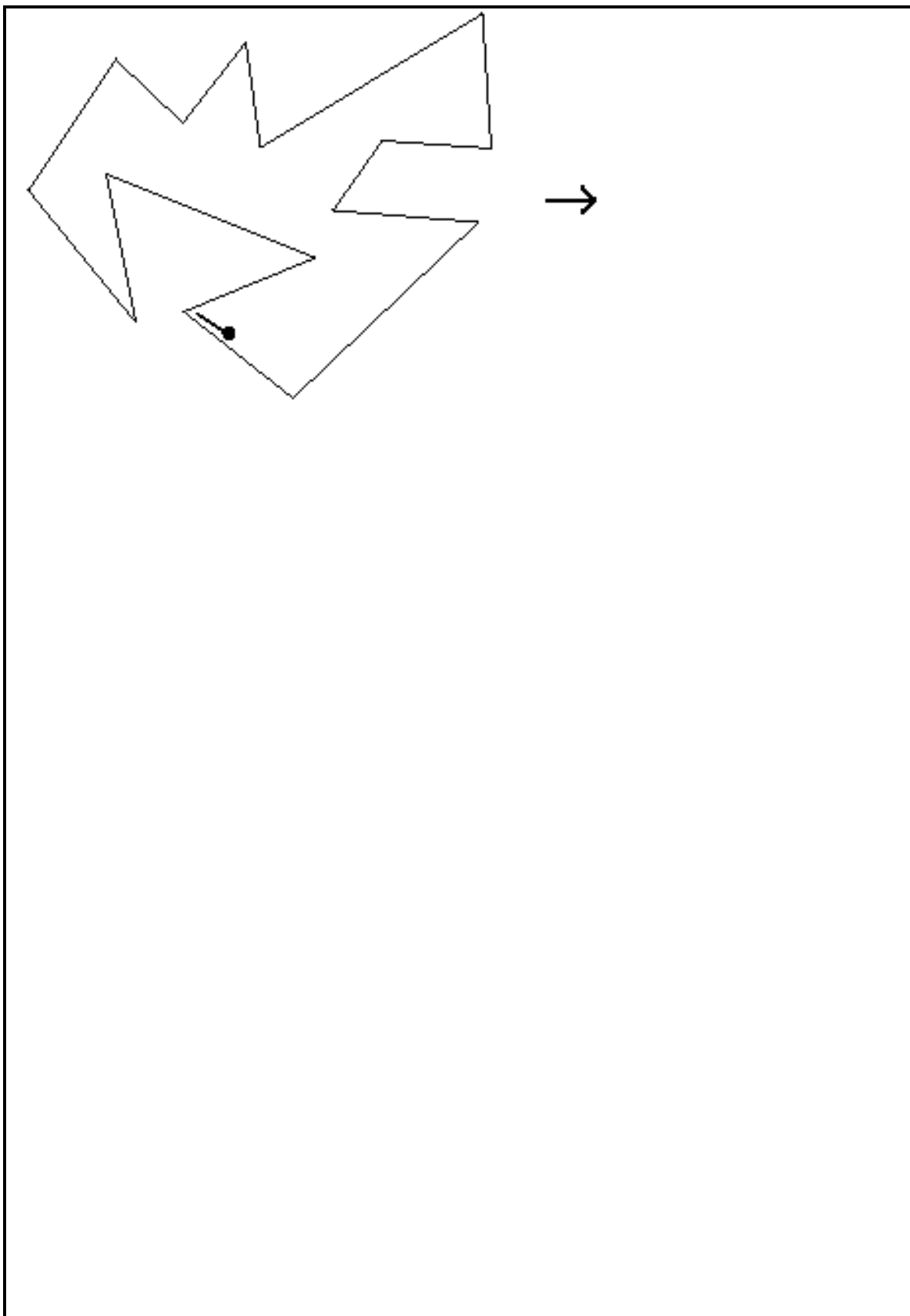

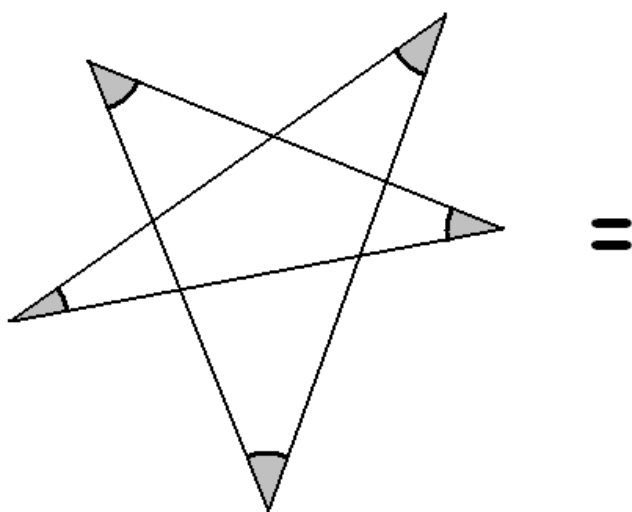



MATH WITHOUT WORDS: 31

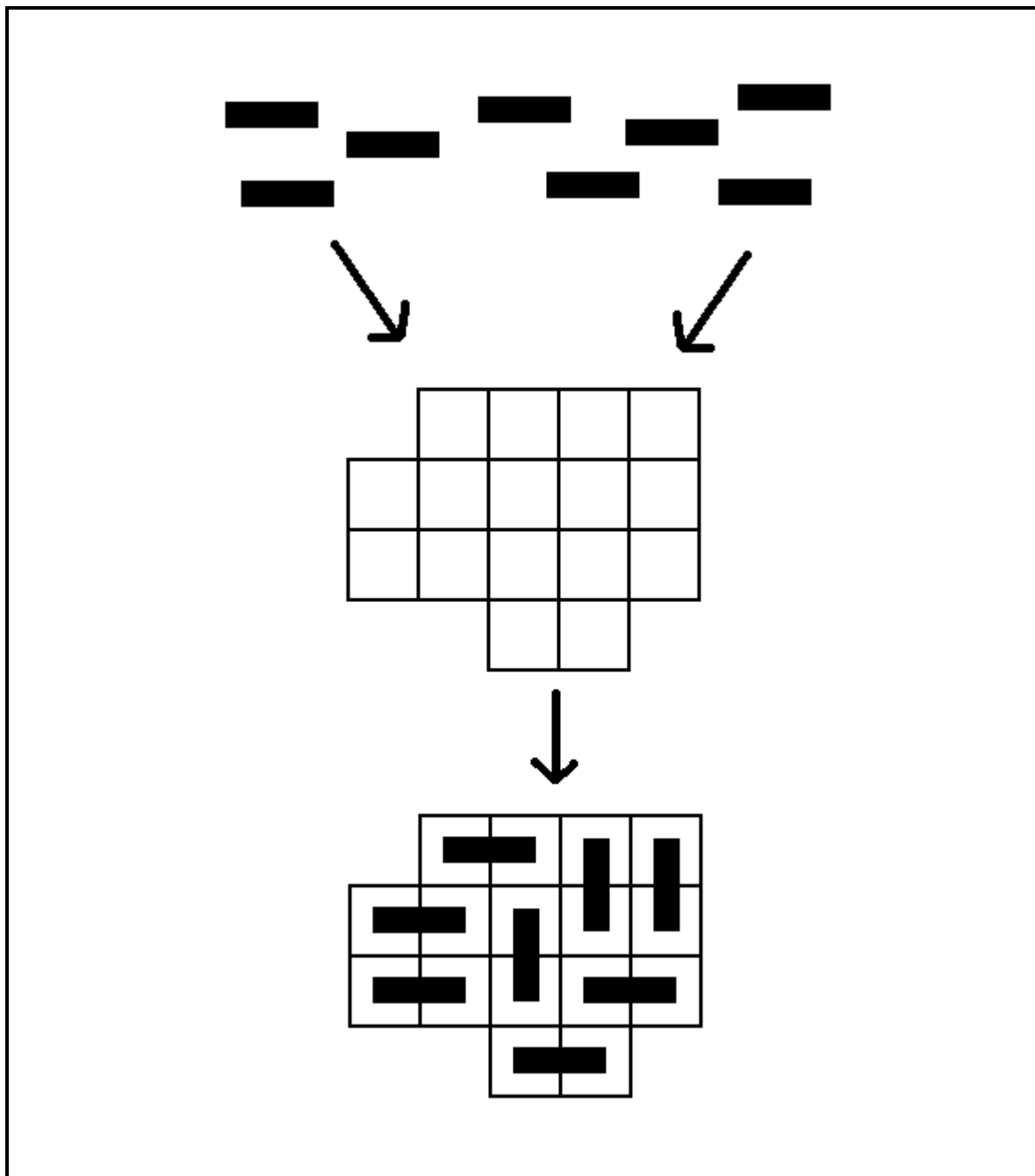

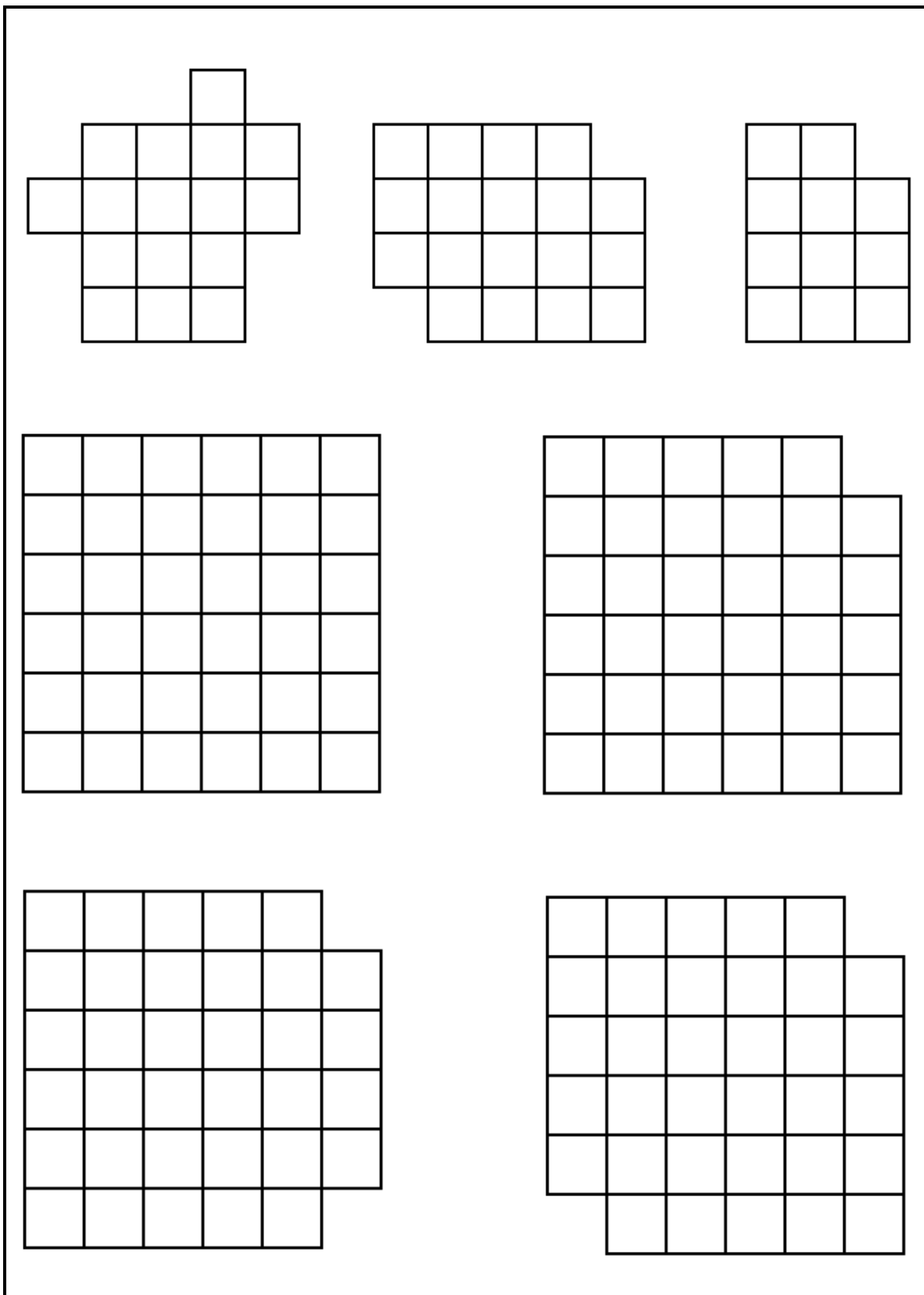



MATH WITHOUT WORDS: 32

●

←

●●

●●●●

↓

●

●●

↓

●●

●

↓

●

●

=

●

●

●●●●●

↓

●●●●

●

↓

●●

●

●

↓

●

●

●

=

●

●

●

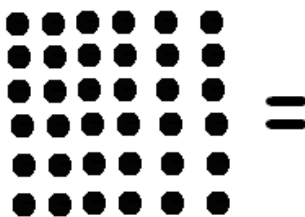
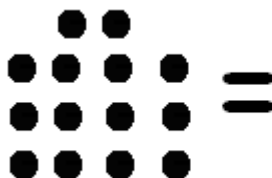
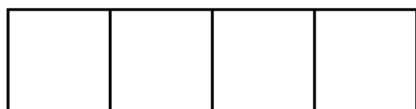
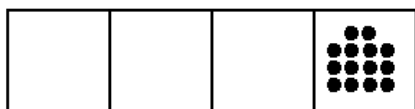
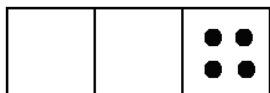

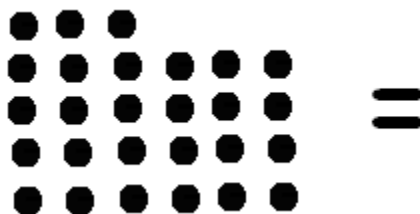
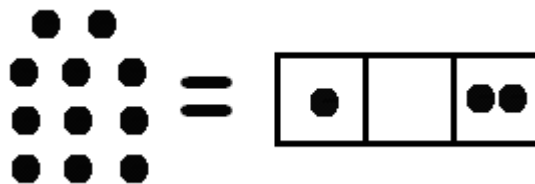
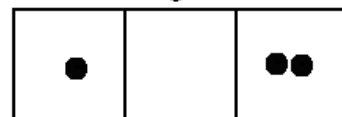
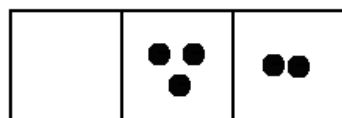
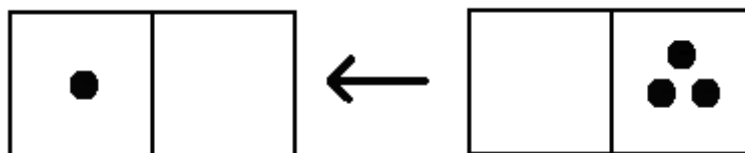

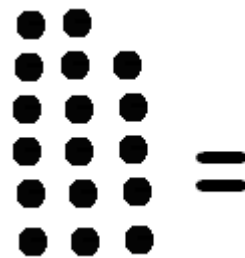
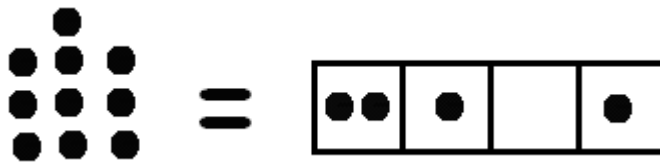
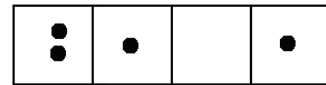
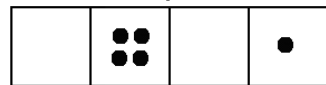
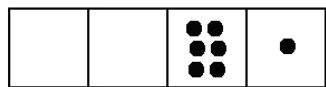



.....

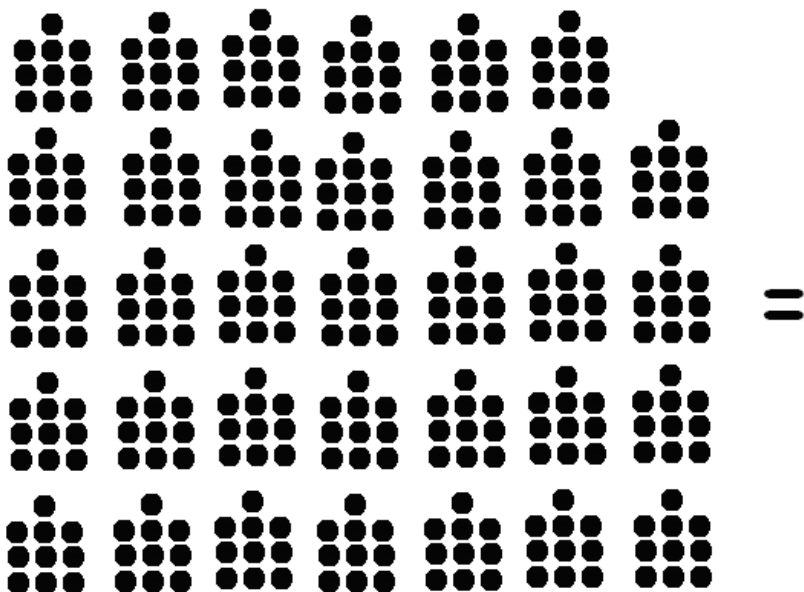



MATH WITHOUT WORDS: 33

| | |
|---|----|
| ● | 1 |
| ●● ●●● | 2 |
| ●●● ●●● ●●● ●●● ●●● | 5 |
| ●●●● ●●●● ●●●● ●●●● | 13 |
| ●●●● ●●●● ●●●● | |
| ●●●● ●●●● ●●●● ●●●● ●●●● ●●●● | |
| ●●●●● | |



MATH WITHOUT WORDS: 34

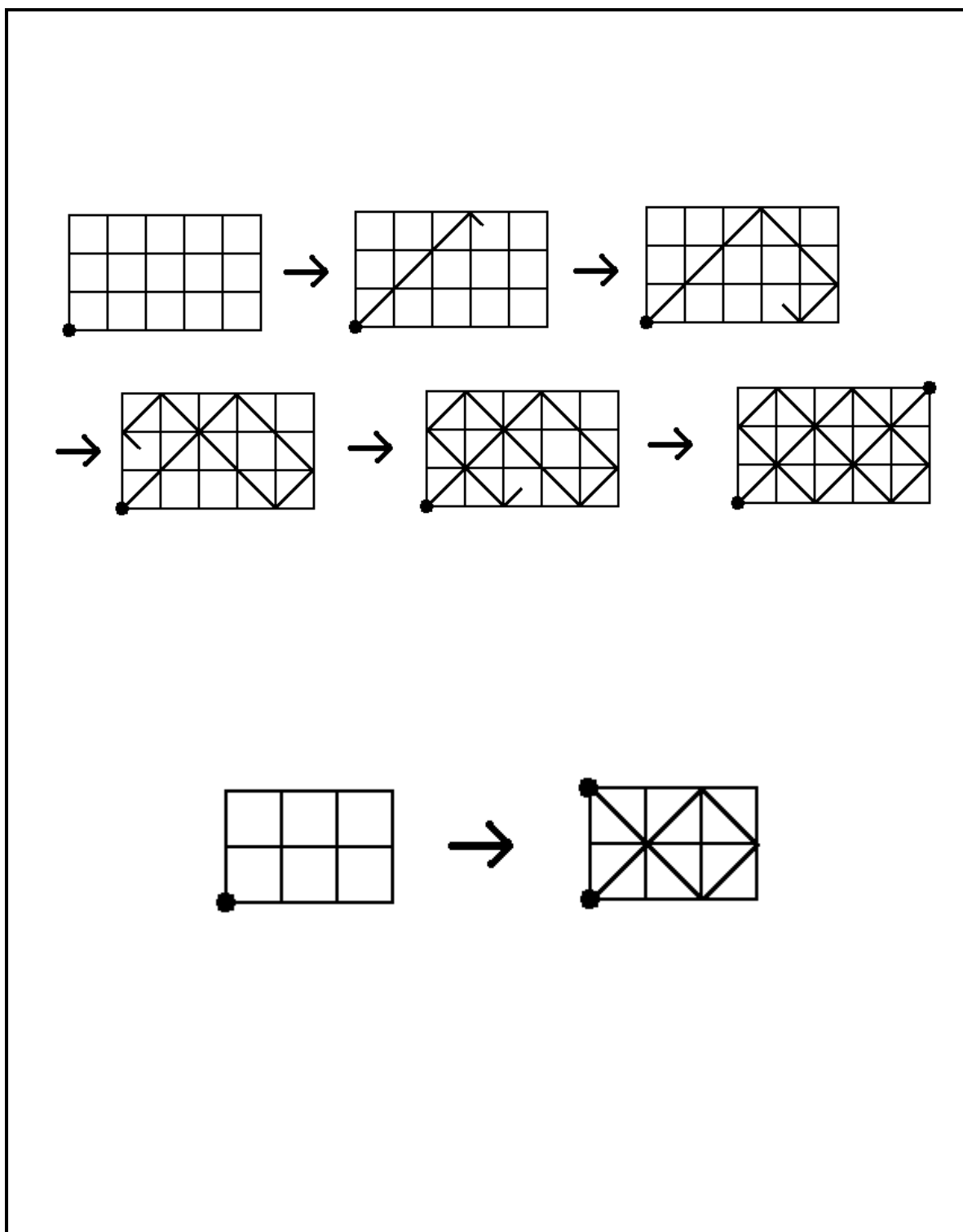

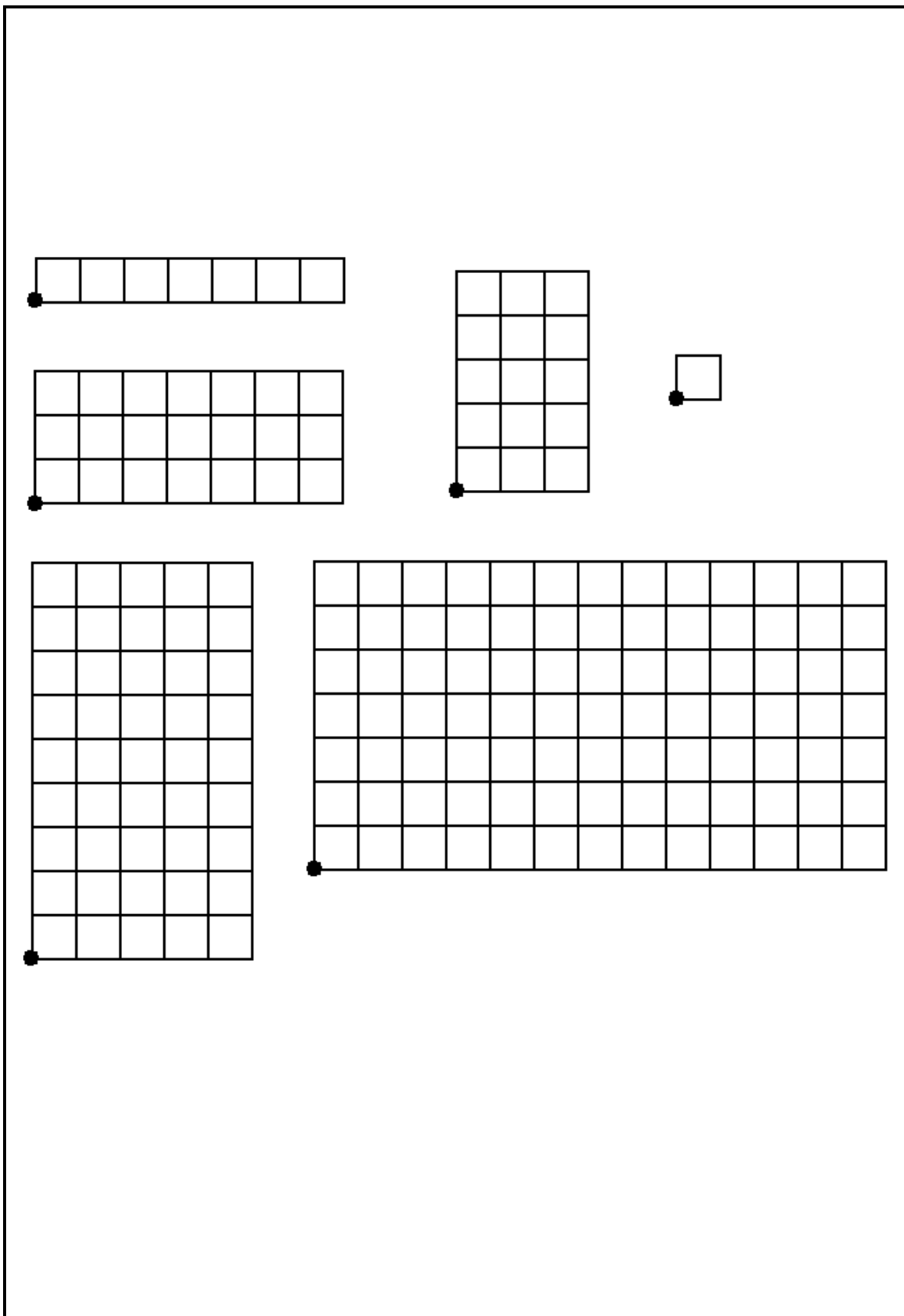

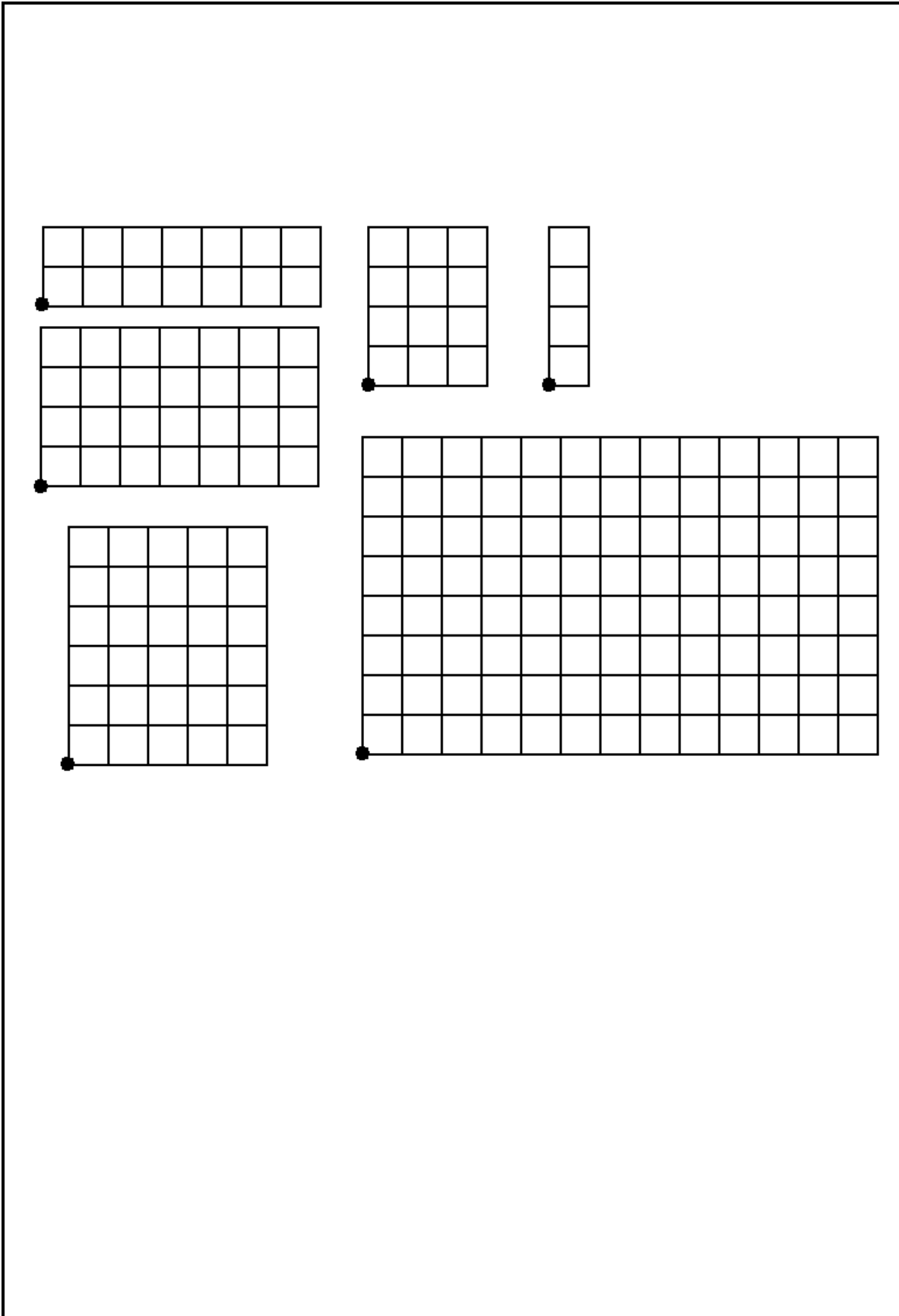

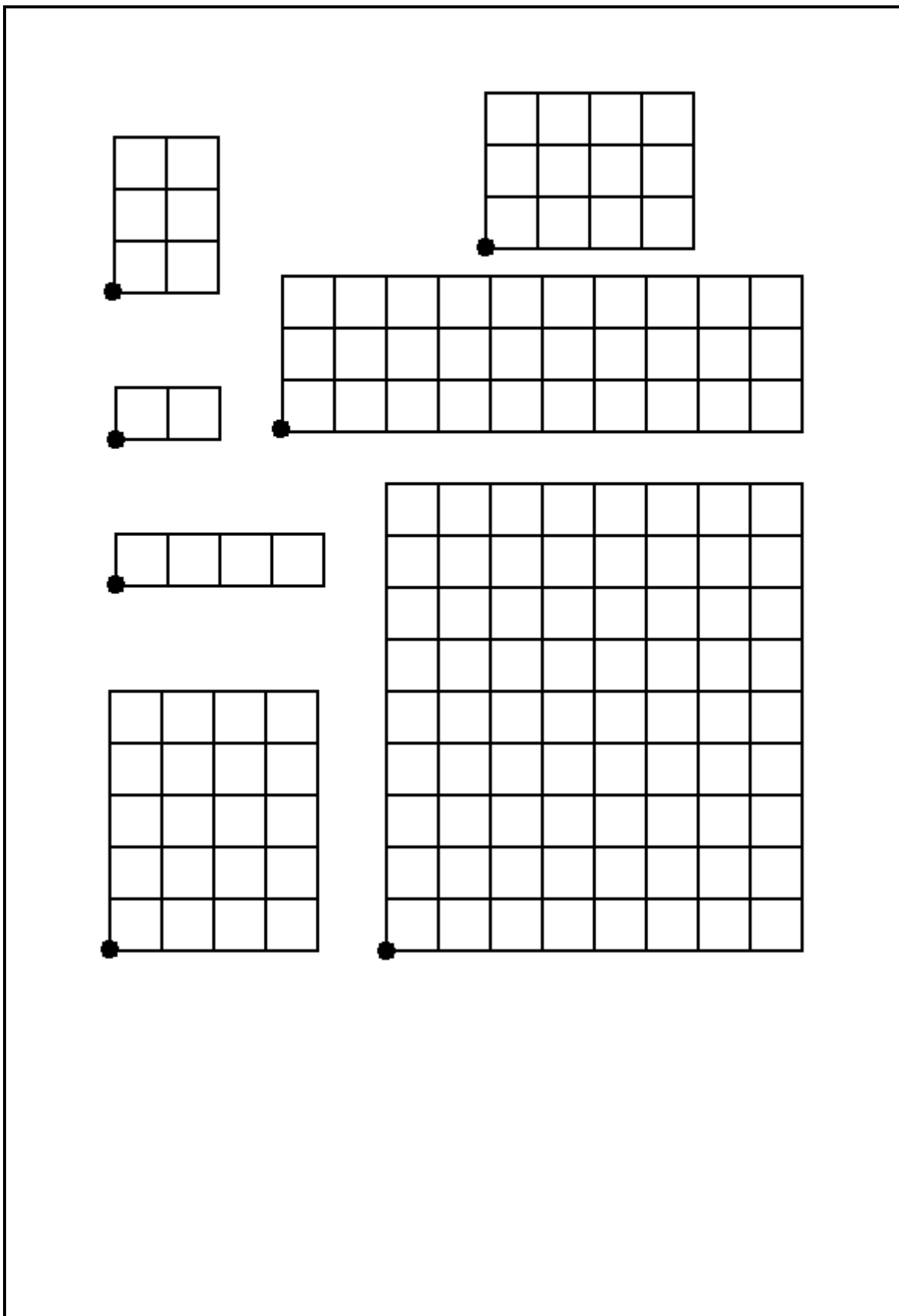

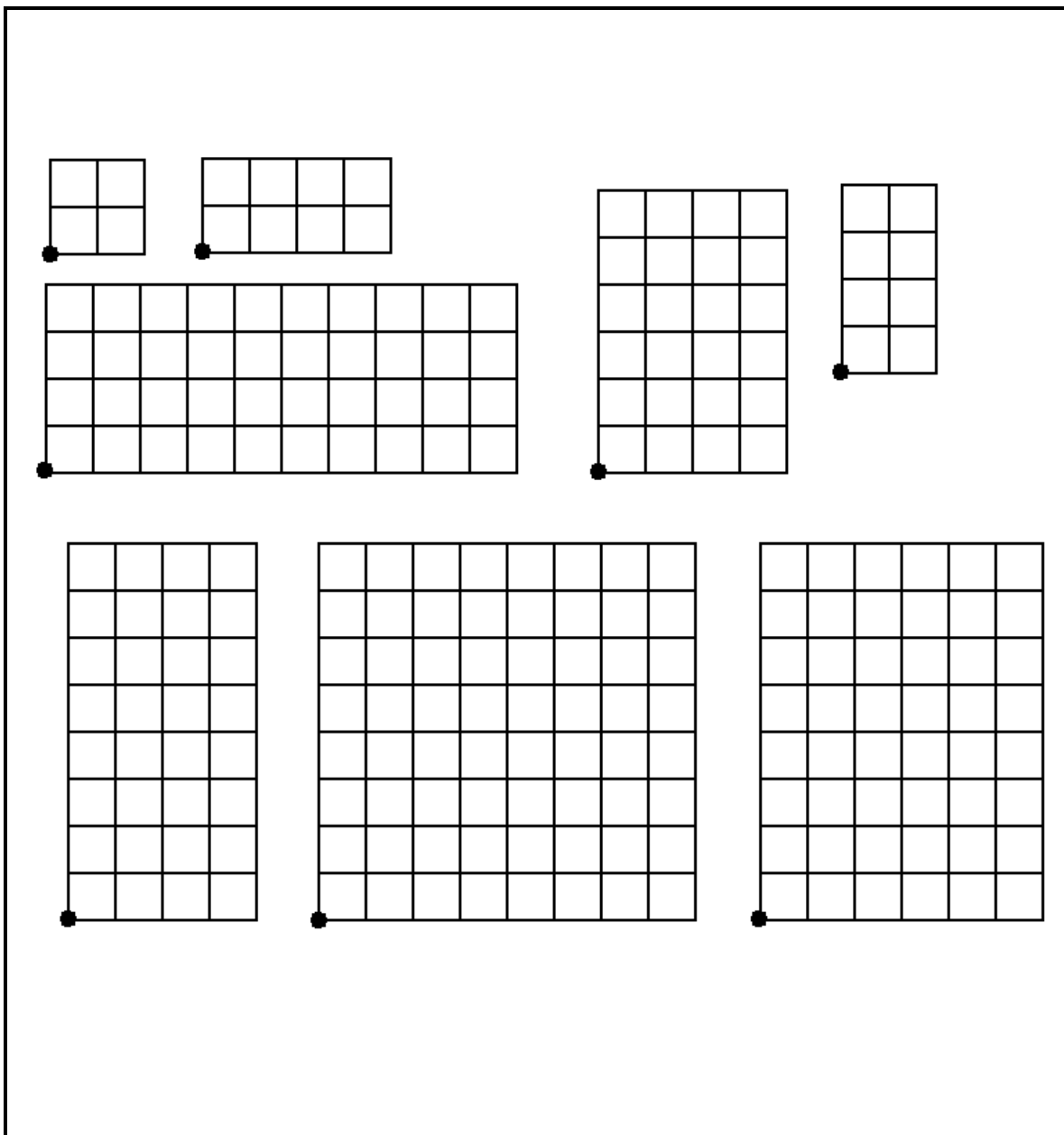





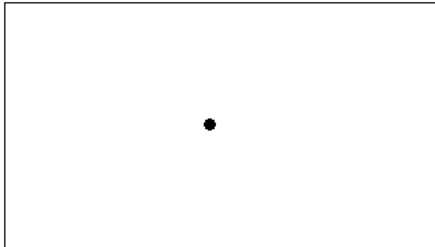

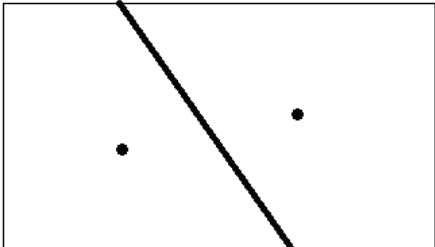

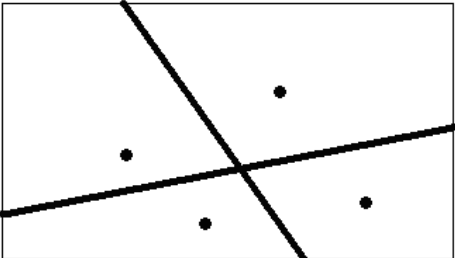
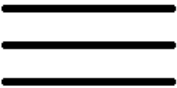
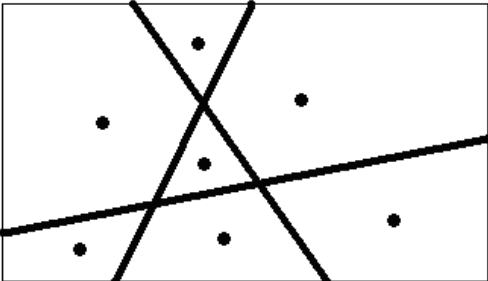













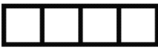
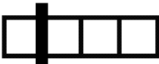

MATH WITHOUT WORDS: 35

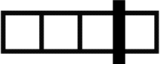
| | | |
|---|--|----------|
| |  | 1 |
|  |  | 2 |
|  |  | 4 |
|  |  | 7 |

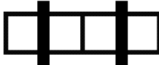
| | | |
|--|--|-----------|
| | | 11 |
| | | 16 |
| | | |





MATH WITHOUT WORDS: 36

| | |
|--|----------|
|  | 1 |
| <hr/> | |
|   | 2 |
| <hr/> | |
|     | 4 |
| <hr/> | |
|     | 8 |
|     | |
| <hr/> | |
|  | |
| <hr/> | |
|  | |
| <hr/> | |
|  | |

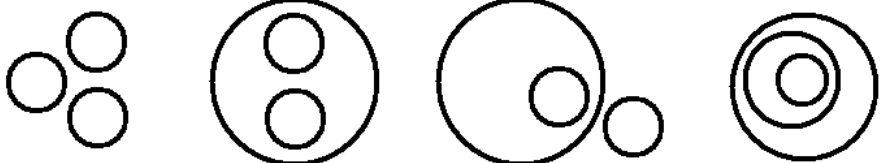
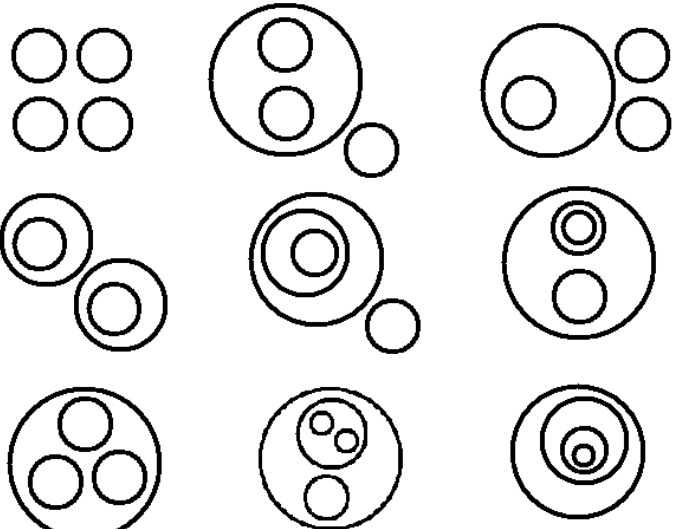

MATH WITHOUT WORDS: 37

| | |
|--|----------|
|  | 1 |
|  | 2 |
|  | 4 |
|  | 9 |

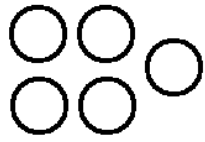

20

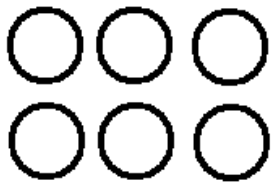



MATH WITHOUT WORDS: 38

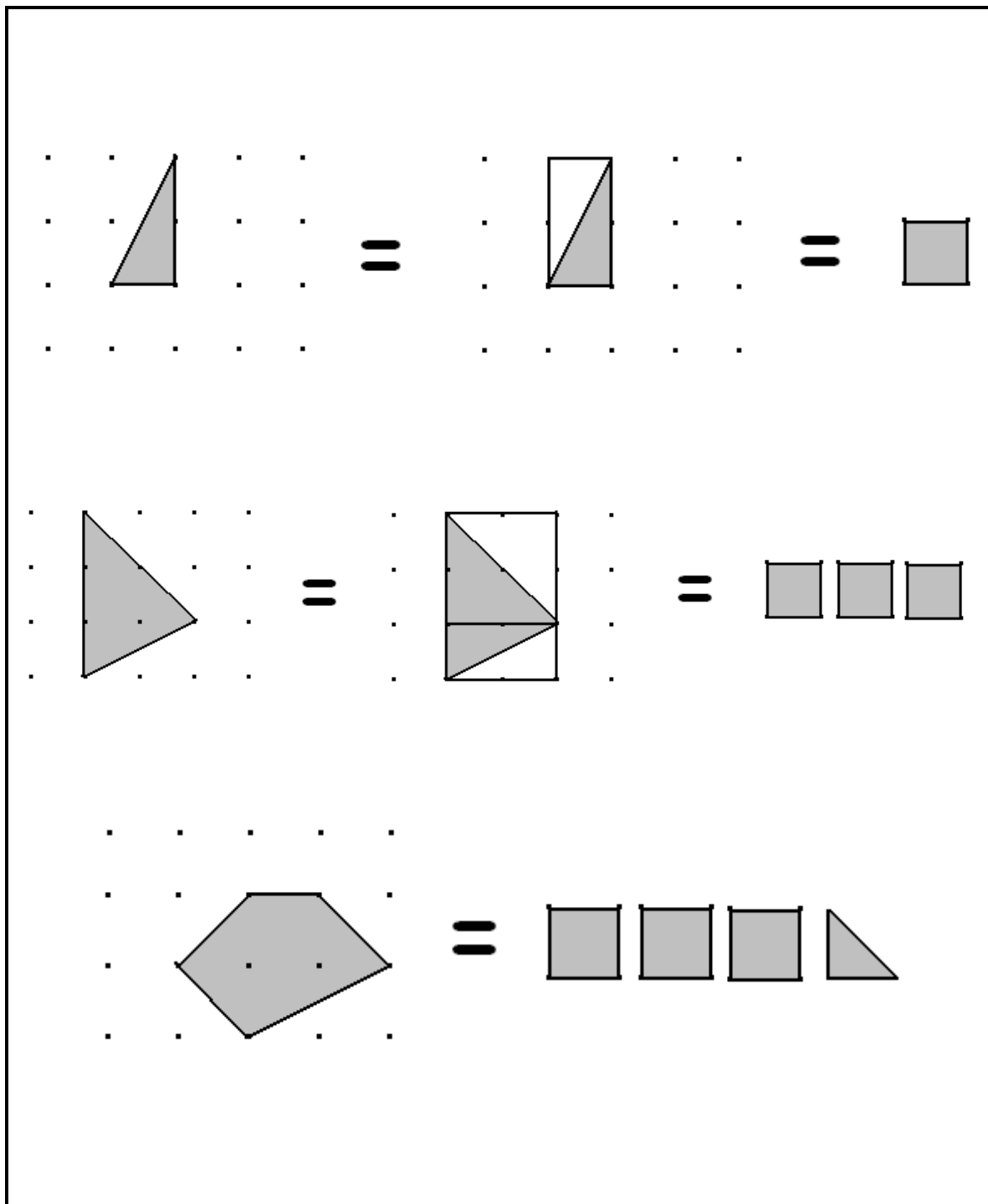

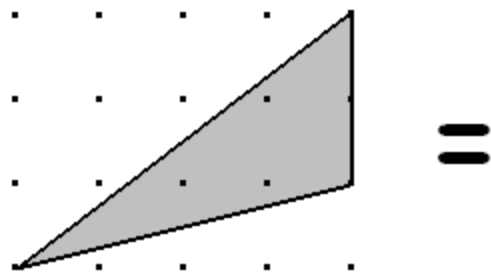
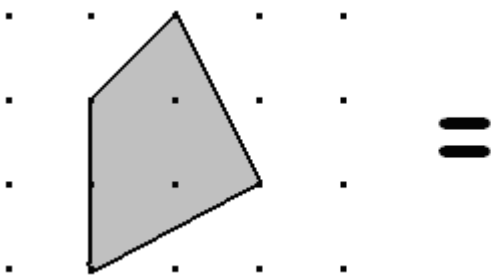
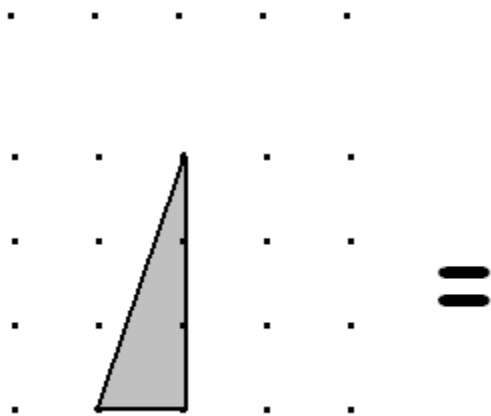
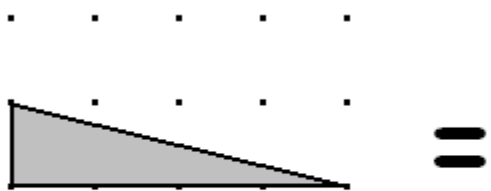

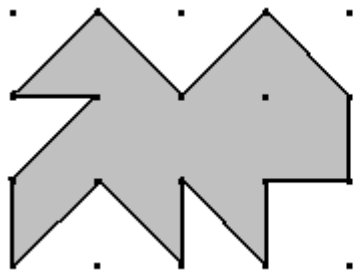

=

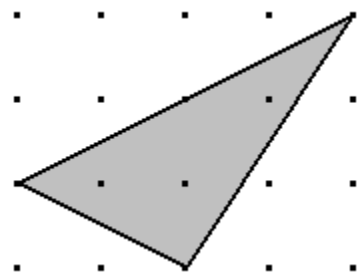

=

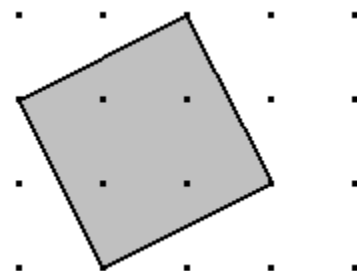

=

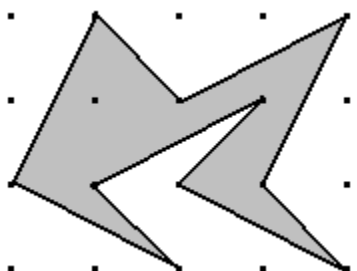

=



MATH WITHOUT WORDS: 39

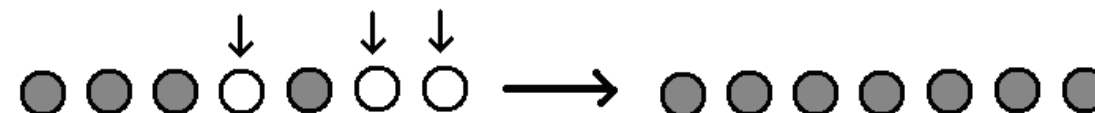
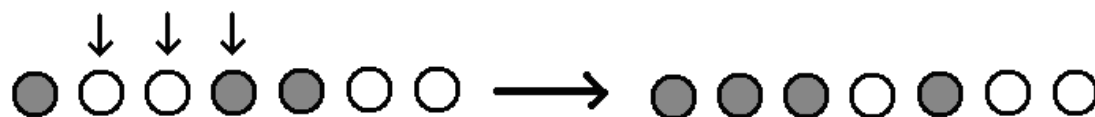
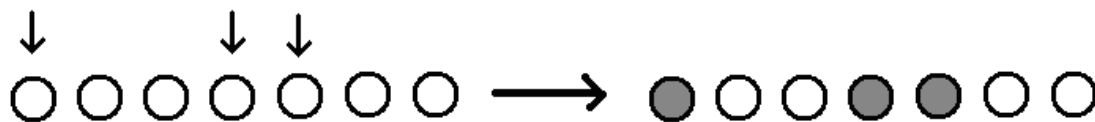

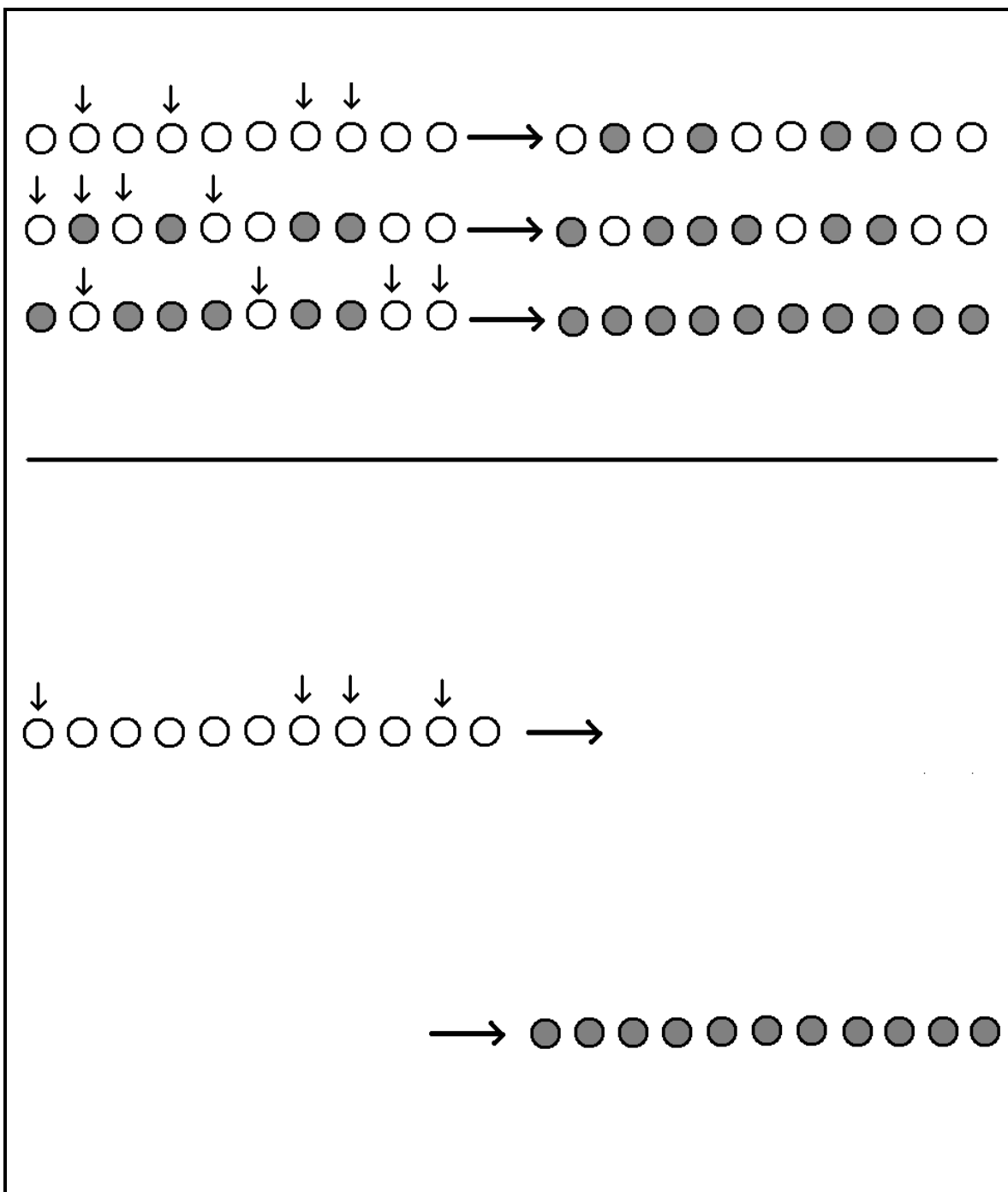



MATH WITHOUT WORDS: 40

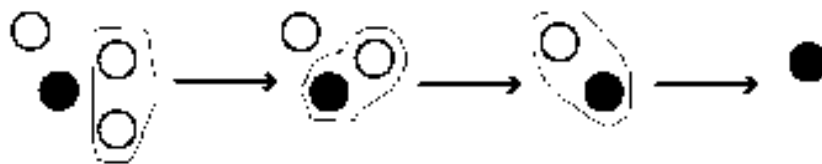
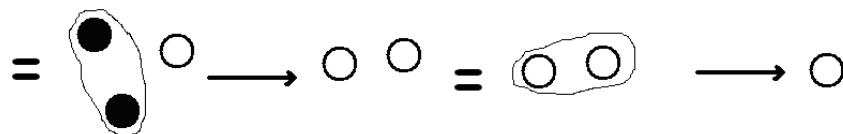
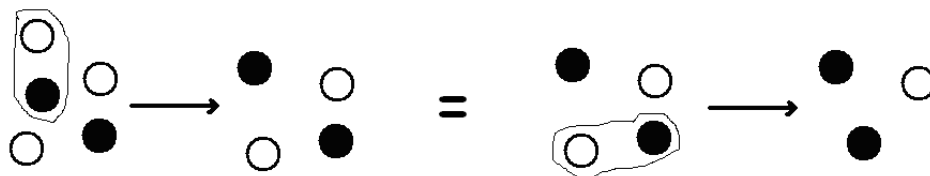
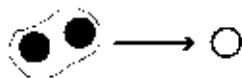
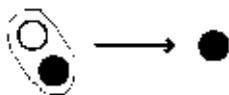
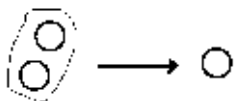

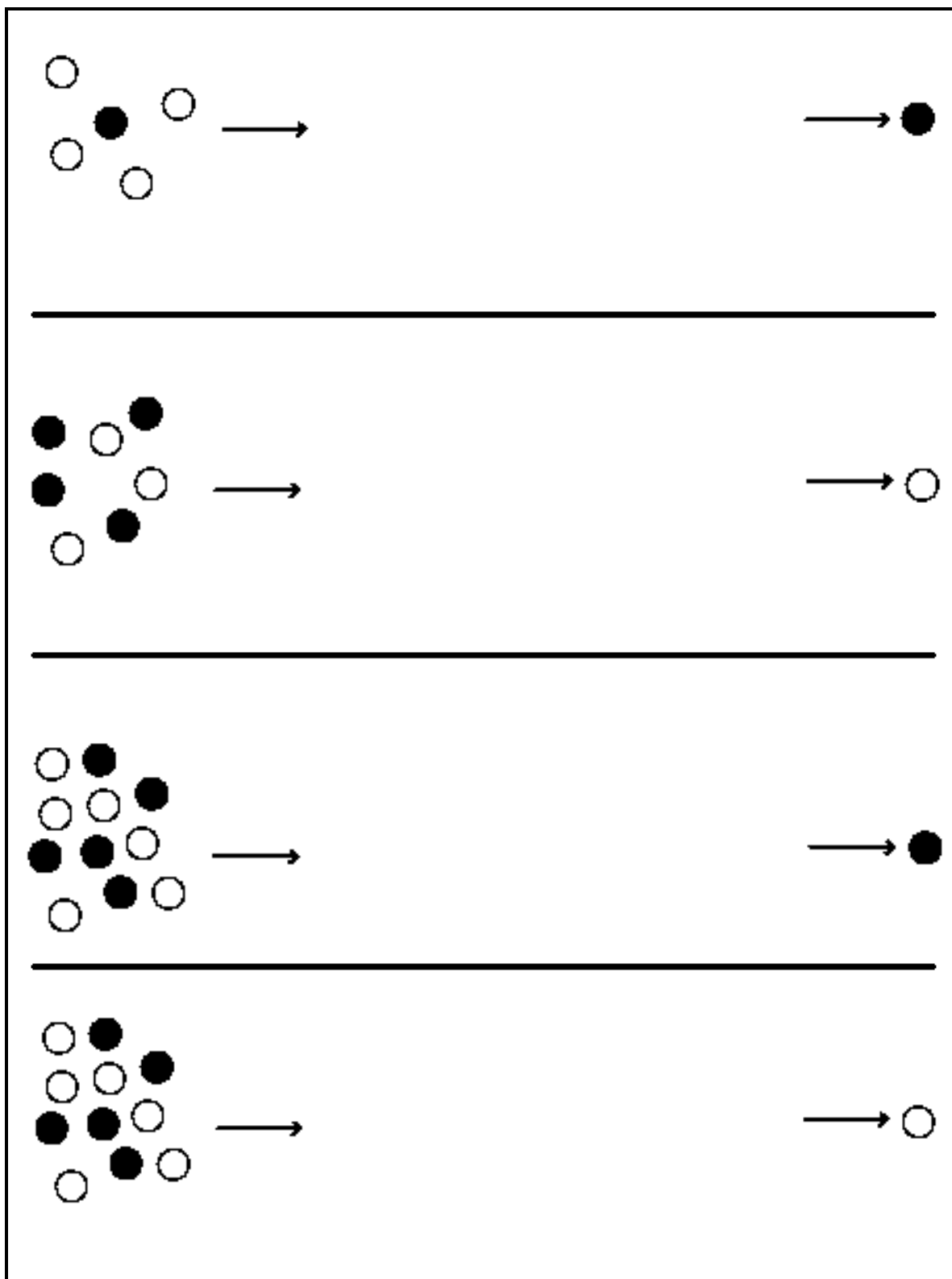



MATH WITHOUT WORDS: 41

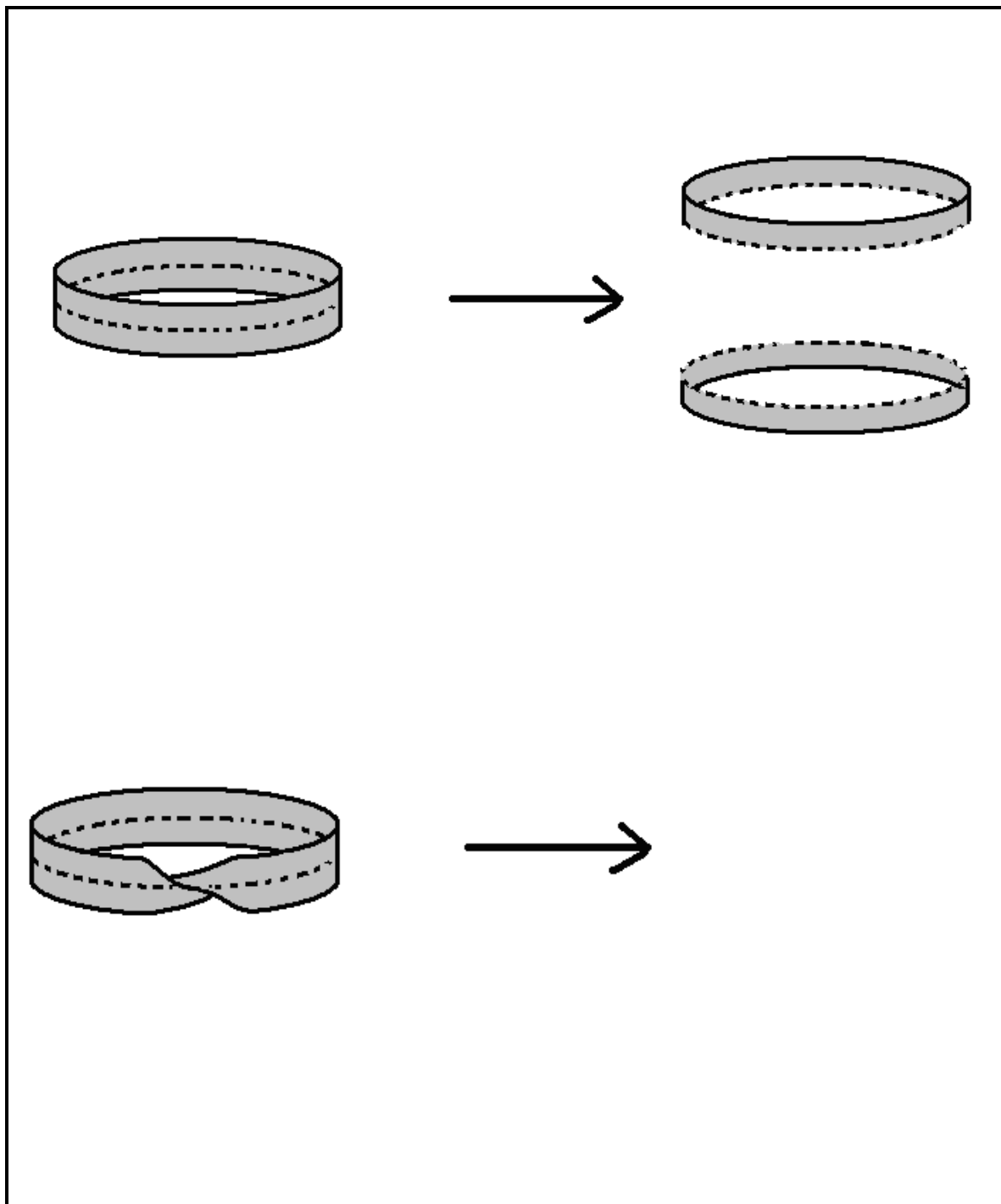

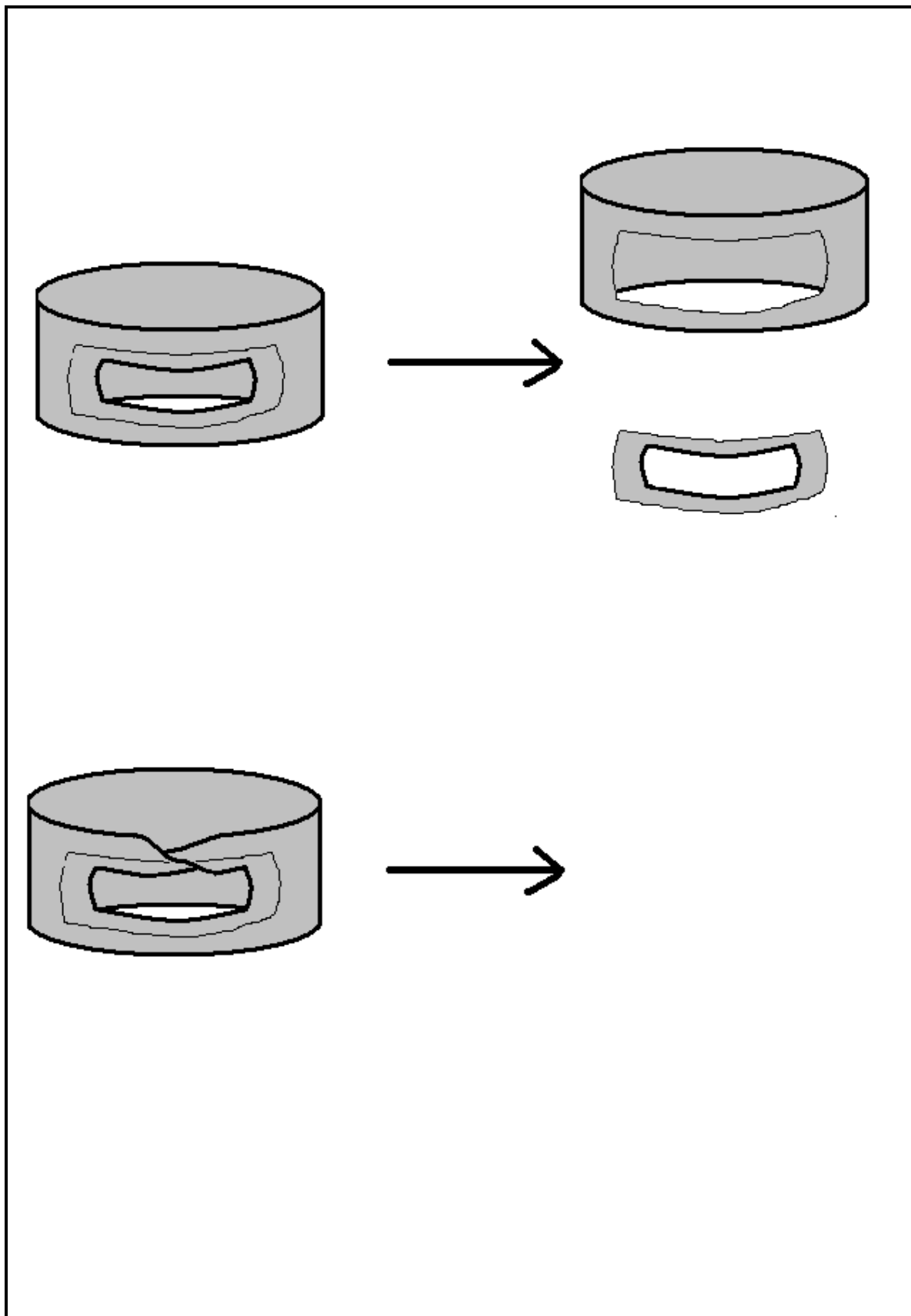

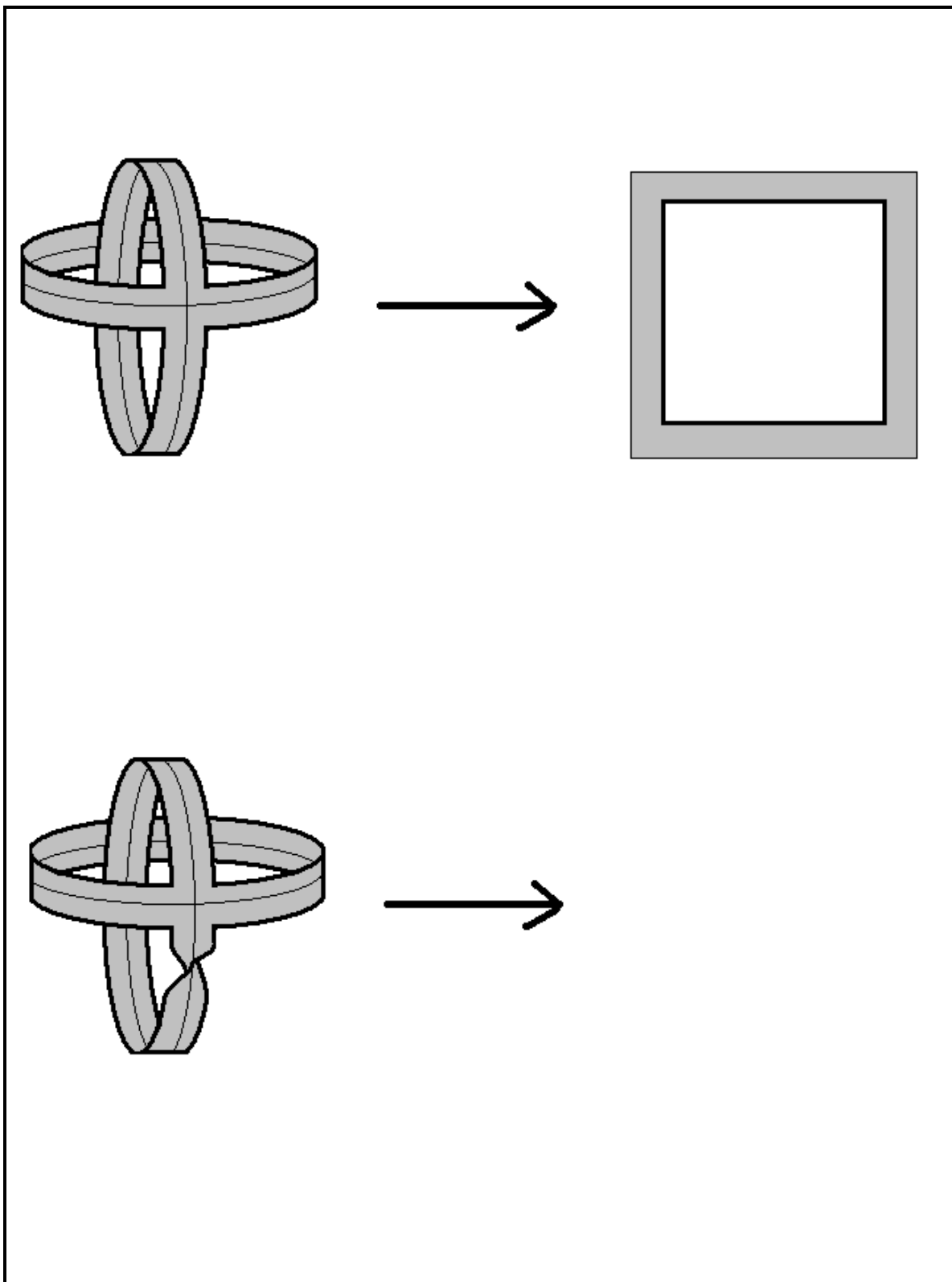



MATH WITHOUT WORDS: 42

$$\oplus = 1$$

$$\blacktriangle = 2$$

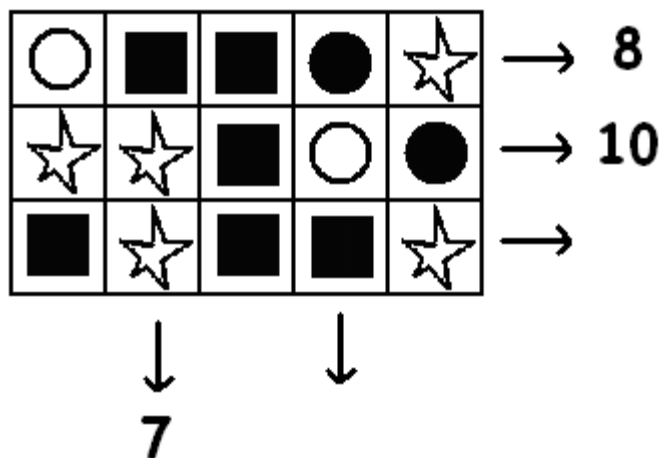
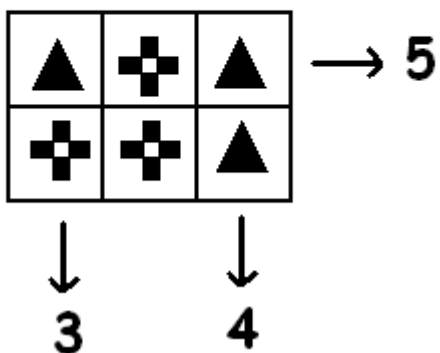





MATH WITHOUT WORDS: 43



1



2



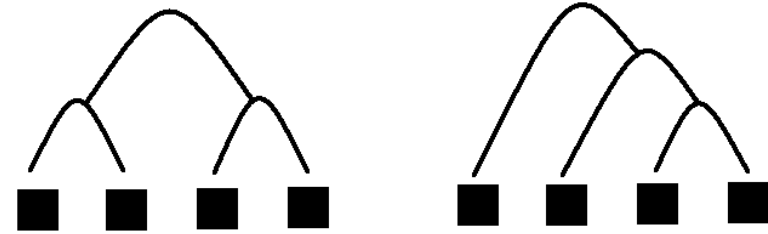

5







MATH WITHOUT WORDS: 44



•

•
• •

•
• • •

•
• • •
• • • •

•
• • •
• • • •
• • • • •

1

3

6

10

15

21

28

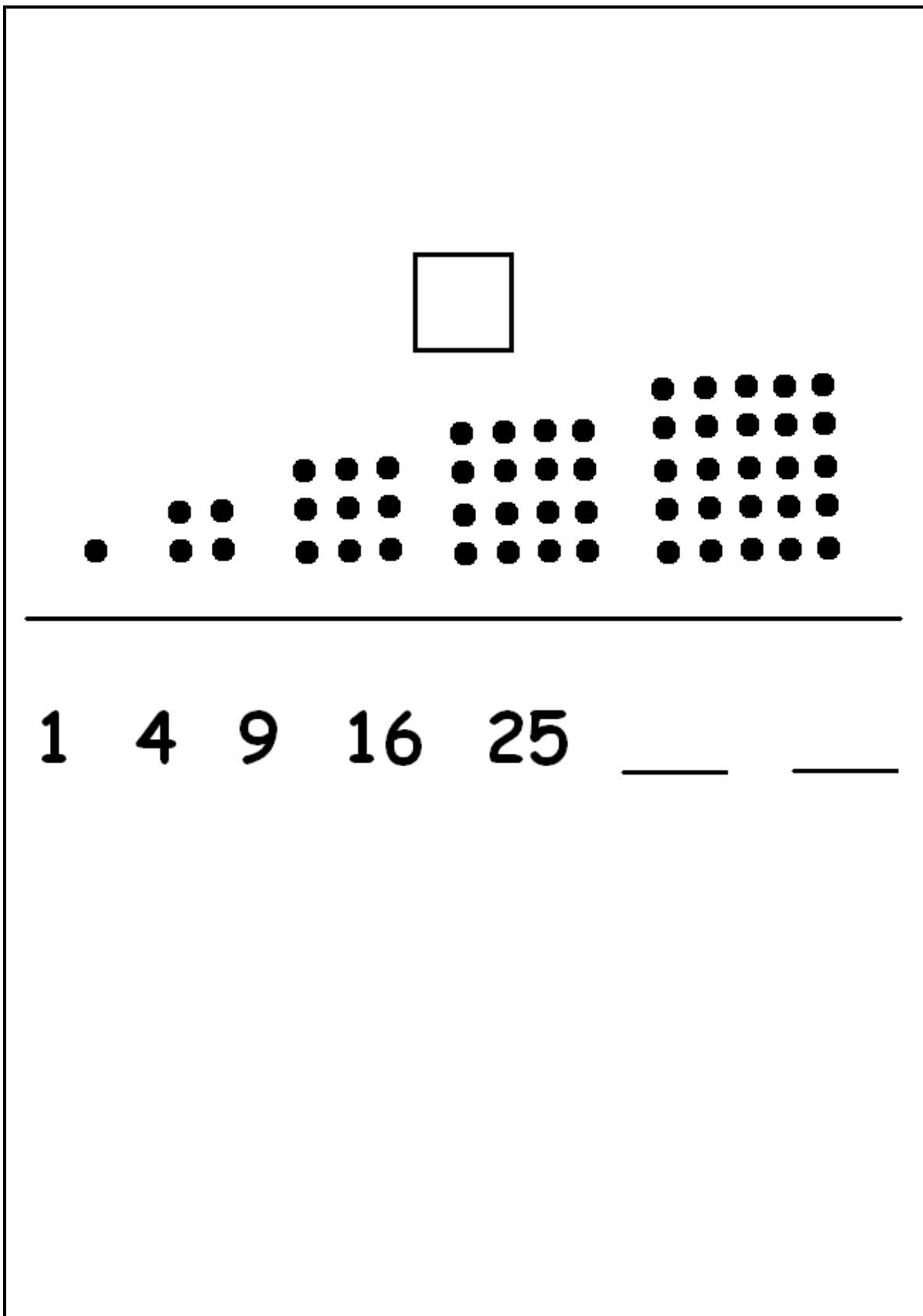

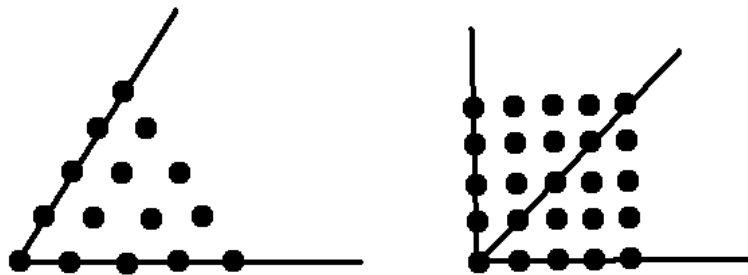

1 5 12 22 _____

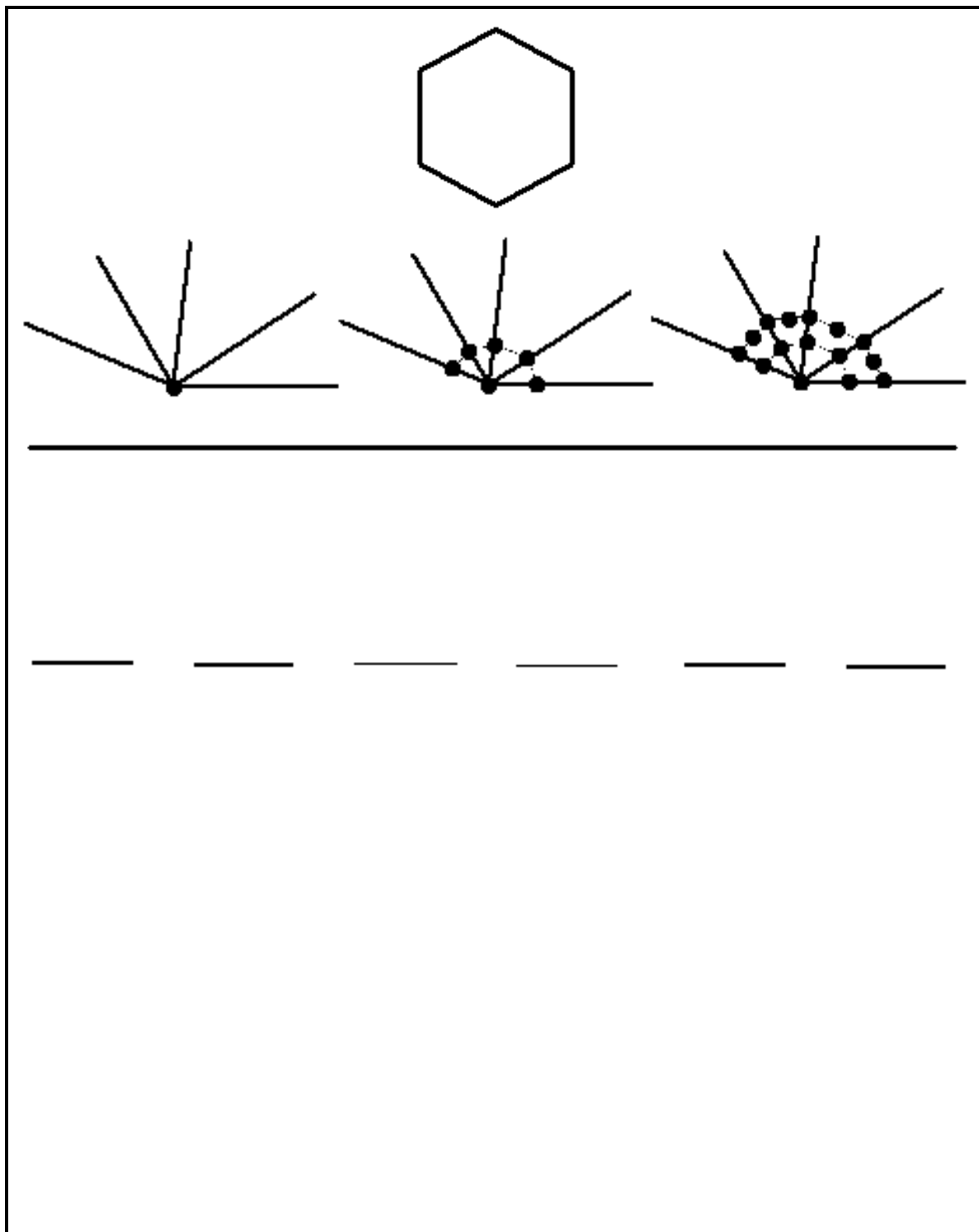

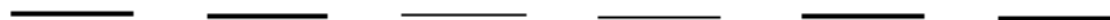
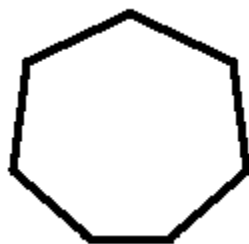



MATH WITHOUT WORDS: 45

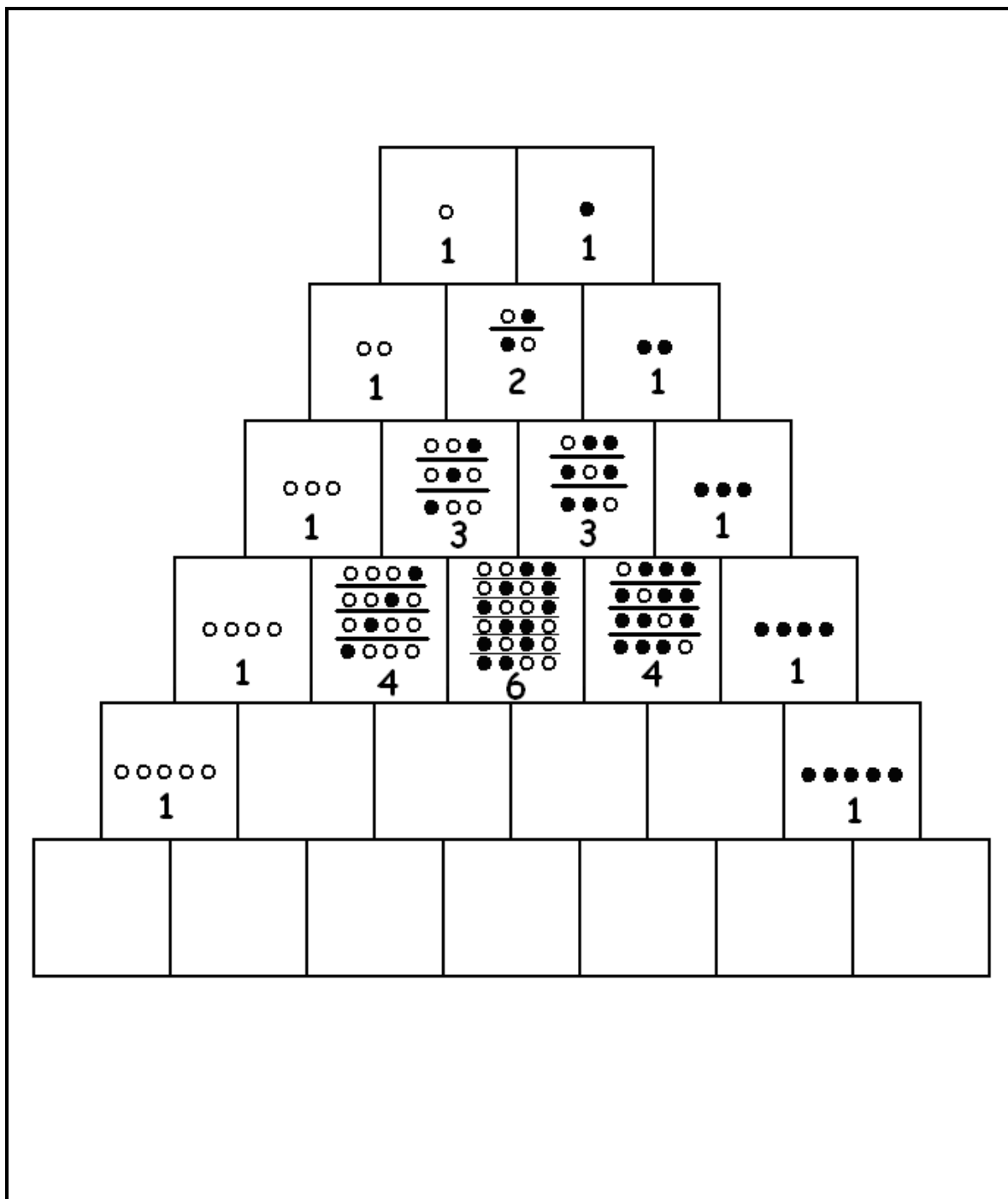



MATH WITHOUT WORDS: 46

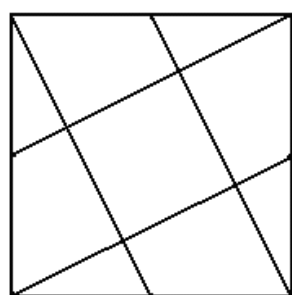
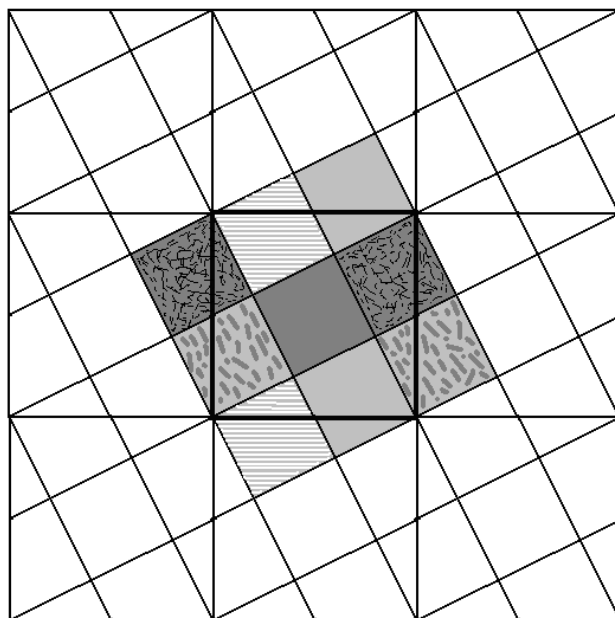

=

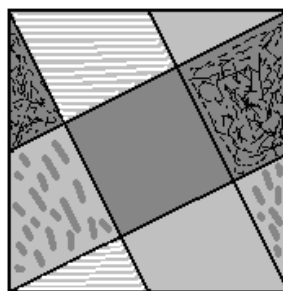

5

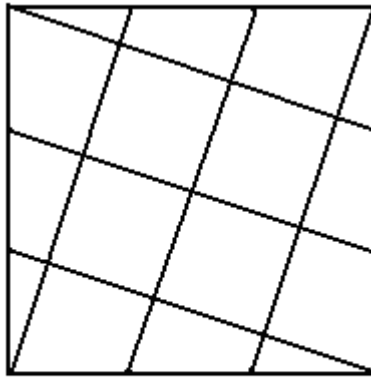

10

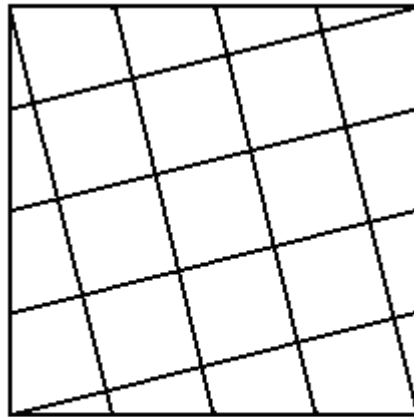

?

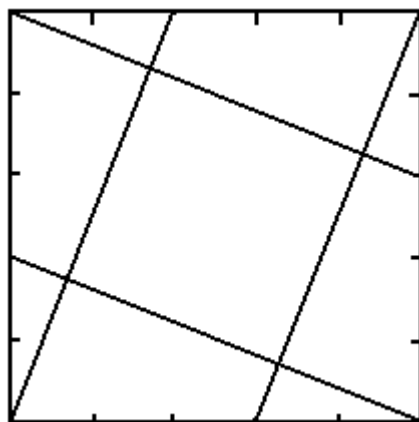
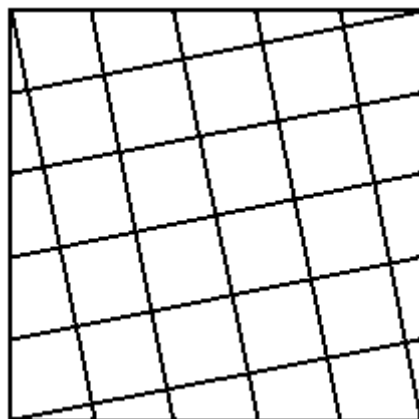



MATH WITHOUT WORDS: 47

| | | |
|--|--|--|
| | | |
| | | |
| | | |

→

| | | |
|--|--|---|
| | | |
| | | ● |
| | | |

→

| | | |
|---|--|---|
| ● | | |
| | | ● |
| | | |

| | |
|---|---|
| ● | ● |
|---|---|

| |
|---|
| ● |
|---|

| | | | |
|--|--|--|--|
| | | | |
| | | | |
| | | | |
| | | | |

→

| | | | |
|---|--|--|--|
| | | | |
| | | | |
| ● | | | |
| | | | |

→

| | | | |
|---|--|--|---|
| | | | |
| | | | |
| | | | ● |
| ● | | | |

| | | | |
|---|---|---|---|
| ● | ● | ● | ● |
|---|---|---|---|

| | | |
|---|---|---|
| ● | ● | ● |
|---|---|---|

| | |
|---|---|
| ● | ● |
|---|---|

→

| | | | |
|--|--|--|--|
| | | | |
| | | | |
| | | | |
| | | | |

→

| | | | |
|--|--|--|--|
| | | | |
| | | | |
| | | | |
| | | | |

| |
|---|
| ● |
|---|

| | |
|---|---|
| ● | ● |
|---|---|

| | |
|---|---|
| ● | ● |
|---|---|

| | | | |
|--|--|--|--|
| | | | |
| | | | |
| | | | |
| | | | |

→

| | | | |
|--|--|--|--|
| | | | |
| | | | |
| | | | |
| | | | |

| |
|---|
| ● |
|---|

| | |
|---|---|
| ● | ● |
|---|---|

| | |
|---|---|
| ● | ● |
|---|---|

| | | | |
|--|--|--|--|
| | | | |
| | | | |
| | | | |
| | | | |

→

| | | | |
|--|--|--|--|
| | | | |
| | | | |
| | | | |
| | | | |

| | |
|---|---|
| ● | ● |
|---|---|

| | |
|---|---|
| ● | ● |
|---|---|

| | |
|---|---|
| ● | ● |
|---|---|

| | | | |
|--|--|--|--|
| | | | |
| | | | |
| | | | |
| | | | |

→

| | | | |
|--|--|--|--|
| | | | |
| | | | |
| | | | |
| | | | |

| | |
|---|---|
| ● | ● |
|---|---|

| | |
|---|---|
| ● | ● |
|---|---|

| | |
|---|---|
| ● | ● |
|---|---|

| | | | |
|--|--|--|--|
| | | | |
| | | | |
| | | | |
| | | | |

→

| | | | |
|--|--|--|--|
| | | | |
| | | | |
| | | | |
| | | | |

| | |
|---|---|
| ● | ● |
|---|---|

| | |
|---|---|
| ● | ● |
|---|---|

| | |
|---|---|
| ● | ● |
|---|---|

| | | | |
|--|--|--|--|
| | | | |
| | | | |
| | | | |
| | | | |

→

| | | | |
|--|--|--|--|
| | | | |
| | | | |
| | | | |
| | | | |

| | |
|---|---|
| ● | ● |
|---|---|

| | |
|---|---|
| ● | ● |
|---|---|

| | |
|---|---|
| ● | ● |
|---|---|

| | | | |
|--|--|--|--|
| | | | |
| | | | |
| | | | |
| | | | |

→

| | | | |
|--|--|--|--|
| | | | |
| | | | |
| | | | |
| | | | |

| | |
|---|---|
| ● | ● |
|---|---|

| | |
|---|---|
| ● | ● |
|---|---|

| | |
|---|---|
| ● | ● |
|---|---|

| | | | |
|--|--|--|--|
| | | | |
| | | | |
| | | | |
| | | | |

→

| | | | |
|--|--|--|--|
| | | | |
| | | | |
| | | | |
| | | | |

| | |
|---|---|
| ● | ● |
|---|---|

| | |
|---|---|
| ● | ● |
|---|---|

| | |
|---|---|
| ● | ● |
|---|---|

| | | | |
|--|--|--|--|
| | | | |
| | | | |
| | | | |
| | | | |

→

| | | | |
|--|--|--|--|
| | | | |
| | | | |
| | | | |
| | | | |

| | |
|---|---|
| ● | ● |
|---|---|

| | |
|---|---|
| ● | ● |
|---|---|

| | |
|---|---|
| ● | ● |
|---|---|

| | | | |
|--|--|--|--|
| | | | |
| | | | |
| | | | |
| | | | |

→

| | | | |
|--|--|--|--|
| | | | |
| | | | |
| | | | |
| | | | |

| | |
|---|---|
| ● | ● |
|---|---|

| | |
|---|---|
| ● | ● |
|---|---|

| | |
|---|---|
| ● | ● |
|---|---|

| | | | |
|--|--|--|--|
| | | | |
| | | | |
| | | | |
| | | | |

→

| | | | |
|--|--|--|--|
| | | | |
| | | | |
| | | | |
| | | | |

| | |
|---|---|
| ● | ● |
|---|---|

| | |
|---|---|
| ● | ● |
|---|---|

| | |
|---|---|
| ● | ● |
|---|---|

| | | | |
|--|--|--|--|
| | | | |
| | | | |
| | | | |
| | | | |

→

| | | | |
|--|--|--|--|
| | | | |
| | | | |
| | | | |
| | | | |

| | |
|---|---|
| ● | ● |
|---|---|

| | |
|---|---|
| ● | ● |
|---|---|

| | |
|---|---|
| ● | ● |
|---|---|

| | | | |
|--|--|--|--|
| | | | |
| | | | |
| | | | |
| | | | |

→

| | | | |
|--|--|--|--|
| | | | |
| | | | |
| | | | |
| | | | |

| | |
|---|---|
| ● | ● |
|---|---|

| | |
|---|---|
| ● | ● |
|---|---|

| | |
|---|---|
| ● | ● |
|---|---|

| | | | |
|--|--|--|--|
| | | | |
| | | | |
| | | | |
| | | | |

→

| | | | |
|--|--|--|--|
| | | | |
| | | | |
| | | | |
| | | | |

| | |
|---|---|
| ● | ● |
|---|---|

| | |
|---|---|
| ● | ● |
|---|---|

| | |
|---|---|
| ● | ● |
|---|---|

| | | | |
|--|--|--|--|
| | | | |
| | | | |
| | | | |
| | | | |

→

| | | | |
|--|--|--|--|
| | | | |
| | | | |
| | | | |
| | | | |

| | |
|---|---|
| ● | ● |
|---|---|

| | |
|---|---|
| ● | ● |
|---|---|

| | |
|---|---|
| ● | ● |
|---|---|

| | | | |
|--|--|--|--|
| | | | |
| | | | |
| | | | |
| | | | |

→

| | | | |
|--|--|--|--|
| | | | |
| | | | |
| | | | |
| | | | |

| | |
|---|---|
| ● | ● |
|---|---|

| | |
|---|---|
| ● | ● |
|---|---|

| | |
|---|---|
| ● | ● |
|---|---|

| | | | |
|--|--|--|--|
| | | | |
| | | | |
| | | | |
| | | | |

→

| | | | |
|--|--|--|--|
| | | | |
| | | | |
| | | | |
| | | | |

| | |
|---|---|
| ● | ● |
|---|---|

| | |
|---|---|
| ● | ● |
|---|---|

| | |
|---|---|
| ● | ● |
|---|---|

| | | | |
|--|--|--|--|
| | | | |
| | | | |
| | | | |
| | | | |

→

| | | | |
|--|--|--|--|
| | | | |
| | | | |
| | | | |
| | | | |

| | |
|---|---|
| ● | ● |
|---|---|

| | |
|---|---|
| ● | ● |
|---|---|

| | |
|---|---|
| ● | ● |
|---|---|

| | | | |
|--|--|--|--|
| | | | |
| | | | |
| | | | |
| | | | |

→

| | | | |
|--|--|--|--|
| | | | |
| | | | |
| | | | |
| | | | |

| | |
|---|---|
| ● | ● |
|---|---|

| | |
|---|---|
| ● | ● |
|---|---|

| | |
|---|---|
| ● | ● |
|---|---|

| | | | |
|--|--|--|--|
| | | | |
| | | | |
| | | | |
| | | | |

→

| | | | |
|--|--|--|--|
| | | | |
| | | | |
| | | | |
| | | | |

| | |
|---|---|
| ● | ● |
|---|---|

| | |
|---|---|
| ● | ● |
|---|---|

| | |
|---|---|
| ● | ● |
|---|---|

| | | | |
|--|--|--|--|
| | | | |
| | | | |
| | | | |
| | | | |

→

| | | | |
|--|--|--|--|
| | | | |
| | | | |
| | | | |
| | | | |

| | |
|---|---|
| ● | ● |
|---|---|

| | |
|---|---|
| ● | ● |
|---|---|

| | |
|---|---|
| ● | ● |
|---|---|

| | | | |
|--|--|--|--|
| | | | |
| | | | |
| | | | |
| | | | |

→

| | | | |
|--|--|--|--|
| | | | |
| | | | |
| | | | |
| | | | |

| | |
|---|---|
| ● | ● |
|---|---|

| | |
|---|---|
| ● | ● |
|---|---|

| | |
|---|---|
| ● | ● |
|---|---|

| | | | |
|--|--|--|--|
| | | | |
| | | | |
| | | | |
| | | | |

→

| | | | |
|--|--|--|--|
| | | | |
| | | | |
| | | | |
| | | | |

| | |
|---|---|
| ● | ● |
|---|---|

| | |
|---|---|
| ● | ● |
|---|---|

| | |
|---|---|
| ● | ● |
|---|---|

| | | | |
|--|--|--|--|
| | | | |
| | | | |
| | | | |
| | | | |

→

| | | | |
|--|--|--|--|
| | | | |
| | | | |
| | | | |
| | | | |

| | |
|---|---|
| ● | ● |
|---|---|

| | |
|---|---|
| ● | ● |
|---|---|

| | |
|---|---|
| ● | ● |
|---|---|

| | | | |
|--|--|--|--|
| | | | |
| | | | |
| | | | |
| | | | |

→

| | | | |
|--|--|--|--|
| | | | |
| | | | |
| | | | |
| | | | |

| | |
|---|---|
| ● | ● |
|---|---|

| | |
|---|---|
| ● | ● |
|---|---|

| | |
|---|---|
| ● | ● |
|---|---|

| | | | |
|--|--|--|--|
| | | | |
| | | | |
| | | | |
| | | | |

→

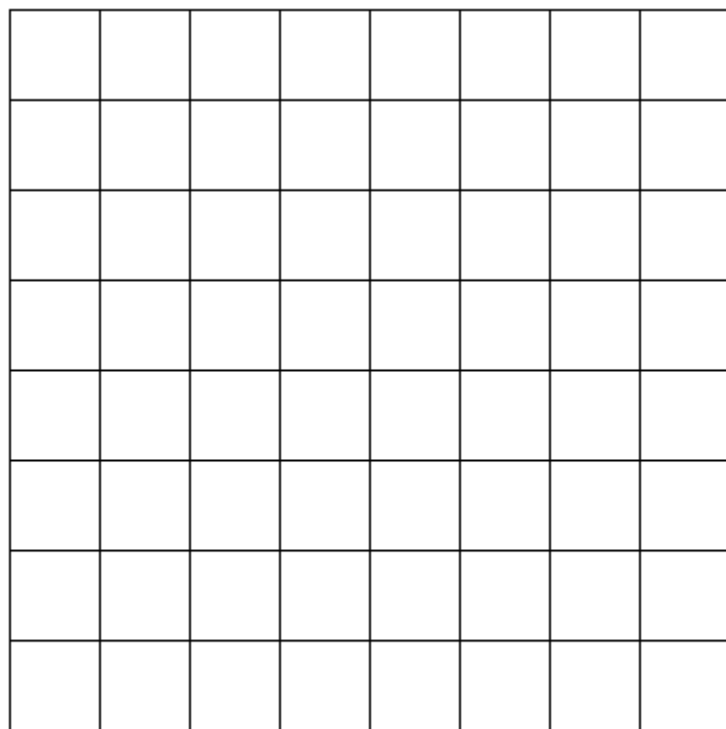
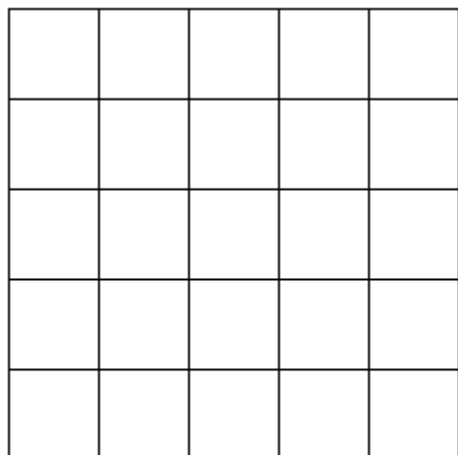



MATH WITHOUT WORDS: 48

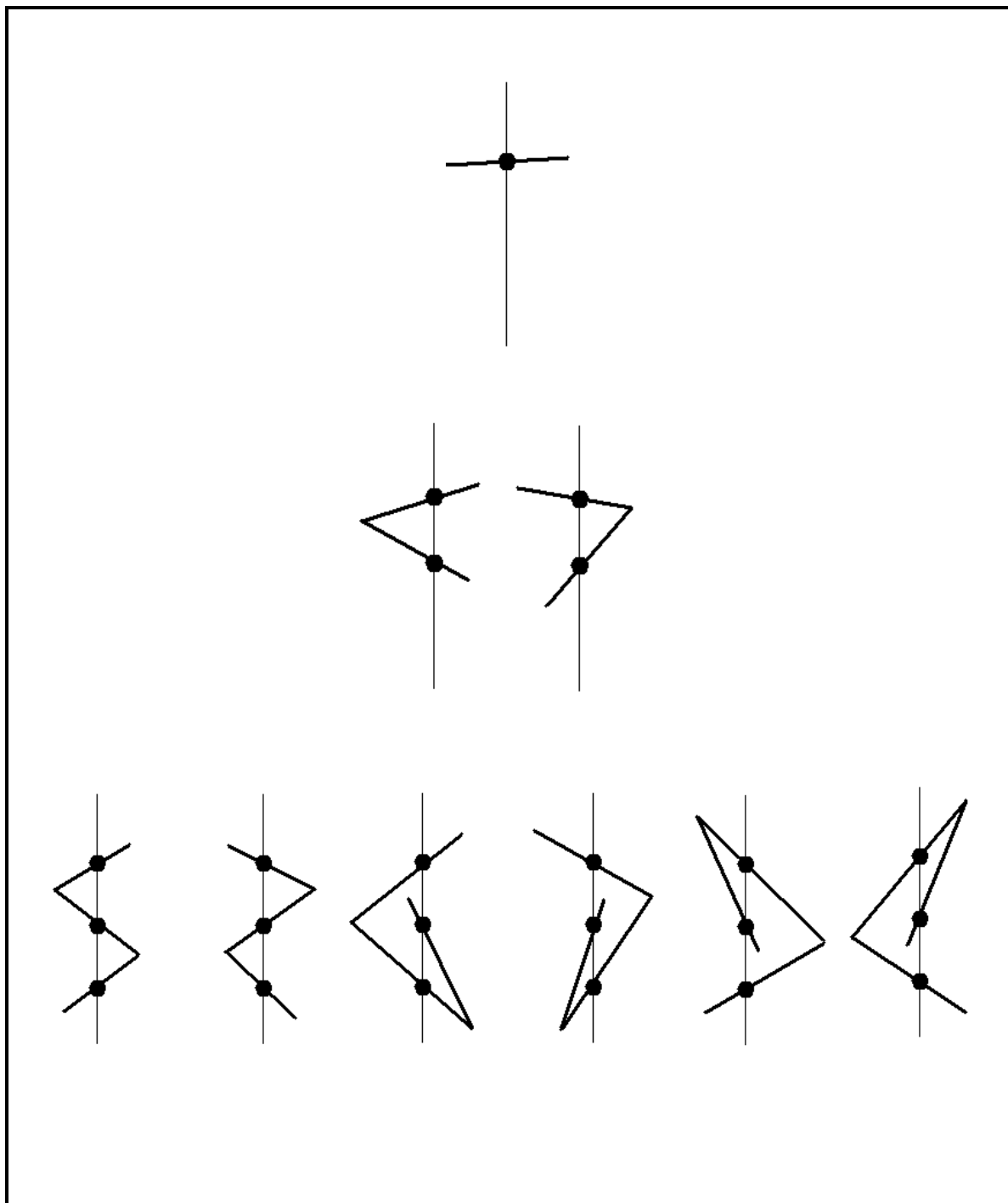

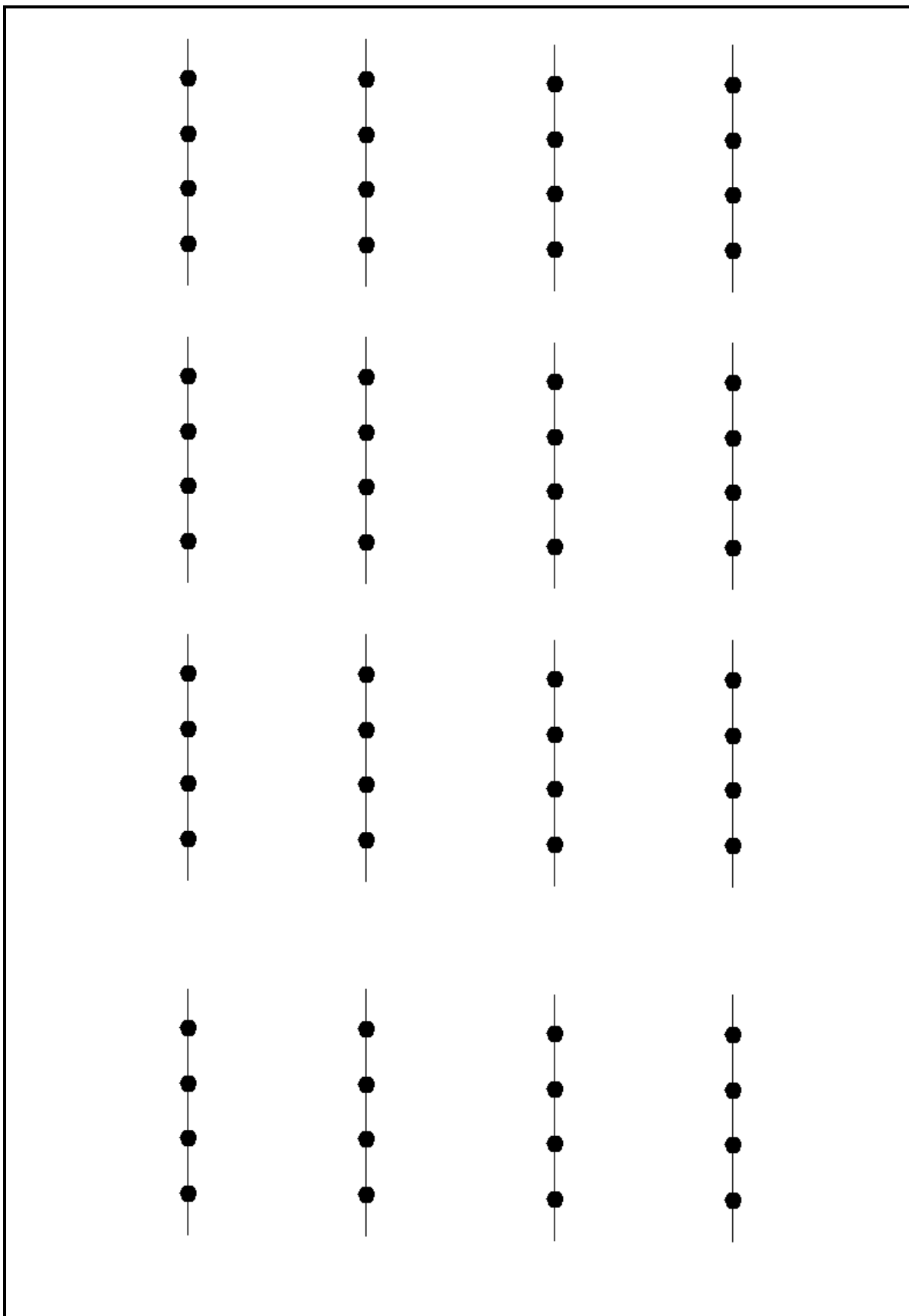

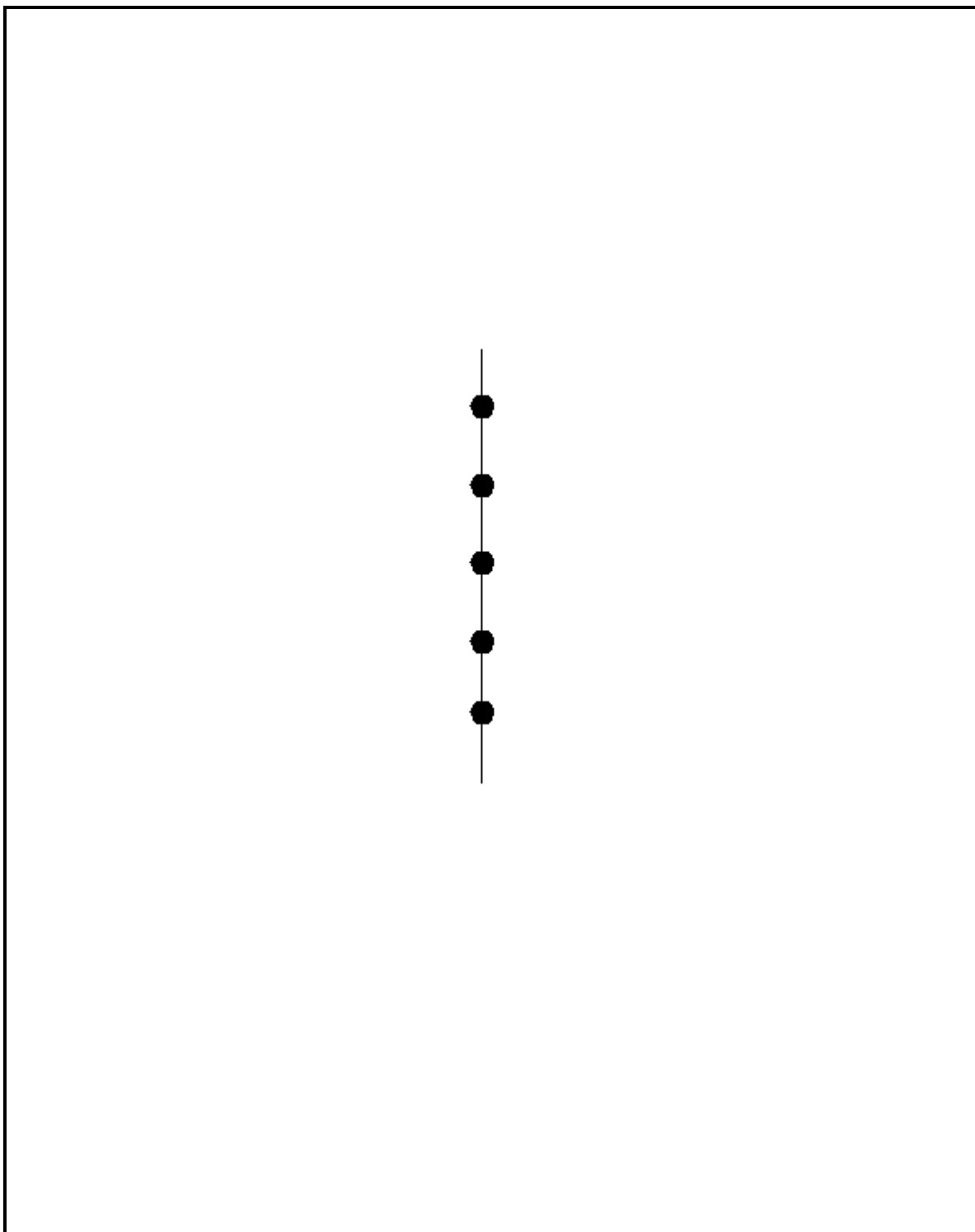



MATH WITHOUT WORDS: 49

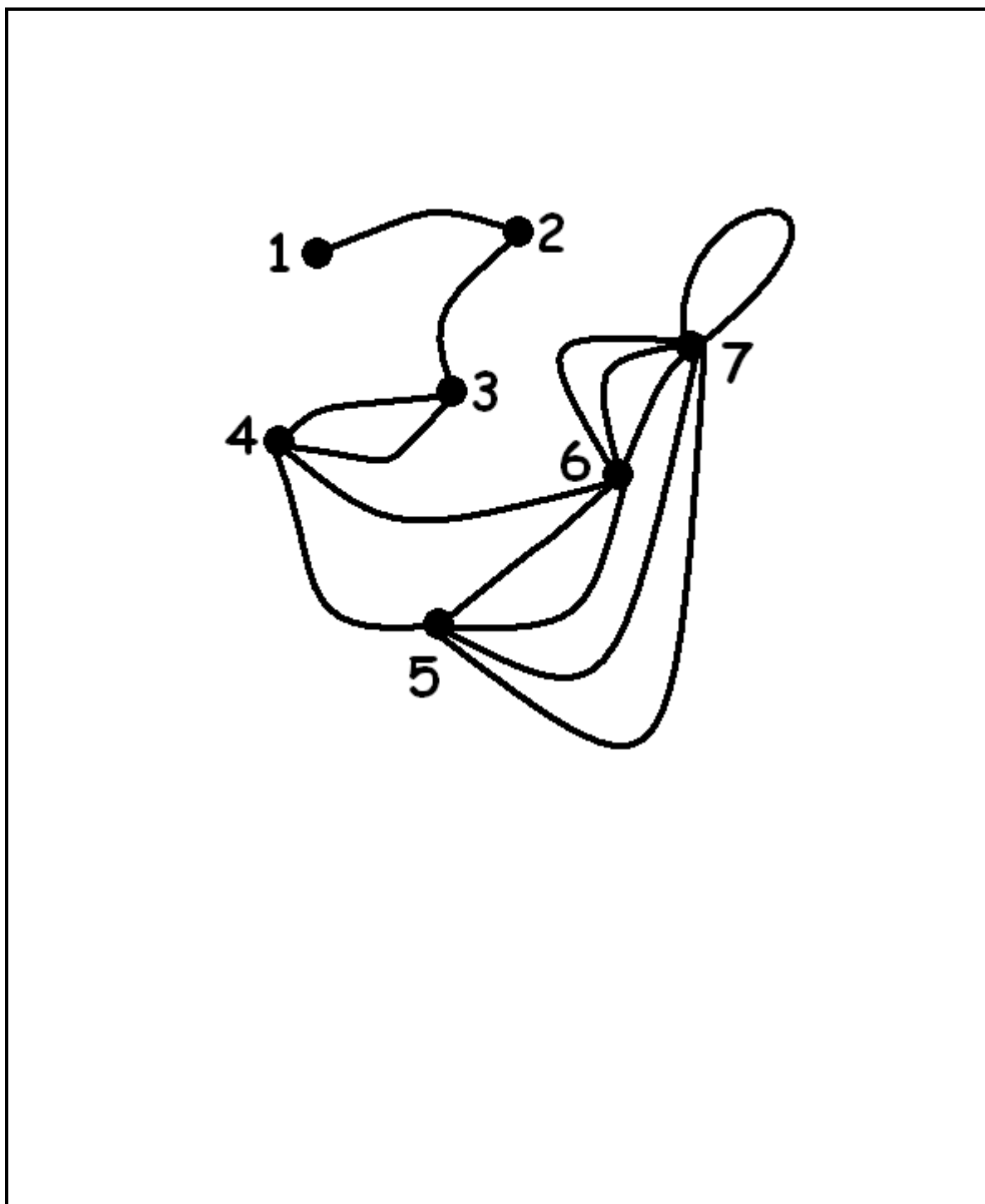

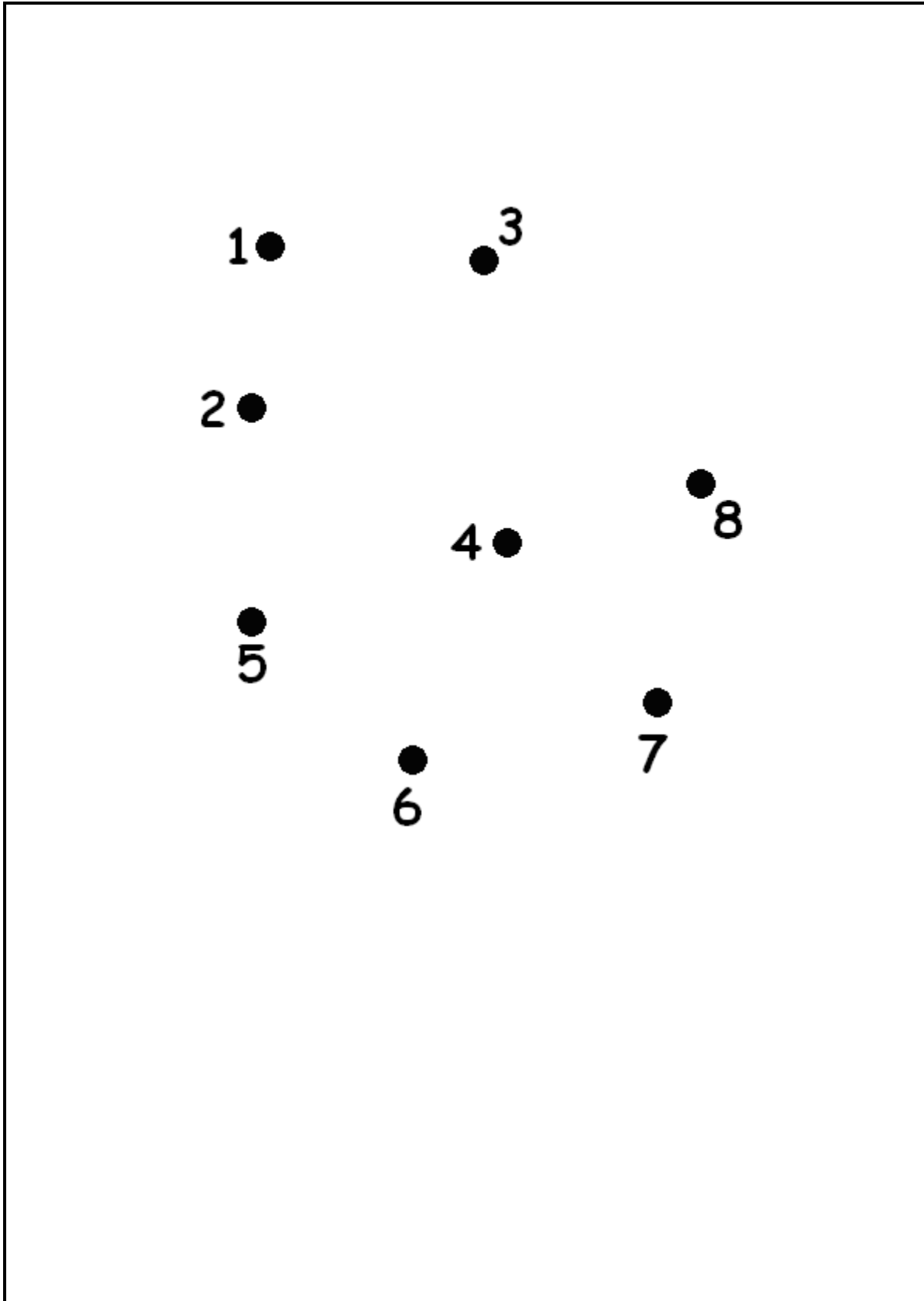

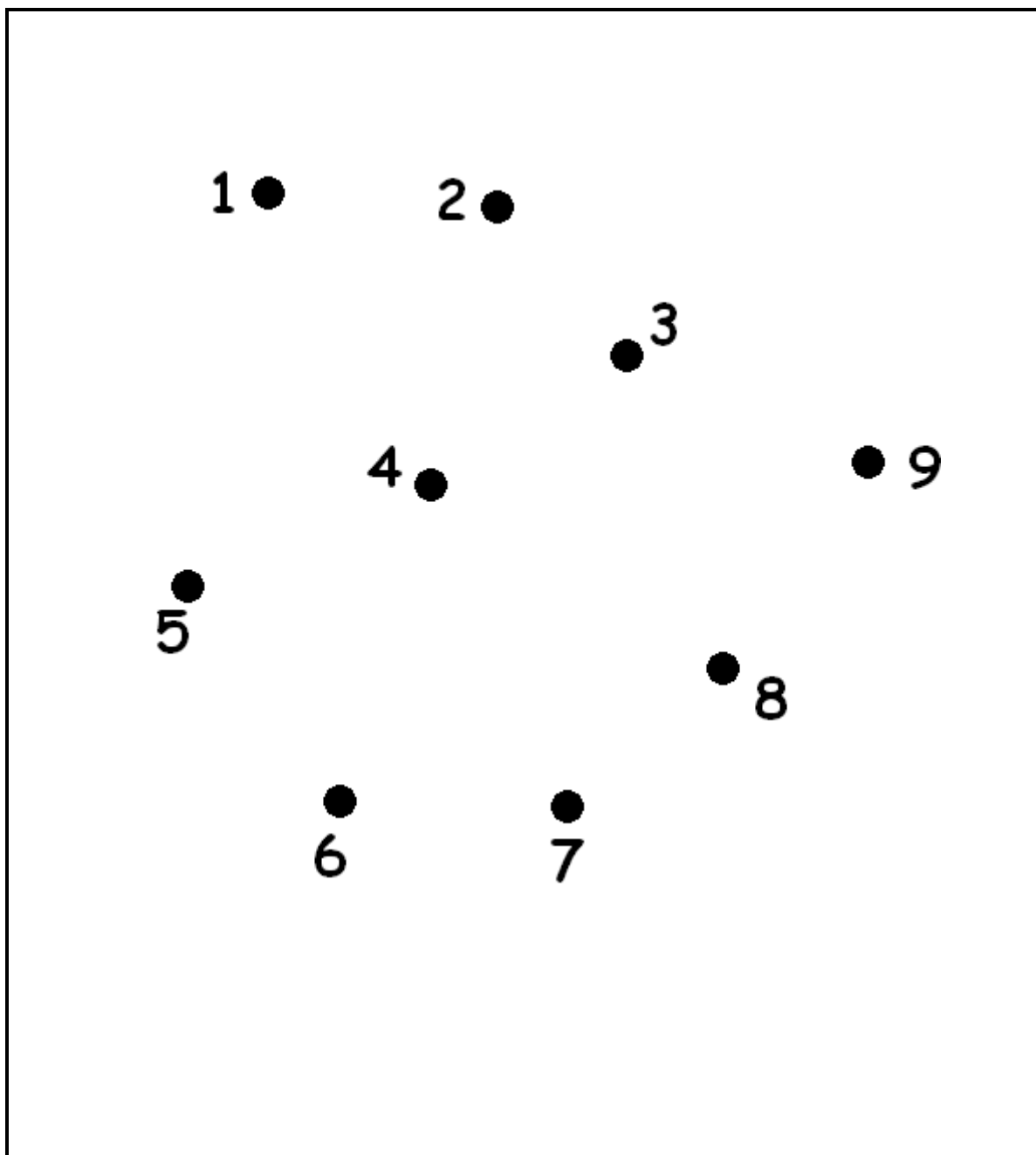



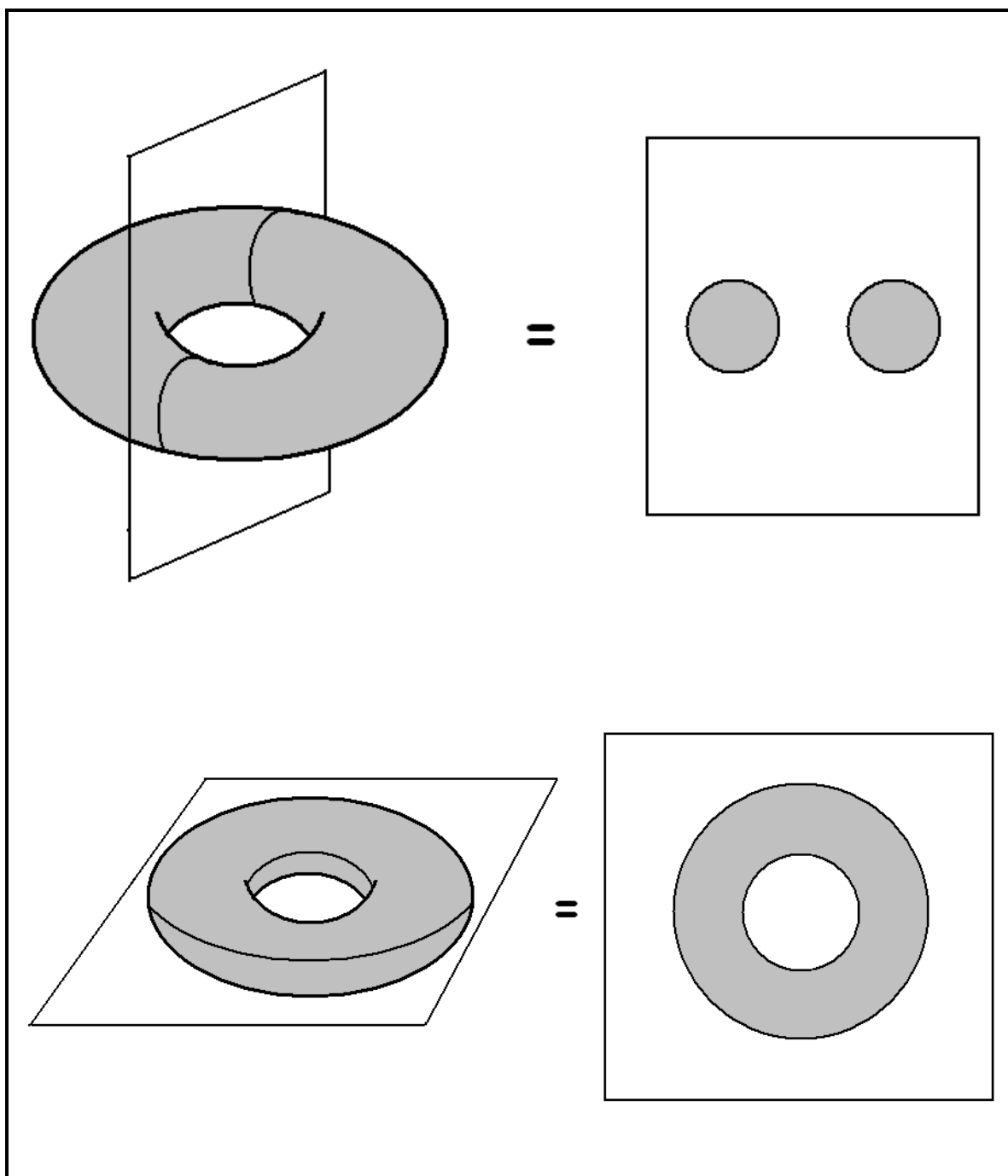

MATH WITHOUT WORDS: 50

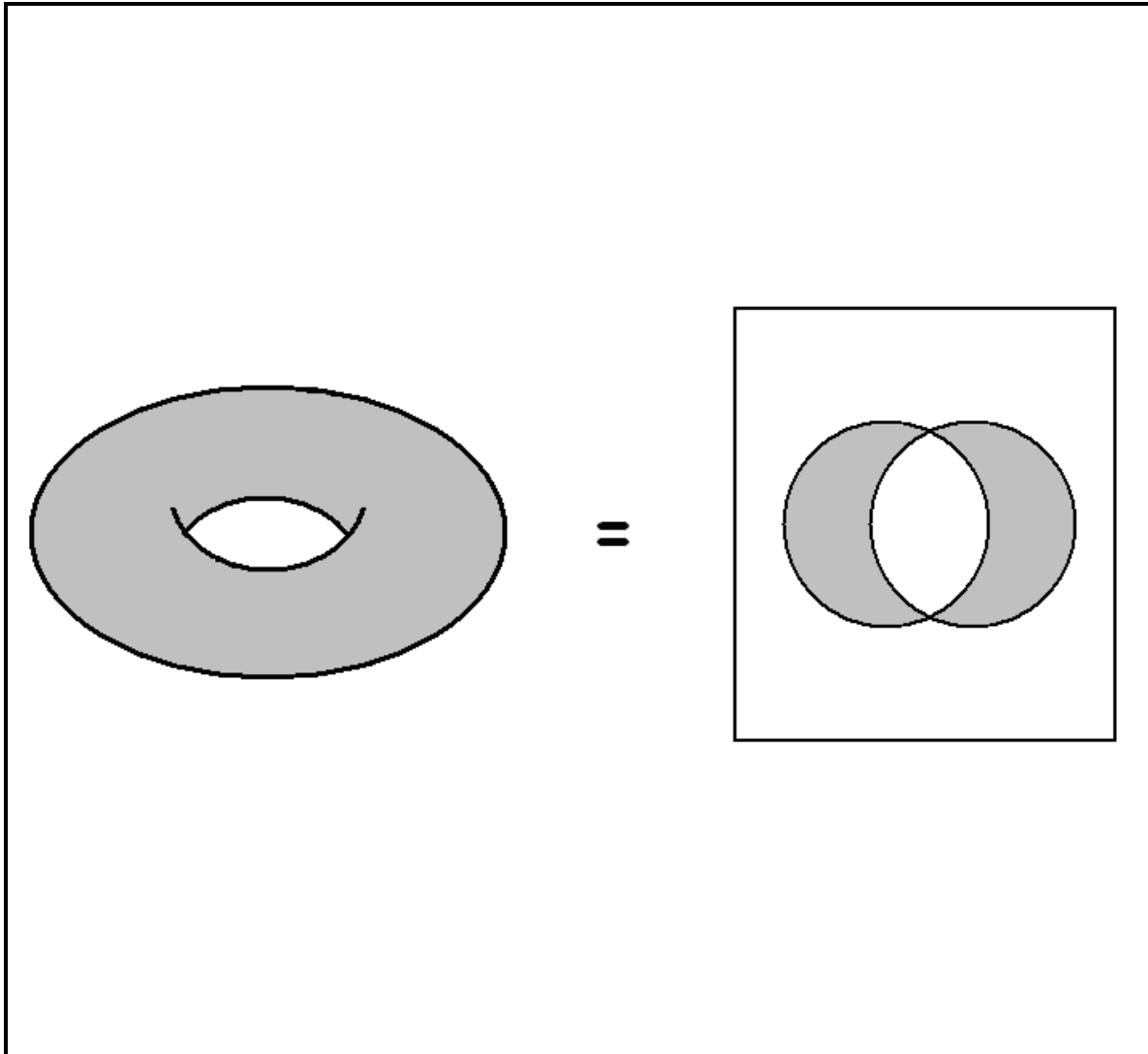







MATH WITHOUT WORDS: 51







 1









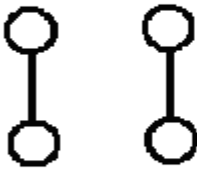

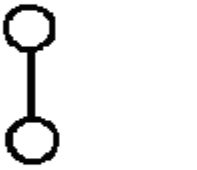

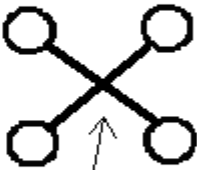





 2

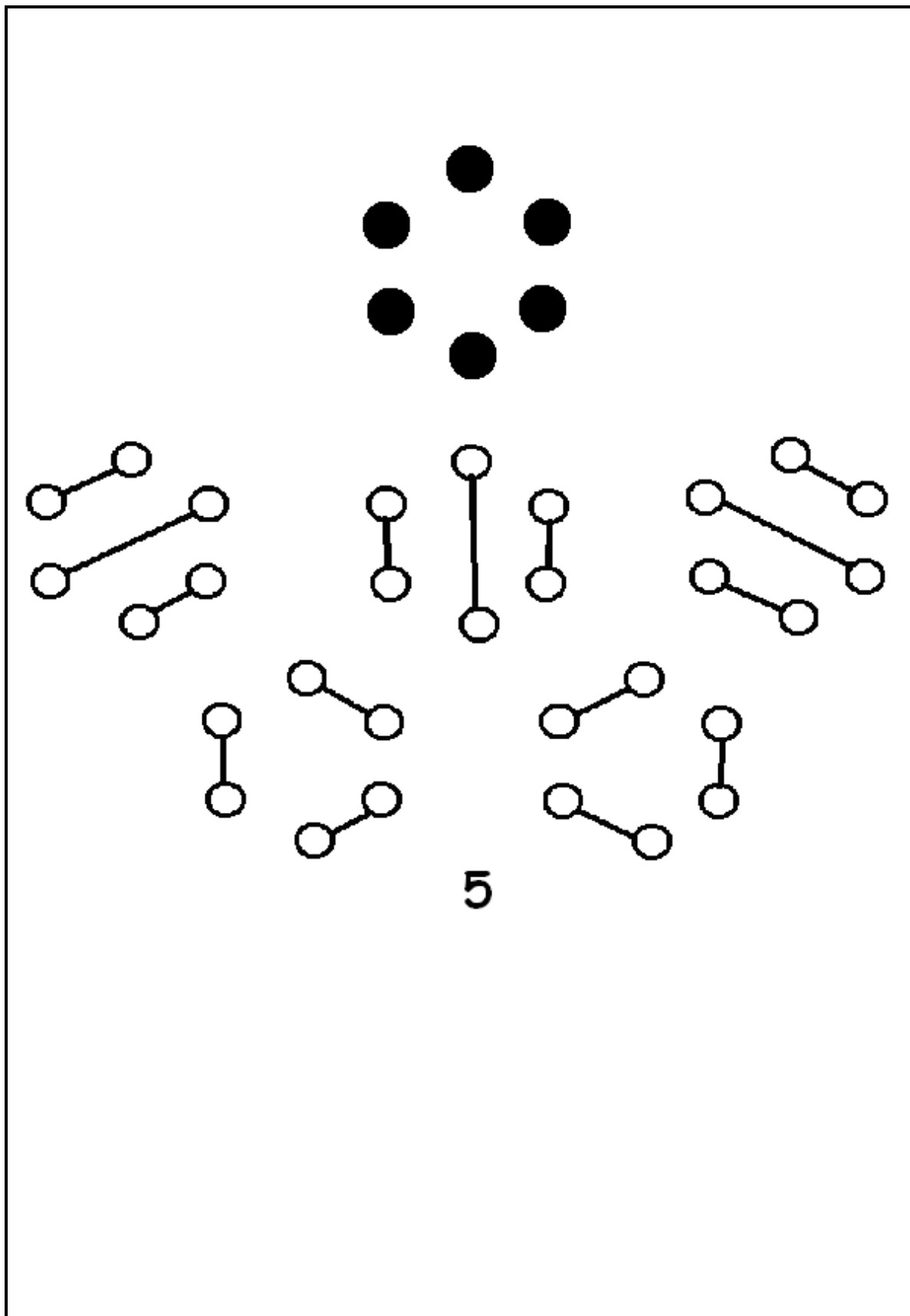

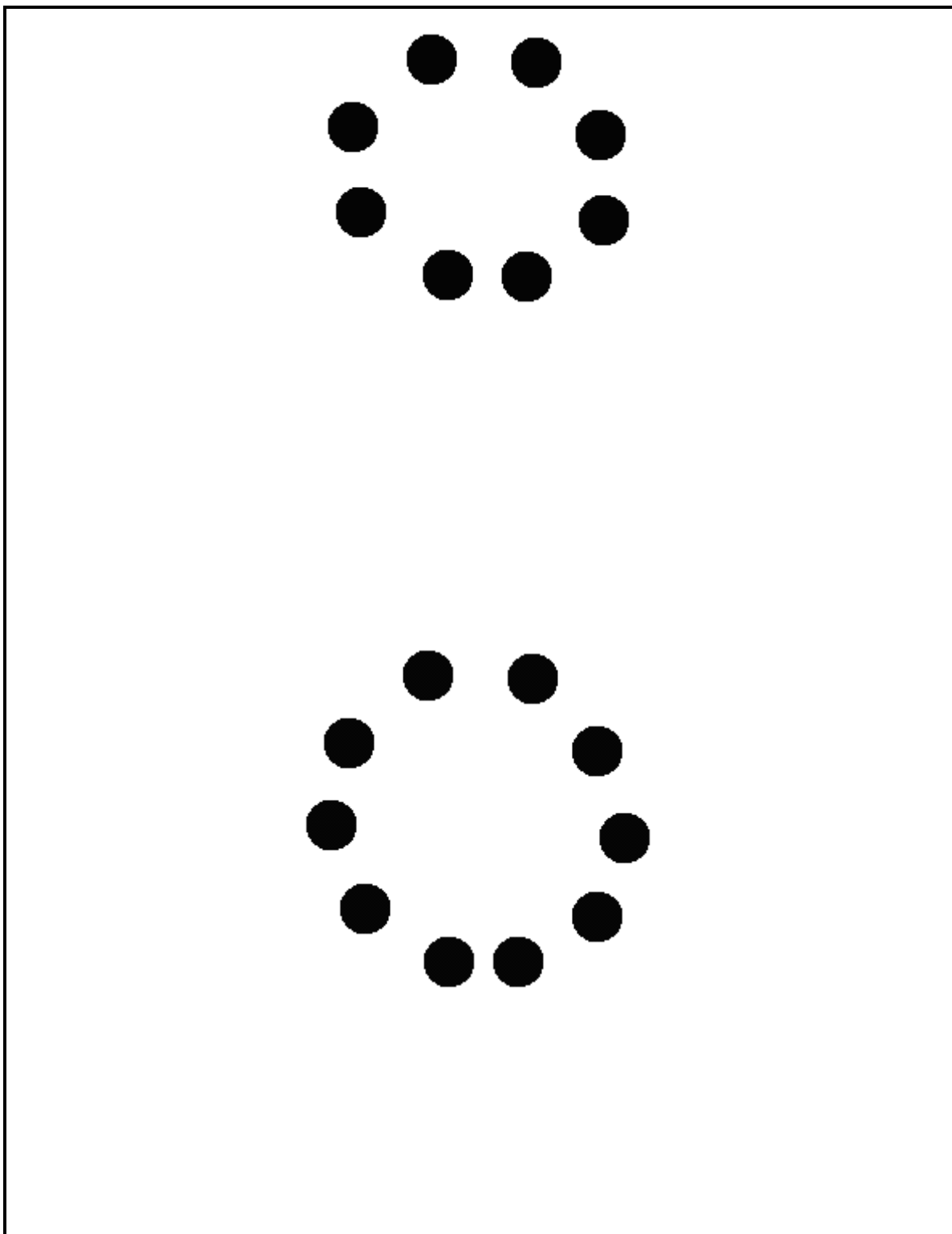



MATH WITHOUT WORDS: 53

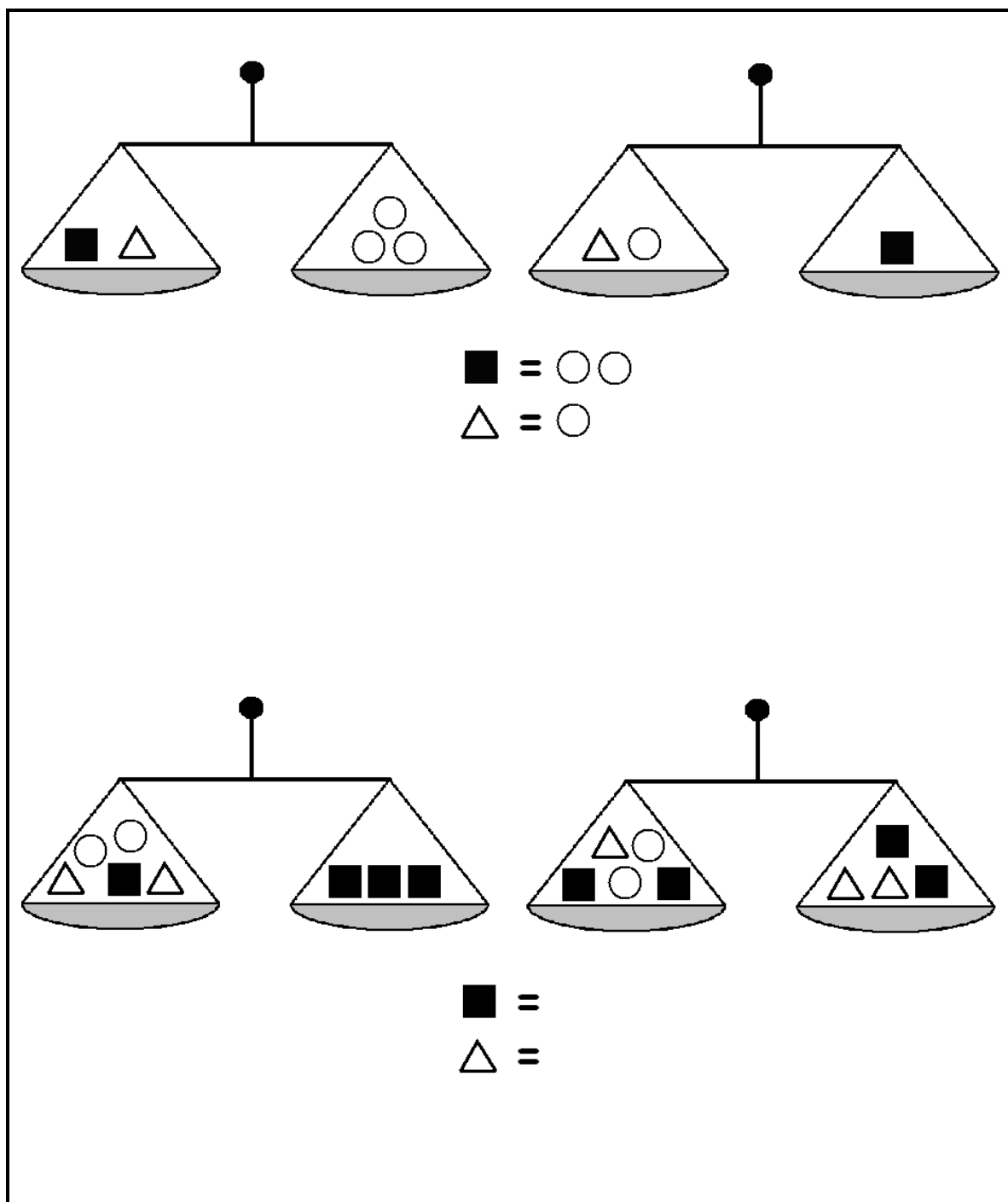

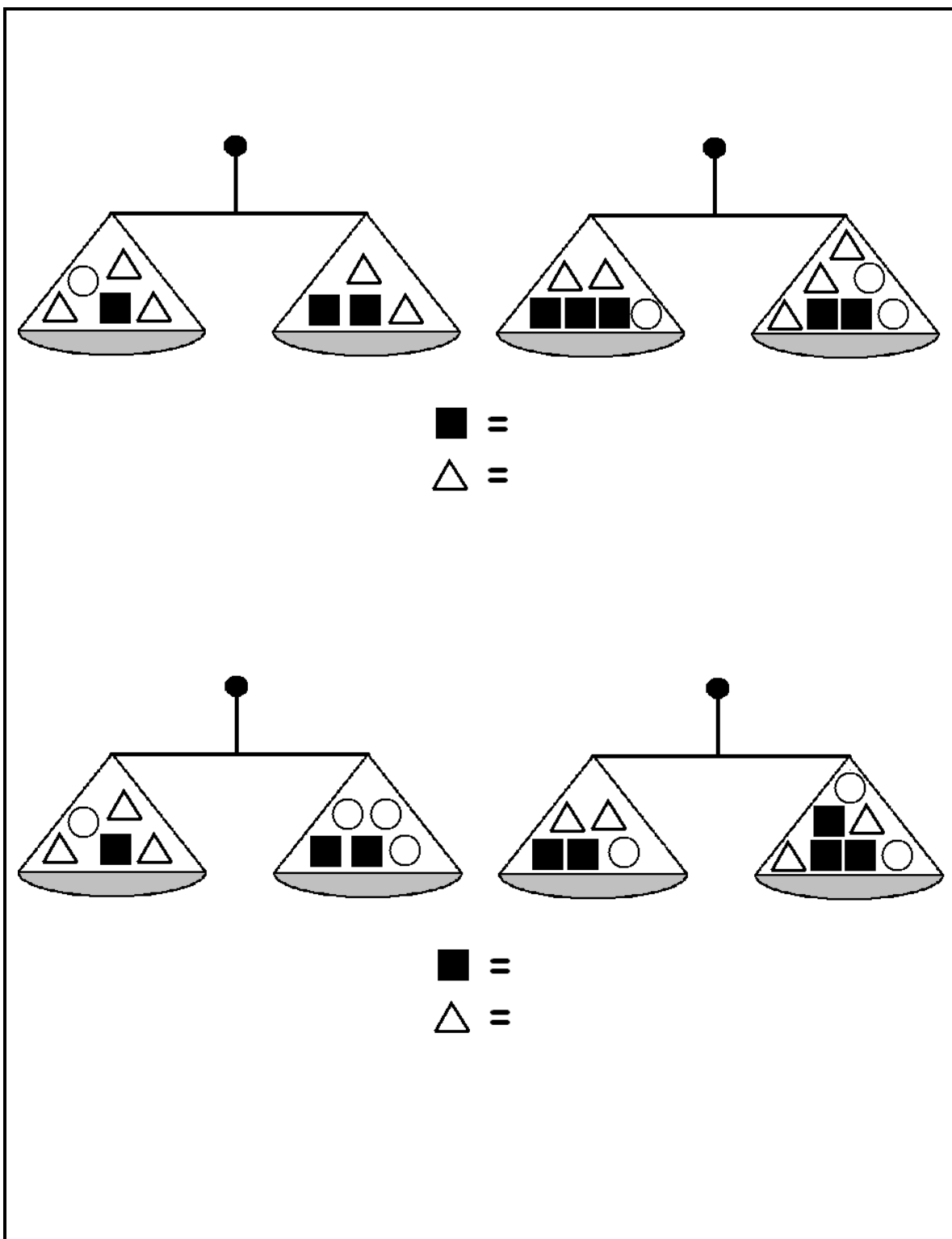



MATH WITHOUT WORDS: 54

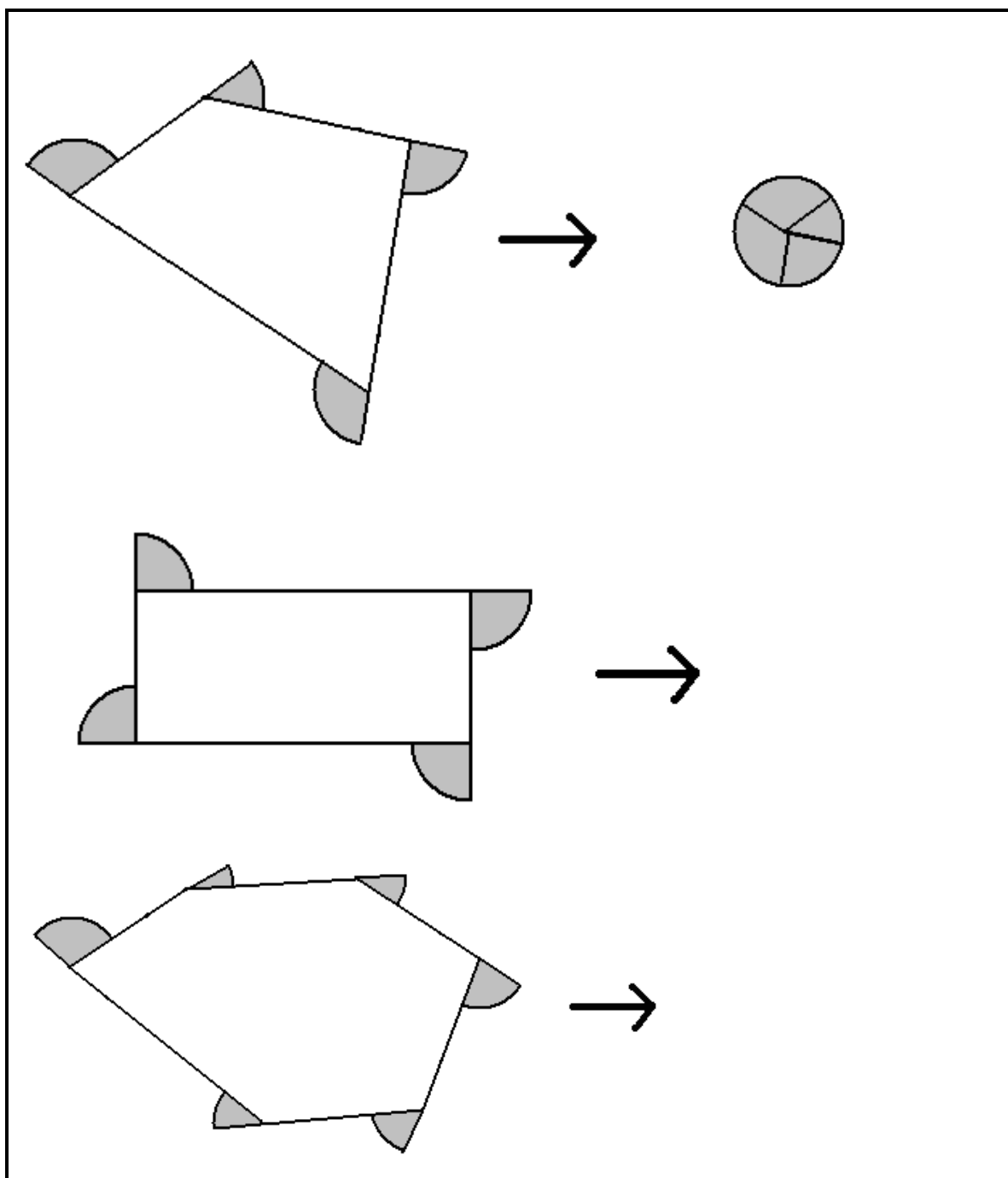

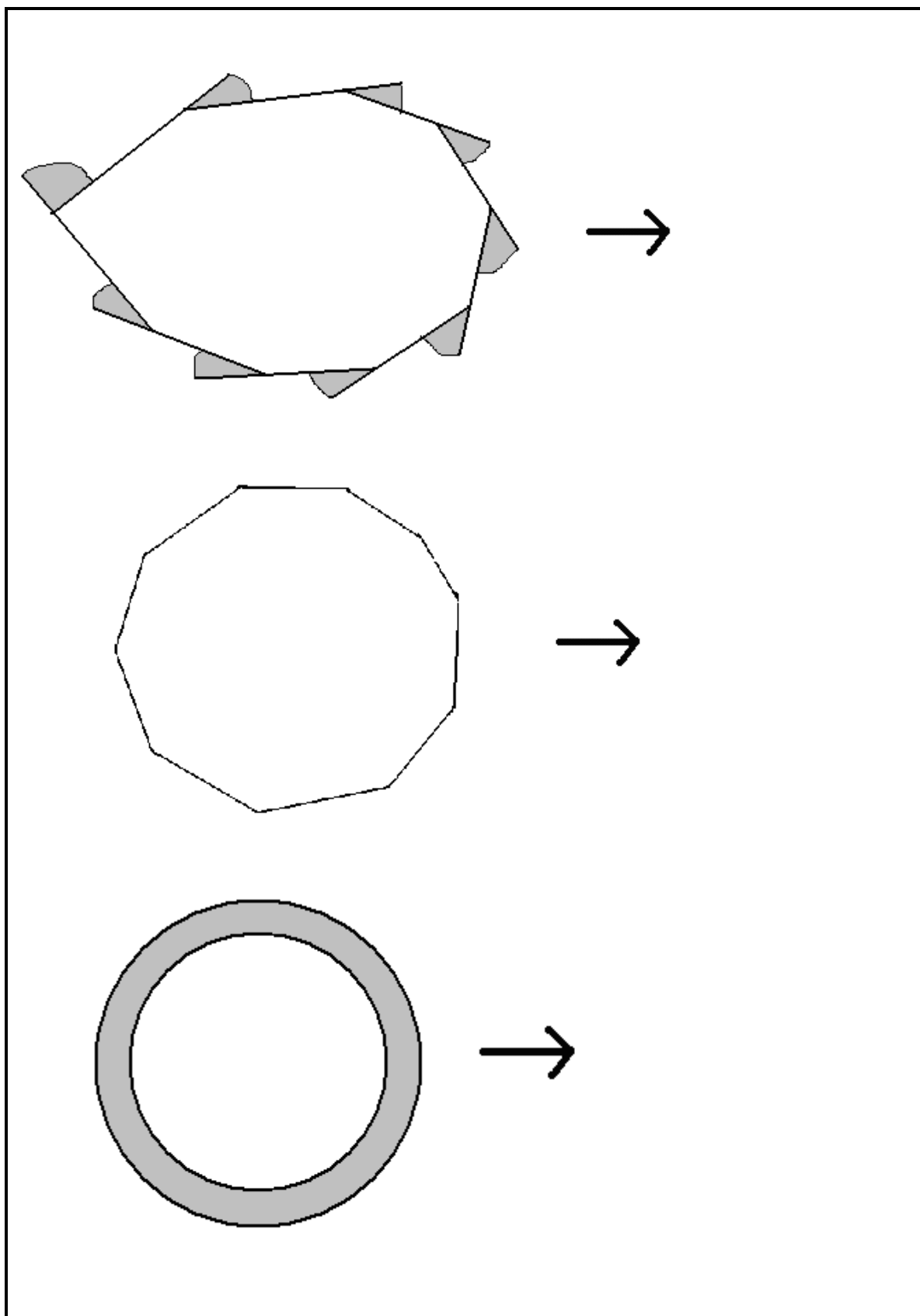

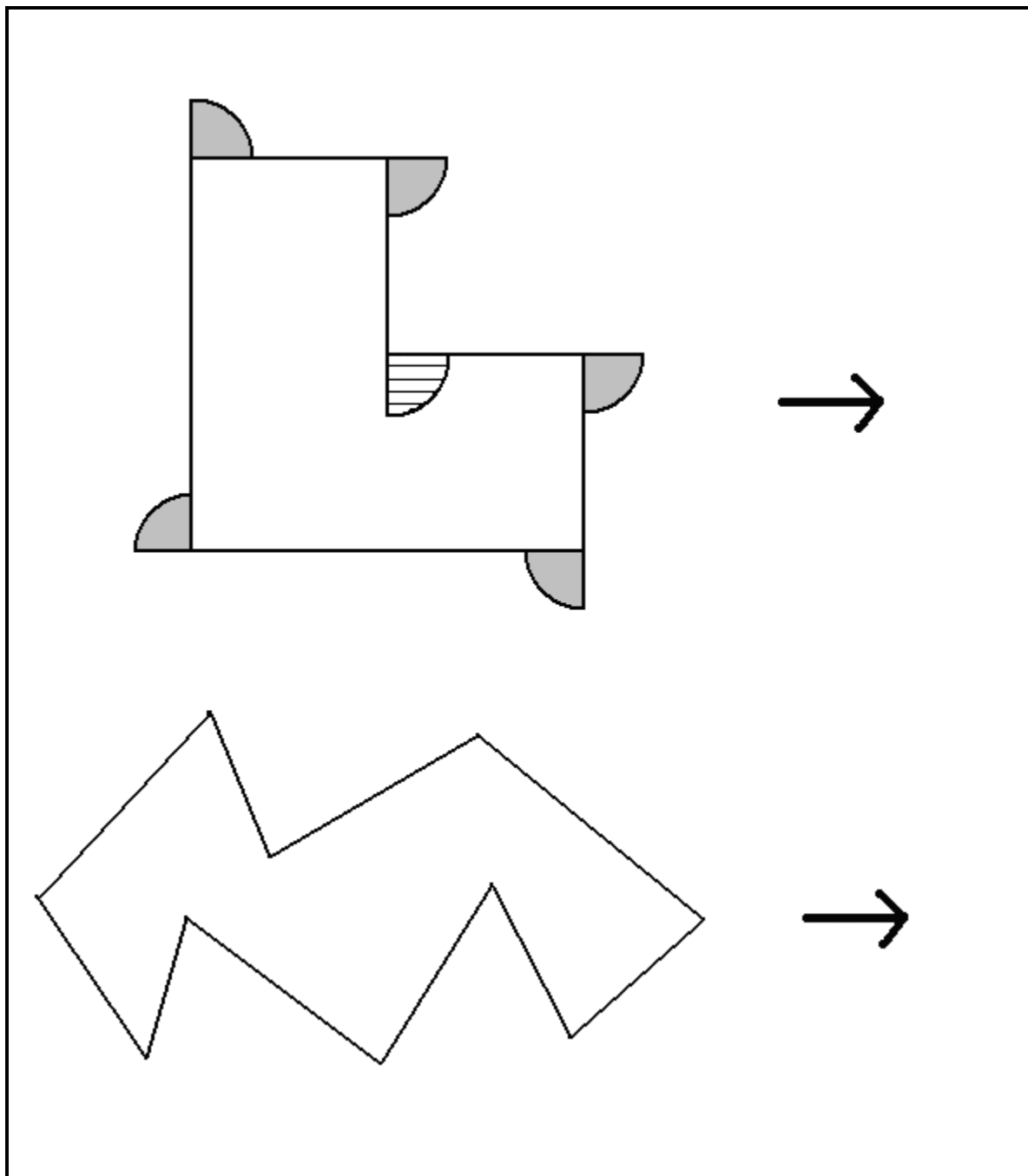



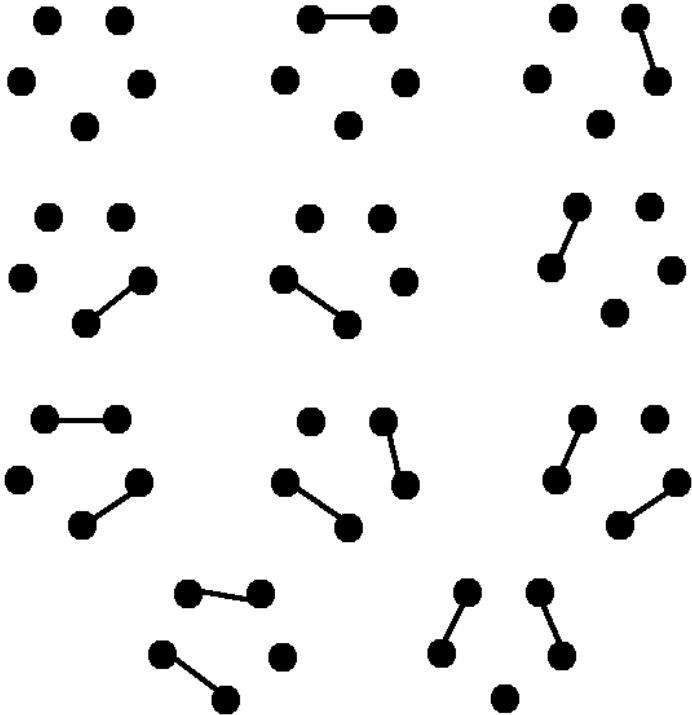

MATH WITHOUT WORDS: 55

| | |
|--|----|
|  | 2 |
| | |
|  | 4 |
| | |
|  | 7 |
| | |
|  | 11 |

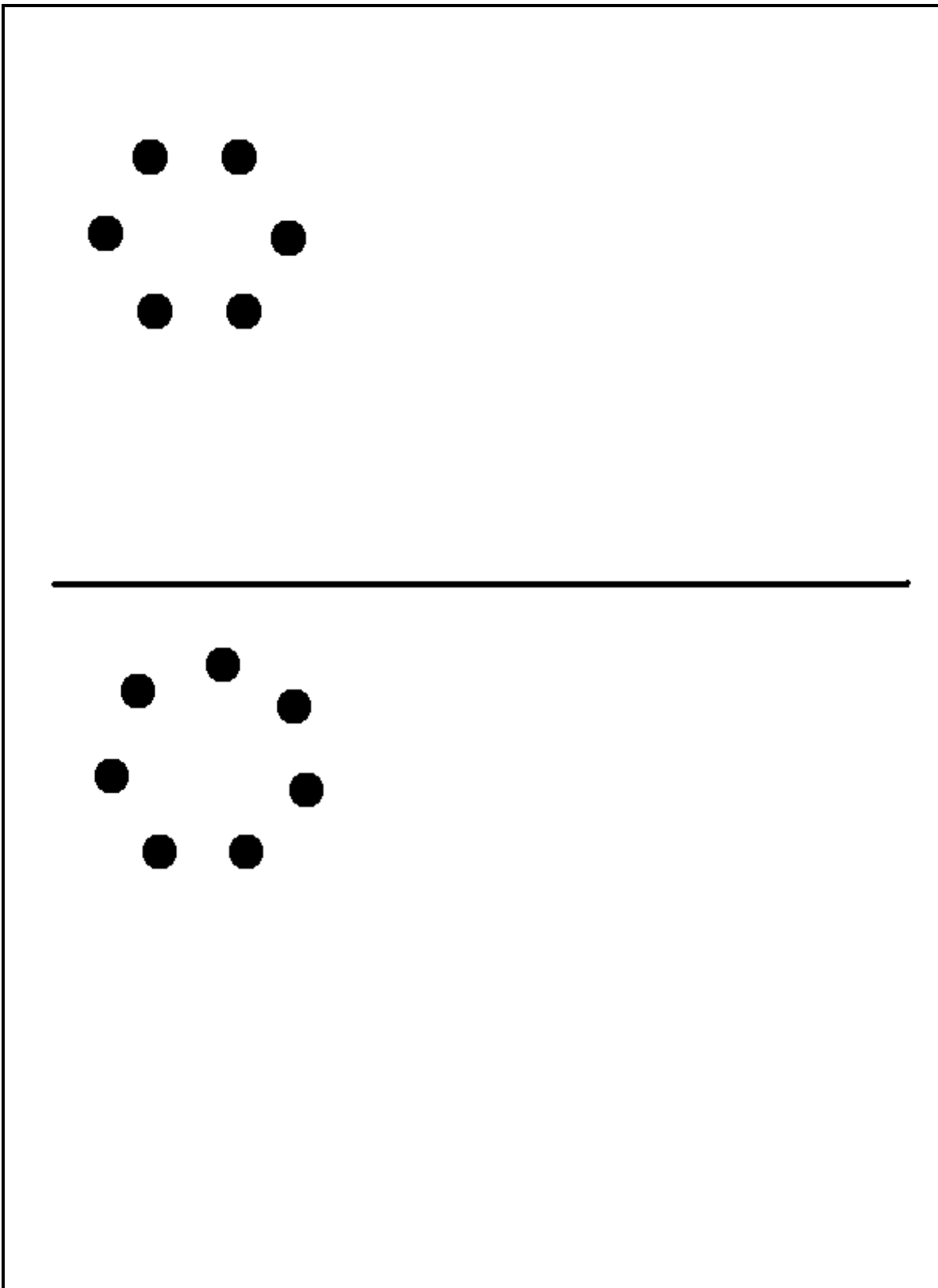

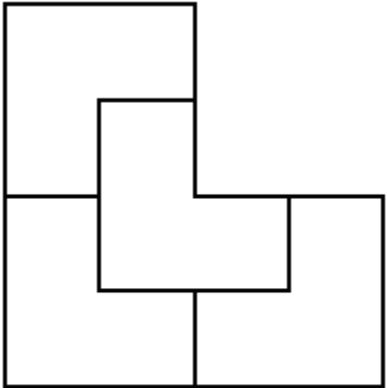
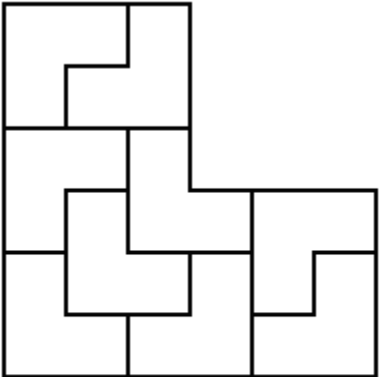
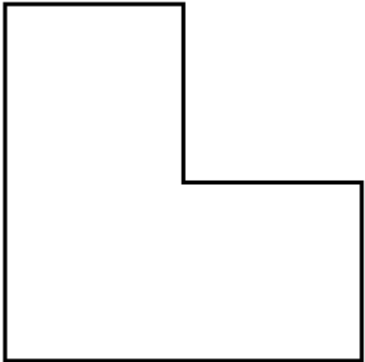
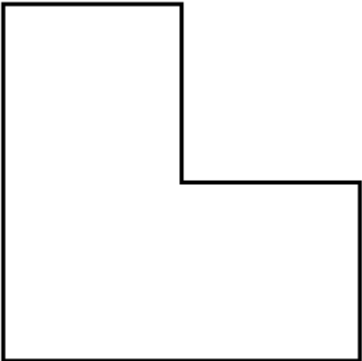

MATH WITHOUT WORDS: 56

| | |
|---|--|
|  <p>4</p> |  <p>9</p> |
|  <p>16</p> |  <p>25</p> |

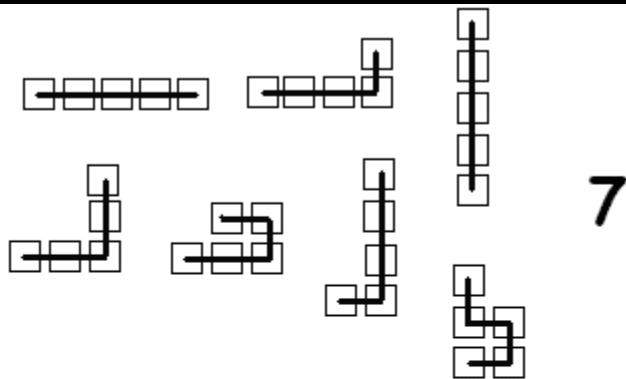

7



11



MATH WITHOUT WORDS: 58

$=$
 $=$
 $=$

$=$

\longrightarrow

\longrightarrow



MATH WITHOUT WORDS: 59



1

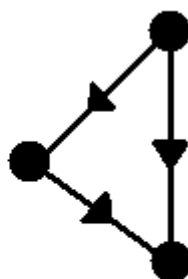

2



1

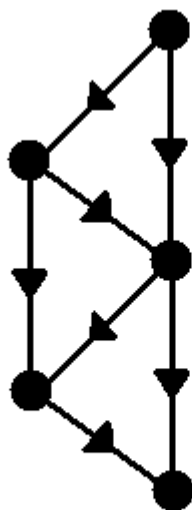

5

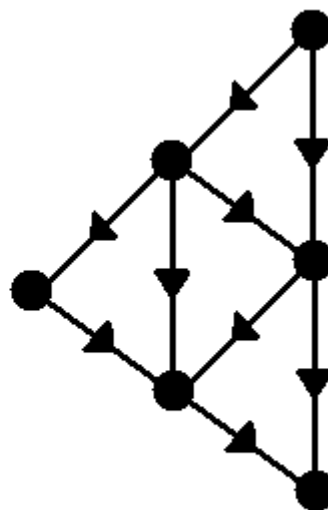

6

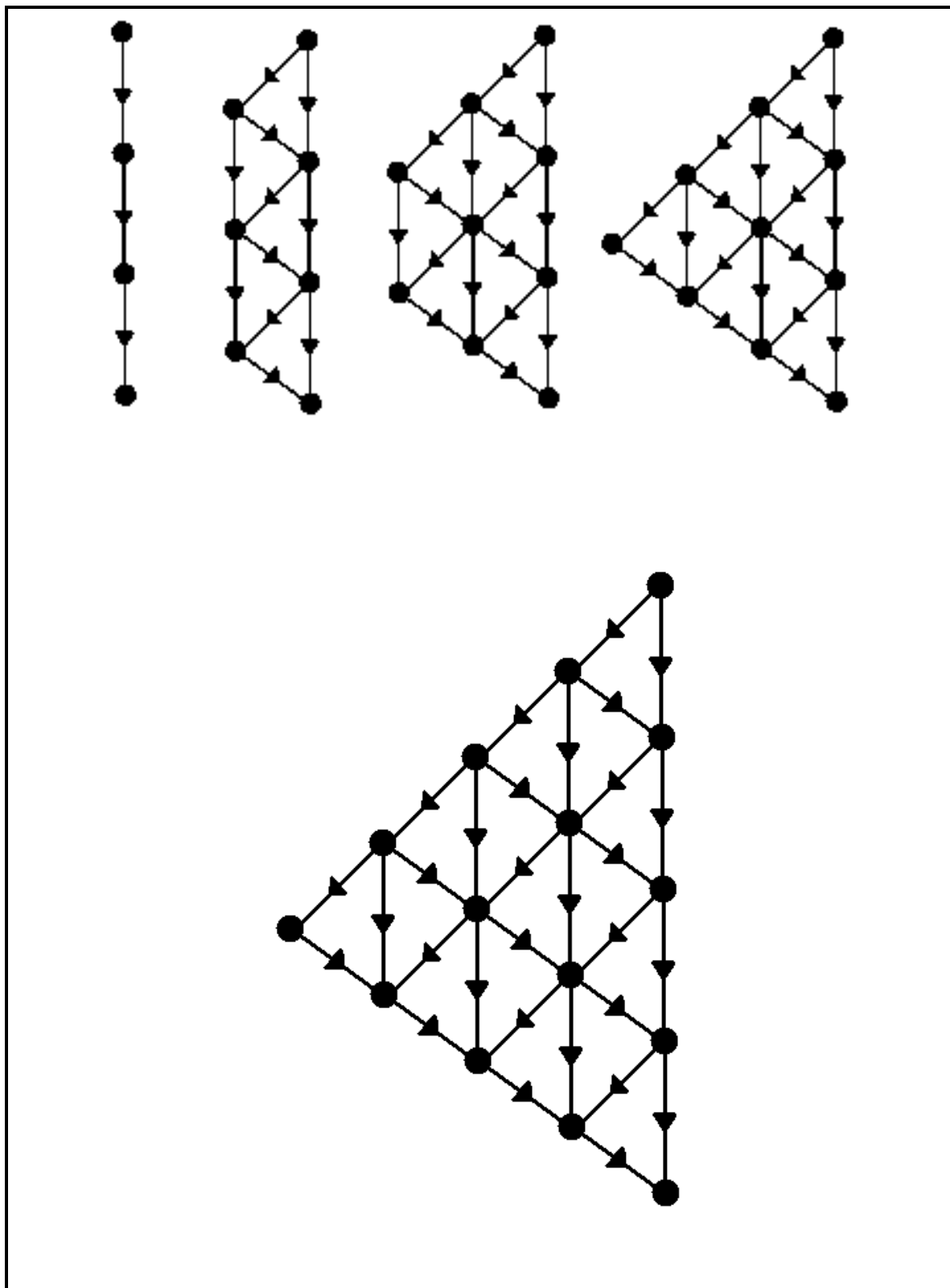



MATH WITHOUT WORDS: 60

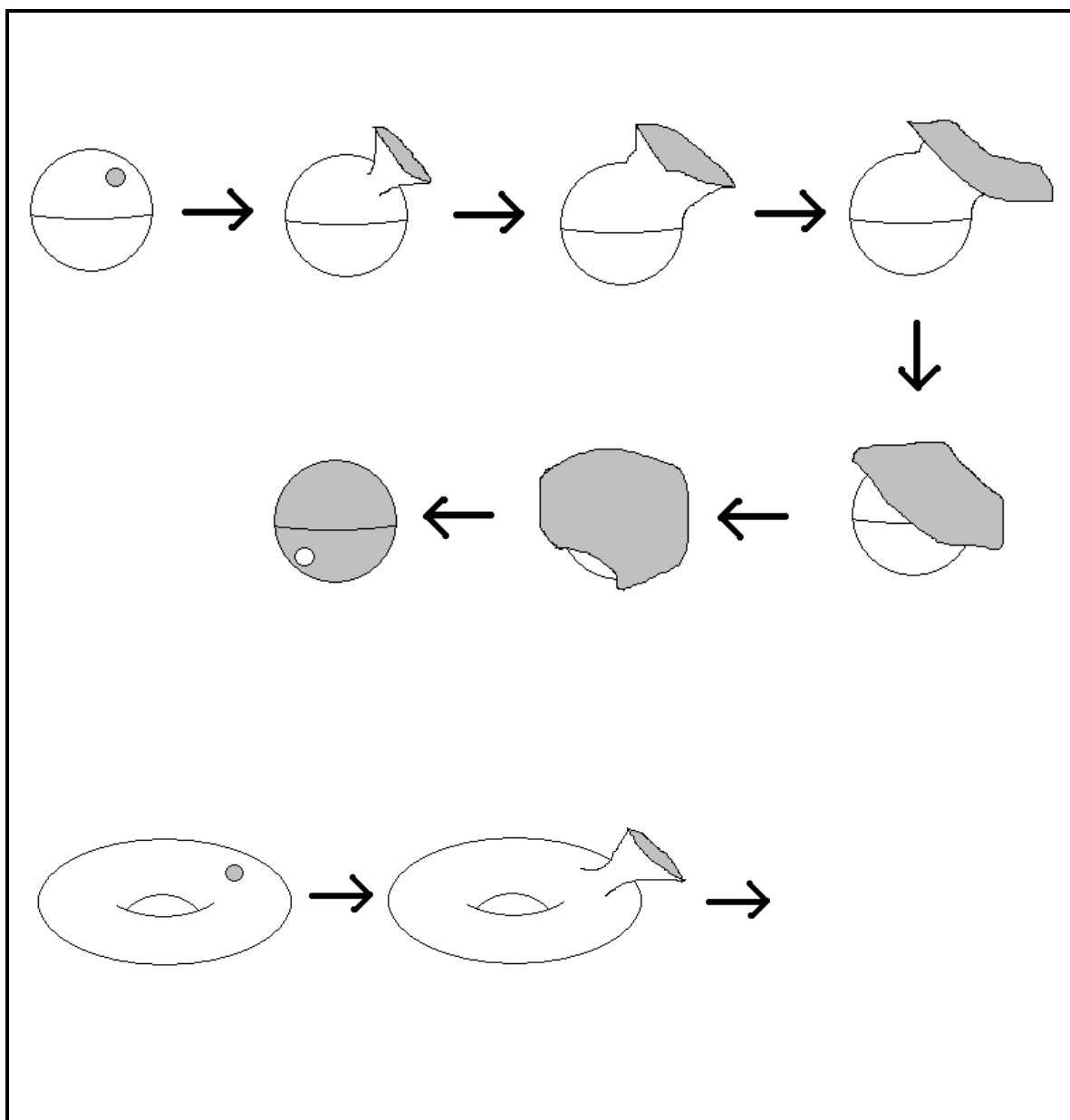



MATH WITHOUT WORDS: 61

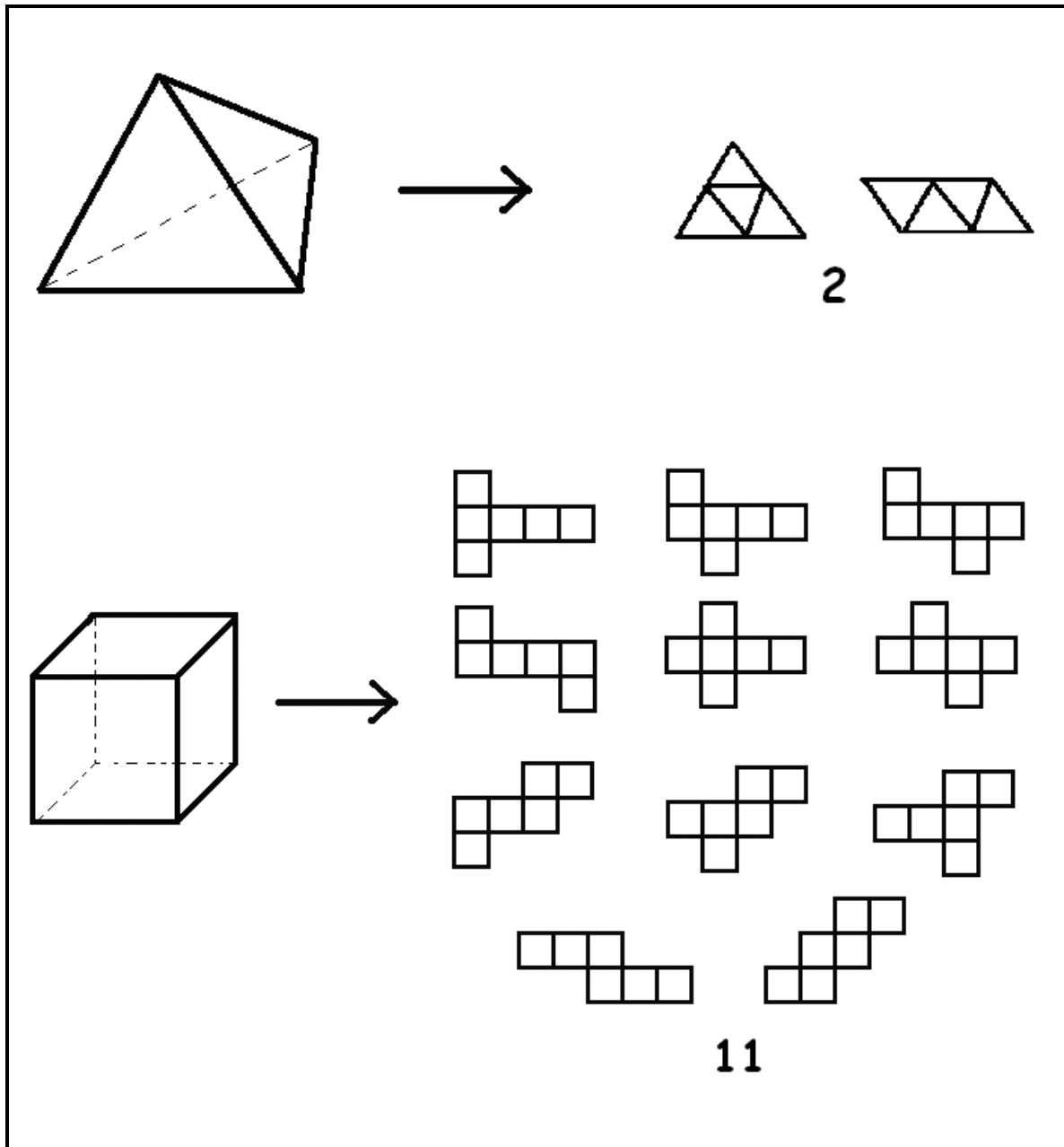

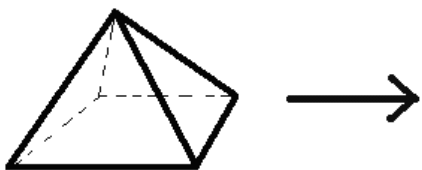

8

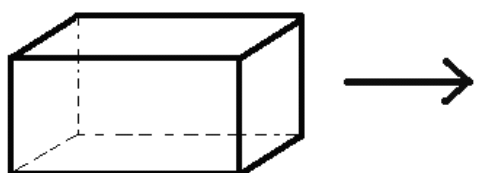

34

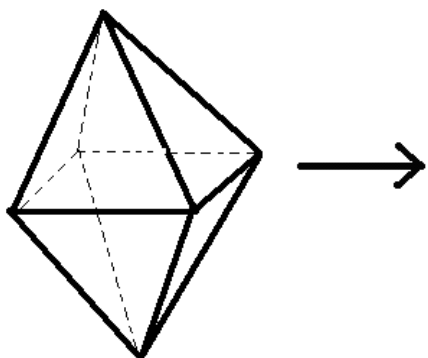



MATH WITHOUT WORDS: 62

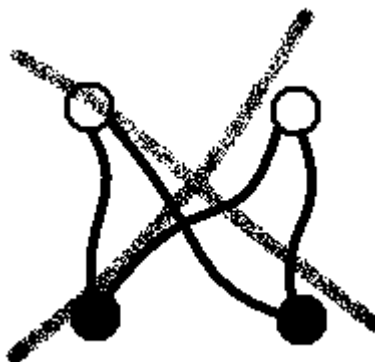
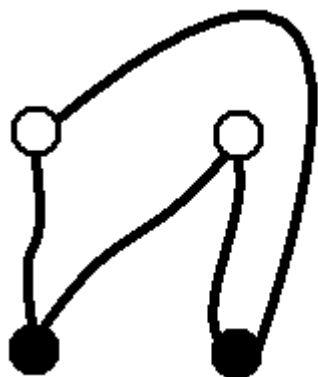
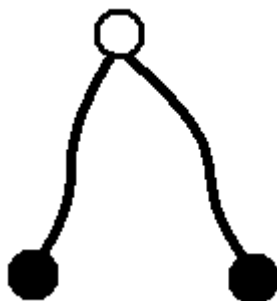

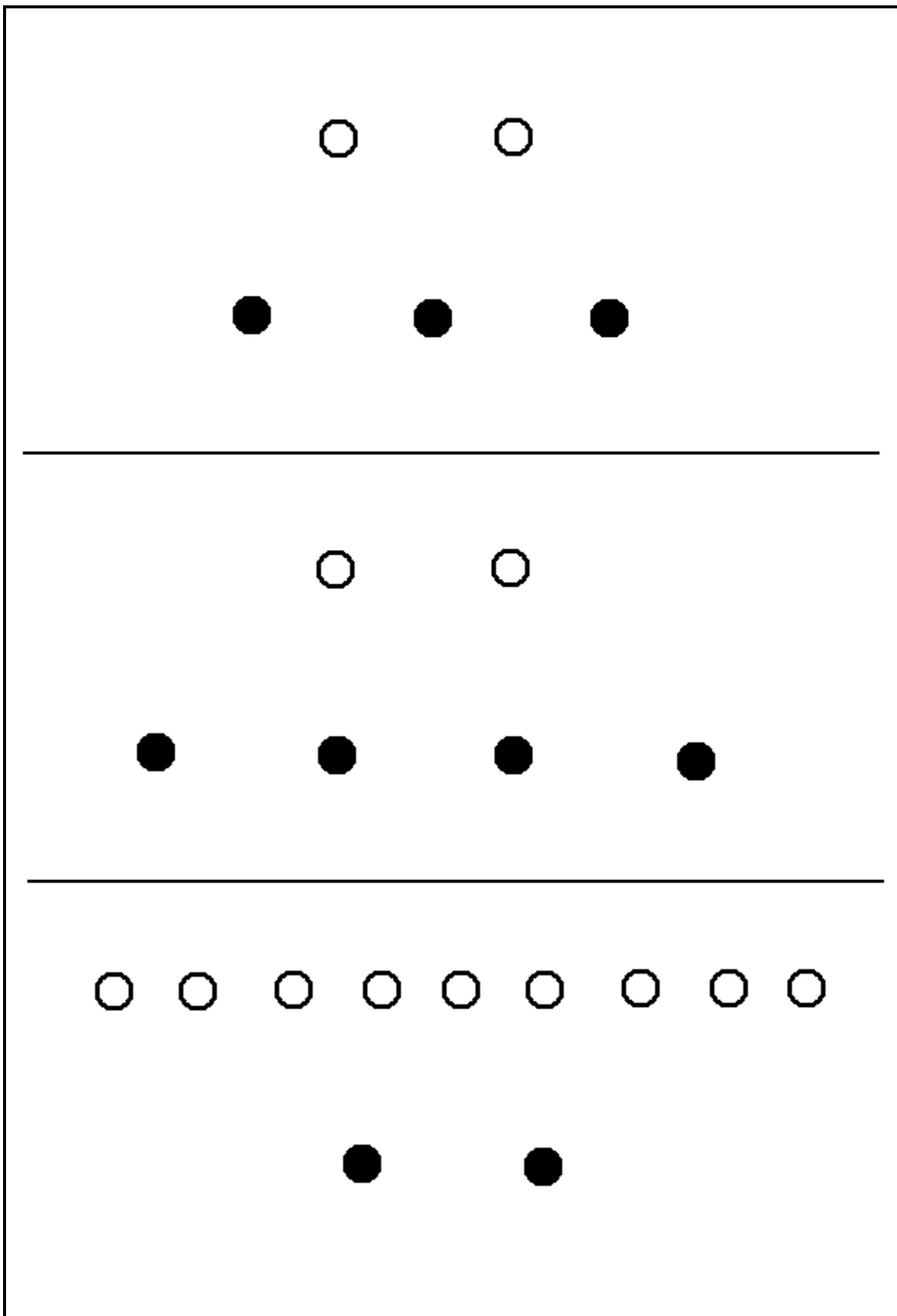

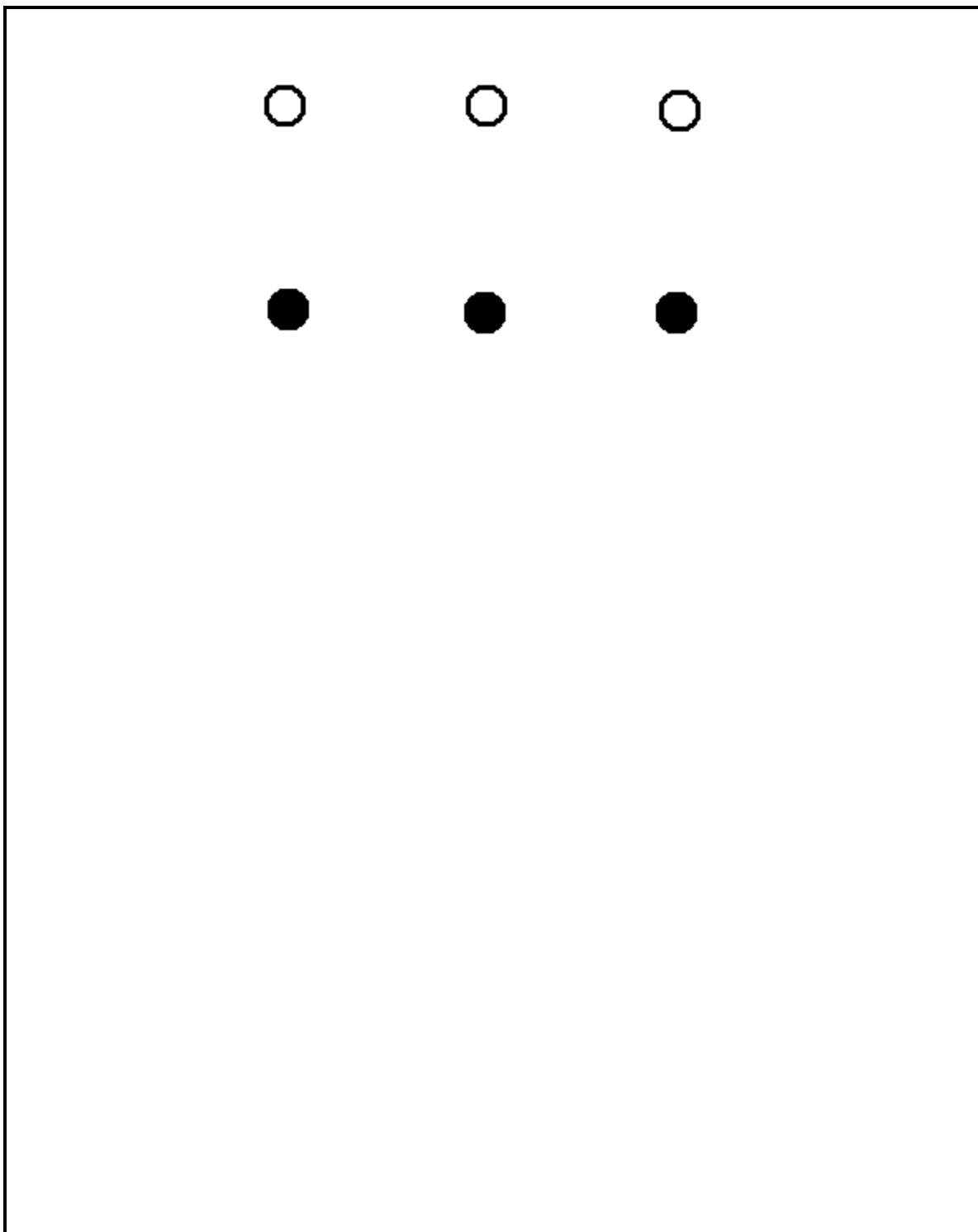

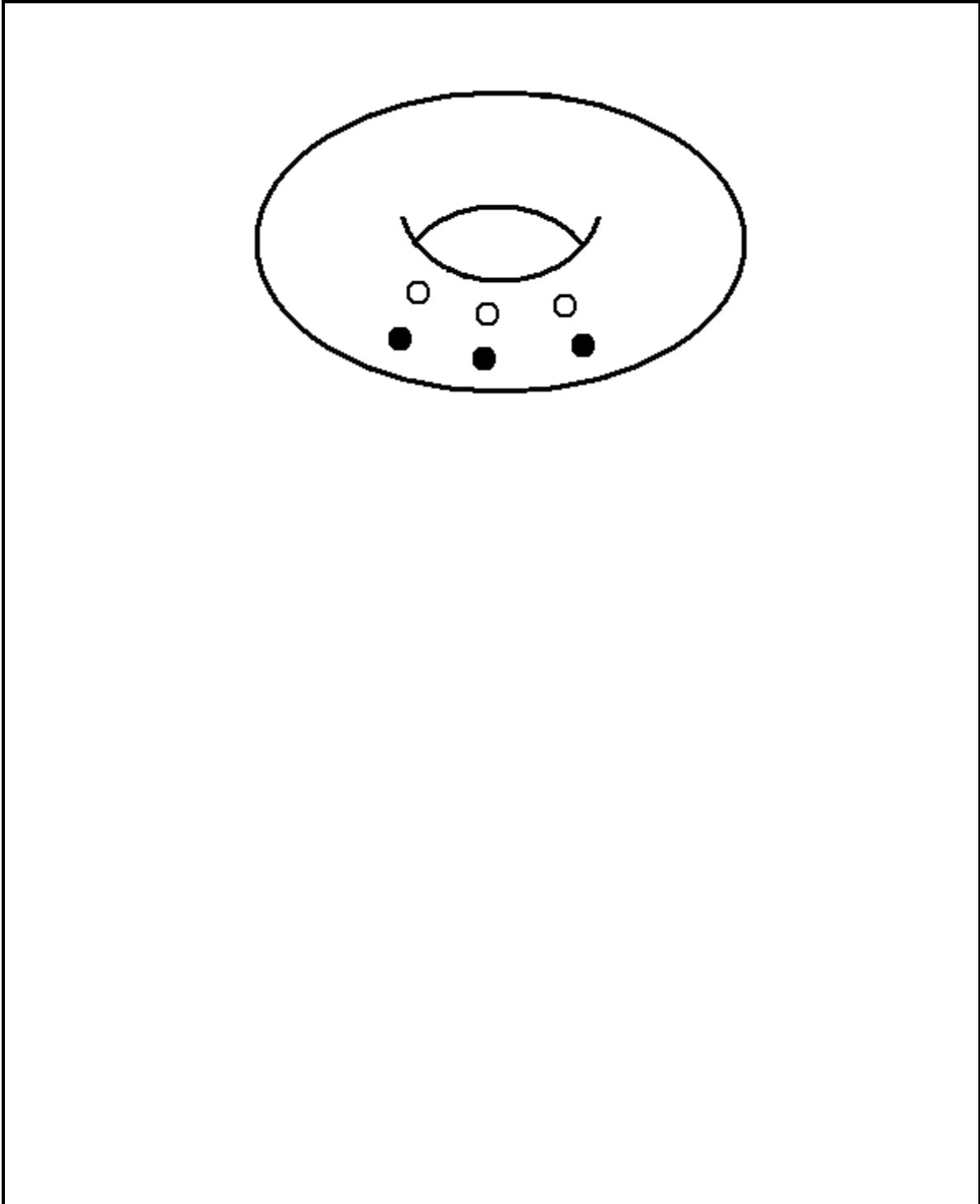



MATH WITHOUT WORDS: 63

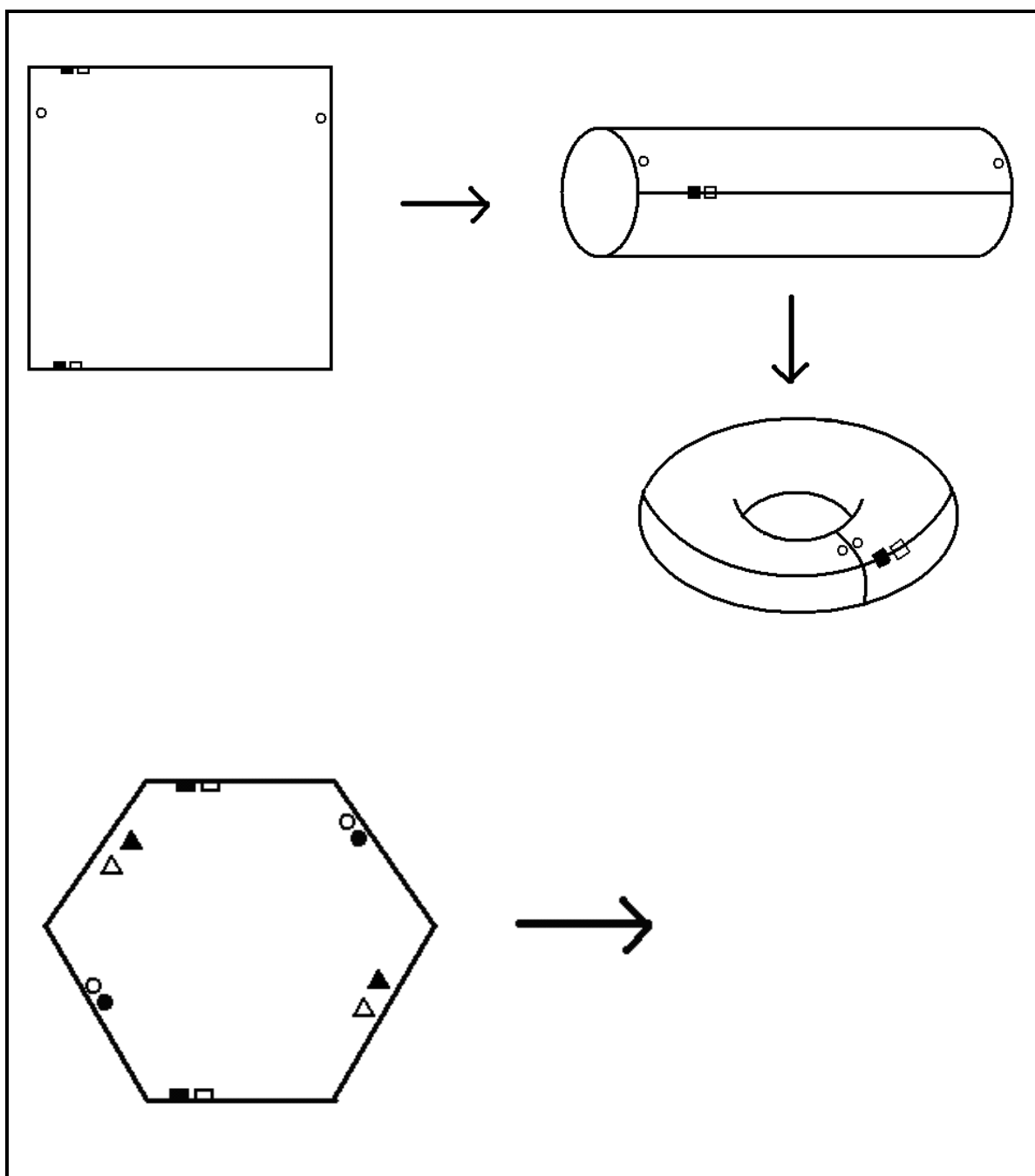

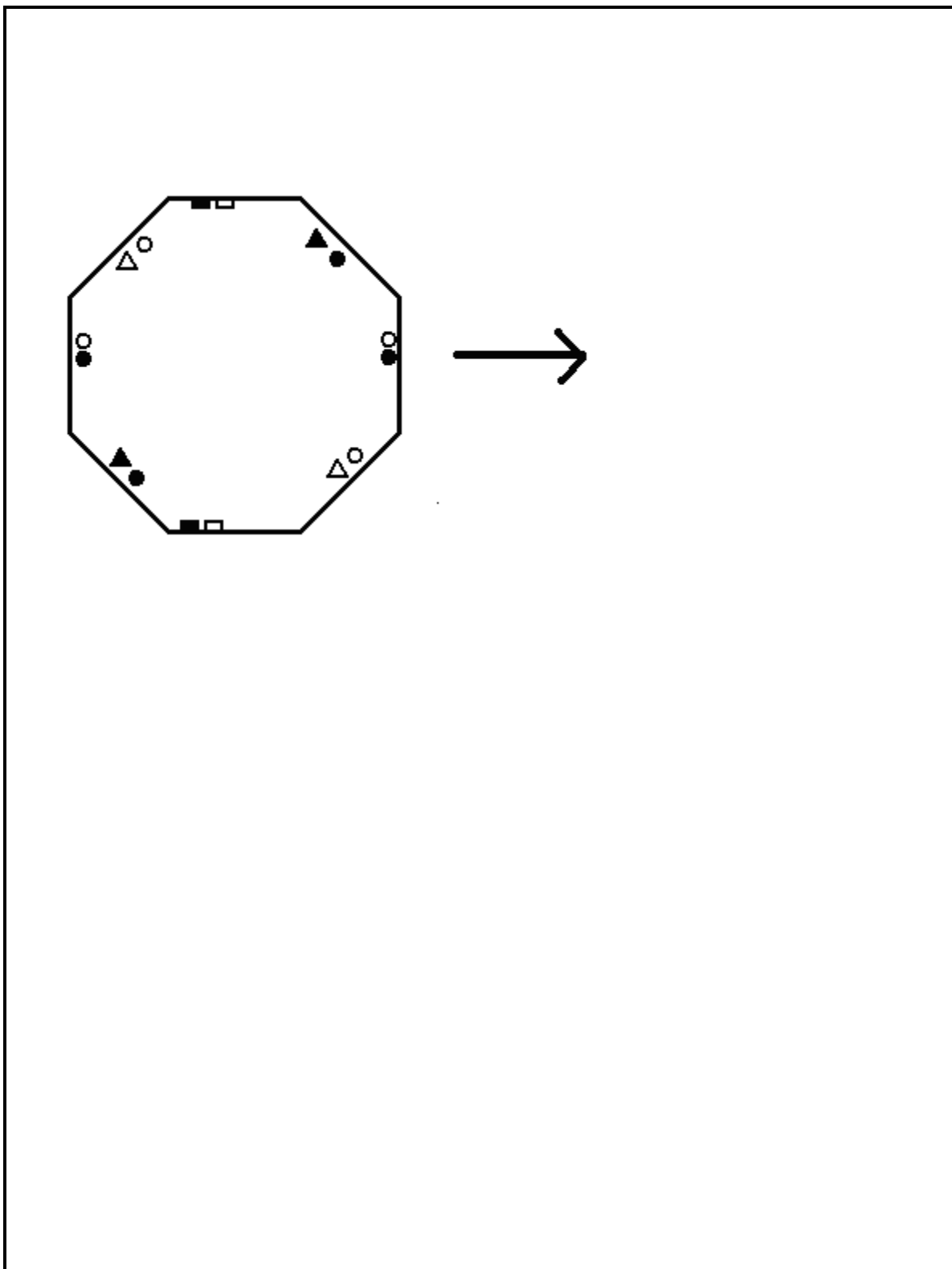



MATH WITHOUT WORDS: 64

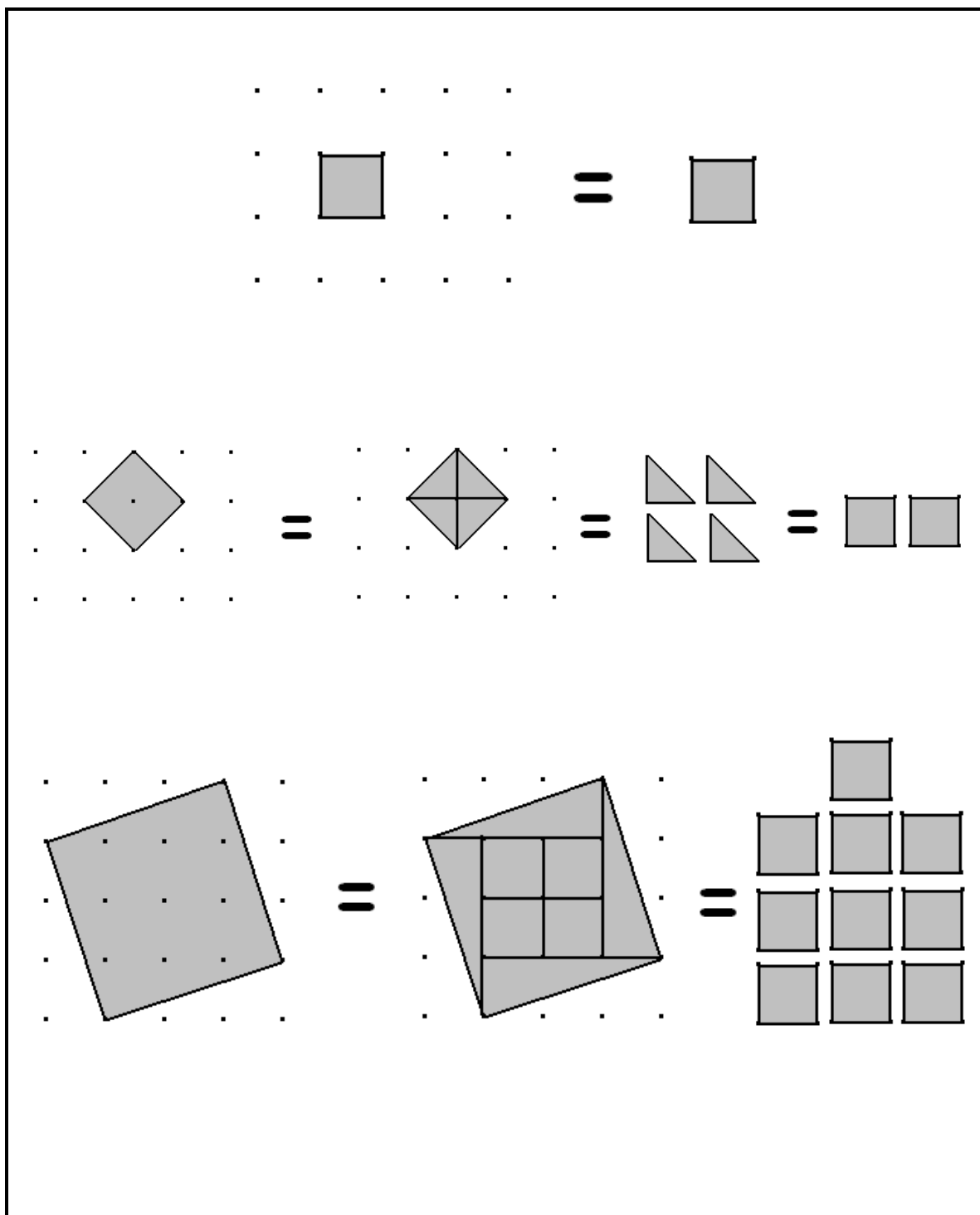

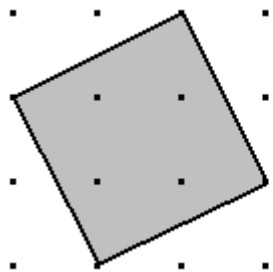

=

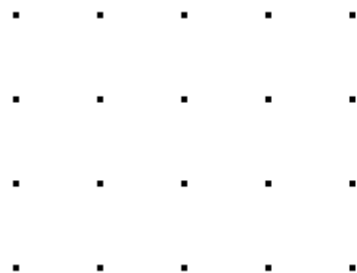

=

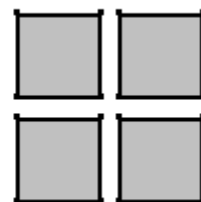

=

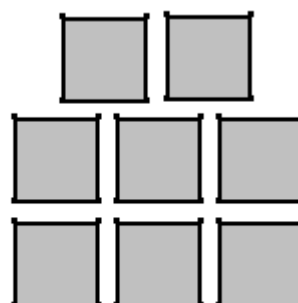

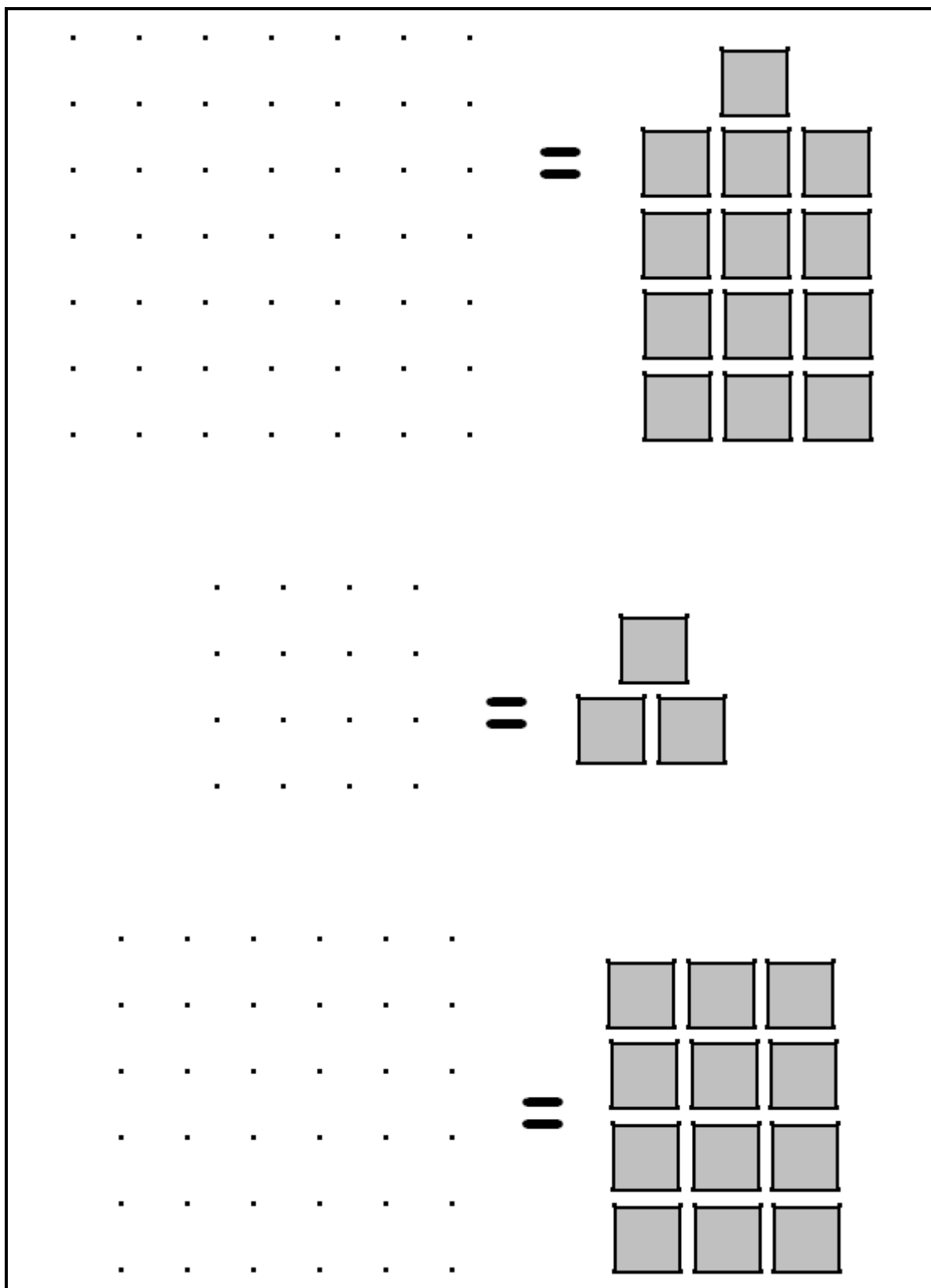



MATH WITHOUT WORDS: 65

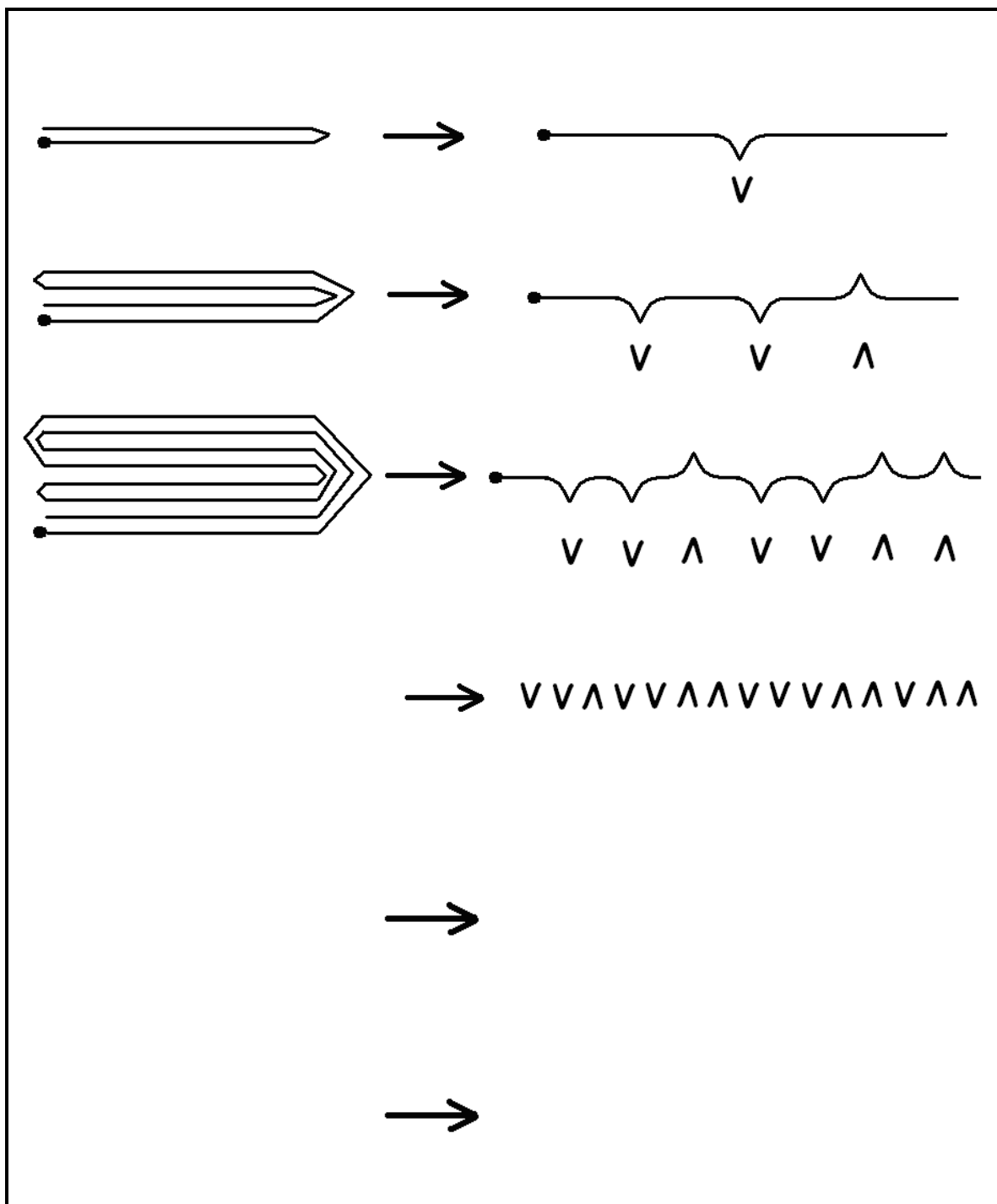



MATH WITHOUT WORDS: 66

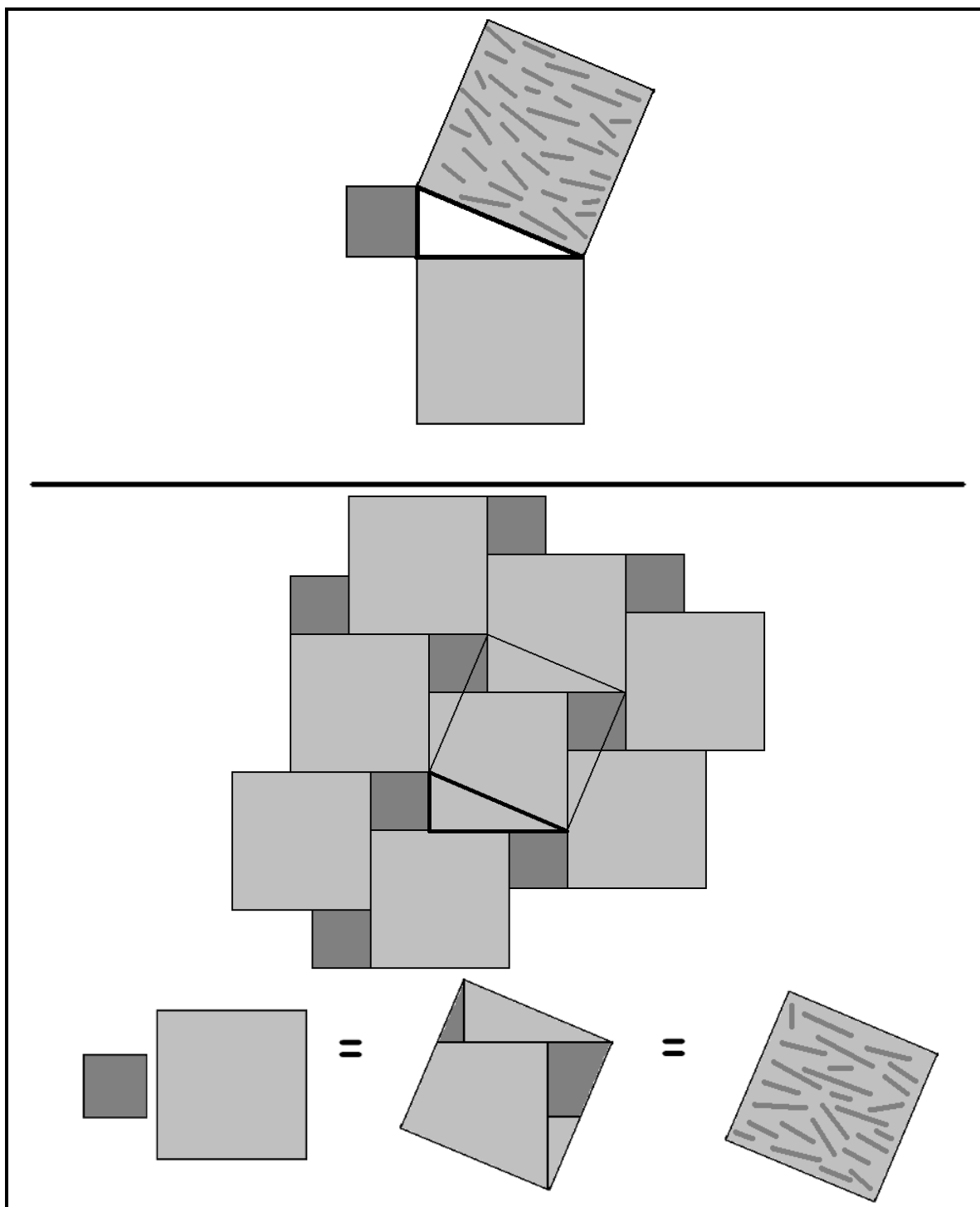

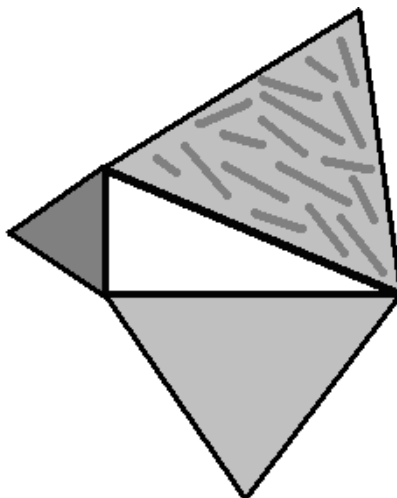



MATH WITHOUT WORDS: 68

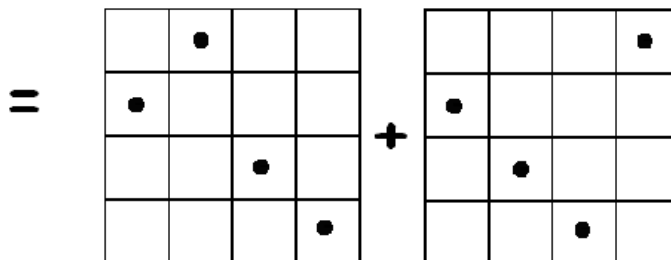
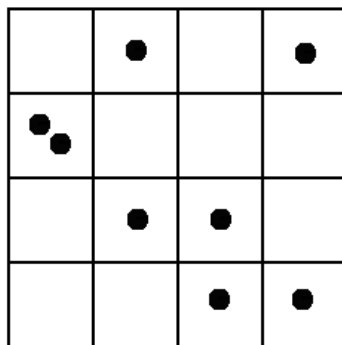
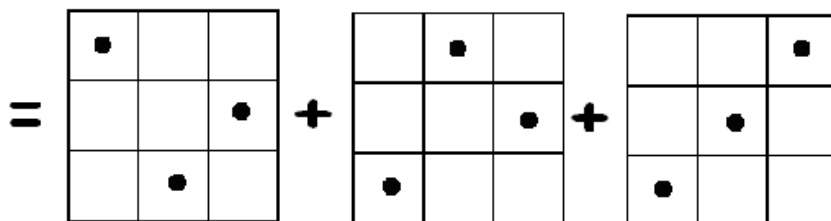
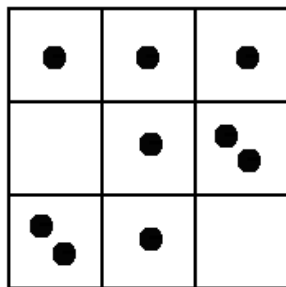

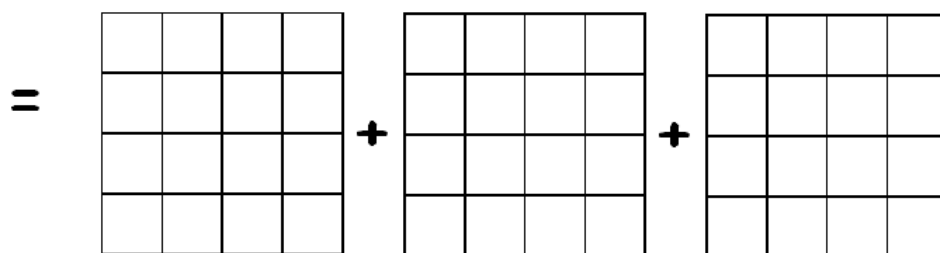
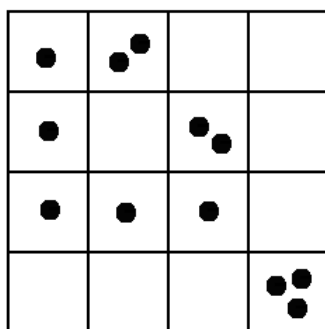
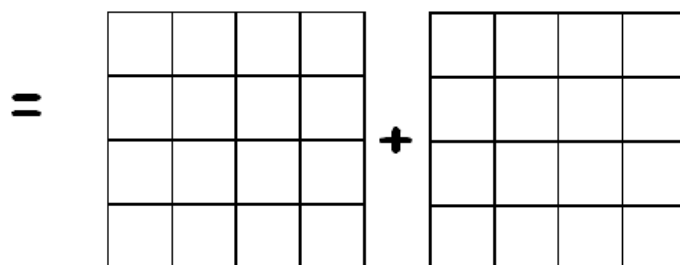
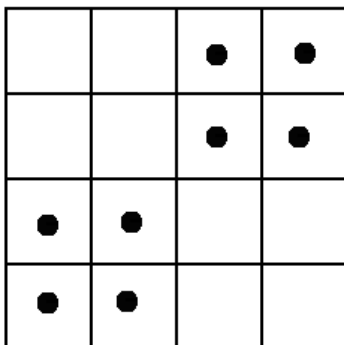

| | | | |
|----|-----|----|----|
| •• | | • | • |
| • | ••• | | |
| • | • | • | • |
| | | •• | •• |

=

| | | |
|---|---|---|
| • | • | • |
| • | • | • |
| • | • | • |

=

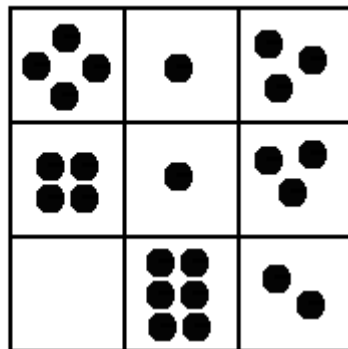

=



MATH WITHOUT WORDS: 69

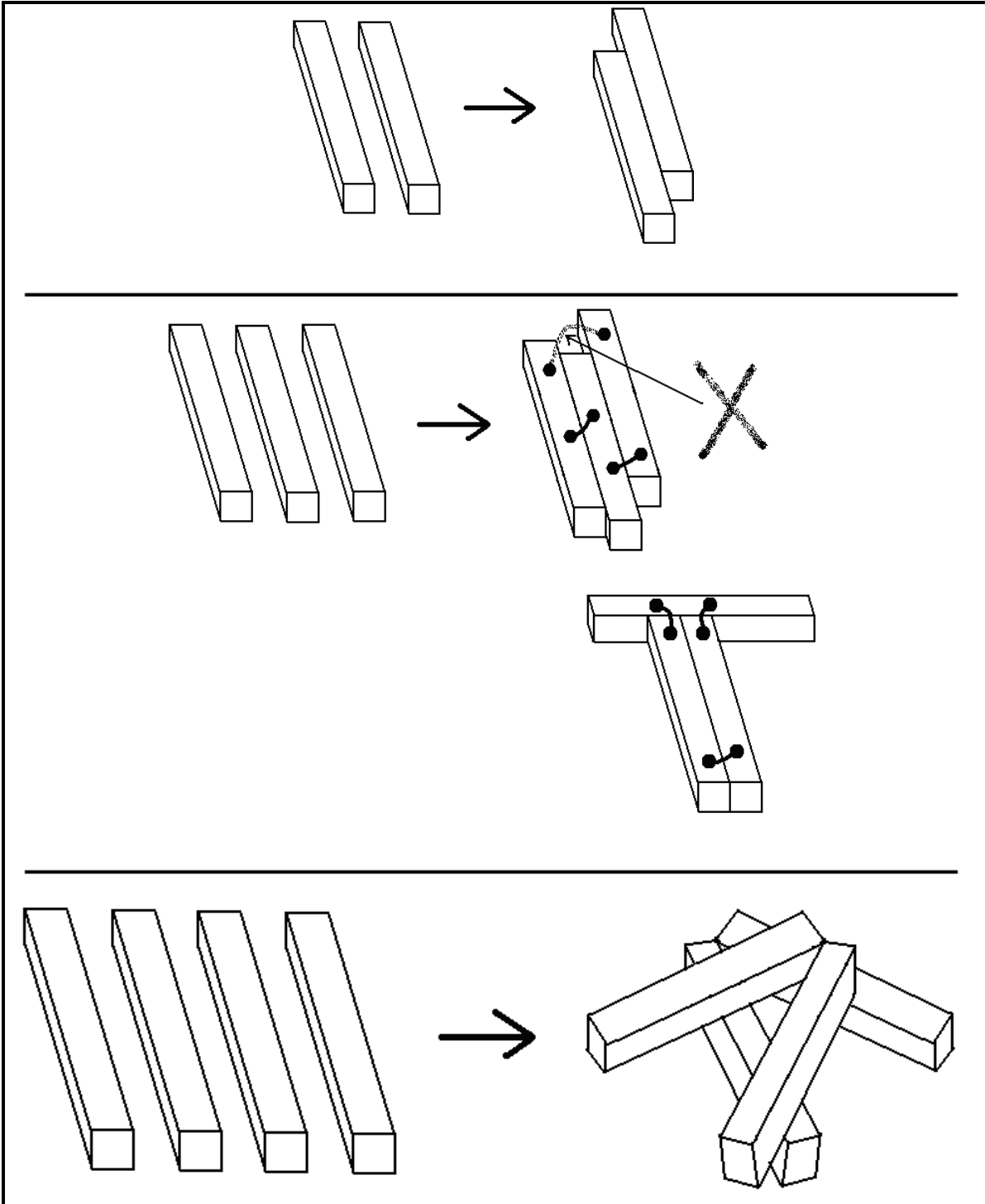

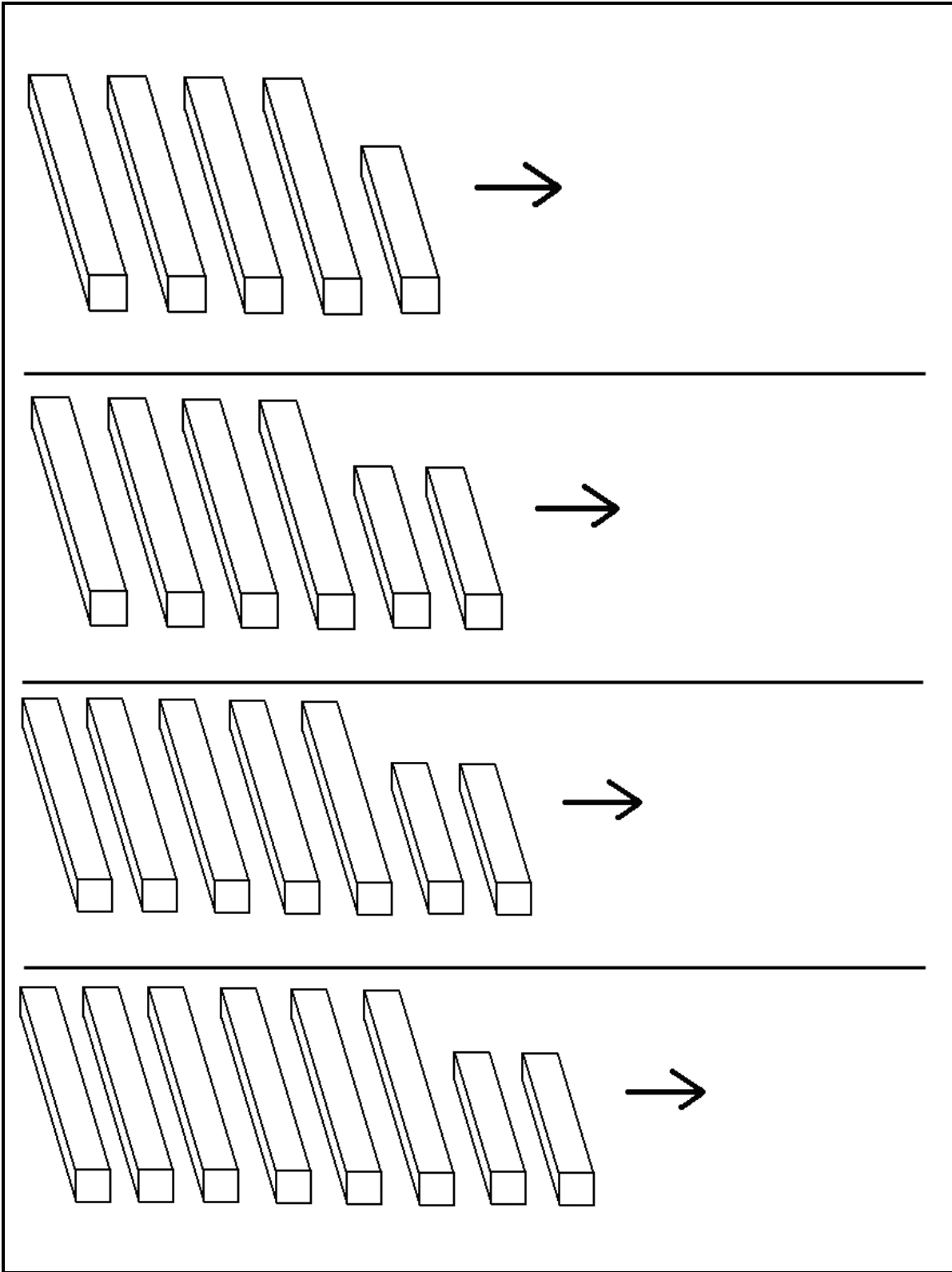



MATH WITHOUT WORDS: 70

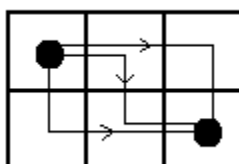

3

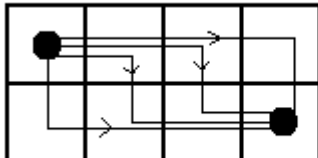

4

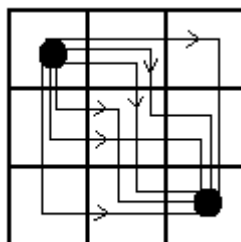

6

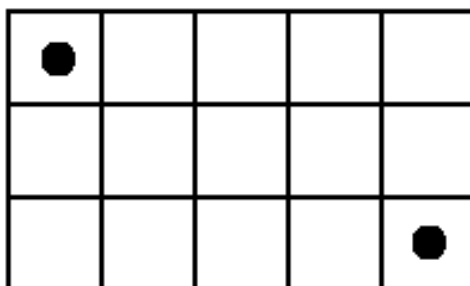
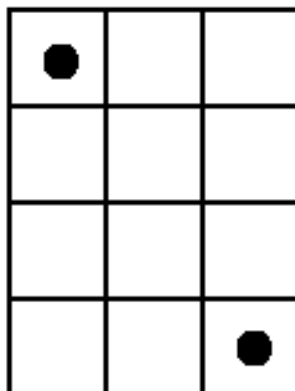
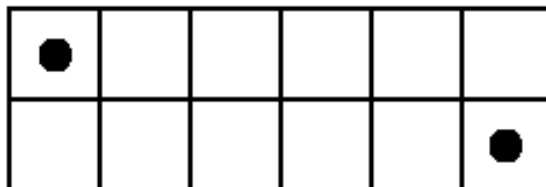
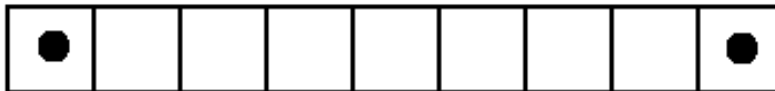



MATH WITHOUT WORDS: 71

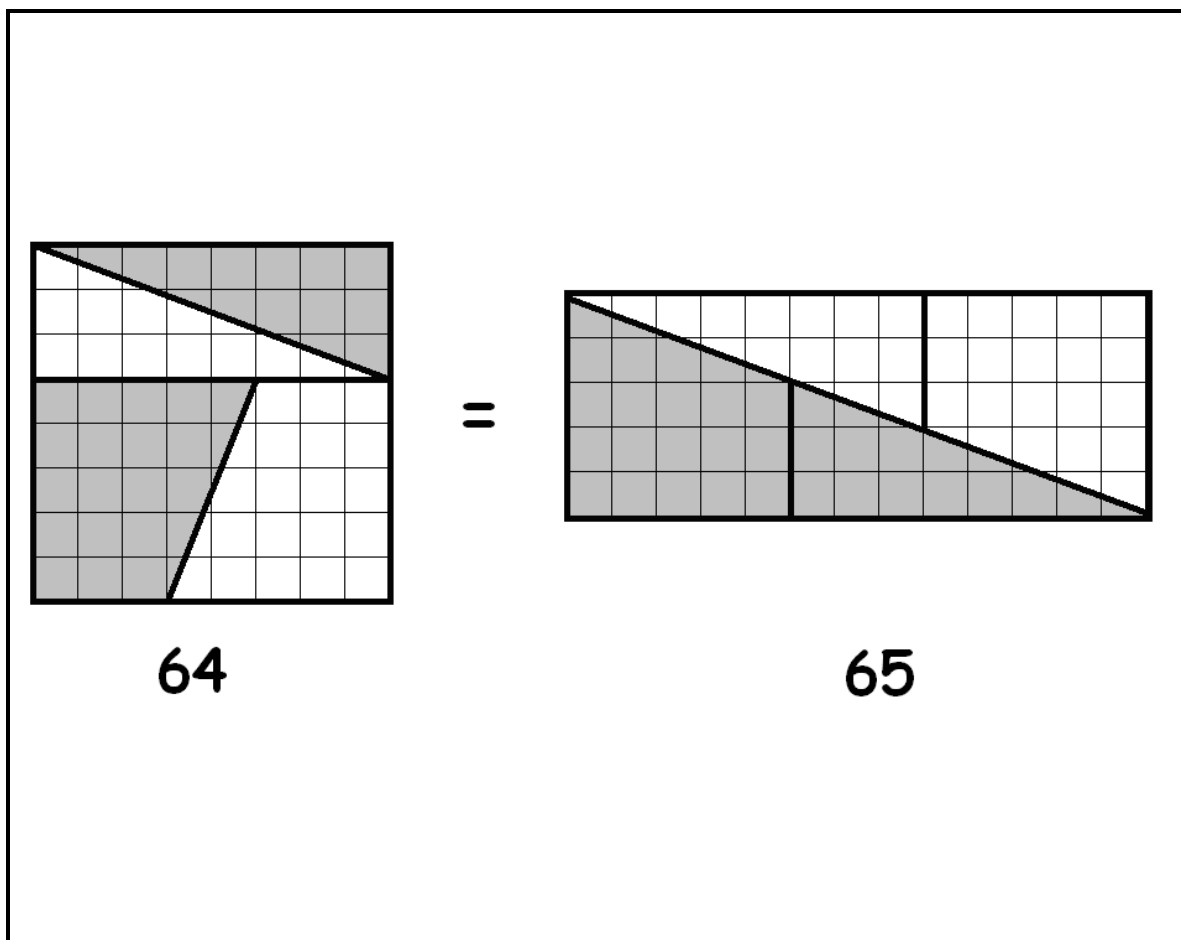



MATH WITHOUT WORDS: 72

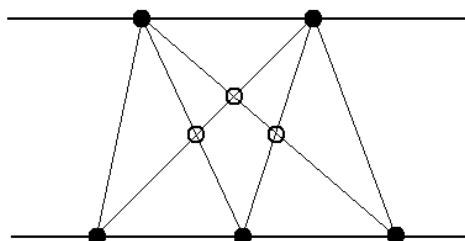

| | | | |
|-----|-------|---|---|
| • • | • • • | → | 3 |
|-----|-------|---|---|

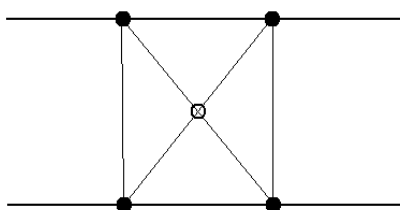

| | | | |
|-----|-----|---|---|
| • • | • • | → | 1 |
|-----|-----|---|---|

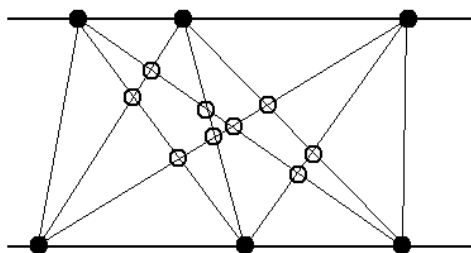

| | | | |
|-------|-------|---|---|
| • • • | • • • | → | 9 |
|-------|-------|---|---|



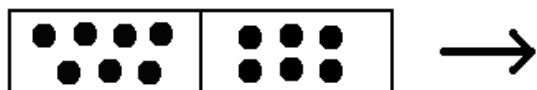
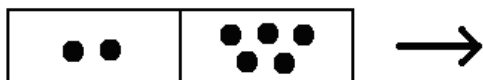
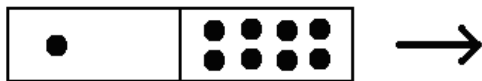



MATH WITHOUT WORDS: 73

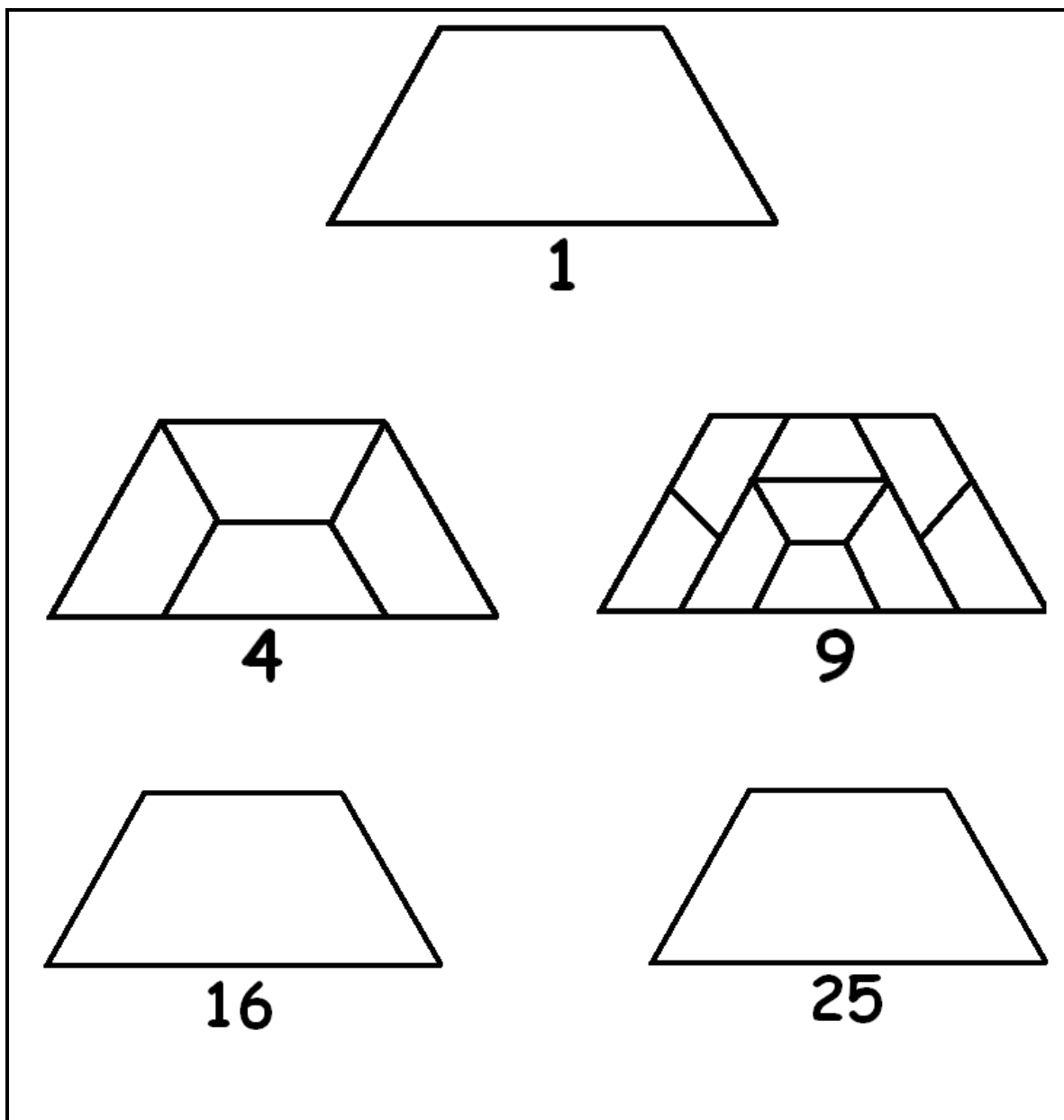



MATH WITHOUT WORDS: 74

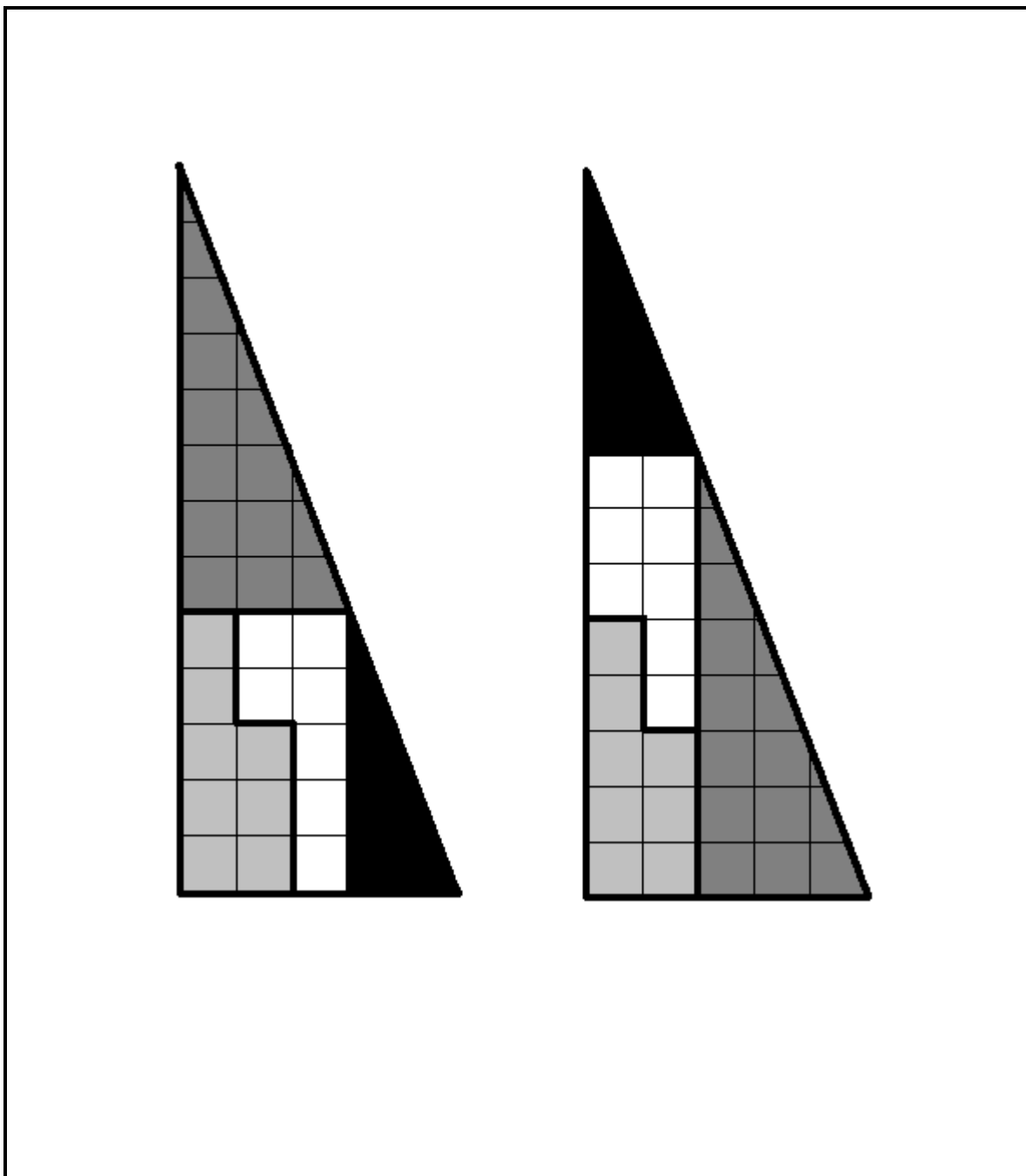



MATH WITHOUT WORDS: 75

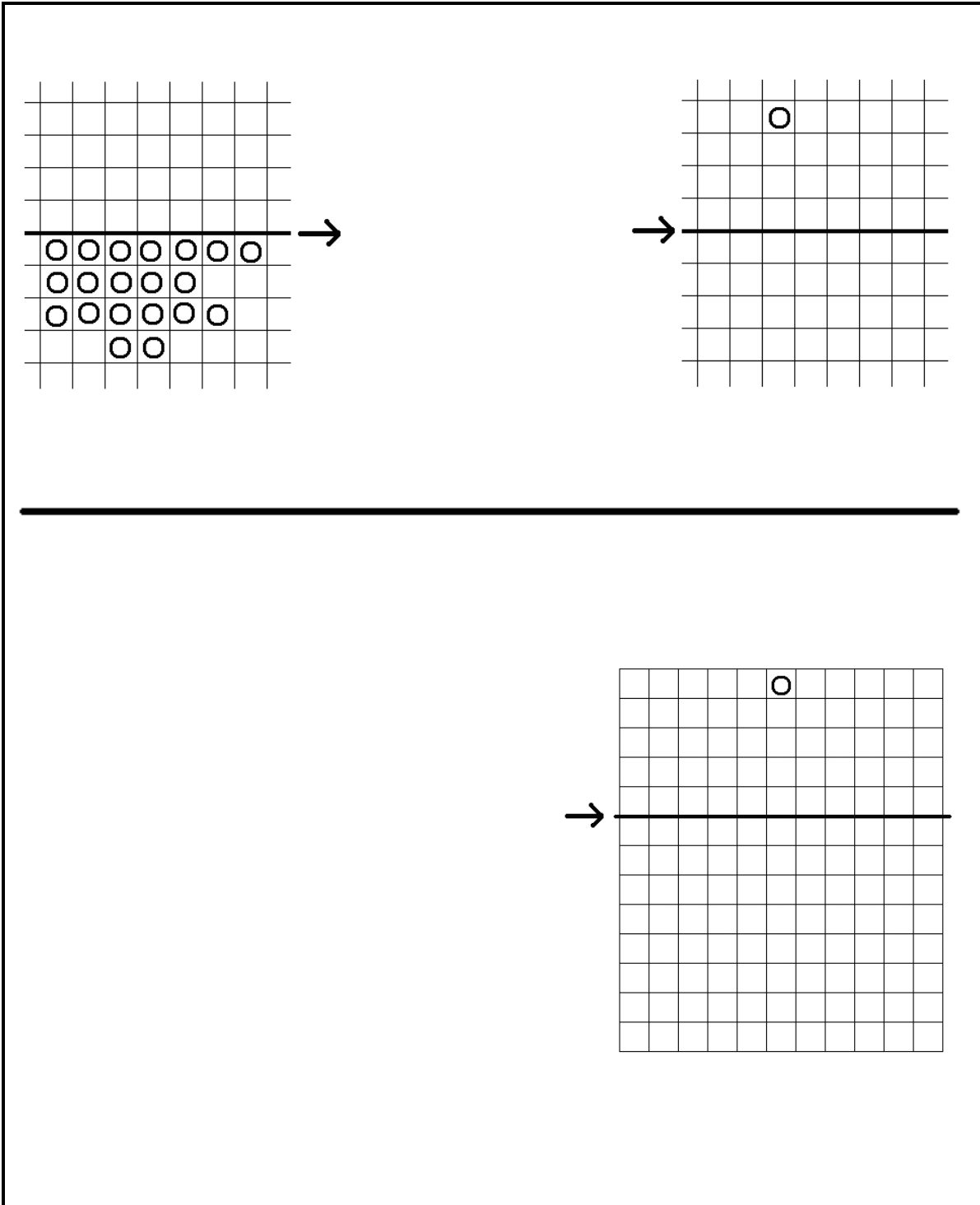

OH SO BRIEF SOLUTIONS

1.

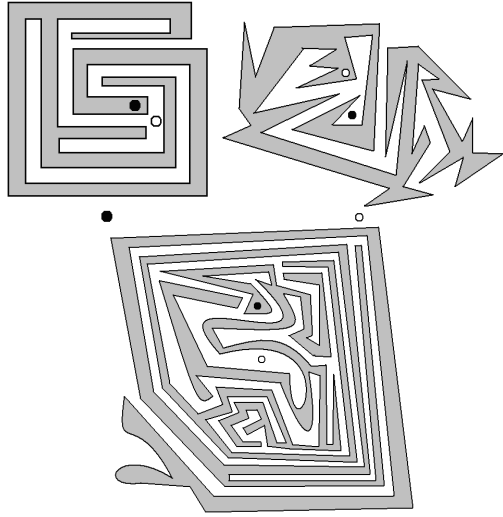

2.

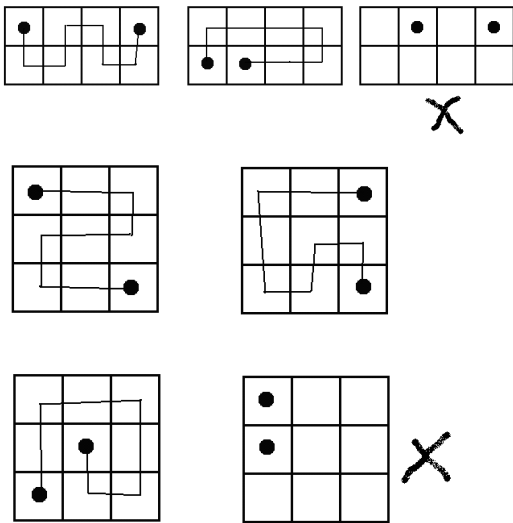

3.

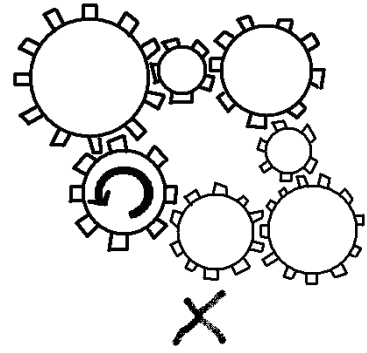
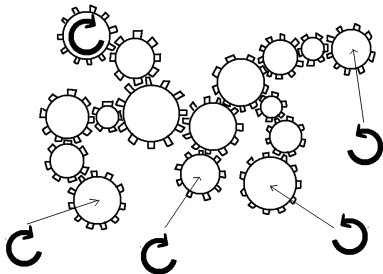

4.

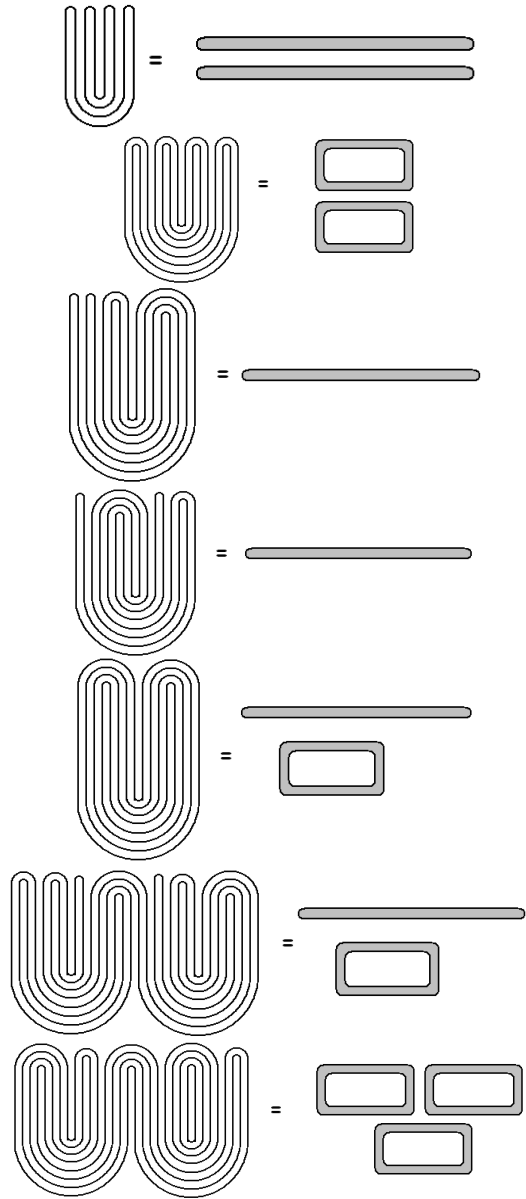

5.

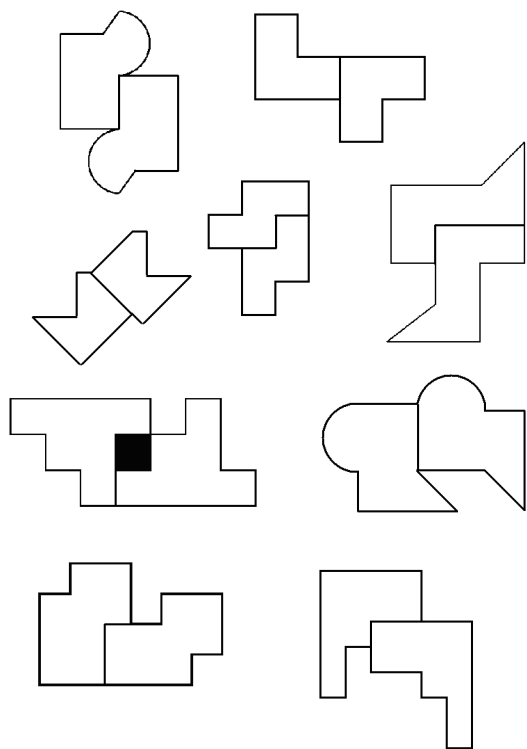

6.

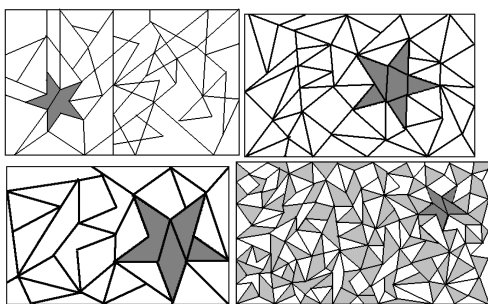

7.

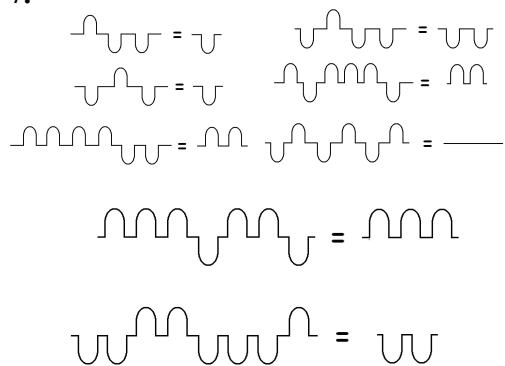

8.

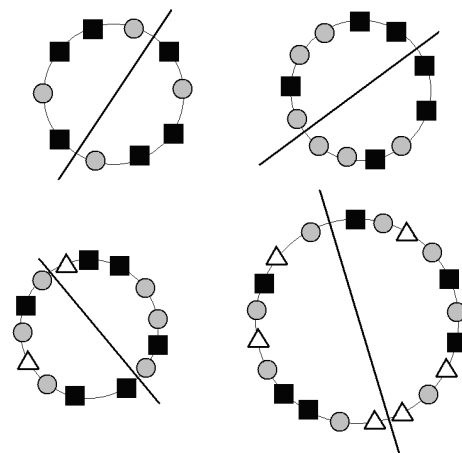

9.

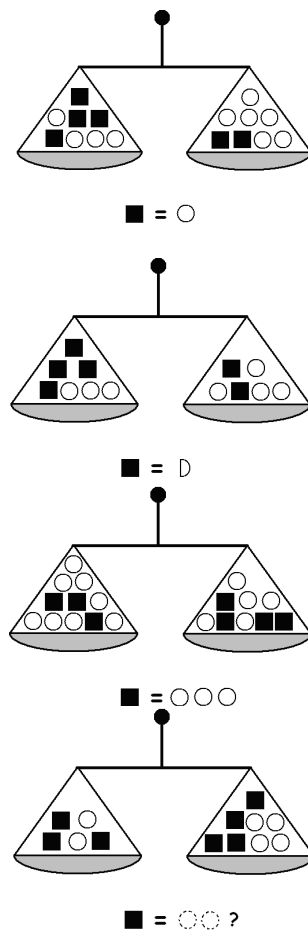

10.

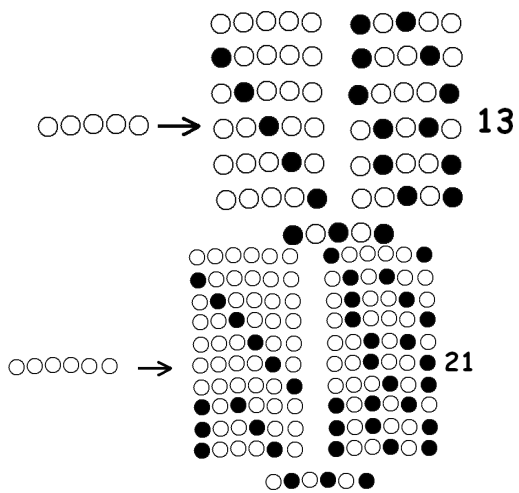

11.

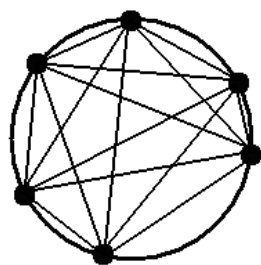

31

12.

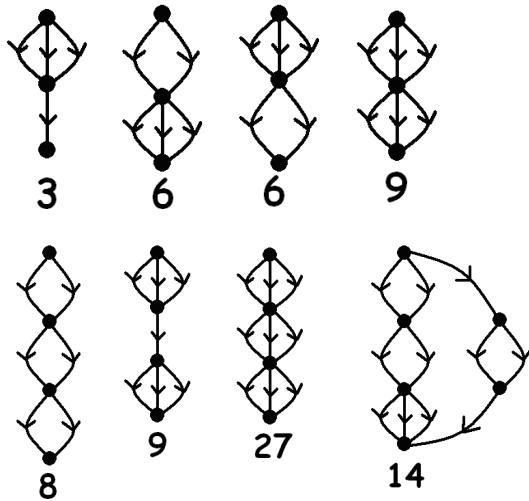

13.

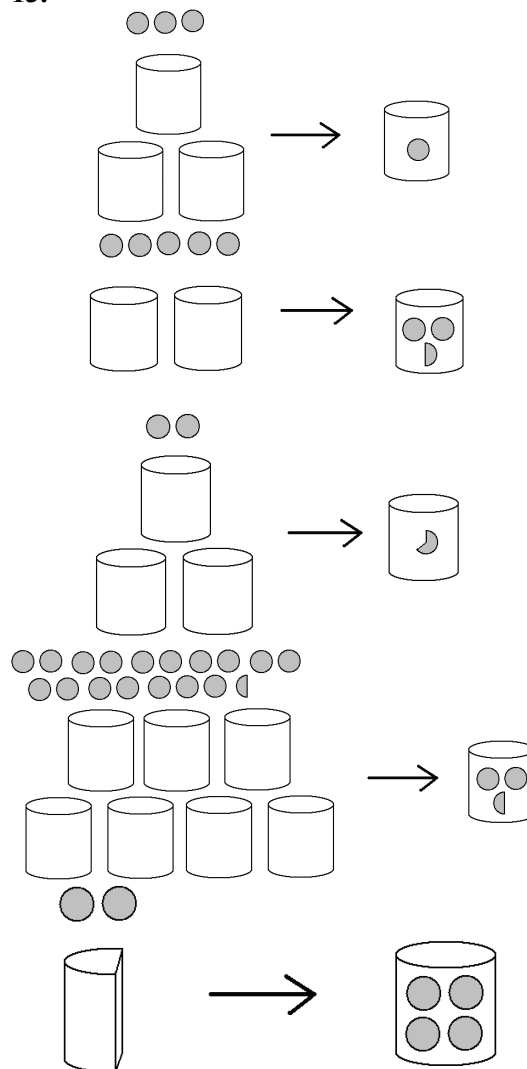

14.

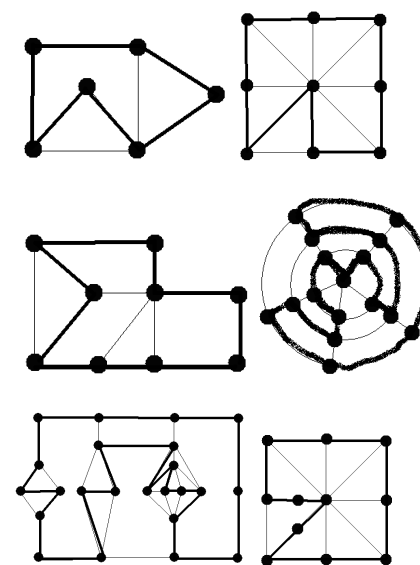

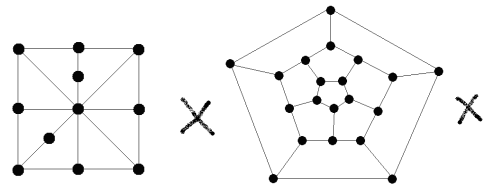

15.

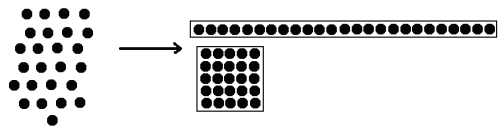
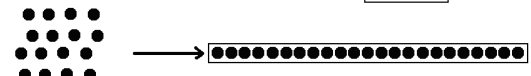
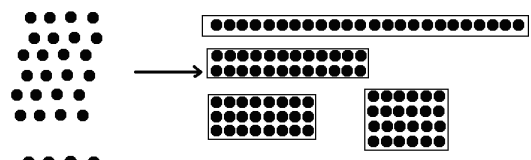
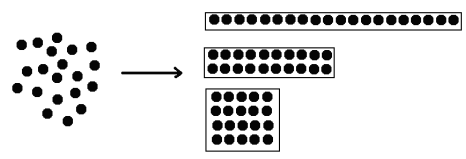
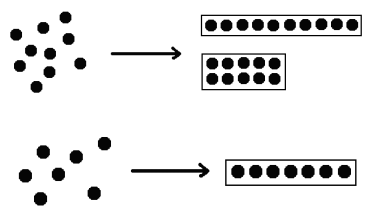

16.

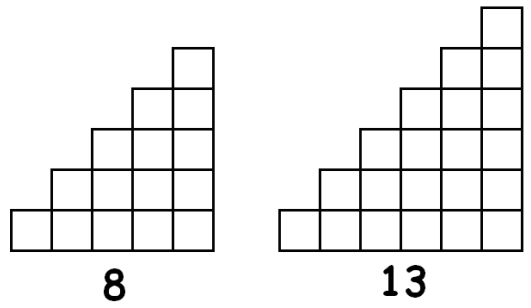

17.

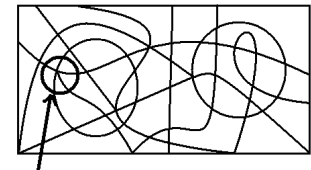
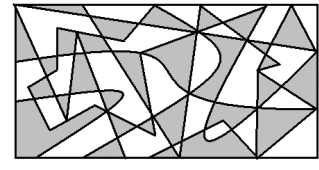
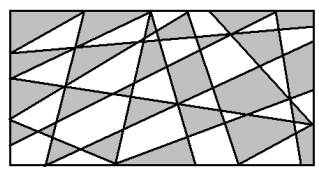

18.

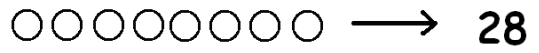
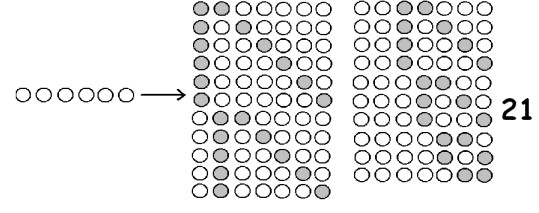
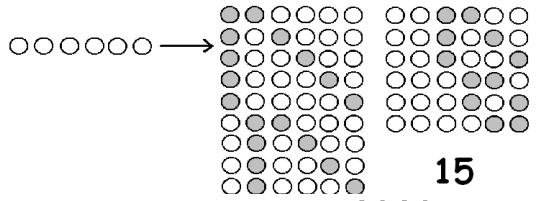

19.

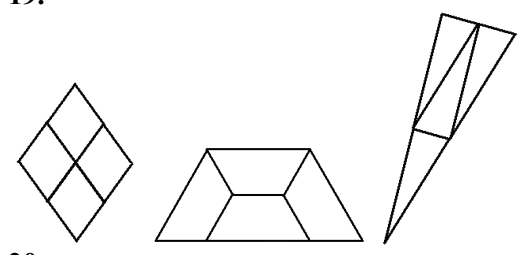

20.

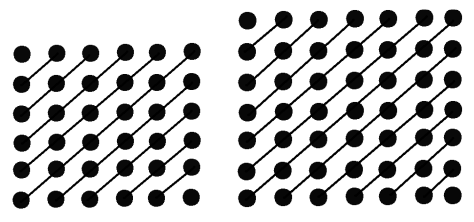
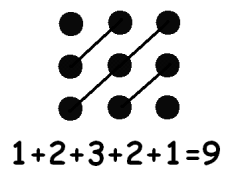

21.

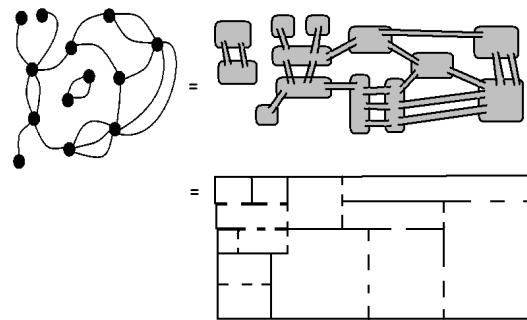
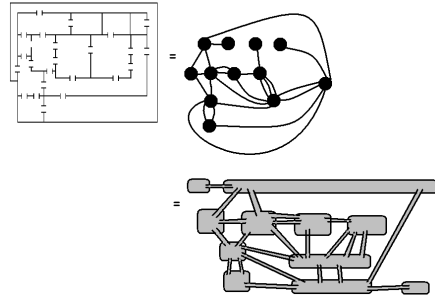
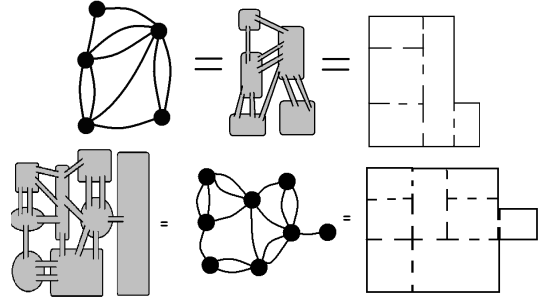
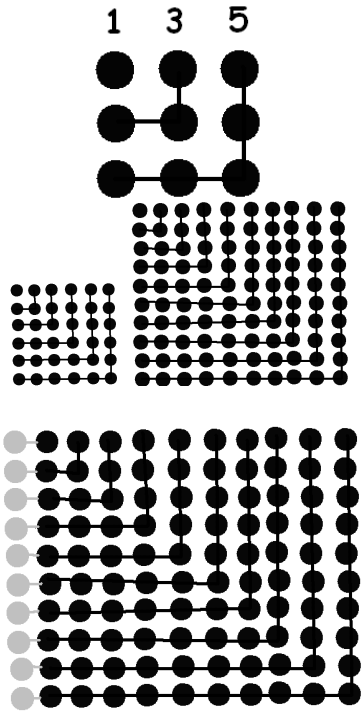

22.

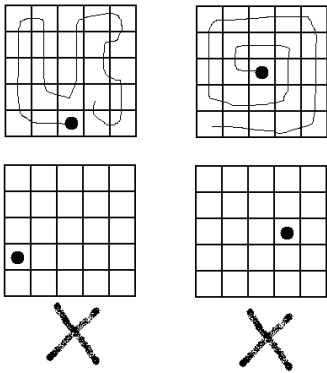

23.

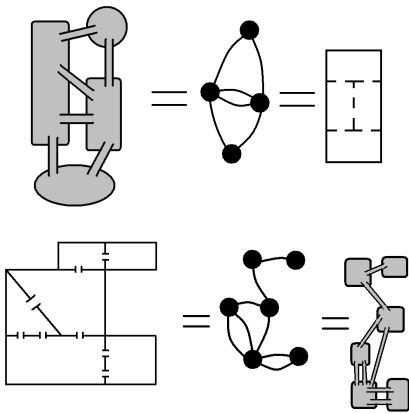

24.

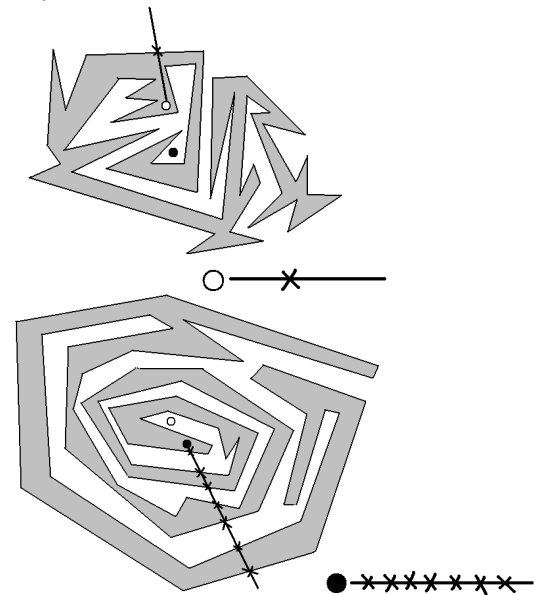

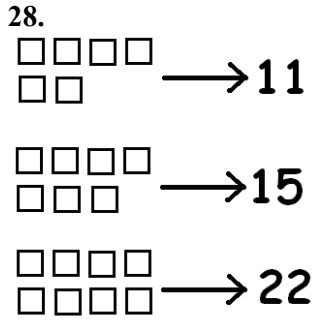
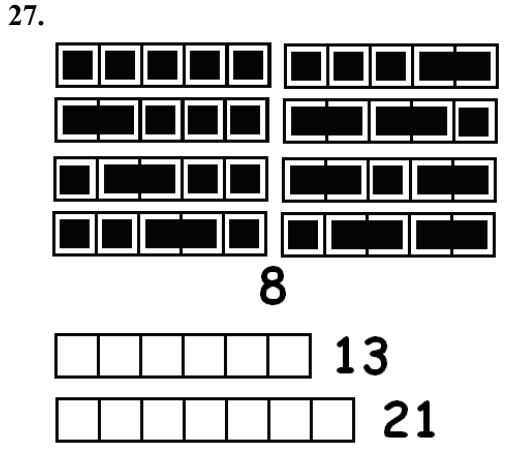
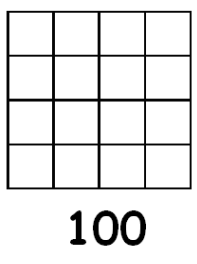
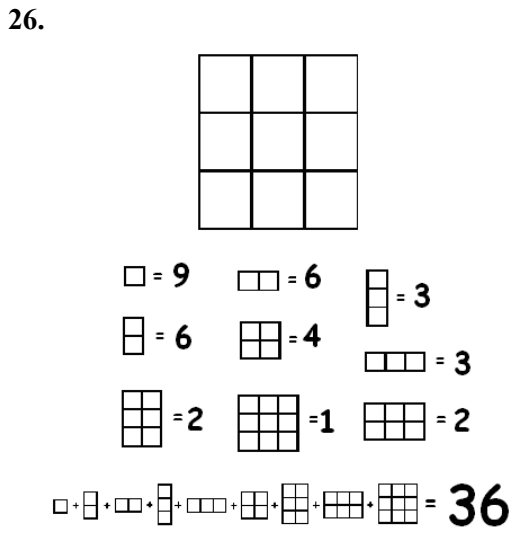
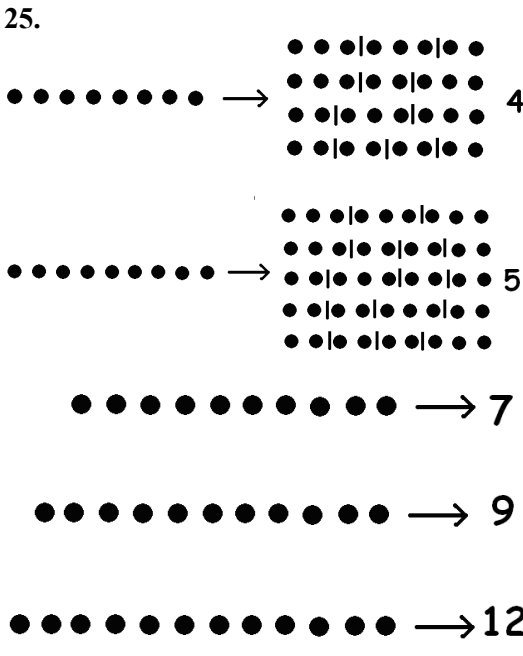
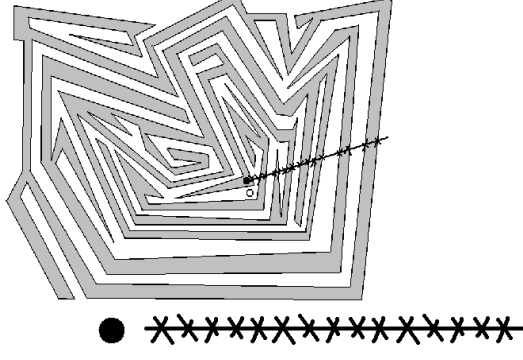
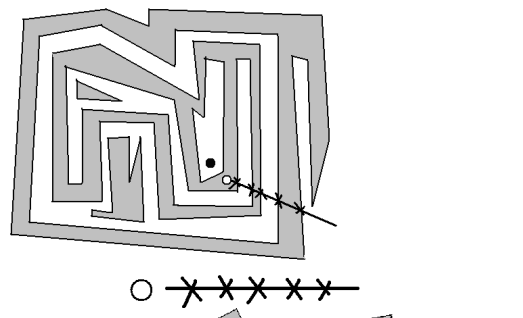
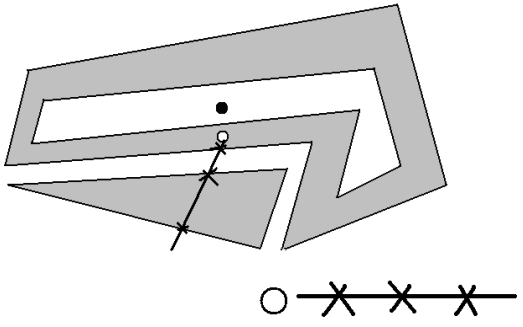

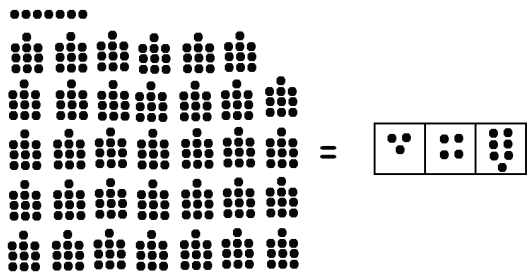

33.

34

34.

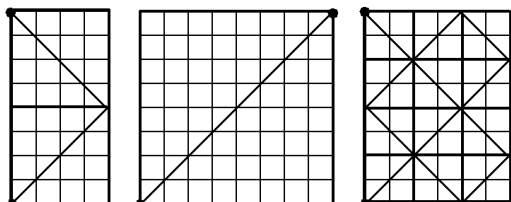
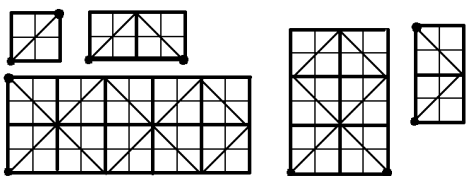
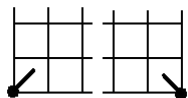
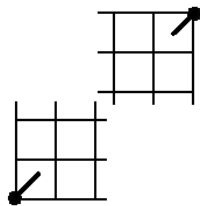

35.

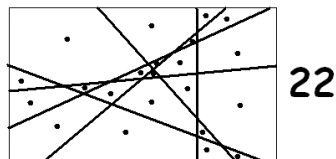
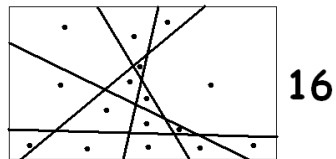
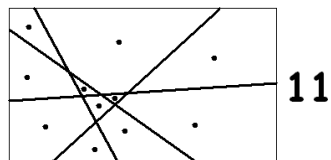

36.

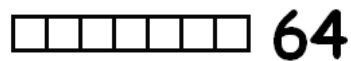
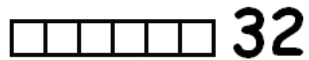
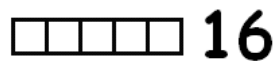

37.

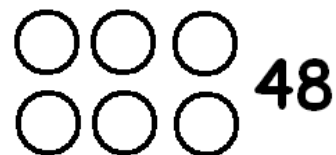

38.

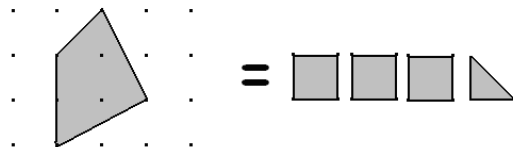
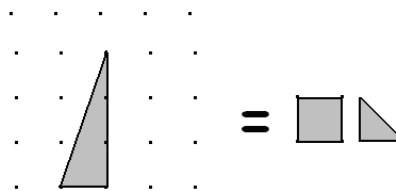
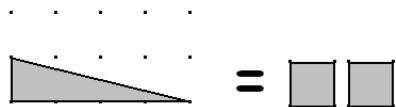

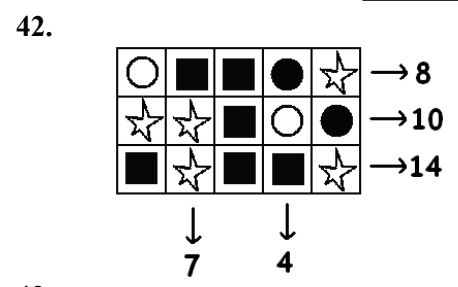
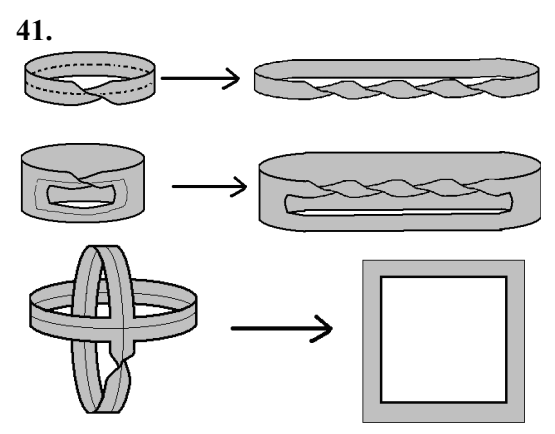
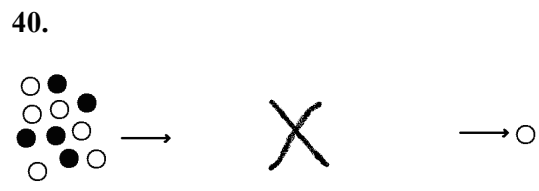
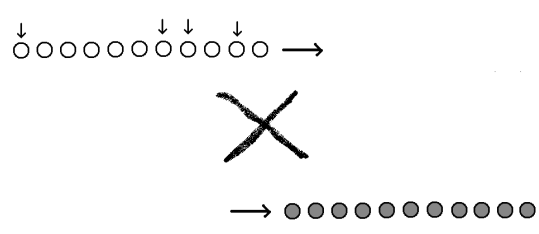
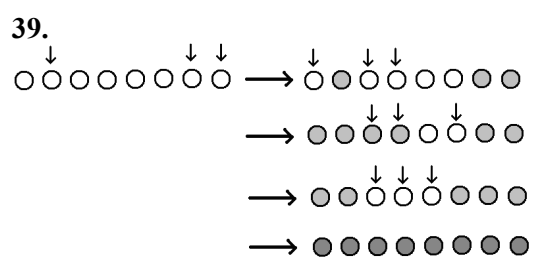
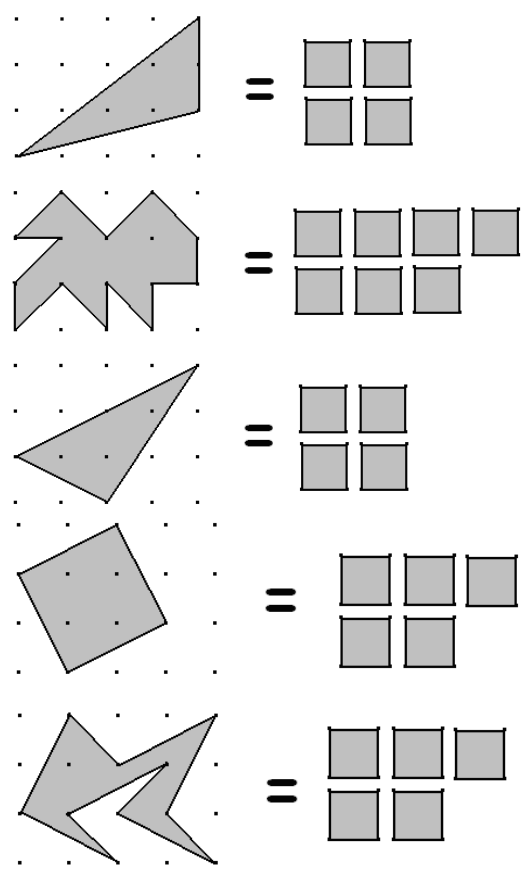

44.

36, 49
35, 51
1, 6, 15, 28, 45, 66
1, 7, 18, 34, 55, 81

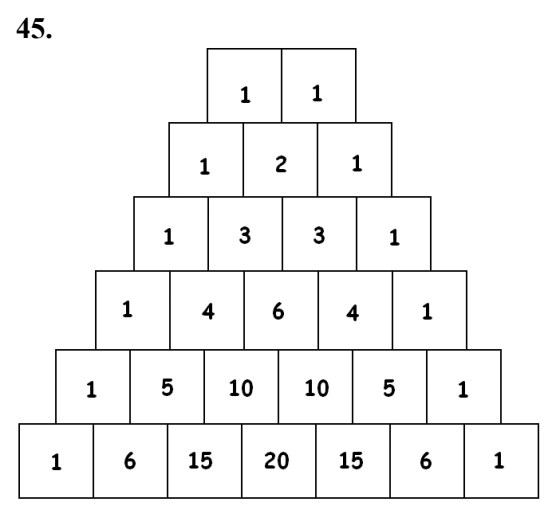

46.

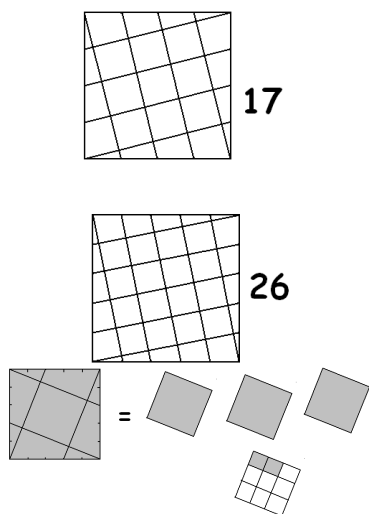

50.

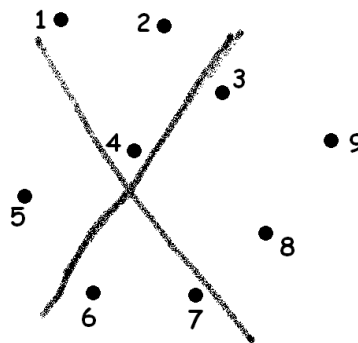

47.

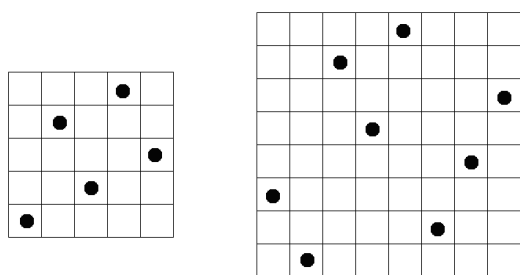

51.

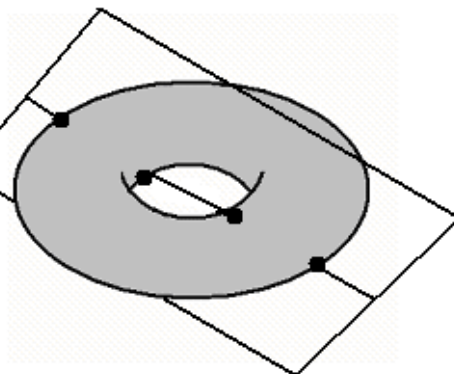

48.

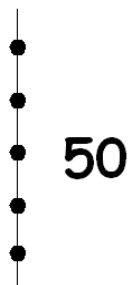

52.

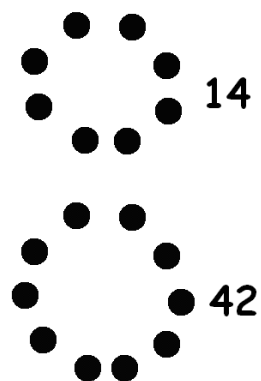

49.

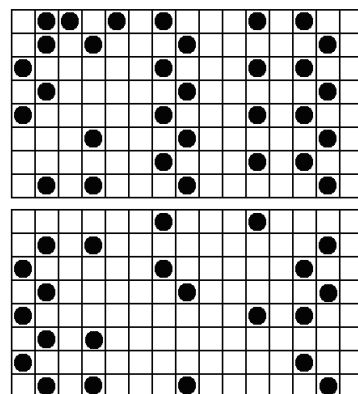
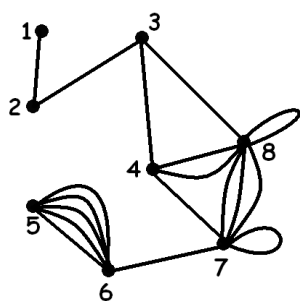

53.

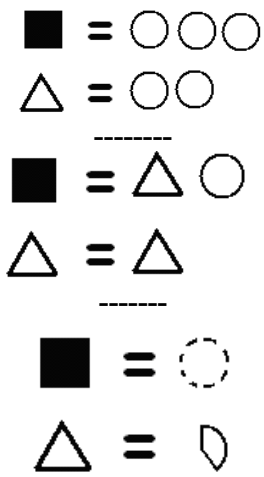

54.

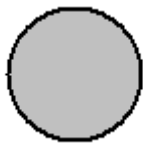

55.

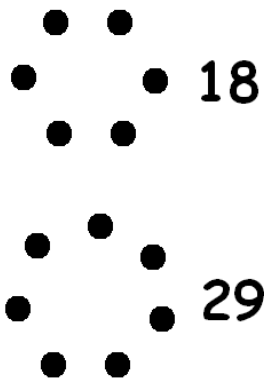

56.

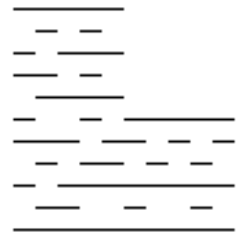

57.

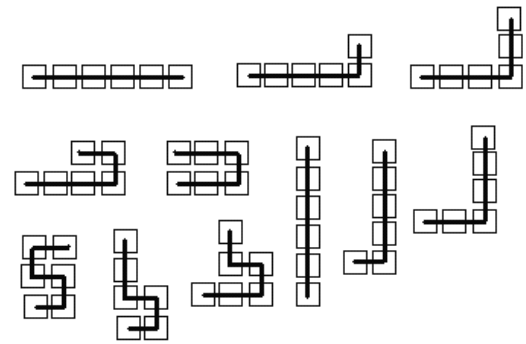

58.

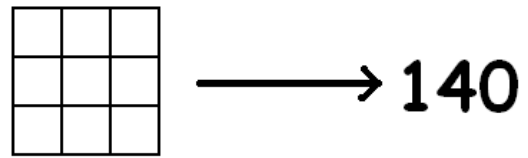

59.

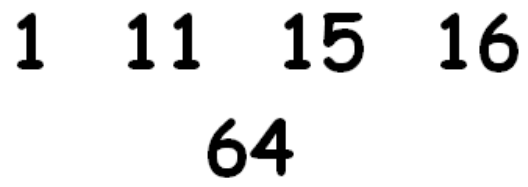

60.

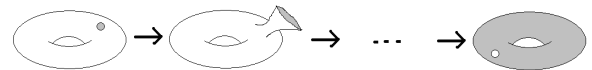

61.

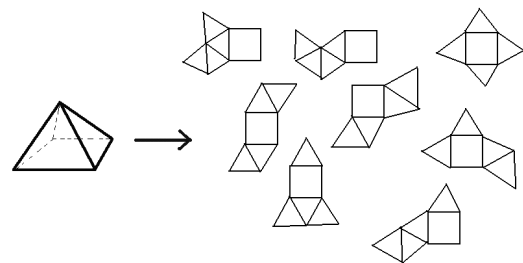

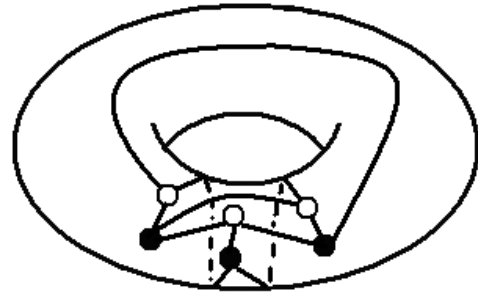
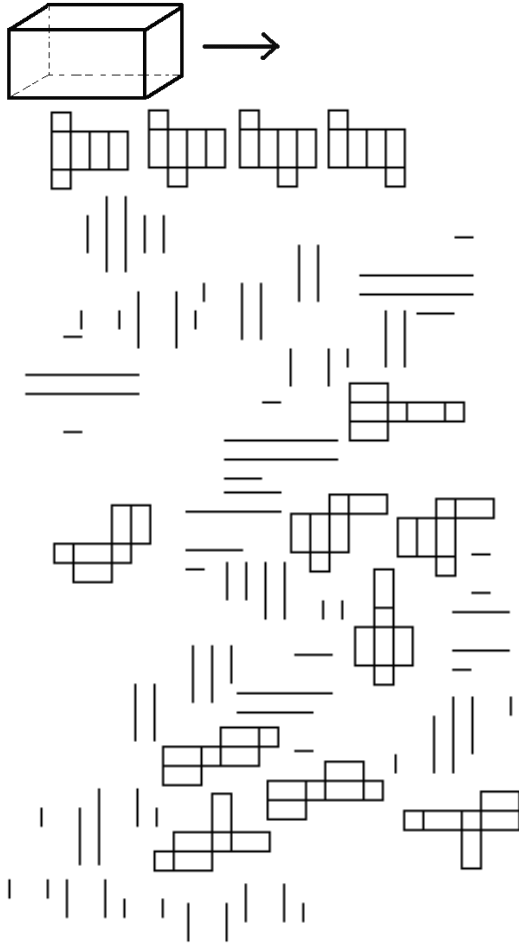

63.

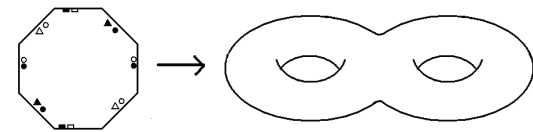
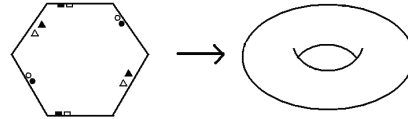

64.

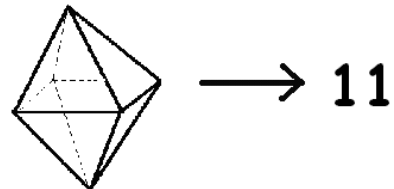
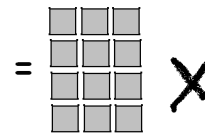
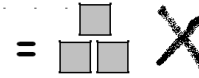
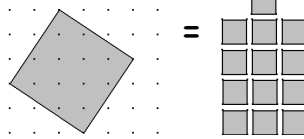
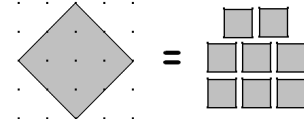
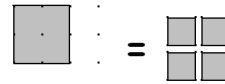
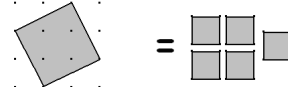

62.

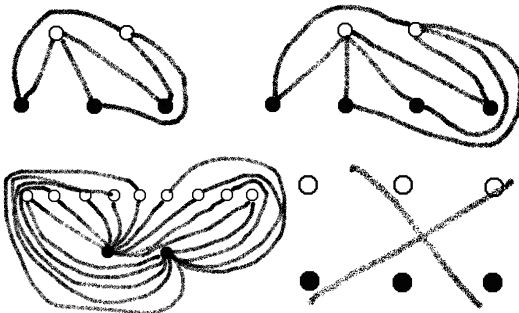

65.

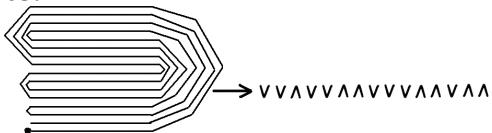

V V A V V A A V V V A A A V V V A V V A A A V V A A V A A

V V A V V A A V V A A A V V A A A V V A A A V V A A A V V A A A

66. ???

67.

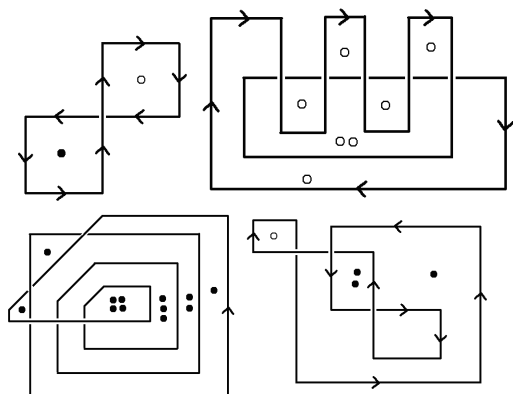

68.

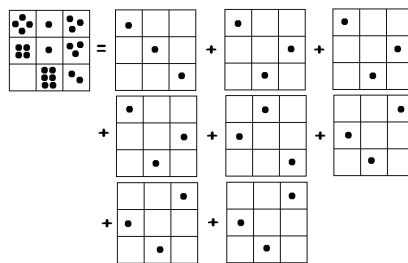
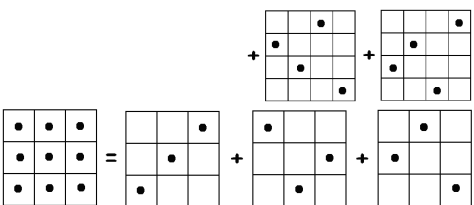
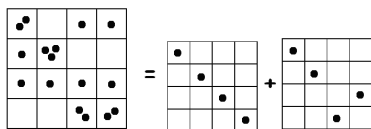
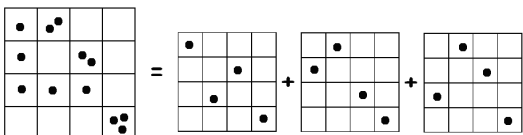
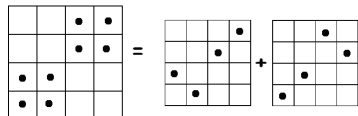

69.

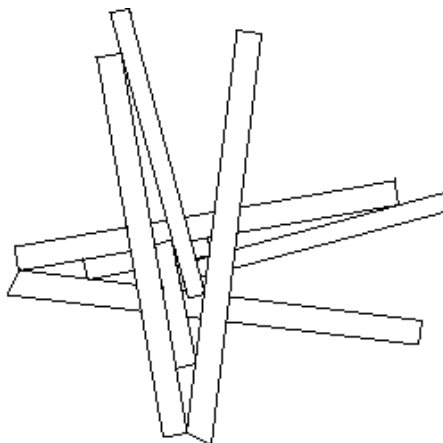

70.

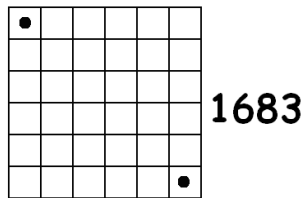
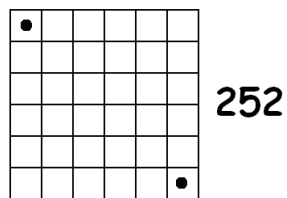
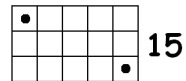
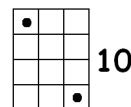
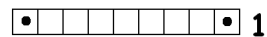

71.

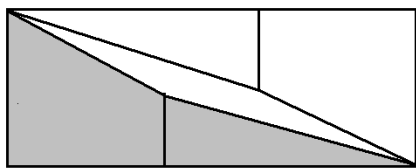

72.

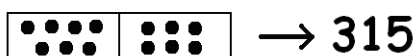
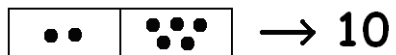
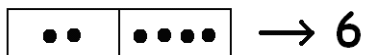
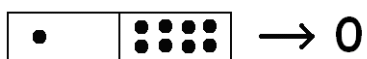
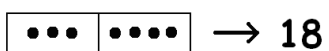
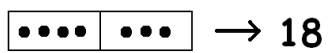
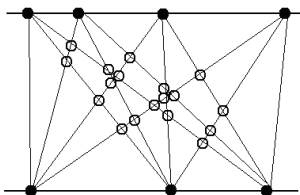

73.

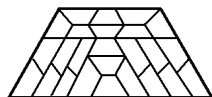
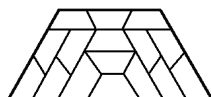

74.

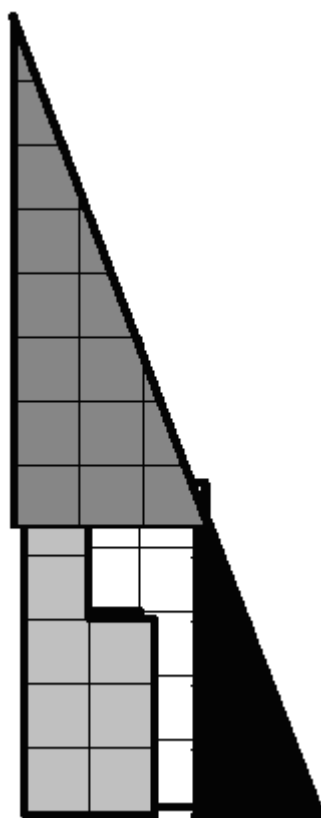

75.

