



Knowledge-Service-Selection
Since 1998

Exposed Fastener Installation Guide

Armour Rib, Armour PBR and Armour 5-V Crimp

*****IMPORTANT*****

PROPER STORAGE OF METAL PANELS

When moisture remains in contact with Galvanized, Galvalume or Aluminum roofing panels in the absence of freely circulating air, corrosion in various forms can begin to form (black, gray, or white). Moisture can get in between the panels and either through humidity or wicking, condensation can form between the panels. If moisture is trapped between the panels this can cause water stains or a condition known as white rust. These conditions may affect the service life of the panels and detract from its attractiveness. If your metal panels will not be utilized immediately store them in a well ventilated, dry area to reduce the exposure to moisture. Remove the shipping straps and allow one foot of clearance off the ground and place the panels on an incline. This will allow air circulation around the panels and give the panels drainage. Should your panels need to be stored outdoors NEVER cover with a non-breathable tarp (plastic or poly tarp) as they promote sweating and condensation, instead canvas or other breathable cover should be utilized.

INSTALLATION INSTRUCTIONS FOR ARMOUR RIB, ARMOUR PBR AND ARMOUR 5-V METAL PANELS

Building Design and Construction

In order to ensure the anticipated performance and longevity, protect metal panels from potentially corrosive situations and materials. When treated lumber will be in direct contact with metal panels or flashings please note the following: Galvanized steel is compatible with the CCA (Chromated Copper Arsenate) pressure-treated lumber that was predominantly used before 2004, but not with the older Penta treated lumber or the new ACQ (Alkaline Copper Quaternary), CA (Copper Azole), or CBA (Copper Boron Azole). Stainless steel or other special treated fasteners should be used into these non-compatible pressure treated lumbers. Aluminum must be separated from contact with all treated wood since the soluble copper in the preservative is corrosive to aluminum. Likewise, dissimilar metals also require a protective barrier between them to prevent galvanic corrosion.

Plastic, synthetic underlayment, builders' felt, bituminous paint, caulking, or gasket material may be used to separate panels from treated wood and dissimilar metals. When using aluminum panels in direct contact with steel, use a separator as described above and fasten with Stainless Steel screws.

Fertilizer, lime, acids, feeds, manure, soils, and many other compounds also cause corrosion in metal panels. Contact between metal panels and any potentially corrosive materials should be prevented. Porous insulation materials may absorb and retain moisture and should not be used in direct contact with metal panels. Use a vapor barrier such as synthetic underlayment, polyethylene plastic or 30-lb felt to prevent moisture from contacting both the insulation and the metal panel. 1ST COAST METAL ROOFING SUPPLY's translucent panels are intended for siding applications only. In all situations, foot traffic should be avoided on translucent panels. Translucent panels used in roofing applications will break down in a short time and cause staining and premature corrosion of the metal panels below. If used on roofs, apply butyl caulking to separate the fiberglass panels from the metal. Translucent panels should be cleaned and sealed regularly, as recommended by the translucent panel manufacturer.

Purlins Girts and Roof Deck

The substructure to which the metal panels are fastened must be properly spaced and sufficiently thick to provide a roof or wall system able to meet required design loads.

A 2" nominal lumber thickness or 1" nominal thickness are both acceptable purlins. When using purlins, 1ST COAST METAL ROOFING SUPPLY recommends a maximum spacing of 24" on-center (note that 5V requires solid decking). Kiln-dried softwood is recommended for purlins or decking (pine, fir, hemlock, and spruce). Hardwoods are difficult to fasten into without splitting and contain tannic acids that are corrosive to metal panels. Green (non-kiln-dried) lumber may warp, twist, and shrink as the wood seasons fully, causing waviness in the panels as well as loosening and leaking of the fasteners. Solid decking is highly recommended for all residential applications. When using solid decking or sheathing, always use synthetic underlayment or 30-lb felt, please refer to the Florida Building Code Specifications.

On re-roofing projects where the condition of the old decking is in question, or where existing shingles will be left in place, new 2x4 or 1x4 purlins should be fastened through the decking and into the rafters. This will provide a solid framework for attaching the metal panels.

Roofing

Panel side laps should face away from prevailing rain. To accomplish this, begin by installing the first sheet square with the eave and gable at the downwind end of the roof, farthest away from the source of prevailing winds or away from the primary viewing location. In applications requiring a panel end lap, please refer to the detailed instructions in this booklet. For best results, lap panels as shown and install in the indicated sequence.

All end laps require sealant. When weather-tightness is critical, use sealant, butyl caulking or sealant tape in all side laps.

To provide a drip edge, allow an overhang of 1 to 2 inches at the eave. At the gable edge, use a gable or sidewall flashing. This will keep weather out, prevent lifting in high winds, and provide a neat, finished appearance. The trim and roofing sheet should be fastened every 12 to 24 inches along the gable edge. Do not step on panel ribs or on trim pieces to prevent kinking.

Roof Pitch

The metal roofing panels shown in this manual require a minimum slope of 1/2" per foot to ensure proper drainage, anything less than 3" per foot requires side lap sealant. For longer slopes and lower roof pitches, contact 1ST COAST METAL ROOFING SUPPLY for other suitable profiles.

Bending and Bowing

Aluminum roofing and siding sheets are roll formed from hardened, tempered metal for maximum strength. If a sheet must be bent, a gentle 90-degree bend is the maximum recommended. Metal should not be re-bent once it has been formed, nor should it be folded back on itself. When a metal roofing sheet must be installed on a curved roof, screws should be installed at every overlapping rib at the sheet ends to resist the natural tendency of the metal to spring back. The standard fastening pattern is permitted over the rest of the sheet. When installing the metal panels shown in this pamphlet over a curved arch, the minimum radius of the arch is 18' for aluminum panels and 24' for steel panels. Use sealant, butyl caulking or sealant tape at all side laps and end laps.

Additional care and fasteners must be provided when securing the top and bottom purlins on an arched rafter building to prevent the curved panels from pulling the purlins loose from the rafters. Ring-shank pole barn nails, heavy wood screws, lag screws, or bolts are often used for attaching these purlins.

Siding

Siding should be installed using the standard fastening and overlap patterns to ensure optimum performance. For strong, neat corners use hemmed corner flashings. **Do not run siding sheets all the way to the ground. Instead, provide a protective base of concrete, masonry, treated wood, or similar material and terminate the siding sheets 4" to 6" above grade.**

If siding sheets are installed horizontally, use sealant tape or butyl caulking at the vertical laps to ensure weather-tight joints. Install panels from the bottom up so that water is directed away from, and not into, the lap joints.

Fastening

1ST COAST METAL ROOFING SUPPLY can supply screws for fastening into dimensional lumber. Screws for use with steel panels are galvanized and then coated with an organic polymer for optimum corrosion resistance. For best results with aluminum panels, use #300 series stainless steel screws.

Wood screws with combination metal and neoprene washers should be installed in the flat area of the panel adjacent to the ribs and tightened such that the washer is compressed. (See illustration below) This will ensure a lasting, leak-proof seal.



Remove any metal filings created by the drilling action of the screws or predrilling of the holes to avoid rust staining on the panel surface. Refer to the Florida Product Approval for your type of panel, for the correct fastener locations.

Flashing and Trim

Always begin flashing installation from the bottom and work up, so that upper flashings are lapped on top of lower flashings. This will prevent moisture from leaking under the flashings and into the structure. **End lap flashings a minimum of 6" and seal the lap joints with sealant. Extend flashings 4-6" beyond the building, cut along the bend lines, apply sealant, and fold the side flaps in and the top flaps down to cap off the ends. Secure with pop-rivets or stitch screws.**

Some roof conditions, such as valleys, may require a longer end lap and/or a larger flashing to properly drain moisture from the roof. Factors that influence flashing size, shape, and end lap requirements include roof pitch, roof geometry, slope length, and climatic factors (such as heavy snowfall or rainfall).

Whenever possible, begin trim installation at the downwind end of the roof, farthest away from the source of prevailing winds, to allow flashing laps to face away from wind-driven rain. Refer to the details in this book for the proper location of fasteners and sealants.

The flashings and trims shown in this book are standard parts. Custom trims are available to meet your specific design needs. If you need a special trim, please furnish a drawing of the desired shape, including dimensions and angles, to your 1st Coast Metal Roofing Supply sales representative to obtain pricing and availability.

Refer to the SMACNA Architectural Sheet Metal Manual for additional information about detailing and installing flashings. (www.SMACNA.org)

Safety

Always work safely when installing metal products and use extreme caution on the roof at all times. Wear gloves and safety glasses to reduce the risk of injury and use hearing protection when operating power tools. Always be sure that ladders are safely positioned and properly secured. Safety harnesses or other special equipment may be required; be sure to consult OSHA guidelines for compliance with all safety requirements.

Do Not walk on panels until all the fasteners are installed. Metal roofing panels are slippery when wet, dusty, frosty, or oily -- Do Not attempt to walk on a metal roof under these conditions. Wear soft-soled shoes to improve traction and to minimize damage to the paint finish. Always be aware of your position on the roof relative to any roof openings, roof edges, co-workers, and penetrations. Installing metal panels or flashings on a windy day can be dangerous and should be avoided if possible.

Cutting Aluminum Panels

To make a cut parallel to the ribs, score the panel deeply with a sharp utility knife and bend back-and-forth along the score, breaking the metal off cleanly. For cuts across the ribs, use straight-cut snips, electric or pneumatic shears, a portable profile shear, or an electric nibbler. Some installers prefer using a circular saw with a metal cutting blade (a fine-tooth hardwood blade, or a standard combination blade reversed in the saw works also). Light oil or soap on the blade will make cutting easier.

Cutting and Drilling Steel Panels

Steel panels may be cut with metal snips, electric or pneumatic shears, a portable profile shear, or an electric nibbler. Some installers prefer using a circular saw to cut metal panels. **Do Not** use self-consuming abrasive blades because of the following: 1. Abrasive blades burn the paint and galvanizing at the cut edge, leaving edges that are jagged and unsightly and rust more quickly 2. Abrasive blades produce hot metal filings that embed in the paint and cause rust marks on the face of the panel 3. All saw cut panels must be turned face down and cut in a location down-wind and well away from the building and other panels to avoid embedment of metal filings on other panels 4. All saw cut panels must be thoroughly wiped to ensure the removal of all metal filings. If saw cutting cannot be avoided, select a carbide-tipped blade specially designed for cutting light-gage ferrous metal panels. These blades are now available at many home centers and lumber yards. Pre-drilling wall panels gives uniform alignment of screw rows. Be sure to remove drill filings once panels are installed to avoid rust marks from the filings.

Building Maintenance

A metal roof should be inspected annually and cleaned as necessary to maintain its beauty and performance. Any debris or residue, including leaves, twigs, and dust should be cleaned off promptly to prevent moisture entrapment against the metal, which may lead to finish deterioration or premature corrosion. Flashings may need to be re-sealed periodically in order to maintain optimum weathertightness.

Proper Storage

Store metal panels indoors when possible; if outdoors, cover and elevate. Elevate one side higher for water drainage. Never cover in plastic; use a tarp that can breathe. Allow for air circulation. If a bundle gets wet, break bands and separate sheets; allow sheets to dry completely and only restack if completely dry. Product should be stored for a maximum of 2-4 weeks before being installed.

Spray Foam Insulation

When insulating metal with spray foam insulation, the first application layer should be getting the insulation behind all framing members. When completing the insulation, ensure the spray foam be installed in 2" thick layers (maximum) until desired thickness is achieved

1. All values based on a 1-hour duration storm of 4"/hr. intensity.
2. Values represent the point at which the panel ribs will flood.
3. Size and frequency of penetrations can greatly reduce the amount of water removed from the roof.
4. All panel end laps must be caulked.
5. When weather-tightness is critical, use sealant, butyl caulking or sealant tape in all side laps.

Standard Colors (29 GA & 26 GA)



Polar White
SR .64 SRI 77



Ivory
SR .69 SRI 84



Light Stone
SR .56 SRI 65



Saddle Tan
SR .47 SRI 53



Taupe
SR .38 SRI 41



Ash Gray
SR .46 SRI 52



Charcoal Gray
SR .37 SRI 31



Burnished Slate
SR .34 SRI 35



Cocoa Brown
SR .35 SRI 37



Colony Green†
SR .28 SRI 27



Evergreen
SR .35 SRI 37



Hawaiian Blue
SR .31 SRI 31



Rustic Red
SR .36 SRI 38



Black†
SR .31 SRI 31



Galvalume

Premium Colors*



Copper Metallic
SR .51 SRI 58



Crimson Red†
SR .31 SRI 31

Please make final color selection from actual metal chips.
Visit 1stcoastmrs.com for the most current information.

* Extended lead times and minimum orders apply.

† 26 gauge only.

Kynar Colors* (26 GA)



Regal White
SR .85 SRI 83



Snow White
SR .75 SRI 73



Almond
SR .64 SRI 60



Sandstone
SR .53 SRI 52



Surrey Beige
SR .39 SRI 39



Brownstone
SR .40 SRI 40



Buckskin*
SR .37 SRI 35



Mansard Brown
SR .28 SRI 28



Ash Gray
SR .46 SRI 52



Tundra*
SR .35 SRI 35



Slate Gray
SR .15 SRI 15



Charcoal Gray
SR .33 SRI 33



Medium Bronze
SR .30 SRI 27



Aged Bronze*
SR .28 SRI 27



Dark Bronze
SR .24 SRI 23



Matte Black
SR .25 SRI 25



Terra Cotta
SR .48 SRI 45



Regal Red
SR .49 SRI 48



Colonial Red
SR .35 SRI 29



Patina Green*
SR .44 SRI 43



Forest Green*
SR .27 SRI 26



Evergreen
SR .24 SRI 22



Regal Blue
SR .25 SRI 24

Premium Colors*



Silver
SR .57 SRI 56



Pre-Weathered Galvalume
SR .27 SRI 24



Copper Metallic
SR .51 SRI 58

Product Approval Codes

24397.8	Armour Rib 29 Ga.	29 Ga. Through-Fastened Metal Roof Panels Over Nominal 15/32" Plywood Sheathing, Anchor Pattern A 24" o.c.
24397.9	Armour Rib 29 Ga.	29 Ga. Through-Fastened Metal Roof Panels Over Nominal 15/32" Plywood Sheathing, Anchor Pattern B 24" o.c.
24397.10	Armour Rib 29 Ga.	29 Ga. Through-Fastened Metal Roof Panels Over Nominal 1x4 SYP Purlins Over Nominal 15/32" Plywood Sheathing, Anchor Pattern A 24" o.c.
24397.11	Armour Rib 29 Ga.	29 Ga. Through-Fastened Metal Roof Panels Over Nominal 1x4 SYP Purlins Over Nominal 15/32" Plywood Sheathing, Anchor Pattern B 24" o.c.
24397.12	Armour Rib 29 Ga.	29 Ga. Through-Fastened Metal Roof Panels Over Nominal 19/32" OSB Sheathing.
27567.2	Armour Rib 29 Ga.	29 Ga. Through-Fastened Metal Roof Panels Over Nominal 2x4 Purlins.
27567.1	Armour PBR	26 Gauge Through-Fastened Structural Metal Roof Panels over 14 Gauge Hat Channel Spaced Supports.
24397.6	Armour PBR	26 Gauge Through-Fastened metal roof panels Over Nominal 15/32" Plywood Sheathing.
24397.1	5V Crimp	26 Ga. Through-Fastened Metal Roof Panels Over Nominal 7/16" OSB Sheathing, Anchor Pattern A 16" o.c.
24397.2	5V Crimp	26 Ga. Through-Fastened Metal Roof Panels Over Nominal 7/16" OSB Sheathing, Anchor Pattern B 24" o.c.
24397.4	Armour 5-V Crimp 0.032" Aluminum	0.032" Aluminum Through-Fastened Metal Roof Panels Over Nominal 15/32" Plywood Sheathing.

Steel Panels

Armour Rib

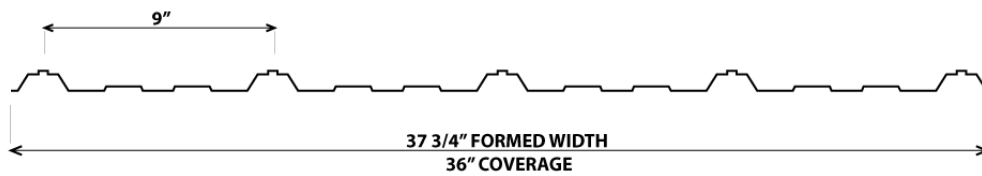

Anchor Pattern A

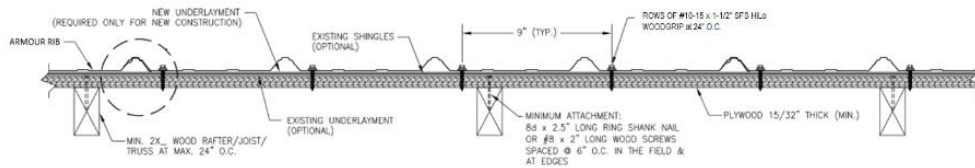

EASTENER PATTERN AT PANEL ENDS

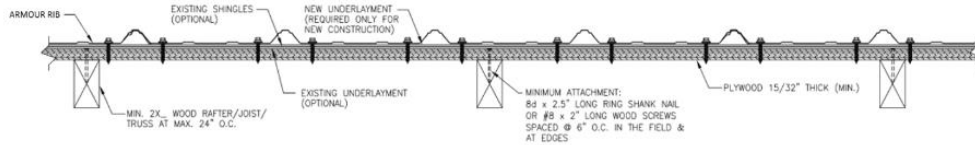

Anchor Pattern B

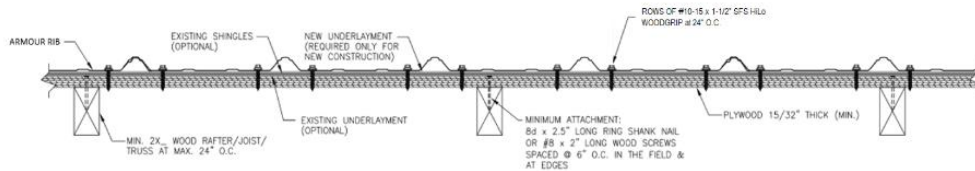

Armour PBR

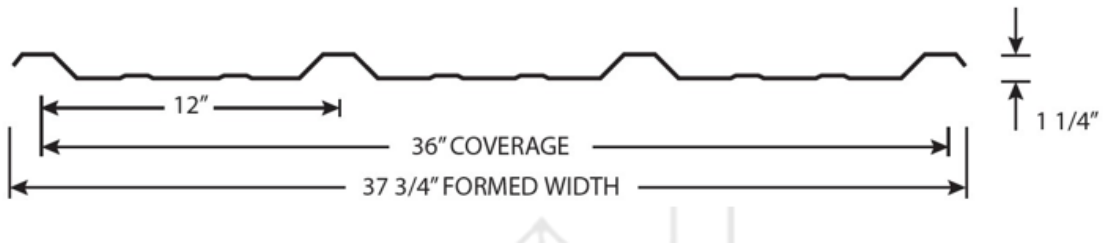
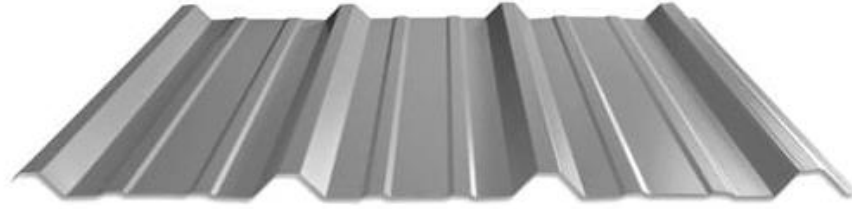

Anchorage Detail

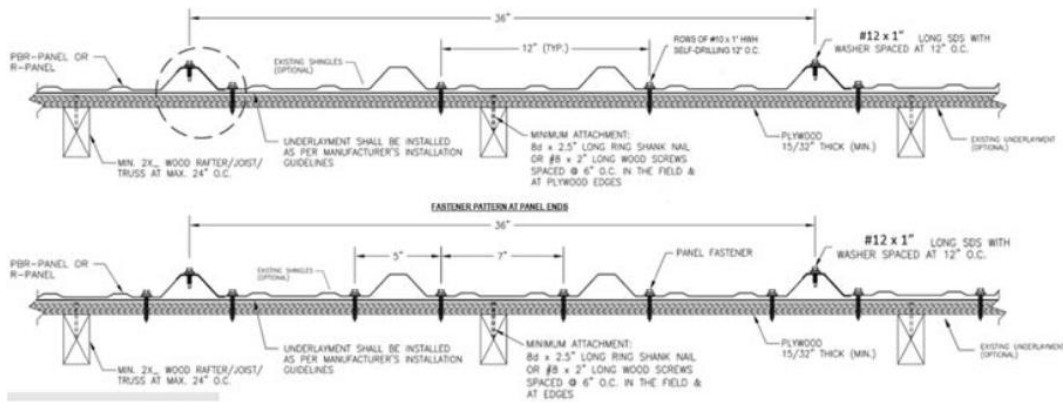

Anchorage Detail

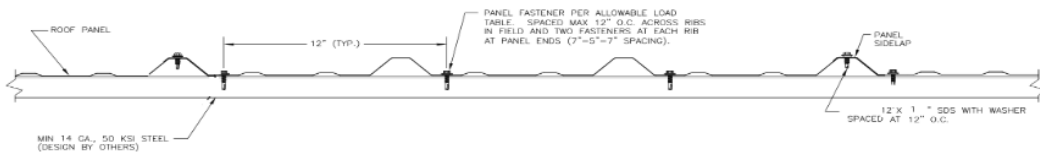

Armour 5-V Crimp

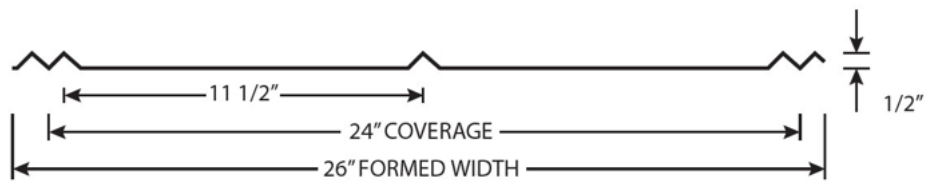
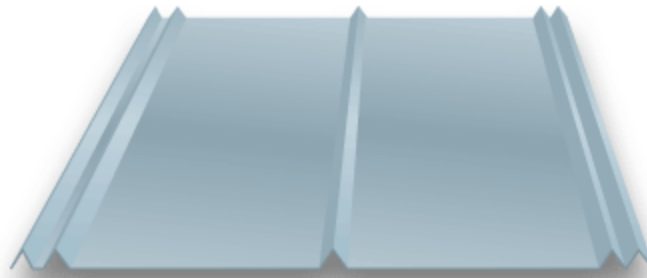

Anchor Pattern A

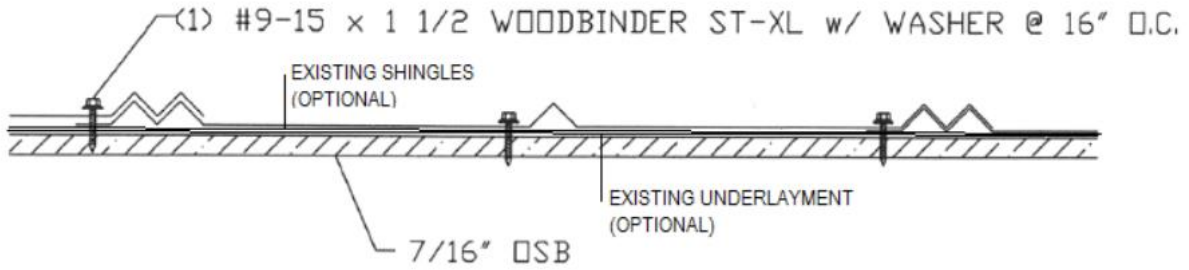

Anchor Pattern B

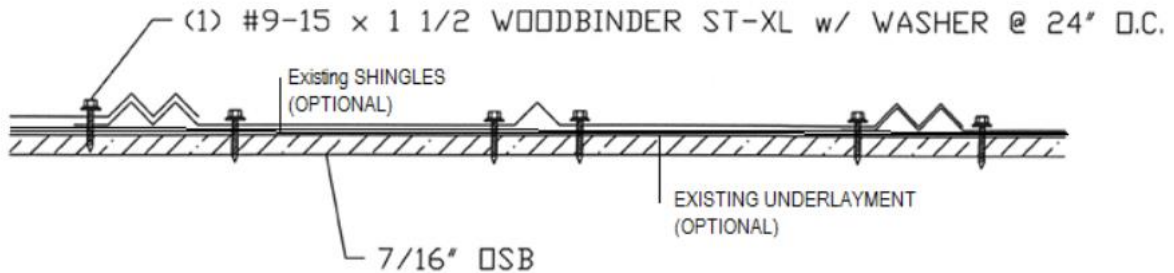

Aluminum Panels

Armour Rib

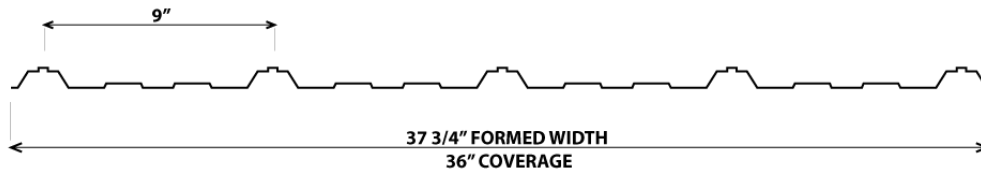

Anchor Detail Illustration

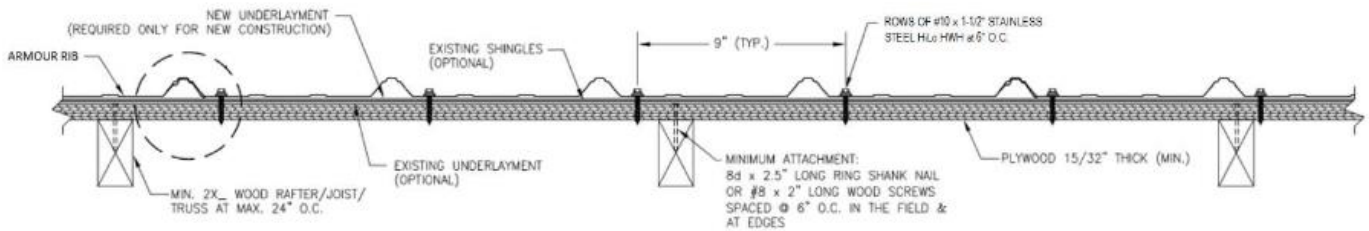

FASTENER PATTERN AT INTERMEDIATE LOCATIONS

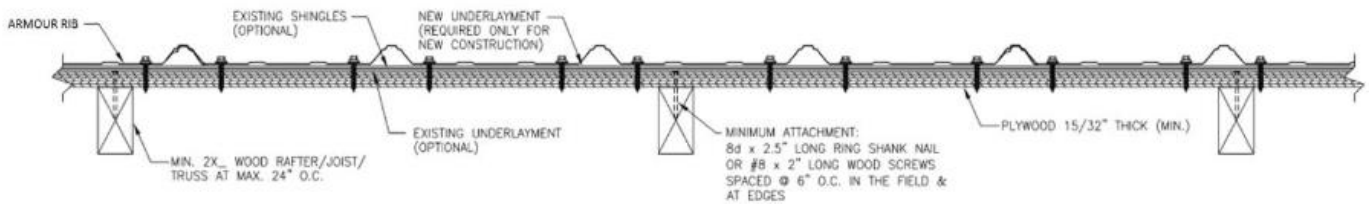

Armour 5-V Crimp

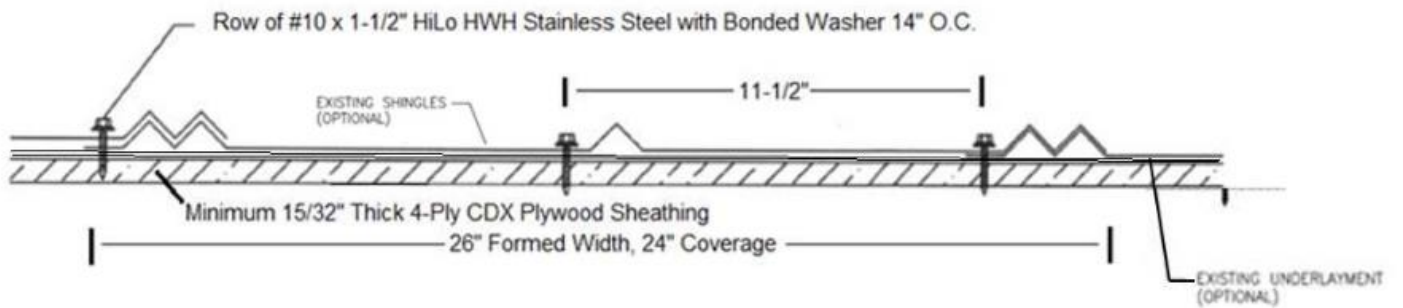
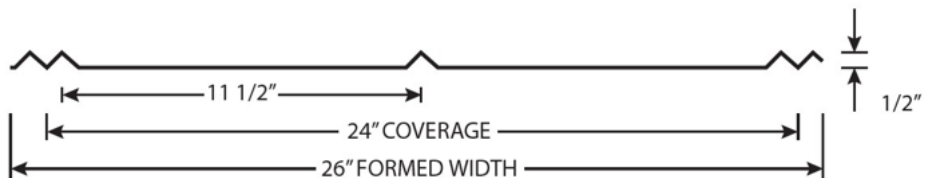
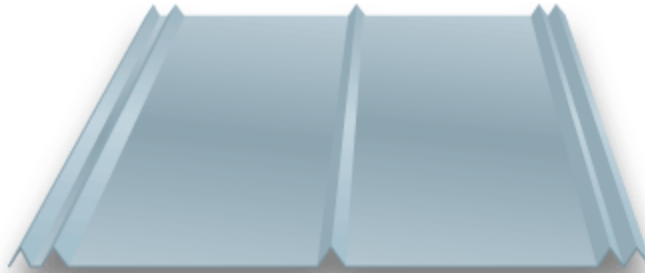

Estimating and Roof Types

Estimate Metal Roofing, Siding and Flashings

Panel lengths are to be determined by the actual field measurements. 1st Coast Metal Roofing Supply provides roof take-off services as a courtesy to our customers. It is the buyer's responsibility to confirm that the lengths, quantities, color and gauge are correct in accordance to their project.

Remember to add for overhangs at the eaves; subtract for a gap at the ridge. Siding should be kept away from the ground with a skirt board.

Number of Panels

The coverage of the panel being used will determine the number of panels at a length (i.e., 3' coverage panel on a 30 ft. long building would require 10 panels on each side of the ridge or 20 panels at that particular length.)

Horizontal Measurement of a Roof

Divide the building width in half, then multiply the slope factor (i.e., 40' wide building with 4/12 slope. 40 divided by 2 equals 20' times 1.054 equals 21'-1" in slope dimensions). Allow for ½" to 1" gap at peak and 1" to 2" eave overhang,

Roof Pitch	Slope Factor
3/12	1.031
4/12	1.054
5/12	1.083
6/12	1.120
7/12	1.188
8/12	1.202
9/12	1.250
10/12	1.302
11/12	1.357
12/12	1.414

Residential exposed-fastener panel Building Details

1. Determine the thickness and type of substrate to be used to support the metal roofing. *Solid decking is highly recommended for all residential applications.* (i.e., plywood, OSB, etc.)
2. Refer to the Load Span table in accordance to the Florida Product Approval to select the proper fastener and spacing to meet loads on your structure. *Nails are NOT recommended for metal roofing applications.*
3. Consult local building codes and restrictions to determine acceptable methods of construction for residential applications in your area.
4. Solid Decking with synthetic underlayment for residential applications. Self-Adhesive membrane is recommended at all valleys. Dormers, chimneys, transitions, skylights and other critical areas.
5. When re-covering with metal panels over an existing shingle roof, metal panels may be installed directly over one-layer of existing shingles or over 1 x 4 purlins.

Roof Types

Saltbox Roof

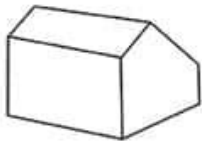

M-Shaped Roof

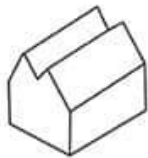

Box Gable Roof

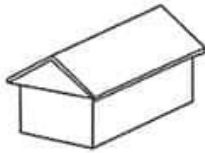

Skillion and Lean-to Roof

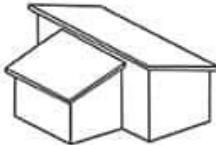

Pyramid Hip Roof

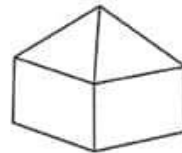

Open Gable Roof

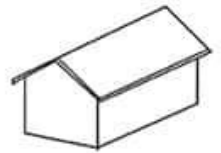

Mansard Roof

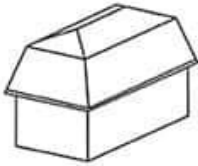

Gambrel Roof

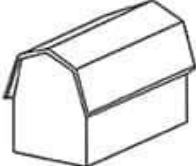

Hip and Valley Roof

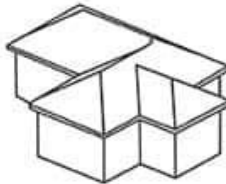

Dormer

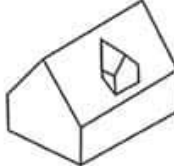

Combination Roof

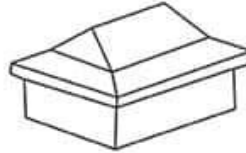

Butterfly Roof

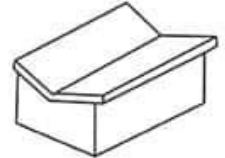

Shed Roof

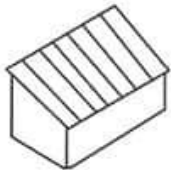

Flat Roof

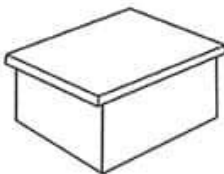

Jerkinhead Roof

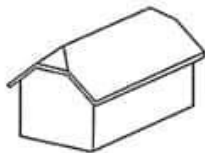

Hexagonal Gazebo Roof



Dutch Gable Roof

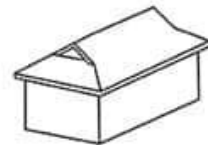

Trim Detail

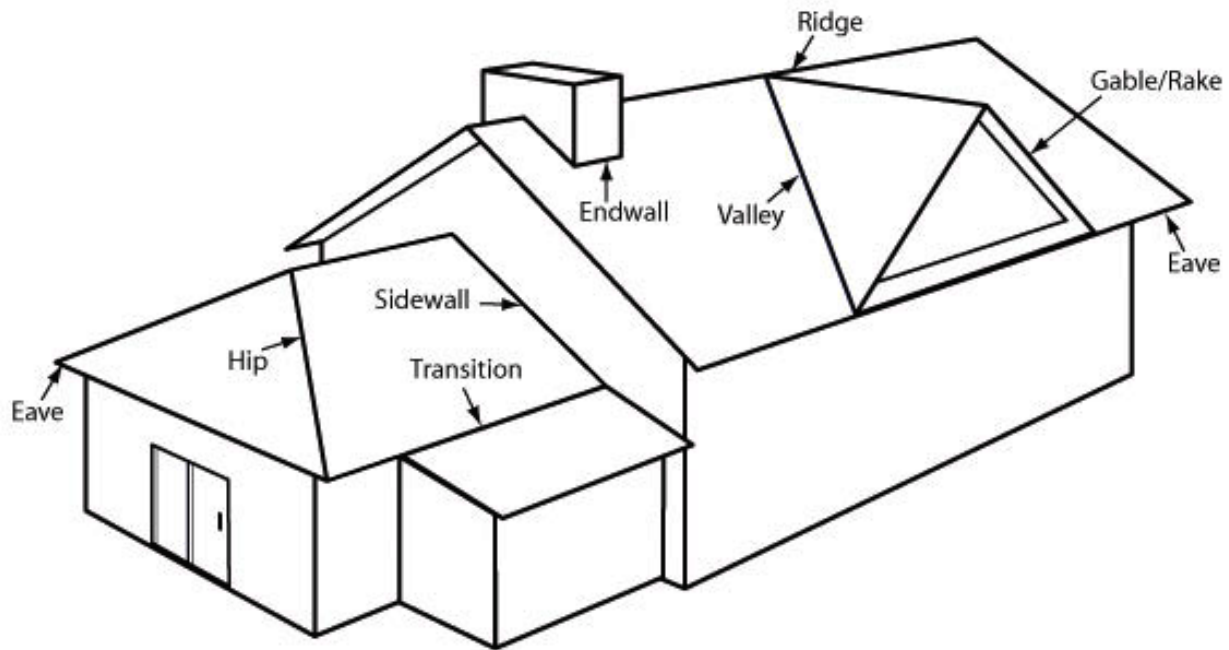

Standard Trim will be quoted unless otherwise specified.

All Trims will be broke at a 3/12 or 4/12 pitch unless otherwise specified.

Ridge Cap

The top of the roof, or the ridge, is made watertight with a ridge cap. There are a variety of styles, sizes, and method of attachment, but the concept is the same. Butyl tape (or sealant) and foam closures are recommended to provide water tightness and protect against wind driven rain. Ventilated closures are available for most panels and should be used if ventilation is desired.

- 3" overlap (minimum). Sealant (caulk or butyl) to seal the laps is recommended, but not required.
- Drive fasteners with sealing washers through both sides of the ridge cap and into the roof deck. Use fasteners which are long enough to reach the roof deck or structure below the panel and match the fastener spacing used for the panel at the ridge. It is typically best to fasten through the panel rib to avoid deforming the ridge cap.
- Closures may be omitted if owner, designer, and installer agree. However, the resulting assembly will NOT be protected from wind driven rain. Insects and other foreign matter may also access these openings.
- If closures are installed, drive ridge cap fasteners through the closures or just above the closures.
- Box off the end of the ridge cap and use sealant and rivets as needed to secure.
- Vented closures are available for most panel types and may be used in place of traditional closures.

Flat Ridge Cap 6" (RGF6)

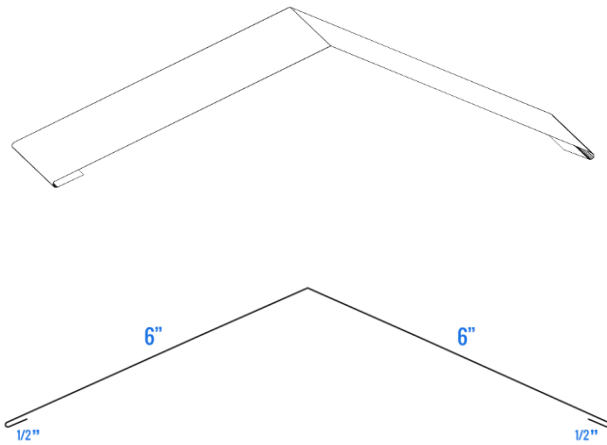

Flat Ridge Cap 8" (RGF8)

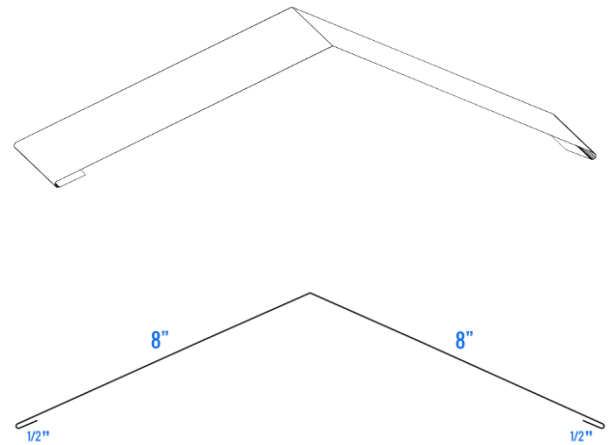

Step Ridge Cap 6" (RG6)

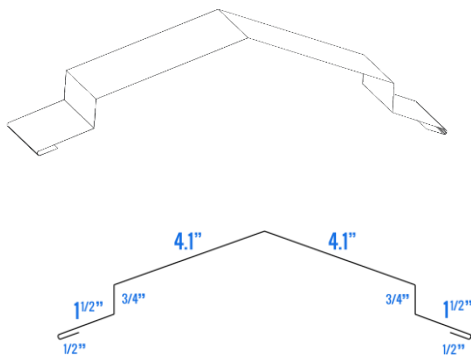

Step Ridge Cap 8" (RG8)

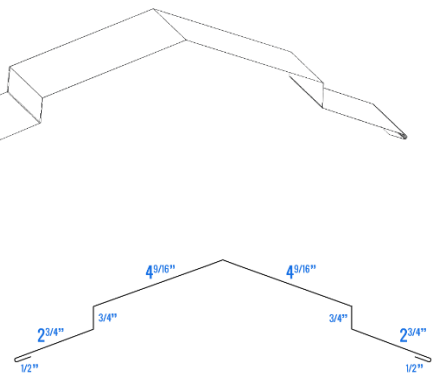

RESIDENTIAL RIDGE/HIP

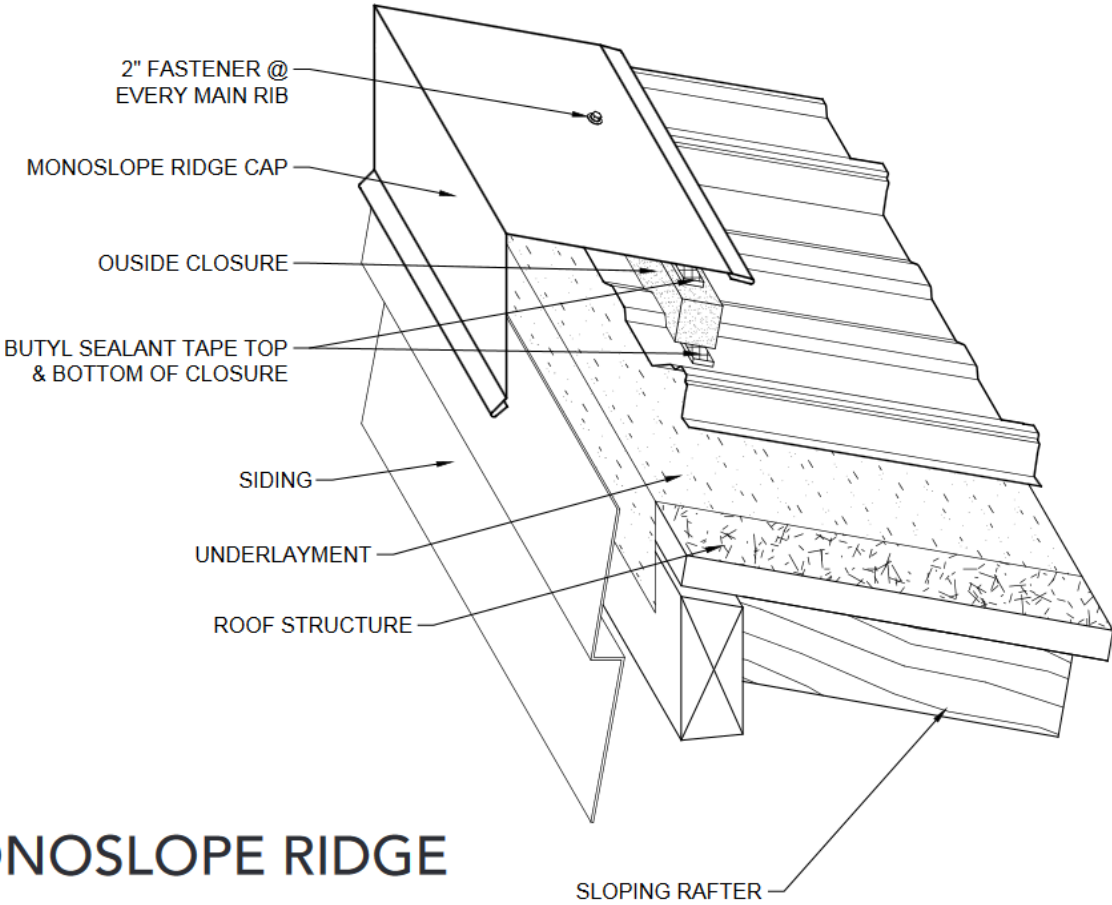
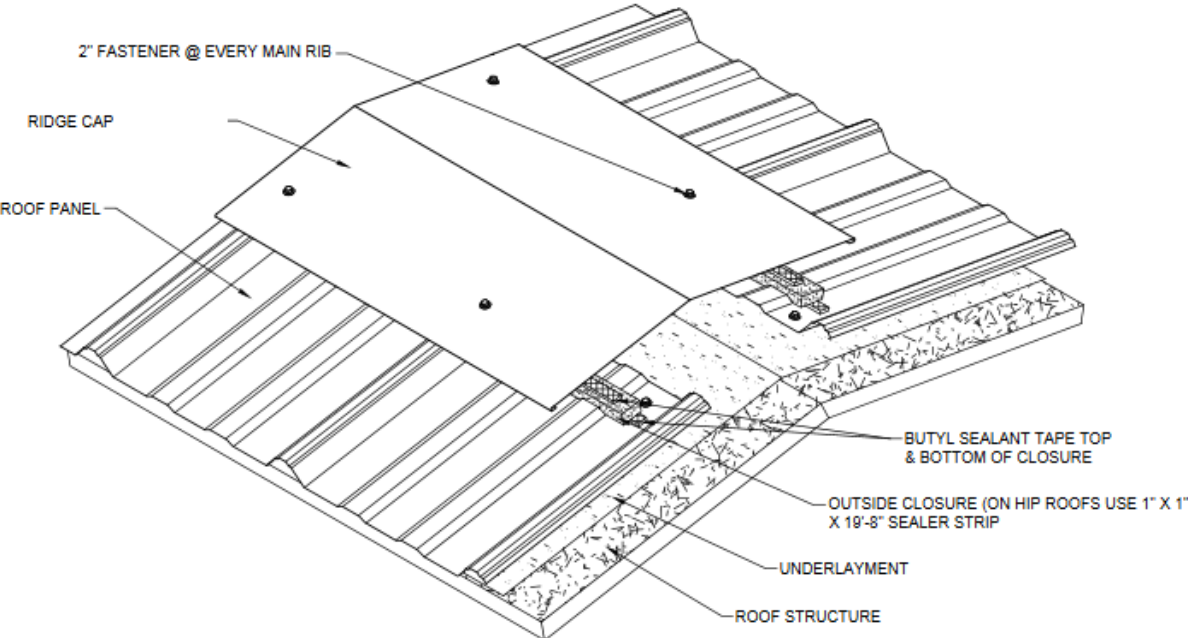

MONOSLOPE RIDGE

Gables

The open sides of a roof, or gable ends, are protected with gable trim. There is a variety of styles, sizes, and methods of attachments, but two primary designs. An eave drip (or similar) can be installed underneath the panels, or a gable rake (or similar) can be installed over the panels. In either case, the use of butyl tape or sealant is recommended to ensure a watertight seal between the roof panel and the trim. Fascia is recommended to fully protect the structural member. • 3" overlap (minimum). Sealant (caulk or butyl) to seal the laps is recommended, but not required. • Install from eave to ridge (bottom to top) so that runoff does not feed into an overlap. • Fasten into the panel/roof deck and into the exposed face on the gable side with the same panel fastener spacing used along the gable. Use fasteners with sealing washers. • Box off the end of the gable and use sealant and rivets as needed to secure. • If an eave drip trim is used underneath the panel vice the gable rake trim over the panel, the fastener in the exposed face on the gable is optional. Follow the eave requirements described following.

Gable (GB3)

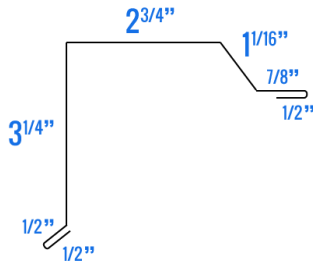
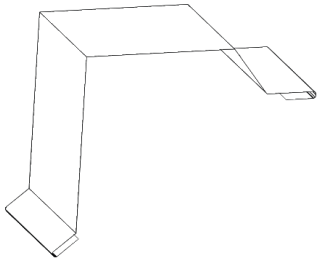

Wide Top Gable (GB4)

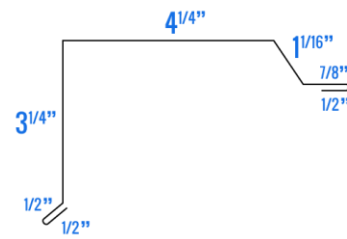
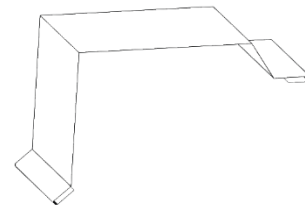

Standard Gable (SGB)

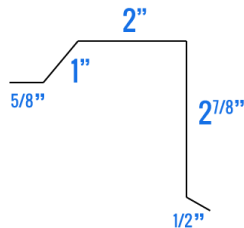
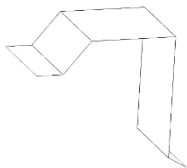

RESIDENTIAL GABLE

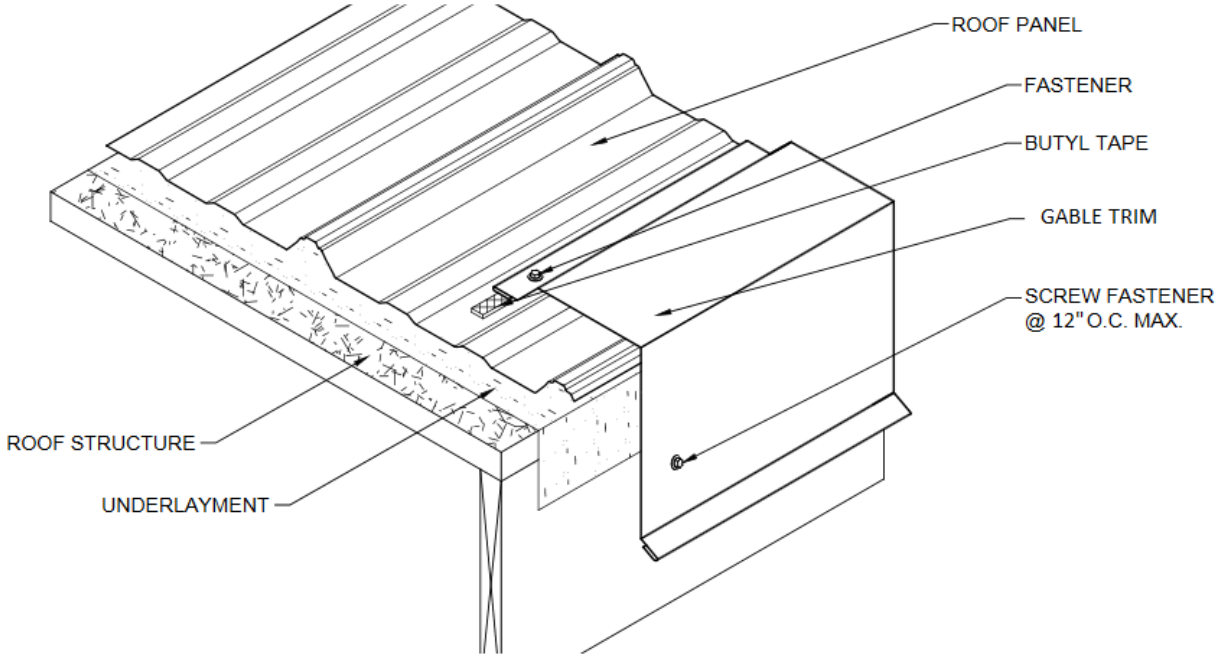

Sidewall/Endwall

Sidewall (SW)

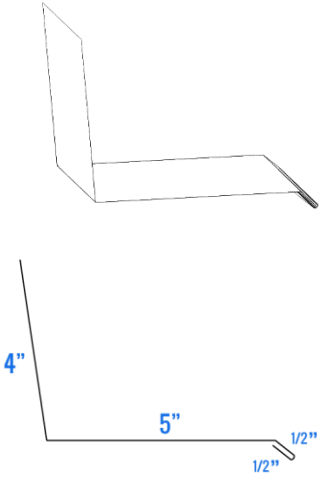

Sidewall with Caulk Channel (SWC)

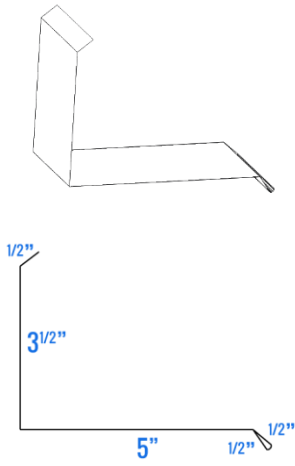

Step Sidewall (SWS)

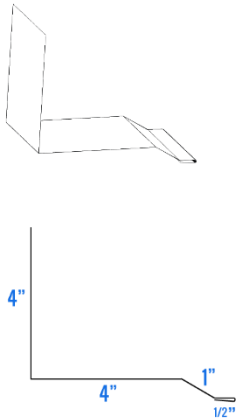

Standard Sidewall (SSW)

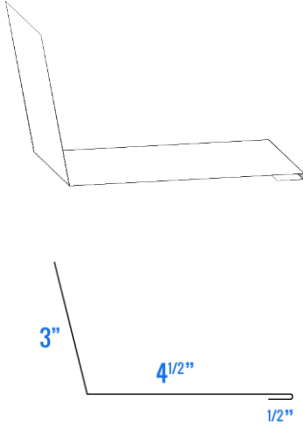

RESIDENTIAL SIDEWALL

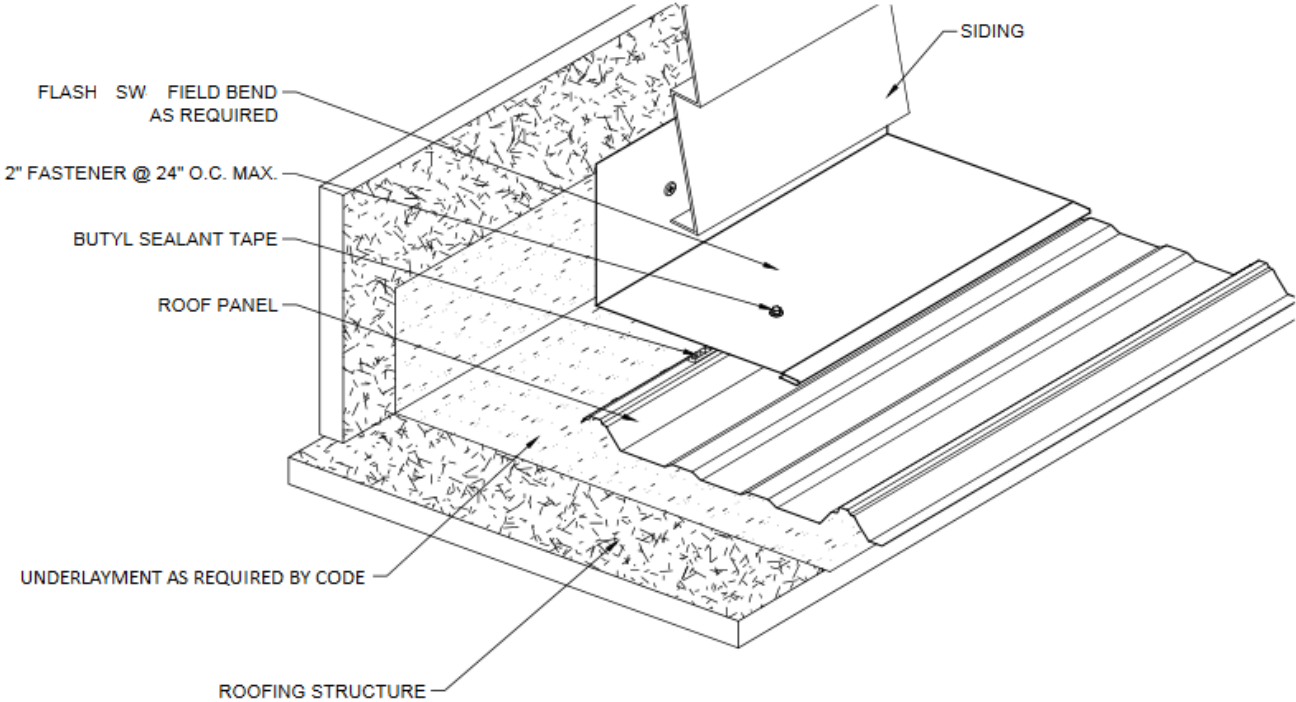

RESIDENTIAL ENDWALL

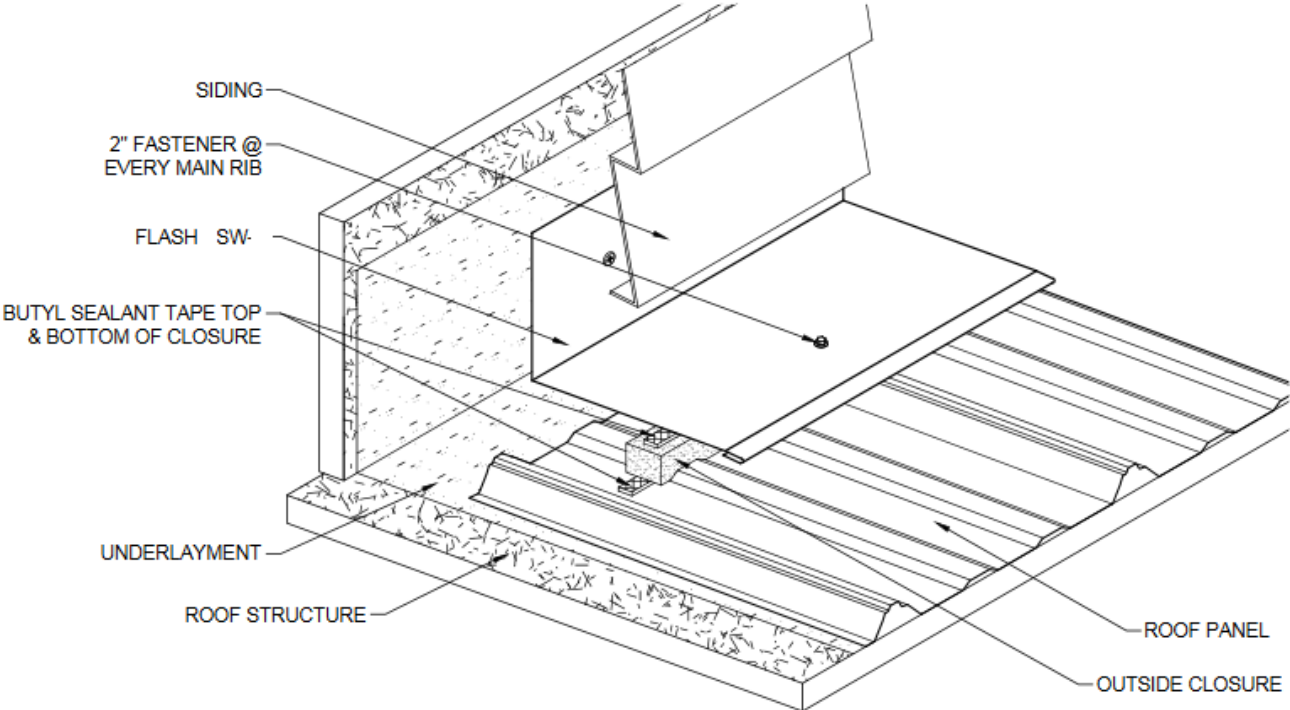

Corners

Flat Corner (CF)

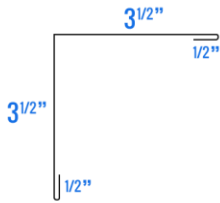
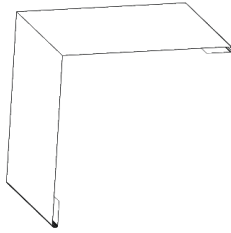

Jackson Corner (JXC)

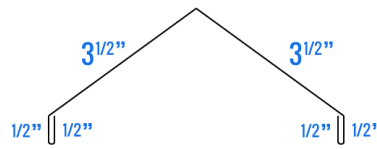
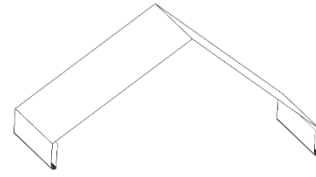

Large Corner (CF)

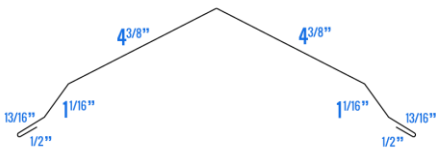
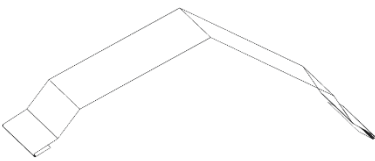

Small Corner (CF)

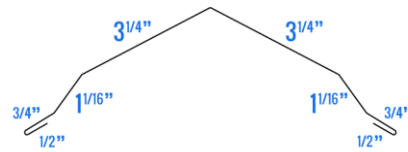
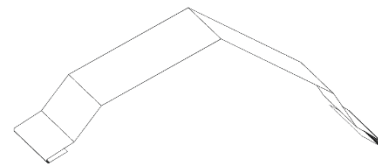

Eaves

The bottom edge of the roof, or the eave, is protected with eave drip to provide a continuous metal surface for water to runoff from the roof to the ground. Fascia trim is recommended below the eave drip to fully cover the structural member. Except in unique cases, eave drip is installed before the panels. • 3" overlap (minimum). Sealant (caulk or butyl tape) to seal laps is recommended, but not required. • Fasten into roof deck with low profile fastener (or another fastener) to match panel fastener spacing along eave. • Fastening of exposed face is not required for faces less than 4". If desired, fasten through the exposed face using fasteners with sealing washers. • Closures may be omitted if owner, designer, and installer agree. However, the resulting assembly will NOT be protected from wind driven rain. Insects and other foreign matter may also access these openings. • If closures are installed, drive panel fasteners through the closures or just above the closures.

Eave (EV3)

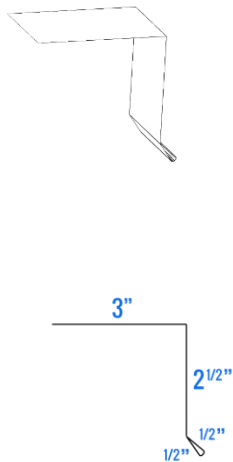

Bullnose Eave (EVB)

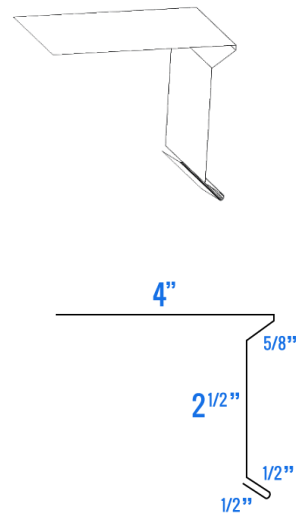

Standard Eave (SEV)

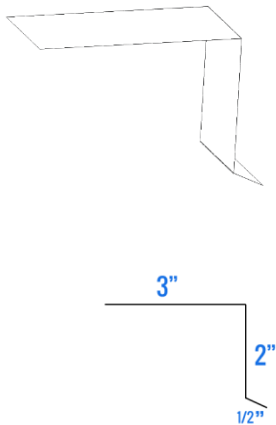

RESIDENTIAL EAVE

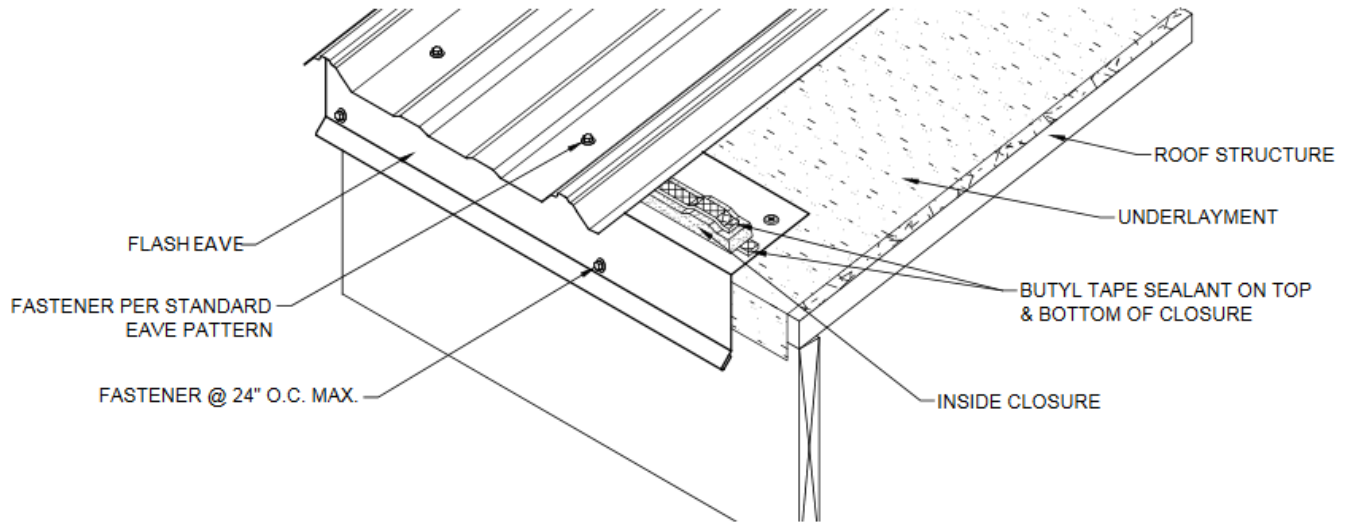

“W” Valley (VL)

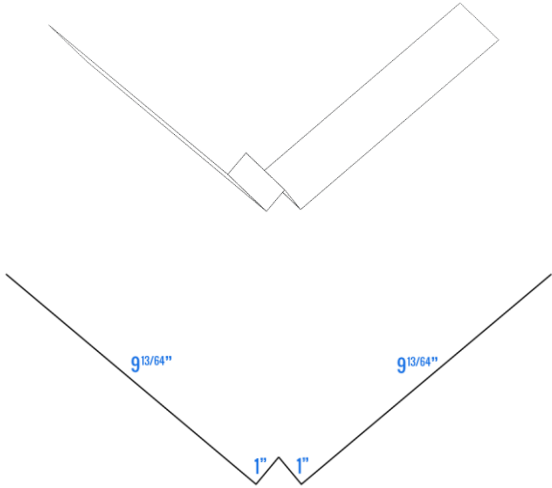

Transition (TR)

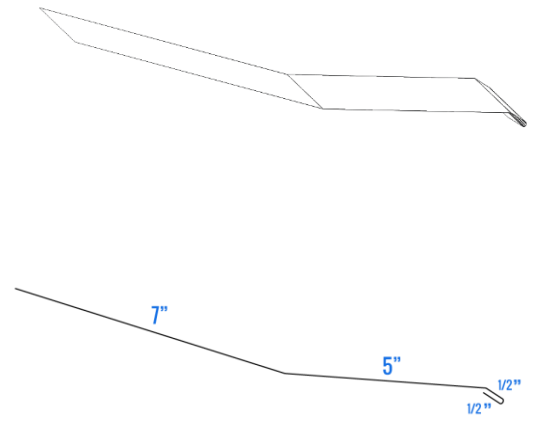

Fascia (FC3 – FC5)

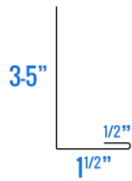
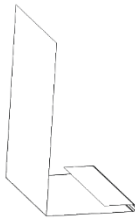

Modified J-Channel (JCM)

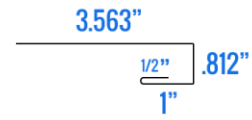

RESIDENTIAL VALLEY

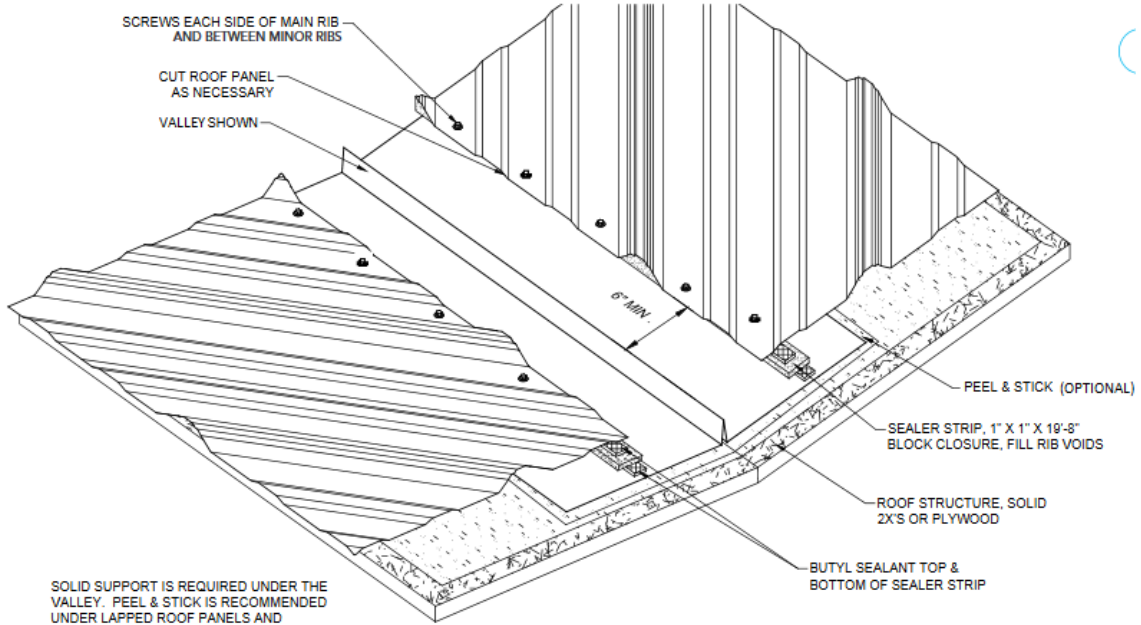

SOLID SUPPORT IS REQUIRED UNDER THE VALLEY. PEEL & STICK IS RECOMMENDED UNDER LAPPED ROOF PANELS AND VALLEY FLASHING. LINING MUST CONTINUE DOWN TO EAVE LINE.

DORMER VALLEY

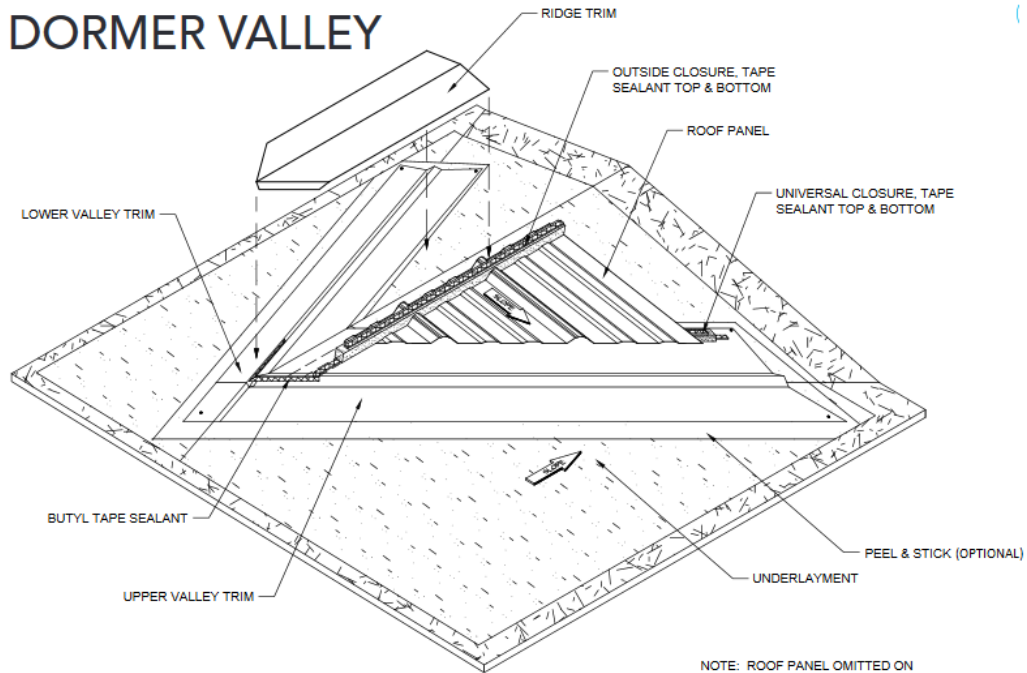

NOTE: ROOF PANEL OMITTED ON OTHER SIDE OF RIDGE FOR CLARITY.

RESIDENTIAL TRANSITION

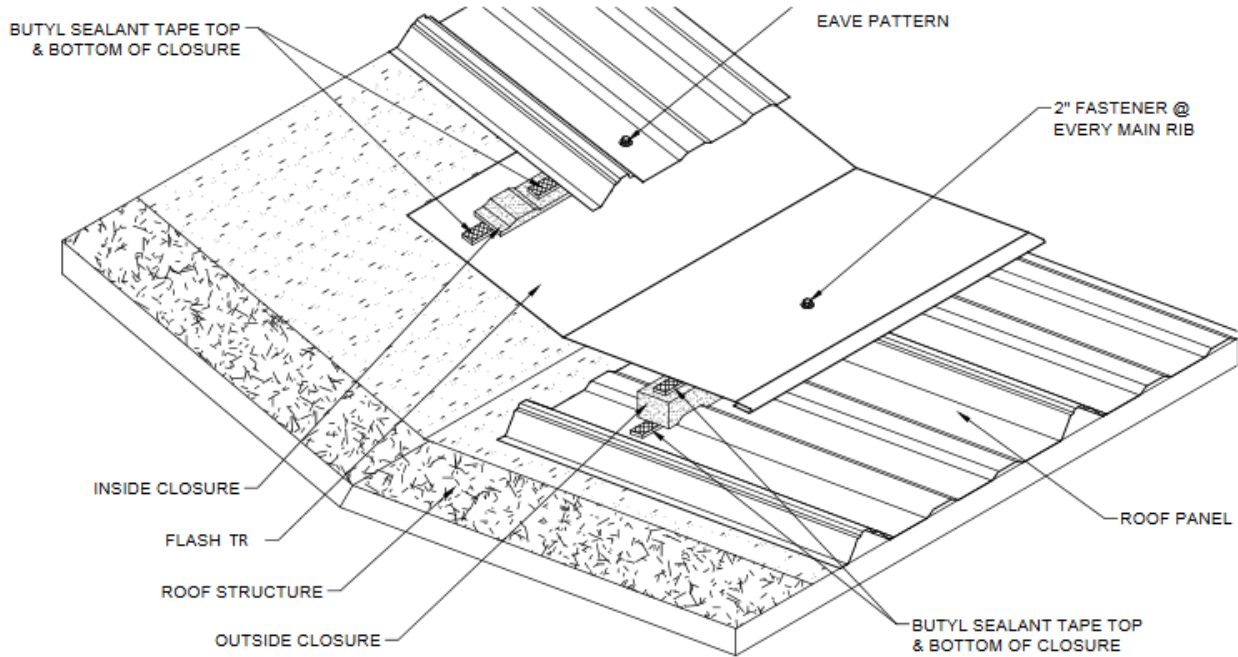

RESIDENTIAL GAMBREL

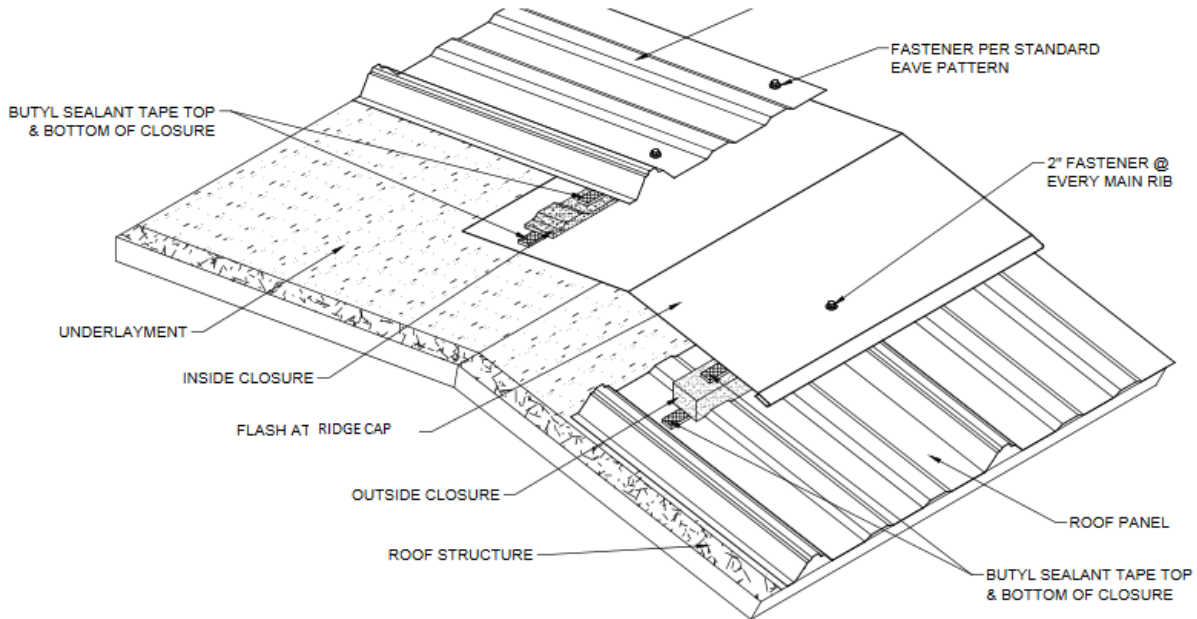

Weatherite Accessories

Screws

Zinc Cap Screws



Powderful™ Coating System

- 2.5 mil of computer-controlled powder coat is applied over zinc plating and chromate sealer.
- Unique polyester powder formulation resists harmful UV rays and chemical breakdown.
- Automated process ensures a consistent color match from batch to batch.
- POWDERFUL is completely free of volatile organic compounds (VOC), and is entirely recyclable.
- There are 35 standard colors that match high volume metal panel paint colors.

KS V-NECK™ Head Design

- HWH with V-neck design adds strength to prevent head twist off under extreme torque.
- UV resistant EPDM rubber is vulcanized to a G-90 steel backed washer to provide maximum sealing ability, which prevents leaks, even when drilled at an angle.
- High tensile steel washer provides excellent pullover strength.
- ST MAGNETIC SOCKETS are designed with an advanced forging process to fit the painted fastener securely, which helps to prevent fastener wobble upon installation

KS LO-ROOT™ Thread Design

- Fastener thread transitions from fine to coarse. The low root design provides excellent pullout strength versus traditional or HI-LO thread forms.

MICRO-BIT® Point Design

- Drill point design consistently penetrates metal panels, which eliminates the need to “punch” the metal panels with a sharp point to start the drilling process.
- MB point is excellent for penetrating multiple thicknesses of steel often found on ridge cap or trim applications.

ALL UNPAINTED WOODBINDER MB FASTENERS COME STANDARD WITH DURASEAL® PLUS ENHANCED CORROSION RESISTANCE COATING. FOR PROPER INSTALLATION, THE USE OF IMPACT DRIVERS ARE NOT RECOMMENDED FOR POWDER COATED OR ANY WET PAINTED FASTENER. PULLOUT & PULLOVER VALUES ARE DETERMINED IN THE ST FASTENING SYSTEMS ENGINEERING LABORATORY USING STEEL PANELS/FRAMING & WOOD DENSITIES WHOSE STRUCTURAL PROPERTIES ARE FOUND IN PRESENT DAY PRODUCTS. THE MB MICRO-BIT POINT MAY GENERATE SMALL METAL SHAVINGS UPON INSTALLATION. IT IS RECOMMENDED TO CLEAN/SWEEP THE METAL PANELS AFTER INSTALLATION TO PREVENT PREMATURE RUST SPECKS.

Available Sizes: (Not All Sizes/Colors are Kept In Stock)

10 X 1"

10 X 1-1/2"

10 X 2"

10 X 2-1/2"

10 X 3"

12 X 3/4" STITCH

Stainless Steel Cap Screws



Lifetime 40 Year Warranty Long Life Fastener.

- Designed as an alternative to the zinc-aluminum alloy head. It is also used to attach steel roofing used in post-frame & residential construction. The smaller cupped HWH provides an attractive low-profile appearance versus larger HWH fasteners.
- 304 Stainless Steel cap provides lifetime warranty against red rust on the head & washer. You may obtain a free copy of the written warranty upon request.
- ST-XL™ is an excellent choice for GALVALUME or other long-life metal roofs.
- The combination of a sharp point & Type 17 drills 29 & 26 gauge consistently & eliminates the metal shavings that can embed themselves in the EPDM rubber washer.

FOR PROPER INSTALLATION, THE USE OF IMPACT DRIVERS ARE NOT RECOMMENDED FOR POWDER COATED OR ANY WET PAINTED FASTENER.

PULLOUT & PULLOVER VALUES ARE DETERMINED IN THE ST FASTENING SYSTEMS ENGINEERING LABORATORY USING STEEL PANELS/FRAMING & WOOD DENSITIES WHOSE STRUCTURAL PROPERTIES ARE FOUND IN PRESENT DAY PRODUCTS.

THE MB MICRO-BIT POINT MAY GENERATE SMALL METAL SHAVINGS UPON INSTALLATION. IT IS RECOMMENDED TO CLEAN/SWEEP THE METAL PANELS AFTER INSTALLATION TO PREVENT PREMATURE RUST SPECKS.

CHECK WITH SUPPLIER FOR COMPATIBILITY WHEN USED IN COASTAL OR MARINE APPLICATIONS

Available Sizes: (Not All Sizes/Colors are Kept In Stock)

9 x 1"	9 x 2 1/2"
9 x 1 1/2"	9 x 3"
9 x 2"	12 x 3/4" Stitch

ROLLING CHANGE

The new Micro-Bit will completely replace the Type 17 sharp point as current inventories are depleted. Sizes listed in GREEN will continue to be sharp points, as inventory levels of those turn over at a slower rate.

ZXL or ZAC Screws



Powderful™ Coating System

- 2.5 mil of computer-controlled powder coat is applied over zinc plating and chromate sealer.
- Unique polyester powder formulation resists harmful UV rays and chemical breakdown.
- Automated process ensures a consistent color match from batch to batch.
- POWDERFUL is completely free of volatile organic compounds (VOC), and is entirely recyclable.
- There are 35 standard colors that match high volume metal panel paint colors.

ZXL™ No Red Rust

- 5/16" Cupped HWH is manufactured from a strong ZAMAC zinc-aluminum alloy, the head is molded. It is not a cap. The molded head encapsulates the EPDM washer, which fits neatly and conforms to the inside of the mold.
- Head and washer face carry a 40-year warranty against red rust.
- ZXL is proudly molded in the USA.

KS LO-ROOT™ Thread Design

- Fastener thread transitions from fine to coarse. The low root design provides excellent pullout strength versus traditional or HI-LO thread forms.

MICRO-BIT® Point Design

- Drill point design consistently penetrates metal panels, which eliminates the need to “punch” the metal panels with a sharp point to start the drilling process.
- MB point is excellent for penetrating multiple thicknesses of steel often found on ridge cap or trim applications.

Available Sizes: (Not All Sizes/Colors are Kept In Stock)

10 x 1" 10 x 1 1/2"

10 x 2" 10 x 2 1/2"

10 x 3"

12 x 3/4"

Full Stainless Screws



Lifetime 40 Year Warranty Long Life Fastener.

- 304 Stainless Steel cupped head & washer provide lifetime protection in the harshest environments. You may obtain a free copy of the written warranty upon request.
- 304 SS Woodbinder is an excellent choice for use in animal confinement applications or for aluminum liner panel applications.
- 304 SS Woodbinder is an economical alternative to Woodbinder ACQ.
- Type A point necessitates a pre-drilled hole in steel, but not aluminum.

FOR PROPER INSTALLATION, THE USE OF IMPACT DRIVERS ARE NOT RECOMMENDED FOR POWDER COATED OR ANY WET PAINTED FASTENER.

PULLOUT & PULLOVER VALUES ARE DETERMINED IN THE ST FASTENING SYSTEMS ENGINEERING LABORATORY USING STEEL PANELS/FRAMING & WOOD DENSITIES WHOSE STRUCTURAL PROPERTIES ARE FOUND IN PRESENT DAY PRODUCTS.

CHECK WITH ALUMINUM SUPPLIER FOR COMPATIBILITY WHEN USED IN COASTAL OR MARINE APPLICATIONS

Available Sizes: (Not All Sizes/Colors are Kept In Stock)

10 x 1"

10 x 1 1/2"

10 x 2"

TEC Screws



Powderful™ Coating System

- 2.5 mil of computer-controlled powder coat is applied over zinc plating and chromate sealer.
- Unique polyester powder formulation resists harmful UV rays and chemical breakdown.
- Automated process ensures a consistent color match from batch to batch.
- POWDERFUL is completely free of volatile organic compounds (VOC), and is entirely recyclable.
- There are 35 standard colors that match high volume metal panel paint colors.

MAXX™ SELF DRILL™ Durable Head Design

- 5/16 Cupped HWH with Encapsulated UV Resistant EPDM Washer
- Good Atmospheric and Chemical Corrosion Resistance
- Outstanding coating adhesion, vibration attenuation, damping capacity and ductility
- Superb aesthetic appearance – Positive Seal at Any Angle
- No Distortion Maximum Pull Over Strength – Cupped head design protects the washer from UV damage.

2+3 HYBRID® Point Design

- No Point Walking--Effortless quick penetration-Easy Multi-Layer Penetration-Drilling capacity to .210"
- Advanced forging process technology - Sharp drill edges consistently cut the metal, eliminating slow or dropped screws and pigtailed that can embed themselves in the rubber washer.
- 1/4" Stitch will securely fasten panel sidelaps up to 18 ga. panel thickness with no strip-out when installed correctly

ALL UNPAINTED MAXX STEELBINDER® FASTENERS COME STANDARD WITH DURASEAL® PLUS ENHANCED CORROSION RESISTANCE COATING. FOR PROPER INSTALLATION, THE USE OF IMPACT DRIVERS ARE NOT RECOMMENDED FOR POWDER COATED OR ANY WET PAINTED FASTENER.

PULLOUT & PULLOVER VALUES ARE DETERMINED IN THE ST FASTENING SYSTEMS ENGINEERING LABORATORY USING STEEL PANELS/FRAMING & WOOD DENSITIES WHOSE STRUCTURAL PROPERTIES ARE FOUND IN PRESENT DAY PRODUCTS.

Available Sizes: (Not All Sizes/Colors are Kept In Stock)

12-14 x 3/4" 12-14 x 1"
12-14 x 1-1/4" 12-14 x 1-1/2"
12-14 x 2" 12-14 x 2-1/2"
12-14 x 3" 1/4 x 7/8" STITCH
1/4 x 7/8" STITCH

Tools

Hand Seamers



Malco Hand Seamers, with forged steel jaws, are the premier choice for bending, folding, flattening, and straightening sheet metal edges or safely gripping and moving sheet metal around the job site. These seamers are available in 3-inch (76.2 mm) and 6-inch (152.4 mm) jaw widths as well as an offset 3-inch (76.2 mm) size for overhead work. The drop-forged, high-impact jaws feature depth markings graduated in 1/4-inch (6.35 mm) increments and are complimented by a powerful compound leverage design. Easily bend flanges or completely flatten seams from 1/4 to 1-1/4 inch (6.35-31.75 mm) deep in 24 gauge (0.71 mm) galvanized or (0.61 mm) mild steel.

Malco's Hand Seamers, with forged steel jaws, also feature ergonomic RedLine Handle technology. An Engineered handle opening compliments the natural power stroke of any user's hand and maximizes the powerful 7:1 mechanical advantage of compound-leverage head to handle linkage. Comfortable handle grip contours, a non-slip grip insert, spring handle actuation and a thumb-operated handle latch ensure a natural fit and feel for comfortable one hand operation anywhere on the job.

Hemming Tools

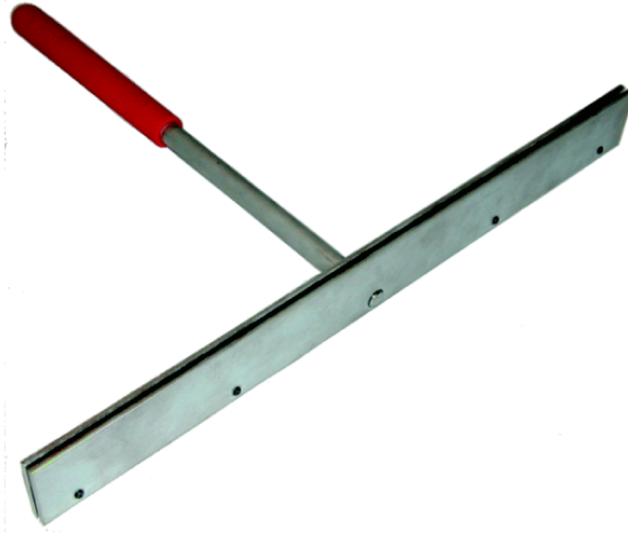

Snips



- Malco Max2000 Series Left Hand Offset Snips
- Cut straight and tight left, 1.25" cut
- Cuts up to 18ga CRS and 20ga Stainless
- Ergonomic Grip

Turboshears



Making your power drill a powerful metal-cutting shear is now a more attractive idea than ever before! This well-tailored attachment quickly inserts into the chuck of a corded or cordless drill to make fast straight, curved or square cuts in most common sheet metals. A sleek, lightweight aluminum cast shear head and molded drill clamp allow maximum portability and ease to go wherever the work is. The compact telescoping drill clamp adjusts to fit both length and width of popular drill sizes including smaller bodied impact drivers. Optional spacers are stored on clamp for large motor housings. The clamp collar allows the shear head to be rotated 360° and set in any position for optimum tool clearance when navigating profiles or to facilitate easy material flow. The shear's wide-opening jaws can operate at high or low speeds for the control you need to follow a precise trim line, navigate crosscuts through profiles of metal building and roofing panels or cut through layered metal and seams, even the ribs of spiral duct. Heavy-duty gearing and beefy, hardened carbon steel blades combine to offer up to 18-gauge (1.22 mm) cutting capacity in mild steel. A lateral blade adjustment capability ensures that optimum cutting performance and maneuverability can be maintained for the life of the blades. Replacement blades are available and easily installed on the job.

What materials will the turbo shear cut?

TSHD - cuts 18-gauge (1.32 mm) galvanized steel (HVAC duct work, auto body panels), 20-gauge (.82 mm) non hardened carbon steel and stainless steel (metal roofing panels), 14-gauge (1.54 mm) aluminum (trim coil, flashing), and .100 inch (2.55 mm) copper (metal roofing, gutters).

The TSHD is also rated to cut 20-gauge (.82 mm) spiral duct work.

How clean is the cut?

TSHD - The Turboshear metal cutting series will make clean cuts throughout the range of thicknesses of material listed above. The tool will need to be adjusted when going from very thin to thick material and vice versa.

How do you adjust the tool to get the optimum cut?

TSHD - The clearance between the cutting jaws is adjustable in order to achieve the optimum cut for thick or thin material. To adjust, locate the 3/16" set screw on the back of the tool, towards the front of the tool near the jaws. Turn it clockwise to tighten the gap of the jaws for thinner material or counterclockwise to make the gap of the jaws larger for thicker material.

Saw Blade

Sheet Metal 7-1/4" x 5/8" x 60T



- Metal cutting grade carbide teeth stay sharp for long-lasting durability
- Thin, yet strong kerf produces faster and smoother cuts for improved productivity at the job site
- Specially calculated teeth combination makes cuts BURR free!
- Anti-kickback tooth shoulder for safer cutting
- Ideal for cutting thin steel
- This product is manufactured in Japan
- This blade was specifically designed to cut material applications such as corrugated sheet metal, spiral ducts, galvanized plates, insulated metal panels, steel siding, metal roofing, and sandwich panels.
- Cutting Ability in thickness is up to 18 gauge

Ridge Venting

MultiVent

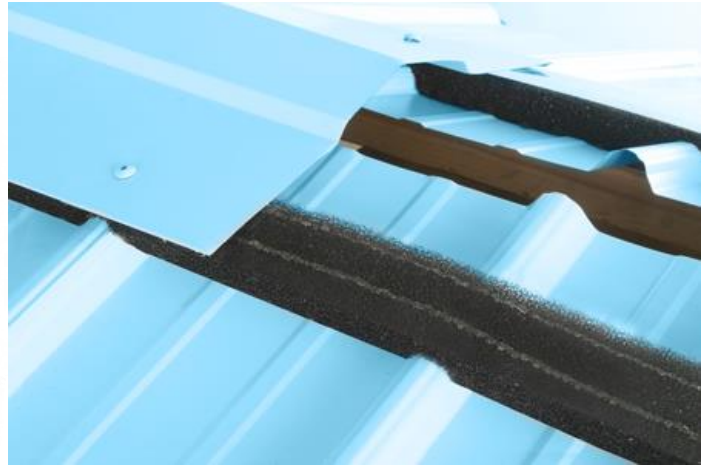

- MultiVent10™ is a ventilated roll product for metal roof ridge cap applications.
- Material is a non-woven, UV resistant, polyester fabric with an acrylic binder that allows for maximum air movement.
- Provides more air movement than polyurethane rolls coated with PVC
- Passes the extreme wind-driven rain test
- 1 1/2" x 2" x 10' Polyester vented strip has pre-applied adhesive strip
- Universal feature allows application to ridge cap.

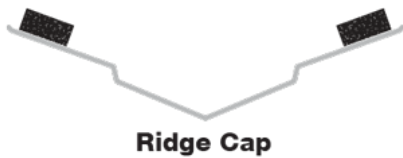

Ridge Cap

1. Roll MultiVent10™ onto ridge cap.

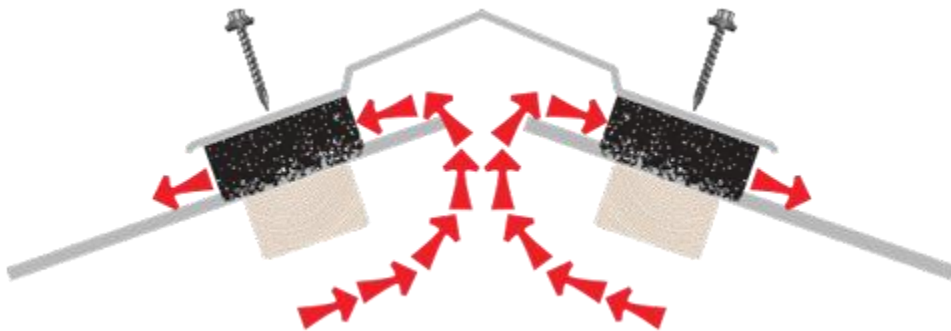

2. Fasten ridge cap to roof with Kwikseal® II Woodbinder® fasteners. MultiVent10™ will mold to roof panel profile

Weathertites



Lower, custom-fit profile

Custom contours fit any pitch, all major metal roof profiles, for either ridge cap application or roof-to-wall applications. LP2™ creates a low-profile look and a seal that helps keep out moisture.

Python™ non-clogging protection.

Python™ is a single-layer, non-fabric-covered ridge vent re-cycled material made from silicone-coated fibers that prohibit clogging. This strong, durable, modified polyester allows the greatest air flow in and out of the attic.

Moisture, net free area and pest-free seal.

The special cut contours plus a 2" Marco closure create an incredible WEATHER TITE™ seal to help keep out moisture, insects, dust, and plant materials.

Non-obtrusive appearance.

The contours give this system a WEATHER TITE™ fit, and to the roof a non-obtrusive appearance to the roof.

Reduces utility costs.

Excellent air flow means your metal structure stays cool while the heat escapes and adds up to reduced utility costs.

One-person, easy installation.

LP2 comes 75 feet to a box, in twenty-five 3-foot sections. LP2™ comes with a double bead of industrial strength adhesive. One person can simply remove the peel and stick strips to apply LP2™ to the metal roof, then secure the ridge cap over the LP2™ with fasteners or nails. It's that easy!

Building code compliant.

When properly installed with soffit or intake vents, LP2™ is building code compliant.

Closure Strips



- Designed to close gaps in roof & sidewall applications. Material is pre-cut to conform to metal panel configurations.
- Applications include closing the openings at the ridge (peak of the building) or at the eave (gutter-line of a building).
- 1.8 lb. Density polyethylene foam is designed to withstand harsh weather elements including moisture & ultraviolet rays.
- Optional pre-applied adhesive helps to keep closure in place before roof panel is fastened.
- Interlocking dovetails provide a secure end to-end fit, eliminating any potential gaps



3/4" Ag Rib



R-Panel



U-Panel



Pro Panel II



2.67" x 7/8" Corrugated

Caulking

Geocel 2300



Product Description:

2300 Construction Tripolymer Sealant is a single component, high-performance elastomeric sealant for use in a wide variety of roofing, trim, architectural metal, manufacturing, underdeck system, solar roof system, and general construction applications.

Sold Through:

Building Supply Center, Industrial Distributor, OEM Distributor for Manufactured Housing and RV's, Roofing Wholesaler, Specialty Supply Center (i.e., Windows, Masonry, HVAC, etc.)

Product Benefits:

Exceptional elongation and flexibility. Excellent adhesion to many building surfaces, even when damp. Remains flexible. UV resistant. Resealable, may be applied over itself. Paintable. Asphalt shingle compatible. Easily applied, non-stringing formulation. Tools and cleans up easily. Cured sealant is mildew resistant.

Limitations:

Do not use on traffic-bearing surfaces. Do not use on extruded polystyrene insulating sheathing (Styrofoam, etc.). Do not use on acrylic skylight glazing surfaces. Do not use in areas where food is processed or stored. Do not use for interior applications. Do not use for potable water applications.

Adheres To:

Asphalt shingles, coated steel (Kynar 500 based finishes), concrete, vinyl, steel, and other common roofing substrates.

Packaging:

10 fl. oz. cartridge

Titebond



Titebond® WeatherMaster™ Metal Roof Sealant is specifically formulated to outperform all other sealant technologies, including VOC solvent, silicones, tripolymers and urethanes. This superior polymer formula provides a weather-tight seal against water, wind, dust and dirt. It offers exceptional adhesion to Kynar™ coated metal materials, along with standard metal, aluminum, steel, galvanized bonderized surfaces, plastics and glass. The product is ideal for use on a wide variety of roofing applications, metal roof, trim, architectural metal siding, aluminum, galvanized steel, galvanized gutters, flashing and downspouts. It also provides unbeatable adhesion to wood, masonry, PVC and most common building materials.

Titebond WeatherMaster Metal Roof Sealant is available in over 50 colors, all of which match today's popular metal roof and metal siding colors, regardless of material or manufacturer. If touch-ups are necessary, it may be painted* with a water-based (latex-based) paint one hour after application. It extrudes in extreme weather conditions (down to 0°F/-18°C) and is UV-resistant, making it the ideal choice for exterior applications. It will expand and contract with the change of weather and temperature and will not crack. This sealant contains no solvents or isocyanates and is VOC-compliant.

Specifications

- Exceeds the requirements of ASTM C920 Type S Grade NS Class 50† Use NT, T, G, A and O
- Federal Specification TT-S-00230C, Type II, Class A
- Meets the requirements of ASTM G155, Surface Flame Spread ASTM E162, and Smoke Generation ASTM E662 (white & colors)
- Meets the requirements of CAN/CGSB-19 13-M87, Classification MCG-2-40-A-N‡
- USDA approved for use in meat and poultry areas (white & colors)
- Meets the requirements of AAMA 808.3-92 (translucent)

*Titebond WeatherMaster Metal Roof Translucent (#61111) is not paintable

† Titebond WeatherMaster Metal Roof Translucent (#61111) is Class 25

‡ Titebond WeatherMaster Metal Roof Translucent (#61111) is Classification MCG-2-25-A-N

- Outperforms silicone, tripolymer and urethane sealants
- Adheres to Kynar™ coated metals
- Applies easily in extreme weather conditions

- Excellent adhesion to most common building materials
- Permanently flexible, weather-tight seal
- UV-resistant
- VOC-compliant

Application Temperature

Above 0°F (-18°C)

Service Temperature Range

-75°F to 300°F (-59°C to 149°C) white & colors, -40°F to 350°F (-40°C to 177°) translucent

Method of Application

Cartridge/caulking gun, bulk/sausage gun

Tooling Time

For a 1/4" bead, approximately 10-15 minutes, depending on temperature and humidity.

Working Surfaces

Surfaces must be cleaned down to the original substrate and free from any material that may prevent adhesion. It is the sole responsibility of the user to thoroughly test any proposed use with all substrates to determine project suitability. To ensure neat sealant lines, mask areas adjacent to joints.

Cleanup

Uncured material may be cleaned with isopropyl alcohol.* After curing, excess sealant must be cut or scraped away. Follow solvent vendor's precautions when using solvents.

Butyl Tape



- TACKY TAPE is 100% solids, asbestos free butyl tape sealant in roll form.
- Applications include metal roof end laps, side laps, vents, gutters, pipe flashings, skylights.
- Service temperature range is -40 Degrees F- +180 Degrees F
- Material will not become brittle or crack.

3/32" x 3/8" x 45'

3/32" x 1/2" x 45'

3/32" x 3/4" x 45'

3/32" x 1" x 45'

X-Seal Tape



- Will not dry out and become hard and brittle
- UV-stable
- Highly resistant to bugs and vermin
- Will not extrude from between joints like caulk or butyl tapes
- Conforms to contours and fills gaps
- Maintains a seal during thermal expansion and contraction of building panels
- Excellent compressibility and recovery (minimal compression set)
- Good thermal and sound insulator
- No shrinkage or blow-out due to closed-cell breakage
- Supplied with self-adhesive on one side. After removal of packaging, material begins gradual expansion – more slowly in cold weather than in hot.

Valleys

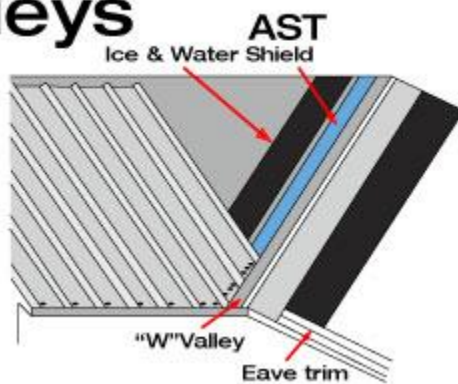

Hips

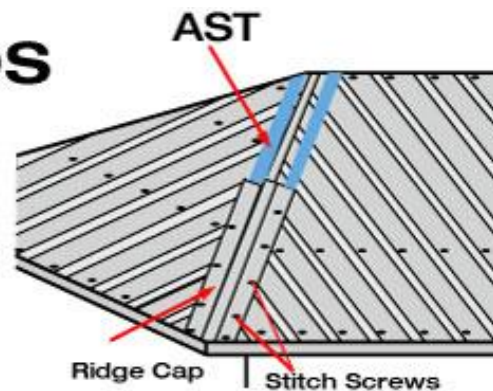

Ridges



Gooseneck Vent



Sheltered internal air dampers provide one-way air venting. Round design enables superior air flow in kitchen or bath exhaust applications. Self-flashing flanges allow for easy installation.

Sizes:

4", 6", and 10"

Rivets

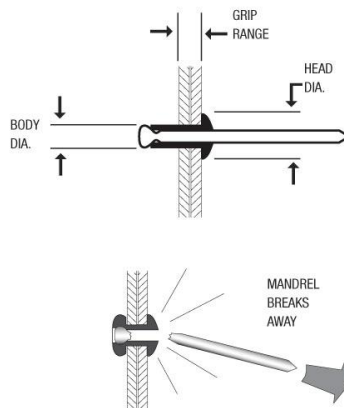

- Open-end blind rivet is designed to attach 2 thin pieces of metal for a low profile appearance.
- Applications include metal roofing ridge-caps, roof gutters & downspouts.
- 304 Stainless Steel, Carbon Steel, & Aluminum are available.
- Painted #43 Stainless are available to match most architectural panel colors.
- Rivets come in bags of 100 pieces.

Pipe Flashings



- Manufactured from EPDM or silicone rubber, ROOFJACK is compounded for maximum resistance to ozone, UV light, & temperature extremes.
- Flexible aluminum base will allow the flashing to conform to any metal roof configuration. Pipe location can be centered in the flat of the panel or the rib. Urethane sealant & self-drilling screws complete the installation
- ROOFJACK are well-marked so they can easily be cut with shears to fit exactly the pipe size used.
- ROOFJACK are available in Black or Gray EPDM as well as Red or Gray high temperature Silicone.

	PIPE SIZE	BASE DIAMETER	COLOR MATERIAL
#1	1/4" -2-1/2"	4.75" (120.7mm)	Black/Gray EPDM & Red/Gray Silicone
#2	1-3/4"-3"	6.21" (157.7mm)	Black/Gray EPDM & Red/Gray Silicone
#3	1/4"-5"	7.74" (196.6mm)	Black/Gray EPDM & Red/Gray Silicone
#4	3"-6-1/4"	9.26" (235.2mm)	Black/Gray EPDM & Red/Gray Silicone
#5	4-1/4"-7-3/4"	10.75" (273.0mm)	Black/Gray EPDM & Red/Gray Silicone
#6	5" - 9"	12.50" (317.5mm)	Black/Gray EPDM & Red/Gray Silicone
#7	6" - 11"	14.60" (370.8mm)	Black/Gray EPDM & Red/Gray Silicone
#8	7" - 13"	16.5" (419.1mm)	Black/Gray EPDM & Red/Gray Silicone
#9	9" - 19"	25.25" (641.1mm)	Black/Gray EPDM & Red/Gray Silicone

Not all Colors are In Stock

RESIDENTIAL PIPE BOOTS

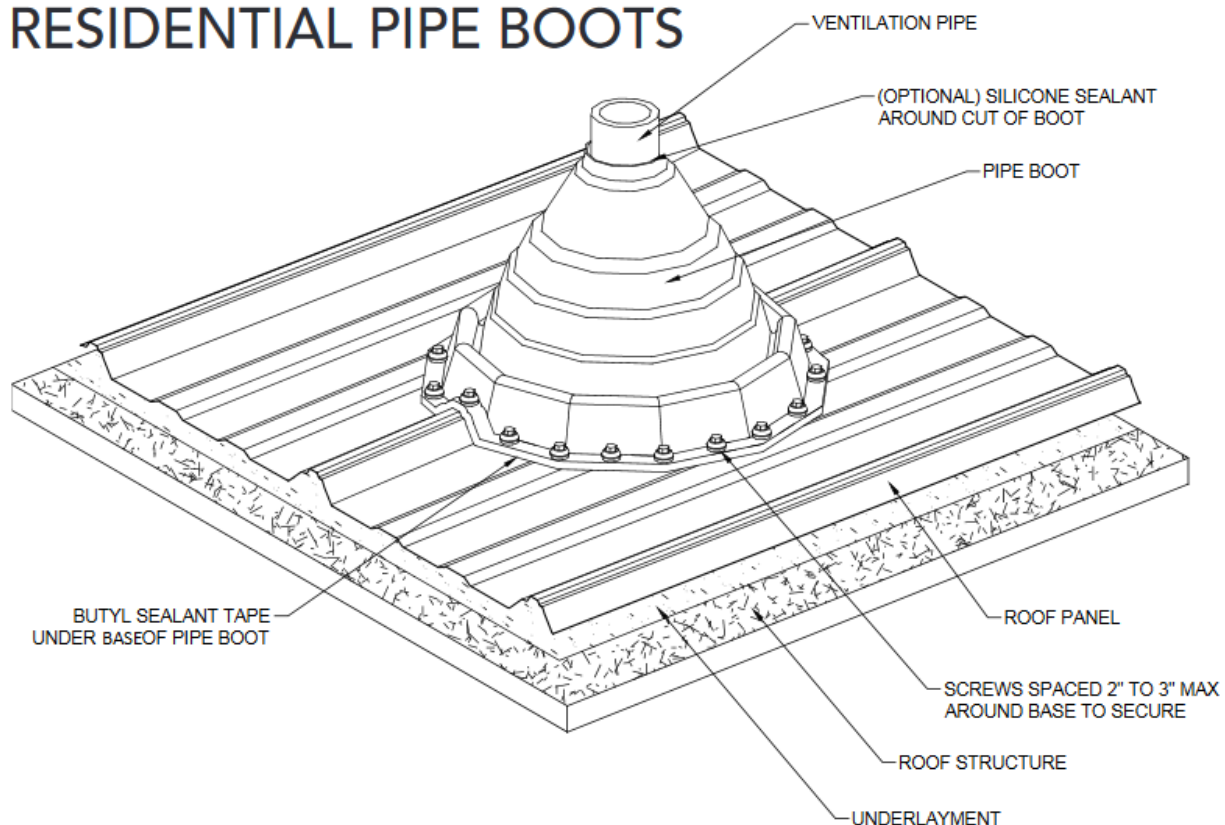

1. Choose pipe opening and trim



2. Slide over pipe



3. Form to roof profile



4. Apply sealant



5. Fasten to complete

Nutsetters



SIZE	TYPE	LENGTH
1/4"	MAGNETIC, SPRING RETAINER	2-9/16", 1-3/4"
5/16"	MAGNETIC, SPRING RETAINER	2-9/16", 1-3/4"
3/8"	MAGNETIC, SPRING RETAINER	2-9/16", 1-3/4"

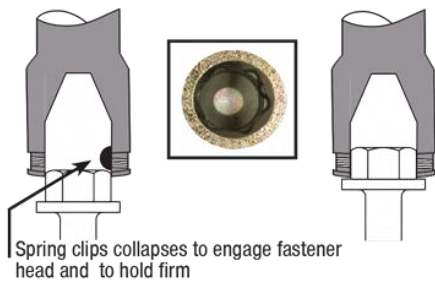
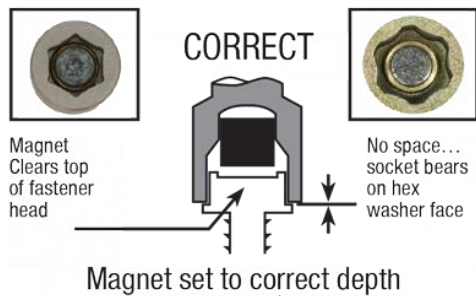

Underlayments

Tarco Synthetic Underlayment



LeakBarrier EasyLay™ is a next-generation hybrid roofing underlayment that combines the value of traditional asphalt saturated felts with the performance of synthetic underlayments. EasyLay is an extremely durable, high performance, polyester-based underlayment that is manufactured by coating a polyester fabric with time-proven, moisture-resistant asphalt to provide excellent weatherability and handling.

Usage

EasyLay is designed to be used in asphalt shingle, shake, slate, tile and metal roofing applications.

Features and Benefits

- Excellent tensile/tear strength and puncture resistance
- Complies with Florida Building Code High Velocity Hurricane Zone requirements. TAS 103 wind uplift test met 52½ psf.
- Significantly more durable than synthetic underlayments
- Asphalt coating allows EasyLay to seal around fasteners
- Lays flat – does not wrinkle
- No possibility of delamination as in plastic-based synthetics
- Non-skid surface provides walkability for slopes up to 10:12, wet or dry
- Versatile upper surface compatible with selfadhering membranes
- Algae, fungi and mold resistant
- Resistant to rot and decay - does not degrade with time

- Packaged like traditional felt
- Does not require the use of plastic cap fasteners - can use roofing nails, pneumatic nailers or plastic cap systems
- Very pliable - easily conforms to rooftop peaks and valleys
- Approved as an underlayment by metal and tile manufacturers
- Suitable surface for foam application of tiles
- Excellent UV resistance - Can be left exposed for up to 6 months without compromising performance
- UL Class A Fire Rating
- Meets ASTM D226
- Florida Building Code Approval FL #10450-R4
- Miami-Dade County Approval - NOA No. 12-0420.02
- ICC-ES ESR #2634
- 25 year Limited Warranty

Storage and Handling

- EasyLay rolls must be stored in a dry location.
- Rolls must be stored on end only. Do not store in a leaning position.
- Rolls must be stored on pallets and not more than one pallet high.
- Do not store rolls in direct sunlight.

General Precautions

- EasyLay shall be installed in strict compliance with applicable Building Code.
- Follow Occupational Safety and Health Administration (OSHA) safety standards; use common sense measures and adequate precautions to prevent accidents.
- Proper ventilation of the attic is required.
- EasyLay shall not be torched or hot mopped to.
- When used in low slope applications (2:12 or lower), EasyLay must be covered the same day. In general, on slopes less than 4:12, a double layer of EasyLay is recommended. Double layer application is best achieved by using 19" side laps, making sure the side laps are "shingled in" to shed water.
- Ensure that sharp objects such as debris, stones, bricks, etc. are not dropped on to the EasyLay surface so as to avoid possible cuts or tears.
- When tin tags/caps are used to secure EasyLay, the material shall be covered immediately after application with an approved underlayment or a suitable roof covering.
- Apply a thin coat of asphalt-based roofing cement to waterproof areas of EasyLay where any cuts or tears have occurred.
- EasyLay is not intended to be used as the weather resistant (primary) roof covering.

Surface Preparation

- The substrate shall be clean and dry prior to installing EasyLay.

Application

- Place a full width piece of EasyLay, parallel to the eave (low) edge of the roof.
- Unroll EasyLay 2 to 3 feet, with the lay lines facing up, and position the end of it to the edge of the eave and rake.
- Install a few fasteners at the top, near the rake, and roll out the sheet to a manageable length.
- Pull, straighten and align the sheet so that any wrinkles are eliminated and the sheet is even with the eave edge.
- EasyLay shall be fastened with 3/8" headed roofing nails or 1" capped plastic nails, driven by hand or pneumatically, spaced 9" o.c. at all laps in the center of the seam area, and two staggered rows fastened 12" o.c. in the field of the sheet, or according to applicable Building Code.
- When using 1" diameter nails, apply so that the head of the nail is flush with the EasyLay surface, without cutting into the EasyLay surface.

- Fastening shall be done from the top to avoid walking or kneeling on unsecured sheet.
- Continue on to the end of the substrate and fasten down.
- Align the next roll over the preceding sheet so as to form a minimum 4” seam or as per applicable Building Code.
- Then install sheet, per instructions above.
- The bottom of the second course of EasyLay shall lay on top of the first course so that any water will flow over the top of EasyLay.
- Apply subsequent sheets in the same pattern and technique, with minimum 4” side laps and 8” end laps over the preceding sheets or according to applicable Building Code.
- Install EasyLay a minimum of 6” up any vertical surfaces.
- Stagger the end laps a minimum of 36” (3’) from the preceding course.
- After installing EasyLay on the field of the roof, install drip edge at the eaves (if used).
- When applying EasyLay in the valley, start at the low point and work to the high point, rolling the membrane from the center outward in each direction
- Make sure there are no rips or large wrinkles in the EasyLay.
- Before applying horizontal sections of EasyLay, install a vertical length of EasyLay down the center of the valley.
- Several sections of EasyLay can be used, but be certain to overlap the higher sections several inches so any water will flow over the top of the sheet.
- EasyLay underlayment in the valley areas must be covered with metal or other valley lining material.
- Seams or joints that require adhesive or sealant can be treated with a high quality plastic cement (asbestos free).
- Prime all metal collars, flashings, valley liners and drip edges with ASTM D41 primer.
- Flash vent pipes, stacks, chimneys and penetrations in compliance with Roof Assembly current Product Control Notice of Acceptance and applicable Building Code.

Wind and Water – Peel and Stick Underlayment



MFM Wind & Water Seal is engineered for use under all roofing materials including metal, asphalt shingles, shake or concrete shingles, and clay tiles. MFM Wind & Water Seal adheres aggressively to most clean, dry substrates including metal, plywood, OSB, foam insulation, house-wrap, rigid vinyl and masonry.

- Composed of a non-slip, polymer film
- Engineered for use under all roofing materials
- Rated for **HIGH TEMPERATURE** applications
- Ideal for secondary water resistance
- Self-sealing around fasteners
- Minimum slope for installation is 2" per foot
- Protects from leaks caused by ice dams and wind-driven rain
- May be left exposed for 60 days

1st Coast Metal Roofing Supply Order Form

Date:	Trim & Accessories		
<i>Pick-Up : Request Date</i> _____	<i>Pitch:</i> _____	<i>Open Hems / Closed Hems</i>	
<i>Delivery : Request Date</i> _____	<i>Ridge Cap (qty):</i> _____	8" 6" / Flat or Stepped	
Address:	<i>Galvalume or Painted</i>	<i>Color:</i> _____	
	<i>Eave Drip (qty):</i> _____	Premium / Bullnose / Extended / Standard	
	<i>Galvalume or Painted</i>	<i>Color:</i> _____	
	<i>Gable (qty):</i> _____	Premium / Standard / PBR / Wide Top	
Special Instructions:	<i>Galvalume or Painted</i>	<i>Color:</i> _____	
	<i>Valley (qty):</i> _____		
	<i>Galvalume or Painted</i>	<i>Color:</i> _____	
	<i>Valley Cleat / Panel Starter (qty):</i> _____		
Panel Details			<i>Galvalume or Painted</i>
<i>Profile: 3/4" Rib / 1" SS / 1.5" SS / 5V / PBR</i>			<i>Color:</i> _____
<i>Gauge: 29 / 26 / 24 / .032</i>			
<i>Finish: Galvalume Painted: _____</i>			
<i>Striated / Flat / Minor Rib</i>			
# of Panels	Feet	Inches	<i>Sidewall (qty):</i> _____
			Premium / Standard / Caulk Channel / Step
			<i>Galvalume or Painted</i>
			<i>Color:</i> _____
			<i>Transition (qty):</i> _____
			Pitch: _____
			<i>Galvalume or Painted</i>
			<i>Color:</i> _____
			<i>J Channel (qty):</i> _____
			Standard / Modified
			<i>Galvalume or Painted</i>
			<i>Color:</i> _____
			<i>Corner (qty):</i> _____
			Inside / Outside - Sculpted / Flat
			<i>Galvalume or Painted</i>
			<i>Color:</i> _____
			<i>Z-Closure (qty):</i> _____
			1" / 1.5"
			<i>Galvalume or Painted</i>
			<i>Color:</i> _____
			<i>Flat Stock (qty):</i> _____
			Width: _____ Length: _____
			<i>Galvalume or Painted</i>
			<i>Color:</i> _____
			<i>Screws (qty):</i> _____
			Mill Finish / Painted: _____
			<i>Application:</i> Metal to Metal / Metal to Wood
			Stainless Steel Cap / Zinc / ZAC (5/16") Cap / Pancake
			Size: #9-10 / #12 / #14
			Length: 1" / 1.5" / 2" / 2.5" / 3"
			Closures
			<i>Inside Closures (qty):</i> _____ <i>Outside Closures (qty):</i> _____
			Vented Closures:
			_____ Multivent _____ Flex Pro _____ Weathertites
			Expandable Foam Tape (qty): _____
			Pipe Flashings
			#3 _____ #4 _____ #5 _____ #6 _____ #7 _____ #8 _____ #9 _____ Retro _____
			Goosenecks 4" _____ 6" _____ 10" _____
			<i>Butyl Tape (qty):</i> _____ 3/8" / 1/2" / 3/4" / 1"
			<i>Caulking (qty):</i> _____ Geocel / Titebond
			<i>Underlayment (qty):</i> _____ Peel N' Stick / Synthetic
			<i>Button Caps (qty):</i> _____

