

A close-up, high-angle shot of a dark-colored car's front end. The image shows the upper part of the grille with three horizontal slats, each containing a red mesh. The hood curves down towards the right, where the front corner of the headlight is visible. The lighting is dramatic, highlighting the metallic textures and sharp lines of the car's bodywork.

44TOOLS™

Paint Protection • Vinyl • Application Tools
for the Professional Film Installer



Our catalog is the most comprehensive group of window tint films, paint protection and vinyl installation tools in the world. We have added many new products this year, bringing the total to more than 700 items for all professional film installers. This catalog is your one-stop shop for all of your tools needs. If you do not see what you need, please check out 44Tools.com, or call 1-866-44TOOLS.

Also, check out our exclusive tools throughout... These tools were created based on testing and feedback from award winning installers. If you have any feedback that you would like to share, please contact us at info@44Tools.com.

We are constantly adding new tools to our collection. By the time you are reading this, we undoubtedly have added many items that

are not pictured in this catalog. Make sure that you check out our new and improved web site at www.44Tools.com. This web site is a much easier way to place your order 24 hours a day, 7 days a week, and you will be able to take advantage of our internet-only specials.

Thank you for taking the time to check out our selection. Give 44Tools.com a try, and find out why we are the fastest growing tool distributor in the industry. With over 100 years of combined industry experience, you can count on the team at 44Tools.com for all of your tool needs. We truly value your business, and will make every effort to keep our customers satisfied.

Hope to hear from you soon,

George R. Lewis

7640 Commerce Place, Plain City, Ohio 43064

phone: 866-448-6657 • fax: 614-873-4899 • email: info@44tools.com • International: 1-614-873-4800

44Tools.com is an independent supplier of professional tools and supplies. Our goal is to provide you with the most up-to-date pricing and product information. Due to the wide variety of suppliers, price changes can occur after catalog publication. Regular prices may go up - or down - without notice. Please call 1-866-44TOOLS or visit www.44Tools.com for the latest prices and availability.

*C. O. D. Available upon approval. Please call for details.

44TOOLS™

CorrectSpec	4	Squeegees & Handles40
Graphtec Plotters	5	Squeegee Blades44
Plotters & Cutters	6	Miscellaneous Installation Tools45
Clean Cut	7	Steamers & Sprayers50
Vinyl & Paint Protection Tools	8	Mark & Measure54
Installation Heating Tools11	Meters55
Olfa Knives & Blades12	Chemical & Cleaning61
NT Knives & Blades22	Shop Tools69
Miscellaneous Knives, Blades & Accessories24	Detailing72
Scrapers & Blades25	Logo Items83
Hard Cards & Bondos33	Restyling School84
Turbos & Squeegees39	Paint Protection Installation Tips87

7640 Commerce Place, Plain City, Ohio 43064
phone: 866-448-6657 • fax: 614-873-4899 • email: info@44tools.com • International: 1-614-873-4800

**SAME DAY
SHIPPING**

44TOOLS™



CorrectSpec[™]

CorrectSpec Decorative Vinyl Window Film

CS Dusted Crystal 4848" x 100' roll
CS Dusted Crystal 6060" x 100' roll
CS Frosted Crystal 4848" x 100' roll
CS Frosted Crystal 6060" x 100' roll

A cast vinyl film with the same visual and material properties associated with the more expensive 3M film brand—making it the most exacting equivalent substitute at a much lower cost to provide higher margins for your business.

- For flat and curved surfaces to include clear substrates such as glass, acrylic, or polycarbonate
- Can be safely applied to double insulated glass units
- Ultraviolet protection - 99%
- Service temperature range -55°F, +225°F (peak values)
- Warranty: 5 years against manufacturer defect

USES: ● ALL ● AUTO ● FLAT ● PPF ● VINYL ● HOBBY/UTILITY/SAFETY

Graphtec Plotters

- FC8600-75 30"
- FC8600-100 40"
- FC8600-160 60"

Plot and cut your own PPF or window film with these Graphtec Plotters and Xpel's DAP design program.

The FC8600 series is a high-performance industry leader for sign makers, graphic artists, automotive aftermarket professionals, countertop installers and other related users. The FC8600 series features a maximum cutting speed of 58.5 inches per second, 4.0G maximum acceleration, and 20-600g selectable cutting forces, allowing users to process high-intensity reflective film, automotive window and paint protection films, self-adhesive vinyl, and other types of media.

Includes floor stands, media roll rack, media catch basket, Graphtec Standalone software, Cutting Master 3 (plug-in software for Adobe Illustrator and CorelDraw).



GRAPHTEC

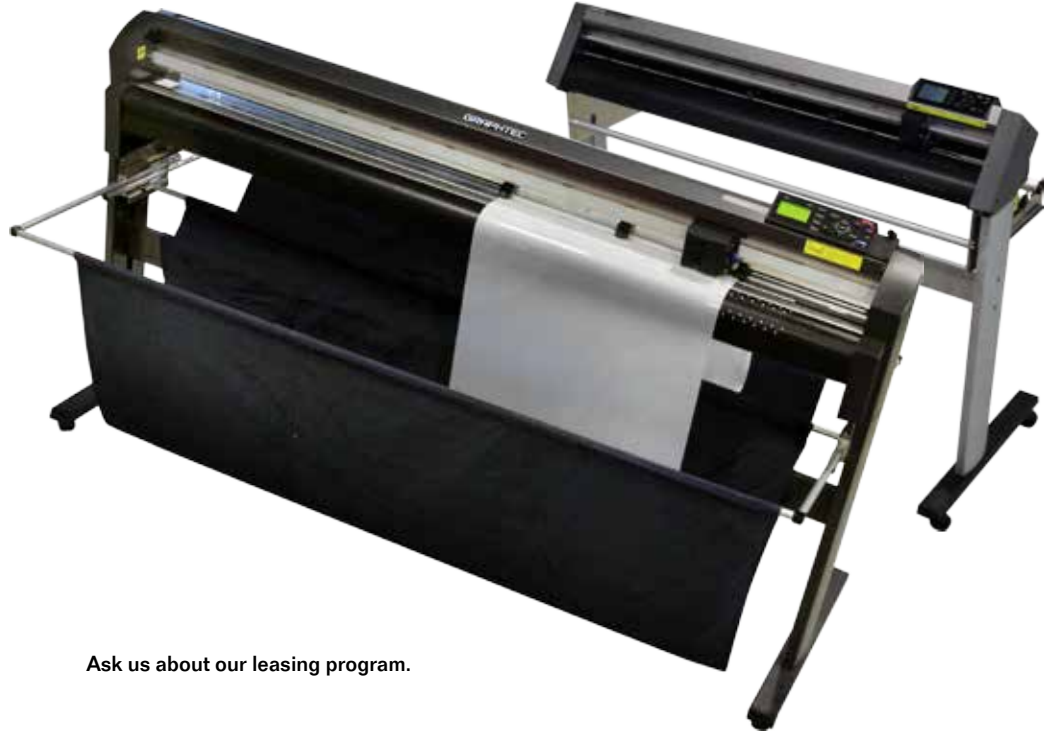

Ask us about our leasing program.

Plotters & Cutters

44TOOLS



Filmhandler - Accessories

- F101-28 3" Roller Assembly Pair
- F101-33 3" Cutter Shim - 1/8" shim ea
- F101-32 3" Cutter Shim - 1/4" shim ea
- F101-30 6" Roller Assembly Pair
- F101-35 6" Cutter Shim - 1/8" shim ea
- F101-34 6" Cutter Shim - 1/4" shim ea
- F101-29 Blade Holder
- F101-27 Cutter Head Assembly
- F101-26 Cutter Blades - 20 Blades

Filmhandler

- F101-72
- F101-60
- F101-61
- F101-VRA

72" Filmhandler
60" Filmhandler
Repair Kit
Filmhandler Vertical Rule Assembly

Minimize waste and save time on all of your flat glass installations with the original Filmhandler.

*Oversized items, additional shipping charges may apply.



Box Mounted Film Slitter

- A0104
- Make any film box into an economic film cutter.





Clean Cut Wall Mount

●●● CCWM

Cutter Head Assembly

●●● CCHA

Replacement Blades

●●● CCHRB (5 blades)

Clean Cut Box Slitter Tray

●●● CCBT

36" Cut Off Bar
40" Cut Off Bar
48" Cut Off Bar
60" Cut Off Bar
72" Cut Off Bar

●●● CC36
●●● CC40
●●● CC48
●●● CC60
●●● CC72



CLEANCUT Products



A basic alternative to more expensive and heavy film handlers

This system is designed to get film up off the floor and also to hold the box when you pull your film out. Each item is sold separately so you can choose your desired length of cutoff bar and the number of cutter head assemblies required.

1. Place the tray on the top of the ladder.
2. Drill out the mounting hole in the top of the ladder.
3. Set the two nuts at the stop distance on the eyeball bolt (not included).
4. Place the box with the clean cut bar facing you. You are now ready to pull film.

Cuts graphic film without using a knife

Make clean, knife-like cuts without damaging substrates. Knifeless Tape can stretch and bend in any direction, making it ideal for auto vinyl designs, stripes and using around handles and mirrors.

Trim anywhere and never worry about cutting a vehicle again!

Knifeless
Tech Systems

A. Design Line Knifeless Tape
● A2510DL 164' roll
Create perfectly cut designs and stripes. Twisted filament for additional flexibility and stretch.

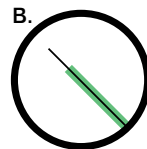
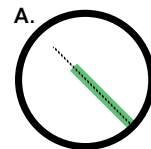

B. Finish Line Knifeless Tape
● A2510FL 164' roll

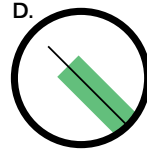
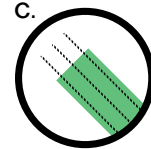

C. 6mm Triline Knifeless Tape
● A2510TL 164' roll
Twisted filament for additional flexibility and stretch.

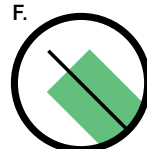
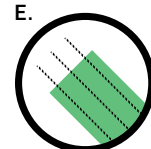

D. Perf Line Knifeless Tape
● A2510PL 164' roll

E. 9mm Triline Knifeless Tape
● A2510TL9 164' roll
Creates 6mm gap or pinstripe. Twisted filament for additional flexibility and stretch.

F. Bridge Line Knifeless Tape
● A2510BL 164' roll
Thicker filament for specific use over door gaps.



USES: ● ALL ● AUTO ● FLAT ● PPF ● VINYL ● HOBBY/UTILITY/SAFETY

4" Monkey Strips

● A2533

Incredible for installing vinyl during dry application. Apply monkey strips to your favorite squeegee and work closer to the vinyl in hard to reach areas.

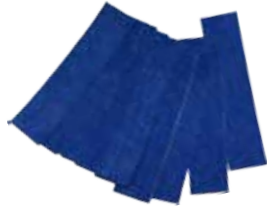

Solskins Strips (wet edge)

●●● A2531 - 1" x 4" pack of 10

●●● A2532 - 1" x 6" pack of 10

●●● A2536 - 2" x 4" pack of 10

Solves the issue of scratching gloss and chrome vinyl. Apply to your squeegee for use in wet applications. This material allows you to work closer to the vinyl while soaking up water. Works great on paint protection applications, and can also be used on turbo squeegees.



Solskins Strip Roll (wet edge)

●●● A2530 - 1" x 10 meter roll

●●● A2535 - 2" x 10 meter roll



Teflon Tape

●●● A2534

Developed by an installer. Apply to your favorite squeegee when heat shrinking. Slides across film with ease. Heat resistant up to 350° F(180° Celsius). Includes specific properties to reduce static.



3M Wet or Dry Squeegee

●● A05517 (Size: 4" x 2.5")

Black paint protection squeegee.



3M Paint Protection Squeegee

● 71607 (Size: 4.5" x 2.75")

Orange paint protection squeegee.



Hard Card Sleeve

● 71603

Used with any bondo card to allow them to slide smoothly. Primarily for paint protection applications.



Performax Felt Squeegee

●● A2390 (2.75" X 4" X .375")



Vinyl & Paint Protection Tools

**Stainless Steel Curved Tweezers**

● SSTWC

Lift film edges without leaving finger prints.

**Stainless Steel Scissors**

● A2905S

Cut paint protection film with precision and smoothness with these economical scissors.

**6 Pack Vinyl Wrap Strip Magnets**

● A610SM6

Keep graphics firmly in place, with 25 lbs. of pull. Move quickly and easily reposition your graphics.

**Magnetic 4" Bondo Card**

●●● A2300MAG

A black bondo card with a set of strong magnets inside.

**1.5" Vinyl Wrap Post Magnet**

● A611PM

For faster and easier installations, keeps vinyl firmly in place with 25 lbs. of pull. Rubber surface helps protect vinyl.

**5.5" Retractable Awl (.060)**

●● A2600E

Sharp, fine point to pierce air bubbles left behind during tinting or paint protection film installations.

**5.5" Retractable Awl (.030)**

●● A2600EX

To help remove air bubbles created during paint protection installations. Replaceable tip and a durable metal design.

USES: ● ALL ● AUTO ● FLAT ● PPF ● VINYL ● HOBBY/UTILITY/SAFETY



Equalizer Heatwave Heat Gun

● A2901

Equalizer Heating Element

● A2901HE

Compact, lightweight, easy to use and perfect for shrinking back windows. Temperature settings of 570°F and 1050°F.

Kevlar Heat Forming Gloves

● B2602

(One Pair)

Protects hands from heat guns while shrinking back windows.

Handy Man's OVE Glove

● B2603

(One Glove)

For heat shrinking (temperatures of up to 540°F). Nomex and Kevlar with an 80% cotton liner. One-size-fits-all woven glove can be worn on either hand.



Wagner HT3500 Digital Heat Gun

● A2910

- Twelve temperature settings from 250°F—1350°F
- Ergonomic handle for comfortable grip and reduced fatigue
- Two fan speeds for optimum air flow control
- Cool-down and automatic shut-off setting to improve tool life
- 500 Watts / 5100 BTU



Wagner HT1000 Heat Gun

● A2909

A good inexpensive general purpose heat gun, suitable for heat shrinking.

Infrared Wrap Heater

● A2911

Quickly "post-heat" larger areas of vinyl to keep it from shrinking back to its original size after it cools and relaxes.

Infrared Replacement Heating Element

● A2911HE





Silver SVR-1 Knife
● A1901

All stainless steel. Features a slide lock and pocket clip/blade snapper.



Silver SVR-2 Knife
● A1903

Auto-locking blade slide, stainless steel handle and safety blade snapper for rapid blade segment change. For left or right handed users.



A1 Knife
● A1906-A1

New and improved version of the A1906.



Pro Load 5 Blade Knife
● A1906P

Think of this as an OLFA A knife with 4 extra blades ready for rapid loading. Comes with a carbon blade. Replace if using on glass.

All OLFA knives come with a lifetime guarantee.



300 Knife
● A1908

Fine tune how much blade is extended with a locking wheel.



SAC-1 Knife
● A1912

With the 7 pt blade, this knife gives precise cutting edge for special situations. Great for paint protection.



XA-1 Knife
● A1913

Ergonomic design provides precise cutting, control and comfort.



180 Multi-Purpose Cutter
● A1918

Ideal for light-duty cutting. Positive slide lock with handle designed for control and comfort, a pocket clip, and built-in blade snapper.

USES: ● ALL ● AUTO ● FLAT ● PPF ● VINYL ● HOBBY/UTILITY/SAFETY



Cushion Grip Handsaver NA-1

● A1920

Snap-off cutter features automatic blade lock and heavy gauge stainless steel blade channel to firmly secure the blade.



UltraMaxCarbon Steel Blades

● B129C (50 blades)

Standard-duty, snap-off replacement blades (ABB). 13 cutting edges per blade strip. 50 pack features 650 cutting edges. Superior sharpness and blade edge retention.



9mm Stainless Steel Blades

● B129S (50 blades)

Stainless steel snap-off blades for use in moist environments (wallpapering, window films, etc.) where rust is a concern. 13 cutting edges per blade strip. Fits OLFA Standard-Duty Knives.



9mm Stainless Steel Blades

● B129S10 (10 blades)

Stainless steel snap-off blades for use in moist environments (wallpapering, window films, etc.) where rust is a concern. 13 cutting edges per blade strip. Superior sharpness and edge retention.

All OLFA knives come with a lifetime guarantee.



DA-1 Snap it 'n' Trap it Auto Lock Knife

● A1924

Remove dull blades easily and safely. Insert the dull blade into the end of the disposal container, snap it off, and a sharp new blade is ready for use.



9mm UltraMaxCarbon Steel Blades

● B129C10 (10 blades)

Standard-duty, snap-off replacement blades (ABB). 13 cutting edges per blade strip. 10 pack features 130 cutting edges. Superior extra sharpness and blade edge retention.



Carbon Blades

● B129CB10 (10 blades)

9mm snap-off blades fit OLFA standard-duty, snap-off knives. Ideal for general crafts, cutting wallpaper, vinyl and paint protection applications, etc. 13 cutting edges per blade strip.



Carbon Blades

● B129CB (50 blades)

9mm snap-off blades fit OLFA standard-duty, snap-off knives. Ideal for general crafts, cutting wallpaper, vinyl and paint protection applications, etc. 50 pack features 650 cutting edges.

OLFA[®]**OLFA Cutter Buckets**

- **A1904 (40 SPC-1 Economy Cutters)**
- **A1918-BKT (36 180 Multi-Purpose Cutters)**

Value-priced cutters. Place by your register for an easy point-of-purchase sale.



XL-2 Extra Length Cutter
● **A1917**

Blade channel offers an extra 6.25" of reach. Ideal for cutting gaskets out of windshields and other industrial applications. Uses heavy duty blades.

Pro Load 6 Blade Cutter PL1
● **A1907**

Meets the need for continuous blade change. Accommodates up to 6 heavy-duty snap off blades. Features auto-lock blade slide for cutting support.

L-1 Ratchet Lock Cutter
● ● **A1919**

Contoured handle, ratchet wheel blade lock. Heavy gauge stainless steel blade channel holds blade tight. For right and left handed use. Tool-free blade change for convenience. For cutting paper, cardboard, roofing, drywall, vinyl, acetates, etc.

L-2 Ratchet Lock Cutter
● ● **A1919-2**

Anti-slip rubber grip, ratchet wheel blade lock. Heavy gauge stainless steel blade channel holds blade tight. For right and left handed use. Tool-free blade change for convenience. For cutting paper, cardboard, roofing, drywall, vinyl, acetates, etc.

USES: ● ALL ● AUTO ● FLAT ● PPF ● VINYL ● HOBBY/UTILITY/SAFETY



● ● LA-X
● ● A1916

Anti-slip, cushion-grip fiberglass handle conjoined with elastomer for chemical resistance and easy cleaning. Snap-off cutter features automatic blade lock and built-in hard metal pick for opening paint cans, removing switch plates, etc.



● ● BN-L
● ● A1923

Ratchet lock utility knife.



● ● Xtra H/D H-1
● ● A1911

Rubber grip insert and ratchet wheel blade lock to prevent slipping. Uses B124 blades.



25mm Xtra Heavy Duty Snap-Off Blades
● ● B124
● ● B124-5



18mm Heavy Duty Snap-Off Blades
● ● B125 (10 blades)
● ● B126 (50 blades)
● ● B126S (50 stainless blades)

Non-stainless, heavy-duty, snap-off replacement blades. Each heavy duty blade is produced using OLFA's precise multi-step process for amazing sharpness and superior edge retention. 8 cutting edges per blade.



● ● Handsaver Soft-Handle HD Cutter
● ● A1921

Maximum comfort and performance. Ratchet wheel blade lock and heavy gauge stainless steel blade channel holds blade tight. Designed for superior sharpness and blade edge retention. Tool-free blade change for convenience.



● ● XH-AL
● ● A1925

Fiberglass rubber grip auto lock utility knife.



● ● Ratchet Lock XHD Cutter
● ● A1915

Extra heavy duty cutter features a ratchet wheel blade lock. Perfect for cutting through difficult materials, such as leather, rubber, cardboard, rope, paper, carpet, fiberglass, acetates, linoleum, plastic, etc. Uses B124 Extra Heavy Duty blades.

OLFA[®]

Blade Disposer Pocket DC-3
● A1910P



Blade Disposer DC-4
● A1910R

Conveniently sized blade dispenser holds all sizes of knife blades. The blades can be emptied and the dispenser re-used.



OLFA[®] Art Knife AK-4
● ● ● A1905

HandSaver[®] cushion grip, quick-spin blade change, and anti-roll device. Includes (2) precision blades, (1) chisel blade and (1) curved carving blade.



OLFA Designer Art Knife with 30 Blades
AK-5
● ● ● A1905D



OLFA Top Sheet Cutter Knife
● A1922

For cutting coupons, printed articles, and other tasks that require only a single, top sheet to be cut and the material beneath to be preserved.



OLFA[®] Compass Cutter 6" Circle
● A2800

Perfect circles every time! Includes 6 blades.
● ● B160 OLFA Compass blades (pk of 15)



7" Scissors
● A2907
Serrated blades.

5" Scissors
● A2905
Serrated blades.

5" Precision Smooth Edge Scissors
● A2905SE

Sharp, thin stainless steel blade edge. Wider holes fit up to three fingers for more comfort. Symmetrical design for ease of handling.



OLFA LBB-5B Ultra Max HD Blades

- B116 (5 pk)
- B117 (50 pk)



Carbon 7 pt Blade
 ● B120 (10 blades)

For use with Olfa SAC-1, A1912 Knife. 30° angle blade gives a precise cutting edge. Ideal for installing paint protection film.



OLFA Top Sheet Cutter Replacement Blades

- B123
- Replacement blades for A1922.

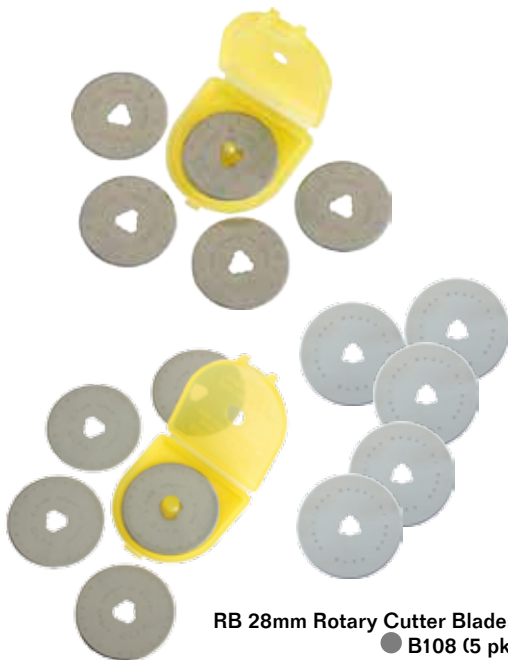

RB 28mm Rotary Cutter Blades

- B108 (5 pk)

RB 45mm Rotary Cutter Blades

- B109 (5 pk)

RB 60mm Rotary Cutter Blades

- B110 (5 pk)

Replacement blades for the OLFA Rotary Cutter.



OLFA® Art Knife Blades KB4-S (5 pk)

- B127 (Use with A1905)

Replacement blades (#11) for the precision art knife (AK-4). For use in a multitude of applications where accurate cuts are required.



Art Knife Blades (25)

- B257 (Use with A1905)

General purpose blade.

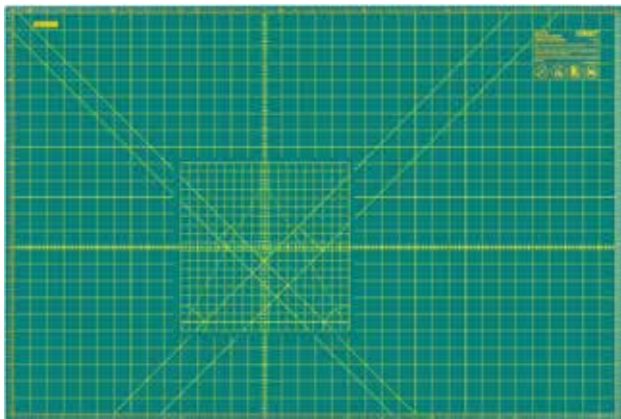
OLFA®**Self Healing Rotary Mat (24x36)**

● OS-RM-MG

1.5mm thick, double-sided, triple layer mats with a dark green base color. Yellow grid lines on one side for detailed cutting and solid green on the reverse for general cutting. Use only Rotary Cutters and Blades.

Heavy Duty Cutting Mat (24x36)

● OS-HD-MG

3.0 mm thick, self-healing professional cutting mat designed for use with OLFA standard-duty cutters, heavy-duty cutters, art knives, rotary cutters and specialty cutters. Double-sided with green base color and gray grid lines on one side, solid green on opposite side.

**Safety Knife Blades for SK-7**

● OS-SKB-7 (10 pk)

The Olfa Safety Knife blade SK-7 is designed for use in the SK-7 Knife.

**Safety Knife Blades**

● OS-SKB-2/5B (5 pk)

● OS-SKB-2/10B (10 pk)

● OS-SKB-2/50B (50 pk)

A great multi-purpose blade that provides double sides for cutting. Fits OS-SK-4 and OS-SK-9.

**Safety Hook Blades for SK-4**

● OS-HOB-2/5 (5PK)

OLFA Safety Hook Blades help protect your cutting surfaces while also reducing the chance of injuries. The hook blades are great for cutting shrink wrap, nylon straps, linoleum, roofing tiles and more. Fits OS-SK-4 and OS-SK-9.

**Rounded Tip Safety Blades**

● OS-RSKB-2/10B (10pk)

● OS-RSKB-2/50B (50pk)

The Olfa Rounded Tip Safety Blade helps reduce the chance of cuts and other injuries with a unique rounded tip. Fits OS-SK-4, OS-SK-6, and OS-SK-9.

**Safety Knife Blades for SK-8**

● OS-SKB-8/10B (10 pk)

The Olfa Safety Knife blade SK-8 is designed for use in the SK-8 Knife.

**SK-10 Blade 10 Pack**

● OS-SKB-10/10B (10pk)

The OS-SK-10 Utilizes the SKB-10/10B Pro Heavy-Duty Utility Blades.



Shrink Wrap Cutter

● OS-SK-10

Cuts shrink wrap, plastic strapping, stretch wrap, plastic sheeting, bubble wrap, leather, nylon, belting, sacks, bags, tape slitting. Uses the SKB-10/10B replacement blades.



Flex Guard Safety Knife

● OS-SK-6

Automatic protection system engages when the blade loses contact with the cutting surface. Built-in safety protection is activated as soon as you start cutting and cannot be overridden. Rounded Safety Tip Blades further reduce the possibility of injury. For left-handed or right-handed users. Cuts to a depth of 0.39" (10mm). Uses OS-RSKB-2/10B and OS-RSKB-2/50B replacement blades.



45mm Ergonomic Rotary Cutter

● OS-RTY-2/DX

Perfect for all of your sewing and quilting needs. Cuts through more than 6 layers of fabric. Ergonomic handle reduces hand and wrist fatigue. Dual-action safety lock allows the blade to lock open for comfort or closed for safety. Tungsten carbide steel blade for sharpness and superior edge retention. For right- and left-handers.



60mm Ergonomic Rotary Cutter

● OS-RTY-3/DX

Ergonomic design provides a comfortable and positive grip. Squeeze the handle to engage the blade. Lock the blade open for comfort or closed for safety. Designed to cut through multiple layers of fabric and difficult materials. Can be used for industrial applications. For both right and left-handed use.



OLO Carton Cutter

● OS-OLO

OLO is designed with safety in mind. This is the Safety Carton Opener, which is an ergonomic and effective box cutter that shields its own blade for safety and efficiency.

OLFA[®]

45mm Rotary Cutter
● OS-RTY-2X

The most popular size available, this cutter features a durable handle with a blade cover for safety. The cutter is a rolling razor blade used to cut materials into shapes, strips and pieces. Sharp and durable blade. For right- and left-handed use.



28mm Rotary Cutter
● OS-RTY-1/G



45mm Rotary Cutter
● OS-RTY-2/G



Self Retracting Safety Knife
● OS-SK-4

Slip resistant ergonomic handle. Spring activation feature that self retracts when the blade loses contact with the cutting surface... The blade only cuts what you want it to cut. For left or right handed users. Cuts to a uniform depth of 0.75" (19mm). Uses OS-SKB-2, OS-RSKB-2/10B, OS-RSKB-2/50B, and OS-HOB-2/5 replacement blades.



Compact Self Retracting Knife
● OS-SK-7

Low profile blade slide reduces the amount of blade exposure when carrying inside a pocket. For left or right handed users. Cuts to a depth of 0.43" (11mm). Uses SKB-7 replacement blades.



Automatic Self Retracting Knife
● OS-SK-8

Heavy duty cutter with a spring blade the produces an audible click when it comes into contact with the material being cut. This ensures the blade automatically retracts the instant it loses contact with the material being cut. This happens even when the blade slide is engaged and cannot be overridden. Cuts to a depth of 0.59" (15mm). Uses SKB-8 replacement blades.



Self Retracting Knife with Tape Slitter
● OS-SK-9

The SK-9 features a comfortable handle with a gently curved blade slide for added comfort. A finger groove on the back of the knife helps secure your grip when cutting. A rounded metal tip on the back of the knife is great for slitting tape, being used as a screwdriver and staple remover. The SK-9 cuts to a depth of 0.75"; 19mm. Uses the SKB-2, RSKB and HOB replacement blades.

USES: ● ALL ● AUTO ● FLAT ● PPF ● VINYL ● HOBBY/UTILITY/SAFETY



Maximize your daily sales without raising your prices: Offer several “Point-of-Purchase” products which are related to the work that you just performed, and your customers willingly add to your bottom line.



Touch Knives

- OS-TK-4N (Navy Blue)
- OS-TK-4R (Red)
- OS-TK-4Y (Yellow)
- OS-TK-4O (Olive)

Pocket-sized, multi-purpose keychain knives, featuring stainless steel slide lock blades.

Touch Knife Display (60 Knives)

- OS-TK-4/60

A must for every store or shop owner seeking easy point-of-purchase sales. Preloaded with 15 of each color (red, navy, olive, yellow).

OLFA Snap-Off Carton Cutter 40 Unit Display

- OS-CTN-1/40W

NT Knives & Blades



NT L-500GR Knife

● **A1896**

Aluminum diecast grip. Sturdy diecast slide section. Uses # B125 & B126 heavy-duty blades.



DISCONTINUED

NT A-500RP Knife

● **A1895**

5 blade cartridge knife with diecast grip. For flat glass and automotive use. Comes with blade snapper. Colors may vary.



NT A-1000RP Knife

● **A1897**

NT's original fast 5 blade system for the professional who changes blades frequently. Comes with blade snapper.

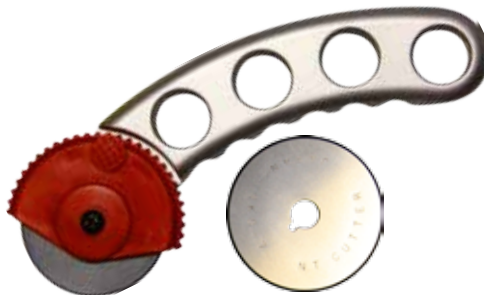

NT RO-1000GP 45mm Rotary Knife

● ● ● **A1893**

NT BR-45P Rotary Cutter Blades 45 mil

● **B107**

45mm Rotary Cutter and replacement blades.



NT 30 Degree Blades

● ● **B121 (10 Blades)**

30° blade angle for special cutting situations. Great for paint protection film installation.



NT Heavy Duty Stainless Blades

● **B129N (50 Blades)**

Very nice stainless steel snap-off blades. One of the sharpest edges available.



NT A-551P Knife

● **A1898**

Affordable cartridge model holds 5 blades for faster changes.



**CLEARANCE
item to be
discontinued**

NT A-300GR Knife

● **A1900**

A quality inexpensive knife with a channel with metal surround for comfort.

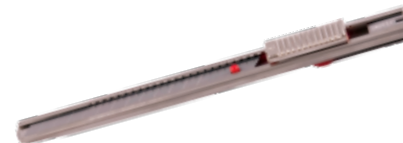

NT PRO A-1P Knife

● **A1899**

The RED DOT is the choice of professionals everywhere. Left or right handed use. Auto-locking blade slide.

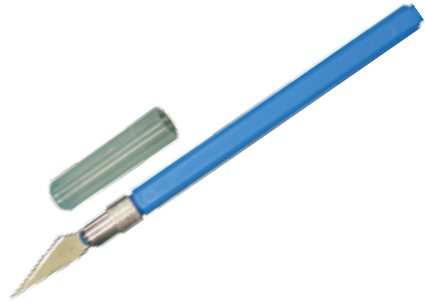

Performax Rite Cut Lite-Duty Art Knife
●●● A1905B

For both professionals and amateurs. Useful for paint protection film installations, weeding vinyl, art work and hobby or craft projects.



Super Cutter
● A1902

Inexpensive knife for those who tend to lose their tools.



Soft Handle #1 Art Knife
●●● A1905A

Lightweight non-slip design for precision cutting. Twist off blade removal. Uses #11 Hobby Knife Blades (# B127, B127B, B127C, B127SB)



Blade Eater Complete
● A1910BEC

● A1910BEH (replacement holster)

The holster's patented built-in blade snapper makes it easy to snap knife blades one-handed. Used blade segments are safely contained in the disposable blade well and the holster keeps track of your snap knife.

Red Anodized Border Edge Cutter
● A1909R-16 1/16"
● A1909R-8 1/8"

Use with a 1" razor blade to slide across the top of side glass to provide a professional micro-edge. Choose 1/8" or 1/16" micro edge.



Miscellaneous Knives, Blades and Accessories



Liner Cutter
● A1926

Cut through the paper backing of a self-adhesive vinyl without the risk of damaging adhesive or cutting through the film side of your vinyl.



Ceramic Safety Film Cutter
● A601

Used for pre-cutting heavy gauge safety films along a cutting-table edge. V-notch ceramic blades cut film perfectly, rapidly in both directions, with no edge burrs or flaws.

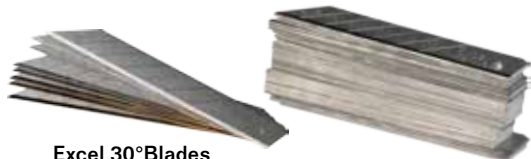

Excel 30° Blades

- B130
- B131

(Knife Blades 10 pk)
(Knife Blades 100 pk)

Made in the U.S.A. Fits all 9mm knives.

#11 Hobby Knife Blades

- ● B127A (Knife Blades 5 pk)
- ● B127B (Knife Blades 100 pk)
- ● B127C (Knife Blades 1000 pk)

Precision made in the U.S.A. for use with A1905 & A1905A.

#11 Stainless Steel Hobby Knife Blades

- ● B127SA (Knife Blades 5 pk)
- ● B127SB (Knife Blades 100 pk)

Wear-resistant stainless steel blades precision made in the U.S.A. for use with A1905 & A1905A.

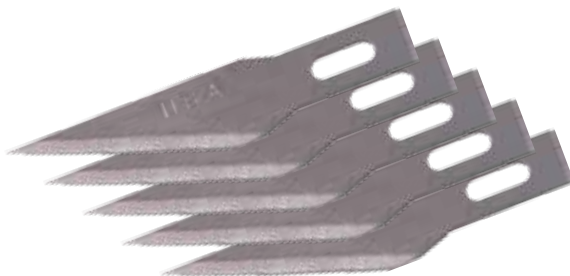

KDS Stainless Blades

- B129K Standard Hone (50 pk)
- B129K10 Standard Hone (10 pk)
- B129KS Fine Hone (50 pk)

All Way Retractable Razor Scraper

- ● A1503AW

Soft Grip Retractable Razor Scraper

- ● A1503SG

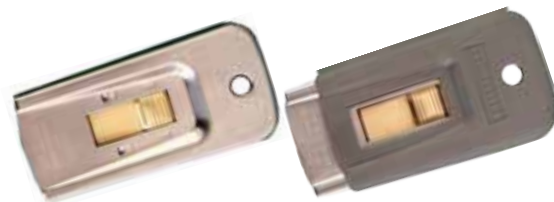

A. Unger Ergotec Scraper
●● A1507E (Uses B135 or B135S).

B. 3" Triumph Handy Scraper
●● A1505 Uses B111 scraper blades.

C. 3 1/4" Hyde Scraper
●● A029 Uses B030.

D. 4" Short Handle Scraper
●● A1500 Uses B128.

E. 4" Red Scraper w/ 9" Handle
●● A1502
Twist Lock for rapid blade changes. Uses most 4" blades, such as B128, B128A, B135 or B135S.

F. Clip Scraper
●●● A1475
Use B122 or hard card for hard to reach areas.
Blades not included.

G. Retractable Razor Blade
●●● A1503 Uses B122 & B122S.

H. Blade Aide / Single Blade
●● A1506 Uses B122, B122S & B144.

I. Neon Blade Aid
●● A1506ASR



Scrapers & Blades



Single Edge Razor Blade
● B122 (100 pk)



Heavy Duty Single Edge Razor Blade
● B122HD (100pk)



S/S Single Edge Razor Blade
● B122S (100 Blades)



GEM S/S Single Edge Razor Blade
● B122SG (100 Blades)



Plastic Razor Blades
● B143P (100 Blades)



Double Edge Plastic Scaperite
Razor Blades with Lil Gripper Holder
● B144H 25-Pack
As seen in Window Film Magazine



Double Edge Plastic Scaperite Razor Blades
● B144C (100 Blades - 200 Edges)
For cleaning rear glass effectively without damaging defroster lines. As seen in Window Film Magazine.



4" Hyde Scraper Blades
● B128H (10 Blades)



4" Scraper Blades in Plastic Tube
● B128 (10 Blades)

4" Scraper Blades
● B128A (100 Blades)



4" Unger Scraper Blades
● B135 (10 Blades)

4" Unger Scraper Blades Stainless
● B135S (10 Blades)



3" Triumph Handy Scraper Blades
● B111 (10 Blades)



3 1/4" Scraper Blade
● B030 (5 US Blades)
● B030H (5 Hyde Blades)



6" Triumph Soft Grip Angled Scraper
●● A1504SGA

A more ergonomically designed grip than the basic hard plastic A1504. The angled head allows for additional leverage. Uses either B145 or B145S blades.



6" Triumph Soft Grip Scraper
●● A1504SG

Utilizes a more ergonomically designed grip than the basic hard plastic A1504. Uses either B145 or B145S blades.



6" Black Triumph Scraper
●● A1504

The original, basic scraper with a hard plastic grip. Uses either B145 or B145S blades.

Excel Knives, Blades and Accessories



● EX1601 Excel K17
Plastic art knife (non-roll).

● EX1600 Excel K1
Knife with safety cap.

● EX3060 Excel Duel Flex Cutter Set
Pin stripe tool. Includes two blades.

● EX1607 Excel K70
Slim snap blade knife with tension nut.

USES: ● ALL ● AUTO ● FLAT ● PPF ● VINYL ● HOBBY/UTILITY/SAFETY



● EX1606
Excel K60 REVO - (Black)
Folding Utility Knife



● EX1606G
Excel K60 REVO - (Grey)
Folding Utility Knife



● EX1606GR
Excel K60 REVO - (Green)
Folding Utility Knife



● EX1606R
Excel K60 REVO- (Red)
Folding Utility Knife

Excel Knives, Blades and Accessories

44TOOLS

Excel Knives, Blades and Accessories



- EX2005 Excel Duel Flex Cutter Blades A (2 pieces)
- EX2269 Excel Standard Utility Blades (100 pieces)
- EX2263 Excel 13pt Snap-off Carbon Blades (100 pieces)
- EX2000 Excel 13pt Snap-off Carbon Blades 9mm (5 pieces)
- EX2260 Excel Standard Single Edge Razor Blades (100 pieces)

USES: ● ALL ● AUTO ● FLAT ● PPF ● VINYL ● HOBBY/UTILITY/SAFETY



- EX3043 Excel Slant Point Tweezers (Black)
- EX3043R Excel Slant Point Tweezers (Red)

- EX3044 Excel Hollow Handle Tweezers (Black)
- EX3044R Excel Hollow Handle Tweezers (Red)

- EX3042 Excel Straight Point Tweezers (Black)
- EX3042R Excel Straight Point Tweezers (Red)

- EX3045 Excel 3 Piece Tweezer Set

Excel Tweezers

44TOOLS



6" Red Heavy Duty Triumph Scraper

● A1504H

A beefed-up version of the original basic scraper (A1504) with a hard plastic grip. Great for film removal. Uses only B145H blades.



6" Black Triumph Angled Scraper

● A1504A

Features an angled head to allow for additional leverage. Uses either B145 or B145S blades.



6" Triumph Scraper Retractable

● A1504R

Features a thumb switch to retract or expose the blade. Uses either B145 or B145S blades.



6" Black Triumph Scraper Blade

● B145

(25 pk)

6 inch Black Triumph Scraper Blade Replacements.



6" Black S/S Triumph Scraper Blade

● B145S

(25 pk)

6 inch Black SS Triumph Scraper Replacement Blades.



6" Red Heavy Duty Triumph Scraper Blade

● B145H

(10 pk)

Thicker and tougher than the B145 and the B145S blades. Fits only in the A1504H Red Heavy Duty Scraper.



6" Triumph Cover

● A1504COVER



6" Triumph Blade Track Replacement

● A1504RBT

Replacement track for 6" Triumph Scraper.



Triumph H/D Stainless Steel Blades

● B145HSS

Triumph replacement blades.



HARD CARDS & BONDOS

Hard Cards & Bondos

44TOOLS[™]

Hard Cards & Bondos



4" Platinum Teflon Card
● A2300TP

4" Purple Teflon Card
● A2300TM

4" White Teflon Card
● A2300TW

4" Gold Teflon Card
● A2300TG

4" Black Teflon Card
● A2300TBK

4" Blue Teflon Card
● A2300TB



AP1 Round Corner Silver Hard Card
● A2350TS

AP1 Round Corner White Hard Card
● A2350TW

AP1 Round Corner Pink Hard Card
● A2350TPK

AP1 Round Corner Black Hard Card
● A2350TBK

AP1 Round Corner Red Hard Card
● A2350TR

AP1 Round Corner Gold Hard Card
● A2350TG

AP1 Round Corner Yellow Hard Card
● A2350TY

AP1 Round Corner Blue Hard Card
● A2350TB

USES: ● ALL ● AUTO ● FLAT ● PPF ● VINYL ● HOBBY/UTILITY/SAFETY



- AP1 Square Corner Hard Card**
- A2350STPK Pink
 - A2350STY Yellow
 - A2350STBK Black
 - A2350STB Blue
 - A2350STS Silver
 - A2350STR Red
 - A2350STW White
 - A2350STG Gold

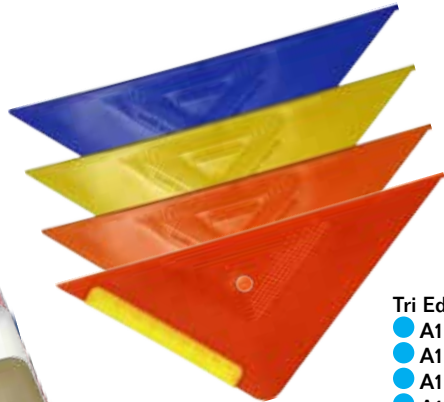

- Tri Edge**
- A101 Blue
 - A102 Yellow
 - A103 Orange
 - A104 Plus

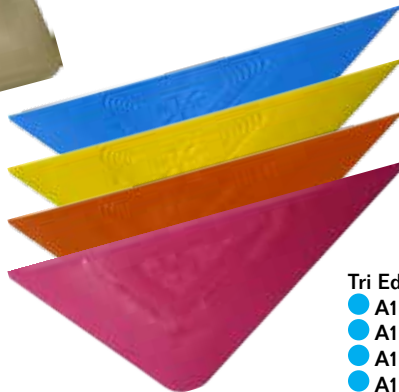

- Tri Edge X**
- A101X Blue
 - A102X Yellow
 - A103X Orange
 - A105X Pink



- 6" Teflon Card**
- A2300TW-6 White
 - A2300TBY-6 Yellow

- 6.5" EZ Reach**
- A205 Gold
 - A214 Platinum



- 6.5" EZ Reach Ultra**
- A205U Gold
 - A214U Platinum



- 6.5" EZ Wing**
- A214L Lime



Hard Cards & Bondos

44TOOLS

Hard Cards & Bondos



CUSTOM:
Your Company
Name or Logo Here

Lil' Chizler

- A2302
- A2302-CUSTOM



The Chizler

- A2302L (Hard - White)
- A2302P (Medium - Pink)
- A2302Y (Soft - Yellow)

Slightly larger than the Lil' Chizler.

Black Little Foot

- A2405BK (Stiffest)

Mango Little Foot

- A2405M (Medium Stiff)

Red Little Foot

- A2405R (Medium Flexible)

Blue Little Foot

- A2405B (Flexible)

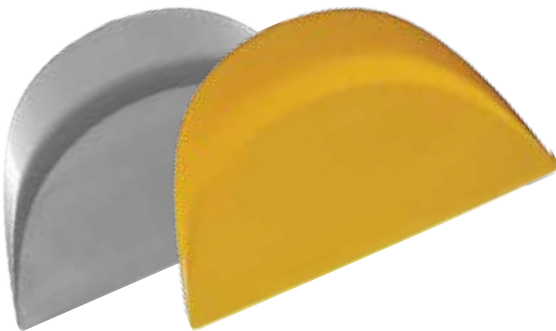
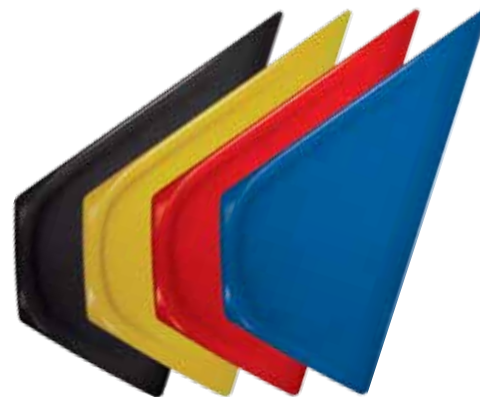

Smart Card

- A2315
- A2315M

Platinum
Mango

New and improved teflon hard cards. 25% wider with a comfortable grip and thin edge.



DISCONTINUED

Rebel

- A218M

A cross between Bondo and Diamond Tip tools.



Yellow Contour

● A204

A versatile tool for reaching out of the way places. One of our most popular tools.

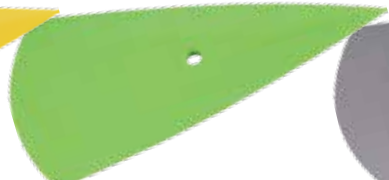

Green Contour

● A210

A softer version of the Yellow Contour. Great for paint protection installs.



Platinum Contour

● A219

Push more water out with this stiffer version of the Yellow Contour.



Gator Blade I

● A221R
● A221

Red
Yellow



Gator Blade II

● A222

A fantastic replacement for hazardous metallic razor blades.

Speed Wings

● A2511-4
● A2511-6
● A2511-8

● A2411-4
● A2411-6
● A2411-8

● A2311-4
● A2311-6
● A2311-8

Winged design helps reach areas typically out of the reach of most bump, bondo, teflon and hard cards. Includes one flat edge and one curved edge. The curved edge disperses the energy of a finger in the material to allow the installer to squeegee the surface flat faster.

Yellow 4"
Yellow 6"
Yellow 8"

Red 4"
Red 6"
Red 8"

Green 4"
Green 6"
Green 8"



Hard Cards & Bondos

44TOOLS

Hard Cards & Bondos



4" 3M Gold Bondo
● A2300G

4" 3M Blue Bondo
● A2300B

4" Lidco Gray Bondo
● A2300GR

4" Lidco Orange Bondo
● A2300Y (Radius Corners)
● A2300YS (Square Corners)

4" Universal Bondo
● A2300U

4" Mango Bondo
● A2300M

Magnetic 4" Bondo Card
● A2300MAG

A black bondo card with a set of strong magnets inside.

6" Lidco Gray Bondo
● A2300GR6



4" Lidco EZ Grip
● A2304EZ

6" Lidco EZ Grip
● A2306EZ

This tool gives you something more substantial to grab onto. Slides on to any bondo card.



4" Lidco Felt Edge Bondo
● A2300F

6" Lidco Felt Edge Bondo
● A2300F6

Felt edge glides over film during installation.



5" Magic Master Bondo
● A2305



4" Bondo Felt Sleeve
● A2300S

6" Bondo Felt Sleeve
● A2300S6

For paint protection installation. Felt sleeve slides right over existing bondo cards.



Yellow Bondo Spreader
● A2300YBS

Super thin, flexible bondo card for tint installations, gets into tight spots with ease.



Green Turbo

- A2218G (18.5" blade)
- A2205G (5.5" blade)
- A2203G (3.5" blade)

A very soft durometer, for installing paint protection films and vinyl applications. Does not include p.v.c. handle.

Yellow Turbo

- A2218 (18.5" blade)
- A2205 (5.5" blade)
- A2203 (3.5" blade)

For installing automotive window tint, paint protection films and vinyl applications.

Yellow Basic Turbo

- A2218B (18.5" blade)
- A2205B (5.5" blade)

Generic version of the original Yellow Turbo. Does not include p.v.c. handle.

Orange Turbo

- A2218OR (18.5" blade)
- A2205OR (5.5" blade)
- A2203OR (3.5" blade)

Slightly harder than the Yellow Turbo helps eliminate more water. Works well on metallized and ceramic films.

Red Baron Turbo

- A2220R (18.5" blade)

Hard durometer for all films and types of applications.

Black Smoothee

- A2228 (28" blade with handle)
- A2228H (grey handle)
- B228 (28" blade without handle)
- A2209 (9" blade with handle)
- A2204 (4" blade with handle)
- B204 (4" blade without handle)

For use as a cleaning squeegee, or for PPF installation.



Yellow Diamond Tip

- A2309Y

The second hardest Diamond Tip. 20° angle corners make it great for tight areas.

Squeegees & Handles



Unger Pro Handle
 ●●● A1400

For Unger metal channels, which then can be fitted with either Pro Replacement Blades for cleaning or Blue Max Inserts for film installation.



Motus D-Handle
 ●● A1400D

Make your Performax or Pro handle two-handed with this tool. Great for security film installations when extra leverage is needed.



Unger ErgoTec Handle
 ●●● A1400E

For Unger metal channels, which then can be fitted with either Pro Replacement Blades for cleaning or Blue Max Inserts for film installation.



Performax
 ● A1400P
 ● A1400G

A heavy duty handle for thicker blades such as Blue Max, Clear Max and Orange Fusion. Threaded so that extensions can be screwed in for two-handed safety film installation.

Squeegee Handle Grip



8" Fusion Squeegee Handle
 ● A1400F8

5" Fusion Squeegee Handle
 ●● A1400F5

5" Short Fusion Squeegee Handle
 ●● A1400SF5

Fits Orange Fusion 5" Blade, Blue Max, and Clear Max blades.



Unger Squeegee with Blue Max Blade
 ● A1600BC
 Cropped Blue Max squeegee blade.



Thor's Hammer
 ● A1402



Power Squeegee without angle
 ● A2251-6 6" squeegee
 ● A2251-8 8" squeegee



Angled Power Squeegee
 ● A2251-6A 6" squeegee
 ● A2251-8A 8" squeegee

DISCONTINUED



Whale Tale Complete with Handle
 ● A2406 (10" blade)

CLEARANCE
 item to be
 discontinued



The Stroke Doctor
 ● A215

Makes difficult-to-reach installations much easier to master. The cushioned grip and wide squeegee blade will help apply more pressure to remove more solution per stroke.

Squeegees & Handles



- Blue Max Insert**
- B195-6 6" insert
 - B195-8 8" insert
 - B195-10 10" insert
 - B195-12 12" insert
 - B195-18 18" insert



- Pro Blade with Channel**
- A1406 6" blade
 - A1608 8" blade
 - A1410 10" blade
 - A1412 12" blade
 - A1418 18" blade



- Pro Replacement Blade**
- B200-6 6" blade
 - B200-8 8" blade
 - B200-10 10" blade
 - B200-12 12" blade
 - B200-18 18" blade
 - B200-42 42" blade



- Power Replacement Blade**
- B192-6 6" blade for A2251-6
 - B192-8 8" blade for A2251-8



- Go Doctor Blue**
A1990BL
● B1990BL (blue replacement blade)
Firm blade.

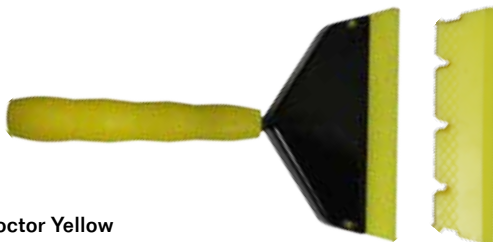

- Go Doctor Yellow**
A1990BY
● B1990BY (yellow replacement blade)
Medium blade.



- Go Doctor Red**
A1990RD
● B1990RD (red replacement blade)
Soft blade.



- 120" Blue Max Roll**
● B195-120
10 feet of Blue Max.
Change often for best results.



- Automotive Bull Dozer**
● A207
Reach into the tightest rear deck area with ease. Plenty of reach and a rubber squeegee tip. A must have tool!



- Flat Glass Bull Dozer**
● A208
Reach difficult areas on a flat glass install. Longer ribs increase the stiffness. The soft rubber tip on the end ensures you won't end up with any scratches on the film.



Side Swiper

- A200 Handle only
- A201 Blade included

One of our top tools. A super stiff tool for automotive tint installation, great for hard to reach back window installations. Sold with or without the 6" Blue Max Blade.



Paddle

- ● A224 (13.5" reach)

Beveled 3" blade with 13.5" of reach for tough rear window installs. Durable hard plastic is still slightly flexible for maximum water removal.

The Scrubber

- ● ● B176

For cleaning rear deck area and other hard to reach areas. Works with a trimmed down White Scrub Pad, B171W.



Grip-n-Glide

- ● ● A1991OR
- ● ● A1991YLW
- ● ● B1991OR
- ● ● B1991YLW

An ergonomic handgrip with high-performance, interchangeable blades for tint, wrap and PPF installations. Features machine milled .24" edge tip blades. Use either the firm yellow 90A or softer orange 85A blade.

- (handle with orange blade)
- (handle with yellow blade)
- (orange replacement blade)
- (yellow replacement blade)

Squeegee Blades

**Orange Crush 8" Blade**

●● B3708

For flat glass film projects. 8"x2" squeegee blade moves much more water per blade stroke. 93 Durometers with a beveled leading edge. Use with A1400F8 Handle.

**Orange Crush 5" Blade**

●● B3705

5"x2" squeegee blade is for automotive installations as well as flat glass or safety film installs. 93 Durometers with a beveled leading edge.

**Orange Crush 5" Cropped Blade**

●● B3705C

A cropped blade is a popular choice for maximum water removal from your automotive or flat glass installations. 5"x2" with beveled leading edge.

**8" Blue Max Blade**

●● B3700

93 Durometers. 8"x2" with beveled leading edge. Use in the A1400F8 Squeegee Handle.

**5" Blue Max Blade**

●● B3701

93 Durometers. 5"x2" with beveled leading edge.

**5" Cropped Blue Max Blade**

●● B3701C

A popular choice for maximum water removal from automotive or flat glass installations. 5"x2" with beveled leading edge.

**5" Blue Max Blade (No Bevel)**

●● B3701SN 5"x1.375"

Can be flipped over for longer life.

**Blue Max Blade (No Bevel)**

●● B3701N 5"x2"

Can be flipped over for longer life.

**Clear Max Blade**

●● B3702

A slightly softer version of the Blue Max (lower durometer).



Spatula

●●●●● A223 (12" reach)

The "Spatula" has a 3" wide blade with a reach 12" for those tough rear window installs. Made of a chemical resistant, flexible and virtually unbreakable nylon material.



Mother Tucker

● A2303MT (12" overall length)

The "Mother Tucker" is a great new tucking tool with a 6" handle and a 6"x 1.75" usable blade. This tool is great for tucking film behind door gaskets, or for getting into those tight fitting, long reach areas.



Chisel

● A2303CH (6.5" overall length)

This tool has an wide installation tip for reaching behind gaskets while keeping your hands out of the way. The Chisel is 6.5" in overall length with approximately 3" of flexible blade.



Shank

● A2303S (7" overall length)

This new tool has an offset installation tip for reaching behind gaskets while keeping your hands out of the way. It is 7" in overall length with approximately 3" of flexible blade. Made of lightweight, yet extremely durable plastic, it is great for tucking film behind those tight door gaskets.



Yellow Slammer

●● A2402Y (12" overall length)

Clear Slammer

●● A2402C (12" overall length)

Use the Slammer as an edge guide or installation tool. Handle provides increased leverage.

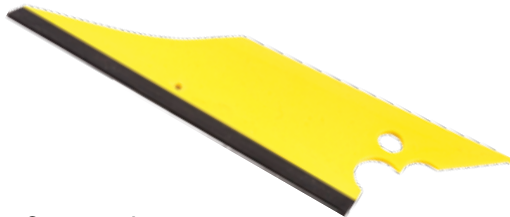
**Conquistador**

● **A202 (6.5" rubber edge)**

New stiffer body. 6.5" rubber edge is molded to the body (not glued) and will not peel away.

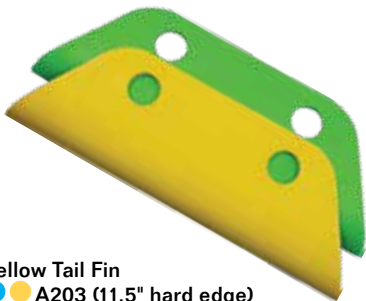
**Yellow Tail Fin**

● **A203 (11.5" hard edge)**

For getting behind hard to reach third brake lights. Negative curve to keep constant pressure on the film and is harder than the Green Tail Fin.

Green Tail Fin

● **A209 (11.5" soft edge)**

Softer than the Yellow Tail Fin.

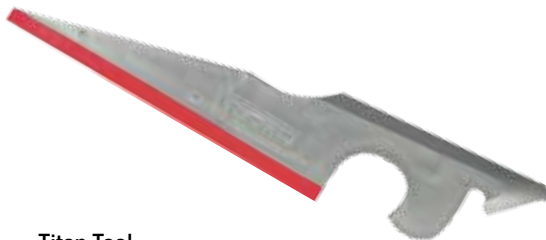
**Titan Tool**

● **A220R (14.75" overall blade length)**

A longer, stiffer version of the Conquistador gets into hard to reach back decks. Increased strength at the tip of the tool pushes out more water than ever. The uniquely designed handles lift inner and upper door seals.

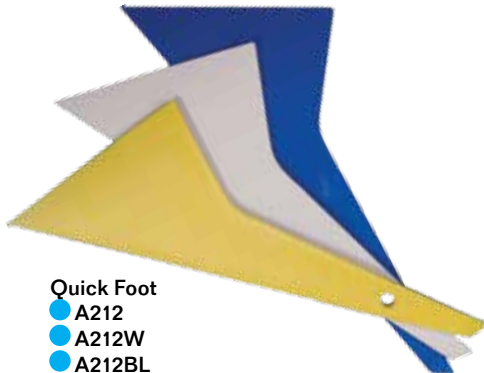
**Quick Foot**

● **A212**
● **A212W**
● **A212BL**

9.5" overall length for those hard-to-reach installations. An economical tool that will help you reach those difficult spots that drive you crazy.

(Yellow)
(White)
(Blue)

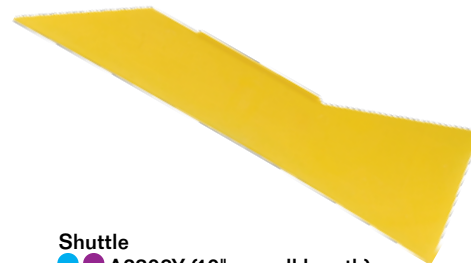
**Shuttle**

● **A2308Y (10" overall length)**

Get behind tight window gaskets or pesky third brake lights.

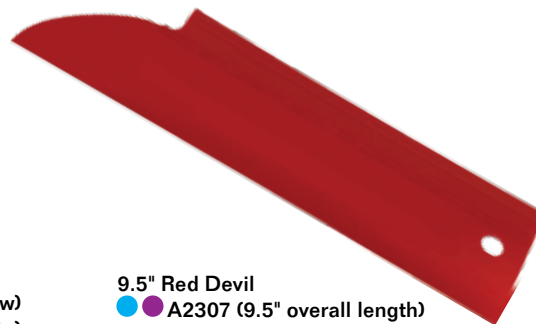
**9.5" Red Devil**

● **A2307 (9.5" overall length)**

Very thin for getting behind those real tight third brake lights when nothing else will.



4" Smoke Squeegee
●● A2504



3" Clear Squeegee
●● A2503

Spehar Squeegee Family

Malleable polyurethane squeegees for truly custom tools. With a heat gun, you can easily shape the squeegee material to create the perfect tool for your needs.



White Knight
●● A2310 (6" edge)

One of the stiffest hard cards available. Narrow handle fits in your hand while allowing you to reach into corners.



5-WAY TOOLS
Use as a trim guide or wrapped in a paper towel to use it as a "bump tool" to get water out.
10" wide edge.

Grey 5-Way Tool
(Thickest, most flexible)
●● A1801

Black 5-Way Tool
(Hardest)
●● A1802

White 5-Way Tool
(Thinnest)
●● A2400



12" White with Black Rubber Edge
●● A2306L



6" White with Black Rubber Edge
●● A2306

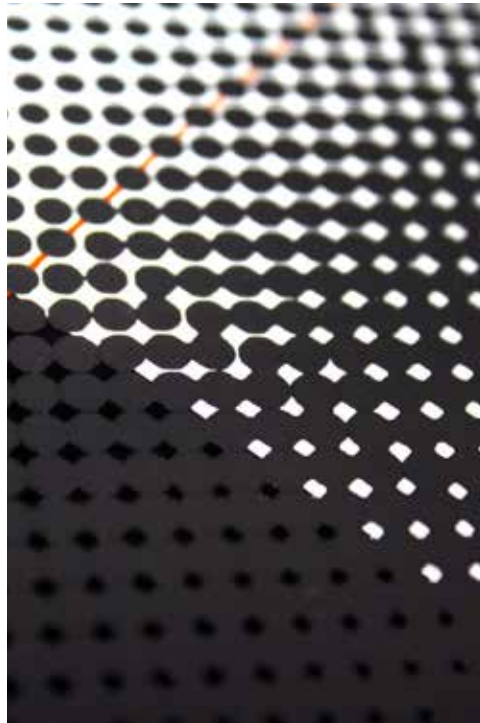

Dotrix (16"x 50' roll)
● A1003-162

A thin black vinyl designed to bond to the matrix areas of rear windows. Enough material to cover the matrix areas on up to 15-20 cars.

Red Window Film Tape

● A1170 (3/8" x 60' roll)

For safely re-taping rolls of film without leaving an adhesive residue. Works well to assist in removing release liner from film.



Window Switch Tape

● A1169 (1000 count roll)

Place a reminder on each window switch to help your customers remember to let the film cure. One saved re-do pays for the whole roll.



Felt Window Guide Tape (50' roll)

● A1171FG Black Felt Flock

Prevents scratching of film from hard window guides. The fully weatherable tape offers long lasting protection.



Gray Window Trim Tape

● A2507

Water resistant masking tape. Apply on felt around auto windows for cleaner installations. Strong adhesive, leaves no residue when removed.



Black-Out Tape (150' roll)

- A2501 .5"
- A2502 1"
- A2508 1.5"

Equalizer Handle

●● A1401

Extra leverage to prevent hand fatigue. The Equalizer Handle will not work with other brands of push sticks.



Equalizer Push Stick A.K.A. "The Bone"

●● A2303E

Push gaskets down to get the film tucked behind the gaskets.



Push Stick

●● A2303 (8" Long)

Inexpensive, easy to use tool, designed to help tuck film behind gaskets on auto doors.



Hook Pulling Tool

●● A2304

Essential tool for pulling rubber gaskets back into place on vehicle doors.



Hard Card Sharpening Tool

●●●●● A2805

Clean rough edges and nicks that hard cards develop over time. Give hard cards a longer life.

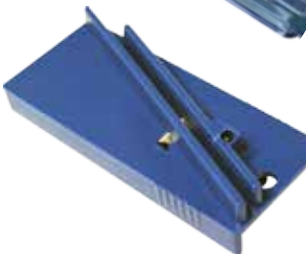

●● Big Foot

A2404

15" overall length for those hard-to-reach back window installations. Soft rubber handle provides non-slip grip.



Slim Foot

●● A2401

Big Foot's thinner, stiffer cousin. Narrower design at the neck to fit in tight spots.

The Edge

●● A2400E

Gasket tool for tinters on a budget. Handheld tool allows you to pull back gaskets for easier film installation. 10" wide edge. Also for use as a flat glass trim guide



Smooth-It

A110

A110-3B (Medium Grit Black Replacment)

A110-3G (Fine Grit Grey Replacement)

Maintain the edge on your tools so they last longer. It is recommended to replace the fabric every two or three months.



Steamers & Sprayers

Steamers are an efficient and effective way to remove window film from rear windows, and are essential tools for paint protection film installations.



Wagner 915 Portable On-Demand Steamer
 ● J-915

This is the essential tool for the installation of paint protection film. Steam is delivered at a reduced temperature so it doesn't harm the film or the installer like is possible with conventional steamers.



Steamblade

● J4000W

Jiffy® Steamer's most powerful commercial model.

- Made in the USA
- Over 1.5 hours of steam per filling
- 1500 watt heating element



Jiffy Professional Steamer

● J2W

● J2WRB Steamer Replacement Bottle (new style)

● J2WRBO Steamer Replacement Bottle (old style)

● J2WRH Steamer Replacement Hose 7.5'

This unit incorporates many of the same components found in our commercial grade steamer. Features a 7.5' hose.

- Quick 2-minute heat-up time
- 1300 watt heating element die cast in solid brass
- Impact resistant 1-gallon water reservoir
- Over 2 hours of steam per filling
- Made in the USA



A1105



A1208



A1103

Stainless Steel Pressurized Sprayer
● A1103 New 3 Gallon Tank
● A1103H 15' Hose

● A1105 New 5 Gallon Tank
● A1105H 25' Hose

Performax 3 Gallon Pump Sprayer

● A1208
● A1208P Replacement Pump Assembly
● A1208S Sprayer Siphon Tube
16' flexible kink resistant hose and utilizes the B231 adjustable fan nozzle.

Steamers & Sprayers



A1205



A1211I



A1211



A1305



A1304



A1307



A1308



A1308-300



B406



B406T



A1307T

Poly II 2.5 Liter Sprayer
Performax 48 oz. Hand Sprayer

- A1205
- A1211

Impact 2 Quart Sprayer

- A1211I
- A1211IR
- A1211ILN

complete sprayer
rebuild kit
long nozzle

32 oz. Spraymaster

Chemically resistant with a high output adjustable sprayer. 5-year guarantee.

- A1307

Mercury Pro+ Sprayer

Sprays twice for each squeeze of the trigger. Twice as much fluid with less hand fatigue.

- A1308

Mercury Pro+ 300 Sprayer

New 360° feature allows continual spray at angles, sideways or even upside down.

- A1308-300

Trigger Sprayer Head

Fits A1304 & A1305.

- B406

Trigger Sprayer Head

A larger, ergonomic trigger. Fits A1304 & A1305.

- B406T

Spraymaster Spray Nozzle

Fits A1304, A1305, A1307

- A1307T

Sprayer Bottles

- A1304 (16 oz. bottle)
- A1305 (32 oz. bottle)



3 and 5 Gallon Stainless Steel Pressurized Sprayer Nozzle
 ● **A1105N**
 Fits 1/4" hose.



3 Gallon Sprayer Body Complete
 ● **B231**
 Palm triggered sprayer body with filter. Fits most sprayers with a hose.



Poly Shut-Off Valve
 ● **A1212**
 Polyethylene shut off valve assembly for use on any sprayer with a hose. Requires A1212N. Fits 3/8" hose.

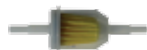

In Line Filter
 ● **A1213**
 Use in-line with any pressurized sprayer with a hose.



Poly Shut-Off Nozzle
 ● **A1212N**
 Compression sprayer poly shut-off nozzle.



Pump Dispenser For Dirt-Off
 ● **M1133P**
Pump Dispenser For Film-On
 ● **M1135P**
 Pump dispensers for Dirt-Off and Film-On. Makes measuring much easier and much more accurate.



Brass Adjustable Nozzle
 ● **A1100BN**
 ● **A1100BAN**
 ● **A1100BHS**
 ● **A1100ILS**
 ● **A1100TL**
 Replacement Nozzle
 Brass Hose Swivel
 Inline Strainers/100 Mesh
 Pressurized Tank Replacement Lid
 More durable than plastic nozzles for stainless tanks.

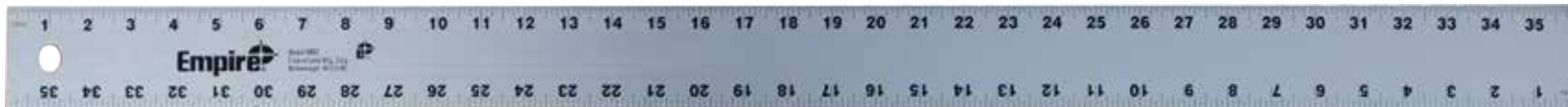

Straight Edge Ruler

- A1872 72"
- A1860 60"
- A1848 48"

Oversized item, additional shipping charges may apply.

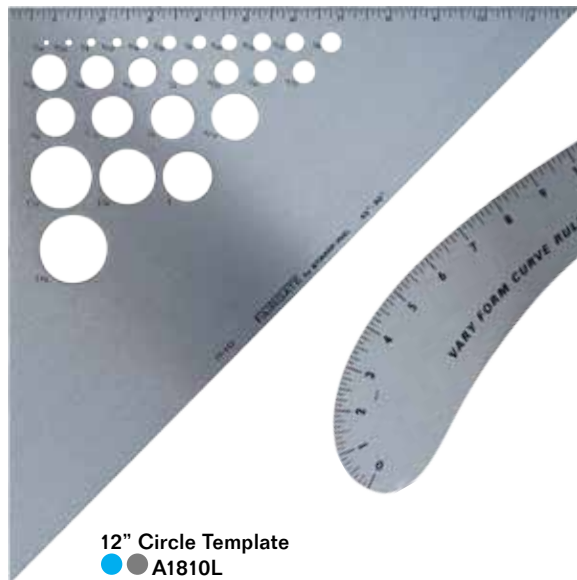

12" Circle Template
● ● A1810L

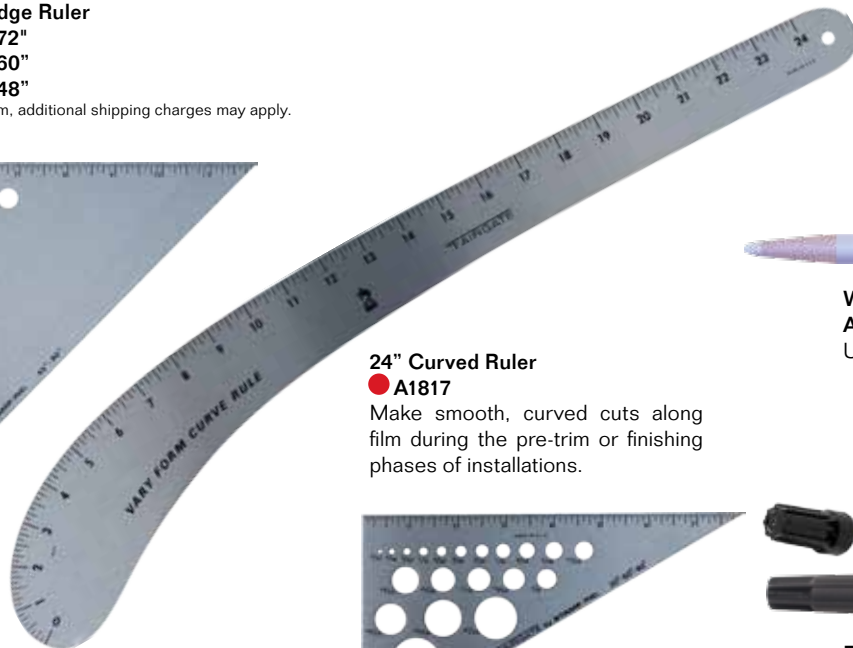

24" Curved Ruler

- A1817

Make smooth, curved cuts along film during the pre-trim or finishing phases of installations.

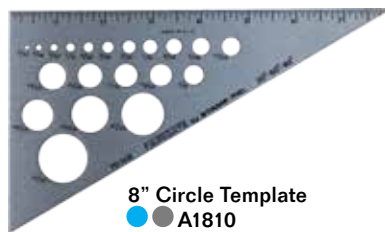

8" Circle Template
● ● A1810



White China Marker
A2500WH

Used for making templates on cars.



Film Markers
A2500WT
A2500FT

Wide Tip
Fine Tip

Great helpers for covering up small light gaps.

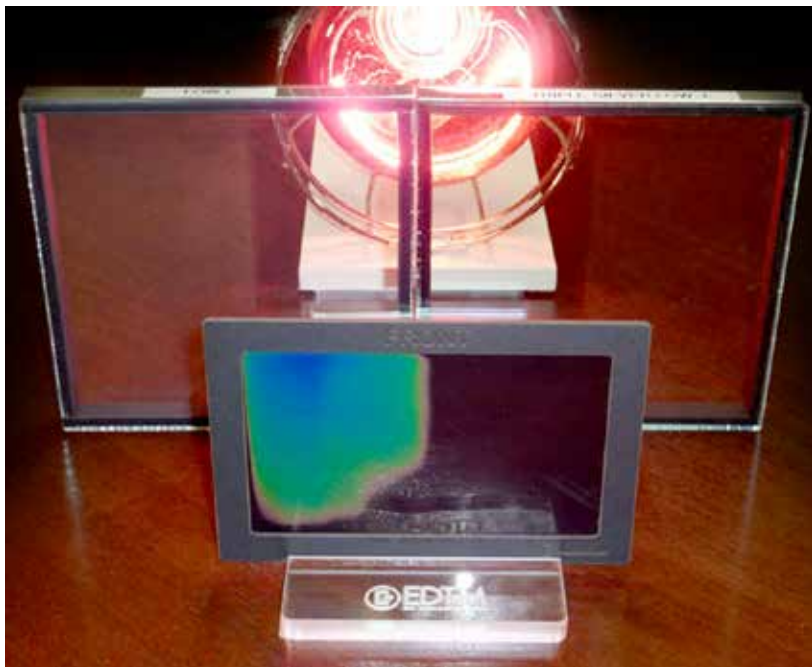

Heat Sheet Temperature Card

●● MTR-HS2050

Heat sensitive demo card changes color when it is exposed to heat. Reusable.

Acrylic Stand for Heat Sheet

● MTR-HS2052

4" x 2" base that holds the Heat Sheet in front of your heat lamp and glass samples.



Film Demonstration Lamp

● MTR-HL1040 (Lamp and Bulb)

● MTR-HL1045 (Extra Bulb)



Raytek Non-Contact Thermometer

● MTR-L1340 with laser pointer

Digital non-contact thermometers help demonstrate the need for high performance window films. Measure the extreme temperature of furnishings near a window to illustrate the poor window performance without film. Includes a laser pointer.

Non Contact Thermometer

● MTR-MT1575 with laser pointer

An extremely effective and convincing sales tool. Easily switches to display in either Celsius or Fahrenheit. Includes a laser pointer.



Meters

44TOOLS



Digital BTU Solar Power Meter
 ● MTR-SP1065

Impress your customer by showing them how well your product can reduce the heat of solar energy that will enter their home. When used with our Glass and Film Sales Demonstration Lamp, you can perform effective indoor demonstrations for your customer. High performance window films are extremely dynamic in this demonstration.



Solar Power & Transmission Meter
 ● MTR-SP2065

Powerful sales aid for demonstrating the solar performance of windows and film. In addition to the benefits of the Solar Power Meter, this meter can measure actual solar transmission percentages. Works directly with the sun or with the Glass & Film Sales Demonstration Lamp. Helps you sell your customers up to high-end products.



UV Transmission Meter
 ● MTR-UV1265

This meter is designed specifically for sales demonstrations. Show your customers how well your product blocks the damaging UV rays of the sun. When used with the UV Demonstration Lamp, you can conduct simple sales presentations safely indoors in front of your customer.



ETEKT+ Low E Coating Detector
 ● MTR-AE1601

The industry standard for detecting the invisible Low E coatings sealed inside windows as well as on single pieces of glass. Identify if a coating exists on surface 1, 2 or 3, and also identify windows with no Low E coatings (clear glass). This rugged portable device is powered by a 9 volt alkaline battery (included).

Basic Infrared Camera Sales Tool Kit

● SK1930

This kit helps close sales on a whole new level. Bring the energy performance of your product to life by setting up a powerful sales demonstration that allows your customer to see the actual heat transfer as it is taking place. The kit comes standard with the VT04A Infrared Camera Sales Tool, as well as the HL1040 Heat Lamp, HS2056 Acrylic Demonstration Base, and a set of either Architectural (#LT1910) or Automotive (#LT1915) LIFETILES.

*Glass set is not included in this kit.

Enhanced Infrared Camera Sales Tool Kit

● SK1940

This kit includes a GS1333 Glass Sample Set and a SP2065 Solar Transmission and BTU Power Meter with SP2075 stand. The kit also includes our HS2050 Heat-Sheet Temperature Demonstration Cards that help illustrate heat transfer.

Infrared Camera Sales Tool

● VT04A

Make the most convincing sales demonstration possible in front of your customer by showing them actual infrared images of your product in action! Your customer can see the actual heat that is (or is not) transmitting through your product. The vibrant, full color display of the VT04A sales tool camera brings the performance to life by allowing you to show comparisons against lesser-performing products.





Tint-Chek 2800
● MTR-TC2800

Measures the Visible Light Transmission on any film or glass up to .25" thick.



Tint-Chek 1800
● MTR-TC1800

Measures the Visible Light Transmission on any film or glass up to .25" thick. Backlit display for easy viewing in low light.



Spectrum Detective Premier Sales Kit

● MTR-SK1540

- SD2400 Energy transmission meter
- RAYMT4 Temperature gun with laser pointer
- HL 1040 Infrared heat lamp
- GSI 331 Glass and IG sample kit
- Soft-shell black canvas case



Glass-Check Pro
 ● MTR-GC3000

Measure glass, air space and overall IG thickness of triple pane windows. Capable of locating a Low E coating on a double pane window from a single side.



The Inspector II
 ● MTR-LL1000

Two-piece design, to work on any glass. A suction cup holds one side in place for hard to reach windows, and magnets hold both sides together for an accurate reading. Suited for inspection stations, where multiple windows are checked.



MIG Manual IG Thickness Gauge
 ● MTR-MG1500

Measures the thickness of glass and air spaces of assembled and installed windows. Handy for measuring triple-glazed windows and laminated glass. With a little training, it can be used to determine the presence of reflective coatings such as soft-coat Low E, mirrored surfaces, and even self-clean coatings.

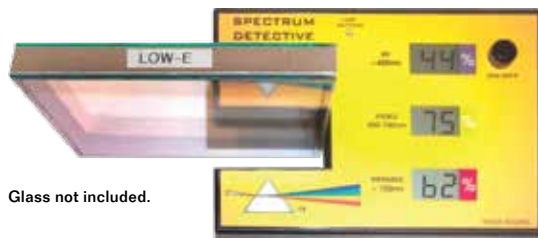

Glass not included.

Spectrum Detective
 ● MTR-SD2400

Simultaneously displays UV, Visible and Infrared transmission values. No additional light sources or power cords necessary, no adjustments with this self-contained unit. Slide the glass sample into the opening and watch the results appear on the display.

Glass & IG Sample Set
 ● MTR-GS1331

Includes: two clear single panes of glass, two clear IG windows and two Low E IG windows. The glass standards can be used to demonstrate solar and UV transmission performance.

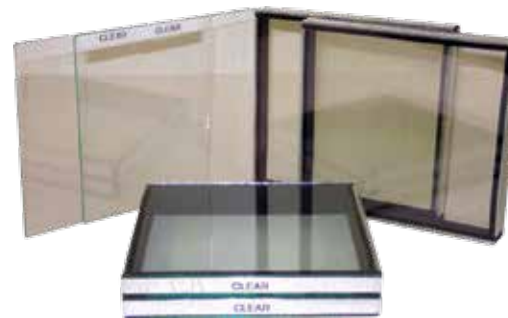



Strengthened Glass Detector

● MTR-SG2700

This detector will alert you to when glass has been strengthened. It can detect on single or multiple panes of glass. The unit is powered by a 9-volt battery and has a helpful auto power down feature.



Soft-Shell Case

● MTR-CC1231

This empty case is available so you can put together your own personalized sales kit.



UV Demonstration Lamp

● MTR-UV1390

● MTR-UV1291

(Extra Bulb)

Conduct dynamic sales presentations indoors for your customers. The lamp is battery operated (4 AA-included) and outputs true UV energy centered at 365nm.

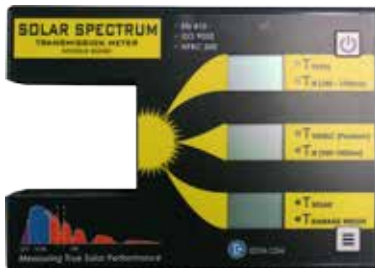

Solar Spectrum Transmission Meter

● MTR-SS2450



Plexi-Glass Auto Tint Display

● MTR-APD

Lightweight clear Plexi-glass display. Apply four or five different color swatches to show different VLT shades that you offer. Give one to each of your car dealerships so they can show and more effectively sell your films.



Become an Aquapel® Glass Treatment Installer

Aquapel is a long-lasting glass treatment that improves safety and visibility. Designed for professional windshields, side windows, rear windows, glass mirrors, or any other glass surface.



A terrific add-on item: Easy to apply and keeps customers coming back for more



- Remarkably improves vision in the rain
- Causes rain to bead up and roll right off
- Makes it easier to clear ice, snow and even dirt and bugs
- Reduces glare in the rain, especially at night
- Lasts for months in normal driving conditions



AQUAPEL APPLICATIONS

Aquapel Pro Kit

● 98994 (24 applications)

Aquapel Pre-Cleaner Towelettes

98994CT

Properly clean glass assures a long lasting glass treatment.

Aquapel Single Application

98994R

For the do-it-yourself customer (package shown).

AQUAPEL SALES TOOLS

Sales Brochure (English, Spanish or French)

98994B-ENG

(Pack of 25)

98994B-FRN

(Pack of 25)

98994B-SPN

(Pack of 25)

Demonstrational Shaker Bottle

98994SB

A simple demonstration tool to help promote Aquapel sales.



Chemical & Cleaning

44TOOLS

Chemical & Cleaning



Film-On Concentrate

● M1135 (1 qt)
Concentrated pure mounting solution designed specifically for film. Will not degrade adhesive like citrus base liquid soaps.

Dirt-Off w/X-100 Concentrate

● ● M1133 (1 qt)
Concentrated cleaning solution used before film application. Mounting solution for CDF adhesive films (excluding bronze and Low-E).

Dot Devil

● M2757 (1 qt)
Cleaning agent formulated to chemically soften matrix areas to aid in preparation of film.



ATR Adhesive Solution

● M2727 (32 oz)
● M2728 (1 gal)
The most powerful adhesive remover in its class. Dissolves adhesive on contact.

Performax Glass Cleaner

● M2748 (19 oz)
Ammonia-free foaming glass cleaner for shop use or retail. Safe for all window films.



NOTE:
Chemicals and aerosols may have shipping restrictions. Please call for details.

Performax Installation Gel

● M1130 (1 gal)
Premixed paint protection installation aid for professional paint protection installers.

TintSlime

● M1134 (1 gal)
The ultimate slip solution for window film installations. Eco-friendly, biodegradable, and tint-safe. Developed for tinters, by tinters.



X-100 Concentrate

● M2715 (1 gal)
Slip agent for CDF adhesive films (excluding bronze and Low-E).

Simple Pink Adhesive Remover

● M2725 (1 gal)
Popular, pink adhesive remover. Effective for most adhesive removal situations.

**Rapid Clear
M2737 (32 ounce)**

Silicone polish safe for window film and leaves it looking brand new.

**Slip Up Concentrate
M2756 (1 gallon)**

Cleaning and installation are a snap with this slip agent.

**Silicone Polish
M2750 (1 gallon)**

Window film safe silicone polish.

**Rapid Prep
● M2758**

125 oz Jug

**Rapid Remover
● M2738 (32 oz)
● M2734 (1 gal)**

Rapid Remover is a fast acting adhesive remover that works in sixty seconds and requires no scraping.



NOTE:

Chemicals and aerosols may have shipping restrictions. Please call for details.

Chemical & Cleaning

**Tint-Off**

● ● ● M2751 (1 qt)

Safe, non-toxic window film remover.

**Tint-Off**

● ● ● M2751G (1 gallon)

Safe, non-toxic window film remover.

**Performax Application Gel**

● M1130

Rapid Tac II

● M2736 (30 oz)

● M2735 (128 oz)

Adhesive promoter designed to help film lay down on dot matrix. Also great on vinyl.

**Rapid Clear**

● M2737 (32 ounce)

Silicone polish safe for window film and leaves it looking brand new.



USES: ● ALL ● AUTO ● FLAT ● PPF ● VINYL ● HOBBY/UTILITY/SAFETY

Custom Label Glass Cleaner Program

● M2747 (20 Cases: 240 19 oz cans)

Put your name on the can and money in your wallet! Show your professionalism by offering your customers this high quality window tint safe glass cleaner. Your company name and logo can be in the hands of every one of your customers.

GREAT ADD-ON SALES

Tell your customers this is what they need to use to clean their tinted windows safely. Double or triple your money on every can.

SUPER GIVEAWAY ITEM

Instead of dropping your prices, offer a can for free (\$5.99 value) with every job or upgrade.

REPEAT CUSTOMERS

A reason for your customers to come back to your shop.

YOUR NEW BUSINESS CARD

Give good prospects a can instead of a business card. Customers are more likely to keep something that they can use and do business with someone who gives them something for free!

Minimum order 20 cases of 12 (240 cans total). Typical lead time on the first order is 3-4 weeks. Subsequent orders ship in approximately 10 days. Please call for details. This product is available in smaller quantities by ordering the Performax glass cleaner (part # M2748).

PLEASE NOTE: This product is permitted to be shipped via ground services only.



Chemical & Cleaning

44TOOLS



B171B



B171R

Blue Scrub Pad

● B171B (3" x 5")

More aggressive than white.
*Will scratch glass.

Nylon Cleaning Sponge

● B171

Scrub pad on one side and sponge on the other.



B171W



B171G

White Scrub Pad (Glass Safe)

● B171W

White Scrub Pad (Glass Safe)

● B171T

Thicker than the white pad shown above.

Basic White Scrub Pad

● B171WB

Generic version of our B171W scrub pads. These basic pads are economical and safe on glass.



B171T



B171

Red Scrub Pad

● B171R

Very coarse pad for Dot Matrix prep ONLY!
*Will scratch glass.

Basic Thick White Scrub Pad

● B171TB

Similar to the B171T scrub pads. These basic pads are economical and safe on glass.



B171WB



B171TB

Grey Scrub Pad

● B171G

Very coarse pad for Dot Matrix prep ONLY!
*Will scratch glass.

Chore Boy Copper Scrub Pad

● CM24

For Dot Matrix prep ONLY!
*Will scratch glass.



CM24



Hi-Sheen Cleaner

● M2745 (19 ounce)

Safe, all-purpose glass cleaner and effective adhesive remover. NOTE: Do not use this to clean tinted windows.

Performax Glass Cleaner

● M2748 (19 oz)

Ammonia-free foaming glass cleaner for shop use or retail. Safe for all window films.



Standard Ultimate Cloth

●● B185

(13.5" x 15.5")

Bad Boy Ultimate Cloth

●● B186

(19.5" x 15.5")

Safe on an array of surfaces including but not limited to windows, window film, paint protection film (PPF), fiber glass, plexi-glass vinyl, paint, vehicles, and more.

**Speed Shine Microfiber Cloths**

●● GG-11231 (Set of 3)

Ultra thick to hold foreign objects deep in the nap so they're not dragged across paint.

Microfiber Polish Removal Cloths

●● GG-11115 (Set of 3)

16" x 16" wedge shaped, microfiber cloths lift and trap used polish away from paint.

Microfiber Wax Removal Cloths

●● GG-11116 (Set of 3)

Wedge shaped microfiber cloths lift and hold more wax than cotton, so you'll turn your cloth less often.

**Low Lint Continuous Roll Paper Towels**

●● B183

Try these economy paper towels instead of "linty" grocery store paper towels. These are virtually lint free, so they are great for tinting or detailing. Use with a dispenser as a center pull or just unroll from the outer edge.

**Super Prep Towel**

●● B184

A great high quality paper towel for window film installations. Absorbent and practically lint free. These durable towels are tough enough to reuse, yet still soft enough for cleaning windows.



Cooling Towel

● ED-6602

Stay cool in the hottest conditions. An advanced PVA material that stays damp without feeling heavy.

Cellucap Shoe Covers

● B2601 (50 Pair)

Make a great first impression when quoting a job. These covers keep you from making a mess and let potential clients know you're a professional and will respect their homes.



Kevlar Heat Forming Gloves

● B2602 (One Pair)

Protects hands from heat guns while shrinking back windows.



Handy Man's OVE Glove

● B2603 (One Glove)

For heat shrinking (temperatures of up to 540°F). Nomex and Kevlar with an 80% cotton liner. One-size-fits-all woven glove can be worn on either hand.



**Fender Gripper
FG44TOOLS**

Can also have your company logo (48 unit minimum).

48 Compartment
Tool Organizer
● ED-5840



Proflex Foam Kneeling Pad
● ED-385 (16"x 28" x 1")
Closed-cell, silicone-free foam.
Non-conductive, resistant to
petroleum and other chemicals.



Honeycomb Gel Knee Pads
● ED-357



25 Pocket Tool Roll Up
● ED-5870
Store and carry your tools in convenience.



Black Utility Waist Apron
● A3115LOGO Includes 44Tools.com logo
● A3115B Plain (no logo)
Two large pouches in the front for tool storage.
Loops on the end for hanging a spray bottle.



13 Pocket Waist Apron
● ED-5706
13 Pocket Waist Apron
● ED-5706C Custom Screen Print
A durable design and a quick release snap buckle
system, this apron provides years of tool storage.



A2305E



A2306E



A2305FH



A1478



A1478RBC



A4003



A1477

Door Upholstery Remover

●●● A1477

Large, comfortable handle.

GM Rear-View Mirror Remover

● A2305E

For mirrors held on by spring clip.

Ford Rear-View Mirror Remover

● A2306E

Easily remove mirrors from Ford products.

Spring-Latch Rear-View Mirror Remover

● A2305FH

For Ford and Honda products.

4.5" Heavy Duty Suction Cup

●●● A4003

Attach to outside of door glass and pull to create extra space between the gasket and the glass.

Gasket Wizard

● A1478

● A1478RBC Replacement bungees

Carefully pulls back rub rails for easy film-to-glass installation.



DETAILING

USES: ● ALL ● AUTO ● FLAT ● PPF ● VINYL ● HOBBY/UTILITY/SAFETY

menzerna



The Complete Solution for Detailing and Reconditioning

The MenzernaUSA system for the paint shop professional and detail reconditioning specialist employs the same polish technology that was developed for paint defect repair in the automotive coatings industry.

MenzernaUSA polishing compounds are the result of a close cooperation with Mercedes-Benz, and are optimized for today's paints, including scratch-resistant clear coat systems. These compounds effortlessly remove sanding scratches, swirl marks, haze, and micro-marring, producing a high gloss, hologram-free finish.

Visit 44Tools.com for the full line of MenzernaUSA products!



Wash & Wax

ROUG1001

Thick, rich suds gently lift dirt, leaving behind a layer of wax.

Dash & Surface Cleaner

ROUG1002

Remove dirt and dust. Leaves a great finish and fresh scent.

Wheel & Tire Cleaner

ROUG1003

Keep your rims and tires looking brand new!



Detailing

44TOOLS

Detailing



3" Glass Polishing Pads
● GG-10665 (set of 3)



6" Glass Polishing Pads
● GG-10614 (set of 3)



4" Red Wax Pad
● GG-11281 (set of 3)



4" Orange Correcting Pad
● GG-11266 (set of 3)



6.5" Orange Correcting Pad
● GG-10615



6.5" Red Wax Pad
● GG-10618



6" Random Orbital
● GG-10813

A polishing system that is safe for your paint and easy for you to achieve flawless results with minimal work. 850-watt motor with low-end torque for low speed polishing for better results.



6" Pad Holder
● GG-11204



Speed Shine

- ● GG-11146 (35 Ounce)
- ● GG-11148 (128 Ounce)

A fast, safe way to keep any painted surface clean and brilliant. Perfect for between-washes cleaner for vehicles. A quick mist and light toweling removes dust and other foreign residue and leaves behind a brilliant surface.



Paint Clay and Speed Shine Kit

- ● GG-11291



Spray on Wax

- ● ● ● GG-11098 (35 Ounce)

When used on a regular basis after each wash, extends the life of natural waxes and paint sealants. Apply it to cars right after washing and rinsing. Just spray on and wipe off while towel drying.

**Glass Polish**

● ● GG-11063 (8 Ounce)

Remove water spots and calcium deposits with Glass Polish and see what you've been missing!

Window Cleaner

● ● GG-11108 (35 Ounce)

Perfectly clean, haze-free glass. A simple thing that makes driving safe and fun, but not always easy to achieve. Perfectly clean windows also allow your windows to defrost much quicker.

Engine Bay Dressing

● ● GG-20244 (12.5 Ounce)

A surface enhancer and protectant for all materials and finishes inside your engine compartment. A single application restores the color and shine to a factory finish.

Micro Fiber & Foam Pad Cleaner

● ● GG-11078 (35 Ounce)

Increase the life and revitalize your micro fiber cloths and foam pads with this powerful cleaner.

Car Wash

● ● ● ● GG-11102 (16 Ounce)

● ● ● ● GG-11103 (128 Ounce)

The most important step in caring for your car's finish is a proper cleaning.

Spray-On Car Wash

● ● GG-11065 (35 oz)

● ● GG-11066 (128 oz)

Safely clean your car without water or a bucket! Wipe off to a deep shine. Clings to the side panels of your vehicle to break up road grime.

USES: ● ALL ● AUTO ● FLAT ● PPF ● VINYL ● HOBBY/UTILITY/SAFETY



Leather Rejuvenator

●● GG-11141 (8 oz)

Neglected leather can still be saved. Natural oils nourish deep fibers, restoring suppleness.

Leather Care

●● GG-11142 (16 oz)

●● GG-10994 (22 oz spray)

Penetrates deep to replenish the natural oils of your leather fibers. Essential for long life of your fine leather.

Plastic Polish

●● GG-11186 (8 oz)

Restore scratched plastic. For tail lights, headlight covers, instrument gauges, and convertible top windows.

Plastic Cleaner

●● GG-11185 (8 oz)

Most of today's interior trim is plastic. Also ideal for motorcycle windshields and turn signals.

Carpet Cleaner

●● GG-10997 (22 oz)

●● GG-11272 (1 gal)

Removes oil, grease, dirt, blood, wine, coffee stains.

**Wheel Cleaner**

●● GG-10970 (22 oz)

This wheel cleaner is made from premium biodegradable ingredients and is safe for all types of wheels.

Interior Cleaner

●● GG-10956 (22 oz)

No dyes or other chemicals to alter the color of the surface being cleaned. Oil, dirt and countless other products lift right up.

Heavy-Duty Wheel Cleaner

●● GG-10973 (22 oz)

Window Cleaner

●● GG-11108 (35 oz)

USES: ● ALL ● AUTO ● FLAT ● PPF ● VINYL ● HOBBY/UTILITY/SAFETY



Undercarriage Spray

- GG-10987 (22 oz)
- GG-11139 (128 oz)

Keep wheel wells looking brand new. For hiding dirty spots and discoloration between black parts, and enhancing chassis items.

Glass Cleaning Clay

- GG-11049 (3.5 Ounce)

Paint Cleaning Clay

- GG-11153 (8 Ounce)

Wheel Cleaning Clay

- GG-11035 (7 Ounce)

These clay products leaves behind an ultra-smooth surface to help wax adhere better and last longer. It also makes surfaces easier to buff out.

Best of Show Wax

●● GG-11171 (16 Ounce)

A non-silicone, carnauba-based liquid wax that produces incredible color, depth, and clarity with just one application.

Paint Sealant

●● GG-11088 (16 Ounce)

Provides all the protection needed, yet still provides a high gloss finish that only has to be applied once a year.

One Step Sealant

●● GG-11075 (16 Ounce)

All the benefits of our Paint Sealant with gentle polishes added to remove scratches, oxidation and swirl marks.

Spray-on Wax

●● GG-11084 (8 Ounce)



USES: ● ALL ● AUTO ● FLAT ● PPF ● VINYL ● HOBBY/UTILITY/SAFETY



Machine Polish

- GG-11161 1 (16 oz)
- GG-11162 2 (16 oz)
- GG-11163 3 (16 oz)
- GG-11091 4 (16 oz)

For random orbital machines with minimal friction and temperature on paint. These granules are engineered to break down under light pressure, getting smaller and smaller as you polish. Safe for removing swirl marks and scratches from painted surfaces.

Long Lasting Tire Dressing

- GG-11044 (16 oz)

Water-repellent tire dressing that lets you decide the finish: high gloss or satin. Looks great even after a rain storm or a good wheel cleaning.

Vinyl & Rubber Dressing

- GG-10981 (22 oz)

For tires that will pass the scrutiny of any concours judge. Superior when judged against all other rubber protectants.



Speed Shine Microfiber Cloths

● ● GG-11231 (Set of 3)

Ultra-thick to cushion paint and hold foreign objects deep in the nap so they're not dragged across the paint.

Microfiber Polish Removal Cloths

● ● GG-11115 (Set of 3)

Non-abrasive, 16" x 16" wedge shaped micro fibers lift and trap used polish away from paint.



Microfiber Wax Removal Cloths

● ● GG-11116 (Set of 3)

Non-abrasive, wedge shaped micro fibers. This lint-free cloth holds more wax than cotton, so you'll turn your cloth less often.

Microfiber Drying Towel

● ● ● ● GG-11117



Microfiber Window Cleaning Cloths

● ● GG-11096 (set of 4)



Well Wheel Brush

● ● GG-15502



Window Cleaner Set

● ● GG-90247

The long, comfortable gripping handle allows you to maneuver into even the tightest of areas. Can be used with an extension pole.



Scrub Brush for Tires

● ● GG-15540



Fender Gripper

FG44TOOLS

Can also have your company logo (48 unit minimum).



Black Utility Waist Apron

● **A3115LOGO**

● **A3115B**

Includes 44Tools.com logo

Plain (no logo)

Includes two large pouches in the front for tool storage along with loops on the end for hanging a spray bottle.



44Tools Tee Shirts

● **A3115TS**

● **A3115TM**

● **A3115TL**

● **A3115TXL**

● **A3115TXXL**

(Small)

(Medium)

(Large)

(X - Large)

(XX - Large)

Logo Items

44TOOLS

RETYLING SCHOOL

a whole new career field:
be a successful film installer and a successful business owner!

44TOOLSTM

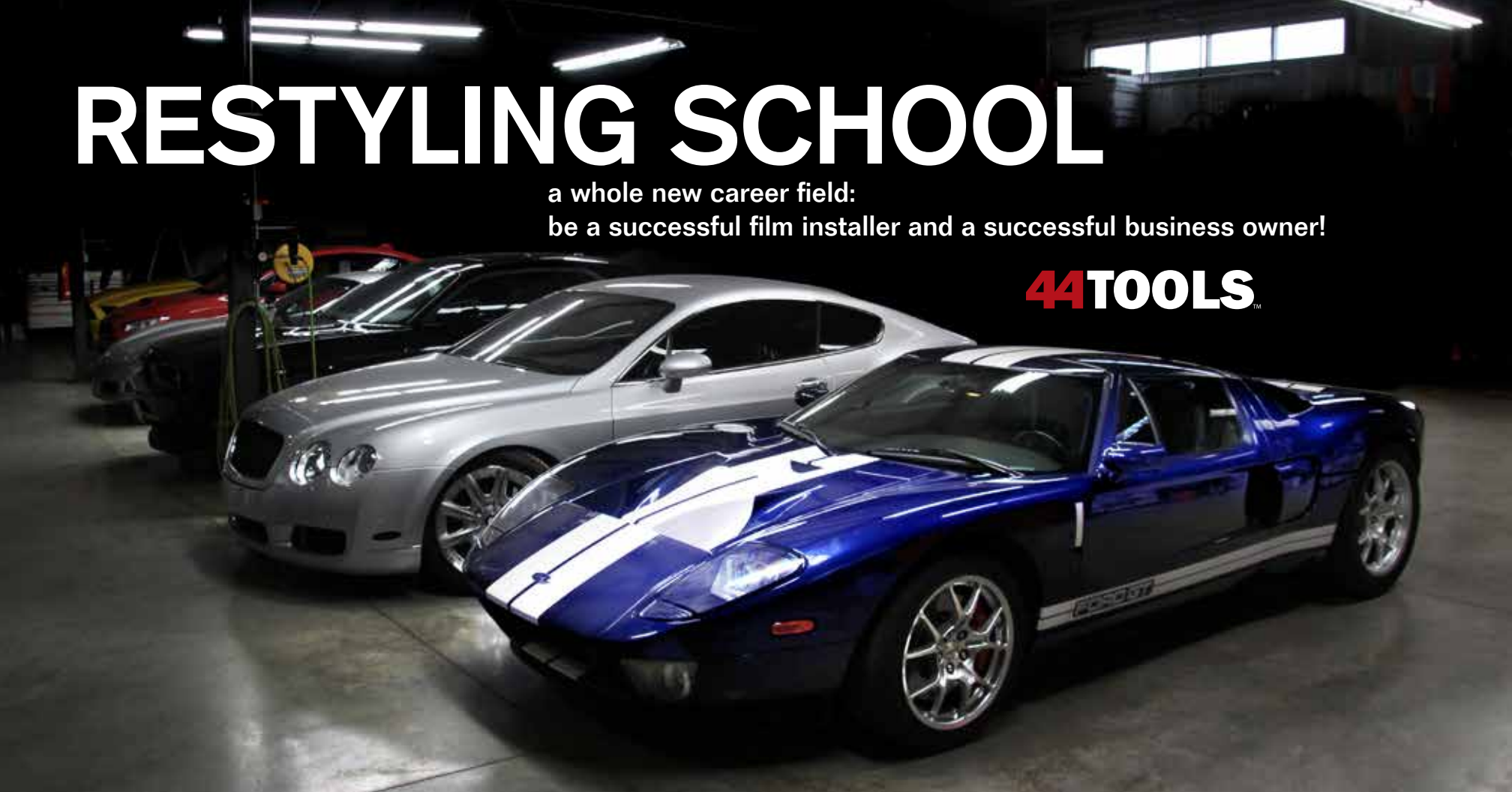



REStYLING SCHOOL

44TOOLS™



THE FILM IS ON US!

We provide all the film used in these classes, allowing you to build your speed and perfection on us. This is less expensive than trying to learn on your own.

Get extensive hands-on training in the use of one of our computerized film cutting plotters.

One, three, and five day courses available in Flat Glass Tinting, Safety and Security Film, Paint Protection Film, Automotive Window Tinting and Vinyl Wrapping. Our instructors will be right there to answer your questions.

Hands-on training will help you develop speed and perfection. We will have one of the nation's best in-tint graphics artists demonstrating how easy it is to use the plotter for custom looks and unbelievable profits.

Our new state-of-the-art facility includes classroom space for over 50 people, 6 training cars, extensive shop space, showroom and sales floor, as well as access to the largest in-house window film tool company.

- **Startup toolkit**
- **Hands-on training: less classroom**
- **Multiple training cars**
- **Learn from multiple instructors**
- **The best facilities in the industry**
- **Learn self promotion**
- **Help with setting up dealership**
- **Best dealer support in the industry**
- **Image appeal**
- **Technical support**
- **Continental breakfast and lunch**
- **Free tee shirt**
- **Hotel booking assistance**
- **Shuttle from hotel to class**

TOP OF THE LINE PAINT PROTECTION AND HEADLAMP PRODUCTS

Our paint protection offers superior value and high quality in today's confusing market. Couple a huge selection of high quality patterns with what we consider the best paint protection film in the world and a terrific warranty, you have a winning combination that can't be matched by any of our competitors!



Protection Products

Protect the leading edge of your customers' vehicles from rocks, gravel, salt or insects through the application of a thin and virtually invisible urethane film. This durable material has been used successfully for years by the military, various auto manufacturers, and NASCAR race teams in rock chip prone areas with incredible results. Products can be computer cut to ensure rapid and damage free installation.

Universal Headlight Kits

With the rising cost of replacement head lamps and fog lamps, it is nice to know that there is a product available to protect your car against the perils of the open road. Our Light Protection Products are made from a proprietary, scratch-resistant, urethane material coupled with strong optically clear adhesive. Designed for maximum durability, our light covers were originally tested under the harshest of circumstances with amazing results.

Door Edge Protection

Protect the door edges of your customers vehicles from chips and scratches with a protective strip. With easy to apply custom kits available in a variety of lengths, we have the right package available whether you have one, two or 100 cars to protect. If you have other areas you would like to protect, you can also order bulk material by the foot.

PAINT PROTECTION INSTALLATION TIPS

Reduce Your Learning Curve

Be sure to overlap strokes to avoid trapping air or solution under the material. Bubbles tend to form most often at curves and contours, so pay special attention in these areas.

Don't be afraid to stretch the material. The plastic is very resilient and can be stretched extensively without harming the kit. This stretching is imperative for proper fit, as our kits are designed to be stretched to reduce the amount of excess material near the edges of contoured surfaces.

The material may be gently pulled back up in areas if necessary to reposition the kit, or if you find that you have trapped dirt or air or an excessive amount of solution trapped under the material, as over time the solution will evaporate, making the spot unnoticeable. However, air must be removed.

Any attempt to pull the material back up must be done within 10 minutes of application, or excessive stretching will occur; check the kit often for bubbles. If you accidentally stretch the material too far, you may end up with the kit overlapping the edges of the panel.

If you are uncertain about any part of the installation, please contact us.

Installation Tools

Everything you need for a perfect installation is available in this catalog, or on our web site at 44Tools.com

44TOOLS™

Performance Tools Distributing
7640 Commerce Place
Plain City, Ohio 43064

866-448-6657 • 614-873-4899 fax
info@44tools.com

International Orders Welcome:
1-614-873-4800



44TOOLS™

7640 Commerce Place
Plain City, Ohio 43064

866-448-6657
614-873-4899 fax
info@44tools.com

International Orders Welcome:
1-614-873-4800

