



Surgical Instrument Catalog



Certified

WBENC



Women's Business Enterprise

A word about our founder, history and quality

The architect of this specialty catalog, Lou Wallace, is a pioneer in the specialty surgical instrument business. Over 50 years ago, Lou developed his first and second instrument catalogs as an executive with V.Mueller. Later, as President, CEO, and Cofounder of Specialty Surgical Instrumentation, Inc., (SSI) Lou maintained relationships with instrument master makers in Tuttlingen, Germany to insure quality and expertise. He developed the SSI Ultra Surgical Instrument Company which quickly became a leader in the industry. During his years at SSI, Lou developed three specialty instrument catalogs. He is also responsible for additional specialty surgical catalogs for general surgery, otolaryngology and laparoscopy, including a specialty catalog exclusively for Dr. Denton Cooley, Cardiovascular Surgeon, Texas Heart Institute.

On behalf of Lou Wallace, we want to dedicate this catalog to you-our customers. We hope that you will find this catalog thorough, easy to use and representative of the quality associated with the years of experience. We are now American Surgical Specialties Company and represent the same quality that has been passed on to us.

Many thanks for your loyalty over the years!

THE AMERICAN SURGICAL SPECIALTIES TEAM



Lou Wallace

Recommendation for Cleaning & Sterilizing American Surgical Stainless Steel Surgical Instruments

- 1.= Rinse instruments in demineralized water.
- 2.= Remove blood and debris with a soft brush and instrument detergent, being careful to open all instruments.
- 3.= Clean instruments in ultrasonic cleaner using the manufacturer's recommended cleaning solution.
- 4.= After cleaning, lubricate instruments using lubricant recommendations and follow manufacturer's guideline for use.
- 5.= Remove excess lubricant from instruments.
- 6.= Autoclave instruments.
- 7.= Make certain wrapped instrument packs are thoroughly dried to prevent corrosion from trapped moisture.
- 8.= Use each instrument only for its intended purpose.
- 9.= Clean autoclaves periodically to minimize the accumulation or residue.

Packing for Sterilization

American Surgical instruments should be placed in suitable packaging for the sterilization process (i.e., central supply wrap (CSR), autoclave bags, paper/Tyvek® pouches, sterilization trays, etc.) and sterilized prior to surgical use. It is important to properly clean all American Surgical instruments prior to sterilization.

Sterilization Recommendations

Table 1: Instrument Categories by Product Features

Device Type	Prevacuum Wrapped	Prevacuum Unwrapped	Gravity Wrapped	Gravity Unwrapped	EO	Chemical Disinfectant	Chemical Sterilant	Peracetic Acid ¹	Gas Plasma ²
Very Rough Surfaces	Yes	Yes	Yes	Yes	Yes	Yes	Yes	No	No
Sliding Hinges	Yes	Yes	Yes	Yes	Yes	Yes	Yes	No	No
Lever Hinges	Yes	Yes	Yes	Yes	Yes	Yes	Yes	No	No
Screw Pivot Hinges	Yes	Yes	Yes	Yes	Yes	Yes	Yes	No	No
Lumens	Yes	Yes	Yes	Yes	Yes	Yes	Yes	No	No
Cords or Cables	Yes	Yes	Yes	Yes	Yes	Yes	Yes	Yes	Yes
Sterilization Trays	Yes	Yes	Yes	Yes	Yes	Yes	Yes	No	No

A "No" indicates American Surgical does not currently have the data to support the recommendation of the specified method of sterilization for the given category. It does not necessarily indicate the inability of the cycle to effectively sterilize this category of device.

- Notes: (1) The peracetic acid cycle references the Steris® System 1 processor.
 (2) The gas plasma cycle references the Sterrad® Sterilization System.

Cycle Parameters (The following cycle parameters relate to Table 1).

Prevacuum Cycle (wrapped and unwrapped): 3 preconditioning pulses with a minimum exposure time of 4 minutes at 270°F (132°C).

Gravity Cycle (wrapped): 270°F (132°C) with a minimum exposure time of 15 minutes.

Gravity Cycle (unwrapped): 270°F (132°C) with a minimum exposure time of 10 minutes.

Ethylene Oxide Cycle:

Sterilant	Temperature	Humidity	Preconditioning	Concentration	Exposure
100% EO	131°F (55°C)	65-75%	1 hour	725 mg/l	120-360 minutes
Aerate a minimum of 12 hours at 131°F (55°C)					

Liquid Chemical Cycle:

Concentration of Glutaraldehyde	Temperature	Exposure for Disinfection	Exposure for Sterilization
2.4%	77°F (25°C)	45 minutes	10 hours

Returns – American Surgical Specialties Company’s surgical instruments can be returned for credit or exchange within 30 days after the date of shipment with prior approval of American Surgical’s general office and/or sales representative. Surgical instruments returned after 30 days but before 60 days will also be assessed a 25% restocking charge. After 90 days from shipping date surgical instruments cannot be returned for credit. Any surgical instrument that is a special order cannot be returned. The following information will be needed in order to return surgical instruments:

- = Catalog number
- = Quantity
- = PO number
- = American Surgical Invoice
- = Reason for return

-All surgical instruments returned in damaged condition or altered packaging will be subject to a refurbishing charge

-Instruments etched or engraved by a customer are not returnable for credit.

-Used or processed instruments are not returnable

-All returns are subject to American Surgical inspection and acceptance

Warranty – AMERICAN SURGICAL SPECIALTIES COMPANY’S products are warranted against defects in packaging, material and workmanship as a lifetime guarantee from the original purchase. No item may be returned without a Return Merchandise Authorization Number from our customer service department. Defective items will be repaired, replaced or refunded at our discretion. Damage caused by neglect, abuse, misuse, alteration of the product, or improper storage is not covered by this warranty.

All Warranty and Return matters should be sent to:

AMERICAN SURGICAL SPECIALTIES COMPANY
475 METROPLEX DR SUITE 401
NASHVILLE, TN 37211
866-387-7021

Amerisurg Surgical Instruments

Table of Contents

Care and Handling.....	X		
Warranty.....	XX		
Return Policy.....	XXX		
Scissors.....	PG 1-34, 110-111, 144-154 240-242, 263-265, 277, 344, 361-364, 431	Forceps/Scissors.....	PG 240-243, 263-276
Thumb Forceps.....	PG 35-53, 155-174, 430	Suture Passer/Knot Pusher.....	PG 281-282
Forceps.....	PG 54-63, 128, 130, 327-328	Cholangiogram Fcp.....	PG 284
Needle Holders.....	PG 64-71, 175-180, 279-280, 431	Uterine Instruments.....	PG 285-286
Retractors.....	PG 72-88, 127, 130-131, 134, 138-140	Retractor Systems.....	PG 288-291
Elevators.....	PG 89-96, 320-324	Storage Systems.....	PG 314-315
Suction.....	PG 97-98, 141, 304-310, 412, 422	Misc.....	PG 219-313
Rasps.....	PG 99-104, 340	Orthopedic.....	PG 316-355
ENT.....	PG 105-130	Elevators/Bone Hooks.....	PG 316-321
Sinus/Nasal.....	PG 107-110, 116	Bone Cutters/Rongeurs.....	PG 322-325
Middle Ear.....	PG 111-115	Retractors.....	PG 329-332
Curettes, Hooks, Picks.....	PG 118-123	Mallets.....	PG 333-334
Speculums.....	PG 117-118	Osteotomes/Chisels.....	PG 335-341
Laryngeal.....	PG 124-130	Hip Revision Instruments.....	PG 339-344
Breast/Plastic.....	PG 131-143	Pin Management.....	PG 346-350
Ophthalmology.....	PG 144-219	Misc.....	PG 351-355
Scissors.....	PG 144-154	Arthroscopy.....	PG 356-372
Thumb Forceps.....	PG 155-174	Spine.....	PG 373-434
Needle Holders.....	PG 175-180	Kerrisons.....	PG 373-378
Knives/Spatulas.....	PG 181-187	Rongeurs.....	PG 379-388
Cannulas.....	PG 188-196	Osteotomes/Elevators.....	PG 390-393
Hooks.....	PG 196-204	Curettes.....	PG 396-402
Speculums.....	PG 206-209	Distraction/Spreaders.....	PG 403-410
Misc.....	PG 210-219	Dissectors.....	PG 407-410
Laparoscopy.....	PG 220-315	Retractor and Systems.....	PG 411-429
Laparoscopes.....	PG 220-221	Bayonet Instruments.....	PG 430-433
Handles.....	PG 226-227	Misc Instruments.....	PG 435-437
One Piece Rotatable.....	PG 222-243		
Modular Rotatable.....	PG 244-266	Alphabetical Index	
Slidelock Series.....	PG 267-274	Numerical Index	
Dissectors/Graspers.....	PG 225-239, 248-262	Notes	
		Conversion Chart/Ruler	

SCISSORS



MAYO Scissors
Supercut

Item #	Description	Length
805-014	straight	5½" (14.0cm)
805-017	straight	6¾" (17.1cm)
805-023	straight	9" (22.9cm)
805-114	curved	5½" (14.0cm)
805-117	curved	6¾" (17.1cm)
805-123	curved	9" (22.9cm)



METZENBAUM Scissors
Supercut

Item #	Description	Length
803-214	straight	5¾" (14.6cm)
803-218	straight	7" (17.8cm)
803-314	curved	5¾" (14.6cm)
803-318	curved	7" (17.8cm)
803-323	curved	9" (22.9cm)



METZENBAUM-BABY Scissors
Supercut, Delicate

Item #	Description	Length
803-305	straight	4½" (11.4cm)
803-306	curved, delicate	4½" (11.4cm)



IRIS Scissors
Supercut

Item #	Description	Length
802-010	straight	4½" (11.4cm)
802-011	curved	4½" (11.4cm)

SCISSORS



JAMISON (REYNOLDS) Tenotomy Scissors
Supercut

Item #	Description	Length
806-714	curved	5½" (14.0cm)
806-716	curved	6¼" (15.9cm)
806-718	curved	7" (17.8cm)



PLASTIC Surgery Scissors
Supercut

Item #	Description	Length
802-612	straight	4¾" (12.1cm)
802-712	curved	4¾" (12.1cm)



STEVENS Tenotomy Scissors
Supercut

Item #	Description	Length
805-012	straight	4½" (11.4cm)
805-013	curved	4½" (11.4cm)



CASTANARES Face Lift Scissors
Supercut

Item #	Description	Length
803-016	straight	6¼" (15.9cm)

SCISSORS



GORNEY Face Lift Scissors
Supercut

Item #	Description	Length
804-618	straight	7½" (19.1cm)
804-718	curved	7½" (19.1cm)



GORNEY-FREEMAN Face Lift Scissors
Supercut

Item #	Description	Length
804-419	straight	7½" (19.1cm)
804-519	curved	7½" (19.1cm)



FREEMAN Face Lift Scissors
Supercut

Item #	Description	Length
804-518	curved	7" (17.8cm)



GORNEY Platysma Scissors
Supercut

Item #	Description	Length
804-623	straight	9" (22.9cm)
804-723	curved	9" (22.9cm)

SCISSORS



KAYE Face Lift Scissors
Supercut

Item #	Description	Length
804-815	curved	6" (15.2cm)
804-819	curved	7½" (19.1cm)



JOSEPH Nasal Scissors
Supercut

Item #	Description	Length
805-015	straight	5½" (14.0cm)
805-115	curved	5½" (14.0cm)



KAYE-FREEMAN Face Lift Scissors
Supercut

Item #	Description	Length
804-438	straight	7" (17.8cm)
804-538	curved	7" (17.8cm)



COTTLE Dorsal Scissors
Supercut

Item #	Description	Length
805-316	angled	6¼" (15.9cm)

SCISSORS



FOMON Dorsal Scissors
Supercut

Item #	Description	Length
805-313	angled	5½" (13.0cm)



PAR Scissors
Supercut, Delicate

Item #	Description	Length
802-180	straight	4½" (11.4cm)
802-185	curved	4½" (11.4cm)



FOMON Saber Back Scissors
Supercut

Item #	Description	Length
804-112	curved	5" (12.7cm)

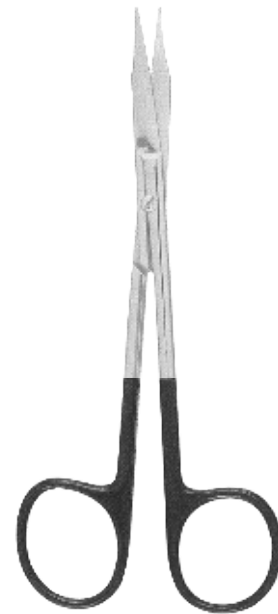

GOLDMAN-FOX Scissors
Supercut

Item #	Description	Length
804-013	curved	5" (12.7cm)

SCISSORS



JABALEY Scissors
Supercut

Item #	Description	Length
802-095	straight	4½" (11.4cm)
802-096	curved	4½" (11.4cm)



OPERATING Scissors
Tungsten Carbide

Item #	Description	Length
326-00	straight, sharp/blunt	5½" (14.0cm)
326-20	straight, sharp/sharp	5½" (14.0cm)
326-40	straight, blunt/blunt	5½" (14.0cm)
326-10	curved, sharp/blunt	5½" (14.0cm)
326-30	curved, sharp/sharp	5½" (14.0cm)
326-50	curved, blunt/blunt	5½" (14.0cm)



RAGNELL (KILNER) Scissors
Supercut

Item #	Description	Length
804-313	curved, flat and blunt tips	5½" (13.0cm)



MAYO Scissors
Tungsten Carbide

Item #	Description	Length
328-10	straight	5½" (14.0cm)
328-30	straight	6¾" (17.1cm)
328-70	straight	9" (22.9cm)
328-00	curved	5½" (14.0cm)
328-20	curved	6¾" (17.1cm)
328-60	curved	9" (22.9cm)

SCISSORS



METZENBAUM Scissors
Tungsten Carbide

Item #	Description	Length
327-20	straight	5¾" (14.6cm)
327-60	straight	7" (17.8cm)
327-95	straight	9" (22.9cm)
327-10	curved	5¾" (14.6cm)
327-50	curved	7" (17.8cm)
327-90	curved	9" (22.9cm)



METZENBAUM Scissors
Tungsten Carbide, Delicate

Item #	Description	Length
327-21	straight	5¾" (14.6cm)
327-61	straight	7" (17.8cm)
327-96	straight	9" (22.9cm)
327-11	curved	5¾" (14.6cm)
327-51	curved	7" (17.8cm)
327-91	curved	9" (22.9cm)



METZENBAUM Scissors
Tungsten Carbide, Sharp/Sharp Tips

Item #	Description	Length
327-22	straight	5¾" (14.6cm)
327-62	straight	7" (17.8cm)
327-97	straight	9" (22.9cm)
327-12	curved	5¾" (14.6cm)
327-52	curved	7" (17.8cm)
327-92	curved	9" (22.9cm)



METZENBAUM Scissors
Tungsten Carbide, Serrated

Item #	Description	Length
326-80	straight	5¾" (14.6cm)
327-74	straight	7" (17.8cm)
326-88	straight	9" (22.9cm)
326-79	curved	5¾" (14.6cm)
326-77	curved	7" (17.8cm)
326-99	curved	9" (22.9cm)

SCISSORS



METZENBAUM Scissors
Tungsten Carbide, Delicate, Serrated

Item #	Description	Length
326-78	curved	5¾" (14.6cm)
326-51	curved	7" (17.8cm)
326-81	curved	9" (22.9cm)



IRIS Scissors
Tungsten Carbide

Item #	Description	Length
327-06	straight	4½" (11.4cm)
327-05	curved	4½" (11.4cm)



NELSON METZENBAUM Scissors
Tungsten Carbide

Item #	Description	Length
328-80	curved	11" (27.9cm)
328-82	curved	12" (30.5cm)



IRIS Scissors
Tungsten Carbide, Serrated

Item #	Description	Length
326-75	curved	4½" (11.4cm)
326-76	straight	4½" (11.4cm)

SCISSORS



STRABISMUS Scissors
Tungsten Carbide

Item #	Description	Length
327-01	straight	4½" (11.4cm)
327-00	curved	4½" (11.4cm)



PAR Scissors
Tungsten Carbide, Delicate

Item #	Description	Length
329-30	curved	4½" (11.4cm)
329-31	curved	5¼" (14.6cm)



STEVENS Tenotomy Scissors
Tungsten Carbide

Item #	Description	Length
327-08	straight	4½" (11.4cm)
327-09	curved	4½" (11.4cm)



GREENBERG PAR Scissors
Tungsten Carbide, Serrated

Item #	Description	Length
321-36	curved	4½" (11.4cm)

SCISSORS



REES Face Lift Scissors
Tungsten Carbide, Serrated

Item #	Description	Length
325-66	straight	6½" (16.5cm)
325-76	curved	6½" (16.5cm)
325-78	curved	8" (20.3cm)



KAYE Face Lift Scissors
Tungsten Carbide, Serrated

Item #	Description	Length
326-90	curved	4½" (11.4cm)
326-98	curved	5¼" (14.6cm)
326-97	curved	7½" (19.1cm)



DAVIS Face Lift Scissors
Tungsten Carbide, Serrated

Item #	Description	Length
325-43	curved, sharp	7" (17.8cm)



KAYE-FREEMAN Face Lift Scissors
Tungsten Carbide, Serrated

Item #	Description	Length
325-53	curved	7" (17.8cm)

SCISSORS



GORNEY Face Lift Scissors
Tungsten Carbide, Serrated

Item #	Description	Length
325-61	straight	7½" (19.1cm)
325-62	straight	9" (22.9cm)
325-71	curved	7½" (19.1cm)
325-72	curved	9" (22.9cm)



FREEMAN Face Lift Scissors
Tungsten Carbide, Serrated

Item #	Description	Length
325-51	curved	7" (17.8cm)



GORNEY-FREEMAN Face Lift Scissors
Tungsten Carbide, Serrated

Item #	Description	Length
325-41	straight	7½" (19.1cm)
325-51	curved	7½" (19.1cm)



KNIGHT Nasal Scissors
Tungsten Carbide, Serrated

Item #	Description	Length
322-83	angled	6¾" (17.1cm)

SCISSORS



FOMON Dorsal Scissors
Tungsten Carbide, Serrated

Item #	Description	Length
325-72	angled	5½" (13.0cm)



PECK-JOSEPH Scissors
Tungsten Carbide, Serrated, Semi-Sharp

Item #	Description	Length
325-17	straight	5½" (14.0cm)
325-18	curved	5½" (14.0cm)



COTTLE Dorsal Scissors
Tungsten Carbide, Serrated

Item #	Description	Length
325-83	angled	6¼" (15.9cm)



RAGNELL (KILNER) Scissors
Tungsten Carbide, Serrated

Item #	Description	Length
321-36	curved, flat tips	5½" (13.0cm)

SCISSORS



GIUNTA Nasal Scissors
Tungsten Carbide, Serrated

Item #	Description	Length
329-43	double angle	5¼" (13.3cm)



KELLY Scissors
Tungsten Carbide

Item #	Description	Length
325-41	straight	6¼" (15.9cm)
325-51	curved	6½" (16.5cm)



GOLDMAN-FOX Scissors
Tungsten Carbide, Serrated

Item #	Description	Length
329-40	curved, fine tips	5" (12.7cm)
329-41	straight, fine tips	5" (12.7cm)



WIRE Cutting Scissors
Tungsten Carbide, Serrated

Item #	Description	Length
329-00	angled to side	4¾" (12.1cm)

SCISSORS

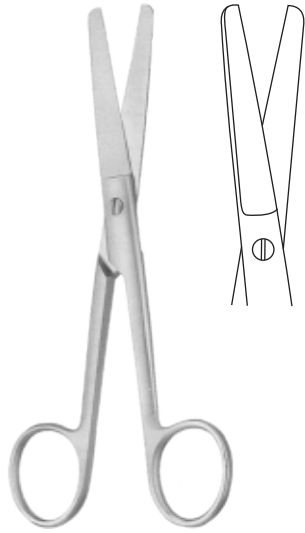

OPERATING Scissors
Blunt/Blunt

Item #	Description	Length
030-211	straight	4½" (11.4cm)
030-214	straight	5¾" (14.6cm)
030-215	straight	6" (15.2cm)
030-216	straight	6½" (16.5cm)
030-314	curved	5¾" (14.6cm)

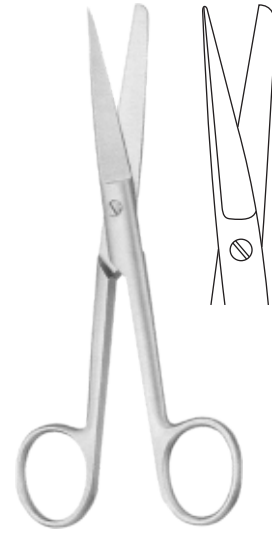

OPERATING Scissors
Sharp/Blunt

Item #	Description	Length
030-611	straight	4½" (11.4cm)
030-613	straight	5" (12.7cm)
030-614	straight	5¾" (14.6cm)
030-615	straight	6" (15.2cm)
030-616	straight	6½" (16.5cm)

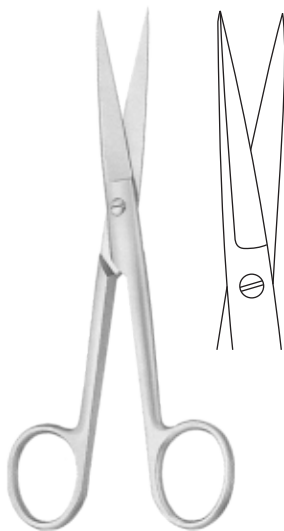

OPERATING Scissors
Sharp/Sharp

Item #	Description	Length
030-411	straight	4½" (11.4cm)
030-413	straight	5" (12.7cm)
030-414	straight	5¾" (14.6cm)
030-415	straight	6" (15.2cm)
030-511	curved	4½" (11.4cm)
030-513	curved	5" (12.7cm)
030-514	curved	5¾" (14.6cm)
030-515	curved	6" (15.2cm)
030-516	curved	6½" (16.5cm)

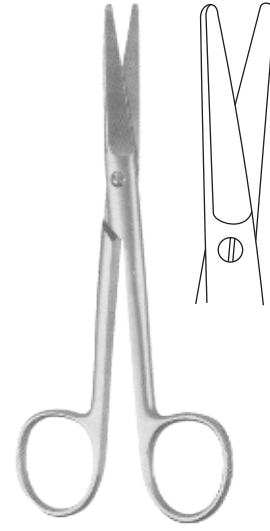

MAYO Scissors
Standard, Beveled Blades

Item #	Description	Length
035-014	straight	5½" (14.0cm)
035-017	straight	6¾" (17.1cm)
035-023	straight	9" (22.9cm)
035-114	curved	5½" (14.0cm)
035-117	curved	6¾" (17.1cm)
035-123	curved	9" (22.9cm)

SCISSORS

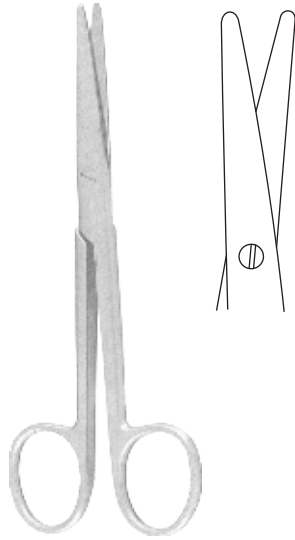

MAYO-STILLE Dissecting Scissors
Rounded Blades

Item #	Description	Length
035-615	straight	6" (15.2cm)
035-617	straight	6¾" (17.1cm)
035-715	curved	6" (15.2cm)
035-717	curved	6¾" (17.1cm)

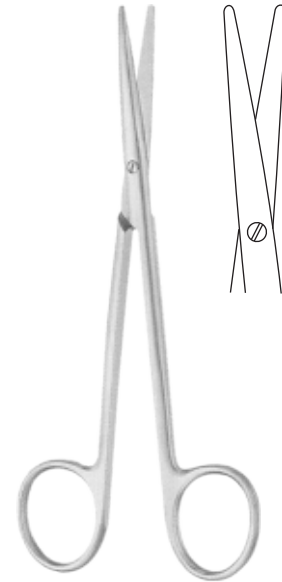

METZENBAUM Scissors

Item #	Description	Length
043-214	straight	5¼" (14.6cm)
043-218	straight	7" (17.8cm)
043-220	straight	8" (20.3cm)
043-223	straight	9" (22.9cm)
043-226	straight	10¼" (26.0cm)
043-314	curved	5¼" (14.6cm)
043-318	curved	7" (17.8cm)
043-320	curved	8" (20.3cm)
043-323	curved	9" (22.9cm)
043-328	curved (NELSON)	11" (27.9cm)

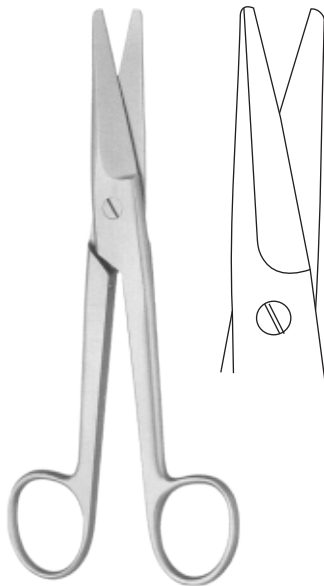

MAYO-NOBLE Dissecting Scissors
Beveled Blades

Item #	Description	Length
035-817	straight	6¾" (17.1cm)
035-917	curved	6¾" (17.1cm)

SCISSORS



METZENBAUM Scissors

Delicate, Slim Pattern

Item #	Description	Length
043-414	straight	5 ³ / ₄ " (14.6cm)
043-418	straight	7" (17.8cm)
043-420	straight	8" (20.3cm)
043-423	straight	9" (22.9cm)
043-514	curved	5 ³ / ₄ " (14.6cm)
043-518	curved	7" (17.8cm)
043-520	curved	8" (20.3cm)
043-523	curved	9" (22.9cm)



SIMS Scissors

Item #	Description	Length
033-420	straight, sharp/blunt	8" (20.3cm)
033-520	curved, sharp/blunt	8" (20.3cm)

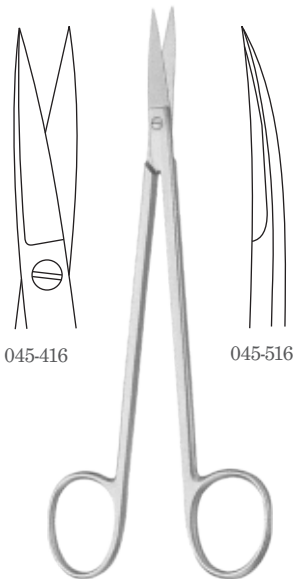

KELLY Scissors

Sharp/Sharp

Item #	Description	Length
045-416	straight	6 ¹ / ₄ " (15.9cm)
045-516	curved	6 ¹ / ₄ " (15.9cm)

SCISSORS

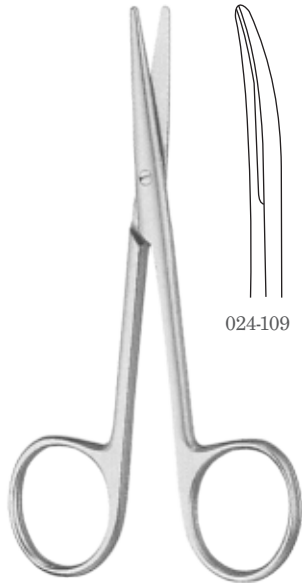

STRABISMUS Scissors
Rounded Blades, Blunt

Item #	Description	Length
024-109	curved	4"(10.2cm)

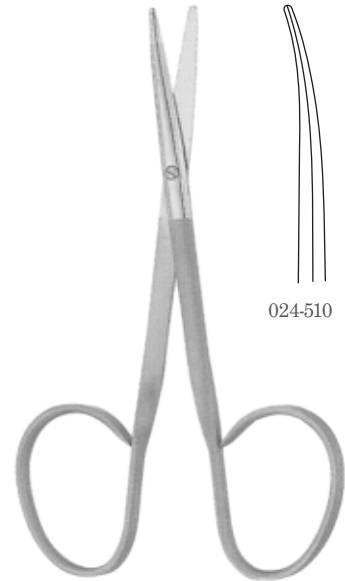

STRABISMUS Scissors
Ribbon Style Ring Handle

Item #	Description	Length
024-510	curved	4"(10.2cm)

SCISSORS

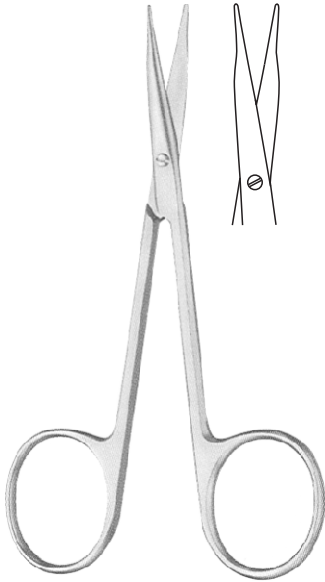

STEVENS Tenotomy Scissors

Blunt Points

Item #	Description	Length
025-012	straight	4 $\frac{1}{8}$ " (11.4cm)
025-013	curved	4 $\frac{1}{2}$ " (11.4cm)
025-111	curved	5 $\frac{7}{8}$ " (14.0cm)
025-123	curved	6 $\frac{1}{2}$ " (16.5cm)

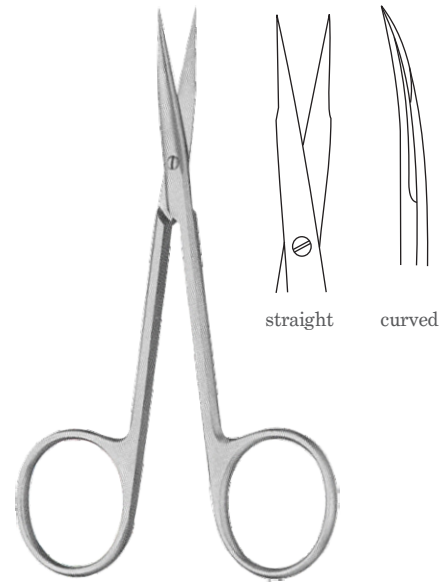

STEVENS Tenotomy Scissors

Sharp Points

Item #	Description	Length
025-002	straight	4 $\frac{1}{2}$ " (11.4cm)
025-003	curved	4 $\frac{1}{2}$ " (11.4cm)

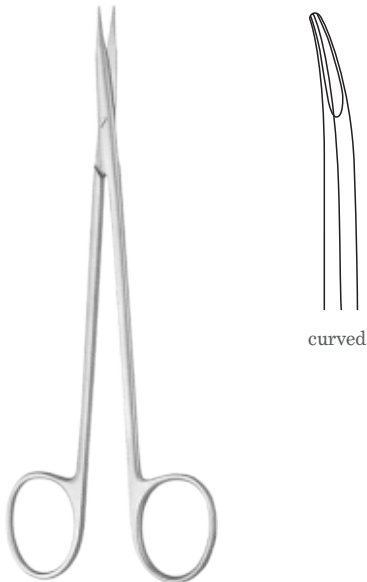

REYNOLDS Dissecting Scissors

Tenotomy-Type Dissecting Tips

Item #	Description	Length
046-716	curved	6 $\frac{1}{4}$ " (15.9cm)
046-718	curved	7" (17.8cm)
551-012	curved, one serrated blade	6 $\frac{1}{4}$ " (15.9cm)
551-014	curved, one serrated blade	7" (17.8cm)

SCISSORS

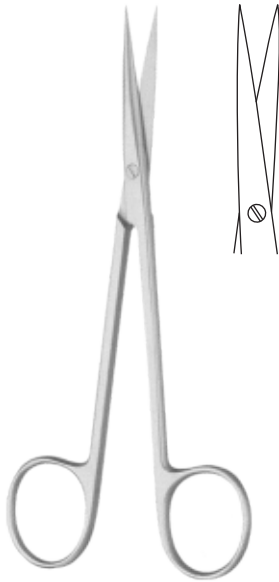

BROPHY Scissors
Sharp Points

Item #	Description	Length
042-014	straight	5½" (14.0cm)
042-114	curved	5½" (14.0cm)

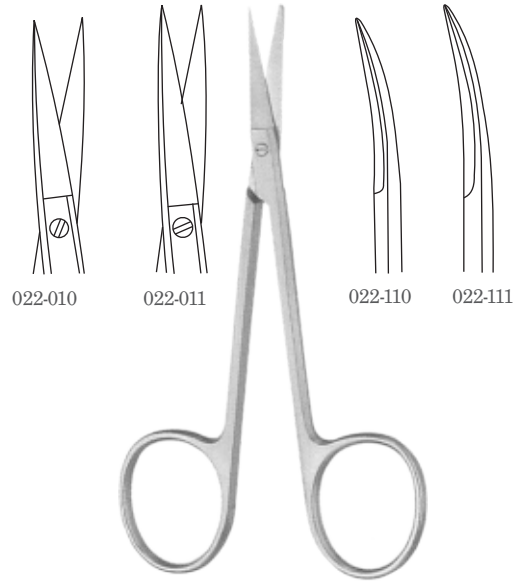

IRIS Scissors

Item #	Description	Length
022-010	straight	4" (10.2cm)
022-011	straight	4½" (11.4cm)
022-110	curved	4" (10.2cm)
022-111	curved	4½" (11.4cm)

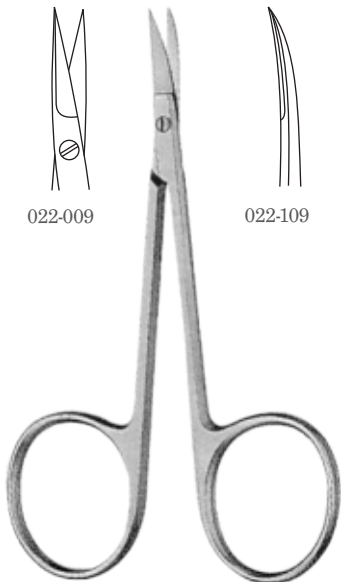

IRIS Scissors
Delicate

Item #	Description	Length
022-009	straight	3½" (8.9cm)
022-109	curved	3½" (8.9cm)

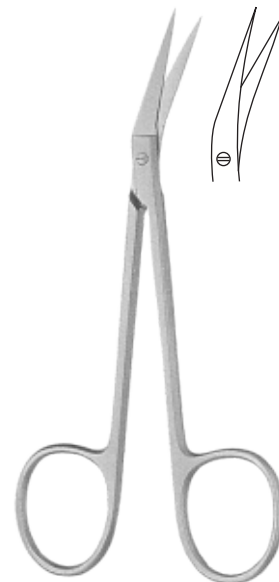

IRIS Scissors

Item #	Description	Length
022-191	angled on side	4½" (11.4cm)

SCISSORS

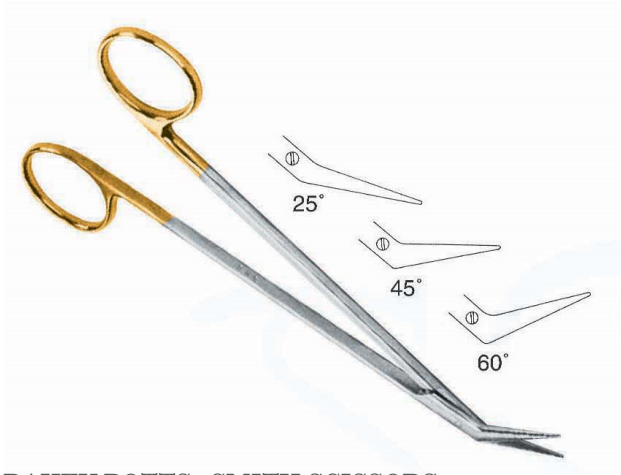

DeBAKEY POTTS - SMITH SCISSORS
With Tungsten carbide inserts

Item #	Description	Length
321-72	Angled 25°	7" (17.5cm)
321-73	Angled 45°	7" (17.5cm)
321-74	Angled 60°	7" (17.5cm)
321-75	Angled 25°	9" (23.0cm)
321-76	Angled 45°	9" (23.0cm)
321-77	Angled 60°	9" (23.0cm)



Jacobson Micro Vascular Scissors

Item #	Description	Length
558-088	Angled Blades	7 1/2"
558-086	Straight Blades	7 1/2"
558-087	Curved Blades	7 1/2"



ZEP SCISSORS

Item #	Description	Length
328-88	Slightly curved	9" (23.0cm)
328-91	Slightly curved	10" (26.0cm)
328-94	Slightly curved	12" (30.0cm)



Yasargil Micro Bayonet Scissors

Item #	Description	Length
581-928	45° Angled	7 1/2 "
581-929	125° Reversed Angled	7"



YASARGIL BAY SCISSOR STR
Flat Bayonet Handle

Item #	Description	Length
591-620	Straight	6 1/4"
592-030	Straight	8"
592-033	Straight, Long	8"
592-320	Blades Straight	9"
592-322	Straight, Serrated	9"
592-330	Straight Vannas Blades	9"
592-340	Straight, Long Blades	9"
591-621	Curved Curved	6 1/4"
592-034	Curved Up, Long Blades	8"
592-031	Curved	9"



Jacobson Micro Scissors
Flat Bayonet Handle

Item #	Description	Length
581-524	Straight Blades	7 1/4"
581-525	Curved Blades	7 1/4"
581-526	Angled Blades	7 1/4"
581-527	Straight Micro Blade	7 1/4"
518-528	Curved Micro Blades	7 1/4"



Micro Vascular Scissors
Extra Delicate, Round Handle

Item #	Description	Length
558-058	Angled 25	7"
558-059	Angled 45	7"
558-060	Angled 60	7"
558-061	Angled 90	7"
558-062	Angled 120	7"
558-091	Angled 25	8"
558-092	Angled 45	8"
558-093	Angled 60	8"
558-094	Angled 90	8"
558-095	Angled 120	8"



Rhoton Micro Bayonet Scissor
Round Bayonet Handle

Item #	Description	Length
595-933	Curved Blades	8 1/4"
595-934	Straight Blades	9 1/4"
595-935	Curved Blades	9 1/4"

SCISSORS

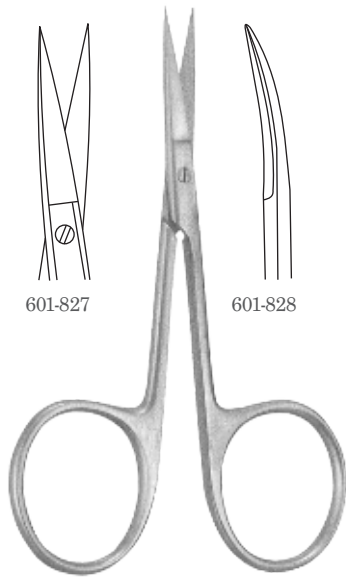

IRIS Scissors

Delicate, Large Finger Rings

Item #	Description	Length
601-827	straight	4" (10.2cm)
601-828	curved	4" (10.2cm)



KNAPP Iris Scissors

Item #	Description	Length
024-010	straight, blunt/blunt	4" (10.2cm)
024-110	curved, blunt/blunt	4" (10.2cm)

SCISSORS



DEAN Dissecting Scissors

Item #	Description	Length
724-550	blades angled on flat, one serrated blade	6¾" (17.1cm)

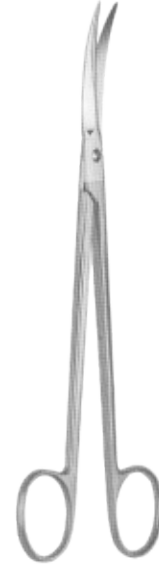

LILLIE Tonsil Scissors

Item #	Description	Length
724-552	curved, 40.0mm blades	8" (20.3cm)

SCISSORS



ALAR Cartilage Scissors

Item #	Description	Length
675-232	curved, sharp	4¾" (12.1cm)

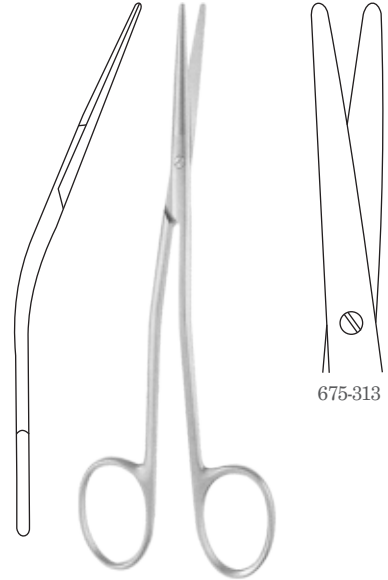

FOMON Dorsal Scissors

Item #	Description	Length
675-313	light pattern with rounded blades, angular shank	5 ½" (13.0cm)

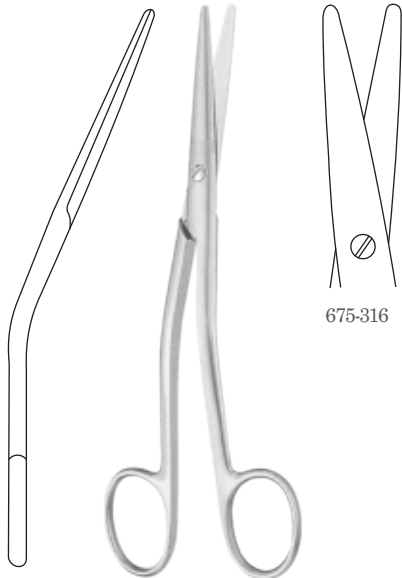

COTTLE Dorsal Scissors

Item #	Description	Length
675-316	heavy pattern with rounded blades, angular shank	6¼" (15.9cm)



HEYMANN Nasal Scissors

Item #	Description	Length
664-020	blunt	7" (17.8cm)

SCISSORS

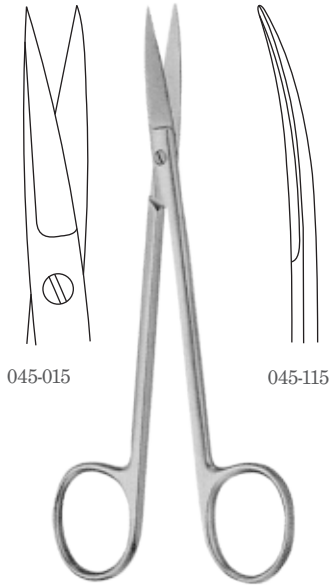

JOSEPH Nasal Scissors

Item #	Description	Length
045-015	straight	5¾" (14.6cm)
045-115	curved	5¾" (14.6cm)

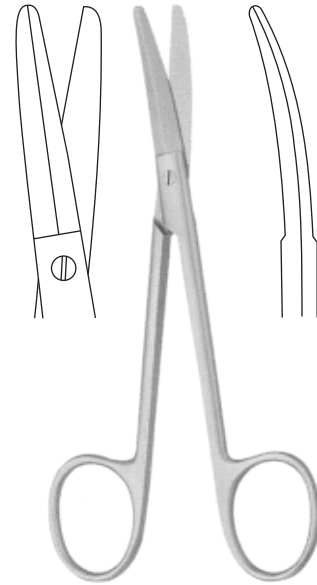

FOMON Saber Back Scissors

Item #	Description	Length
675-112	slightly-curved, semi-sharp outer edges	5" (12.7cm)

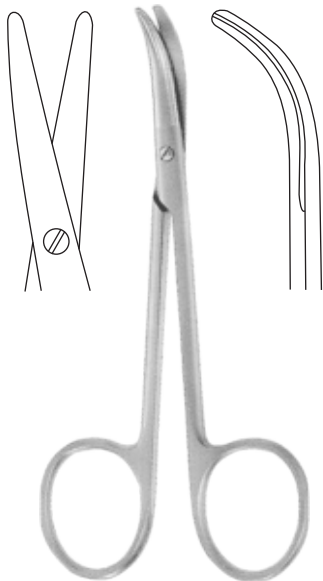

FOMON Lower Lateral Scissors

Item #	Description	Length
675-212	full curve	5" (12.7cm)



CONVERSE Dorsal Scissors

Item #	Description	Length
675-511	serrated blades	6¾" (16.2cm)

SCISSORS

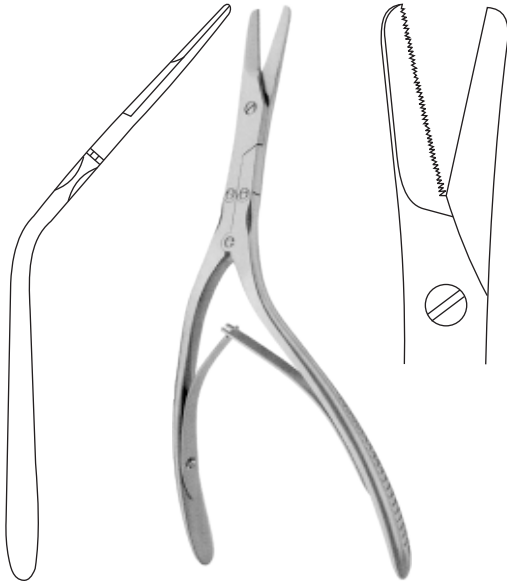

CAPLAN Septum Scissors

Item #	Description	Length
675-371	double action, serrated, angled handles	8" (20.3cm)



BECKER Septum Scissors

Item #	Description	Length
675-505	double action, serrated, angled handles	7 1/8" (18.1cm)



JACKSON Turbinate Scissors

Item #	Description	Length
675-516	blunt, angled blades, heavy pattern	7 7/8" (20.0cm)

SCISSORS

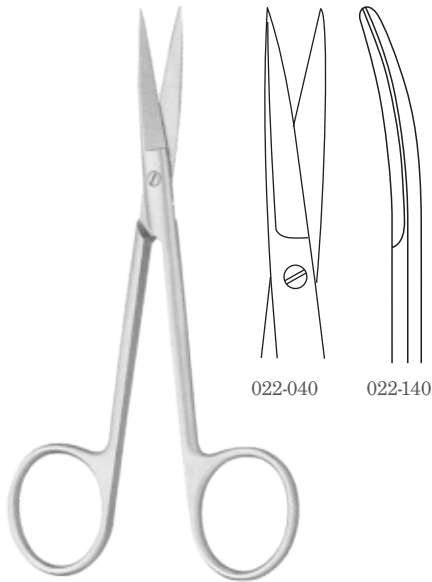

PLASTIC Utility Scissors
Fine Pattern, Sharp

Item #	Description	Length
022-040	straight	4" (10.2cm)
022-140	slightly-curved	4" (10.2cm)

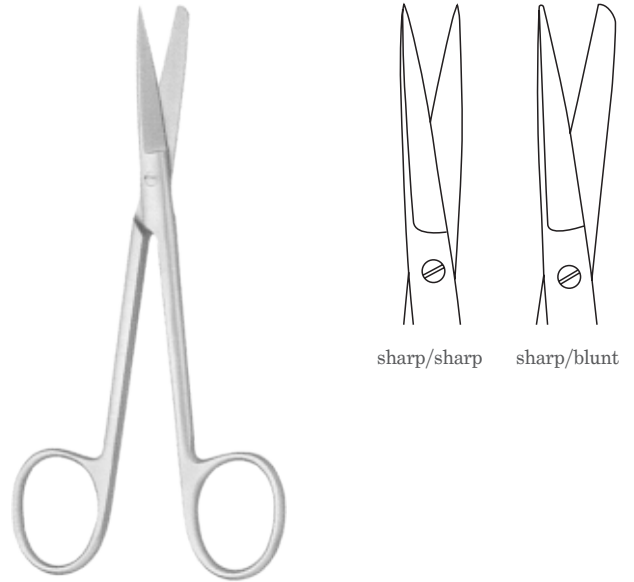

WAGNER Plastic Surgery Scissors
Fine Pattern

Item #	Description	Length
020-612	straight, sharp/sharp	4¾" (12.1cm)
020-632	curved, sharp/sharp	4¾" (12.1cm)
020-712	curved, sharp/blunt	4¾" (12.1cm)
020-732	curved, blunt/blunt	4¾" (12.1cm)



KAYE Blepharoplasty Scissors
Ribbon Style Ring Handle, Serrated

Item #	Description	Length
675-120	straight	4¼" (10.8cm)
675-121	curved	4¼" (10.8cm)

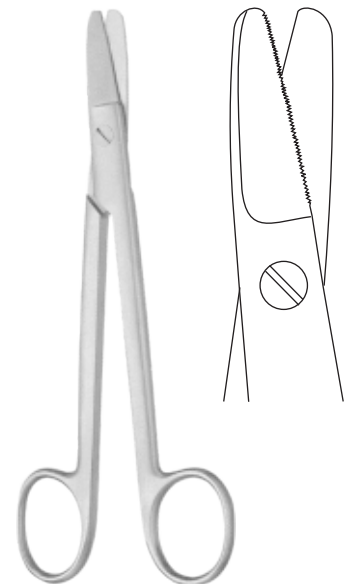

CASTANARES Face Lift Scissors

Item #	Description	Length
675-016	straight	6¼" (15.9cm)

SCISSORS

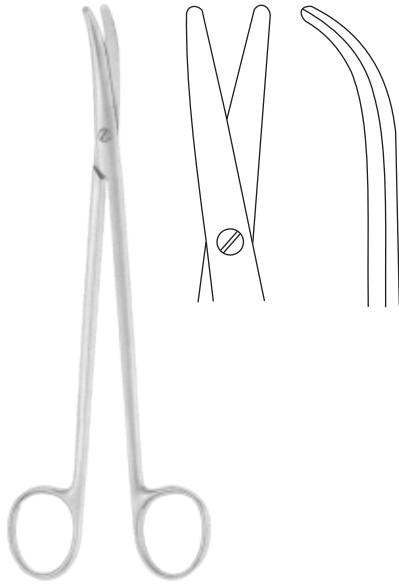

THOREK Scissors
Full Curve

Item #	Length
512-519	7¼" (18.4cm)
512-523	9" (22.9cm)

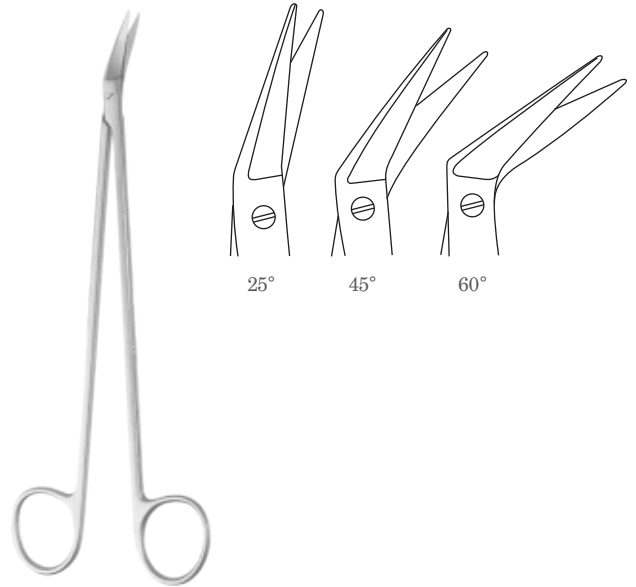

POTTS-SMITH Scissors
Standard Pattern, Blunt Tips

Item #	Description	Length
551-032	25 degrees, angled on side	7½" (19.1cm)
551-033	45 degrees, angled on side	7½" (19.1cm)
551-034	60 degrees, angled on side	7½" (19.1cm)



WILMER (CONVERSE) Scissors

Item #	Description	Length
601-850	angled on flat	4¼" (10.8cm)

SCISSORS

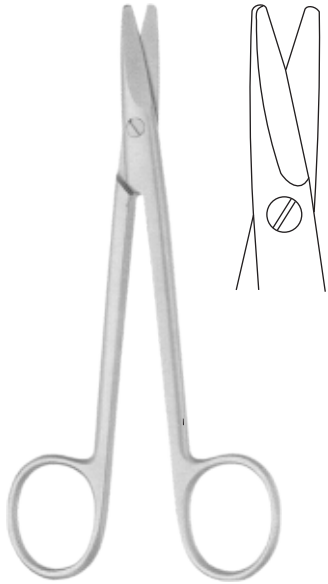

SISTRUNK Operating Scissors

Item #	Description	Length
036-714	slightly-curved	5½" (14.0cm)



IRIS MICRO Dissecting Scissors

Item #	Description	Length
601-854	straight	4" (10.2cm)
601-852	curved	4" (10.2cm)

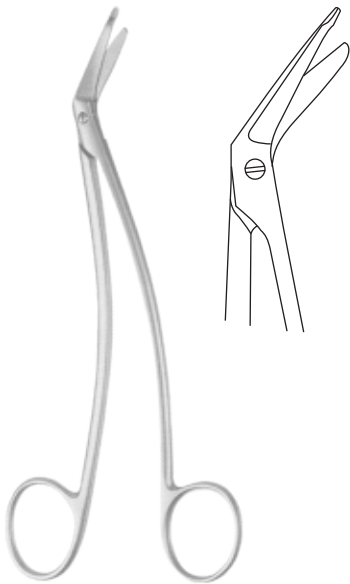

TAYLOR Dural Scissors

Item #	Description	Length
572-516	angled, one blade has probe	6¼" (15.9cm)



WESTCOTT Stitch Scissors

Item #	Description	Length
601-808	curved, sharp tips	4" (10.2cm)

SCISSORS

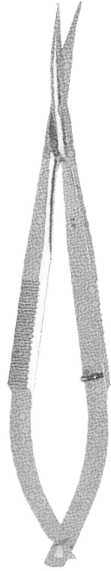

WESTCOTT Utility Scissors

Item #	Description	Length
601-842	curved, round, sharp tips	5 1/8" (13.0cm)



MICRO Surgery Scissors

Sharp Points, 6.0mm Blades, Round Handles

Item #	Description	Length
051-574	straight	6" (15.2cm)
051-578	straight	7 1/8" (18.1cm)
051-575	curved	6" (15.2cm)
051-579	curved	7 1/8" (18.1cm)



VANNAS Scissors

Item #	Description	Length
601-834	straight blades	3 3/8" (8.6cm)
601-835	curved blades	3 3/8" (8.6cm)

SCISSORS

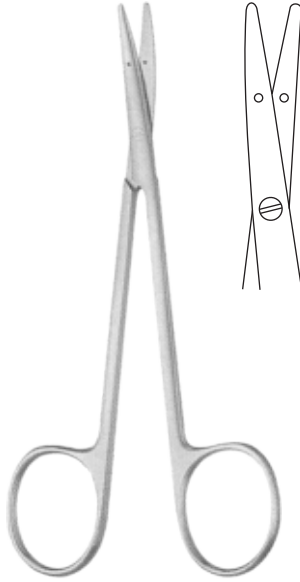

LITTLER Plastic Surgery & Suture Scissors
Suture Hole In Blades

Item #	Description	Length
601-868	curved	4¾" (12.1cm)

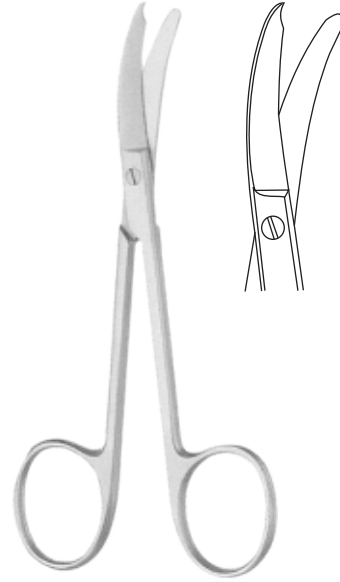

NORTHBENT Stitch Scissors

Item #	Description	Length
140-712	curved, light pattern	4¾" (12.1cm)

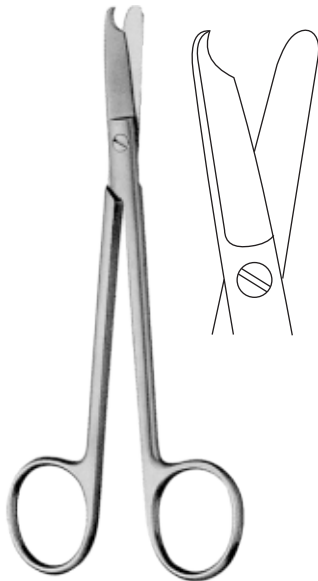

LITTAUER Stitch Scissors

Item #	Description	Length
140-613	standard pattern	5⅞" (13.0cm)

SCISSORS



O'BRIEN Stitch Scissors

Item #	Description	Length
140-709	angled, sharp points	3¾" (9.5cm)

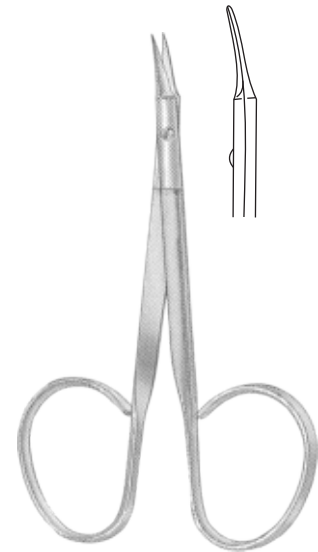

STITCH Scissors

Ribbon Style Ring Handle

Item #	Description	Length
601-813	curved, sharp pointed tips	3⅞" (9.8cm)
675-870	curved, sharp pointed tips	4½" (11.4cm)

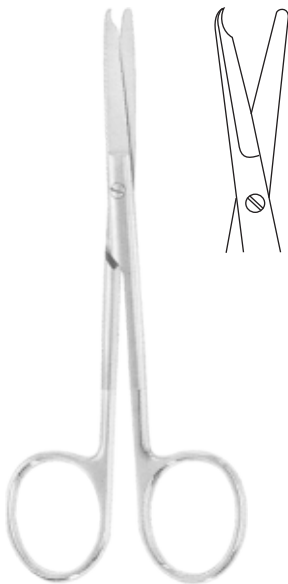

SPENCER Stitch Scissors

Item #	Description	Length
140-609	delicate pattern	3½" (8.9cm)
140-612	standard pattern	4¾" (12.1cm)

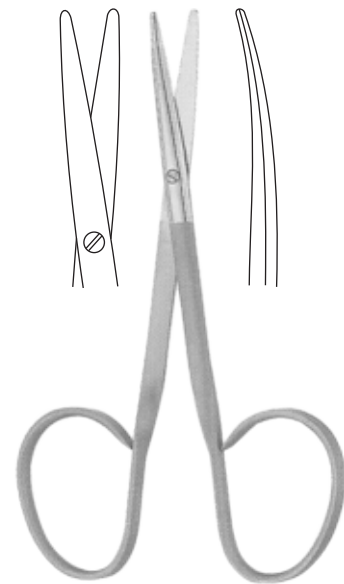

UTILITY Scissors

Ribbon Style Ring Handle

Item #	Description	Length
601-853	curved, blunt tips	4⅞" (10.3cm)

SCISSORS

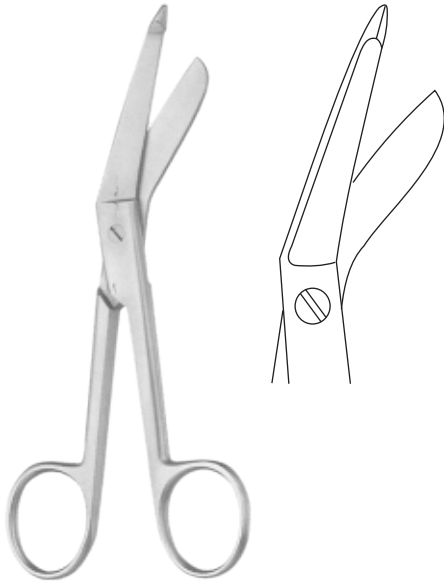

LISTER Bandage Scissors

Item #	Length
402-509	3½" (8.9cm)
402-511	4½" (11.4cm)
402-514	5½" (14.0cm)
402-518	7¼" (18.4cm)
402-520	8" (20.3cm)

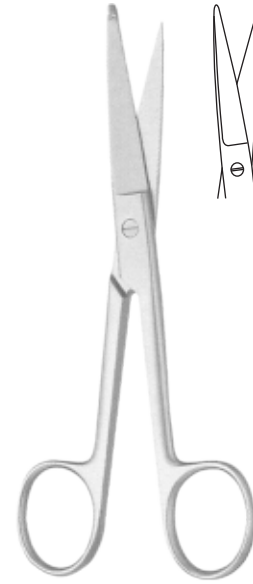

KNOWLES Bandage Scissors

Item #	Description	Length
402-014	straight	5½" (14.0cm)

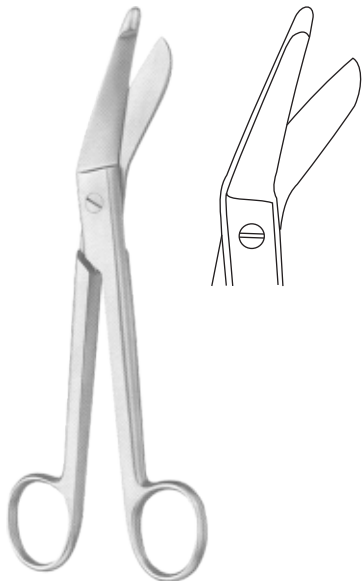

ESMARCH Heavy-Duty Bandage & Cast Shears

Item #	Length
403-120	8" (20.3cm)



BANDAGE & UTILITY Scissors

Item #	Description	Length
404-718	serrated blade, large autoclavable plastic handles	7½" (19.1cm)

SCISSORS

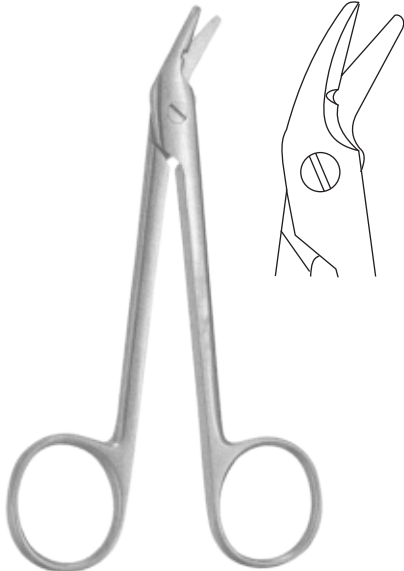

WIRE Cutting Scissors

Item #	Description	Length
142-312	angled to one side, one serrated blade	4 ³ / ₄ " (12.1cm)

THUMB FORCEPS



ADSON Dressing Forceps
Tungsten Carbide Inserts

Item #	Description	Length
325-00	serrated platform	4¾" (12.1cm)
325-05	delicate, smooth platform	4¾" (12.1cm)



BROWN-ADSON Tissue Forceps
Tungsten Carbide Inserts

Item #	Description	Teeth	Length
325-06	serrated platform	7x7	4¾" (12.1cm)



ADSON Tissue Forceps
Tungsten Carbide Inserts, 1x2 Teeth

Item #	Description	Length
325-03	serrated platform	4¾" (12.1cm)
325-04	delicate, serrated platform	4¾" (12.1cm)
325-08	smooth platform	4¾" (12.1cm)
325-09	serrated platform	4¾" (12.1cm)
		6" (15.2cm)



GENERAL Style Dressing Forceps
Tungsten Carbide Inserts

Item #	Description	Length
325-10	serrated platform	6" (15.2cm)

THUMB FORCEPS



CUSHING Dressing Forceps
Tungsten Carbide Inserts, Serrated Platform

Item #	Description	Length
325-20	standard	7" (17.8cm)
325-25	bayonet	7¾" (19.7cm)



GERALD Thumb Forceps
Tungsten Carbide Inserts

Item #	Description	Tip Width	Length
325-70	serrated tips	1.0mm	7" (17.8cm)
325-67	serrated tips	1.0mm	9" (22.9cm)
325-68	1x2 teeth, serrated platform	1.0mm	7" (17.8cm)



POTTS-SMITH Dressing Forceps
Tungsten Carbide Inserts, Serrated Platform

Item #	Length
325-27	7" (17.8cm)



DRESSING Forceps
Standard Pattern, Serrated Handles & Tips

Item #	Length
060-011	4½" (11.4cm)
060-013	5" (12.7cm)
060-014	5½" (14.0cm)
060-015	6" (15.2cm)
060-018	7" (17.8cm)
060-020	8" (20.3cm)
060-025	10" (25.4cm)
060-030	12" (30.5cm)

THUMB FORCEPS



TISSUE Forceps
Standard Pattern, Serrated Handles

Item #	Teeth	Length
060-511	1 x 2	4½" (11.4cm)
060-513	1 x 2	5" (12.7cm)
060-514	1 x 2	5½" (14.0cm)
060-515	1 x 2	6" (15.2cm)
060-518	1 x 2	7" (17.8cm)
060-520	1 x 2	8" (20.3cm)
060-525	1 x 2	10" (25.4cm)
060-530	1 x 2	12" (30.5cm)
061-014	2 x 3	4½" (11.4cm)
061-113	3 x 4	5½" (14.0cm)



CUSHING Thumb Forceps
Bayonet, Scraper End

Item #	Description	Length
072-618	dressing forceps, serrated	7¼" (18.4cm)
072-718	tissue forceps, 1x2 teeth	7¼" (18.4cm)

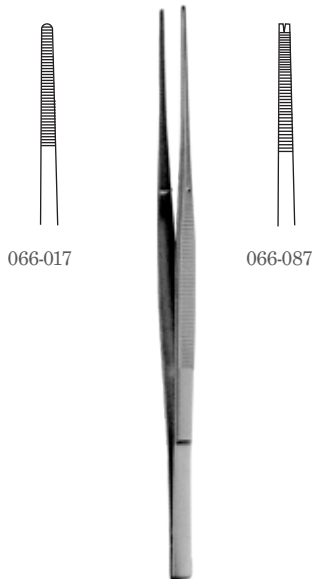

CUSHING Thumb Forceps
Flat Serrated Handles, Scraper End

Item #	Description	Length
066-017	dressing forceps, serrated	7⅞" (18.1cm)
066-087	tissue forceps, 1x2 teeth	7⅞" (18.1cm)

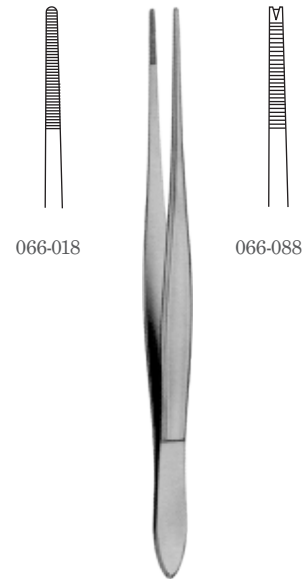

CUSHING Thumb Forceps
Gutsch Handle, Scraper End

Item #	Description	Length
066-018	dressing forceps, serrated	7" (17.8cm)
066-088	tissue forceps, 1x2 teeth	7" (17.8cm)

THUMB FORCEPS

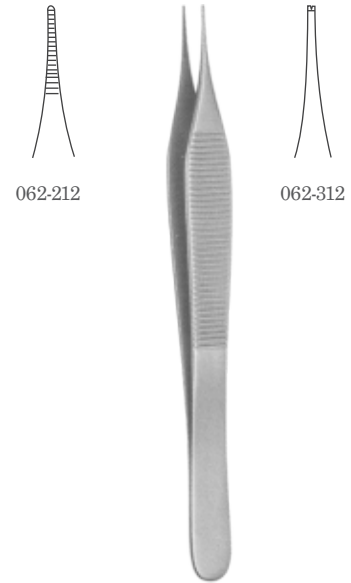
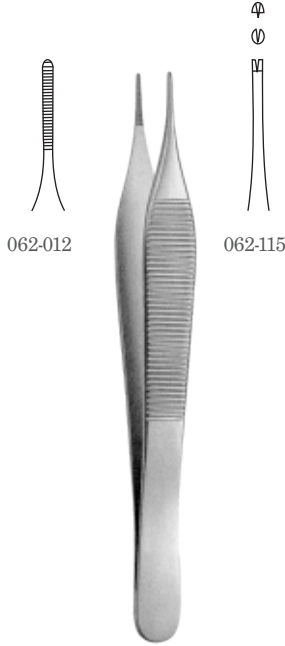

ADSON Thumb Forceps Standard Pattern

Item #	Description	Length
062-012	dressing forceps, serrated	4¾" (12.1cm)
062-112	tissue forceps, 1x2 teeth	4¾" (12.1cm)
062-015	dressing forceps, serrated	6" (15.2cm)
062-115	tissue forceps, 1x2 teeth	6" (15.2cm)

ADSON-MICRO Thumb Forceps

Item #	Description	Length
062-212	dressing forceps, serrated	4¾" (12.1cm)
062-312	tissue forceps, 1x2 teeth	4¾" (12.1cm)

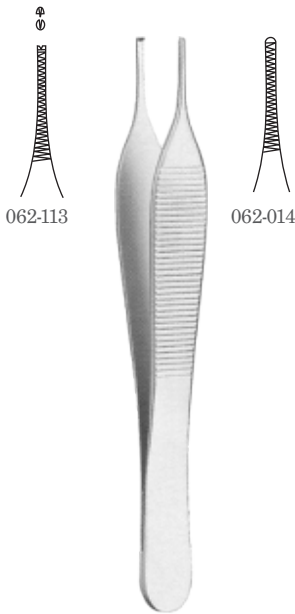

ADSON Thumb Forceps Cross Serrated Tips

Item #	Description	Length
062-014	dressing forceps, serrated	4¾" (12.1cm)
062-113	tissue forceps, 1x2 teeth	4¾" (12.1cm)

ADSON Thumb Forceps

Item #	Description	Length
062-413	tissue forceps, 2x3 teeth	4¾" (12.1cm)

THUMB FORCEPS



BROWN-ADSON Tissue Forceps
Standard Pattern

Item #	Description	Length
062-512	7x7 teeth	4 $\frac{3}{4}$ " (12.1cm)



BROWN-ADSON Tissue Forceps
Angled Tips

Item #	Description	Length
062-572	9x9 teeth	4 $\frac{3}{4}$ " (12.1cm)

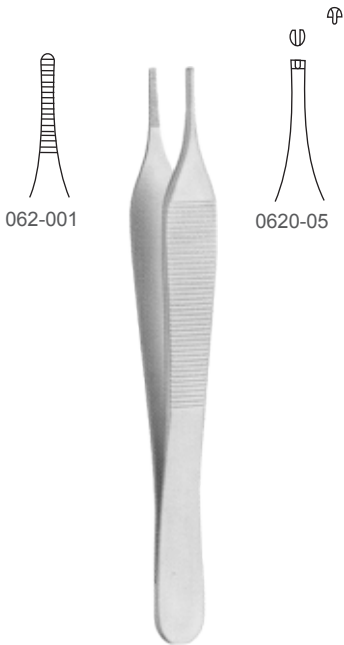

HUDSON (EWALD) Thumb Forceps

Item #	Description	Length
062-001	dressing forceps, serrated	4 $\frac{3}{4}$ " (12.1cm)
062-005	tissue forceps, 1x2 teeth	4 $\frac{3}{4}$ " (12.1cm)

THUMB FORCEPS

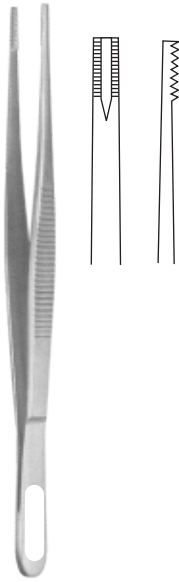

BROWN Tissue Forceps

Item #	Description	Length
071-015	8x8 teeth	6" (15.2cm)
071-020	8x8 teeth	8" (20.3cm)



ADSON-GRAEFE Tissue Forceps

Item #	Length
062-582	4¾" (12.1cm)

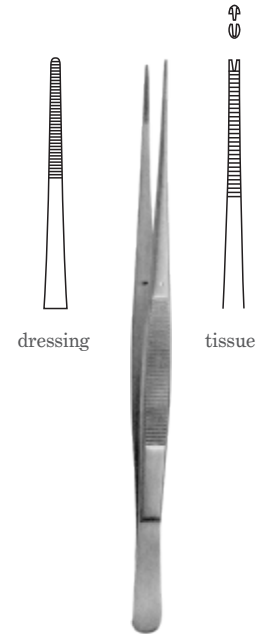

POTTS-SMITH Dressing Forceps

Serrated	
Item #	Length
064-618	7" (17.8cm)
064-620	8¼" (21.0cm)
064-625	9½" (24.1cm)



POTTS-SMITH Tissue Forceps
1x2 Teeth, Serrated

Item #	Length
064-818	7" (17.8cm)
064-820	8¼" (21.0cm)
064-825	9½" (24.1cm)

THUMB FORCEPS



Micro Ring Tip Forceps
1.0mm TC Dust Tips, Round Handle

Item #	Description	Length
559-055	Without Platform	7 1/2"
559-056	Without Platform	8 1/4"
559-057	Without Platform	9"
559-041	With Platform	7 1/2"
559-042	With Platform	8 1/4"

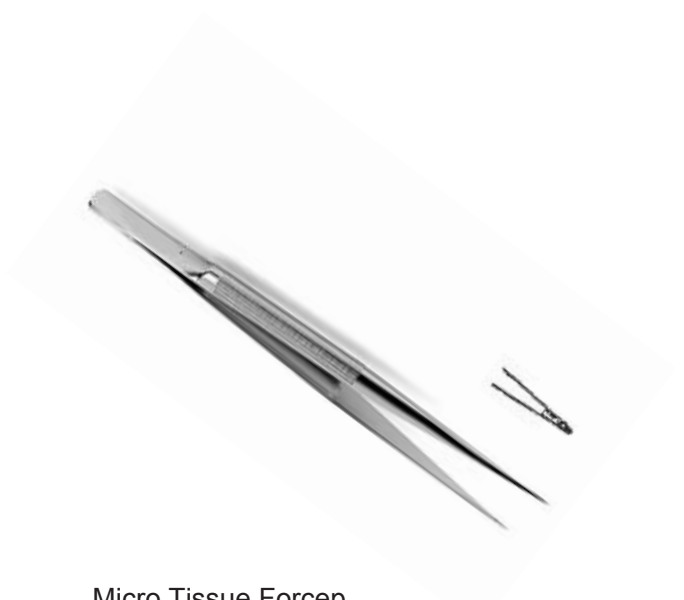

Micro Tissue Forcep
1.0mm Tips with TC Dust, Round handle

Item #	Description	Length
559-080	Straight With Platform	7 1/8"
559-083	Curved With Platform	7 1/8"
559-060	Straight Without Platform	7 1/8"
559-065	Straight with Platform	8 1/4"
559-084	Curved with Platform	8 1/4"
559-082	Straight with Platform	9"
559-085	Curved with Platform	9"



Wheeler Plaque Forceps

Item #	Length
558-910	6"
558-915	7 3/4"
558-920	9"



Ferris-Smith Tissue Forcep

Item #	Description	Length
068-792	1x2 Teeth	7 1/8"
068-793	2x3 Teeth	7 1/8"

THUMB FORCEPS



RUSSIAN Tissue Forceps

Item #	Length
071-515	6" (15.2cm)
071-520	8" (20.3cm)
071-525	10" (25.4cm)

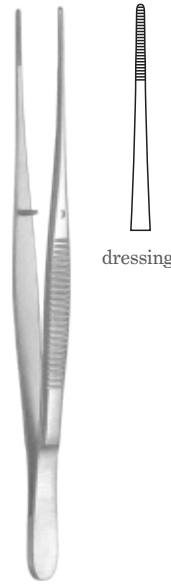

SEMKEN Dressing Forceps
Serrated

Item #	Description	Length
063-012	straight	5" (12.7cm)
063-015	straight	6" (15.2cm)
063-022	curved	5" (12.7cm)

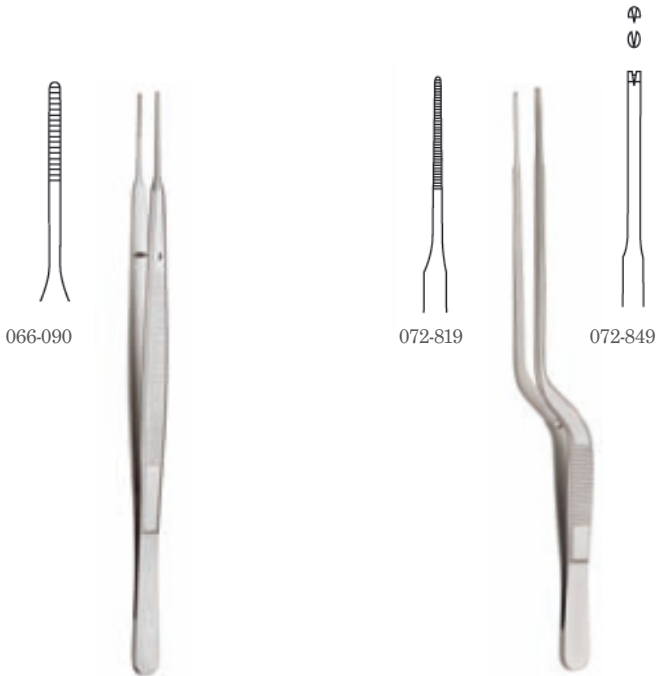
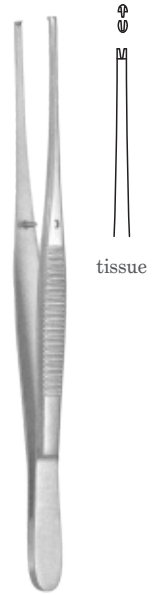

GERALD Thumb Forceps

Item #	Description	Length
066-090	dressing forceps, narrow tips, serrated	7" (17.8cm)
072-819	bayonet, dressing forceps, narrow tips serrated	7½" (19.1cm)
072-849	bayonet, tissue forceps, narrow tips, 1x2 teeth	7½ (19.1cm)



VON GRAEFE Tissue Forceps

Item #	Description	Length
601-529	fine, multiple atraumatic teeth	4¼" (10.8cm)

THUMB FORCEPS



GILLIES Dissecting Forceps

Item #	Description	Length
064-085	fine, 1x2 teeth on serrated jaws	6" (15.2cm)

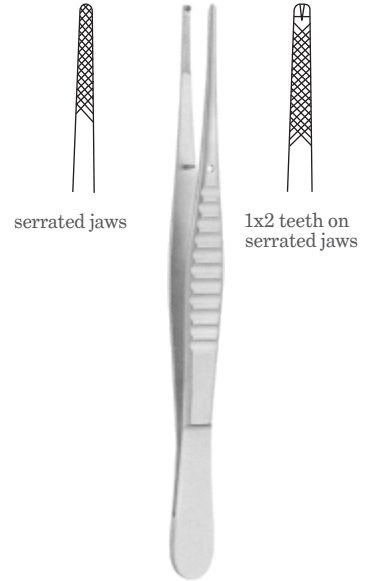

WAUGH Dissecting Forceps

Fine

Item #	Description	Length
064-315	1x2 teeth on serrated jaws	6" (15.2cm)
064-320	1x2 teeth on serrated jaws	8" (20.3cm)
064-215	serrated jaws	6" (15.2cm)
064-220	serrated jaws	8" (20.3cm)



MCINDOE Dissecting Forceps

Item #	Description	Length
064-015	serrated jaws	6" (15.2cm)

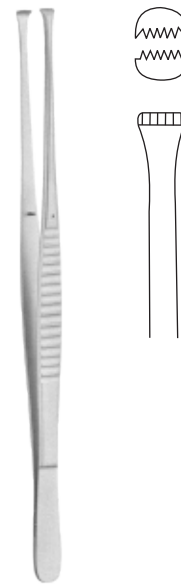

NELSON Tissue Forceps

Item #	Description	Length
071-915	6x7 teeth	6" (15.2cm)
071-918	6x7 teeth	7" (17.8cm)

THUMB FORCEPS

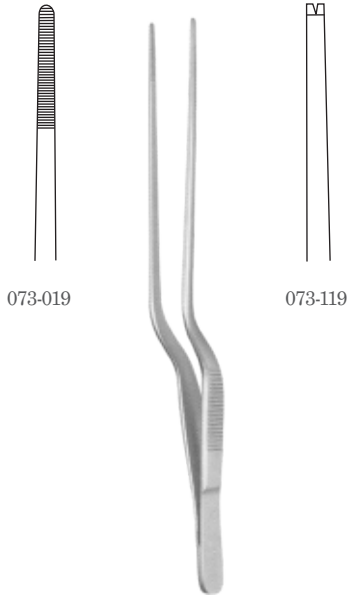

GRUENWALD (JANSEN) Thumb Forceps
Bayonet

Item #	Description	Length
073-016	dressing forceps, serrated	6¼" (15.9cm)
073-019	dressing forceps, serrated	7¾" (19.7cm)
073-116	tissue forceps, 1x2 teeth	6¼" (15.9cm)
073-119	tissue forceps, 1x2 teeth	7¾" (19.7cm)

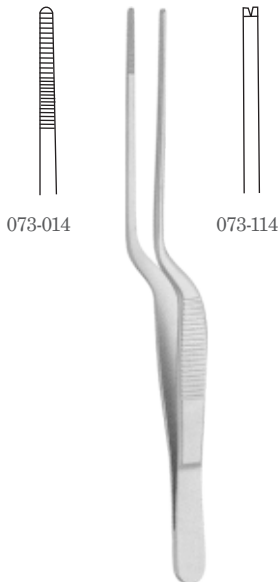

LUCAE Ear Forceps
Bayonet

Item #	Description	Length
073-014	serrated tips	5½" (14.0cm)
073-114	1x2 teeth	5½" (14.0cm)

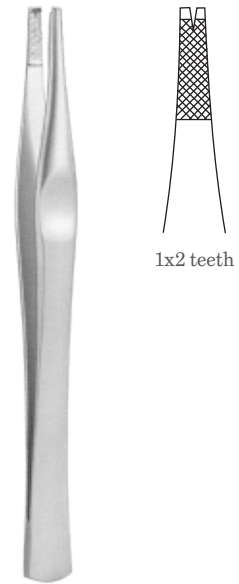

LANES Tissue Forceps
Cross Serrated

Item #	Description	Length
061-814	1x2 teeth	5¾" (14.6cm)
061-818	1x2 teeth	7" (17.8cm)
061-864	2x3 teeth	5¾" (14.6cm)
061-868	2x3 teeth	7" (17.8cm)



WILDE Dressing Forceps
Angled, Serrated Tips

Item #	Description	Length
610-108	Delicate	5 3/4"
610-109	Regular	5 3/4"

THUMB FORCEPS

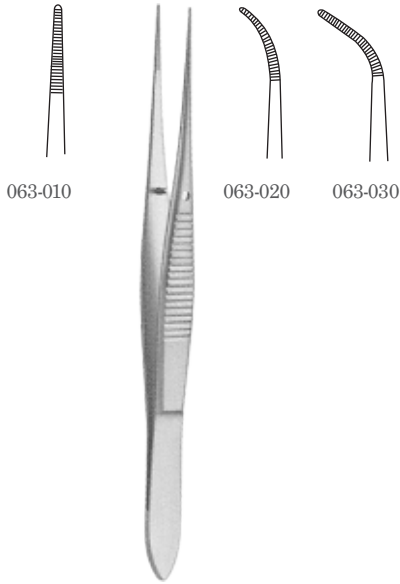

IRIS Dressing Forceps
Standard Pattern, Delicate, Serrated

Item #	Description	Length
063-010	straight	4" (10.2cm)
063-020	half curve	4" (10.2cm)
063-030	full curve	4" (10.2cm)

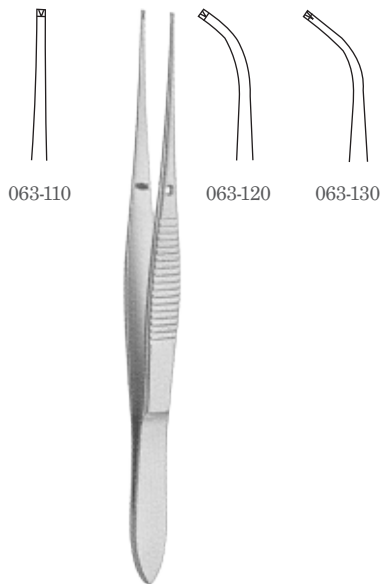

IRIS Tissue Forceps
Standard Pattern, 1x2 Teeth

Item #	Description	Length
063-110	straight, delicate	4" (10.2cm)
063-120	half curve, delicate	4" (10.2cm)
063-130	full curve, delicate	4" (10.2cm)
063-110D	straight, extra delicate	4" (10.2cm)

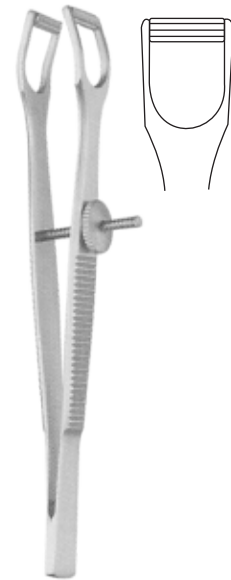

COTTLE Columella Forceps

Item #	Width	Length
675-860	10.0mm jaw	4½" (11.4cm)



DESMARRES Chalazion Forceps

Item #	Description	Width	Length
605-501	small	17.0mm x 11.0mm	3½" (8.9cm)
605-502	medium	23.0mm x 12.0mm	3½" (8.9cm)
605-503	large	28.0mm x 17.0mm	3½" (8.9cm)

THUMB FORCEPS



BERKE Ptosis Forceps
with Slide Lock

Item #	Description	Length
605-485	20.0mm long blades with longitudinal serrations	4" (10.2cm)
605-486	27.0mm long blades with longitudinal serrations	4" (10.2cm)



CONVERSE (GREEN) Eye Fixation Forceps
Jaws with Fine Teeth

Item #	Description	Jaw	Length
601-532	standard pattern	5.0mm	4" (10.2cm)
601-533	standard pattern	10.0mm	4" (10.2cm)
601-531	standard pattern	13.0mm	4" (10.2cm)
601-533L	with lock	10.0mm	4" (10.2cm)



CASTROVIEJO Suture Forceps
Wide Handle, Delicate, 1x2 Teeth, with Tying Platform

Item #	Tip Width	Length
604-751	0.12mm	4 1/4" (10.8cm)
604-753	0.30mm	4 1/4" (10.8cm)
604-755	0.50mm	4 1/4" (10.8cm)
604-759	0.90mm	4 1/4" (10.8cm)
604-765	1.50mm	4 1/4" (10.8cm)

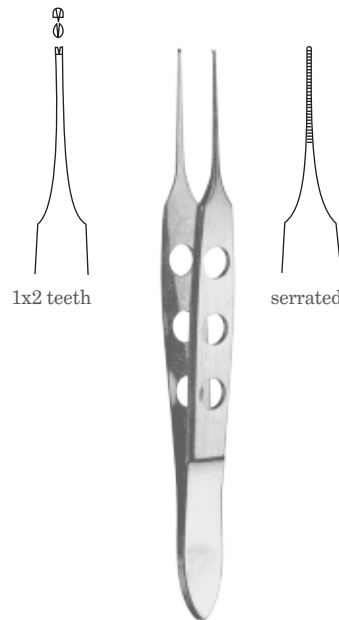

BISHOP-HARMON Iris Forceps

Item #	Description	Length
601-522	1x2 teeth, delicate	3 3/8" (8.6cm)
601-523	1x2 teeth, extra-delicate	3 3/8" (8.6cm)
601-524	serrated, delicate	3 3/8" (8.6cm)

THUMB FORCEPS



BONN Micro Iris Forceps
1x2 Teeth

Item #	Tip Width	Length
604-407	0.12mm	3" (7.5cm)
604-410	0.12mm	4" (10.0cm)



JACOBSON Bayonet Forceps

Item #	Description	Length
581-532	sharp tip	7¼" (18.4cm)
581-533	blunt tip	7¼" (18.4cm)
581-534	blunt angled tip	7¼" (18.4cm)



FOERSTER Eye Forceps
Octagonal Grip

Item #	Description	Tip Width	Length
604-261	tissue forceps, 1x2 teeth, full curve	0.5mm	¾" (9.5cm)
604-263	dressing forceps, serrated, straight	0.5mm	¾" (9.5cm)
604-264	dressing forceps, serrated, full curve	0.5mm	¾" (9.5cm)



SHEEN Gripping Forceps

Item #	Description	Length
066-199	with pins	5" (12.7cm)

THUMB FORCEPS



BLEPHAROPLASTY Forceps Tungsten Carbide Inserts

Item #	Description	Length
690-013	delicate hooks on ADSON forceps	5" (12.7cm)
690-113	standard hooks on ADSON forceps, with platform	5" (12.7cm)
690-011	extra-fine hooks on CASTROVIEJO forceps	4¾" (12.1cm)

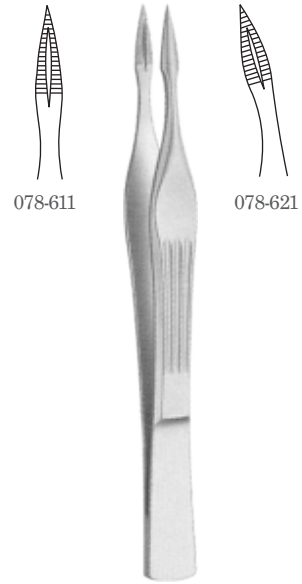

WALTER Splinter Forceps

Item #	Description	Length
078-611	straight	4¼" (10.8cm)
078-621	curved	4¼" (10.8cm)

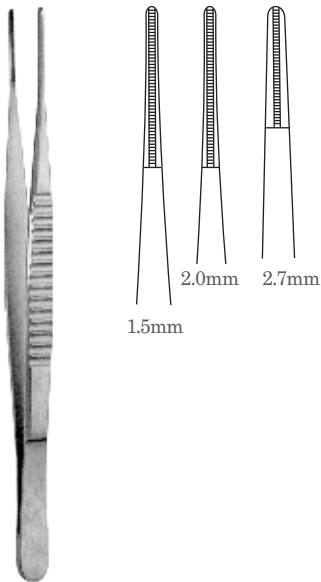

DEBAKEY Vascular Tissue Forceps

Item #	Jaw	Length
552-004	1.0mm	6" (15.2cm)
552-005	1.0mm	8" (20.3cm)
552-006	1.0mm	9½" (24.1cm)
552-003	1.0mm	12" (30.5cm)
552-007	2.0mm	6" (15.2cm)
552-008	2.0mm	8" (20.3cm)
552-009	2.0mm	9½" (24.1cm)
552-010	2.0mm	12" (30.5cm)
552-018	3.0mm	6" (15.2cm)
552-019	3.0mm	7½" (19.1cm)
552-020	3.0mm	9½" (24.1cm)
552-021	3.0mm	12" (30.5cm)

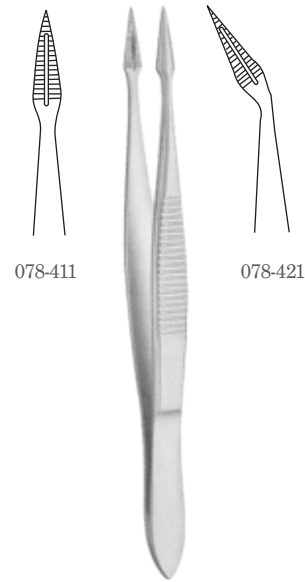

CARMALT (HUNTER) Splinter Forceps

Item #	Description	Length
078-411	straight	4¼" (10.8cm)
078-421	curved	4¼" (10.8cm)

THUMB FORCEPS



FEILCHENFELD Splinter Forceps

Item #	Length
078-207	3" (7.6cm)
078-211	4½" (11.4cm)



PLAIN Splinter Forceps
Angled

Item #	Length
078-109	3½" (8.9cm)
078-110	4" (10.2cm)
078-111	4½" (11.4cm)



PLAIN Splinter Forceps
Straight

Item #	Length
078-009	3½" (8.9cm)
078-010	4" (10.2cm)
078-011	4½" (11.4cm)



VIRTUS Splinter Forceps

Item #	Description	Length
079-414	straight	6" (15.2cm)
079-424	angled	6" (15.2cm)

THUMB FORCEPS

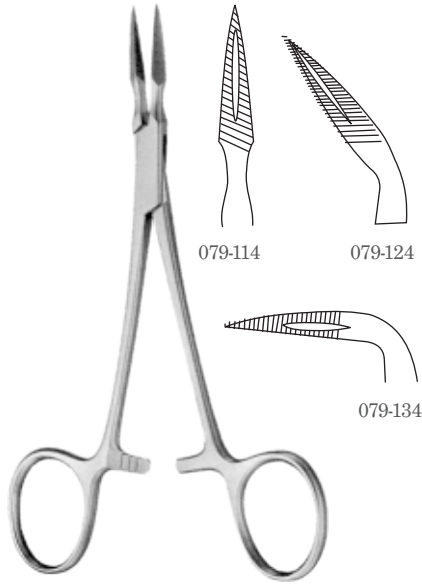

WILLIAMS (STIEGLITZ) Splinter Forceps

Item #	Description	Length
079-114	straight	5½" (14.0cm)
079-124	45-degree angle	5½" (14.0cm)
079-134	right angle	5½" (14.0cm)



SWISS Cilia Forceps

Item #	Description	Tip Width	Length
605-709	precision-fitted diagonal jaws	3.0mm	3¾" (9.5cm)



BERGH Cilia Forceps

Item #	Description	Length
605-725	horizontal serrations	3½" (8.9cm)



MICRO Suture Forceps
with Tying Platform

Item #	Tip Width	Length
076-403	0.3mm	4¾" (12.1cm)
076-404	0.3mm	6" (15.2cm)

THUMB FORCEPS



SWISS Jeweler Style Forceps
Fine

Item #	Description	Length
076-001	style 1	4 ³ / ₄ " (12.1cm)



SWISS Jeweler Style Forceps
Fine

Item #	Description	Length
076-004	style 4	4 ³ / ₈ " (11.1cm)



SWISS Jeweler Style Forceps
Narrow, Fine

Item #	Description	Length
076-003	style 3, straight	4 ³ / ₄ " (12.1cm)
076-003C	style 3C, curved	4 ³ / ₈ " (11.1cm)



SWISS Jeweler Style Forceps
Super Fine

Item #	Description	Length
076-005	style 5, straight	4 ³ / ₈ " (11.1cm)
076-005A	style 5A, angled	4 ³ / ₈ " (11.1cm)

THUMB FORCEPS



SWISS Jeweler Style Forceps
Fine

Item #	Description	Length
076-007	style 7, curved	4½" (11.4cm)



JEWELER'S Bipolar Forceps

Item #	Description	Tip Width	Length
073-630	straight	0.4mm	4" (10.2cm)
073-629	curved	0.4mm	4" (10.2cm)



ADSON Bipolar Forceps

Item #	Tip Width	Length
073-380	1.0mm	4¾" (12.1cm)



CUSHING Bipolar Forceps

Item #	Tip Width	Length
073-392	0.7mm	6⅞" (15.6cm)
073-400	1.5mm	7⅞" (18.1cm)

THUMB FORCEPS



CUSHING BIPOLAR Bayonet Forceps

Item #	Tip Width	Length
073-416	1.0mm	7½" (19.1cm)
073-420	1.5mm	7½" (19.1cm)



BIPOLAR Instrument Cable

Item #	Description	Length
074-700	reusable	12 feet



SEMKEN BIPOLAR Forceps

Item #	Tip Width	Length
073-371	0.7mm	6" (15cm)

FORCEPS

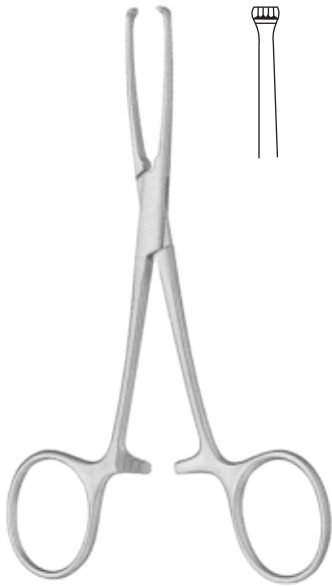

ALLIS-BABY Tissue Forceps
4x5 Teeth

Item #	Description	Length
500-213	extra-delicate jaws	5" (12.7cm)
500-214	delicate jaws	5½" (14.0cm)
500-215	regular pattern	6"
500-216	regular patter 5 x 6	6"

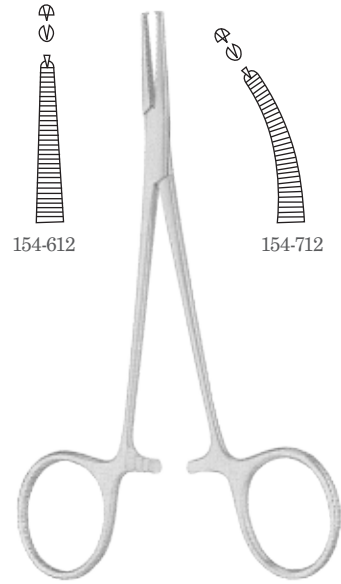

HALSTED Mosquito Forceps
Standard Pattern, 1x2 Teeth

Item #	Description	Length
154-612	straight	5" (12.7cm)
154-712	curved	5" (12.7cm)

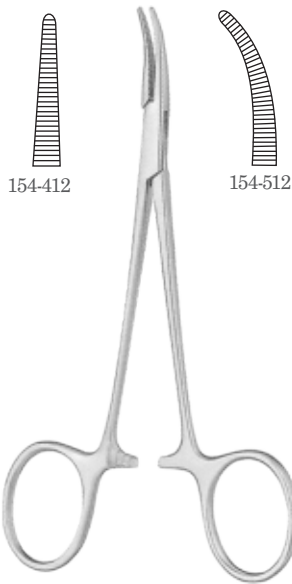

HALSTED Mosquito Forceps
Standard Pattern

Item #	Description	Length
154-412	straight	5" (12.7cm)
154-512	curved	5" (12.7cm)

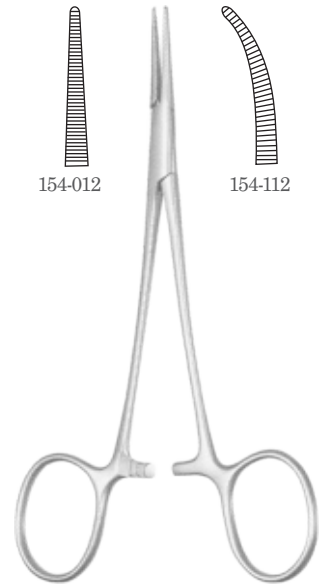

HALSTED-MICRO Mosquito Forceps
Extra-Delicate

Item #	Description	Length
154-012	straight	5" (12.7cm)
154-112	curved	5" (12.7cm)

FORCEPS

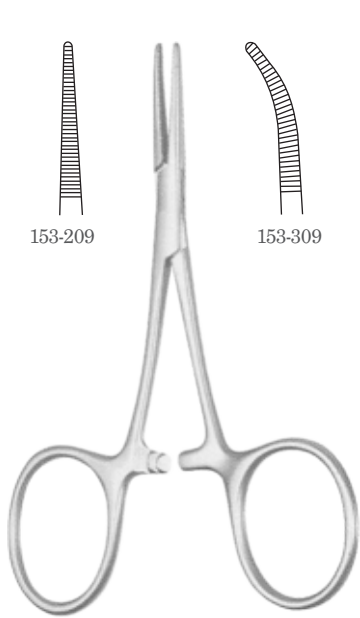

HARTMAN Mosquito Forceps

Item #	Description	Length
153-209	straight	3½" (8.9cm)
153-309	curved	3½" (8.9cm)

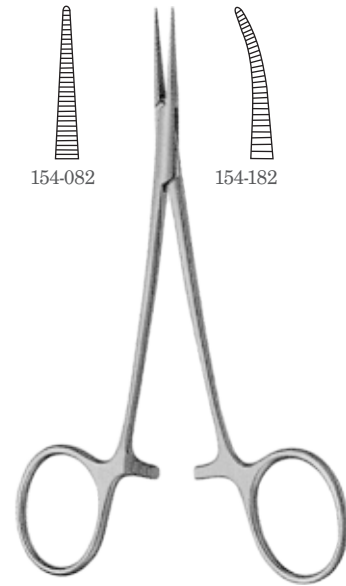

JACOBSON-MICRO Mosquito Forceps
Very Slender Pattern

Item #	Description	Length
153-501	straight	4" (10.2cm)
153-502	curved	4" (10.2cm)
154-082	straight	5" (12.7cm)
154-182	curved	5" (12.7cm)

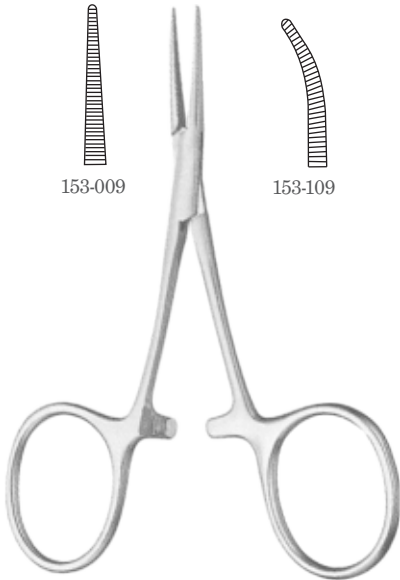

HARTMAN-MICRO Mosquito Forceps

Item #	Description	Length
153-009	straight	3½" (8.9cm)
153-109	curved	3½" (8.9cm)

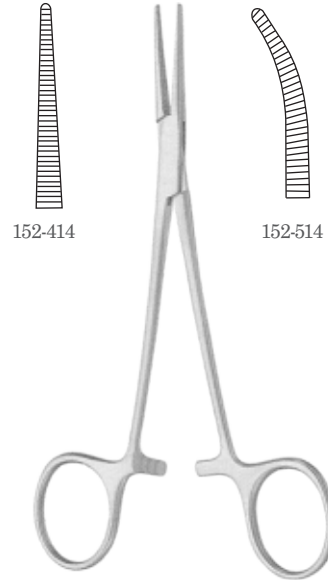

CRILE-BABY Forceps
Extra-Delicate

Item #	Description	Length
152-414	straight	5½" (14.0cm)
152-514	curved	5½" (14.0cm)

FORCEPS

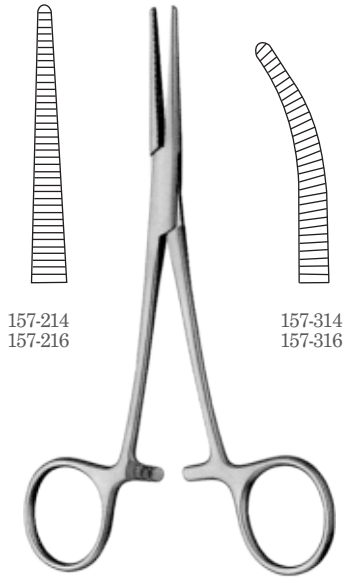

CRILE Forceps

Item #	Description	Length
157-214	straight	5½" (14.0cm)
157-216	straight	6¼" (15.9cm)
157-314	curved	5½" (14.0cm)
157-316	curved	6¼" (15.9cm)

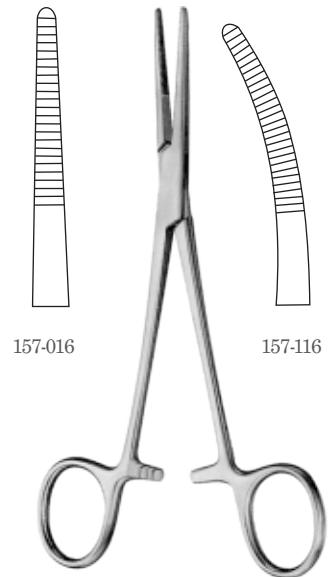

KELLY-RANKIN Forceps

Item #	Description	Length
157-016	straight	6¼" (15.9cm)
157-116	curved	6¼" (15.9cm)

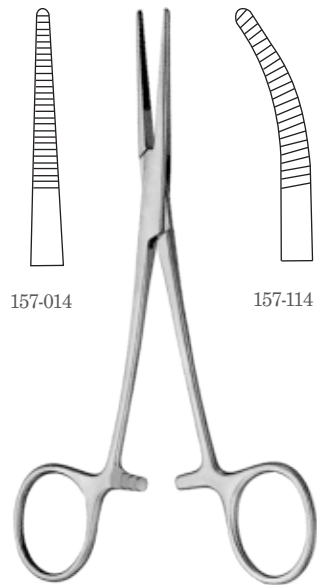

KELLY Forceps

Item #	Description	Length
157-014	straight	5½" (14.0cm)
157-114	curved	5½" (14.0cm)

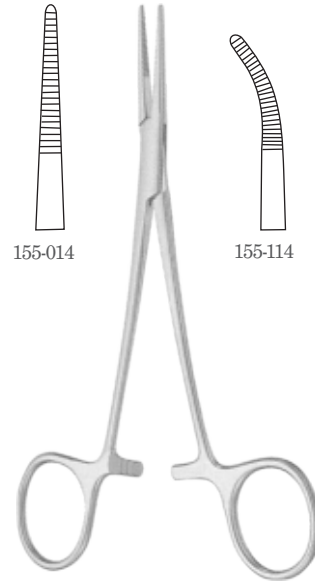

PROVIDENCE Hospital Forceps

Item #	Description	Length
155-014	straight	5½" (14.0cm)
155-114	curved	5½" (14.0cm)

FORCEPS

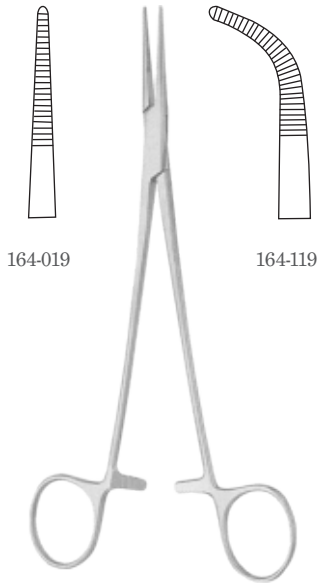

ADSON Hemostatic Forceps

Item #	Description	Length
164-019	straight	7¼" (18.4cm)
164-119	curved	7¼" (18.4cm)

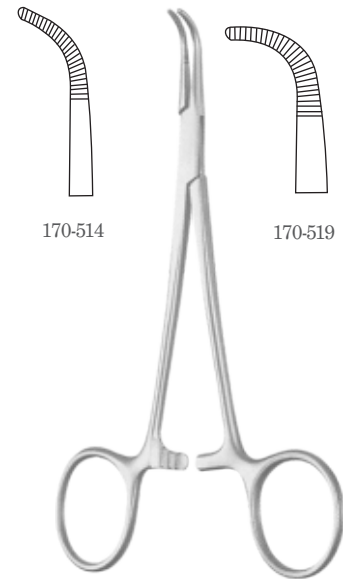

ADSON-BABY Forceps Narrow, Very Delicate, Curved

Item #	Length
170-514	5½" (14.0cm)
170-519	7½" (19.1cm)

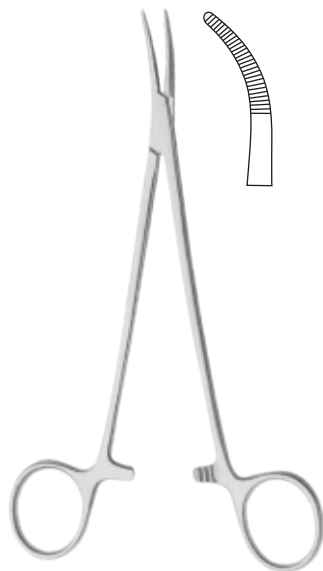

ADSON Hemostatic Forceps

Item #	Description	Length
164-118	curved, delicate pattern	7⅞" (18.1cm)

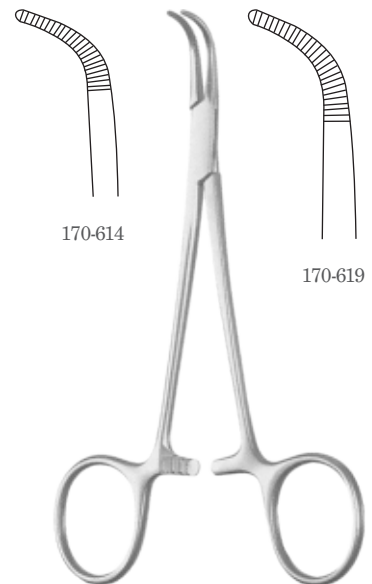

MIXTER-BABY Forceps Curved

Item #	Length
170-614	5½" (14.0cm)
170-619	7½" (19.1cm)

FORCEPS

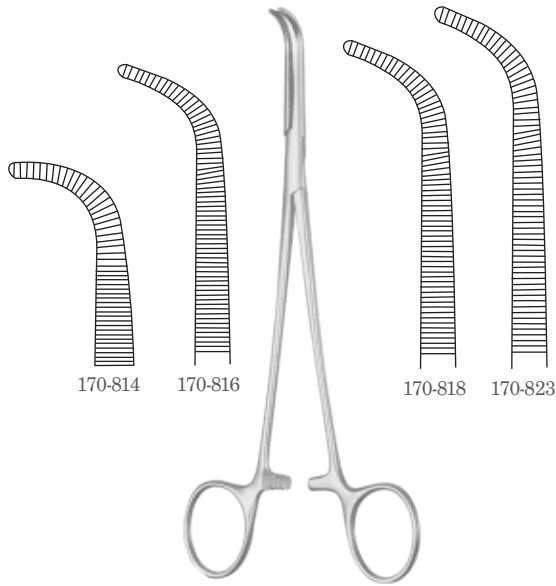

MIXTER Forceps
Strongly Curved

Item #	Length
170-814	5½" (14.0cm)
170-816	6¼" (15.9cm)
170-818	7½" (19.1cm)
170-823	9" (22.9cm)

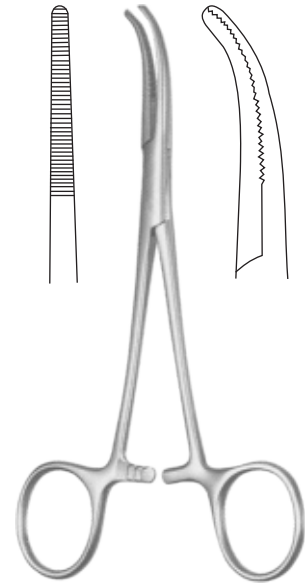

DANDY Forceps

Item #	Description	Length
161-184	curved sideways	5½" (14.0cm)

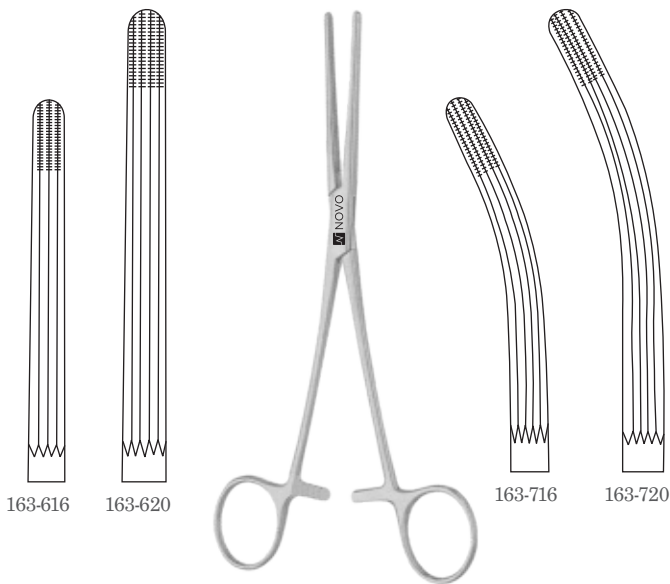

ROCHESTER-CARMALT Forceps

Item #	Description	Length
163-616	straight	6¼" (15.9cm)
163-620	straight	8" (20.3cm)
163-716	curved	6¼" (15.9cm)
163-720	curved	8" (20.3cm)

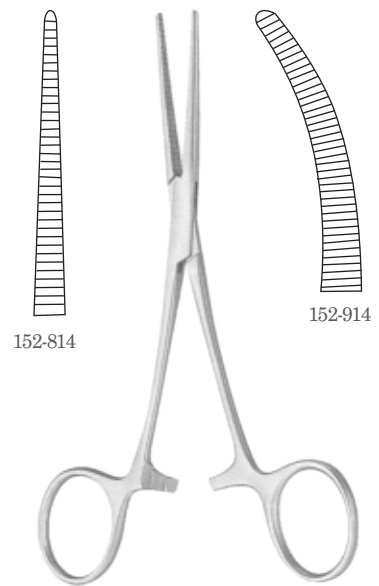

PEAN-BABY Forceps
Extra Delicate

Item #	Description	Length
152-814	straight	5½" (14.0cm)
152-914	curved	5½" (14.0cm)

FORCEPS

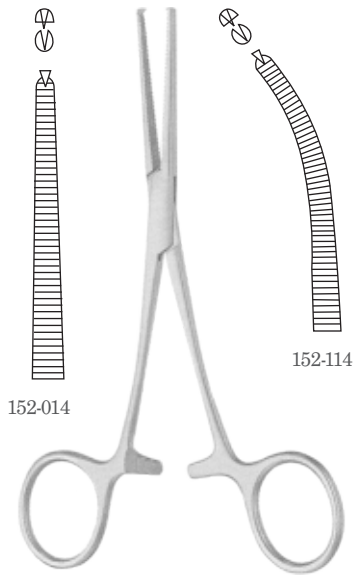

OCHSNER-BABY Forceps Extra Delicate

Item #	Description	Teeth	Length
152-014	straight	1x2	5½" (14.0cm)
152-114	curved	1x2	5½" (14.0cm)

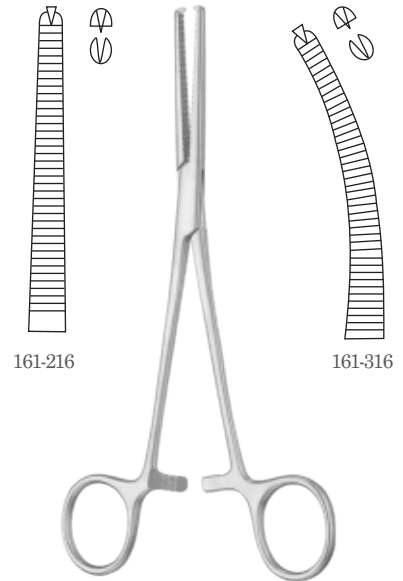

ROCHESTER-OCHSNER Forceps

Item #	Description	Length
161-216	straight	6¼" (15.9cm)
161-220	straight	8" (20.3cm)
161-222	straight	8¾" (22.2cm)
161-316	curved	6¼" (15.9cm)
161-318	curved	7¼" (18.4cm)
161-320	curved	8" (20.3cm)
161-322	curved	8¾" (22.2cm)

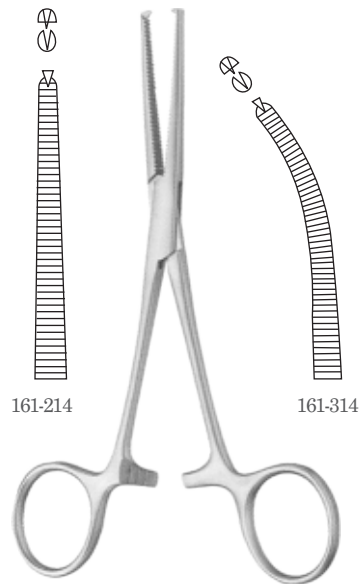

KOCHER Forceps

Item #	Description	Teeth	Length
161-214	straight	1x2	5½" (14.0cm)
161-314	curved	1x2	5½" (14.0cm)

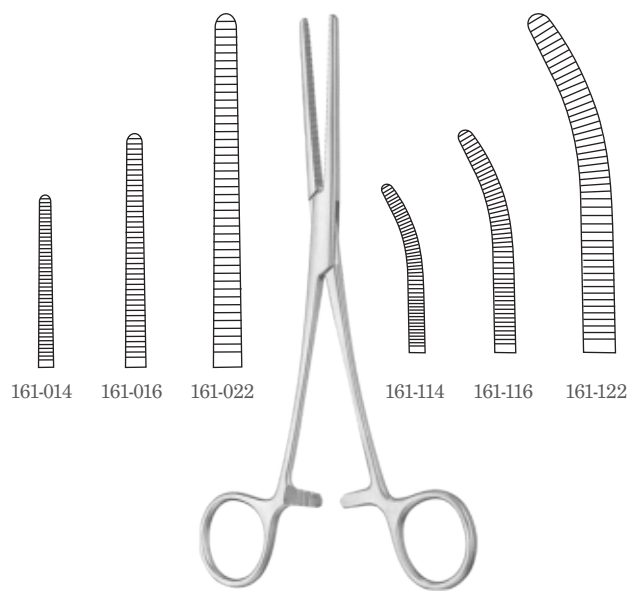

ROCHESTER-PEAN Forceps

Item #	Description	Length
161-014	straight	5½" (14.0cm)
161-016	straight	6¼" (15.9cm)
161-022	straight	8¾" (22.2cm)
161-114	curved	5½" (14.0cm)
161-116	curved	6¼" (15.9cm)
161-122	curved	8¾" (22.2cm)
161-120	curved	8"

FORCEPS

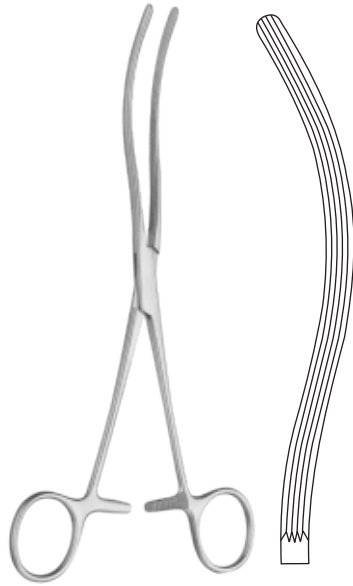

KOCHER Clamp Forceps

Item #	Description	Jaw	Length
502-326	curved, longitudinal serrations	5"	10¼" (26.0cm)

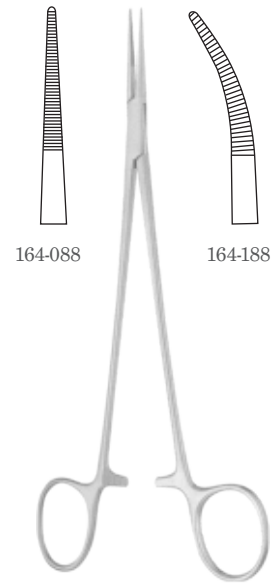

JACOBSON MICRO Artery Forceps

Delicate

Item #	Description	Length
164-088	straight	7 1/8" (18.1cm)
164-188	curved	7 1/8" (18.1cm)

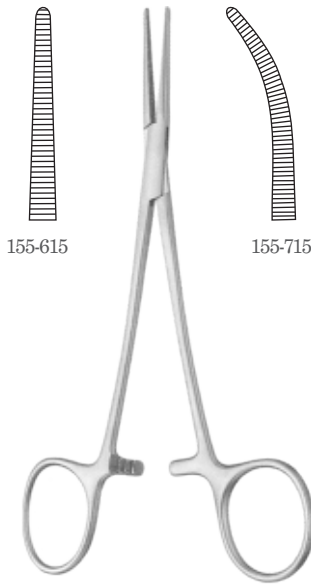

LERICHE Artery Forceps

Item #	Description	Length
155-615	straight	6" (15.2cm)
155-715	curved	6" (15.2cm)

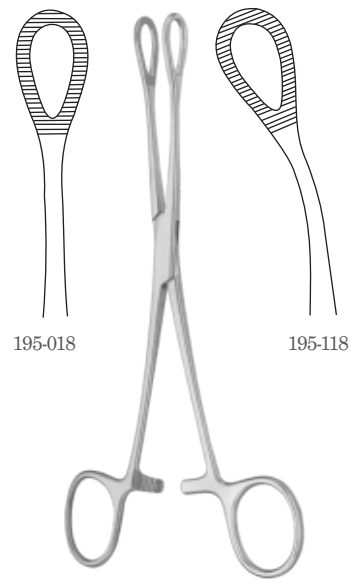

FOERSTER Sponge Forceps

Item #	Description	Length
195-018	straight, serrated jaws	7" (17.8cm)
195-024	straight, serrated jaws	9½" (24.1cm)
195-118	curved, serrated jaws	7" (17.8cm)
195-124	curved, serrated jaws	9½" (24.1cm)
195-218	straight, smooth jaws	7" (17.8cm)
195-224	straight, smooth jaws	9½" (24.1cm)
195-318	curved, smooth jaws	7" (17.8cm)
195-324	curved, smooth jaws	9½" (24.1cm)

FORCEPS



JONES Towel Clamp
Cross Action

Item #	Length
175-008	3 1/8 (7.9cm)

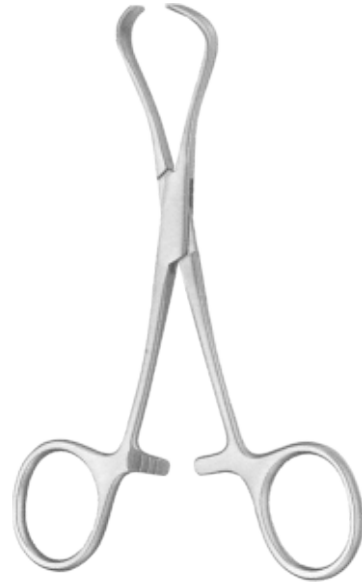

LORNA (EDNA) Non-Perforating Towel Forceps

Item #	Length
175-709	3 1/2" (8.9cm)
175-714	5 1/4" (13.3cm)



BACKHAUS Towel Clamp

Item #	Length
175-508	3 1/2" (8.9cm)
175-513	5 1/4" (13.3cm)



NON-PERFORATING Towel Clamp

Item #	Length
175-783	5 1/8 (13.0cm)

FORCEPS



YOUNG Tongue Seizing Forceps

Item #	Description	Length
458-216	with soft rubber jaws	6½" (16.5cm)
458-217	replacement rubber jaws for YOUNG tongue seizing forceps	

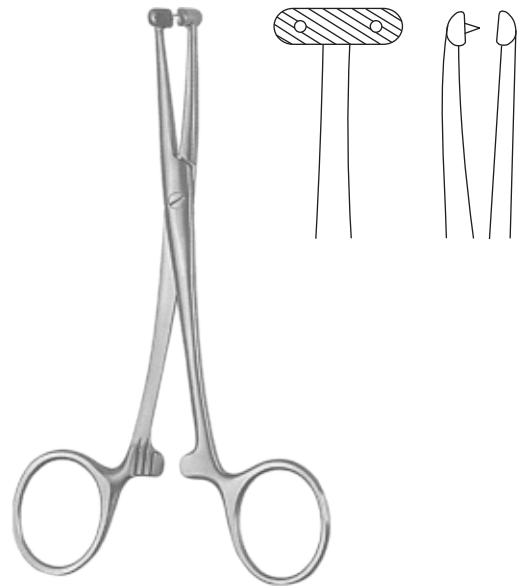

DEMARTEL Scalp/Flap Grasping Forceps

Item #	Length
531-314	5½" (14.0cm)



LAHEY Traction Forceps

Item #	Teeth	Length
737-233	3x3	6¼" (15.9cm)



RANEY Scalp Clip Applying Forceps

Item #	Description	Length
578-505	forceps	6¼" (15.9cm)
578-501	RANEY reusable scalp clips, 10 clips per unit	

FORCEPS

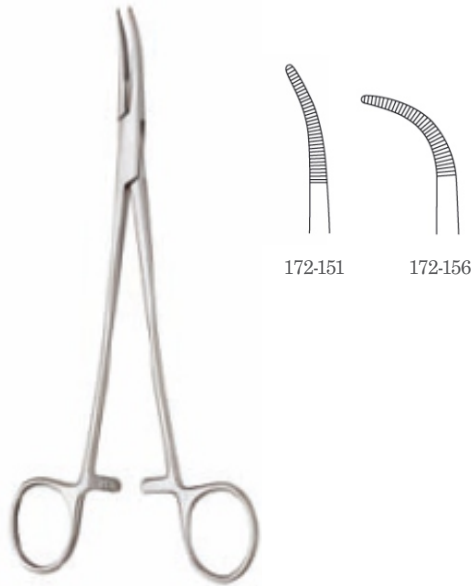

SCHNIDT Tonsil Forceps

Closed Rings

Item #	Description	Length
172-151	"BOETTCHER," light curve	7½" (19.1cm)
172-156	"SAWTELL," full curve	7½" (19.1cm)



SCHNIDT Tonsil Forceps

One Open Ring

Item #	Description	Length
172-150	"BOETTCHER," light curve	7½" (19.1cm)
172-155	"SAWTELL," full curve	7½" (19.1cm)



BABCOCK Tissue Forcep

Item #	Description	Length
501-016	Standard Pattern	6 1/4"
501-020	Standard Pattern	8"
501-023	Standard Pattern	9"
501-024	Standard Pattern	12"
501-026	Standard Pattern	14"
501-040	Standard Pattern	16"
501-045	Standard Pattern Baby -	18"
501-015	Babcock Delicate Baby -	6 1/4"
501-014	Babcock Delicate	5 1/4"

NEEDLE HOLDERS



RUBIO Wire Twister
Tungsten Carbide

Item #	Description	Length
323-02	serrated jaws, snub nose	5" (12.7cm)



BAUMGARTNER Needle Holder
Tungsten Carbide

Item #	Description	Length
321-10	serrated jaws	5½" (14.0cm)



CORWIN Wire Twister
Tungsten Carbide

Item #	Description	Length
321-24	serrated jaws	6" (15.2cm)



MAYO-HEGAR Needle Holder
Tungsten Carbide, Serrated Jaws

Item #	Length
321-20	6" (15.2cm)
321-30	7" (17.8cm)
321-40	8" (20.3cm)
321-45	9" (22.9cm)

NEEDLE HOLDERS

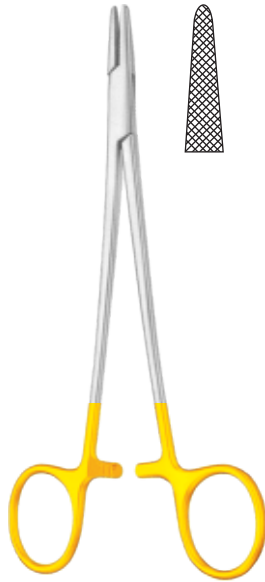

MAYO-HEGAR Needle Holder
Tungsten Carbide, Serrated Jaws, Left-Handed

Item #	Length
321-20L	6" (15.2cm)
321-30L	7" (17.8cm)
321-40L	8" (20.3cm)



CRILE-WOOD Needle Holder
Tungsten Carbide, Left-Handed

Item #	Description	Length
324-35L	smooth jaws	6" (15.2cm)
324-30L	serrated jaws	6" (15.2cm)
323-20L	serrated jaws	7" (17.8cm)
323-25L	serrated jaws	8" (20.3cm)
323-50L	serrated jaws	9" (22.9cm)



CRILE-WOOD Needle Holder
Tungsten Carbide

Item #	Description	Length
324-30	serrated jaws	6" (15.2cm)
324-35	smooth jaws	6" (15.2cm)
323-20	serrated jaws	7" (17.8cm)
323-30	serrated jaws, curved	7" (17.8cm)
323-25	serrated jaws	8" (20.3cm)
323-50	serrated jaws	9" (22.9cm)
323-60	serrated jaws, curved	9" (22.9cm)



OLSEN-HEGAR Needle Holder & Scissors
Tungsten Carbide

Item #	Description	Length
321-59	serrated jaws	4½" (11.4cm)
321-59S	smooth jaws	4½" (11.4cm)
321-60	serrated jaws	5½" (14.0cm)
321-60S	smooth jaws	5½" (14.0cm)
321-70	serrated jaws	6½" (16.5cm)
321-80	serrated jaws	7½" (19.1cm)

NEEDLE HOLDERS

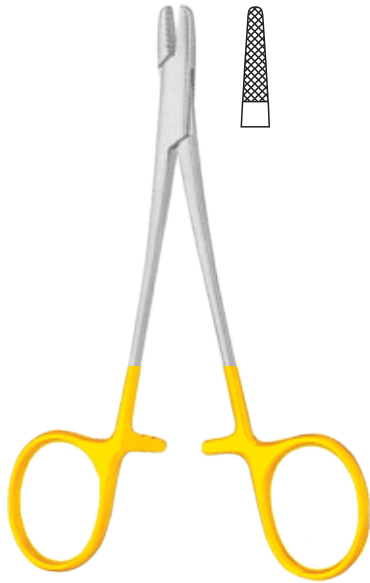

DERF Needle Holder
Tungsten Carbide, Serrated Jaws

Item #	Description	Length
324-00	standard pattern	4 $\frac{3}{4}$ " (12.1cm)
324-00L	left-handed	4 $\frac{3}{4}$ " (12.1cm)

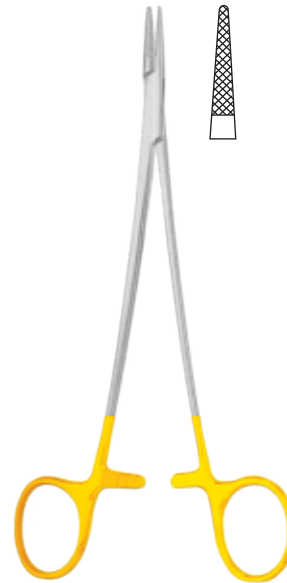

MICRO Vascular Needle Holder
Tungsten Carbide

Item #	Description	Length
324-31	serrated jaws	6" (15.2cm)
324-31S	smooth jaws	6" (15.2cm)
323-22	serrated jaws	7" (17.8cm)
323-52	serrated jaws	8" (20.3cm)



HALSEY Needle Holder
Tungsten Carbide

Item #	Description	Length
324-10	serrated jaws	5" (12.7cm)
324-15	smooth jaws	5" (12.7cm)
324-10L	serrated jaws, left-handed	5" (12.7cm)
324-15L	smooth jaws, left-handed	5" (12.7cm)



WEBSTER Needle Holder
Tungsten Carbide

Item #	Description	Length
324-05	"baby," smooth jaws, delicate pattern	4 $\frac{3}{4}$ " (12.1cm)
324-07	"baby," serrated jaws, delicate pattern	4 $\frac{3}{4}$ " (12.1cm)
324-06	smooth jaws, standard pattern	5" (12.7cm)

NEEDLE HOLDERS



GILLIES Needle Holder
Tungsten Carbide, Needle Holder & Scissors Combination on Offset Design

Item #	Description	Length
324-25	curved, serrated jaws	6¼" (15.9cm)

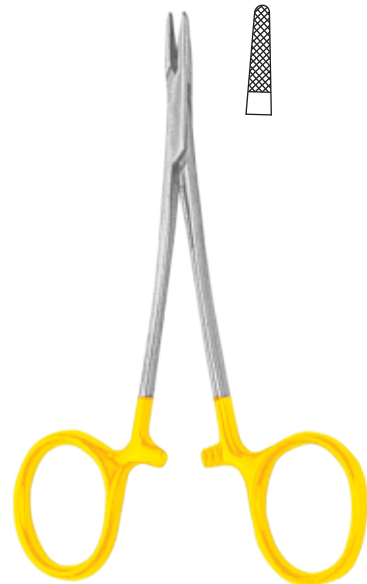

PAR Needle Holder
Tungsten Carbide, Serrated Jaws, Delicate

Item #	Length
324-03	4½" (11.4cm)
324-04	5" (12.7cm)



NEIVERT Needle Holder
Tungsten Carbide

Item #	Description	Length
324-20	serrated jaws, one angled ring	5" (12.7cm)

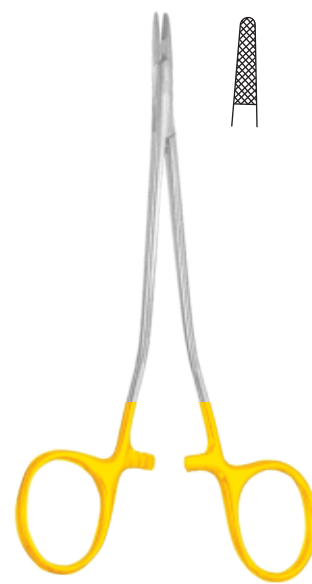

SWEDISH Needle Holder
Tungsten Carbide

Item #	Description	Length
324-60	serrated jaws, light handles	6.5" (16.5cm)

NEEDLE HOLDERS



RYDER Needle Holder
Tungsten Carbide

Item #	Description	Length
324-65	serrated jaws	5" (12.7cm)
324-66	serrated jaws	6" (15.2cm)
324-67	serrated jaws	7" (17.8cm)
324-68	serrated jaws	8" (20.3cm)
324-69	serrated jaws	9" (22.9cm)
324-65S	smooth jaws	5" (12.7cm)
324-66S	smooth jaws	6" (15.2cm)
324-67S	smooth jaws	7" (17.8cm)
324-68S	smooth jaws	8" (20.3cm)



CONVERSE-DERF Needle Holder

Item #	Description	Length
101-282	longitudinal serrations, large finger rings	4 1/4" (10.8cm)



CASTROVIEJO Needle Holder
Tungsten Carbide, with Lock

Item #	Description	Length
324-40	straight, serrated jaws	5 1/2" (14.0cm)
324-41	curved, serrated jaws	5 1/2" (14.0cm)
324-42	straight, serrated jaws	8 1/2" (21.6cm)
324-45	straight, smooth jaws	5 1/2" (14.0cm)
324-46	curved, smooth jaws	5 1/2" (14.0cm)
324-47	straight, smooth jaws	8 1/2" (21.6cm)



DERF Needle Holder

Item #	Length
100-212	4 3/4" (12.1cm)

NEEDLE HOLDERS

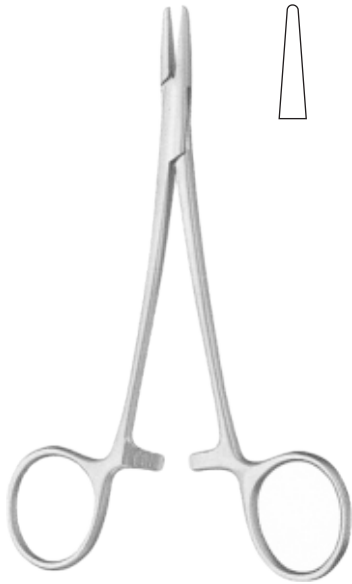

WEBSTER Needle Holder
Smooth Jaws

Item #	Description	Length
101-012	"baby," extra delicate	4 $\frac{3}{4}$ " (12.1cm)
101-014	delicate, standard pattern	5" (12.7cm)



HALSEY Needle Holder

Item #	Description	Length
101-213	serrated jaws	5 $\frac{3}{8}$ " (13.7cm)
101-013	smooth jaws	5 $\frac{3}{8}$ " (13.7cm)



BROWN Needle Holder

Item #	Description	Length
101-513	convex jaws, fine serrations	5 $\frac{1}{4}$ " (13.3cm)

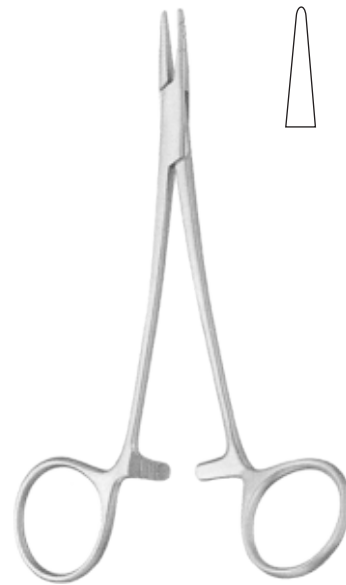

NEIVERT Needle Holder

Item #	Description	Length
100-812	one offset ring	5" (12.7cm)

NEEDLE HOLDERS



GILLIES Needle Holder
with Suture Scissors

Item #	Description	Length
105-916	curved, one fenestrated jaw	6½" (16.5cm)



MAYO-HEGAR Needle Holder
Fenestrated Jaws

Item #	Length
101-813	5" (12.7cm)
101-815	6" (15.2cm)
101-818	7" (17.8cm)
101-820	8" (20.3cm)
101-823	9" (22.9cm)

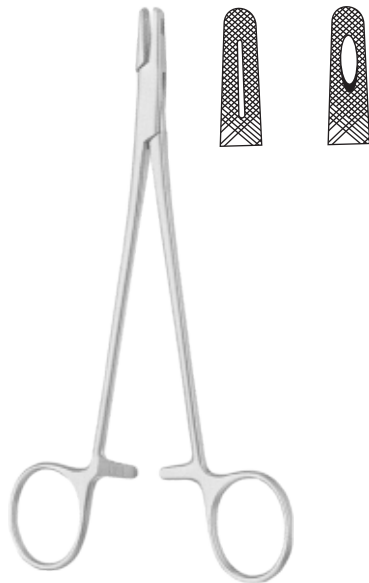

METZENBAUM Needle Holder
Fenestrated Jaws

Item #	Description	Length
103-618	straight	7¼" (18.4cm)
103-620	curved	7¼" (18.4cm)



CRILE-WOOD Needle Holder
Serrated Jaws

Item #	Length
102-015	6" (15.2cm)
102-018	7" (17.8cm)
102-020	8" (20.3cm)

NEEDLE HOLDERS



CASTROVIEJO Needle Holder
Smooth

Item #	Description	Length
601-917	straight, with lock	5½" (14.0cm)
601-909	curved, with lock	5½" (14.0cm)
601-921	straight, without lock	5½" (14.0cm)
601-910	curved, without lock	5½" (14.0cm)



MICROSURGERY Needle Holder
Round Handles

Item #	Description	Length
552-880	straight jaws, without lock	7" (17.8cm)
552-881	curved jaws, without lock	7" (17.8cm)
552-882	straight jaws, with lock	7" (17.8cm)
552-883	curved jaws, with lock	7" (17.8cm)



BARRAQUER Micro Needle Holder
Round Handles

Item #	Description	Length
601-906	straight jaws, without lock	5" (12.7cm)
601-903	curved jaws, without lock	5" (12.7cm)
601-905	straight jaws, with lock	5" (12.7cm)
601-904	curved jaws, with lock	5" (12.7cm)

RETRACTORS



FRAZIER Skin Hook

Item #	Description	Diam.	Length
203-013	blunt point	5.0mm	5" (12.7cm)
203-012	sharp point	5.0mm	5" (12.7cm)



TYRELL Hook

Item #	Description	Diam.	Length
602-202	sharp	2.0mm	5" (12.7cm)
602-203	blunt	2.0mm	5" (12.7cm)



KILNER Skin Hook

Knurled Handle

Item #	Description	Diam.	Length
205-109	sharp	4.5mm	5" (12.7cm)

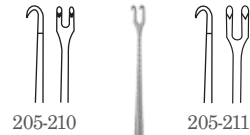

GUTHRIE Hook

Delicate, Sharp, Double Prongs

Item #	Tip Width	Length
205-210	1.5mm	4 ³ / ₄ " (12.1cm)
205-211	2.0mm	4 ³ / ₄ " (12.1cm)

RETRACTORS



205-202

FREER Skin Hook

Item #	Description	Tip Width	Length
205-202	sharp, double prongs	2.5mm	6" (15.2cm)



205-001

JOSEPH Single Hook

Item #	Description	Length
205-001	one sharp prong	6 1/4" (15.9cm)



205-002

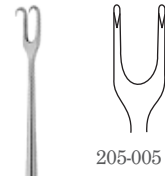

205-005



205-007



205-010



JOSEPH Double Hook

Two Sharp Prongs

Item #	Tip Width	Length
205-002	2.0mm	6 1/4" (15.9cm)
205-005	5.0mm	6 1/4" (15.9cm)
205-007	7.0mm	6 1/4" (15.9cm)
205-010	10.0mm	6 1/4" (15.9cm)
205-012	12.0mm	6 1/4" (15.9cm)



203-019



203-020



GILLIES (CONVERSE) Skin Hook

Item #	Description	Length
203-019	small	7" (17.8cm)
203-020	large	7" (17.8cm)

RETRACTORS



COTTLE Skin Hook

Item #	Description	Length
630-302	small, shallow curve	5½" (14.0cm)
630-303	small, deep curve	5½" (14.0cm)
630-304	large, deep curve	5½" (14.0cm)



LAHEY Hook/Retractor

Item #	Description	Diam.	Length
203-031	1-sharp prong	3.0mm	4¾" (12.1cm)
203-032	2-sharp prongs	4.0mm	4¾" (12.1cm)

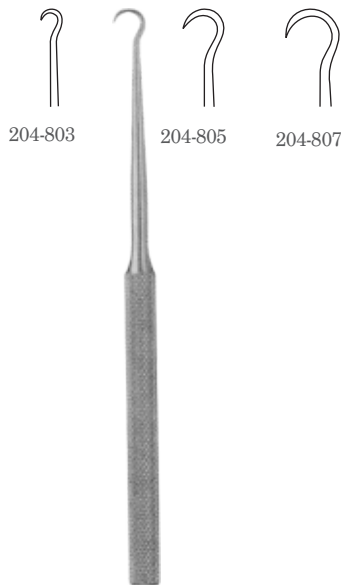

KLEINERT-KUTZ Hook

Item #	Description	Diam.	Length
204-803	small	3.0mm	6" (15.2cm)
204-805	medium	5.0mm	6" (15.2cm)
204-807	large	7.0mm	6" (15.2cm)



HUMBY Double Skin Hook

Item #	Description	Diam.	Length
203-532	sharp, hinged, adjustable	3.0mm	4¾" (12.1cm)

RETRACTORS



BARSKY Double Skin Hook
Knurled Handle

Item #	Description	Tip Width	Length
203-502	sharp, double hook	9.5mm	6" (15.2cm)



DINGMAN Zygoma Hook

Item #	Description	Diam.	Length
771-010	heavy, sharp	9.0mm	7" (17.8cm)

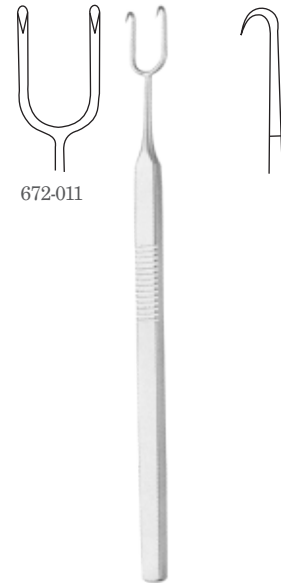

COTTLE Retractor/Hook

Item #	Description	Tip Width	Length
672-011	2 sharp prongs	12.0mm	5½" (14.0cm)
672-012	2 ball end prongs	12.0mm	5½" (14.0cm)

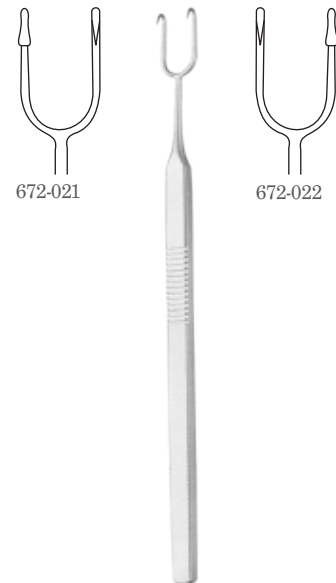

COTTLE Nasal Retractor/Hook
One Blunt Ball-End Prong, One Sharp Prong

Item #	Description	Tip Width	Length
672-021	ball right	10.0mm	5½" (14.0cm)
672-022	ball left	10.0mm	5½" (14.0cm)

RETRACTORS



NASAL Tenaculum Hook

Item #	Description	Width	Length
203-506	2 sharp prongs	6.0mm	6¼" (15.9cm)
203-507	2 sharp prongs	7.0mm	6¼" (15.9cm)
203-509	2 sharp prongs	9.0mm	6¼" (15.9cm)



COTTLE-NEIVERT Retractor Needle Guide

Item #	Length
672-052	8¼" (21.0cm)

RETRACTORS

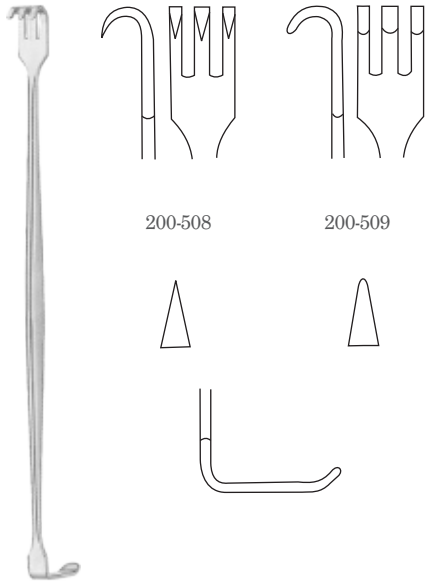

SENN Retractor
Double-Ended

Item #	Description	Length
200-508	sharp	6 ³ / ₈ " (16.2cm)
200-509	blunt	6 ³ / ₈ " (16.2cm)



MATHIEU Retractor
Double-Ended

Item #	Description	Length
200-512	blunt	6 ¹ / ₂ " (16.5cm)
200-513	sharp	6 ¹ / ₂ " (16.5cm)



LOVE Nerve Root Retractor

Item #	Description	Width	Length
201-701	straight	7.0mm	8 ¹ / ₂ " (21.6cm)
201-702	angled, 45 degrees	7.0mm	8 ¹ / ₂ " (21.6cm)
201-703	angled, 90 degrees	7.0mm	8 ¹ / ₂ " (21.6cm)



RAGNELL Retractor
Double-Ended

Item #	Width	Length
200-525	3.0mm x 8.0mm blades, 5.0mm x 15.0mm blades	6" (15.2cm)

RETRACTORS

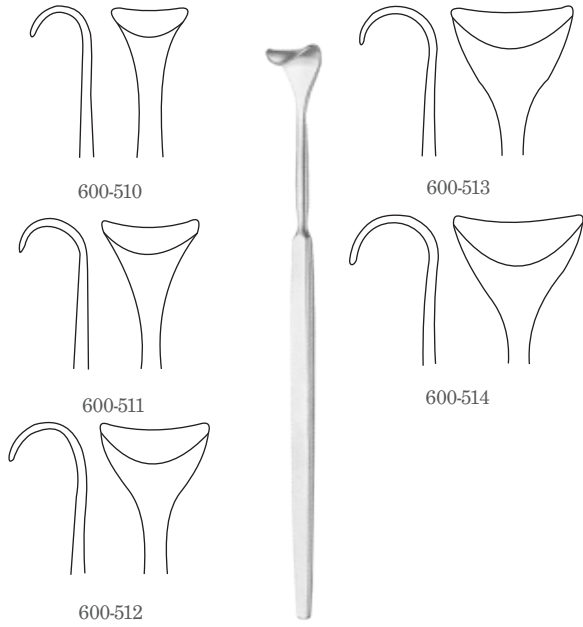

DESMARRES Lid Retractor

Item #	Size	Width	Length
600-510	#0	10.0mm	5½" (14.0cm)
600-511	#1	12.0mm	5½" (14.0cm)
600-512	#2	14.0mm	5½" (14.0cm)
600-513	#3	16.0mm	5½" (14.0cm)
600-514	#4	18.0mm	5½" (14.0cm)



DESMARRES Lid Retractor

Insulated, Non-Conductive

Item #	Size	Width	Length
600-511NC	#0	10.0mm	5½" (14.0cm)
600-512NC	#1	12.0mm	5½" (14.0cm)
600-513NC	#2	14.0mm	5½" (14.0cm)



DESMARRES Double-Ended Retractor

Insulated, Non-Conductive

Item #	Width	Length
600-518	8.0mm x 10.0mm	6" (15.2cm)



CUSHING Vein Retractor

Item #	Width	Length
201-750	11.0mm x 13.0mm	9" (22.9cm)

RETRACTORS



FARABEUF-BABY Retractor
Double-Ended, Set of 2

Item #	Length
221-012	4¾" (12.1cm)



DEAVER Retractor
Delicate

Item #	Width	Length
237-225	1"	8" (20.3cm)
237-217	5/8"	8" (20.3cm)



U.S. ARMY Retractor
Double-Ended, Set of Two

Item #	Length
221-821	8½" (21.6cm)



DEAVER Retractor

Item #	Description	Width	Length
237-504	size 1	1"	12" (30.5mm)
237-505	size 2	1"	13" (33.0mm)
237-507	size 3	1½"	12" (30.5mm)
237-508	size 4	2"	12" (30.5mm)

RETRACTORS



CRILE Retractor

Item #	Description	Length
200-930	double-ended, 3.0mm x 11.0mm and 6.0mm x 20.0mm blades	4½" (11.4cm)



RIBBON Retractor
Malleable

Item #	Width	Length
220-000	5/8"	6¾" (17.1cm)
220-006	¼"	8" (20.3cm)
220-012	½"	8" (20.3cm)
220-017	5/8"	8" (20.3cm)
220-020	¾"	8" (20.3cm)
220-025	1"	8" (20.3cm)
220-251	¾"	13" (33.0cm)
220-252	1"	13" (33.0cm)
220-253	1"	13" (33.0cm)
220-254	1¼"	13" (33.0cm)
220-255	1½"	13" (33.0cm)
220-256	2"	13" (33.0cm)
220-257	2½"	13" (33.0cm)
	3"	13" (33.0cm)

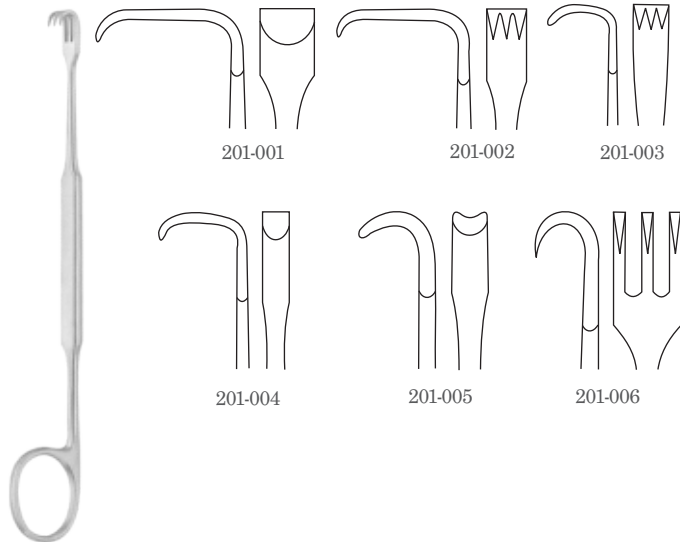

MEYERDING Finger Retractor

Item #	Description	Size	Length
201-001	style A, long blunt blade	6.0mm x 17.0mm	7" (17.8cm)
201-002	style B, long-toothed blade	5.0mm x 16.0mm	7" (17.8cm)
201-003	style C, short-toothed blade	3.0mm x 6.0mm	7" (17.8cm)
201-004	style D, short blunt blade	3.0mm x 10.0mm	7" (17.8cm)
201-005	style E, curved blunt blade	4.0mm x 8.0mm	7" (17.8cm)
201-006	style F, curved three-pronged sharp blade	10.0mm x 4.0mm	7" (17.8cm)



SPRING Retractor

Item #	Description	Length
240-301	1x1 sharp prongs	3 5/8" (8.6cm)

RETRACTORS

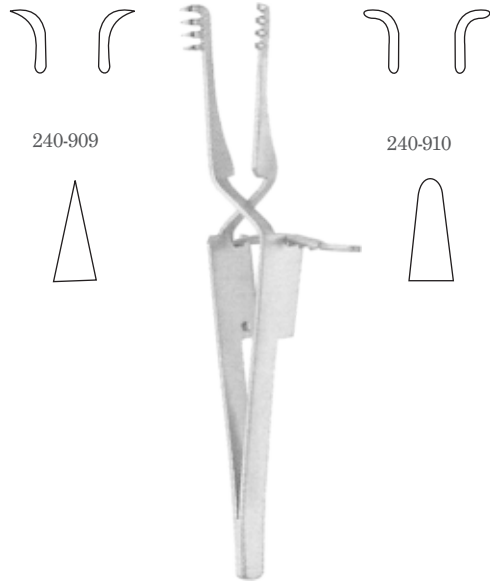

HEISS (HOLZHEIMER) Cross Action Retractor

Item #	Description	Length
240-909	4x4 sharp prongs	4" (10.2cm)
240-910	4x4 blunt prongs	4" (10.2cm)



GELPI Retractor

Item #	Length
244-013	3½" (8.9cm)
244-015	4½" (11.4cm)
244-014	5½" (14.0cm)
244-018	7½" (19.1cm)

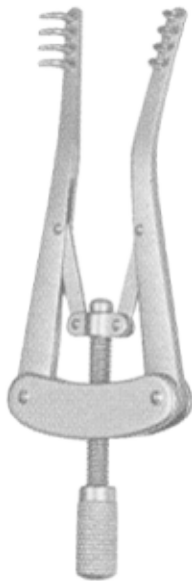

ALM Retractor

Item #	Description	Length
241-007	4x4 sharp prongs, 2.0" spread	2¾" (7.0cm)
241-008	4x4 blunt prongs, 2.0" spread	2¾" (7.0cm)
241-010	4x4 sharp prongs, 2.5" spread	4" (10.2cm)
241-011	4x4 blunt prongs, 2.5" spread	4" (10.2cm)

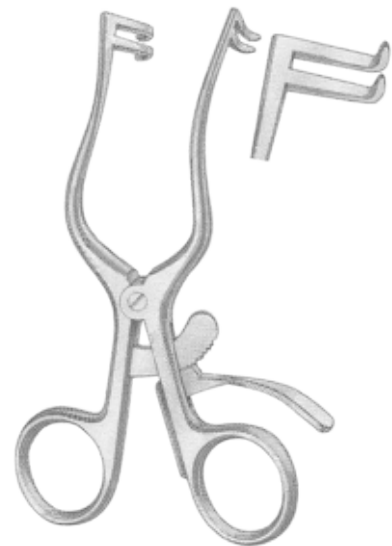

PAPARELLA-WEITLANER Retractor

Item #	Description	Length
610-604	3.3cm inside spread, 2x2 semi-sharp teeth, self-retaining prongs, 13.0mm long	5 ¾" (13.0cm)

RETRACTORS



WEITLANER Retractor

Item #	Description	Length
242-210	sharp prongs, 2x3	4¼" (10.8cm)
242-213	sharp prongs, 3x4	5½" (14.0cm)
242-216	sharp prongs, 3x4	6½" (16.5cm)
242-211	blunt prongs, 2x3	4¼" (10.8cm)
242-214	blunt prongs, 3x4	5½" (14.0cm)
242-217	blunt prongs, 3x4	6½" (16.5cm)



JAEGER Lid Plate

Item #	Width	Length
600-595	21.0mm and 24.0mm ends	4¼" (10.8cm)



S Retractor

Item #	Description	Length
906-004	double-ended, 15.0mm x 11.0mm and 14.0mm x 10.0mm blades	4½" (11.4cm)

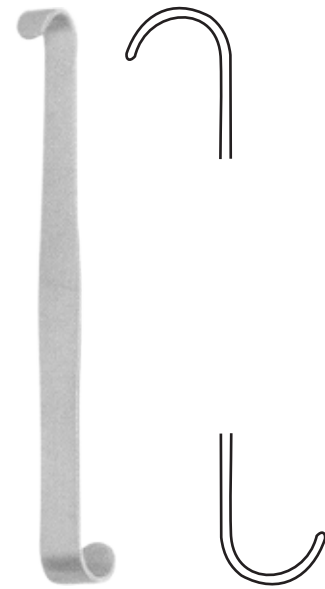

LUER "S" Shape Retractor

Item #	Description	Length
200-911	double-ended, 10.0mm x 5.0mm and 14.0mm x 9.0mm	5½" (14.0cm)

RETRACTORS

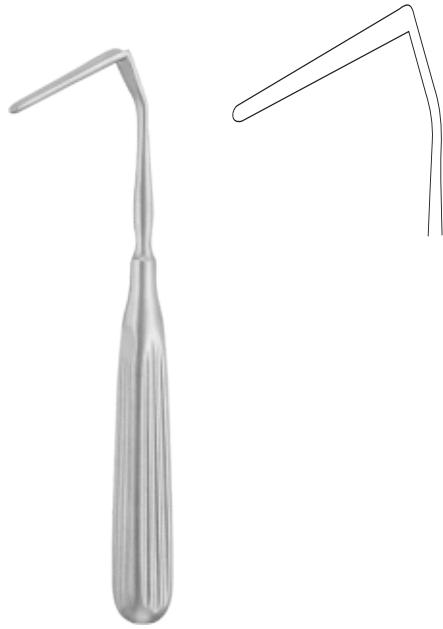

AUFRICHT Nasal Retractor
Solid Blade

Item #	Blade	Length
672-135	10.0mm x 45.0mm	7 $\frac{1}{8}$ " (18.1cm)
672-136	11.0mm x 60.0mm	7 $\frac{1}{8}$ " (18.1cm)



KASDAN Hand Retractor

Item #	Description	Length
678-760	double-ended, 13.0mm x 6.5mm and 19.0mm x 9.5mm	6 $\frac{1}{4}$ " (15.9cm)



CONVERSE Blade Retractor

Item #	Width	Length
634-016	set of 4	3 $\frac{1}{2}$ " (8.9cm)
634-017	9.0mm x 19.0mm	3 $\frac{1}{2}$ " (8.9cm)
634-018	13.0mm x 30.0mm	3 $\frac{1}{2}$ " (8.9cm)
634-019	13.0mm x 43.0mm	3 $\frac{1}{2}$ " (8.9cm)
634-020	13.0mm x 55.0mm	3 $\frac{1}{2}$ " (8.9cm)

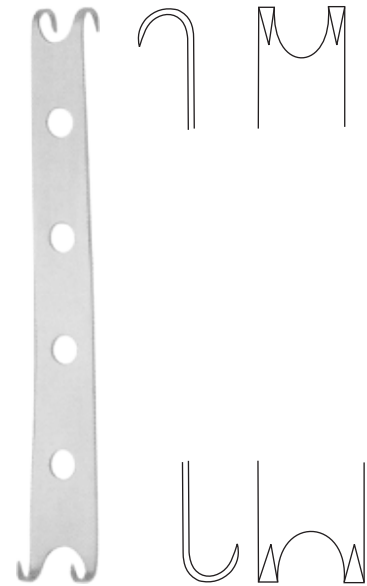

CONVERSE Alar Retractor

Item #	Description	Length
672-010	double-ended	4" (10.2cm)

RETRACTORS



FREEMAN Flap Retractor

Item #	Width	Length
222-002	½" (12.7mm) blade	8" (20.3cm)
222-003	1" (25.4mm) blade	8" (20.3cm)



MILLARD Thumb Double Hook

Item #	Description	Width	Length
672-023	with thumb ring	5.0mm x 12.0mm	2 ½" (5.4cm)



MALINIAC Nasal Retractor

Item #	Width	Length
672-125	45.0mm x 9.0mm blade	4" (10.2cm)



MARTINEZ-KILNER Nasal Retractor

Item #	Description	Width	Length
672-009	2 sharp prongs with thumb ring	7.5mm	4 ¼" (10.8cm)

RETRACTORS

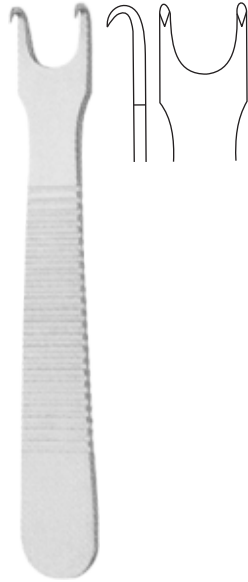

KILNER Alae Retractor

Item #	Description	Width	Length
672-007	2 sharp prongs	9.5mm	3 1/8" (7.9cm)



ROLLET (KNAPP) Retractor

Item #	Description	Width	Length
205-517	with 4 sharp prongs	6.0mm	5 1/4" (13.3cm)



KNAPP Retractor

Item #	Description	Width	Length
205-516	with 4 blunt prongs	6.0mm	5 1/4" (13.3cm)



FLEXIBLE Neck Rake Retractor

Item #	Description	Length
206-450	1 sharp prong	6" (15.2cm)
206-550	1 blunt prong	6" (15.2cm)
206-452	2 sharp prongs	6" (15.2cm)
206-552	2 blunt prongs	6" (15.2cm)
206-453	3 sharp prongs	6" (15.2cm)
206-553	3 blunt prongs	6" (15.2cm)

RETRACTORS



MILLER Rake Retractor

Item #	Description	Length
222-044	9 blunt prongs	5¼" (13.3cm)
222-043	9 sharp prongs	5¼" (13.3cm)



YANCOSKIE CORONAL Lift Retractor

Item #	Description	Width	Length
222-265	6 offset sharp prongs	18.0cm	9" (22.9cm)



RIGID Neck Rake Retractor

Item #	Description	Width	Length
206-601	1 sharp prong	n/a	6" (15.2cm)
206-602	2 sharp prongs	5.0mm	6" (15.2cm)
206-603	3 sharp prongs	9.0mm	6" (15.2cm)
206-604	4 sharp prongs	12.0mm	6" (15.2cm)
206-701	1 blunt prong	n/a	6" (15.2cm)
206-702	2 blunt prongs	5.0mm	6" (15.2cm)
206-703	3 blunt prongs	9.0mm	6" (15.2cm)
206-704	4 blunt prongs	12.0mm	6" (15.2cm)



CORONAL BROW Lift Retractor

Item #	Description	Width	Length
222-008	7 sharp offset prongs, small curved finger grip on end of handle	7.0cm	7¼" (18.4cm)

RETRACTORS



YANCOSKIE Abdominoplasty Retractor

Item #	Description	Width	Length
222-130	6 sharp in-line prongs, lightweight design with ergonomic rib grip handle	6"	7½" (19.1cm)



GORNEY Rake Retractor
Spring Neck

Item #	Description	Width	Length
206-465	4 sharp prongs	1.5"	3" (7.6cm)



MAXWELL Flap Retractor

Item #	Width	Length
222-006	38.0mm	4" (10.2cm)
222-007	22.0mm	4" (10.2cm)



FREEMAN Rake Retractor

Item #	Description	Width	Length
222-010	4 sharp prongs	1"	4¼" (10.8cm)
222-013	4 sharp prongs	1½"	4" (10.2cm)
222-018	4 blunt prongs	¾"	7" (17.8cm)
222-019	4 sharp prongs	7/8"	7" (17.8cm)
222-024	4 sharp prongs	1½"	7" (17.8cm)

RETRACTORS



FREEMAN Mini Rake Retractor

Item #	Description	Width	Length
222-014	4 sharp prongs, with small curved grip on end of handle	1"	4¾"(12.1cm)



BIGGS Face Lift Retractor

Item #	Width	Length
222-284	5.2mm	8" (20.3cm)

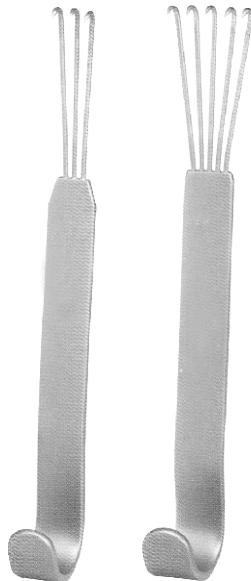

ANDERSON Bear Claw Retractor

Item #	Description	Length
222-001	3 prongs	4¾"(12.1cm)
222-005	5 prongs	4¾"(12.1cm)



FERREIRA Face Lift Retractor

Item #	Width	Length
242-440	22.0mm	4¼" (10.8cm)

ELEVATORS



FREER Spatula
Hoe-Shaped

Item #	Blade	Length
665-262	5.0mm x 2.8mm	6½" (16.5cm)



GORNEY Septum Suction Elevator

Item #	Tip Width	Length
637-570	3.0mm	8½" (21.6cm)



PIERCE Septum Elevator
Double-Ended

Item #	Description	Length
665-455	with right and left blades	8½" (21.6cm)

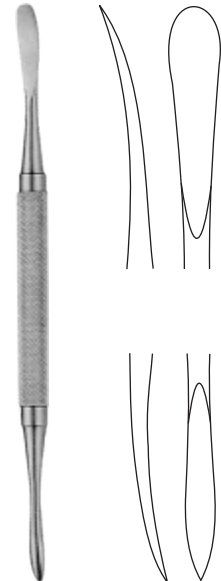

DINGMAN Periosteal Elevator
Double-Ended

Item #	Width	Length
680-905	5.8mm x 6.7mm	7¼" (18.4cm)

ELEVATORS

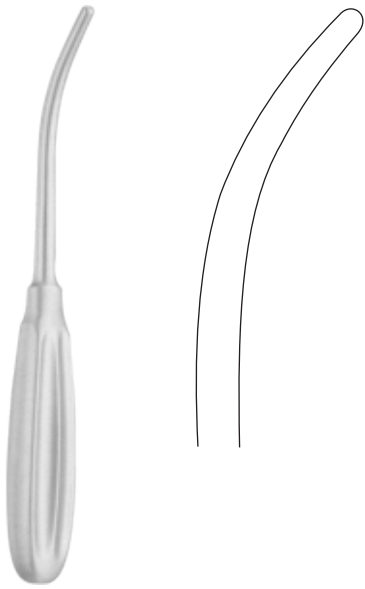

DINGMAN Zygomatic Elevator

Item #	Tip Width	Length
680-920	5.5mm	8¾" (22.2cm)

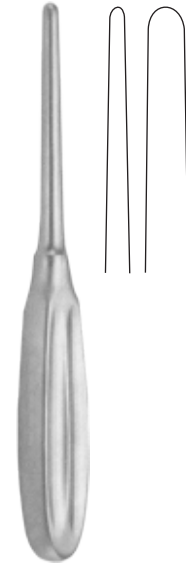

GOLDMAN Displacer Septum Elevator
Slightly-Tapered Blade

Item #	Tip Width	Length
671-575	6.0mm	7½" (19.1cm)

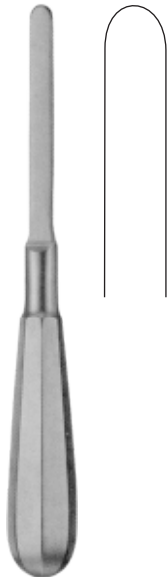

BOIES Nasal Fracture Elevator

Item #	Tip Width	Length
671-570	9.0mm	7½" (19.1cm)

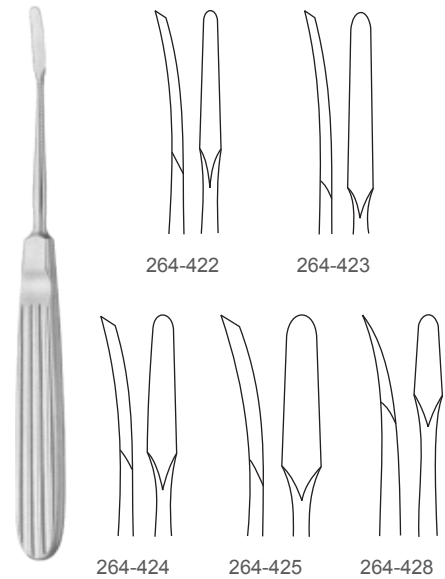

LEMPERT Periosteal Elevator

Item #	Description	Tip Width	Length
264-422	pattern 1	2.0mm	6¾" (17.1cm)
264-423	pattern 2	3.0mm	6¾" (17.1cm)
264-424	pattern 3	4.0mm	6¾" (17.1cm)
264-425	pattern 4	5.0mm	6¾" (17.1cm)
264-428	pattern 5	3.0mm	6¾" (17.1cm)

ELEVATORS



KLEINERT-KUTZ Elevator & Dissector
Double-Ended

Item #	Description	Length
201-788	2.0mm & 3.0mm wide, sharp, round blades	5" (12.7cm)



HALLE Septum Elevator
Narrow

Item #	Tip Width	Length
665-332	3.0mm	7" (17.8cm)



LEMPERT Elevator
Heavy Pattern

Item #	Description	Tip Width	Length
610-514	curved	7.0mm	7¼" (18.4cm)

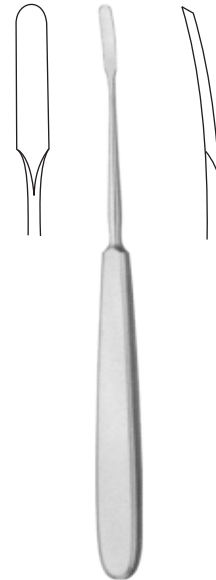

JOSEPH Periosteal Elevator

Item #	Description	Tip Width	Length
264-404	slightly-curved	4.0mm	6½" (16.5cm)

ELEVATORS



ROGER Septum Elevator
Double-Ended

Item #	Description	Length
665-500	curved, semi-sharp & blunt blades	7 ³ / ₄ " (19.7cm)

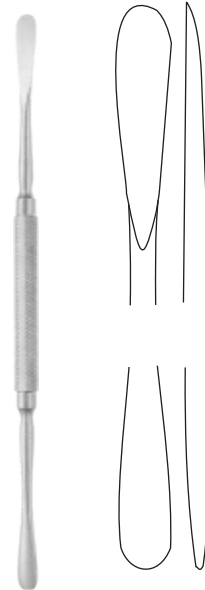

HAJEK-BALLENGER Septum Elevator
Double-Ended

Item #	Description	Length
665-430	straight, semi-sharp & blunt blades	7 ¹ / ₄ " (18.4cm)

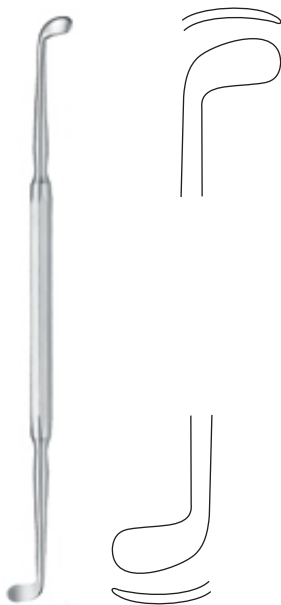

PENNINGTON Septum Elevator
Double-Ended

Item #	Description	Length
665-450	sharp, with blades to left and right sides	8 ¹ / ₄ " (21.0cm)



KISTNER Septum Ball End Elevator
Double-Ended

Item #	Diameter	Length
665-490	2.0mm x 2.5mm ball tips	7 ¹ / ₂ " (19.1cm)

ELEVATORS

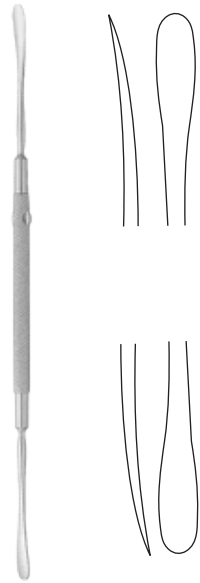

FREER Elevator
Double-Ended, Sharp & Blunt Blades

Item #	Tip Width	Length
263-502	5.0mm	7" (17.8cm)
263-503	6.5mm	7¾" (19.7cm)



HOWARTH Septum Elevator
Double-Ended

Item #	Width	Length
665-440	5.0mm	8½" (21.6cm)



FREER Septum Elevator
Double-Ended

Item #	Description	Width	Length
665-302	curved	5.0mm	7½" (19.1cm)



KILLIAN Septum Elevator
Double-Ended

Item #	Description	Length
665-410	one end 4.0mm with 3.4mm taper, opposite end 4.3mm with 3.0mm taper	7¼" (18.4cm)
665-415	one end 5.0mm with 4.5mm taper, opposite end 4.3mm with 3.0mm taper	9" (22.9cm)

ELEVATORS

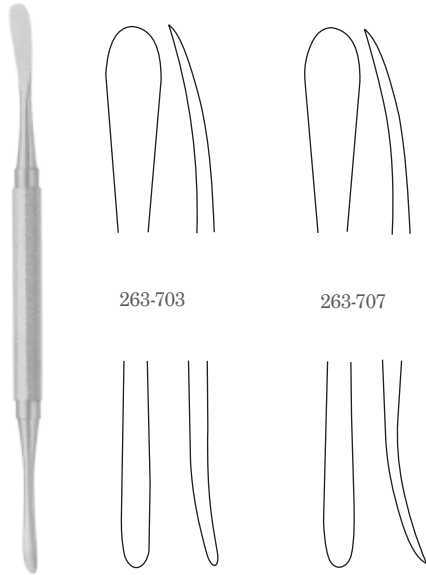

MOLT Dissector & Raspatory
Double-Ended

Item #	Description	Length
263-703	sharp/blunt ends	7" (17.8cm)
263-707	sharp/sharp ends	7" (17.8cm)



MCKENTY Elevator
Curved Tip

Item #	Tip Width	Length
264-224	4.0mm	5½" (14.0cm)
264-225	5.0mm	5½" (14.0cm)



WOODSON Elevator

Item #	Description	Length
573-515	straight and angled end	7" (17.8cm)



WOODSON Dura Separator & Spatula

Item #	Tip Width	Length
573-516	4.0mm	7½" (19.1 cm)

ELEVATORS

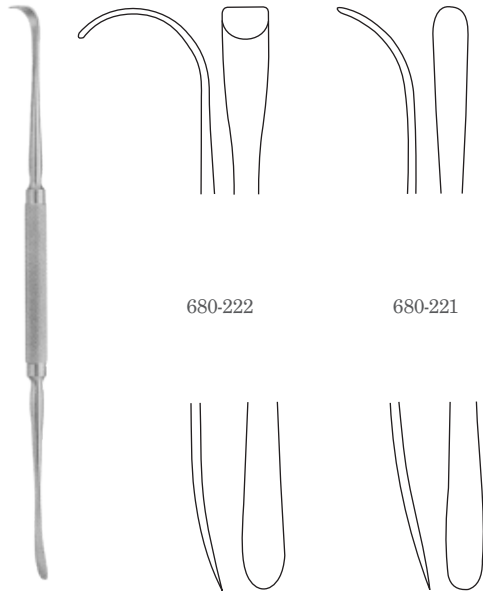

OBWEGESSER-FREER Periosteal Elevator

Item #	Description	Tip Width	Length
680-221	slight curve	6.3mm	9" (22.9cm)
680-222	strong curve	6.3mm	9" (22.9cm)



LANGENBECK Periosteal Elevator

Item #	Description	Tip Width	Length
544-009	narrow model, blunt blade	7.0mm	7½" (19.1cm)
266-035	wide model, sharp blade	17.0mm	7½" (19.1cm)



CUSHING "Little Joker" Periosteal Elevator

Wide Blade, Solid Handle

Item #	Blade	Length
266-203	6.0mm	6" (15.2cm)
266-204	6.0mm	7½" (19.1cm)

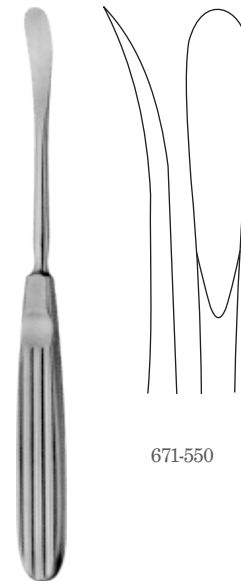

COTTLE SKIN Elevator

Slightly-Curved Blade

Item #	Description	Tip Width	Length
671-550	sharp	9.0mm	7½" (19.1cm)
671-551	blunt	9.0mm	7½" (19.1cm)

ELEVATORS



671-565

CONVERSE Periosteal Elevator

Item #	Tip Width	Length
671-565	4.0mm	7" (17.8cm)



BLAIR Cleft Palate Elevator

Item #	Description	Tip Width	Length
671-749	right-angle	5.0mm	7½" (19.1cm)



COTTLE Septum Elevator
Double-Ended

Item #	Description	Length
671-623	graduated in cm, 4.0mm wide blade and 3.0mm wide round end	9" (22.9cm)

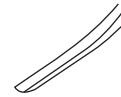

610-376



610-394

HOUSE Elevator & Chisel

Item #	Description	Tip Width	Length
610-394	88.0mm working length, curved scraping tip, flat bayonet handle	1.0mm	6¾" (17.1cm)
610-376	"The Gimmick," 12.0mm long tip angled at 15 degrees, octagonal handle	1.0mm	6½" (16.5cm)

SUCTION TUBES



FRAZIER Suction Tube
Angled, with Finger Cut-Off

Item #	Diameter	Length
098-305	5 fr., 1.7mm	4" (10.2cm)
098-306	6 fr., 2.0mm	4" (10.2cm)
098-307	7 fr., 2.3mm	4" (10.2cm)
098-308	8 fr., 2.6mm	4" (10.2cm)
098-309	9 fr., 3.0mm	4" (10.2cm)
098-310	10 fr., 3.3mm	4" (10.2cm)
098-311	11 fr., 3.6mm	4" (10.2cm)
098-312	12 fr., 4.0mm	4" (10.2cm)



KILLIAN (VON-EICKEN) Antrum Cannula

Item #	Description	Length
637-566	2.5mm diameter, bulbous tip, center opening	5¾" (14.6cm)



FRAZIER Suction Tube
Extra Long, with Finger Cut-Off

Item #	Diameter	Length
098-375	5 fr., 1.7mm	7 1/8" (18.0cm)
098-376	6 fr., 2.0mm	7 1/8" (18.0cm)
098-377	7 fr., 2.3mm	7 1/8" (18.0cm)
098-378	8 fr., 2.6mm	7 1/8" (18.0cm)
098-379	9 fr., 3.0mm	7 1/8" (18.0cm)
098-380	10 fr., 3.3mm	7 1/8" (18.0cm)
098-381	11 fr., 3.6mm	7 1/8" (18.0cm)
098-382	12 fr., 4.0mm	7 1/8" (18.0cm)



HOUSE Cutoff Adaptor

Item #	Description
622-148	4.0mm diameter tubing end, for use with ROSEN suction tubes

SUCTION TUBES



ROSEN Suction Tube

Item #	Description	Working Length
611-034	14 gauge	2.4" (6.0cm)
611-035	15 gauge	2.4" (6.0cm)
611-036	16 gauge	2.4" (6.0cm)
611-037	17 gauge	2.4" (6.0cm)
611-038	18 gauge	2.4" (6.0cm)
611-039	19 gauge	2.4" (6.0cm)
611-040	20 gauge	2.4" (6.0cm)
611-041	22 gauge	2.4" (6.0cm)
611-042	24 gauge	2.4" (6.0cm)
611-043	26 gauge	2.4" (6.0cm)



HOUSE Suction-Irrigation Tube

Item #	Description	Length
611-056	2.0 x 2.5 fr.	3.3" (8.5cm)
611-057	2.5 x 4.0 fr.	2.8" (7.0cm)
611-058	2.5 x 4.0 fr.	3.7" (9.5cm)
611-059	4.0 x 5.0 fr.	2.8" (7.0cm)
611-060	4.0 x 5.0 fr.	3.7" (9.5cm)
611-061	5.0 x 7.0 fr.	3.7" (9.5cm)
611-062	6.0 x 8.0 fr.	3.7" (9.5cm)
611-063	7.0 x 10.0 fr.	3.7" (9.5cm)
611-064	8.0 x 12.0 fr.	3.7" (9.5cm)
611-065	12.0 x 14.0 fr.	3.7" (9.5cm)



SCHUKNECHT Suction Tube

Item #	Description	Working Length
622-230	20 gauge	3.1" (7.8cm)
622-231	24 gauge	3.1" (7.8cm)



BARON Suction Tube

Item #	Diameter	Length
622-210	3 fr.	3" (7.6cm)
622-215	5 fr.	3" (7.6cm)
622-220	7 fr.	3" (7.6cm)

RASPS



GLABELLA Rasp
Tungsten Carbide, Down Cutting

Item #	Description	Width	Length
630-549	coarse grit	6.0mm	8½" (21.6cm)
630-548	medium grit	6.0mm	8¼" (21.0cm)



MALTZ Nasal Rasp
Tungsten Carbide, Straight

Item #	Description	Width	Length
675-927	up cutting	7.5mm	7" (17.8cm)
675-926	down cutting	7.5mm	7" (17.8cm)

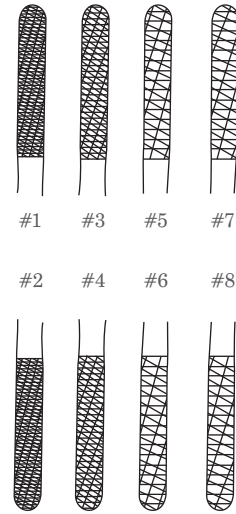

FOMON Nasal Rasp
Tungsten Carbide, Double-Ended, Down Cutting

Item #	Description	Width	Length
676-060	#1 very fine and #2 fine grit	6.5mm	8" (20.3cm)
676-061	#3 fine and #4 coarse grit	6.5mm	8" (20.3cm)
676-062	#5 coarse and #6 coarse grit	6.5mm	8" (20.3cm)
676-063	#7 coarse and #8 very coarse grit	6.5mm	8" (20.3cm)

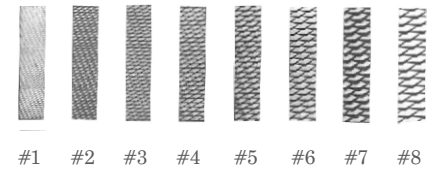

PARKES Rasp
Tungsten Carbide, with Down Cutting Teeth

Item #	Description	Length
630-525	#1 very fine grit	8" (20.3cm)
630-526	#2 fine grit	8" (20.3cm)
630-527	#3 fine grit	8" (20.3cm)
630-528	#4 coarse grit	8" (20.3cm)
630-529	#5 coarse grit	8" (20.3cm)
630-530	#6 coarse grit	8" (20.3cm)
630-531	#7 coarse grit	8" (20.3cm)
630-532	#8 very coarse grit	8" (20.3cm)

RASPS



PEET Nasal Rasp
Tungsten Carbide Dust

Item #	Description	Length
630-560	straight	7½" (19.1cm)
630-561	curved	7½" (19.1cm)



JOSEPH Nasal Rasp
Up Cutting Teeth

Item #	Description	Length
630-503	#1 fine teeth	6¾" (17.1cm)
630-504	#2 medium teeth	6¾" (17.1cm)

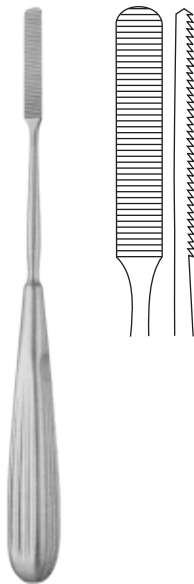

COTTLE Rasp

Item #	Description	Length
675-935	down cutting	8" (20.3cm)

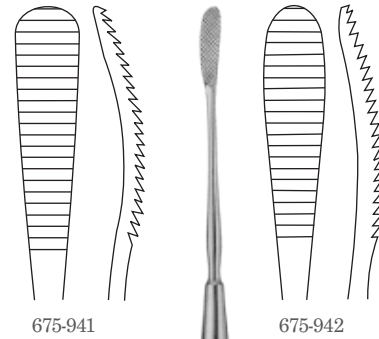

AUFRICHT Rasp
Curved

Item #	Description	Length
675-941	down cutting	8¼" (21.0cm)
675-942	up cutting	8¼" (21.0cm)



RASPS

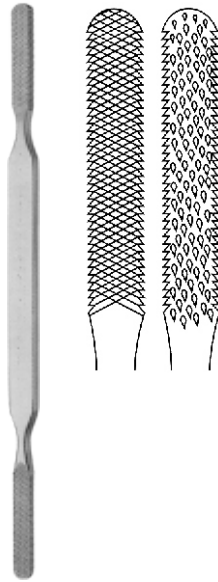

FOMON Rasp
Double-Ended

Item #	Description	Length
675-960	4 working surfaces, 2 surfaces with fine and 2 with course serrations, flat and convex	8¼" (21.0cm)



FOMON Rasp
Double-Ended

Item #	Description	Length
630-512	coarse	8¼" (21.0cm)
630-511	fine	8¼" (21.0cm)



MALTZ Nasal Rasp

Item #	Description	Width	Length
675-925	reverse cut straight	7.5mm	7¼" (18.4cm)
675-920	forward cut straight, deep serrations	7.2mm	7¼" (18.4cm)



PARKES Rasp

Item #	Description	Length
630-509	coarse, reverse cut	8" (20.3cm)
630-510	fine, reverse cut	8" (20.3cm)

RASPS

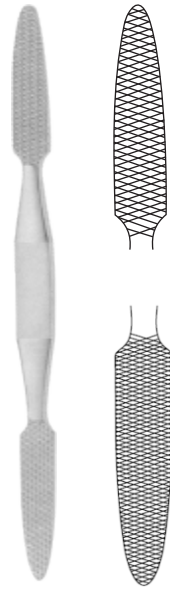

CONVERSE Rasp
Double-Ended, Down-Cutting Teeth

Item #	Description	Width	Length
675-965	fine and coarse ends	11.0mm	7" (17.8cm)



MILLER Bone File
Double-Ended, Down-Cutting Teeth

Item #	Description	Length
261-012	small and extra-small ends	7" (17.8cm)

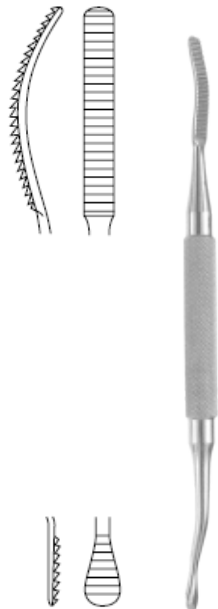

MILLER Bone File
Double-Ended, Down-Cutting Teeth

Item #	Description	Length
261-010	large and small ends	7" (17.8cm)



MILLER Bone File
Double-Ended, Down-Cutting Teeth

Item #	Description	Length
261-013	small and medium ends	7 1/4" (18.4cm)

RASPS

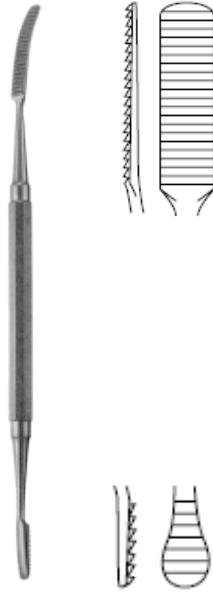

MILLER-COLBURN File
Double-Ended, Down-Cutting Teeth

Item #	Description	Length
261-014	medium and large ends, octagonal handle	7¼" (18.4cm)



RUBIN Nasal Frontal Rasp
GLABELLA Button Rasp

Item #	Description	Length
678-921	down-cutting teeth	7¼" (18.4cm)

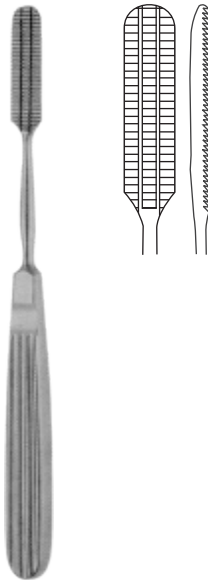

RUBIN Nasal Rasp
Down Cutting Teeth

Item #	Description	Length
678-920	30% oblique, concave	8" (20.3cm)



LEWIS Nasal Rasp
Down-Cutting Teeth

Item #	Description	Length
675-931	coarse teeth	7½" (19.1cm)
675-930	fine teeth	7½" (19.1cm)

RASPS

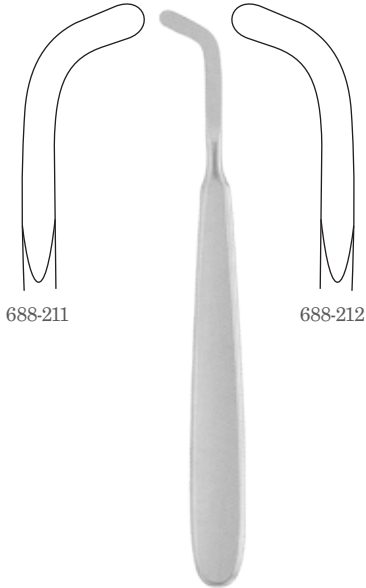

CLEFT Palate Rasp
Curved Up

Item #	Description	Width	Length
688-211	left	5.0mm	5½" (14.0cm)
688-212	right	5.0mm	5½" (14.0cm)

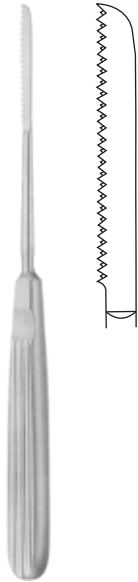

JOSEPH Nasal Saw

Item #	Description	Blade Length	Length
676-010	straight	38.0mm	7½" (19.1cm)

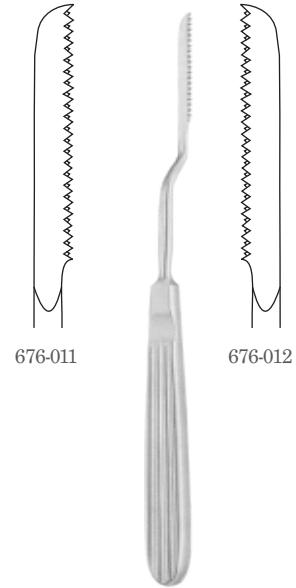

JOSEPH Nasal Saw

Item #	Description	Blade Length	Length
676-011	bayonet left	37.0mm	7½" (19.1cm)
676-012	bayonet right	37.0mm	7½" (19.1cm)

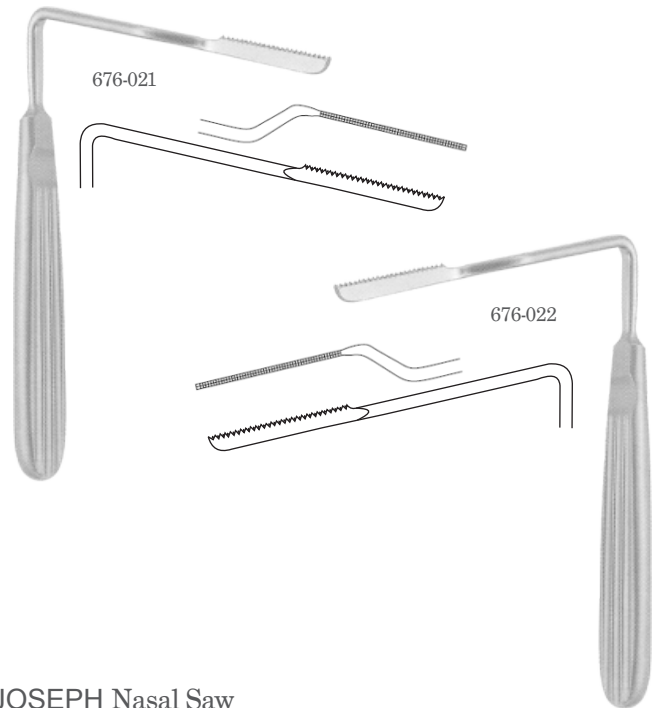

JOSEPH Nasal Saw

Item #	Description	Working Length	Blade Length	Length
676-021	angled left	¾"(8.3cm)	35.0mm	5" (12.7cm)
676-022	angled right	¾"(8.3cm)	35.0mm	5" (12.7cm)

SINUS/NASAL



JANSEN-MIDDLETON Septum Forceps

Item #	Description	Bite Size	Length
662-565	through-cutting	4.0mm x 14.0mm	7½" (19.1cm)

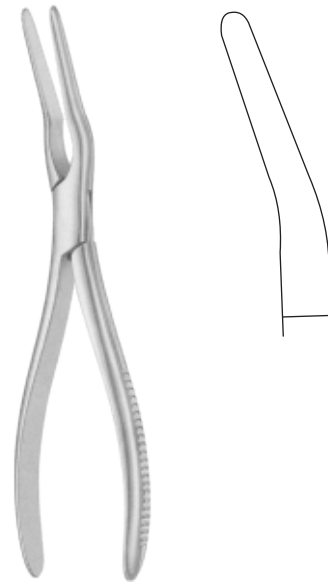

ASCH Septum Straightening Forceps

Item #	Description	Jaw Size	Length
676-520	angled blades	44.0mm x 7.0mm	9" (22.9cm)



JANSEN-MIDDLETON Septum Forceps

Item #	Description	Cup Size	Length
662-560	spoon-shaped cups	5.0mm x 15.0mm	7½" (19.1cm)

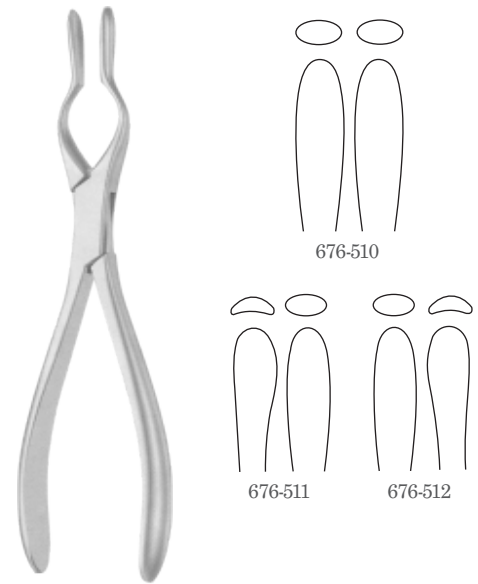

WALSHAM Septum Straightening Forceps

Item #	Description	Length
676-510	universal, 33.0mm x 10.0mm concave jaws	9" (22.9cm)
676-511	right, 33.0mm x 7.0mm flat & 33.0mm x 9.5mm concave jaws	9" (22.9cm)
676-512	left, 33.0mm x 7.0mm flat & 33.0mm x 9.5mm concave jaws	9" (22.9cm)
676-500	set of 3 contains 6765-10, 6765-11 & 6765-12	9" (22.9cm)

SINUS/NASAL

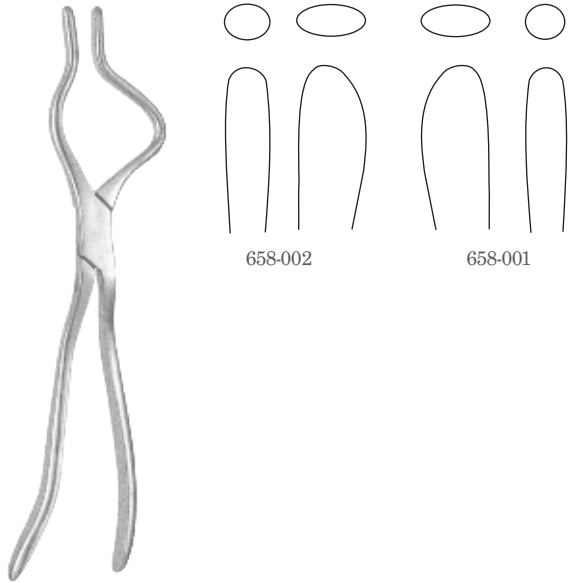

ROWE Maxillary Disimpaction Forceps

Item #	Description	Length
685-001	left	9¾" (24.8cm)
685-002	right	9¾" (24.8cm)



SHEEN-KILLIAN Septum Forceps

Item #	Description	Length
662-023	angled flat, serrated jaws	6½" (16.5cm)

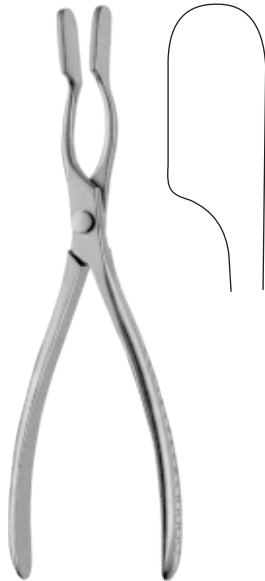

COTTLE-WALSHAM Septum Straightening Forceps

Item #	Description	Jaw Size	Length
676-515	straight	33.0mm x 7.0mm	9" (22.9cm)

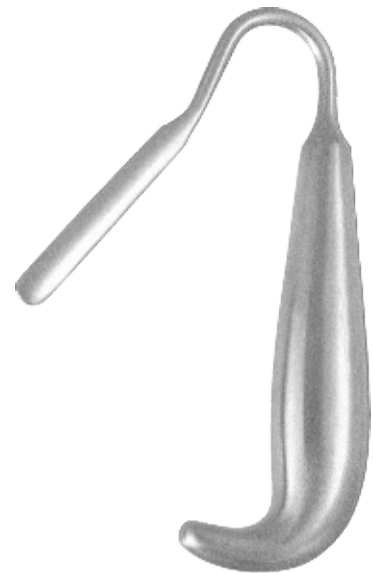

SALINGER Nasal Reduction Instrument

Item #	Width	Length
675-884	9.5mm	5½" (14.0cm)

SINUS/NASAL



GRUENWALD Nasal Forceps
Through-Cutting

Item #	Jaw	Shaft Length
663-121	#1, 2.0mm x 10.0mm	4½" (11.4cm)
663-122	#2, 2.5mm x 12.0mm	4½" (11.4cm)
663-123	#3, 3.0mm x 12.0mm	4½" (11.4cm)



TAKAHASHI Ethmoid Forceps

Item #	Bite Size	Shaft Length
662-752	2.5mm x 10.0mm	4½" (11.4cm)
662-754	4.0mm x 10.0mm	4½" (11.4cm)
662-784	2.5mm x 10.0mm, up-turned 45 degrees	4½" (11.4cm)

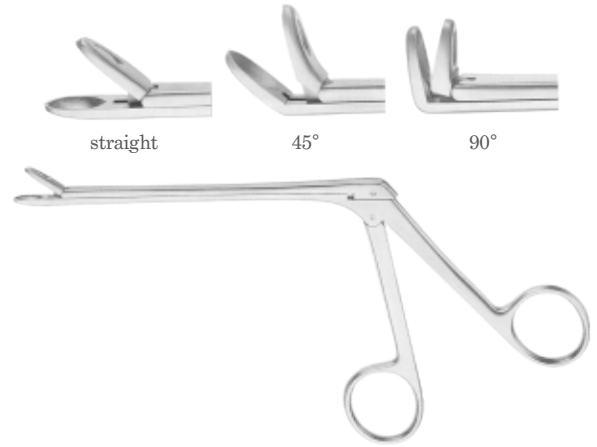

WEIL-BLAKESLEY Nasal Forceps
Pointed Fenestrated Cups

Item #	Description	Jaw	Shaft Length
662-801	#1, straight	3.0mm	4¾" (12.0cm)
662-802	#2, straight	3.6mm	4¾" (12.0cm)
662-803	#3, straight	4.2mm	4¾" (12.0cm)
662-804	#4, straight	4.8mm	4¾" (12.0cm)
662-811	#1, angled up, 45 degrees	3.0mm	4¾" (12.0cm)
662-812	#2, angled up, 45 degrees	3.6mm	4¾" (12.0cm)
662-813	#3, angled up, 45 degrees	4.2mm	4¾" (12.0cm)
662-814	#4, angled up, 45 degrees	4.8mm	4¾" (12.0cm)
662-831	#1, angled up, 90 degrees	3.0mm	4¾" (12.0cm)
662-832	#2, angled up, 90 degrees	3.6mm	4¾" (12.0cm)
662-833	#3, angled up, 90 degrees	4.2mm	4¾" (12.0cm)
662-834	#4, angled up, 90 degrees	4.8mm	4¾" (12.0cm)



WEIL-BLAKESLEY Through-Cutting Forceps

Item #	Description	Jaw	Shaft Length
662-806	straight	2.0mm	4¾" (12.0cm)
662-807	straight	2.5mm	4¾" (12.0cm)
662-808	straight	3.0mm	4¾" (12.0cm)
662-815	angled up, 45 degrees	2.0mm	4¾" (12.0cm)
662-816	angled up, 45 degrees	2.5mm	4¾" (12.0cm)
662-817	angled up, 45 degrees	3.0mm	4¾" (12.0cm)

SINUS/NASAL

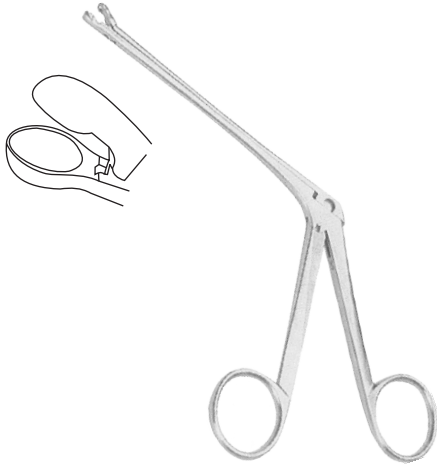

SINUS Cup Forceps

Item #	Cups	Shaft Length
637-655	3.0mm	4" (10.2cm)



FERRIS-SMITH Sponge & Fragment Forceps

Item #	Description	Jaw Size	Shaft Length
622-540	serrated jaws, fenestrated	6.0mm x 8.0mm	4½" (11.4cm)

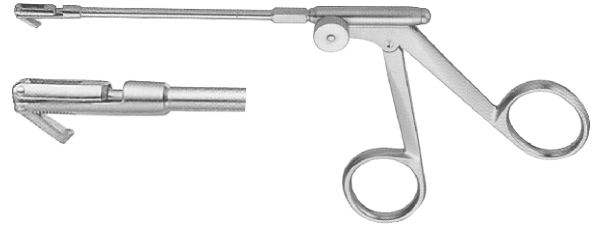

NASAL Rotating Back Biter Forceps
Shaft Rotates 360 Degrees

Item #	Description	Jaw	Shaft Length
663-263	adult	2.5mm x 7.0mm	4" (10.0cm)
663-258	pediatric	1.5mm x 5.0mm	4" (10.0cm)

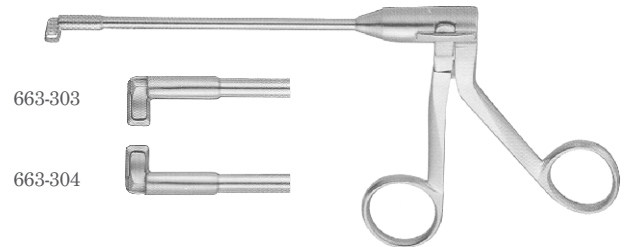

ANTRUM Punch Side-Biting Forceps

Item #	Description	Bite Size	Shaft Length
663-304	right-side cutting	3.5mm x 8.5mm	4" (10.0cm)
663-303	left-side cutting	3.5mm x 8.5mm	4" (10.0cm)

SINUS/NASAL

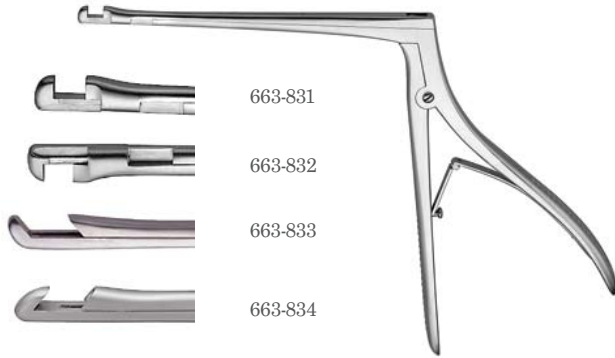

HAJEK Antrum Punch Forceps

Item #	Description	Bite Size	Shaft Length
663-831	90 degrees, up biting	4.0mm	5½" (14.0cm)
663-832	90 degrees, down biting	4.0mm	5½" (14.0cm)
663-833	45 degrees, forward biting	4.0mm	5½" (14.0cm)
663-834	45 degrees, backward biting	4.0mm	5½" (14.0cm)

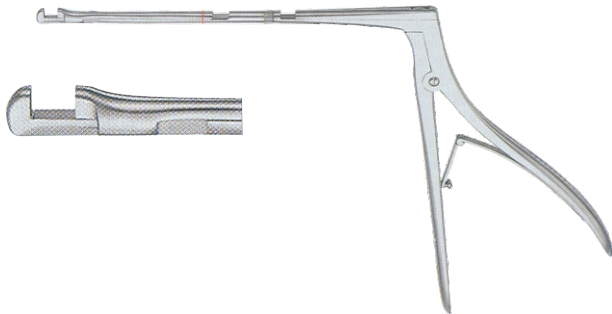

HAJEK-KOFLER Sphenoid Punch Forceps

Item #	Description	Width	Shaft Length
663-810	small solid biting jaws, 360 degrees rotatable	3.0mm x 7.0mm	6" (15.2cm)

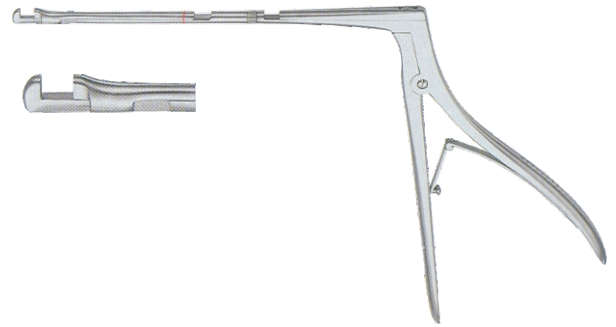

HAJEK-KOFLER Sphenoid Punch Forceps

Item #	Description	Width	Shaft Length
663-805	up and through-cutting delicate jaws	2.0mm x 3.0mm	6¾" (16.2cm)



MCKENTY Sphenoid Punch Forceps

Item #	Description	Width	Shaft Length
663-840	360 degrees rotatable, through-cutting small jaws	1.5mm x 4.0mm	5¾" (14.6cm)

SINUS/NASAL



KERRISON MASTOID Rongeur

Item #	Size	Bite Size	Shaft Length
626-203	#0	3.0mm	4" (10.2cm)
626-204	#1	4.0mm	4" (10.2cm)
626-205	#2	5.0mm	4" (10.2cm)
626-206	#3	6.0mm	4" (10.2cm)



PUNCH Rongeur

Item #	Bite Size	Shaft Length
663-811	1.5mm	6" (15.2cm)
663-812	2.5mm	6" (15.2cm)



KERRISON-COSTEN Rongeur

Item #	Description	Shaft Length
635-010	curved shaft	4" (10.2cm)

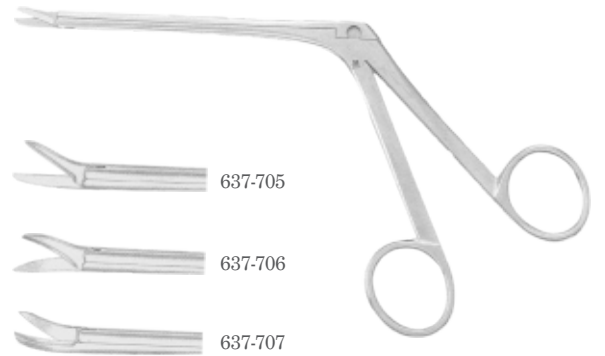

NASAL Alligator Scissors

Item #	Description	Blade Size	Shaft Length
637-705	straight	11.0mm	4¼" (10.8cm)
637-706	left curved blades	11.0mm	4¼" (10.8cm)
637-707	right curved blades	11.0mm	4¼" (10.8cm)

MIDDLE EAR



BELLUCCI Alligator Scissors

Item #	Description	Blade Size	Shaft Length
610-710	straight	7.0mm	3" (7.6cm)
610-704	left curved blades	7.0mm	3" (7.6cm)
610-705	right curved blades	7.0mm	3" (7.6cm)



GREVEN Ear Forceps

Item #	Description	Shaft Length
624-910	5.0mm jaws with 2.5mm serrated tips	2 3/4" (7.0cm)

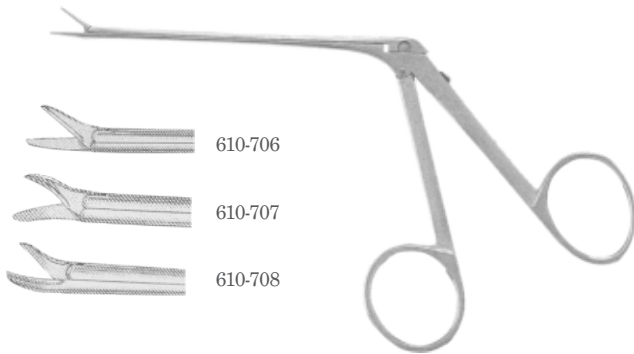

HOUSE-BELLUCCI Alligator Scissors

Item #	Description	Blade Size	Shaft Length
610-706	straight	5.0mm	3" (7.6cm)
610-707	left curved blades	5.0mm	3" (7.6cm)
610-708	right curved blades	5.0mm	3" (7.6cm)

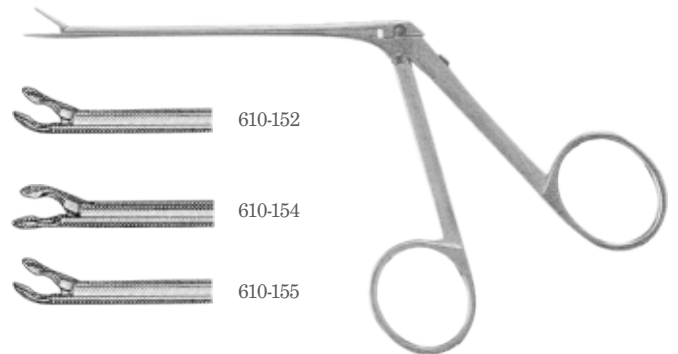

HOUSE Miniature Ear Forceps

Item #	Description	Shaft Length
610-152	straight	2 3/4" (7.0cm)
610-154	angled left 15 degrees	2 3/4" (7.0cm)
610-155	angled right 15 degrees	2 3/4" (7.0cm)

MIDDLE EAR

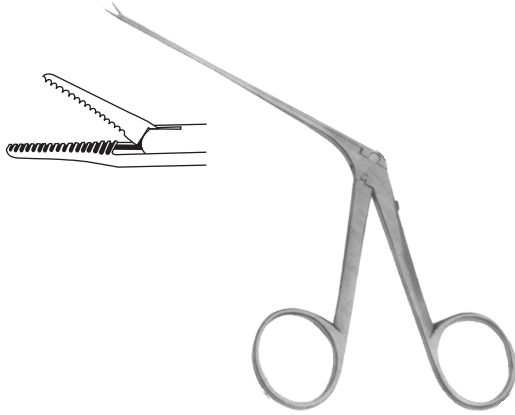

HOUSE Alligator "Crimper" Forceps

Item #	Description	Jaw	Shaft Length
610-138	very flat serrated, tapered jaws, dull point	8.0mm	2¾" (7.0cm)

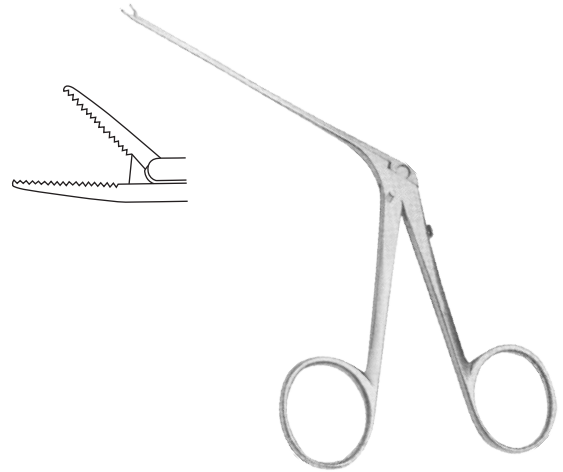

HOUSE Forceps

Item #	Description	Jaw	Shaft Length
610-146	serrated jaws	6.0mm	2¾" (7.0cm)

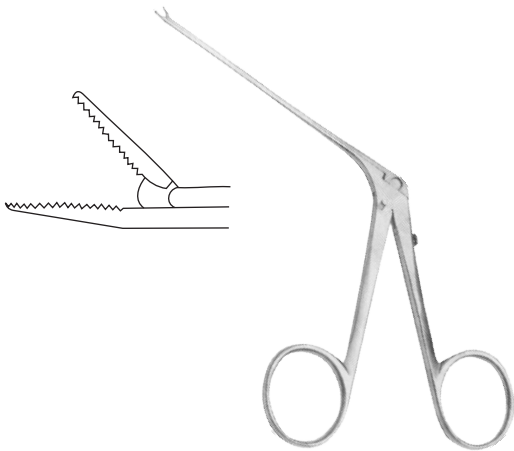

HOUSE Miniature Forceps

Item #	Description	Jaw	Shaft Length
610-147	finely serrated, extra-delicate jaws	4.0mm	2¾" (7.0cm)

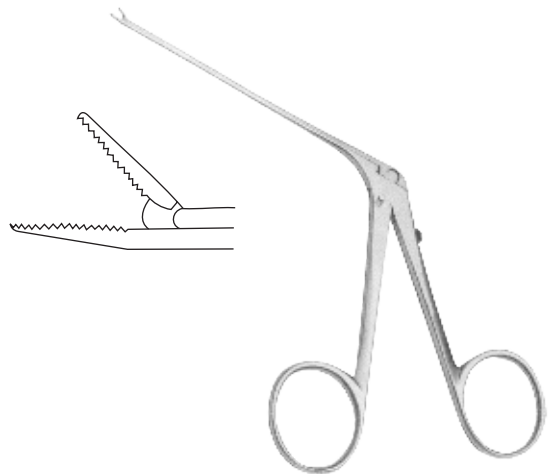

MICRO Alligator Ear Forceps

Item #	Description	Jaw Size	Shaft Length
610-160	serrated jaws, 0.6mm wide	3.0mm	2¾" (7.0cm)

MIDDLE EAR

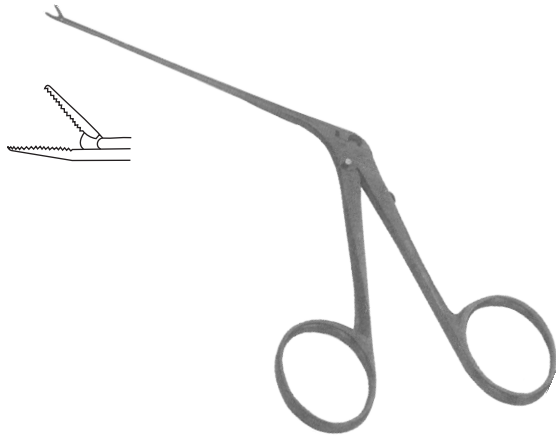

MICRO Alligator Ear Forceps
Ebonized

Item #	Description	Jaw Size	Shaft Length
610-160E	serrated jaws, 0.6mm wide	3.0mm	2¾" (7.0cm)

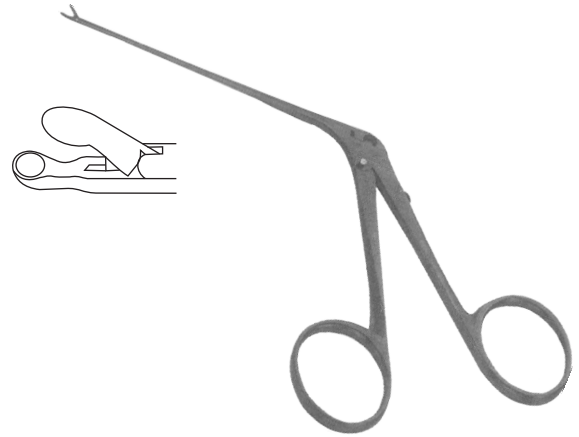

HOUSE-WULLSTEIN Alligator Ear Forceps
Ebonized

Item #	Cup Size	Shaft Length
614-122E	0.6mm x 1.0mm	3" (7.6cm)

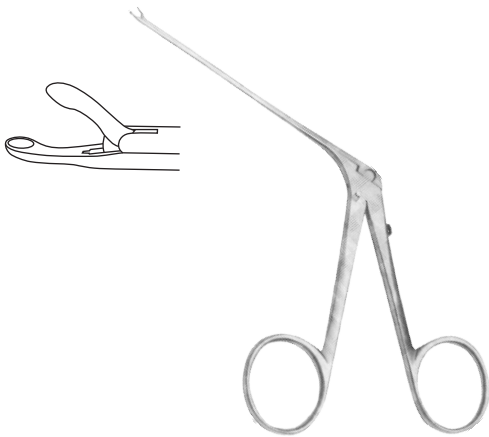

HOUSE-WULLSTEIN Alligator Ear Forceps

Item #	Cup Size	Shaft Length
614-122	0.6mm x 1.0mm	3" (7.6cm)

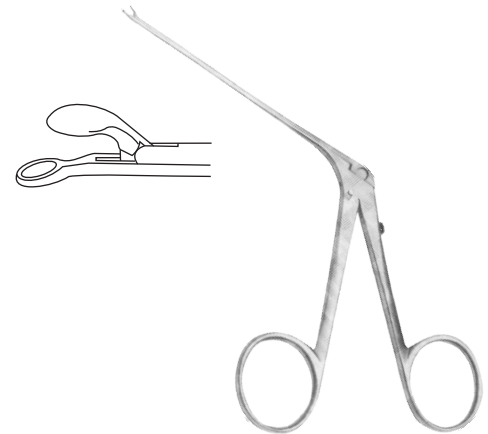

HOUSE Oval Cup Forceps
Angled Cups

Item #	Description	Cup	Shaft Length
610-142	angled right, 15 degrees	0.9mm	2¾" (7.0cm)
610-143	angled left, 15 degrees	0.9mm	2¾" (7.0cm)

MIDDLE EAR

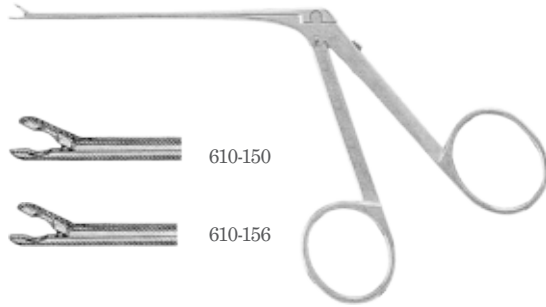

EAR Oval Cup Forceps

Item #	Description	Shaft Length
610-150	0.9mm x 2.0mm cups, extra fine	2 $\frac{3}{4}$ " (7.0cm)
610-156	0.75mm cups	2 $\frac{3}{4}$ " (7.0cm)



STRUEMPEL Ear Forceps

Item #	Description	Shaft Length
623-260	2.5mm x 6.0mm, fenestrated oval spoon	3" (7.6cm)

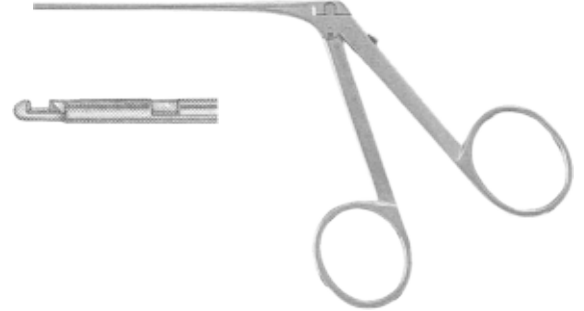

HOUSE-DIETERS Malleus Nipper

Item #	Jaw	Shaft Length
610-157	2.0mm	3" (7.6cm)

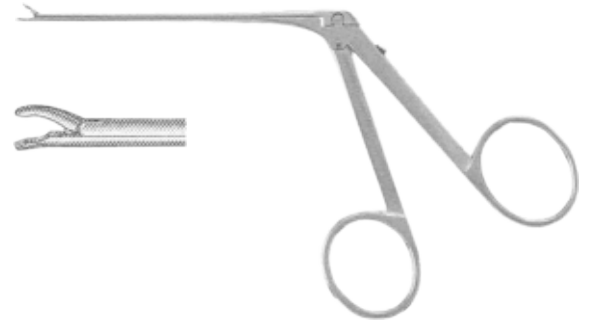

MCGEE Crimper/Wire Closure Forceps

Item #	Description	Jaw	Shaft Length
610-125	short jaws, angled slightly downward	3.0mm	2 $\frac{3}{4}$ " (7.0cm)

MIDDLE EAR



BELLUCCI Ear Forceps

Item #	Description	Jaw	Shaft Length
610-132	serrated jaws	8.0mm	3" (7.6cm)



HARTMAN Ear Forceps

Item #	Description	Shaft Length
610-111	delicate, 3.0mm x 6.0mm jaws	3" (7.6cm)

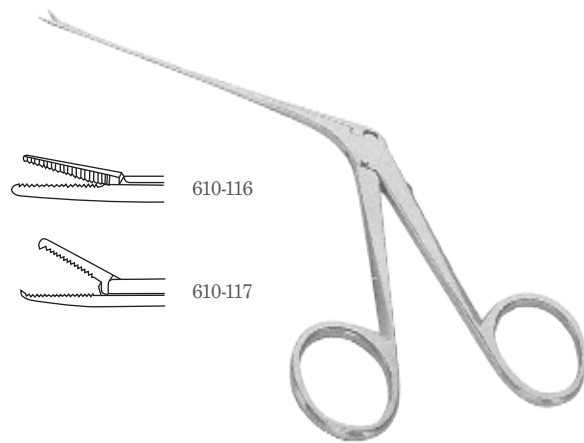

NOYES Alligator Forceps

Item #	Description	Jaw	Shaft Length
610-116	serrated jaws	7.0mm	5½" (14.0cm)
610-117	1x2 teeth, serrated jaws	7.0mm	5½" (14.0cm)

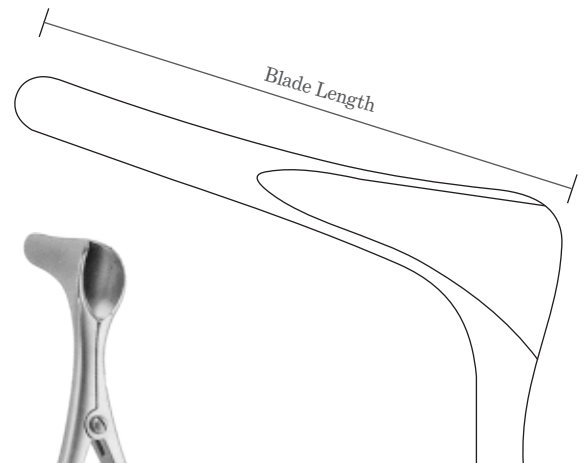

KILLIAN Septum Speculum

Item #	Description	Blade	Length
636-265	self-retaining, side adjusting set-screw	2.0"	6" (15.2cm)
636-266	self-retaining, side adjusting set-screw	2.5"	6" (15.2cm)
636-267	self-retaining, side adjusting set-screw	3.0"	6" (15.2cm)
636-268	self-retaining, side adjusting set-screw	3.5"	6" (15.2cm)
636-265E	ebonized (black coated), without set-screw	2.0"	6" (15.2cm)
636-267E	ebonized (black coated), without set-screw	3.0"	6" (15.2cm)

NASAL



VIENNA Nasal Speculum

Item #	Description	Blade	Length
636-241	size 1	24.0mm	5¼" (13.3cm)
636-242	size 2	30.0mm	5¼" (13.3cm)
636-243	size 3	32.0mm	5¼" (13.3cm)
636-244	size 4	34.0mm	5¼" (13.3cm)



TIECK-HALLE Infant Speculum

Item #	Blade	Length
660-111	18.0mm	5¾" (14.6cm)

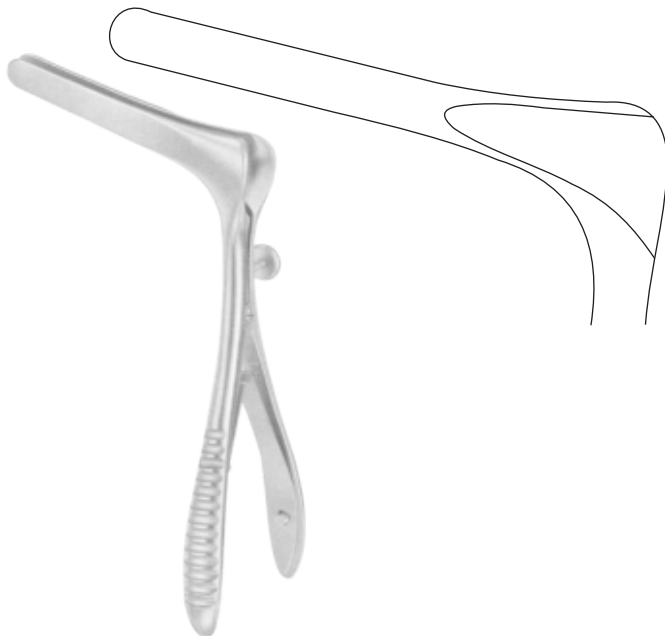

COTTLE Septum Speculum

Self-Retaining, Side Adjusting Set-Screw

Item #	Blade	length
670-230	30.0mm	5½" (14.0cm)
670-235	35.0mm	5½" (14.0cm)
670-255	55.0mm	5½" (14.0cm)
670-275	75.0mm	5½" (14.0cm)
670-290	90.0mm	5½" (14.0cm)

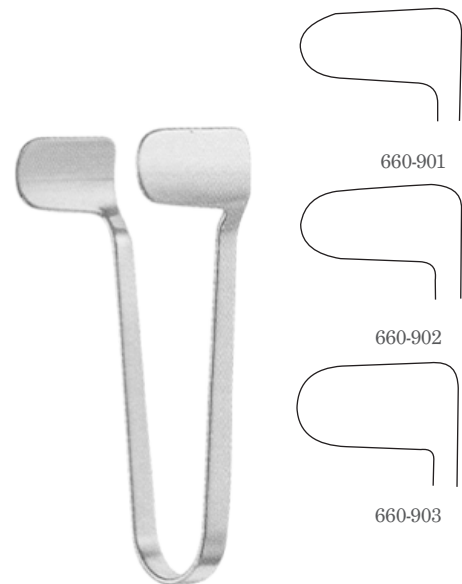

THUDICHUMS Nasal Speculum

Item #	Description	Length
660-901	size 1	2½" (6.4cm)
660-902	size 2	2½" (6.4cm)
660-903	size 3	2½" (6.4cm)

EAR SPECULUMS



BOUCHERON Ear Speculum
Round

Item #	Description
620-161	set of 4, sizes 1, 2, 3 & 4
620-166	size 1, 4.5mm
620-167	size 2, 5.5mm
620-168	size 3, 6.5mm
620-169	size 4, 7.5mm



HARTMAN Ear Speculum
Round

Item #	Description
610-951	set of 4, sizes 4.0 to 7.0mm
610-953	4.0mm
610-954	5.0mm
610-955	6.0mm
610-956	7.0mm



TOYNBEE Ear Speculum
Round

Item #	Description
620-130	set of 3, sizes 1, 2 & 3
620-136	size 1, 4.0mm
620-137	size 2, 5.0mm
620-138	size 3, 6.0mm



HARTMAN Ear Speculum
Oval

Item #	Description
610-957	set of 4 sizes
610-958	4.5mm x 5.0mm
610-959	5.5mm x 6.0mm
610-960	6.5mm x 7.0mm
610-961	7.5mm x 8.0mm

MIDDLE EAR

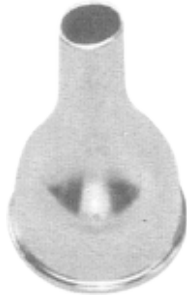

GRUBER Ear Speculum
Oval, Child & Infant Size, Light Short Pattern

Item #	Description
610-964	set of 4, sizes 1, 2, 3 & 4
610-979	single, size 1, 2.0mm x 3.0mm
610-965	single, size 2, 3.0mm x 4.0mm
610-966	single, size 3, 4.0mm x 5.0mm
610-967	single, size 4, 5.0mm x 6.0mm



FARRIOR Ear Speculum
Oval, Angled End, Non-Glare Stainless

Item #	Description
610-980	size 1, 3.0mm x 4.0mm
610-982	size 2, 4.0mm x 5.0mm
610-931	size 3, 4.5mm x 5.5mm
610-932	size 4, 5.0mm x 6.0mm
610-933	size 5, 5.5mm x 6.5mm
610-934	size 6, 6.0mm x 7.0mm
610-935	size 7, 6.5mm x 7.5mm
610-936	size 8, 7.0mm x 8.0mm
610-937	size 9, 7.5mm x 8.5mm



GRUBER Ear Speculum
Oval, Standard Adult Sizes, Long Pattern

Item #	Description
610-972	set of 4, sizes 1, 2, 3 & 4, without case
610-973	size 1, 4.0mm x 5.0mm
610-969	size 2, 5.0mm x 6.0mm
610-970	size 3, 6.0mm x 7.0mm
610-971	size 4, 7.0mm x 8.0mm



BUCK Ear Curette
Sharp

Item #	Description	Length
621-109	straight, size 00	6½" (16.5cm)
621-110	straight, size 0	6½" (16.5cm)
621-111	straight, size 1	6½" (16.5cm)
621-112	straight, size 2	6½" (16.5cm)
621-113	straight, size 3	6½" (16.5cm)
621-209	angled, size 00	6½" (16.5cm)
621-210	angled, size 0	6½" (16.5cm)
621-211	angled, size 1	6½" (16.5cm)
621-212	angled, size 2	6½" (16.5cm)
621-213	angled, size 3	6½" (16.5cm)

MIDDLE EAR



BUCK Ear Curette
Blunt

Item #	Description	Length
621-159	straight, size 00	6½" (16.5cm)
621-160	straight, size 0	6½" (16.5cm)
621-161	straight, size 1	6½" (16.5cm)
621-162	straight, size 2	6½" (16.5cm)
621-163	straight, size 3	6½" (16.5cm)
621-309	angled, size 00	6½" (16.5cm)
621-310	angled, size 0	6½" (16.5cm)
621-311	angled, size 1	6½" (16.5cm)
621-312	angled, size 2	6½" (16.5cm)
621-313	angled, size 3	6½" (16.5cm)

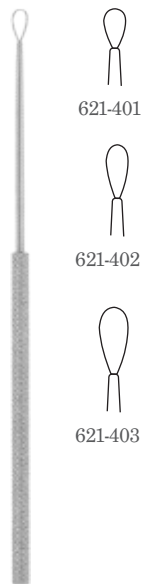

BILLEAU Flexible Ear Loop

Item #	Description	Length
621-401	small size, #1	6½" (16.5cm)
621-402	medium size, #2	6½" (16.5cm)
621-403	large size, #3	6½" (16.5cm)

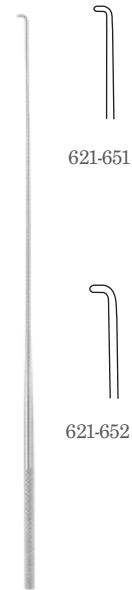

DAY Ear Hook

Item #	Description	Length
621-651	small size	6½" (16.5cm)
621-652	large size	6½" (16.5cm)



HOUSE Tympanoplasty Knife
Octagonal Handle

Item #	Description	Length
610-395	7.0mm curved blade	6½" (16.5cm)

MIDDLE EAR



HOUSE Lancet Knife
Octagonal Handle

Item #	Description	Length
610-377	2.0mm x 3.0mm tapered tip, angled 45 degrees, known as "No. 2 Knife"	6½" (16.5cm)



HOUSE Incudostapedial Joint Knife
Octagonal Handle

Item #	Description	Length
610-378	0.75mm diameter blade, angled 60 degrees	6½" (16.5cm)



HOUSE Incudostapedial Joint Knife
Octagonal Handle

Item #	Description	Length
610-396	0.5mm x 1.5mm long blade, angled 20 degrees	6½" (16.5cm)



HOUSE Sickle Knife
Octagonal Handle

Item #	Description	Length
610-379	0.75mm curved blade, known as "No. 1 Knife"	6½" (16.5cm)

MIDDLE EAR



HOUSE Myringotomy Knife
Octagonal Handle

Item #	Description	Length
610-397	3.5mm blade	6½" (16.5cm)



ROSEN Knife Curette
Octagonal Handle, Angled Up 45 Degrees

Item #	Description	Length
610-451	small, 2.0mm diameter blade	6½" (16.5cm)
610-450	large, 2.5mm diameter blade	6½" (16.5cm)

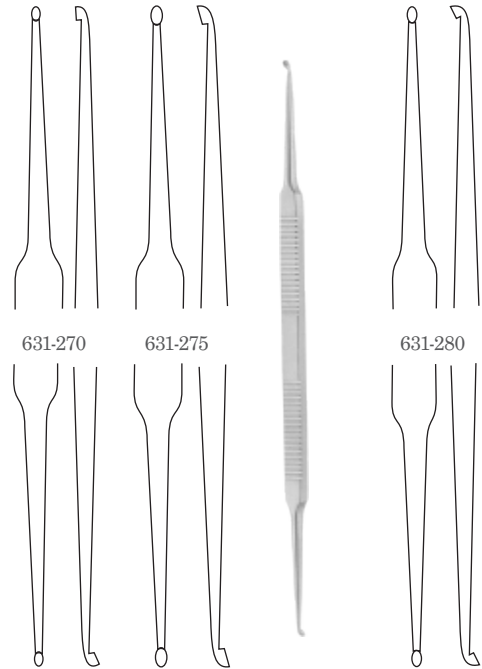

HOUSE Curette
Double-Ended, Flat Handle

Item #	Description	Length
631-270	light angle, 2.0mm & 2.5mm oval cups	7" (17.8cm)
631-275	strong angle, 2.25mm x 3.0mm & 2.0mm x 2.5mm cups	7" (17.8cm)
631-280	strong angle, 2.25mm x 3.0mm & 2.0mm x 2.5mm cups	6" (15.2cm)



HOUSE SHEEHY Knife Curette
"Small Weapon"

Item #	Description	Length
610-381	2.0mm diameter semi-sharp blade, malleable shaft, octagonal handle	6½" (16.5cm)

MIDDLE EAR

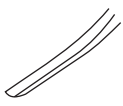

610-376



610-394



HOUSE Elevator & Chisel

Item #	Description	Width	Length
610-394	88.0mm working length, curved scraping tip, flat bayonet handle	1.0mm	6 ³ / ₄ " (17.1cm)
610-376	"The Gimmick," 12.0mm long tip, angled at 15 degrees, octagonal handle	1.0mm	6 ¹ / ₂ " (16.5cm)



HOUSE Strut Caliper

Item #	Description	Length
610-370	5.0mm mark from tip, malleable shaft	6 ¹ / ₂ " (16.5cm)



HOUSE Barbara Pick

Item #	Description	Length
610-365	straight point, malleable shaft	6 ¹ / ₂ " (16.5cm)

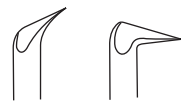

610-383
610-384

610-374
610-373

HOUSE Oval Window Pick

Item #	Description	Length
610-383	0.33mm long point, angled 30 degrees, malleable shaft	6 ¹ / ₂ " (16.5cm)
610-384	0.66mm long point, angled 30 degrees, malleable shaft	6 ¹ / ₂ " (16.5cm)
610-374	0.50mm long point, angled 90 degrees, malleable medium shaft	6 ¹ / ₂ " (16.5cm)
610-373	0.33mm long point, angled 90 degrees, malleable medium shaft	6 ¹ / ₂ " (16.5cm)

MIDDLE EAR



HOUSE Strut Pick
Octagonal Handle

Item #	Description	Length
610-375	0.6mm long point, angled 90 degrees, medium shaft	6½" (16.5cm)



CARTILAGE Cutting Board

Item #	Description
671-975	85.0mm x 55.0mm x 10.0mm

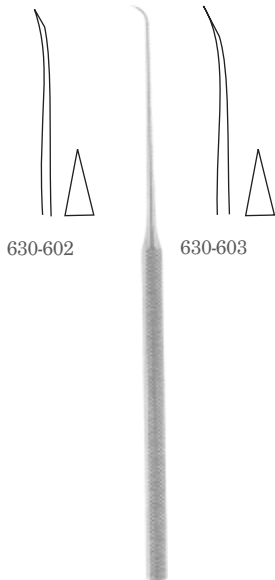

ROSEN Pick
Curved

Item #	Description	Length
630-602	1.5mm from tip	6½" (16.5cm)
630-603	3.0mm from tip	6½" (16.5cm)

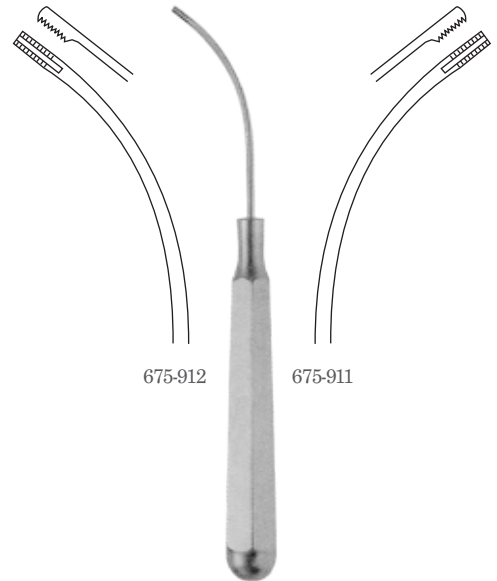

DINGMAN Otoabradars

Item #	Description	Length
675-910	set of 2, right & left	6" (15.2cm)
675-911	right	6" (15.2cm)
675-912	left	6" (15.2cm)

THROAT, LARYNGEAL & ORAL

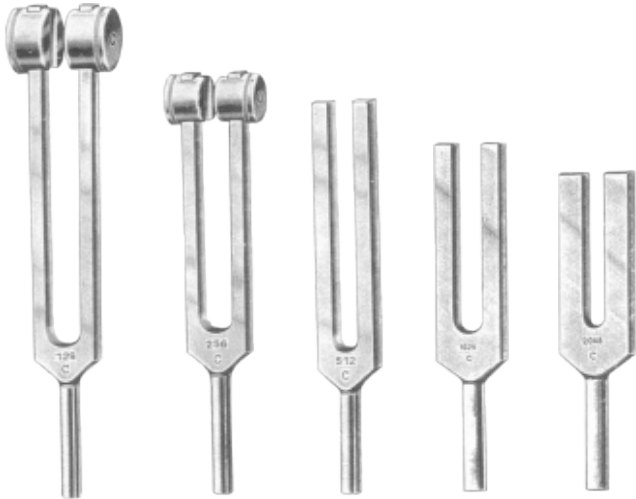

TUNING Forks
Aluminum Alloy

Item #	Description
620-709	c-64 vibrations
620-710	c-128 vibrations
620-711	c-256 vibrations
620-712	c-512 vibrations
620-713	c-1024 vibrations
620-714	c-2048 vibrations
620-715	c-4096 vibrations
620-705	set of 5 tuning forks, c-128, c-256, c-512, c-1024 and c-2048, with case



DINGMAN Tongue Blade

Item #	Description
720-811	small, 24.0mm x 52.0mm
720-812	medium, 28.0mm x 55.0mm
720-813	large, 30.0mm x 68.0mm



DINGMAN Mouth Gag

Item #	Description
720-800	complete set of 3 tongue blades, 2 adjustable upper blades and 2 cheek retractors, grooved tongue blades, coil springs on upper frame for suture handling



KILNERS-DOUGHTY Mouth Gag Set

Item #	Description
455-702	set includes three tongue blades (4557-11, 4557-12, 4557-13), palate plate (4557-19) and frame (4557-22)

THROAT, LARYNGEAL & ORAL

KILNERS-DOUGHTY Mouth Gag

Item #	Description
455-722	frame only

KILNERS-DOUGHTY Mouth Gag

Item #	Description
455-711	tongue blade #1 (28.0mm x 65.0mm)
455-712	tongue blade #2 (32.0mm x 75.0mm)
455-713	tongue blade #3 (37.0mm x 80.0mm)
455-714	tongue blade #4 (40.0mm x 90.0mm)
455-715	tongue blade #5 (45.0mm x 100.0mm)

KILNERS-DOUGHTY Mouth Gag

Item #	Description
455-719	palate plate only

DAVIS Mouth Gag

Item #	Description	Length
455-102	complete set includes right frame (4551-22) and 5 blades (4551-11, 4551-12, 4551-13, 4551-14, 4551-15)	6¼" (15.9cm)
455-121	left frame, without blades	6¼" (15.9cm)
455-122	right frame, without blades	6¼" (15.9cm)

THROAT, LARYNGEAL & ORAL



McIVOR Mouth Gag

Item #	Description	Length
455-300	complete set includes frame (4553-20) and 3 blades (4551-11, 4551-12, 4551-13)	5¾" (14.6cm)
455-320	frame only	5¾" (14.6cm)

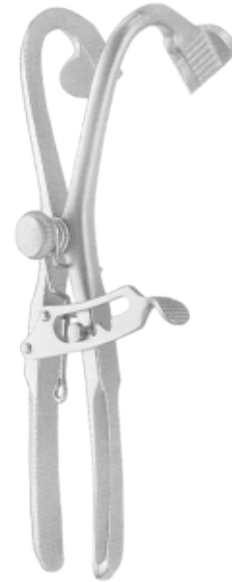

DENHARDT Mouth Gag

Item #	Description	Length
720-560	with grip lock	5" (12.7cm)



BLADES for DAVIS or McIVOR Mouth Gags

Item #	Description
455-111	size #1, 19.0mm x 25.0mm
455-112	size #2, 25.0mm x 70.0mm
455-113	size #3, 25.0mm x 83.0mm
455-114	size #4, 25.0mm x 95.0mm
455-115	size #5, 25.0mm x 102.0mm



MOLT (SLUDER-JANSEN) Mouth Gag
with Grip Lock

Item #	Description	Spread	Length
720-510	child	40.0mm	4" (10.2cm)
720-515	adult	50.0mm	6" (15.2cm)

THROAT, LARYNGEAL & ORAL



JENNINGS Mouth Gag

Item #	Description	Spread	Length
720-709	infant size	3 $\frac{3}{4}$ " (9.5cm)	8" (20.3cm)
720-713	child size	4 $\frac{3}{4}$ " (12.1cm)	7" (17.8cm)
720-715	adult size	6" (15.2cm)	6 $\frac{1}{4}$ " (15.9cm)

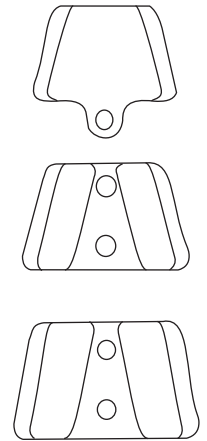
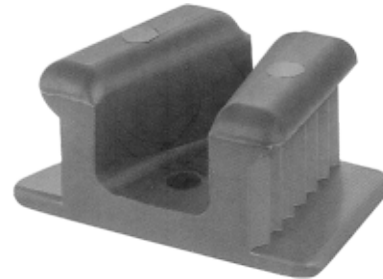

MOUTH PROP

Two Mouth Props per Unit

Item #	Description
721-101	small
721-102	medium
721-103	large

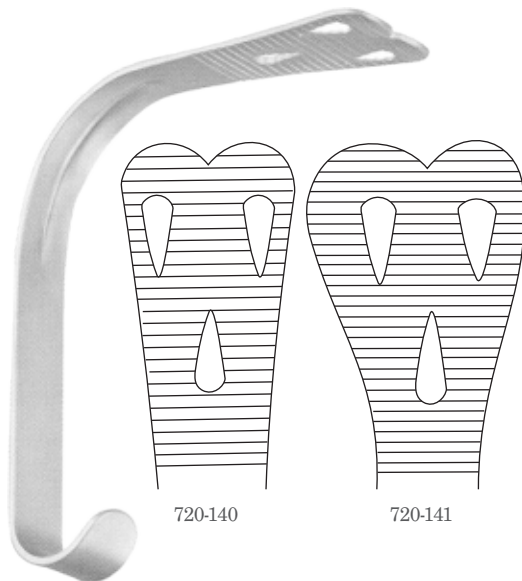

WIEDER Cheek & Tongue Retractor

Serrated

Item #	Description	Blade Size	Length
720-140	small blade	28.0mm	5" (12.7cm)
720-141	large blade	36.0mm	5" (12.7cm)



KING Adenoid Punch Forceps

Triangular Jaw & Strongly Curved Shaft

Item #	Description	Length (Shaft)
726-179	6.0mm upper jaw and 7.0mm lower basket	4 $\frac{1}{2}$ " (10.5cm)

THROAT, LARYNGEAL & ORAL

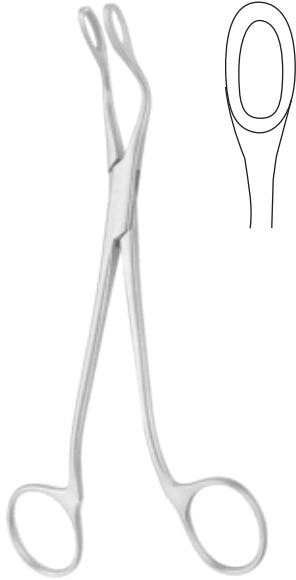

ST. CLAIR Adenoid Forceps

Item #	Description	Length
715-018	5.0mm x 10.0mm ring jaws	7¼" (18.4cm)



LABORDE Tracheal Dilator
Three Blades, Two Flat, One Cupper

Item #	Description	Length
736-603	adult	6" (15.2cm)
736-604	child	5½" (13.0cm)



TROSSEU Tracheal Dilator
Dual-Bladed, Curved

Item #	Description	Length
736-601	child	4¾" (12.1cm)
736-602	adult	5½" (14.0cm)

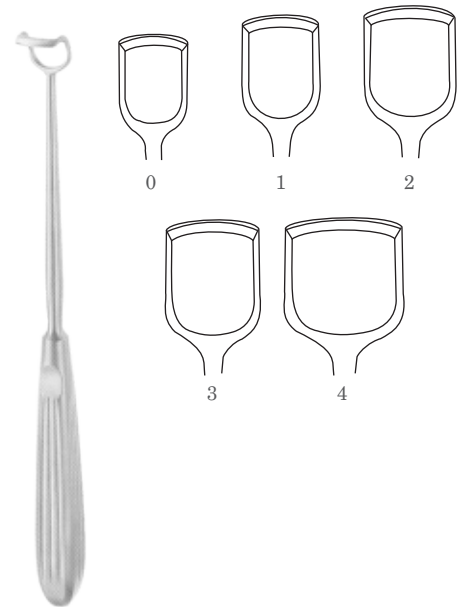

BARNHILL Adenoid Curette

Item #	Description	Cutting Edge	Length
713-610	size 0	10.0mm	8¾" (22.2cm)
713-612	size 1	12.0mm	8¾" (22.2cm)
713-614	size 2	14.0mm	8¾" (22.2cm)
713-616	size 3	16.0mm	8¾" (22.2cm)
713-618	size 4	18.0mm	8¾" (22.2cm)

THROAT, LARYNGEAL & ORAL

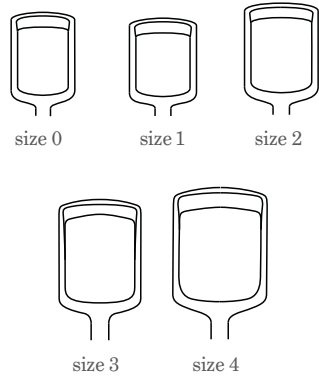

BARNHILL Adenoid Curette
Reverse Curve

Item #	Description	Cutting Edge	Length
713-810	size 0	10.0mm	8 ³ / ₄ " (22.2cm)
713-812	size 1	12.0mm	8 ³ / ₄ " (22.2cm)
713-814	size 2	14.0mm	8 ³ / ₄ " (22.2cm)
713-816	size 3	16.0mm	8 ³ / ₄ " (22.2cm)
713-818	size 4	18.0mm	8 ³ / ₄ " (22.2cm)



LOGAN Bow

Item #	Description	Width
720-910	with teeth	1" (2.5cm)
720-911	with teeth	1 ¹ / ₄ " (3.2cm)
720-912	with teeth	1 ³ / ₈ " (3.5cm)
720-920	without teeth	1" (2.5cm)
720-921	without teeth	1 ¹ / ₄ " (3.2cm)
720-922	without teeth	1 ³ / ₈ " (3.5cm)

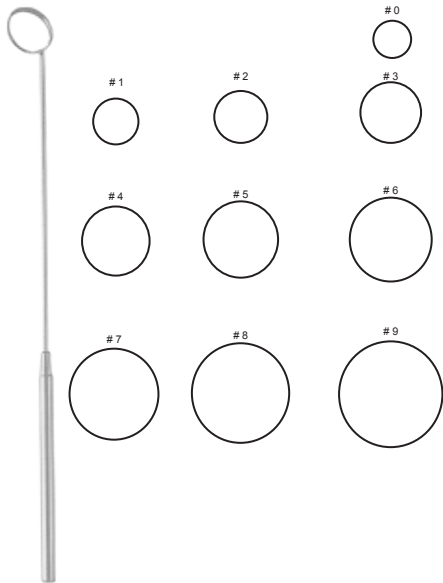

LARYNGEAL Mirror
with Octagonal Handle

Item #	Description	Diameter	Length
734-810	size 0	10.0mm	8" (20.3cm)
734-812	size 1	12.0mm	8" (20.3cm)
734-814	size 2	14.0mm	8" (20.3cm)
734-816	size 3	16.0mm	8" (20.3cm)
734-818	size 4	18.0mm	8" (20.3cm)
734-820	size 5	20.0mm	8" (20.3cm)
734-822	size 6	22.0mm	8" (20.3cm)
734-824	size 7	24.0mm	8" (20.3cm)
734-826	size 8	26.0mm	8" (20.3cm)
734-828	size 9	28.0mm	8" (20.3cm)



LAFORCE Adentome

Item #	Description	Width	Length
711-011	small	12.0mm	9 ¹ / ₄ (23.5cm)
711-012	medium	16.0mm	9 ¹ / ₄ (23.5cm)
711-013	large	18.0mm	9 ¹ / ₄ (23.5cm)

THROAT, LARYNGEAL & ORAL



ALLIS-COAKLEY Tonsil Forceps
One Open Ring Handle

Item #	Description	Length
721-002	straight	7¾" (19.7cm)
721-003	slight curve	7¾" (19.7cm)
721-004	strong curve	7¾" (19.7cm)



HURD Dissector & PILLAR Retractor

Item #	Description	Length
722-520	8.0mm dissector, 13.0mm retractor	7" (17.8cm)

PLASTIC



FERREIRA Face Lift Retractor

Item #	Width	Length
242-440	22.0mm	4¼" (10.8cm)



DOUBLE-ENDED Breast Retractor

Item #	Description	Length
249-090	37.0mm x 70.0mm and 22.0mm x 54.0mm ends	12¼" (31.1cm)

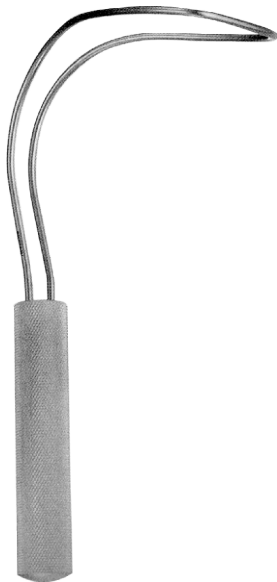

BIGGS Face Lift Retractor

Item #	Width	Length
222-284	5.2mm	8" (20.3cm)



MACCOLLUM-DINGMAN Breast Dissector

Item #	Width	Length
242-430	1½" (38.0mm)	16" (40.6cm)

PLASTIC



MACCOLLUM-DINGMAN Submammary Dissector

Item #	Width	Length
242-435	20.0mm	11¾" (29.8 cm)



AGRI-DINGMAN Submammary Dissector

Item #	Description	Length
242-490	set of 2, right & left	14" (35.6cm)
242-470	set of 2, right & left, extra-long	16" (40.6cm)



REYNOLDS Transaxillary Breast Dissector

Item #	Description	Width	Length
672-465	fenestrated	1½" (38.0mm)	15½" (39.4cm)
672-463	non-fenestrated	1½" (38.0mm)	13" (33.0cm)



SILVERSTEIN Breast Dissector

Item #	Length
242-454	13½" (34.3cm)

PLASTIC

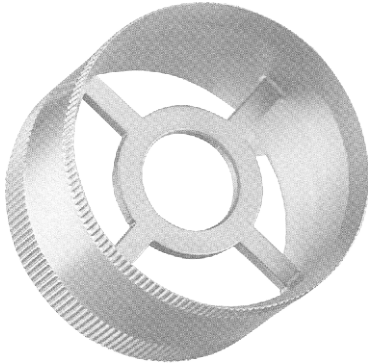

FREEMAN Areola Marker
Improved Pattern

Item #	Diameter
670-136	36.0mm
670-138	38.0mm
670-142	42.0mm
670-145	45.0mm

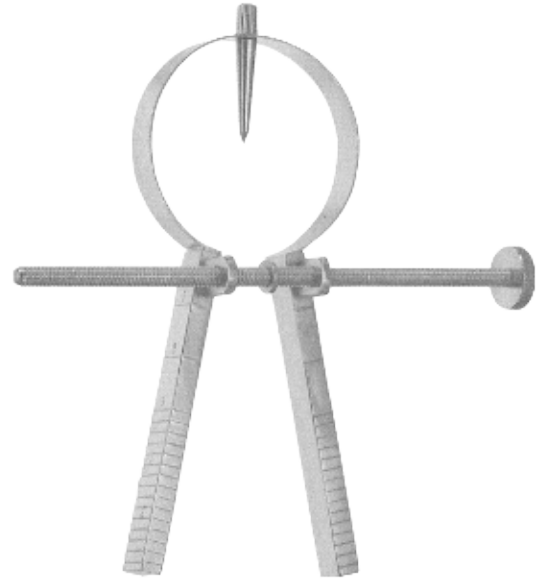

HALPERN Breast Marker

Item #	Diameter
242-512	38.0mm
242-513	42.0mm

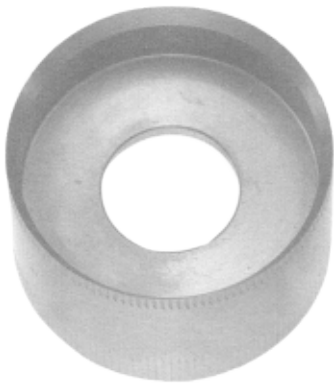

FREEMAN Areola Marker
Standard Pattern

Item #	Diameter
670-036	36.0mm
670-042	42.0mm
670-045	45.0mm



MCKISSOCK Mammoplasty Caliper

Item #	Length
678-750	11¼" (28.6 cm)

PLASTIC



MCKISSOCK Breast Marker
Keyhole Pattern

Item #	Diameter
670-050	38.0mm
670-051	42.0 mm
670-052	45.0 mm



BIGGS Mammoplasty Retractor
Narrow

Item #	Width	Length
222-230	30.0mm	6" (15.2cm)

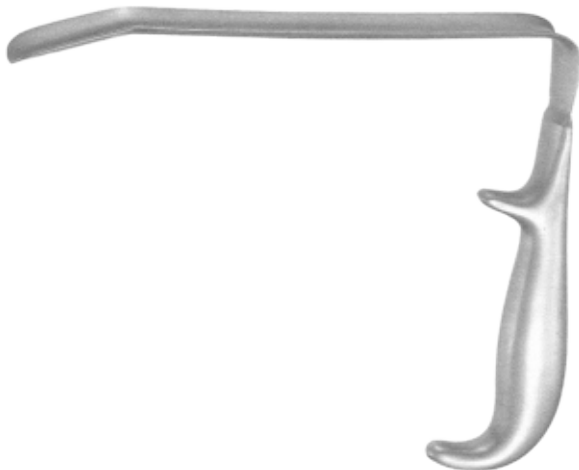

FERREIRA Breast Augmentation Retractor

Item #	Description	Length
242-445	25.0mm x 171.0mm blade	5½" (13.0cm)



BIGGS Mammoplasty Retractor
Standard

Item #	Width	Length
222-229	50.0mm	8" (20.3cm)

PLASTIC



MAMMAPLASTY/MASTECTOMY Hook

Item #	Description	Hook Width	Length
241-503	sharp	10.0mm	7½" (19.1cm)



ENDOPLASTIC Facial Dissector with Ergonomic Handle
for Broad Quick Scalp Dissection

Item #	Description	Tip Width	Length
690-322	tapered chisel tip, 30 degrees, slightly curved shaft	12.5mm	9½" (24.1cm)



ENDOPLASTIC Facial Dissector with Ergonomic Handle
Tip is Bent Up to Accommodate Delicate Dissection Sites

Item #	Description	Length
690-321	round button finishing tip, s-shaped shaft	9½" (24.1cm)



ENDOPLASTIC Facial Dissector with Ergonomic Handle
Small Chisel Head for Orbital Rim Dissection

Item #	Description	Length
690-323	mini-LANGENBECK tip, half curved shaft	9½" (24.1cm)

PLASTIC



ENDOPLASTIC Facial Dissector with Ergonomic Handle
Extended Shaft for Distant Reach into Periorbital Areas

Item #	Description	Tip Width	Length
690-324	LANGENBECK chisel tip, s-shaped shaft	7.0mm	10½" (26.7cm)



ENDOPLASTIC Facial Dissector with Ergonomic Handle
Temporal Dissector

Item #	Description	Length
690-326	concave shovel tip, straight shaft	9½" (24.1cm)



ENDOPLASTIC Facial Dissector with Ergonomic Handle
Periosteal Dissector

Item #	Description	Length
690-325	concave shovel tip, curved shaft	10" (25.4cm)



ENDOPLASTIC Facial Dissector with Ergonomic Handle
for Early Dissection, LANGENBECK Chisel Tip, Slightly-Curved Shaft

Item #	Tip Width	Length
690-327	5.0mm	9½" (24.1cm)
690-328	7.0mm	9½" (24.1cm)
690-329	10.0mm	9½" (24.1cm)
690-330	5.0mm	8" (20.3cm)

PLASTIC

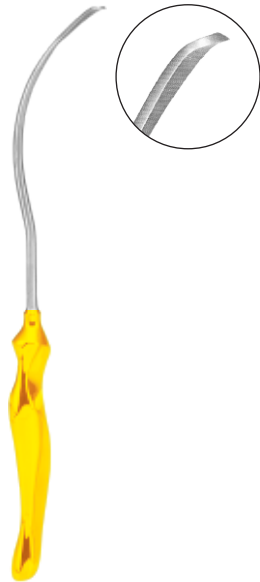

ENDOPLASTIC Facial Dissector with Ergonomic Handle
Mid Face Facial Dissector

Item #	Description	Tip Width	Length
690-332	rounded tip, s-shaped shaft	10.0mm	9½" (24.1cm)



ENDOPLASTIC Facial Dissector with Ergonomic Handle
for Early Dissection, Slightly-Curved LANGENBECK Chisel Tip

Item #	Description	Tip Width	Length
690-337	straight shaft	5.0mm	8¾" (22.2cm)
690-338	straight shaft	7.0mm	8¾" (22.2cm)
690-339	straight shaft	10.0mm	8¾" (22.2cm)



ENDOPLASTIC Facial Dissector with Ergonomic Handle
Small Cobra-Shaped Head for Nerve Dissection

Item #	Description	Tip Width	Length
690-336	mini-COTTLE finishing tip, slightly curved shaft	4.0mm	9½" (24.1cm)



ENDOPLASTIC Facial Dissector with Ergonomic Handle
Provides Effective Dissection

Item #	Description	Tip Width	Length
690-340	tapered chisel tip, slightly curved shaft	12.5mm	9" (22.9cm)

PLASTIC

FIBER OPTIC RETRACTORS ARE DESIGNED TO ENHANCE VISUALIZATION & CONTROL DURING A WIDE RANGE OF PROCEDURES, THEREBY MINIMIZING FATIGUE. UNIVERSAL ADAPTOR IS COMPATIBLE WITH STANDARD LIGHT SOURCES.



FERRIERA Style Endoscopic Retractor
with Smooth Rounded End

Item #	Description	Blade Size
690-401	with fiber optic light	80mm x 16mm
690-402	with fiber optic light & suction tube	80mm x 16mm
691-001	with fiber optic light	100mm x 25mm
691-002	with fiber optic light & suction tube	100mm x 25mm
691-101	with fiber optic light	120mm x 25mm
691-102	with fiber optic light & suction tube	120mm x 25mm
691-201	with fiber optic light	150mm x 25mm
691-202	with fiber optic light & suction tube	150mm x 25mm
691-301	with fiber optic light	120mm x 30mm
691-302	with fiber optic light & suction tube	120mm x 30mm
691-401	with fiber optic light	150mm x 30mm
691-402	with fiber optic light & suction tube	150mm x 30mm

TEBBETTS Style Endoscopic Retractor
with Tooth Serrated End

Item #	Description	Blade Size
695-101	with fiber optic light	80mm x 16mm
695-102	with fiber optic light & suction tube	80mm x 16mm
695-401	with fiber optic light	100mm x 25mm
695-402	with fiber optic light & suction tube	100mm x 25mm
695-501	with fiber optic light	120mm x 25mm
695-502	with fiber optic light & suction tube	120mm x 25mm
695-601	with fiber optic light	150mm x 25mm
695-602	with fiber optic light & suction tube	150mm x 25mm
695-801	with fiber optic light	120mm x 30mm
695-802	with fiber optic light & suction tube	120mm x 30mm
695-901	with fiber optic light	150mm x 30mm
695-902	with fiber optic light & suction tube	150mm x 30mm

PLASTIC



DOUBLE-ENDED Breast Retractor
with Fiber Optic Light

Item #	Description	Length
249-090FO	37.0mm x 70.0mm and 22.0mm x 54.0mm ends	12¼" (31.1cm)



AUFRICHT Nasal Retractor
with Fiber Optic Light

Item #	Blade Width	Length
672-134FO	7.0mm	6¼" (15.9cm)



MALINIAC Nasal Retractor
with Fiber Optic Light

Item #	Description	Length
672-125FO	11.0mm x 44.0mm blade	4¼" (10.8cm)



BIGGS Face Lift Retractor
with Fiber Optic Light

Item #	Blade Width	Length
222-284FO	5.5cm	9" (22.9cm)

PLASTIC



BIGGS Mammoplasty Retractor
with Fiber Optic Light, Fenestrated Blade, Narrow

Item #	Blade Width	Length
222-230FO	30.0mm	6" (15.2cm)



BIGGS Mammoplasty Retractor
with Fiber Optic Light, Fenestrated Blade, Standard

Item #	Blade Width	Length
222-229FO	50.0mm	8" (20.3cm)



DEAVER Retractor
with Fiber Optic Light, Flat Handle

Item #	Description	Blade Width	Length
237-217FO	delicate pattern	17.0mm	8" (20.3cm)
237-502FO	delicate pattern	25.0mm	8" (20.3cm)
237-219FO	standard pattern	16.0mm	9" (22.9cm)
237-503FO	standard pattern	25.0mm	9" (22.9cm)
237-504FO	standard pattern	25.0mm	12" (30.5cm)
237-507FO	standard pattern	38.0mm	12" (30.5cm)
237-509FO	standard pattern	75.0mm	12" (30.5cm)
237-505FO	standard pattern	25.0mm	13" (33.0cm)



FERREIRA Breast Augmentation Retractor
with Fiber Optic Light

Item #	Blade Width	Length
242-445FO	25.0mm x 171.0mm blade	5 1/8" (13.0cm)

PLASTIC



699-306

699-307

LIPOSUCTION Cannula

Gasparotti, with Thumb Plate, Angled, One Central Hole, 13.0mm Tube Connection for Use with Suction Pump

Item#	Diameter	Length (Working)
699-306	3.0mm	6" (15.2cm)

LIPOSUCTION Cannula

Gasparotti, with Thumb Plate, Slightly-Curved Tip, One Central Hole, 13.0mm Tube Connection for Use with Suction Pump

Item#	Diameter	Length (Working)
699-307	6.0mm	6" (15.2cm)
699-308	6.0mm	10" (25.4cm)

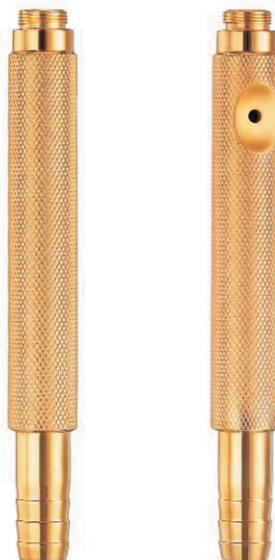

CANNULA Handle

Top has Connection Thread for Cannulas, Bottom has Tube Connection

Item#	Description	Diameter	Length
698-745	no hole	13.0mm	5¼" (13.3cm)
698-746	with hole for interrupting the suction process	13.0mm	5¼" (13.3cm)



CANNULA Adaptor

Item#	Description
698-785	luer-lock tube connector for infiltration pump

PLASTIC

SINGLE-USE Infiltration Cannula

Single Use Only, Sterile, Luer-Lock Connection, Packing Unit of 100 Pieces

Item#	Diameter	Length
698-805	0.9mm	2 $\frac{1}{4}$ " (7.0cm)
698-806	1.0mm	4 $\frac{1}{4}$ " (12.1cm)



VACUUM Glass-Barrel Syringe

Luer-Lock Connection

Item#	Description
698-782	50mL, stop 25/50mL
698-780	10mL
697-847	spare barrel for vacuum glass-barrel syringe (6987-82)
697-844	spare barrel for vacuum glass-barrel syringe (6987-80)

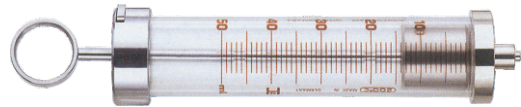

HOLDING Device

For Storage of Luer-Lock Syringes Containing Sacked Fat

Item#
698-786



PLASTIC Syringe

Single Use Only, Sterile

Item#	Description
698-743	packing unit, 60 pieces, 50mL



WASHERS

Packing Unit, 10 Pieces (not pictured)

Item#	Description
691-048	spare 15.0mm diameter washers

ALUMINUM Stop Lock for Syringes

Item#	Description	Length
698-744	for establishing a vacuum in syringe	5 $\frac{1}{8}$ " (13.0cm)



PLASTIC



SILVERS Miniature Skin Graft Knife/Dermatome

Item #	Description	Length
780-500	adjustable, thickness of cut 0.1mm to 2.0mm, width of cut 40.0mm max.	7½" (19.1cm)
019-419	pack of 10 double edge blades	n/a



WATSON Skin Graft Knife/Dermatome

Item #	Description	Length
671-435	adjustable, thickness of cut 0.1mm to 2.0mm, width of cut 155.0mm max.	12" (30.5cm)
671-431	pack of 10 replacement blades for WATSON knife	



KEYES Dermal Punch

Item #	Tip Diameter	Length
430-100	set includes 4303-02, 4303-03, 4303-04, 4303-05, 4303-06, 4303-08	4" (10.2cm)
430-302	2.0mm	4" (10.2cm)
430-303	3.0mm	4" (10.2cm)
430-304	4.0mm	4" (10.2cm)
430-305	5.0mm	4" (10.2cm)
430-306	6.0mm	4" (10.2cm)
430-308	8.0mm	4" (10.2cm)



FOX Dermal Curette
Round

Item #	Tip Diameter	Length
431-301	1.0mm	5½" (14.0cm)
431-302	2.0mm	5½" (14.0cm)
431-303	3.0mm	5½" (14.0cm)
431-304	4.0mm	5½" (14.0cm)
431-305	5.0mm	5½" (14.0cm)
431-306	6.0mm	5½" (14.0cm)

EYE



IRIS SCISSORS
With Tungsten carbide inserts

327-05	Curved	4"	
327-06	Straight	4"	
326-75	Curved	4"	one blade "Serrated"

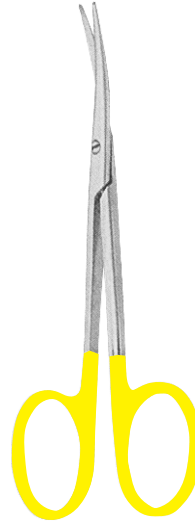

STRABISMUS SCISSORS
With Tungsten carbide inserts, Blunt tips

327-00	Curved	4"	
327-01	Straight	4"	
326-70	Curved	4"	one blade "Serrated"
326-71	Straight	4"	one blade "Serrated"

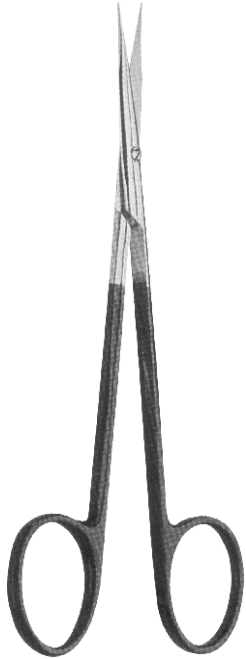

**SUPER CUT "SERRATED" STEVENS
 TENOTOMY SCISSORS**

852-001	Straight	4"
852-002	Curved	4"
852-600	Straight	5"
852-601	Curved	5"



**SUPER CUT "SERRATED" BABY
 METZENBAUM SCISSORS**

853-000	Straight	4"
853-005	Curved	4"

EYE



STEVENS TENOTOMY SCISSORS
With Tungsten carbide inserts

327-08	Straight	4"
327-09	Curved	4"

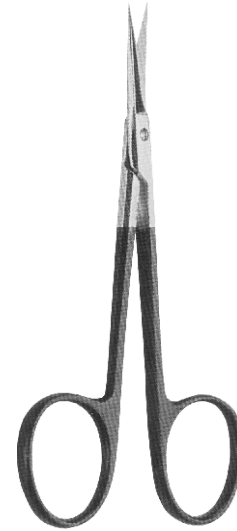

SUPER CUT "RAZOR EDGE" IRIS SCISSORS

802-010	Straight	4"
802-011	Curved	4"

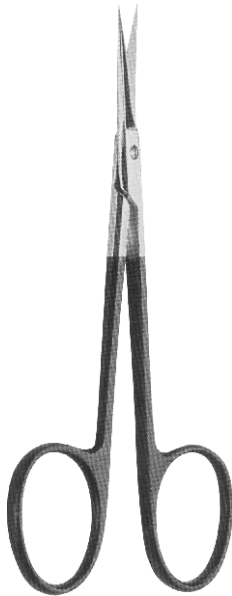

SUPER CUT "SERRATED" IRIS SCISSORS

852-010	Straight	4 1/8"
852-011	Curved	4 1/8"
852-013	Straight	4 1/8"
852-015	Curved	4 1/8"



IRIS SCISSORS
Standard pattern

601-847	Straight	4"
601-848	Curved	4"

EYE



**SUPER CUT "RAZOR EDGE"
BABY METZENBAUM SCISSORS**

803-305	Straight	4"
803-306	Curved	4"

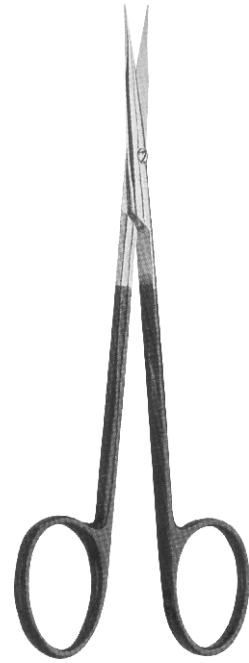

**SUPER CUT "RAZOR EDGE" STEVENS
TENOTOMY SCISSORS**

805-012	Straight	5"
805-013	Curved	5"
805-025	Straight	7"
805-125	Curved	7"

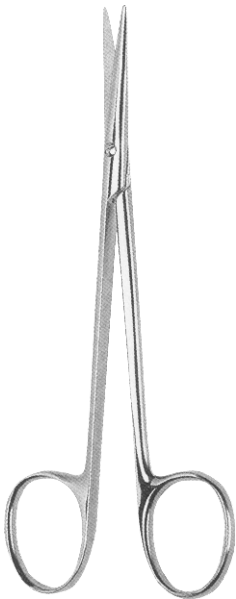

KNAPP STRABISMUS SCISSORS
Standard, Blunt tips, Rounded blades

601-865	Straight	4"
601-866	Curved	4"

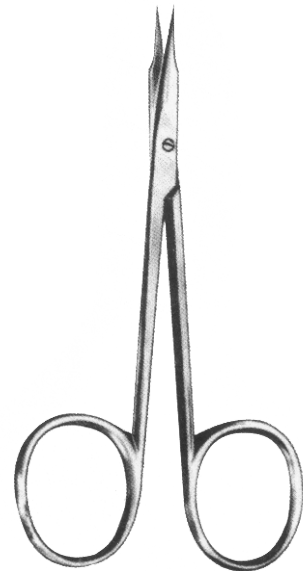

STEVENS TENOTOMY SCISSORS
Sharp tips

025-002	Straight	4"
025-003	Curved	4"

EYE

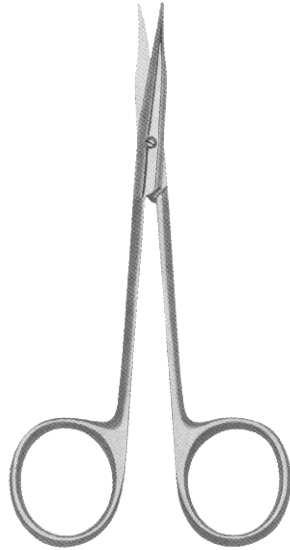

STEVENS TENOTOMY SCISSORS
Blunt tips

601-805	Straight	4"
025-012	Straight	4"
025-110	Straight	5"
601-806	Curved	4"
025-013	Curved	4"
025-111	Curved	5"
025-123	Curved	6"
025-125	Curved	7"



ENUCLEATION SCISSORS

601-749	Light curve	5"
601-750	Medium curve	5"
601-751	Strong curve	5"

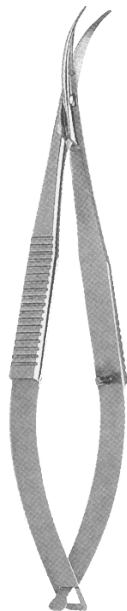

CASTROVIEJO CORNEAL SCISSORS
Medium pattern, Blunt tips

601-754	Strongly	4"
---------	----------	----



CASTROVIEJO KERATOPLASTY AND KERATECTOMY SCISSORS
Medium pattern, Blunt tips, Wide handle

601-755	Slightly curved	5"
---------	-----------------	----

EYE



CASTROVIEJO CORNEAL SCISSORS

Miniature pattern, Blunt tips

601-752	Angled left	4	1/8"
601-753	Angled right	4	1/8"



KATZIN CORNEAL TRANSPLANT SCISSORS

Miniature pattern, Uneven blunt blades,
Upper blade shorter than lower blade

601-759	Strongly curved left	4
601-760	Strongly curved right	4



CASTROVIEJO CORNEAL SCISSORS

Delicate, Blunt tips

601-756	Angled	4
---------	--------	---

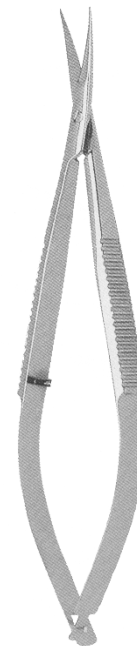

CASTROVIEJO CORNEAL SCISSORS

Curved, Blunt tips

601-768	12.0mm blades	4"
601-769	8.0mm blades	4"
601-770	7.0mm blades	4"

EYE



**TROUTMAN-KATZIN CORNEAL
TRANSPLANT SCISSORS**

With lock, Medium blades, Blunt tips

601-761	Curved right	4
601-762	Curved left	4



**TROUTMAN-KATZIN CORNEAL
TRANSPLANT SCISSORS**

Without lock, Small blades, Blunt tips

601-763	Curved right	4
601-764	Curved left	4

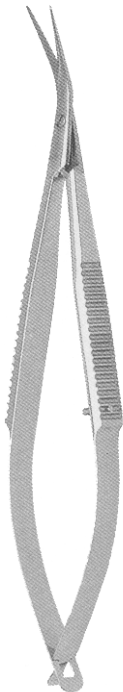

AEBLI CORNEAL SECTION SCISSORS

Delicate, Blunt tips

601-773	Angled right	4"
601-774	Angled left	4"

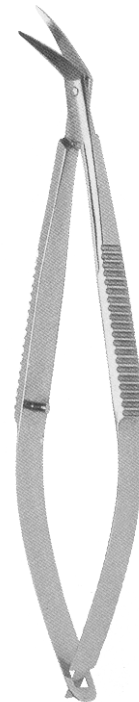

**CASTROVIEJO CORNEAL
SECTION SCISSORS**

Lower blade 1.0mm longer than upper blade
14.0mm lower blade

601-776	Curved right	4"
601-779	Curved left	4"

EYE



CASTROVIEJO CORNEAL SECTION SCISSORS
 Lower blade 0.5mm longer than upper blade
10.0mm lower blade
 601-780 Curved right 4¼”
 601-781 Curved left 4¼”



CASTROVIEJO CORNEAL SECTION SCISSORS
 Miniature pattern, Lower blade 8.0mm, Blunt tips
10.0mm lower blade
 601-782 Curved right 4
 601-783 Curved left 4

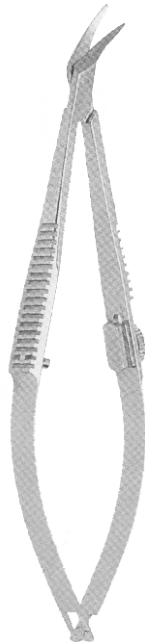

TROUTMAN-CASTROVIEJO CORNEAL SECTION SCISSORS
 Miniature pattern, 6.0mm equal length blades
With lock
 601-790 Curved right 4½”
 601-791 Curved left 4½”



CASTROVIEJO MICRO SCISSORS
 Round handle, sharp delicate blades
558-049 Angled 25° 4½”
 558-050 Angled 45° 4½”
 558-051 Angled 60° 4½”
 558-052 Angled 90° 4½”
 558-053 Angled 125° 4½”

EYE



CASTROVIEJO CORNEAL SECTION SCISSORS

Micro pattern, Lower blade 0.5mm longer than upper blade 6.0mm lower blade, Blunt tips

601-786	Curved right	4
601-787	Curved left	4



TROUTMAN-CASTROVIEJO CORNEAL SECTION SCISSORS

Miniature pattern, 10.0mm equal length blades

With lock

601-794	Curved right	4
601-795	Curved left	4

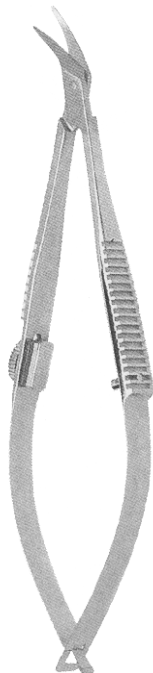

TROUTMAN-CASTROVIEJO CORNEOSCLERAL SCISSORS

Micro pattern, 6.0mm equal length blades

With lock

601-792	Curved right	4
601-793	Curved left	4



WESTCOTT TENOTOMY SCISSORS

Wide handle, Curved blunt tips

601-799	Right-handed	5½"
---------	--------------	-----

EYE



WESTCOTT TENOTOMY SCISSORS

Curved blunt tips
601-796 Left-handed 4½”
601-797 Right-handed 4½”



WESTCOTT TENOTOMY SCISSORS

Wide handle, Curved blunt tips
601-798 Left-handed 5½”

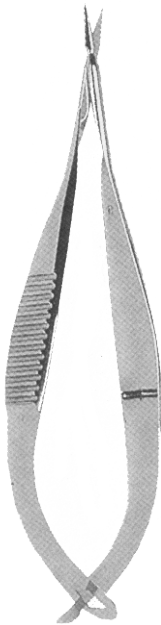

VANNAS CAPSULOTOMY SCISSORS

Very delicate 6.0mm blades, Wide handle
601-832 Straight 4½”
601-833 Curved 4½”

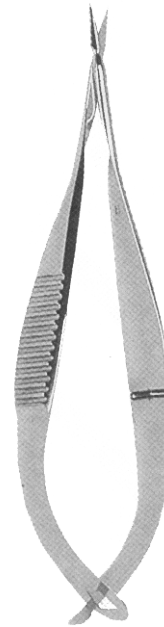

VANNAS CAPSULOTOMY SCISSORS

Very delicate 6.0mm blades
601-834 Straight blades 3
601-835 Curved blades 3
601-836 Up angled blades 3
601-839 Side angled blades 3

EYE

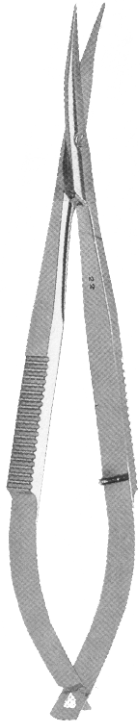

WESTCOTT UTILITY SCISSORS
Round sharp tips
601-842 Curved 5 1/8"

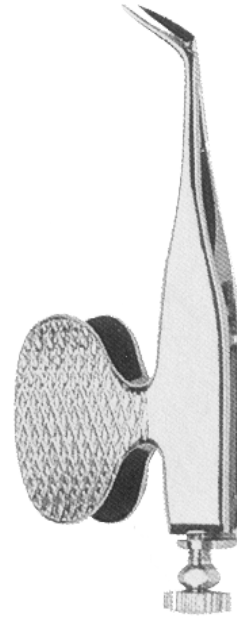

BARRAQUER IRIS SCISSORS
Delicate blunt blades
601-821 7.0mm blades 2"
601-831 10.0mm blades 2"

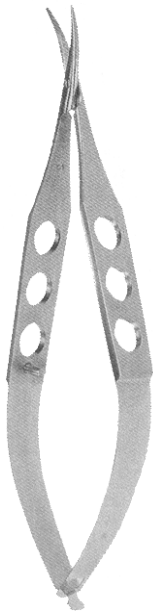

JAFFE STITCH SCISSORS
Medium blades, Very sharp tips
601-817 Curved 4"

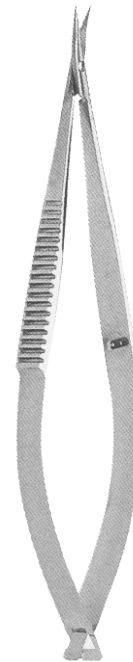

McPHERSON-WESTCOTT STITCH SCISSORS
Small curved blades
601-801 Sharp tips 4"

EYE

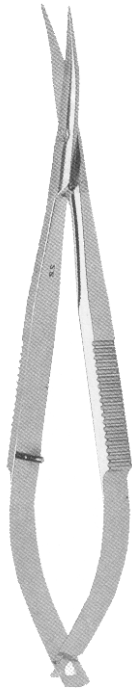

**SHEPARD-WESTCOTT TENOTOMY
SCISSORS**

Blunt tips, Serrated upper blade,
20.0mm from screw to tip
601-822 Curved 4 ⁷/₈"



WESTCOTT TENOTOMY SCISSORS

Micro pattern, Curved blunt tips
601-800 Right-handed 3 ¹/₂"

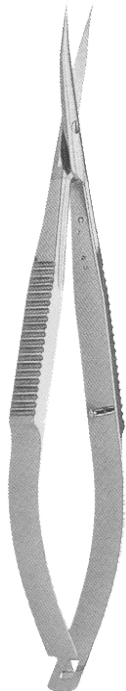

WESTCOTT STITCH SCISSORS

Sharp tips, 21.0mm from screw to tip
601-808 Curved 4 ¹/₂"



WESTCOTT STITCH SCISSORS

Wide handle, Sharp tips, 22.0mm from screw to tip
601-809 Curved 5 ¹/₂"

EYE

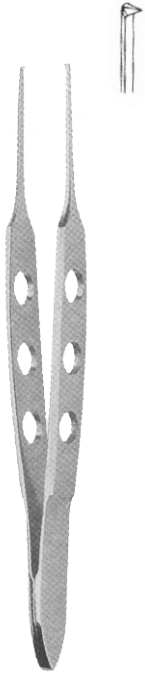

BISHOP-HARMON TISSUE FORCEPS

Straight, 1x2 teeth
601-522 Standard 3 1/8"
601-523 Extra delicate 3 1/8"

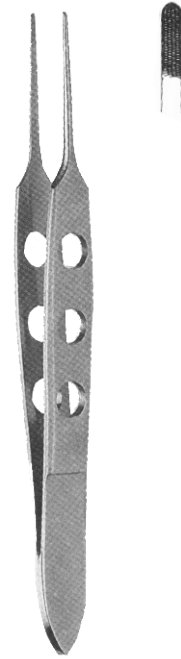

BISHOP-HARMON DRESSING FORCEPS

No teeth, cross-serrated tips
601-524 3 1/8"

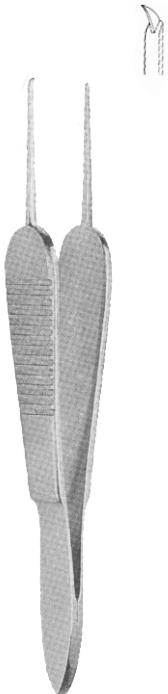

SAUER SUTURE FORCEPS
1x2 teeth at oblique angle to shaft
601-650 3 1/8"

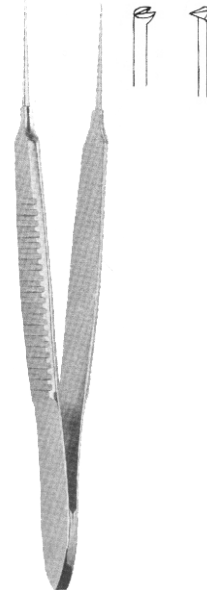

BONN SUTURE FORCEPS
Extra delicate, 12.0mm teeth
601-641 Without platform 3"

EYE

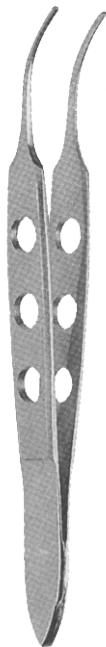

BISHOP-HARMON TISSUE FORCEPS
Curved with 1x2 teeth
 601-525 3 1/8"



CASTROVIEJO SUTURE FORCEPS
With platform, teeth on straight shaft, wide handle

601-629	0.12mm teeth	4 1/4"
601-631	0.3mm teeth	4 1/4"
601-632	0.5mm teeth	4 1/4"
601-637	0.9mm teeth	4 1/4"
601-634	1.5mm teeth	4 1/4"

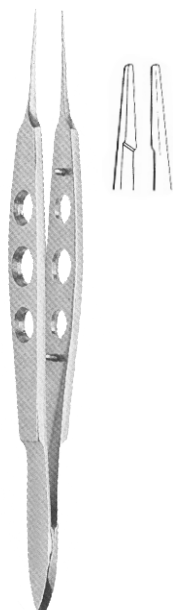

JAFFE TYING FORCEPS
Very delicate smooth jaws with platform

601-608	Straight	3 1/8"
601-609	Curved	3 1/8"

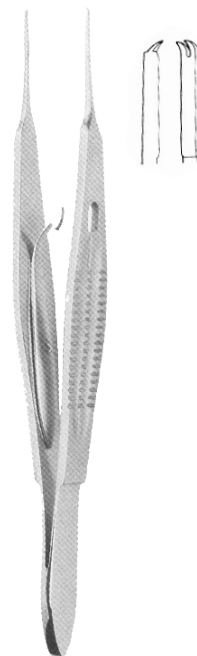

STERN-CASTROVIEJO SUTURE FORCEPS
0.5mm teeth and lock, With platform

601-633	Straight	4 1/8"
---------	----------	--------

EYE

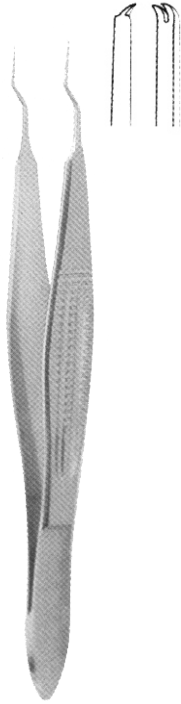

CASTROVIEJO SUTURE FORCEPS
Bayonet shape, 6.0mm tying platform
601-620 0.3mm teeth 4

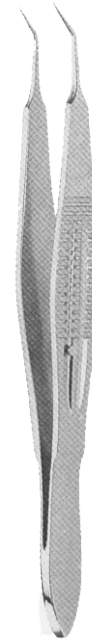

CASTROVIEJO SUTURE FORCEPS
With platform, teeth on angled shaft, Wide handle
601-630 0.12mm teeth 4 1/8"
601-628 0.3mm teeth 4 1/8"
601-627 0.5mm teeth 4 1/8"



GIRARD CORNEO-SCLERAL FORCEPS
Tying platform
601-453 0.5mm smooth tips 4 1/8"
601-654 0.3mm 1x2 teeth 4 1/8"
601-653 0.12mm 1x2 teeth 4 1/8"

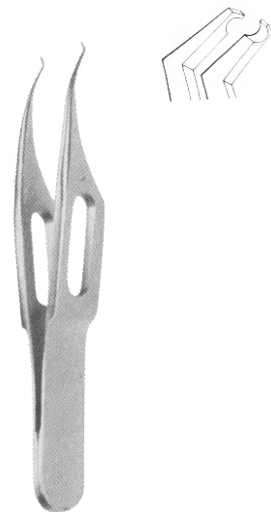

PIERSE TYPE COLIBRI FORCEPS
0.3mm Pierse type tips
601-557 3 1/8"

EYE

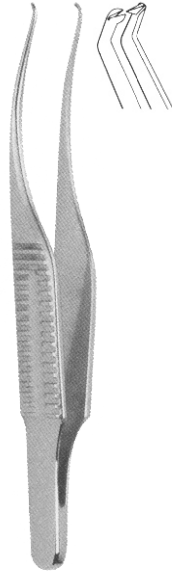

TROUTMAN-BARRAQUER CORNEAL UTILITY FORCEPS

- 1X2 teeth on 45° angle slightly overlapping
 601-459 0.3mm teeth with platform 3"
 601-460 0.5mm teeth with platform 3"
 601-461 0.5mm teeth without platform 3"

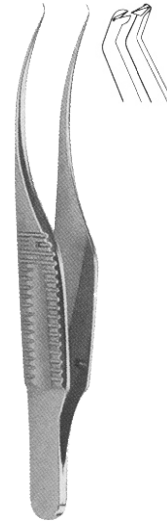

TROUTMAN-BARRAQUER CORNEAL UTILITY FORCEPS (COLIBRI TYPE)

- Very delicate .12mm teeth
 601-462 0.12mm teeth with platform 3"
 601-463 0.12mm teeth without platform 3"

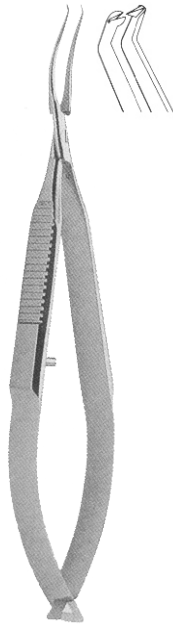

MAUMENEE CORNEAL FORCEPS Colibri type with .5mm tying platform mounted on a pivot action handle

- 601-469 0.10mm teeth angled 45° 4¾"
 601-470 0.10mm teeth angled 90° 4¾"

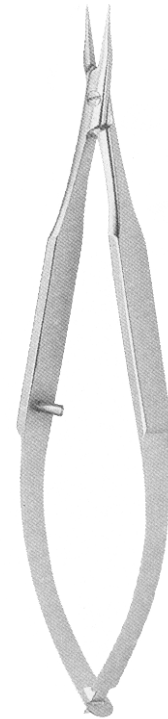

SINSKEY TYING FORCEPS
Micro tip with 7.0mm tying platform
 601-598 Straight 4¼"

EYE

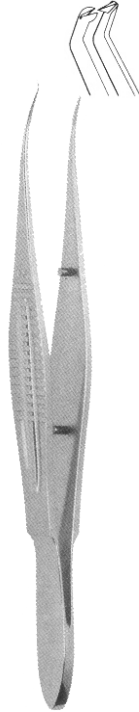

COLIBRI TYPE CORNEAL UTILITY FORCEPS

0.12mm angled 45°

601-467 6.0mm tying platform 4 1/8"

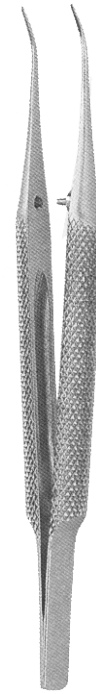

O'GAWA TYING FORCEPS

Smooth, 0.5mm platform,

0.3mm gap at heel of platform

601-605 Straight 4 1/2"

601-606 Angled 4 1/2"



CATALANO MICRO TYING FORCEPS

Round handle, 6.0mm platform with cross-serrations at tip

601-602 Straight 4 1/2"

601-603 Angled 4 1/2"

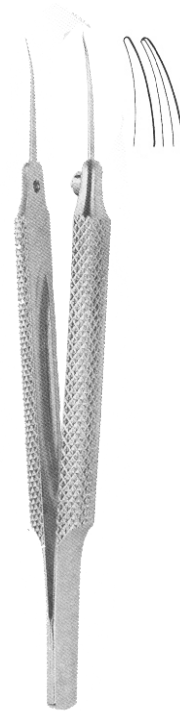

TENNANT TYING FORCEPS

6.0mm smooth platform

601-618 Curved 4"

601-619 Straight 4"

EYE

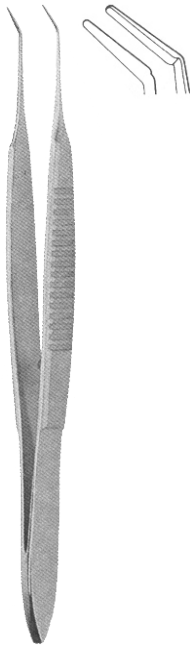

McPHERSON TYING FORCEPS
Smooth, 5.0mm jaws, 3.5mm platform
 601-592 Angled 3 1/8"
 601-596 Straight 3 1/8"

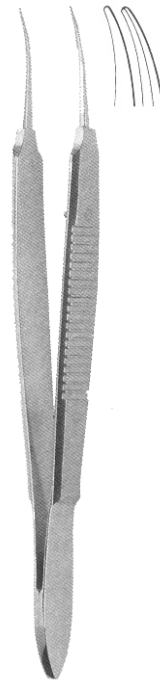

HARMSTUBINGEN TYING FORCEPS
 601-611 Curved 4 1/8"
 601-612 Straight 4 1/8"

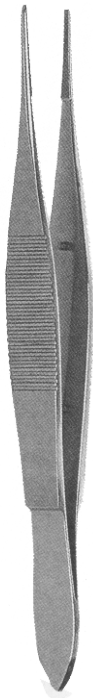

WILLS HOSPITAL UTILITY FORCEPS
13.0mm platform with cross-serrations
 601-675 4 1/8"



BONACCOLTO UTILITY FORCEPS
Cross-serrated at tip, rear of jaw fluted
 601-677 1.2mm tips 4"
 601-678 1.7mm tips 4"

EYE

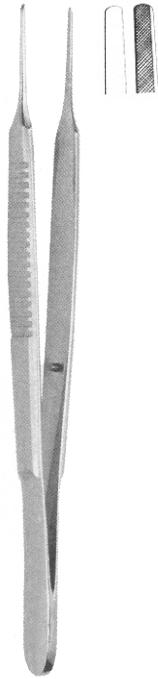

McCULLOUGH UTILITY FORCEPS
601-680 Cross-serrated 3³/₄"
601-681 Smooth jaws 3³/₄"



SCHAFF FOREIGN BODY FORCEPS
Grooved jaw
601-696 4 1/8"

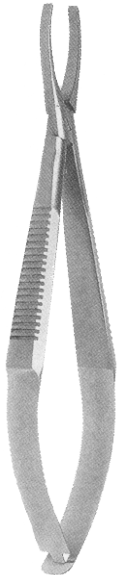

GRADLE CILIA FORCEPS
Cross-action jaws with guard
601-702 3³/₄"

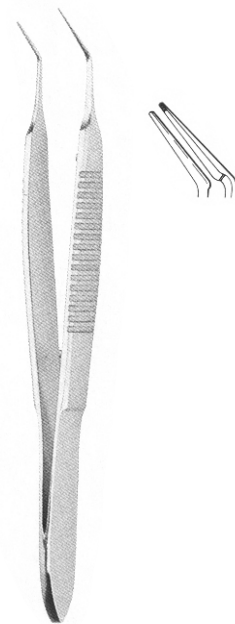

SHEETS-McPHERSON TYING FORCEPS
Angled, 10.0mm tying platform,
1.0mm of tip cross-serrated
601-577 Angled 3 1/8"

EYE



BARRAQUER CILIA FORCEPS
Slightly curved jaws with platform
601-699 4 1/4"



KELMAN-McPHERSON TYING FORCEPS
Smooth jaws, 7.5mm tying platform
601-579 Angled 3 1/8"

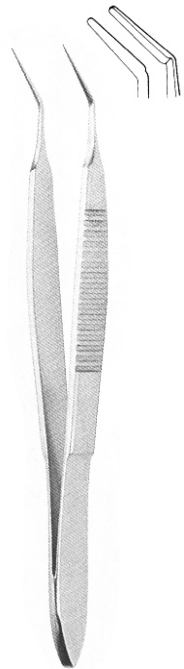

BECHERT-McPHERSON TYING FORCEPS
Angled, Smooth jaws, 10.0mm tying platform
601-578 Angled 3 1/8"

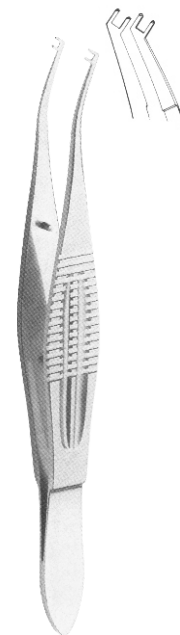

LIEBERMAN SUTURING FORCEPS
Colibri style, double toothed tips, 7.0mm tying platform
601-647 4 1/3"

EYE

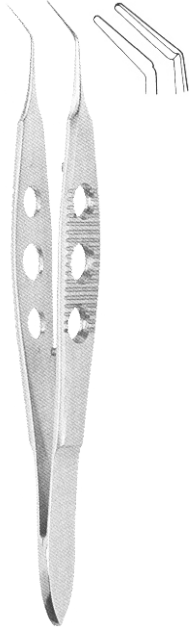

KELMAN-McPHERSON TYING FORCEPS
Very delicate, smooth jaws, 7.5mm tying platform
601-580 Angled 3/4"

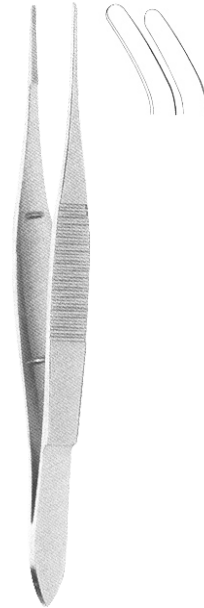

NUGENT UTILITY FORCEPS
10.0mm jaws angled 45°
601-673 Smooth jaws 4"
601-674 Serrated jaws 4"



LESTER FIXATION FORCEPS
601-534 1x2 teeth 3/4"
601-535 2x3 teeth 3/4"



ELSCHMIG FIXATION FORCEPS
Heavy, 1x2 angled teeth
601-540 4/4"

EYE

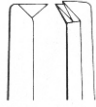
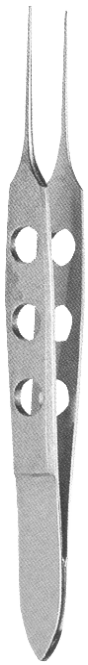

ELSCHMIG FIXATION FORCEPS
Wide handle, Heavy, 1x2 angled teeth
601-541 4¹/₄"



THORPE CONJUNCTIVAL FIXATION FORCEPS
2x3 teeth, with platform
601-544 0.6mm teeth 3³/₄"
601-546 0.12mm teeth 3³/₄"

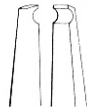
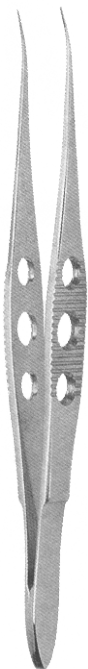

PIERSE FIXATION FORCEPS
601-572 0.3mm tips 3³/₄"
601-573 0.1mm tips 3³/₄"

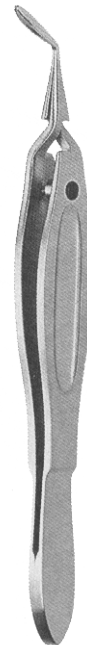

FAULKNER LENS FOLDING FORCEPS
601-575 4¹/₂"

EYE



CASTROVIEJO FIXATION FORCEPS

Wide handle. Without platform. 1x2 teeth

- 601-547 0.3mm teeth 4 1/8"
- 601-548 0.5mm teeth 4 1/8"



DODICK NUCLEUS SPLITTER

Serrated paddle jaws

- 601-583 4 1/8"

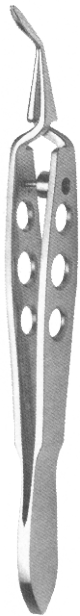

ERNEST-McDONALD SOFT IOL HOLDING FORCEPS

- 601-581 4"

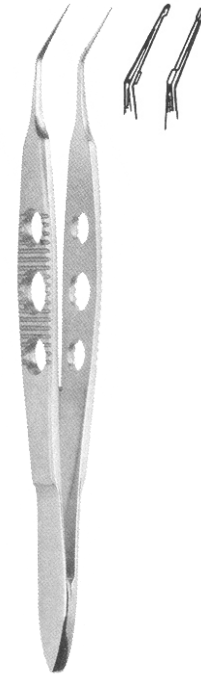

KRAFF CAPSULE TAG FORCEPS

11.0mm angled jaws, 15.0mm smooth platform

- 601-490 4"

EYE

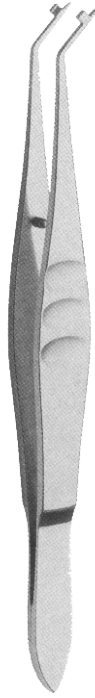

LIVERNOIS PICKUP AND FOLDING FORCEPS
601-588

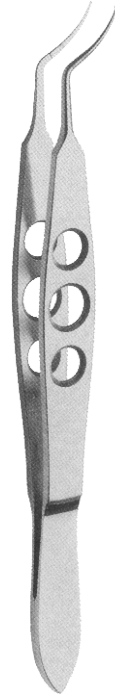

MASKET CAPSULORHEXIS FORCEPS
11.0mm jaws
601-553

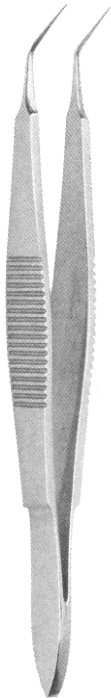

GASKIN FRAGMENT FORCEPS
11.0mm angled smooth jaws, Very delicate
601-491 0.3mm tips 4"

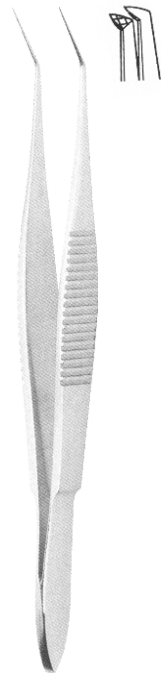

UTRATA CAPSULORHEXIS FORCEPS
12.0mm long angled jaws with iris stop
601-492 Flat handle 3 1/8"

EYE



UTRATA CAPSULORHEXIS FORCEPS
12.0mm long angled jaws with iris stop, extra delicate 0.5mm pad at distal tips.
601-499 Round handle 4 $\frac{1}{4}$ "

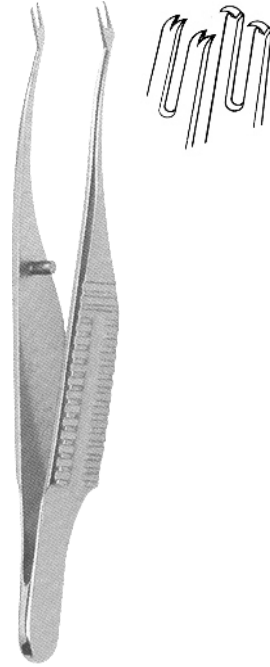

POLACK DOUBLE CORNEAL FORCEPS
Prongs 5.0mm from angle to tip, 1 x2 teeth
601-472 Flat handle 2 $\frac{3}{4}$ "

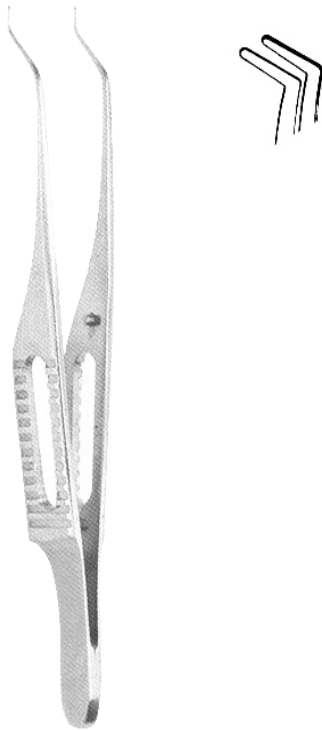

GILLS-WELSH CAPSULE FORCEPS
601-496 Smooth tips 2 $\frac{3}{4}$ "

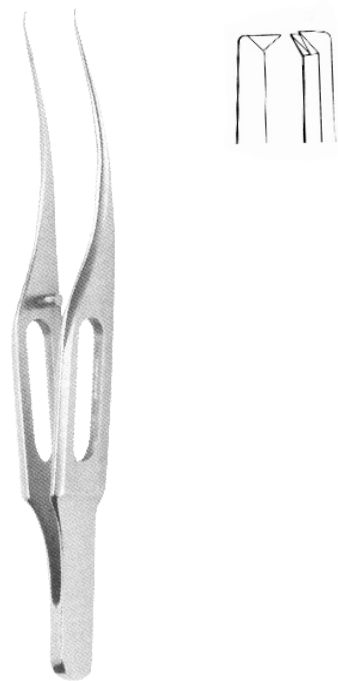

GILLS-HESS IRIS FORCEPS
1 x2, 0.12mm forward teeth
601-509 Bayonet tips 2 $\frac{3}{4}$ "

EYE

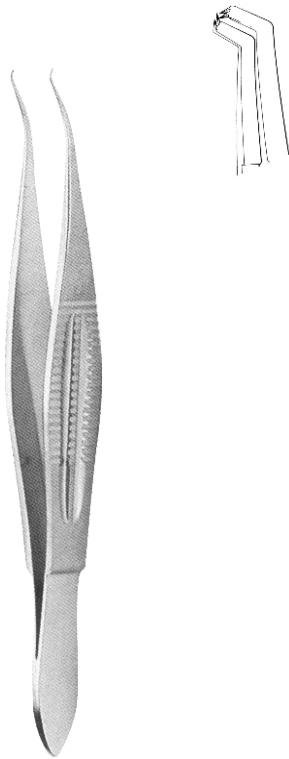

UNIVERSITY OF KANSAS CORNEAL FORCEPS
Colibri style 2x2 teeth angled 45°, 7.0mm tying Platform

- 601-471 0.12mm teeth 4 1/8"
- 601-477 0.25mm teeth 4 1/8"

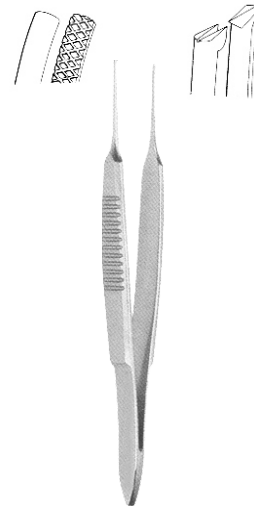

GRAEFE IRIS FORCEPS

- 601-515 1 x2 teeth 2 1/2"
- 601-516 Curved cross-serrated tips 2 1/2"
- 601-517 Straight cross-serrated tips 2 1/2"
- 601-518 Curved 1x2 teeth 2 1/2"

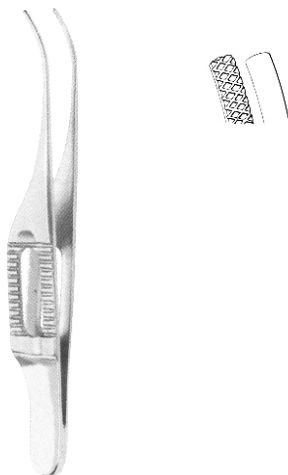

GILLS IRIS FORCEPS

Slight curved

- 601-510 1x2 teeth 2 3/4"
- 601-511 Cross-serrated tips 2 3/4"

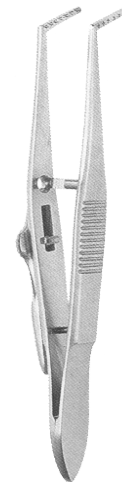

JAMESON MUSCLE FORCEPS

12.0mm jaw, Slide lock 60-1664 Left

- 601-664 Left 4"
- 601-665 Right 4"

EYE

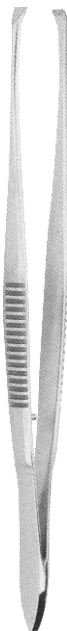

GRAEFE FIXATION FORCEPS

Without lock

601-528 3.5mm jaw 4 1/8"

601-529 4.5mm jaw 4 1/8"

With lock

601-530 4.5mm jaw 4 1/2"



GREEN FIXATION FORCEPS

601-532 5.0mm jaw 4"

601-531 12.0mm jaw 4"



BERENS MUSCLE CLAMP

13.5mm blades, teeth on bottom blade

601-668 3 1/2"



BERKE PTOSIS FORCEPS

Serrated blades, slide lock

601-669 20.0mm blades 4"

601-670 27.0mm blades 4"

EYE

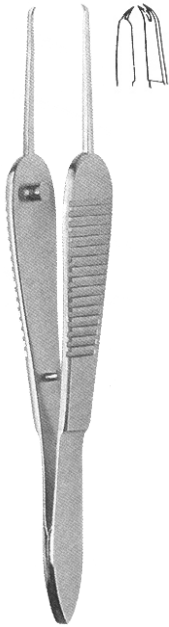

PAUFIQUE SUTURE FORCEPS
1x2 strong teeth, with platform
601-651 3½"

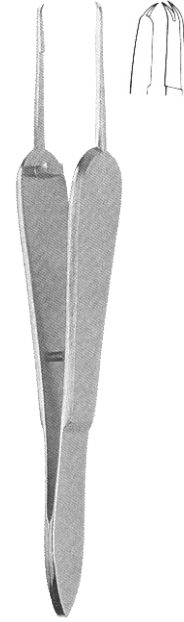

MANHATTAN EYE AND EAR SUTURE FORCEPS
1x2 teeth, with platform
601-652 3½"

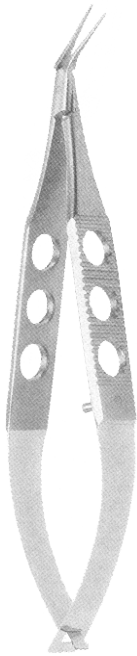

THORNTON IOL FORCEPS
Angled 45°, smooth flat cross-action handle
601-735 11.0mm jaws 3½"



WATZKE SLEEVE SPREADING FORCEPS
Angled 30°, Serrated 10.0mm tips
601-732 4½"

EYE

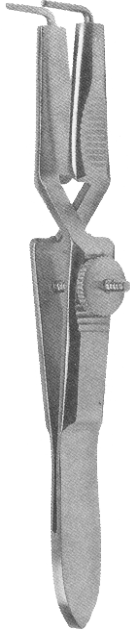

LAMBERT SLEEVE SPREADER
Smooth 90° jaws
601-734 4 1/8"

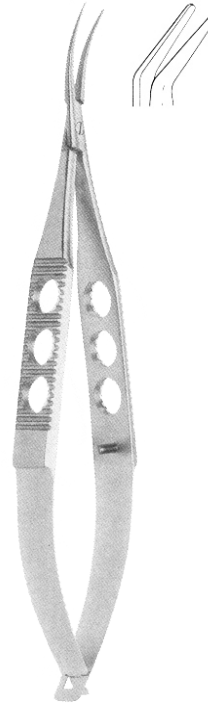

KRATZ LENS HOLDING FORCEPS
Very delicate narrow jaws, smooth, Slightly curved
601-727 Without lock 4 1/2"
601-728 With lock 4 1/2"

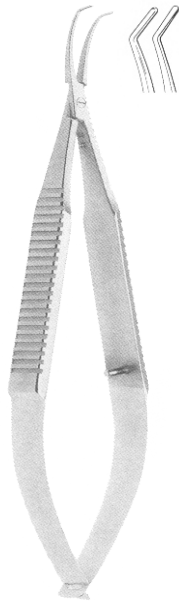

CLAYMAN IOL FORCEPS
Angled 70°, 3.0mm tips
601-733 4 3/4"



HUNT CHALAZION FORCEPS
Open smooth blade, locking thumb screw
601-714 12.0mm blade

EYE

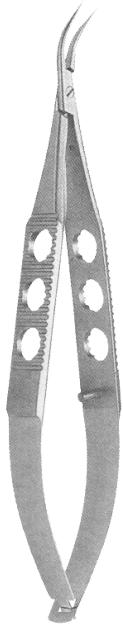

BLAYDES LENS HOLDING FORCEPS
Very delicate narrow, smooth jaws
601-739 Angled 45° 4½"



VON MANDACH CAPSULE FRAGMENT AND CLOT FORCEPS
10.0mm long curved jaws with platform for grasping at tip
601-742 2¼"



LAMBERT CHALAZION FORCEPS
smooth blade, locking thumb screw
601-715 Small, 9.0mm opening 3½"
601-716 Large, 12.0mm opening 3½"

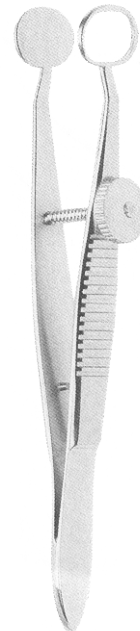

BAIRD CHALAZION FORCEPS
Open blade is 8.0mm x 12.0mm,
locking thumb screw
601-717 3½"

EYE



DESMARRES CHALAZION FORCEPS

smooth blade, locking thumb screw

- 601-711 Small, 3½"
- 601-718 Medium, 3½"
- 601-719 Large, 3½"



FRANCIS CHALAZION FORCEPS

Smooth blade, inside dimensions 12.0mm x 14.0mm long,
locking thumb screw

- 601-712 3¾"

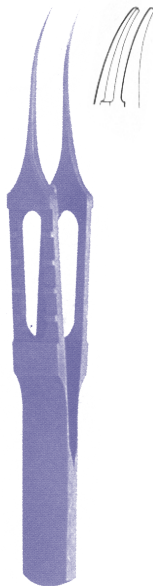

TITANIUM TYING FORCEPS

With tying platform

- 605-400 Straight 3½"
- 605-402 Curved 3½"
- 605-404 Angled 3½"

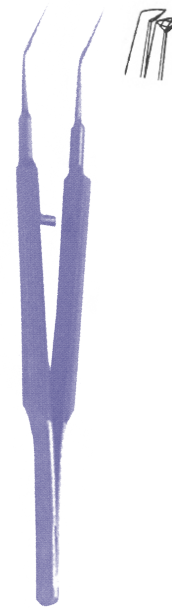

TITANIUM CAPSULORHEXIS FORCEPS

- 605-150 Flat handle 4"
- 605-151 Round handle 4"

EYE

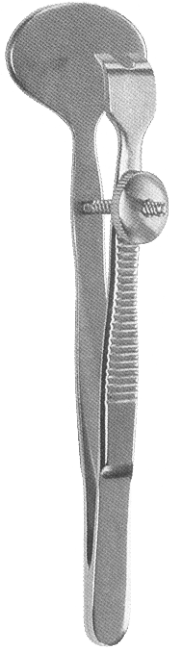

EHRHARDT LID FORCEPS
14.0mm oval lower plate, straight 9.0mm serrated upper jaw
 605-530 4"

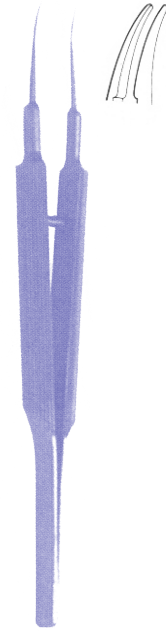

TENNANT TITANIUM TYING FORCEPS
With guide pin and platform
 605-325 Straight
 605-326 Curved

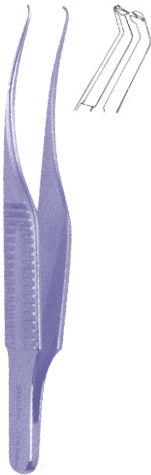

COLIBRI TITANIUM FORCEPS
Angled tips
 605-320 4½"
 605-315 3"

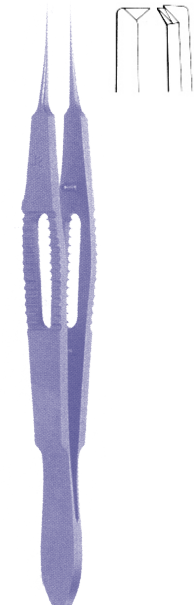

CASTROVIEJO TITANIUM SUTURE FORCEPS
 605-300 0.12mm teeth 4¼"
 605-301 0.3mm teeth 4¼"
 605-302 0.5mm teeth 4¼"

EYE

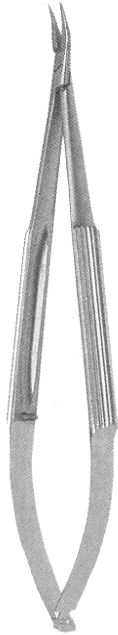

TROUTMAN NEEDLE HOLDER
Very delicate 9.0mm jaws, Round handles
601-899 Curved without lock 4³/₄"
601-900 Curved with lock 4³/₄"

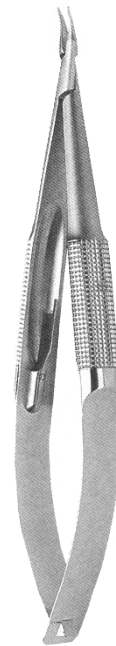

BARRAQUER NEEDLE HOLDER
10.0mm delicate jaws, Round handles
601-896 Curved without lock
601-897 Curved with lock 5¹/₄"

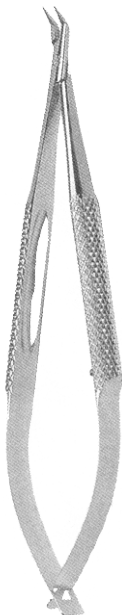

TROUTMAN-BARRAQUER NEEDLE HOLDER
Smooth jaws, Round handles
601-902 Angled without lock 4¹/₂"
601-901 Angled with lock 4¹/₂"



BARRAQUER NEEDLE HOLDER
Delicate, 8.0mm jaws, Round handles
601-903 Curved without lock
601-904 Curved with lock 5¹/₄"
601-905 Straight with lock 5¹/₄"
601-906 Straight without lock

EYE

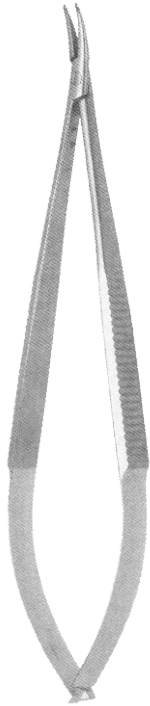

CASTROVIEJO NEEDLE HOLDER
Medium, 10.0mm jaws, Flat handles

- 601-917 Straight with lock 5½"
- 601-921 Straight without lock 5½"
- 601-909 Curved with lock 5½"
- 601-910 Curved without lock 5½"

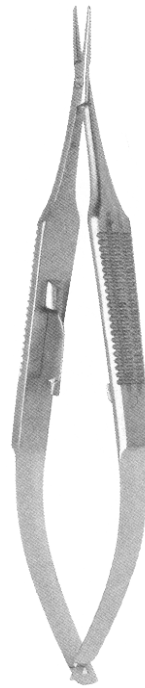

CASTROVIEJO NEEDLE HOLDER
Very delicate, 9.0mm jaws, Wide flat handles

- 601-918 Straight with lock 5
- 601-923 Straight without lock
- 601-919 Curved with lock 5
- 601-920 Curved without lock 5

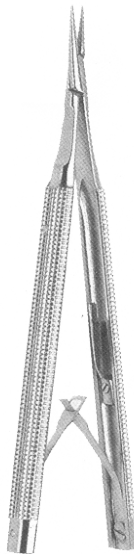

CASTROVIEJO NEEDLE HOLDER
9.0mm jaws, Round handles

- 601-874 Straight with lock 4¾"

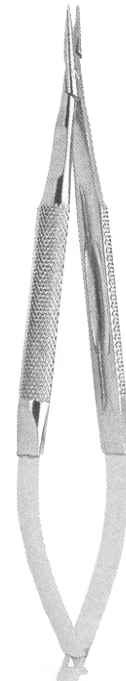

NEEDLE HOLDER
Conical 9.0mm jaws, Round handles

- 601-875 Straight with lock 5"
- 601-876 Straight without lock 5"
- 601-877 Curved with lock 5"
- 601-879 Curved without lock 5"

EYE

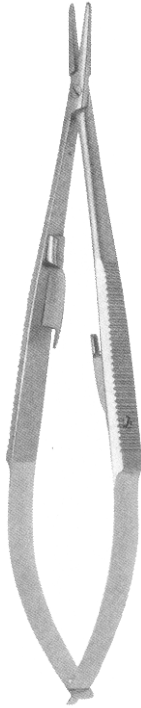

CASTROVIEJO NEEDLE HOLDER
Heavy, 16.0mm jaws, Flat handles
601-922 Straight with lock 6"

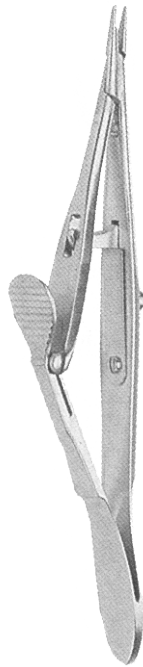

KALT NEEDLE HOLDER
Delicate, 10.0mm serrated jaws
601-883 Straight with lock 5 1/4"



BARRAQUER MICRO NEEDLE HOLDER
Very delicate, Round handles
601-885 Curved with lock 4 3/4"
601-886 Curved without lock 4 3/4"
601-887 Straight with lock 4 3/4"
601-888 Straight without lock 4 3/4"

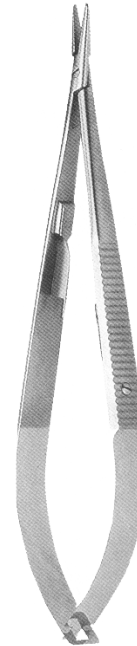

CASTROVIEJO NEEDLE HOLDER
Standard, 12.0mm jaws
601-924 Straight with lock 5 1/2"
601-925 Curved with lock 5 1/2"

EYE

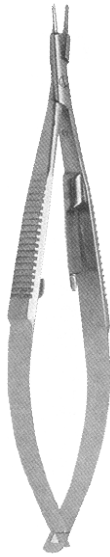

McPHERSON NEEDLE HOLDER
Smooth 10.0mm tapered jaw. Extra delicate
 601-890 Straight without lock
 601-891 Straight with lock 4"
 601-892 Curved with lock 4"
 601-893 Curved without lock 4"

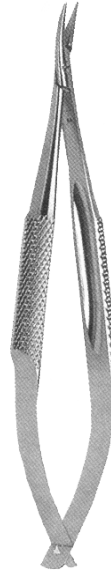

COHAN NEEDLE HOLDER
Micro, 7.0mm jaws. Round handles
 601-894 Curved without lock 4 1/8"
 601-895 Curved with lock 4 1/8"



ANIS NEEDLE HOLDER
Extra delicate, 8.0mm jaws
 602-801 Straight with lock 5"
 602-802 Straight without lock
 602-803 Curved with lock 5"
 602-804 Curved without lock 5"

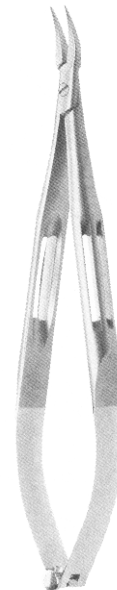

MICRO NEEDLE HOLDER
Without lock, delicate. Round fenestrated handles
 602-900 Curved 10.0mm jaws 4 1/8"
 602-905 Curved 11.0mm jaws 4 1/8"

EYE

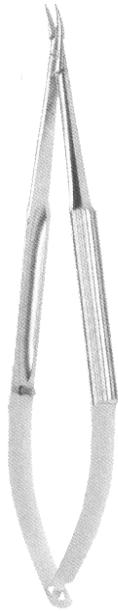

MICRO NEEDLE HOLDER

Extremely delicate 7.0mm jaws, Round fluted handles

- 603-002 Curved with lock 4 $\frac{3}{4}$ "
- 603-003 Straight with lock 4 $\frac{3}{4}$ "
- 603-004 Curved without lock 4 $\frac{3}{4}$ "
- 603-005 Straight without lock 4 $\frac{3}{4}$ "

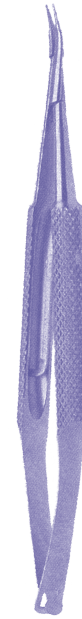

TITANIUM BARRAQUER NEEDLE HOLDER

Delicate jaws

- 605-509 Straight without lock 4 $\frac{1}{4}$ "
- 605-510 Straight with lock 4 $\frac{1}{4}$ "
- 605-511 Curved without lock 4 $\frac{1}{4}$ "
- 605-512 Curved with lock 4 $\frac{1}{4}$ "



KELLY DECEMET PUNCH

Produces a precise .75mm
Serrated squeeze handle
601-000

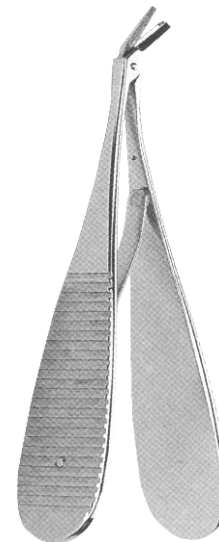

HOLTZ CORNEOSCLERAL PUNCH

1.0mm wide 7.0mm long punch
601-007 3 $\frac{1}{2}$ "

EYE



TITANIUM BARRAQUER NEEDLE HOLDER

Medium jaws

- 605-503 Straight without lock 4 1/4"
- 605-504 Straight with lock 4 1/4"
- 605-502 Curved without lock 4 1/4"
- 605-505 Curved with lock 4 1/4"



SERREFINE

- 602-026 Straight 1 1/2"
- 602-027 Curved 1 1/2"



CHUCK HANDLE FOR MRV BLADE

600-010

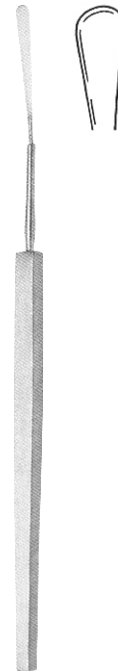

KIMURA PLATINUM SPATULA

4.0mm x 17.5mm flat platinum spatula with 34.0mm shaft
601-089 5 3/4"

EYE



TOOKE CORNEAL KNIFE
Smooth, 3.0mm x 19.0mm blade
601-045 4³/₄"



GILL CORNEAL KNIFE
3.0mm wide
601-046 Straight 5¹/₄"
601-047 Curved 5¹/₄"



CULLER IRIS SPATULA
Sterling
601-090 2.0mm x 33.0mm 5"
601-091 1.0mm x 28.0mm 5"



IRIS SPATULA
Malleable
601-092 1.0mm x 33.0mm 5"

EYE

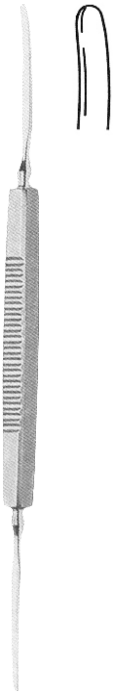

WHEELER DOUBLE ENDED CYCLODIALYSIS SPATULA
601-099

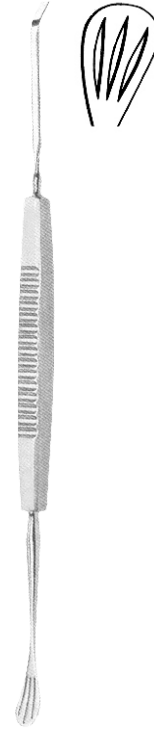

PATON DOUBLE ENDED SPATULA
With groove, 6.0mm x 15.0mm and 2.0mm x 31.0mm, end of
blade angled up 7.0mm
601-105 5³/₄"



GIRARD SYNECHIA SPATULA
Semi-sharp tip
601-106 0.5mm 4¹/₂"

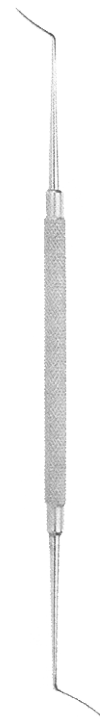

CASTROVIEJO SYNECHIA SPATULA
Double ended, 0.5mm x 10.0mm and 0.5mm
and 0.5mm and 15.0mm blades
601-066 5¹/₂"

EYE

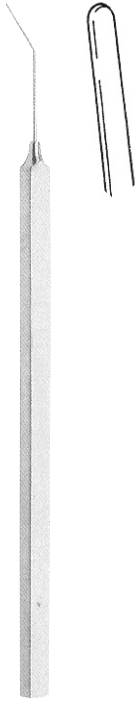

JAFFE LENS SPATULA
Flat, smooth
601-109 5.0mm wide 4³/₄"



BARRAQUER CYCLODIALYSIS SPATULA
601-068 0.5mm tip 4³/₄"
601-071 0.25mm tip 4³/₄"

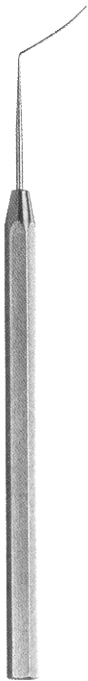

BARRAQUER IRIS SPATULA
Hexagonal handle
601-067 0.25mm tip 3¹/₂"
601-069 0.5mm tip 3¹/₂"



CASTROVIEJO CYCLODIALYSIS SPATULA
Double-ended, 0.25mm x 10.0mm x 0.25mm wide
601-076 5¹/₄"

EYE

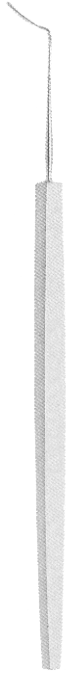

ELSCHMIG CYCLODIALYSIS SPATULA
Blade 10.0mm x 1.0mm
601-073 4³/₄"

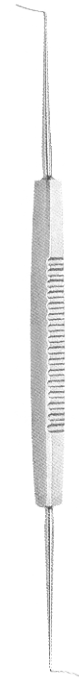

CASTROVIEJO CYCLODIALYSIS SPATULA
Double-ended, 0.5mm x 15.0mm x 0.5mm wide
601-074 5¹/₄"

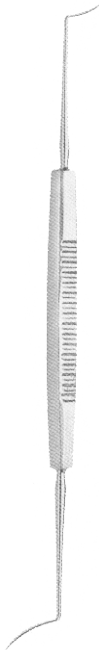

CASTROVIEJO CYCLODIALYSIS SPATULA
1.0mm x 16.0mm x 0.75mm wide
601-077 5¹/₄"

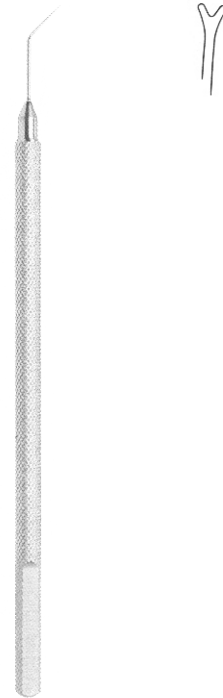

JAFFE-BECHERT LENS NUCLEUS ROTATOR
Blunt forked tip angled 9.0mm from tip
601-117

EYE



BECHERT LENS NUCLEUS ROTATOR
Fork on front
601-118 5"



LESTER LENS PUSHER
0.25mm diameter, Hourglass tip
601-126 Straight 4½"
601-127 Angled 4½"

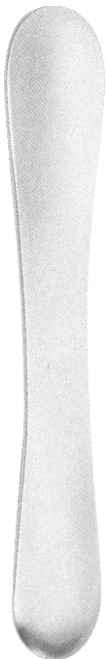

BERKE-JAEGER LENS PLATE
Stainless, 23.0mm wide
601-070 4¼"



WILDER LENS LOOP
Serrated, 4.0mmx15.0mm loop on flat handle
601-275 5½"

EYE

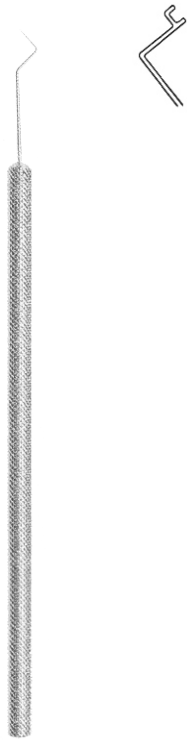

LEISKE-SMITH LENS PUSHER
U-shaped tip
 601-128 4½"

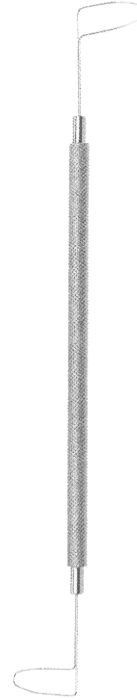

SIMCOE LENS LOOP
Double ended, 4.0mm x 20.0 serrated loops
 601-280 5½"



LEWIS LENS LOOP
 601-276 Large 5½"
 601-277 Small 5½"



BUNGE EVISCERATION SPOON
 601-294 Small 5¼"
 601-295 Large 5½"

EYE



NEW ORLEANS EYE AND EAR LENS LOOP
601-281 5½"



KIRBY INTRA-CAPSULAR LENS LOOP
Long, slender loop
601-285 5½"

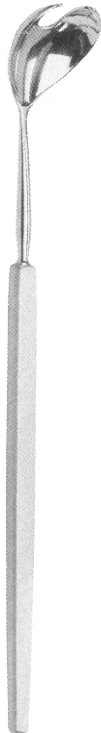

WELLS ENUCLEATION SPOON
12.0mm
601-296 5½"



JENSEN CAPSULE POLISHER
Front port, diamond dust tip
601-146 25-gauge
601-147 27-gauge

EYE

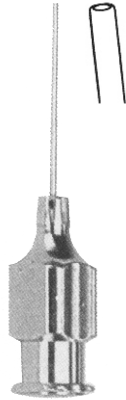

McINTYRE ANTERIOR CHAMBER CANNULA

601-154	Straight	23-gauge
601-155	Angled	23-gauge
601-156	Straight	26-gauge
601-157	Angled	26-gauge
601-158	Straight	30-gauge
601-159	Angled	30-gauge



AIR INJECTION CANNULA

601-148	27-gauge
601-149	30-gauge



KELMAN DIPSTICK

19-gauge cannula, marked at 5.0, 6.0 and 7.0mm, tow irrigating ports
601-927

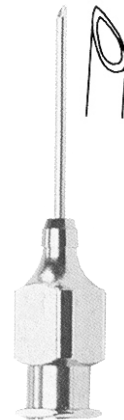

SCHEIE ASPIRATING CATARACT NEEDLE

Sharp, beveled point
601-150 19-gauge

EYE

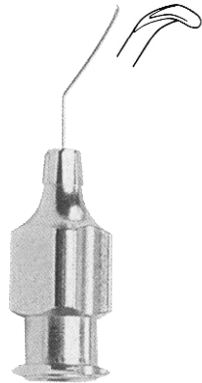

KRATZ LENS MANIPULATOR CANNULA
601-130 30-gauge



KRATZ CAPSULE SCRAPER
1.0mm tip, angled 30°, sandblasted
601-131 23-gauge 3/4"



MAUMENEE VITREOUS ASPIRATING NEEDLE
Blunt tip with markings, 5.0mm, 10.0mm and 15.0mm
601-151 18-gauge



KRATZ CYSTOTOME
Shaft with sharp top, shaft angled 60°
601-030 22-gauge 1/2"

EYE



KELMAN CYCLODIALYSIS CANNULA

Tip flattened

- 601-085 Port on right side 19-gauge
- 601-086 Port on left side 19-gauge



RANDOLPH CYCLODIALYSIS CANNULA

Front air injection port, 12.0mm angled tip

- 601-087 Flat tip 19-gauge
- 601-088 Thin spatula blade 19-gauge



LIEPPMAN CYSTOTOME

With guard

- 601-032 22-gauge 2"

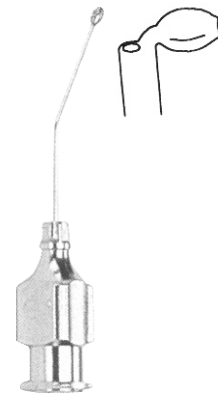

GILL-WELSH OLIVE TIP CANNULA

Angled 45°

- 601-180 25-gauge

EYE



**BISHOP HARMON ANTERIOR CHAMBER
IRRIGATOR**

601-185 Complete (includes 601-192, 601-187 and 601-193)

- 601-192 Adapter for irrigator
- 601-187 Bishop-Harmon irrigating cannula
- 601-193 19-gauge Silicone bulb



SILICONE BULB

601-186 Complete with 601-187 and 601-193

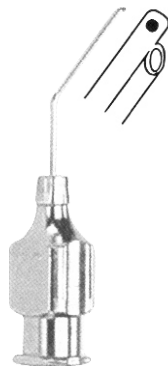

**SIMCOE REVERSE DOUBLE-BARRELED
IRRIGATING/ASPIRATING UNIT**

Irrigation through main with aspiration through side taper

601-175 23.0mm port



SHEETS IRRIGATING VECTUS

Ports at 3, 9 and 12 o'clock with serrations on top of 6.0mmx10.0mm loop

601-257 21-gauge 1½"

EYE

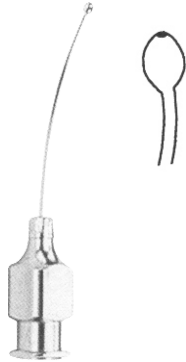

TROUTMAN ALPHA-CHYMOTRYPSIN CANNULA
Bulb tip

601-179 25-gauge 1¼"

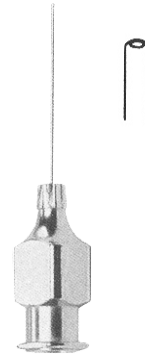

SCHEIE ANTERIOR CHAMBER CANNULA
Blunt

601-188 27-gauge ¾"



KNOLLE-PEARCE IRRIGATING LENS LOOP
Irrigating ports at 12, 10, and 2 o'clock

601-255 23-gauge 1¼"

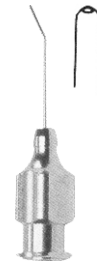

GILLS-WELSH CANNULA
Angled

601-198 5.0mm angle 25-gauge
601-199 7.0mm angle 25-gauge
601-200 8.0mm angle 25-gauge
601-201 10.0mm angle 25-gauge

EYE



BRACKEN ANTERIOR CHAMBER CANNULA
Curved
601-189 19-gauge 1¼"



WELSH FLAT OLIVE TIP CANNULA
601-195 Left 25-gauge
601-196 Right 25-gauge
601-197 Straight 25-gauge

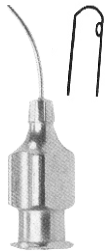

SIMCOE CORTEX EXTRACTOR
601-203 23-gauge ½"
601-204 23-gauge ¾"



McINTYRE LACRIMAL PROBE CANNULA
601-208 Straight 23-gauge
601-209 Curved 23-gauge

EYE



LACRIMAL CANNULA
601-210 Straight, 23-gauge 1"



LACRIMAL CANNULA
601-211 Length of shaft, 35.0mm with 20.0mm reinforced
Straight 23-gauge 1 1/2"

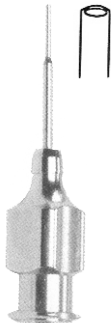

BAILEY LACRIMAL CANNULA
Reinforced shaft
601-215 23-gauge 1/2"



WEST LACRIMAL CANNULA
601-217 23-gauge 1/4"

EYE



LACRIMAL CANNULA
Reinforced shaft
601-212 Curved, 23-gauge 1½"



HEALON INJECTION CANNULA
601-227 Flat tip 25-gauge 1¼"



ATKINSON RETROBULBAR NEEDLE
Sharp rounded point
601-225 23-gauge
601-226 25-gauge



GRAETHER COLLAR BUTTON
Iris retractor, posterior surface for capsule polishing
601-387 Straight 23-gauge 1"
601-388 Angled 23-gauge 1"

EYE



BINKHORST IRRIGATING CANNULA

Smooth blunt tip, front opening

601-229	Straight	22-gauge
601-230	Right	22-gauge
601-231	Left	22-gauge



McINTYRE-BINKHORST IRRIGATING CANNULA

Smooth blunt tip, front opening

601-234	Straight	26-gauge
601-235	Right	26-gauge
601-236	Left	26-gauge



BURCH FIXATION PICK

601-297	4 1/4"
---------	--------



DOUBLE FIXATION HOOK

601-298	1.5mm between tips	5
601-299	2.0mm between tips	5

EYE

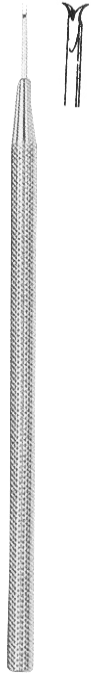

TWIST FIXATION HOOK

601-300	0.5mm right	4¼"
601-301	0.3mm right	4¼"
601-302	0.5mm left	4¼"
601-303	0.3mm left	4¼"



JAFFE LENS MANIPULATING HOOK

<u>0.15mm diameter</u>	
601-371	Straight 4½"



LEWICKY LENS MANIPULATING HOOK

<u>9.0mm shaft, 90° angled 2.0mm tip</u>	
601-306	Curved 4½"



CLAYMAN-JAFFE LENS MANIPULATING HOOK

<u>9.0mm shaft with 0.2mm hook</u>	
601-309	Angled 45° 4¾"

EYE



OSHER "Y" HOOK
601-307



MALTZMAN-FENZL LENS MANIPULATING HOOK
0.15mm V-shaped tip
601-311 Angled 4³/₄" 601-312 Straight 4³/₄"



SINSKEY LENS MANIPULATING HOOK
Blunt tip, 2.0mm diameter
601-310 Straight
601-310A Angled



MALONEY NO-HOLE IOL MANIPULATOR
Tear drop shape tip with post
601-333 4³/₄"

EYE



KUGLEN IRIS HOOK AND LENS MANIPULATOR
Straight shaft, 0.5mm hook
601-313 Blunt 4¾"



OSHER NUCLEUS MANIPULATOR
Smaller than 60-1313, 0.5mm two-prong tip
601-314 Blunt 4½"



FENZEL LENS MANIPULATOR
10.0mm shaft with 0.2mm T-shaped hook
601-316 Angled 4¾"
601-318 straight 4¾"

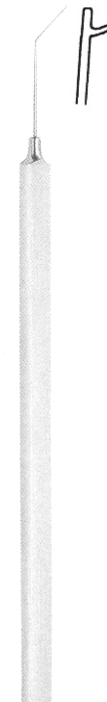

JAFFE-MALTZMAN LENS MANIPULATOR HOOK
0.15 V-shaped angled tip, flat handle
601-317 4¾"

EYE



CLYMAN IRIS HOOK
Angled 45°, 9.0mm from tip to angle
601-319 4³/₄"

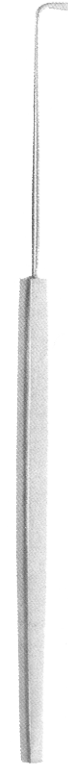

GASS RETINAL DETACHMENT HOOK
604-991 5³/₄"



BONN IRIS HOOK
3.0mm hook
601-324 Curved 5"



KOCH STOP AND CHOP MANIPULATOR
Angled shaft with 1.5mm tip
601-108 4¹/₂"

EYE



TYRELL IRIS HOOK
2.0mm hook
601-321 Sharp 4³/₄"



SHEET IRIS HOOK
0.3mm hook with guard
601-327 5¹/₈"



HIRSCHMAN IRIS HOOK
0.75mm hook
601-326 Angled 4³/₄"



GREEN STRABISMUS HOOK
Flat handle
601-343 5 1/₈"

EYE



TENNANT NUCLEUS MANIPULATOR
601-125



JAMESON MUSCLE HOOK
601-339 Large
601-340 Small

5
5



VON GRAEFE STRABISMUS HOOK
601-344 #1 5¼"
601-345 #2 5½"
601-346 #3 5¾"



STEVENS TENOTOMY HOOK
6.0mm curved hook
601-348 4¾"

EYE



KUGLEN IRIS HOOK AND LENS MANIPULATOR
Push-pull pattern
601-361 Straight 4½"
601-362 Angled 4½"



SINSKEY LENS MANIPULATING HOOK
Round handle, 0.25mm blunt tip
601-363 Straight

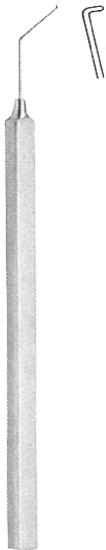

HARRIS-SINSKEY LENS MANIPULATING HOOK
0.25mm diameter, blunt tip
601-369 Angled

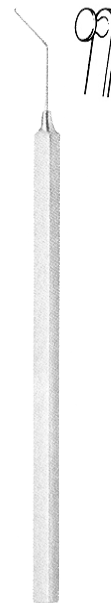

GRAETHER COLLAR BUTTON ON HANDLE
601-389 Straight
601-390 Angled

EYE



SINSKEY II LENS MANIPULATING HOOK
Round handle, 0.2mm diameter, blunt tip
601-366 Straight
160-1367 Angled



MACKOOL LENS CAPSULE RETRACTOR
1.0mm hook suspended 0.5mm from end of tip,
45° angled shaft
601-943 4³/₄"

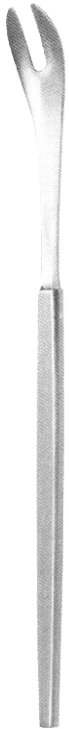

SCHEPENS ORBITAL RETRACTOR
Smooth 14.0mm x 57.0mm blade with
notched end, 4.5mm wide notch
605-008 6"



JAFFE LID RETRACTOR
9.0mm wide
601-408 Set of 2

EYE



ROSENBAUM-DREWS IRIS RETRACTOR

4.0mm wide blade, Delrin

601-396 Left 5
601-397 Right 5



DESMARRES IRIS RETRACTOR

601-404 Size 0, 11.0mm wide
601-405 Size 1, 13.0mm wide
601-406 Size 2, 15.0mm wide
601-407 Size 3, 17.0mm wide

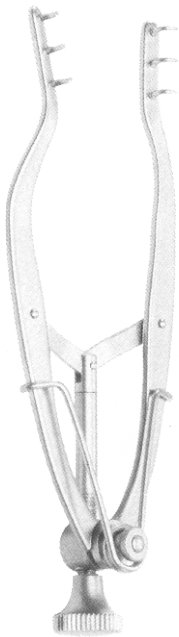

STEVENSON LACRIMAL SAC RETRACTOR

Curved teeth, 1.0mm x 5.0mm, spread 20.0mm

601-413 3

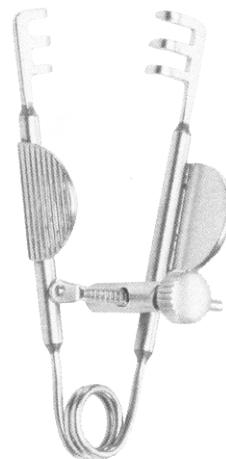

AGRICOLA LACRIMAL SAC RETRACTOR

3x3 sharp prongs

601-416 1 1/2"

EYE

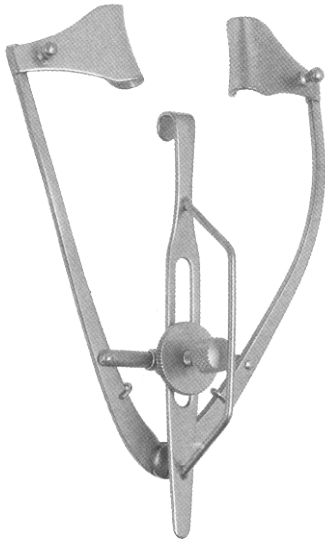

GUYTON-PARK SPECULUM
 Horizontal suture posts, blade spread
38.0mm, 14.0mm wide blades
 601-937 Fenestrated blades 3
 601-938 Solid blades 3

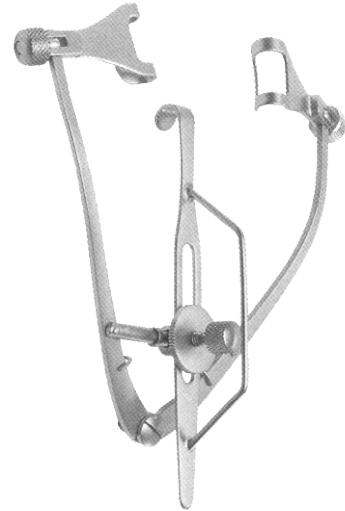

MAUMENEE-PARK SPECULUM
Blade spread 43.0mm, 14.0mm wide blades
 601-941 Fenestrated blades 3/4"
 601-942 Solid blades 3/4"

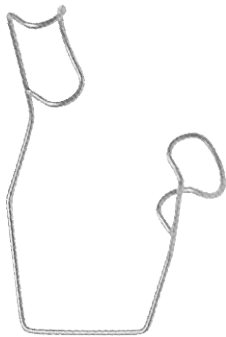

TEMPORAL WIRE SPECULUM
14.0mm wide with spread of 43.0mm
 601-412 Closed wire
 601-411 Open wire
 601-410 Solid

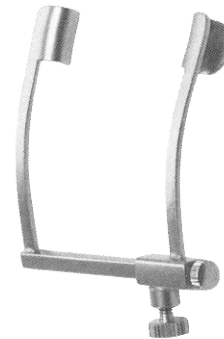

COOK SPECULUM
With lock nut
 601-957 Infant, blade 7.0mm
 601-958 Child, blade 10.0mm
 601-959 Adult, blade 15.0mm

EYE

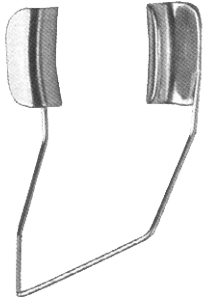

BARRAQUER SPECULUM

Solid blades

601-966 Adult
601-969 Child

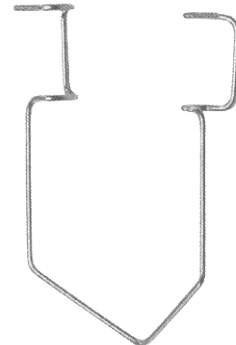

KRATZ-BARRAQUER SPECULUM

Open blades, 14.0mm wide

601-968

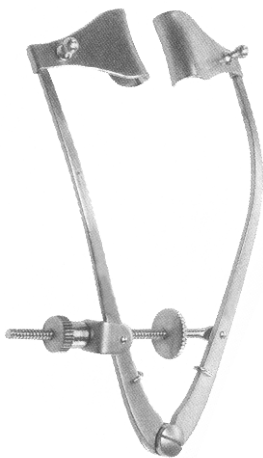

McPHERSON SPECULUM

Solid blades 14.0mm wide, spread 30.0mm

601-946 3¼"



CASTROVIEJO SPECULUM

601-947 Small curved arms,
blades 15.0mm wide,
spread 36.0mm

601-948 Medium curved arms,
blades 17.0mm wide,
spread 40.0mm

EYE

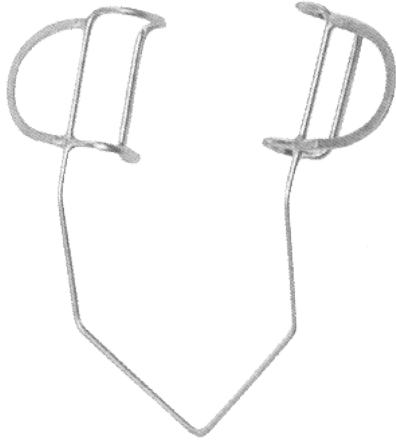

KRATZ-BARRAQUER SPECULUM
With wings
601-970



LANCASTER SPECULUM
Blades 15.0mm, spread 35.0mm
601-951 3/4"



WILLIAMS SPECULUM
601-949 Adult blades 14.0mm wide,
spread 62.0mm
601-950 Child blades 12.0mm wide,
spread 53.0mm

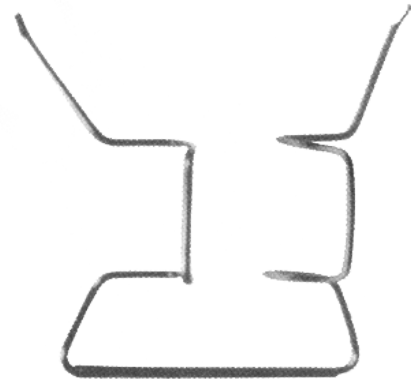

PIERSE EYE SPECULUM
Blades 11.0mm wide, spread 20.0mm
601-961

EYE



LESTER-BURCH SPECULUM
Blades 21.0mm wide, spread 32.0mm
601-953 3¹/₄"



KNAPP EYE SPECULUM
Blades 14.0mm wide, spread 60.0mm
601-954 3¹/₈"



SAUER SPECULUM
Blades 21.0mm wide, spread 32.0mm
601-971 4.0mm blades, spread 14.0mm
601-972 8.0mm blades, spread 25.0mm

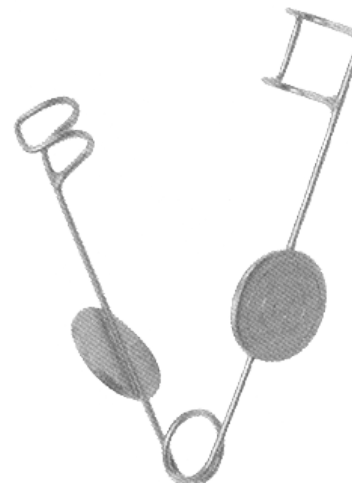

ALFONSO EYE SPECULUM
Blades 5.0mm wide, spread 25.0mm
601-974

EYE



FLIERINGA FIXATION RING

- 603-011 11.0mm diameter
- 603-012 12.0mm diameter
- 603-013 13.0mm diameter
- 603-014 14.0mm diameter
- 603-015 15.0mm diameter
- 603-016 16.0mm diameter
- 603-017 17.0mm diameter
- 603-018 18.0mm diameter
- 603-019 19.0mm diameter
- 603-020 20.0mm diameter
- 603-021 21.0mm diameter
- 603-022 22.0mm diameter



SCHEPENS SCLERAL DEPRESSOR

On thimble

- 602-000 Small
- 602-001 Medium
- 602-002 Large

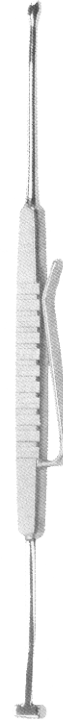

SCHOCKET SCLERAL DEPRESSOR

Double ended, 6.0mm wide bar, teardrop shaped tip, pocket clip

- 602-010 5 1/4" (13.5cm)



O'CONNOR SCLERAL DEPRESSOR-MARKER

3.0mm teardrop on one end, 1.5mm Gass marker

- on other end
602-012 5 1/8"

EYE



FLYNN SCLERAL DEPRESSOR
Lens loop style
602-009 3 1/8"



SKEELE CURETTE
Serrated edge, 2.0mm
601-427 5"



MEYERHOFFER CHALAZION CURETTE
601-421 #0, 1.5mm
601-422 #1, 1.7mm
601-423 #2, 2.0mm
601-424 #3, 2.5mm
601-425 #4, 3.5mm

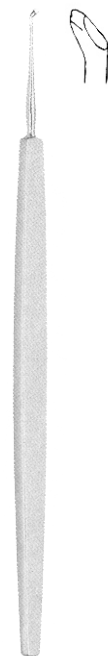

GOLF CLUB SPUD
Small, sharp
601-438

EYE



HEATH CHALAZION CURETTE

601-428	#1, 1.0mm	5"
601-429	#2, 2.0mm	5"
601-430	#3, 3.0mm	5"

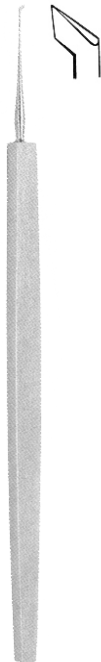

FRANCIS SPUD

Flag shaped, sharp
601-439 4³/₄"

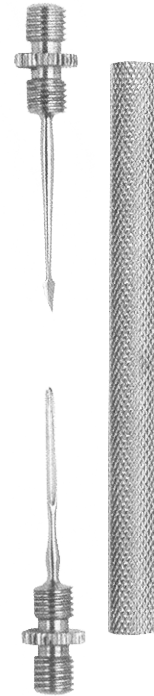

DIX NEEDLE AND GOUGE
In reversible screw handle

601-434	Complete set
601-435	Needle only
601-436	Gouge only
601-437	Handle only

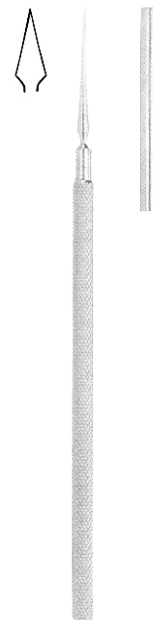

FOREIGN BODY SPUD

Arrowhead shape, with guard
601-441 4³/₄"

EYE



ELLIS FOREIGN BODY SPUD
Curved 1.0mm blade
601-443

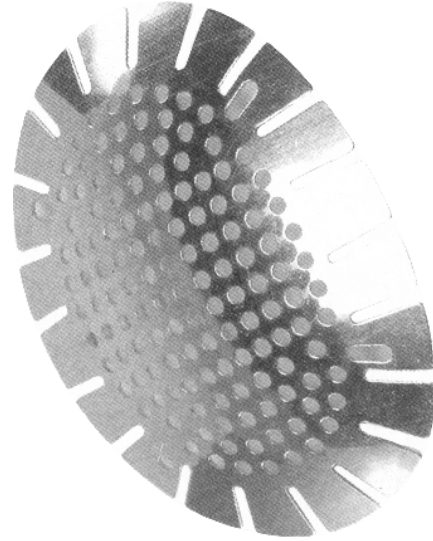

FOX EYE SHIELD
Aluminum
603-006

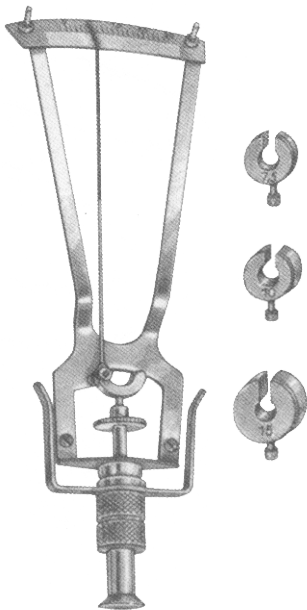

ALLEN-SCHIOTZ TONOMETER
606-031

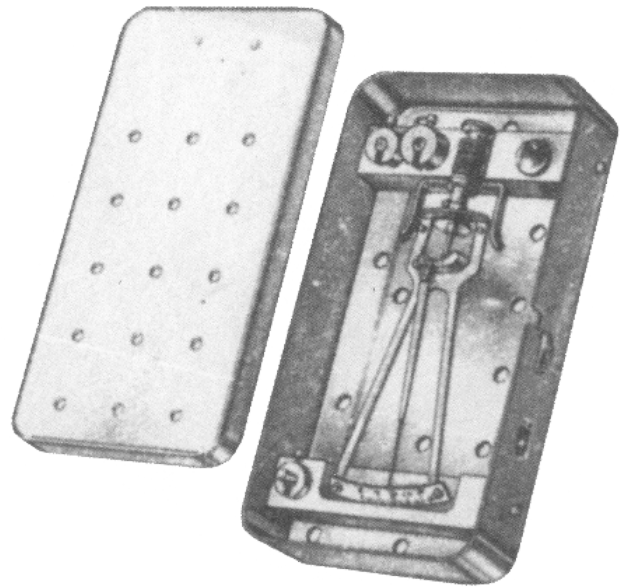

STERILIZING CASE
For Allen-Schiotz Tonometer
606-033 4½" x 3½" x 1¼"

EYE



FOX SPHERE INTRODUCER
603-023



WILLIAMS LACRIMAL PROBE

- Sterling
- 601-982 Size 00-00
 - 601-983 Size 1-2
 - 601-984 Size 3-4
 - 601-985 Size 5-6
 - 601-986 Size 7-8



BOWMAN LACRIMAL PROBE

- Sterling
- 601-976 Size 0000-000
 - 601-977 Size 00-0
 - 601-978 Size 1-2
 - 601-979 Size 3-4
 - 601-980 Size 5-6
 - 601-981 Size 7-8



WILDER DILATOR

- Blunt
- 601-993 Short 4"
 - 601-994 Medium 4"
 - 601-995 Large 4"

EYE



PIGTAIL PROBE
With suture eyes just behind blunt ends
601-989



CASTROVIEJO LACRIMAL DILATOR
Double-ended
601-991



RUEDEMANN LACRIMAL DILATOR
Short, needle type
601-996

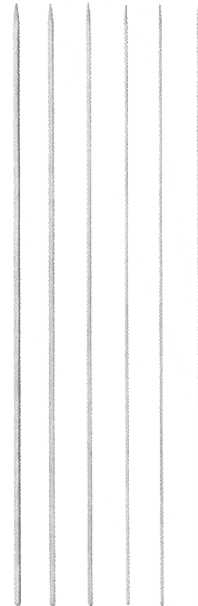

QUICKERT LACRIMAL INTUBATION PROBE

602-100	Size 00
602-110	Size 0
602-111	Size 1
602-112	Size 2
602-113	Size 3
602-114	Size 4

EYE

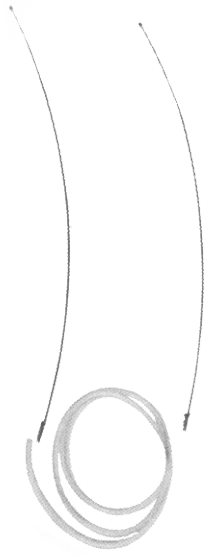

CRAWFORD LACRIMAL INTUBATION SET
 Two olive tip stainless steel probes (6")
with 11³/₄" of silicone tubing attached
 602-014

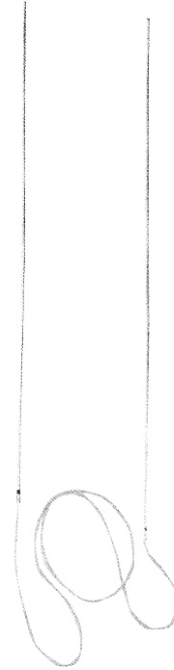

JACKSON LACRIMAL INTUBATION SET
 Two 20-gauge thin wall probes (6")
with 11³/₄" of silicone tubing attached
 601-990

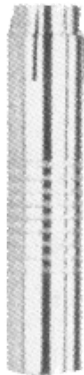

CORNEAL BLADES AND HANDLE

Non-sterile

- 604-060 Trephine blade short 6.0mm
- 604-065 Trephine blade short 6.5mm
- 604-067 Trephine blade short 6.75mm
- 604-070 Trephine blade short 7.0mm
- 604-075 Trephine blade short 7.5mm
- 604-077 Trephine blade short 7.75mm
- 604-080 Trephine blade short 8.0mm
- 604-082 Trephine blade short 8.25mm

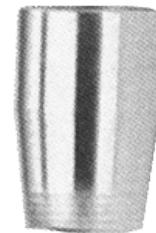

CORNEAL BLADES AND HANDLE

Non sterile

- 604-160 Trephine blade long 6.0mm
- 604-165 Trephine blade long 6.5mm
- 604-167 Trephine blade long 6.75mm
- 604-170 Trephine blade long 7.0mm
- 604-172 Trephine blade long 7.25mm
- 604-175 Trephine blade long 7.5mm
- 604-177 Trephine blade long 7.75mm
- 604-180 Trephine blade long 8.0mm
- 604-182 Trephine blade long 8.25mm
- 604-185 Trephine blade long 8.5mm
- 604-190 Trephine blade long 9.0mm
- 604-195 Trephine blade long 9.5mm

EYE



OSHER-NEUMANN CORNEAL MARKER

For radial keratotomy, 4.5mm inner diameter

- 608-036 4 blades 4 1/4"
- 608-037 6 blades 4 1/4"
- 608-038 8 blades 4 1/4"

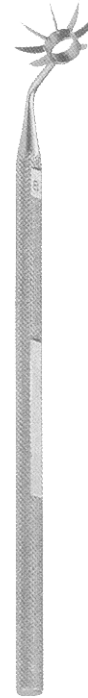

BORES RADIAL MARKER

4.0mm center opening, 9.5mm O.D

- 607-051 6 blades
- 607-052 8 blades

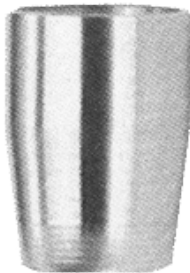

CORNEAL HANDLE

- 604-260 Trephine handle 6.0mm
- 604-265 Trephine handle 6.5mm
- 604-270 Trephine handle 7.0mm
- 604-275 Trephine handle 7.5mm
- 604-285 Trephine handle 8.5mm
- 604-090 Trephine handle 9.0mm
- 604-095 Trephine handle 9.5mm

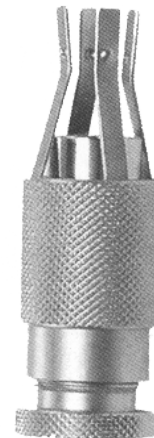

UNIVERSAL TREPHINE HANDLE

604-000

EYE

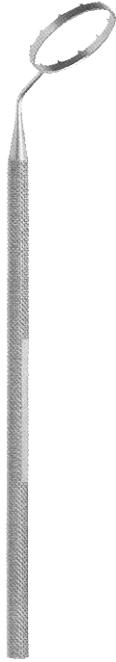

THORTON FIXATION RING
16.00mm ring with multiple teeth
 607-000 4³/₄"
 607-001 Swivel handle 4³/₄"

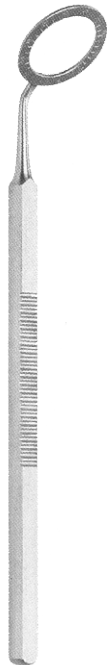

MENDEZ DEGREE GUAGE
 607-086 I.D. 12.0mm

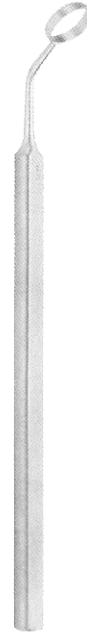

BORES OPTIC ZONE MARKER

607-002	2.75mm	3 ³ / ₄ "
607-003	3.00mm	3 ³ / ₄ "
607-004	3.25mm	3 ³ / ₄ "
607-005	3.50mm	3 ³ / ₄ "
607-006	3.75mm	3 ³ / ₄ "
607-007	4.00mm	3 ³ / ₄ "
607-008	4.25mm	3 ³ / ₄ "
607-009	4.50mm	3 ³ / ₄ "
607-010	4.75mm	3 ³ / ₄ "
607-011	5.00mm	3 ³ / ₄ "
607-012	6.00mm	3 ³ / ₄ "
607-013	7.00mm	3 ³ / ₄ "
607-014	8.00mm	3 ³ / ₄ "

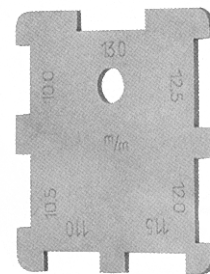

STAHL A/C CALIPER
 601-930

EYE

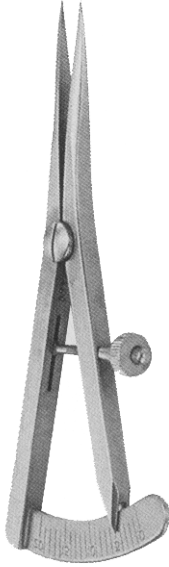

CASTROVIEJO CALIPER
0 to 2.0.mm scale
601-931 3½"

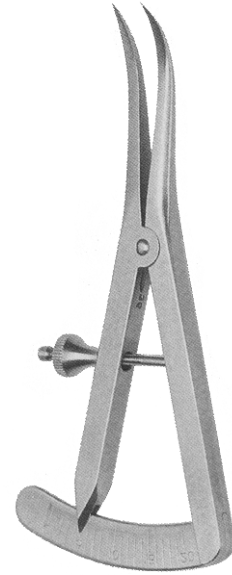

CASTROVIEJO CALIPER
Curved shaft, 0 to 2.0.mm scale
601-932 3½"

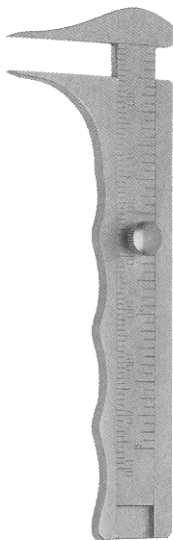

JAMESON
CALIPER
601-934

EOS HD Laparoscopes

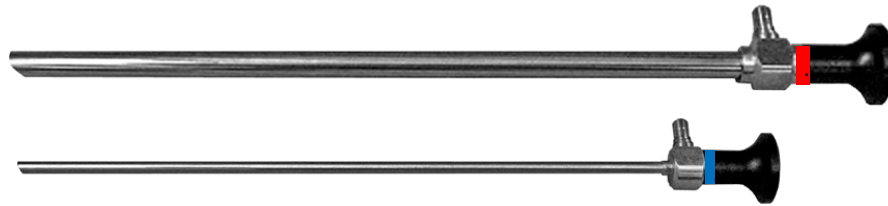

ITEM NO.	SIZE	DESCRIPTION
52205-00	5MM X 26CM	0° LAPAROSCOPE, HD, AUTOCLAVABLE, COLOR CODE: BLUE
52205-01	5MM X 26CM	30° LAPAROSCOPE, HD, AUTOCLAVABLE, COLOR CODE: RED
52205-02	5MM X 30CM	0° LAPAROSCOPE, HD, AUTOCLAVABLE, COLOR CODE: BLUE
52205-03	5MM X 30CM	30° LAPAROSCOPE, HD, AUTOCLAVABLE, COLOR CODE: RED
52205-04	5MM X 30CM	45° LAPAROSCOPE, HD, AUTOCLAVABLE, COLOR CODE: BLACK
52215-00	5MM X 50CM	0° LAPAROSCOPE, HD, AUTOCLAVABLE, COLOR CODE: BLUE
52215-01	5MM X 50CM	30° LAPAROSCOPE, HD, AUTOCLAVABLE, COLOR CODE: RED
52215-02	5MM X 50CM	45° LAPAROSCOPE, HD, AUTOCLAVABLE, COLOR CODE: BLACK
52210-00	10MM X 30CM	0° LAPAROSCOPE, HD, AUTOCLAVABLE, COLOR CODE: BLUE
52210-01	10MM X 30CM	30° LAPAROSCOPE, HD, AUTOCLAVABLE, COLOR CODE: RED
52210-02	10MM X 30CM	45° LAPAROSCOPE, HD, AUTOCLAVABLE, COLOR CODE: BLACK
52215-00	10MM X 50CM	0° LAPAROSCOPE, HD, AUTOCLAVABLE, COLOR CODE: BLUE
52215-01	10MM X 50CM	30° LAPAROSCOPE, HD, AUTOCLAVABLE, COLOR CODE: RED
52215-02	10MM X 50CM	45° LAPAROSCOPE, HD, AUTOCLAVABLE, COLOR CODE: BLACK

EOS HD Operating Laparoscopes



LIST NO.	DESCRIPTION
52110-01	0 DEGREE, 10 MM Ø, RIGHT ANGLE EYE PIECE, 3 MM INSTRUMENT CHANNEL
52110-02	0 DEGREE VIEWING, 10 MM Ø, 45 DEGREE ANGLE EYE PIECE, 3 MM INSTRUMENT CHANNEL.
52110-03	0 DEGREE VIEWING, 10 MM Ø, RIGHT ANGLE EYE PIECE, 5.5 MM INSTRUMENT CHANNEL
52110-04	0 DEGREE VIEWING, 11 MM Ø, 45 DEGREE ANGLE EYE PIECE, 6 MM INSTRUMENT CHANNEL
52110-05	0 DEGREE VIEWING, 11 MM Ø, RIGHT ANGLE EYE PIECE, 6 MM INSTRUMENT CHANNEL
52110-06	0 DEGREE VIEWING, 12 MM Ø, RIGHT ANGLE EYE PIECE, 7 MM INSTRUMENT CHANNEL
52110-07	0 DEGREE VIEWING, 12 MM Ø, 45 DEGREE ANGLE EYE PIECE, 7 MM INSTRUMENT CHANNEL
52110-08	0 DEGREE VIEWING, 10 MM Ø, 45 DEGREE ANGLE EYE PIECE, 5.5 MM INSTRUMENT CHANNEL

One Piece Rotatable Laparoscopic Instruments



BASIN SERIES:

ROTATABLE ONE-PIECE INSTRUMENT WITH FLUSH PORT

HANDLES: Insulated & Carbon Fiber

52555-40-01

INSULATED STAINLESS STEEL
W/ RF POST
(TYPE 1)



52555-40-02

INSULATED STAINLESS STEEL
W/ RF-POST & RATCHET
(TYPE 2)



52555-40-05

INSULATED W/ RF-POST &
RATCHET (TYPE 5)



52555-40-06

LIGHTWEIGHT CARBON
FIBER W/ RF-POST & RATCHET
(TYPE 6)



52555-40-07

LIGHTWEIGHT CARBON-FIBER
W/ RF POST,
RATCHET / RATCHET
DEFEATING (TYPE 7)



52555-40-08

LIGHTWEIGHT CARBON-FIBER
W/ RF POST, ON DEMAND
FRENCH ON/OFF RATCHET
(TYPE 8)



52555-40-09

LIGHTWEIGHT CARBON-FIBER
W/ RF POST, W/ LARGE FINGER
LOOPS
(TYPE 9)



52555-40-10

LIGHTWEIGHT
CARBON-FIBER W/ RF POST,
RATCHET / RATCHET
DEFEATING W/ LARGE FINGER
LOOPS (TYPE 10)



52555-40-14

INSULATED STAINLESS STEEL
LINVATEC-WECK STYLE W/
LONG SHANKS (TYPE 14)



52555-40-17

LIGHTWEIGHT THERMOS-
PLASTIC W/ RF POST
(TYPE 17)



52555-40-18

LIGHTWEIGHT THERMO-
PLASTIC W/ RF POST,
RATCHET / RATCHET
DEFEATING (TYPE 18)



52555-40-23

LIGHTWEIGHT THERMO-
PLASTIC W/ RF POST,
NON-RATCHET (TYPE 23)



52555-40-24

LIGHTWEIGHT THERMO-
PLASTIC W/ RF POST,
W/ RATCHET (TYPE 24)



HANDLES: Non-Insulated

52555-40-03

NON-INSULATED
STAINLESS STEEL
(TYPE 3)



52555-40-15

NON-INSULATED STAINLESS
STEEL LINVATEC-WECK STYLE
W/ QUICK RELEASE RATCHET &
LONG SHANKS (TYPE 15)



52555-40-04

NON-INSULATED
STAINLESS STEEL W/ RATCHET
(TYPE 4)



52555-40-16

NON-INSULATED STAINLESS
STEEL W/ SPRING ASSIST
CLOSING (TYPE 16)



52555-40-11

NON-INSULATED RING AXIAL
HANDLE (TYPE 11)



52555-40-13

STAINLESS STEEL AXIAL
HANDLE W/ PRECISE
ENGAGEMENT RATCHET
(TYPE 13)



52555-40-12

NON-INSULATED RING
AXIAL HANDLE W/
RATCHET (TYPE 12)









STYLE B:

ROTATABLE, ONE-PIECE INSTRUMENT WITH FLUSH PORT



Dissectors & Graspers







TIP ID.	DIAMETER	LENGTH	52555-40-01	52555-40-17	52555-40-18	52555-40-10	52555-40-03	52555-40-04
			INSULATED & CARBON FIBER HANDLES				NON-INSULATED HANDLES	
 MICRO REDDICK OLSEN 12MM	5MM	24CM	52224-01B1	52224-01B17	52224-01B18	52224-01B10	52224-01B3	52224-01B4
	5MM	33CM	52255-01B1	52255-01B17	52255-01B18	52255-01B10	52255-01B3	52255-01B4
	5MM	36CM	52236-01B1	52236-01B17	52236-01B18	52236-01B10	52236-01B3	52236-01B4
	5MM	45CM	52155-01B1	52155-01B17	52155-01B18	52155-01B10	52155-01B3	52155-01B4
 STANDARD GRASPER W/ SPOON 12MM TIP	5MM	24CM	52224-02B1	52224-02B17	52224-02B18	52224-02B10	52224-02B3	52224-02B4
	5MM	33CM	52255-02B1	52255-02B17	52255-02B18	52255-02B10	52255-02B3	52255-02B4
	5MM	36CM	52236-02B1	52236-02B17	52236-02B18	52236-02B10	52236-02B3	52236-02B4
	5MM	45CM	52155-02B1	52155-02B17	52155-02B18	52155-02B10	52155-02B3	52155-02B4
 STANDARD GRASPER W/ SPOON, LONG 20MM TIP	5MM	24CM	52224-52B1	52224-52B17	52224-52B18	52224-52B10	52224-52B3	52224-52B4
	5MM	33CM	52255-52B1	52255-52B17	52255-52B18	52255-52B10	52255-52B3	52255-52B4
	5MM	36CM	52236-52B1	52236-52B17	52236-52B18	52236-52B10	52236-52B3	52236-52B4
	5MM	45CM	52155-52B1	52155-52B17	52155-52B18	52155-52B10	52155-52B3	52155-52B4
 STANDARD GRASPER 12MM TIP	5MM	24CM	52224-03B1	52224-03B17	52224-03B18	52224-03B10	52224-03B3	52224-03B4
	5MM	33CM	52255-03B1	52255-03B17	52255-03B18	52255-03B10	52255-03B3	52255-03B4
	5MM	36CM	52236-03B1	52236-03B17	52236-03B18	52236-03B10	52236-03B3	52236-03B4
	5MM	45CM	52155-03B1	52155-03B17	52155-03B18	52155-03B10	52155-03B3	52155-03B4
 BULLET-NOSE GRASPER W/ SPOON 12MM TIP	5MM	24CM	52224-04B1	52224-04B17	52224-04B18	52224-04B10	52224-04B3	52224-04B4
	5MM	33CM	52255-04B1	52255-04B17	52255-04B18	52255-04B10	52255-04B3	52255-04B4
	5MM	36CM	52236-04B1	52236-04B17	52236-04B18	52236-04B10	52236-04B3	52236-04B4
	5MM	45CM	52155-04B1	52155-04B17	52155-04B18	52155-04B10	52155-04B3	52155-04B4
 TAPERED DOLPHIN-NOSE 15MM TIP	5MM	24CM	52224-05B1	52224-05B17	52224-05B18	52224-05B10	52224-05B3	52224-05B4
	5MM	33CM	52255-05B1	52255-05B17	52255-05B18	52255-05B10	52255-05B3	52255-05B4
	5MM	36CM	52236-05B1	52236-05B17	52236-05B18	52236-05B10	52236-05B3	52236-05B4
	5MM	45CM	52155-05B1	52155-05B17	52155-05B18	52155-05B10	52155-05B3	52155-05B4



STYLE B:

ROTATABLE, ONE-PIECE INSTRUMENT WITH FLUSH PORT

Dissectors & Graspers







TIP ID.	DIAMETER	LENGTH	52555-40-01	52555-40-17	52555-40-18	52555-40-10	52555-40-03	52555-40-04
			INSULATED & CARBON FIBER HANDLES				NON-INSULATED HANDLES	
 15MM TIP	5MM	24CM	52224-105B1	52224-105B17	52224-105B18	52224-105B10	52224-105B3	52224-105B4
	5MM	33CM	52255-105B1	52255-105B17	52255-105B18	52255-105B10	52255-105B3	52255-105B4
	5MM	36CM	52236-105B1	52236-105B17	52236-105B18	52236-105B10	52236-105B3	52236-105B4
	5MM	45CM	52155-105B1	52155-105B17	52155-105B18	52155-105B10	52155-105B3	52155-105B4
 18MM TIP	5MM	24CM	52224-06B1	52224-06B17	52224-06B18	52224-06B10	52224-06B3	52224-06B4
	5MM	33CM	52255-06B1	52255-06B17	52255-06B18	52255-06B10	52255-06B3	52255-06B4
	5MM	36CM	52236-06B1	52236-06B17	52236-06B18	52236-06B10	52236-06B3	52236-06B4
	5MM	45CM	52155-06B1	52155-06B17	52155-06B18	52155-06B10	52155-06B3	52155-06B4
	10MM	33CM	52102-06B1	52102-06B17	52102-06B18	52102-06B10	52102-06B3	52102-06B4
	10MM	36CM	52103-06B1	52103-06B17	52103-06B18	52103-06B10	52103-06B3	52103-06B4
 18MM TIP	5MM	24CM	52224-106B1	52224-106B17	52224-106B18	52224-106B10	52224-106B3	52224-106B4
	5MM	33CM	52255-106B1	52255-106B17	52255-106B18	52255-106B10	52255-106B3	52255-106B4
	5MM	36CM	52236-106B1	52236-106B17	52236-106B18	52236-106B10	52236-106B3	52236-106B4
	5MM	45CM	52155-106B1	52155-106B17	52155-106B18	52155-106B10	52155-106B3	52155-106B4
 15MM TIP	5MM	24CM	52224-206B1	52224-206B17	52224-206B18	52224-206B10	52224-206B3	52224-206B4
	5MM	33CM	52255-206B1	52255-206B17	52255-206B18	52255-206B10	52255-206B3	52255-206B4
	5MM	36CM	52236-206B1	52236-206B17	52236-206B18	52236-206B10	52236-206B3	52236-206B4
	5MM	45CM	52155-206B1	52155-206B17	52155-206B18	52155-206B10	52155-206B3	52155-206B4
 22MM TIP	5MM	24CM	52224-07B1	52224-07B17	52224-07B18	52224-07B10	52224-07B3	52224-07B4
	5MM	33CM	52255-07B1	52255-07B17	52255-07B18	52255-07B10	52255-07B3	52255-07B4
	5MM	36CM	52236-07B1	52236-07B17	52236-07B18	52236-07B10	52236-07B3	52236-07B4
	5MM	45CM	52155-07B1	52155-07B17	52155-07B18	52155-07B10	52155-07B3	52155-07B4
	10MM	33CM	52102-07B1	52102-07B17	52102-07B18	52102-07B10	52102-07B3	52102-07B4
	10MM	36CM	52103-07B1	52103-07B17	52103-07B18	52103-07B10	52103-07B3	52103-07B4
 12MM TIP	5MM	24CM	52224-59B1	52224-59B17	52224-59B18	52224-59B10	52224-59B3	52224-59B4
	5MM	33CM	52255-59B1	52255-59B17	52255-59B18	52255-59B10	52255-59B3	52255-59B4
	5MM	36CM	52236-59B1	52236-59B17	52236-59B18	52236-59B10	52236-59B3	52236-59B4
	5MM	45CM	52155-59B1	52155-59B17	52155-59B18	52155-59B10	52155-59B3	52155-59B4
	10MM	33CM	52102-59B1	52102-59B17	52102-59B18	52102-59B10	52102-59B3	52102-59B4
	10MM	36CM	52103-59B1	52103-59B17	52103-59B18	52103-59B10	52103-59B3	52103-59B4
10MM	45CM	52101-59B1	52101-59B17	52101-59B18	52101-59B10	52101-59B3	52101-59B4	



STYLE B:

ROTATABLE, ONE-PIECE INSTRUMENT WITH FLUSH PORT

Dissectors & Graspers







TIP ID.	DIAMETER	LENGTH	52555-40-01	52555-40-17	52555-40-18	52555-40-10	52555-40-03	52555-40-04
			INSULATED & CARBON FIBER HANDLES				NON-INSULATED HANDLES	
 PETELIN DISSECTOR, 30 DEGREE ANGLE, SA 10MM TIP	5MM	24CM	52224-13B1	52224-13B17	52224-13B18	52224-13B10	52224-13B3	52224-13B4
	5MM	33CM	52255-13B1	52255-13B17	52255-13B18	52255-13B10	52255-13B3	52255-13B4
	5MM	36CM	52236-13B1	52236-13B17	52236-13B18	52236-13B10	52236-13B3	52236-13B4
	5MM	45CM	52155-13B1	52155-13B17	52155-13B18	52155-13B10	52155-13B3	52155-13B4
 MICRO GRASPER, FENESTRATED 10MM TIP	5MM	24CM	52224-14B1	52224-14B17	52224-14B18	52224-14B10	52224-14B3	52224-14B4
	5MM	33CM	52255-14B1	52255-14B17	52255-14B18	52255-14B10	52255-14B3	52255-14B4
	5MM	36CM	52236-14B1	52236-14B17	52236-14B18	52236-14B10	52236-14B3	52236-14B4
	5MM	45CM	52155-14B1	52155-14B17	52155-14B18	52155-14B10	52155-14B3	52155-14B4
 COBRA GRASPER, DOUBLE-ACTION 10MM TIP	5MM	24CM	52224-15B1	52224-15B17	52224-15B18	52224-15B10	52224-15B3	52224-15B4
	5MM	33CM	52255-15B1	52255-15B17	52255-15B18	52255-15B10	52255-15B3	52255-15B4
	5MM	36CM	52236-15B1	52236-15B17	52236-15B18	52236-15B10	52236-15B3	52236-15B4
	5MM	45CM	52155-15B1	52155-15B17	52155-15B18	52155-15B10	52155-15B3	52155-15B4
 BABCOCK GRASPER, FENESTRATED TIP 30MM TIP	5MM	24CM	52224-16B1	52224-16B17	52224-16B18	52224-16B10	52224-16B3	52224-16B4
	5MM	33CM	52255-16B1	52255-16B17	52255-16B18	52255-16B10	52255-16B3	52255-16B4
	5MM	36CM	52236-16B1	52236-16B17	52236-16B18	52236-16B10	52236-16B3	52236-16B4
	5MM	45CM	52155-16B1	52155-16B17	52155-16B18	52155-16B10	52155-16B3	52155-16B4
	10MM	33CM	52102-16B1	52102-16B17	52102-16B18	52102-16B10	52102-16B3	52102-16B4
	10MM	36CM	52103-16B1	52103-16B17	52103-16B18	52103-16B10	52103-16B3	52103-16B4
 BABCOCK GRASPER, AXIS STYLE, FENESTRATED 30MM TIP	5MM	24CM	52224-116B1	52224-116B17	52224-116B18	52224-116B10	52224-116B3	52224-116B4
	5MM	33CM	52255-116B1	52255-116B17	52255-116B18	52255-116B10	52255-116B3	52255-116B4
	5MM	36CM	52236-116B1	52236-116B17	52236-116B18	52236-116B10	52236-116B3	52236-116B4
	5MM	45CM	52155-116B1	52155-116B17	52155-116B18	52155-116B10	52155-116B3	52155-116B4
 BABCOCK GRASPER, SHORT DELICATE 20MM TIP	5MM	24CM	52224-17B1	52224-17B17	52224-17B18	52224-17B10	52224-17B3	52224-17B4
	5MM	33CM	52255-17B1	52255-17B17	52255-17B18	52255-17B10	52255-17B3	52255-17B4
	5MM	36CM	52236-17B1	52236-17B17	52236-17B18	52236-17B10	52236-17B3	52236-17B4
	5MM	45CM	52155-17B1	52155-17B17	52155-17B18	52155-17B10	52155-17B3	52155-17B4

STYLE B:

ROTATABLE, ONE-PIECE INSTRUMENT WITH FLUSH PORT



Dissectors & Graspers







TIP ID.	DIAMETER	LENGTH	52555-40-01	52555-40-17	52555-40-18	52555-40-10	52555-40-03	52555-40-04
			INSULATED & CARBON FIBER HANDLES				NON-INSULATED HANDLES	
 ALLIS GRASPER, SHORT VERSION, SA 15MM TIP	5MM	24CM	52224-18B1	52224-18B17	52224-18B18	52224-18B10	52224-18B3	52224-18B4
	5MM	33CM	52255-18B1	52255-18B17	52255-18B18	52255-18B10	52255-18B3	52255-18B4
	5MM	36CM	52236-18B1	52236-18B17	52236-18B18	52236-18B10	52236-18B3	52236-18B4
	5MM	45CM	52155-18B1	52155-18B17	52155-18B18	52155-18B10	52155-18B3	52155-18B4
 ALLIS, SHORT VERSION, 3 X 4 TEETH, SERRATED 12MM TIP	5MM	24CM	52224-19B1	52224-19B17	52224-19B18	52224-19B10	52224-19B3	52224-19B4
	5MM	33CM	52255-19B1	52255-19B17	52255-19B18	52255-19B10	52255-19B3	52255-19B4
	5MM	36CM	52236-19B1	52236-19B17	52236-19B18	52236-19B10	52236-19B3	52236-19B4
	5MM	45CM	52155-19B1	52155-19B17	52155-19B18	52155-19B10	52155-19B3	52155-19B4
 ALLIS, SHORT VERSION, DOUBLE ROW OF TEETH, SERRATED 12MM TIP	5MM	24CM	52224-119B1	52224-119B17	52224-119B18	52224-119B10	52224-119B3	52224-119B4
	5MM	33CM	52255-119B1	52255-119B17	52255-119B18	52255-119B10	52255-119B3	52255-119B4
	5MM	36CM	52236-119B1	52236-119B17	52236-119B18	52236-119B10	52236-119B3	52236-119B4
	5MM	45CM	52155-119B1	52155-119B17	52155-119B18	52155-119B10	52155-119B3	52155-119B4
 ALLIS, LONG VERSION, DOUBLE ROW OF TEETH, SERRATED 25MM TIP	5MM	24CM	52224-219B1	52224-219B17	52224-219B18	52224-219B10	52224-219B3	52224-219B4
	5MM	33CM	52255-219B1	52255-219B17	52255-219B18	52255-219B10	52255-219B3	52255-219B4
	5MM	36CM	52236-219B1	52236-219B17	52236-219B18	52236-219B10	52236-219B3	52236-219B4
	5MM	45CM	52155-219B1	52155-219B17	52155-219B18	52155-219B10	52155-219B3	52155-219B4
 ALLIS GRASPER, MEDIUM, WECK STYLE 20MM TIP	5MM	24CM	52224-20B1	52224-20B17	52224-20B18	52224-20B10	52224-20B3	52224-20B4
	5MM	33CM	52255-20B1	52255-20B17	52255-20B18	52255-20B10	52255-20B3	52255-20B4
	5MM	36CM	52236-20B1	52236-20B17	52236-20B18	52236-20B10	52236-20B3	52236-20B4
	5MM	45CM	52155-20B1	52155-20B17	52155-20B18	52155-20B10	52155-20B3	52155-20B4
 ALLIS GRASPER, STANDARD VERSION 30MM TIP	5MM	24CM	52224-21B1	52224-21B17	52224-21B18	52224-21B10	52224-21B3	52224-21B4
	5MM	33CM	52255-21B1	52255-21B17	52255-21B18	52255-21B10	52255-21B3	52255-21B4
	5MM	36CM	52236-21B1	52236-21B17	52236-21B18	52236-21B10	52236-21B3	52236-21B4
	5MM	45CM	52155-21B1	52155-21B17	52155-21B18	52155-21B10	52155-21B3	52155-21B4
	10MM	33CM	52102-21B1	52102-21B17	52102-21B18	52102-21B10	52102-21B3	52102-21B4
	10MM	36CM	52103-21B1	52103-21B17	52103-21B18	52103-21B10	52103-21B3	52103-21B4
	10MM	45CM	52101-21B1	52101-21B17	52101-21B18	52101-21B10	52101-21B3	52101-21B4



STYLE B:

ROTATABLE, ONE-PIECE INSTRUMENT WITH FLUSH PORT

Dissectors & Graspers





TIP ID.	DIAMETER	LENGTH	52555-40-01	52555-40-17	52555-40-18	52555-40-10	52555-40-03	52555-40-04
			INSULATED & CARBON FIBER HANDLES				NON-INSULATED HANDLES	
 ALLIS GRASPER, TC, STANDARD VERSION 35MM TIP	5MM	24CM	52224-57B1	52224-57B17	52224-57B18	52224-57B10	52224-57B3	52224-57B4
	5MM	33CM	52255-57B1	52255-57B17	52255-57B18	52255-57B10	52255-57B3	52255-57B4
	5MM	36CM	52236-57B1	52236-57B17	52236-57B18	52236-57B10	52236-57B3	52236-57B4
	5MM	45CM	52155-57B1	52155-57B17	52155-57B18	52155-57B10	52155-57B3	52155-57B4
 DEBAKEY GRASPER, 20MM JAW 20MM TIP	5MM	24CM	52224-22B1	52224-22B17	52224-22B18	52224-22B10	52224-22B3	52224-22B4
	5MM	33CM	52255-22B1	52255-22B17	52255-22B18	52255-22B10	52255-22B3	52255-22B4
	5MM	36CM	52236-22B1	52236-22B17	52236-22B18	52236-22B10	52236-22B3	52236-22B4
	5MM	45CM	52155-22B1	52155-22B17	52155-22B18	52155-22B10	52155-22B3	52155-22B4
 DEBAKEY GRASPER, 40MM JAW 40MM TIP	5MM	24CM	52224-23B1	52224-23B17	52224-23B18	52224-23B10	52224-23B3	52224-23B4
	5MM	33CM	52255-23B1	52255-23B17	52255-23B18	52255-23B10	52255-23B3	52255-23B4
	5MM	36CM	52236-23B1	52236-23B17	52236-23B18	52236-23B10	52236-23B3	52236-23B4
	5MM	45CM	52155-23B1	52155-23B17	52155-23B18	52155-23B10	52155-23B3	52155-23B4
	10MM	33CM	52102-22B1	52102-22B17	52102-22B18	52102-22B10	52102-22B3	52102-22B4
	10MM	36CM	52103-22B1	52103-22B17	52103-22B18	52103-22B10	52103-22B3	52103-22B4
 DEBAKEY GRASPER, 60MM JAW 60MM TIP	5MM	24CM	52224-160B1	52224-160B17	52224-160B18	52224-160B10	52224-160B3	52224-160B4
	5MM	33CM	52255-160B1	52255-160B17	52255-160B18	52255-160B10	52255-160B3	52255-160B4
	5MM	36CM	52236-160B1	52236-160B17	52236-160B18	52236-160B10	52236-160B3	52236-160B4
	5MM	45CM	52155-160B1	52155-160B17	52155-160B18	52155-160B10	52155-160B3	52155-160B4
	10MM	33CM	52102-23B1	52102-23B17	52102-23B18	52102-23B10	52102-23B3	52102-23B4
	10MM	36CM	52103-23B1	52103-23B17	52103-23B18	52103-23B10	52103-23B3	52103-23B4
 HUNTER DEBAKEY, FENESTRATED, 20MM 20MM TIP	5MM	24CM	52224-58B1	52224-58B17	52224-58B18	52224-58B10	52224-58B3	52224-58B4
	5MM	33CM	52255-58B1	52255-58B17	52255-58B18	52255-58B10	52255-58B3	52255-58B4
	5MM	36CM	52236-58B1	52236-58B17	52236-58B18	52236-58B10	52236-58B3	52236-58B4
	5MM	45CM	52155-58B1	52155-58B17	52155-58B18	52155-58B10	52155-58B3	52155-58B4
 HUNTER DEBAKEY, FENESTRATED, 40MM 40MM TIP	5MM	24CM	52224-159B1	52224-159B17	52224-159B18	52224-159B10	52224-159B3	52224-159B4
	5MM	33CM	52255-159B1	52255-159B17	52255-159B18	52255-159B10	52255-159B3	52255-159B4
	5MM	36CM	52236-159B1	52236-159B17	52236-159B18	52236-159B10	52236-159B3	52236-159B4
	5MM	45CM	52155-159B1	52155-159B17	52155-159B18	52155-159B10	52155-159B3	52155-159B4

STYLE B:

ROTATABLE, ONE-PIECE INSTRUMENT WITH FLUSH PORT



Dissectors & Graspers

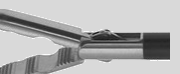



TIP ID.	DIAMETER	LENGTH	52555-40-01	52555-40-17	52555-40-18	52555-40-10	52555-40-03	52555-40-04
			INSULATED & CARBON FIBER HANDLES				NON-INSULATED HANDLES	
 HUNTER DEBAKEY, FENESTRATED, 60MM 60MM TIP	5MM	24CM	52224-160B1	52224-160B17	52224-160B18	52224-160B10	52224-160B3	52224-160B4
	5MM	33CM	52255-160B1	52255-160B17	52255-160B18	52255-160B10	52255-160B3	52255-160B4
	5MM	36CM	52236-160B1	52236-160B17	52236-160B18	52236-160B10	52236-160B3	52236-160B4
	5MM	45CM	52155-160B1	52155-160B17	52155-160B18	52155-160B10	52155-160B3	52155-160B4
 DEBAKEY GRASPER, CURVED 30MM TIP	5MM	24CM	52224-46B1	52224-46B17	52224-46B18	52224-46B10	52224-46B3	52224-46B4
	5MM	33CM	52255-46B1	52255-46B17	52255-46B18	52255-46B10	52255-46B3	52255-46B4
	5MM	36CM	52236-46B1	52236-46B17	52236-46B18	52236-46B10	52236-46B3	52236-46B4
	5MM	45CM	52155-46B1	52155-46B17	52155-46B18	52155-46B10	52155-46B3	52155-46B4
 DEBAKEY MARYLAND GRASPER 35MM TIP	5MM	24CM	52224-149B1	52224-149B17	52224-149B18	52224-149B10	52224-149B3	52224-149B4
	5MM	33CM	52255-149B1	52255-149B17	52255-149B18	52255-149B10	52255-149B3	52255-149B4
	5MM	36CM	52236-149B1	52236-149B17	52236-149B18	52236-149B10	52236-149B3	52236-149B4
	5MM	45CM	52155-149B1	52155-149B17	52155-149B18	52155-149B10	52155-149B3	52155-149B4
 GLASSMAN ATRAUMATIC GRASPER 30MM TIP	5MM	24CM	52224-24B1	52224-24B17	52224-24B18	52224-24B10	52224-24B3	52224-24B4
	5MM	33CM	52255-24B1	52255-24B17	52255-24B18	52255-24B10	52255-24B3	52255-24B4
	5MM	36CM	52236-24B1	52236-24B17	52236-24B18	52236-24B10	52236-24B3	52236-24B4
	5MM	45CM	52155-24B1	52155-24B17	52155-24B18	52155-24B10	52155-24B3	52155-24B4
 GRASPER, CROSS SERRATED, SINGLE ACTION 10MM TIP	5MM	24CM	52224-25B1	52224-25B17	52224-25B18	52224-25B10	52224-25B3	52224-25B4
	5MM	33CM	52255-25B1	52255-25B17	52255-25B18	52255-25B10	52255-25B3	52255-25B4
	5MM	36CM	52236-25B1	52236-25B17	52236-25B18	52236-25B10	52236-25B3	52236-25B4
	5MM	45CM	52155-25B1	52155-25B17	52155-25B18	52155-25B10	52155-25B3	52155-25B4
 DOUBLE CUP FUNDUS MAXI GRASPER 16MM TIP	5MM	24CM	52224-26B1	52224-26B17	52224-26B18	52224-26B10	52224-26B3	52224-26B4
	5MM	33CM	52255-26B1	52255-26B17	52255-26B18	52255-26B10	52255-26B3	52255-26B4
	5MM	36CM	52236-26B1	52236-26B17	52236-26B18	52236-26B10	52236-26B3	52236-26B4
	5MM	45CM	52155-26B1	52155-26B17	52155-26B18	52155-26B10	52155-26B3	52155-26B4

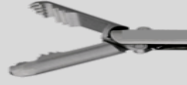

STYLE B:

ROTATABLE, ONE-PIECE INSTRUMENT WITH FLUSH PORT

Dissectors & Graspers





TIP ID.	DIAMETER	LENGTH	52555-40-01	52555-40-17	52555-40-18	52555-40-10	52555-40-03	52555-40-04
			INSULATED & CARBON FIBER HANDLES				NON-INSULATED HANDLES	
 "WINER" STYLE FUNDUS GRASPER 16MM TIP	5MM	24CM	52224-326B1	52224-326B17	52224-326B18	52224-326B10	52224-326B3	52224-326B4
	5MM	33CM	52255-326B1	52255-326B17	52255-326B18	52255-326B10	52255-326B3	52255-326B4
	5MM	36CM	52236-326B1	52236-326B17	52236-326B18	52236-326B10	52236-326B3	52236-326B4
	5MM	45CM	52155-326B1	52155-326B17	52155-326B18	52155-326B10	52155-326B3	52155-326B4
 "MCKEARNAN" STYLE FUNDUS GRASPER 16MM TIP	5MM	24CM	52224-126B1	52224-126B17	52224-126B18	52224-126B10	52224-126B3	52224-126B4
	5MM	33CM	52255-126B1	52255-126B17	52255-126B18	52255-126B10	52255-126B3	52255-126B4
	5MM	36CM	52236-126B1	52236-126B17	52236-126B18	52236-126B10	52236-126B3	52236-126B4
	5MM	45CM	52155-126B1	52155-126B17	52155-126B18	52155-126B10	52155-126B3	52155-126B4
 FENESTRATED DOUBLE FUNDUS GRASPER 16MM TIP	5MM	24CM	52224-226B1	52224-226B17	52224-226B18	52224-226B10	52224-226B3	52224-226B4
	5MM	33CM	52255-226B1	52255-226B17	52255-226B18	52255-226B10	52255-226B3	52255-226B4
	5MM	36CM	52236-226B1	52236-226B17	52236-226B18	52236-226B10	52236-226B3	52236-226B4
	5MM	45CM	52155-226B1	52155-226B17	52155-226B18	52155-226B10	52155-226B3	52155-226B4
 "JARIT STYLE" GRASPING FORCEPS DUAL CUP 16MM TIP	5MM	24CM	52224-426A1	52224-426A17	52224-426A18	52224-426A10	52224-426A3	52224-426A4
	5MM	33CM	52255-426A1	52255-426A17	52255-426A18	52255-426A10	52255-426A3	52255-426A4
	5MM	36CM	52236-426A1	52236-426A17	52236-426A18	52236-426A10	52236-426A3	52236-426A4
	5MM	45CM	52155-426A1	52155-426A17	52155-426A18	52155-426A10	52155-426A3	52155-426A4
 ENDOCLINCH FENESTRATED GRASPER 20MM TIP	5MM	24CM	52224-27B1	52224-27B17	52224-27B18	52224-27B10	52224-27B3	52224-27B4
	5MM	33CM	52255-27B1	52255-27B17	52255-27B18	52255-27B10	52255-27B3	52255-27B4
	5MM	36CM	52236-27B1	52236-27B17	52236-27B18	52236-27B10	52236-27B3	52236-27B4
	5MM	45CM	52155-27B1	52155-27B17	52155-27B18	52155-27B10	52155-27B3	52155-27B4
 RETRO-FACING, RAT TOOTH W/ CUP 10MM TIP	5MM	24CM	52224-28B1	52224-28B17	52224-28B18	52224-28B10	52224-28B3	52224-28B4
	5MM	33CM	52255-28B1	52255-28B17	52255-28B18	52255-28B10	52255-28B3	52255-28B4
	5MM	36CM	52236-28B1	52236-28B17	52236-28B18	52236-28B10	52236-28B3	52236-28B4
	5MM	45CM	52155-28B1	52155-28B17	52155-28B18	52155-28B10	52155-28B3	52155-28B4

STYLE B:

ROTATABLE, ONE-PIECE INSTRUMENT WITH FLUSH PORT

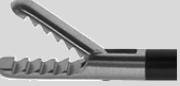

Dissectors & Graspers





TIP ID.	DIAMETER	LENGTH	52555-40-01	52555-40-17	52555-40-18	52555-40-10	52555-40-03	52555-40-04
			INSULATED & CARBON FIBER HANDLES				NON-INSULATED HANDLES	
 ALLIGATOR GRASPER, RETRO-FACING TEETH, 10MM TIP	5MM	24CM	52224-29B1	52224-29B17	52224-29B18	52224-29B10	52224-29B3	52224-29B4
	5MM	33CM	52255-29B1	52255-29B17	52255-29B18	52255-29B10	52255-29B3	52255-29B4
	5MM	36CM	52236-29B1	52236-29B17	52236-29B18	52236-29B10	52236-29B3	52236-29B4
	5MM	45CM	52155-29B1	52155-29B17	52155-29B18	52155-29B10	52155-29B3	52155-29B4
 ALLIGATOR GRASPER, RETRO-FACING TEETH, SINGLE ACTION 15MM JAW	5MM	24CM	52224-30B1	52224-30B17	52224-30B18	52224-30B10	52224-30B3	52224-30B4
	5MM	33CM	52255-30B1	52255-30B17	52255-30B18	52255-30B10	52255-30B3	52255-30B4
	5MM	36CM	52236-30B1	52236-30B17	52236-30B18	52236-30B10	52236-30B3	52236-30B4
	5MM	45CM	52155-30B1	52155-30B17	52155-30B18	52155-30B10	52155-30B3	52155-30B4
 CUP SHAPED GRASPER, W/ RETRO-FACING TEETH 10MM JAW	5MM	24CM	52224-31B1	52224-31B17	52224-31B18	52224-31B10	52224-31B3	52224-31B4
	5MM	33CM	52255-31B1	52255-31B17	52255-31B18	52255-31B10	52255-31B3	52255-31B4
	5MM	36CM	52236-31B1	52236-31B17	52236-31B18	52236-31B10	52236-31B3	52236-31B4
	5MM	45CM	52155-31B1	52155-31B17	52155-31B18	52155-31B10	52155-31B3	52155-31B4
 WAVE GRASPER, LONG BEVELED EDGE, DOUBLE ACTION 22MM JAW	5MM	24CM	52224-32B1	52224-32B17	52224-32B18	52224-32B10	52224-32B3	52224-32B4
	5MM	33CM	52255-32B1	52255-32B17	52255-32B18	52255-32B10	52255-32B3	52255-32B4
	5MM	36CM	52236-32B1	52236-32B17	52236-32B18	52236-32B10	52236-32B3	52236-32B4
	5MM	45CM	52155-32B1	52155-32B17	52155-32B18	52155-32B10	52155-32B3	52155-32B4
 WAVE GRASPER, LONG BEVELED EDGE, SINGLE ACTION 22MM JAW	5MM	24CM	52224-33B1	52224-33B17	52224-33B18	52224-33B10	52224-33B3	52224-33B4
	5MM	33CM	52255-33B1	52255-33B17	52255-33B18	52255-33B10	52255-33B3	52255-33B4
	5MM	36CM	52236-33B1	52236-33B17	52236-33B18	52236-33B10	52236-33B3	52236-33B4
	5MM	45CM	52155-33B1	52155-33B17	52155-33B18	52155-33B10	52155-33B3	52155-33B4
 CLAW GRASPER, 2 X 3 TEETH, SINGLE ACTION 20MM JAW	5MM	24CM	52224-36B1	52224-36B17	52224-36B18	52224-36B10	52224-36B3	52224-36B4
	5MM	33CM	52255-36B1	52255-36B17	52255-36B18	52255-36B10	52255-36B3	52255-36B4
	5MM	36CM	52236-36B1	52236-36B17	52236-36B18	52236-36B10	52236-36B3	52236-36B4
	5MM	45CM	52155-36B1	52155-36B17	52155-36B18	52155-36B10	52155-36B3	52155-36B4
	10MM	33CM	52102-36B1	52102-36B17	52102-36B18	52102-36B10	52102-36B3	52102-36B4
	10MM	36CM	52103-36B1	52103-36B17	52103-36B18	52103-36B10	52103-36B3	52103-36B4
	10MM	45CM	52101-36B1	52101-36B17	52101-36B18	52101-36B10	52101-36B3	52101-36B4

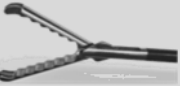

STYLE B:

ROTATABLE, ONE-PIECE INSTRUMENT WITH FLUSH PORT

Dissectors & Graspers

TIP ID.	DIAMETER	LENGTH	52555-40-01	52555-40-17	52555-40-18	52555-40-10	52555-40-03	52555-40-04
			INSULATED & CARBON FIBER HANDLES				NON-INSULATED HANDLES	
CLAW GRASPER, 2 X 3 TEETH, W/ XTRA ROW OF TEETH  20MM JAW	5MM	24CM	52224-136B1	52224-136B17	52224-136B18	52224-136B10	52224-136B3	52224-136B4
	5MM	33CM	52255-136B1	52255-136B17	52255-136B18	52255-136B10	52255-136B3	52255-136B4
	5MM	36CM	52236-136B1	52236-136B17	52236-136B18	52236-136B10	52236-136B3	52236-136B4
	5MM	45CM	52155-136B1	52155-136B17	52155-136B18	52155-136B10	52155-136B3	52155-136B4
RETRACTION GRASPER, 2 X 3 TEETH, COBRA STYLE, DA  20MM JAW	5MM	24CM	52224-34B1	52224-34B17	52224-34B18	52224-34B10	52224-34B3	52224-34B4
	5MM	33CM	52255-34B1	52255-34B17	52255-34B18	52255-34B10	52255-34B3	52255-34B4
	5MM	36CM	52236-34B1	52236-34B17	52236-34B18	52236-34B10	52236-34B3	52236-34B4
	5MM	45CM	52155-34B1	52155-34B17	52155-34B18	52155-34B10	52155-34B3	52155-34B4
RETRACTION GRASPER, 2 X 3 TEETH, COBRA STYLE, SA  20MM JAW	5MM	24CM	52224-35B1	52224-35B17	52224-35B18	52224-35B10	52224-35B3	52224-35B4
	5MM	33CM	52255-35B1	52255-35B17	52255-35B18	52255-35B10	52255-35B3	52255-35B4
	5MM	36CM	52236-35B1	52236-35B17	52236-35B18	52236-35B10	52236-35B3	52236-35B4
	5MM	45CM	52155-35B1	52155-35B17	52155-35B18	52155-35B10	52155-35B3	52155-35B4
RETRACTION GRASPER, 2 X 3 TEETH, JARIT STYLE, DA  20MM JAW	5MM	24CM	52224-134B1	52224-134B17	52224-134B18	52224-134B10	52224-134B3	52224-134B4
	5MM	33CM	52255-134B1	52255-134B17	52255-134B18	52255-134B10	52255-134B3	52255-134B4
	5MM	36CM	52236-134B1	52236-134B17	52236-134B18	52236-134B10	52236-134B3	52236-134B4
	5MM	45CM	52155-134B1	52155-134B17	52155-134B18	52155-134B10	52155-134B3	52155-134B4
RETRACTION GRASPER, 2 X 3 TEETH, JARIT STYLE, SA  20MM JAW	5MM	24CM	52224-135B1	52224-135B17	52224-135B18	52224-135B10	52224-135B3	52224-135B4
	5MM	33CM	52255-135B1	52255-135B17	52255-135B18	52255-135B10	52255-135B3	52255-135B4
	5MM	36CM	52236-135B1	52236-135B17	52236-135B18	52236-135B10	52236-135B3	52236-135B4
	5MM	45CM	52155-135B1	52155-135B17	52155-135B18	52155-135B10	52155-135B3	52155-135B4
ATRUAMATIC FENESTRATED GRASPER, CURVED  16MM JAW	5MM	24CM	52224-37B1	52224-37B17	52224-37B18	52224-37B10	52224-37B3	52224-37B4
	5MM	33CM	52255-37B1	52255-37B17	52255-37B18	52255-37B10	52255-37B3	52255-37B4
	5MM	36CM	52236-37B1	52236-37B17	52236-37B18	52236-37B10	52236-37B3	52236-37B4
	5MM	45CM	52155-37B1	52155-37B17	52155-37B18	52155-37B10	52155-37B3	52155-37B4

STYLE B:

ROTATABLE, ONE-PIECE INSTRUMENT WITH FLUSH PORT



Dissectors & Graspers







TIP ID.	DIAMETER	LENGTH	52555-40-01	52555-40-17	52555-40-18	52555-40-10	52555-40-03	52555-40-04
			INSULATED & CARBON FIBER HANDLES				NON-INSULATED HANDLES	
FENESTRATED GRASPER, 16MM JAW  16MM JAW	5MM	24CM	52224-38B1	52224-38B17	52224-38B18	52224-38B10	52224-38B3	52224-38B4
	5MM	33CM	52255-38B1	52255-38B17	52255-38B18	52255-38B10	52255-38B3	52255-38B4
	5MM	36CM	52236-38B1	52236-38B17	52236-38B18	52236-38B10	52236-38B3	52236-38B4
	5MM	45CM	52155-38B1	52155-38B17	52155-38B18	52155-38B10	52155-38B3	52155-38B4
FENESTRATED GRASPER, 22MM JAW  22MM JAW	5MM	24CM	52224-39B1	52224-39B17	52224-39B18	52224-39B10	52224-39B3	52224-39B4
	5MM	33CM	52255-39B1	52255-39B17	52255-39B18	52255-39B10	52255-39B3	52255-39B4
	5MM	36CM	52236-39B1	52236-39B17	52236-39B18	52236-39B10	52236-39B3	52236-39B4
	5MM	45CM	52155-39B1	52155-39B17	52155-39B18	52155-39B10	52155-39B3	52155-39B4
FENESTRATED GRASPER, 40MM JAW  40MM JAW	5MM	24CM	52224-40B1	52224-40B17	52224-40B18	52224-40B10	52224-40B3	52224-40B4
	5MM	33CM	52255-40B1	52255-40B17	52255-40B18	52255-40B10	52255-40B3	52255-40B4
	5MM	36CM	52236-40B1	52236-40B17	52236-40B18	52236-40B10	52236-40B3	52236-40B4
	5MM	45CM	52155-40B1	52155-40B17	52155-40B18	52155-40B10	52155-40B3	52155-40B4
JOHAN FENESTRATED GRASPER, 20MM TIP, SINGLE ACTION  20MM JAW	5MM	24CM	52224-41B1	52224-41B17	52224-41B18	52224-41B10	52224-41B3	52224-41B4
	5MM	33CM	52255-41B1	52255-41B17	52255-41B18	52255-41B10	52255-41B3	52255-41B4
	5MM	36CM	52236-41B1	52236-41B17	52236-41B18	52236-41B10	52236-41B3	52236-41B4
	5MM	45CM	52155-41B1	52155-41B17	52155-41B18	52155-41B10	52155-41B3	52155-41B4
JOHAN FENESTRATED GRASPER, 45MM TIP, SINGLE ACTION  45MM JAW	5MM	24CM	52224-42B1	52224-42B17	52224-42B18	52224-42B10	52224-42B3	52224-42B4
	5MM	33CM	52255-42B1	52255-42B17	52255-42B18	52255-42B10	52255-42B3	52255-42B4
	5MM	36CM	52236-42B1	52236-42B17	52236-42B18	52236-42B10	52236-42B3	52236-42B4
	5MM	45CM	52155-42B1	52155-42B17	52155-42B18	52155-42B10	52155-42B3	52155-42B4
DOUBLE FENESTRATED GRASPER, 25MM JAW  25MM JAW	5MM	24CM	52224-139B1	52224-139B17	52224-139B18	52224-139B10	52224-139B3	52224-139B4
	5MM	33CM	52255-139B1	52255-139B17	52255-139B18	52255-139B10	52255-139B3	52255-139B4
	5MM	36CM	52236-139B1	52236-139B17	52236-139B18	52236-139B10	52236-139B3	52236-139B4
	5MM	45CM	52155-139B1	52155-139B17	52155-139B18	52155-139B10	52155-139B3	52155-139B4



STYLE B:

ROTATABLE, ONE-PIECE INSTRUMENT WITH FLUSH PORT

Dissectors & Graspers





TIP ID.	DIAMETER	LENGTH	52555-40-01	52555-40-17	52555-40-18	52555-40-10	52555-40-03	52555-40-04
			INSULATED & CARBON FIBER HANDLES				NON-INSULATED HANDLES	
 KOCHER GRASPER, 1 X 2 TEETH, SINGLE ACTION 15MM JAW	5MM	24CM	52224-43B1	52224-43B17	52224-43B18	52224-43B10	52224-43B3	52224-43B4
	5MM	33CM	52255-43B1	52255-43B17	52255-43B18	52255-43B10	52255-43B3	52255-43B4
	5MM	36CM	52236-43B1	52236-43B17	52236-43B18	52236-43B10	52236-43B3	52236-43B4
	5MM	45CM	52155-43B1	52155-43B17	52155-43B18	52155-43B10	52155-43B3	52155-43B4
 KOCHER GRASPER, 1 X 2 TEETH, DOUBLE- ACTION (WECK TYPE) 15MM JAW	5MM	24CM	52224-44B1	52224-44B17	52224-44B18	52224-44B10	52224-44B3	52224-44B4
	5MM	33CM	52255-44B1	52255-44B17	52255-44B18	52255-44B10	52255-44B3	52255-44B4
	5MM	36CM	52236-44B1	52236-44B17	52236-44B18	52236-44B10	52236-44B3	52236-44B4
	5MM	45CM	52155-44B1	52155-44B17	52155-44B18	52155-44B10	52155-44B3	52155-44B4
 SCHROEDER TENACULUM, SINGLE TOOTH, ROUND TIP 25MM JAW	5MM	24CM	52224-45B1	52224-45B17	52224-45B18	52224-45B10	52224-45B3	52224-45B4
	5MM	33CM	52255-45B1	52255-45B17	52255-45B18	52255-45B10	52255-45B3	52255-45B4
	5MM	36CM	52236-45B1	52236-45B17	52236-45B18	52236-45B10	52236-45B3	52236-45B4
	5MM	45CM	52155-45B1	52155-45B17	52155-45B18	52155-45B10	52155-45B3	52155-45B4
	10MM	33CM	52102-45B1	52102-45B17	52102-45B18	52102-45B10	52102-45B3	52102-45B4
	10MM	36CM	52103-45B1	52103-45B17	52103-45B18	52103-45B10	52103-45B3	52103-45B4
 SCHROEDER TENACULUM, SINGLE TOOTH, SQUARE TIP 25MM JAW	5MM	24CM	52224-245B1	52224-245B17	52224-245B18	52224-245B10	52224-245B3	52224-245B4
	5MM	33CM	52255-245B1	52255-245B17	52255-245B18	52255-245B10	52255-245B3	52255-245B4
	5MM	36CM	52236-245B1	52236-245B17	52236-245B18	52236-245B10	52236-245B3	52236-245B4
	5MM	45CM	52155-245B1	52155-245B17	52155-245B18	52155-245B10	52155-245B3	52155-245B4
 SCHROEDER TENACULUM GRASPER, SINGLE TEETH w/ EXTRA GUIDE TOOTH 25MM JAW	5MM	24CM	52224-94B1	52224-94B17	52224-94B18	52224-94B10	52224-94B3	52224-94B4
	5MM	33CM	52255-94B1	52255-94B17	52255-94B18	52255-94B10	52255-94B3	52255-94B4
	5MM	36CM	52236-94B1	52236-94B17	52236-94B18	52236-94B10	52236-94B3	52236-94B4
	5MM	45CM	52155-94B1	52155-94B17	52155-94B18	52155-94B10	52155-94B3	52155-94B4
	10MM	33CM	52102-94B1	52102-94B17	52102-94B18	52102-94B10	52102-94B3	52102-94B4
	10MM	36CM	52103-94B1	52103-94B17	52103-94B18	52103-94B10	52103-94B3	52103-94B4
 BLUNT ATRAUMATIC GRASPING FORCEPS, DOUBLE-ACTION 14MM	5MM	24CM	52224-47B1	52224-47B17	52224-47B18	52224-47B10	52224-47B3	52224-47B4
	5MM	33CM	52255-47B1	52255-47B17	52255-47B18	52255-47B10	52255-47B3	52255-47B4
	5MM	36CM	52236-47B1	52236-47B17	52236-47B18	52236-47B10	52236-47B3	52236-47B4
	5MM	45CM	52155-47B1	52155-47B17	52155-47B18	52155-47B10	52155-47B3	52155-47B4

STYLE B:

ROTATABLE, ONE-PIECE INSTRUMENT WITH FLUSH PORT

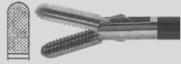
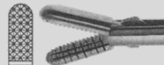

Dissectors & Graspers







TIP ID.	DIAMETER	LENGTH	52555-40-01	52555-40-17	52555-40-18	52555-40-10	52555-40-03	52555-40-04
			INSULATED & CARBON FIBER HANDLES				NON-INSULATED HANDLES	
 14MM JAW	5MM	24CM	52224-56B1	52224-56B17	52224-56B18	52224-56B10	52224-56B3	52224-56B4
	5MM	33CM	52255-56B1	52255-56B17	52255-56B18	52255-56B10	52255-56B3	52255-56B4
	5MM	36CM	52236-56B1	52236-56B17	52236-56B18	52236-56B10	52236-56B3	52236-56B4
	5MM	45CM	52155-56B1	52155-56B17	52155-56B18	52155-56B10	52155-56B3	52155-56B4
 15MM JAW	5MM	24CM	52224-48B1	52224-48B17	52224-48B18	52224-48B10	52224-48B3	52224-48B4
	5MM	33CM	52255-48B1	52255-48B17	52255-48B18	52255-48B10	52255-48B3	52255-48B4
	5MM	36CM	52236-48B1	52236-48B17	52236-48B18	52236-48B10	52236-48B3	52236-48B4
	5MM	45CM	52155-48B1	52155-48B17	52155-48B18	52155-48B10	52155-48B3	52155-48B4
 15MM JAW	5MM	24CM	52224-49B1	52224-49B17	52224-49B18	52224-49B10	52224-49B3	52224-49B4
	5MM	33CM	52255-49B1	52255-49B17	52255-49B18	52255-49B10	52255-49B3	52255-49B4
	5MM	36CM	52236-49B1	52236-49B17	52236-49B18	52236-49B10	52236-49B3	52236-49B4
	5MM	45CM	52155-49B1	52155-49B17	52155-49B18	52155-49B10	52155-49B3	52155-49B4
 20MM JAW	5MM	24CM	52224-51B1	52224-51B17	52224-51B18	52224-51B10	52224-51B3	52224-51B4
	5MM	33CM	52255-51B1	52255-51B17	52255-51B18	52255-51B10	52255-51B3	52255-51B4
	5MM	36CM	52236-51B1	52236-51B17	52236-51B18	52236-51B10	52236-51B3	52236-51B4
	5MM	45CM	52155-51B1	52155-51B17	52155-51B18	52155-51B10	52155-51B3	52155-51B4
 14MM JAW	5MM	24CM	52224-54B1	52224-54B17	52224-54B18	52224-54B10	52224-54B3	52224-54B4
	5MM	33CM	52255-54B1	52255-54B17	52255-54B18	52255-54B10	52255-54B3	52255-54B4
	5MM	36CM	52236-54B1	52236-54B17	52236-54B18	52236-54B10	52236-54B3	52236-54B4
	5MM	45CM	52155-54B1	52155-54B17	52155-54B18	52155-54B10	52155-54B3	52155-54B4
 15MM JAW	5MM	24CM	52224-90B1	52224-90B17	52224-90B18	52224-90B10	52224-90B3	52224-90B4
	5MM	33CM	52255-90B1	52255-90B17	52255-90B18	52255-90B10	52255-90B3	52255-90B4
	5MM	36CM	52236-90B1	52236-90B17	52236-90B18	52236-90B10	52236-90B3	52236-90B4
	5MM	45CM	52155-90B1	52155-90B17	52155-90B18	52155-90B10	52155-90B3	52155-90B4

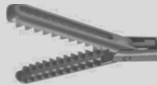

STYLE B:

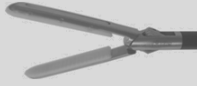
ROTATABLE, ONE-PIECE INSTRUMENT WITH FLUSH PORT

Dissectors & Graspers





TIP ID.	DIAMETER	LENGTH	52555-40-01	52555-40-17	52555-40-18	52555-40-10	52555-40-03	52555-40-04
			INSULATED & CARBON FIBER HANDLES				NON-INSULATED HANDLES	
"ACCESS" TYPE, FENESTRATED GRASPER  20MM JAW	5MM	24CM	52224-91B1	52224-91B17	52224-91B18	52224-91B10	52224-91B3	52224-91B4
	5MM	33CM	52255-91B1	52255-91B17	52255-91B18	52255-91B10	52255-91B3	52255-91B4
	5MM	36CM	52236-91B1	52236-91B17	52236-91B18	52236-91B10	52236-91B3	52236-91B4
	5MM	45CM	52155-91B1	52155-91B17	52155-91B18	52155-91B10	52155-91B3	52155-91B4
DOUBLE ACTION CLAW GRASPER, 2 X 3 TEETH  30MM JAW	10MM	33CM	52102-436B1	52102-436B17	52102-436B18	52102-436B10	52102-436B3	52102-436B4
	10MM	36CM	52103-436B1	52103-436B17	52103-436B18	52103-436B10	52103-436B3	52103-436B4
	10MM	45CM	52101-436B1	52101-436B17	52101-436B18	52101-436B10	52101-436B3	52101-436B4
"SOFT TOUCH" GRASPER, 40MM JAW, TEFLON INSERTS  40MM JAW	5MM	24CM	52224-145B1	52224-145B17	52224-145B18	52224-145B10	52224-145B3	52224-145B4
	5MM	33CM	52255-145B1	52255-145B17	52255-145B18	52255-145B10	52255-145B3	52255-145B4
	5MM	36CM	52236-145B1	52236-145B17	52236-145B18	52236-145B10	52236-145B3	52236-145B4
	5MM	45CM	52155-145B1	52155-145B17	52155-145B18	52155-145B10	52155-145B3	52155-145B4
TUBAL GRASPER, DOUBLE ACTION  10MM JAW	5MM	24CM	52224-156B1	52224-156B17	52224-156B18	52224-156B10	52224-156B3	52224-156B4
	5MM	33CM	52255-156B1	52255-156B17	52255-156B18	52255-156B10	52255-156B3	52255-156B4
	5MM	36CM	52236-156B1	52236-156B17	52236-156B18	52236-156B10	52236-156B3	52236-156B4
	5MM	45CM	52155-156B1	52155-156B17	52155-156B18	52155-156B10	52155-156B3	52155-156B4
US BABCOCK GRASPER, SPRING TENSION, ATRAUMATIC  MM	10MM	33CM	52102-17B1	52102-17B17	52102-17B18	52102-17B10	52102-17B3	52102-17B4
	10MM	36CM	52103-17B1	52103-17B17	52103-17B18	52103-17B10	52103-17B3	52103-17B4
	10MM	45CM	52101-17B1	52101-17B17	52101-17B18	52101-17B10	52101-17B3	52101-17B4
DUVAL GRASPER, 40MM JAW, AXIAL SERRATIONS  40MM JAW	10MM	33CM	52102-26B1	52102-26B17	52102-26B18	52102-26B10	52102-26B3	52102-26B4
	10MM	36CM	52103-26B1	52103-26B17	52103-26B18	52103-26B10	52103-26B3	52103-26B4
	10MM	45CM	52101-26B1	52101-26B17	52101-26B18	52101-26B10	52101-26B3	52101-26B4

STYLE B:

ROTATABLE, ONE-PIECE INSTRUMENT WITH FLUSH PORT

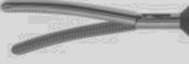

Dissectors & Graspers







TIP ID.	DIAMETER	LENGTH	52555-40-01	52555-40-17	52555-40-18	52555-40-10	52555-40-03	52555-40-04
			INSULATED & CARBON FIBER HANDLES				NON-INSULATED HANDLES	
 STRONG ATRAUMATIC CLAMP, 40MM STRAIGHT JAW 40MM JAW	10MM	33CM	52102-46B1	52102-46B17	52102-46B18	52102-46B10	52102-46B3	52102-46B4
	10MM	36CM	52103-46B1	52103-46B17	52103-46B18	52103-46B10	52103-46B3	52103-46B4
	10MM	45CM	52101-46B1	52101-46B17	52101-46B18	52101-46B10	52101-46B3	52101-46B4
 STRONG ATRAUMATIC CLAMP, 40MM CURVED JAW 40MM JAW	10MM	33CM	52102-47B1	52102-47B17	52102-47B18	52102-47B10	52102-47B3	52102-47B4
	10MM	36CM	52103-47B1	52103-47B17	52103-47B18	52103-47B10	52103-47B3	52103-47B4
	10MM	45CM	52101-47B1	52101-47B17	52101-47B18	52101-47B10	52101-47B3	52101-47B4
 ANVIL GRASPER TO GRASP & HOLD ANVIL OF CIRCULAR STAPLER	10MM	33CM	52102-20B1	52102-20B17	52102-20B18	52102-20B10	52102-20B3	52102-20B4
	10MM	36CM	52103-20B1	52103-20B17	52103-20B18	52103-20B10	52103-20B3	52103-20B4
	10MM	45CM	52101-20B1	52101-20B17	52101-20B18	52101-20B10	52101-20B3	52101-20B4
 ALLIGATOR GRASPER, RETRO-FACING TEETH, 15MM JAW	5MM	24CM	52224-129B1	52224-129B17	52224-129B18	52224-129B10	52224-129B3	52224-129B4
	5MM	33CM	52255-129B1	52255-129B17	52255-129B18	52255-129B10	52255-129B3	52255-129B4
	5MM	36CM	52236-129B1	52236-129B17	52236-129B18	52236-129B10	52236-129B3	52236-129B4
	5MM	45CM	52155-129B1	52155-129B17	52155-129B18	52155-129B10	52155-129B3	52155-129B4
 DEBAKEY GRASPER, 34MM JAW 34MM TIP	5MM	24CM	52224-122B1	52224-122B17	52224-122B18	52224-122B10	52224-122B3	52224-122B4
	5MM	33CM	52255-122B1	52255-122B17	52255-122B18	52255-122B10	52255-122B3	52255-122B4
	5MM	36CM	52236-122B1	52236-122B17	52236-122B18	52236-122B10	52236-122B3	52236-122B4
	5MM	45CM	52155-122B1	52155-122B17	52155-122B18	52155-122B10	52155-122B3	52155-122B4
 PADDLE BABCOCK GRASPER 30MM TIP	5MM	24CM	52224-216B1	52224-216B17	52224-216B18	52224-216B10	52224-216B3	52224-216B4
	5MM	33CM	52255-216B1	52255-216B17	52255-216B18	52255-216B10	52255-216B3	52255-216B4
	5MM	36CM	52236-216B1	52236-216B17	52236-216B18	52236-216B10	52236-216B3	52236-216B4
	5MM	45CM	52155-216B1	52155-216B17	52155-216B18	52155-216B10	52155-216B3	52155-216B4



STYLE B:

ROTATABLE, ONE-PIECE INSTRUMENT WITH FLUSH PORT

Forceps & Scissors







TIP ID.	DIAMETER	LENGTH	52555-40-01	52555-40-17	52555-40-18	52555-40-10	52555-40-03	52555-40-15
			INSULATED & CARBON FIBER HANDLES				NON-INSULATED HANDLES	
HOOK SCISSORS, SINGLE-ACTION  10MM TIP	5MM	24CM	52224-60B1	52224-60B17	52224-60B18	52224-60B10	52224-60B3	52224-60B15
	5MM	33CM	52255-60B1	52255-60B17	52255-60B18	52255-60B10	52255-60B3	52255-60B15
	5MM	36CM	52236-60B1	52236-60B17	52236-60B18	52236-60B10	52236-60B3	52236-60B15
	5MM	45CM	52155-60B1	52155-60B17	52155-60B18	52155-60B10	52155-60B3	52155-60B15
MICRO TIP SCISSORS, STRAIGHT, SINGLE-ACTION  5MM TIP	5MM	24CM	52224-61B1	52224-61B17	52224-61B18	52224-61B10	52224-61B3	52224-61B15
	5MM	33CM	52255-61B1	52255-61B17	52255-61B18	52255-61B10	52255-61B3	52255-61B15
	5MM	36CM	52236-61B1	52236-61B17	52236-61B18	52236-61B10	52236-61B3	52236-61B15
	5MM	45CM	52155-61B1	52155-61B17	52155-61B18	52155-61B10	52155-61B3	52155-61B15
MICRO TIP SCISSORS, CURVED, SINGLE-ACTION  5MM JAW	5MM	24CM	52224-62B1	52224-62B17	52224-62B18	52224-62B10	52224-62B3	52224-62B15
	5MM	33CM	52255-62B1	52255-62B17	52255-62B18	52255-62B10	52255-62B3	52255-62B15
	5MM	36CM	52236-62B1	52236-62B17	52236-62B18	52236-62B10	52236-62B3	52236-62B15
	5MM	45CM	52155-62B1	52155-62B17	52155-62B18	52155-62B10	52155-62B3	52155-62B15
METZENBAUM SCISSORS, STRAIGHT, LONG BLADE (20MM)  20MM JAW	5MM	24CM	52224-63B1	52224-63B17	52224-63B18	52224-63B10	52224-63B3	52224-63B15
	5MM	33CM	52255-63B1	52255-63B17	52255-63B18	52255-63B10	52255-63B3	52255-63B15
	5MM	36CM	52236-63B1	52236-63B17	52236-63B18	52236-63B10	52236-63B3	52236-63B15
	5MM	45CM	52155-63B1	52155-63B17	52155-63B18	52155-63B10	52155-63B3	52155-63B15
METZENBAUM SCISSORS, STRAIGHT, SHORT BLADE (12MM)  12MM JAW	5MM	24CM	52224-64B1	52224-64B17	52224-64B18	52224-64B10	52224-64B3	52224-64B15
	5MM	33CM	52255-64B1	52255-64B17	52255-64B18	52255-64B10	52255-64B3	52255-64B15
	5MM	36CM	52236-64B1	52236-64B17	52236-64B18	52236-64B10	52236-64B3	52236-64B15
	5MM	45CM	52155-64B1	52155-64B17	52155-64B18	52155-64B10	52155-64B3	52155-64B15
METZENBAUM SCISSORS, CURVED, LONG BLADE (16MM)  16MM JAW	5MM	24CM	52224-65B1	52224-65B17	52224-65B18	52224-65B10	52224-65B3	52224-65B15
	5MM	33CM	52255-65B1	52255-65B17	52255-65B18	52255-65B10	52255-65B3	52255-65B15
	5MM	36CM	52236-65B1	52236-65B17	52236-65B18	52236-65B10	52236-65B3	52236-65B15
	5MM	45CM	52155-65B1	52155-65B17	52155-65B18	52155-65B10	52155-65B3	52155-65B15

STYLE B:

ROTATABLE, ONE-PIECE INSTRUMENT WITH FLUSH PORT



Forceps & Scissors







TIP ID.	DIAMETER	LENGTH	52555-40-01	52555-40-17	52555-40-18	52555-40-10	52555-40-03	52555-40-15
			INSULATED & CARBON FIBER HANDLES				NON-INSULATED HANDLES	
 METZENBAUM SCISSORS, HARDENED STEEL, CURVED BLADE (16MM TIP) 16MM JAW	5MM	24CM	52224-165B1	52224-165B17	52224-165B18	52224-165B10	52224-165B3	52224-165B15
	5MM	33CM	52255-165B1	52255-165B17	52255-165B18	52255-165B10	52255-165B3	52255-165B15
	5MM	36CM	52236-165B1	52236-165B17	52236-165B18	52236-165B10	52236-165B3	52236-165B15
	5MM	45CM	52155-165B1	52155-165B17	52155-165B18	52155-165B10	52155-165B3	52155-165B15
 METZENBAUM SCISSORS, WONDER-CUT , CURVED BLADE (20MM TIP) 20MM JAW	5MM	24CM	52224-265B1	52224-265B17	52224-265B18	52224-265B10	52224-265B3	52224-265B15
	5MM	33CM	52255-265B1	52255-265B17	52255-265B18	52255-265B10	52255-265B3	52255-265B15
	5MM	36CM	52236-265B1	52236-265B17	52236-265B18	52236-265B10	52236-265B3	52236-265B15
	5MM	45CM	52155-265B1	52155-265B17	52155-265B18	52155-265B10	52155-265B3	52155-265B15
 METZENBAUM SCISSORS, CURVED, SHORT BLADE (12MM) 12MM JAW	5MM	24CM	52224-166B1	52224-166B17	52224-166B18	52224-166B10	52224-166B3	52224-166B15
	5MM	33CM	52255-166B1	52255-166B17	52255-166B18	52255-166B10	52255-166B3	52255-166B15
	5MM	36CM	52236-166B1	52236-166B17	52236-166B18	52236-166B10	52236-166B3	52236-166B15
	5MM	45CM	52155-166B1	52155-166B17	52155-166B18	52155-166B10	52155-166B3	52155-166B15
 PERITONEAL SCISSORS, SINGLE-ACTION 15MM JAW	5MM	24CM	52224-67B1	52224-67B17	52224-67B18	52224-67B10	52224-67B3	52224-67B15
	5MM	33CM	52255-67B1	52255-67B17	52255-67B18	52255-67B10	52255-67B3	52255-67B15
	5MM	36CM	52236-67B1	52236-67B17	52236-67B18	52236-67B10	52236-67B3	52236-67B15
	5MM	45CM	52155-67B1	52155-67B17	52155-67B18	52155-67B10	52155-67B3	52155-67B15
 HOOK SCISSORS, TS, EXTRA HARD STEEL 10MM JAW	5MM	24CM	52224-76B1	52224-76B17	52224-76B18	52224-76B10	52224-76B3	52224-76B15
	5MM	33CM	52255-76B1	52255-76B17	52255-76B18	52255-76B10	52255-76B3	52255-76B15
	5MM	36CM	52236-76B1	52236-76B17	52236-76B18	52236-76B10	52236-76B3	52236-76B15
	5MM	45CM	52155-76B1	52155-76B17	52155-76B18	52155-76B10	52155-76B3	52155-76B15
 PERITONEAL SCISSORS, TS, EXTRA HARD STEEL, SINGLE-ACTION 15MM JAW	5MM	24CM	52224-77B1	52224-77B17	52224-77B18	52224-77B10	52224-77B3	52224-77B15
	5MM	33CM	52255-77B1	52255-77B17	52255-77B18	52255-77B10	52255-77B3	52255-77B15
	5MM	36CM	52236-77B1	52236-77B17	52236-77B18	52236-77B10	52236-77B3	52236-77B15
	5MM	45CM	52155-77B1	52155-77B17	52155-77B18	52155-77B10	52155-77B3	52155-77B15



STYLE B:

ROTATABLE, ONE-PIECE INSTRUMENT WITH FLUSH PORT

Forceps & Scissors





TIP ID.	DIAMETER	LENGTH	52555-40-01	52555-40-17	52555-40-18	52555-40-10	52555-40-03	52555-40-15
			INSULATED & CARBON FIBER HANDLES				NON-INSULATED HANDLES	
PERITONEAL SCISSORS, TS, EXTRA HARD STEEL, DOUBLE ACTION  15MM JAW	5MM	24CM	52224-78B1	52224-78B17	52224-78B18	52224-78B10	52224-78B3	52224-78B15
	5MM	33CM	52255-78B1	52255-78B17	52255-78B18	52255-78B10	52255-78B3	52255-78B15
	5MM	36CM	52236-78B1	52236-78B17	52236-78B18	52236-78B10	52236-78B3	52236-78B15
	5MM	45CM	52155-78B1	52155-78B17	52155-78B18	52155-78B10	52155-78B3	52155-78B15
STRAIGHT SCISSORS, SINGLE ACTION  20MM JAW	10MM	33CM	52102-64B1	52102-64B17	52102-64B18	52102-64B10	52102-64B3	52102-64B4
	10MM	36CM	52103-64B1	52103-64B17	52103-64B18	52103-64B10	52103-64B3	52103-64B4
	10MM	45CM	52101-64B1	52101-64B17	52101-64B18	52101-64B10	52101-64B3	52101-64B4
CURVED SCISSORS, DOUBLE ACTION  20MM JAW	10MM	33CM	52102-66B1	52102-66B17	52102-66B18	52102-66B10	52102-66B3	52102-66B4
	10MM	36CM	52103-66B1	52103-66B17	52103-66B18	52103-66B10	52103-66B3	52103-66B4
	10MM	45CM	52101-66B1	52101-66B17	52101-66B18	52101-66B10	52101-66B3	52101-66B4
BIOPSY SPOON FORCEPS W/ TOOTH, (SEMM-TYPE)  10MM JAW	5MM	24CM	52224-79B1	52224-79B17	52224-79B18	52224-79B10	52224-79B3	52224-79B15
	5MM	33CM	52255-79B1	52255-79B17	52255-79B18	52255-79B10	52255-79B3	52255-79B15
	5MM	36CM	52236-79B1	52236-79B17	52236-79B18	52236-79B10	52236-79B3	52236-79B15
	5MM	45CM	52155-79B1	52155-79B17	52155-79B18	52155-79B10	52155-79B3	52155-79B15
BIOPSY SPOON FORCEPS, SHORT, SINGLE-ACTION  10MM JAW	5MM	24CM	52224-69B1	52224-69B17	52224-69B18	52224-69B10	52224-69B3	52224-69B15
	5MM	33CM	52255-69B1	52255-69B17	52255-69B18	52255-69B10	52255-69B3	52255-69B15
	5MM	36CM	52236-69B1	52236-69B17	52236-69B18	52236-69B10	52236-69B3	52236-69B15
	5MM	45CM	52155-69B1	52155-69B17	52155-69B18	52155-69B10	52155-69B3	52155-69B15
	10MM	33CM	52102-37B1	52102-37B17	52102-37B18	52102-37B10	52102-37B3	52102-37B4
	10MM	36CM	52103-37B1	52103-37B17	52103-37B18	52103-37B10	52103-37B3	52103-37B4
BIOPSY SPOON FORCEPS, LONG, DOUBLE-ACTION  25MM JAW	10MM	33CM	52102-38B1	52102-38B17	52102-38B18	52102-38B10	52102-38B3	52102-38B4
	10MM	36CM	52103-38B1	52103-38B17	52103-38B18	52103-38B10	52103-38B3	52103-38B4
	10MM	45CM	52101-38B1	52101-38B17	52101-38B18	52101-38B10	52101-38B3	52101-38B4

STYLE B:

ROTATABLE, ONE-PIECE INSTRUMENT WITH FLUSH PORT

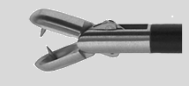

Forceps & Scissors

TIP ID.	DIAMETER	LENGTH	52555-40-01	52555-40-17	52555-40-18	52555-40-10	52555-40-03	52555-40-15
			INSULATED & CARBON FIBER HANDLES				NON-INSULATED HANDLES	
BIOPSY SPOON FORCEPS, DOUBLE- ACTION  10MM JAW	5MM	24CM	52224-70B1	52224-70B17	52224-70B18	52224-70B10	52224-70B3	52224-70B15
	5MM	33CM	52255-70B1	52255-70B17	52255-70B18	52255-70B10	52255-70B3	52255-70B15
	5MM	36CM	52236-70B1	52236-70B17	52236-70B18	52236-70B10	52236-70B3	52236-70B15
	5MM	45CM	52155-70B1	52155-70B17	52155-70B18	52155-70B10	52155-70B3	52155-70B15
BIOPSY SPOON FORCEPS, W/ TOOTH (SEMM-TYPE), DBL- ACTION  10MM JAW	5MM	24CM	52224-68B1	52224-68B17	52224-68B18	52224-68B10	52224-68B3	52224-68B15
	5MM	33CM	52255-68B1	52255-68B17	52255-68B18	52255-68B10	52255-68B3	52255-68B15
	5MM	36CM	52236-68B1	52236-68B17	52236-68B18	52236-68B10	52236-68B3	52236-68B15
	5MM	45CM	52155-68B1	52155-68B17	52155-68B18	52155-68B10	52155-68B3	52155-68B15
POINTED BIOPSY SPOON FORCEPS, SINGLE ACTION  10MM TIP	5MM	24CM	52224-305B1	52224-305B17	52224-305B18	52224-305B10	52224-305B3	52224-305B4
	5MM	33CM	52255-305B1	52255-305B17	52255-305B18	52255-305B10	52255-305B3	52255-305B4
	5MM	36CM	52236-305B1	52236-305B17	52236-305B18	52236-305B10	52236-305B3	52236-305B4
	5MM	45CM	52155-305B1	52155-305B17	52155-305B18	52155-305B10	52155-305B3	52155-305B4
BIOPSY PUNCH, SINGLE-ACTION  10MM TIP	5MM	24CM	52224-71B1	52224-71B17	52224-71B18	52224-71B10	52224-71B3	52224-71B15
	5MM	33CM	52255-71B1	52255-71B17	52255-71B18	52255-71B10	52255-71B3	52255-71B15
	5MM	36CM	52236-71B1	52236-71B17	52236-71B18	52236-71B10	52236-71B3	52236-71B15
	5MM	45CM	52155-71B1	52155-71B17	52155-71B18	52155-71B10	52155-71B3	52155-71B15
BIOPSY PUNCH WITH TOOTH, SINGLE- ACTION  10MM JAW	5MM	24CM	52224-72B1	52224-72B17	52224-72B18	52224-72B10	52224-72B3	52224-72B15
	5MM	33CM	52255-72B1	52255-72B17	52255-72B18	52255-72B10	52255-72B3	52255-72B15
	5MM	36CM	52236-72B1	52236-72B17	52236-72B18	52236-72B10	52236-72B3	52236-72B15
	5MM	45CM	52155-72B1	52155-72B17	52155-72B18	52155-72B10	52155-72B3	52155-72B15
BIOPSY PUNCH, SINGLE-ACTION  10MM JAW	5MM	24CM	52224-73B1	52224-73B17	52224-73B18	52224-73B10	52224-73B3	52224-73B15
	5MM	33CM	52255-73B1	52255-73B17	52255-73B18	52255-73B10	52255-73B3	52255-73B15
	5MM	36CM	52236-73B1	52236-73B17	52236-73B18	52236-73B10	52236-73B3	52236-73B15
	5MM	45CM	52155-73B1	52155-73B17	52155-73B18	52155-73B10	52155-73B3	52155-73B15

The *Summit Series* 5mm Modular, Three-Piece Detachable instruments is our most extensive line of Laparoscopic Instruments, offering over 2000 different combinations for the most precise instrumentation needed for any procedure. Our Three-Piece Modular Instruments are designed to come apart for superior cleaning. They are also completely interchangeable with any of our Laparoscopic Handles giving Hospitals & Surgery Centers the flexibility to quickly assemble instruments without having to match up every insert, shaft, & handle.

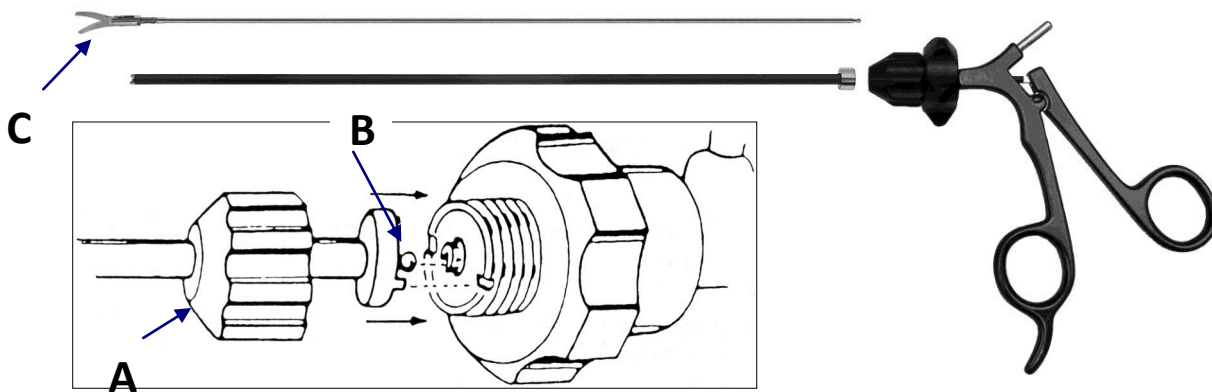

ASSEMBLY:

1. Turn the **Tip (C)** clockwise into the shaft
2. Set the handle in the open position & engage the **Ball (B) of Inner Rod** into its fixation in the handle port.
3. Turn main **Screw Cap (A)** clockwise until it engages the handle.

Summit Series Outer Tubes & Accessories



5MM INSULATED SHAFT	
ITEM NO.	DESCRIPTION
52555-49	5MM X 24CM
52555-45	5MM X 33CM
52555-39	5MM X 36CM
52555-47	5MM X 45CM

5MM NON-INSULATED SHAFT	
ITEM NO.	DESCRIPTION
52555-32	5MM X 24CM
52555-51	5MM X 33CM
52555-34	5MM X 36CM
52555-35	5MM X 45CM



10MM INSULATED SHAFT	
ITEM NO.	DESCRIPTION
52555-50	10MM X 24CM
52555-46	10MM X 33CM
52555-56	10MM X 36CM
52555-48	10MM X 45CM

10MM NON-INSULATED SHAFT	
ITEM NO.	DESCRIPTION
52555-55	10MM X 24CM
52555-52	10MM X 33CM
52555-53	10MM X 36CM
52555-54	10MM X 45CM



52555-47-01	SHAFT LOCKING CAP PK. OF 10
-------------	--------------------------------

REUSABLE CABLES FOR MONOPOLAR
INSTRUMENTS & GENERATORS



GENERATOR END



INSTRUMENT END

ITEM NO. 52005-31	4MM DIA. PLUG (UNIT) & 4MM DIA. FEMALE INST. PLUG
----------------------	--



GENERATOR END



INSTRUMENT END

ITEM NO. 52005-32	8MM DIA. "BOVIE" PLUG (UNIT) & 4MM DIA. FEMALE INST. PLUG
----------------------	--

HANDLES: Insulated & Carbon Fiber

52555-40-01

INSULATED STAINLESS STEEL
W/ RF POST
(TYPE 1)



52555-40-02

INSULATED STAINLESS STEEL
W/ RF-POST & RATCHET
(TYPE 2)



52555-40-05

INSULATED W/ RF-POST &
RATCHET (TYPE 5)



52555-40-06

LIGHTWEIGHT CARBON
FIBER W/ RF-POST & RATCHET
(TYPE 6)



52555-40-07

LIGHTWEIGHT CARBON-FIBER
W/ RF POST,
RATCHET / RATCHET
DEFEATING (TYPE 7)



52555-40-08

LIGHTWEIGHT CARBON-FIBER
W/ RF POST, ON DEMAND
FRENCH ON/OFF RATCHET
(TYPE 8)



52555-40-09

LIGHTWEIGHT CARBON-FIBER
W/ RF POST, W/ LARGE FINGER
LOOPS
(TYPE 9)



52555-40-10

LIGHTWEIGHT
CARBON-FIBER W/ RF POST,
RATCHET / RATCHET
DEFEATING W/ LARGE FINGER
LOOPS (TYPE 10)



52555-40-14

INSULATED STAINLESS STEEL
LINVATEC-WECK STYLE W/
LONG SHANKS (TYPE 14)



52555-40-17

LIGHTWEIGHT CARBON
FIBER W/ RF POST
(TYPE 17)



52555-40-18

LIGHTWEIGHT CARBON-FIBER
W/ RF POST,
RATCHET / RATCHET
DEFEATING (TYPE 18)



52555-40-23

LIGHTWEIGHT THERMO-
PLASTIC W/ RF POST,
NON-RATCHET (TYPE 23)



52555-40-24

LIGHTWEIGHT THERMO-
PLASTIC W/ RF POST,
W/ RATCHET (TYPE 24)



SUMMIT SERIES HANDLES: Non-Insulated

52555-40-03

NON-INSULATED
STAINLESS STEEL



52555-40-15

NON-INSULATED STAINLESS
STEEL LINVATEC-WECK STYLE
W/ QUICK RELEASE RATCHET &
LONG SHANKS



52555-40-04

NON-INSULATED
STAINLESS STEEL W/ RATCHET



52555-40-16

NON-INSULATED STAINLESS
STEEL W/ SPRING ASSIST
CLOSING



52555-40-11

NON-INSULATED RING AXIAL
HANDLE

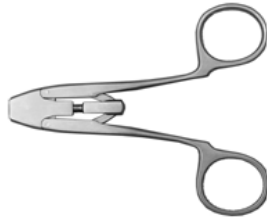

52555-40-13

STAINLESS STEEL AXIAL
HANDLE W/ PRECISE
ENGAGEMENT RATCHET



52555-40-12

NON-INSULATED RING
AXIAL HANDLE W/
RATCHET









STYLE C:

ROTATABLE, THREE PIECE MODULAR INSTRUMENT

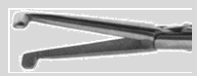

Dissectors & Graspers











TIP ID.	DIAMETER	LENGTH	INSERT NO.	52555-40-01	52555-40-17	52555-40-18	52555-40-10	52555-40-03	52555-40-04
				INSULATED & CARBON FIBER HANDLES				NON-INSULATED HANDLES	
 15MM JAW	5MM	24CM	52224-105I	52224-105C1	52224-105C17	52224-105C18	52224-105C10	52224-105C3	52224-105C4
	5MM	33CM	52255-105I	52255-105C1	52255-105C17	52255-105C18	52255-105C10	52255-105C3	52255-105C4
	5MM	36CM	52236-105I	52236-105C1	52236-105C17	52236-105C18	52236-105C10	52236-105C3	52236-105C4
	5MM	45CM	52155-105I	52155-105C1	52155-105C17	52155-105C18	52155-105C10	52155-105C3	52155-105C4
 18MM JAW	5MM	24CM	52224-06I	52224-06C1	52224-06C17	52224-06C18	52224-06C10	52224-06C3	52224-06C4
	5MM	33CM	52255-06I	52255-06C1	52255-06C17	52255-06C18	52255-06C10	52255-06C3	52255-06C4
	5MM	36CM	52236-06I	52236-06C1	52236-06C17	52236-06C18	52236-06C10	52236-06C3	52236-06C4
	5MM	45CM	52155-06I	52155-06C1	52155-06C17	52155-06C18	52155-06C10	52155-06C3	52155-06C4
	10MM	33CM	52102-06I	52102-06C1	52102-06C17	52102-06C18	52102-06C10	52102-06C3	52102-06C4
	10MM	36CM	52103-06I	52103-06C1	52103-06C17	52103-06C18	52103-06C10	52103-06C3	52103-06C4
 18MM JAW	5MM	24CM	52224-106I	52224-106C1	52224-106C17	52224-106C18	52224-106C10	52224-106C3	52224-106C4
	5MM	33CM	52255-106I	52255-106C1	52255-106C17	52255-106C18	52255-106C10	52255-106C3	52255-106C4
	5MM	36CM	52236-106I	52236-106C1	52236-106C17	52236-106C18	52236-106C10	52236-106C3	52236-106C4
	5MM	45CM	52155-106I	52155-106C1	52155-106C17	52155-106C18	52155-106C10	52155-106C3	52155-106C4
 15MM JAW	5MM	24CM	52224-206I	52224-206C1	52224-206C17	52224-206C18	52224-206C10	52224-206C3	52224-206C4
	5MM	33CM	52255-206I	52255-206C1	52255-206C17	52255-206C18	52255-206C10	52255-206C3	52255-206C4
	5MM	36CM	52236-206I	52236-206C1	52236-206C17	52236-206C18	52236-206C10	52236-206C3	52236-206C4
	5MM	45CM	52155-206I	52155-206C1	52155-206C17	52155-206C18	52155-206C10	52155-206C3	52155-206C4
 22MM JAW	5MM	24CM	52224-07I	52224-07C1	52224-07C17	52224-07C18	52224-07C10	52224-07C3	52224-07C4
	5MM	33CM	52255-07I	52255-07C1	52255-07C17	52255-07C18	52255-07C10	52255-07C3	52255-07C4
	5MM	36CM	52236-07I	52236-07C1	52236-07C17	52236-07C18	52236-07C10	52236-07C3	52236-07C4
	5MM	45CM	52155-07I	52155-07C1	52155-07C17	52155-07C18	52155-07C10	52155-07C3	52155-07C4
	10MM	33CM	52102-07I	52102-07C1	52102-07C17	52102-07C18	52102-07C10	52102-07C3	52102-07C4
	10MM	36CM	52103-07I	52103-07C1	52103-07C17	52103-07C18	52103-07C10	52103-07C3	52103-07C4
 12MM TIP	5MM	24CM	52224-59I	52224-59C1	52224-59C17	52224-59C18	52224-59C10	52224-59C3	52224-59C4
	5MM	33CM	52255-59I	52255-59C1	52255-59C17	52255-59C18	52255-59C10	52255-59C3	52255-59C4
	5MM	36CM	52236-59I	52236-59C1	52236-59C17	52236-59C18	52236-59C10	52236-59C3	52236-59C4
	5MM	45CM	52155-59I	52155-59C1	52155-59C17	52155-59C18	52155-59C10	52155-59C3	52155-59C4
	10MM	33CM	52102-59I	52102-59C1	52102-59C17	52102-59C18	52102-59C10	52102-59C3	52102-59C4
	10MM	36CM	52103-59I	52103-59C1	52103-59C17	52103-59C18	52103-59C10	52103-59C3	52103-59C4

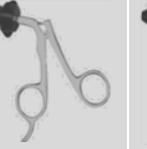

STYLE C:

ROTATABLE, THREE PIECE MODULAR INSTRUMENT

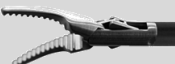
Dissectors & Graspers







TIP ID.	DIAMETER	LENGTH	INSERT NO.	52555-40-01	52555-40-17	52555-40-18	52555-40-10	52555-40-03	52555-40-04
									
				INSULATED & CARBON FIBER HANDLES				NON-INSULATED HANDLES	
45 DEGREE ANGLED MIXTER  20MM JAW	5MM	24CM	52224-08I	52224-08C1	52224-08C17	52224-08C18	52224-08C10	52224-08C3	52224-08C4
	5MM	33CM	52255-08I	52255-08C1	52255-08C17	52255-08C18	52255-08C10	52255-08C3	52255-08C4
	5MM	36CM	52236-08I	52236-08C1	52236-08C17	52236-08C18	52236-08C10	52236-08C3	52236-08C4
	5MM	45CM	52155-08I	52155-08C1	52155-08C17	52155-08C18	52155-08C10	52155-08C3	52155-08C4
	10MM	33CM	52102-08I	52102-08C1	52102-08C17	52102-08C18	52102-08C10	52102-08C3	52102-08C4
	10MM	36CM	52103-08I	52103-08C1	52103-08C17	52103-08C18	52103-08C10	52103-08C3	52103-08C4
DUCKBILL GRASPER  12MM JAW	5MM	24CM	52224-09I	52224-09C1	52224-09C17	52224-09C18	52224-09C10	52224-09C3	52224-09C4
	5MM	33CM	52255-09I	52255-09C1	52255-09C17	52255-09C18	52255-09C10	52255-09C3	52255-09C4
	5MM	36CM	52236-09I	52236-09C1	52236-09C17	52236-09C18	52236-09C10	52236-09C3	52236-09C4
	5MM	45CM	52155-09I	52155-09C1	52155-09C17	52155-09C18	52155-09C10	52155-09C3	52155-09C4
NEEDLE-NOSE GRASPER  20MM JAW	5MM	24CM	52224-10I	52224-10C1	52224-10C17	52224-10C18	52224-10C10	52224-10C3	52224-10C4
	5MM	33CM	52255-10I	52255-10C1	52255-10C17	52255-10C18	52255-10C10	52255-10C3	52255-10C4
	5MM	36CM	52236-10I	52236-10C1	52236-10C17	52236-10C18	52236-10C10	52236-10C3	52236-10C4
	5MM	45CM	52155-10I	52155-10C1	52155-10C17	52155-10C18	52155-10C10	52155-10C3	52155-10C4
KELLY GRASPER  14MM JAW	5MM	24CM	52224-11I	52224-11C1	52224-11C17	52224-11C18	52224-11C10	52224-11C3	52224-11C4
	5MM	33CM	52255-11I	52255-11C1	52255-11C17	52255-11C18	52255-11C10	52255-11C3	52255-11C4
	5MM	36CM	52236-11I	52236-11C1	52236-11C17	52236-11C18	52236-11C10	52236-11C3	52236-11C4
	5MM	45CM	52155-11I	52155-11C1	52155-11C17	52155-11C18	52155-11C10	52155-11C3	52155-11C4
RIGHT ANGLE, LONG REACH GRASPER  22MM JAW	5MM	24CM	52224-53I	52224-53C1	52224-53C17	52224-53C18	52224-53C10	52224-53C3	52224-53C4
	5MM	33CM	52255-53I	52255-53C1	52255-53C17	52255-53C18	52255-53C10	52255-53C3	52255-53C4
	5MM	36CM	52236-53I	52236-53C1	52236-53C17	52236-53C18	52236-53C10	52236-53C3	52236-53C4
	5MM	45CM	52155-53I	52155-53C1	52155-53C17	52155-53C18	52155-53C10	52155-53C3	52155-53C4
PETELIN DISSECTOR, 60 DEGREE ANGLE, SA  10MM JAW	5MM	24CM	52224-12I	52224-12C1	52224-12C17	52224-12C18	52224-12C10	52224-12C3	52224-12C4
	5MM	33CM	52255-12I	52255-12C1	52255-12C17	52255-12C18	52255-12C10	52255-12C3	52255-12C4
	5MM	36CM	52236-12I	52236-12C1	52236-12C17	52236-12C18	52236-12C10	52236-12C3	52236-12C4
	5MM	45CM	52155-12I	52155-12C1	52155-12C17	52155-12C18	52155-12C10	52155-12C3	52155-12C4

STYLE C:

ROTATABLE, THREE PIECE MODULAR INSTRUMENT



Dissectors & Graspers







TIP ID.	DIAMETER	LENGTH	INSERT NO.	52555-40-01	52555-40-17	52555-40-18	52555-40-10	52555-40-03	52555-40-04
				INSULATED & CARBON FIBER HANDLES				NON-INSULATED HANDLES	
 PETELIN DISSECTOR, 30 DEGREE ANGLE, SA 10MM JAW	5MM	24CM	52224-13I	52224-13C1	52224-13C17	52224-13C18	52224-13C10	52224-13C3	52224-13C4
	5MM	33CM	52255-13I	52255-13C1	52255-13C17	52255-13C18	52255-13C10	52255-13C3	52255-13C4
	5MM	36CM	52236-13I	52236-13C1	52236-13C17	52236-13C18	52236-13C10	52236-13C3	52236-13C4
	5MM	45CM	52155-13I	52155-13C1	52155-13C17	52155-13C18	52155-13C10	52155-13C3	52155-13C4
 MICRO GRASPER, FENESTRATED 10MM JAW	5MM	24CM	52224-14I	52224-14C1	52224-14C17	52224-14C18	52224-14C10	52224-14C3	52224-14C4
	5MM	33CM	52255-14I	52255-14C1	52255-14C17	52255-14C18	52255-14C10	52255-14C3	52255-14C4
	5MM	36CM	52236-14I	52236-14C1	52236-14C17	52236-14C18	52236-14C10	52236-14C3	52236-14C4
	5MM	45CM	52155-14I	52155-14C1	52155-14C17	52155-14C18	52155-14C10	52155-14C3	52155-14C4
 COBRA GRASPER, DOUBLE-ACTION 10MM JAW	5MM	24CM	52224-15I	52224-15C1	52224-15C17	52224-15C18	52224-15C10	52224-15C3	52224-15C4
	5MM	33CM	52255-15I	52255-15C1	52255-15C17	52255-15C18	52255-15C10	52255-15C3	52255-15C4
	5MM	36CM	52236-15I	52236-15C1	52236-15C17	52236-15C18	52236-15C10	52236-15C3	52236-15C4
	5MM	45CM	52155-15I	52155-15C1	52155-15C17	52155-15C18	52155-15C10	52155-15C3	52155-15C4
 BABCOCK GRASPER, FENESTRATED TIP 30MM JAW	5MM	24CM	52224-16I	52224-16C1	52224-16C17	52224-16C18	52224-16C10	52224-16C3	52224-16C4
	5MM	33CM	52255-16I	52255-16C1	52255-16C17	52255-16C18	52255-16C10	52255-16C3	52255-16C4
	5MM	36CM	52236-16I	52236-16C1	52236-16C17	52236-16C18	52236-16C10	52236-16C3	52236-16C4
	5MM	45CM	52155-16I	52155-16C1	52155-16C17	52155-16C18	52155-16C10	52155-16C3	52155-16C4
	10MM	33CM	52102-16I	52102-16C1	52102-16C17	52102-16C18	52102-16C10	52102-16C3	52102-16C4
	10MM	36CM	52103-16I	52103-16C1	52103-16C17	52103-16C18	52103-16C10	52103-16C3	52103-16C4
 BABCOCK GRASPER, AXIS STYLE, FENESTRATED 30MM JAW	5MM	24CM	52224-116I	52224-116C1	52224-116C17	52224-116C18	52224-116C10	52224-116C3	52224-116C4
	5MM	33CM	52255-116I	52255-116C1	52255-116C17	52255-116C18	52255-116C10	52255-116C3	52255-116C4
	5MM	36CM	52236-116I	52236-116C1	52236-116C17	52236-116C18	52236-116C10	52236-116C3	52236-116C4
	5MM	45CM	52155-116I	52155-116C1	52155-116C17	52155-116C18	52155-116C10	52155-116C3	52155-116C4
 BABCOCK GRASPER, SHORT DELICATE 20MM JAW	5MM	24CM	52224-17I	52224-17C1	52224-17C17	52224-17C18	52224-17C10	52224-17C3	52224-17C4
	5MM	33CM	52255-17I	52255-17C1	52255-17C17	52255-17C18	52255-17C10	52255-17C3	52255-17C4
	5MM	36CM	52236-17I	52236-17C1	52236-17C17	52236-17C18	52236-17C10	52236-17C3	52236-17C4
	5MM	45CM	52155-17I	52155-17C1	52155-17C17	52155-17C18	52155-17C10	52155-17C3	52155-17C4



STYLE C:

ROTATABLE, THREE PIECE MODULAR INSTRUMENT

Dissectors & Graspers







TIP ID.	DIAMETER	LENGTH	INSERT NO.	52555-40-01	52555-40-17	52555-40-18	52555-40-10	52555-40-03	52555-40-04
				INSULATED & CARBON FIBER HANDLES				NON-INSULATED HANDLES	
 ALLIS GRASPER, SHORT VERSION, SA 15MM JAW	5MM	24CM	52224-18I	52224-18C1	52224-18C17	52224-18C18	52224-18C10	52224-18C3	52224-18C4
	5MM	33CM	52255-18I	52255-18C1	52255-18C17	52255-18C18	52255-18C10	52255-18C3	52255-18C4
	5MM	36CM	52236-18I	52236-18C1	52236-18C17	52236-18C18	52236-18C10	52236-18C3	52236-18C4
	5MM	45CM	52155-18I	52155-18C1	52155-18C17	52155-18C18	52155-18C10	52155-18C3	52155-18C4
 ALLIS, SHORT VERSION, 3 X 4 TEETH, SERRATED 12MM JAW	5MM	24CM	52224-19I	52224-19C1	52224-19C17	52224-19C18	52224-19C10	52224-19C3	52224-19C4
	5MM	33CM	52255-19I	52255-19C1	52255-19C17	52255-19C18	52255-19C10	52255-19C3	52255-19C4
	5MM	36CM	52236-19I	52236-19C1	52236-19C17	52236-19C18	52236-19C10	52236-19C3	52236-19C4
	5MM	45CM	52155-19I	52155-19C1	52155-19C17	52155-19C18	52155-19C10	52155-19C3	52155-19C4
 ALLIS, SHORT VERSION, DOUBLE ROW OF TEETH, SERRATED 12MM JAW	5MM	24CM	52224-119I	52224-119C1	52224-119C17	52224-119C18	52224-119C10	52224-119C3	52224-119C4
	5MM	33CM	52255-119I	52255-119C1	52255-119C17	52255-119C18	52255-119C10	52255-119C3	52255-119C4
	5MM	36CM	52236-119I	52236-119C1	52236-119C17	52236-119C18	52236-119C10	52236-119C3	52236-119C4
	5MM	45CM	52155-119I	52155-119C1	52155-119C17	52155-119C18	52155-119C10	52155-119C3	52155-119C4
 ALLIS, LONG VERSION, DOUBLE ROW OF TEETH, SERRATED 25MM JAW	5MM	24CM	52224-219I	52224-219C1	52224-219C17	52224-219C18	52224-219C10	52224-219C3	52224-219C4
	5MM	33CM	52255-219I	52255-219C1	52255-219C17	52255-219C18	52255-219C10	52255-219C3	52255-219C4
	5MM	36CM	52236-219I	52236-219C1	52236-219C17	52236-219C18	52236-219C10	52236-219C3	52236-219C4
	5MM	45CM	52155-219I	52155-219C1	52155-219C17	52155-219C18	52155-219C10	52155-219C3	52155-219C4
 ALLIS GRASPER, MEDIUM, WECK STYLE 20MM JAW	5MM	24CM	52224-20I	52224-20C1	52224-20C17	52224-20C18	52224-20C10	52224-20C3	52224-20C4
	5MM	33CM	52255-20I	52255-20C1	52255-20C17	52255-20C18	52255-20C10	52255-20C3	52255-20C4
	5MM	36CM	52236-20I	52236-20C1	52236-20C17	52236-20C18	52236-20C10	52236-20C3	52236-20C4
	5MM	45CM	52155-20I	52155-20C1	52155-20C17	52155-20C18	52155-20C10	52155-20C3	52155-20C4
 ALLIS GRASPER, STANDARD VERSION 30MM JAW	5MM	24CM	52224-21I	52224-21C1	52224-21C17	52224-21C18	52224-21C10	52224-21C3	52224-21C4
	5MM	33CM	52255-21I	52255-21C1	52255-21C17	52255-21C18	52255-21C10	52255-21C3	52255-21C4
	5MM	36CM	52236-21I	52236-21C1	52236-21C17	52236-21C18	52236-21C10	52236-21C3	52236-21C4
	5MM	45CM	52155-21I	52155-21C1	52155-21C17	52155-21C18	52155-21C10	52155-21C3	52155-21C4
	10MM	33CM	52102-21I	52102-21C1	52102-21C17	52102-21C18	52102-21C10	52102-21C3	52102-21C4
	10MM	36CM	52103-21I	52103-21C1	52103-21C17	52103-21C18	52103-21C10	52103-21C3	52103-21C4
10MM	45CM	52101-21I	52101-21C1	52101-21C17	52101-21C18	52101-21C10	52101-21C3	52101-21C4	

STYLE C:

ROTATABLE, THREE PIECE MODULAR INSTRUMENT



Dissectors & Graspers













TIP ID.	DIAMETER	LENGTH	INSERT NO.	52555-40-01	52555-40-17	52555-40-18	52555-40-10	52555-40-03	52555-40-04
				INSULATED & CARBON FIBER HANDLES				NON-INSULATED HANDLES	
 ALLIS GRASPER, TC, STANDARD VERSION 35MM JAW	5MM	24CM	52224-57I	52224-57C1	52224-57C17	52224-57C18	52224-57C10	52224-57C3	52224-57C4
	5MM	33CM	52255-57I	52255-57C1	52255-57C17	52255-57C18	52255-57C10	52255-57C3	52255-57C4
	5MM	36CM	52236-57I	52236-57C1	52236-57C17	52236-57C18	52236-57C10	52236-57C3	52236-57C4
	5MM	45CM	52155-57I	52155-57C1	52155-57C17	52155-57C18	52155-57C10	52155-57C3	52155-57C4
 DEBAKEY GRASPER, 20MM JAW 20MM JAW	5MM	24CM	52224-22I	52224-22C1	52224-22C17	52224-22C18	52224-22C10	52224-22C3	52224-22C4
	5MM	33CM	52255-22I	52255-22C1	52255-22C17	52255-22C18	52255-22C10	52255-22C3	52255-22C4
	5MM	36CM	52236-22I	52236-22C1	52236-22C17	52236-22C18	52236-22C10	52236-22C3	52236-22C4
	5MM	45CM	52155-22I	52155-22C1	52155-22C17	52155-22C18	52155-22C10	52155-22C3	52155-22C4
 DEBAKEY GRASPER, 40MM JAW 40MM JAW	5MM	24CM	52224-23I	52224-23C1	52224-23C17	52224-23C18	52224-23C10	52224-23C3	52224-23C4
	5MM	33CM	52255-23I	52255-23C1	52255-23C17	52255-23C18	52255-23C10	52255-23C3	52255-23C4
	5MM	36CM	52236-23I	52236-23C1	52236-23C17	52236-23C18	52236-23C10	52236-23C3	52236-23C4
	5MM	45CM	52155-23I	52155-23C1	52155-23C17	52155-23C18	52155-23C10	52155-23C3	52155-23C4
	10MM	33CM	52102-22I	52102-22C1	52102-22C17	52102-22C18	52102-22C10	52102-22C3	52102-22C4
	10MM	36CM	52103-22I	52103-22C1	52103-22C17	52103-22C18	52103-22C10	52103-22C3	52103-22C4
 DEBAKEY GRASPER, 60MM JAW 60MM	5MM	24CM	52224-160I	52224-160C1	52224-160C17	52224-160C18	52224-160C10	52224-160C3	52224-160C4
	5MM	33CM	52255-160I	52255-160C1	52255-160C17	52255-160C18	52255-160C10	52255-160C3	52255-160C4
	5MM	36CM	52236-160I	52236-160C1	52236-160C17	52236-160C18	52236-160C10	52236-160C3	52236-160C4
	5MM	45CM	52155-160I	52155-160C1	52155-160C17	52155-160C18	52155-160C10	52155-160C3	52155-160C4
	10MM	33CM	52102-23I	52102-23C1	52102-23C17	52102-23C18	52102-23C10	52102-23C3	52102-23C4
	10MM	36CM	52103-23I	52103-23C1	52103-23C17	52103-23C18	52103-23C10	52103-23C3	52103-23C4
 HUNTER DEBAKEY, FENESTRATED, 20MM 20MM JAW	5MM	24CM	52224-58I	52224-58C1	52224-58C17	52224-58C18	52224-58C10	52224-58C3	52224-58C4
	5MM	33CM	52255-58I	52255-58C1	52255-58C17	52255-58C18	52255-58C10	52255-58C3	52255-58C4
	5MM	36CM	52236-58I	52236-58C1	52236-58C17	52236-58C18	52236-58C10	52236-58C3	52236-58C4
	5MM	45CM	52155-58I	52155-58C1	52155-58C17	52155-58C18	52155-58C10	52155-58C3	52155-58C4
 HUNTER DEBAKEY, FENESTRATED, 40MM 40MM JAW	5MM	24CM	52224-159I	52224-159C1	52224-159C17	52224-159C18	52224-159C10	52224-159C3	52224-159C4
	5MM	33CM	52255-159I	52255-159C1	52255-159C17	52255-159C18	52255-159C10	52255-159C3	52255-159C4
	5MM	36CM	52236-159I	52236-159C1	52236-159C17	52236-159C18	52236-159C10	52236-159C3	52236-159C4
	5MM	45CM	52155-159I	52155-159C1	52155-159C17	52155-159C18	52155-159C10	52155-159C3	52155-159C4

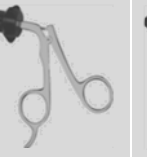

STYLE C:

ROTATABLE, THREE PIECE MODULAR INSTRUMENT

Dissectors & Graspers







TIP ID.	DIAMETER	LENGTH	INSERT NO.	52555-40-01	52555-40-17	52555-40-18	52555-40-10	52555-40-03	52555-40-04
									
				INSULATED & CARBON FIBER HANDLES				NON-INSULATED HANDLES	
 HUNTER DEBAKEY, FENESTRATED, 60MM 60MM JAW	5MM	24CM	52224-160I	52224-160C1	52224-160C17	52224-160C18	52224-160C10	52224-160C3	52224-160C4
	5MM	33CM	52255-160I	52255-160C1	52255-160C17	52255-160C18	52255-160C10	52255-160C3	52255-160C4
	5MM	36CM	52236-160I	52236-160C1	52236-160C17	52236-160C18	52236-160C10	52236-160C3	52236-160C4
	5MM	45CM	52155-160I	52155-160C1	52155-160C17	52155-160C18	52155-160C10	52155-160C3	52155-160C4
 DEBAKEY GRASPER, CURVED 30MM JAW	5MM	24CM	52224-46I	52224-46C1	52224-46C17	52224-46C18	52224-46C10	52224-46C3	52224-46C4
	5MM	33CM	52255-46I	52255-46C1	52255-46C17	52255-46C18	52255-46C10	52255-46C3	52255-46C4
	5MM	36CM	52236-46I	52236-46C1	52236-46C17	52236-46C18	52236-46C10	52236-46C3	52236-46C4
	5MM	45CM	52155-46I	52155-46C1	52155-46C17	52155-46C18	52155-46C10	52155-46C3	52155-46C4
 DEBAKEY MARYLAND GRASPER 35MM JAW	5MM	24CM	52224-149I	52224-149C1	52224-149C17	52224-149C18	52224-149C10	52224-149C3	52224-149C4
	5MM	33CM	52255-149I	52255-149C1	52255-149C17	52255-149C18	52255-149C10	52255-149C3	52255-149C4
	5MM	36CM	52236-149I	52236-149C1	52236-149C17	52236-149C18	52236-149C10	52236-149C3	52236-149C4
	5MM	45CM	52155-149I	52155-149C1	52155-149C17	52155-149C18	52155-149C10	52155-149C3	52155-149C4
 GLASSMAN ATRAUMATIC GRASPER 30MM JAW	5MM	24CM	52224-24I	52224-24C1	52224-24C17	52224-24C18	52224-24C10	52224-24C3	52224-24C4
	5MM	33CM	52255-24I	52255-24C1	52255-24C17	52255-24C18	52255-24C10	52255-24C3	52255-24C4
	5MM	36CM	52236-24I	52236-24C1	52236-24C17	52236-24C18	52236-24C10	52236-24C3	52236-24C4
	5MM	45CM	52155-24I	52155-24C1	52155-24C17	52155-24C18	52155-24C10	52155-24C3	52155-24C4
 GRASPER, CROSS SERRATED, SINGLE ACTION 10MM JAW	5MM	24CM	52224-25I	52224-25C1	52224-25C17	52224-25C18	52224-25C10	52224-25C3	52224-25C4
	5MM	33CM	52255-25I	52255-25C1	52255-25C17	52255-25C18	52255-25C10	52255-25C3	52255-25C4
	5MM	36CM	52236-25I	52236-25C1	52236-25C17	52236-25C18	52236-25C10	52236-25C3	52236-25C4
	5MM	45CM	52155-25I	52155-25C1	52155-25C17	52155-25C18	52155-25C10	52155-25C3	52155-25C4
 DOUBLE CUP FUNDUS MAXI GRASPER 16MM JAW	5MM	24CM	52224-26I	52224-26C1	52224-26C17	52224-26C18	52224-26C10	52224-26C3	52224-26C4
	5MM	33CM	52255-26I	52255-26C1	52255-26C17	52255-26C18	52255-26C10	52255-26C3	52255-26C4
	5MM	36CM	52236-26I	52236-26C1	52236-26C17	52236-26C18	52236-26C10	52236-26C3	52236-26C4
	5MM	45CM	52155-26I	52155-26C1	52155-26C17	52155-26C18	52155-26C10	52155-26C3	52155-26C4



STYLE C:

ROTATABLE, THREE PIECE MODULAR INSTRUMENT

Dissectors & Graspers











TIP ID.	DIAMETER	LENGTH	INSERT NO.	52555-40-01	52555-40-17	52555-40-18	52555-40-10	52555-40-03	52555-40-04
				INSULATED & CARBON FIBER HANDLES				NON-INSULATED HANDLES	
ALLIGATOR GRASPER, RETRO-FACING TEETH, 10MM JAW 	5MM	24CM	52224-29I	52224-29C1	52224-29C17	52224-29C18	52224-29C10	52224-29C3	52224-29C4
	5MM	33CM	52255-29I	52255-29C1	52255-29C17	52255-29C18	52255-29C10	52255-29C3	52255-29C4
	5MM	36CM	52236-29I	52236-29C1	52236-29C17	52236-29C18	52236-29C10	52236-29C3	52236-29C4
	5MM	45CM	52155-29I	52155-29C1	52155-29C17	52155-29C18	52155-29C10	52155-29C3	52155-29C4
ALLIGATOR GRASPER, RETRO-FACING TEETH, SINGLE ACTION 	5MM	24CM	52224-30I	52224-30C1	52224-30C17	52224-30C18	52224-30C10	52224-30C3	52224-30C4
	5MM	33CM	52255-30I	52255-30C1	52255-30C17	52255-30C18	52255-30C10	52255-30C3	52255-30C4
	5MM	36CM	52236-30I	52236-30C1	52236-30C17	52236-30C18	52236-30C10	52236-30C3	52236-30C4
	5MM	45CM	52155-30I	52155-30C1	52155-30C17	52155-30C18	52155-30C10	52155-30C3	52155-30C4
CUP SHAPED GRASPER, W/ RETRO-FACING TEETH 	5MM	24CM	52224-31I	52224-31C1	52224-31C17	52224-31C18	52224-31C10	52224-31C3	52224-31C4
	5MM	33CM	52255-31I	52255-31C1	52255-31C17	52255-31C18	52255-31C10	52255-31C3	52255-31C4
	5MM	36CM	52236-31I	52236-31C1	52236-31C17	52236-31C18	52236-31C10	52236-31C3	52236-31C4
	5MM	45CM	52155-31I	52155-31C1	52155-31C17	52155-31C18	52155-31C10	52155-31C3	52155-31C4
WAVE GRASPER, LONG BEVELED EDGE, DOUBLE ACTION 	5MM	24CM	52224-32I	52224-32C1	52224-32C17	52224-32C18	52224-32C10	52224-32C3	52224-32C4
	5MM	33CM	52255-32I	52255-32C1	52255-32C17	52255-32C18	52255-32C10	52255-32C3	52255-32C4
	5MM	36CM	52236-32I	52236-32C1	52236-32C17	52236-32C18	52236-32C10	52236-32C3	52236-32C4
	5MM	45CM	52155-32I	52155-32C1	52155-32C17	52155-32C18	52155-32C10	52155-32C3	52155-32C4
WAVE GRASPER, LONG BEVELED EDGE, SINGLE ACTION 	5MM	24CM	52224-33I	52224-33C1	52224-33C17	52224-33C18	52224-33C10	52224-33C3	52224-33C4
	5MM	33CM	52255-33I	52255-33C1	52255-33C17	52255-33C18	52255-33C10	52255-33C3	52255-33C4
	5MM	36CM	52236-33I	52236-33C1	52236-33C17	52236-33C18	52236-33C10	52236-33C3	52236-33C4
	5MM	45CM	52155-33I	52155-33C1	52155-33C17	52155-33C18	52155-33C10	52155-33C3	52155-33C4
CLAW GRASPER, 2 X 3 TEETH, SINGLE ACTION 	5MM	24CM	52224-36I	52224-36C1	52224-36C17	52224-36C18	52224-36C10	52224-36C3	52224-36C4
	5MM	33CM	52255-36I	52255-36C1	52255-36C17	52255-36C18	52255-36C10	52255-36C3	52255-36C4
	5MM	36CM	52236-36I	52236-36C1	52236-36C17	52236-36C18	52236-36C10	52236-36C3	52236-36C4
	5MM	45CM	52155-36I	52155-36C1	52155-36C17	52155-36C18	52155-36C10	52155-36C3	52155-36C4
	10MM	33CM	52102-36I	52102-36C1	52102-36C17	52102-36C18	52102-36C10	52102-36C3	52102-36C4
	10MM	45CM	52101-36I	52101-36C1	52101-36C17	52101-36C18	52101-36C10	52101-36C3	52101-36C4

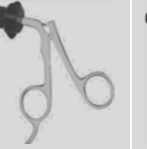

STYLE C:

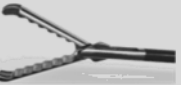
ROTATABLE, THREE PIECE MODULAR INSTRUMENT

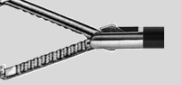
Dissectors & Graspers







TIP ID.	DIAMETER	LENGTH	INSERT NO.	52555-40-01	52555-40-17	52555-40-18	52555-40-10	52555-40-03	52555-40-04
									
				INSULATED & CARBON FIBER HANDLES				NON-INSULATED HANDLES	
CLAW GRASPER, 2 X 3 TEETH, W/ XTRA ROW OF TEETH  20MM JAW	5MM	24CM	52224-136I	52224-136C1	52224-136C17	52224-136C18	52224-136C10	52224-136C3	52224-136C4
	5MM	33CM	52255-136I	52255-136C1	52255-136C17	52255-136C18	52255-136C10	52255-136C3	52255-136C4
	5MM	36CM	52236-136I	52236-136C1	52236-136C17	52236-136C18	52236-136C10	52236-136C3	52236-136C4
	5MM	45CM	52155-136I	52155-136C1	52155-136C17	52155-136C18	52155-136C10	52155-136C3	52155-136C4
RETRACTION GRASPER, 2 X 3 TEETH, COBRA STYLE, DA  20MM JAW	5MM	24CM	52224-34I	52224-34C1	52224-34C17	52224-34C18	52224-34C10	52224-34C3	52224-34C4
	5MM	33CM	52255-34I	52255-34C1	52255-34C17	52255-34C18	52255-34C10	52255-34C3	52255-34C4
	5MM	36CM	52236-34I	52236-34C1	52236-34C17	52236-34C18	52236-34C10	52236-34C3	52236-34C4
	5MM	45CM	52155-34I	52155-34C1	52155-34C17	52155-34C18	52155-34C10	52155-34C3	52155-34C4
RETRACTION GRASPER, 2 X 3 TEETH, COBRA STYLE, SA  20MM JAW	5MM	24CM	52224-35I	52224-35C1	52224-35C17	52224-35C18	52224-35C10	52224-35C3	52224-35C4
	5MM	33CM	52255-35I	52255-35C1	52255-35C17	52255-35C18	52255-35C10	52255-35C3	52255-35C4
	5MM	36CM	52236-35I	52236-35C1	52236-35C17	52236-35C18	52236-35C10	52236-35C3	52236-35C4
	5MM	45CM	52155-35I	52155-35C1	52155-35C17	52155-35C18	52155-35C10	52155-35C3	52155-35C4
RETRACTION GRASPER, 2 X 3 TEETH, JARIT STYLE, DA  20MM JAW	5MM	24CM	52224-134I	52224-134C1	52224-134C17	52224-134C18	52224-134C10	52224-134C3	52224-134C4
	5MM	33CM	52255-134I	52255-134C1	52255-134C17	52255-134C18	52255-134C10	52255-134C3	52255-134C4
	5MM	36CM	52236-134I	52236-134C1	52236-134C17	52236-134C18	52236-134C10	52236-134C3	52236-134C4
	5MM	45CM	52155-134I	52155-134C1	52155-134C17	52155-134C18	52155-134C10	52155-134C3	52155-134C4
RETRACTION GRASPER, 2 X 3 TEETH, JARIT STYLE, SA  20MM JAW	5MM	24CM	52224-135I	52224-135C1	52224-135C17	52224-135C18	52224-135C10	52224-135C3	52224-135C4
	5MM	33CM	52255-135I	52255-135C1	52255-135C17	52255-135C18	52255-135C10	52255-135C3	52255-135C4
	5MM	36CM	52236-135I	52236-135C1	52236-135C17	52236-135C18	52236-135C10	52236-135C3	52236-135C4
	5MM	45CM	52155-135I	52155-135C1	52155-135C17	52155-135C18	52155-135C10	52155-135C3	52155-135C4
ATRUAMATIC FENESTRATED GRASPER, CURVED  16MM JAW	5MM	24CM	52224-37I	52224-37C1	52224-37C17	52224-37C18	52224-37C10	52224-37C3	52224-37C4
	5MM	33CM	52255-37I	52255-37C1	52255-37C17	52255-37C18	52255-37C10	52255-37C3	52255-37C4
	5MM	36CM	52236-37I	52236-37C1	52236-37C17	52236-37C18	52236-37C10	52236-37C3	52236-37C4
	5MM	45CM	52155-37I	52155-37C1	52155-37C17	52155-37C18	52155-37C10	52155-37C3	52155-37C4



STYLE C:

ROTATABLE, THREE PIECE MODULAR INSTRUMENT

Dissectors & Graspers





TIP ID.	DIAMETER	LENGTH	INSERT NO.	52555-40-01	52555-40-17	52555-40-18	52555-40-10	52555-40-03	52555-40-04
				INSULATED & CARBON FIBER HANDLES				NON-INSULATED HANDLES	
 FENESTRATED GRASPER, 16MM JAW 16MM JAW	5MM	24CM	52224-38I	52224-38C1	52224-38C17	52224-38C18	52224-38C10	52224-38C3	52224-38C4
	5MM	33CM	52255-38I	52255-38C1	52255-38C17	52255-38C18	52255-38C10	52255-38C3	52255-38C4
	5MM	36CM	52236-38I	52236-38C1	52236-38C17	52236-38C18	52236-38C10	52236-38C3	52236-38C4
	5MM	45CM	52155-38I	52155-38C1	52155-38C17	52155-38C18	52155-38C10	52155-38C3	52155-38C4
 FENESTRATED GRASPER, 20MM JAW 22MM JAW	5MM	24CM	52224-39I	52224-39C1	52224-39C17	52224-39C18	52224-39C10	52224-39C3	52224-39C4
	5MM	33CM	52255-39I	52255-39C1	52255-39C17	52255-39C18	52255-39C10	52255-39C3	52255-39C4
	5MM	36CM	52236-39I	52236-39C1	52236-39C17	52236-39C18	52236-39C10	52236-39C3	52236-39C4
	5MM	45CM	52155-39I	52155-39C1	52155-39C17	52155-39C18	52155-39C10	52155-39C3	52155-39C4
 FENESTRATED GRASPER, 40MM JAW 40MM JAW	5MM	24CM	52224-40I	52224-40C1	52224-40C17	52224-40C18	52224-40C10	52224-40C3	52224-40C4
	5MM	33CM	52255-40I	52255-40C1	52255-40C17	52255-40C18	52255-40C10	52255-40C3	52255-40C4
	5MM	36CM	52236-40I	52236-40C1	52236-40C17	52236-40C18	52236-40C10	52236-40C3	52236-40C4
	5MM	45CM	52155-40I	52155-40C1	52155-40C17	52155-40C18	52155-40C10	52155-40C3	52155-40C4
 JOHAN FENESTRATED GRASPER, 20MM TIP, SINGLE ACTION 20MM JAW	5MM	24CM	52224-41I	52224-41C1	52224-41C17	52224-41C18	52224-41C10	52224-41C3	52224-41C4
	5MM	33CM	52255-41I	52255-41C1	52255-41C17	52255-41C18	52255-41C10	52255-41C3	52255-41C4
	5MM	36CM	52236-41I	52236-41C1	52236-41C17	52236-41C18	52236-41C10	52236-41C3	52236-41C4
	5MM	45CM	52155-41I	52155-41C1	52155-41C17	52155-41C18	52155-41C10	52155-41C3	52155-41C4
 JOHAN FENESTRATED GRASPER, 45MM TIP, SINGLE ACTION 45MM JAW	5MM	24CM	52224-42I	52224-42C1	52224-42C17	52224-42C18	52224-42C10	52224-42C3	52224-42C4
	5MM	33CM	52255-42I	52255-42C1	52255-42C17	52255-42C18	52255-42C10	52255-42C3	52255-42C4
	5MM	36CM	52236-42I	52236-42C1	52236-42C17	52236-42C18	52236-42C10	52236-42C3	52236-42C4
	5MM	45CM	52155-42I	52155-42C1	52155-42C17	52155-42C18	52155-42C10	52155-42C3	52155-42C4
 DOUBLE FENESTRATED GRASPER, 25MM JAW 25MM JAW	5MM	24CM	52224-139I	52224-139C1	52224-139C17	52224-139C18	52224-139C10	52224-139C3	52224-139C4
	5MM	33CM	52255-139I	52255-139C1	52255-139C17	52255-139C18	52255-139C10	52255-139C3	52255-139C4
	5MM	36CM	52236-139I	52236-139C1	52236-139C17	52236-139C18	52236-139C10	52236-139C3	52236-139C4
	5MM	45CM	52155-139I	52155-139C1	52155-139C17	52155-139C18	52155-139C10	52155-139C3	52155-139C4



STYLE C:

ROTATABLE, THREE PIECE MODULAR INSTRUMENT

Dissectors & Graspers

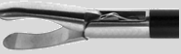



TIP ID.	DIAMETER	LENGTH	INSERT NO.	52555-40-01	52555-40-17	52555-40-18	52555-40-10	52555-40-03	52555-40-04
				INSULATED & CARBON FIBER HANDLES				NON-INSULATED HANDLES	
KOCHER GRASPER, 1 X 2 TEETH, SINGLE ACTION  15MM JAW	5MM	24CM	52224-43I	52224-43C1	52224-43C17	52224-43C18	52224-43C10	52224-43C3	52224-43C4
	5MM	33CM	52255-43I	52255-43C1	52255-43C17	52255-43C18	52255-43C10	52255-43C3	52255-43C4
	5MM	36CM	52236-43I	52236-43C1	52236-43C17	52236-43C18	52236-43C10	52236-43C3	52236-43C4
	5MM	45CM	52155-43I	52155-43C1	52155-43C17	52155-43C18	52155-43C10	52155-43C3	52155-43C4
KOCHER GRASPER, 1 X 2 TEETH, DOUBLE- ACTION (WECK TYPE)  15MM JAW	5MM	24CM	52224-44I	52224-44C1	52224-44C17	52224-44C18	52224-44C10	52224-44C3	52224-44C4
	5MM	33CM	52255-44I	52255-44C1	52255-44C17	52255-44C18	52255-44C10	52255-44C3	52255-44C4
	5MM	36CM	52236-44I	52236-44C1	52236-44C17	52236-44C18	52236-44C10	52236-44C3	52236-44C4
	5MM	45CM	52155-44I	52155-44C1	52155-44C17	52155-44C18	52155-44C10	52155-44C3	52155-44C4
SCHROEDER TENACULUM, SINGLE TOOTH, ROUND TIP  25MM JAW	5MM	24CM	52224-45I	52224-45C1	52224-45C17	52224-45C18	52224-45C10	52224-45C3	52224-45C4
	5MM	33CM	52255-45I	52255-45C1	52255-45C17	52255-45C18	52255-45C10	52255-45C3	52255-45C4
	5MM	36CM	52236-45I	52236-45C1	52236-45C17	52236-45C18	52236-45C10	52236-45C3	52236-45C4
	5MM	45CM	52155-45I	52155-45C1	52155-45C17	52155-45C18	52155-45C10	52155-45C3	52155-45C4
	10MM	33CM	52102-45I	52102-45C1	52102-45C17	52102-45C18	52102-45C10	52102-45C3	52102-45C4
	10MM	36CM	52103-45I	52103-45C1	52103-45C17	52103-45C18	52103-45C10	52103-45C3	52103-45C4
SCHROEDER TENACULUM, SINGLE TOOTH, SQUARE TIP  25MM JAW	5MM	24CM	52224-145I	52224-145C1	52224-145C17	52224-145C18	52224-145C10	52224-145C3	52224-145C4
	5MM	33CM	52255-145I	52255-145C1	52255-145C17	52255-145C18	52255-145C10	52255-145C3	52255-145C4
	5MM	36CM	52236-145I	52236-145C1	52236-145C17	52236-145C18	52236-145C10	52236-145C3	52236-145C4
	5MM	45CM	52155-145I	52155-145C1	52155-145C17	52155-145C18	52155-145C10	52155-145C3	52155-145C4
SCHROEDER TENACULUM GRASPER, SINGLE TOOTH w/ EXTRA GUIDE TOOTH  25MM JAW	5MM	24CM	52224-94I	52224-94C1	52224-94C17	52224-94C18	52224-94C10	52224-94C3	52224-94C4
	5MM	33CM	52255-94I	52255-94C1	52255-94C17	52255-94C18	52255-94C10	52255-94C3	52255-94C4
	5MM	36CM	52236-94I	52236-94C1	52236-94C17	52236-94C18	52236-94C10	52236-94C3	52236-94C4
	5MM	45CM	52155-94I	52155-94C1	52155-94C17	52155-94C18	52155-94C10	52155-94C3	52155-94C4
	10MM	33CM	52102-94I	52102-94C1	52102-94C17	52102-94C18	52102-94C10	52102-94C3	52102-94C4
	10MM	36CM	52103-94I	52103-94C1	52103-94C17	52103-94C18	52103-94C10	52103-94C3	52103-94C4
BLUNT ATRAUMATIC GRASPING FORCEPS, DOUBLE-ACTION  14MM JAW	5MM	24CM	52224-47I	52224-47C1	52224-47C17	52224-47C18	52224-47C10	52224-47C3	52224-47C4
	5MM	33CM	52255-47I	52255-47C1	52255-47C17	52255-47C18	52255-47C10	52255-47C3	52255-47C4
	5MM	36CM	52236-47I	52236-47C1	52236-47C17	52236-47C18	52236-47C10	52236-47C3	52236-47C4
	5MM	45CM	52155-47I	52155-47C1	52155-47C17	52155-47C18	52155-47C10	52155-47C3	52155-47C4

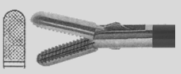
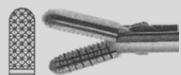

STYLE C:

ROTATABLE, THREE PIECE MODULAR INSTRUMENT

Dissectors & Graspers







TIP ID.	DIAMETER	LENGTH	INSERT NO.	52555-40-01	52555-40-17	52555-40-18	52555-40-10	52555-40-03	52555-40-04
				INSULATED & CARBON FIBER HANDLES				NON-INSULATED HANDLES	
 14MM	5MM	24CM	52224-56I	52224-56C1	52224-56C17	52224-56C18	52224-56C10	52224-56C3	52224-56C4
	5MM	33CM	52255-56I	52255-56C1	52255-56C17	52255-56C18	52255-56C10	52255-56C3	52255-56C4
	5MM	36CM	52236-56I	52236-56C1	52236-56C17	52236-56C18	52236-56C10	52236-56C3	52236-56C4
	5MM	45CM	52155-56I	52155-56C1	52155-56C17	52155-56C18	52155-56C10	52155-56C3	52155-56C4
 15MM	5MM	24CM	52224-48I	52224-48C1	52224-48C17	52224-48C18	52224-48C10	52224-48C3	52224-48C4
	5MM	33CM	52255-48I	52255-48C1	52255-48C17	52255-48C18	52255-48C10	52255-48C3	52255-48C4
	5MM	36CM	52236-48I	52236-48C1	52236-48C17	52236-48C18	52236-48C10	52236-48C3	52236-48C4
	5MM	45CM	52155-48I	52155-48C1	52155-48C17	52155-48C18	52155-48C10	52155-48C3	52155-48C4
 15MM JAW	5MM	24CM	52224-49I	52224-49C1	52224-49C17	52224-49C18	52224-49C10	52224-49C3	52224-49C4
	5MM	33CM	52255-49I	52255-49C1	52255-49C17	52255-49C18	52255-49C10	52255-49C3	52255-49C4
	5MM	36CM	52236-49I	52236-49C1	52236-49C17	52236-49C18	52236-49C10	52236-49C3	52236-49C4
	5MM	45CM	52155-49I	52155-49C1	52155-49C17	52155-49C18	52155-49C10	52155-49C3	52155-49C4
 20MM JAW	5MM	24CM	52224-51I	52224-51C1	52224-51C17	52224-51C18	52224-51C10	52224-51C3	52224-51C4
	5MM	33CM	52255-51I	52255-51C1	52255-51C17	52255-51C18	52255-51C10	52255-51C3	52255-51C4
	5MM	36CM	52236-51I	52236-51C1	52236-51C17	52236-51C18	52236-51C10	52236-51C3	52236-51C4
	5MM	45CM	52155-51I	52155-51C1	52155-51C17	52155-51C18	52155-51C10	52155-51C3	52155-51C4
 14MM JAW	5MM	24CM	52224-54I	52224-54C1	52224-54C17	52224-54C18	52224-54C10	52224-54C3	52224-54C4
	5MM	33CM	52255-54I	52255-54C1	52255-54C17	52255-54C18	52255-54C10	52255-54C3	52255-54C4
	5MM	36CM	52236-54I	52236-54C1	52236-54C17	52236-54C18	52236-54C10	52236-54C3	52236-54C4
	5MM	45CM	52155-54I	52155-54C1	52155-54C17	52155-54C18	52155-54C10	52155-54C3	52155-54C4
 15MM JAW	5MM	24CM	52224-90I	52224-90C1	52224-90C17	52224-90C18	52224-90C10	52224-90C3	52224-90C4
	5MM	33CM	52255-90I	52255-90C1	52255-90C17	52255-90C18	52255-90C10	52255-90C3	52255-90C4
	5MM	36CM	52236-90I	52236-90C1	52236-90C17	52236-90C18	52236-90C10	52236-90C3	52236-90C4
	5MM	45CM	52155-90I	52155-90C1	52155-90C17	52155-90C18	52155-90C10	52155-90C3	52155-90C4



STYLE C:

ROTATABLE, THREE PIECE MODULAR INSTRUMENT

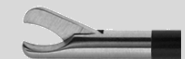
Forceps & Scissors





TIP ID.	DIAMETER	LENGTH	INSERT NO.	52555-40-01	52555-40-17	52555-40-18	52555-40-10	52555-40-03	52555-40-15
				INSULATED & CARBON FIBER HANDLES				NON-INSULATED HANDLES	
 METZENBAUM SCISSORS, HARDENED STEEL, CURVED BLADE (16MM TIP) 16MM JAW	5MM	24CM	52224-165I	52224-165C1	52224-165C17	52224-165C18	52224-165C10	52224-165C3	52224-165C15
	5MM	33CM	52255-165I	52255-165C1	52255-165C17	52255-165C18	52255-165C10	52255-165C3	52255-165C15
	5MM	36CM	52236-165I	52236-165C1	52236-165C17	52236-165C18	52236-165C10	52236-165C3	52236-165C15
	5MM	45CM	52155-165I	52155-165C1	52155-165C17	52155-165C18	52155-165C10	52155-165C3	52155-165C15
 METZENBAUM SCISSORS, WONDER-CUT , CURVED BLADE (20MM TIP) 20MM JAW	5MM	24CM	52224-265I	52224-265C1	52224-265C17	52224-265C18	52224-265C10	52224-265C3	52224-265C15
	5MM	33CM	52255-265I	52255-265C1	52255-265C17	52255-265C18	52255-265C10	52255-265C3	52255-265C15
	5MM	36CM	52236-265I	52236-265C1	52236-265C17	52236-265C18	52236-265C10	52236-265C3	52236-265C15
	5MM	45CM	52155-265I	52155-265C1	52155-265C17	52155-265C18	52155-265C10	52155-265C3	52155-265C15
 METZENBAUM SCISSORS, CURVED, SHORT BLADE (12MM) 12MM JAW	5MM	24CM	52224-166I	52224-166C1	52224-166C17	52224-166C18	52224-166C10	52224-166C3	52224-166C15
	5MM	33CM	52255-166I	52255-166C1	52255-166C17	52255-166C18	52255-166C10	52255-166C3	52255-166C15
	5MM	36CM	52236-166I	52236-166C1	52236-166C17	52236-166C18	52236-166C10	52236-166C3	52236-166C15
	5MM	45CM	52155-166I	52155-166C1	52155-166C17	52155-166C18	52155-166C10	52155-166C3	52155-166C15
 PERITONEAL SCISSORS, SINGLE-ACTION 15MM JAW	5MM	24CM	52224-67I	52224-67C1	52224-67C17	52224-67C18	52224-67C10	52224-67C3	52224-67C15
	5MM	33CM	52255-67I	52255-67C1	52255-67C17	52255-67C18	52255-67C10	52255-67C3	52255-67C15
	5MM	36CM	52236-67I	52236-67C1	52236-67C17	52236-67C18	52236-67C10	52236-67C3	52236-67C15
	5MM	45CM	52155-67I	52155-67C1	52155-67C17	52155-67C18	52155-67C10	52155-67C3	52155-67C15
 HOOK SCISSORS, TS, EXTRA HARD STEEL 10MM JAW	5MM	24CM	52224-76I	52224-76C1	52224-76C17	52224-76C18	52224-76C10	52224-76C3	52224-76C15
	5MM	33CM	52255-76I	52255-76C1	52255-76C17	52255-76C18	52255-76C10	52255-76C3	52255-76C15
	5MM	36CM	52236-76I	52236-76C1	52236-76C17	52236-76C18	52236-76C10	52236-76C3	52236-76C15
	5MM	45CM	52155-76I	52155-76C1	52155-76C17	52155-76C18	52155-76C10	52155-76C3	52155-76C15
 PERITONEAL SCISSORS, TS, EXTRA HARD STEEL, SINGLE-ACTION 15MM JAW	5MM	24CM	52224-77I	52224-77C1	52224-77C17	52224-77C18	52224-77C10	52224-77C3	52224-77C15
	5MM	33CM	52255-77I	52255-77C1	52255-77C17	52255-77C18	52255-77C10	52255-77C3	52255-77C15
	5MM	36CM	52236-77I	52236-77C1	52236-77C17	52236-77C18	52236-77C10	52236-77C3	52236-77C15
	5MM	45CM	52155-77I	52155-77C1	52155-77C17	52155-77C18	52155-77C10	52155-77C3	52155-77C15

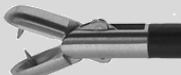

STYLE C:

ROTATABLE, THREE PIECE MODULAR INSTRUMENT

Forceps & Scissors

TIP ID.	DIAMETER	LENGTH	INSERT NO.	52555-40-01	52555-40-17	52555-40-18	52555-40-10	52555-40-03	52555-40-15
				INSULATED & CARBON FIBER HANDLES				NON-INSULATED HANDLES	
 10MM JAW	5MM	24CM	52224-70I	52224-70C1	52224-70C17	52224-70C18	52224-70C10	52224-70C3	52224-70C15
	5MM	33CM	52255-70I	52255-70C1	52255-70C17	52255-70C18	52255-70C10	52255-70C3	52255-70C15
	5MM	36CM	52236-70I	52236-70C1	52236-70C17	52236-70C18	52236-70C10	52236-70C3	52236-70C15
	5MM	45CM	52155-70I	52155-70C1	52155-70C17	52155-70C18	52155-70C10	52155-70C3	52155-70C15
 10MM JAW	5MM	24CM	52224-68I	52224-68C1	52224-68C17	52224-68C18	52224-68C10	52224-68C3	52224-68C15
	5MM	33CM	52255-68I	52255-68C1	52255-68C17	52255-68C18	52255-68C10	52255-68C3	52255-68C15
	5MM	36CM	52236-68I	52236-68C1	52236-68C17	52236-68C18	52236-68C10	52236-68C3	52236-68C15
	5MM	45CM	52155-68I	52155-68C1	52155-68C17	52155-68C18	52155-68C10	52155-68C3	52155-68C15
 10MM JAW	5MM	24CM	52224-71I	52224-71C1	52224-71C17	52224-71C18	52224-71C10	52224-71C3	52224-71C15
	5MM	33CM	52255-71I	52255-71C1	52255-71C17	52255-71C18	52255-71C10	52255-71C3	52255-71C15
	5MM	36CM	52236-71I	52236-71C1	52236-71C17	52236-71C18	52236-71C10	52236-71C3	52236-71C15
	5MM	45CM	52155-71I	52155-71C1	52155-71C17	52155-71C18	52155-71C10	52155-71C3	52155-71C15
 10MM JAW	5MM	24CM	52224-72I	52224-72C1	52224-72C17	52224-72C18	52224-72C10	52224-72C3	52224-72C15
	5MM	33CM	52255-72I	52255-72C1	52255-72C17	52255-72C18	52255-72C10	52255-72C3	52255-72C15
	5MM	36CM	52236-72I	52236-72C1	52236-72C17	52236-72C18	52236-72C10	52236-72C3	52236-72C15
	5MM	45CM	52155-72I	52155-72C1	52155-72C17	52155-72C18	52155-72C10	52155-72C3	52155-72C15
 10MM JAW	5MM	24CM	52224-73I	52224-73C1	52224-73C17	52224-73C18	52224-73C10	52224-73C3	52224-73C15
	5MM	33CM	52255-73I	52255-73C1	52255-73C17	52255-73C18	52255-73C10	52255-73C3	52255-73C15
	5MM	36CM	52236-73I	52236-73C1	52236-73C17	52236-73C18	52236-73C10	52236-73C3	52236-73C15
	5MM	45CM	52155-73I	52155-73C1	52155-73C17	52155-73C18	52155-73C10	52155-73C3	52155-79C15
 10MM TIP	5MM	24CM	52224-305I	52224-305C1	52224-305C17	52224-305C18	52224-305C10	52224-305C3	52224-305C4
	5MM	33CM	52255-305I	52255-305C1	52255-305C17	52255-305C18	52255-305C10	52255-305C3	52255-305C4
	5MM	36CM	52236-305I	52236-305C1	52236-305C17	52236-305C18	52236-305C10	52236-305C3	52236-305C4
	5MM	45CM	52155-305I	52155-305C1	52155-305C17	52155-305C18	52155-305C10	52155-305C3	52155-305C4

Sure-Grip Slide-Lock





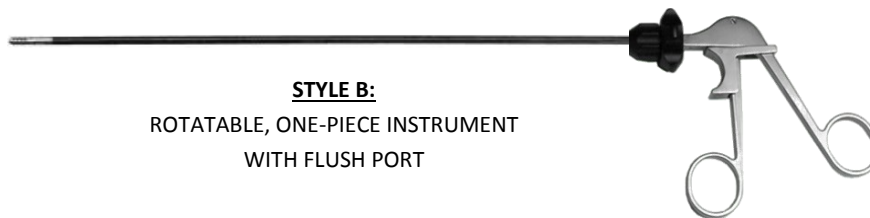
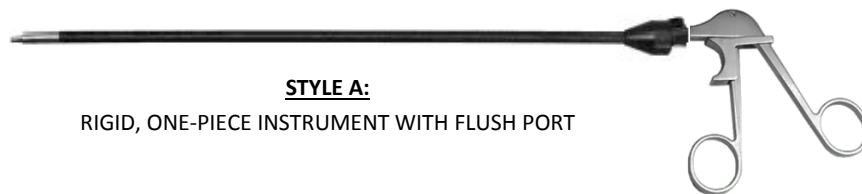

The *Sure-Grip* 5mm & 10mm Graspers have **Positive, Precise Action For Sure-Grip Grasping & Retraction.**

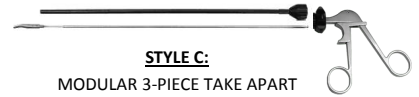
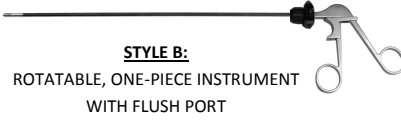
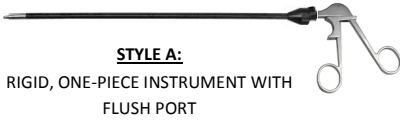
Available in One-Piece Rigid, One-Piece Rotatable & Three-Piece Screw Apart Instruments

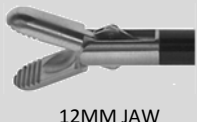



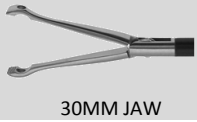

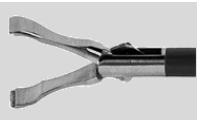

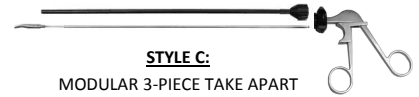
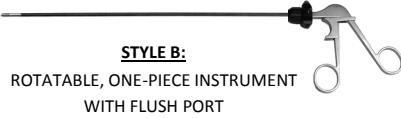
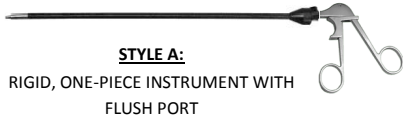

Graspers



TIP ID.	DESCRIPTION	DIAMETER	LENGTH	INSERT NO.	STYLE A	STYLE B	STYLE C
 12MM JAW	STANDARD GRASPER W/ SPOON	5MM	24CM	52224-02I	52624-02A	52624-02B	52624-02C
		5MM	33CM	52255-02I	52605-02A	52605-02B	52605-02C
		5MM	36CM	52236-02I	52636-02A	52636-02B	52636-02C
		5MM	45CM	52155-02I	52615-02A	52615-02B	52615-02C
 12MM JAW	STANDARD GRASPER	5MM	24CM	52224-03I	52624-03A	52624-03B	52624-03C
		5MM	33CM	52255-03I	52605-03A	52605-03B	52605-03C
		5MM	36CM	52236-03I	52636-03A	52636-03B	52636-03C
		5MM	45CM	52155-03I	52615-03A	52615-03B	52615-03C
 15MM JAW	TAPERED DOLPHIN-NOSE	5MM	24CM	52224-05I	52624-05A	52624-05B	52624-05C
		5MM	33CM	52255-05I	52605-05A	52605-05B	52605-05C
		5MM	36CM	52236-05I	52636-05A	52636-05B	52636-05C
		5MM	45CM	52155-05I	52615-05A	52615-05B	52615-05C
 12MM JAW	TAPERED DOLPHIN-NOSE W/ SPOON	5MM	24CM	52224-105I	52624-105A	52624-105B	52624-105C
		5MM	33CM	52255-105I	52605-105A	52605-105B	52605-105C
		5MM	36CM	52236-105I	52636-105A	52636-105B	52636-105C
		5MM	45CM	52155-105I	52615-105A	52615-105B	52615-105C
 10MM JAW	COBRA GRASPER, DOUBLE-ACTION	5MM	24CM	52224-15I	52624-15A	52624-15B	52624-15C
		5MM	33CM	52255-15I	52605-15A	52605-15B	52605-15C
		5MM	36CM	52236-15I	52636-15A	52636-15B	52636-15C
		5MM	45CM	52155-15I	52615-15A	52615-15B	52615-15C
 30MM JAW	BABCOCK GRASPER, FENESTRATED TIP	5MM	24CM	52224-16I	52624-16A	52624-16B	52624-16C
		5MM	33CM	52255-16I	52605-16A	52605-16B	52605-16C
		5MM	36CM	52236-16I	52636-16A	52636-16B	52636-16C
		5MM	45CM	52155-16I	52615-16A	52615-16B	52615-16C
 30MM JAW	BABCOCK GRASPER, AXIS STYLE, FENESTRATED	5MM	24CM	52224-116I	52624-116A	52624-116B	52624-116C
		5MM	33CM	52255-116I	52605-116A	52605-116B	52605-116C
		5MM	36CM	52236-116I	52636-116A	52636-116B	52636-116C
		5MM	45CM	52155-116I	52615-116A	52615-116B	52615-116C
 10MM JAW	BABCOCK GRASPER, SHORT DELICATE	5MM	24CM	52224-17I	52624-17A	52624-17B	52624-17C
		5MM	33CM	52255-17I	52605-17A	52605-17B	52605-17C
		5MM	36CM	52236-17I	52636-17A	52636-17B	52636-17C
		5MM	45CM	52155-17I	52615-17A	52615-17B	52615-17C







Graspers

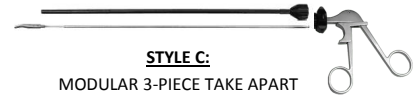
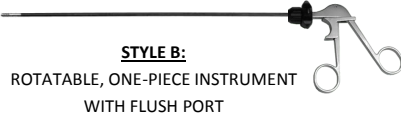
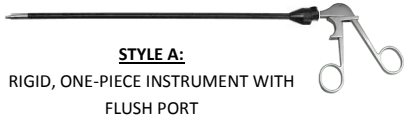

TIP ID.	DESCRIPTION	DIAMETER	LENGTH	INSERT NO.	STYLE A	STYLE B	STYLE C
 15MM JAW	ALLIS GRASPER, SHORT VERSION, SA	5MM	24CM	52224-18I	52624-18A	52624-18B	52624-18C
		5MM	33CM	52255-18I	52605-18A	52605-18B	52605-18C
		5MM	36CM	52236-18I	52636-18A	52636-18B	52636-18C
		5MM	45CM	52155-18I	52615-18A	52615-18B	52615-18C
 12MM JAW	ALLIS, SHORT VERSION, 3 X 4 TEETH, SERRATED	5MM	24CM	52224-19I	52624-19A	52624-19B	52624-19C
		5MM	33CM	52255-19I	52605-19A	52605-19B	52605-19C
		5MM	36CM	52236-19I	52636-19A	52636-19B	52636-19C
		5MM	45CM	52155-19I	52615-19A	52615-19B	52615-19C
 12MM JAW	ALLIS, SHORT VERSION, DOUBLE ROW OF TEETH, SERRATED	5MM	24CM	52224-119I	52624-119A	52624-119B	52624-119C
		5MM	33CM	52255-119I	52605-119A	52605-119B	52605-119C
		5MM	36CM	52236-119I	52636-119A	52636-119B	52636-119C
		5MM	45CM	52155-119I	52615-119A	52615-119B	52615-119C
 25MM JAW	ALLIS, LONG VERSION, DOUBLE ROW OF TEETH, SERRATED	5MM	24CM	52224-219I	52624-219A	52624-219B	52624-219C
		5MM	33CM	52255-219I	52605-219A	52605-219B	52605-219C
		5MM	36CM	52236-219I	52636-219A	52636-219B	52636-219C
		5MM	45CM	52155-219I	52615-219A	52615-219B	52615-219C
 20MM JAW	ALLIS GRASPER, MEDIUM, WECK STYLE	5MM	24CM	52224-20I	52624-20A	52624-20B	52624-20C
		5MM	33CM	52255-20I	52605-20A	52605-20B	52605-20C
		5MM	36CM	52236-20I	52636-20A	52636-20B	52636-20C
		5MM	45CM	52155-20I	52615-20A	52615-20B	52615-20C
 30MM JAW	ALLIS GRASPER, STANDARD VERSION	5MM	24CM	52224-21I	52624-21A	52624-21B	52624-21C
		5MM	33CM	52255-21I	52605-21A	52605-21B	52605-21C
		5MM	36CM	52236-21I	52636-21A	52636-21B	52636-21C
		5MM	45CM	52155-21I	52615-21A	52615-21B	52615-21C
 35MM JAW	ALLIS GRASPER, TC, STANDARD VERSION	5MM	24CM	52224-57I	52624-57A	52624-57B	52624-57C
		5MM	33CM	52255-57I	52605-57A	52605-57B	52605-57C
		5MM	36CM	52236-57I	52636-57A	52636-57B	52636-57C
		5MM	45CM	52155-57I	52615-57A	52615-57B	52615-57C
 20MM JAW	DEBAKEY GRASPER, 20MM JAW	5MM	24CM	52224-22I	52624-22A	52624-22B	52624-22C
		5MM	33CM	52255-22I	52605-22A	52605-22B	52605-22C
		5MM	36CM	52236-22I	52636-22A	52636-22B	52636-22C
		5MM	45CM	52155-22I	52615-22A	52615-22B	52615-22C





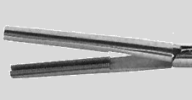

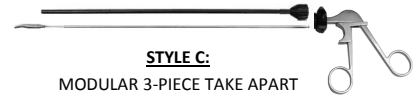
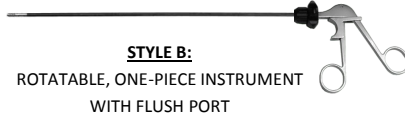
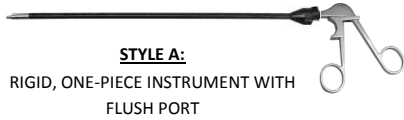

Graspers



TIP ID.	DESCRIPTION	DIAMETER	LENGTH	INSERT NO.	STYLE A	STYLE B	STYLE C
 40MM JAW	DEBAKEY GRASPER, 40MM JAW	5MM	24CM	52224-23I	52624-23A	52624-23B	52624-23C
		5MM	33CM	52255-23I	52605-23A	52605-23B	52605-23C
		5MM	36CM	52236-23I	52636-23A	52636-23B	52636-23C
		5MM	45CM	52155-23I	52615-23A	52615-23B	52615-23C
 60MM JAW	DEBAKEY GRASPER, 60MM JAW	5MM	24CM	52224-123I	52624-123A	52624-123B	52624-123C
		5MM	33CM	52255-123I	52605-123A	52605-123B	52605-123C
		5MM	36CM	52236-123I	52636-123A	52636-123B	52636-123C
		5MM	45CM	52155-123I	52615-123A	52615-123B	52615-123C
 20MM JAW	HUNTER DEBAKEY, FENESTRATED, 20MM	5MM	24CM	52224-58I	52624-58A	52624-58B	52624-58C
		5MM	33CM	52255-58I	52605-58A	52605-58B	52605-58C
		5MM	36CM	52236-58I	52636-58A	52636-58B	52636-58C
		5MM	45CM	52155-58I	52615-58A	52615-58B	52615-58C
 40MM JAW	HUNTER DEBAKEY, FENESTRATED, 40MM	5MM	24CM	52224-159I	52624-159A	52624-159B	52624-159C
		5MM	33CM	52255-159I	52605-159A	52605-159B	52605-159C
		5MM	36CM	52236-159I	52636-159A	52636-159B	52636-159C
		5MM	45CM	52155-159I	52615-159A	52615-159B	52615-159C
 60MM JAW	HUNTER DEBAKEY, FENESTRATED, 60MM	5MM	24CM	52224-160I	52624-160A	52624-160B	52624-160C
		5MM	33CM	52255-160I	52605-160A	52605-160B	52605-160C
		5MM	36CM	52236-160I	52636-160A	52636-160B	52636-160C
		5MM	45CM	52155-160I	52615-160A	52615-160B	52615-160C
 30MM JAW	DEBAKEY GRASPER, CURVED	5MM	24CM	52224-46I	52624-46A	52624-46B	52624-46C
		5MM	33CM	52255-46I	52605-46A	52605-46B	52605-46C
		5MM	36CM	52236-46I	52636-46A	52636-46B	52636-46C
		5MM	45CM	52155-46I	52615-46A	52615-46B	52615-46C
 35MM JAW	DEBAKEY MARYLAND GRASPER	5MM	24CM	52224-149I	52624-149A	52624-149B	52624-149C
		5MM	33CM	52255-149I	52605-149A	52605-149B	52605-149C
		5MM	36CM	52236-149I	52636-149A	52636-149B	52636-149C
		5MM	45CM	52155-149I	52615-149A	52615-149B	52615-149C
 30MM JAW	GLASSMAN ATRAUMATIC GRASPER	5MM	24CM	52224-24I	52624-24A	52624-24B	52624-24C
		5MM	33CM	52255-24I	52605-24A	52605-24B	52605-24C
		5MM	36CM	52236-24I	52636-24A	52636-24B	52636-24C
		5MM	45CM	52155-24I	52615-24A	52615-24B	52615-24C







Graspers

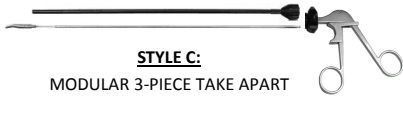
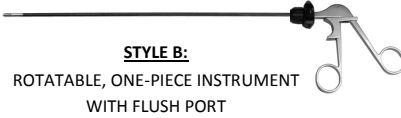
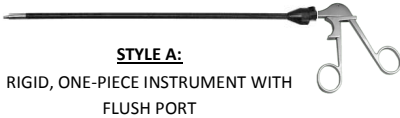

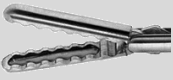
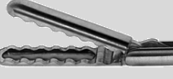
TIP ID.	DESCRIPTION	DIAMETER	LENGTH	INSERT NO.	STYLE A	STYLE B	STYLE C
 16MM JAW	DOUBLE CUP FUNDUS MAXI GRASPER	5MM	24CM	52224-26I	52624-26A	52624-26B	52624-26C
		5MM	33CM	52255-26I	52605-26A	52605-26B	52605-26C
		5MM	36CM	52236-26I	52636-26A	52636-26B	52636-26C
		5MM	45CM	52155-26I	52615-26A	52615-26B	52615-26C
 16MM JAW	"WINER" STYLE FUNDUS GRASPER	5MM	24CM	52224-326I	52624-326A	52624-326B	52624-326C
		5MM	33CM	52255-326I	52605-326A	52605-326B	52605-326C
		5MM	36CM	52236-326I	52636-326A	52636-326B	52636-326C
		5MM	45CM	52155-326I	52615-326A	52615-326B	52615-326C
 16MM JAW	"MCKEARNAN" STYLE FUNDUS GRASPER	5MM	24CM	52224-126I	52624-126A	52624-126B	52624-126C
		5MM	33CM	52255-126I	52605-126A	52605-126B	52605-126C
		5MM	36CM	52236-126I	52636-126A	52636-126B	52636-126C
		5MM	45CM	52155-126I	52615-126A	52615-126B	52615-126C
 16MM JAW	FENESTRATED DOUBLE FUNDUS GRASPER	5MM	24CM	52224-226I	52624-226A	52624-226B	52624-226C
		5MM	33CM	52255-226I	52605-226A	52605-226B	52605-226C
		5MM	36CM	52236-226I	52636-226A	52636-226B	52636-226C
		5MM	45CM	52155-226I	52615-226A	52615-226B	52615-226C
 20MM JAW	ENDOCLINCH FENESTRATED GRASPER	5MM	24CM	52224-27I	52624-27A	52624-27B	52624-27C
		5MM	33CM	52255-27I	52605-27A	52605-27B	52605-27C
		5MM	36CM	52236-27I	52636-27A	52636-27B	52636-27C
		5MM	45CM	52155-27I	52615-27A	52615-27B	52615-27C
 10MM JAW	ALLIGATOR GRASPER, RETRO-FACING TEETH, 10MM JAW	5MM	24CM	52224-29I	52624-29A	52624-29B	52624-29C
		5MM	33CM	52255-29I	52605-29A	52605-29B	52605-29C
		5MM	36CM	52236-29I	52636-29A	52636-29B	52636-29C
		5MM	45CM	52155-29I	52615-29A	52615-29B	52615-29C
 15MM JAW	ALLIGATOR GRASPER, RETRO-FACING TEETH, 15MM JAW	5MM	24CM	52224-129I	52624-129A	52624-129B	52624-129C
		5MM	33CM	52255-129I	52605-129A	52605-129B	52605-129C
		5MM	36CM	52236-129I	52636-129A	52636-129B	52636-129C
		5MM	45CM	52155-129I	52615-129A	52615-129B	52615-129C
 15MM JAW	GLASSMAN ATRAUMATIC GRASPER	5MM	24CM	52224-30I	52624-30A	52624-30B	52624-30C
		5MM	33CM	52255-30I	52605-30A	52605-30B	52605-30C
		5MM	36CM	52236-30I	52636-30A	52636-30B	52636-30C
		5MM	45CM	52155-30I	52615-30A	52615-30B	52615-30C

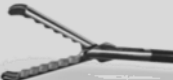





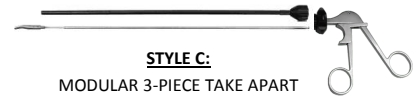
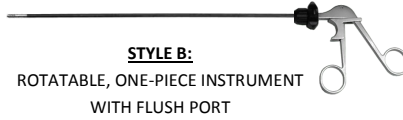
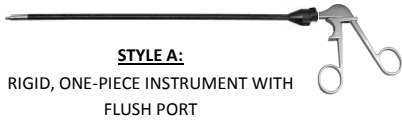

Graspers

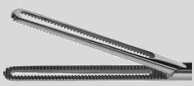

TIP ID.	DESCRIPTION	DIAMETER	LENGTH	INSERT NO.	STYLE A	STYLE B	STYLE C
 22MM JAW	WAVE GRASPER, LONG BEVELED EDGE, DOUBLE ACTION	5MM	24CM	52224-32I	52624-32A	52624-32B	52624-32C
		5MM	33CM	52255-32I	52605-32A	52605-32B	52605-32C
		5MM	36CM	52236-32I	52636-32A	52636-32B	52636-32C
		5MM	45CM	52155-32I	52615-32A	52615-32B	52615-32C
 22MM JAW	WAVE GRASPER, LONG BEVELED EDGE, SINGLE ACTION	5MM	24CM	52224-33I	52624-33A	52624-33B	52624-33C
		5MM	33CM	52255-33I	52605-33A	52605-33B	52605-33C
		5MM	36CM	52236-33I	52636-33A	52636-33B	52636-33C
		5MM	45CM	52155-33I	52615-33A	52615-33B	52615-33C
 20MM JAW	CLAW GRASPER, 2 X 3 TEETH, SINGLE ACTION	5MM	24CM	52224-36I	52624-36A	52624-36B	52624-36C
		5MM	33CM	52255-36I	52605-36A	52605-36B	52605-36C
		5MM	36CM	52236-36I	52636-36A	52636-36B	52636-36C
		5MM	45CM	52155-36I	52615-36A	52615-36B	52615-36C
 20MM JAW	CLAW GRASPER, 2 X 3 TEETH, W/ XTRA ROW OF TEETH	5MM	24CM	52224-136I	52624-136A	52624-136B	52624-136C
		5MM	33CM	52255-136I	52605-136A	52605-136B	52605-136C
		5MM	36CM	52236-136I	52636-136A	52636-136B	52636-136C
		5MM	45CM	52155-136I	52615-136A	52615-136B	52615-136C
 20MM JAW	RETRACTION GRASPER, 2 X 3 TEETH, COBRA STYLE, DA	5MM	24CM	52224-34I	52624-34A	52624-34B	52624-34C
		5MM	33CM	52255-34I	52605-34A	52605-34B	52605-34C
		5MM	36CM	52236-34I	52636-34A	52636-34B	52636-34C
		5MM	45CM	52155-34I	52615-34A	52615-34B	52615-34C
 20MM JAW	RETRACTION GRASPER, 2 X 3 TEETH, COBRA STYLE, SA	5MM	24CM	52224-35I	52624-35A	52624-35B	52624-35C
		5MM	33CM	52255-35I	52605-35A	52605-35B	52605-35C
		5MM	36CM	52236-35I	52636-35A	52636-35B	52636-35C
		5MM	45CM	52155-35I	52615-35A	52615-35B	52615-35C
 20MM JAW	RETRACTION GRASPER, 2 X 3 TEETH, JARIT STYLE, DA	5MM	24CM	52224-134I	52624-134A	52624-134B	52624-134C
		5MM	33CM	52255-134I	52605-134A	52605-134B	52605-134C
		5MM	36CM	52236-134I	52636-134A	52636-134B	52636-134C
		5MM	45CM	52155-134I	52615-134A	52615-134B	52615-134C
 20MM JAW	RETRACTION GRASPER, 2 X 3 TEETH, JARIT STYLE, SA	5MM	24CM	52224-135I	52624-135A	52624-135B	52624-135C
		5MM	33CM	52255-135I	52605-135A	52605-135B	52605-135C
		5MM	36CM	52236-135I	52636-135A	52636-135B	52636-135C
		5MM	45CM	52155-135I	52615-135A	52615-135B	52615-135C

Graspers







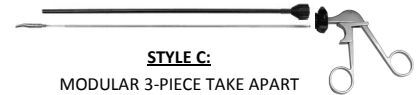
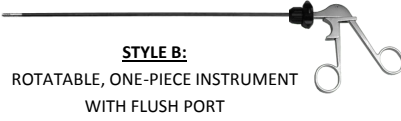
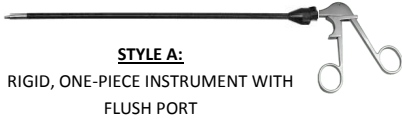







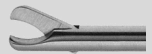

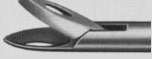
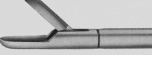
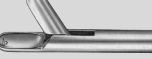

TIP ID.	DESCRIPTION	DIAMETER	LENGTH	INSERT NO.	STYLE A	STYLE B	STYLE C
 16MM JAW	FENESTRATED GRASPER, 16MM JAW	5MM	24CM	52224-38I	52624-38A	52624-38B	52624-38C
		5MM	33CM	52255-38I	52605-38A	52605-38B	52605-38C
		5MM	36CM	52236-38I	52636-38A	52636-38B	52636-38C
		5MM	45CM	52155-38I	52615-38A	52615-38B	52615-38C
 22MM JAW	FENESTRATED GRASPER, 20MM JAW	5MM	24CM	52224-39I	52624-39A	52624-39B	52624-39C
		5MM	33CM	52255-39I	52605-39A	52605-39B	52605-39C
		5MM	36CM	52236-39I	52636-39A	52636-39B	52636-39C
		5MM	45CM	52155-39I	52615-39A	52615-39B	52615-39C
 40MM JAW	FENESTRATED GRASPER, 40MM JAW	5MM	24CM	52224-40I	52624-40A	52624-40B	52624-40C
		5MM	33CM	52255-40I	52605-40A	52605-40B	52605-40C
		5MM	36CM	52236-40I	52636-40A	52636-40B	52636-40C
		5MM	45CM	52155-40I	52615-40A	52615-40B	52615-40C
 20MM JAW	JOHAN FENESTRATED GRASPER, 20MM TIP, SINGLE ACTION	5MM	24CM	52224-41I	52624-41A	52624-41B	52624-41C
		5MM	33CM	52255-41I	52605-41A	52605-41B	52605-41C
		5MM	36CM	52236-41I	52636-41A	52636-41B	52636-41C
		5MM	45CM	52155-41I	52615-41A	52615-41B	52615-41C
 45MM JAW	JOHAN FENESTRATED GRASPER, 45MM TIP, SINGLE ACTION	5MM	24CM	52224-42I	52624-42A	52624-42B	52624-42C
		5MM	33CM	52255-42I	52605-42A	52605-42B	52605-42C
		5MM	36CM	52236-42I	52636-42A	52636-42B	52636-42C
		5MM	45CM	52155-42I	52615-42A	52615-42B	52615-42C
 25MM JAW	DOUBLE FENESTRATED GRASPER, 25MM JAW	5MM	24CM	52224-139I	52624-139A	52624-139B	52624-139C
		5MM	33CM	52255-139I	52605-139A	52605-139B	52605-139C
		5MM	36CM	52236-139I	52636-139A	52636-139B	52636-139C
		5MM	45CM	52155-139I	52615-139A	52615-139B	52615-139C
 25MM JAW	SCHROEDER TENACULUM, SINGLE TOOTH, ROUND TIP	5MM	24CM	52224-45I	52624-45A	52624-45B	52624-45C
		5MM	33CM	52255-45I	52605-45A	52605-45B	52605-45C
		5MM	36CM	52236-45I	52636-45A	52636-45B	52636-45C
		5MM	45CM	52155-134I	52615-134A	52615-134B	52615-134C
 25MM JAW	SCHROEDER TENACULUM, SINGLE TOOTH, SQUARE TIP	5MM	24CM	52224-145I	52624-145A	52624-145B	52624-145C
		5MM	33CM	52255-145I	52605-145A	52605-145B	52605-145C
		5MM	36CM	52236-145I	52636-145A	52636-145B	52636-145C
		5MM	45CM	52155-145I	52615-145A	52615-145B	52615-145C

Graspers





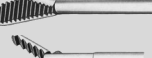

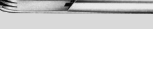

TIP ID.	DESCRIPTION	DIAMETER	LENGTH	INSERT NO.	STYLE A	STYLE B	STYLE C
 25MM JAW	SCHROEDER TENACULUM GRASPER, SINGLE TOOTH w/ EXTRA GUIDE TOOTH	5MM	24CM	52224-94I	52624-94A	52624-94B	52624-94C
		5MM	33CM	52255-94I	52605-94A	52605-94B	52605-94C
		5MM	36CM	52236-94I	52636-94A	52636-94B	52636-94C
		5MM	45CM	52155-94I	52615-94A	52615-94B	52615-94C
 15MM JAW	BULLET NOSE GRASPER TC, MICRO DIAMOND JAW PATTERN	5MM	24CM	52224-48I	52624-48A	52624-48B	52624-48C
		5MM	33CM	52255-48I	52605-48A	52605-48B	52605-48C
		5MM	36CM	52236-48I	52636-48A	52636-48B	52636-48C
		5MM	45CM	52155-48I	52615-48A	52615-48B	52615-48C
 15MM JAW	BULLET NOSE GRASPER, TC, CROSS DIAMOND JAW PATTERN	5MM	24CM	52224-49I	52624-49A	52624-49B	52624-49C
		5MM	33CM	52255-49I	52605-49A	52605-49B	52605-49C
		5MM	36CM	52236-49I	52636-49A	52636-49B	52636-49C
		5MM	45CM	52155-49I	52615-49A	52615-49B	52615-49C
 15MM JAW	DAVOL" TYPE, GRASPER, SCOOPED-OUT JAW & GENTLY MASHING TEETH	5MM	24CM	52224-41I	52624-41A	52624-41B	52624-41C
		5MM	33CM	52255-41I	52605-41A	52605-41B	52605-41C
		5MM	36CM	52236-41I	52636-41A	52636-41B	52636-41C
		5MM	45CM	52155-41I	52615-41A	52615-41B	52615-41C
 20MM JAW	ACCESS" TYPE, FENESTRATED GRASPER, 20MM JAW	5MM	24CM	52224-42I	52624-42A	52624-42B	52624-42C
		5MM	33CM	52255-42I	52605-42A	52605-42B	52605-42C
		5MM	36CM	52236-42I	52636-42A	52636-42B	52636-42C
		5MM	45CM	52155-42I	52615-42A	52615-42B	52615-42C

Traditional 5mm Laparoscopic Instruments

TIP ID.	DESCRIPTION	DIAMETER	LENGTH			
				STANDARD HANDLE	SPRING HANDLE	RATCHET HANDLE
	HOOK SCISSORS	5MM	33CM	52502-01A	52502-01B	52502-01C
		5MM	45CM	52501-01A	52501-01B	52501-01C
	PERITONEAL SCISSORS	5MM	33CM	52502-02A	52502-02B	52502-02C
		5MM	45CM	52501-02A	52501-02B	52501-02C
	SERRATED SCISSORS	5MM	33CM	52502-03A	52502-03B	52502-03C
		5MM	45CM	52501-03A	52501-03B	52501-03C
	METZENBAUM SCISSORS, CURVED	5MM	33CM	52502-04A	52502-04B	52502-04C
		5MM	45CM	52501-04A	52501-04B	52501-04C
	POINTED SPOON FORCEPS	5MM	33CM	52502-05A	52502-05B	52502-05C
		5MM	45CM	52501-05A	52501-05B	52501-05C
	SPOON FORCEPS	5MM	33CM	52502-06A	52502-06B	52502-06C
		5MM	45CM	52501-06A	52501-06B	52501-06C
	SPOON FOECEPS W/ TEETH	5MM	33CM	52502-07A	52502-07B	52502-07C
		5MM	45CM	52501-07A	52501-07B	52501-07C
	DOUBLE-ACTION SPOON FORCEPS	5MM	33CM	52502-08A	52502-08B	52502-08C
		5MM	45CM	52501-08A	52501-08B	52501-08C
	DBL-ACTION SPOON FORCEPS W/ TEETH	5MM	33CM	52502-09A	52502-09B	52502-09C
		5MM	45CM	52501-09A	52501-09B	52501-09C
	BIOPSY PUNCH FORCEPS	5MM	33CM	52502-10A	52502-10B	52502-10C
		5MM	45CM	52501-10A	52501-10B	52501-10C
	BIOPSY PUNCH W/ TEETH	5MM	33CM	52502-11A	52502-11B	52502-11C
		5MM	45CM	52501-11A	52501-11B	52501-11C
	HOOK PUNCH	5MM	33CM	52502-12A	52502-12B	52502-12C
		5MM	45CM	52501-12A	52501-12B	52501-12C
	STANDARD GRASPER W/ SPOON	5MM	33CM	52502-13A	52502-13B	52502-13C
		5MM	45CM	52501-13A	52501-13B	52501-13C
	POINTED GRASPER W/ SPOON	5MM	33CM	52502-14A	52502-14B	52502-14C
		5MM	45CM	52501-14A	52501-14B	52501-14C
	STANDARD GRASPER	5MM	33CM	52502-15A	52502-15B	52502-15C
		5MM	45CM	52501-15A	52501-15B	52501-15C
	BACKBITING GRASPER	5MM	33CM	52502-16A	52502-16B	52502-16C
		5MM	45CM	52501-16A	52501-16B	52501-16C
	ATRAUMATIC GRASPER	5MM	33CM	52502-17A	52502-17B	52502-17C
		5MM	45CM	52501-17A	52501-17B	52501-17C
	CLAW GRASPER	5MM	33CM	52502-18A	52502-18B	52502-18C
		5MM	45CM	52501-18A	52501-18B	52501-18C

Traditional 5mm Laparoscopic Instruments

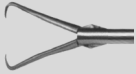
TIP ID.	DESCRIPTION	DIAMETER	LENGTH			
				STANDARD HANDLE	SPRING HANDLE	RATCHET HANDLE
	PETELIN DISSECTOR 60°	5MM	33CM	52502-19A	52502-19B	52502-19C
		5MM	45CM	52501-19A	52501-19B	52501-19C
	PETELIN DISSECTOR 30°	5MM	33CM	52502-20A	52502-20B	52502-20C
		5MM	45CM	52501-20A	52501-20B	52501-20C
	STRONG RIGHT ANGLE DISSECTOR	5MM	33CM	52502-31A	52502-31B	52502-31C
		5MM	45CM	52501-31A	52501-31B	52501-31C
	SPOON FOECEPS W/ TEETH	5MM	33CM	52502-32A	52502-32B	52502-32C
		5MM	45CM	52501-32A	52501-32B	52501-32C
	SCHROEDER TENACULUM GRASPER, SINGLE TOOTH	5MM	33CM	52502-33A	52502-33B	52502-33C
		5MM	45CM	52501-33A	52501-33B	52501-33C

Traditional 5mm Micro-Laparoscopic Instruments



All Stainless Steel Construction w/ Micro Tips & Standard Handle



CURVED MICRO SCISSORS	33 CM	52502-21
	45 CM	52501-21



STRAIGHT MICRO SCISSORS	33 CM	52502-22
	45 CM	52501-22



MICRO GRASPER	33 CM	52502-23
	45 CM	52501-23

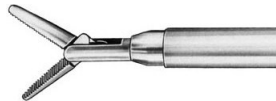

DBL-ACTION MICRO GRASPER	33 CM	52502-24
	45 CM	52501-24



MICRO BIOPSY PUNCH	33 CM	52502-25
	45 CM	52501-25

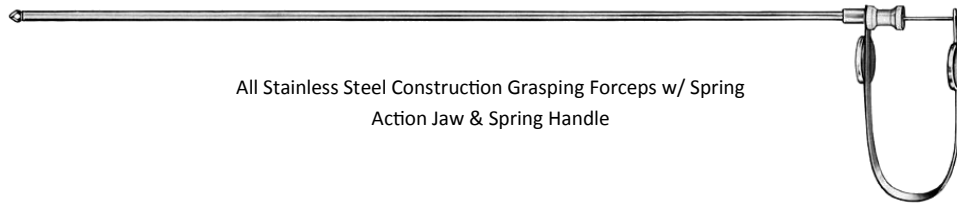

All Stainless Steel Construction Grasping Forceps w/ Spring Action Jaw & Spring Handle

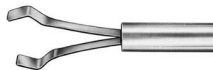

STANDARD GRASPER	33 CM	52502-50
	45 CM	52501-50



ATRAMATIC GRASPER	33 CM	52502-51
	45 CM	52501-51



ATRAMATIC GRASPER W/ STRONG JAW	33 CM	52502-52
	45 CM	52501-52



ROUND BOWEL GRASPER	33 CM	52502-53
	45 CM	52501-53



"T" BOWEL GRASPER	33 CM	52502-54
	45 CM	52501-54

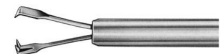

CYST GRASPER	33 CM	52502-55
	45 CM	52501-55















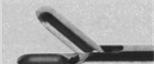

TUBAL GRASPER	33 CM	52502-56
	45 CM	52501-56









FENESTRATED GRASPER	33 CM	52502-57
	45 CM	52501-57

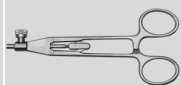
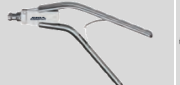

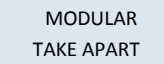
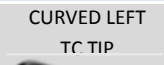
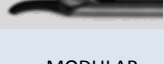
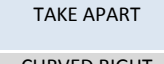

Traditional 10mm Laparoscopic Instruments

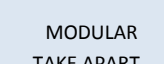
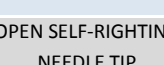
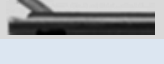
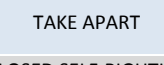
TIP ID.	DESCRIPTION	DIAMETER	LENGTH			
				STANDARD HANDLE	SPRING HANDLE	RATCHET HANDLE
	STRAIGHT SCISSORS	10MM	33CM	52112-01A	52112-01B	52112-01C
		10MM	45CM	52111-01A	52111-01B	52111-01C
	SPOON FORCEPS	10MM	33CM	52112-02A	52112-02B	52112-02C
		10MM	45CM	52111-02A	52111-02B	52111-02C
	CLAW FORCEPS	10MM	33CM	52112-03A	52112-03B	52112-03C
		10MM	45CM	52111-03A	52111-03B	52111-03C
	GRASPING FORCEPS	10MM	33CM	52112-04A	52112-04B	52112-04C
		10MM	45CM	52111-04A	52111-04B	52111-04C
	DEBAKEY STRAIGHT	10MM	33CM	52112-05A	52112-05B	52112-05C
		10MM	45CM	52111-05A	52111-05B	52111-05C
	BABCOCK FORCEPS	10MM	33CM	52112-07A	52112-07B	52112-07C
		10MM	45CM	52111-07A	52111-07B	52111-07C
	ALLIS FORCEPS	10MM	33CM	52112-08A	52112-08B	52112-08C
		10MM	45CM	52111-08A	52111-08B	52111-08C
	MARYLAND FORCEPS	10MM	33CM	52112-09A	52112-09B	52112-09C
		10MM	45CM	52111-09A	52111-09B	52111-09C
	MIXTER FORCEPS 90°	10MM	33CM	52112-10A	52112-10B	52112-10C
		10MM	45CM	52111-10A	52111-10B	52111-10C
	DUVAL FORCEPS	10MM	33CM	52112-11A	52112-11B	52112-11C
		10MM	45CM	52111-11A	52111-11B	52111-11C
	TENACULUM FORCEPS	10MM	33CM	52112-15A	52112-15B	52112-15C
		10MM	45CM	52111-15A	52111-15B	52111-15C
	GLASSMAN FORCEPS	10MM	33CM	52112-16A	52112-16B	52112-16C
		10MM	45CM	52111-16A	52111-16B	52111-16C

Laparoscopic 5mm Needle Holders

TIP ID.	DIAMETER	LENGTH	INSERT NO.	52555-40-13	52555-40-19	52555-40-20	52555-40-21	52555-40-22
				 STAINLESS STEEL, RING AXIAL HANDLE W/ RATCHET	 LIGHT WEIGHT AXIAL HANDLE, CURVED DOWN W/ RATCHET	 STRAIGHT AXIAL HANDLE SINGLE ACTION W/ RATCHET	 LIGHTWEIGHT STRAIGHT AXIAL HANDLE W/ RATCHET	 STAINLESS STEEL, RING AXIAL HANDLE CURVED DOWN, RATCHET
NON-INSULATED HANDLES								
 STRAIGHT 8 MM TC TIP	5MM	33CM		52505-45	52505-70	52505-85	52505-77	52505-100
	5MM	36CM		52536-45	52536-70	52536-85	52536-77	52536-100
	5MM	45CM		52515-45	52515-70	52515-85	52515-77	52515-100
 MODULAR TAKE APART	5MM	33CM	52505-60I	52505-45C	52505-70C	52505-85C	52505-77C	52505-100C
	5MM	36CM	52536-60I	52536-45C	52536-70C	52536-85C	52536-77C	52536-100C
	5MM	45CM	52515-60I	52515-45C	52515-70C	52515-85C	52515-77C	52515-100C
 CURVED LEFT TC TIP	5MM	33CM		52505-46	52505-71	52505-86	52505-78	52505-101
	5MM	36CM		52536-46	52536-71	52536-86	52536-78	52536-101
	5MM	45CM		52515-46	52515-71	52515-86	52515-78	52515-101
 MODULAR TAKE APART	5MM	33CM	52505-62I	52505-46C	52505-71C	52505-86C	52505-78C	52505-101C
	5MM	36CM	52536-62I	52536-46C	52536-71C	52536-86C	52536-78C	52536-101C
	5MM	45CM	52515-62I	52515-46C	52515-71C	52515-86C	52515-78C	52515-101C
 CURVED RIGHT TC TIP	5MM	33CM		52505-47	52505-72	52505-87	52505-79	52505-102
	5MM	36CM		52536-47	52536-72	52536-87	52536-79	52536-102
	5MM	45CM		52515-47	52515-72	52515-87	52515-79	52515-102
 MODULAR TAKE APART	5MM	33CM	52505-63I	52505-47C	52505-72C	52505-87C	52505-79C	52505-102C
	5MM	36CM	52536-63I	52536-47C	52536-72C	52536-87C	52536-79C	52536-102C
	5MM	45CM	52515-63I	52515-47C	52515-72C	52515-87C	52515-79C	52515-102C
 OPEN SELF-RIGHTING NEEDLE TIP	5MM	33CM		52505-66	52505-73	52505-88	52505-82	52505-103
	5MM	36CM		52536-66	52536-73	52536-88	52536-82	52536-103
	5MM	45CM		52515-66	52515-73	52515-88	52515-82	52515-103
 MODULAR TAKE APART	5MM	33CM	52505-64I	52505-66C	52505-73C	52505-88C	52505-82C	52505-103C
	5MM	36CM	52536-64I	52536-66C	52536-73C	52536-88C	52536-82C	52536-103C
	5MM	45CM	52515-64I	52515-66C	52515-73C	52515-88C	52515-82C	52515-103C
 CLOSED SELF-RIGHTING NEEDLE TIP	5MM	33CM		52505-67	52505-74	52505-89	52505-83	52505-90
	5MM	36CM		52536-67	52536-74	52536-89	52536-83	52536-90
	5MM	45CM		52515-67	52515-74	52515-89	52515-83	52515-90
 MODULAR TAKE APART	5MM	33CM	52505-65I	52505-67C	52505-74C	52505-89C	52505-83C	52505-90C
	5MM	36CM	52536-65I	52536-67C	52536-74C	52536-89C	52536-83C	52536-90C
	5MM	45CM	52515-65I	52515-67C	52515-74C	52515-89C	52515-83C	52515-90C

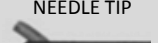
Laparoscopic 5mm Needle Holders

TIP ID.	DIAMETER	LENGTH	INSERT NO.	52555-40-26	52555-40-27	
				 THERMO-PLASTIC AXIAL HANDLE, CURVED DOWN W/ RATCHET	 THERMO-PLASTIC STRAIGHT AXIAL HANDLE SINGLE ACTION W/ RATCHET	 STRAIGHT AXIAL HANDLE, DOUBLE ACTION W/ RATCHET
NON-INSULATED HANDLES						
STRAIGHT 8 MM TC TIP 	5MM	33CM		52505-70P	52505-85P	52505-60
	5MM	36CM		52536-70P	52536-85P	52536-60
	5MM	45CM		52515-70P	52515-85P	52515-60
MODULAR TAKE APART	5MM	33CM	52505-60I	52505-70CP	52505-85PC	52505-60C
	5MM	36CM	52536-60I	52536-70CP	52536-85PC	52536-60C
	5MM	45CM	52515-60I	52515-70CP	52515-85PC	52515-60C
CURVED LEFT TC TIP 	5MM	33CM		52505-71P	52505-86P	52505-62
	5MM	36CM		52536-71P	52536-86P	52536-62
	5MM	45CM		52515-71P	52515-86P	52515-62
MODULAR TAKE APART	5MM	33CM	52505-62I	52505-71CP	52505-86PC	52505-62C
	5MM	36CM	52536-62I	52536-71CP	52536-86PC	52536-62C
	5MM	45CM	52515-62I	52515-71CP	52515-86PC	52515-62C
CURVED RIGHT TC TIP 	5MM	33CM		52505-72P	52505-87P	52505-63
	5MM	36CM		52536-72P	52536-87P	52536-63
	5MM	45CM		52515-72P	52515-87P	52515-63
MODULAR TAKE APART	5MM	33CM	52505-63I	52505-72CP	52505-87PC	52505-63C
	5MM	36CM	52536-63I	52536-72CP	52536-87PC	52536-63C
	5MM	45CM	52515-63I	52515-72CP	52515-87PC	52515-63C
OPEN SELF-RIGHTING NEEDLE TIP 	5MM	33CM		52505-73P	52505-88P	52505-64
	5MM	36CM		52536-73P	52536-88P	52536-64
	5MM	45CM		52515-73P	52515-88P	52515-64
MODULAR TAKE APART	5MM	33CM	52505-64I	52505-73CP	52505-88PC	52505-64C
	5MM	36CM	52536-64I	52536-73CP	52536-88PC	52536-64C
	5MM	45CM	52515-64I	52515-73CP	52515-88PC	52515-64C
CLOSED SELF-RIGHTING NEEDLE TIP 	5MM	33CM		52505-74P	52505-89P	52505-65
	5MM	36CM		52536-74P	52536-89P	52536-65
	5MM	45CM		52515-74P	52515-89P	52515-65
MODULAR TAKE APART	5MM	33CM	52505-65I	52505-74CP	52505-89PC	52505-65C
	5MM	36CM	52536-65I	52536-74CP	52536-89PC	52536-65C
	5MM	45CM	52515-65I	52515-74CP	52515-89PC	52515-65C

Knot Pushers

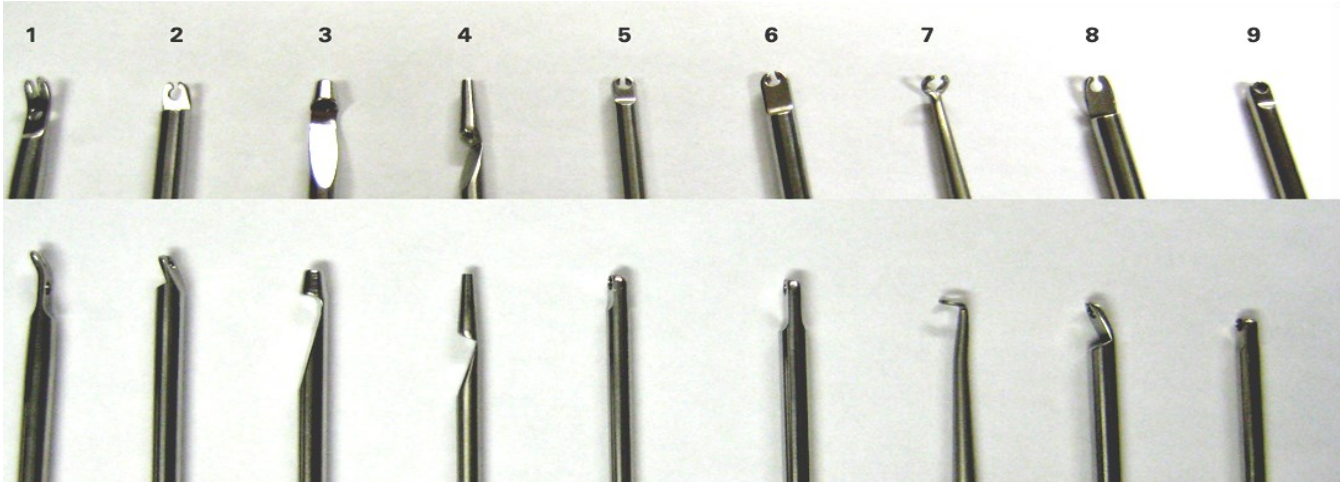

DESCRIPTION	33CM LIST NO.	45CM LIST NO.
KNOT PUSHER, STAINLESS STEEL 5mm DIA., STYLE 1	52205-61-01	52105-61-01
KNOT PUSHER, STAINLESS STEEL 5mm DIA., STYLE 2	52205-61-02	52105-61-02
KNOT PUSHER, STAINLESS STEEL 5mm DIA., STYLE 3	52205-61-03	52105-61-03
KNOT PUSHER, STAINLESS STEEL 5mm DIA., STYLE 4	52205-61-04	52105-61-04
KNOT PUSHER, STAINLESS STEEL 5mm DIA., STYLE 5	52205-61-05	52105-61-05
KNOT PUSHER, STAINLESS STEEL 5mm DIA., STYLE 6	52205-61-06	52105-61-06
KNOT PUSHER, STAINLESS STEEL 5mm DIA., STYLE 7	52205-61-07	52105-61-07
KNOT PUSHER, STAINLESS STEEL 5mm DIA., STYLE 8	52205-61-08	52105-61-08
KNOT PUSHER, STAINLESS STEEL 5mm DIA., STYLE 9	52205-61-09	52105-61-09
KNOT PUSHER, CLOSED, STAINLESS STEEL 5mm DIA., STYLE 1	52205-61-01C	52105-61-01C
KNOT PUSHER, CLOSED, STAINLESS STEEL 5mm DIA., STYLE 2	52205-61-02C	52105-61-02C
KNOT PUSHER, CLOSED, STAINLESS STEEL 5mm DIA., STYLE 5	52205-61-05C	52105-61-05C
KNOT PUSHER, CLOSED, STAINLESS STEEL 5mm DIA., STYLE 6	52205-61-06C	52105-61-06C
KNOT PUSHER, CLOSED, STAINLESS STEEL 5mm DIA., STYLE 7	52205-61-07C	52105-61-07C
KNOT PUSHER, CLOSED, STAINLESS STEEL 5mm DIA., STYLE 8	52205-61-08C	52105-61-08C

Laparoscopic Suture Passer



PRECISION MICRO-POINTED AND POLISHED TIP WITH PLATFORM ON ALL OF SUTURE RETRIEVERS

LIST NO. 52203-41	LAPAROSCOPIC TROCAR INCISION WOUND CLOSURE & HERNIA SUTURE RETRIEVER- 3.0 MM DIAMETER, 17 CM WORKING LENGTH, SPRING HANDLE, CLEANING FLUSH PORT
LIST NO. 52203-41C	LAPAROSCOPIC TROCAR INCISION WOUND CLOSURE & HERNIA SUTURE RETRIEVER- 3.0 MM DIAMETER, 17 CM WORKING LENGTH, SPRING HANDLE, CLEANING FLUSH PORT (2-PIECE TAKE APART)
LIST NO. 52213-41	BARIATRIC LAPAROSCOPIC TROCAR INCISION WOUND CLOSURE & HERNIA SUTURE RETRIEVER- 3.0 MM DIAMETER, 20 CM WORKING LENGTH, SPRING HANDLE, CLEANING FLUSH PORT
LIST NO. 52213-41C	BARIATRIC LAPAROSCOPIC TROCAR INCISION WOUND CLOSURE & HERNIA SUTURE RETRIEVER- 3.0 MM DIAMETER, 20 CM WORKING LENGTH, SPRING HANDLE, CLEANING FLUSH PORT (2-PIECE TAKE APART)
LIST NO. 52203-00	LAPAROSCOPIC TROCAR INCISION WOUND CLOSURE & HERNIA SUTURE RETRIEVER- 3.0 MM DIAMETER, 17 CM WORKING LENGTH, SY-RINGE HANDLE, CLEANING FLUSH PORT,
LIST NO. 52213-00	LAPAROSCOPIC TROCAR INCISION WOUND CLOSURE & HERNIA SUTURE RETRIEVER- 3.0 MM DIAMETER, 20 CM WORKING LENGTH, SY-RINGE HANDLE, CLEANING FLUSH PORT,

Stainless Steel Trocar Guide Cones

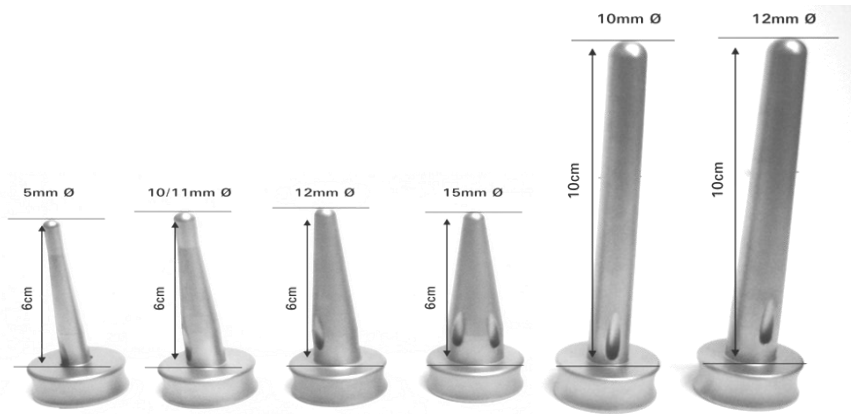

6CM LENGTH		10CM LENGTH	
LIST NO. 52203-05	5MM DIAMETER	LIST NO. 52204-05	5MM DIAMETER
LIST NO. 52203-10/11	10/11MM DIAMETER	LIST NO. 52204-10/11	10/11MM DIAMETER
LIST NO. 52203-12	12MM DIAMETER	LIST NO. 52204-12	12MM DIAMETER
LIST NO. 52203-15	15MM DIAMETER	LIST NO. 52204-15	15MM DIAMETER

Hasson 3-Prong Grasper

The Ultimate Laparoscopic Instrument for Retraction of Myomas, Fibroids, Ovaries & Other Organs



LIST NO. 52505-52	5MM, 32CM, 3-PRONG BULLDOG HASSON GRASPER AGGRESSIVE JAWS
LIST NO. 52515-52	5MM, 45CM, 3-PRONG BULLDOG HASSON GRASPER AGGRESSIVE JAWS

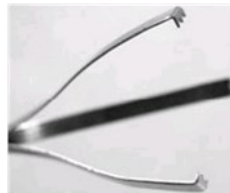

LIST NO. 52505-53	5MM, 32CM, 3-PRONG HASSON GRASPER, CURVED ALLIS TEETH
LIST NO. 52515-53	5MM, 45CM, 3-PRONG HASSON GRASPER, CURVED ALLIS TEETH

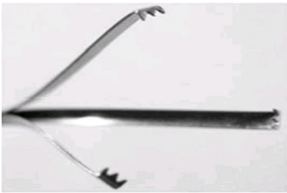

LIST NO. 52505-54	5MM, 32CM, 3-PRONG HASSON GRASPER, STRAIGHT ALLIS TEETH
LIST NO. 52515-54	5MM, 45CM, 3-PRONG HASSON GRASPER, STRAIGHT ALLIS TEETH

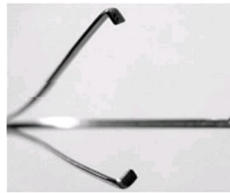

LIST NO. 52505-55	5MM, 32CM, 3-PRONG HASSON GRASPER, BLUNT EDGED JAWS
LIST NO. 52515-55	5MM, 45CM, 3-PRONG HASSON GRASPER, BLUNT EDGED JAWS

Myoma Screw



Precision Machined Tip

Solid stainless steel construction with precision machined tip for precise manipulation and securing of thick walled myomas.
Completely reusable, helping reduce your spiraling surgical procedure costs.

LIST NO. 52505-98	5MM Ø, 33CM WORKING LENGTH MYOMA SCREW
LIST NO. 52515-98	5MM Ø, 45CM WORKING LENGTH MYOMA SCREW

LIST NO. 52505-99	10MM Ø, 33CM WORKING LENGTH MYOMA SCREW
LIST NO. 52515-99	10MM Ø, 45CM WORKING LENGTH MYOMA SCREW

Cholangiogram Clamp

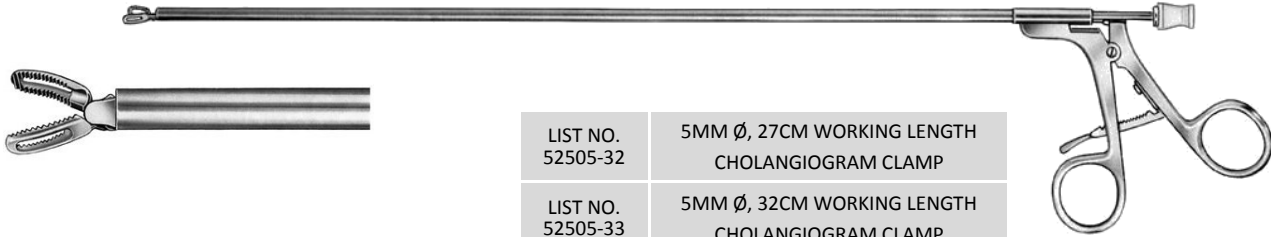

All 5mm Diameter,
4 Different Working Lengths

LIST NO. 52505-32	5MM Ø, 27CM WORKING LENGTH CHOLANGIOGRAM CLAMP
LIST NO. 52505-33	5MM Ø, 32CM WORKING LENGTH CHOLANGIOGRAM CLAMP
LIST NO. 52505-34	5MM Ø, 36CM WORKING LENGTH CHOLANGIOGRAM CLAMP
LIST NO. 52505-35	5MM Ø, 45CM WORKING LENGTH CHOLANGIOGRAM CLAMP

Endoscopic Magnetic Rod

Stainless Steel Construction With Serrated Handle for Precise
Important: Instrument to be used ONLY under direct vision*



LIST NO. 52805-01	5MM Ø, 33CM LAPAROSCOPIC MAGNETIC ROD	LIST NO. 52810-01	10MM Ø, 33CM LAPAROSCOPIC MAG- NETIC ROD
LIST NO. 52805-02	5MM Ø, 45CM LAPAROSCOPIC MAGNETIC ROD	LIST NO. 52810-02	10MM Ø, 45CM LAPAROSCOPIC MAGNETIC ROD
LIST NO. 52803-01	3MM Ø, 33CM LAPAROSCOPIC MAGNETIC ROD		
LIST NO. 52803-02	3MM Ø, 45CM LAPAROSCOPIC MAGNETIC ROD		

Retractable Endoscopic Knife

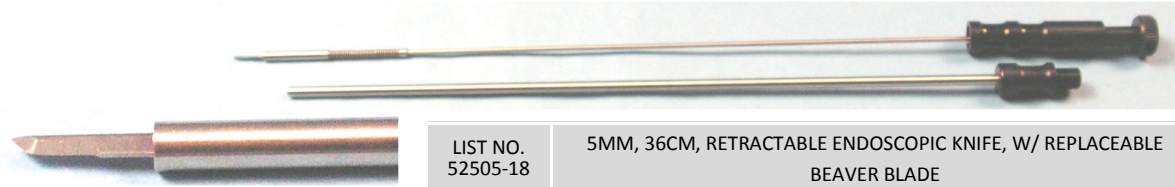

LIST NO. 52505-18	5MM, 36CM, RETRACTABLE ENDOSCOPIC KNIFE, W/ BEAVER BLADE
----------------------	---

Silastic Ring Applicator for Tubular Sterilization

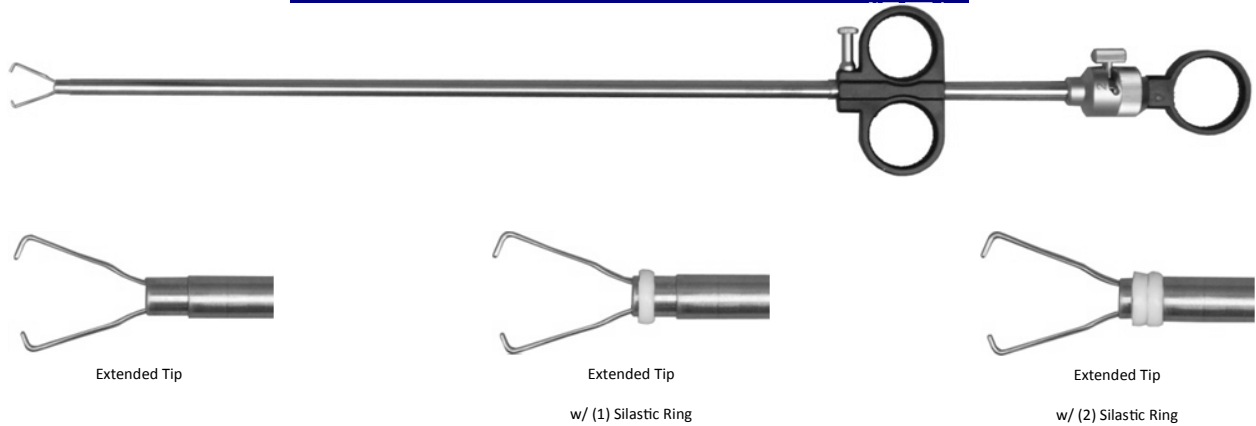

LIST NO. 52105-500	6MM Ø, 40CM SILASTIC RING APPLICATOR- FOR SINGLE AND DUAL RING APPLICATION; USE WITH OPERATING LAPAROSCOPE WITH 6MM Ø INSTRUMENT CHANNEL (SUGGEST LIST NO. 52110-06).
LIST NO. 52205-501	6 MM Ø, 33 CM SILASTIC RING APPLICATOR FOR SINGLE AND DUAL RING APPLICATION; USE WITH LAPAROSCOPE AND 6MM Ø TROCAR SLEEVE (SEE DATA SHEET FOR APPROPRIATE SLEEVE).
LIST NO. 52208-501	8 MM Ø, 27 CM SILASTIC RING APPLICATOR- FOR SINGLE AND DUAL RING APPLICATION; USE WITH LAPAROSCOPE AND 8MM Ø TROCAR SLEEVE (SEE DATA SHEET FOR APPROPRIATE SLEEVE). SAME DIAMETER AS ACMI
LIST NO. 52208-501	8 MM Ø, 33 CM SILASTIC RING APPLICATOR- FOR SINGLE AND DUAL RING APPLICATION; USE WITH LAPAROSCOPE AND 8MM Ø TROCAR SLEEVE (SEE DATA SHEET FOR APPROPRIATE SLEEVE). SAME DIAMETER AS ACMI
LIST NO. 52005-500	SILASTIC RING (PACKAGE OF 10) FOR TUBAL LIGATION NON-STERILE, AUTOCLAVABLE
LIST NO. 52005-501	SILASTIC RING APPLIER AND GUIDE CONE SET (NOTE: (1) SET COMES WITH NEW INSTRUMENT)

Cohen Cannula



LIST NO. 52001-13	COHEN CANNULA 2/ LARGE/SMALL REPLACEABLE TIPS
LIST NO. 52001-19L	REPLACEMENT ACORN, LARGE, FOR 52001-13
LIST NO. 52001-19S	REPLACEMENT ACORN, SMALL, FOR 52001-13
LIST NO. 52001-13W	COHEN CANNULA WITH LARGE/SMALL REPLACABLE TIPS- SLOTTED HANDLE-WOLF STYLE
LIST NO. 52001-29	3MM CLEANING BRUSH FOR FRONT TUBE OF COHEN CANNULA (QTY 12/PACK)
LIST NO. 52001-31	5MM CLEANING BRUSH FOR REAR TUBE OF COHEN CANNULA (QTY 12/PACK)

LIST NO. 52001-12S	COHEN CANNULA WITH FIXED SMALL STAINLESS STEEL ACORN
LIST NO. 52001-12L	COHEN CANNULA WITH FIXED LARGE STAINLESS STEEL ACORN
LIST NO. 52001-29	3MM CLEANING BRUSH FOR FRONT TUBE OF COHEN CANNULA (QTY 12/PACK)
LIST NO. 52001-31	5MM CLEANING BRUSH FOR REAR TUBE OF COHEN CANNULA (QTY 12/PACK)

Uterine Manipulator

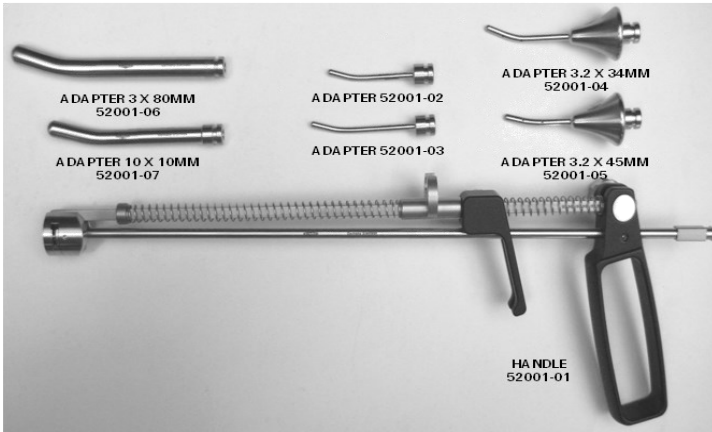
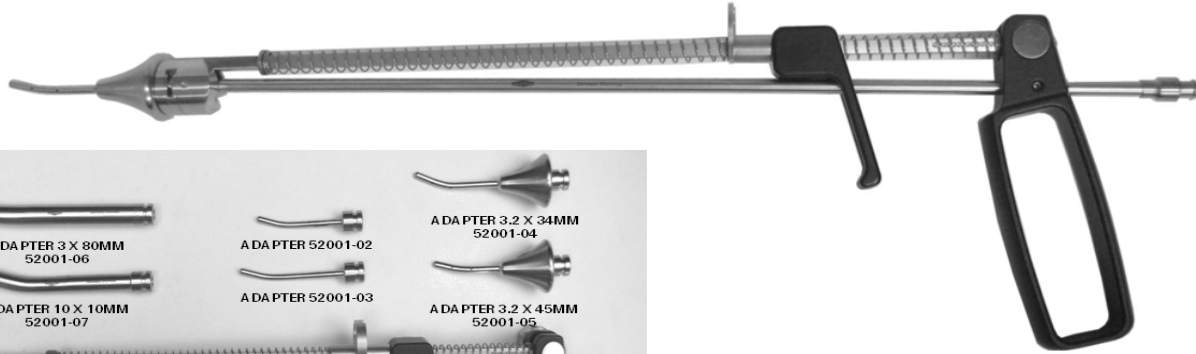

LIST NO. 52001-00
 V/T (VALTEHER/PELOSI) UTERINE MANIPULATOR: COMPLETE W/ SET OF (6) INTERCHANGEABLE OBTURATORS & CANNULA

Uterine Tenacula

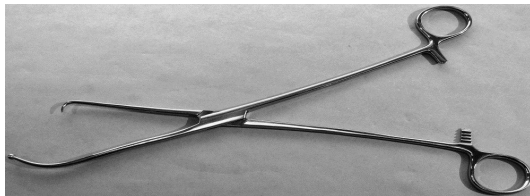

LIST NO. 52001-09
 HULKA UTERINE MANIPULATOR TENACULUM

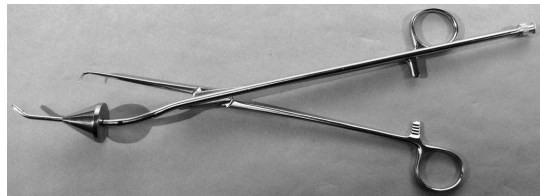

LIST NO. 52001-16
 BEHRMAN UTERINE MANIPULATOR TENACULUM

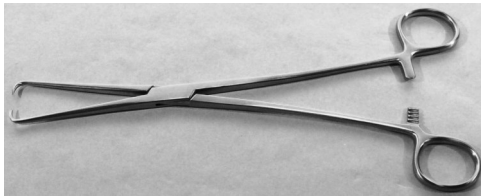

LIST NO. 52001-14
 SCHROEDER TENACULUM SINGLE TOOTH (9 1/2")

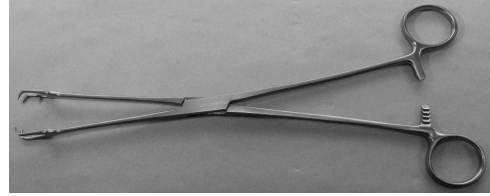

LIST NO. 52001-08
 SCHROEDER VULSELLUM DOUBLE TOOTH (9 1/2")

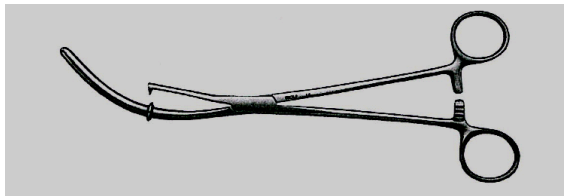

LIST NO. 52001-18
 SARGIS UTERINE GRASPING FORCEPS (9 1/2")

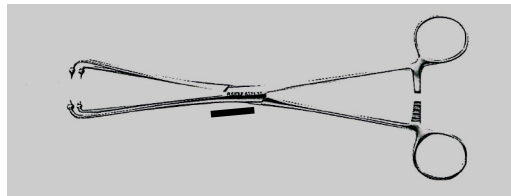

LIST NO. 52001-17
 GIMPELSON CERVICAL SEALING TENACULUM (9 1/2")

Aspiration Needles

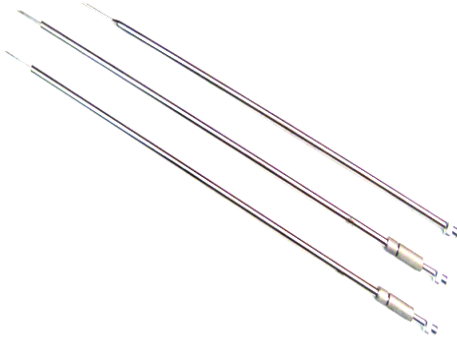

LIST NO. 52103-19	3MM, 45CM INJECTION, ASPIRATION, & BIOPSY NEEDLE
LIST NO. 52803-02	5MM, 45CM ASPIRATION NEEDLE, 15 GA. NEEDLE SIZE- STANDARD (18 GA TO 25 GA AVAILABLE-PLEASE SPECIFY)
LIST NO. 52105-27R	5MM, 45CM RETRACTABLE ASPIRATION NEEDLE, 15 GA. NEEDLE SIZE-STANDARD (18 GA. TO 25 GA. AVAILABLE - PLEASE SPECIFY)
LIST NO. 52105-27W	5MM DIA., 45CM ASPIRATION NEEDLE, WITH ANGLED 45 DEGREE TUBE, 15 GA. NEEDLE SIZE - STANDARD (18 GA. TO 25 GA. AVAILABLE - PLEASE SPECIFY)
LIST NO. 52203-22	3MM DIA., 33CM INJECTION, ASPIRATION AND BIOPSY NEEDLE
LIST NO. 52205-31	5MM DIA., 33CM ASPIRATION NEEDLE 15 GA. NEEDLE SIZE - STANDARD (18 GA. TO 25 GA. AVAILABLE - PLEASE SPECIFY)
LIST NO. 52205-31R	5MM DIA., 33CM RETRACTABLE ASPIRATION NEEDLE 15 GA. NEEDLE SIZE - (STANDARD 18 GA. TO 25 GA. AVAILABLE - PLEASE SPECIFY)

Verres Needles



LIST NO. 52003-07	2 MM DIA., 260 MM (10") VERESS INSUFLATION NEEDLE	LIST NO. 52003-10	2 MM DIA., 100 MM (4") VERESS INSUFLATION NEEDLE
LIST NO. 52003-08	2 MM DIA., 180 MM (7") VERESS INSUFLATION NEEDLE	LIST NO. 52003-11	2 MM DIA., 120 MM (5") VERESS INSUFLATION NEEDLE
LIST NO. 52003-09	2 MM DIA., 55 MM (2") VERESS INSUFLATION NEEDLE	LIST NO. 52003-12	2 MM DIA., 150 MM (6") VERESS INSUFLATION NEEDLE

Palpation Tactile Probes W/ CM Markings



LIST NO. 52205-29	5MM, 33CM, PALPATION TACTILE PROBE W/ CM MARKINGS
LIST NO. 52105-25	5MM, 45CM, PALPATION TACTILE PROBE W/ CM MARKINGS
LIST NO. 52133-25	10MM, 33CM, PALPATION TACTILE PROBE W/ CM MARKINGS
LIST NO. 52145-25	10MM, 45CM, PALPATION TACTILE PROBE W/ CM MARKINGS

Retract Robot in Laparoscopic Surgery

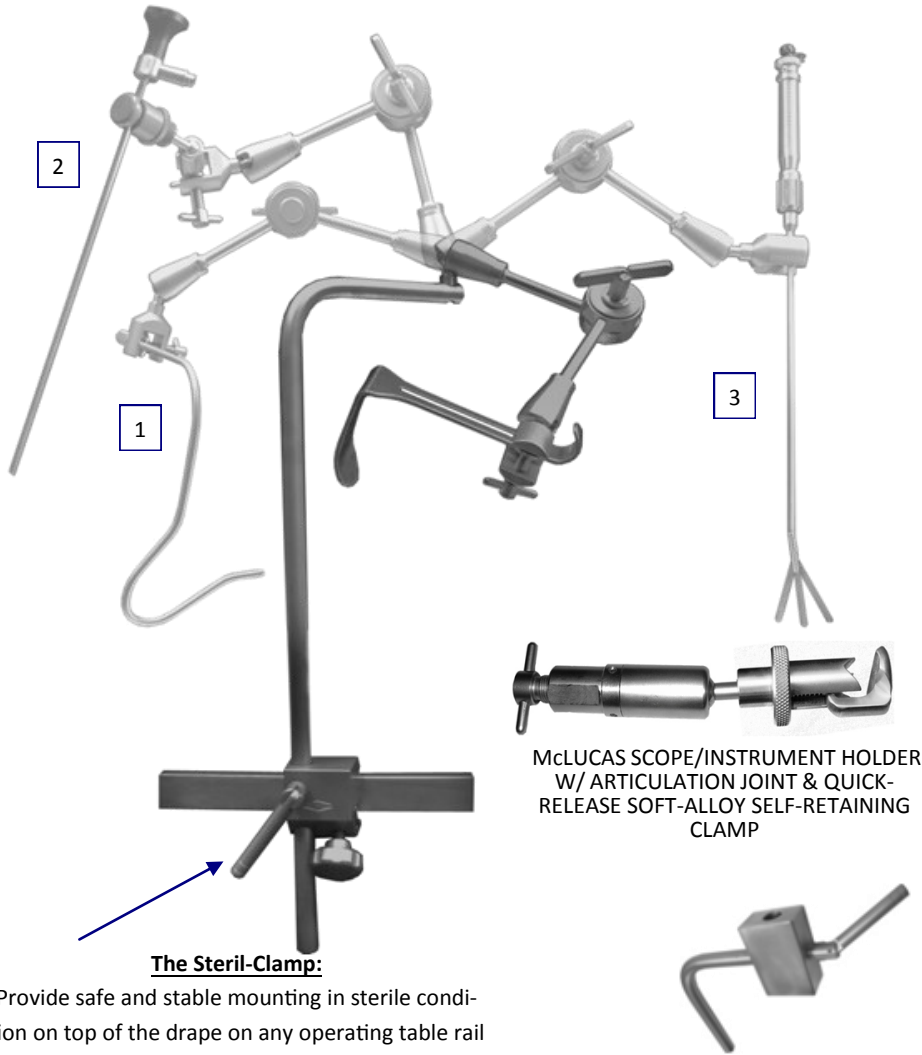

VARIOUS INSTRUMENTS SHOWN WITH THE SINGLE-ARM RETRACT-ROBOT:

- 1) With the Nathanson Liver Retractor
- 2) With the articulating scope holder: quick, stable & precise adjustment can be made with the turn of a knob.
- 3) With the Fan Retractor; any type of retractor can be held in a stable, fully adjustable position at maximum retraction, e.g. flat, round, etc.

The Steril-Clamp:

Provide safe and stable mounting in sterile condition on top of the drape on any operating table rail

EXTENSION CLAMP FOR BARIATRIC SURGERY (FITS INTO STERIL-CLAMP)

LIST NO	DESCRIPTION
15088-00	IRETRACT-ROBOT SINGLE ARM INSTRUMENT
15088-01	RETRACT-ROBOT SINGLE ARM INSTRUMENT W/ EXTRA-LONG MOUNTING ROD (26") (BARIATRIC)
15090-53	STERIL-CLAMP HEAVY DUTY, 5/8" ROUND HOLE OR 1/2" X 1" SLOT (FOR EXTRA LONG ROBOT ARM)
15090-56	STERIL-CLAMP STANDARD, AUTOCLAVABLE W/ ROUND 5/8" ACCESSORY OPENING
15090-57	EXTENSION CLAMP FOR BARIATRIC SURGERY: AUTOCLAVABLE, 5/8" ACCESSORY OPENING
52410-01	ISCOPE/INSTRUMENT HOLDER W/ ARTICULATION JOINT SELF-RETAINING CLAMP (SLEEVE STYLE)
52400-00	ENODOSCOPIC FIXATION DEVICE CONSISTING OF:LIST NO.'S: 15088-00, 15090-56, & 52410-01
52400-01	BARIATRIC ENODOSCOPIC FIXATION DEVICE CONSISTING OF LIST NO.'S: 15088-01, 15090-53, & 52410-01

Goose Neck Retractor in Laparoscopic Surgery

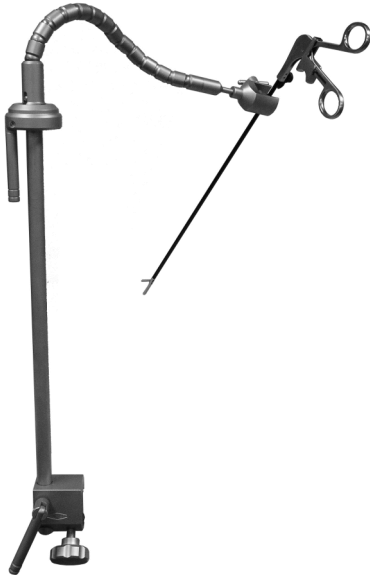

Features of the Goose-Neck System:

- All components are made of a high grade stainless steel.
- The complete system, including the Steril-Clamp™, may be flash auto-claved
- The self-retaining joints rotate & twist in every desirable position
- The instrument shaft fits into table accessory clamps such as those used for stirrups & leg holders, as well as all of the other over-the-drape clamps with an opening of 5/8"
- The vertical shaft (5/8") may be lowered or heightened within the clamp for flexible adjustment
- Two different models with different instrument holders available

LIST NO. 15090-60	GOOSE-NECK RETRACTOR SYSTEM WITH SELF-RETAINING SLEEVE CLAP WITH ARTICULATING JOINT FOR HOLDING TELESCOPES INCLUDES 15090-56: STERIL-CLAMP™ FOR ATTACHING TO TABLE
LIST NO. 15090-61	GOOSE-NECK RETRACTOR SYSTEM WITH UNIVERSAL MOUNTING CLAMP FOR HOLDING ALL TYPES OF INSTRUMENTS INCLUDES 15090-56: STERIL-CLAMP™ FOR ATTACHING TO TABLE

Retract Robot & Goose Neck Retractor Sterilization Containers

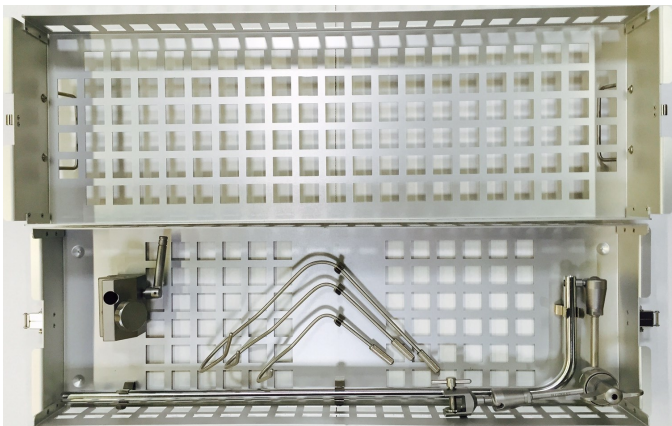

LIST NO. 55040-03	ALUMINUM STORAGE/STERILIZATION CONTAINER w/ PERFO-RATED LID & BOTTOM, w/ BRACKETS FOR MOUNTING RETRACT-ROBOT #15088-00 & #15090-53 or 15090-56. FOR WRAPPING.) DIMENSIONS: 26"L x 10"W x 7"H (63.5CM x 25CM x 13CM).
LIST NO. 55040-02	ALUMINUM STORAGE/STERILIZATION CONTAINER w/ PERFORATED LID & BOTTOM, w/ BRACKETS FOR MOUNTING RETRACT-ROBOT #15088-01 or 15088-03 & STERIL CLAMP #15090-53 or 15090-56. (FOR WRAPPING.) DIMENSIONS: 30"L x 10"W x 6"H (76CM x 25CM x 15CM).

Nathanson Liver Retractors

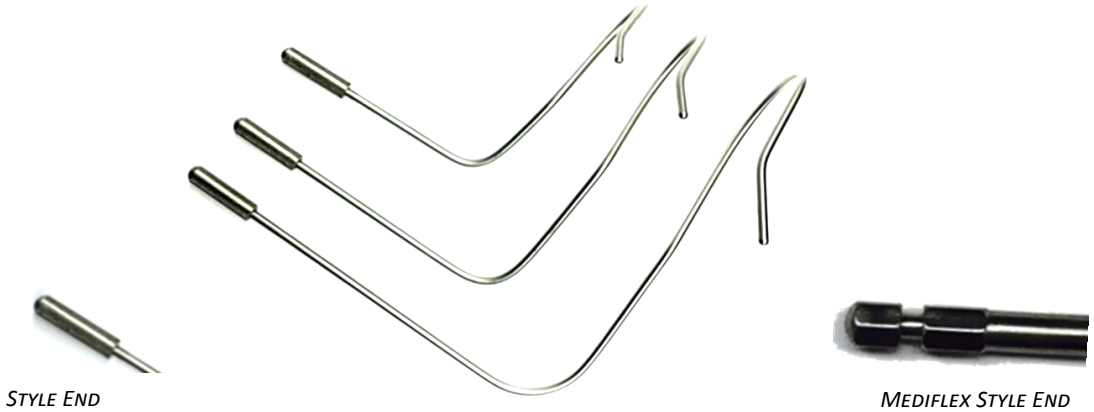

52420-00	NATHANSON STYLE LIVER RETRACTORS 6.5MM DIA. SET OF THREE - SIZES: SMALL, MEDIUM, LARGE
52420-01	NATHANSON STYLE LIVER RETRACTORS, 6.5MM DIA. - SIZE: SMALL
52420-02	NATHANSON STYLE LIVER RETRACTORS, 6.5MM DIA. - SIZE: MEDIUM
52420-03	NATHANSON STYLE LIVER RETRACTORS, 6.5MM DIA. - SIZE: LARGE

52440-00	NATHANSON STYLE LIVER RETRACTORS, 6.5MM DIA. - SET OF THREE - SIZES: SMALL, MEDIUM, LARGE
52440-01	NATHANSON STYLE LIVER RETRACTORS, 6.5MM DIA. SIZE: SMALL
52440-02	NATHANSON STYLE LIVER RETRACTORS, 6.5MM DIA. SIZE: MEDIUM
52440-03	NATHANSON STYLE LIVER RETRACTORS, 6.5MM DIA. SIZE: LARGE

52430-00	NATHANSON STYLE LIVER RETRACTORS, 5MM DIA. - SET OF THREE - SIZES: SMALL, MEDIUM, LARGE
52430-01	NATHANSON STYLE LIVER RETRACTORS, 5MM DIA. SIZE: SMALL
52430-02	NATHANSON STYLE LIVER RETRACTORS, 5MM DIA. SIZE: MEDIUM
52430-03	NATHANSON STYLE LIVER RETRACTORS, 5MM DIA. SIZE: LARGE
52430-04	NATHANSON STYLE LIVER RETRACTORS, 5MM DIA. SIZE: EXTRA SMALLL

52450-00	NATHANSON STYLE LIVER RETRACTORS, 5MM DIA. - SET OF THREE - SIZES: SMALL, MEDIUM, LARGE
52450-01	NATHANSON STYLE LIVER RETRACTORS, 5MM DIA. SIZE: SMALL
52450-02	NATHANSON STYLE LIVER RETRACTORS, 5MM DIA. SIZE: MEDIUM
52450-03	NATHANSON STYLE LIVER RETRACTORS, 5MM DIA. SIZE: LARGE
52450-04	NATHANSON STYLE LIVER RETRACTORS, 5MM DIA. SIZE: EXTRA SMALLL

52460-00	NATHANSON STYLE LIVER RETRACTORS, 3.2MM DIA. - SET OF THREE - SIZES: SMALL, MEDIUM, LARGE
52460-03	NATHANSON STYLE LIVER RETRACTORS, 3.2MM DIA. SIZE: SMALL
52460-04	NATHANSON STYLE LIVER RETRACTORS, 3.2MM DIA. SIZE: MEDIUM
52460-05	NATHANSON STYLE LIVER RETRACTORS, 3.2MM DIA. SIZE: LARGE
52460-06	NATHANSON STYLE LIVER RETRACTORS, 3.2MM DIA. SIZE: EXTRA SMALLL

52460-00	NATHANSON STYLE LIVER RETRACTORS, 3.2MM DIA. - SET OF THREE - SIZES: SMALL, MEDIUM, LARGE
52460-01	NATHANSON STYLE LIVER RETRACTORS, 3.2MM DIA. SIZE: SMALL
52460-02	NATHANSON STYLE LIVER RETRACTORS, 3.2MM DIA. SIZE: MEDIUM
52460-03	NATHANSON STYLE LIVER RETRACTORS, 3.2MM DIA. SIZE: LARGE
52460-04	NATHANSON STYLE LIVER RETRACTORS, 3.2MM DIA. SIZE: EXTRA SMALLL

90° Articulating Flat Blade Retractors

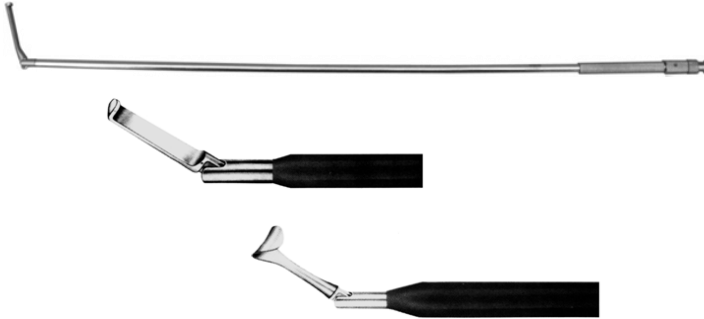

LIST NO. 52505-48	5 MM Ø, 33 CM RETRACTOR; 90 DEGREE ARTICULATING FLAT BLADE, WITH FLUSH PORT
LIST NO. 52515-48	5 MM Ø, 45 CM RETRACTOR; 90 DEGREE ARTICULATING FLAT BLADE, WITH FLUSH PORT
LIST NO. 52510-87	10 MM Ø, 33 CM RETRACTOR; 90 DEGREE ARTICULATING FLAT BLADE, WITH FLUSH PORT
LIST NO. 52511-87	10 MM Ø, 45 CM RETRACTOR; 90 DEGREE ARTICULATING FLAT BLADE, WITH FLUSH PORT
LIST NO. 52510-86	10 MM Ø, 33 CM RETRACTOR; 90 DEGREE ARTICULATING "CUSHING"-TYPE BLADE, WITH FLUSH PORT
LIST NO. 52511-86	10 MM Ø, 45 CM RETRACTOR; 90 DEGREE ARTICULATING "CUSHING"-TYPE BLADE, WITH FLUSH PORT

Lap Banding Retractors



LIST NO. 52525-21	5 MM DIA., 36 CM, ESOPHAGEAL RETRACTOR FOR APPLICATION GASTRIC BANDING 90 DEGREE ARTICULATING
LIST NO. 52515-21	10 MM DIA., 36 CM, ESOPHAGEAL RETRACTOR FOR APPLICATION GASTRIC BANDING 90 DEGREE ARTICULATING DISTAL TIP, FLUSH PORT
LIST NO. 52525-30	5MM DIA., 41CM, ESOPHAGEAL RETRACTOR FOR APPLICATION GASTRIC BANDING 90 DEGREE ARTICULATING
LIST NO. 52515-30	10MM DIA., 41CM, ESOPHAGEAL RETRACTOR WITH ARTICULATING CONTROL KNOB ON HANDLE, WITH FLUSHPORT

Lap Banding Retractors W/ Ratchet Handle



LIST NO. 52525-21B4	5MM DIA., 34CM ARTICULATING RETRACTOR FOR LAP BANDING HANDLE W/ RATCHET, ROTATING-ONE PIECE W/FLUSH PORT
LIST NO. 52515-21B4	10 MM DIA., 34 CM ARTICULATING RETRACTOR FOR LAP BANDING HANDLE W/ RATCHET, ROTATING-ONE PIECE W/FLUSH PORT
LIST NO. 52525-30B4	5MM DIA., 41CM, ESOPHAGEAL RETRACTOR-GASTRIC BAND MANIPULATOR 90 DEG. ANGULATION WITH RING RATCHET HANDLE RIGID - ONE PIECE WITH FLUSH PORT
LIST NO. 52515-30B4	10MM DIA., 41CM, ESOPHAGEAL RETRACTOR-GASTRIC BAND MANIPULATOR, 90 DEG., ANGULATION, WITH RING RATCHET HANDLE, ROTATABLE- ONE PIECE W/FLUSH PORT

Snake Retractors

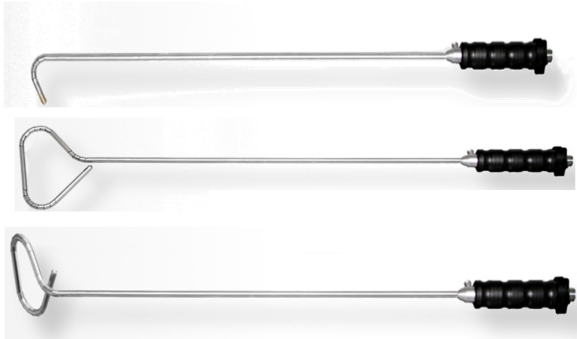

LIST NO. 52550-07	5MM, 40CM LAPAROSCOPIC RETRACTOR W/ FLEXIBLE, RIGHT ANGLED, FORMABLE TIP
LIST NO. 52550-05	5 MM DIA., 40 CM, LAPAROSCOPIC RETRACTOR W/ FLEXIBLE TRIANGULAR FORMABLE TIP
LIST NO. 52550-06	5MM, 40CM LAPAROSCOPIC RETRACTOR W/ FLEXIBLE TRIANGULAR, RIGHT ANGLED FORMABLE TIP

Fan Retractors

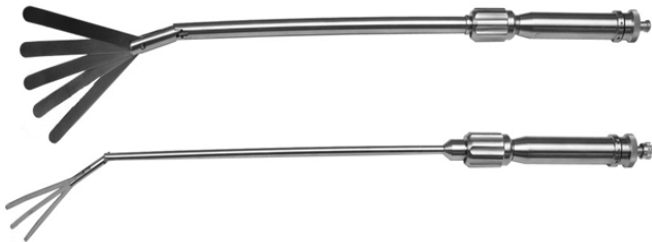

LIST NO. 52505-15	5 MM Ø, 34 CM ARTICULATING FAN RETRACTOR RETRACTOR / ELEVATOR WITH 3 FLAT, 60 DEGREE ARTICULATING AND FOLDING BLADES, (60 MM MAX WIDTH), ADJUSTABLE HANDLE WITH FLUSHPORT, STAINLESS STEEL
LIST NO. 52510-15	10 MM Ø, 34 CM ARTICULATING FAN RETRACTOR RETRACTOR / ELEVATOR WITH 5 FLAT, 60 DEGREE ARTICULATING AND FOLDING BLADES, (90 MM MAX WIDTH), ADJUSTABLE HANDLE WITH FLUSHPORT, STAINLESS STEEL
LIST NO. 52525-15	5 MM Ø, 45 CM ARTICULATING FAN RETRACTOR RETRACTOR / ELEVATOR WITH 3 FLAT, 60 DEGREE ARTICULATING AND FOLDING BLADES, (60 MM MAX WIDTH), ADJUSTABLE HANDLE WITH FLUSHPORT, STAINLESS STEEL
LIST NO. 52515-15	10 MM Ø, 45 CM ARTICULATING FAN RETRACTOR RETRACTOR / ELEVATOR WITH 5 FLAT, 60 DEGREE ARTICULATING AND FOLDING BLADES, (90 MM MAX WIDTH), ADJUSTABLE HANDLE WITH FLUSHPORT, STAINLESS STEEL

Kite Retractors

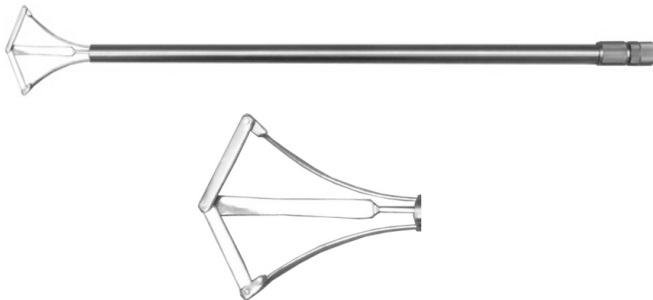

LIST NO. 52505-50	5 MM Ø, 33 CM RETRACTOR/ELEVATOR CURVED, ROTATABLE, TRIANGULAR KITE-SHAPED BLADE, LOCKING HANDLE
LIST NO. 52515-50	5 MM Ø, 45 CM RETRACTOR/ELEVATOR CURVED, ROTATABLE, TRIANGULAR KITE-SHAPED BLADE, LOCKING HANDLE
LIST NO. 52505-51	5 MM Ø, 33 CM RETRACTOR/ELEVATOR STRAIGHT, ROTATABLE, TRIANGULAR KITE-SHAPED BLADE, LOCKING HANDLE
LIST NO. 52515-51	5 MM Ø, 45 CM RETRACTOR/ELEVATOR STRAIGHT, ROTATABLE, TRIANGULAR KITE-SHAPED BLADE, LOCKING HANDLE
LIST NO. 52510-50	5 MM Ø, 45 CM RETRACTOR/ELEVATOR CURVED, ROTATABLE, TRIANGULAR KITE-SHAPED BLADE, LOCKING HANDLE
LIST NO. 52511-50	10 MM Ø, 45 CM RETRACTOR/ELEVATOR STRAIGHT, ROTATABLE, TRIANGULAR KITE-SHAPED BLADE, LOCKING HANDLE

Minimally Invasive Retractors/Elevators



LIST NO. 52505-40	5 MM Ø, 33 CM RETRACTOR/ELEVATOR 90 DEGREE ARTICULATING TEFLON TIP, ACCORDING TO DR. VALLE, WITH FLUSH
----------------------	--



LIST NO. 52505-51	5 MM Ø, 33 CM ELEVATOR/PROBE STRAIGHT, TEFLON TIP, ACCORDING TO DR. VALLE
----------------------	---



LIST NO. 52505-39	5 MM Ø, 33 CM LEVER/ELEVATOR RETRACTABLE, STRAIGHT, 4-FINGER BLADES, ROTATABLE INSERT
LIST NO. 52515-39	5 MM Ø, 45 CM LEVER/ELEVATOR RETRACTABLE, STRAIGHT, 4-FINGER BLADES, ROTATABLE INSERT

The Original Kleppinger Bipolar Laparoscopic Forceps



SYRINGE-TYPE KLEPPINGER BIPOLAR FORCEPS

5MM DIAMETER, 32CM LENGTH		5MM DIAMETER, 45CM LENGTH	
LIST NO.	DESCRIPTION	LIST NO.	DESCRIPTION
52205-100	FLAT TIP	52105-100	FLAT TIP
52205-100S	STANDARD TIP	52105-100S	STANDARD TIP
52205-100T	FENESTRATED TIP	52105-100T	FENESTRATED TIP
52205-100M	MICRO TIP	52105-100M	MICRO TIP

Bipolar Cables For Kleppinger Forceps



WOLF KLEPPINGER PLUG & DUAL-BANANA GENERATOR PLUG
LIST NO. 52005-24

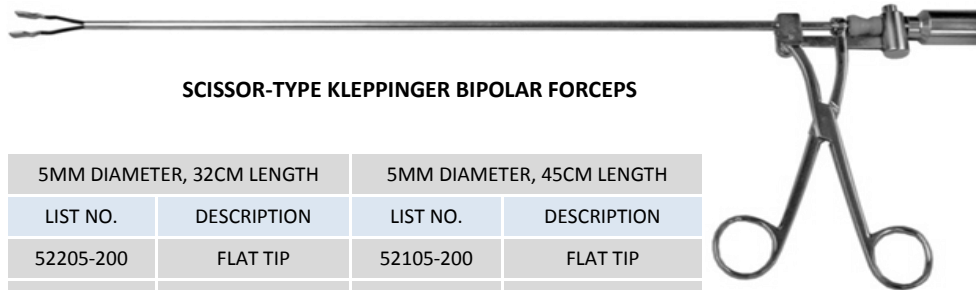

SCISSOR-TYPE KLEPPINGER BIPOLAR FORCEPS

5MM DIAMETER, 32CM LENGTH		5MM DIAMETER, 45CM LENGTH	
LIST NO.	DESCRIPTION	LIST NO.	DESCRIPTION
52205-200	FLAT TIP	52105-200	FLAT TIP
52205-200S	STANDARD TIP	52105-200S	STANDARD TIP
52205-200T	FENESTRATED TIP	52105-200T	FENESTRATED TIP
52205-200M	MICRO TIP	52105-200M	MICRO TIP

OR



WOLF KLEPPINGER PLUG & WOLF GENERATOR PLUG
LIST NO. 52005-23

Reusable Replacement Tongs For Kleppinger Type Forceps

All of our inner tongs are interchangeable with the original Wolf style

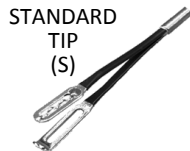
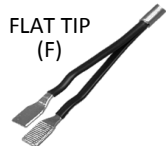

LIST NO.	DESCRIPTION
52205-101	32 CM - FLAT TIP (ORIGINAL KLEPPINGER) INNER TONG - F
52105-101	45 CM - FLAT TIP (ORIGINAL KLEPPINGER) INNER TONG - F
52205-102	32 CM - STANDARD TIP (FENESTRATED WITH WIRE) - INNER TONG - S
52105-102	45 CM - STANDARD TIP (FENESTRATED WITH WIRE) - INNER TONG - S
52205-103	32 CM - MICRO TIP (NARROW SHORT TIP) - INNER TONG - M
52105-103	45 CM - MICRO TIP (NARROW SHORT TIP) - INNER TONG - M
52205-104	32 CM - FENESTRATED TIP (FENESTRATED WITH TOOTH) - INNER TONG - T
52105-104	45 CM - FENESTRATED TIP (FENESTRATED WITH TOOTH) - INNER TONG - T

Note:

Both the syringe and scissor handle Kleppinger forceps are available with the optional inner tongs. Use the first number from above for the instrument and add the letter of your choice for the optional insert S, T, M.

We also have reusable replacement tongs available for Storz, ACMI, Pilling and other brands of bipolar laparoscopic forceps

Kleppinger Type III Bipolar Laparoscopic Forceps

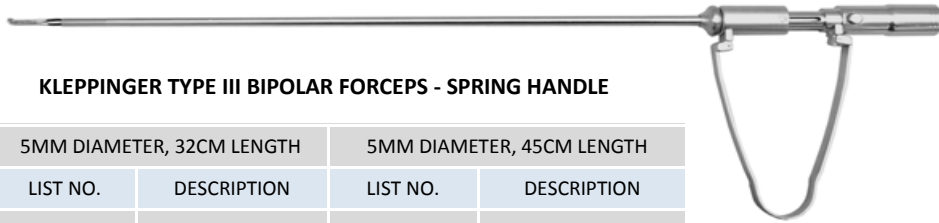

KLEPPINGER TYPE III BIPOLAR FORCEPS - SPRING HANDLE

5MM DIAMETER, 32CM LENGTH		5MM DIAMETER, 45CM LENGTH	
LIST NO.	DESCRIPTION	LIST NO.	DESCRIPTION
52205-85S	STANDARD TIP	52105-67S	STANDARD TIP
52205-85F	FLAT TIP	52105-67F	FLAT TIP
52205-85M	MICRO TIP	52105-67M	MICRO TIP

Features:

- Micro Polished Tip
- Stationary Inner Tong - it does not move in & out while opening & closing, giving the surgeon complete control of placement
- New type of cable connector for easier cleaning of handle & positive connection
 - Interchangeable inner tongs
- Pressure-loaded mechanism of the spring handle assists in closing of the Instrument

Bipolar Cables For Use With Type III Kleppinger Forceps



TYPE III KLEPPINGER PLUG & DUAL-BANANA GENERATOR PLUG
LIST NO. 52005-20

OR



TYPE III KLEPPINGER PLUG & WOLF GENERATOR PLUG
LIST NO. 52005-19

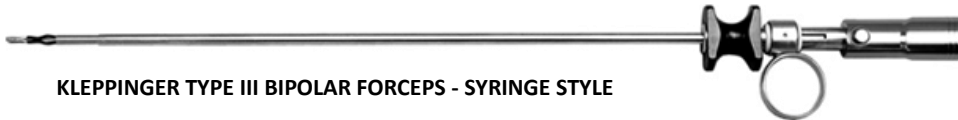

KLEPPINGER TYPE III BIPOLAR FORCEPS - SYRINGE STYLE

5MM DIAMETER, 32CM LENGTH		5MM DIAMETER, 45CM LENGTH	
LIST NO.	DESCRIPTION	LIST NO.	DESCRIPTION
52205-96S	STANDARD TIP	52105-68S	STANDARD TIP
52205-96F	FLAT TIP	52105-68F	FLAT TIP
52205-96M	MICRO TIP	52105-68M	MICRO TIP

Features:

- Micro Polished Tip
- Stationary Inner Tong
- Interchangeable inner tongs
- Jaws close with closing of hand action, giving the surgeon complete control of how much pressure is exerted on the tissue

Reusable Replacement Tongs For Kleppinger Type III

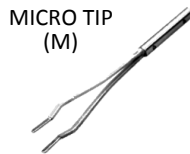
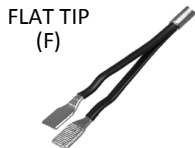
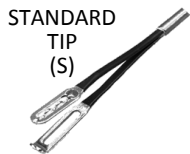

STANDARD TIP FOR SECURE SLIP-FREE GRIP		FLAT TIP, CONVENTIONAL KLEPPINGER STYLE		MICRO TIP FOR PRECISE, PIN-POINT COAGULATION	
32CM	45CM	32CM	45CM	32CM	45CM
52205-44	52105-70	52205-91	52105-71	52205-47	52105-72

Note:

When ordering replacement tongs for Slide Handle Bipolar Forceps with a single tube or with irrigation tube, add letters "ST" to the above List Numbers (the price remains the same). For handle replacement parts for all Laparoscopic Bipolar Forceps refer to the operating instructions.

Kleppinger Type II Bipolar Laparoscopic Forceps



KLEPPINGER TYPE II BIPOLAR FORCEPS - SLIDE HANDLE

5MM DIAMETER, 32CM LENGTH		5MM DIAMETER, 45CM LENGTH	
LIST NO.	DESCRIPTION	LIST NO.	DESCRIPTION
52205-43S	STANDARD TIP	52105-64S	STANDARD TIP
52205-43F	FLAT TIP	52105-64F	FLAT TIP
52205-43M	MICRO TIP	52105-64M	MICRO TIP

Features:

- Micro Polished Tip
- Stationary Inner Tong
- Interchangeable inner tongs
- Opening & closing of the jaw is controlled by sliding the handle back & forward, giving the surgeon complete control of how much pressure is exerted on the tissue

Bipolar Cables For Use With Type II Kleppinger Forceps



TYPE II KLEPPINGER PLUG & DUAL-BANANA GENERATOR PLUG

LIST NO. 52005-22

OR



Infinity TYPE II KLEPPINGER PLUG & Infinity / WOLF GENERATOR PLUG

LIST NO. 52005-21



CLASSIC BIPOLAR FORCEPS - SLIDE HANDLE

5MM DIAMETER, 32CM LENGTH		5MM DIAMETER, 45CM LENGTH	
LIST NO.	DESCRIPTION	LIST NO.	DESCRIPTION
52205-50	MICRO JAW	52105-37	MICRO JAW
52205-41	HOOK JAW	52105-38	HOOK JAW

Features:

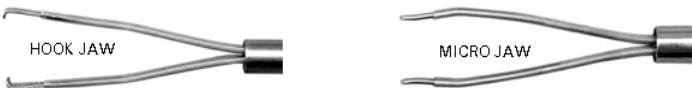

Reusable Replacement Tongs For Kleppinger Type III

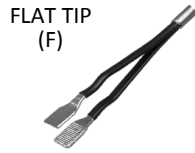
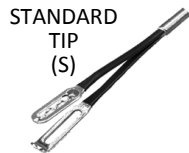

STANDARD TIP FOR SECURE SLIP-FREE GRIP		FLAT TIP, CONVENTIONAL KLEPPINGER STYLE		MICRO TIP FOR PRECISE, PIN-POINT COAGULATION	
32CM	45CM	32CM	45CM	32CM	45CM
52205-44	52105-70	52205-91	52105-71	52205-47	52105-72

Note:

When ordering replacement tongs for Slide Handle Bipolar Forceps with a single tube or with irrigation tube, add letters "ST" to the above List Numbers (the price remains the same). For handle replacement parts for all Laparoscopic Bipolar Forceps refer to the operating instructions.

Powergrip Bipolar Scissors & Forceps



Features:

-The bipolar POWERGRIP coagulation forceps is an instrument used for grasping, cutting and bipolar coagulation in minimally invasive surgery. Their mechanism enables active and precise opening and closing of the jaws as well as applying very high pressure when grasping and cutting while precisely coagulating the tissue. Electrode inserts for different applications can be exchanged within a few seconds

-3-piece take apart for efficient cleaning and interchange of inserts.

-The plug for standardized bipolar cables, which enables the connection to nearly all common high frequency generators, is integrated in the particularly ergonomic handle.

-Reusable instrument and bipolar cable for cost containment.



LIST NO. 52205-510	5MM, 34CM SCISSORS, CURVED		LIST NO. 52205-521	5MM, 34CM LARGE GRASPING FORCEPS
		LIST NO. 52205-524		
LIST NO. 52205-516	5MM, 34CM MARYLAND DISSECTOR, CURVED	LIST NO. 52205-524	LIST NO. 52205-522	5MM, 34CM FORCEPS, CURVED
LIST NO. 52205-520	5MM, 34CM GRASPING FORCEPS, CURVED		LIST NO. 52205-523	5MM, 34CM DELTA GRASPER

Bipolar Cables For Use With InfinityBipolar Powergrip Forceps & Scissors

TYPE II KLEPPINGER PLUG & DUAL-BANANA GENERATOR PLUG

LIST NO. 52005-22

OR

TYPE II KLEPPINGER PLUG & INFI-NITY/WOLF GENERATOR PLUG

LIST NO. 52005-21

360° Rotatable Orbitaris Bipolar Scissors & Forceps

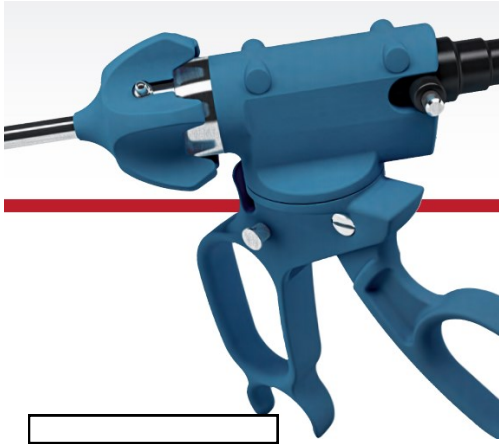

Features:

- The handle can be rotated through 360°, so the surgeons ideal ergonomic handling position can be achieved. The surgeon and patient requirement for function and safety has been greatly enhanced, over standard handles, to include surgeon comfort during the demands of minimally invasive surgery.
- 3-piece take apart for efficient cleaning and interchange of inserts.
- The plug for standardized bipolar cables, which enables the connection to nearly all common high frequency generators, is integrated in the particularly ergonomic handle.
- Reusable instrument and bipolar cable for cost containment.



LIST NO. 52205-010
5MM, 34CM SCISSORS, CURVED



LIST NO. 52205-024
5MM, 34CM GRASPING FORCEPS W/ 2X3 TEETH



LIST NO. 52205-021
5MM, 34CM LARGE GRASPING FORCEPS



LIST NO. 52205-016
5MM, 34CM MARYLAND DISSECTOR, CURVED



LIST NO. 52205-022
5MM, 34CM FORCEPS, CURVED



LIST NO. 52205-020
5MM, 34CM GRASPING FORCEPS, CURVED



LIST NO. 52205-023
5MM, 34CM DELTA GRASPER

Bipolar Cables For Use With Bipolar Powergrip Forceps & Scissors



TYPE II KLEPPINGER PLUG & DUAL-BANANA GENERATOR PLUG
LIST NO. 52005-22

OR



TYPE II KLEPPINGER PLUG & / WOLF GENERATOR PLUG
LIST NO. 52005-21

Powergrip 3.0mm Bipolar Dissector & Grasper

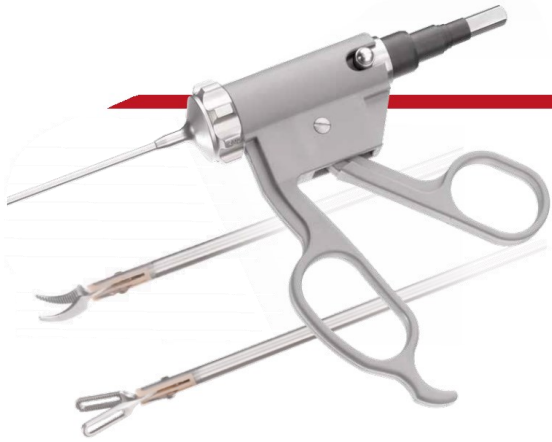

Features:

- Powergrip 3.0 micro - bipolar coagulation forceps 0 3mm Offer all benefits of the tried and tested Powergrip coagulation pliers, but entice with their shaft diameter of only 3 mm
- 3-piece take apart for efficient cleaning and interchange of inserts.
- The plug for standardized bipolar cables, which enables the connection to nearly all common high frequency generators, is integrated in the particularly ergonomic handle.
- Reusable instrument and bipolar cable for cost containment.

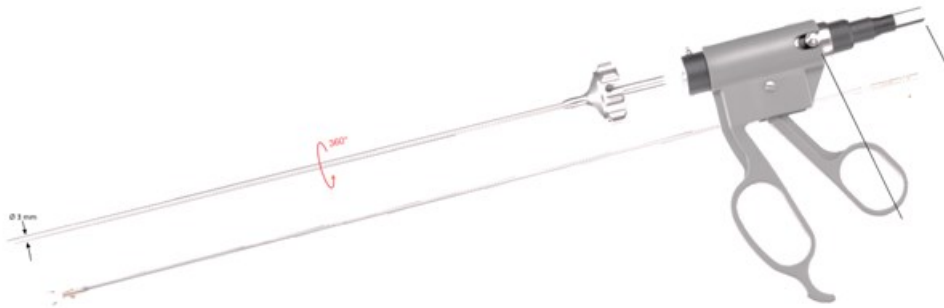

TIP ID.	DIAMETER	LENGTH	INSERT NO.	HANDLE NO.	SHAFT NO.	COMPLETE INSTRUMENT
 MARYLAND DISSECTOR, CURVED	3MM	20CM	53020-322I	52203-152	52203-204	53020-322
	3MM	29CM	53029-302I	52203-152	52203-202	53029-302
 FENESTRATED GRASPING FORCEPS	3MM	20CM	53020-320I	52203-152	52203-204	53020-320
	3MM	29CM	53029-300I	52203-152	52203-202	53029-300

Bipolar Cables For Use With AMERISURG Bipolar Dissector & Grasper



TYPE II KLEPPINGER PLUG & DUAL-BANANA GENERATOR PLUG
LIST NO. 52005-22

OR



TYPE II KLEPPINGER PLUG & WOLF GENERATOR PLUG
LIST NO. 52005-21

Classic Bipolar Scissors & Forceps

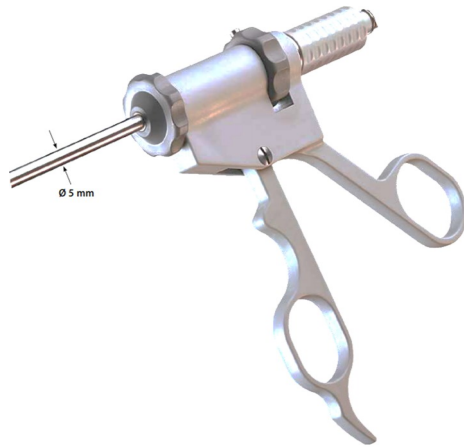

Features:

-The bipolar coagulation forceps which can be dismantled is a reusable instrument to be used for laparoscopy for grasping and cutting the tissue with simultaneous bipolar coagulation. The easy dismantling enables the use of different electrodes, facilitates cleaning and the execution of repair work. By using an adapter, the forceps can be connected with bipolar standard forceps cables to nearly all common high-frequency generators.

-3-piece take apart for efficient cleaning and interchange of inserts.

-The plug for standardized bipolar cables, which enables the connection to nearly all common high frequency generators, is integrated in the particularly ergonomic handle.

-Reusable instrument and bipolar cable for cost containment.

ELECTRODES	DIAMETER	LENGTH	INSERT NO.	HANDLE NO.	INTERIOR TUBE	EXTERIOR TUBE	2-PIN PLUG	COMPLETE INSTRUMENT
 FENESTRATED GRASPER W/ WAVE	5MM	20CM	55020-060I	52000-00	55020-051	55020-052	52000-401	55020-060
	5MM	34CM	55034-010I		55034-002	55034-003		55034-010
	5MM	45CM	55045-020I		55045-006	55045-007		55045-020
 FLUTED TIP, 1MM	5MM	20CM	55020-061I	52000-00	55020-051	55020-052	52000-401	55020-061
	5MM	34CM	55034-011I		55034-002	55034-003		55034-011
	5MM	45CM	55045-021I		55045-006	55045-007		55045-021
 KLEPPINGER, SERRATED	5MM	20CM	55020-063I	52000-00	55020-051	55020-052	52000-401	55020-063
	5MM	34CM	55034-013I		55034-002	55034-003		55034-013
	5MM	45CM	55045-023I		55045-006	55045-007		55045-023
 TONG-TYPE BIT, 3MM	5MM	20CM	55020-065I	52000-00	55020-051	55020-052	52000-401	55020-065
	5MM	34CM	55034-015I		55034-002	55034-003		55034-015
	5MM	45CM	55045-025I		55045-006	55045-007		55045-025
 SCISSORS, CURVED	5MM	20CM	55020-067I	52000-00	55020-051	55020-052	52000-401	55020-067
	5MM	34CM	55034-017I		55034-002	55034-003		55034-017
	5MM	45CM	55045-027I		55045-006	55045-007		55045-027
 SCISSORS W/ TC BLADE CURVED	5MM	20CM	55020-068I	52000-00	55020-051	55020-052	52000-401	55020-068
	5MM	34CM	55034-018I		55034-002	55034-003		55034-018
	5MM	45CM	55045-028I		55045-006	55045-007		55045-028
 MARYLAND DISSCETOR, CURVED	5MM	20CM	55020-069I	52000-00	55020-051	55020-052	52000-401	55020-069
	5MM	34CM	55034-019I		55034-002	55034-003		55034-019
	5MM	45CM	55045-029I		55045-006	55045-007		55045-029

TYPE II KLEPPINGER PLUG & / WOLF GENERATOR PLUG

LIST NO. 52005-45

Bipolar Cables For Use With Bipolar Dissector & Grasper

TYPE II KLEPPINGER PLUG & DUAL-BANANA GENERATOR PLUG

LIST NO. 52005-46

Triple Function Forceps

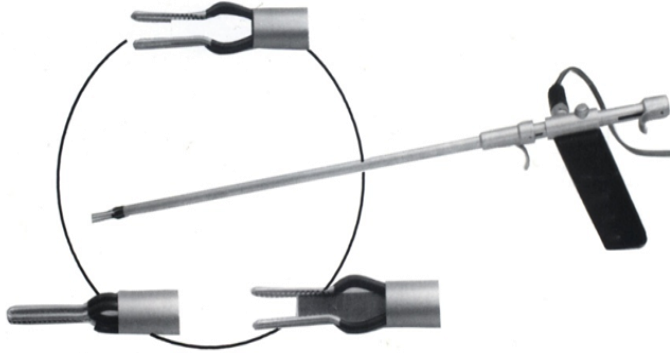

The Most Effective Multipurpose Instrument of Its Kind, With Features Such As:

- **Multiple Functions** - Securely Grasp / Dissect Tissue / Safely Coagulate in the Bipolar Mode / Transect Tissue / Retract Tissue
- **Reusability** - easy, cost effective cleaning & maintenance
- Eliminating costly stapling devices
- One instrument, One insertion
- Reducing procedure time

Bipolar Cables For Use With Bipolar Triple Function Forceps

LIST NO.	DESCRIPTION
52510-00	BIPOLAR TRIPLE FUNCTION FORCEPS: 30 CM LONG, 10 MM
52510-00-01	COMPLETE INNER SHAFT ASSEMBLY WITH BLADE
52510-00-02	BLADE ASSEMBLY FOR TRIPLE FUNCTION FORCEPS

LIST NO.	DESCRIPTION
52005-80	BIPOLAR RF-CABLE FOR BIPOLAR TRIPLE FUNCTION FORCEPS AND / WOLF GENERATORS
52005-81	BIPOLAR RF-CABLE FOR BIPOLAR TRIPLE FUNCTION FORCEPS AND MACHINE WITH TWO BANANA-PLUG CONNECTION

Bipolar Coagulation Probes

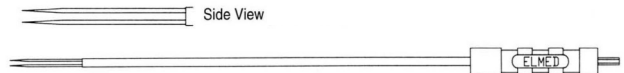

LIST NO.	DESCRIPTION
52103-35	3MM, 33CM BIPOLAR SPOT COAGULATION PROBE
52203-35	3MM, 45CM BIPOLAR SPOT COAGULATION PROBE
52205-42	5MM, 33CM BIPOLAR SPOT COAGULATION PROBE
52105-37	5MM, 45CM BIPOLAR SPOT COAGULATION PROBE

LIST NO.	DESCRIPTION
52005-99	5MM, 33CM BIPOLAR MYOMA COAGULATOR
52005-98	5MM, 45CM BIPOLAR MYOMA COAGULATOR
52005-97	5MM, 33CM BIPOLAR MYOMA COAGULATOR W/ TRUMPET VALVE
52005-96	5MM, 45CM BIPOLAR MYOMA COAGULATOR W/ TRUMPET VALVE

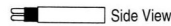

LIST NO.	DESCRIPTION
52205-92	5MM, 33CM BIPOLAR PROBE, TWO BLUNT PRONGS
52205-93	5MM, 33CM BIPOLAR PROBE, TWO BLUNT PRONGS W/ TRUMPET VALVE

Bipolar Cables For Use With Bipolar Coagulation Probes



LIST NO. 52005-22
TYPE II KLEPPINGER PLUG & DUAL-BANANA GENERATOR PLUG

OR



LIST NO. 52005-21
TYPE II KLEPPINGER PLUG & WOLF GENERATOR PLUG

Amerisurg Bi-Pol Cutter

The Amerisurg Bi-Pol Cutter consists of a fully insulated bipolar system w/ a retractable needle. When surgery is to be performed, the needle is advanced up to 4mm, depending on the depth of the desired cut. The end of the electrode, which has a ball-type shape, serves as the “return” electrode.

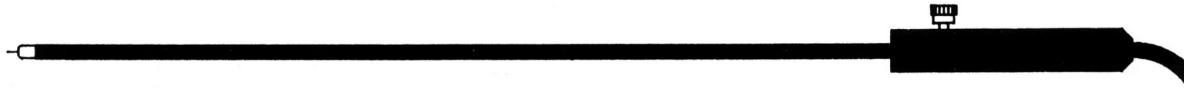

LIST NO.	DESCRIPTION
52205-90	5MM, 33CM BI-POL CUTTER
52105-90	5MM, 45CM BI-POL CUTTER

Bipolar J-Hook, L-Hook & Spatula Electrodes

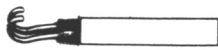

J-HOOK

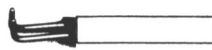

L-HOOK



SPATULA

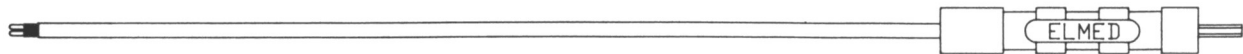

LIST NO.	DESCRIPTION
52205-120	5MM, 33CM BIPOLAR J-HOOK ELECTRODE
52205-121	5MM, 33CM BIPOLAR J-HOOK ELECTRODE W/ TRUMPET VALVE FOR IRRIGATION
52205-122	5MM, 33CM BIPOLAR L-HOOK ELECTRODE
52205-123	5MM, 33CM BIPOLAR L-HOOK ELECTRODE W/ TRUMPET VALVE FOR IRRIGATION
52205-124	5MM, 33CM BIPOLAR SPATULA ELECTRODE
52205-125	5MM, 33CM BIPOLAR SPATULA ELECTRODE W/ TRUMPET VALVE FOR IRRIGATION

LIST NO.	DESCRIPTION
52105-120	5MM, 45CM BIPOLAR J-HOOK ELECTRODE
52105-121	5MM, 45CM BIPOLAR J-HOOK ELECTRODE W/ TRUMPET VALVE FOR IRRIGATION
52105-122	5MM, 45CM BIPOLAR L-HOOK ELECTRODE
52105-123	5MM, 45CM BIPOLAR L-HOOK ELECTRODE W/ TRUMPET VALVE FOR IRRIGATION
52105-124	5MM, 45CM BIPOLAR SPATULA ELECTRODE
52105-125	5MM, 45CM BIPOLAR SPATULA ELECTRODE W/ TRUMPET VALVE FOR IRRIGATION

Bipolar Cables For Use With Amerisurg Bipolar Coagulation Probes



LIST NO. 52005-22
TYPE II KLEPPINGER PLUG & DUAL-BANANA GENERATOR PLUG

OR



LIST NO. 52005-21
AMERISURG TYPE II KLEPPINGER PLUG & AMERISURG / WOLF GENERATOR PLUG

Reusable Cables For Bipolar Instruments & Generators



WOLF GENERATOR END



DUAL-BANANNA PLUG GENERATOR END

LIST NO. 52005-21 / 5302	AMERISURG/WOLF PLUG (UNIT)& AMERISURG (DIN) INSTRUMENT PLUG
LIST NO. 52005-19	AMERISURG/WOLF PLUG (UNIT) & AMERISURG TYPE III
LIST NO. 52005-23	AMERISURG/WOLF UNIT PLUG & WOLF INST. PLUG
LIST NO. 52005-25	AMERISURG/WOLF PLUG (UNIT) & STORZ/WISAP/JARIT METAL INST.
LIST NO. 52005-17	AMERISURG/WOLF PLUG (UNIT) & STORZ/WISAP BARREL STYLE INST.
LIST NO. 52005-39	AMERISURG/WOLF PLUG (UNIT) & KLI/CIRCON INST.
LIST NO. 52005-41	AMERISURG/WOLF PLUG (UNIT) & EVEREST/COBALT
LIST NO. 52005-43	AMERISURG/WOLF PLUG (UNIT) & DAVOL INST. PLUG
LIST NO. 52005-45 / 5991	AMERISURG/WOLF PLUG (UNIT) & AESCULAP/DAVOL/MARINA 2-PIN INST. PLUG
LIST NO. 52005-60	AMERISURG/WOLF PLUG (UNIT) & LINVATEC/WECK/PILLING INST. PLUG
LIST NO. 52005-91	AMERISURG/WOLF PLUG (UNIT) & JARIT, ERBE INST.
LIST NO. 52005-13	AMERISURG/WOLF PLUG (UNIT) & IAMERISURG BI-CUT SCISSORS

INSTRUMENT END



BIPOLAR CABLE ADAPTERS

LIST NO. 52005-22 / 5230	DUAL-BANANA PLUG (UNIT) & AMERISURG(DIN) INSTRUMENT PLUG
LIST NO. 52005-20	DUAL-BANANA PLUG (UNIT) & AMERISURG TYPE III INST.
LIST NO. 52005-24	DUAL-BANANA PLUG (UNIT) & WOLF INST. PLUG
LIST NO. 52005-26	DUAL-BANANA PLUG (UNIT) & STORZ/WISAP/JARIT METAL PLUG
LIST NO. 52005-18	DUAL-BANANA PLUG (UNIT) & STORZ/WISAP BARREL STYLE INST. PLUG
LIST NO. 52005-40	DUAL-BANANA PLUG (UNIT) & KLI/CIRCON INST. PLUG
LIST NO. 52005-42	DUAL-BANANA PLUG (UNIT) & EVEREST/COBALT INST. PLUG
LIST NO. 52005-44	DUAL-BANANA PLUG (UNIT) & DAVOL INST. PLUG
LIST NO. 52005-46 / 5990	DUAL-BANANA PLUG (UNIT) & AESCULAP/DAVOL/MARINA 2-PIN INST. PLUG
LIST NO. 52005-61	DUAL-BANANA PLUG (UNIT) & LINVATEC/WECK/PILLING INST. PLUG
LIST NO. 52005-92	DUAL-BANANA PLUG (UNIT) & JARIT, ERBE INST. PLUG
LIST NO. 52005-14	DUAL-BANANA PLUG (UNIT) & AMERISURG BI-CUT SCISSORS



LIST NO.
5352
ADAPTER FOR AMERISURG /
WOLF GENERATOR PLUG &
4MM FEMALE BANANA CABLE
PLUGS



LIST NO.
52005-83
ADAPTER FOR DUAL MALE
BANA-NA GENERATOR PLUGS &
AMERISURG / WOLF RECEPTACLE
PLUG









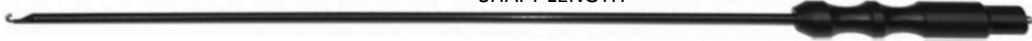

LIST NO.
52005-84
ADAPTER FOR DUAL MALE
BANANA GENERATOR PLUGS &
WOLF KLEPPINGER FORCEPS PLUG

5mm Diameter Monopolar Electrodes

32CM OR 45CM
SHAFT LENGTH

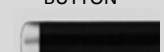

ELECTRODES	DIAMETER	LENGTH	<u>SIDE MOUNTED RF CONNECTOR</u>	<u>REAR MOUNTED RF CONNECTOR</u>
				
 J-HOOK	5MM	33CM	52205-38	52205-81
	5MM	45CM	52105-33	52105-81
 L-HOOK	5MM	33CM	52205-78	52205-82
	5MM	45CM	52105-35	52105-82
 SPATULA	5MM	33CM	52205-56	52205-83
	5MM	45CM	52105-46	52105-83
 CONE	5MM	33CM	52205-36	52205-88
	5MM	45CM	52105-31	52105-88
 BALL	5MM	33CM	52205-07	52205-89
	5MM	45CM	52105-07	52105-89
 KNIFE	5MM	33CM	52205-35	52205-90
	5MM	45CM	52105-30	52105-90
 NEEDLE	5MM	33CM	52205-37	52205-76
	5MM	45CM	52105-45	52105-74
 BUTTON	5MM	33CM	52205-37	52205-37R
	5MM	45CM	52105-02	52105-02R

Monopolar Cables For Use With Electrodes



LIST NO. 52005-31
4MM DIA. PLUG (UNIT) &
4MM DIA. FEMALE INST. PLUG



LIST NO. 52005-32
8MM DIA. "BOVIE" PLUG (UNIT) &
4MM DIA. FEMALE INST. PLUG

**5mm Diameter Monopolar Electrodes-
With Suction/Irrigation Port**

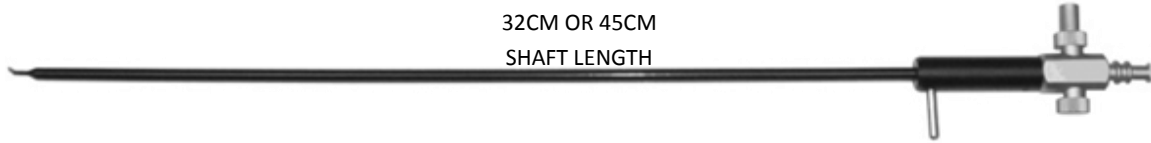

HANDLE STYLES	DIAMETER	LENGTH	J-HOOK	L-HOOK	SPATULA	CONE	SLING	KNIFE	NEEDLE	SUCTION TIP
 WITH LUER LOCK	5MM	33CM	52205-57L	52205-72L	52205-58L	52205-77L	52205-66L	52205-65L	52205-74L	52205-28L
	5MM	45CM	52105-48L	52105-56L	52105-58L	52105-58L	52105-48L	52105-47L	52105-74L	52105-28L
 WITH STOPCOCK	5MM	33CM	52205-57	52205-72	52205-58	52205-77	52205-66	52205-65	52205-74S	52205-27
	5MM	45CM	52105-48	52105-56	52105-58	52105-58	52105-48	52105-47	52105-74S	52105-24
 WITH TRUMPET VALVE	5MM	33CM	52205-63	52205-73	52205-64	52205-84	52205-68	52205-67	52205-74T	52205-26
	5MM	45CM	52105-54	52105-57	52105-50	52105-60	52105-52	52105-51	52105-74T	52105-23



LIST NO. 52005-31
4MM DIA. PLUG (UNIT) &
4MM DIA. FEMALE INST. PLUG

Monopolar Cables For Use With Electrodes



LIST NO. 52005-32
8MM DIA. "BOVIE" PLUG (UNIT) &
4MM DIA. FEMALE INST. PLUG

5mm Diameter Monopolar Electrodes - For Use W/ Hand-Switching Handles



"J" HOOK

33CM	LIST NO. 52850-81
36CM	LIST NO. 52836-81
45CM	LIST NO. 52815-81



"L" HOOK

33CM	LIST NO. 52850-82
36CM	LIST NO. 52836-82
45CM	LIST NO. 52815-82



SPATULA

33CM	LIST NO. 52850-83
36CM	LIST NO. 52836-83
45CM	LIST NO. 52815-83



CONE

33CM	LIST NO. 52850-84
36CM	LIST NO. 52836-84
45CM	LIST NO. 52815-84



BALL

33CM	LIST NO. 52850-85
36CM	LIST NO. 52836-85
45CM	LIST NO. 52815-85



KNIFE

33CM	LIST NO. 52850-86
36CM	LIST NO. 52836-86
45CM	LIST NO. 52815-86



NEEDLE

33CM	LIST NO. 52850-87
36CM	LIST NO. 52836-87
45CM	LIST NO. 52815-87



BUTTON

33CM	LIST NO. 52850-88
36CM	LIST NO. 52836-88
45CM	LIST NO. 52815-88

Reusable Cables For Monopolar Instruments & Generators



4MM "BANANA" GENERATOR END



8MM "BOVIE" GENERATOR END

INSTRUMENT END

LIST NO. 5021	4MM DIA. MALE INST. PLUG
LIST NO. 5022	OLSEN TYPE SCREW-ON INST. PLUG
LIST NO. 5029	OLYMPUS TYPE INST. PLUG
LIST NO. 5260	ACMI TYPE INST. PLUG
LIST NO. 5268	TAPERED "DOWNS" TYPE INST. PLUG
LIST NO. 52005-29	3MM DIA. FEMALE INST. PLUG
LIST NO. 52005-31	4MM DIA. FEMALE INST. PLUG
LIST NO. 52005-35	CORSON NEEDLE ELECTRODE INST. PLU
LIST NO. 52005-37	DUAL STAGE MALE (STORZ) INST. PLUG
LIST NO. 52005-47	RESECTOSCOPE INST. PLUG
LIST NO. 52005-49	4MM DIA. RECESSED PIN (WOLF/CORSON/STORZ) INST. PLUG
LIST NO. 52005-69	4MM DIA. SELF-RETAINING PLUG FOR STORZ SOLID POST INST.
LIST NO. 52005-71	4MM DIA. INSULATED OUTER SLEEVE PLUG FOR V.MUELLER INST
LIST NO. 52005-73	4MM DIA. EXTRA-LONG PLUG & 4MM DIA. EXTRA-LONG PLUG: STORZ INST.
LIST NO. 52005-75	4MM DIA. RIGHT ANGLE FEMALE INST. PLUG.
LIST NO. 52005-77	MALE LUER LOCK INST. PLUG
LIST NO. 52005-53	3MM DIA RECESSED POST PLUG FOR OLYMPUS RESECTOSCOPE
LIST NO. 5025	SCREW ON CODMAN TYPE PLUG



LIST NO. 5009	4MM DIA. MALE INST. PLUG
LIST NO. 5023	OLSEN TYPE SCREW-ON INST. PLUG
LIST NO. 5030	OLYMPUS TYPE INST. PLUG
LIST NO. 5261	ACMI TYPE INST. PLUG
LIST NO. 5269	TAPERED "DOWNS" TYPE INST. PLUG
LIST NO. 52005-30	3MM DIA. FEMALE INST. PLUG
LIST NO. 52005-32	4MM DIA. FEMALE INST. PLUG
LIST NO. 52005-36	CORSON NEEDLE ELECTRODE INST. PLU
LIST NO. 52005-38	DUAL STAGE MALE (STORZ) INST. PLUG
LIST NO. 52005-48	RESECTOSCOPE INST. PLUG
LIST NO. 52005-50	4MM DIA. RECESSED PIN (WOLF/CORSON/STORZ) INST. PLUG
LIST NO. 52005-70	4MM DIA. SELF-RETAINING PLUG FOR STORZ SOLID POST INST.
LIST NO. 52005-72	4MM DIA. INSULATED OUTER SLEEVE PLUG FOR V.MUELLER INST
LIST NO. 52005-74	4MM DIA. EXTRA-LONG PLUG & 4MM DIA. EXTRA-LONG PLUG: STORZ INST.
LIST NO. 52005-76	4MM DIA. RIGHT ANGLE FEMALE INST. PLUG.
LIST NO. 52005-78	MALE LUER LOCK INST. PLUG
LIST NO. 52005-54	3MM DIA RECESSED POST PLUG FOR OLYMPUS RESECTOSCOPE
LIST NO. 5026	SCREW ON CODMAN TYPE PLUG

MONOPOLAR CABLE ADAPTERS



LIST NO. 5414
ADAPTER FOR MALE "BOVIE" GENERATOR PLUG & 4MM FEMALE BANANA CABLE PLUG



LIST NO. 5415
ADAPTER FOR MALE "BOVIE" GENERATOR PLUG & DISPOSABLE INSTRUMENT PLUG



LIST NO. 5416
ADAPTER FOR MALE BANANA GENERATOR PLUG & DISPOSABLE INSTRUMENT PLUG

Irrigation / Suction Tubes

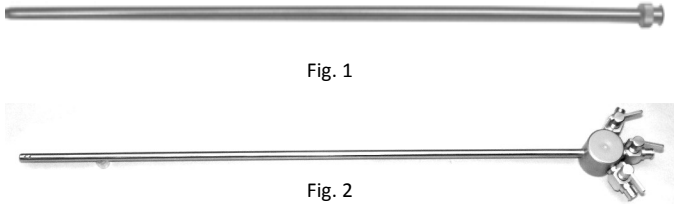

Fig. 1

Fig. 2

LIST NO. 52205-30	IRRIGATION / SUCTION TUBE w/ LUER FITTING, 33cm, 5mm DIA. -- Fig. 1
LIST NO. 52105-26	IRRIGATION / SUCTION TUBE w/ LUER FITTING, 45cm, 5mm DIA.
LIST NO. 52205-32	IRRIGATION / SUCTION PROBE w/ CM MARKINGS & STOPCOCK, 33cm, 5mm DIA.
LIST NO. 52105-28	IRRIGATION / SUCTION PROBE w/ CM MARKINGS & STOPCOCK, 45cm, 5mm DIA.
LIST NO. 52205-32T	IRRIGATION / SUCTION PROBE w/ CM MARKINGS & TRUMPET VALVE, 33cm, 5mm DIA.
LIST NO. 52105-28T	IRRIGATION / SUCTION PROBE w/ CM MARKINGS & TRUMPET VALVE, 45cm, 5mm DIA.
LIST NO. 52205-33	LAVAGE CANNULA w/ 3-WAY STOPCOCK, POOLE SUCTION TIP w/ LATERAL HOLES, 33cm, 5mm DIA.-- Fig. 2
LIST NO. 52105-33	LAVAGE CANNULA w/ 3-WAY STOPCOCK, POOLE SUCTION TIP w/ LATERAL HOLES, 45cm, 5mm DIA.

Irrigation / Suction Systems

EXTRA LARGE SUCTION PORTS

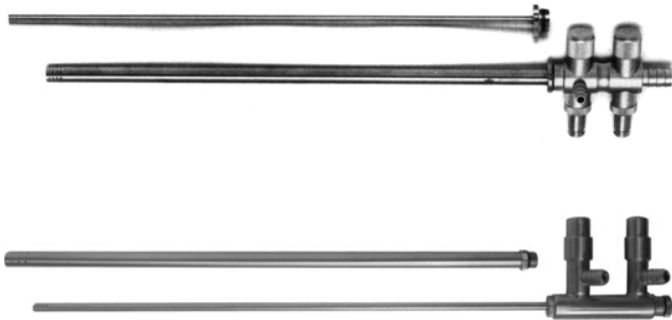

LIST NO. 52500-15	IRRIGATION / SUCTION SYSTEM W/ DUAL-VALVE HANDLE, COMPLETE W/ 33CM, 10MM & 5MM DIAMETER CANNULA
LIST NO. 52500-30	IRRIGATION / SUCTION SYSTEM W/ DOUBLE "O" RING TRUMPET VALVE HANDLE, W/ INSTRUMENT CHANNEL, COMPLETE W/ 33CM, 10MM & 5MM DIA. CANNULA
LIST NO. 52500-31	IRRIGATION / SUCTION SYSTEM W/ DOUBLE "O" RING TRUMPET VALVE HANDLE, W/ INSTRUMENT CHANNEL, COMPLETE W/ 45CM, 10MM & 5MM DIA. CANNULA

TWO-WAY VALVE IRRIGATION/SUCTION SYSTEM



LIST NO. 52500-25	5MM, 33CM IRRIGATION / SUCTION SYSTEM W/ TWO-WAY LEVER VALVE, CANNULA W/ CENTRAL & LATERAL DISTAL OPENINGS
LIST NO. 52500-26	5MM, 45CM, IRRIGATION / SUCTION SYSTEM W/ TWO-WAY LEVER VALVE, CANNULA W/ CENTRAL & LATERAL DISTAL OPENINGS

Irrigation / Suction Tubes

NETZHAT STYLE IRRIGATION/SUCTION SYSTEM



LIST NO. 52500-16	NETZHAT STYLE IRRIGATION / SUCTION SYSTEM W/ DUAL TRUMPET VALVE HANDLE, COMPLETE W/ 33CM, 10MM & 5MM DIAMETER CANNULA
----------------------	---

CORSON STYLE IRRIGATION/SUCTION SYSTEM



LIST NO. 52205-94	CORSON STYLE IRRIGATION / SUCTION SYSTEM (NOT INCLUDING NEEDLE ELECTRODE), W/ 33CM, 5MM DIAMETER CANNULA
LIST NO. 52205-95	CORSON STYLE NEEDLE ELECTRODE FOR CANNULA
LIST NO. 52003-13	SEALING CAP FOR CORSON STYLE CANNULA, (PKG. OF 10)

Monopolar Cables For Use With Corson Style Irrigation / Suction System



LIST NO. 52005-35
4MM DIA. PLUG & CORSON NEEDLE ELECTRODE INST. PLUG



LIST NO. 52005-36
8MM DIA. "BOVIE" PLUG & CORSON NEEDLE ELECTRODE INST. PLUG

Triple Function Suction / Irrigation Cannula

Our special Triple Function Irrigation / Suction instruments feature interchangeable cannula and will accept standard instruments through their center allowing three functions through one portal. The instruments consist of unique handles, List No. 52500-10 and 52500-11, incorporating two trumpet valves with 7mm diameter ports, one controls the suction, the other one controls the irrigation. The 7mm diameter ports and perfect seal trumpet valve provide a greater flow volume, no clogging and perfect sealing, thus preventing the irrigation fluid from leaking into the instrument. These handles and their respective cannula will accept standard diameter laparoscopic and pelviscopic instruments. These Irrigation / Suction Cannula are ideally suited for use with the new AMERISURG or other brands of laparoscopic electrosurgical instruments. A variety of different cannula are available for the irrigation/suction handle. These cannula will fit through all standard 10mm and 5mm diameter trocar sleeves and are available in both 33cm and 45cm lengths. Poole suction tip cannula are available – see below.

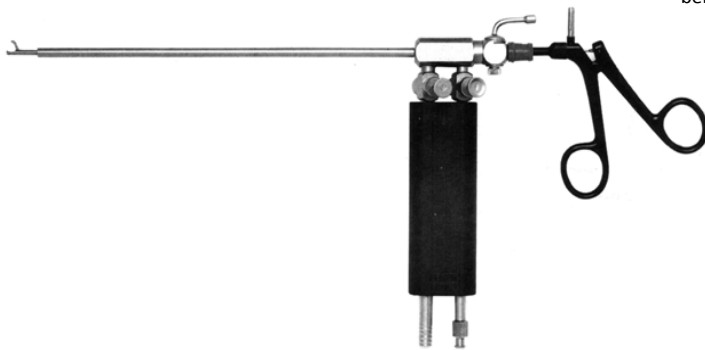

LIST NO. 52500-10	McLUCAS TRIPLE-FUNCTION HANDLE, COMPLETE w/ 33cm, 5mm DIAMETER CANNULA (Illustrated w/ an instrument inserted through its center)
----------------------	---

TECHNICAL & ORDERING DATA FOR McLUCAS & AMERISUG TRIPLE-FUNCTION CANNULA COMPLETE SYSTEMS

LIST NO. 52500-00	IRRIGATION / SUCTION CANNULA SYSTEM ACCORDING TO BRUCE McLUCAS, M.D., w/ 33cm CANNULA; INCLUDES: LIST NO. 52500-10 HANDLE & LIST NOS. 52510-01 & 52505-21 CANNULA
LIST NO. 52500-01	IRRIGATION / SUCTION CANNULA SYSTEM ACCORDING TO BRUCE McLUCAS, M.D., w/ 45cm CANNULA; INCLUDES: LIST NO. 52500-10 HANDLE & LIST NOS. 52510-03 & 52505-23 CANNULA
LIST NO. 52500-02	IRRIGATION / SUCTION CANNULA SYSTEM, w/ 33cm CANNULA; INCLUDES: LIST NO. 52500-11 HANDLE & LIST NOS. 52510-01 & 52505-21 CANNULA
LIST NO. 52500-03	IRRIGATION / SUCTION CANNULA SYSTEM, w/ 45cm CANNULA; INCLUDES: LIST NO. 52500-11 HANDLE & LIST NOS. 52510-03 & 52505-23 CANNULA

INDIVIDUAL COMPONENTS:



LIST NO. 52500-11	TRIPLE-FUNCTION HANDLE, w/ DUAL TRUMPET VALVES, COMPLETE w/ 33cm, 5mm DIAMETER CANNULA
----------------------	--

LIST NO. 52500-10	MCLUCAS TRIPLE-FUNCTION SUCTION/IRRIGATION LONG HANDLE W/ TWO 7MM DIAMETER TRUMPET VALVES, WITHOUT CANNULA
LIST NO. 52500-11	TRIPLE-FUNCTION SUCTION/IRRIGATION SHORT HANDLE W/ TWO 7MM DIAMETER TRUMPET VALVES, WITHOUT CANNULA
LIST NO. 52505-21	5MM DIA., 33CM LONG CANNULA, (FOR 3MM DIAMETER INSTRUMENTS)
LIST NO. 52505-22	5MM DIA., 33CM LONG SUCTION CANNULA, W/ POOLE SUCTION TIP
LIST NO. 52505-23	5MM DIA., 45CM LONG CANNULA, (FOR 3MM DIAMETER INSTRUMENTS)
LIST NO. 52505-24	5MM DIA., 45CM LONG SUCTION CANNULA, W/ POOLE SUCTION TIP
LIST NO. 52510-01	10MM DIA., 33CM LONG CANNULA, (FOR 3MM DIAMETER INSTRUMENTS)
LIST NO. 52510-02	10MM DIA., 33CM LONG SUCTION CANNULA, 5MM DIA., W/ POOLE SUCTION TIP
LIST NO. 52510-03	10MM DIA., 45CM LONG CANNULA, 5MM DIA. (FOR 3MM DIAMETER INSTRUMENTS)
LIST NO. 52510-04	10MM DIA., 45CM LONG SUCTION CANNULA, 5MM DIA., W/ POOLE SUCTION TIP

Irrigation / Suction Tubes For Disposable Handles



STYLE	DIAMETER	LENGTH	STRYKER™ STYLE	BARD™/DAVOL™ STYLE	CARDINAL HEALTH™ PULSEWAVE™ STYLE	CIRCON™/ACMI™ SURGI-FLEX™ STYLE	COMED™ CORE STYLE
REGULAR TIP- VENTED STAINLESS STEEL FINISH	3MM	20CM	52720-403	52920-403	52420-403	52620-403	52820-403
	3MM	30CM	52730-403	52930-403	52430-403	52630-403	52830-403
	5MM	28CM	52728-403	52928-403	52428-403	52628-403	52828-403
	5MM	32CM	52732-403	52932-403	52432-403	52632-403	52832-403
	5MM	45CM	52745-403	52945-403	52445-403	52645-403	52845-403
	10MM	28CM	52728-404	52928-404	52428-404	52628-404	52828-404
	10MM	32CM	52732-404	52932-404	52432-404	52632-404	52832-404
	10MM	45CM	52745-404	52945-404	52445-404	52645-404	52845-404
REGULAR TIP NON-VENTED REFLECTIVE FINISH	3MM	20CM	52720-409	52920-409	52420-409	52620-409	52820-409
	3MM	30CM	52730-409	52930-409	52430-409	52630-409	52830-409
	5MM	28CM	52728-409	52928-409	52428-409	52628-409	52828-409
	5MM	32CM	52732-409	52932-409	52432-409	52632-409	52832-409
	5MM	45CM	52745-409	52945-409	52445-409	52645-409	52845-409
	10MM	28CM	52728-410	52928-410	52428-410	52628-410	52828-410
	10MM	32CM	52732-410	52932-410	52432-410	52632-410	52832-410
	10MM	45CM	52745-410	52945-410	52445-410	52645-410	52845-410
POOL SUCTION TIP	3MM	20CM	52720-406	52920-406	52420-406	52620-406	52820-406
	3MM	30CM	52730-406	52930-406	52430-406	52630-406	52830-406
	5MM	28CM	52728-406	52928-406	52428-406	52628-406	52828-406
	5MM	32CM	52732-406	52932-406	52432-406	52632-406	52832-406
	5MM	45CM	52745-406	52945-406	52445-406	52645-406	52845-406
	10MM	28CM	52728-405	52928-405	52428-405	52628-405	52828-405
	10MM	32CM	52732-405	52932-405	52432-405	52632-405	52832-405
	10MM	45CM	52745-405	52945-405	52445-405	52645-405	52845-405

Irrigation / Suction Tubes For Disposable Handles
--



STYLE	DIAMETER	LENGTH	STRYKER™ STYLE	BARD™/DAVOL™ STYLE	CARDINAL HEALTH™ PULSEWAVE™ STYLE	CIRCON™/ACMI™ SURGI-FLEX™ STYLE	COMED™ CORE STYLE
STONE SCOOPER	10MM	32CM	52732-492	52932-492	52432-492	52632-492	52832-492
	10MM	45CM	52745-492	52945-492	52445-492	52645-492	52845-492
HYDRO- DISSECTION TIP	3MM	20CM	52720-407	52920-407	52420-407	52620-407	52820-407
	3MM	30CM	52730-407	52930-407	52430-407	52630-407	52830-407
	5MM	32CM	52732-407	52932-407	52432-407	52632-407	52832-407
	5MM	45CM	52745-407	52945-407	52445-407	52645-407	52845-407
ASPIRATION NEEDLE TIP	3MM	20CM	52720-437	52920-437	52420-437	52620-437	52820-437
	3MM	30CM	52730-437	52930-437	52430-437	52630-437	52830-437
	5MM	32CM	52732-437	52932-437	52432-437	52632-437	52832-437
	5MM	45CM	52745-437	52945-437	52445-437	52645-437	52845-437

OPTIONS FOR STAINLESS STEEL CANNULAS:

- NON-REFLECTIVE FINISH— ADD LETTERS “NR” TO NUMBER
- BLACK EBONIZED FINISH FOR LASER APPLICATION—ADD LETTER “E” TO NUMBER
- CUSTOM WORKING LENGTH—ADD LENGTH TO DESCRIPTION—NON-RETURNABLE

Monopolar RF Electrodes For Disposable Handles

- Double insulated w/ replaceable tip protector sleeve for increased safety
- Quick disconnect for easy cleaning & re-sterilization
- Suction / Irrigation with cutting coagulation

STYLE	DIAMETER	LENGTH	STRYKER™ STYLE	BARD™/DAVOL™ STYLE	CARDINAL HEALTH™ PULSEWAVE™ STYLE	CIRCON™/ACMI™ SURGI-FLEX™ STYLE	COMED™ CORE STYLE
SPATULA TIP	5MM	32CM	52732-441	52932-441	52432-441	52632-441	52832-441
	5MM	45CM	52745-441	52945-441	52445-441	52645-441	52845-441
L-HOOK TIP	5MM	32CM	52732-442	52932-442	52432-442	52632-442	52832-442
	5MM	45CM	52745-442	52945-442	52445-442	52645-442	52845-442
J-HOOK TIP	5MM	32CM	52732-443	52932-443	52432-443	52632-443	52832-443
	5MM	45CM	52745-443	52945-443	52445-443	52645-443	52845-443
NEEDLE TIP	5MM	32CM	52732-444	52932-444	52432-444	52632-444	52832-444
	5MM	45CM	52745-444	52945-444	52445-444	52645-444	52845-444
BALL TIP	5MM	32CM	52732-445	52932-445	52432-445	52632-445	52832-445
	5MM	45CM	52745-445	52945-445	52445-445	52645-445	52845-445
BULLET SUCTION TIP	5MM	32CM	52732-446	52932-446	52432-446	52632-446	52832-446
	5MM	45CM	52745-446	52945-446	52445-446	52645-446	52845-446
PROTECTOR SHEATH-3/PK	5MM	32CM	52732-500	52932-500	52432-500	52632-500	52832-500
	5MM	45CM	52745-500	52945-500	52445-500	52645-500	52845-500

Endo-Test Units For Insulation Testing



1ST GENERATION

LIST NO. 52-5685

ENDO-TEST UNIT - COMPLETE PACKAGE INCLUDES: AUTOCLAVABLE TEST ELECTRODES (INSULATION TEST); 3MM SPONGES (5), 5MM SPONGES (5) & 10MM SPONGES (5); TEST CABLES (INSULATION TEST). *PLEASE SPECIFY CABLE FOR VALLEYLAB UNITS IF REQUIRED – ORDER EXTRA



2ND GENERATION

LIST NO. 52-5686

ENDO-TEST UNIT WITH MONOPOLAR & BIPOLAR CABLE TESTER CIRCUIT COMPLETE PACKAGE INCLUDES SAME AS #52-5685 PLUS ADAPTERS & CABLE REQUIRED FOR CABLE TEST



3RD GENERATION

LIST NO. 52-5687

ENDO-TEST UNIT WITH MONOPOLAR & BIPOLAR CABLE TESTER CIRCUIT W/ ADVANCED SENSORY DETECTION OF INSULATION DEFECTS: COMPLETE PACKAGE INCLUDES SAME AS #52-5685 PLUS ADAPTERS & CABLE REQUIRED FOR CABLE TEST

ACCESSORIES FOR ENDO-TEST:

LIST NO	DESCRIPTION
52-5685-01	ELECTRODE FOR CAPACITANCE TEST
52-5685-02	ELECTRODE FOR INSULATION TEST
52-5685-03	5 MM SPONGE INSERT FOR INSULATION TEST (10/PKG.)
52-5685-04	10 MM SPONGE INSERT FOR INSULATION TEST (10/PKG.)
52-5685-05	TEST CABLE FOR INSULATION TEST W/ 4 MM FEMALE CONNECTOR
52-5685-06	TEST CABLE FOR CAPACITANCE TEST W/ 1/4" PHONO PLUG
52-5685-07	*TEST CABLE FOR CAPACITANCE TEST FOR VALLEYLAB UNITS
52-5685-08	3 MM SPONGE INSERT FOR INSULATION TEST (10/PKG.)

ACCESSORIES FOR CABLE TESTER:

LIST NO	DESCRIPTION
52-5686-11	BIPOLAR ADAPTER CABLE
52-5686-12	BOVIE PLUG ADAPTER
52-5686-13	BANANA PLUG ADAPTER
52-5686-14	BANANA PLUG CONVERTOR ADAPTER
52-5680-15	BIPOLAR CABLE ADAPTER FOR KLEPPINGER FORCEPS CABLES
52-5680-16	BIPOLAR CABLE ADAPTER FOR 2-PIN PLUG CABLES
52-5680-17	ALLIGATOR TEST CLIP FOR ENDO-TESTER
52-5685-10	INSULATED HANDLE TEST ELECTRODE W/ ATTACHED CABLE, FOR USE W/ INSULATION TEST ELECTRODE

Supplies For Laparoscopic Procedures & Instrument Maintenance



LIST NO. 52003-80	WATER JET CLEANING GUN FOR CONNECTION TO
----------------------	--

The Instrument Cleaning Kit is an effective and easy-to-use solution to your laparoscopic instrumentation cleaning needs. It was designed with your convenience in mind.

The Instrument Cleaning Kit consists of List No. 52003-80 & List No. 52003-81

- A) SHEATHS AND INSERTS, SYRINGES, INJECTION CANNULA
 - B) SHEATHS, PIPETTES
 - C) CATHETERS
 - D) DRAINAGE TUBES
 - E) COCKS, CANNULA AND SYRINGES
 - F) BOTTLES
 - G) DOUCHE FITTINGS
 - H) WATER JET PUMP
- (ALSO SUITABLE FOR DRYING IN CONJUNCTION W/ THE FITTINGS)

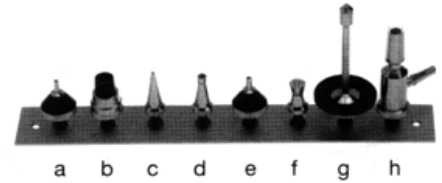

LIST NO. 52003-81	SET OF ADAPTERS FOR THE CLEANING OF (A) THROUGH (H)
----------------------	---

ULTRASTOP "PRO MED" ANTI-FOGGING AGENT



Ultrastop is the most cost-effective method of protecting your medical optics from fogging up: it eliminates the need to warm up your endoscopes prior to use; and due to its

LIST NO. 52003-37	ULTRASTOP, PER DOZEN BOTTLES
LIST NO. 52003-38	ULTRASTOP, PER BOTTLE

LUBRICATING OIL FOR SURGICAL INSTRUMENTS



To maintain high quality of costly surgical instrument joints and other components, a light application of surgical instruments should be made prior to sterilization

LIST NO. 52003-39	ONE DOZEN, 0.5 OZ EACH, NON-STERILE
LIST NO. 52003-40	ONE BOTTLE, 0.5 OZ. EACH, NON-STERILE

CLEANING BRUSHES FOR ENDOSCOPIC INSTRUMENTS



LIST NO. (QTY. 10)	STAINLESS STEEL WIRE AND ANTI-MICROBIAL BRUSHES MADE IN THE USA	LIST NO. (QTY. 1)
52003-56	2 MM Ø FOR 2MM Ø CANNULAS (12" LONG)	52003-57
52003-21	4 MM Ø FOR 3, 4 MM Ø CANNULAS (TROCAR SLEEVES, ETC) 12" LONG	52003-22
52003-23	6 MM Ø FOR 5, 6 MM Ø CANNULAS (TROCAR SLEEVES, ETC) 12" LONG	52003-24
52003-25	8 MM Ø FOR 7, 8 MM Ø CANNULAS (TROCAR SLEEVES, ETC) 12" LONG	52003-26
52003-27	12 MM Ø FOR 10, 11, 12 MM Ø CANNULAS (TROCAR SLEEVES, ETC) 12" LONG	52003-28
52003-29	4 MM Ø FOR 3, 4 MM Ø CANNULAS (SINGLE PUNCTURE LAPAROSCOPE, ETC) 19" LONG	52003-30
52003-31	6 MM Ø FOR 5, 6 MM Ø CANNULAS (S.P. LAPAROSCOPE, BIPOLAR FCPS, ETC) 19" LONG	52003-32
52003-33	8 MM Ø FOR 7, 8 MM Ø CANNULAS (S.P. LAPAROSCOPE, SUCTION TUBES, ETC) 19" LONG	52003-34
52003-48	12 MM Ø FOR 10, 11, 12 MM Ø CANNULAS (LAP. INSTR, SUCTION TUBES, ETC) 19" LONG	52003-49
52003-35	VERRES NEEDLES (8" LONG)	52003-36
52003-41	NYLON BRISTLE BRUSH WITH HANDLE 7" LONG 52003-43	52003-42
52003-45	STAINLESS STEEL BRISTLE BRUSH WITH HANDLE 7" LONG	52003-47
52003-54	DOUBLE END NYLON BRISTLE BRUSH W/HANDLE FOR LAPAROSCOPIC INST. 7" LONG	52003-55

Sterilization & Storage Containers For Lap Instruments & Scopes

NEW FROM AMERISURG!!!

Light Weight Aluminum Sterilization & Storage Containers That Can Hold Up To 16 Instruments (also available with a removable tray for general instruments as well)

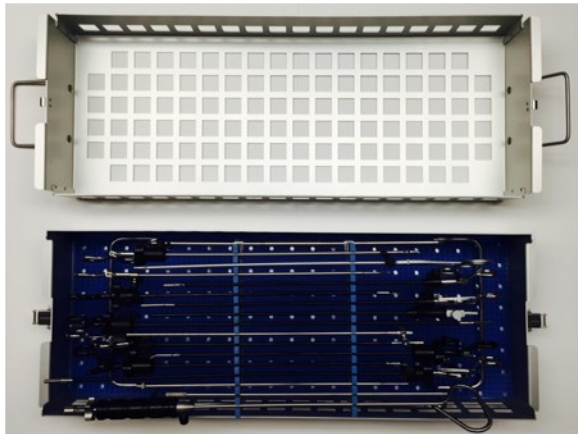

LIST NO. 52038-48
 ALUMINUM LIGHTWEIGHT LAP INSTRUMENT STERILIZATION & STORAGE CONTAINER FOR 33CM & 45CM INSTRUMENTS; HOLDS UP TO (16) 5MM & 10MM DIAMETER INSTRUMENTS (26" X 10" X 7")

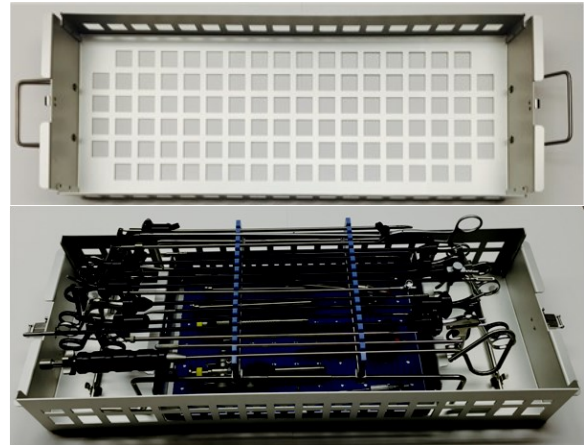

LIST NO. 52038-49
 ALUMINUM LIGHTWEIGHT LAP INSTRUMENT STERILIZATION & STORAGE CONTAINER FOR 33CM & 45CM INSTRUMENTS; HOLDS UP TO (16) 5MM & 10MM DIAMETER INSTRUMENTS ALONG WITH TAKE OUT TRAY FOR MISC. INSTRUMENTS (26" X 10" X 7")



LIST NO. 52038-53
 LAP INSTRUMENT STERILIZATION & STORAGE CONTAINER FOR 33CM INSTRUMENTS; HOLDS UP TO (12) 5MM & 10MM DIAMETER INSTRUMENTS (MOLDED MEDICAL GRADE POLYMER, 21" X 10" X 4")

LIST NO. 52038-54
 LAP INSTRUMENT STERILIZATION & STORAGE CONTAINER FOR 45CM INSTRUMENTS; HOLDS UP TO (16) 5&10MM DIAMETER INSTRUMENTS (MOLDED MEDICAL GRADE POLYMER, 25" X 12" X 5")



LIST NO. 52038-51
 LAP INSTRUMENT CONTAINER W/ REMOVABLE TRAY FOR 33CM INSTRUMENT HOLDS UP TO (12) 5MM & 10MM DIAMETER INSTRUMENTS (MOLDED MEDICAL GRADE POLYMER & SILICONE, 21" X 10" X 7")

LIST NO. 52038-52
 LAP INSTRUMENT CONTAINER W/ REMOVABLE TRAY FOR 45CM INSTRUMENTS; HOLDS UP TO (10) 5&10MM DIAMETER INSTRUMENTS (MOLDED MEDICAL GRADE POLYMER & SILICONE, 26" X 9 1/2" X 7")

Sterilization & Storage Containers For Lap Instruments & Scopes



LIST NO. 52037-00-B4	ALUMINUM STERILIZATION CONTAINER 25" X 5" X 2", W/ 4 BARS
-------------------------	--

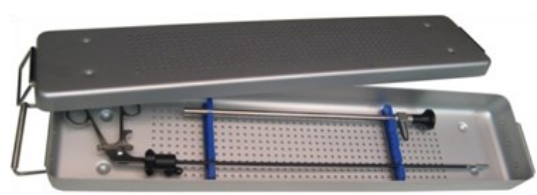

LIST NO. 52037-00-B2	ALUMINUM STERILIZATION CONTAINER 25" X 5" X 2", W/ 2 BARS
-------------------------	--



LIST NO. 52037-07	THERMOPLASTIC STERILIZATION & STORAGE CONTAINER W/ SILICONE MOUNTING BARS FOR MULTIPLE LAP/HYSTO/CYSTO SCOPE OR SINGLE HYST/CYST SHEATH SYSTEM, (MOLDED MEDICAL-GRADE POLYMER & SILICONE), 18"L X 7"W X 1.5"H
----------------------	---



LIST NO. 52037-06	THERMOPLASTIC STERILIZATION & STORAGE CONTAINER FOR 2 LAP/HYSTO/CYSTO SCOPES OR SINGLE HYST/CYST SHEATH SYSTEM, (MOLDED MEDICAL-GRADE POLYMER & SILICONE), 18"L X 3"W X 1.5"H
----------------------	---

ALSO AVAILABLE, BUT NOT PICTURED...

LIST NO. 52037-05	THERMOPLASTIC STERILIZATION & STORAGE CONTAINER FOR SINGLE LAP/HYSTO/CYSTO SCOPE OR SINGLE HYST/CYST SHEATH SYSTEM (MOLDED MEDICAL-GRADE POLYMER & SILICONE) 18"L X 3"W X 1.5"H
LIST NO. 52037-08	THERMOPLASTIC STERILIZATION & STORAGE CONTAINER (DOUBLE HEIGHT) FOR MULTIPLE LAP/HYSTO/CYSTO SCOPE OR SINGLE HYST/CYST SHEATH SYSTEM, (MOLDED MEDICAL-GRADE POLYMER & SILICONE), 18"L X 7"W X 3"H
LIST NO. 52038-15	STERILIZATION & STORAGE CONTAINER FOR EXTRA-LONG SCOPE & CABLE, 25" X 6" X 1.5" (MOLDED MEDICAL-GRADE POLYMER & SILICONE); HOLDS 2 SCOPES UP TO 50CM LONG
LIST NO. 52037-11	MUSLIN CLOTH FOR 52037-00 & 52037-01 CONTAINER

ELEVATORS

Femoral Dislocation Lever

31cm/12½" length
26mm width

771-620



Muller Femoral Retractor

35cm/13½" length
28mm width

771-610



For retraction of the femoral neck.

MINI ELEVATORS

Mini Bone Lever

- | 14cm/5½"
- | 2.8mm width

201-776



Hohmann Style Mini-Bone Lever

- | 16cm/6¼"
- | 6mm width

771-050



Mini-Cobra Bone Lever

- | 16cm/6¼"
- | 15mm width

771-120



McGlamry Metatarsal Elevator

- | 17cm/6½"
- | Sharp

	Width
785-009	9mm
785-011	11mm
785-013	13mm
785-015	15mm
785-017	19mm



ELEVATORS

Hohmann Bone Elevator

22cm/8½" length
8mm width

771-008



Hohmann Bone Elevator

24cm/9½" length
18mm width

771-118



Hohmann Bone Elevator

24.5cm/9½" length
43mm width

771-142



Hohmann Large Bone Elevator

24cm/9½" length
70mm width

771-165



Hohmann Bone Elevator

28cm/11" length
33mm width

771-133



Hohmann Bone Elevator

26cm/10" length
24mm width

771-167



ELEVATORS

Long Curved Hohmann Inferior Hip Elevator

40cm/16" length
22mm width

771-188



Modified Hohmann Elevator

90° angled

775-010



Modified Cobra Aufrang Elevator

33cm/13" long blade
30mm x 100mm

774-210



Shallow Bone Elevator

25cm/9³/₄" length

775-525



Concave Moor Elevator

33cm/13" long blade

774-220



ELEVATORS

Murphy Bone Skid Elevator

23cm/9" length
For dislocation of the femoral head
Double ended

771-193

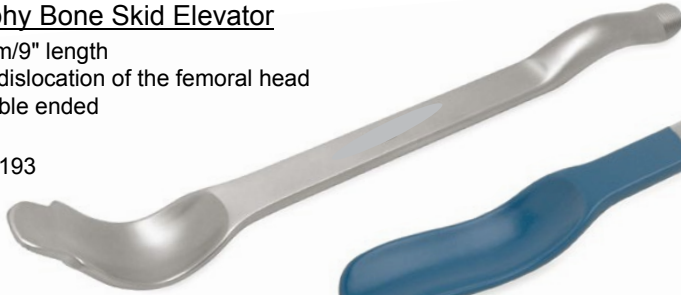

Murphy Insulated Bone Skid Elevator

33cm/13" length
Double ended

771-194I



Infero-Posterior Acetabular Capsule Retractor

35cm/14" length

Right

777-210

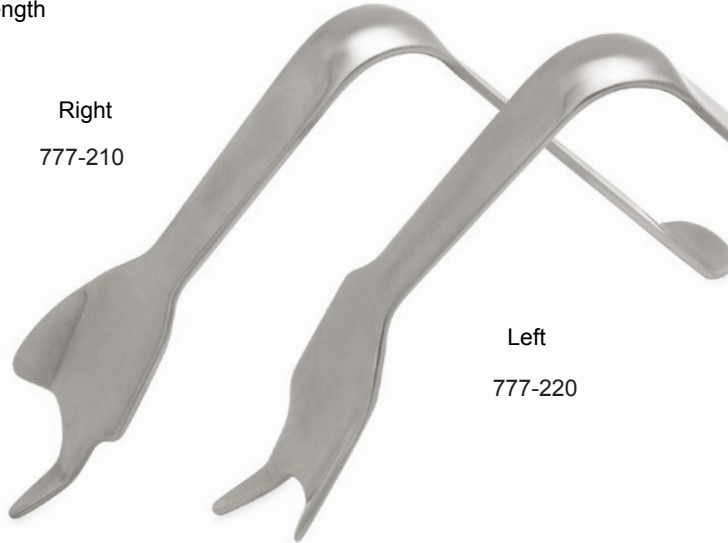

Left

777-220



PCL Retractor

25cm/10" length
To straddle the cruciate ligament
4mm wide prongs
21mm wide tips

776-110

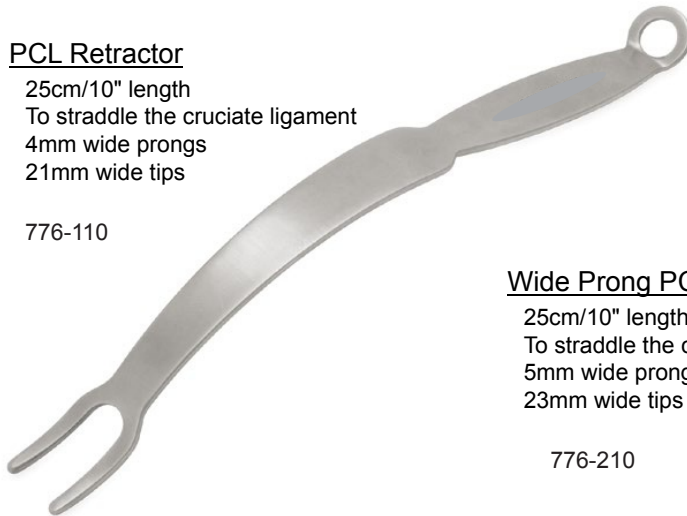

Wide Prong PCL Retractor

25cm/10" length
To straddle the cruciate ligame
5mm wide prongs
23mm wide tips

776-210



BONE HOOKS

Bone Hook Sharp

24.5cm/9³/₄" length
Sharp

771-044



Blunt Hook

20cm/8" length

771-041



BONE CUTTERS

Bohler Bone Cutters

- 15cm/6" length
- Double action

Straight
335-015

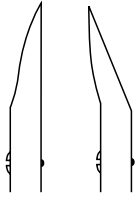

Angled
335-115



McIndoe Bone Cutters

- 18cm/7" length
- Double action
- Angled jaws

335-917



Ruskin-Liston Bone Cutters

- 19cm/7½" length
- Double action

Straight
335-618

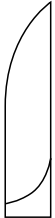

Angled
335-718



Stille-Liston Bone Cutters

- 27cm/ 10 3/4" length
- Double action

Straight
337-027



Angled
337-127

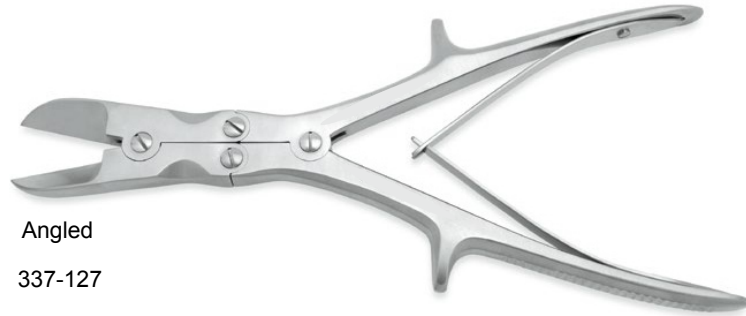

Liston-Key-Horsley Bone Cutters

- 27cm/ 10 3/4"
- Double action Angled

337-527

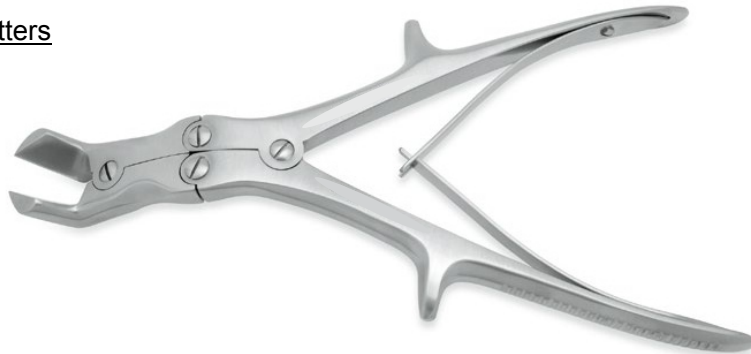

BONE RONGEURS

Kleinert-Kutz Bone Rongeurs

- 14cm/4½" length
- Curved

2mm Bite
307-613



Lempert Bone Rongeurs

- 19cm/7½" length
- Single action

3mm Bite
307-624

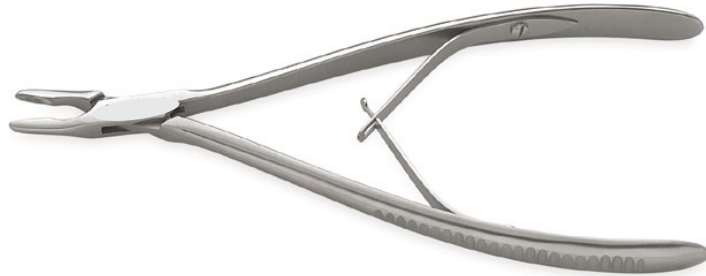

Luer Bone Rongeurs

- 18cm/7" length
- Single action

Straight
8mm Bite
305-217

Curved
8mm Bite
305-317

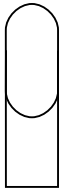

Adsons Bone Rongeurs

- 20cm/8" length
- Single action

7mm Bite
305-421



BONE RONGEURS

Bohler Bone Rongeurs

- ┆ Curved double action
- ┆ 15cm/6"

3mm Bite
310-503



Marquardt Bone Rongeurs

- ┆ 20cm/8" length
- ┆ Curved double action

3mm Bite
310-520

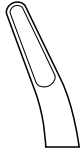

Beyer Bone Rongeurs

- ┆ Curved double action
- ┆ 18cm/7"

4mm Bite
311-104



Jansen Bone Rongeurs

- ┆ Curved double action
- ┆ 18cm/7"

5mm Bite
311-105

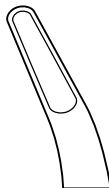

BONE RONGEURS

Smith-Peterson Bone Rongeurs

24cm/9½" length
Double action

Straight	Light Curve	Bite Size
310-903	310-913	3mm

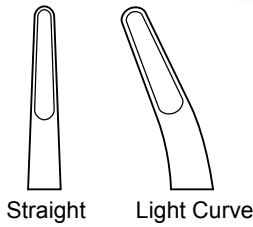

Straight Light Curve

Leksell Bone Rongeurs

24cm/9½" length
Double action angled

Angled Jaw	Bite Size
315-103	3mm
315-105	5mm
315-108	8mm

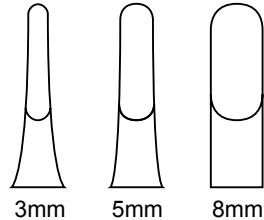

3mm 5mm 8mm

Stille-Luer Bone Rongeurs

22cm/8¾" length
Double action

Straight	Curved
10mm Bite	10mm Bite
313-023	313-123



'Mr Blobby' Stille-Luer Bone Rongeurs

26cm/10¼" length
Double action

Straight	Curved
17mm Bite	17mm Bite
313-027	313-127



BONE HOLDING FORCEPS

Fergusson Bone Holding Forceps

20cm/8" length
Screw joint

355-221



Langenbeck Bone Holding Forceps

21cm/8¼" length

355-021



BONE HOLDING FORCEPS

Semb Bone Holding Forceps

19cm/7½" length
Angled to side

351-136



Verbrugge Bone Holding Forceps

	Length	
357-525	25cm/10"	Small
357-526	26cm/10½"	Medium
357-527	27cm/11"	Large



PELVIC REDUCTION INSTRUMENTS

Pelvic Reduction Forceps

19cm/7½" length
Angled, small
Pointed ball tips
Speed lock

351-162



Pelvic Reduction Forceps

23cm/9" length
Angled, large
Pointed ball tips
Speed lock

351-163



Pelvic Reduction Forceps

25cm/10" length
Straight, large
Pointed ball tips
Speed lock

351-172



Pelvic Reduction Forceps

40cm/16" length
Pointed ball tips
Speed lock

351-173



Pelvic Reduction Forceps

40cm/16" length
3 pointed ball tips
Speed lock

351-175



RETRACTORS

Meyerding Retractor

22cm/9" length



Blade size

236-301	50mm x 16mm
236-302	70mm x 25mm
236-303	90mm x 50mm

Langenbeck Retractor

21.5cm/8½" length



Blade size

230-710	22mm x 6mm	Small
230-713	45mm x 13mm	Medium
230-716	65mm x 25mm	Large
230-718	90mm x 20mm	Extra large

Volkman Catspaw Retractor

21.5cm/8½" length

Semi sharp teeth

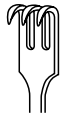

15 x 15mm
3 Prong
223-403



15 x 20mm
4 Prong
223-404

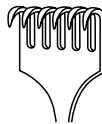

15 x 30mm
6 Prong
223-406

HIP RETRACTORS

Charnley Initial Incision Retractor Set

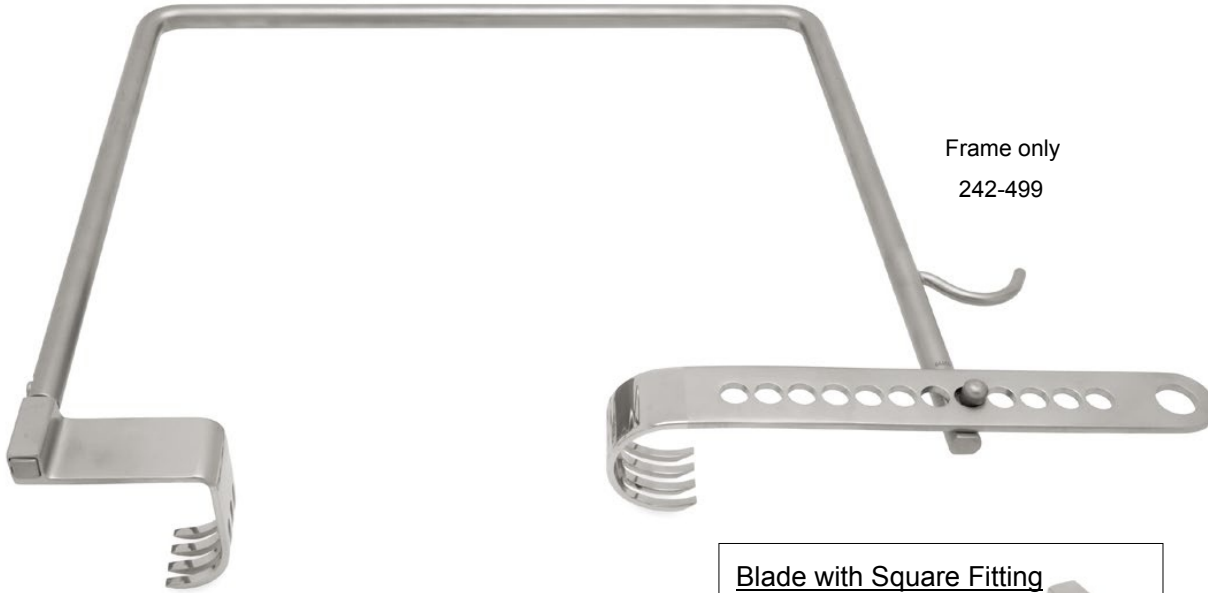

Frame only
242-499

242-000 Complete Set - Basic

Consisting of:

- 1x Frame
- 1x Weight & chain
- 1x Square fitting blade - 50mm depth
- 1x Round fitting blade - 40mm depth

242-001 Complete Set - Extended

Consisting of:

- 1x Frame
- 1x Weight & chain
- 3x Square fitting blades:
 - 50mm depth
 - 75mm depth
 - 100mm depth
- 3x Round fitting blades:
 - 40mm depth
 - 75mm depth
 - 100mm depth

Blade with Square Fitting



- 242-500 Standard depth 50mm
- 242-505 Extra depth 75mm
- 242-506 Extra, extra depth 100mm

Blade with Round Fitting

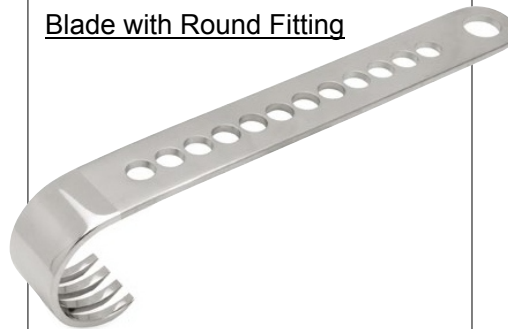

- 242-011 Standard depth 40mm
- 242-005 Extra depth 75mm
- 242-101 Extra, extra depth 100mm



Weight & chain

242-100

Chain only

242-101

RETRACTORS

Weitlaner S/R Retractor

14cm/5½" length
3x4 Sharp Prongs

242-213



Weitlaner S/R Retractor

14cm/5½" length
3x4 Blunt prongs

242-214

Gelpi Laminectomy Retractor

Sharp prongs

	Length	Prong depth
244-017	18.5cm/7¼"	30mm



Cones Self Retaining Retractor

3x4 Prongs
Jointed arms

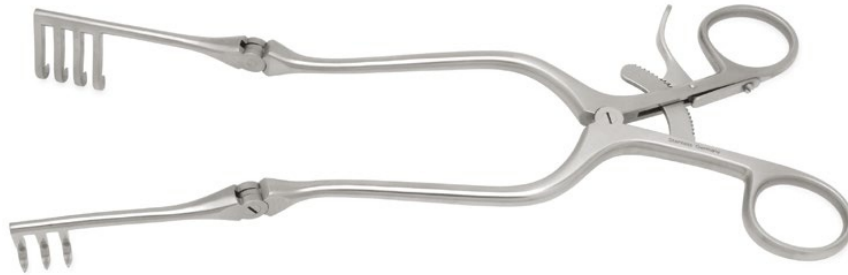

Blunt Prongs	Length	Depth	Sharp Prongs	Length	Depth
243-014	13cm/5"	15mm	243-013	13cm/5"	15mm
243-017	16cm/6"	15mm	243-016	16cm/6"	15mm
243-021	20cm/8"	20mm	243-020	20cm/8"	20mm
243-024	24cm/9"	25mm	243-023	24cm/9½"	25mm

RETRACTORS

Viper Hinged Scoliosis Retractor

30cm/11¾" length
Sharp

	Depth Prongs
7248-38H	40mm
7248-40H	70mm
7248-50H	100mm

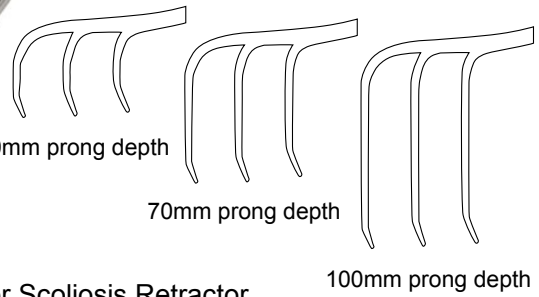
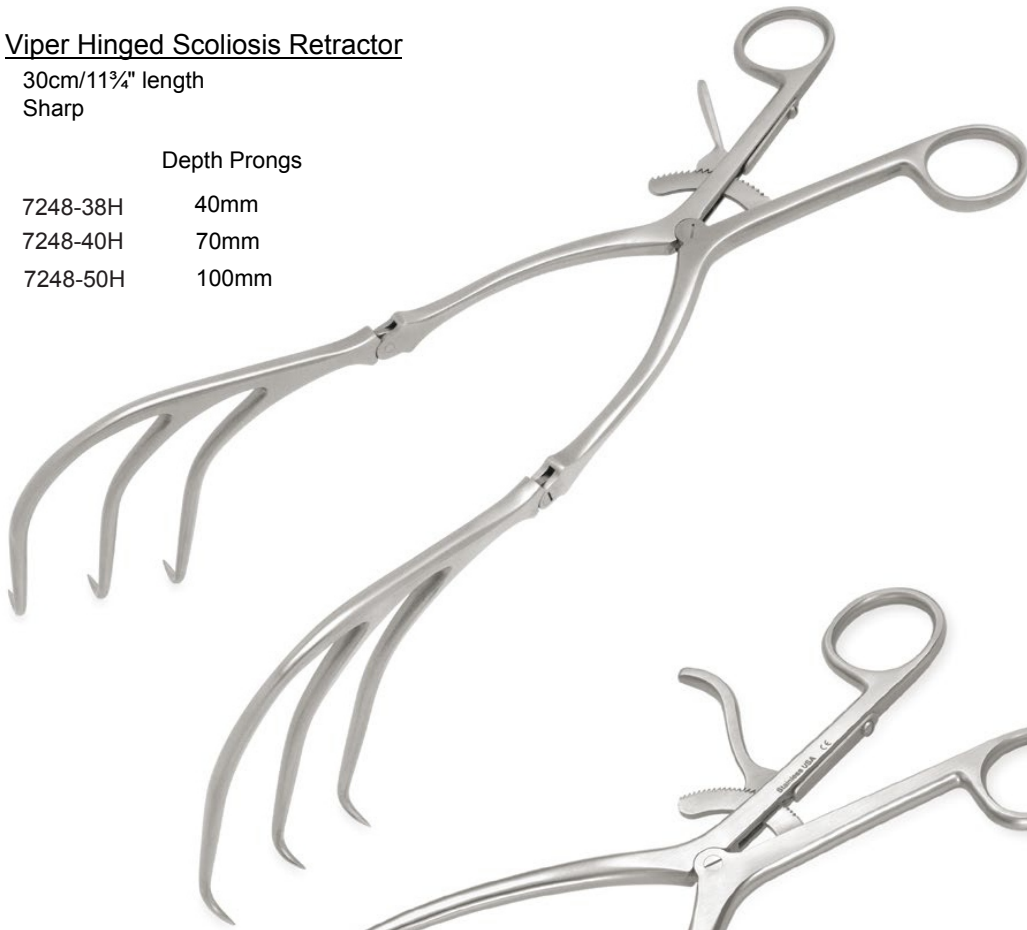

Viper Scoliosis Retractor

30cm/11¾" length
Sharp prongs

	Depth Prongs
7248-38	40mm
7248-40	70mm
7248-50	100mm

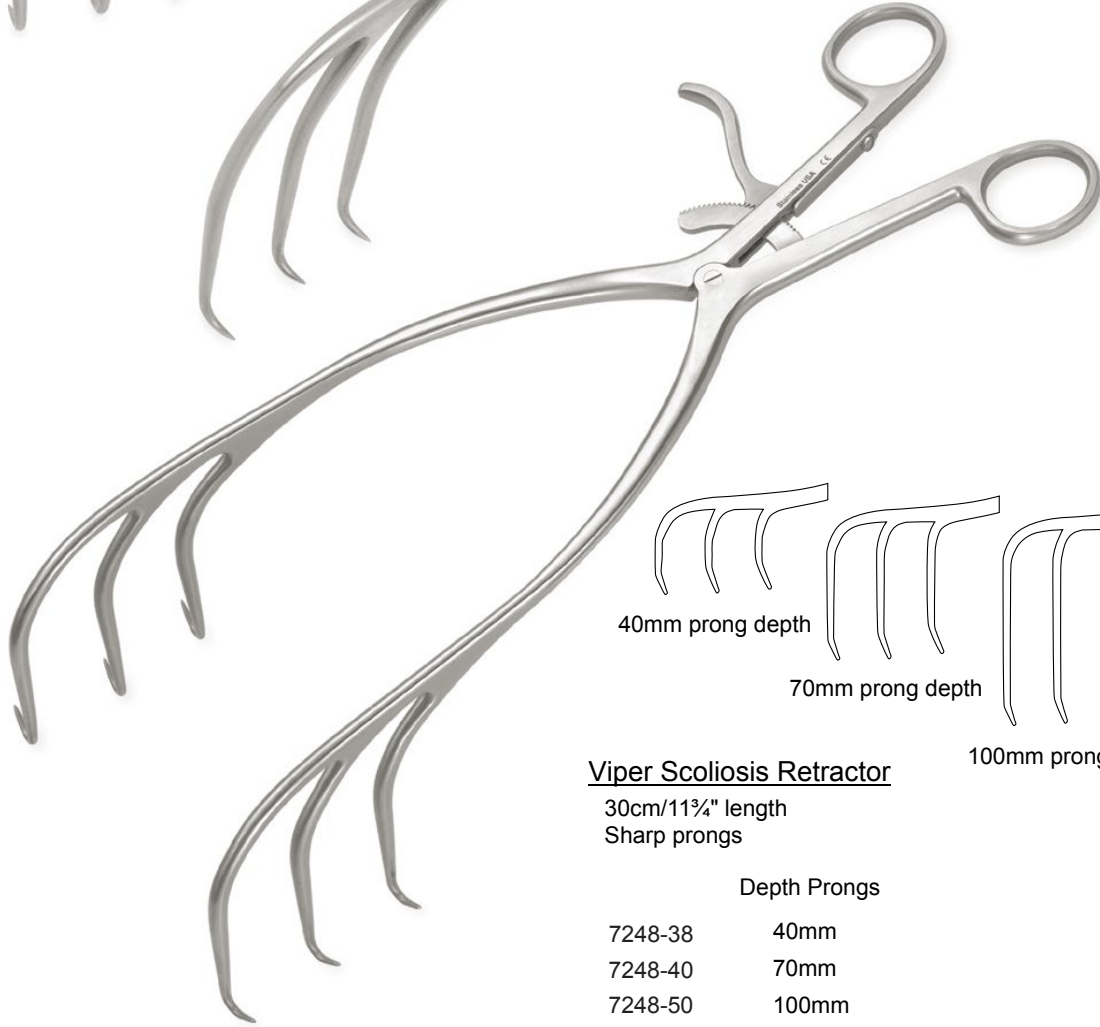

MALLETS

Toffee Mallet

- | 19cm/7½" length
- | Head size 22mm Ø
- | Weight 165g/6oz

270-423



Ultra Fine Mallet

- | 17cm/6¾" length
- | Head size 20mm Ø
- | Weight 145g/5oz

270-210



Mallet with Tufnol Handle

- | 23cm/9" length
- | Medium head size 35mm Ø
- | Weight 550g/20oz

270-500

- | Large head size 40mm Ø
- | Weight 700g/25oz

270-501

- | Large head size 40mm Ø
- | Weight 900g/32oz

270-502



Heavy Orthopaedic Mallet

- | 25cm/10" length
- | Head size 40mm Ø
- | Weight 900g/32oz
- | Ergonomic handle

270-875



MALLETS

Ombredanne Mallet

24cm/9½" length
Head size 40mm Ø
Weight 550g/20oz

270-885



Heath Mallet

19cm/7" length
Stainless steel head
Head size 40mm Ø
Weight 1020g/36oz

270-880



OSTEOTOMES

Mini-Lambotte Osteotome

12.5cm/5" length



	Width
275-702	2mm
275-703	3mm
275-704	4mm
275-706	6mm
275-708	8mm

Lambotte Osteotome

25cm/9¾" length



Straight	Width	Curved	Width
289-404	4mm	289-454	4mm
289-406	6mm	289-456	6mm
289-408	8mm	289-458	8mm
289-410	10mm	289-460	10mm
289-413	13mm	289-463	13mm
289-415	15mm	289-465	15mm
289-418	18mm	289-468	18mm
289-420	20mm	289-470	20mm
289-425	25mm	289-475	25mm
289-430	30mm	289-480	30mm

OSTEOTOMES

Mini-Stillle Osteotome

16cm/6¼" length

Straight	Width
284-204	4mm
284-206	6mm
284-208	8mm



Stillle (Swedish) Osteotome

20cm/8" length

Straight	Width
284-40	6mm
284-40	8mm
284-41	10mm
284-41	12mm
284-41	15mm
284-42	20mm
284-42	25mm
284-43	30mm



Hibbs Osteotome with thin blade

20cm/8" length
Extra thin blade

Straight	Width	Curved	Width
285-104	4mm	285-154	4mm
285-106	6mm	285-156	6mm
285-108	8mm	285-158	8mm
285-110	10mm	285-160	10mm
285-112	12mm	285-162	12mm
285-115	15mm	285-165	15mm
285-120	20mm	285-170	20mm
285-125	25mm	285-175	25mm
285-130	30mm	285-180	30mm



Smith Petersen Osteotome

20cm/8" length

	Width
287-110	10mm
287-115	15mm
287-120	20mm
287-125	25mm
287-130	30mm



OSTEOTOMES

Mini-Lexer Osteotome

18cm/7" length
Tufnol handle



Width

285-402	2mm
285-404	4mm
285-406	6mm
285-408	8mm
285-410	10mm

Lexer Osteotome

22cm/8½" length
Tufnol handle



Width

285-432	7mm
285-433	10mm
285-435	15mm
285-436	20mm
285-438	25mm

OSTEOTOMES & GOUGES

Box Chisel

- | 29cm/13½" length
- | For preparation of the proximal femur
- | 31mm width x 6mm

285-306



Pelvic Osteotome

- | 30cm/12" length
- | Tufnol handle
- | Angled shaft

15mm width	20mm width
275-230	275-330



Chisel with Interchangeable Blades

- | 20cm/8" length
- | Tufnol handle
- | Very thin blades

275-800

Complete set with 4 blades* & key

	Blade Width
275-805	5mm*
275-808	8mm
275-810	10mm*
275-812	12mm
275-815	15mm*
275-825	25mm*



Capener Lamina Gouge

- | 23cm/9" length
- | Cranked shaft

	Width
286-106	6mm
286-108	8mm
286-111	11mm
286-116	16mm



HIP REVISION

Cup Extraction Chisel

32cm/12½" length
Curved 7mm tip
Metal strike plate
Tufnol handle

286-732



Bayonet Gouge

32cm/12½" length
Metal strike plate
Tufnol handle
8mm width

286-832



Swan Necked Gouge

28.5cm/11" length
25mm width

286-528



Cement Gouge

34.5cm/13½" length



9mm width

286-934

11mm width

286-834

Cement Chisel Angled 15°

35.5cm/14 length
9mm tip

286-935



HIP REVISION

Cement Osteotome

30cm/12" length
Tufnol handle with strike plate



Cement Splitting Osteotome

30cm/12" length
Tufnol handle with strike plate
Guarded blade



Straight Cement Gouge

30cm/12" length
Tufnol handle with strike plate



Bayonet Cement Rasp

52cm/20½" length
Tufnol handle



- | | | |
|---------|---|---------------------|
| 630-050 |  | V-shape |
| 630-060 |  | Strong round shape* |
| 630-070 |  | Flat round curve |

HIP REVISION

Bayonet Cement Chisel

40cm/15³/₄" length
Tufnol handle with strike plate

	Width
273-540	5mm
273-740	7mm
273-040	10mm



Bayonet Cement Splitting Osteotome

40cm/15³/₄" length
Tufnol handle with strike plate
Guarded blade

	Width
273-605	5mm
273-607	7mm
273-610	10mm



Bayonet Cement Gouge

40cm/15³/₄" length
Tufnol handle with strike plate

	Width
273-705	5mm
273-707	7mm
273-710	10mm



Bayonet Cement Gouge

40cm/15³/₄" length
Tufnol handle with strike plate

	Width
273-805	5mm
273-807	7mm
273-810	10mm



For cement removal through fenestration in the femur.

HIP REVISION

Malleable Cement Probe

38cm/15" length
For probing the Femur

273-038



Cement Plug Extractor

48cm/19" length
T-handle
For extraction of cement plug

	Thread Dia.
273-748	7mm
273-948	9mm
273-148	11mm



Used with a slotted mallet

Retrograde Cement Chisel

50cm/19³/₄" length
Tufnol T-handle
Striking plate

	Width
273-505	5mm
273-507	7mm
273-510	10mm



Slotted Mallet

270-902



Cement Extraction Hook

34.5cm/14" length

273-534

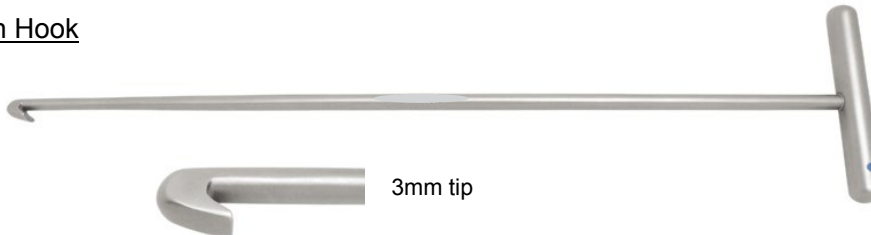

3mm tip

HIP REVISION

Cement Twist Drill Long

40cm/15³/₄" length



	Diameter
273-306	6mm
273-308	8mm
273-310	10mm

Fine Cement Duckbill Grasping Forceps

35cm/14" shaft length

Fine jaws



Heavy Cement Grasping Forceps

26cm/10" shaft length

Serrated jaws 6mm width



HIP REVISION

Femoral Head Extractor

23cm/9" length
Tufnol handle

771-623



Moore Femoral Head Extractor

20.5cm/8" length
Metal handle

771-420



Joint Capsule Clamp

21cm/8¹/₄" length
25mm jaw length

352-150



Joint Capsule Scissors

25cm/9³/₄" length
Angled blades

775-535



HIP JOINT

Femoral Head Impactor

20cm/8" length
Nylon head

771-820



McGoey Bone Punch

Double ended



* illustrated

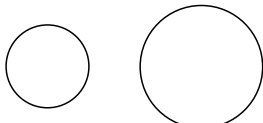

No 1. 13mm x 19mm Ø 771-319 Large size



No 2. 6mm x 10mm Ø 771-610A *Small size



No 3. 6mm x 13mm Ø 771-613
With flats

PLIERS AND WIRE CUTTERS

Universal Fine Pliers and Cutters

15cm/6" length

145-415

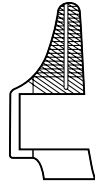

Slim & Square Ended Wire Pliers

19cm/7½" length

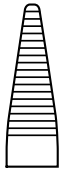

Slim Nose
145-519

Serrated jaw



Square Ended*
145-419

*illustrated



Pliers for Screw Removal

20cm/8" length

145-120



Muller Claus Wire Pullers

18cm/7" length
Double action
Tungsten jaws

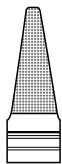

2mm Jaws
321-11

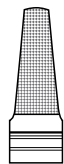

4mm Jaws
321-12

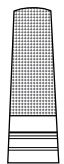

6mm Jaws
321-13



WIRE CUTTERS

Muller Claus Wire Cutters

16cm/6" length
 Tungsten carbide edges
 Cuts wire up to 1.6mm Ø

321-26



Muller Claus Wire Cutters

Tungsten carbide edges

321-27

18cm/7" length*
 Cuts wire up to 2mm Ø

321-28

22cm/8¾" length
 Cuts wire up to 3mm Ø



*illustrated

End Wire Cutters

18cm/7" length
 Tungsten carbide edges
 Cuts wire up to 1.7mm Ø

321-29



Bolt Cutters with dismantable arms

Max. cap 6.3mm pins

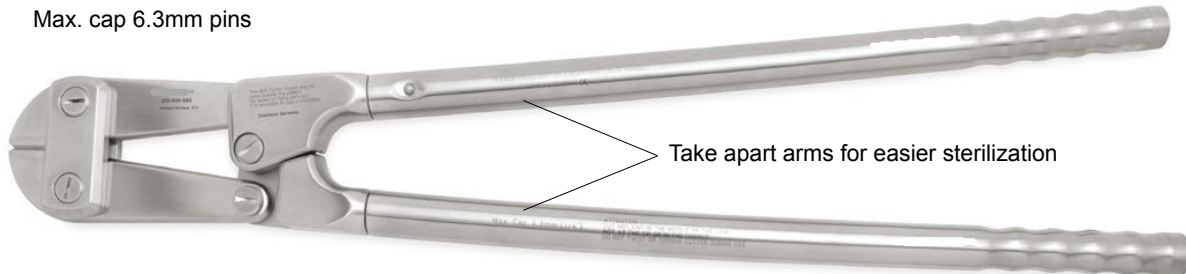

764-550

Must be used in conjunction with a Rod Holder

WIRE CUTTERS

Combined Wire Cutters & Pliers

18cm/7" length
Suitable for wires up to 1.6mm Ø
Parallel closing jaws

145-620



Wire Cutters with T/C Jaws

24cm/9½" length
Double action
Cuts plates & wires up to 2.7mm Ø

321-07



'Power Cut' Wire Cutters

20cm/8" length
Cutting inserts are T/C and can be replaced
Cuts wires up to 3mm Ø

321-06



LOCKING PLIERS

Needle Nosed Locking Pliers



Code	Length	
147- 505	22cm/8¾"	Small
147- 509	25cm/9¾"	Medium
147- 512	30cm/11¾"	Large

A very useful instrument for orthopaedic surgery allowing the surgeon to securely clamp on to wires and implants.

Pliers modified for Slap Hammer

Code	Length	
147- 705	22cm/8¾"	Small
147- 709	25cm/9¾"	Medium
147- 712	30cm/11¾"	Large

<u>Slap Hammer attachment only</u>		
Code	Length	Weight
147-730	35cm/13¾"	400g*
147-750	40cm/15¾"	700g ⁺
*Fits pliers - small & medium size		
*Fits pliers - large size		

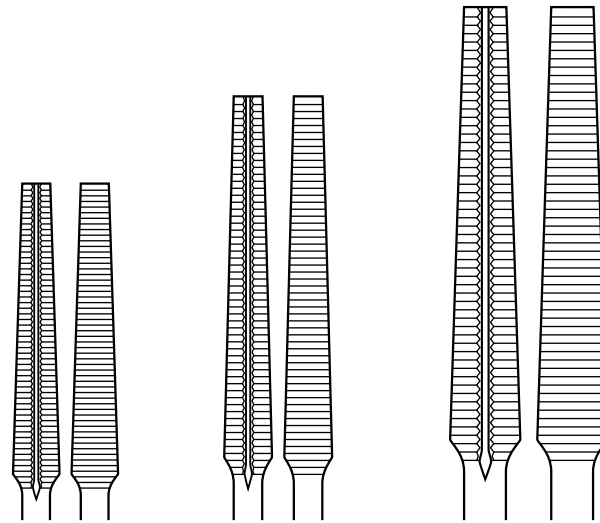

N.B. When used with slap hammer the locking pliers need modification.

22cm/8¾" Small 25cm/9¾" Medium 30cm/11¾" Large



Orthopaedic Locking Pliers

Hardened jaws

Code	Length	
145-690	18cm/7"	Small
145-700	20cm/8"	Medium
145-750	24cm/9½"	Large



Orthopaedic Locking Pliers modified for Slap Hammer

Code	Length	
145-590	18cm/7"	Small
145-591	20cm/8"	Medium
145-592	24cm/9½"	Large

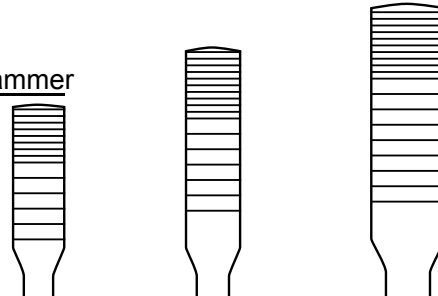

N.B. When used with slap hammer the locking pliers need modification.

18cm/7" Small 20cm/8" Medium 24cm/9½" Large

PIN INTRODUCERS

Kirschner Wire Introducing THandle

12cm/4³/₄" length
1.5mm Ø wires

760-903



Steinmann Pin Introducer THandle

14cm/5¹/₂" length
0.5mm - 8mm Ø pins
With Jacobs chuck & key

760-374



Steinmann Pin Introducer T-Handle

14cm/5¹/₂" length
0.7mm - 6mm Ø pins
Universal chuck

760-375



MISC

Bone Mill

Table mounted with crank handle
With removable cutting drum*

760-100

For grinding bone chips
used for bone graft
procedures.



Cutting Drum Sizes

- * 3mm Ø hole bore 760-003
- 4mm Ø hole bore 760-004
- 5mm Ø hole bore 760-005

Wire Passing Guide

21cm/8¼" length



Used for passing wire around bones.

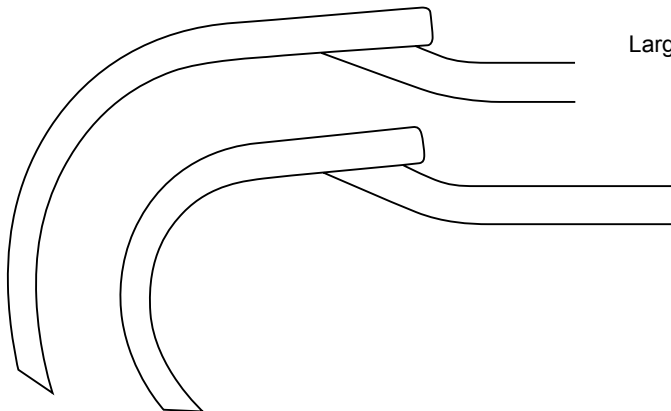

Large curve 70mm Ø
760-521

Small curve 45mm Ø
760-421

Bone Awl

Straight with eye

	Diameter	Length
771-212	2.0mm	125mm
771-213	2.4mm	130mm
771-214	2.8mm	145mm
771-215	3.2mm	160mm
771-216	3.6mm	165mm
771-217	4.0mm	175mm



SCREWDRIVERS

Hexagonal Head

25cm/10" length
For hexagonal head screws 2.7mm - 4.0mm



2.5mm Hex
775-725



3.5mm Hex
775-825

For 2.7mm to 3.5mm screws For 4.5mm to 6.5mm screws

Screwdriver Handle

To fit shafts with quick lock attachment

775-002



Screwdriver Handle Small

To fit shafts with quick lock attachment

775-001



Shaft with Quick Lock Fitting

Hexagonal tip



Shaft	Diameter
775-100	2.5mm
775-200	3.5mm

SCREWDRIVERS

Slotted Head

17cm/6³/₄" length
For head screws 2.7mm - 4.0mm

775-417



Long Slotted Head

25cm/10" length
For head screws 2.7mm - 4.0mm

775-425



Phillips Head

25cm/10" length
For small Phillips head screws 6mm

775-525



Cross Slotted Head

25cm/10" length
For cross slot screws 6mm

775-625



DISSECTORS

Howarth Elevator

21.5cm/8½" length



550-171

MacDonald Elevator/Dissector



263-790 Size
19cm/7

Freer Elevator/Dissector

18.5cm/7¼" length



557-027

MEASURING

Stainless Steel Measuring Ruler

Code	Length
443-715	15cm/6"
443-730	30cm/12"



Measuring Caliper

25cm/10" length
Measuring range 0-50mm

781-520



Vernier Caliper

22.5cm/9" length
Measuring range 15cm

575-650A



Depth Gauge

Measuring depth up to 50mm
Hook part of probe: \varnothing .7mm
Measuring probe (bottom): \varnothing 6mm

781-098



Depth Gauge

Measuring depth up to 70mm

781-099



Direct Reading Depth Gauge

23cm length
Measuring depth up to 40mm

575-199



Here at Amerisurg we understand and have a long history of flexibility with our instruments. And in keeping with that tradition we offer the most extensive line of handle choices with our Arthroscopy line. Below you will find different handles to choose from that suit the needs of all the Surgeon's in your facility, without having to go to several different companies for what you may need.

NON-RATCHET HANDLES



RING HANDLE DESIGN
(RH)



LOOP HANDLE DESIGN
(LH)



PRO HANDLE DESIGN
(PH)



WISHBONE HANDLE DESIGN
(WH)



CIGAR HANDLE DESIGN
(CH)

RATCHET HANDLES



SLIDE LOCK HANDLE DESIGN
(SLH)

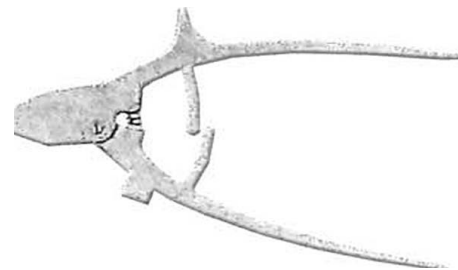

WISHBONE W/ RATCHET HANDLE DESIGN
(WHR)

ARTHROSCOPIC HAND INSTRUMENTS

PUNCHES

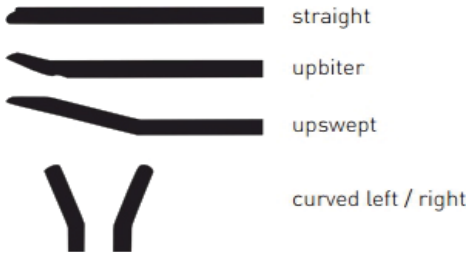

Ring Handle Design (RH)



Loop Handle Design (LH)



Pro Handle Design (PH)



Wishbone Handle Design (WH)



BASKET PUNCH - SCOOP

SHAFT DESIGN	BITE WIDTH	RING HANDLE	LOOP HANDLE	PRO HANDLE	WISHBONE HANDLE
STRAIGHT	1.8 mm	23-2011RH	23-2011LH	23-2011PH	23-2011WH
STRAIGHT	2.0 mm	23-2012RH	23-2012LH	23-2012PH	23-2012WH
UPBITER	1.6 mm	23-2020RH	23-2020LH	23-2020PH	23-2020WH
STRAIGHT	1.6 mm	23-2029RH	23-2029LH	23-2029PH	23-2029WH
UPBITER	1.6 mm	23-2030RH	23-2030LH	23-2030PH	23-2030WH
UPSWEPT	1.6 mm	23-2031RH	23-2031LH	23-2031PH	23-2031WH
UPSWEPT	1.6 mm	23-2032RH	23-2032LH	23-2032PH	23-2032WH
DOWNBITER	1.6 mm	23-2033RH	23-2033LH	23-2033PH	23-2033WH
STRAIGHT	1.6 mm	23-2034RH	23-2034LH	23-2034PH	23-2034WH
CURVED LEFT	1.6 mm	23-2040RH	23-2040LH	23-2040PH	23-2040WH
CURVED RIGHT	1.6 mm	23-2041RH	23-2041LH	23-2041PH	23-2041WH
UPBITER-CURVED LEFT	1.6 mm	23-2042RH	23-2042LH	23-2042PH	23-2042WH
UPBITER-CURVED RIGHT	1.6 mm	23-2043RH	23-2043LH	23-2043PH	23-2043WH



BASKET PUNCH - DUCKBILL

SHAFT DESIGN	BITE WIDTH	RING HANDLE	LOOP HANDLE	PRO HANDLE	WISHBONE HANDLE
UPSWEPT	3.2 mm	23-2000RH	23-2000LH	23-2000PH	23-2000WH
STRAIGHT	3.2 mm	23-2013RH	23-2013LH	23-2013PH	23-2013WH
UPBITER	3.2 mm	23-2014RH	23-2014LH	23-2014PH	23-2014WH
UPBITER, CURVED LEFT	3.2 mm	23-2015RH	23-2015LH	23-2015PH	23-2015WH
UPBITER, CURVED RIGHT	3.2 mm	23-2016RH	23-2016LH	23-2016PH	23-2016WH

ARTHROSCOPIC HAND INSTRUMENTS

PUNCHES

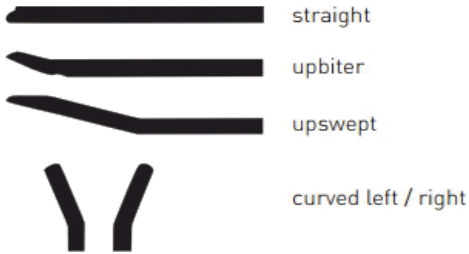

Ring Handle Design (RH)



Loop Handle Design (LH)



Pro Handle Design (PH)



Wishbone Handle Design (WH)



BASKET PUNCH - DUCKLING

SHAFT DESIGN	BITE WIDTH	RING HANDLE	LOOP HANDLE	PRO HANDLE	WISHBONE HANDLE
UPSWEPT	3.2 mm	23-2044RH	23-2044LH	23-2044PH	23-2044WH
STRAIGHT	3.2 mm	23-2045RH	23-2045LH	23-2045PH	23-2045WH
UPBITER	3.2 mm	23-2046RH	23-2046LH	23-2046PH	23-2046WH
UPBITER, CURVED LEFT	3.2 mm	23-2047RH	23-2047LH	23-2047PH	23-2047WH
UPBITER, CURVED RIGHT	3.2 mm	23-2048RH	23-2048LH	23-2048PH	23-2048WH



BASKET PUNCH - BLUNT NOSE

SHAFT DESIGN	BITE WIDTH	RING HANDLE	LOOP HANDLE	PRO HANDLE	WISHBONE HANDLE
STRAIGHT	1.7 mm	23-2035RH	23-2035LH	23-2035PH	23-2035WH



OVAL PUNCH

SHAFT DESIGN	BITE WIDTH	RING HANDLE	LOOP HANDLE	PRO HANDLE	WISHBONE HANDLE
UPBITER	4.4 mm	23-7200RH	23-7200LH	23-7200PH	23-7200PH
STRAIGHT	4.4 mm	23-7201RH	23-7201LH	23-7201PH	23-7201PH
UPBITER-CURVED LEFT	4.4 mm	23-7294RH	23-7294LH	23-7294PH	23-7294PH
UPBITER-CURVED RIGHT	4.4 mm	23-7295RH	23-7295LH	23-7295PH	23-7295PH
UPSWEPT	4.4 mm	23-7296RH	23-7296LH	23-7296PH	23-7296PH



BASKET PUNCH - NARROWLINE

SHAFT DESIGN	BITE WIDTH	RING HANDLE	LOOP HANDLE	PRO HANDLE	WISHBONE HANDLE
UPBITER	1.7 mm	23-2051RH	23-2051LH	23-2051PH	23-2051WH
STRAIGHT	1.7 mm	23-2052RH	23-2052LH	23-2052PH	23-2052WH
UPBITER-CURVED LEFT	1.7 mm	23-2053RH	23-2053LH	23-2053PH	23-2053WH
UPBITER-CURVED RIGHT	1.7 mm	23-2054RH	23-2054LH	23-2054PH	23-2054WH
UPSWEPT	1.7 mm	23-2055RH	23-2055LH	23-2055PH	23-2055WH

ARTHROSCOPIC HAND INSTRUMENTS

PUNCHES

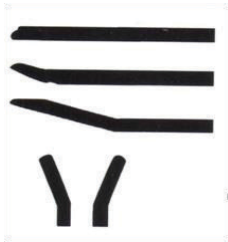

STRAIGHT

UPBITER

UPSWEPT

CURVED LEFT / RIGHT



Ring Handle Design (RH)



Loop Handle Design (LH)



Pro Handle Design (PH)



Wishbone Handle Design (WH)



SCISSOR PUNCH

SHAFT DESIGN	BITE WIDTH	RING HANDLE	LOOP HANDLE	PRO HANDLE	WISHBONE HANDLE
STRAIGHT	0.7 MM	23-2036RH	23-2036LH	23-2036PH	23-2036WH
UPBITER	0.7 MM	23-2037RH	23-2037LH	23-2037PH	23-2037WH
UPBITER-CURVED LEFT	0.7 MM	23-2038RH	23-2037LH	23-2037PH	23-2037WH
UPBITER-CURVED RIGHT	0.7 MM	23-2039RH	23-2038LH	23-2038PH	23-2038WH



BASKET PUNCH - BACKBITER

SHAFT DESIGN	BITE WIDTH	RING HANDLE	LOOP HANDLE	PRO HANDLE	WISHBONE HANDLE
RIGHT	2.4 MM	23-2058RH	23-2058LH	23-2058PH	23-2058WH
LEFT	2.4 MM	23-2059RH	23-2059LH	23-2059PH	23-2059WH



POSTERIOR PUNCH

SHAFT DESIGN	BITE WIDTH	RING HANDLE	LOOP HANDLE	PRO HANDLE	WISHBONE HANDLE
UPBITER	2.2 MM	23-2201RH	23-2201LH	23-2201PH	23-2201WH
UPSWEPT	2.2 MM	23-2201RH	23-2202LH	23-2202PH	23-2202WH
STRAIGHT	2.2 MM	23-2203RH	23-2203LH	23-2203PH	23-2203WH
CURVED LEFT	2.2 MM	23-2204RH	23-2204LH	23-2204PH	23-2204WH
CURVED RIGHT	2.2 MM	23-2205RH	23-2205H	23-2205PH	23-2205WH



MENISCAL PUNCH - OVERBITER

SHAFT DESIGN	BITE WIDTH	RING HANDLE	LOOP HANDLE	PRO HANDLE	WISHBONE HANDLE
OVERBITE	—	23-9878RH	23-9878LH	23-9878PH	23-9878WH

ARTHROSCOPIC HAND INSTRUMENTS

GRASPING FORCEPS

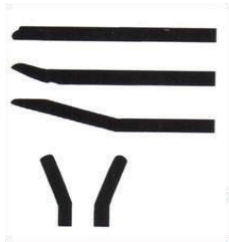

STRAIGHT

UPBITER

UPSWEPT

CURVED LEFT / RIGHT



Ring Handle Design (RH)



Loop Handle Design (LH)



Pro Handle Design (PH)



Wishbone w/ Ratchet Design (WHR)



Slide Lock Handle Design (SLH)



GRASPING FORCEPS - PITBULL

SHAFT DESIGN	BITE WIDTH	RING HANDLE	LOOP HANDLE	PRO HANDLE	WISHBONE HANDLE W/ RATCHET	SLIDE LOCK HANDLE
STRAIGHT	3.4 MM	23-1022RH	23-1022LH	23-1022PH	23-1022WHR	23-1022SLH

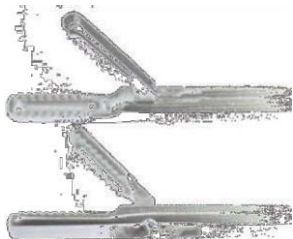

GRASPING FORCEPS - CUPPED

SHAFT DESIGN	BITE WIDTH	RING HANDLE	LOOP HANDLE	PRO HANDLE	WISHBONE HANDLE W/ RATCHET	SLIDE LOCK HANDLE
STRAIGHT	2.7 MM	23-1012RH	23-1012LH	23-1012PH	23-1012WHR	23-1012SLH
STRAIGHT	3.4 MM	23-1014RH	23-1014LH	23-1014PH	23-1014WHR	23-1014SLH



GRASPING FORCEPS - RONGEUR

SHAFT DESIGN	BITE WIDTH	RING HANDLE	LOOP HANDLE	PRO HANDLE	WISHBONE HANDLE W/ RATCHET	SLIDE LOCK HANDLE
RAPTOR	—	23-4720RH	23-4720LH	23-4720PH	23-4720WHR	23-4720SLH
RAPTOR JR	—	23-4843RH	23-4843LH	23-4843PH	23-4843WHR	23-4843SLH

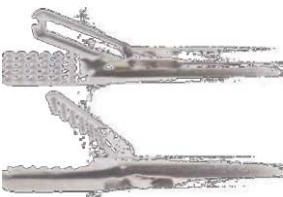

GRASPING FORCEPS - ALLIGATOR

SHAFT DESIGN	BITE WIDTH	RING HANDLE	LOOP HANDLE	PRO HANDLE	WISHBONE HANDLE W/ RATCHET	SLIDE LOCK HANDLE
STRAIGHT	3.0 MM	23-1020RH	23-1020LH	23-1020PH	23-1020WHR	23-1020SLH
UPCURVED	3.0 MM	23-1021RH	23-1021LH	23-1021PH	23-1021WHR	23-1021SLH
STRAIGHT	3.5 MM	23-1024RH	23-1024LH	23-1024PH	23-1024WHR	23-1024SLH

ARTHROSCOPIC HAND INSTRUMENTS

ROTARY PUNCHES

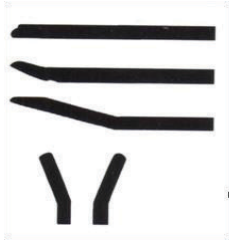

STRAIGHT

UPBITER

UPSWEPT

CURVED LEFT / RIGHT



Cigar Handle
Design
(CH)



Loop Handle
Design
(LH)

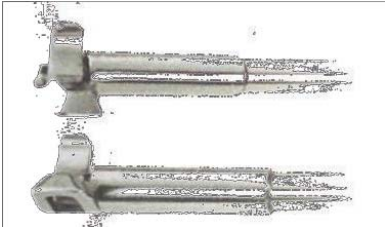

BASKET PUNCH - 90° ROTARY

SHAFT DESIGN	TIP HEIGHT	BITE WIDTH	CIGAR HANDLE	LOOP HANDLE
90° - LEFT	3.9 MM	3.4 MM	23-0900CH	23-0900LH
90° - RIGHT	3.9 MM	3.4 MM	23-0901CH	23-0901LH
90° - LEFT	3.4 MM	2.2 MM	23-0906CH	23-0906LH
90° - RIGHT	3.4 MM	2.2 MM	23-0907CH	23-0907LH



HOOK ROTARY SCISSORS

SHAFT DESIGN	TIP HEIGHT	BITE WIDTH	CIGAR HANDLE	LOOP HANDLE
20° - LEFT	---	---	23-0800CH	23-0800LH
20° - RIGHT	---	---	23-0801CH	23-0801LH
60° - LEFT	---	---	23-0802CH	23-0802LH
60° - RIGHT	---	---	23-0803CH	23-0803LH

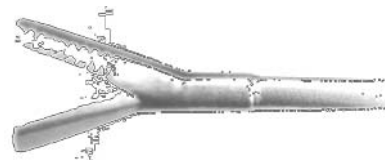

ROTARY SCISSORS

SHAFT DESIGN	TIP HEIGHT	BITE WIDTH	CIGAR HANDLE	LOOP HANDLE
20° SERRATED - LEFT	---	---	23-0806CH	23-0806LH
20° SERRATED - RIGHT	---	---	23-0807CH	23-0807LH

ARTHROSCOPIC HAND INSTRUMENTS

HOOK SCISSORS, HOOK PUNCHES & WIDE JAW PUNCHES

AVAILABLE HANDLES FOR THE INSTRUMENTS BELOW...
Please see example for ordering

23-8903XX + **R**ing **H**andle = 23-8903RH



Ring Handle Design (RH)



Loop Handle Design (LH)



Pro Handle Design (PH)



Wishbone Handle Design



SHAFT DESIGN	SHAFT DIAMETER	HOOK SCISSORS	HOOK PUNCH W/ SCOOP	HOOK PUNCH, SET DOWN	HOOK PUNCH, ANGULAR
STRAIGHT	3.4 MM	23-2503XX	23-2903XX	23-3503XX	23-3703XX
	2.7 MM	23-2502XX	23-2902XX	23-3502XX	---
30°- RIGHT	3.4 MM	23-2513XX	23-2913XX	23-3513XX	23-3713XX
	2.7 MM	23-2512XX	23-2912XX	23-3512XX	---
30°- LEFT	3.4 MM	23-2533XX	23-2933XX	23-3533XX	23-3733XX
	2.7 MM	23-2532XX	23-2932XX	23-3532XX	---
45°- RIGHT	3.4 MM	23-2553XX	23-2953XX	23-3553XX	23-3753XX
	2.7 MM	23-2552XX	23-2952XX	23-3552XX	---
45°- LEFT	3.4 MM	23-2573XX	23-2973XX	23-3573XX	23-3773XX
	2.7 MM	23-2572XX	23-2972XX	23-3572XX	---
7°- UP	3.4 MM	23-2593XX	23-2993XX	23-3593XX	23-3793XX
	2.7 MM	23-2592XX	23-2992XX	23-3592XX	---
7°- DOWN	3.4 MM	23-2613XX	23-3013XX	23-3613XX	23-3813XX
	2.7 MM	23-2612XX	23-3012XX	23-3612XX	---
15°- UP	3.4 MM	23-2633XX	23-3033XX	23-3633XX	23-3833XX
	2.7 MM	23-2632XX	23-3032XX	23-3632XX	---
15°- DOWN	3.4 MM	23-2653XX	23-3053XX	23-3653XX	23-3853XX
	2.7 MM	23-2652XX	23-3052XX	23-3652XX	---



SHAFT DESIGN	SHAFT DIAMETER	HOOK PUNCH, 15°	WIDE JAW PUNCH, 4.5 MM BITE	WIDE JAW PUNCH, 3.5 MM BITE	WIDE JAW PUNCH, 2.5 MM BITE
STRAIGHT	3.4 MM	23-3903XX	23-4903XX	23-5603XX	23-6303XX
30°- RIGHT	3.4 MM	23-3913XX	23-4913XX	23-5613XX	23-6313XX
30°- LEFT	3.4 MM	23-3933XX	23-4933XX	23-5633XX	23-6333XX
45°- RIGHT	3.4 MM	23-3953XX	23-4953XX	23-5653XX	23-6353XX
45°- LEFT	3.4 MM	23-3973XX	23-4973XX	23-5673XX	23-6373XX
7°- UP	3.4 MM	23-3993XX	23-4993XX	23-5693XX	23-6393XX
7°- DOWN	3.4 MM	23-4013XX	23-5013XX	23-5713XX	23-6413XX
15°- UP	3.4 MM	23-4033XX	23-5033XX	23-5733XX	23-6433XX
15°- DOWN	3.4 MM	23-4053XX	23-5053XX	23-5753XX	23-6453XX

ARTHROSCOPIC HAND INSTRUMENTS

AVAILABLE HANDLES FOR THE INSTRUMENTS BELOW...
Please see example for ordering

23-8903XX + Ring Handle = 23-8903RH



Ring Handle Design (RH)



Loop Handle Design (LH)











Pro Handle Design (PH)



Wishbone Handle Design (WH)









WIDE JAW PUNCH - 15° UP-MILLED



	SHAFT DESIGN	SHAFT DIAMETER	WIDE JAW PUNCH, 4.5 MM	WIDE JAW PUNCH, 3.5 MM	WIDE JAW PUNCH, 2.5 MM	WIDE JAW PUNCH, 45° UP, 2.0 MM
	STRAIGHT	3.4 MM	23-5303XX	23-6003XX	23-6803XX	23-6983XX
	30°- RIGHT	3.4 MM	23-5313XX	23-6013XX	23-6813XX	---
	30°- LEFT	3.4 MM	23-5333XX	23-6033XX	23-6833XX	---
	45°- RIGHT	3.4 MM	23-5353XX	23-6053XX	23-6853XX	---
	45°- LEFT	3.4 MM	23-5373XX	23-6073XX	23-6873XX	---
	7°- UP	3.4 MM	23-5393XX	23-6093XX	23-6893XX	---
	7°- DOWN	3.4 MM	23-5413XX	23-6113XX	23-6913XX	---
	15°- UP	3.4 MM	23-5433XX	23-6133XX	23-6933XX	---
	15°- DOWN	3.4 MM	23-5453XX	23-6153XX	23-6953XX	---

SCISSOR PUNCHES



	SHAFT DESIGN	SHAFT DIAMETER	SCISSOR PUNCH	SCISSOR PUNCH, 15° UP-MILLED
	STRAIGHT	3.4 MM	23-5303XX	23-6003XX
	30°- RIGHT	3.4 MM	23-5313XX	23-6013XX
	30°- LEFT	3.4 MM	23-5333XX	23-6033XX
	45°- RIGHT	3.4 MM	23-5353XX	23-6053XX
	45°- LEFT	3.4 MM	23-5373XX	23-6073XX
	7°- UP	3.4 MM	23-5393XX	23-6093XX
	7°- DOWN	3.4 MM	23-5413XX	23-6113XX
	15°- UP	3.4 MM	23-5433XX	23-6133XX
	15°- DOWN	3.4 MM	23-5453XX	23-6153XX

AVAILABLE HANDLES FOR THE INSTRUMENTS BELOW...
Please see example for ordering

23-8903XX + Ring Handle = 23-8903RH



Ring Handle Design (RH)



Loop Handle Design (LH)



Pro Handle Design (PH)

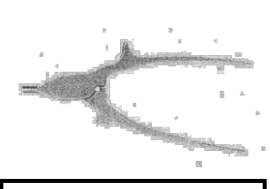

Wishbone Handle Design
/ / / /

45° HOOK SCISSORS & PUNCHES



TIP DESIGN	SHAFT DIAMETER	HOOK SCISSOR	HOOK PUNCH W/ SCOOP	HOOK PUNCH, BLUNT
45° RIGHT	3.4 MM	23-2703XX	23-4103XX	23-4203XX
45° LEFT	3.4 MM	23-2803XX	23-4303XX	23-4403XX

90° HOOK PUNCHES & WIDE JAW PUNCHES



TIP DESIGN	SHAFT DIAMETER	HOOK PUNCH W/ SCOOP	HOOK PUNCH, BLUNT	WIDE JAW PUNCH, 3.0 MM	WIDE JAW PUNCH, 1.8 MM
90° RIGHT	3.4 MM	23-4503XX	23-46503XX	23-7403XX	23-7603XX
90° LEFT	3.4 MM	23-47033XX	23-4803XX	23-7503XX	23-7703XX

GRASPING FORCEPS



SHAFT DESIGN	SHAFT DIAMETER	GRASPING FORCEPS	GRASPING FORCEPS 1 X 2 TEETH, FINE	GRASPING FORCEPS 1 X 2 TEETH, CRASS
STRAIGHT	2.7 MM	23-8002XX	---	23-3202XX
STRAIGHT	3.4 MM	23-8003XX	23-8203XX	23-3203XX



SHAFT DESIGN	SHAFT DIAMETER	GRASPING & BIOPSY FORCEPS	BULLDOG GRASPING FORCEPS	BIOPSY FORCEP	BIOPSY FORCEP W/ SPIKE
STRAIGHT	2.7 MM			23-3602XX	23-3602-01XX
STRAIGHT	3.4 MM	23-8603XX	---	23-3603XX	23-3603-01XX
STRAIGHT	4.5 MM	---	23-8454XX	---	---

ARTHROSCOPIC HAND INSTRUMENTS

AVAILABLE HANDLES FOR THE INSTRUMENTS BELOW...
Please see example for ordering

23-8903XX + Ring Handle = 23-8903RH



Ring Handle Design (RH)



Loop Handle Design (LH)



Pro Handle Design (PH)

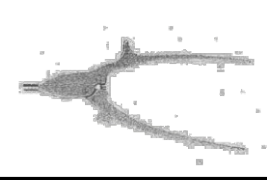

Wishbone Handle Design (WH)

BIRD BEAK SUTURE FORCEPS



TIP DESIGN	SHAFT DIAMETER	BIRD BEAK SUTURE HOOK FORCEPS
STRAIGHT	3.4 MM	23-9003XX



TIP DESIGN	SHAFT DIAMETER	BIRD BEAK SUTURE HOOK FORCEPS
10° - UPMILLED	3.4 MM	23-8953XX



TIP DESIGN	SHAFT DIAMETER	BIRD BEAK SUTURE HOOK FORCEPS
20° - UPMILLED	3.4 MM	23-3122XX



TIP DESIGN	SHAFT DIAMETER	BIRD BEAK SUTURE HOOK FORCEPS
40° - UPMILLED	3.4 MM	23-3125XX



TIP DESIGN	SHAFT DIAMETER	BIRD BEAK SUTURE HOOK FORCEPS
45° - UPMILLED	3.4 MM	23-8933XX



TIP DESIGN	SHAFT DIAMETER	BIRD BEAK SUTURE HOOK FORCEPS
45°- LEFT	3.4 MM	23-3116XX



TIP DESIGN	SHAFT DIAMETER	BIRD BEAK SUTURE HOOK FORCEPS
45°- RIGHT	3.4 MM	23-3119XX

ARTHROSCOPIC HAND INSTRUMENTS

AVAILABLE HANDLES FOR THE INSTRUMENTS BELOW...
Please see example for ordering

23-8903XX + **R**ing **H**andle = 23-8903RH



Ring Handle Design (RH)



Loop Handle Design (LH)



Pro Handle Design (PH)



Wishbone Handle Design (WH)

SUTURE GRASPING FORCEPS



TIP DESIGN	SHAFT DIAMETER	SUTURE GRASPING FORCEPS
STRAIGHT	3.4 MM	23-8933XX



TIP DESIGN	SHAFT DIAMETER	SERRATED SUTURE GRASPING FORCEPS
STRAIGHT	3.4 MM	23-3136XX

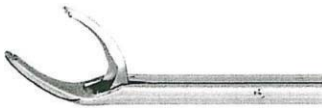

TIP DESIGN	SHAFT DIAMETER	SERRATED SUTURE GRASPING FORCEPS
45°- LEFT	3.4 MM	23-3138XX



TIP DESIGN	SHAFT DIAMETER	SERRATED SUTURE GRASPING FORCEPS
45°- RIGHT	3.4 MM	23-3140XX



TIP DESIGN	SHAFT DIAMETER	SERRATED SUTURE GRASPING FORCEPS
15°- UPMILLED	3.4 MM	23-3142XX

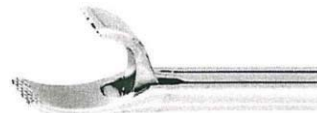

TIP DESIGN	SHAFT DIAMETER	KING SUTURE GRASPING FORCEPS
STRAIGHT	3.4 MM	23-3142XX

ARTHROSCOPIC HAND INSTRUMENTS

AVAILABLE HANDLES FOR THE INSTRUMENTS BELOW...
Please see example for ordering

23-8903XX + Ring Handle = 23-8903RH



Ring Handle Design (RH)



Loop Handle Design (LH)



Pro Handle Design (PH)



Wishbone Handle Design (WH)

SUTURE HOOKS



TIP DESIGN	SHAFT DIAMETER	SUTURE HOOK
POINTED LEFT	3.4 MM	23-3128XX



TIP DESIGN	SHAFT DIAMETER	SUTURE HOOK
POINTED RIGHT	3.4 MM	23-3130XX



TIP DESIGN	SHAFT DIAMETER	SUTURE HOOK
TURNED LEFT	3.4 MM	23-3132XX



TIP DESIGN	SHAFT DIAMETER	SUTURE HOOK
TURNED RIGHT	3.4 MM	23-3134XX



ARTHROSCOPIC HAND INSTRUMENTS

ARTHROSCOPIC PUNCHES

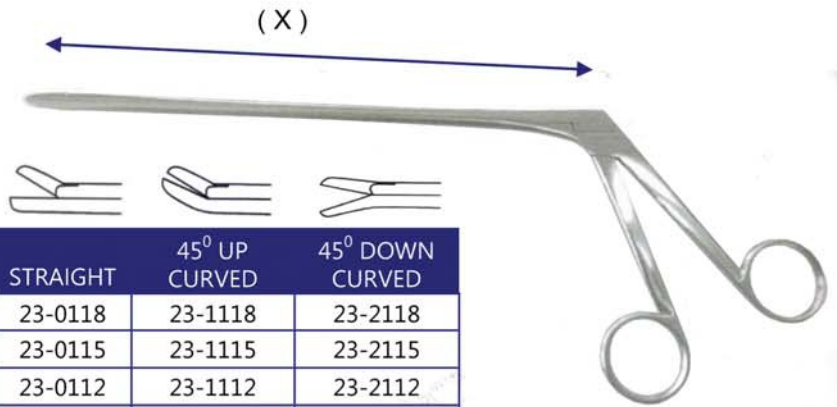

	WORKING LENGTH	BITE DIMENSION	STRAIGHT	45° UP CURVED	45° DOWN CURVED
CUSHING 2 X 10 MM	X=180 MM	2 X 10 MM	23-0118	23-1118	23-2118
	X=150 MM	2 X 10 MM	23-0115	23-1115	23-2115
	X=120MM	2 X 10 MM	23-0112	23-1112	23-2112
LOVE - GRUNWALD 3 X 10 MM	X=180 MM	3 X 10 MM	23-0218	23-1218	23-2218
	X=150 MM	3 X 10 MM	23-0215	23-1215	23-2215
	X=120MM	3 X 10 MM	23-0212	23-1212	23-2212
SPURLING 4 X 10 MM	X=180 MM	4 X 10 MM	23-0318	23-1318	23-2318
	X=150 MM	4 X 10 MM	23-0315	23-1315	23-2315
	X=120MM	4 X 10 MM	23-0312	23-1312	23-2312

MENISCUS GRASPING FORCEPS

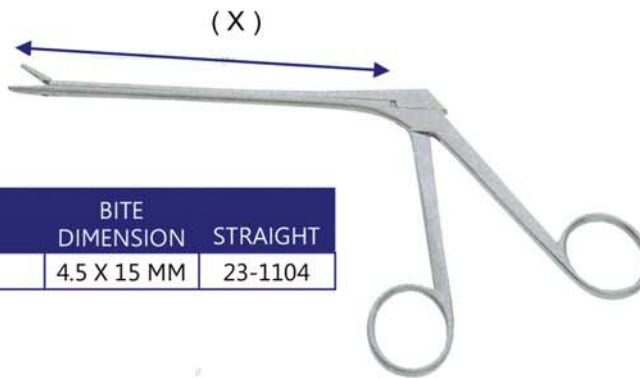

WORKING LENGTH	BITE DIMENSION	STRAIGHT
X=120 MM	4.5 X 15 MM	23-1104

MENISCUS RETRACTING FORCEPS



STANDARD TIP



1x2 TEETH

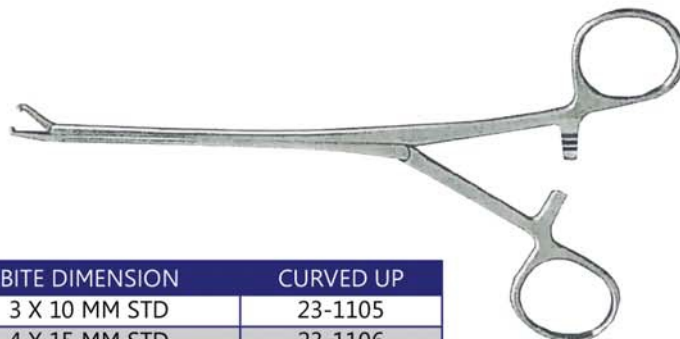

WORKING LENGTH	OVERALL LENGTH	BITE DIMENSION	CURVED UP
85 CM	15 CM	3 X 10 MM STD	23-1105
120 MM	19 CM	4 X 15 MM STD	23-1106
85 MM	15 CM	3 X 10 MM 1x2 TEETH	23-1107
120 MM	19 CM	4 X 15 MM 1x2 TEETH	23-1108



TENDON GRASPING FORCEPS - STRAIGHT, RIGHT & LEFT

(X)

WORKING LENGTH	STRAIGHT
X=190 MM	23-0045

(X)

WORKING LENGTH	
X=190 MM	23-1045

(X)

WORKING LENGTH	LEFT
X=190 MM	23-2045

CAROLL TENDON GRASPING FORCEPS

WORKING LENGTH	STRAIGHT
X=190 MM	23-0101

ARTHROSCOPIC INSTRUMENTS



2 PIECE INSTRUMENT W/ ROUND HANDLE

240MM OVERALL LENGTH



1 PIECE INSTRUMENT W/ TRIANGLE HANDLE



HOOK PROBE & RETRACTOR, POINTED

23-0012C



KNIFE, 45° ANGLED

23-0012A

23-0022C

23-0022A



23-0032C

BAYONET KNIFE

23-0032A



23-0042C

BANANA KNIFE, SERRATED

23-0042A



23-0052C

BANANA KNIFE, SMOOTH

23-0052A

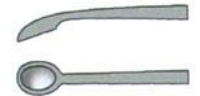

23-0062C

SPOON, CURVED 30°, 3MM

23-0062A



23-0072C

RING CURETTE, 15° ANGLED, 3MM

23-0072A



23-0082C

RING CURETTE, 15° ANGLED, 7MM

23-0082A



23-0092C

HOOK PROBE, GRADUATED, 3MM

23-0092A

ARTHROSCOPIC INSTRUMENTS



2 PIECE INSTRUMENT W/ ROUND HANDLE

240MM OVERALL LENGTH

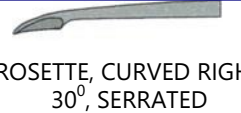

1 PIECE INSTRUMENT W/ TRIANGLE HANDLE

23-0102C		23-0102A
23-0112C		23-0112A
23-0122C		23-0122A
23-0132C		23-0132A
23-0142C		23-0142A
23-0152C		23-0152A
23-0162C		23-0162A
23-0172C		23-0172A
23-0182C		23-0182A
23-0192C		23-0192A

ARTHROSCOPIC INSTRUMENTS-ECONOMY LINE



190MM OVERALL LENGTH



HOOK PROBE &
RETRACTOR, POINTED

23-0012E



KNIFE, 45° ANGLED

23-0022E



BAYONET KNIFE

23-0032E



BANANA KNIFE,
SERRATED

23-0042E



BANANA KNIFE,
SMOOTH

23-0052E

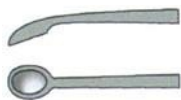

SPOON, CURVED 30°,
3MM

23-0062E



RING CURETTE, 15°
ANGLED, 3MM

23-0072E



RING CURETTE, 15°
ANGLED, 7MM

23-0082E



HOOK PROBE,
GRADUATED, 3MM

23-0092E



HOOK PROBE,
GRADUATED, 5MM

23-0102E



SMILLIE MENISCOTOME,
3MM

23-0112E



SMILLIE MENISCOTOME,
5MM

23-0122E



SMILLIE MENISCOTOME,
7MM

23-0132E



SCALPEL KNIFE

23-0142E



ROSETTE, STRAIGHT,
SERRATED

23-0152E



ROSETTE, CURVED LEFT
30°, SERRATED

23-0162E

LAMINECTOMY PUNCH



Micro Kerrison Convertible Rongeurs

40° jaw angle

E - Ejector (Not available in 1mm)
T - Thin Footplate
C - ceramic

7" (18.0cm)	8" (20.0cm)	9" (23.0cm)	Bite Size
581-180	581-200	581-230	1mm
582-180	582-200	582-230	2mm
583-180	583-200	583-230	3mm
584-180	584-200	584-230	4mm
585-180	585-200	585-230	5mm
586-180	586-200	586-230	6mm



Micro Kerrison Convertible Rongeur

40° jaw angle 15mm opening

E - Ejector
C - ceramic

8" (20.0cm)	Bite Size
592-200	2mm
593-200	3mm
594-200	4mm
595-200	5mm



LAMINECTOMY PUNCH

'Black Line' Kerrison Laminectomy Punch

- 40° UPWARD jaw angle
- With special titanium coating on surface
- Bone ejector

40° UPWARD JAW			
18cm/7" Shaft	20cm/8" Shaft	23cm/9" Shaft	Bite Size
570-721-BD	570-761-BD	570-891-BD	1mm*
570-722-BD	570-762-BD	570-892-BD	2mm
570-723-BD	570-763-BD	570-893-BD	3mm
570-724-BD	570-764-BD	570-894-BD	4mm
570-725-BD	570-765-BD	570-895-BD	5mm
570-726-BD	570-766-BD	570-896-BD	6mm

*1mm size not available with Bone Ejector

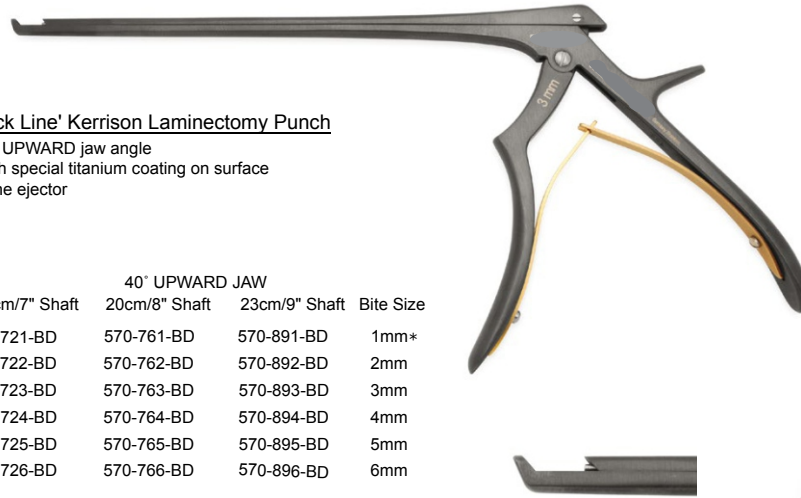

40° UPWARD

Kerrison Laminectomy Punch with Bone Ejector

- 40° UPWARD jaw angle
- Bone ejector

40° UPWARD JAW		
18cm/7" Shaft	20cm/8" Shaft	Bite Size
570-392	570-692	2mm
570-393	570-693	3mm
570-394	570-694	4mm
570-395	570-695	5mm
570-396	570-696	6mm

*1mm size not available with Bone Ejector



40° UPWARD

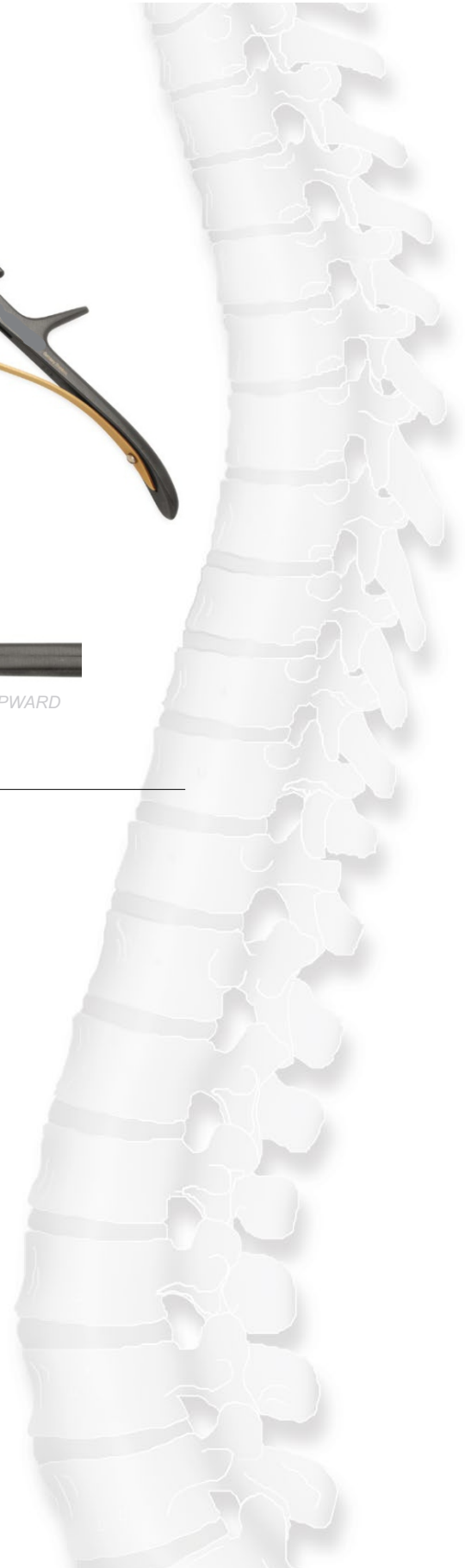

LAMINECTOMY PUNCH

Clean Wave™ Kerrison w/ejector 10mm opening



7" (18.0cm)	8" (20.0cm)	9" (23.0cm)	Bite Size
570-721CW	570-761CW	570-891CW	1mm
570-722CW	570-762CW	570-892CW	2mm
570-723CW	570-763CW	570-893CW	3mm
570-724CW	570-764CW	570-894CW	4mm
570-725CW	570-765CW	570-895CW	5mm

T-Thin FootPlate
 C-Ceramic

40° UPWARD JAW

*1mm not available with bone ejector

Clean Wave™ Caspar IVD Rongeur



7.25" (18.5cm)

Straight

2x12mm	572-901CW
3x12mm	572-902CW
4x14mm	572-903CW

Angled Up

2X12mm	572-910CW
3x12mm	572-905CW
4x14mm	572-906CW

Angled Down

2X12mm	572-911CW
3x12mm	572-909CW
4x14mm	572-908CW

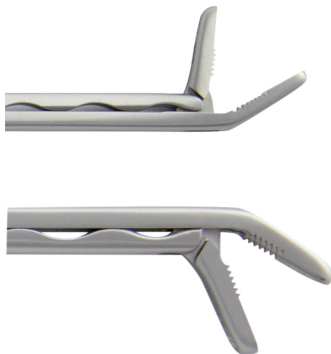

LAMINECTOMY PUNCH

Bayonet Kerrison

40° UPWARD jaw angle

Shaft 6.25" (16cm)

Bite Size

571-122 2mm
571-123 3mm
571-124 4mm
571-125 5mm



Bayonet IVD Rongeur

Shaft 6.25" (16.0cm)

Straight

2x8mm 571-812
3x9mm 571-813
4x10mm 571-814

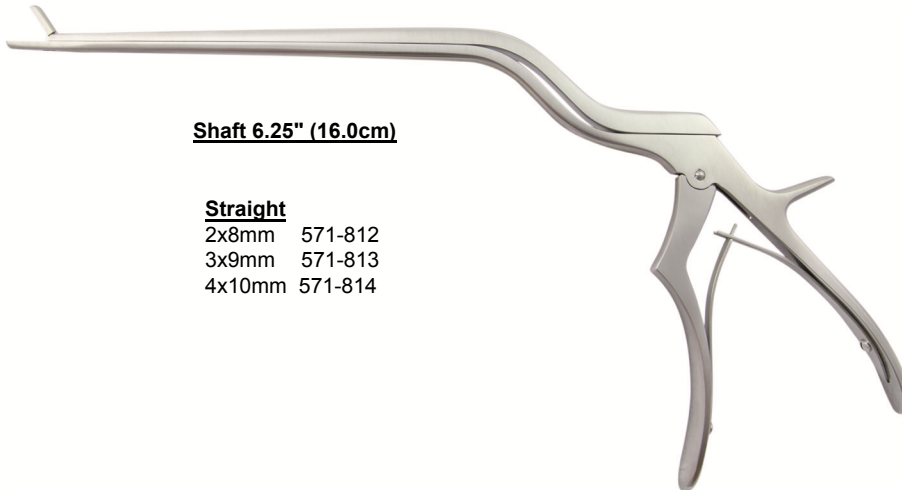

LAMINECTOMY PUNCH

Long Anterior Kerrison Laminectomy Punch

- 40° UPWARD jaw angle
- With special titanium coating on surface
- Extra-long shaft for thoracic approach
- Bone ejector

40° UPWARD JAW
28cm/11" Shaft Bite Size

570-991BD	1mm*
570-992BD	2mm
570-993BD	3mm
570-994BD	4mm
570-995BD	5mm
570-996BD	6mm



40° UPWARD

*1mm not available with bone ejector

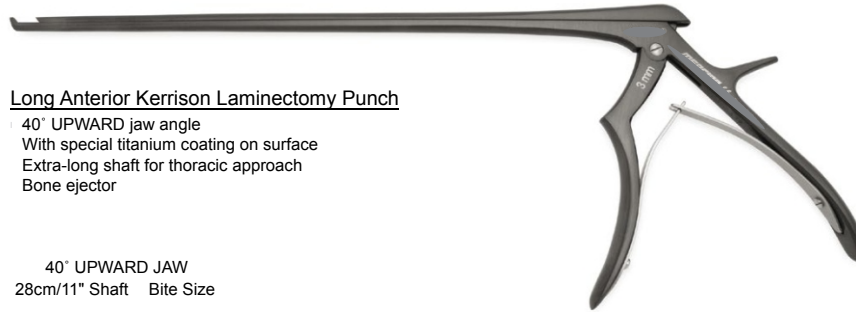

Curved Foramenotomy Punch

- 40° UPWARD jaw angle
- Curved shaft designed to improve access to the foramen

20cm/8" Shaft Bite Size

571-100	2mm
571-102	3mm
571-104	4mm



LAMINECTOMY PUNCH

Ferris-Smith Kerrison Laminectomy Punch

- 40° UPWARD jaw angle
- Modified ring handle

40° UPWARD JAW		Bite Size
18cm/7" Shaft		
571-025		3mm
571-035		5mm

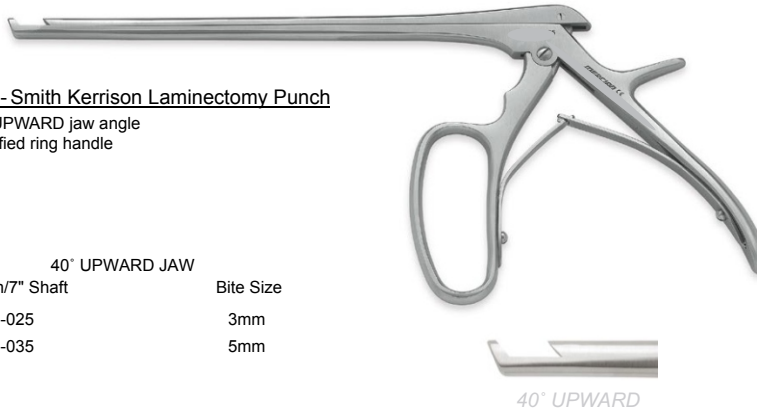

Osteo-Rotating Punch

- 40° UPWARD jaw angle
- Thin foot plate for tight areas
- Full 360° rotation of shaft
- Removable shaft allows cleaning & replacement
- Ergonomically shaped handle

40° UPWARD JAW		
18cm/7" Shaft	21cm/8¼" Shaft	Bite Size
7375-40	7376-40	0.6mm
7375-41	7376-41	1mm
7375-42	7376-42	2mm
7375-43	7376-43	3mm
7375-44	7376-44	4mm

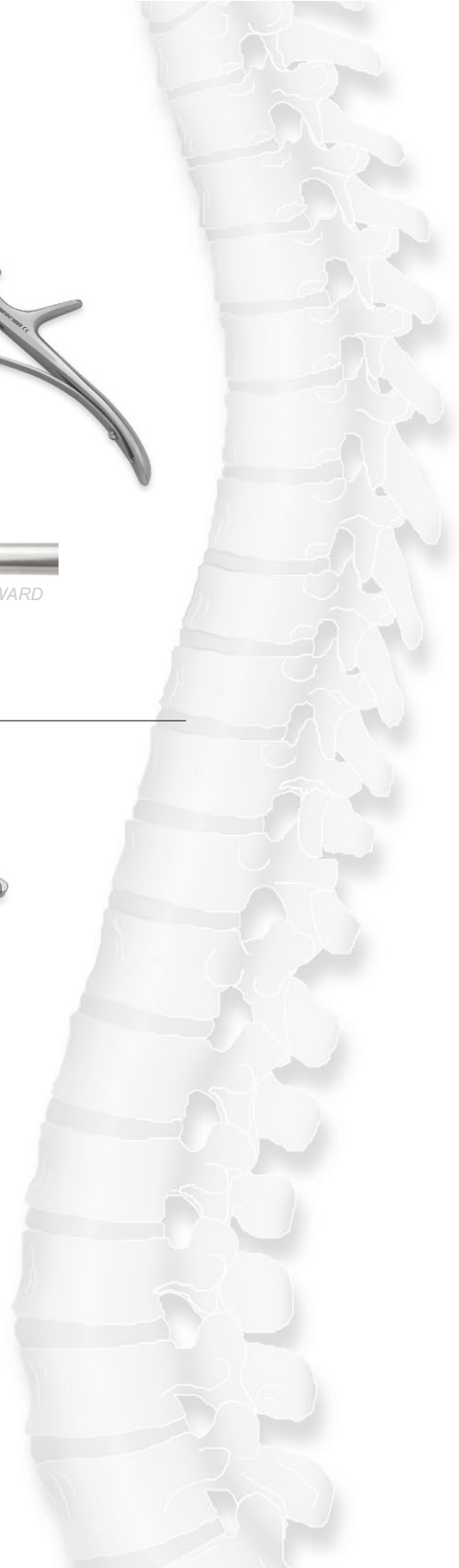

DISC RONGEURS

Caspar Toothed Disc Rongeur

Serrated and fenestrated jaws

STRAIGHT JAW		
16cm/6 1/4" Shaft	18cm/7" Shaft	Bite Size
572-912	572-901	2mm
572-913	572-902	3mm
572-914	572-903	4mm
572-915	572-904	5mm

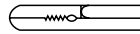

UPWARD JAW		
16cm/6 1/4" Shaft	18cm/7" Shaft	Bite Size
572-917	572-905	3mm
572-918	572-906	4mm
572-919	572-907	5mm

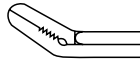

DOWNWARD JAW		
16cm/6 1/4" Shaft	18cm/7" Shaft	Bite Size
572-920	572-909	3mm
572-921	572-908	4mm

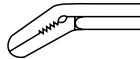

Schlesinger Toothed Rongeur

Fine serration on the jaw edge

STRAIGHT JAW	
15cm/6" Shaft	Bite Size
572-432	2mm
572-433	3mm
572-434	4mm



DISC RONGEURS

Williams Discectomy Rongeur

14cm/5½" shaft length

572-091



Single toothed cup 1mm bite



'Pea Pod' Disc Rongeur

Short 10mm length jaw

15cm/6" Bite Size

572-090 2mm

572-092 3mm

572-094 4mm



Oldberg Rongeur

572-296 6.0mm Cup 7"



DISC RONGEURS

Decker Rongeur

15cm/6" shaft length
Straight jaw

572-098



Cushing IVD Rongeurs

2.0mm x 10.0mm Jaws

572-002	Straight	5"
572-012	Straight	6"
572-022	Straight	7"
572-060	Straight	9"
572-030	Straight	11"
572-036	Straight	12"
572-032	Angled Up	5"
572-042	Angled Up	6"
572-052	Angled Up	7"
572-063	Angled Up	9"
572-033	Angled Up	11"
572-037	Angled Up	12"
572-062	Angled Down	5"
572-072	Angled Down	6"
572-082	Angled Down	7"
572-065	Angled Down	9"
572-035	Angled Down	11"
572-038	Angled Down	12"



DISC RONGEURS

Ferris-Smith Disc Rongeur

Ring handle

18cm/7" Shaft

- 572-220
- 572-230
- 572-240
- 572-250

Bite Size

- 2mm
- 3mm
- 4mm
- 5mm

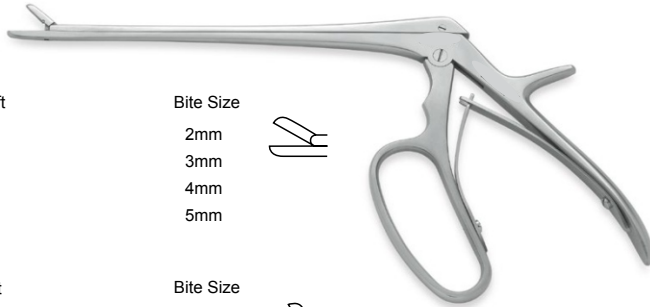

20cm/8" Shaft

- 571-320
- 571-330
- 571-340

Bite Size

- 2mm
- 3mm
- 4mm

Anterior Disc Rongeur

28cm/11" shaft length

Longer 28cm shaft for greater reach in the anterior approach

Straight

- 572-030
- 572-040
- 572-290

Bite Size

- 2x10mm
- 3x10mm
- 4x10mm



Spurling IVD Rongeur

4.0mm x 10.0mm Jaws

572-204	Straight	5"
572-214	Straight	6"
572-224	Straight	7"
572-270	Straight	9"
572-290	Straight	11"
572-297	Straight	12"
572-234	Angled Up	5"
572-244	Angled Up	6"
572-254	Angled Up	7"
572-273	Angled Up	9"
572-293	Angled Up	11"
572-298	Angled Up	12"
572-264	Angled Down	5"
572-274	Angled Down	6"
572-284	Angled Down	7"
572-275	Angled Down	9"
572-294	Angled Down	11"
572-299	Angled Down	12"

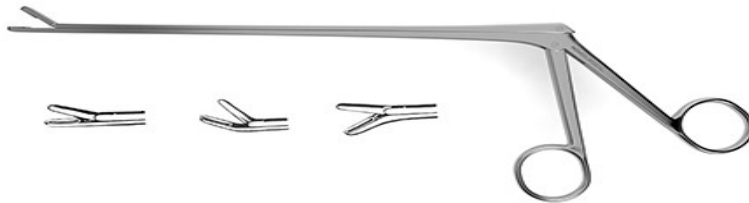

BONE RONGEURS

Lempert Bone Rongeurs

19cm/7½" length
Single action

3mm Bite
307-624



Luer Bone Rongeurs

18cm/7" length
Single action



Straight
8mm Bite
305-217



Curved
8mm Bite
305-317



Adson Bone Rongeurs

20cm/8" length
Single action



7mm Bite
305-421



BONE RONGEURS

'Rat Toothed' Bone Rongeurs

21cm/8¼" length
Single action

8mm Bite
305-422



3 x 3 Teeth



BONE RONGEURS

Zielke Intervertebral Rongeur

Angled parallel jaws

21cm/8"
305-523
305-525

Bite Size
3mm
5mm

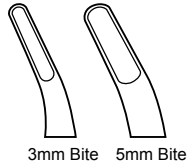

Beyer Bone Rongeurs

18cm/7" length
Curved double action

4mm Bite
311-104



Ruskin Bone Rongeur

Double Action, Jaws 5.0mm Wide

310-605 Straight 7 1/8"
310-625 Straight 9 1/2"
310-705 Curved 7 1/8"
310-725 Curved 9 1/2"



BONE RONGEURS

Jansen Bone Rongeurs

18cm/7" length
Curved double action

5mm Bite
311-105



Marquardt Bone Rongeurs

20cm/8" length
Curved double action

3mm Bite
310-520



Smith-Peterson Bone Rongeurs

24cm/9½" length
Double action

Straight	Light Curve	Bite Size
310-903	310-913	3mm

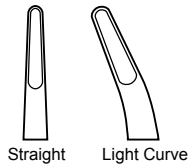

BONE RONGEURS

Leksell Bone Rongeurs

24cm/9½" length
Double action angled

Angled Jaw	Bite Size
315-103	3mm
315-105	5mm
315-108	8mm

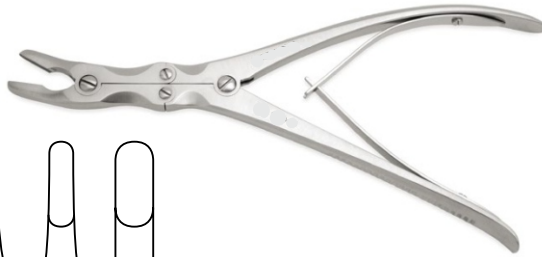
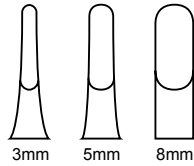

Stille-Luer Bone Rongeurs

22cm/8¾" length
Double action

Straight 10mm Bite 313-023	Curved 10mm Bite 313-123



Stille-Luer Bone Rongeurs

26cm/10¼" length
Double action

Straight 17mm Bite 313-027	Curved 17mm Bite 313-127



BONE RONGEURS

Echlin Duckbill Rongeurs

23cm/9" length
Double action



2mm Bite
316-102



3mm Bite
316-103



4mm Bite
316-104

Long Anterior Leksell Bone Rongeurs

30cm/12" length
Double action

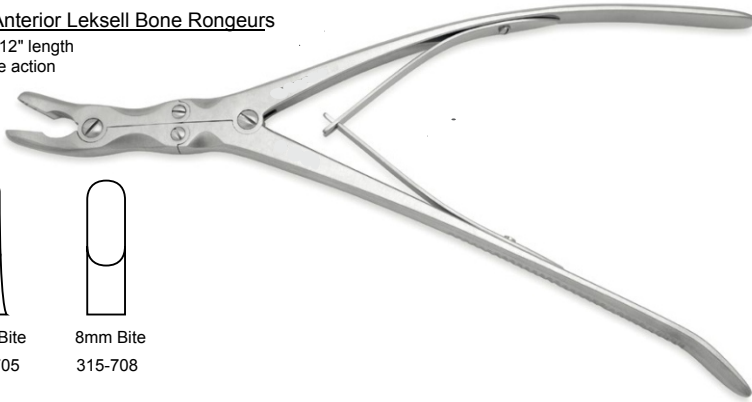

5mm Bite
315-705



8mm Bite
315-708

Sypert Bone Rongeurs

36cm/14 1/4" length
Double action - very long

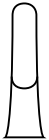

5mm Bite
315-905



8mm Bite
315-908



BONE CUTTERS

McIndoe Bone Cutters

18cm/7" length
Double action
Angled jaws



335-917



Stille-Liston Bone Cutters

27cm/10 3/4" length



Straight

337-027



Angled

337-127

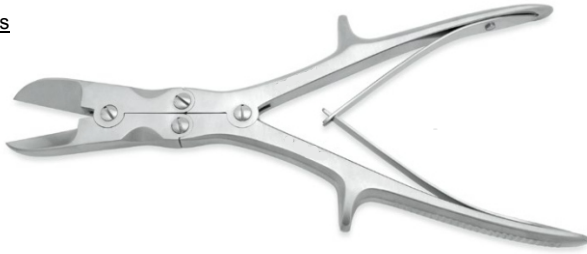

Liston-Key-Horsley Bone Cutters

27cm/10 3/4" length



337-527



OSTEOTOMES

Lexer Osteotome

22cm/8½" length
Tufnol handle



	Width
285-432	7mm
285-433	10mm
285-435	15mm
285-436	20mm
285-437	25mm

OSTEOTOMES

Lambotte Osteotome



25cm/9¾" length		23cm/9" length	
Straight	Width	Curved	Width
289-404	4mm	289-454	4mm
289-406	6mm	289-456	6mm
289-408	8mm	289-458	8mm
289-410	10mm	289-460	10mm
289-413	13mm	289-463	13mm
289-416	16mm	289-466	16mm
289-418	18mm	289-468	18mm
289-420	20mm	289-470	20mm
289-425	25mm	289-475	25mm
289-430	30mm	289-480	30mm



OSTEOTOMES

Stille (Swedish) Osteotome

20cm/8" length

Straight	Width
284-406	6mm
284-408	8mm
284-410	10mm
284-412	12mm
284-415	15mm
284-420	20mm
284-425	25mm
284-430	30mm



Smith Petersen Osteotome

20cm/8" length

	Width
287-110	10mm
287-115	15mm
287-120	20mm
287-125	25mm
287-130	30mm



COBB ELEVATORS

Cobb Spinal Elevator

31cm/12 $\frac{1}{4}$ " overall length
18cm/7" handle length



10mm
264-910



13mm
264-913



19mm
264-919



Harrington Cobb Spinal Elevator

30.5cm/12" overall length



10mm
264-910H



13mm
264-913H



19mm
264-919H



COBB ELEVATORS

Comfort Cobb Elevator

32cm/12½" overall length
20cm/8" handle length



10mm
7551-10



15mm
7551-15



20mm
7551-20



25mm
7551-25

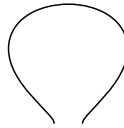

30mm
7551-30

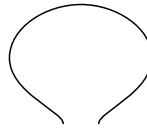

Long Anterior Comfort Cobb Elevator

47cm/18½" overall length

10mm
7551-50



15mm
7551-55



20mm
7551-60



25mm
7551-65



30mm
7551-70

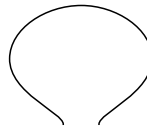

DISSECTORS

Howarth Elevator

21.5cm/8½" overall length



550-171

MacDonald Elevator/Dissector



Size
263-790 18cm/7"

Freer Elevator/Dissector

18.5cm/7¼" overall length



557-027

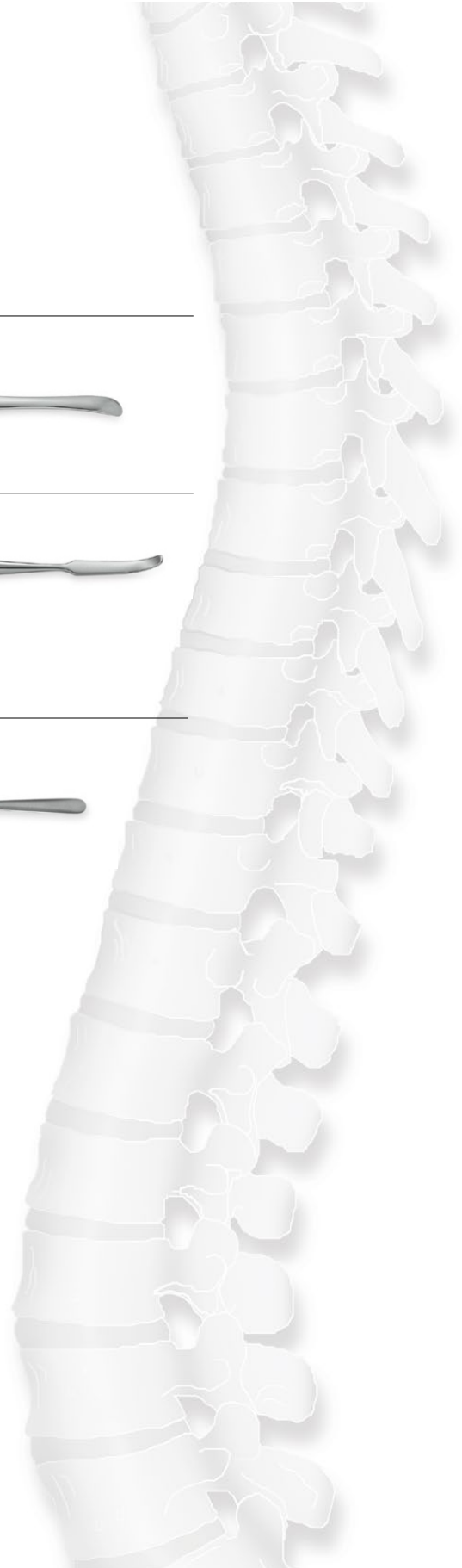

BONE GRAFT IMPACTORS

Cervical Bone Graft Impactor 90 Offset

22cm/8½" length



6mm x 12mm Tip
575-246



3.5mm x 6mm Tip
575-248
18cm length



Lumbar Bone Graft Impactor

22cm/8½" length



7mm x 12mm
575-241



10mm x 13mm
575-243



Anterior Bone Graft Impactor

34cm/13½" length



9 x 16mm Tip
7439-48



9 x 23mm Tip
7439-50

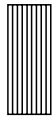

Caspar Bone Graft Holder and Impactor

21.8cm/8½" length



6 x 12mm Tip
772-020

Dowel holder for taking larger
block grafts and for vertebral
body replacement



BAYONET CERVICAL MICRO CURETTES

Cervical Micro Discectomy Curette Set

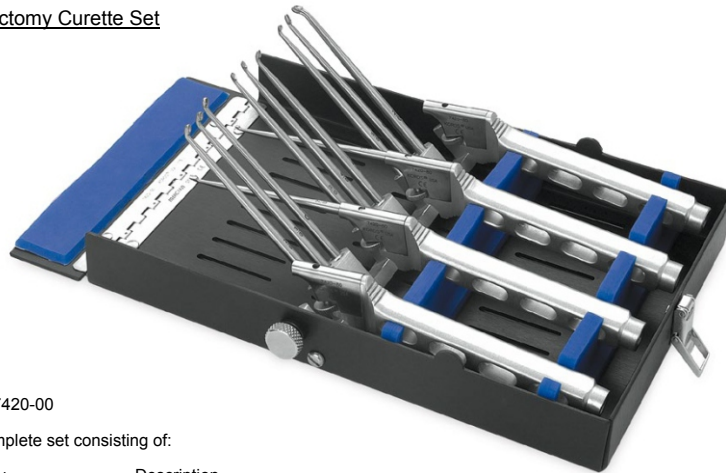

7420-00

Complete set consisting of:

Qty	Description
4	7420-80 Curette Handles
12	Cervical Curette Shafts - includes: 5 Straight Shafts/5 Angled Shafts/2 Down Pushing Shafts
1	7420-90 Sterilising Case



Bayonet handled design for improved visualisation

360° rotating shafts are interchangeable

Shaft length is adjustable

Lightweight handle

Instrument length: 23cm max. for standard curettes

Shaft length 10cm

0	0	0	0	0
00000	0000	000	00	0
cup size	cup size	cup size	cup size	cup size

Straight Cup	Cup Size	Forward Angle	Cup Size
7420-50	00000	7422-50	00000
7420-40	0000	7422-40	0000
7420-30	000	7422-30	000
7420-20	00	7422-20	00
7420-10	0	7422-10	0



BAYONET CERVICAL MICRO CURETTES



Bayonet Cervical Curette

24cm/9½" overall length
12cm/4¾" shaft length

ø	ø	ø	ø	ø
0000 cup size	000 cup size	00 cup size	0 cup size	1 bone cutter

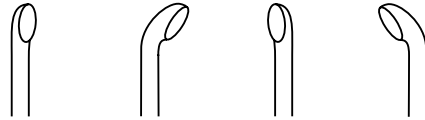

Straight Cup	Forward Angled	Backward Straight	Backward Angled	Cup Size	
588-629	588-634	588-639	588-644	0.5mm	0000
588-628	588-633	588-638	588-643	1mm	000
588-627	588-632	588-637	588-642	2mm	00
588-626	588-631	588-636	588-641	3mm	0
588-630	588-635	588-640	588-645	4mm	Bone Cutter



Container for 12 curettes
7418-95

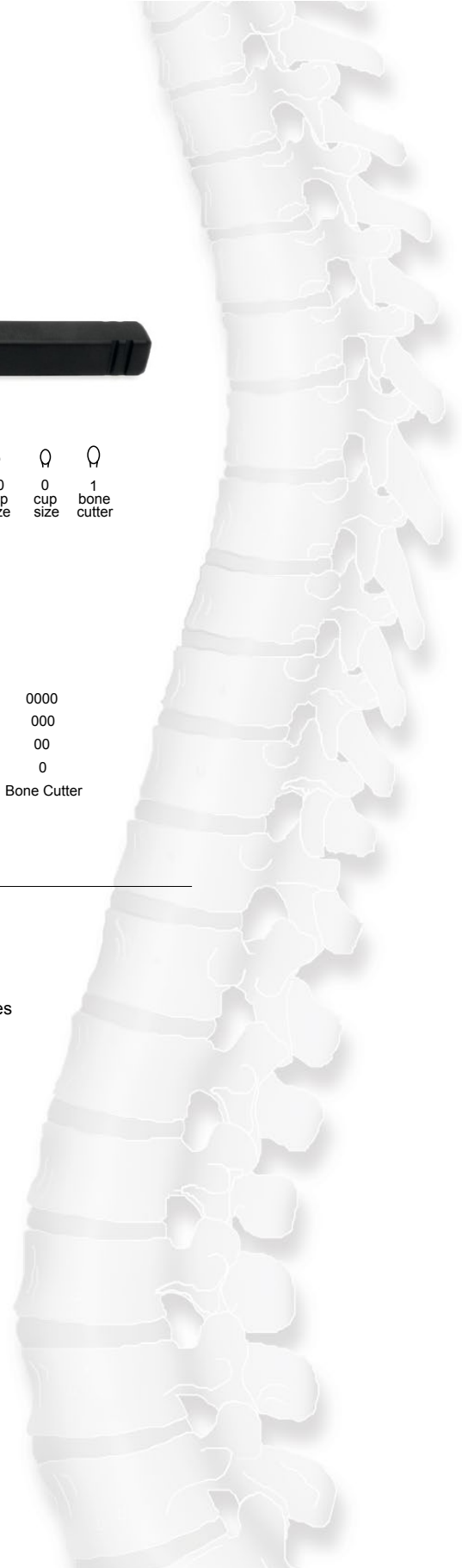

SPINAL CURETTES

Lempert Curette

21cm/8¼" overall length



Straight	Cup Size	Angled	Cup Size
296-715	00000	296-815	00000
296-724	0000	296-824	0000
296-733	000	296-833	000
296-742	00	296-842	00
296-750	0	296-850	0
296-751	1	296-851	1

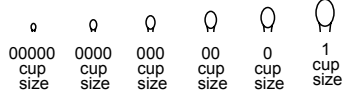

Bruns Curette

23cm/9" overall length



Straight	Cup Size	Angled	Cup Size
295-333	000	295-373	000
295-342	00	295-382	00
295-350	0	295-390	0
295-351	1	295-391	1
295-352	2	295-392	2
295-353	3	295-392	3

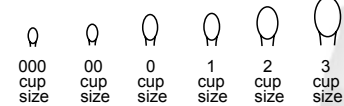



angled
straight
reverse angled



Bruns Currettes

9" Oval, Reverse Angle

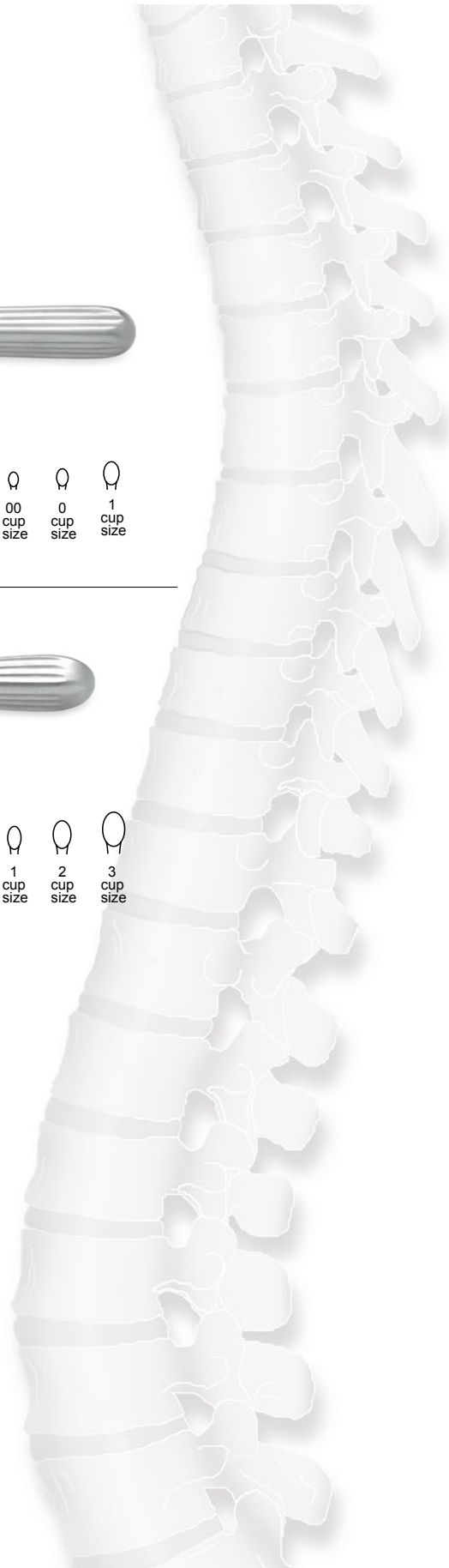
295-407	#00000
295-397	#0000
295-398	#000
295-399	#00
295-400	#0
295-401	#1
295-402	#2
295-403	#3
295-404	#4
295-405	#5
295-406	#6



SPINAL CURETTES

Cobb Bone Curette

28cm/11" length



Straight	Cup Size	Angled	Cup Size
298-817	2.0mm	298-817A	2.0mm
298-818	2.5mm	298-818A	2.5mm
298-819	3.0mm	298-819A	3.0mm
298-820	3.5mm	298-820A	3.5mm
298-821	4.0mm	298-821-A	4.0mm
298-822	4.5mm	298-822-A	4.5mm
298-823	5.0mm	298-823-A	5.0mm
298-824	5.5mm	298-824-A	5.5mm
298-825	6.5mm	298-825-A	6.5mm
298-826	8.0mm	298-826-A	8.0mm

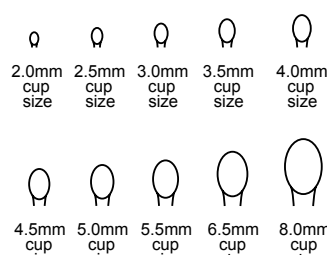

Comfort Handle Curette

29cm/11½" overall length
20cm/8" handle length



Straight	Cup Size	Angled	Cup Size
7561-07	6.5mm	7563-07	6.5mm
7561-09	8.5mm	7563-09	8.5mm
7561-11	11mm	7563-11	11mm
7561-13	13mm	7563-13	13mm
7561-15	15mm	7563-15	15mm

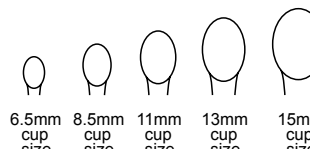

Long-Anterior Curette

38cm/15" overall length

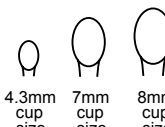
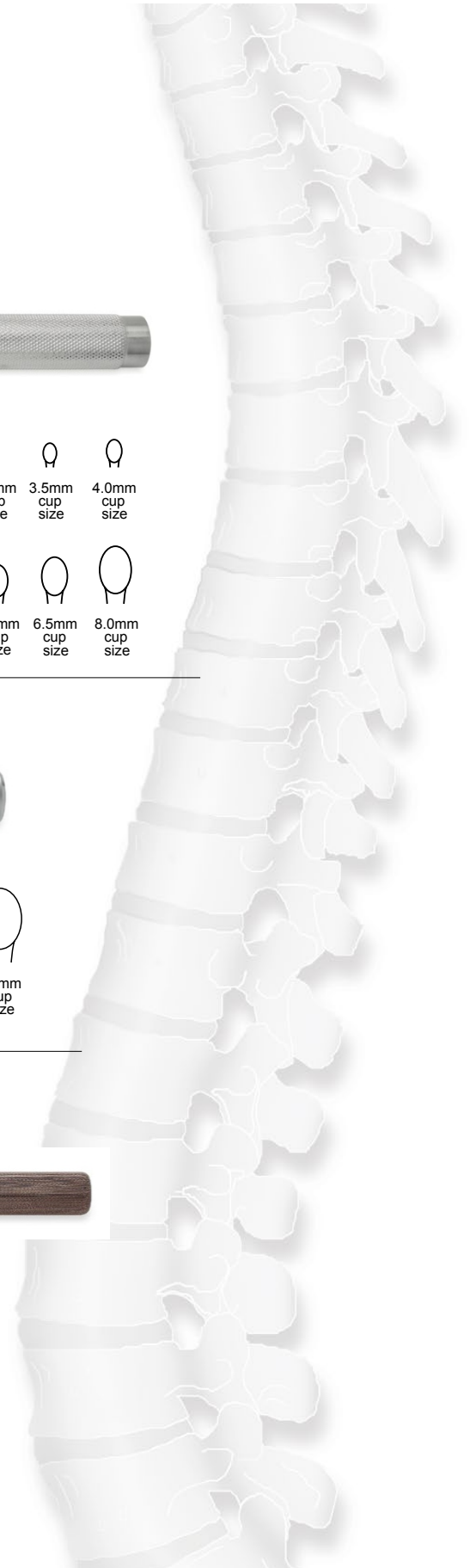

Straight	Cup Size	Angled	Cup Size
7439-10	4.3mm	7439-12	4.3mm
7439-20	7mm	7439-22	7mm
7439-30	8mm	7439-32	8mm

SPINAL CURETTES

Light-Grip Cervical Curettes

28cm/10³/₄" overall length
 13cm/5¹/₄" handle length
 Colour coded handles



Light-Grip Cervical Curette Rack
 Holds 12 Cervical Curettes

7404-90

Cup Size	Straight	Forward Angled	Down Angled
6-0	7403-06	7405-06	7406-06
5-0	7403-05	7405-05	7406-05
4-0	7403-04	7405-04	7406-04
3-0	7403-03	7405-03	7406-03
2-0	7403-02	7405-02	7406-02
0	7403-01	7405-01	7406-01
1	7403-10	7405-10	7406-10
2	7403-20	7405-20	7406-20
3	7403-30	7405-30	7406-30
4	7403-40	7405-40	7406-40
5	7403-50	7405-50	7406-50
6	7403-60	7405-60	7406-60

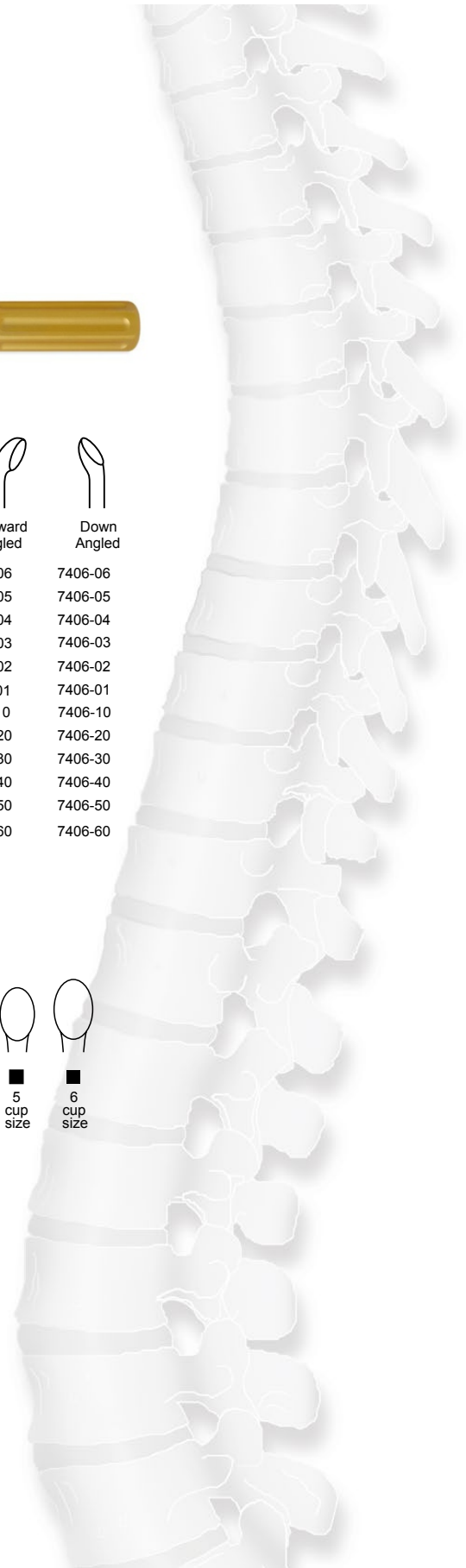
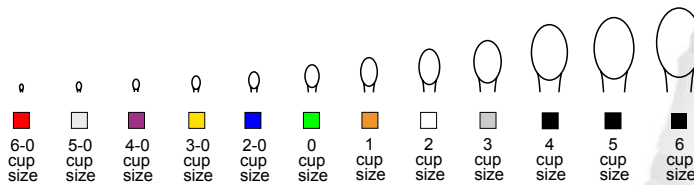

SPINAL CURETTES

Light-Grip Lumbar Currettes

34cm/13½" overall length
 20cm/8" handle length
 Colour coded handles



Cup Size	Straight	Forward Angled	Down Angled
6-0	7407-06	7408-06	7409-06
5-0	7407-05	7408-05	7409-05
4-0	7407-04	7408-04	7409-04
3-0	7407-03	7408-03	7409-03
2-0	7407-02	7408-02	7409-02
0	7407-01	7408-01	7409-01
1	7407-10	7408-10	7409-10
2	7407-20	7408-20	7409-20
3	7407-30	7408-30	7409-30
4	7407-40	7408-40	7409-40
5	7407-50	7408-50	7409-50
6	7407-60	7408-60	7409-60

Light-Grip Lumbar Curette Rack
 Holds 12 Lumbar Currettes
 7407-90

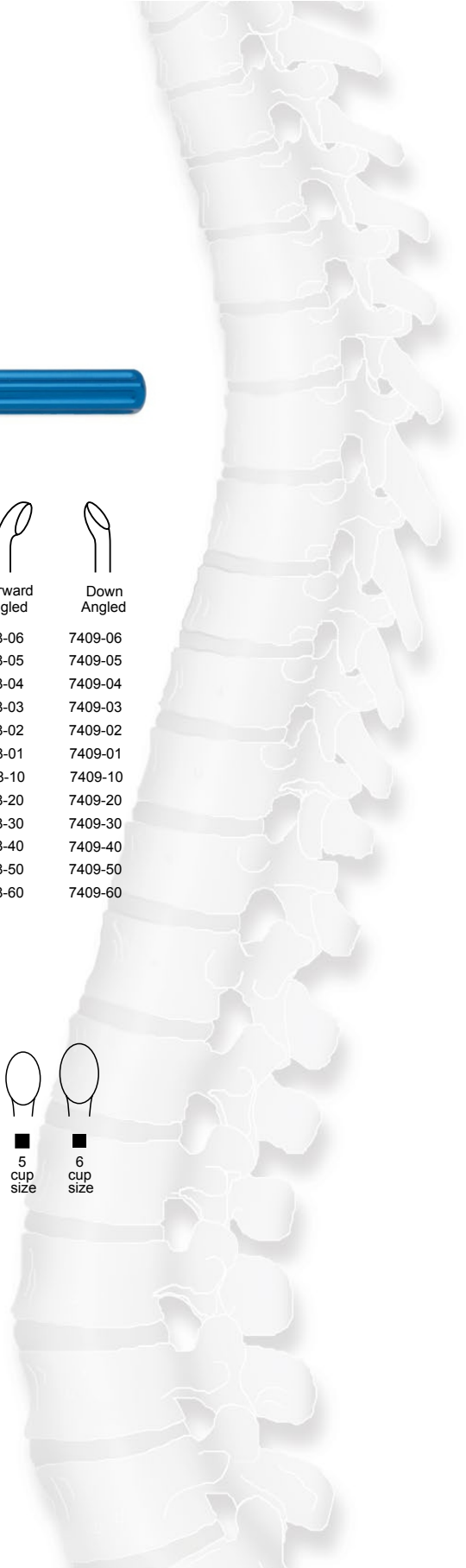
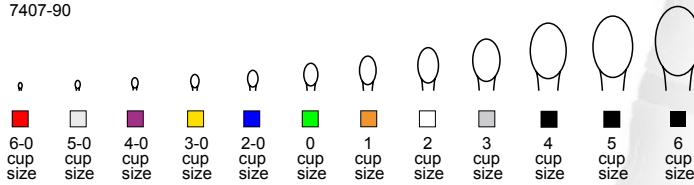



SPINAL CURETTES

Cones Ring Curette

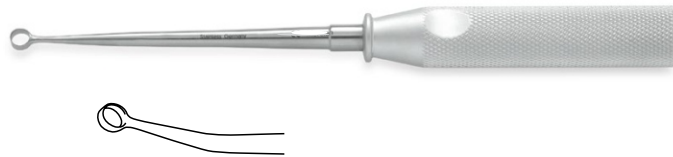
23cm/9" overall length











Straight	Ring Size	Angled	Ring Size		
574-701	3mm	574-711	3mm		3mm ring size
574-702	6mm	574-712	6mm		6mm ring size
574-703	8mm	574-713	8mm		8mm ring size

Volkman Double Ended Curette

22cm/8 3/4" overall length



	Size			
298-513	Small			
298-514	Medium			
298-515	Large			
		Small	Medium	Large



Distraction Retractors



CASPAR CERVICAL DISTRACTION SET

Drill Guide

575-694R Right



575-695 Left



Screw Driver

575-109



Distraction Drill

For pre-drilling pilot holes for distraction screws in combination with the drill guide
Drill 2mmØ

575-111



Caspar Distraction Screws

7cm/2¾" post length
Sterile packed

Thread length



length	Thread
575-106	12mm
575-107	14mm
575-108	16mm



Supplied sterile in boxes of 10



LAMINA & VERTEBRAL SPREADERS

Cervical Vertebral Spreader

13cm/5¼" length
3mm tip

	Depth
575-584	70mm
575-585	95mm*

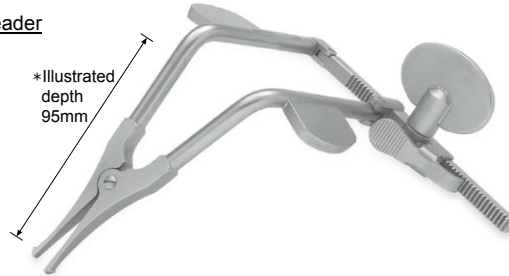

Cloward Cervical Spreader

17cm/6¾" length
Max opening 20mm

7340-10



Cloward Lamina Spreader

15cm/6" length

575-580



LAMINA & VERTEBRAL SPREADERS

Baby Inge Lamina Spreader

18cm/7" length



7mm
Toothed



575-505

7mm
Smooth



575-509

7mm
Cross Serrated



575-517

Inge Lamina Spreader

24cm/9½" length
Max opening 50mm

575-507

10mm



20mm



Long Anterior Lamina Spreader

28cm/11" length
Max opening 40mm

7346-10



HOOKS & PROBES

Adson Dural Hook

19cm/7½" length
3mm tip length

Sharp	Blunt
202-722	202-723



Weary Blunt Nerve Hook

19.5cm/7¾" length
6mm fine tip length

381-020



Crile Blunt Hook

20cm/8" length
7mm tip length

202-737



Emmet Sharp Hook

22cm/8¾" length
5mm tip length

529-010



Cushing Blunt Hook

28cm/11" length
5mm tip length

202-236



HOOKS & PROBES

Adson Hook

20cm/8" length
5mm tip length



Ball Tipped Probe

23cm/9" length
2mm Ø ball

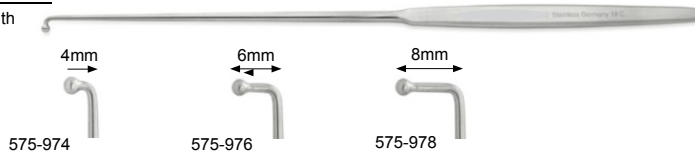

Ball Tipped Probe - Fine Pattern

23cm/9" length
1mm Ø ball

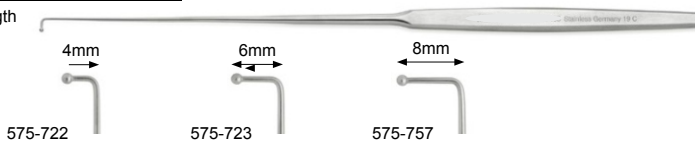

Manipulation Hook

23.5cm/9 1/4" length
4mm tip length



Caspar Exploration Hook Insulated

24.5cm/9 3/4" length
Insulated shaft

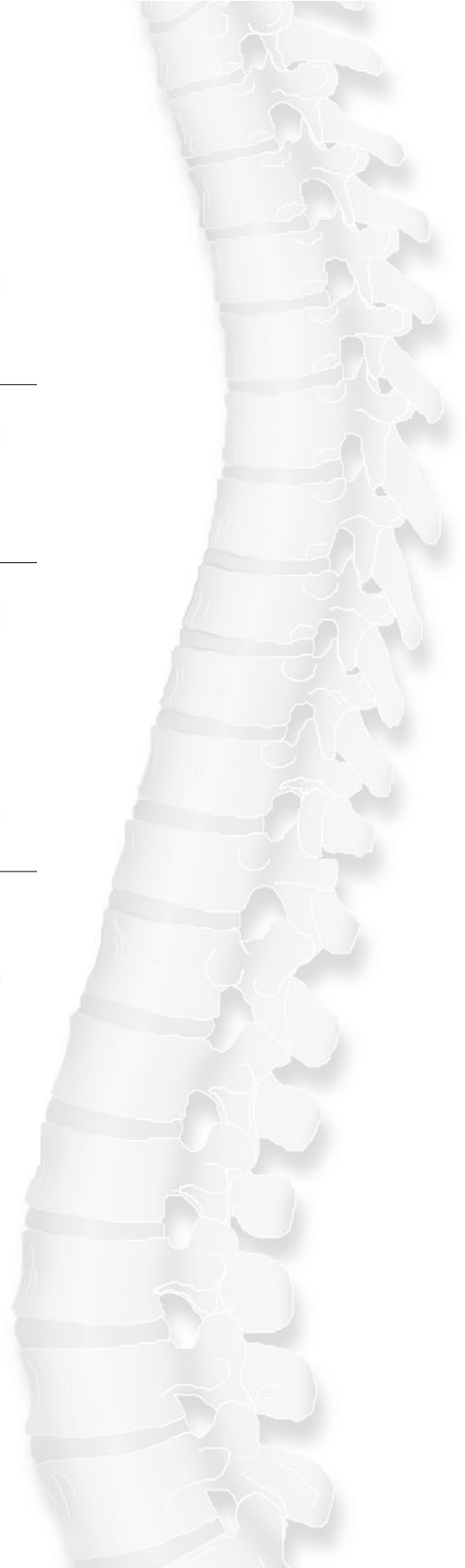
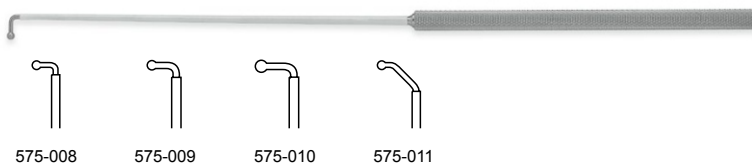

RHOTON MICRO DISSECTORS

19cm/7½" length

Titanium Micro Round Dissectors



Titanium Micro Elevators

19cm/7½" length

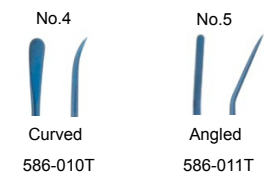

Titanium Micro Spatula Dissectors

19cm/7½" length



Titanium Micro Hooks

19cm/7½" length

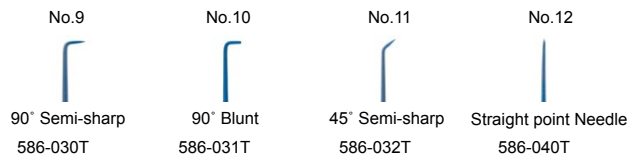

RHOTON MICRO DISSECTORS

Titanium Micro Curettes

19cm/7½" length

No.13



Small Cup

586-050T

No.14



Large Cup

586-051T



Titanium Micro Ball Dissectors

19cm/7½" length

No.15



Straight

586-074T

No.16



90°3mm Tip

586-070T

No.17



90°5mm Tip

586-071T

No.18



40°4mm Tip

586-072T

No.19



40°8mm Tip

586-073T



Complete Set

Including Rack and 19 Micro Dissectors

586-000



Dissector Sterilizing Rack

To hold 19 Micro Dissectors

586-180

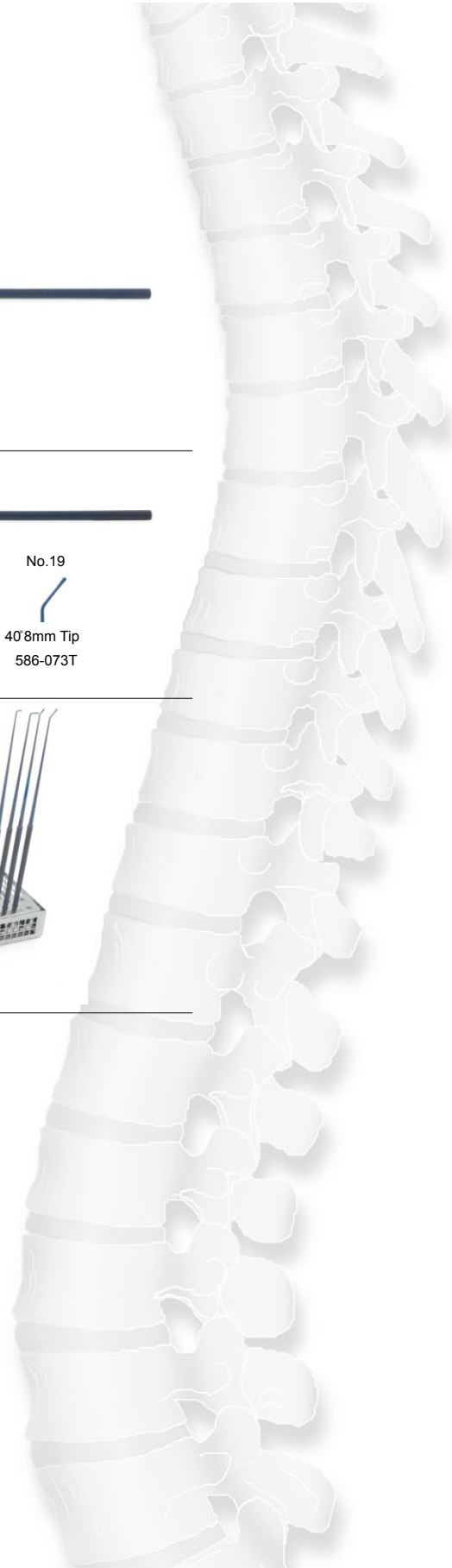

NERVE ROOT RETRACTORS

Love Bayonet Nerve Root Retractor

21cm/8¼" length

575-060 Width
 4mm



Caspar Bayonet Nerve Root Retractor

24cm/9½" length

579-004 Width
579-006 4mm
 6mm

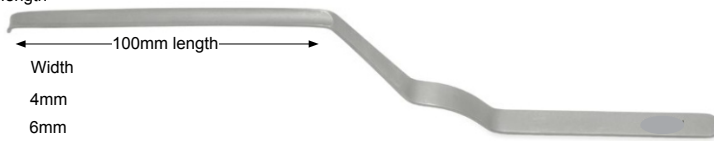

Love Nerve Root Retractor

22cm/8¾" length
5mm tip width

201-701 Straight
201-702 Angled
201-703 Angled



McCulloch Nerve Root Retractor

12.5cm/5" working length
90° angled
6mm tip

575-761

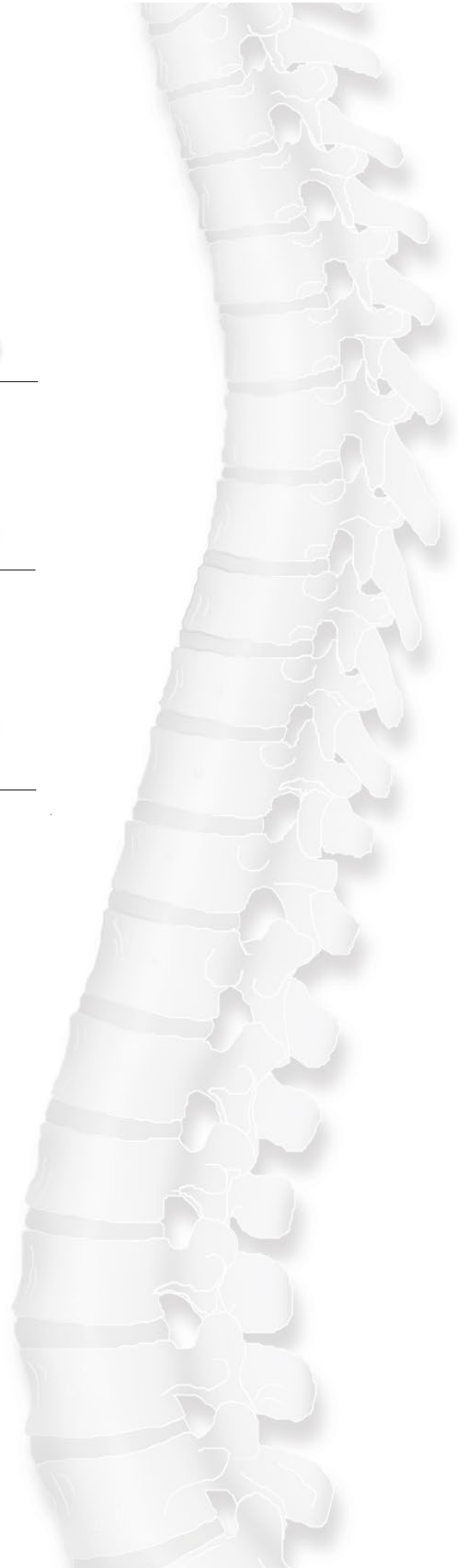

NERVE ROOT RETRACTORS

Nerve Root Retractor

31cm/12" length
With suction
7mm tip width

585-000

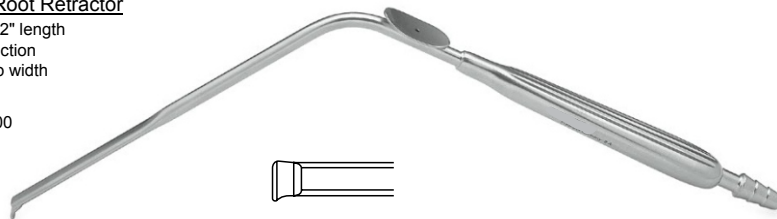

HAND HELD RETRACTORS

Meyerding Retractor

22.5cm/9" length

	Blade size
263-301	50mm x 16mm
263-302	75mm x 25mm
263-303	90mm x 50mm



Langenbeck Retractor

21.5cm/8½" length

	Blade size	
230-710	22mm x 6mm	Small
230-713	45mm x 13mm	Medium
230-716	65mm x 25mm	Large
230-720	90mm x 20mm	X-Large

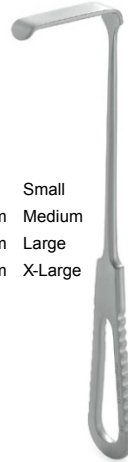

Taylor Hip Retractor

19cm/7½" length

	Depth
575-412	70mm
575-407	85mm
575-410	100mm



Cloward Style Blade Retractor

11cm/4¼" length

	Width
575-497	13mm
575-498	18mm
575-499	20mm

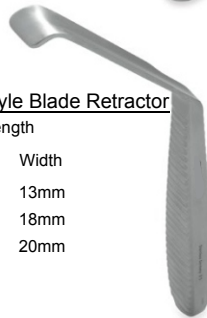

Volkman Catspaw Retractor

21.5cm/8½" length
Semi sharp teeth



15 x 15mm
3 Prong
223-403



15 x 20mm
4 Prong
223-404



15 x 30mm
6 Prong
223-406



SELF RETAINING RETRACTORS

Weitlaner S/R Retractor

14cm/5½" length
3 x 4 Sharp prongs
Prong depth 18mm
242-213



Weitlaner S/R Retractor

14cm/5½" length
3 x 4 Blunt prongs
Prong depth 18mm
242-214

Adson Cerebellar Retractor

Angled Arms

242-802 4x4 Sharp Prongs 7 1/2"



Straight Arms

242-801 4x4 Sharp 7
242-803 4x4 Blunt 7 1/2"



SELF RETAINING RETRACTORS

Cones Self Retaining Retractor

3x4 Prongs
Jointed arms



Blunt Prongs	Length	Depth	Sharp Prongs	Length	Depth
243-014	13cm/5"	15mm	243-013	13cm/5"	15mm
243-017	16cm/6"	15mm	243-016	16cm/6"	15mm
243-021	20cm/8"	20mm	243-020	20cm/8"	20mm
243-024	24cm/9"	25mm	243-023	24cm/9"	25mm

Beckman - Adson Retractor

33cm/13" length
4 x 5 Blunt prongs
Prong depth 32mm
Jointed arms

243-206



Self Retaining Retractors

Meyerding Hemi Laminectomy Retractor

18cm/7" length

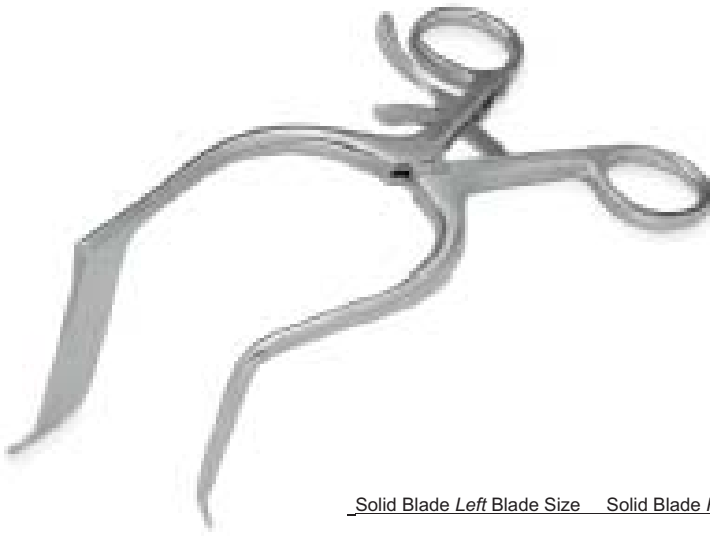

<u>Solid Blade</u>	<u>Left Blade Size</u>	<u>Solid Blade</u>	<u>Right</u>	
572-851	50 x 10mm	572-951		
572-861	60 x 10mm	572-961		Narrow Blade
572-871	70 x 10mm	572-971		
572-852	50 x 20mm	572-952		
572-862	60 x 20mm	572-962		Wide Blade
572-872	70 x 20mm	572-972		





Universal Ring Retractor

Includes:

- 245-823 1 ea Horizontal Flex
- 245-811 1 ea Horizontal
- 245-810 1 ea Table
- 245-812 1 ea Post Coupler
- 245-813 1 ea Medium Oval Ring
- 245-828 1 ea Segmented Ring
- 245-827 2 ea Ratchet
- 245-818 6 ea Tilt Ratchet
- 245-815 2 ea 2" x 3" Kelly Retractor
- 245-816 1 ea 2" x 4" Kelly Retractor
- 245-821 1 ea 2" x 5" Kelly Retractor
- 245-822 1 ea 2" x 6" Kelly Retractor
- 245-817 1 ea Balfour Retractor
- 245-814 2 ea 2" x 6" Malleable Retractor
- 245-819 1 ea 1.5" x 6" Malleable Retractor
- 245-820 1 ea 3" x 6" Malleable Retractor
- 245-824 1 ea Harrington Retractor
- 245-825 1 ea Gelpi Retractor

McCULLOCH RETRACTOR SET



This Retractor allows the consultant the optimal exposure to the disc with the minimum incision.

The design of the retractor allows unhindered access around the wound with the jointed arms folding along the patients back.

The black finish eliminates distracting reflections under the microscope during surgery.

The wide selection of blades available allows the surgeon full flexibility in approaches to the disc.

Basic McCulloch Retractor Set

575-800

Complete set consisting of:

Qty	Order Code	Description
1 each	575-721	Retractor Frame
4 pairs		Wide Muscle Blades Sizes 4cm to 7cm depth
4 pairs		Narrow Muscle Blades Sizes 4cm to 7cm depth
4 each		Hook Blades Sizes 3cm to 6cm depth
4 each		Toothed Blades Sizes 3cm to 6cm depth
1 each		Instrument Container

Extended McCulloch Retractor Set

575-800X

Complete set consisting of:

Qty	Order Code	Description
2 each	575-721	Retractor Frames
6 pairs		Wide Muscle Blades Sizes 3cm to 8cm depth
6 pairs		Narrow Muscle Blades Sizes 3cm to 8cm depth
6 each		Hook Blades Sizes 2cm to 7cm depth
6 each		Toothed Blades Sizes 2cm to 7cm depth
1 each		Instrument Container

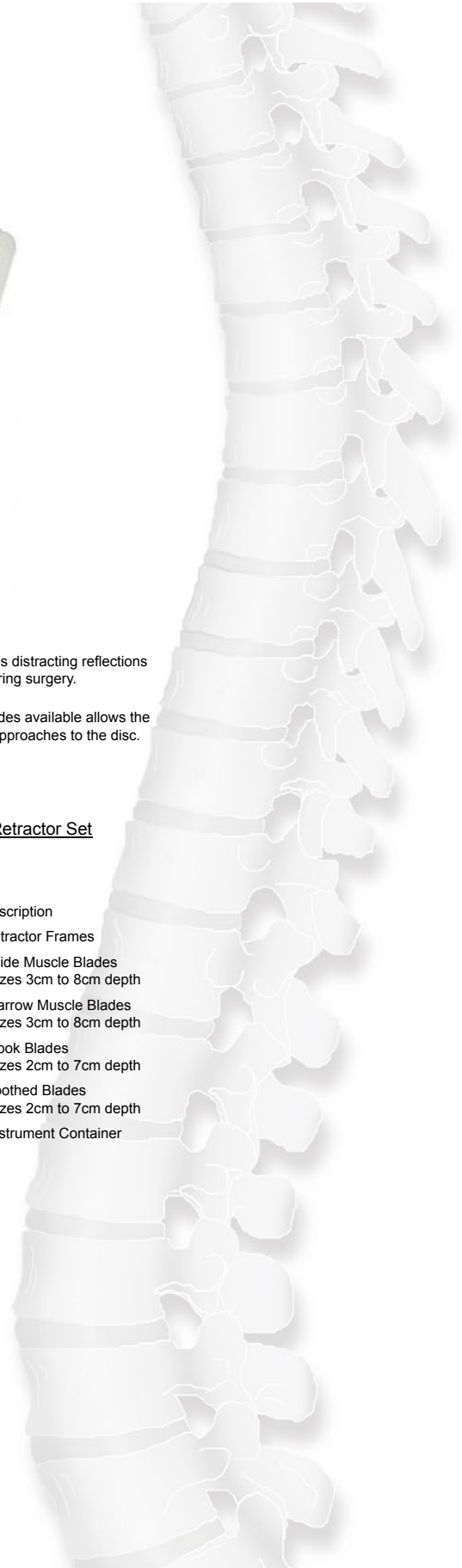

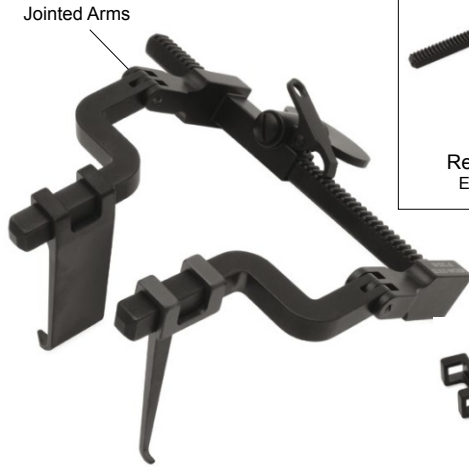

	Retractor Frame Jointed arms Maximum spread 70mm 575-721
	Retractor Frame Rigid arms 575-720
Retractor Frame Extra long rack 140mm spread	

	27mm width	
	575-726	3cm depth
	575-727	4cm depth
	575-728	5cm depth
	575-729	6cm depth
	575-730	7cm depth
Wide Muscle Blades - 6 Teeth	575-731	8cm depth

	575-738	2cm depth
	575-739	3cm depth
	575-740	4cm depth
	575-741	5cm depth
	575-742	6cm depth
Hook Blades	575-743	7cm depth

	20mm width	
	575-732	3cm depth
	575-733	4cm depth
	575-734	5cm depth
	575-735	6cm depth
	575-736	7cm depth
	575-737	8cm depth
	Narrow Muscle Blades - 4 Teeth	

	575-744	2cm depth
	575-745	3cm depth
	575-746	4cm depth
	575-747	5cm depth
	575-748	6cm depth
Toothed Blades	575-749	7cm depth

	17mm width	
	575-750	3cm depth
	575-751	4cm depth
	575-752	5cm depth
	575-753	6cm depth
	575-754	7cm depth
	575-755	8cm depth
Thin Muscle Blades - 2 Teeth		

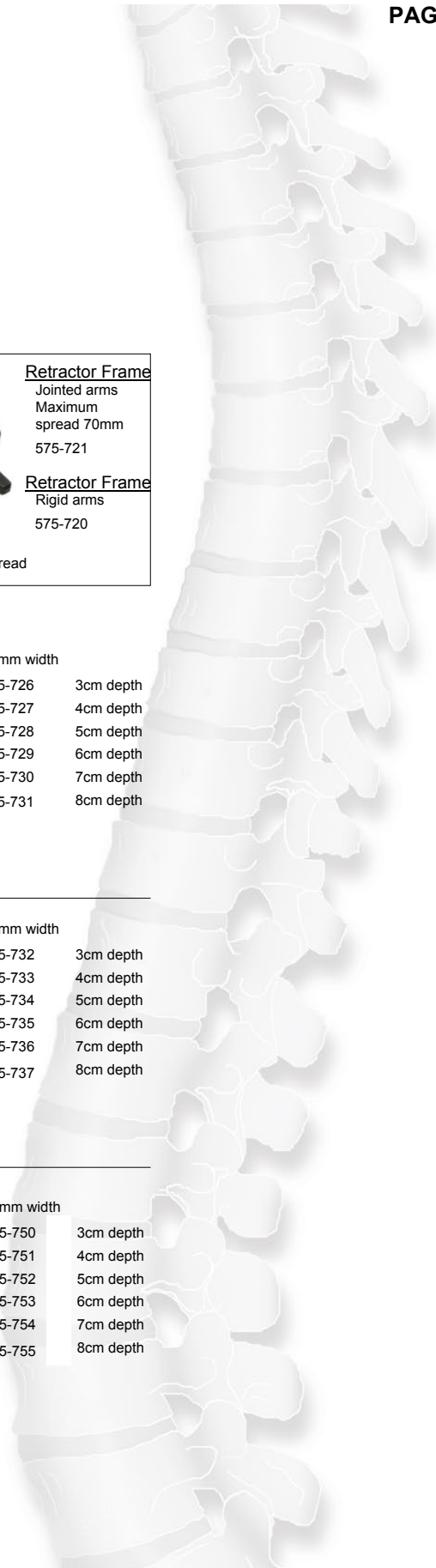

McCULLOCH INSTRUMENTS

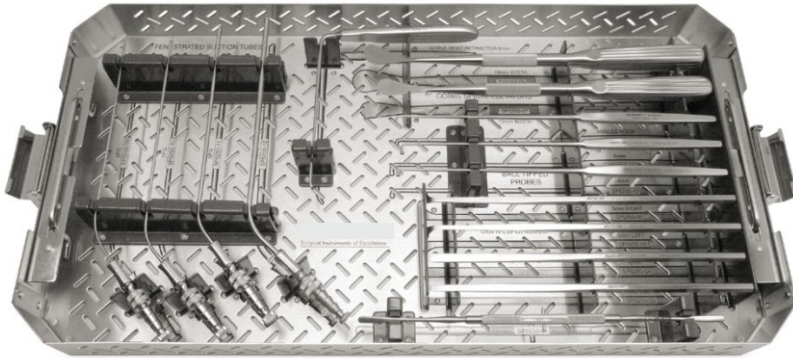

McCulloch Style Instrument Set with Container

Complete set consisting of:

Qty	Order Code	Description
1	575-759	McCulloch Spinal Hook, 4mm tip - 23cm/9" length
1	575-722	McCulloch Spinal Probe, 4mm tip - 23cm/9" length
1	575-723	McCulloch Spinal Probe, 6mm tip - 23cm/9" length
1	575-613	Cobb Spinal Elevator, 12mm width - 26cm/10¼" length
1	575-619	Cobb Spinal Elevator, 19mm width - 26cm/10¼" length
1	575-764	Spinal Osteotome, 4mm width - 22cm/8½" length
1	575-765	Spinal Osteotome, 6mm width - 22cm/8½" length
1	575-766	'Hockey Stick' Chisel, 5mm width - 22cm/8½" length, curved right
1	575-767	'Hockey Stick' Chisel, 5mm width - 22cm/8½" length, curved left
1	575-768	Elevator Double Ended, 24cm/9½" length
1	575-703	McCulloch Suction Tube, Fenestrated tip, 23cm/9" length, 6FG, 2.0mm Ø
1	575-704	McCulloch Suction Tube, Fenestrated tip, 23cm/9" length, 7FG, 2.3mm Ø
1	575-705	McCulloch Suction Tube, Fenestrated tip, 23cm/9" length, 9FG, 3.0mm Ø
1	575-706	McCulloch Suction Tube, Fenestrated tip, 23cm/9" length, 12FG, 4.0mm Ø
1	575-761	McCulloch Nerve Root Retractor, 90angled, 6mm tip, 12.5cm/5" working length

McCulloch Style Spinal Hook/Probe

23cm/9" length

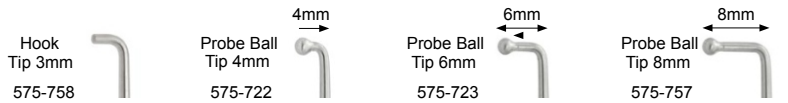

MICRO DISCECTOMY SET

Cobb Spinal Elevator

26cm/10 $\frac{1}{4}$ " length

	Width
575-613	12mm
575-619	19mm



Spinal Osteotome

22cm/8 $\frac{1}{2}$ " length

	Width
575-764	4mm
575-765	6mm



'Hockey Stick' Chisel

22cm/8 $\frac{3}{4}$ " length
5mm width

575-766	Curved right
575-767	Curved left



Elevator Double Ended

24cm/9 $\frac{3}{4}$ " length

575-768



McCulloch Suction Tube

23cm/9" length
Fenestrated tip

	FG	Diameter
575-703	6FG	2.0mm Ø
575-704	7FG	2.3mm Ø
575-705	9FG	3.0mm Ø
575-706	12FG	4.0mm Ø



McCulloch Nerve Root Retractor

12.5cm/5" working length
90° angled
6mm tip

575-761



'BLACK BELT' CERVICAL RETRACTOR SET

* Titanium Blade Set illustrated

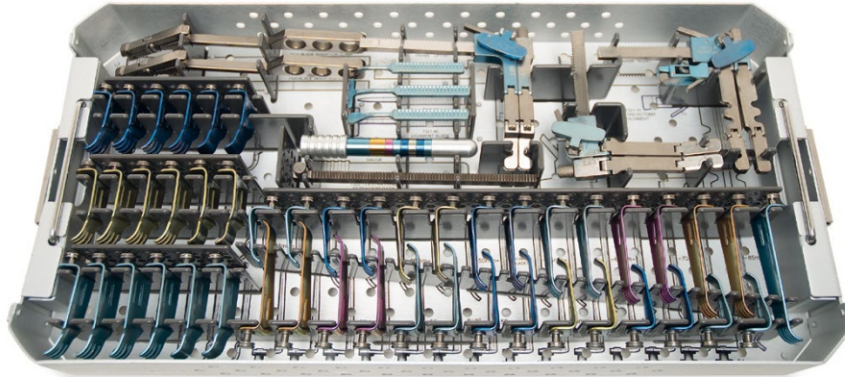

An advanced cervical retractor system suitable for both anterior and posterior cervical surgery but with attachments for micro discectomy surgery.

Basic 'Black Belt' Cervical Retractor System 7320-00

Complete set consisting of:

Qty	Order Code	Description
1	7320-10	Retractor Frame RIGHT
1	7320-20	Retractor Frame LEFT
1	7320-30	Retractor Frame OFFSET
2	7320-40	Blade Insertion Clamps
14	7322-34/70	Pronged Blades 34mm- 70mm
14	7324-34/70	Blunt Blades 34mm- 70mm
12	7326-40/55	Two Level Pronged Blades 40mm- 55mm
6	7328-40/55	Two Level Blunt Blades 40mm- 55mm
1	7320-50	Container

Extended 'Black Belt' Cervical Retractor System 7320-05

Consisting of:

Standard 'Black Belt' Retractor with the addition of Micro Discectomy Attachments

Coloured Titanium Extended 'Black Belt' Cervical Retractor System 7320-05M

Complete set consisting of:

Qty	Order Code	Description
1	7320-10M	Retractor Frame RIGHT
1	7320-20M	Retractor Frame LEFT
1	7320-30M	Retractor Frame OFFSET
2	7320-40M	Blade Insertion Clamps
14	7322-34/70M	Pronged Blades 34mm- 70mm
14	7324-34/70M	Blunt Blades 34mm- 70mm
12	7326-40/55M	Two Level Pronged Blades 40mm- 55mm
6	7328-40/55M	Two Level Blunt Blades 40mm- 55mm
1	7320-50M	Container
1	7321-10	Micro Disc attachment
1	7321-20	Spike Blade
1	7321-30	TShape Blade
1	7321-40	Inner Spine Ligament Blade
1	7321-85	Pronged Blade 85mm depth

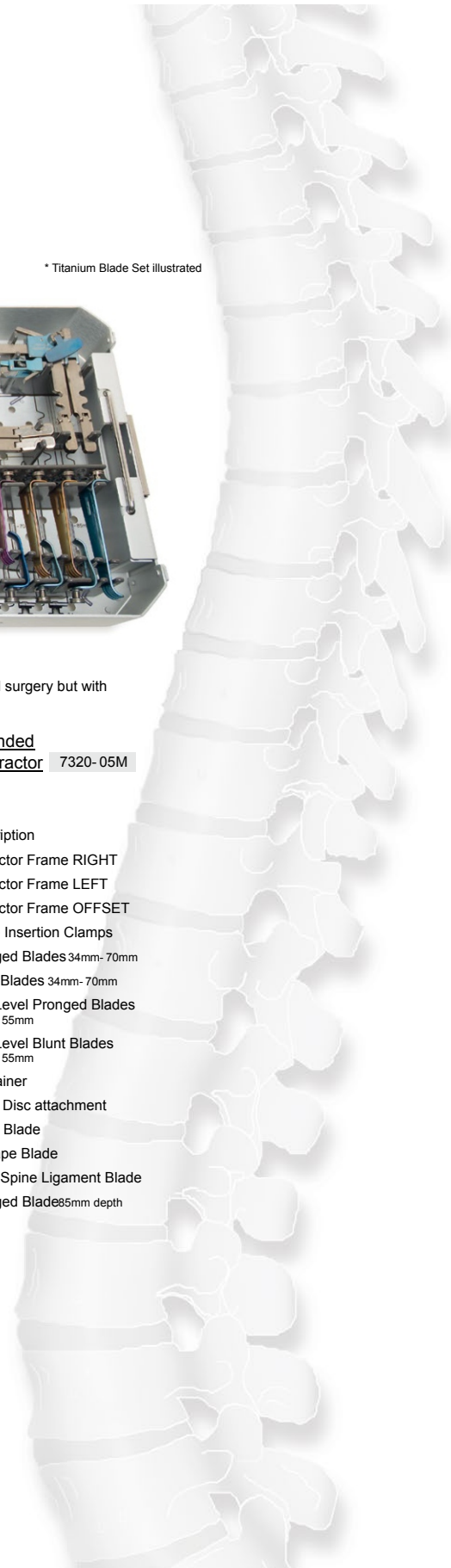

'BLACK BELT' CERVICAL RETRACTOR SET



Full jointed retractor arms
Black non-glare finish
Wide blade range
Suitable for single or multi level retraction

Blades

The blade shape is designed to resist climbing out of the surgical site
The wider two level blades have an extra bend near the tip, which follows the contour of the vertebrae for visualising



22mm wide blunt blade
22mm wide pronged blade
27mm wide two level blunt blade
27mm wide two level pronged blade
17mm wide optional narrow Cervical blades 40mm to 60mm depth

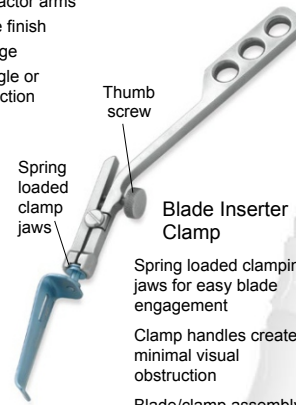

Blade Inserter Clamp

Spring loaded clamping jaws for easy blade engagement
Clamp handles create minimal visual obstruction
Blade/clamp assembly may be used for hand retraction
Clamps are quickly/easily removed after retractor arms have securely engaged the blades

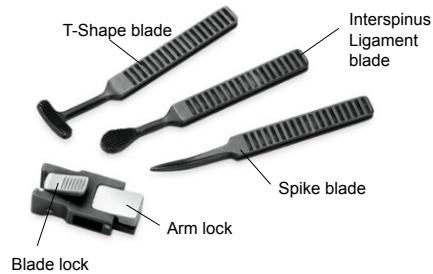

Blade lock

Lumbar Micro Discectomy Attachments

With this set the standard Cervical Retractor becomes a Lumbar Microdiscectomy Retractor unit.

7321-00

Complete set consisting of:

Qty	Order Code	Description
1	7321-10	Micro Disc attachment
1	7321-20	Spike Blade
1	7321-30	T-Shape Blade
1	7321-40	Inner Spine Ligament Blade
1	7322-85	Pronged Blade 85mm depth

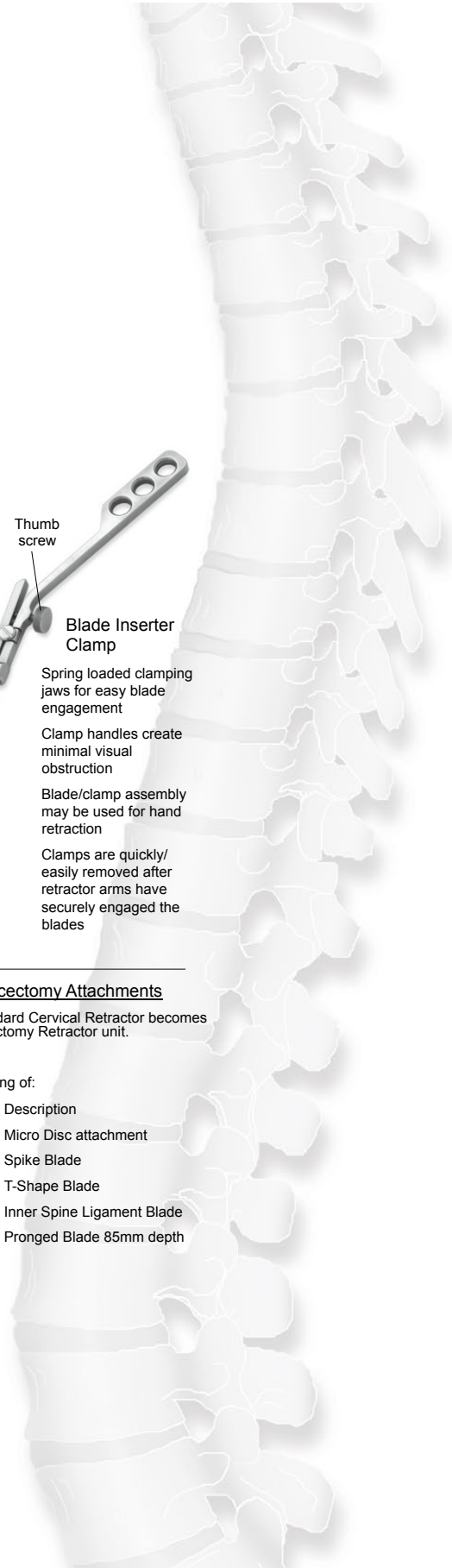

SUPER-SLIDE II LAMINECTOMY RETRACTOR SET

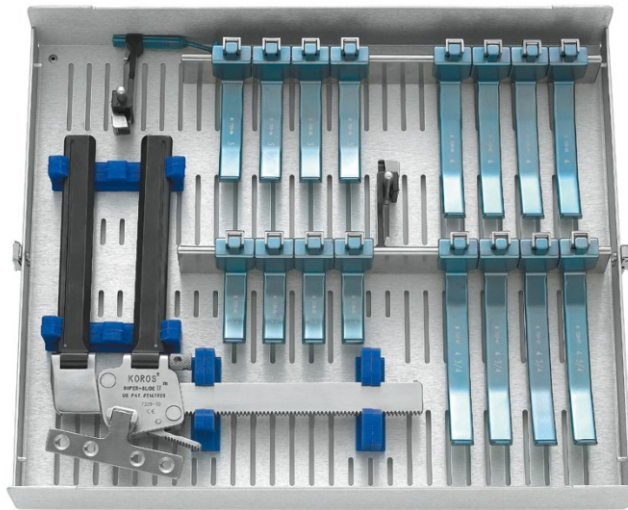

* Titanium Blade Set illustrated

A powerful retractor with a selection of blade depths which can be positioned anywhere along the retractor arms. Allows excellent exposure of the spine in Pedicle Screw and Laminectomy procedures.

Super-Slide Retractor Basic Set

7329-00

Complete set consisting of:

Qty	Order Code	Description
1	7329-10	Retractor Frame
4	7329-20	Small Blades 2" depth
4	7329-30	Medium Blades 3" depth
4	7329-40	Large Blades 4" depth
1	7329-50	Instrument Container

Super-Slide Retractor Extended Set

7329-05 Includes components of basic set plus:

Qty	Order Code	Description
4	7329-47	Supplementary Blades 4¾" depth
2	7329-60	Unilateral Blade heads
2	7329-62	Unilateral T-Blades

Titanium Super-Slide Retractor Basic Set

7329-06

Complete set consisting of:

Qty	Order Code	Description
1	7329-10	Retractor Frame
4	7329-82	Small Titanium Blades 2" depth
4	7329-84	Medium Titanium Blades 3" depth
4	7329-86	Large Titanium Blades 4" depth
1	7329-90	Instrument Container

Titanium Super-Slide Retractor Extended Set

7329-09 Includes components of titanium basic set plus:

Qty	Order Code	Description
4	7329-87	Supplementary Titanium Blades 4¾" depth
2	7329-60	Unilateral Blade Heads
2	7329-62M	Unilateral Titanium T-Blades



SUPER-SLIDE II LAMINECTOMY RETRACTOR SET

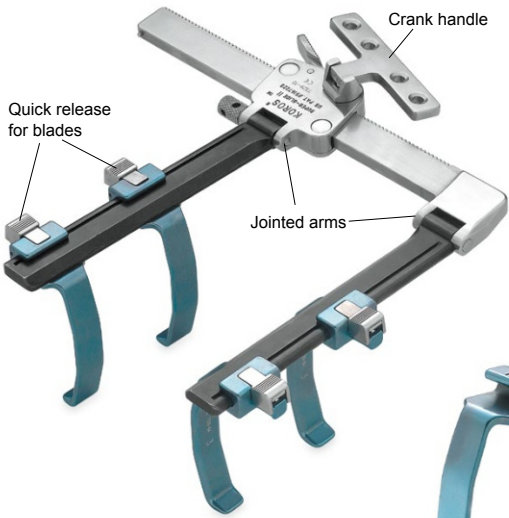

Super-Slide Retractor Blades

Will not slip out of wound during surgery

Narrow blade design minimises potential of tissue necrosis at blade and tissue contact point

Blades feature quick release locking system

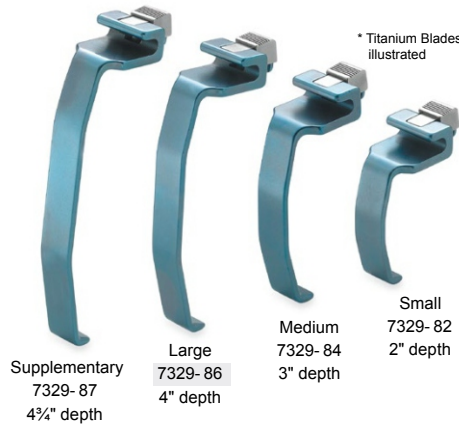
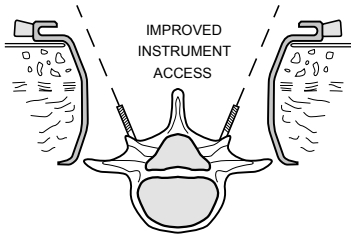

Unilateral Blade Attachment

Blades lock into any chosen position along the retractor arms and may be changed at any time during surgery

Arm locks allow the surgeon the choice of either attaching to the retractor arms then placing the unit into the wound or placing the blades into the wound then engaging the frame arms

To obtain a unilateral exposure, use the unilateral blade attachments contained in the extended set. The T-Blade is designed to attain a firm purchase on the Spinous process

The T-Blade can be adjusted to the correct depth with the blade lock

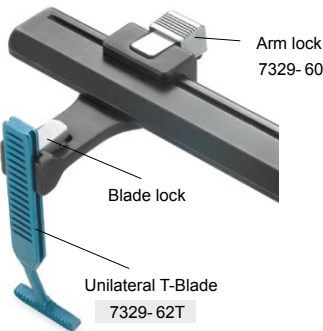

CASPAR MICRO LUMBAR DISCECTOMY RETRACTOR SET

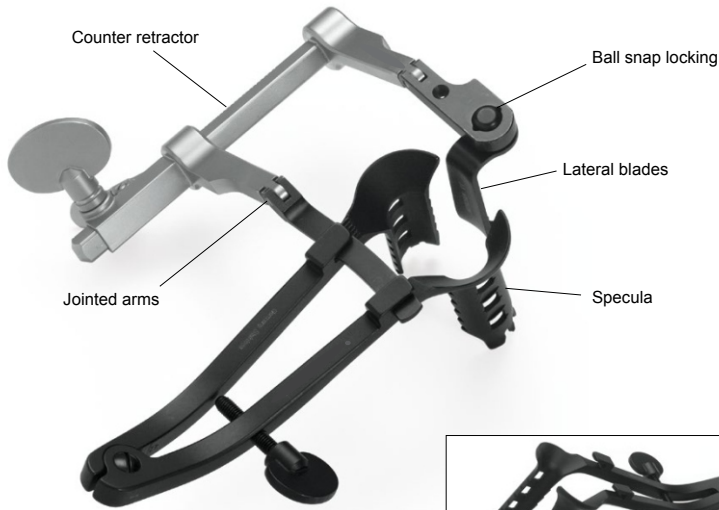

Caspar Micro Discectomy Retractor

This Retractor Set allows a micro surgery approach to Lumbar Disc
 Specula have a black surface finish to prevent glare
 Fenestrated blades on the specula reduce the risk of movement during surgery

Complete Set

575-658

Consisting of:

Lateral Blades	Depth	Specula	Depth	
575-652	40mm	575-646	40mm	575-657 Counter Retractor Frame
575-653	45mm	575-647	45mm	575-690 Blade Ejector Forceps
575-654	50mm	575-648	50mm	
575-655	55mm	575-649	55mm	
575-656	60mm	575-650	60mm	
575-657	65mm	575-650-65	65mm	
575-657-75	75mm	575-650-75	75mm	



CASPAR MICRO LUMBAR DISCECTOMY RETRACTOR SET

Lateral Blades

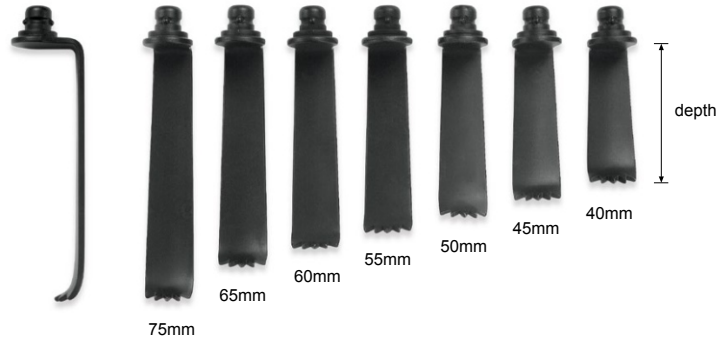

Blade Ejector Forceps 575-690



Specula Range

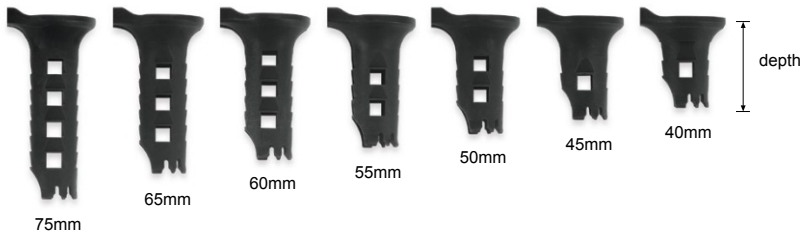

Caspar Micro Discectomy Retractor Frame 575-657F

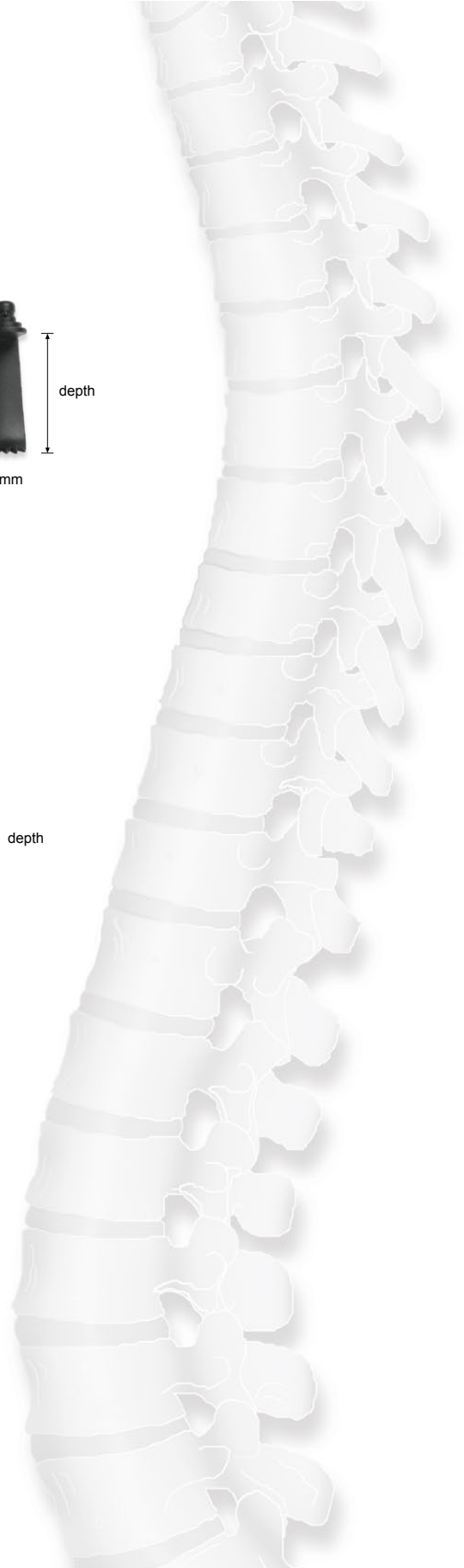

BLACK BELT MICRO DISCECTOMY RETRACTOR SET

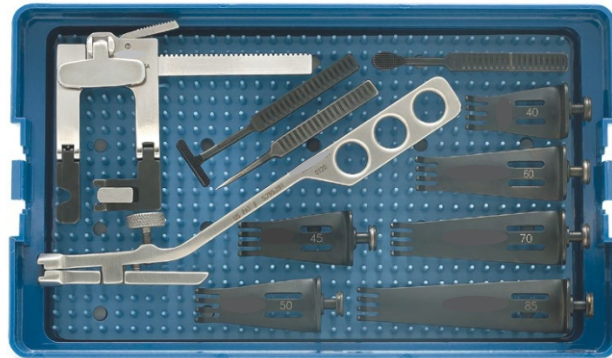

Black Belt Micro Discectomy Retractor Set

A specialist retractor for Lumbar Micro Discectomy Surgery featuring:

- Jointed retractor arms
- Adjustable blade depth
- Range of pronged blades
- Powerful ratchet action with quick release mechanism

7276-00 Complete Set

Complete set consisting of:

Qty	Order Code	Description
1	7276-10	Retractor Frame
1	7276-15	Blade Inserting Clamp
1	7276-20	Spike Blade
1	7276-30	T-Shape Blade
1	7276-35	Inner Spine - Ligament Blade
1	7276-40	Pronged Blade 40mm
1	7276-45	Pronged Blade 45mm
1	7276-50	Pronged Blade 50mm
1	7276-60	Pronged Blade 60mm
1	7276-70	Pronged Blade 70mm
1	7276-85	Pronged Blade 85mm
1	7276-90	Sterilising Container

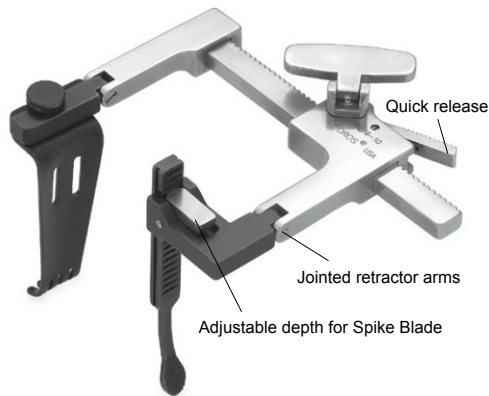
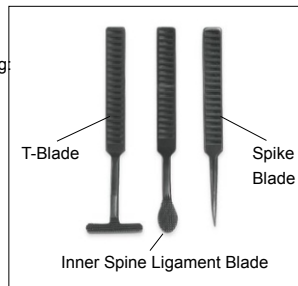

BAYONET MICRO INSTRUMENTS

Yasargil Bayonet Micro Forceps

Flat handed
Blunt tips

			
		Tip size	
22.5cm/8½"	581-544	1mm	

Yasargil Bayonet Tumour Grasping Forceps

Flat handed



Spoon shaped jaws		Tip size	
22.5cm/8½"	584-645	3mm	⊙
22.5cm/8½"	584-650	5mm	⊙
Flat serrated jaws		Tip size	
22.5cm/8½"	584-652	3mm	⊙
22.5cm/8½"	584-654	5mm	⊙
Curette toothed jaws		Tip size	
22.5cm/8½"	584-656	3mm	⊙
22.5cm/8½"	584-658	5mm	⊙



BAYONET MICRO INSTRUMENTS

Yasargil Bayonet Micro Needle Holder

Flat handled
Delicate 1mm jaws



Without Lock	Straight	Curved
23cm/9"	592-349	592-350

Bayonet Micro Needle Holder

Round bodied
Delicate 1mm jaws



With Lock	Straight	Curved
21cm/8¼"	585-936	585-937
23cm/9"	585-938	585-939

Yasargil Bayonet Micro Scissors

Flat handled
22.5cm/8¾" length



Regular Blades



Straight
592-320



Curved
592-321

Vannas Fine Blades



Straight
592-330



Curved
592-331



STRAIGHT BIPOLAR FORCEPS

Straight Bipolar Forceps

Non-Stick Tips



The material specially developed for ® non-stick forceps prevents overheating of the tips during coagulation.

18.5cm/7¼" length Tip size









073-392NS	0.7mm	Fine tip	
073-394NS	1.0mm	Regular tip	



BAYONET BIPOLAR FORCEPS

Bayonet Bipolar Forceps Non-Stick Tips



20cm/8 1/2 length	Tip size	
073-414NS	0.7mm	
073-416NS	1.0mm	
073-418NS	1.2mm	
23cm/9 length	Tip size	
073-533NS	0.7mm	
073-535NS	1.0mm	
073-537NS	1.2mm	
25cm/9 3/4 length	Tip size	
073-543NS	0.7mm	
073-545NS	1.0mm	
073-547NS	1.2mm	

The material specially developed for non-stick forceps prevents overheating of the tips during coagulation.

Bayonet Bipolar Forceps 22.5cm/8 3/4" length Non-stick tips Mallis 2 pin fitting



Tip Size	
0.5mm	073-681NS
0.7mm	073-682NS
1.0mm	073-683NS
1.5mm	073-685NS



BIPOLAR CABLES

Bipolar Lead

Fitting Block End Forceps
Banana Plug Valleylab Machine Fitting
4.5 metre length

074-700



SCAPEL HANDLES



Item #	Description	Length
012-804	#4 standard	5 1/4" (13.0 cm)
012-814	#4L long	8 3/8" (21.3 cm)

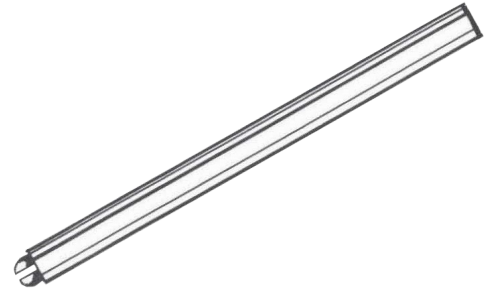

Item #	Description	Length
013-036	3HL	6" (15.0 cm)
013-034	3H	4" (10.0 cm)



Item #	Description	Length
012-703	#3 standard	5" (12.5 cm)
012-713	#3L long	8 3/8" (21.3 cm)
012-723	#3LA angled	8 3/8" (21.3 cm)
012-733	#3 standard	12" (30.5 cm)



Item #	Description	Length
012-850	3K	4" (10.0 cm)

Misc



Item #	Description
576-406	Gigli Wire Handle/Pair
576-407	Gigli Saw Handle W/Lock



Item #	Description
576-430	Gigli Wire Saw 11 3/4"
576-440	Gigli Wire Saw 15 3/4"
576-450	Gigli Wire Saw 19 3/4"
576-460	Gigli Wire Saw 23 3/4"
576-470	Gigli Wire Saw 27 1/2"



Item #	Description
570-001	Small Silicone Brain Spatula
570-002	Medium Silicone Brain Spatula
570-003	Large Silicone Brain Spatula
570-004	X large Brain Spatula

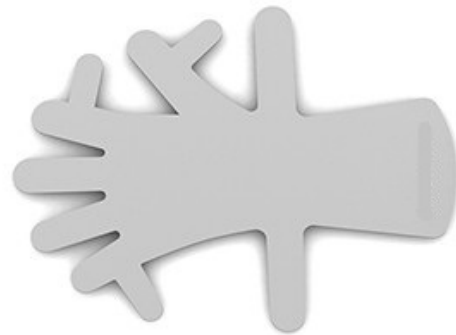

Item #	Description
780-001	Lead Hand Child
780-002	Lead hand Adult

Misc

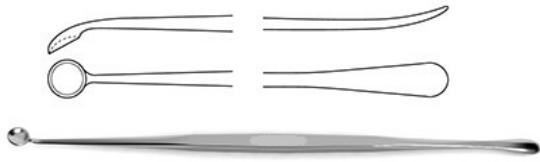

Item #	Description
573-651	Penfield Dissector #1



Item #	Description
573-652	Penfield Dissector #2



Item #	Description
573-653	Penfield Dissector #3

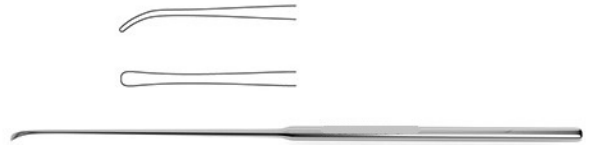

Item #	Description
573-654	Penfield Dissector #4

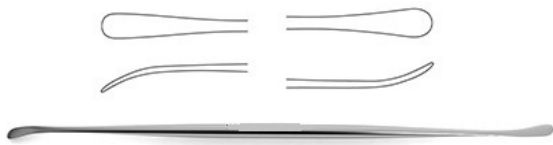

Item #	Description
573-655	Penfield Dissector #5

Alphabetical Index

A

Adson-Graefe Tissue Forcep	40	Arthroscopic Hook Scissors	362
Adson Bayonet Dressing Forcep	41	Arthroscopic Hooks	371
Adson Bipolar Forcep	52	Arthroscopic Instruments	372
Adson Bone Rongeur	323,383	Arthroscopic Knives	370
Adson Cerebellar Retractor	414	Arthroscopic Meniscus Grasping Fcp	368
Adson Dressing Forcep	35	Arthroscopic Meniscus Retracting Fcp	368
Adson Dural Hook	407	Arthroscopic Probes	371
Adson Hemostatic Forcep	57	Arthroscopic Punches	357,358,359,368
Adson Hook	408	Arthroscopic Rotary Punches	361
Adson Micro Forcep	38	Arthroscopic Scissor Punches	363,364
Adson Thumb Forcep	38	Arthroscopic Suture Forceps	365
Adson Tissue Forcep	35	Arthroscopic Suture Grasping Fcp	366
Adson-Baby Forcep	57	Arthroscopic Suture Hooks	367
Adson-Brown Tissue Forcep	39	Arthroscopic Wide Jaw Punches	363
Aebli Corneal Section Scissors	149	Articulating Blade Retractor	291
Agricola Lacrimal Sac Retractor	205	Asch Septum Forcep	105
Agris-Dingman Dissector	132	Aspiration Needles	287
Air Injection Cannula	188	Arthroscopic Tendon Grasping Fcp	369
Alar Cartilage Scissors	24	Atkinson Retobulbar Needle	195
		Atraumatic Grasper	239,257
Alfonso Eye Speculum	209		259,275,277
Allens-Schiotz Tonometer	213	Aufricht Lighted Nasal Retractor	139
Allens-Schiotz Tonometer Case	213	Aufricht Nasal Retractor	83
Alligator Grasper	233,239		
	256,262,271	Aufricht Rasp	100
Allis Grasper	229,230		
	252,269,278	B	
		Babcock Grasper	228,239
Allis-Baby Tissue Forcep	54		251,268,278
Allis-Coakley Tonsil Forcep	130	Babcock Tissue Forcep	63
Alm Retractor	81	Baby Inge Spreader	406
Anderson Bear Claw Retractor	88	Backhaus Towel Clamp	61
Anis Needle Holder	178	Bailey Lacrimal Cannula	194
Anterior Bone Graft Impactor	395	Baird Chalazion Forcep	172
Anterior Disc Rongeur	382	Ball Monopolar Electrode	303
Anterior Lamina Spreader	406	Ball Tip Probe	408
Anterior Leksell Bone Rongeur	388	Bandage and Utility Scissors	33
Antrum Punch Side-Biting Forcep	108	Barnhill Adenoid Curette	128,129
Anvil Grasper	239,262	Baron Suction Tube	98
Arthroscopic Curettes	371	Barraquer Cilia Forcep	162
Arthroscopic Grasping Forceps	360	Barraquer Cyclodialysis Spatula	183
Arthroscopic Handles	356	Barraquer Iris Scissor	153
Arthroscopic Hook Punches	362	Barraquer Iris Spatula	183



Barraquer Micro Needle Holder	71	Bohler Bone Cutter	322
Barraquer Needle Holder	175,177		
	179,180	Bohler Bone Rongeur	324
Barraquer Speculum	207	Boies Nasal Elevator	90
Barraquer Titanium Needle Holder	179	Bolt Cutter	347
Barsky Skin Hook	76	Bonaccolto Utility Forcep	160
Baumgartner Needle Holder	64	Bone Awl	351
Baynet Cement Chisel	341	Bone Cutter	
Bayonet Bipolar Forcep	433	Bone Hook	321
Bayonet Cement Gouge	341	Bone Mill	351
Bayonet Cement Rasp	340	Bonn Iris Forcep	47
Bayonet Cement Splitting Osteotome	341	Bonn Iris Hook	200
Bayonet Gouge	339	Bonn Suture Forcep	155
Bayonet Kerrison	376	Bores Optic Zone Marker	218
Bayonet Rongeur	376	Bores Radial Marker	217
Bechert Lens Nucleus Rotator	185	Boucheron Ear Speculum	117
Bechert-McPherson Tying Forcep	162	Bowman Lacrimal Probe	214
Becker Septum Scissors	26	Box Chisel	338
Beckman-Adson Retractor	415	Bracken Anterior Chamber Cannula	193
Bellucci Alligator Scissor	111	Brophy Scissors	19
Bellucci Ear Forcep	115	Brown-Adson Tissue Forcep	35,39
Berens Muscle Clamp	169	Brown Needle Holder	69
Bergh Cilia Forcep	50	Brown Tissue Forcep	40
Berke Ptosis Forcep	46,169	Bruns Curette	398
Berke-Jaeger Lens Plate	185	Buck Ear Curette	118,119
Beyer Bone Rongeur	324,385	Bullet Nose Grasper	237,260,274
Biggs Face Lift Retractor	88,131	Bullet-Nose Lap Grasper with Spoon	225,248
Biggs Lighted Face Lift Retractor	139	Bunge Evisceration Spoon	186
Biggs Lighted Mammoplasty Ret	140	Burch Fication Pick	196
Biggs Mammoplasty Retractor	134	Button Monopolar Electrode	303
Billeau Flexible Ear Loop	119	C	
Binkhorst Irrigating Cannula	196	Cannulas	190-195
Biopsy Punch	243,266	Cannula Adaptor	141
Bi-Pol Cutter	301	Cannula Handle	141
Bipolar Cable	53	Capener Lamina Gouge	338
Bipolar Cable	300,434	Caplan Septum Scissors	26
Bipolar Cable	434	Carmalt (Hunter) Splinter Forcep	48
Bishop-Harmon Ant Chamber Irrigator	191	Cartilage Cutting Board	123
Bishop-Harmon Dressing Forcep	155	Caspar Bone Graft Holder	395
Bishop-Harmon Iris Forcep	46	Caspar Disc Rongeur	379
Bishop-Harmon Tissue Forcep	155,156	Caspar Distraction Drill	404
"Black Belt" Cervical Retractor Set	423,424	Caspar Distraction Screw	404
"Black Belt" Micro Discectomy Set	424,429	Caspar Drill Guide	404
Blair Cleft Palate Elevator	96	Caspar Hook	408
Blaydes Lens Holding Forcep	172	Caspar Micro Lumbar Discectomy Set	427,428
Blepharoplasty Forcep	48	Caspar Nerve Root Retractor	411
Blunt Atraumatic Grasper	260	Caspar Screw Driver	404



Castanares Face Lift Scissor	2,27	Colibri Titanium Forcep	174
Castroviejo Caliper	219	Colibri Type Utility Forcep	159
Castroviejo Corneal Scissor	147,148		
	149,150,151	Comfort Cobb Elevator	393
Castroviejo Cyclodialysis Spatula	183,184	Concave Moor Elevator	319
Castroviejo Fixation Forcep	165	Cone Monopolar Electrode	303
Castroviejo Keratoplasty Scissors	147	Cone Ring Curette	402
Castroviejo Lacrimal Probe	215	Cones S/R Retractor	331,415
Castroviejo Micro Scissor	150	Converse (Green) Fixation Forcep	46
Castroviejo Needle Holder	68,71,176,177	Converse Alar Retractor	83
Castroviejo Speculum	207	Converse Blade Retractor	83
Castroviejo Suture Forceps	46,156,157	Converse Dorsal Scissors	25
Castroviejo Synechia Spatula	182	Converse Periosteal Elevator	96
Castroviejo Titanium Suture Fcp	174	Converse Rasp	102
Catalano Tying Forcep	159	Converse-Derf Needle Holder	68
Cement Chisel	339	Cook Speculum	206
Cement Extraction Hook	342	Corneal Blades and Handle	216,217
Cement Gouge	339	Coronal Brow Lift Retractor	86
Cement Osteotome	340	Corwin Wire Twister	64
Cement Plug Extractor	342	Cottle Columella Forcep	45
Cement Splitting Osteotome	340	Cottle Dorsal Scissors	4, 12,24
Cement Twist Drill	343	Cottle Rasp	100
Cervical Bone Graft Impactor	395	Cottle Septum Elevator	96
Cervical Vertebral Spreader	405	Cottle Septum Speculum	116
Charnley Retractor	330	Cottle Skin Elevator	95
Chisels	96,122,338-342	Cottle Skin Hook	74,75
Chisel with Interchangable Blades	338	Cottle-Neivert Needle Guide	76
Cholangiogram Clamp	284	Cottle-Walsham Septum Forcep	106
Chuck Handle for MVR Blade	180	Crawford Lacrimal Intubation Set	216
Claw Grasper	233,234,238		
	256,275,278	Crile Forcep	56
Clayman IOL Forcep	171	Crile Hook	407
Clayman-Jaffe Lens Manipulating Hook	197	Crile Retractor	80
Clean-Wave Kerrison	375	Crile-Baby Forcep	55
Clean-Wave Rongeur	375	Crile-Wood Needle Holder	65,70
Cleft Palate Rasp	104	Culler Iris Spatula	181
Cloward Blade Retractor	413	Cup Extraction Chisel	339
Cloward Cervical Spreader	405	Cup Shaped Grasper	233,256
Cloward Lamina Spreader	405	Cushing "Little Joker" Periosteal Elevator	95
Clyman Iris Hook	200	Cushing Bayonet Thumb Forcep	37
Cobb Bone Curette	399	Cushing Bipolar Forcep	52,53
Cobb Spinal Elevator	392	Cushing Dressing Forcep	36
Cobra Aufrang Elevator-Modified	319	Cushing Hook	407
Cobra Grasper, Double Action	228,251,268	Cushing IVD Rongeur	381
Cohan Needle Holder	178	Cushing Thumb Forcep	37
Cohen Cannula	285	Cushing Vein Retractor	78



D

Dandy Forcep	58
Davis Facelift Scissors	10
Davis Mouth Gag	125
Davis Mouth Gag Blades	126
Davol Type Grasper	237,260,274
Day Ear Hook	119
Dean Dissecting Scissors	23
Deaver Lighted Retractor	140
Deaver Retractor	79
	230,231,239,253
	254,262,269,270,2

Debakey Grasper	78
Debakey Maryland Dissector	231,254
Debakey Potts-Smith Scissor	20
Debakey Tissue Forcep	48
Decker Rongeur	381
Demartel Scalp Forcep	62
Denhardt Mouth Gag	126
Depth Gauge	355
Derf Needle Holder	68
Desmarres Chalazion Forcep	45,173
Desmarres DE Retractor	78
Desmarres Iris Retractor	205
Desmarres Lid Retractor	78
Dingman Hook	75
Dingman Mouth Gag	124
Dingman Otoabradars	123
Dingman Periosteal Elevator	89
Dingman Tongue Blade	124
Dingman Zygomatic Elevator	90
Distraction Retractor	403
Dix Needle and Gouge	212
Dodick Nucleus Splitter	165
Dolphin Nose Grasper w/Spoon	225,249,268
Double Fixation Hook	196
Double-Ended Breast Retractor	131
DE Lighted Breast Retractor	139
Dressing Forcep	35,36
Duckbill Grasper	227,250
Duval Grasper	238,261,278

E

Ear Oval Cup Forcep	114
Echlin Duckbill Rongeur	388
Ehrhardt Lid Forcep	174

Elschnig Cyclodialysis Spatula	184
Elschnig Fixation Forcep	163,164
Emmet Hook	407
End Wire Cutter	347
Endo Test Units	312
Endoclinch Grasper	232,255,271
Endoplastic Facial Dissectors	135-137
Endoscopes	220-221
Endoscopes-Laparoscopes	220
Endoscopes-Operating Laproscopes	221

Endoscopic Magnetic Rod	284
Endoscopic Retractable Knife	284
Enucleation Scissors	147
Ernest-McDonald Soft IOL Holding Forcep	165
Esmarch Bandage Scissors	33

F

Face Lift Scissor	2,3,4
Fan Retractors-Lap	292
Farabeuf-Baby Retractor	79
Farrion Ear Speculum	118
Faulkner Lens Folding Forcep	164
Feilchenfeld Splinter Forcep	49
Femoral Dislocation Lever	316
Femoral Head Extractor	344
Femoral Head Impactor	345
Fenestrated Grasper	235,238,258,273
Fenzel Lens Manipulator	199
Ferguson Bone Holding Forcep	326
Ferreira Breast Augmentation Retractor	134
Ferreira Face Lift Retractor	88,131
Ferreira Lighted Breast Augmentation Re	140
Ferriera Lighted Retractor	138
Ferris-Smith Disc Rongeur	382
Ferris-Smith Punch	378
Ferris-Smith Sponge and Fragment Force	108
Ferris-Smith Tissue Forcep	41
Fine Cement Duckbill Forcep	343
Flexible Neck Rake Retractor	85
Flieringa Fixation Ring	210
Flynn Scleral Depressor	211
Foerster Eye Forcep	47
Foerster Sponge Forcep	60
Fomon Dorsal Scissors	5, 12



Ellis Foreign Body Spud	213	Fomon Lower Lateral Scissors	25
Fomon Nasal Rasp	99,101	Goldman Septum Elevator	90
Fomon Saber Back Scissors	5,25	Goldman-Fox Scissors	5, 13
Foramenotomy Kerrison	377	Gorney-Freeman Face Lift Scissor	3, 11
Foreign Body Spud	212	Gorney Platysma Scissor	3
Fox Dermal Curette	143	Gorney Rake Retractor	87
Fox Eye Shield	213	Goose Neck Retractor-Laparoscopy	289
Fox Sphere Introducer	214	Gorney Face Lift Scissor	3, 11
Francis Chalazion Forcep	173	Gorney Septum Suction Elevator	89
Francis Spud	212	Gradle Cilia Forcep	161
Frazier Skin Hook	72	Graefe Fixation Forcep	169
Frazier Suction Tube	97	Graether Collar Button	195
Freeman Areola Marker	133	Graether Collar Button on Handle	203
Freeman Face Lift Scissors	3, 11	Graffe Iris Forcep	168
Freeman Flap Retractor	84	Grasper "Access" Type	238
Freeman Rake Retractor	87,88	Grasper Cross Serrated	231,254
Freer Elevator	93,354,394	Green Fixation Forcep	169
Freer Skin Hook	73	Green Strabismus Hook	201
Freer Spatula	89	Greenberg Par Scissors	9
Fundus "Winer" Style Grasper	232,255,271	Greven Ear Forcep	111
	231,232		
Fundus Double Cup Grasper	254,255,271	Gruber Ear Speculum	118
G		Gruenwald Nasal Forcep	107
Gaskin Fragment Forcep	166	Gruenwald Thumb Forcep	44
Gass Retinal Detachment Hook	200	Gutherie Hook	72
Gelpi Laminectomy Retractor	331	Guyton-Park Speculum	206
Gelpi Retractor	81	H	
General Dressing Forcep	35	Hajek Antrum Punch Forcep	109
Gerald Thumb Forcep	36,42	Hajek-Ballenger Septum Elevator	92,109
Gigli Saw	436	Hajek-Kofler Sphenoid Punch Forcep	109
Gigli Saw Handle	436	Halle Septum Elevator	91
Gill Corneal Knife	181	Halpern Breast Marker	133
Gilles Dissecting Forcep	43	Halsey Needle Holder	66,69
Gillies (Converse) Skin Hook	73	Halsted Mosquito Forcep	54
Gillies Needle Holder	67,70	Harms-Tubingen Tying Forcep	160
Gills Iris Forcep	168	Harrington Cobb Spinal Elevator	392
Gills-Hess Iris Forcep	167	Harris-Sinsky Lens Manipulating Hook	203
Gills-Welsh Cannula	192	Hartman Ear Forcep	115
Gills-Welsh Capsule Forcep	167	Hartman Ear Speculum	117
Gill-Welsh Olive Tip Cannula	190	Hartman Mosquito Forcep	55
Gimpelson Cervical Tenaculum	286	Hasson Grasper	283
Girard Corneo-Scleral Forcep	157	Healon Injection Cannula	195
Girard Synechia Spatula	182	Heath Chalazion Curette	212
Giunta Nasal Scissors	13	Heath Mallet	334
Glabella Rasp	99	Heymann Nasal Scissors	24
	231,254		
Glassman Grasper	270,271,278	Heavy Cement Grasping Forcep	343



Gluf Club Spud	211	Heiss Retractor	81
Hibbs Osteotome	336	Irrigation/Suction Systems	307-310
Hirschman Iris Hook	201	Irrigation/Suction Tubes	306-307
"Hockey Stick" Chisel	421	J	
Hohmann Bone Elevator	318	Jabaley Scissors	6
Hohmann Elevator-Modified	319	Jackson Lacrimal Intubation Set	216
Hohmann Inferior Hip Elevator	319	Jackson Turbinate Scissors	26
Hohmann Style Mini Bone Lever	217	Jacobson Bayonet Forcep	47
Holth Corneoscleral Punch	179	Jacobson Micro Artery Forcep	60
Hook Scissors	240,264	Jacobson Micro Mosquito Forcep	55
House Alligator Forcep	112	Jacobson Micro Scissor	21
House Barbara Pick	122	Jacobson Micro Vascular Scissor	20
House Curette	121	Jaeger Lid Plate	82
House Cutoff Adaptor	97	Jaffe Lens Manipulating Hook	197
House Elevator and Chisel	96,122	Jaffe Lens Spatula	183
House Forcep	112	Jaffe Lid Retractor	204
House Joint Knife	120	Jaffe Stitch Scissor	153
House Lancet Knife	120	Jaffe Tying Forcep	156
House Miniature Ear Forcep	111	Jaffe-Bechert Lens Nucleus Rotator	184
House Myringotomy Knife	121	Jaffe-Maltzman Lens Hook	199
House Oval Cup Forcep	113	Jameson Caliper	219
House Oval Window Pick	122	Jameson Muscle Forcep	168
House Sheehy Knife Curette	121	Jameson Muscle Hook	202
House Sickle Knife	120	Jamison (Reynolds) Tenotomy Scr	2
House Strut Caliper	122	Jansen Bone Rongeur	324,386
House Strut Pick	123	Jansen-Middleton Septum Forcep	105
House Suction Irrigation Tube	98	"Jarit Style" Grasper	232
House Tympanoplasty Knife	119	Jennings Mouth Gag	127
House-Bellucci Alligator Scissor	111	Jensen Capsule Polisher	187
House-Dieters Malleus Nipper	114	Jewelers Bipolar Forcep	52
House-Wullstein Alligator Ear Fcp	113	J-Hook Monopolor Electrode	303
Howarth Elevator	93,354,394	Johan Grasper	235,258,273
Hudson (Ewald) Thumb Forcep	39	Joint Capsule Clamp	344
Hulka Uterine Tenaculum	286	Joint Capsule Scissors	344
Humby Skin Hook	74	Jones Towel Clamp	61
Hunt Chalazion Forcep	171	Joseph Nasal Rasp	100
Hunter Debakey Grasper	231,253,270	Joseph Nasal Saw	104
Hurd Dissector and Pillar Retractor	130	Joseph Nasal Scissors	4,25
I		Joseph Periosteal Elevator	91
Infero-Posterior Acetabular Capsule Retractor	320	Joseph Skin Hook	73
Inge Spreader	406	K	
Iris Dressing Forcep	45	Kalt Needle Holder	177
Iris Micro Scissors	29	"Karlin" Style Micro Curettes	397
Iris Scissor	1, 8,19,22,144	Kasdan Hand Retractor	83
Iris Spatula	181	Katzin Corneal Transplant Scissor	148



Iris Tissue Forcep	45	Kaye Blepharoplasty Scissors	27
Kaye Face Lift Scissor	4, 10	Kratz Lens Manipulator Cannula	189
Kaye-Freeman Face Lift Scissor	4, 10	Kratz-Barraquer Speculum	207,208
Kelly Decemet Punch	179	Kuglen Iris Hook	199
Kelly Forcep	56	Kuglen Iris Hook and Lens Manipulator	199,203
Kelly Grasper	227,250	L	
Kelly Scissors	13,16	Laborde Tracheal Dilator	128
Kelly-Rankin Forcep	56	Lacrimonal Cannula	194,195
Kelman Cyclodialysis Cannula	190	Laforce Adentome	129
Kelman Dipstick	188	Lahey Hook	74
Kelman-McPherson Tying Forcep	162,163	Lahey Traction Forcep	62
Kerrison Mastoid Rongeur	110	Lambert Chalazion Forcep	172
Kerrison Punch	373-378	Lambert Sleeve Spreader	171
Kerrison-Costen Rongeur	110	Lambotte Osteotome	335,390
Keyes Dermal Punch	143	Laminectomy Punch	373-378
Killian (Von-Eicken) Antrum Cannula	97	Lancaster Speculum	208
Killian Septum Elevator	93	Lanes Tissue Forcep	44
Killian Septum Speculum	115	Langenbeck Bone Holding Forcep	326
Kilner Alae Retractor	85	Langenbeck Periosteal Elevator	95
Kilner Skin Hook	72	Langenbeck Retractor	329,413
Kilners-Doughty Mouth Gag	124,125	Lap Banding Retractors	291
Kimura Platinum Spatula	180	Lap Containers and Storage	314,315
King Adenoid Punch Forcep	127	Lap Grasper Standard w/Spoon	248,275
Kirby Intra-Capsulor Lens Loop	187	Lap Grasper Standard w/Spoon, Long	248,275
Kirschner Wire Introducing Handle	350	Lap Hook Scissors	241,263,275
Kistner Septum Ball-End Elevator	92	Lap Instrument Maintenance	313,314
Kite Retractors-Lap	292	Lap Metzenbaum Scissors	240,241,263,275
Kleinert-Kutz Bone Rongeur	323	Lap Mixer Forceps	278
Kleinert-Kutz Elevator and Dissector	91	Lap Micro Tip Scissors	240,263,264
Kleinert-Kutz Hook	74	Lap Peritoneal Scissors	242,275
Kleppinger Bipolar Forceps	293-295	Lap Scissors Straight	242,265,278
Knapp Eye Speculum	209	Lap Tenaculum Forceps	278
Knapp Retractor	85	Laparoscopic Handles	223,224
Knapp Scissors	22,146	Lap-Biopsy Spoon	243,265,266,278
Knife Handle		Laparoscopes	220
Knife Monopolar Electrode	303	Laparoscopes-Operating	221
Knight Nasal Scissors	11	Laposcopic Knot Pushers	281
Knolle-Pearce Irrigating Lens Loop	192	Laposcopic Needle Holders	279,280
Knowles Bandage Scissors	33	Laposcopic Suture Passer	282
Koch Stop and Chop Manipulator	200	Laposcopic Trocar Guides	282
Kocher Clamp Forcep	60	Laryngeal Mirror	129
Kocher Forcep	59	Lead Hand	436
Kocher Grasper	236,259	Leiske-Smith Lens Pusher	186
Kraff Capsule Tag Forcep	165	Leksell Bone Rongeur	325,387
Kratz Capsule Scraper	189	Lempert Bone Rongeur	323,383
Kratz Cystotome	189	Lempert Curette	398



Kratz Lens Holding Forcep	171	Lempert Elevator	91
Lempert Periosteal Elevator	90	Masket Capsulorhexis Forcep	166
Leriche Artery Forcep	60	Mathieu Retractor	77
Lester Fixation Forcep	163	Maumenee Corneal Forcep	158
Lester Lens Pusher	185	Maumenee Vitreous Aspirating Ndl	189
Lester-Burch Speculum	209	Maumenee-Park Speculum	206
Lewicky Lens Manipulating Hook	197	Maxwell Flap Retractor	87
Lewis Lens Loop	186	Mayo Scissor	1,6, 14
Lewis Nasal Rasp	103	Mayo-Hegar Needle Holder	64,65,70
Lexer Osteotome	337,390	Mayo-Noble Scissors	15
L-Hook Monopolar Electrode	303	Mayo-Stille Dissecting Scissors	15
Lid Retractor	78	McCulloch Instrument Set	420
Lieberman Suturing Forcep	162	McCulloch Nerve Root Retractor	411,422
Lieppman Cystotome	190	McCulloch Retractor Blades	419
Lillie Tonsil Scissors	23	McCulloch Retractor Frame	419
Liposuction Cannula	141	McCulloch Retractor Set	418
Lister Bandage Scissors	33	McCulloch Suction Tube	421,422
Liston-Key Bone Cutter	322,389	McCullough Utility Forcep	161
Littauer Stitch Scissors	31	McDonald Elevator	354,394
Littler Plastic Scissors	31	McGee Crimper/Wire Closure Fcp	114
Livernois Pickup and Folding Fcp	166	McGlamry Metatarsal Elevator	317
Logan Bow	129	McGoey Bone Punch	345
Long Anterior Curette	399	McIndoe Bone Cutter	322,389
Long Taper Grasper	237,260	McIndoe Dissecting Forcep	43
Lorna (Edna) Towel Clamp	61	McIntyre Anterior Chamber Cannula	188
Love Nerve Root Retractor	77	McIntyre Lacrimal Probe Cannula	193
Lubricating Oil	313	McIntyre-Binkhorst Irrigating Cannula	196
Lucae Ear Forcep	44	McIvor Mouth Gag	126
Luer Bone Rongeur	323,383	McIvor Mouth Gag Blades	126
Luer Retractor	82	McKearnan Style Fundus Grasper	232,255,271
Lumbar Bone Graft Impactor	395	McKenty Elevator	94
M		McKenty Shenoid Punch Forcep	109
Maccollum-Dingman Dissector	131,132	McKissock Breast Marker	134
Macdonald Elevator/Dissector	354	McKissock Mammoplasty Caliper	133
Mackool Lens Capsule Retractor	204	McPherson Needle Holder	178
Maliniac Lighted Nasal Retractor	139	McPherson Speculum	207
Maliniac Nasal Retractor	84	McPherson Tying Forcep	160
Malleable Cement Probe	342	McPherson-Westcott Stitch Scissor	153
Maloney No-Hole IOL Manipulator	198	Measuring Caliper	355
Maltz Nasal Rasp	99,101	Mendez Degree Gauge	218
Maltzman-Fenzl Lens Manipulating Hook	198	Metzenbaum Needle Holder	70
Manhattan Eye and Ear Suture Forcep	170	Metzenbaum Scissor	1,7,8,15,16
Manipulation Hook	408	Metzenbaum-Baby Scissor	1,144,146
Marquardt Bone Rongeur	324,386	Meyerding Finger Retractor	80
Martinez-Kilner Nasal Retractor	84	Meyerding Hemi-Laminectomy Retractor	416
Maryland Dissector	226,249,278	Meyerding Retractor	329,413



Maryland Dissector-Tapered	226,249	Maryland Dissector-Short	226,249
Meyerhoffer Chalazion Curette	211	Needle Nose Grasper	227,250
Micro Alligator Ear Forcep	112,113	Needle Nose Pliers	349
Micro Bayonet Cervical Curettes	396	Neivert Needle Holder	67,69
Micro Bayonet Needle Holder	431	Nelson Metzenbaum Scissor	8
Micro Fenestrated Grasper	228,251	Nelson Tissue Forcep	43
Micro Kerrison Convertible	373	Nerve Root Retractor w Suction	412
Micro Needle Holder	178,179	New Orleans Eye and Ear Lens Loop	187
Micro Reddick Olsen Dissector	225,248	Non-Perforating Towel Clamp	61
Micro Ring Tip Forcep	41	Northbent Stitch Scissors	31
Micro Surgery Needle Holder	71	Noyes Alligator Forcep	115
Micro Surgery Scissor	30	Nugent Utility Forceps	163
Micro Suture Forcep	50	O	
Micro Tissue Forcep	41	O'Brien Stitch Scissors	32
Micro Vascular Needle Holder	66	Obwegesser-Freer Periosteal Elevator	95
Micro Vascular Scissors	21	Ochsner-Baby Forcep	59
Millard Thumb Hook	84	O'Connor Scleral Depressor-Marker	210
Miller Bone File	102	O'Gawa Tying Forcep	159
Miller Rake Retractor	86	Oldberg Rongeur	380
Miller-Colburn File	103	Olsen-Hegar Needle Holder	65
Mini Bone Lever	317	Ombredanne Mallet	334
Mini Cobra Bone Lever	317	Operating Scissors	6, 14
Minimally Invasive Retractors	292	Orbitaris Bipolar Scissors and Fcp	297-299
Mirco Grasper, Fenestrated	253	Orthopedic Locking Pliers	349
Mixer 45° Angle Dissector	227,250	Orthopedic Mallet	333
Mixer Forcep	58	Osher "Y" Hook	198
Mixer Right Angle Dissector, Long	226,249	Osher Nucleus Manipulator	199
Mixer Right Angle Dissector, Short	226,249	Osher-Neumann Corneal Marker	217
Mixer-Baby Forcep	57	Osteo-Rotating Punch	378
		Osteotomes	336,337,340
Molt (Sluder-Jansen) Mouth Gag	126		341,391
Molt Dissector and Rasp	94	P	
Monopolar Cables	305	Paddle Babcock Grasper	262
Moore Femoral Head Extractor	344	Palpation Probes	287
Mouth Prop	127	Paparella-Weitlaner Retractor	81
Muller Claus Wire Cutter	347	Par Needle Holder	67
Muller Claus Wire Pullers	346	Par Scissor	4, 9
Muller Femoral Retractor	316	Parkes Rasp	99,101
Murphy Bone Skid Elevator	320	Paton Spatula	182
Myoma Screw	283	Paufique Suture Forcep	170
N		PCL Retractor	320
Nasal Alligator Scissor	110	Pea Pod Disc Rongeur	380
Nasal Rotating Backbiter Forcep	108	Pean-Baby Forcep	58
Nasal Tenaculum Hook	76	Peck-Joseph Scissors	12
Nathanson Liver Retractor	290	Peet Nasal Rasp	100



Needle Monopolar Electrode	303	Pelvic Reduction Forcep	328
Penfield Dissector	437	RazorEdge Kaye-Freeman Facelift Scr	4
Pennington Septum Elevator	92	Razor Edge Mayo Scissor	1
Peritoneal Scissors	241,264,265 227,228	Razor Edge Metzenbaum Scissor	1
Petelin Dissector	250,251,276	Razor Edge Metzenbaum-Baby Scissor	1
Phoenix Needle Holder	176	Razor Edge Par Scissor	5
Pierce Fixation Forcep	164	Razor Edge Plastic Scissor	2
Pierce Septum Elevator	89	Razor Edge Ragnell (Kilner) Scissor	6
Pierse Eye Speculum	208	Razor Edge Stevens Tenotomy Scissor	2
Pierse Type Colibri Forcep	157	Rees Face Lift Scissors	10
Pigtail Probe	215	Retraction Grasper	234,257,272
Plain Splinter Forcep	49	Retrograde Cement Chisel	342
Plastic Utility Scissors	27	Reynolds Breast Dissector	132
Plastic Surgery Scissor	2	Reynolds Dissecting Scissors	18
Pliers for Screw Removal	346	Rhoton Dissector	409,410
Polack Double Corneal Forcep	167	Rhoton Elevator	409
Potts-Smith Dressing Forcep	36,40	Rhoton Hook	409
Potts-Smith Scissors	28,40	Rhoton Micro Bayonet Scissor	21
Powergrip Bipolar Scissors and Fcp	296	Rhoton Spatula	409
Providence Hosp Forcep	56	Rhoton Sterilization Case	410
Punch Rongeur	110,373-378	Ribbon Retractor	80
Q		Right Angle, Long Reach Grasper	227,250
Quickert Lacrimal Intubation Probe	215	Rigid Neck Rake Retractor	86
R		Robotic Retractor-Laparoscopy	288
Ragnell (Kilner) Scissors	6, 12	Rochester-Carmalt Forcep	58
Ragnell Retractor	77	Rochester-Ochsner Forcep	59
Randolph Cyclodialysis Cannula	190	Rochester-Pean Forcep	59
Raney Scalp Clip Appling Forcep	62	Roger Septum Elevator	92
Rat Tooth Bone Rongeur	384	Rollet Retractor	85
Rat Tooth Grasper	232,255	Rongeurs	373-378
RazorEdge Castanares Facelift Scissor	2	Rongeur Punch	373-178
RazorEdge Cottle Dorsal Scissor	4	Rosen Knife Curette	121
RazorEdge Fomon Dorsal Scissor	5	Rosen Pick	123
RazorEdge Fomon Saber Back Scissor	5	Rosen Suction Tube	98
RazorEdge Freeman Facelift Scissor	3	Rosenbaum-Drews Iris Retractor	205
RazorEdge Goldman-Fox Scissor	5	Rowe Maxillary Forcep	106
RazorEdge Gorney Facelift Scissor	3	Rubin Nasal Rasp	103
RazorEdge Gorney Platysma Scissor	3	Rubio Wire Twister	64
RazorEdge Gorney-Freeman Facelift Scissor	3	Ruedemann Lacrimal Dialator	215
RazorEdge Iris Scissor	1	Ruler	355
RazorEdge Jabaley Scissor	6	Ruskin Bone Rongeur	385
RazorEdge Jamison Tenotomy Scissor	2	Ruskin-Liston Bone Cutter	322
RazorEdge Joseph Nasal Scissor	4	Russian Forcep	42
RazorEdge Kaye Facelift Scissor	4	Ryder Needle Holder	68
Pelvic Osteotome	338		

S

Salinger Nasal Reduction Instrument	106	Sinskey II Lens Manipulating Hook	204
Sargis Uterine Grasping Forcep	286	Sinskey Lens Manipulating Hook	198, 203
Sauer Speculum	209	Sinskey Tying Forcep	158
Sauer Suture Forceps	155	Sinus Cup Forcep	108
Scalpel Handle	435	Sistrunk Operating Scissors	29
Schaff Foreign Body Forcep	161	Skeele Curette	211
Scheie Anterior Chamber Cannula	192	S Retractor	82
Scheie Aspirating Cataract Needle	188	Skin Hooks	72-76
Schepens Orbital Retractor	204	Slap Hammer	349
Schepens Sceral Depressor	210	Slotted Mallet	342
Schlesinger Tooth Rongeur	379	Smith Peterson Osteotome	336,391
Schmidt Tonsil Forcep	63	Smith-Peterson Bone Rongeur	325,386
Schocket Scleral Depressor	210	Snake Retractors-Lap	291
Schroeder Tenaculum	236	Spatula Monopolar Electrode	303
	236,259	Spencer Stitch Scissors	32
Schroeder Tenaculum Grasper	273,274,276	Spinal Curette	400,401
Schroeder Vulsellum Dbl Tooth	286	Spinal Osteotome	421
Schuknecht Suction Tube	98	Splinter Forceps	49
Screwdrivers	352,353	Sponge Forceps	60
Semb Bone Holding Forcep	327	Spring Retractor	80
Semken Bipolar Forcep	53	Spurling IVD Rongeur	382
Semken Dressing Forcep	42	Square ended Pliers	346
Semken Tissue Forcep	42	St Claire Adenoid Forcep	128
Senn Retractor	77	Stahl A/C Caliper	218
Serrefine	180	Standard Lap Grasper	225,278
Shallow Bone Elevator	319	Steinmann Pin Introducer	350
Sheen Gripping Forcep	47	Steinmann Pin Introducer Handle	350
		Sterilization Case-Robot	
Sheen -Killian Septum Forcep	106	Retractor and Goose Neck	289
Sheet Iris Hook	201	Stern-Castroviejo Suture Forcep	156
Sheets Irrigating Vectus	191	Stevens Tenotomy Hook	202
		Stevens Tenotomy Scissor	2, 9,18,144, 145,146,147
Sheets-McPherson Tying Forcep	161	Stevenson Lacrimal Sac Retactor	205
Shepard-Westcott Tenotomy Scr	154	Stille Osteotome	336,391
Silastic Ring Applicator	285	Stille-Liston Bone Cutter	322,392
Silicone Bulb	191	Stille-Luer Bone Rongeur	325,387
Silicone Brain Spatula	436	Stitch Scissors	32
Silvers Miniature Skin Graft Knife	143	Strabismus Scissor	9, 17,144
Silverstein Breast Dissector	132	Straight Bipolar Forcep	432
Simcoe Cortex Extractor	193	Straight Cement Gouge	340
Simcoe Lens Loop	186	Struempel Ear Forcep	114
Simcoe Rev Dbl Barrel Irrigating Unit	191	Suction Tubes	97,98,306, 307,421,422
		Suction/Irrigation Monopolar Electrodes	311
Sims Scissors	16		
Single Use Cannulas and Syringes	142		



Superslide II Laminectomy Retractor Set	425,426	U	
Swan Neck Gouge	339	Ultra Fine Mallet	333
Swedish Needle Holder	67	Universal Pliers and Cutter	346
Swiss Cilia Forcep	50	Universal Ring Retractor System	417
Swiss Jeweler Forcep	51,52	Universal Trephine Handle	217
Sypert Bone Rongeur	388	University of Kansas Corneal Fcp	168
T		US Army Retractor	79
Takahashi Ethmoid Forcep	107	US Babcock Grasper	238,261
Tapered Dolphin Nose Grasper	226,248,268	Uterine Manipulator	286
Taylor Dural Scissors	29	Uterine Tenacula	286
Taylor Hip Retractor	413	Utility Scissors	32
Tear-Drop Suction	NEED 437	Utrata Capsulorhexis Forcep	166,167
Tebbetts Lighted Retractor	138	V	
Temporal Wire Speculum	206	Vannas Capsulotomy Scissor	152
Tenaculum Hook	76	Vannas Scissors	30
Tennant Nucleus Manipulator	202	Verbrugge Bone Holding Forcep	327
Tennant Titanium Tying Forcep	174	Vernier Caliper	355
Tennant Tying Forcep	159	Verres Needles	287
Thorek Scissors	28	Vienna Nasal Speculum	116
Thornton IOL Forcep	170	Viper Scoliosis Retractor	332
Thorpe Conjunctival Fixation Fcp	164	Virtus Splinter Forcep	49
Thorton Fixation Ring	218	Volkman Curette	402
Thudichums Nasal Speculum	116	Volkman Retractor	329,413
Tieck-Halle Infant Speculum	116	Von Graefe Strabismus Hook	202
Tissue Forcep	37	Von Graefe Tissue Forcep	42
Titanium Capsulorhexis Forcep	173	Von Mandach Capsule Fragment Fcp	172
Titanium Tying Forcep	173	W	
Toffee Mallet	333	Wagner Plastic Scissors	27
Tonsil Forcep	63,130	Walsham Septum Forcep	105
Tooke Corneal Knife	181	Walter Splinter Forcep	48
Towel Clamp	61	Watson Skin Graft Knife	143
Toynbee Ear Speculum	117	Watzke Sleeve Spreading Forcep	170
Trosseau Tracheal Dilator	128	Waugh Dissecting Forcep	43
Troutman Alpha-Chymotrypsin Cannula	192	Wave Grasper	233,256,272
Troutman Needle Holder	175	Wave Grasper, Pointed	237,260
Troutman-Barraquer Corneal Forcep	158	Weary Nerve Hook	407
Troutman-Barraquer Needle Holder	175	Webster Needle Holder	66,69
Troutman-Castroviejo Corneal Scr	150,151	Weil-Blakesley Nasal Forcep	107
Troutman-Katzin Corneal Scissor	149	Weitlaner Retractor	82,331,414
Tubal Grasper	238	Wells Enucleation Spoon	187
Tuning Fork	124	Welsh Flat Olive Tip Cannula	193
Twist Fixation Hook	197	Westcott Stitch Scissors	29,154
Tyrell Hook	72	Westcott Utility Scissors	153
Tyrell Iris Hook	201	West Lacrimal Cannula	194

Westcott Tenotomy Scissor	151,152,154
Westcott Utility Scissor	30,153
Wests S/R Retractor	331,418
Wheeler Cyclodialysis Spatula	182
Wheeler Plaque Forcep	41
Wieder Cheek and Tongue Retractor	127
Wilde Dressing Forcep	44
Wilder Dilator	214
Wilder Lens Loop	185
Williams (Stieglitz) Splinter Fcp	50
Williams Discectomy Rongeur	380
Williams Lacrimal Probe	214
Williams Speculum	208
Wills Hosp Utility Forcep	160
Wilmer (Converse) Scissors	28
Wire Cutter/Plier	348
Wire Cutting Scissors	13,34
Wire Passing Guide	351
Woodson Dura Separator and Spatula	94
Woodson Elevator	94
Y	
Yancoskie Abdominoplasty Retractor	87
Yancoskie Coronal Lift Retractor	86
Yasargil Bayonet Forcep	430
Yasargil Bayonet Needle Holder	431
Yasargil Bayonet Scissor	431
Yasargil Bayonet Tumor Forcep	430
Yasargil Micro Bayonet Scissor	20
Young Tongue Seizing Forcep	62
Z	
Zep Scissor	20
Zilke Bone Rongeur	385



Numerical Index

012-703	435	030-414	14	043-518	16	062-312	38	071-918	43
012-707	435	030-415	14	043-520	16	062-413	38	072-618	37
012-713	435	030-511	14	043-523	16	062-512	39	072-620	41
012-723	435	030-513	14	045-015	25	062-572	39	072-718	37
012-733	435	030-514	14	045-115	25	062-582	40	072-819	42
012-804	435	030-515	14	045-416	16	063-010	45	072-849	42
012-814	435	030-516	14	045-516	16	063-012	42	073-014	44
012-850	435	030-611	14	046-716	18	063-015	42	073-016	44
013-034	435	030-613	14	046-718	18	063-020	45	073-019	44
013-036	435	030-614	14	051-574	30	063-022	42	073-114	44
019-419	143	030-615	14	051-575	30	063-030	45	073-116	44
020-612	27	030-616	14	051-578	30	063-110	45	073-119	44
020-632	27	033-420	16	051-579	30	063-110D	45	073-371	53
020-712	27	033-520	16	060-011	36	063-112	42	073-380	52
020-732	27	035-014	14	060-013	36	063-115	42	073-392	52
022-009	19	035-017	14	060-014	36	063-120	45	073-392NS	432
022-010	19	035-023	14	060-015	36	063-122	42	073-394NS	432
022-011	19	035-114	14	060-018	36	063-130	45	073-400	52
022-040	27	035-117	14	060-020	36	064-015	43	073-414NS	433
022-109	19	035-123	14	060-025	36	064-085	43	073-416	53
022-110	19	035-615	15	060-030	36	064-215	43	073-416NS	433
022-111	19	035-617	15	060-511	37	064-220	43	073-418NS	433
022-140	27	035-715	15	060-513	37	064-315	43	073-420	53
022-191	19	035-717	15	060-514	37	064-320	43	073-533NS	433
024-010	22	035-817	15	060-515	37	064-618	40	073-535NS	433
024-109	17	035-917	15	060-518	37	064-620	40	073-537NS	433
024-110	22	036-714	29	060-520	37	064-625	40	073-543NS	433
024-510	17	042-014	19	060-525	37	064-818	40	073-545NS	433
025-002	18, 146	042-114	19	060-530	37	064-820	40	073-547NS	433
025-003	18, 146	043-214	15	061-014	37	064-825	40	073-629	52
025-012	18, 147	043-218	15	061-113	37	066-017	37	073-630	52
025-013	18, 147	043-220	15	061-814	44	066-018	37	073-681NS	433
025-013	18	043-223	15	061-818	44	066-087	37	073-682NS	433
025-110	147	043-226	15	061-864	44	066-088	37	073-683NS	433
025-111	18, 147	043-314	15	061-868	44	066-090	42	073-685NS	433
025-123	18, 147	043-318	15	062-001	39	066-199	47	074-700	53, 434
025-125	147	043-320	15	062-005	39	068-792	41	076-001	51
030-211	14	043-323	15	062-012	38	068-793	41	076-003	51
030-214	14	043-328	15	062-014	38	071-015	40	076-003C	51
030-215	14	043-414	16	062-015	38	071-020	40	076-004	51
030-216	14	043-418	16	062-112	38	071-515	42	076-005	51
030-314	14	043-420	16	062-113	38	071-520	42	076-005A	51
030-411	14	043-423	16	062-115	38	071-525	42	076-007	52
030-413	14	043-514	16	062-212	38	071-915	43	076-403	50



076-404	50	101-820	70	154-182	55	170-814	58	203-019	73
078-009	49	101-823	70	154-412	54	170-816	58	203-020	73
078-010	49	102-015	70	154-512	54	170-818	58	203-031	74
078-011	49	102-018	70	154-612	54	170-823	58	203-032	74
078-109	49	102-020	70	154-712	54	172-150	63	203-502	75
078-110	49	103-618	70	155-014	56	172-151	63	203-506	76
078-111	49	103-620	70	155-114	56	172-155	63	203-507	76
078-207	49	105-916	70	155-615	60	172-156	63	203-509	76
078-211	49	140-609	32	155-715	60	175-008	61	203-532	74
078-411	48	140-612	32	157-014	56	175-508	61	204-803	74
078-421	48	140-613	31	157-016	56	175-513	61	204-805	74
078-611	48	140-709	32	157-114	56	175-709	61	204-807	74
078-621	48	140-712	31	157-116	56	175-714	61	205-001	73
079-114	50	142-312	34	157-214	56	175-783	61	205-002	73
079-124	50	145-120	346	157-216	56	195-018	60	205-005	73
079-134	50	145-415	346	157-314	56	195-024	60	205-007	73
079-414	49	145-419	346	157-316	56	195-118	60	205-010	73
079-424	49	145-620	348	161-014	59	195-124	60	205-012	73
098-305	97	145-690	349	161-016	59	195-218	60	205-109	72
098-306	97	145-700	349	161-022	59	195-224	60	205-202	73
098-307	97	145-750	349	161-114	59	195-318	60	205-210	72
098-308	97	147-505	349	161-116	59	195-324	60	205-211	72
098-309	97	147-509	349	161-120	59	200-508	77	205-516	85
098-310	97	147-512	349	161-122	59	200-509	77	205-517	85
098-311	97	147-705	349	161-184	58	200-512	77	206-450	85
098-312	97	147-709	349	161-214	59	200-513	77	206-452	85
098-375	97	147-712	349	161-216	59	200-525	77	206-453	85
098-376	97	147-730	349	161-220	59	200-911	82	206-465	87
098-377	97	147-750	349	161-222	59	200-930	80	206-550	85
098-378	97	15088-00	288	161-314	59	201-001	80	206-552	85
098-379	97	15090-60	289	161-316	59	201-002	80	206-553	85
098-380	97	15090-61	289	161-318	59	201-003	80	206-601	86
098-381	97	152-014	59	161-320	59	201-004	80	206-602	86
098-382	97	152-114	59	161-322	59	201-005	80	206-603	86
100-212	68	152-414	55	163-616	58	201-006	80	206-604	86
100-812	69	152-514	55	163-620	58	201-701	77, 411	206-701	86
101-012	69	152-814	58	163-716	58	201-702	77, 411	206-702	86
101-013	69	152-914	58	163-720	58	201-703	77, 411	206-703	86
101-014	69	153-009	55	164-019	57	201-750	78	206-704	86
101-212	68	153-109	55	164-088	60	201-776	317	220-000	80
101-213	69	153-209	55	164-118	57	201-788	91	220-006	80
101-282	68	153-309	55	164-119	57	202-236	407	220-012	80
101-513	69	153-501	55	164-188	60	202-722	407, 408	220-017	80
101-812	69	153-502	55	170-514	57	202-723	407, 408	220-020	80
101-813	70	154-012	54	170-519	57	202-737	407	220-025	80
101-815	70	154-082	55	170-614	57	203-012	72	220-251	80
101-818	70	154-112	54	170-619	57	203-013	72	220-252	80



220-253	80	23-0072E	372	23-1020RH	360	23-2203RH	359	23-4720RH	360
220-254	80	23-0082C	370	23-1021RH	360	23-2204RH	359	23-4803RH	364
220-255	80	23-0082E	372	23-1022RH	360	23-2205RH	359	23-4843RH	360
220-256	80	23-0092C	370	23-1024RH	360	23-2502RH	362	23-5303RH	363
220-257	80	23-0092E	372	23-1045	369	23-2503RH	362	23-5313RH	363
221-012	79	23-0101	369	23-1104	368	23-2513RH	362	23-5333RH	363
221-821	79	23-0102C	371	23-1105	368	23-2533RH	362	23-5353RH	363
222-001	88	23-0102E	372	23-1106	368	23-2573RH	362	23-5373RH	363
222-002	84	23-0112	368	23-1107	368	23-2593RH	362	23-5393RH	363
222-003	84	23-0112C	371	23-1108	368	23-2613RH	362	23-5413RH	363
222-005	88	23-0112E	372	23-2000RH	357	23-2633RH	362	23-5433RH	363
222-006	87	23-0115	368	23-2011RH	357	23-2653RH	362	23-5453RH	363
222-007	87	23-0118	368	23-2012RH	357	23-2703RH	364	236-301	329
222-008	86	23-0122C	371	23-2013RH	357	23-2803RH	364	236-302	329
222-010	87	23-0122E	372	23-2014RH	357	23-3116RH	365	236-303	329
222-013	87	23-0132C	371	23-2015RH	357	23-3119RH	365	23-7200RH	358
222-014	88	23-0132E	372	23-2016RH	357	23-3122RH	365	23-7201RH	358
222-018	87	23-0142C	371	23-2020RH	357	23-3125RH	365	237-217	79
222-019	87	23-0142E	372	23-2029RH	357	23-3128RH	367	237-217FO	140
222-024	87	23-0152C	371	23-2030RH	357	23-3130RH	367	237-219FO	140
222-043	86	23-0152E	372	23-2031RH	357	23-3132RH	366	237-225	79
222-044	86	23-0162C	371	23-2032RH	357	23-3134RH	367	23-7294RH	358
222-130	87	23-0162E	372	23-2033RH	357	23-3136RH	366	23-7295RH	358
222-229	134	23-0172C	371	23-2034RH	357	23-3138RH	366	23-7296RH	358
222-229FO	140	23-0182C	371	23-2035RH	358	23-3140RH	366	23-7403RH	364
222-230	134	23-0192C	371	23-2036RH	359	23-3142RH	366	237-502FO	140
222-230FO	140	23-0212	368	23-2037RH	359	23-3202RH	365	237-503FO	140
222-265	86	23-0215	368	23-2038RH	359	23-3203RH	365	237-504	79
222-284	88, 131	23-0218	368	23-2039RH	359	23-3602RH	364	237-504FO	140
222-284FO	139	23-0312	368	23-2040RH	357	23-3603RH	364	237-505	79
223-403	413	23-0315	368	23-2041RH	357	23-3605RH	365	237-505FO	140
223-404	413	23-0318	368	23-2042RH	357	23-3903RH	362	237-507	79
223-406	413	230-710	329, 413	23-2043RH	357	23-3913RH	362	237-507FO	140
23-0012C	370	230-713	329, 413	23-2044RH	358	23-3933RH	362	237-508	79
23-0012E	372	230-716	329, 413	23-2045	369	23-3953RH	362	237-509FO	140
23-0022C	370	230-718	329	23-2045RH	358	23-3973RH	362	23-7703RH	364
23-0022E	372	230-720	413	23-2046RH	358	23-3993RH	362	23-8002RH	364
23-0032C	370	23-0800CH	361	23-2047RH	358	23-4013RH	362	23-8003RH	364
23-0032E	372	23-0801CH	361	23-2048RH	358	23-4033RH	362	23-8203RH	364
23-0042C	370	23-0802CH	361	23-2051RH	358	23-4053RH	362	23-8454RH	364
23-0042E	372	23-0803CH	361	23-2052RH	358	23-4103RH	364	23-8603RH	364
23-0045	369	23-0806CH	361	23-2053RH	358	23-4203RH	364	23-8933RH	365
23-0052C	370	23-0807CH	361	23-2054RH	358	23-4303RH	364	23-8953RH	365
23-0052E	372	23-0900CH	361	23-2055RH	358	23-4403RH	364	23-9003RH	365
23-0062C	370	23-0901CH	361	23-2058RH	359	23-4503RH	364	23-9878RH	359
23-0062E	372	23-1012RH	360	23-2059RH	359	23-4603RH	364	240-301	80
23-0072C	370	23-1014RH	360	23-2201RH	359	23-4703RH	364	240-909	81



240-910	81	244-017	331	264-919H	392	275-808	338	285-437	390
241-007	81	244-018	81	266-035	95	275-810	338	285-438	337
241-008	81	245-810	417	266-203	95	275-812	338	285-530	340
241-010	81	245-811	417	266-204	95	275-815	338	285-540	340
241-011	81	245-812	417	270-210	333	275-825	338	286-106	338
241-503	135	245-813	417	270-423	333	284-204	336	286-108	338
242-000	330	245-814	417	270-500	333	284-206	336	286-111	338
242-001	330	245-815	417	270-501	333	284-208	336	286-116	338
242-005	330	245-816	417	270-502	333	284-406	336, 391	286-528	339
242-011	330	245-817	417	270-875	333	284-408	336, 391	286-535	340
242-100	330	245-818	417	270-880	334	284-410	336, 391	286-537	340
242-101	330	245-819	417	270-885	334	284-412	336, 391	286-540	340
242-210	82	245-820	417	270-902	342	284-415	336, 391	286-732	339
242-211	82	245-821	417	273-024	343	284-420	336, 391	286-832	339
242-213	331, 414	245-822	417	273-026	343	284-425	336, 391	286-834	339
242-214	331, 414	245-823	417	273-038	342	284-430	336, 391	286-934	339
242-216	82	245-824	417	273-040	341	285-104	336	286-935	339
242-217	82	245-825	417	273-148	342	285-106	336	287-110	336, 391
242-430	131	245-827	417	273-306	343	285-108	336	287-115	336, 391
242-435	132	245-828	417	273-308	343	285-110	336	287-120	336, 391
242-440	88, 131	249-090	131	273-310	343	285-112	336	287-125	336, 391
242-445	134	249-090FO	139	273-505	342	285-115	336	287-130	336, 391
242-445FO	140	261-010	102	273-507	342	285-120	336	289-404	335, 390
242-454	132	261-012	102	273-510	342	285-125	336	289-406	335, 390
242-470	132	261-013	102	273-534	342	285-130	336	289-408	335, 390
242-490	132	261-014	103	273-540	341	285-154	336	289-410	335, 390
242-499	330	263-301	413	273-605	341	285-156	336	289-413	335, 390
242-500	330	263-302	413	273-607	341	285-158	336	289-416	335, 390
242-505	330	263-303	413	273-610	341	285-160	336	289-418	335, 390
242-506	330	263-502	93	273-705	341	285-162	336	289-420	335, 390
242-512	133	263-503	93	273-707	341	285-165	336	289-425	335, 390
242-513	133	263-703	94	273-710	341	285-170	336	289-430	335, 390
242-801	414	263-707	94	273-740	341	285-175	336	289-454	335, 390
242-802	414	263-790	354, 394	273-748	342	285-180	336	289-456	335, 390
242-803	414	264-224	94	273-805	341	285-305	340	289-458	335, 390
243-013	331, 415	264-225	94	273-807	341	285-306	338	289-460	335, 390
243-014	331, 415	264-404	91	273-810	341	285-307	340	289-463	335, 390
243-016	331, 415	264-422	90	273-948	342	285-310	340	289-466	335, 390
243-017	331, 415	264-423	90	275-230	338	285-402	337	289-468	335, 390
243-020	331, 415	264-424	90	275-330	338	285-404	337	289-470	335, 390
243-021	331, 415	264-425	90	275-702	335	285-406	337	289-475	335, 390
243-023	331, 415	264-428	90	275-703	335	285-408	337	289-480	335, 390
243-024	331, 415	264-910	392	275-704	335	285-410	337	295-333	398
243-206	415	264-910H	392	275-706	335	285-432	337, 390	295-342	398
244-013	81	264-913	392	275-708	335	285-433	337, 390	295-350	398
244-014	81	264-913H	392	275-800	338	285-435	337, 390	295-351	398
244-015	81	264-919	392	275-805	338	285-436	337, 390	295-352	398



295-353	398	298-826	399	321-30L	65	324-40	68	326-20	6
295-390	398	298-826A	399	321-36	9	324-41	68	326-30	6
295-392	398	305-217	323, 383	321-40	64	324-42	68	326-40	6
295-397	398	305-317	323, 383	321-40L	65	324-45	68	326-50	6
295-398	398	305-421	323, 383	321-45	64	324-46	68	326-51	8
295-399	398	305-422	384	321-59	65	324-47	68	326-70	144
295-400	398	305-523	385	321-59S	65	324-60	67	326-71	144
295-401	398	305-525	385	321-60	65	324-65	68	326-75	8, 144
295-402	398	307-613	323	321-60S	65	324-65S	68	326-76	8
295-403	398	307-624	323, 383	321-70	65	324-66	68	326-77	7
295-404	398	310-503	324	321-72	20	324-66S	68	326-78	8
295-405	398	310-520	324, 386	321-73	20	324-67	68	326-79	7
295-406	398	310-605	385	321-74	20	324-67S	68	326-80	7
295-407	398	310-625	385	321-75	20	324-68	68	326-81	8
296-715	398	310-705	385	321-76	20	324-68S	68	326-88	7
296-724	398	310-725	385	321-77	20	324-69	68	326-90	10
296-733	398	310-903	325, 386	321-80	65	325-00	35	326-97	10
296-742	398	310-913	325, 386	322-83	11	325-03	35	326-98	10
296-750	398	311-104	324, 385	323-02	64	325-04	35	326-99	7
296-751	398	311-105	324, 386	323-20	65	325-05	35	327-00	9, 144
296-815	398	313-023	325, 387	323-20L	65	325-06	35	327-01	9, 144
296-824	398	313-027	325, 387	323-22	66	325-08	35	327-05	8, 144
296-833	398	313-123	325, 387	323-25	65	325-09	35	327-06	8, 144
296-842	398	313-127	325, 387	323-25L	65	325-10	35	327-08	9, 145
296-850	398	315-103	325, 387	323-30	65	325-17	12	327-09	9, 145
296-851	398	315-105	325, 387	323-50	65	325-18	12	327-10	7
298-513	402	315-108	325, 387	323-50L	65	325-20	36	327-11	7
298-514	402	315-705	388	323-52	66	325-25	36	327-12	7
298-515	402	315-708	388	323-60	65	325-27	36	327-20	7
298-817	399	315-905	388	324-00	66	325-41	11	327-21	7
298-817A	399	315-908	388	324-00L	66	325-416		327-22	7
298-818	399	316-102	388	324-03	67	325-43	10	327-50	7
298-818A	399	316-103	388	324-04	67	325-51	11	327-51	7
298-819	399	316-104	388	324-05	66	325-53	10	327-52	7
298-819A	399	321-06	348	324-06	66	325-61	11	327-60	7
298-820	399	321-07	348	324-07	66	325-62	11	327-61	7
298-820A	399	321-10	64	324-10L	66	325-66	10	327-62	7
298-821	399	321-11	346	324-15	66	325-67	36	327-74	7
298-821A	399	321-12	346	324-15L	66	325-68	36	327-90	7
298-822	399	321-13	346	324-20	67	325-70	36	327-91	7
298-822A	399	321-20	64	324-25	67	325-71	11	327-92	7
298-823	399	321-20L	65	324-30	65	325-72	11	327-95	7
298-823A	399	321-24	64	324-30L	65	325-76	10	327-96	7
298-824	399	321-27	347	324-31	66	325-78	10	327-97	7
298-824A	399	321-28	347	324-31S	66	325-83	12	328-00	6
298-825	399	321-29	347	324-35	65	326-00	6	328-10	6
298-825A	399	321-30	64	324-35L	65	326-10	6	328-20	6



328-30	6	404-718	33	5261	305	52003-39	313	52102-17C1	261
328-60	6	430-100	143	5268	305	52003-40	313	52102-20B1	239
328-70	6	430-302	143	5269	305	52003-48	313	52102-26B1	238
328-80	8	430-303	143	5414	305	52003-56	313	52102-26C1	261
328-82	8	430-304	143	5415	305	52003-80	313	52102-38B1	242
328-88	20	430-305	143	5416	305	52003-81	313	52102-436B1	238
328-91	20	430-306	143	501-014	63	52005-17	302	52102-46B1	239
328-94	20	430-308	143	501-015	63	52005-18	302	52102-47B1	239
329-00	13	431-301	143	501-016	63	52005-19	302	52102-64B1	242
329-30	9	431-302	143	501-020	63	52005-20	302	52102-66B1	242
329-31	9	431-303	143	501-023	63	52005-21	302	52103-19	287
329-40	13	431-304	143	501-024	63	52005-22	295	52103-35	300
329-41	13	431-305	143	501-026	63	52005-23	302	52105-101	293
329-43	13	431-306	143	501-040	63	52005-24	302	52105-102	293
335-015	322	443-715	355	501-045	63	52005-25	302	52105-103	293
335-115	322	443-730	355	502-326	60	52005-26	302	52105-104	293
335-618	322	455-102	125	512-519	29	52005-29	302	52105-25	287
335-718	322	455-111	126	512-523	29	52005-30	302	52105-27R	287
335-917	322, 389	455-112	126	52001-00	286	52005-31	245	52105-27W	287
337-027	322, 389	455-113	126	52001-08	286	52005-32	245	52105-500	285
337-127	322, 389	455-114	126	52001-09	286	52005-35	307	52105-70	294
337-527	322, 389	455-115	126	52001-12L	285	52005-36	307	52110-01	221
351-136	327	455-121	125	52001-12S	285	52005-37	307	52110-02	221
351-162	328	455-122	125	52001-13	285	52005-38	307	52110-03	221
351-163	328	455-300	126	52001-13W	285	52005-41	307	52110-04	221
351-172	328	455-320	126	52001-14	286	52005-43	307	52110-05	221
351-173	328	455-702	124	52001-16	286	52005-45	307	52110-06	221
351-175	328	455-711	125	52001-17	286	52005-47	307	52110-07	221
352-150	344	455-712	125	52001-18	286	52005-48	307	52110-08	221
355-021	326	455-713	125	52001-19L	285	52005-49	307	52112-01B	278
355-221	326	455-714	125	52001-19S	285	52005-500	285	52112-02B	278
357-525	327	455-715	125	52001-29	285	52005-501	285	52112-03B	278
357-526	327	455-719	125	52001-31	285	52037-00-B2	315	52112-04B	278
357-527	327	455-722	125	52003-07	287	52037-00-B4	315	52112-05B	278
381-020	407	458-216	62	52003-09	287	52037-05	315	52112-06B	278
390-330		458-217	62	52003-10	287	52037-06	315	52112-07B	278
395-373		500-213	54	52003-11	287	52037-07	315	52112-08B	278
395-382		500-214	54	52003-12	287	52037-08	315	52112-09B	278
395-391		500-215	54	52003-21	313	52037-11	315	52112-10B	278
395-392		500-216	54	52003-23	313	52038-15	315	52112-11B	278
402-014	33	5009	305	52003-25	313	52038-48	314	52112-15B	278
402-509	33	5021	305	52003-27	313	52038-49	314	52112-16B	278
402-511	33	5022	305	52003-29	313	52038-51	314	52133-25	287
402-514	33	5023	305	52003-31	313	52038-52	314	52145-25	287
402-518	33	5029	305	52003-33	313	52038-53	314	52155-01B1	225
402-520	33	5030	305	52003-37	313	52038-54	314	52155-01B10	225
403-120	33	5260	305	52003-38	313	52102-17B1	238	52155-01B17	225



52155-01B18	225	52205-31R	287	52205-96M	294	52255-02B3	225	52255-09B3	227
52155-01B3	225	52205-32	306	52205-96S	294	52255-02B4	225	52255-09B4	227
52155-01B4	225	52205-32T	306	52208-501	285	52255-02C1	248	52255-09C1	250
52155-02B1	225	52205-33	306	52210-00	220	52255-03B1	225	52255-105B1	226
52155-02B10	225	52205-35	303	52210-01	220	52255-03B10	225	52255-105B10	226
52155-02B18	225	52205-36	303	52210-02	220	52255-03B17	225	52255-105B17	226
52155-02B3	225	52205-37	303	52213-41	282	52255-03B18	225	52255-105B18	226
52155-02B4	225	52205-37R	303	52213-41C	282	52255-03B3	225	52255-105B3	226
52203-05	282	52205-38	303	52215-00	220	52255-03B4	225	52255-105B4	226
52203-08	286	52205-44	294	52215-01	220	52255-03C1	248	52255-105C1	249
52203-10	282	52205-45	303	52215-02	220	52255-04B1	225	52255-106B1	226
52203-12	282	52205-47	294	52215-02B17	225	52255-04B10	225	52255-106B10	226
52203-15	282	52205-510	296	52224-01B1	225	52255-04B17	225	52255-106B17	226
52203-22	287	52205-56	303	52224-01B10	225	52255-04B17	225	52255-106B18	226
52203-41	282	52205-57	304	52224-01B17	225	52255-04B18	225	52255-106B3	226
52203-41C	282	52205-57L	304	52224-01B18	225	52255-04B3	225	52255-106B4	226
52205-00	220	52205-58	304	52224-01B3	225	52255-04B4	225	52255-106C1	249
52205-01	220	52205-58L	304	52224-01B4	225	52255-04C1	248	52255-10B1	227
52205-010	297	52205-63	304	52224-02B1	225	52255-05B1	225	52255-10B10	227
52205-02	220	52205-64	304	52224-02B10	225	52255-05B10	225	52255-10B17	227
52205-03	220	52205-65	304	52224-02B17	225	52255-05B18	225	52255-10B18	227
52205-04	220	52205-65L	304	52224-02B18	225	52255-05B3	225	52255-10B3	227
52205-07	303	52205-66	304	52224-02B3	225	52255-05B4	225	52255-10B4	227
52205-100	293	52205-66L	304	52224-02B4	225	52255-05C1	248	52255-10C1	250
52205-100M	293	52205-67	304	52236-01B1	225	52255-06B1	226	52255-116C1	251
52205-100S	293	52205-68	304	52236-01B10	225	52255-06B10	226	52255-119B1	228
52205-100T	293	52205-72	304	52236-01B17	225	52255-06B17	226	52255-119C1	252
52205-101	293	52205-72L	304	52236-01B18	225	52255-06B18	226	52255-11B1	227
52205-102	293	52205-73	304	52236-01B3	225	52255-06B3	226	52255-11B10	227
52205-103	293	52205-74	304	52236-01B4	225	52255-06B4	226	52255-11B17	227
52205-104	293	52205-74L	304	52236-02B1	225	52255-07B1	226	52255-11B18	227
52205-120	301	52205-74S	304	52236-02B10	225	52255-07B10	226	52255-11B3	227
52205-121	301	52205-74T	304	52236-02B17	225	52255-07B17	226	52255-11B4	227
52205-122	301	52205-77	304	52236-02B18	225	52255-07B18	226	52255-11C1	250
52205-123	301	52205-77L	304	52236-02B3	225	52255-07B3	226	52255-122B1	239
52205-124	301	52205-78	303	52236-02B4	225	52255-07B4	226	52255-122C1	262
52205-125	301	52205-84	304	52255-01B1	225	52255-07C1	249	52255-126B1	232
52205-200	293	52205-85F	294	52255-01B10	225	52255-08B10	227	52255-126C1	255
52205-200M	293	52205-85M	294	52255-01B17	225	52255-08B17	227	52255-129B1	239
52205-200S	293	52205-85S	294	52255-01B18	225	52255-08B18	227	52255-129C1	262
52205-200T	293	52205-90	301	52255-01B3	225	52255-08B3	227	52255-12B1	227
52205-26	304	52205-91	294	52255-01B4	225	52255-08B4	227	52255-12C1	250
52205-27	304	52205-92	300	52255-01C1	248	52255-08C1	250	52255-134B1	234
52205-28L	304	52205-93	300	52255-02B1	225	52255-09B1	227	52255-134C1	257
52205-29	287	52205-94	307	52255-02B10	225	52255-09B10	227	52255-135B1	234
52205-30	306	52205-95	307	52255-02B17	225	52255-09B17	227	52255-135C1	257
52205-31	287	52205-96F	294	52255-02B18	225	52255-09B18	227	52255-136B1	234



52255-136C1	257	52255-226B1	232	52255-41B1	235	52255-59C1	249	52500-01	308
52255-139B1	235	52255-226C1	255	52255-41C1	258	52255-60B1	240	52500-02	308
52255-139C1	258	52255-22B1	230	52255-426A1	232	52255-60C1	263	52500-03	308
52255-13B1	228	52255-22C1	253	52255-426C1	255	52255-61B1	240	52500-10	308
52255-13C1	251	52255-23B1	230	52255-42B1	235	52255-61C1	263	52500-11	308
52255-144C1	261	52255-23C1	253	52255-43B1	236	52255-62B1	240	52500-16	307
52255-145B1	238	52255-245B1	236	52255-43C1	259	52255-62C1	263	52500-25	306
52255-145C1	259	52255-24B1	231	52255-44B1	236	52255-63B1	240	52500-26	306
52255-149B1	231	52255-24C1	254	52255-44C1	259	52255-63C1	263	52500-30	306
52255-149C1	254	52255-25B1	231	52255-45B1	236	52255-64B1	240	52500-31	306
52255-14B1	228	52255-25C1	254	52255-45C1	259	52255-64C1	263	52502-01B	275
52255-14C1	251	52255-265B1	241	52255-46B1	231	52255-65B1	240	52502-02B	275
52255-156B1	238	52255-265C1	264	52255-46C1	254	52255-65C1	263	52502-03B	275
52255-156C1	261	52255-26B1	231	52255-47B1	236	52255-67B1	241	52502-04B	275
52255-159B1	230	52255-26C1	254	52255-47C1	259	52255-67C1	264	52502-05B	275
52255-159C1	253	52255-27B1	232	52255-48B1	237	52255-68B1	243	52502-06B	275
52255-15B1	228	52255-27C1	255	52255-48C1	260	52255-68C1	266	52502-07B	275
52255-15C1	251	52255-28B1	232	52255-49B1	237	52255-69B1	242	52502-08B	275
52255-160B1	231	52255-28C1	255	52255-49C1	260	52255-69C1	265	52502-09B	275
52255-160C1	253	52255-29B1	233	52255-51B1	237	52255-70B1	243	52502-10B	275
52255-165B1	241	52255-29C1	256	52255-51C1	260	52255-70C1	266	52502-11B	275
52255-165C1	264	52255-305B1	243	52255-52B1	225	52255-71B1	243	52502-12B	275
52255-166B1	241	52255-305C1	266	52255-52B17	225	52255-71C1	266	52502-13B	275
52255-166C1	264	52255-30B1	233	52255-52B18	225	52255-72B1	243	52502-14B	275
52255-16B1	228	52255-30C1	256	52255-52B3	225	52255-72C1	266	52502-15B	275
52255-16C1	251	52255-31B1	233	52255-52B4	225	52255-73B1	243	52502-16B	275
52255-17B1	228	52255-31C1	256	52255-53B1	227	52255-73C1	266	52502-17B	275
52255-17C1	251	52255-326B1	232	52255-53B10	227	52255-76B1	241	52502-18B	275
52255-18B1	229	52255-326C1	255	52255-53B17	227	52255-76C1	264	52502-19B	276
52255-18C1	252	52255-32B1	233	52255-53B18	227	52255-77B1	241	52502-20B	276
52255-19B1	229	52255-32C1	256	52255-53B3	227	52255-77C1	264	52502-21	277
52255-19C1	252	52255-33B1	233	52255-53B4	227	52255-78B1	242	52502-22	277
52255-206B1	226	52255-33C1	256	52255-53C1	250	52255-78C1	265	52502-23	277
52255-206B10	226	52255-34B1	234	52255-54B1	237	52255-79B1	242	52502-24	277
52255-206B17	226	52255-34C1	257	52255-54C1	260	52255-90B1	237	52502-25	277
52255-206B18	226	52255-35B1	234	52255-56B1	237	52255-90C1	260	52502-31B	276
52255-206B3	226	52255-35C1	257	52255-56C1	260	52255-91B1	238	52502-32B	276
52255-206B4	226	52255-36B1	233	52255-57B1	230	52255-91C1	261	52502-33B	276
52255-206C1	249	52255-36C1	256	52255-57C1	253	52255-94B1	236	52502-50	277
52255-20B1	229	52255-37B1	234	52255-58B1	230	52255-94C1	259	52502-51	277
52255-20C1	252	52255-37C1	257	52255-58C1	253	52420-00	290	52502-52	277
52255-216B1	239	52255-38B1	235	52255-59B1	226	52430-00	290	52502-53	277
52255-216C1	262	52255-38C1	258	52255-59B10	226	52440-00	290	52502-54	277
52255-219B1	229	52255-39B1	235	52255-59B17	226	52450-00	290	52502-55	277
52255-219C1	252	52255-39C1	258	52255-59B18	226	52460-00	290	52502-56	277
52255-21B1	229	52255-40B1	235	52255-59B3	226	52470-00	290	52502-57	277
52255-21C1	252	52255-40C1	258	52255-59B4	226	52500-00	308	52505-15	292



52505-18	284	52515-39	292	52605-17B	268	52732-443	311	552-020	48
52505-22	308	52525-21	291	52605-18B	269	52732-446	311	552-021	48
52505-32	284	52525-21B4	291	52605-19B	269	52732-500	311	552-880	71
52505-33	284	52550-05	291	52605-20B	269	52745-407	310	552-881	71
52505-34	284	52550-06	291	52605-219B	269	52745-437	310	552-882	71
52505-40	292	52550-07	291	52605-21B	269	52745-441	311	552-883	71
52505-45	279	52555-40-01	223	52605-226B	271	52745-442	311	557-027	354, 394
52505-46	279	52555-40-02	223	52605-22B	269	52745-443	311	558-049	150
52505-47	279	52555-40-03	224	52605-23B	270	52745-444	311	558-050	150
52505-48	291	52555-40-04	224	52605-24B	270	52745-445	311	558-051	150
52505-50	292	52555-40-05	223	52605-26B	271	52803-01	284	558-052	150
52505-51	292	52555-40-06	223	52605-27B	271	52803-02	284	558-053	150
52505-52	283	52555-40-07	223	52605-29B	271	52805-01	284	558-058	21
52505-53	283	52555-40-08	223	52605-30B	271	52805-02	284	558-059	21
52505-54	283	52555-40-09	223	52605-326B	271	52810-01	284	558-060	21
52505-55	283	52555-40-10	223	52605-32B	272	52810-02	284	558-061	21
52505-61-01	281	52555-40-11	224	52605-33B	272	52850-81	304	558-062	21
52505-61-01C	281	52555-40-12	224	52605-34B	272	52850-82	304	558-086	20
52505-61-02	281	52555-40-13	224	52605-35B	272	52850-83	304	558-087	20
52505-61-02C	281	52555-40-14	223	52605-36B	272	52850-84	304	558-088	20
52505-61-03	281	52555-40-15	224	52605-38B	273	52850-85	304	558-091	21
52505-61-04	281	52555-40-16	224	52605-39B	273	52850-86	304	558-092	21
52505-61-05	281	52555-40-17	223	52605-40B	273	52850-87	304	558-093	21
52505-61-05C	281	52555-40-18	223	52605-41B	273	52850-88	304	558-094	21
52505-61-06	281	52555-40-23	223	52605-42B	273	529-010	407	558-095	21
52505-61-06C	281	52555-40-24	223	52605-45B	273	53020-322I	298	558-910	41
52505-61-07	281	52-5685	312	52605-46B	270	531-314	62	558-915	41
52505-61-07C	281	52-5686	312	52605-48B	274	544-009	95	558-920	41
52505-61-08	281	52-5687	312	52605-49B	274	550-171	354, 394	559-041	41
52505-61-08C	281	52605-02B	268	52605-57B	269	55020-060I	299	559-042	41
52505-61-09	281	52605-03B	268	52605-58B	270	55040-02	289	559-055	41
52505-66	279	52605-05B	268	52605-94B	274	55040-03	289	559-056	41
52505-67	279	52605-105B	268	52620-407	310	551-012	18	559-057	41
52505-70P	280	52605-116B	268	52630-437	310	551-014	18	559-060	41
52505-71P	280	52605-119B	269	52632-407	310	551-032	28	559-065	41
52505-72P	280	52605-123B	270	52632-437	310	551-033	28	559-080	41
52505-73P	280	52605-126B	271	52632-493	310	551-034	28	559-082	41
52505-74P	280	52605-129B	271	52720-407	310	552-003	48	559-083	41
52505-98	283	52605-134B	272	52720-437	310	552-004	48	559-084	41
52505-99	283	52605-135B	272	52728-403	309	552-005	48	559-085	41
52510-00	300	52605-139B	273	52728-405	309	552-006	48	570-001	436
52510-15	292	52605-145B	273	52728-406	309	552-007	48	570-002	436
52511-86	291	52605-149B	270	52728-409	309	552-008	48	570-003	436
52515-15	292	52605-159B	270	52730-407	310	552-009	48	570-004	436
52515-21	291	52605-15B	268	52730-437	310	552-010	48	570-392	374
52515-21B4	291	52605-160B	270	52732-441	311	552-018	48	570-393	374
52515-30B4	291	52605-16B	268	52732-442	311	552-019	48	570-394	374



570-395	374	570-993BD	377	572-224	382	572-911CW	375	575-410	413
570-396	374	570-994BD	377	572-230	382	572-912	379	575-412	413
570-581-BD	375	570-995BD	377	572-234	382	572-913	379	575-497	413
570-582-BD	375	570-996BD	377	572-240	382	572-914	379	575-498	413
570-583-BD	375	571-025	378	572-244	382	572-915	379	575-499	413
570-584-BD	375	571-035	378	572-250	382	572-917	379	575-505	406
570-585-BD	375	571-100	377	572-254	382	572-918	379	575-507	406
570-586-BD	375	571-102	377	572-264	382	572-919	379	575-509	406
570-692	374	571-104	377	572-270	382	572-920	379	575-517	406
570-693	374	571-122	376	572-273	382	572-921	379	575-580	405
570-694	374	571-123	376	572-274	382	572-951	416	575-584	405
570-695	374	571-124	376	572-275	382	572-952	416	575-585	405
570-696	374	571-125	376	572-284	382	572-961	416	575-613	420, 421
570-721-BD	374	571-320	382	572-290	382	572-962	416	575-619	420, 421
570-721CW	375	571-330	382	572-293	382	572-971	416	575-646	427
570-722-BD	374	571-340	382	572-294	382	572-972	416	575-647	427
570-722CW	375	571-350	382	572-296	380	573-515	94	575-648	427
570-723-BD	374	571-812	376	572-297	382	573-516	94	575-649	427
570-723CW	375	571-813	376	572-298	382	573-651	436	575-650	427
570-724-BD	374	571-814	376	572-299	382	573-652	437	575-650-65	427
570-724CW	375	572-002	381	572-432	379	573-653	437	575-650-75	427
570-725-BD	374	572-012	381	572-433	379	573-654	437	575-650A	355
570-725CW	375	572-022	381	572-434	379	573-655	437	575-652	427
570-726-BD	374	572-030	381	572-516	29	574-701	402	575-654	427
570-761-BD	374	572-032	381	572-851	416	574-702	402	575-655	427
570-761CW	375	572-033	381	572-852	416	574-703	402	575-656	427
570-762-BD	374	572-035	381	572-861	416	574-711	402	575-657	427
570-762CW	375	572-036	381	572-862	416	574-712	402	575-657-75	427
570-763-BD	374	572-037	381	572-871	416	574-713	402	575-657F	427, 428
570-763CW	375	572-038	381	572-872	416	575-008	408	575-657F	427
570-764-BD	374	572-040	381	572-901	379	575-009	408	575-658	427
570-764CW	375	572-042	381	572-901CW	375	575-010	408	575-690	427
570-765-BD	374	572-052	381	572-902	379	575-011	408	575-694R	404
570-765CW	375	572-060	381	572-902CW	375	575-060	411	575-695	404
570-766-BD	374	572-062	381	572-903	379	575-101	403	575-703	420, 422
570-891-BD	374	572-063	381	572-903CW	375	575-105	403	575-704	420, 422
570-891CW	375	572-065	381	572-904	379	575-106	404	575-705	420, 422
570-892-BD	374	572-072	381	572-905	379	575-107	404	575-706	420, 422
570-892CW	375	572-082	381	572-905CW	375	575-108	404	575-720	419
570-893-BD	374	572-090	380	572-906	379	575-109	404	575-721	418, 419
570-893CW	375	572-091	380	572-906CW	375	575-111	404	575-722	408, 420
570-894-BD	374	572-092	380	572-907	379	575-199	355	575-723	408, 420
570-894CW	375	572-094	380	572-908	379	575-241	395	575-726	419
570-895CW	375	572-098	381	572-909CW	375	575-243	395	575-727	419
570-896-BD	374	572-204	382	572-909	379	575-246	395	575-728	419
570-991BD	377	572-214	382	572-909CW	375	575-248	395	575-729	419
570-992BD	377	572-220	382	572-910CW	375	575-407	413	575-730	419



575-731	419	581-525	21	586-051T	410	595-935	21	601-128	186
575-732	419	581-526	21	586-070T	410	600-010	180	601-130	189
575-733	419	581-527	21	586-071T	410	600-510	78	601-131	189
575-734	419	581-528	21	586-072T	410	600-511	78	601-146	187
575-735	419	581-532	47	586-073T	410	600-511NC	78	601-147	187
575-736	419	581-533	47	586-074T	410	600-512	78	601-148	188
575-737	419	581-534	47	586-180	173, 410	600-512NC	78	601-149	188
575-738	419	581-544	430	586-200	373	600-513	78	601-150	188
575-739	419	581-928	20	586-230	373	600-513NC	78	601-151	189
575-740	419	581-929	20	588-626	397	600-514	78	601-154	188
575-741	419	582-180	373	588-627	397	600-518	78	601-155	188
575-742	419	582-200	373	588-628	397	600-595	82	601-156	188
575-743	419	582-230	373	588-629	397	601-000	179	601-157	188
575-744	419	583-180	373	588-630	397	601-007	179	601-158	188
575-745	419	583-200	373	588-631	397	601-030	189	601-159	188
575-746	419	583-230	373	588-632	397	601-032	190	601-175	191
575-747	419	584-180	373	588-633	397	601-045	181	601-179	192
575-748	419	584-200	373	588-634	397	601-046	181	601-180	190
575-749	419	584-230	373	588-635	397	601-047	181	601-185	191
575-750	419	584-645	430	588-636	397	601-066	182	601-186	191
575-751	419	584-650	430	588-637	397	601-067	183	601-187	191
575-752	419	584-652	430	588-638	397	601-068	183	601-188	192
575-753	419	584-654	430	588-639	397	601-069	183	601-189	193
575-754	419	584-656	430	588-640	397	601-070	185	601-192	191
575-755	419	584-658	430	588-641	397	601-071	183	601-193	191
575-757	408, 420	585-000	412	588-642	397	601-073	184	601-195	193
575-758	420	585-180	373	588-643	397	601-074	184	601-196	193
575-759	408, 420	585-200	373	588-644	397	601-076	183	601-197	193
575-761	411, 420	585-230	373	588-645	397	601-077	184	601-198	192
575-764	420, 421	585-936	431	591-620	21	601-085	190	601-199	192
575-765	420, 421	585-937	431	591-621	21	601-086	190	601-200	192
575-766	420, 421	585-938	431	592-030	21	601-087	190	601-201	192
575-767	420, 421	585-939	431	592-031	21	601-088	190	601-203	193
575-768	420, 421	586-000	410	592-033	21	601-089	180	601-204	193
575-800	418	586-001T	409	592-034	21	601-090	181	601-208	193
575-800x	418	586-002T	409	592-200	373	601-091	181	601-209	193
575-974	408	586-003T	409	593-200	373	601-092	181	601-210	194
575-976	408	586-010T	409	594-200	373	601-099	182	601-211	194
575-978	408	586-011T	409	595-200	373	601-105	182	601-212	195
578-501	62	586-020T	409	592-320	431	601-106	182	601-215	194
578-505	62	586-021T	409	592-321	431	601-108	200	601-217	194
579-004	411	586-022T	409	592-322	21	601-109	183	601-225	195
579-006	411	586-030T	409	592-330	21, 431	601-117	184	601-226	195
581-180	373	586-031T	409	592-331	431	601-118	185	601-227	195
581-200	373	586-032T	409	592-350	431	601-125	202	601-229	196
581-230	373	586-040T	409	595-933	21	601-126	185	601-230	196
581-524	21	586-050T	410	595-934	21	601-127	185	601-231	196



601-234	196	601-363	203	601-471	168	601-596	160	601-716	172
601-235	196	601-366	204	601-472	167	601-598	158	601-717	172
601-236	196	601-367	204	601-477	168	601-602	159	601-718	173
601-255	192	601-369	203	601-490	165	601-603	159	601-719	173
601-257	191	601-371	197	601-491	166	601-605	159	601-727	171
601-275	185	601-387	195	601-492	166	601-606	159	601-728	171
601-276	186	601-388	195	601-496	167	601-608	156	601-732	170
601-277	186	601-389	203	601-499	167	601-609	156	601-733	171
601-280	186	601-390	203	601-509	167	601-611	160	601-734	171
601-281	187	601-396	205	601-510	168	601-612	160	601-735	170
601-285	187	601-397	205	601-511	168	601-618	159	601-739	172
601-294	186	601-404	205	601-515	168	601-619	159	601-742	172
601-295	186	601-405	205	601-516	168	601-620	157	601-749	147
601-296	187	601-406	205	601-517	168	601-627	157	601-750	147
601-297	196	601-407	205	601-518	168	601-628	157	601-751	147
601-298	196	601-408	204	601-522	46, 155	601-629	156	601-752	148
601-299	196	601-410	206	601-523	46, 155	601-630	157	601-753	148
601-300	197	601-411	206	601-524	46, 155	601-631	156	601-754	147
601-301	197	601-412	206	601-525	156	601-632	156	601-755	147
601-302	197	601-413	205	601-528	169	601-633	156	601-756	148
601-303	197	601-416	205	601-529	42, 169	601-634	156	601-759	148
601-306	197	601-421	211	601-530	169	601-637	156	601-760	148
601-307	198	601-422	211	601-531	46, 169	601-641	155	601-761	149
601-309	197	601-423	211	601-532	46, 169	601-647	162	601-762	149
601-310	198	601-424	211	601-533	46	601-650	155	601-763	149
601-310A	198	601-425	211	601-533L	46	601-651	170	601-764	149
601-311	198	601-427	211	601-534	163	601-652	170	601-768	148
601-313	199	601-428	212	601-535	163	601-653	157	601-769	148
601-314	199	601-429	212	601-540	163	601-654	157	601-770	148
601-316	199	601-430	212	601-541	164	601-664	168	601-773	149
601-317	199	601-434	212	601-544	164	601-665	168	601-774	149
601-318	199	601-435	212	601-546	164	601-668	169	601-776	149
601-319	200	601-436	212	601-547	165	601-669	169	601-779	149
601-321	201	601-437	212	601-548	165	601-670	169	601-780	150
601-324	200	601-438	211	601-553	166	601-673	163	601-781	150
601-326	201	601-439	212	601-557	157	601-674	163	601-782	150
601-327	201	601-441	212	601-572	164	601-675	160	601-783	150
601-333	198	601-443	213	601-573	164	601-677	160	601-786	151
601-339	202	601-453	157	601-575	164	601-678	160	601-787	151
601-340	202	601-459	158	601-577	161	601-680	161	601-790	150
601-343	201	601-460	158	601-578	162	601-681	161	601-791	150
601-344	202	601-461	158	601-579	162	601-696	161	601-792	151
601-345	202	601-462	158	601-580	163	601-699	162	601-793	151
601-346	202	601-463	158	601-581	165	601-702	161	601-794	151
601-348	202	601-467	159	601-583	165	601-712	173	601-795	151
601-361	203	601-469	158	601-588	166	601-714	171	601-796	152
601-362	203	601-470	158	601-592	160	601-715	172	601-797	152



601-798	152	601-899	175	601-974	209	603-011	210	604-751	46
601-799	151	601-900	175	601-976	214	603-012	210	604-753	46
601-800	154	601-901	175	601-977	214	603-013	210	604-755	46
601-801	153	601-902	175	601-978	214	603-014	210	604-759	46
601-808	29, 154	601-903	71, 175	601-979	214	603-015	210	604-765	46
601-809	154	601-904	71, 175	601-980	214	603-016	210	604-991	200
601-813	32	601-905	71, 175	601-981	214	603-017	210	605-008	204
601-817	153	601-906	71, 175	601-982	214	603-018	210	605-150	173
601-821	153	601-909	71, 176	601-983	214	603-019	210	605-151	173
601-822	154	601-910	71, 176	601-984	214	603-020	210	605-300	174
601-827	22	601-917	71, 176	601-985	214	603-021	210	605-301	174
601-828	22	601-918	176	601-986	214	603-022	210	605-302	174
601-831	153	601-919	176	601-989	215	603-023	214	605-315	174
601-832	152	601-920	176	601-990	216	604-000	217	605-320	174
601-833	152	601-921	71, 176	601-991	215	604-060	216	605-325	174
601-834	30, 152	601-922	177	601-993	214	604-065	216	605-326	175
601-835	30, 152	601-923	176	601-994	214	604-067	216	605-400	173
601-836	152	601-924	177	601-995	214	604-070	216	605-402	173
601-839	152	601-925	177	601-996	215	604-075	216	605-404	173
601-842	30, 153	601-927	188	602-000	210	604-077	216	605-485	46
601-847	145	601-930	218	602-001	210	604-080	216	605-486	46
601-848	145	601-931	219	602-002	210	604-082	216	605-501	45
601-850	28	601-932	219	602-009	211	604-085	216	605-502	45, 180
601-852	29	601-934	219	602-010	210	604-090	216	605-503	45, 180
601-853	32	601-937	206	602-012	210	604-095	216	605-504	180
601-854	29	601-938	206	602-014	216	604-160	216	605-505	180
601-865	146	601-941	206	602-026	180	604-165	216	605-509	179
601-866	146	601-942	206	602-027	180	604-167	216	605-510	179
601-868	31	601-943	204	602-100	215	604-170	216	605-511	179
601-874	176	601-946	207	602-110	215	604-172	216	605-512	179
601-875	176	601-947	207	602-111	215	604-175	216	605-530	174
601-876	176	601-948	207	602-112	215	604-177	216	605-709	50
601-877	176	601-949	208	602-113	215	604-180	216	605-725	50
601-879	176	601-950	208	602-114	215	604-182	216	606-031	213
601-883	177	601-951	208	602-202	72	604-185	216	606-033	213
601-885	177	601-953	209	602-203	72	604-190	216	607-000	218
601-886	177	601-954	209	602-801	178	604-195	216	607-001	218
601-887	177	601-957	206	602-802	178	604-260	217	607-002	218
601-888	177	601-958	206	602-803	178	604-261	47	607-003	218
601-890	178	601-959	206	602-804	178	604-263	47	607-004	218
601-891	178	601-961	208	602-900	178	604-264	47	607-005	218
601-892	178	601-966	207	602-905	178	604-265	217	607-006	218
601-893	178	601-968	207	603-002	179	604-270	217	607-007	218
601-894	178	601-969	207	603-003	179	604-275	217	607-008	218
601-895	178	601-970	208	603-004	179	604-285	217	607-009	218
601-896	175	601-971	209	603-005	179	604-407	47	607-010	218
601-897	175	601-972	209	603-006	213	604-410	47	607-011	218



607-012	218	610-514	91	611-056	98	621-313	119	631-275	121
607-013	218	610-604	81	611-057	98	621-401	119	631-280	121
607-014	218	610-704	111	611-058	98	621-402	119	634-016	83
607-051	217	610-705	111	611-059	98	621-403	119	634-017	83
607-052	217	610-706	111	611-060	98	621-611	118	634-018	83
607-086	218	610-707	111	611-061	98	621-651	119	634-019	83
608-036	217	610-708	111	611-062	98	621-652	199	634-020	83
608-037	217	610-710	111	611-063	98	622-148	97	635-010	110
608-038	217	610-931	118	611-064	98	622-210	98	636-241	116
610-108	44	610-932	118	611-065	98	622-215	98	636-242	116
610-109	44	610-933	118	614-122	113	622-220	98	636-243	116
610-111	115	610-934	118	614-122E	113	622-230	98	636-244	116
610-116	115	610-935	118	620-130	117	622-231	98	636-265	115
610-117	115	610-936	118	620-136	117	622-540	108	636-265E	115
610-125	114	610-937	118	620-137	117	623-260	114	636-266	115
610-132	115	610-951	117	620-138	117	624-910	111	636-267	115
610-138	112	610-953	117	620-161	117	626-203	110	636-267E	115
610-142	113	610-954	117	620-166	117	626-204	110	636-268	115
610-143	113	610-955	117	620-167	117	626-205	110	637-566	97
610-146	112	610-956	117	620-168	117	626-206	110	637-570	89
610-147	112	610-957	117	620-169	117	630-050	340	637-655	108
610-150	114	610-958	117	620-705	124	630-060	340	637-705	110
610-152	111	610-959	117	620-709	124	630-070	340	637-706	110
610-154	111	610-960	117	620-710	124	630-302	74	637-707	110
610-155	111	610-961	117	620-711	124	630-303	74	660-111	116
610-156	114	610-964	118	620-712	124	630-304	74	660-901	116
610-157	114	610-965	118	620-713	124	630-503	100	660-902	116
610-160	112	610-966	118	620-714	124	630-504	100	660-903	116
610-160E	113	610-967	118	620-715	124	630-509	101	662-023	106
610-365	122	610-969	118	621-109	118	630-510	101	662-560	105
610-370	122	610-970	118	621-110	118	630-511	101	662-565	105
610-373	122	610-971	118	621-111	118	630-512	101	662-752	107
610-374	122	610-972	118	621-112	118	630-525	99	662-754	107
610-375	123	610-973	118	621-113	118	630-526	99	662-784	107
610-376	96, 122	610-979	118	621-159	119	630-527	99	662-801	107
610-377	120	610-980	118	621-160	119	630-528	99	662-802	107
610-378	120	610-982	118	621-161	119	630-529	99	662-803	107
610-379	120	611-034	98	621-162	119	630-530	99	662-804	107
610-381	121	611-035	98	621-163	119	630-531	99	662-806	107
610-383	122	611-036	98	621-209	118	630-532	99	662-807	107
610-384	122	611-037	98	621-210	118	630-548	99	662-808	107
610-394	96, 122	611-038	98	621-211	118	630-549	99	662-811	107
610-395	119	611-039	98	621-212	118	630-560	100	662-812	107
610-396	120	611-040	98	621-213	118	630-561	100	662-813	107
610-397	121	611-041	98	621-309	119	630-602	123	662-814	107
610-450	121	611-042	98	621-310	119	630-603	123	662-815	107
610-451	121	611-043	98	621-312	119	631-270	121	662-816	107



662-817	107	670-290	116	675-925	101	690-328	136	699-307	141
662-831	107	671-431	143	675-926	99	690-329	136	699-308	141
662-832	107	671-435	143	675-927	99	690-330	136	711-011	129
662-833	107	671-550	95	675-930	103	690-332	137	711-012	129
662-834	107	671-551	95	675-931	103	690-336	137	711-013	129
663-121	107	671-565	96	675-935	100	690-337	137	713-610	128
663-122	107	671-570	90	675-941	100	690-338	137	713-612	128
663-123	107	671-575	90	675-942	100	690-339	137	713-614	128
663-258	108	671-623	96	675-960	101	690-340	137	713-616	128
663-263	108	671-749	96	675-965	102	690-401	138	713-618	128
663-303	108	671-975	123	676-010	104	690-402	138	713-810	129
663-304	108	672-007	85	676-011	104	691-001	138	713-812	129
663-805	109	672-009	84	676-012	104	691-002	138	713-814	129
663-810	109	672-010	83	676-021	104	691-048	142	713-816	129
663-811	110	672-011	75	676-022	104	691-101	138	713-818	129
663-812	110	672-012	75	676-060	99	691-102	138	715-018	128
663-831	109	672-021	75	676-061	99	691-201	138	720-140	127
663-832	109	672-022	75	676-062	99	691-202	138	720-141	127
663-833	109	672-023	84	676-063	99	691-301	138	720-510	126
663-834	109	672-025	76	676-500	105	691-302	138	720-515	126
663-840	109	672-052	76	676-510	105	691-401	138	720-560	126
664-020	24	672-125	84	676-511	105	691-402	138	720-709	127
665-262	89	672-125FO	139	676-512	105	695-101	138	720-713	127
665-302	93	672-134FO	139	676-515	106	695-102	138	720-715	127
665-332	91	672-135	83	676-520	105	695-401	138	720-800	124
665-410	93	672-136	83	678-750	133	695-402	138	720-811	124
665-415	93	672-463	132	678-760	83	695-501	138	720-812	124
665-430	92	672-465	132	678-920	103	695-502	138	720-813	124
665-440	93	675-016	27	678-921	103	695-601	138	720-910	129
665-450	92	675-112	25	680-221	95	695-602	138	720-911	129
665-455	89	675-120	27	680-222	95	695-801	138	720-912	129
665-490	92	675-121	27	680-905	89	695-802	138	720-920	129
665-500	92	675-212	25	680-920	90	695-901	138	720-921	129
670-036	133	675-232	24	685-001	106	695-902	138	720-922	129
670-042	133	675-313	24	685-002	106	697-844	142	721-002	130
670-045	133	675-316	24	688-211	104	697-847	142	721-003	130
670-050	134	675-371	26	688-212	104	698-743	142	721-004	130
670-051	134	675-505	26	690-011	48	698-744	142	721-101	127
670-052	134	675-511	25	690-013	48	698-745	141	721-102	127
670-136	133	675-516	26	690-113	48	698-746	141	721-103	127
670-138	133	675-860	45	690-321	135	698-780	142	722-520	130
670-142	133	675-870	32	690-322	135	698-782	142	724-550	23
670-145	133	675-884	106	690-323	135	698-785	141	724-552	23
670-230	116	675-910	123	690-324	136	698-786	142	7248-38	332
670-235	116	675-911	123	690-325	136	698-805	142	7248-38H	332
670-255	116	675-912	123	690-326	136	698-806	142	7248-40	332
670-275	116	675-920	101	690-327	136	699-306	141	7248-40H	332



7248-50	332	7329-10	425	7403-10	400	7409-06	401	7563-15	399
7248-50H	332	7329-20	425	7403-20	400	7409-10	401	760-003	351
726-179	127	7329-30	425	7403-30	400	7409-20	401	760-004	351
7276-00	429	7329-40	425	7403-40	400	7409-30	401	760-005	351
7276-10	429	7329-47	425	7403-50	400	7409-40	401	760-100	351
7276-15	429	7329-50	425	7403-60	400	7409-50	401	760-374	350
7276-20	429	7329-60	425	7405-01	400	7409-60	401	760-375	350
7276-30	429	7329-62	425	7405-02	400	7418-95	397	760-421	351
7276-35	429	7329-62M	425	7405-03	400	7420-10	396	760-521	351
7276-40	429	7329-62T	426	7405-04	400	7420-20	396	760-903	350
7276-45	429	7329-82	425, 426	7405-05	400	7420-30	396	764-550	347
7276-50	429	7329-84	425, 426	7405-06	400	7420-40	396	771-008	318
7276-60	429	7329-86	425, 426	7405-10	400	7420-50	396	771-010	75
7276-70	429	7329-87	425, 426	7405-20	400	7420-80	396	771-041	321
7276-85	429	7329-90	425	7405-30	400	7420-90	396	771-044	321
7276-90	429	7340-10	405	7405-40	400	7422-10	396	771-050	317
7320-00	423	7346-10	406	7405-50	400	7422-20	396	771-118	318
7320-05	423	734-810	129	7405-60	400	7422-30	396	771-120	317
7320-05M	423	734-812	129	7407-01	401	7422-40	396	771-133	318
7320-10	423	734-814	129	7407-02	401	7422-50	396	771-142	318
7320-10M	423	734-818	129	7407-03	401	7439-10	399	771-165	318
7320-20	423	734-820	129	7407-04	401	7439-12	399	771-167	318
7320-20M	423	734-822	129	7407-05	401	7439-20	399	771-188	319
7320-30	423	734-824	129	7407-06	401	7439-22	399	771-193	320
7320-30M	423	734-826	129	7407-10	401	7439-30	399	771-194I	320
7320-40	423	734-828	129	7407-20	401	7439-32	399	771-212	351
7320-40M	423	736-601	128	7407-30	401	7439-48	395	771-213	351
7320-50	423	736-602	128	7407-40	401	7439-50	395	771-214	351
7320-50M	423	736-603	128	7407-50	401	7551-10	393	771-215	351
7321-00	424	736-604	128	7407-60	401	7551-15	393	771-216	351
7321-10	423, 424	737-233	62	7408-01	401	7551-20	393	771-217	351
7321-20	423, 424	7375-40	378	7408-02	401	7551-25	393	771-319	345
7321-30	423, 424	7375-41	378	7408-03	401	7551-30	393	771-420	344
7321-40	423, 424	7375-42	378	7408-04	401	7551-50	393	771-610	316, 345
7321-85	423	7375-43	378	7408-05	401	7551-55	393	771-613	345
7322-34/70	423	7375-44	378	7408-06	401	7551-60	393	771-620	316
7322-34/70M	423	7376-40	378	7408-10	401	7551-65	393	771-623	344
7324-34/70	423	7376-41	378	7408-20	401	7551-70	393	771-820	345
7324-34/70M	423	7376-42	378	7408-30	401	7561-07	399	772-020	395
7326-40/55	423	7376-43	378	7408-40	401	7561-09	399	774-210	319
7326-40/55M	423	7376-44	378	7408-50	401	7561-11	399	774-220	319
7328-40/55	423	7403-01	400	7408-60	401	7561-13	399	775-001	352
7328-40/55M	423	7403-02	400	7409-01	401	7561-15	399	775-002	352
7329-00	425	7403-03	400	7409-02	401	7563-07	399	775-010	319
7329-05	425	7403-04	400	7409-03	401	7563-09	399	775-100	352
7329-06	425	7403-05	400	7409-04	401	7563-11	399	775-200	352
7329-09	425	7403-06	400	7409-05	401	7563-13	399	775-417	353



775-425	353	804-815	4
775-525	319,353	804-819	4
775-535	344	805-012	2, 146
775-625	353	805-013	2, 146
775-725	352	805-014	1
775-825	352	805-015	4
776-110	320	805-017	1
776-210	320	805-023	1
777-210	320	805-025	146
777-220	320	805-114	1
780-500	143	805-115	4
781-098	355	805-117	1
781-099	355	805-123	1
781-520	355	805-125	146
785-009	317	805-313	5
785-011	317	805-316	4
785-013	317	806-714	2
785-015	317	806-716	2
785-017	317	806-718	2
802-010	1, 145	852-001	144
802-011	1, 145	852-002	144
802-095	6	852-010	145
802-096	6	852-011	145
802-180	5	852-013	145
802-185	5	852-015	145
802-612	2	852-600	144
802-712	2	852-601	144
803-016	2	853-000	144
803-214	1	853-005	144
803-218	1	906-004	82
803-305	1, 146		
803-306	1, 146		
803-314	1		
803-318	1		
803-323	1		
804-013	5		
804-112	5		
804-313	6		
804-419	3		
804-438	4		
804-518	3		
804-519	3		
804-538	4		
804-618	3		
804-623	3		
804-718	3		
804-723	3		



Authorized Distributor for
Tontarra Medizintechnik GmbH
Daimlerstrasse 15
D-78573 Wurmlingen
Germany

MEASUREMENT CONVERSION CHARTS

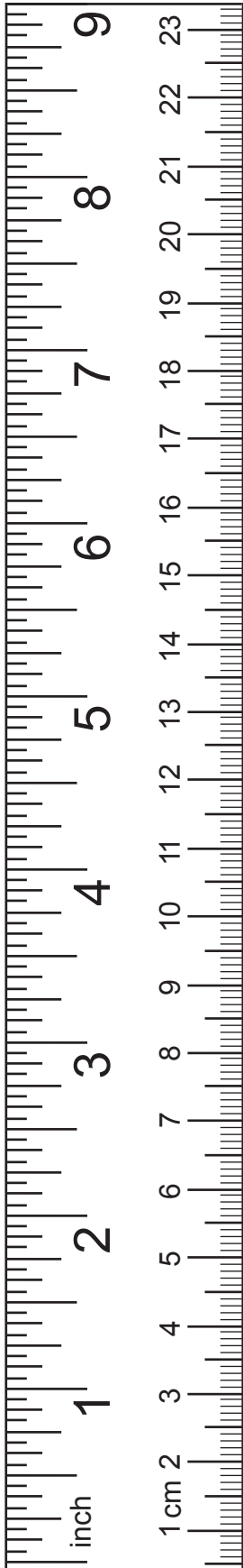

Metric to Metric Conversions

to convert	to	multiply by
millimeters (mm)	centimeters (cm)	0.1
millimeters (mm)	meters (m)	0.001
centimeters (cm)	millimeters (mm)	10
centimeters (cm)	meters (m)	0.01
meters (m)	millimeters (mm)	1.000
meters (m)	centimeters (cm)	100
grams (g)	kilograms (kg)	0.001
Kilograms (kg)	grams (g)	1,000

English to Metric Conversions

to convert	to	multiply by
inches	millimeters (mm)	25.4
inches	centimeters (cm)	2.54
millimeters (mm)	inches	0.0394
centimeters (cm)	inches	0.394
ounces (oz)	grams (g)	28.3
pounds (lbs)	kilograms (kg)	0.454
grams (g)	ounces (oz)	0.035
kilograms (kg)	pounds (lbs)	2.20

Fractions to Millimeters

inch	millimeters
1/16	1.59
1/8	3.18
3/16	4.74
1/4	6.35
5/16	7.94
3/8	9.53
7/16	11.11
1/2	12.70
9/16	14.29
5/8	15.88
11/16	17.46
3/4	19.05
13/16	20.64
7/8	22.23
15/16	23.81
1	25.40

French Scale fr/mm

3	4	5	6	7	8	9
•	•	•	•	•	•	•
1mm			2mm			3mm
10	11	12	13	14	15	
•	•	•	•	•	•	
		4mm				5mm
16	17	18	19	20	22	24
•	•	•	•	•	•	•
		6mm				8mm
26	28	30	32	34		
•	•	•	•	•		
		10mm				

French Scale fr/mm

inch	millimeters
3 fr	1.0mm
4 fr	1.3mm
5 fr	1.7mm
6 fr	2.0mm
7 fr	2.3mm
8 fr	2.7mm
9 fr	3.0mm
10 fr	3.3mm
11 fr	3.7mm
12 fr	4.0mm
13 fr	4.3mm
14 fr	4.7mm
15 fr	5.0mm
16 fr	5.3mm
17 fr	5.7mm
18 fr	6.0mm
19 fr	6.3mm
20 fr	6.7mm
22 fr	7.3mm
24 fr	8.0mm
26 fr	8.7mm
28 fr	9.3mm
30 fr	10.0mm
32 fr	10.7mm
34 fr	11.3mm



American Surgical Specialties Company
475 Metroplex Dr. Suite 401
Nashville, TN 37211
866-387-7021 (O) 615-997-3388 (F)
www.americansurg.com
sales@americansurg.com