

NEMA Premium
IE3

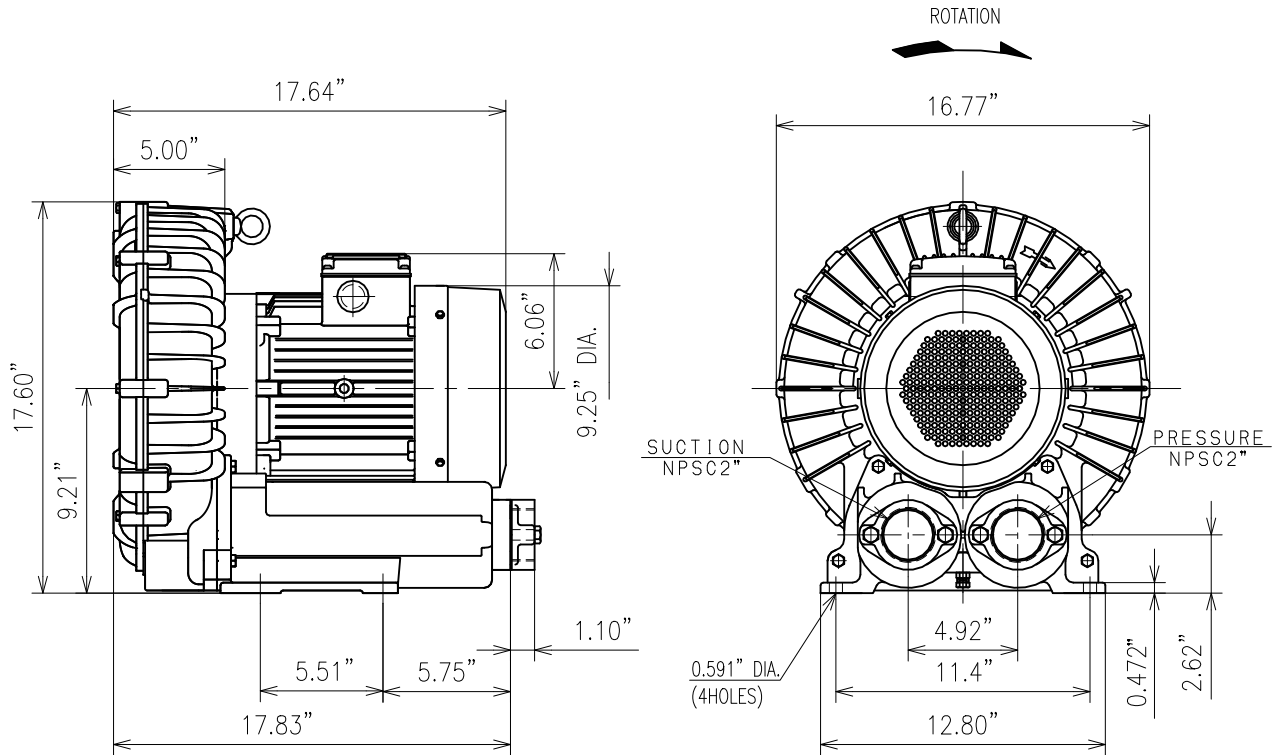

Specifications

Model	VFZ701A-5W
HP	6.7
Hz	60
Phase	3
Voltage	575
Max. Amps	6.5
Locked Rotor Amps	84
Max. Pressure (in. H2O)	130
Max. Vacuum (in. H2O)	99
Max. Airflow Pressure (SCFM)	250
Max. Airflow Vacuum (SCFM)	220
Min. Airflow Pressure (SCFM)	87
Min. Airflow Vacuum (SCFM)	0
Max. Air Temperature Rise (°F)	145
Weight (lbs.)	134

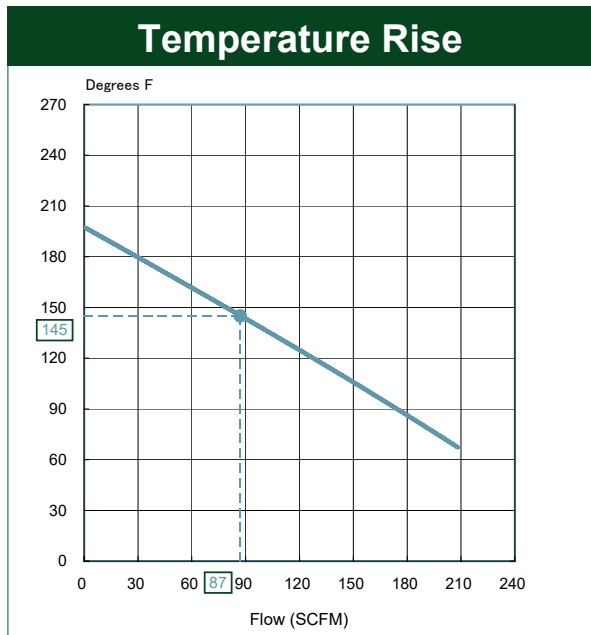
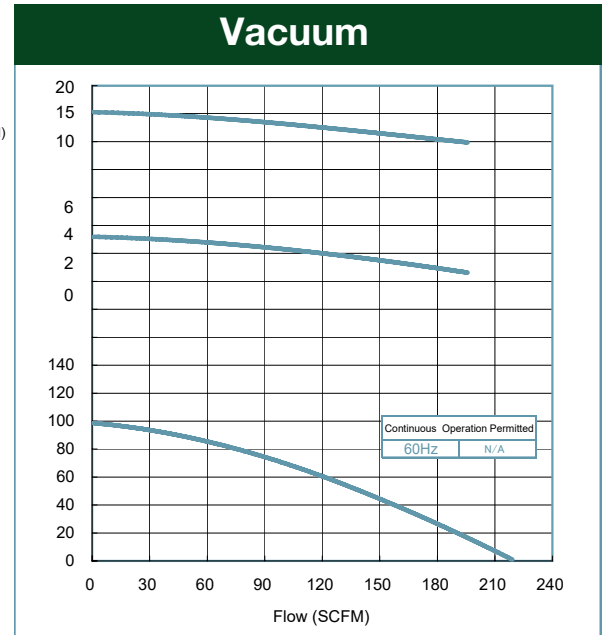
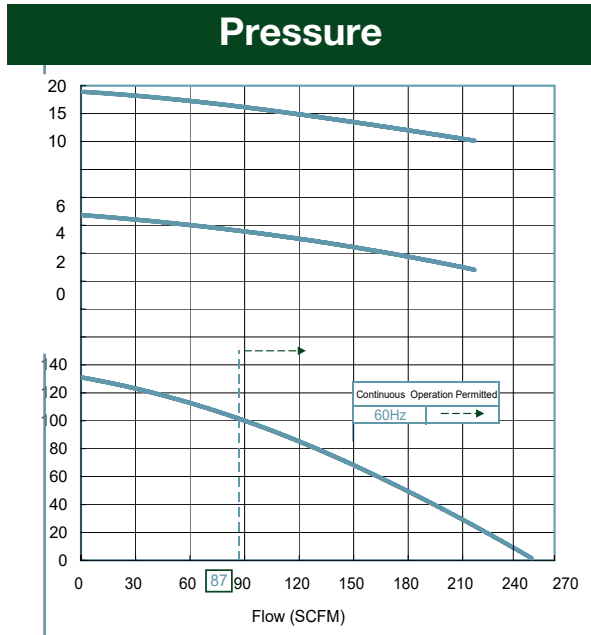

Max. Air Temperature is Value Marked •
 Plus 40 Degrees C Ambient Temperature

Accessories

Inlet Filter	F-67
Inlet Filter/ Silencer	FS-67
In-Line Vacuum Filter	IVF-67
Pressure Relief Valve	PV7
Vacuum Relief Valve	Not Required
Silencer 2"	VFY026A