

UNEX-T Solvent for Cs, Sr and Actinides Separation from PUREX Raffinate – 14154

Igor Smirnov, Khlopin Radium Institute

ABSTRACT

The UNiversal solvent EXtraction (UNEX) process, which was jointly developed at the Khlopin Radium Institute and the Idaho National Laboratory, permits the separation of cesium, strontium, lanthanides and actinides from acidic radioactive wastes in one extraction cycle. The UNEX solvent is comprised of three active components: chlorinated cobalt dicarbollide (CCD), polyethylene glycol and carbamoylphosphine oxide dissolved in a polar diluent. The main disadvantages of UNEX solvent are: co-extraction of lanthanides and the composition change as a result of differences in solubility and hydrolytical stability of their components. 2,6-bis(1-aryl-1H-tetrazol-5-yl)pyridines (ATP) can be used instead of polyethylene glycol and carbamoylphosphine oxide in UNEX solvent. Synergistic extraction mixture of ATP with CCD in a polar diluent (UNEX-T solvent) selectively separates ^{90}Sr , ^{137}Cs and actinides from acidic HLW. Higher stability of ATP in 6 M HNO_3 as compared with carbamoylphosphine oxide was shown. The characteristics of the UNEX-T solvent change slightly after irradiation up to dose 2,4 MGy or 24-hours boiling with 6 M HNO_3 . The extractability of radionuclides in 1 M nitric acid decreases in the range: $\text{Am(III)} \approx \text{Cs} > \text{Pu(III)} > \text{Sr(II)} > \text{Pu(IV)} > \text{Pu(VI)} > \text{Eu(III)} > \text{U(VI)} > \text{Np(V)}$ with separation factors of $\text{Am/Eu} \approx 100$ and $\text{Am/Np} > 2000$. Among the stable HLW components Pb, Pd, Co and Ni coextract remarkably. The principle technological flowsheet for separation of actinides, cesium and strontium from PUREX-process raffinate was developed and tested. The separation factor of americium and the sum of lanthanides on the three-stage countercurrent extraction is about 1000.

INTRODUCTION

Long-lived radionuclides such as ^{90}Sr , ^{137}Cs and TRU are the most hazardous components of HLW. Their selective separations from the waste bulk for subsequent long-term storage, transmutation or final disposal will permit significantly to increase the ecological safety and efficiency of nuclear fuel cycle. The Universal solvent Extraction (UNEX) process, which has been jointly developed at the Khlopin Radium Institute and the Idaho National Laboratory, permits separation and concentration of the hazardous long-lived radionuclides – cesium, strontium, lanthanides and actinides – from acidic radioactive wastes in one extraction cycle [1]. The use of one extraction cycle instead of 2-3 cycles drastically decreases the cost of waste treatment. The UNEX solvent is comprised of three active components: chlorinated cobalt dicarbollide (CCD), polyethylene glycol and carbamoylphosphine oxide dissolved in a polar diluent.

Rais et al. first reported the applicability of cobalt dicarbollide in solvent extraction processes [2]. Cobalt dicarbollide selectively extracts cesium through an uncommon cation-exchange mechanism with dissociation of the solvated species in the organic phase. CCD is simultaneously a strong acid and extremely hydrophobic. This combination of properties enables CCD to extract cesium from acidic media and provides low solubility of CCD in aqueous solutions. Aliphatic and aromatic nitro-compounds, such as nitrobenzene, are the best diluents for CCD. Halogenated derivatives of cobalt dicarbollide, especially chlorinated cobalt dicarbollide, have a high resistance to acid hydrolysis, reductants, and radiation. Therefore, the hexachloro-derivative of cobalt dicarbollide has historically been used in development efforts associated with radioactive waste treatment [2]. The unique extraction properties of CCD/PEG

mixtures allow the separation of Cs and Sr from acidic radioactivity waste. Commercial scale processing of high level waste (HLW) in Russia was initiated after the development of *m*-nitro-trifluoromethyl benzene (F-3), a diluent technically amenable to large-scale use. Approximately 1600 m³ of acidic HLW with total β -activity 54 million Ci commercially processed using the CCD/PEG/F-3 system at the “Mayak” Production Association (Russia) [3].

The UNEX solvent incorporates small quantities (0.03 - 0.1 M) of chlorinated cobalt dicarbollide (Fig. 1), polyethylene glycol with an average molecular weight of 400 g/mol, (PEG-400), and diphenyl-*N,N*-di-*n*-butyl-carbamoylmethylphosphine oxide (CMPO) dissolved in a polar diluent to simultaneously extract the radionuclides from aqueous HNO₃ solutions up to ~2 M HNO₃ and ~4 M total nitrates. UNEX development efforts culminated with the identification of phenyltrifluoromethyl sulfone (C₆H₅SO₂CF₃, designated FS-13) as a suitable, polar diluent for the UNEX process, eliminating the use of nitroaromatic-based diluents. The FS-13 diluent exhibits excellent radiolytic and chemical stability, is relatively innocuous, and provides necessary solubility of CCD, PEG, and CMPO and their respective metal complexes. Finally, the density and viscosity of the organic phase are suitable for solvent extraction. This variant of the UNEX-process was successfully subjected on the model and real HLW to the dynamic test [4]. It was proposed to use as a synergistic additive the diamide derivatives of dipicolinic acid instead of CMPO to increase the capacity of the UNEX solvent [5].

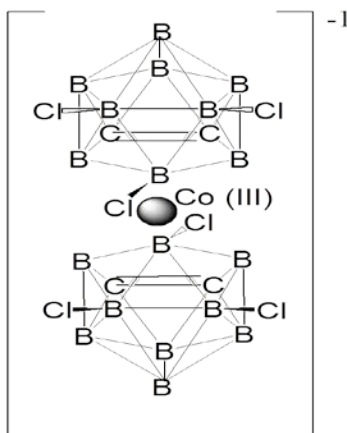

Fig. 1. Structure of the chlorinated cobalt dicarbollide anion (CCD)

The main disadvantages of all variants of UNEX solvents are: co-extraction of lanthanides and the composition change as a result of differences in solubility and hydrolytical stability of their components. The goals of our investigation were to increase stability and selectivity of the UNEX solvent.

It was shown before that bis-tetrazolyl pyridine can be used as a synergistic additive to CCD [6]. Extraction of americium and europium by synergistic mixture of 2,6-bis(1-aryl-1H-tetrazol-5-yl)pyridines (ATP) with chlorinated cobalt dicarbollide (CCD) in polar diluents is possible from high acidic media. At the optimal ratio of ATP:CCD=1:1 the Am/Eu separation factor exceeded 90. This synergistic mixture extracts cesium and strontium from nitric-acidic media. Higher stability of ATPs in 6 M HNO₃ as compared with CMPO was shown. These results let us propose the new UNEX-T solvent on the base of CCD and ATP. Its advantages are: less components (3 instead of 4), high selectivity to transplutonium elements, radiation and hydrolytic resistance.

METHODS

The 2,6-bis(1-(3-methylphenyl)-1H-tetrazol-5-yl) pyridine (MeATP, Fig. 2) used in this work was synthesized in Saint-Petersburg State Technological Institute (Russia) [6].

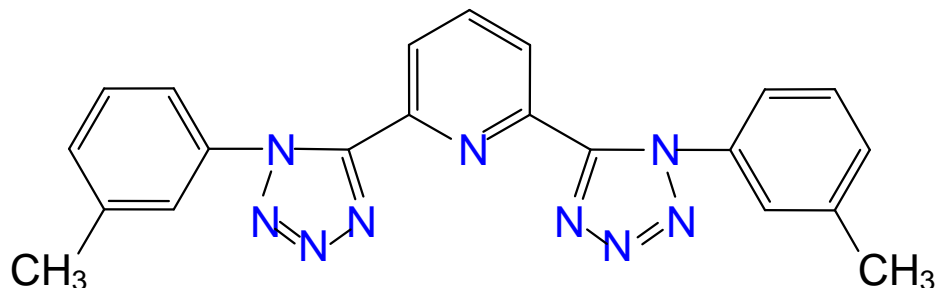

Fig.2. Structure of the 2,6-bis(1-(3-methylphenyl)-1H-tetrazol-5-yl) pyridine (MeATP)

Meta-nitrobenzotrifluoride (F-3, RHODIA, France) was used as diluent without purification. Cesium salt of chlorinated cobalt dicarbollide (CCD, Fig. 1) was produced by “KatChem” Co (Czech Republic). For the preparation of extractant mixtures, a concentrated stock solution of CCD was first prepared by dissolution of the appropriate amount of CsCCD salt in the diluent. This stock solution was then converted to the acidic form of CCD by repeated batch contacts with equal volumes of 6 M HNO₃. This stock solution, nominally at 0.15 – 0.17 M HCCD, was used for UNEX-T solvent preparation. The concentration of CCD in the stock solution was determined by potentiometric titration of HCCD with standard base. Aqueous process solutions were prepared by exact weighing portions of substance.

To determine the distribution ratios of radionuclide, organic and aqueous phases were poured into polyethylene test tube and stirred at 20±2°C for 5 min. As follows from the preliminary test data, this duration was sufficient to establish equilibrium. The phases were separated by centrifugation; then samples of each phase were taken into polyethylene tubes. Radiometric measurements of organic and aqueous phase activity were conducted on Canberra scintillation gamma-spectrometer using a 51×51 mm NaI well detector. Radiometric measurements were performed in duplicate and typical errors were ±15%. Distribution ratios (D) were calculated as: $D = A_{Org}/A_{Aq}$. Distribution ratios were determined using trace amounts of radioactive isotopes of ⁸⁵Sr, ¹³³Ba, ¹³⁷Cs, ¹⁵²Eu, ²³³U, ²³⁷Np, ²³⁹Pu and ²⁴¹Am. Stable metals in aqueous phases were determined by AAS Hitachi Z8000.

DISCUSSION

Actinides and fission product extraction by UNEX-T Solvent (0.02 M MeATP + 0.02 M CCD in F-3) from HNO₃ media was studied. It was found that extractability of radionuclides in 1 M nitric acid decreases in the range: Am(III) ≈ Cs > Pu(III) > Sr(II) > Pu(IV) > Pu(VI) > Eu(III) > U(VI) > Np(V) with separation factors of Am/Eu ≈ 100 and Am/Np(V) > 2000 (Fig. 3, 4).

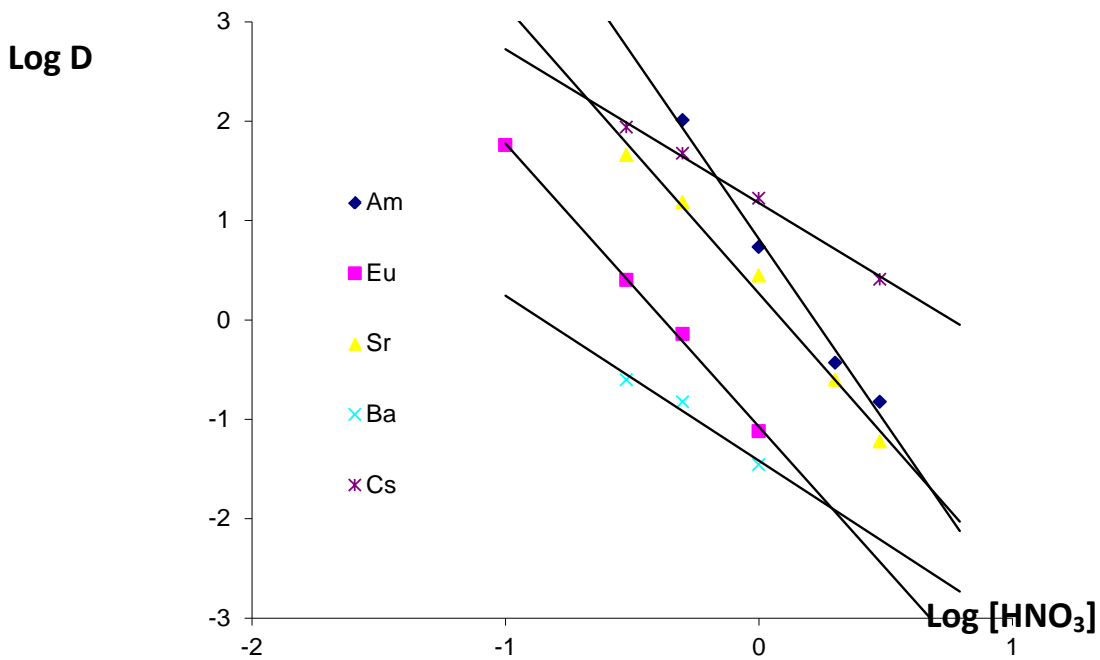

Fig. 3. Extraction of radionuclides by UNEX-T Solvent (0.02 M MeATP – 0.02 M CCD in F-3) from HNO₃.

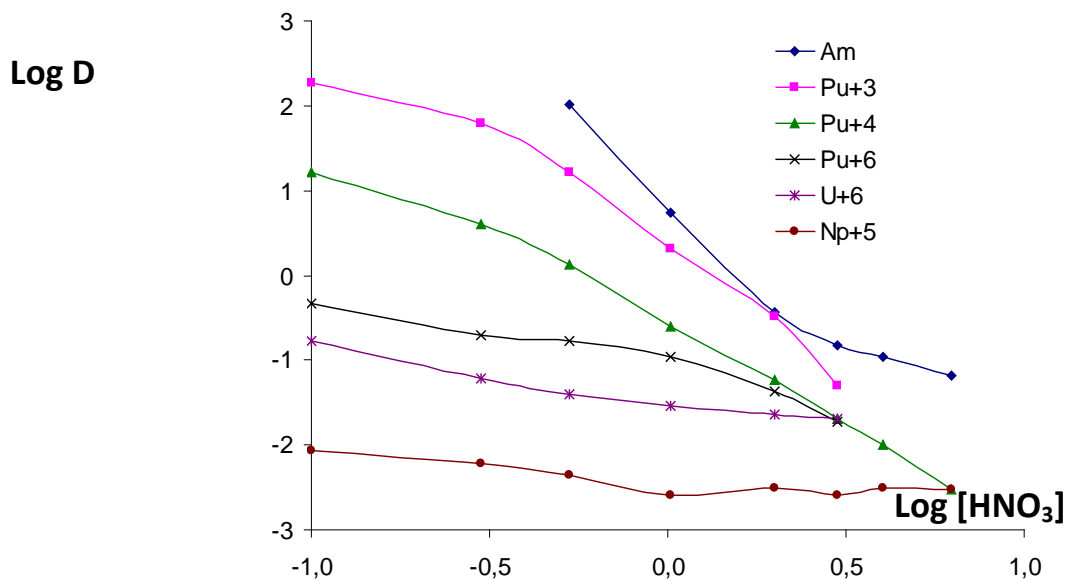

Fig.4. Extraction of actinides by UNEX-T Solvent (0.02 M MeATP – 0.02 M CCD in F-3) from HNO₃.

Among the stable HLW components Pb, Pd, Ni and Co extract remarkably (Fig. 5).

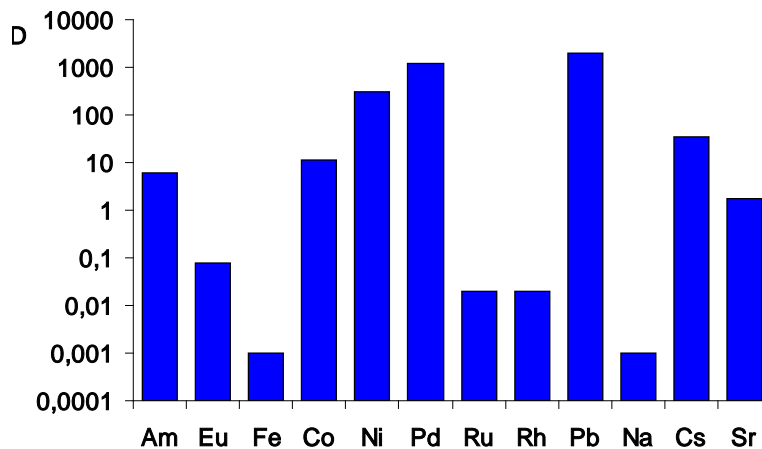

Fig.5. Extraction of radionuclides and stable components of HLW by UNEX-T Solvent (0.02 M MeATP – 0.02 M CCD in F-3) from 1 M HNO₃.

The most difficult task was to choose the conditions of the selective extraction of the transplutonium elements (TPE) without a considerable co-extraction of the rare earth elements (REE) extensively present in HLW. There are 3 options for increasing TPE/REE separation factor: solvent saturation by REE at extraction stages, selective removal of REE at scrubbing stages and selective removal of TPE at stripping stages. All these options were tested.

The UNEX-T Solvent (0.05 M MeATP – 0.05 M CCD in F-3) was used as it provided the high distribution ratios of Am and demonstrated the adequate capacity for radionuclides. The solution simulating the high-level raffinate of PUREX - process arising from reprocessing of MOX fuel with burn-up of 26 GW*d/t was used as simulated HLW (Table 2). The high content of REE is the characteristic feature of this solution.

The flowsheet development

The Am/Eu separation factor begins to increase on attaining the phase volume ratio of Org:Aq=2:1. Further increase of UNEX-T Solvent excess has no influence on selectivity. After three successive contacts of UNEX-T Solvent with fresh simulated HLW the value of Am distribution coefficient is equal to 1.04, which affords the effective extraction process under counter-current conditions.

A series of other metals, including REE, was extracted in combination with americium. To produce purer americium, these metals should be removed by selective stripping. The complexones like citric, oxalic and oxyethylidene diphosphonic acids were unsuccessfully tested as selective stripping agents for REE. In composition of stripping agent some substances which form cationic particles in acidic medium capable of displacing Am and Eu cations from extract into aqueous phase were introduced. Hydrazine, acetamide and carbamide were tested as such cation displacing agents. The application of acetamide or carbamide permits to obtain the distribution coefficients of Am and Eu which are needed for effective separation of them at the stage of selective REE stripping. The solution of 0.3 M carbamide (CO(NH₂)₂) in 0.7 M HNO₃ was chosen as selective stripping agent (Strip agent 1).

As a strip agent for all radionuclides the solution of methyl ammonium carbonate (MAC) with DTPA additions was chosen (Strip agent 2). Inter cycle regeneration of recycled solvent was conducted by 3M HNO₃. As a result of the studies the UNEX-T process flowsheet has been elaborated for removal of americium, cesium and strontium from PUREX raffinate (scheme and relative flowrate are given in Fig. 6).

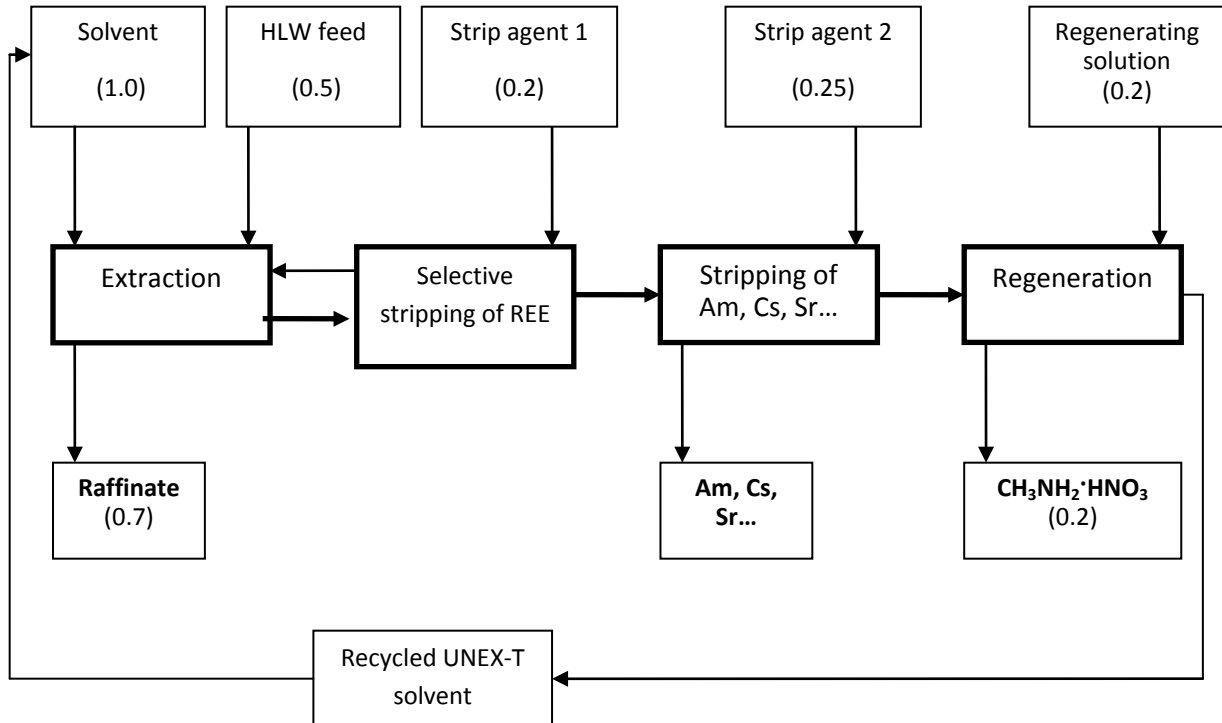
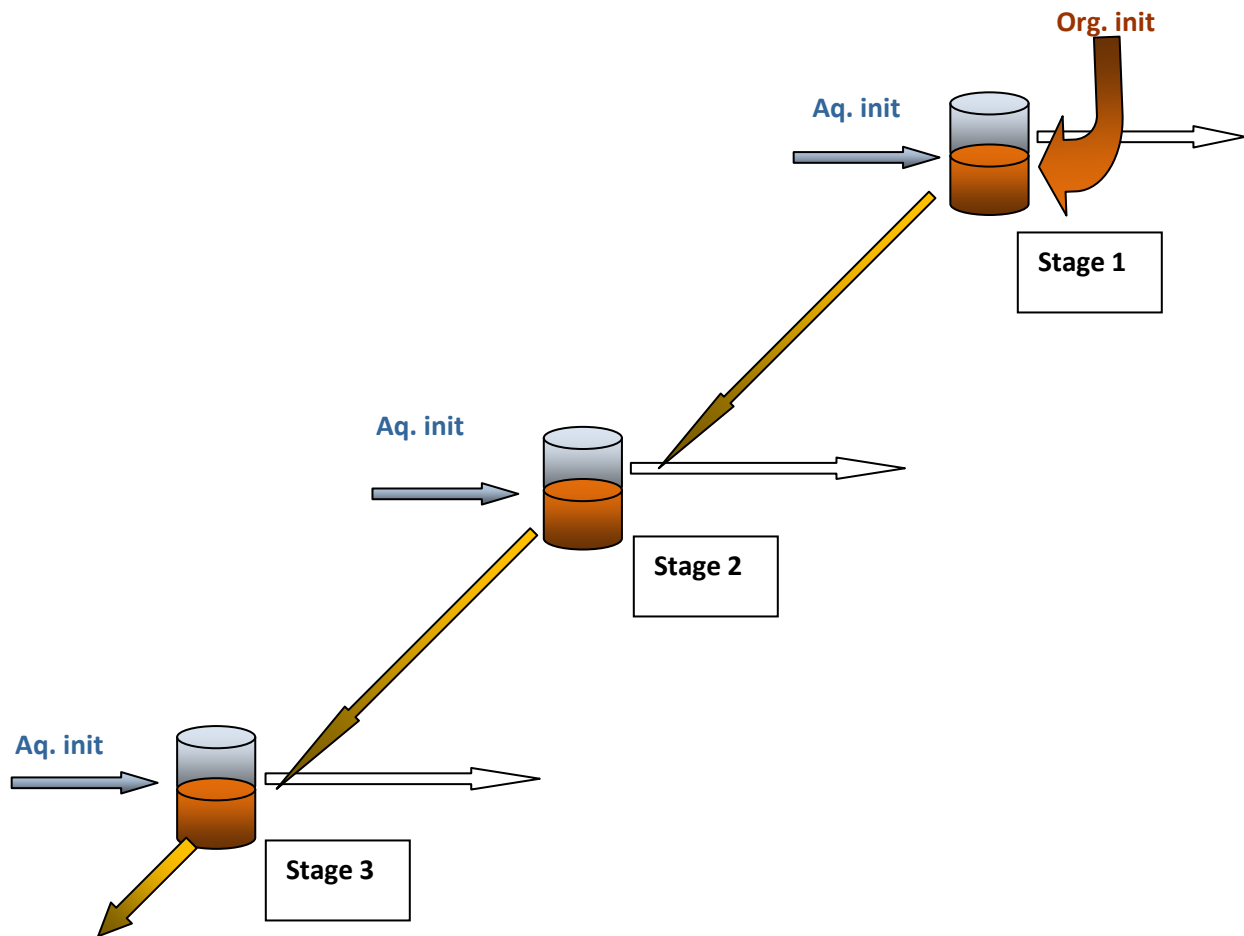

Fig.6. The UNEX-T process flowsheet for separation of Am, Cs and Sr from HLW

In connection with the small volume of UNEX-T solvent, it was decided to replace dynamic tests (3 stages of countercurrent extraction) by a combination of static tests. Two options of the static tests were used: crosscurrent (Fig.7.) and countercurrent (Fig.8.). In accordance with these two procedures the main operations of the flowsheet for UNEX-T process were simulated.



Saturated UNEX-T solvent

Fig.7. Schematic diagram of test in crosscurrent regime

Extraction

Experiments on simulating the countercurrent extraction were performed in the regime of crosscurrent (Fig.7) which adequately models the saturation of UNEX-T Solvent by recoverable radionuclides. At the first experiment the simulated solution contained a mixture of REE in concentrations corresponding to their content in real PUREX-process raffinate. The results obtained are shown in Table 1 (Organic to aqueous ratios were 1 at all stages).

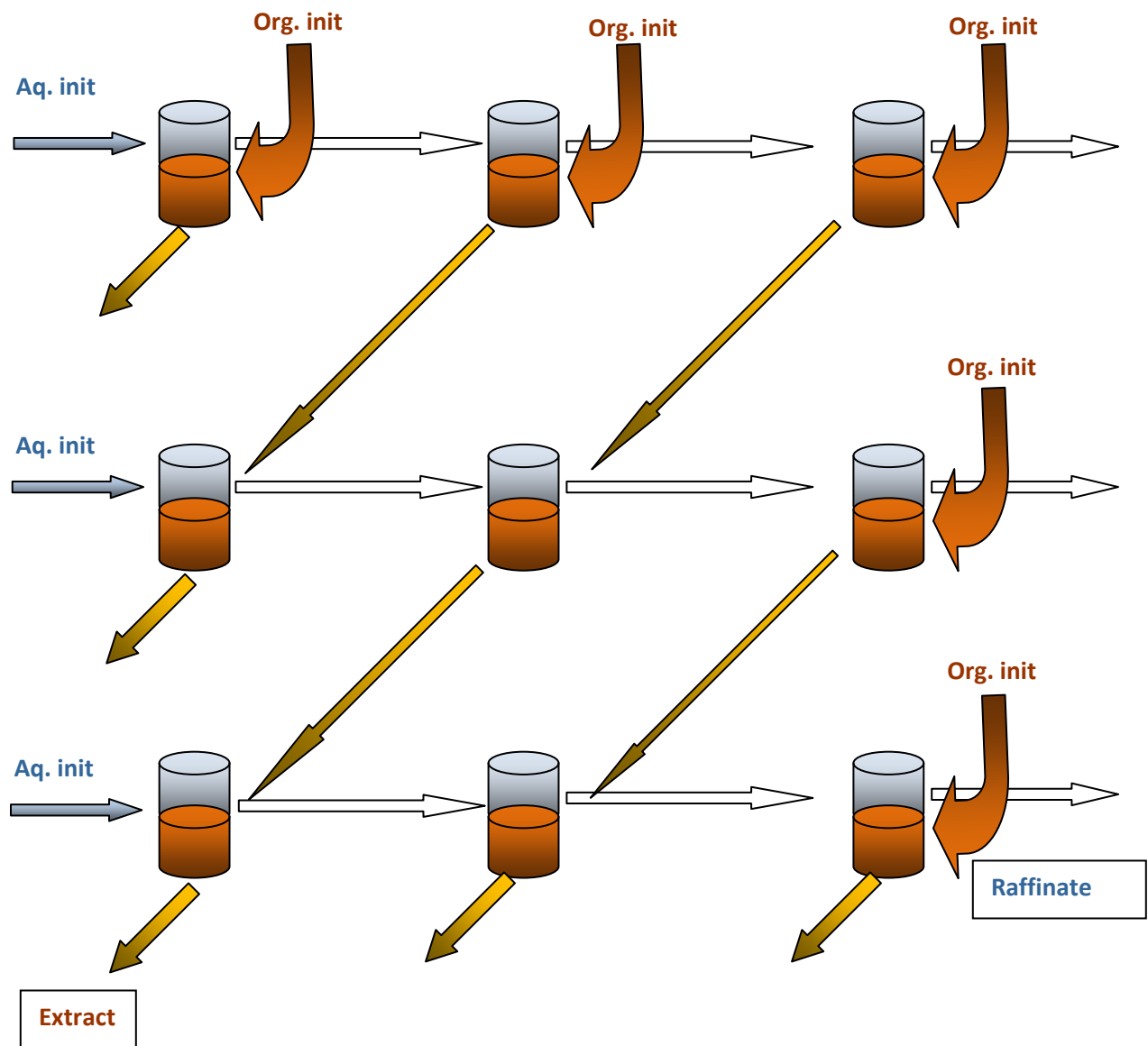

Fig.8. Schematic diagram of test in countercurrent regime

It is evident that only Sm, Eu and Gd are extracted under conditions of complete saturation of UNEX-T Solvent with REE. Americium, cesium and strontium are extracted by 99 % under these conditions. The other REE are left in aqueous phase and the separation factor of Am and REE exceed 50.

Table 1. Extraction of REE according to crosscurrent flowsheet (Fig. 7)

Component	Concentration in simulated solution, g/l	Concentration in extract, g/l (after stage 3)
HNO ₃	0.5 M	below 0.01 M
Y	2.2	Not determined
La	5.76	below 0.01
Ce	10.8	below 0.01
Pr	4.9	below 0.01
Nd	19	below 0.01
Sm	3.6	0.27
Eu	0.7	0.32
Gd	0.54	0.40

At the second experiment the simulated solution contained the main stable components of real PUREX-process raffinate (Table 2) with addition of trace quantities of Am²⁴¹ and Eu¹⁵².

Table 2. Composition of simulated HLW (1 M HNO₃)

Elements	Concentration, g/l	Elements	Concentration, g/l
Cs	0.941	La	0.339
Rb	0.11	Ce	0.635
Sr	0.235	Pr	0.288
Y	0.129	Nd	1.118
Zr	0.75	Sm	0.212
Mo	0.936	Eu	0.042
Ba	0.45	Gd	0.032
Na	2.84	Cr	0.255
Fe	1.6	Ni	0.255
Pd	0.24	Co	0.27

The results obtained are given in Table 3.

Table 3. Distribution ratios of Am²⁴¹ and Eu¹⁵² over stages of crosscurrent flowsheet (Fig.7).

Stage number	1	2	3
Distribution ratio of Am	7.15	0.27	0.11
Distribution ratio of Eu	0.30	0.009	0.004
Separation factor	24	30	28

Based on the data given in Table 3, the following conclusions can be drawn:

- ✓ values of Am and Eu distribution ratios decrease at each subsequent stage. This is connected to reducing the concentration of free UNEX-T Solvent due to co-extraction of palladium, cobalt and nickel;
- ✓ value of Am and Eu separation factor is constant at each stage.

Hence, the Am/REE separation factor should be attained in the range of 30 ÷ 200 at extraction stage depending on HLW composition.

Selective stripping of REE

The selective stripping of REE was checked in crosscurrent regime (Fig. 7). Extract was produced by one contact of UNEX-T Solvent with simulated feed solution containing 9.5 g/l REE in 1 M HNO₃. The solution of 0.3 M CO(NH₂)₂ in 0.7 M HNO₃ was used as selective strip agent 1. The results obtained are shown in Table 4.

Table 4. Distribution ratios of Am²⁴¹ and Eu¹⁵² over stages of crosscurrent flowsheet (Fig.7)

Stage number	1	2	3
Distribution ratio of Am	9.4	9.0	14.0
Distribution ratio of Eu	0.31	0.19	0.17
Separation factor	30	50	84

The obtained data point to the practically complete (by 99%) scrubbing of extract from europium. The americium losses with REE strip solution do not exceed 7.5%. In the process flowsheet this strip product is combined with feed and thus there are no TPE, Cs and Sr losses generated.

Stripping of TPE and regeneration of UNEX-T Solvent

All the investigated components of HLW are completely recovered from saturated UNEX-T Solvent by the solution of methyl ammonium carbonate (MAC) with DTPA additions. In operation of UNEX-T Solvent regeneration by 3 M HNO₃ solution the complete washing of methylammonium from organic phase is achieved on 3 stages at Org/Aq ratio of 2:1. After such a washing the UNEX-T Solvent does not differ in properties from the fresh one. For performing the tests we used the same portion of UNEX-T Solvent subjected to regeneration more than 20 times. No changes in its extraction properties were observed.

Distribution of the main components of simulated HLW over the flowsheet products

The experiment on investigating the behavior of the main components of stimulant HLW (Table 2) over the flowsheet was performed using combination of counter- and crosscurrent regimes. The countercurrent regime (Fig. 8) was used to prepare extract and raffinate. The obtained raffinate was analyzed and extract was used in crosscurrent test. The crosscurrent test consists of one stage of REE stripping from extract, three TPE stripping stages and one stages of UNEX-T Solvent regeneration. Organic to aqueous ratios were 1 at all stages. Composition of REE strip agent: 0.3 M CO(NH₂)₂ + 0.7 M HNO₃; TPE strip agent: 1 M MAC + 5 g/l DTPA in water; regeneration solution: 3 M HNO₃. The conducted static tests data was used to calculate distribution of the main HLW components over products of the flowsheet (Fig. 6). The results are presented in Table 5.

Table 5. Distribution of ²⁴¹Am and REE of HLW (% of initial value) over flowsheet products

Component	Raffinate	Strip product Am	Regenerating solution	Recycle extractant
²⁴¹ Am	< 0.3	> 99.0	< 0.01	< 0.1
¹⁵² Eu	> 99.0	< 0.7	< 0.01	< 0.01
Total REE	> 99.8	< 0.1	< 0.01	< 0.01

The results obtained confirm the possibility of using the UNEX-T solvent (0.05 M MeATP + 0.05 M CCD in F-3) for selective recovery of TPE directly from PUREX-process raffinate.

The experiment on investigating the behavior of stable components of HLW was performed under the same conditions. But the simulated HLW (Table 2) was three times diluted by 1 M HNO₃. The application of the diluted solution allows to avoid the UNEX-T Solvent saturation and makes it possible to obtain the data on distribution of all metals. The experimental results are given in Table 6.

Table 6. Distribution of ²⁴¹Am and stable components of simulated HLW over main products of the flowsheet (% of content in initial HLW).

Product	²⁴¹ Am	Eu	Ce	Co	Cr	Cs	Ba	Fe	Gd	La	Nd	Pd	Sm	Sr	Zr	Ni
Raffinate	4	40	76	8	92	5	74	88	41	79	61	5	45	11	58	48
Strip product 1	23	17	0	7	0	12	10	0	11	0	1	0	22	28	4	0
Strip product 2 (stage 1)	76	3	0	62	0	43	1	0	6	0	0	87	1	50	6	57
Strip product 2 (stage 3)	0.4	0	0	0	0	4	0	0	0	0	0	0	0	0	0	0

The strip product 2 from stage 2 was not analyzed and material balance was not calculated.

It is evident that only palladium, cobalt, nickel and lead co-extracted with radionuclides. These elements are adequately stripped by carbonate strip agent and were not accumulated in recycle UNEX-T Solvent.

Conclusion

The fundamental flowsheet for recovery of TPE, Cs and Sr from PUREX-process raffinate by the UNEX-T solvent has been elaborated. A possibility of using the UNEX-T solvent (0.05 M MeATP + 0.05 M CCD in F-3) for selective recovery of TPE, Cs and Sr directly from PUREX-process raffinate has been demonstrated. The separation factor of ~1000 has been achieved for Am and REE sum. As to the investigated stable components of HLW, only palladium, cobalt, nickel and lead are co-extracted. All these elements are effectively stripped by carbonate strip agent and are not accumulated in recycle UNEX-T Solvent.

REFERENCES

1. V.N. ROMANOVSKIY, I.V. SMIRNOV, V.A. BABAIN, T.A. TODD, R.S. HERBST, J.D. LAW, K.N. BREWER, "The Universal Solvent Extraction (UNEX) Process. I. Development of the UNEX Process Solvent for the Separation of Cesium, Strontium, and the Actinides from Acidic Radioactive Waste", *Solv. Extr. Ion Exch.*, **19**, 1, (2001).
2. J. RAIS, B. GRUNER, *Ion Exchange and Solvent Extraction*, Volume 17, pp. 243-334, Y. MARCUS and A. K. SENGUPTA, eds., Marcel Dekker Inc, New York, NY (2004).
3. M.V. LOGUNOV, I.G. TANANAEV, B.F. MYASOEDOV, "HLW partitioning: main principles and current situation". *Fundamental aspects of the safe geological disposal of radioactive wastes*, Moscow, 15-16 October 2013, pp. 94-96, Granitsa (2013).
4. R. S. HERBST, J. D. LAW, T. A. TODD, V. N. ROMANOVSKIY, I. V. SMIRNOV, V. A. BABAIN, "Development of the universal extraction (UNEX) process for the simultaneous recovery of Cs, Sr and actinides from acidic radioactive wastes", *Separation Science and Technology*, **38**, 2685 (2003).
5. D. R. PETERMAN, R. S. HERBST, J. D. LAW, R. D. TILLOTSON, T. G. GARN, T. A. TODD, "Diamide derivatives of dipicolinic acid as actinide and lanthanide extractants in a variation of the UNEX process". *GLOBAL 2007: Advanced Nuclear Fuel Cycles and*

Systems, Boise, Idaho, September 9-13, 2007, p. 1106-1110 (2007).

6. I.V. SMIRNOV, A.V. CHIRKOV, V.A. BABAIN, E.YU. POKROVSKAYA, T.V. ARTAMONOVA, "Separation of americium and europium in acidic media by synergistic extraction mixtures of substituted bis-tetrazolyl pyridine with chlorinated cobalt dicarbollide", *Radiochimica Acta*, **97**, 593 (2009).

ACKNOWLEDGEMENTS

The work was partly carried out under financial support of ISTC Project # 3405.