



**COMMERCIAL
RESIDENTIAL
LIGHTING**

*New Standard
in Lighting!*

**PRODUCT CATALOG
2024**



SINCE 1999 **ASD LIGHTING CORP**

ASD Lighting Corp has become one of the leading LED lighting brands in the United States for commercial and residential applications.



QUALITY

For the production of ASD Luminaires we carefully choose the highest quality components to ensure efficiency and longevity.







LOGISTICS

We are constantly improving our warehouse system so that delivery and storage of ASD products is not only profitable but fast and convenient.



COMMERCIAL LIGHTING





HIGH BAYS

- 8 LED LINEAR HIGH BAY WITH Q-BASE
ASD-WHB5B 
- 10 LED LINEAR HIGH BAY WITH Q-BASE
PRO series
ASD-WHB5B-PRO 
- 12 LED UFO HIGH BAY WITH Q-BASE
ASD-UHB2A 
- 14 LED UFO HIGH BAY WITH Q-BASE
PRO series
ASD-UHB2A-PRO 



NSF LIGHTING

- 16 NSF LED UFO HIGH BAY
ASD-UFS-PRO 

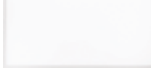

LINEAR LIGHTS

- 17 LED WRAP FIXTURE
ASD-WRL, ASD-WRL2 
- 18 LED SEAMLESS VAPOR PROOF FIXTURE
ASD-LVP2SM 
- 20 LED STRIPLIGHT FIXTURE
ASD-LSF5 
- 22 LED STRIPLIGHT FIXTURE WITH Q-BASE
ASD-LSF7A 

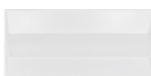

PANELS & TROFFERS

- 24 LED BACK-LIT FLAT PANEL
ASD-BLP 
- 25 NLS LED BACK-LIT FLAT PANEL
ASD-BLP-SM, ASD-BLP-SM-RGBW 
- 26 LED TROFFER LIGHTS
ASD-LTR 
- 27 LED TROFFER KIT
ASD-LTRK 



DOWNLIGHTS

- 28 LED COMMERCIAL DOWNLIGHT
ASD-CDL7, ASD-CDL7R 
- 30 LED ROUND RECESSED MINI PANEL
100-277V WITH BAFFLE TRIM
ASD-JBRB-MV 
- 31 LED ROUND RECESSED MINI PANEL
FIRE RATED
ASD-JFR, ASD-JFRB-MV 



AREA LIGHTS

- 32 LED AREA LIGHT
ASD-LSB5 
- 34 LED AREA LIGHT WITH Q-BASE
PRO series
ASD-LSB5-PRO 

SPORT LIGHTS

- 36 LED SPORT LIGHT
ASD-SPFL7 
- 37 LED SPORT LIGHT WITH DMX
ASD-SPFL7-DMX,
ASD-SPFL7-RGBW-DMX 





CANOPIES

- 38 LED SLIM CANOPY
ASD-CAN05 
- 39 LED LOW-PROFILE CANOPY
WITH Q-BASE
ASD-CAN07A 
- 40 LED EDGE-LIT CANOPY SQUARE
WITH Q-BASE
ASD-CAN09S 

SECURITY & FLOODLIGHTS

- 41 LED SECURITY LIGHT
WITH MOTION SENSOR
ASD-LSR, ASD-LSR2, ASD-LSR3 
- 42 LED SECURITY FLOODLIGHT
WITH MOTION SENSOR
ASD-SFL 
- 43 LED SECURITY FLOODLIGHT
WITH CAMERA
ASD-SFL-SC 
- 44 LED FLOODLIGHT WITH ARM
ASD-FL01K 

WALLPACKS

- 45 LED SECURITY WALLPACK
WITH PHOTOCELL
ASD-LSWP01 
- 46 LED TRADITIONAL WALLPACK
ASD-WLP01 
- 47 LED SLIM WALLPACK
ASD-WLP01SL 
- 48 LED ADJUSTABLE CUTOFF WALLPACK
ASD-WLP02A 
- 49 LED FULL CUTOFF WALLPACK
ASD-WLP03 

SENSORS AND BATTERIES

- 50 MOTION SENSOR
WITH MAGNET & AUDIO JACK BASE
ASD-M2MW-NLS, ASD-08MW 
- 51 MOTION SENSOR
WITH 3-PIN BASE
ASD-09IR, ASD-09MW 
- 52 NLS MOTION SENSOR
WITH 3-PIN BASE
ASD-09IR-NLS, ASD-09MW-NLS 
- 53 NLS EMERGENCY BATTERY BACK-UP
ASD-EMA15-NLS, ASD-EMB40-NLS 
- 54 EMERGENCY BATTERY BACK-UP
ASD-EMK, BLD-HM 
- 55 EMERGENCY BATTERY BACK-UP
BLD-RM, BLD-GM60R-HV 

RESIDENTIAL LIGHTING



FLUSHMOUNT LIGHTS

- 58 LED DOUBLE RING FLUSHMOUNT
ASD-LFMDR 
- 60 LED OVAL DOUBLE RING FLUSHMOUNT
ASD-LFMOV, ASD-FMOV 
- 61 LOFT LED FLUSHMOUNT
ASD-LOFT-FM 
- 62 LED FLUSHMOUNT COMFORT 5CCT
ASD-LFC 
- 63 LED FLUSHMOUNT COMFORT-SMART
ASD-LFC-RGB-SMART 
- 64 LED SURFACE MINI PANEL
ASD-MPR, ASD-MPS 
- 66 LED DISK LIGHT
ASD-LDS 



CANLESS RECESSED LIGHTS

- 68 LED ROUND RECESSED MINI PANEL
ASD-JBR 
- 68 LED SQUARE RECESSED MINI PANEL
ASD-JBS 
- 69 LED ROUND RECESSED MINI PANEL WITH RGBW
ASD-JBR-RGBW 
- 70 LED ROUND RECESSED MINI PANEL GIMBAL
ASD-JBR-GB, ASD-JBR-GBA, ASD-LMPJBR-GB 
- 75 LED DOWNLIGHT 1 & 2 INCH
ASD-CD-P, ASD-CD-C 
- 76 LED DOWNLIGHT 2 INCH WITH WALL WASH TRIM
ASD-CD-PWR 
- 77 NEW CONSTRUCTION MOUNTING PLATE
ASD-MPL-FA, ASD-MPL-FS, ASD-MPL-SC 







TRIMLESS DOWNLIGHTS

- 72 LED TRIMLESS DOWNLIGHT
ASD-CD-TR, ASD-CD-TS 
- 73 LED TRIMLESS DOWNLIGHT GIMBAL
ASD-CD-TG 
- 74 LED TRIMLESS DOWNLIGHT COMBO GIMBAL
ASD-TCS 



RETROFIT DOWNLIGHTS

- 78 LED ROUND DOWNLIGHT RETROFIT KIT
ASD-LRKR 
- 78 LED SQUARE DOWNLIGHT RETROFIT KIT
ASD-LRKS 
- 79 LED DOWNLIGHT RETROFIT KIT GIMBAL
ASD-LRK-GBR 

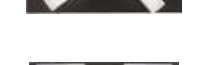

LED VANITY LIGHTS

- 80 LED VANITY LINEAR LOFT
ASD-LOFT-LF 
- 81 LED VANITY LINEAR LIGHT
ASD-LVF21 
- 82 LED VANITY LINEAR LIGHT
ASD-LVF22 
- 83 LED VANITY LINEAR LIGHT
ASD-LVF23 
- 84 LED VANITY LIGHT
ASD-LVF24M 
- 85 LED VANITY LIGHT WITH ROTATABLE HEADS
ASD-LVF25M 
- 86 LED VANITY LIGHT
ASD-LVF26M 



BULB VANITY & PENDANT LIGHTS

- 87 VANITY LIGHT & MINI-PENDANT
ASD-VF27, ASD-MP27 
- 88 VANITY LIGHT & MINI-PENDANT
ASD-VF44, ASD-MP44 
- 89 VANITY LIGHT & MINI-PENDANT
ASD-VF45, ASD-MP45 

INDOOR WALL SCONCES

- 90 LED WALL SCONCE LOFT
ASD-LOFT-WS 
- 91 LED WALL SCONCE
ASD-LWS-11 
- 92 LED WALL SCONCE
ASD-LWS-12 

UNDER CABINET LIGHTS

- 93 LED UNDER CABINET BULLNOSE
ASD-UBN 
- 94 LED UNDER CABINET LINEAR
ASD-UCL 
- 95 LED UNDER CABINET SWIVEL
ASD-UCS 



OUTDOOR LED LIGHTS

- 96 LED STEP LIGHT HORIZONTAL
ASD-LSTL, ASD-STLA-RGB 
- 98 LED SWIVEL HARDSCAPE LIGHT
ASD-HSLS, ASD-HSLS-RGB 

OUTDOOR LED WALL LIGHTS

- 100 LED OUTDOOR WALL SCONCE
ASD-OLWS-21 
- 101 LED OUTDOOR WALL SCONCE
ASD-OLWS-22 
- 102 LED OUTDOOR WALL SCONCE
ASD-OLWS-23 
- 103 LED OUTDOOR WALL SCONCE
ASD-LWS26S, ASD-LWS26S-RGBWC 
- 104 LED OUTDOOR WALL SCONCE
ASD-LWS27A, ASD-LWS27A-RGB 
- 105 LED OUTDOOR NARROW WALL SCONCE
ASD-LWS27N, ASD-LWS27N-RGB 
- 106 LED OUTDOOR BACK-LIGHT WALL SCONCE
ASD-LWS27B, ASD-LWS27B-RGB 
- 107 LED OUTDOOR WALL SCONCE WITH CENTRAL LIGHT
ASD-LWS27C 
- 108 LED OUTDOOR WALL SCONCE
ASD-LWS28S 
- 109 LED OUTDOOR WALL CYLINDER WITH RGBW
ASD-LCLR2-RGBW 
- 110 LED OUTDOOR WALL CYLINDER
ASD-LCLR, ASD-LCLS 

OUTDOOR BULB LIGHTS

- 112 BULB OUTDOOR WALL CYLINDER
ASD-OCLR, ASD-OCLS 
- 113 BULB OUTDOOR WALL CYLINDER WITH DECORATIVE RINGS
ASD-OCLR-B, ASD-OCLS-B 



COMMERCIAL LIGHTING



LED LINEAR HIGH BAY WITH Q-BASE

ASD-WHB5B



BUILT-IN MOTION SENSOR BASE



POWER ADJUSTABLE



DIE-CAST ALUMINUM HOUSING WITH EXCELLENT HEAT DISSIPATION



IK10 IMPACT RESISTANT

150 lm/W Efficiency	120-277V voltage	6kV Surge protection	Battery Back-up
IK 10	Damp locations	Motion Sensor	



PRODUCT SIZES
14", 17", 20", 35"



POWER ADJUSTABLE
100W, 160W, 220W, 320W, 500W



COLOR TEMPERATURE
5 000K

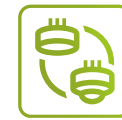

MOTION SENSOR



AUTOMATICALLY SWITCHES ON/OFF



INFRARED OR MICROWAVE SENSOR



REMOTE CONTROL
Sold separately



BATTERY BACK-UP KIT



MORE THAN 4500lm IN EMERGENCY MODE FOR 90min



AUTOMATIC SELF-CHECKING OPTION



OVERCHARGE AND OVER-DISCHARGE PROTECTION

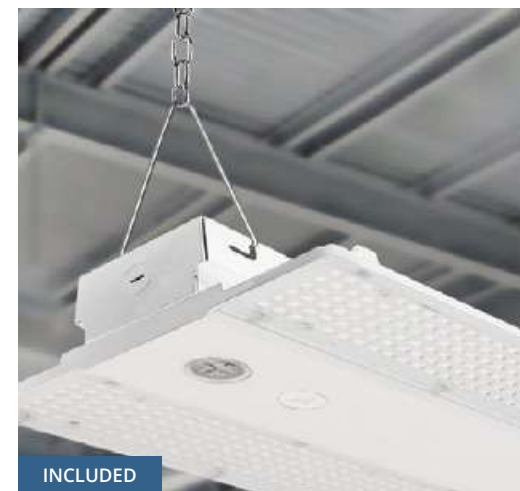

INCLUDED

SUSPENDED MOUNT KIT



PENDANT MOUNT BRACKET



SURFACE MOUNT BRACKET

LED LINEAR HIGH BAY WITH Q-BASE PRO series

ASD-WHB5B-PRO



170lm/W
EXTREME EFFICIENCY

BUILT-IN
MOTION SENSOR BASE

COLOR AND POWER
SELECTABLE

IK10
IMPACT PROTECTION

170
lm/W
Efficiency

120-277V
voltage

6kV
Surge
protection

Motion
Sensor

IK
10

277-480V
voltage

Damp
locations

PRODUCT
SIZES
14", 17", 20", 35"

W **POWER ADJUSTABLE**
100W, 160W, 220W,
320W, 500W

3CCT **COLOR**
SELECTABLE
3500K - 5000K

MOTION
SENSOR

- AUTOMATICALLY SWITCHES ON/OFF
- INFRARED OR MICROWAVE SENSOR
- REMOTE CONTROL
Sold separately

BATTERY
BACK-UP

- MORE THAN 4500lm
IN EMERGENCY MODE FOR 90min
- AUTOMATIC
SELF-CHECKING OPTION
- OVERCHARGE AND
OVER-DISCHARGE PROTECTION

POWER ADJUSTABLE
& **COLOR SELECTABLE**

- 3CCT** 3 POWER AND COLOR
TEMPERATURE OPTIONS
- EASILY ADJUSTABLE
VIA DIP SWITCH



SUSPENDED MOUNT KIT



PENDANT MOUNT BRACKET



SURFACE MOUNT BRACKET

LED UFO HIGH BAY WITH Q-BASE

ASD-UHB2A



DIE-CAST ALUMINUM HOUSING WITH EXCELLENT HEAT DISSIPATION

IP69K RATED, ALLOWS HIGH PRESSURE WASHING

White

-40°F TO 140°F FOR A WIDE VARIETY OF APPLICATIONS

SURGE PROTECTION 6KV AGAINST VOLTAGE SPIKES AND CURRENT SURGES

Black

- 150 lm/W Efficiency
- 120-277V voltage
- 6kV Surge protection
- Battery Back-up

POWER ADJUSTABLE
150W, 200W, 240W, 300W

COLOR TEMPERATURE
5 000K

- Wet locations
- Motion Sensor

MOTION SENSOR

AUTOMATICALLY SWITCHES ON/OFF

INFRARED OR MICROWAVE SENSOR

REMOTE CONTROL
Sold separately



BATTERY BACK-UP KIT

MORE THAN 6 400lm IN EMERGENCY MODE FOR 90min

AUTOMATIC SELF-CHECKING OPTION

THE INDICATOR ALLOWS YOU TO SEE BACK-UP MODE OR AC MODE

REMOTE CONTROL
Sold separately



SCREW-BOLT HOOK AND SPRING HOOK



PENDANT MOUNT BRACKET



PENDANT MOUNT BRACKET WITH J-BOX



SURFACE MOUNT BRACKET



DIFFUSORS AND LENSES

LED UFO HIGH BAY WITH Q-BASE PRO series

ASD-UHB2A-PRO

 170lm/W
EXTREME EFFICIENCY

 BUILT-IN
MOTION SENSOR BASE

 COLOR AND POWER
SELECTABLE

 IP69K RATED,
ALLOWS HIGH PRESSURE WASHING

Black

170
lm/W
Efficiency

 120-277V
voltage

 6kV
Surge
protection

 Battery
Back-up

 277-480V
voltage

 Wet
locations

 Motion
Sensor

W POWER ADJUSTABLE
150W, 200W,
240W, 300W, 500W

3CCT COLOR
SELECTABLE
3 000K – 5 000K

 MOTION
SENSOR

 AUTOMATICALLY
SWITCHES ON/OFF

 INFRARED OR MICROWAVE
SENSOR

 REMOTE CONTROL
Sold separately



 BATTERY
BACK-UP KIT

 MORE THAN 6 800lm
IN EMERGENCY MODE FOR 90min

 AUTOMATIC
SELF-CHECKING OPTION

 SOLUTION
FOR 120-277V & 277-480V

 REMOTE CONTROL
Sold separately



SCREW-BOLT HOOK
AND SPRING HOOK



PENDANT MOUNT
BRACKET



PENDANT MOUNT
BRACKET WITH J-BOX



SURFACE MOUNT
BRACKET



DIFFUSORS
AND LENSES

NSF LED UFO HIGH BAY

ASD-UFS-PRO

NSF FOOD GRADE FIXTURE. NSF CERTIFIED

IP69K RATED, ALLOWS HIGH PRESSURE WASHING

EXTREMELY EFFICIENT 160lm/W

COLOR AND POWER SELECTABLE

160 Efficiency
120-277V voltage
Surge protection

W POWER ADJUSTABLE
200W, 300W

3CCT COLOR SELECTABLE
3 000K - 5 000K

Wet locations

NSF CERTIFIED DLC LISTED PREMIUM 5 year warranty

LED WRAP FIXTURE

ASD-WRL



ASD-WRL2

CLASSIC DESIGN

COLOR AND POWER SELECTABLE

ANTI-GLARE PMMA LENS WITH EVEN LIGHT DISTRIBUTION

0-10V DIMMABLE

115 Efficiency
120-277V voltage
Damp locations

PRODUCT SIZES
4ft

W POWER ADJUSTABLE
45W, 48W

3CCT COLOR SELECTABLE
3 500K - 5 000K

LINEAR LIGHTS

i 117 INFO PAGE

CERTIFIED DLC LISTED 5 year warranty

LED SEAMLESS VAPOR PROOF FIXTURE

ASD-LVP2SM



 IMPACT-RESISTANT POLYCARBONATE BODY

 COLOR AND POWER SELECTABLE

 LINKABLE DESIGN

 WATERPROOF FOR USE IN DIFFERENT LOCATIONS

150
lm/W
Efficiency

120-277V
voltage

6kV
Surge protection

Battery Back-up

 **PRODUCT SIZES**
4ft, 8ft

 **POWER ADJUSTABLE**
56W, 120W

 **3 CCT** **COLOR SELECTABLE**
3 500K - 5 000K

 Wet locations

 **BUILT-IN BATTERY BACK-UP**
ASD-LVP2SM-EM

 MORE THAN 2000lm IN EMERGENCY MODE FOR 90min

 THE INDICATOR ALLOWS YOU TO SEE BACK-UP MODE OR AC MODE



 **CONNECTING MULTIPLE FIXTURES**

 EASY TO CONNECT MULTIPLE FIXTURES

 MULTIPLE FIXTURES WITH DIFFERENT SIZES AND WATTAGES CAN BE LINKED



SUSPENDED MOUNTING



SURFACE MOUNTING

LED STRIPLIGHT FIXTURE

ASD-LSF5



DURABLE COMMERCIAL GRADE HOUSING
RESISTANT TO RUST AND IMPACT



COLOR AND POWER SELECTABLE



ANTI-GLARE PMMA LENS
WITH EVEN LIGHT DISTRIBUTION



LINKABLE DESIGN

- 140**
lm/W
Efficiency
- 120-277V
voltage
- Damp
Locations
- Battery
Back-up



PRODUCT SIZES
2ft, 4ft, 8ft



POWER ADJUSTABLE
28W, 44W, 90W



COLOR SELECTABLE
3 500K - 5 000K



Motion Sensor



BUILT-IN MOTION SENSOR
ASD-LSF5-MS



STAIRWELL AND PASSAGEWAY
LUMINAIRES CLASSIFICATION



ADJUSTABLE
SENSOR



BI-LEVEL MICROWAVE
MOTION SENSOR



REMOTE CONTROL
Sold separately



BUILT-IN BATTERY BACK-UP
ASD-LSF5-EM



MORE THAN 2 000lm
IN EMERGENCY MODE FOR 90min



THE INDICATOR ALLOWS YOU TO
SEE BACK-UP MODE OR AC MODE



BUILT-IN MOTION SENSOR & BATTERY BACK-UP
ASD-LSF5-EM-MS



STAIRWELL AND PASSAGEWAY
LUMINAIRES CLASSIFICATION



BI-LEVEL MICROWAVE
MOTION SENSOR



MORE THAN 2 000lm
IN EMERGENCY MODE FOR 90min



REMOTE CONTROL
Sold separately



INCLUDED



SUSPENDED MOUNT V-HOOK SURFACE MOUNTING



CONNECTION BRACKET



WIRE GUARD

LED STRIPLIGHT FIXTURE WITH Q-BASE

ASD-LSF7A



 BUILT-IN
MOTION SENSOR BASE

 LINKABLE DESIGN

White

 DURABLE COMMERCIAL GRADE HOUSING
RESISTANT TO RUST AND IMPACT

 COLOR AND POWER
SELECTABLE

Black

130
lm/W
Efficiency

 120-277V
voltage

 Damp
Locations

 Battery
Back-up

 PRODUCT
SIZES
2ft, 4ft, 8ft

 POWER
ADJUSTABLE
25W, 40W, 90W

 3 CCT
COLOR
SELECTABLE
3 500K - 5 000K

 277-480V
voltage

 Motion
Sensor

 MOTION
SENSOR

 STAIRWELL AND PASSAGEWAY
LUMINAIRES CLASSIFICATION

 AUTOMATICALLY
SWITCHES ON/OFF

 BI-LEVEL MICROWAVE
MOTION SENSOR

 REMOTE CONTROL
Sold separately



 BUILT-IN
BATTERY BACK-UP
ASD-LSF7-EM

 STAIRWELL AND PASSAGEWAY
LUMINAIRES CLASSIFICATION

 MORE THAN 2500lm
IN EMERGENCY MODE FOR 90min

 THE INDICATOR ALLOWS YOU TO
SEE BACK-UP MODE OR AC MODE



SUSPENDED MOUNT
V-HOOK



SURFACE MOUNTING



CONNECTION BRACKET



WIRE GUARD

LED BACK-LIT FLAT PANEL

ASD-BLP
ASD-BLP-SM
ASD-BLP-SM-RGBW

 DURABLE COMMERCIAL GRADE HOUSING
RESISTANT TO RUST AND IMPACT

 COLOR AND POWER
SELECTABLE

 ASD APP

 ANTI-GLARE PC LENS
WITH EVEN LIGHT DISTRIBUTION

 SURGE PROTECTION AGAINST
VOLTAGE AND CURRENT SURGES

works with 

125
lm/W
Efficiency

 120-277V
voltage

 Damp
Locations

 Battery
Back-up

 PRODUCT
SIZES
2x2, 2x4

 AVAILABLE
POWER
30W, 40W, 50W

 COLOR
SELECTABLE
3 500K - 5 000K

 RGBW

 Motion
Sensor

 **BUILT-IN
MOTION SENSOR**
ASD-BLP-MS

 AUTOMATICALLY
SWITCHES ON/OFF

 REMOTE CONTROL
Sold separately

 **BUILT-IN
BATTERY BACK-UP**
ASD-BLP-EM

 MORE THAN 1000lm
IN EMERGENCY MODE FOR 90min

 THE INDICATOR ALLOWS YOU TO
SEE BACK-UP MODE OR AC MODE

 **NLS PANELS**
ASD-BLP-SM
ASD-BLP-SM-RGB

 CONTROLLED BY ASD APP
ON YOUR PHONE

 RGBW DESIGN
WITH 16.7 MILLION COLORS

works with  COMPATIBLE WITH ALEXA
AND GOOGLE ASSISTANT



RECESSED MOUNTING



SUSPENDED MOUNT KIT



SURFACE MOUNT KIT

LED TROFFER LIGHTS

ASD-LTR

LED TROFFER KIT

ASD-LTRK



DURABLE IRON COMMERCIAL GRADE HOUSING RESISTANT TO RUST AND IMPACT



COLOR AND POWER SELECTABLE



ANTI-GLARE PC LENS WITH EVEN LIGHT DISTRIBUTION



QUICK AND EASY INSTALLATION



DURABLE IRON COMMERCIAL GRADE HOUSING RESISTANT TO RUST AND IMPACT



COLOR AND POWER SELECTABLE



ANTI-GLARE PC LENS WITH EVEN LIGHT DISTRIBUTION



QUICK AND EASY INSTALLATION

125 lm/W Efficiency

120-277V voltage

Damp locations

Battery Back-up



PRODUCT SIZES
2x2, 2x4



POWER ADJUSTABLE
30W, 45W



COLOR SELECTABLE
3 500K - 5 000K



PRODUCT SIZES
2x2, 2x4



AVAILABLE POWER
30W, 45W



COLOR SELECTABLE
3 500K - 5 000K

125 lm/W Efficiency

120-277V voltage

Damp locations

LED COMMERCIAL DOWNLIGHT

ASD-CDL7 ROUND
ASD-CDL7R ROUND
ASD-CDL7S SQUARE



COLOR AND POWER SELECTABLE



IC RATED CANLESS SOLUTION

White



CR190+ RICH AND NATURAL COLORS



COMMERCIAL 120-277V WITH 0-10V DIMMING

Black

90
lm/W
Efficiency

120-277V
voltage

Wet
locations

Battery
Back-up

120
lm/W
Efficiency



PRODUCT SIZES
4", 6", 8", 10"



POWER ADJUSTABLE
13W, 22W, 30W, 35W,
40W, 60W



COLOR SELECTABLE
2700K - 5000K

120
lm/W
Efficiency



BUILT-IN BATTERY BACK-UP
ASD-CDL7R-EM



MORE THAN 1800lm
IN EMERGENCY MODE FOR 90min



AUTOMATIC
SELF-CHECKING OPTION



THE INDICATOR ALLOWS YOU TO
SEE BACK-UP MODE OR AC MODE



BATTERY BACK-UP KIT



MORE THAN 1800lm
IN EMERGENCY MODE FOR 90min



AUTOMATIC
SELF-CHECKING OPTION



THE INDICATOR ALLOWS YOU TO
SEE BACK-UP MODE OR AC MODE



COLOR & POWER SELECTABLE



5 POWER AND COLOR
TEMPERATURE OPTIONS



EASILY ADJUSTABLE
VIA DIP SWITCH



LED ROUND RECESSED MINI PANEL WITH BAFFLE TRIM

ASD-JBRB-MV



LED ROUND RECESSED MINI PANEL FIRE RATED

ASD-JFR
ASD-JFRB-MV





 OPERATES ON 120-277V CIRCUITS

 5 COLOR TEMPERATURE OPTIONS

White

 2 HOUR FIRE RESISTANCE DUE TO REINFORCED AND HEAT RESISTANT STEEL BODY

 CRI90+ RICH AND NATURAL COLORS



 HEAVY DUTY SPRING CLIPS WITH INCREASED HEIGHT

 AIR TIGHT AND IC RATED CANLESS SOLUTION

Black

 HEAVY DUTY COMMERCIAL GRADE SPRING CLIPS WITH INCREASED HEIGHT

 AIR TIGHT AND IC RATED CANLESS SOLUTION

80 Im/W Efficiency
 120-277V voltage
 Wet locations
 Battery Back-up

 **PRODUCT SIZES**
4", 6"



 **AVAILABLE POWER**
12W, 15W

 **COLOR SELECTABLE**
2 700K - 5 000K

 **PRODUCT SIZES**
4", 6"

 **AVAILABLE POWER**
12W, 15W

 **COLOR SELECTABLE**
2 700K - 5 000K

80 Im/W Efficiency
 120V voltage
 2 hour fire rating
 Battery Back-up

 120-277V voltage
 Wet locations

LED AREA LIGHT

ASD-LSB5





 DIE-CAST ALUMINUM HOUSING WITH EXCELLENT HEAT DISSIPATION

 3G VIBRATION RATING THAT CONFORMS TO STANDARDS FOR ROADWAY

 10kV SURGE PROTECTION AGAINST VOLTAGE AND CURRENT SURGES

 SHOEBOX, WALLPACK, FLOODLIGHT OR STREETLIGHT BRACKETS

 150 lm/W Efficiency

 120-277V voltage

 10kV Surge protection

 Photocell

 AVAILABLE POWER
150W, 200W, 240W, 300W

 COLOR TEMPERATURE
5 000K

 Wet locations

 BUILT-IN PHOTOCELL

 BUILT-IN DUSK TO DAWN PHOTOCELL

 AUTOMATICALLY SWITCHES ON/OFF

 PHOTOCELL WITH ON/OFF SWITCH

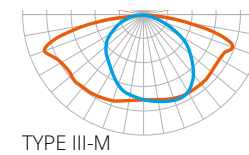
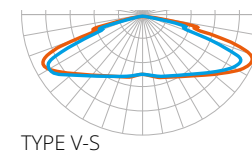
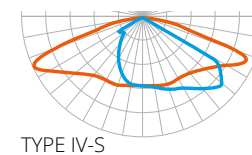
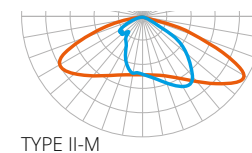

LENS TYPES

DEFAULT

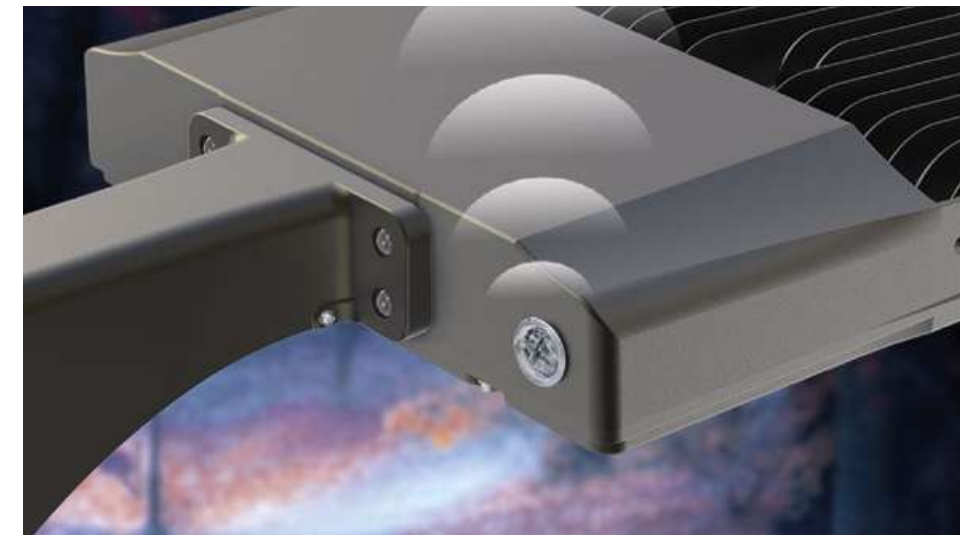

ARM MOUNTING BRACKET
(for round & square poles)



ADJUSTABLE ARM MOUNTING BRACKET
(for round & square poles)



SLIP FITTER
(for poles Ø2")

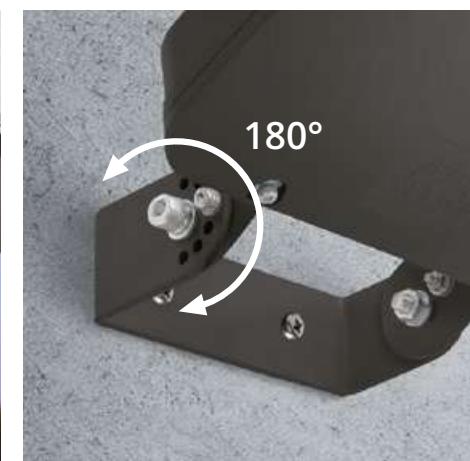

FULL TRUNNION MOUNTING BRACKET



FLOODLIGHT MOUNTING BRACKET

LED AREA LIGHT WITH Q-BASE PRO series

ASD-LSB5A-PRO
ASD-LSB5B-PRO



 BUILT-IN MOTION SENSOR BASE





 COLOR AND POWER SELECTABLE

White Silver

 170lm/W EXTREMELY EFFICIENT

 3G VIBRATION RATING THAT CONFORMS TO STANDARDS FOR ROADWAY

Bronze Black

 170 lm/W Efficiency
 120-277V voltage
 10kV Surge protection
 Photocell

 POWER ADJUSTABLE
150W, 200W, 240W, 300W, 500W

 COLOR SELECTABLE
3 000K - 5 000K

 200-480V voltage
 Wet locations
 Motion Sensor

 MOTION SENSOR

 AUTOMATICALLY SWITCHES ON/OFF

 INFRARED OR MICROWAVE SENSOR

 REMOTE CONTROL
Sold separately



 BUILT-IN PHOTOCELL

 BUILT-IN DUSK TO DAWN PHOTOCELL

 AUTOMATICALLY SWITCHES ON/OFF

 PHOTOCELL WITH ON/OFF SWITCH



ARM MOUNTING BRACKET
(for round & square poles)

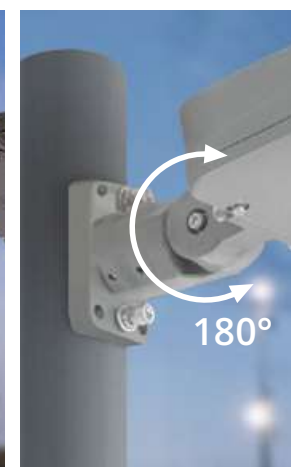

ADJUSTABLE ARM MOUNTING BRACKET
(for round & square poles)



SLIP FITTER
(for poles Ø2")

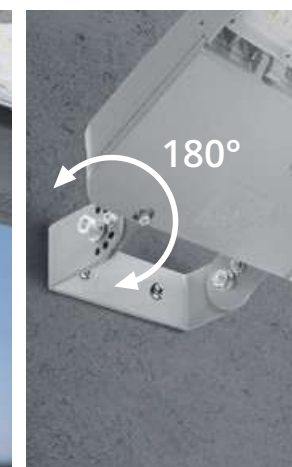

FULL TRUNNION MOUNTING BRACKET

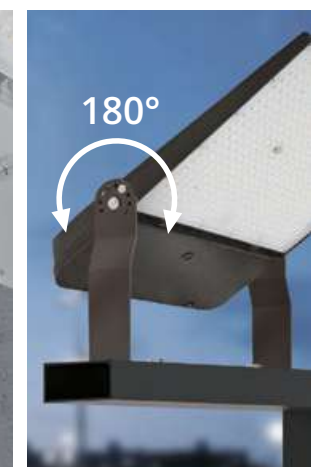

FLOODLIGHT MOUNTING BRACKET

LED SPORT LIGHT

ASD-SPFL7



DIE-CAST ALUMINUM HOUSING WITH EXCELLENT HEAT DISSIPATION



CR180+ RICH AND NATURAL COLORS



SURGE PROTECTION AGAINST VOLTAGE AND CURRENT SURGES



3G VIBRATION RATING

LENS BEAM ANGLES:

300–500 W
Default – 45°;
Option – 30°

750–1 000 W
Default – 45°;
Option – 20°

150 lm/W
Efficiency

120-277V
voltage

10kV
Surge protection

RGBW

200-480V
voltage

Wet locations

W

AVAILABLE POWER

300W, 450W, 500W,
750W, 1 000W, 1 300W

K

COLOR TEMPERATURE

5CCT, 5 000K



LED SPORT LIGHT WITH DMX

ASD-SPFL7-DMX



DMX PROTOCOL



SUITABLE FOR HIGHLY DYNAMIC LIGHT SHOWS



VARIETY OF LIGHTING PATTERNS AND SCENES



LED SPORT LIGHT WITH DMX & RGBW

ASD-SPFL7-RGBW-DMX



DMX PROTOCOL



RGBW DESIGN WITH RED, GREEN, BLUE, WHITE COLORS OR ITS COMBINATIONS



SUITABLE FOR HIGHLY DYNAMIC LIGHT SHOWS



VARIETY OF LIGHTING PATTERNS AND SCENES



INCLUDED

U BRACKET



SLIP-FITTER BRACKET



LASER POINTER

LED SLIM CANOPY

ASD-CAN05



DIE-CAST ALUMINUM HOUSING WITH EXCELLENT HEAT DISSIPATION

SURGE PROTECTION AGAINST VOLTAGE AND CURRENT SURGES

ANTI-GLARE PC LENS WITH EVEN LIGHT DISTRIBUTION

COLOR AND POWER SELECTABLE

POWER ADJUSTABLE
40W, 70W

COLOR SELECTABLE
3 000K - 5 000K

140 lm/W
Efficiency

120-277V
voltage

5kV
Surge protection

Wet locations

LED LOW-PROFILE CANOPY WITH Q-BASE

ASD-CAN07A



BUILT-IN MOTION SENSOR BASE

3 COLOR TEMPERATURE OPTIONS

White

DIE-CAST ALUMINUM HOUSING WITH EXCELLENT HEAT DISSIPATION

SURGE PROTECTION AGAINST VOLTAGE AND CURRENT SURGES

Black

AVAILABLE POWER
45W, 70W

COLOR SELECTABLE
3 000K - 5 000K

140 lm/W
Efficiency

120-277V
voltage

6kV
Surge protection

Battery Back-up

Wet locations

Motion Sensor

LED EDGE-LIT CANOPY SQUARE WITH Q-BASE

ASD-CAN09S



BUILT-IN MOTION SENSOR BASE



COLOR AND POWER SELECTABLE

White



DIE-CAST ALUMINUM HOUSING WITH EXCELLENT HEAT DISSIPATION



5kV SURGE PROTECTION AGAINST VOLTAGE AND CURRENT SURGES

Black

- 140 lm/W Efficiency
- 120-277V voltage
- 6kV Surge protection
- Motion Sensor

W POWER ADJUSTABLE
70W, 100W

3CCT COLOR SELECTABLE
3 000K - 5 000K

Wet locations

LED SECURITY LIGHT WITH MOTION SENSOR

ASD-LSR
ASD-LSR3

ASD-LSR2



360° ROTATABLE LIGHT HEADS FOR DIRECTIONAL LIGHT CONTROL



FLEXIBLE ADJUSTABLE SETTINGS: ON TIME/AUTO/D2D

White



HIGHLY SENSITIVE BUILT-IN 180° MOTION SENSOR



3 COLOR TEMPERATURE OPTIONS

Black

- 100 lm/W Efficiency
- 120V voltage
- Wet locations
- Photocell

W AVAILABLE POWER
20W, 25W

3CCT COLOR SELECTABLE
3 000K - 5 000K

120-277V voltage

Motion Sensor

LED SECURITY FLOODLIGHT WITH MOTION SENSOR

ASD-SFL



 ROTATABLE LIGHT HEADS FOR DIRECTIONAL LIGHT CONTROL



 FLEXIBLE SETTINGS: ON TIME/AUTO/D2D

White

 HIGHLY SENSITIVE BUILT-IN 180° MOTION SENSOR

 5 COLOR TEMPERATURE OPTIONS

Black

100 lm/W Efficiency
 120V voltage
 Wet locations
 Photocell

W AVAILABLE POWER
20W

5CCT COLOR SELECTABLE
2 700K - 5 000K

 Motion Sensor

LED SECURITY FLOODLIGHT WITH CAMERA

ASD-SFL-SC



 ROTATABLE LIGHT HEADS FOR DIRECTIONAL LIGHT CONTROL



 5 COLOR TEMPERATURE OPTIONS

 AREA REMOTE MONITORING

works with  WORKS WITH ALEXA AND GOOGLE ASSISTANT

 Micro SD Card



100 lm/W Efficiency
 120V voltage
 Wet locations
 Photocell

W AVAILABLE POWER
20W

5CCT COLOR SELECTABLE
2 700K - 5 000K

 Motion Sensor

LED FLOODLIGHT WITH ARM

ASD-FL01K



 DIE-CAST ALUMINUM HOUSING WITH EXCELLENT HEAT DISSIPATION

 COLOR AND POWER SELECTABLE

 ANTI-GLARE PC LENS WITH EVEN LIGHT DISTRIBUTION

 WET LOCATIONS RATED

W POWER ADJUSTABLE
55W, 75W

3CCT COLOR SELECTABLE
3 000K - 5 000K

125 Efficiency
lm/W
120-277V voltage
5kV Surge protection

0-10V dimming
Wet locations

  

LED SECURITY WALLPACK WITH PHOTOCELL

ASD-LSWP01



 DIE-CAST ALUMINUM HOUSING WITH EXCELLENT HEAT DISSIPATION

 3 COLOR TEMPERATURE OPTIONS

 ANTI-GLARE PC LENS WITH EVEN LIGHT DISTRIBUTION

 IP65 RATED FOR ALL WEATHER CONDITIONS

W AVAILABLE POWER
18W, 26W

3CCT COLOR SELECTABLE
3 000K - 5 000K

130 Efficiency
lm/W
120-277V voltage
Wet locations
Battery Back-up

Photocell

 

LED TRADITIONAL WALLPACK

ASD-WLP01



 DIE-CAST ALUMINUM HOUSING WITH EXCELLENT HEAT DISSIPATION

 3 COLOR TEMPERATURE OPTIONS

 TEMPERED GLASS LENS FOR HIGH ILLUMINANCE

 REMOVABLE HINGE DOOR FOR QUICK AND EASY WIRING

LED SLIM WALLPACK

ASD-WLP01SL



 DIE-CAST ALUMINUM HOUSING WITH EXCELLENT HEAT DISSIPATION

 REMOVABLE HINGE DOOR FOR QUICK AND EASY WIRING

 TEMPERED GLASS LENS FOR HIGH ILLUMINANCE

 SURGE PROTECTION AGAINST VOLTAGE AND CURRENT SURGES

150 Efficiency
120-277V voltage
6kV Surge protection
Battery Back-up

 **PRODUCT SIZES**
10", 14"

 **AVAILABLE POWER**
50W, 80W, 120W

 **COLOR TEMPERATURE**
3CCT, 5 000K

 Wet locations
 Photocell

 **POWER ADJUSTABLE**
60W, 80W, 120W

 **COLOR SELECTABLE**
3 000K - 5 000K

140 Efficiency
120-277V voltage
6kV Surge protection
Photocell

 Wet locations

LED ADJUSTABLE CUTOFF WALLPACK

ASD-WLP02A





 DIE-CAST ALUMINUM HOUSING WITH EXCELLENT HEAT DISSIPATION

 3 COLOR TEMPERATURE OPTIONS

 ADJUSTABLE CUTOFF DESIGN 0-90°

 REMOVABLE HINGE DOOR FOR QUICK AND EASY WIRING

140 Efficiency
 120-277V voltage
 6kV Surge protection
 Photocell

 Wet locations

W AVAILABLE POWER
12W, 30W, 50W

3CCT COLOR SELECTABLE
3 000K - 5 000K

LED FULL CUTOFF WALLPACK

ASD-WLP03





 DIE-CAST ALUMINUM HOUSING WITH EXCELLENT HEAT DISSIPATION

 FULL CUTOFF DESIGN WITH DIRECTED LIGHT

 ANTI-GLARE PC LENS WITH EVEN LIGHT DISTRIBUTION

 COLOR AND POWER SELECTABLE

145 Efficiency
 120-277V voltage
 4kV Surge protection
 Photocell

 Wet locations

W POWER ADJUSTABLE
50W, 80W, 120W

K COLOR TEMPERATURE
3CCT, 5 000K

Q-BASE MOTION SENSOR WITH MAGNET & AUDIO JACK BASE

Microwave Motion Sensor
ASD-M2MW-NLS



Microwave Motion Sensor
ASD-08MW-WH



SETTINGS

SETTINGS	DEFAULT	ADJUSTMENTS
DETECTION AREA	100%	25% – 100%
HOLDTIME	10min	5s – 120min
DAYLIGHT THRESHOLD	DISABLE	2 – 400Lux
STANDBY DIMMING LEVEL	10%	10 – 50%
STANDBY PERIOD	0s	0s – +∞



ASD-06RC



QUICK ADJUSTMENTS WITH REMOTE CONTROL



0-10V DIMMING OPTION

White



INSTALLATION HEIGHT UP TO 52FT



EMERGENCY BACK-UP COMPATIBILITY



Q-BASE MOTION SENSOR WITH 3-PIN BASE

Infrared Motion Sensor
ASD-09IR-BK / ASD-09IR-WH / ASD-09IR50-WH



Microwave Motion Sensor
ASD-09MW-BK / ASD-09MW-WH



SETTINGS

SETTINGS	DEFAULT	ADJUSTMENTS
DETECTION AREA	100%	25% – 100%
HOLDTIME	10min	5s – 30min
DAYLIGHT THRESHOLD	DISABLE	2 – 400Lux
STANDBY DIMMING LEVEL	10%	0 – 50%
STANDBY PERIOD	0s	0s – +∞



ASD-06RC



QUICK ADJUSTMENTS ON SENSOR WITH ROTATING SWITCH & REMOTE CONTROL



WET LOCATION RATED

White



INSTALLATION HEIGHT UP TO 50FT



EMERGENCY BACK-UP COMPATIBILITY

Black



NLS MOTION SENSOR WITH 3-PIN BASE

Infrared Motion Sensor NLS
ASD-09IR-NLS-WH



Microwave Motion Sensor NLS
ASD-09MW-NLS-WH



SETTINGS	DEFAULT	ADJUSTMENTS
DETECTION AREA	100%	25% - 100%
HOLDTIME	10min	5s - 30min
DAYLIGHT THRESHOLD	DISABLE	2 - 400Lux
STANDBY DIMMING LEVEL	10%	0 - 50%
STANDBY PERIOD	0s	0s - +∞



ASD-06RC-NLS

 ASD NLS CONTROL APP AND SOFTWARE

 WI-FI ROUTER AVAILABLE

 INSTALLATION HEIGHT UP TO 49FT

 EMERGENCY BACK-UP COMPATIBILITY



ASD-G02-NLS

NLS Battery Back-Up
For LED COMMERCIAL DOWNLIGHT



ASD-EMA15-NLS

NLS Battery Back-Up
For LED UFO HIGH BAY



ASD-EMB40-NLS

 90 MINUTES OF POWER IN EMERGENCY MODE

 REGULAR SELF TESTING

 OVERLOAD & SHORT-CIRCUIT PROTECTION

 ASD NLS CONTROL APP AND SOFTWARE



ASD-G02-NLS



ASD-EMA15-NLS



ASD-EMB40-NLS



EMERGENCY BATTERY BACK-UP KIT

Battery Back-Up kit
For LED LINEAR HIGH BAY



ASD-EMK20W-WHB5A
ASD-EMK20W-WHB5B
ASD-EMK30W-WHB5A

Battery Back-Up kit
For LED COMMERCIAL DOWNLIGHT



BLD-HM08D



BLD-HM15D

Battery Back-Up kit
For LED UFO HIGH BAY



BLD-RM40R
BLD-RM60R

EMERGENCY BATTERY BACK-UP KIT

Battery Back-Up kit
For LED UFO HIGH BAY 277-480V



BLD-GM60R-HV

90 MINUTES OF POWER
IN EMERGENCY MODE

BACK-UP OR AC MODE
INDICATOR

REGULAR SELF
TESTING

OVERLOAD
& SHORT-CIRCUIT PROTECTION

90 MINUTES OF POWER
IN EMERGENCY MODE

WITH MULTI-PROTECTION
FUNCTION

REGULAR
SELF TESTING

WET LOCATION
RATED



RN1



ASD-EMK20W-WHB5A



BLD-HM15D

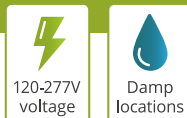

BLD-RM40R / BLD-RM60R



BLD-GM60R-HV





RESIDENTIAL LIGHTING

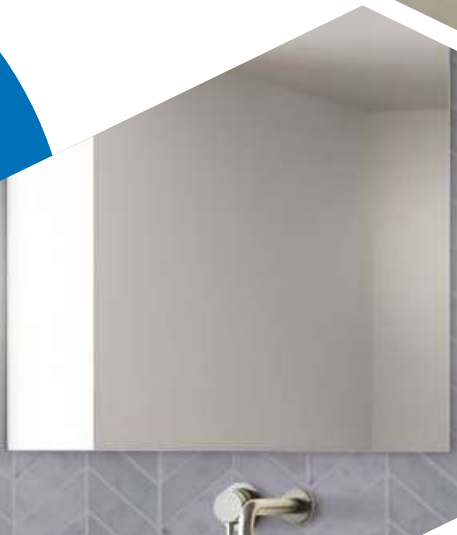

LED DOUBLE RING FLUSHMOUNT

ASD-LFMDR



DURABLE HOUSING RESISTANT TO RUST AND IMPACT



3 COLOR TEMPERATURE OPTIONS



ACRYLIC LENS WITH EVEN LIGHT DISTRIBUTION



2.75" AND 3.5" MOUNTING HOLES FOR ADVANCED INSTALLATION OPTIONS



PRODUCT SIZES

10", 12", 14", 16", 18"



AVAILABLE POWER

15W - 28W



COLOR SELECTABLE

3 000K - 5 000K



120V voltage



Damp locations



Battery Back-up



120-277V voltage



Motion Sensor



BUILT-IN MOTION SENSOR

ASD-LFMDR-MS



AUTOMATICALLY SWITCHES ON/OFF



BUILT-IN ADJUSTABLE MOTION SENSOR



DETECTION RANGE UP TO 52.5ft



BUILT-IN BATTERY BACK-UP

ASD-LFMDR-EM



BUILT-IN BACK-UP BATTERY



90 MINUTES OF POWER IN CASE OF EMERGENCY



BUILT-IN WORKING MODE INDICATOR



CCT SELECTABLE



3 COLOR TEMPERATURE OPTIONS



COLOR SELECTABLE SWITCH ON PLATE

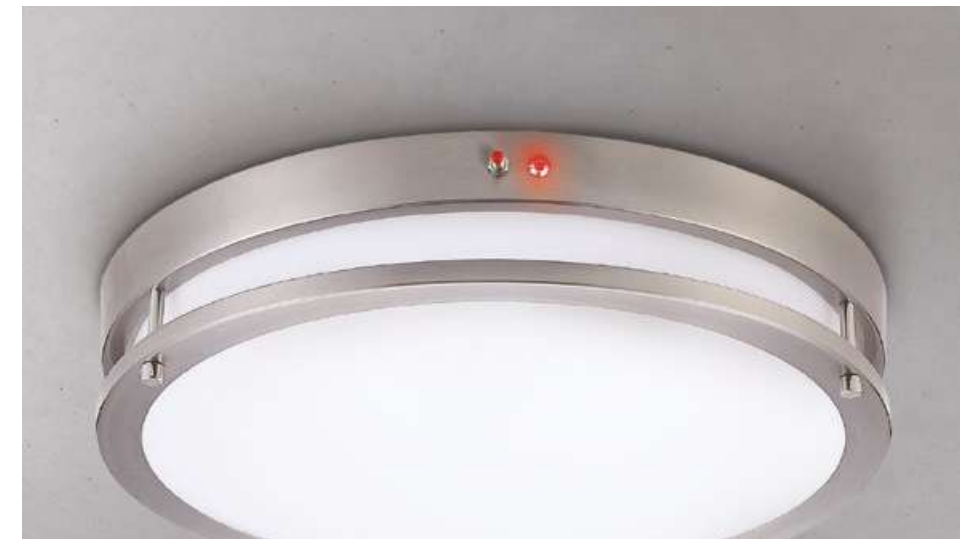

LED OVAL DOUBLE RING FLUSHMOUNT

ASD-LFMOV
ASD-FMOV



ACRYLIC LENS WITH EVEN LIGHT DISTRIBUTION



5 COLOR TEMPERATURE OPTIONS



OPERATE ON 120-277V CIRCUITS



SEAMLESS TRIAC DIMMING TO ADJUST BRIGHTNESS LEVEL AND SAVE ENERGY



120V voltage



6kV Surge protection



PRODUCT SIZES

24", 32"



AVAILABLE POWER

38W, 45W, 50W



COLOR SELECTABLE

2 700K - 5 000K



120-277V voltage



Damp locations



LOFT LED FLUSHMOUNT

ASD-LOFT-FM



CONTEMPORARY SOLUTION TO UPGRADE YOUR FLUSHMOUNTS



5 COLOR TEMPERATURE OPTIONS



ACRYLIC LENS WITH EVEN LIGHT DISTRIBUTION



SEAMLESS TRIAC DIMMING TO ADJUST BRIGHTNESS LEVEL AND SAVE ENERGY

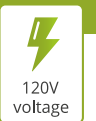

120V voltage



Damp locations



PRODUCT SIZES

12", 14", 16", 18", 20"



AVAILABLE POWER

20W - 42W



COLOR SELECTABLE

2 700K - 5 000K



LED FLUSHMOUNT COMFORT 5CCT

ASD-LFC



CONTEMPORARY SOLUTION TO UPGRADE YOUR FLUSHMOUNTS



5 COLOR TEMPERATURE OPTIONS



ACRYLIC LENS WITH EVEN LIGHT DISTRIBUTION



SEAMLESS DIMMING TO ADJUST BRIGHTNESS LEVEL AND SAVE ENERGY



PRODUCT SIZES

16", 20"



AVAILABLE POWER

28W, 42W



COLOR SELECTABLE

2 700K - 5 000K



i 128 INFO PAGE

LED FLUSHMOUNT COMFORT-SMART

ASD-LFC-RGB-SMART

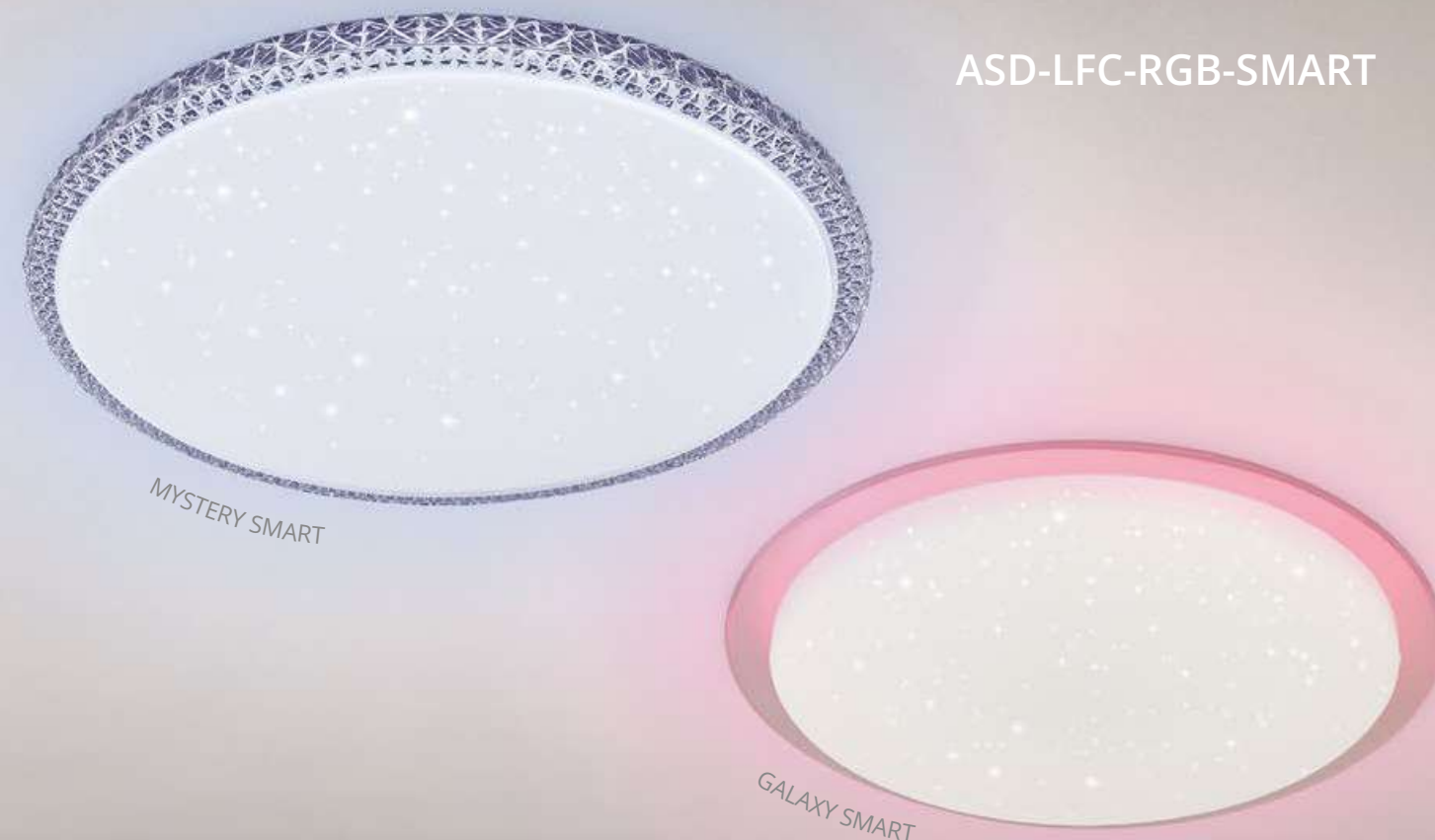

USE YOUR SMARTPHONE TO CONTROL THROUGH THE APP



STARLIGHT EFFECT



COMPATIBLE WITH AMAZON ALEXA



RGB ADJUSTABLE FOR PERSONALIZATION



PRODUCT SIZES

20"



AVAILABLE POWER

42W



COLOR CHANGING

2 700K - 5 000K



i 128 INFO PAGE

LED SURFACE MINI PANEL

ASD-MPR ROUND
ASD-MPS SQUARE



LOW-PROFILE DESIGN IS AN IDEAL SOLUTION FOR LOW CEILINGS



3 COLOR TEMPERATURE OPTIONS



ACRYLIC LENS WITH EVEN LIGHT DISTRIBUTION



J-BOX OR CAN MOUNT INSTALLATION

White

Black



PRODUCT SIZES

5", 7", 9", 12", 15", 18", 24", 32"



AVAILABLE POWER

10W - 45W



COLOR SELECTABLE

2 700K - 6 000K



120V voltage



Damp Locations



Battery Back-up



120-277V voltage



Motion Sensor



BUILT-IN MOTION SENSOR

ASD-MPR-MS



AUTOMATICALLY SWITCHES ON/OFF



BUILT-IN MICROWAVE MOTION SENSOR



ADJUSTABLE PHOTOCELL SENSOR



DETECTION RANGE UP TO 16.4ft



BUILT-IN BATTERY BACK-UP

ASD-MPR-EM



BUILT-IN BACK-UP BATTERY



90 MINUTES OF POWER IN CASE OF EMERGENCY



BUILT-IN WORKING MODE INDICATOR



J-BOX MOUNT INSTALLATION
(for 2.75", 3.5" mounting holes)



CAN MOUNT INSTALLATION
(for 4" or 6" housings)



SUB-PLATE INSTALLATION
(for 2.75", 3.5" mounting holes)

LED DISK LIGHT

ASD-LDS



LOW-PROFILE DESIGN IS AN IDEAL SOLUTION FOR LOW CEILINGS



2.75", 3.5" AND 4" MOUNTING HOLES FOR ADVANCED INSTALLATION OPTIONS



SURGE PROTECTION AGAINST VOLTAGE AND CURRENT SURGES



J-BOX OR CAN MOUNT INSTALLATION



PRODUCT SIZES

4", 6"



AVAILABLE POWER

10W, 15W



COLOR SELECTABLE

2 700K - 5 000K



120V voltage



2.5kV Surge protection



Motion Sensor



Wet locations



BUILT-IN MOTION SENSOR
ASD-LDS-MS



AUTOMATICALLY SWITCHES ON/OFF



BUILT-IN ADJUSTABLE MOTION SENSOR



DETECTION RANGE UP TO 16ft



CCT SELECTABLE



5 COLOR TEMPERATURE OPTIONS



COLOR SELECTABLE SWITCH ON PLATE

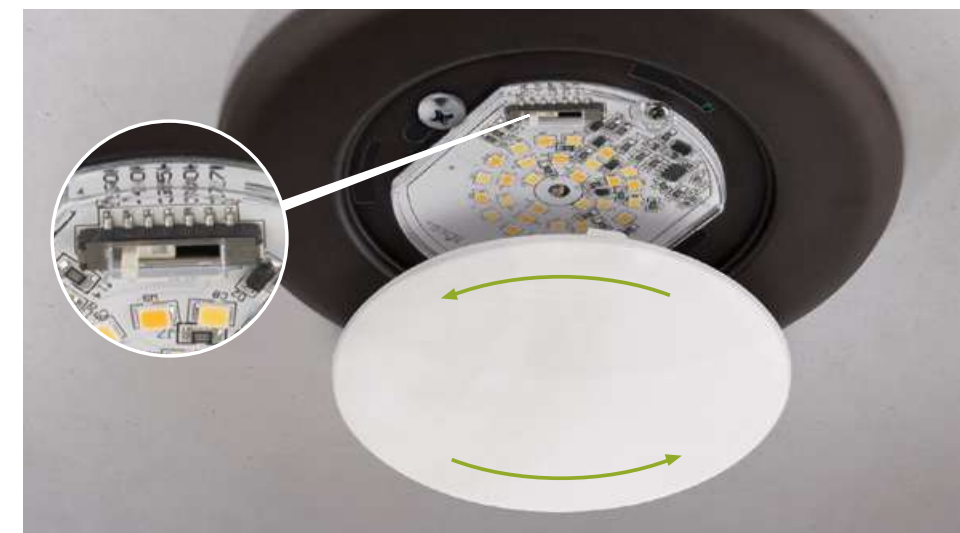

J-BOX MOUNT INSTALLATION
(for 4" housings)



J-BOX MOUNT INSTALLATION
(for 6" housings)



CAN MOUNT INSTALLATION
(for 4" or 6" housings)

LED RECESSED MINI PANEL

ASD-JBR ROUND
ASD-JBS SQUARE

LED ROUND RECESSED MINI PANEL WITH RGBW

ASD-JBR-RGBW

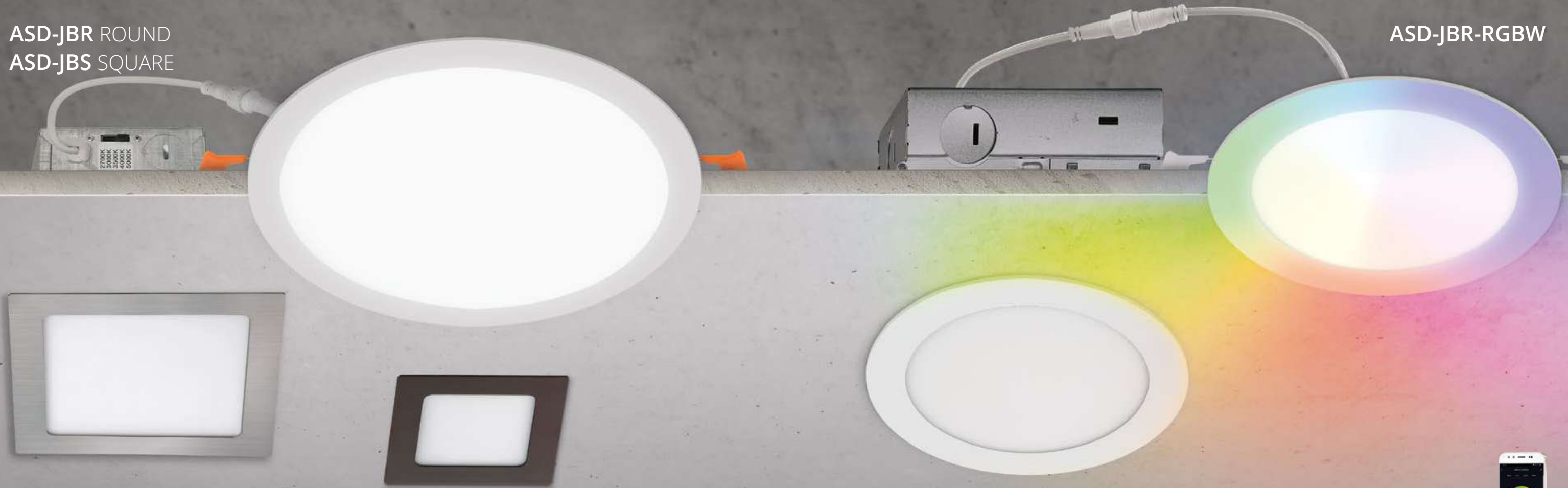

LOW-PROFILE DESIGN IS AN IDEAL SOLUTION FOR LOW CEILINGS



5 COLOR TEMPERATURE OPTIONS

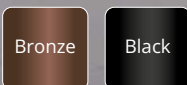
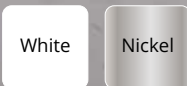

CONTROLLED BY ASD SMART APP ON YOUR SMARTPHONE



IC RATED CANLESS SOLUTION



RGBW DESIGN WITH 16.7 MILLION COLORS



SPRING-LOADED CLIPS ENSURE A SNUG FIT



IC RATED CANLESS SOLUTION

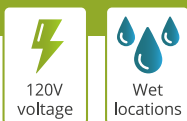

PRODUCT SIZES
3", 4", 6", 8", 12"



AVAILABLE POWER
6W - 24W



COLOR SELECTABLE
2 700K - 5 000K



PRODUCT SIZES
6"



AVAILABLE POWER
15W



COLOR SELECTABLE
2 700K - 6 500K

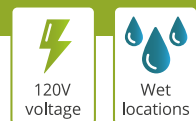

LED ROUND RECESSED MINI PANEL GIMBAL

ASD-JBR-GB GIMBAL
ASD-JBR-GBA GIMBAL AIRTIGHT

LED ROUND RECESSED MINI PANEL GIMBAL

ASD-LMPJBR-GB



SWIVEL LENS WITH 25° TILT AND 355° ROTATION FOR DIRECTIONAL LIGHT CONTROL



5 COLOR TEMPERATURE OPTIONS

White



CR190+ RICH AND NATURAL COLORS



AIR TIGHT AND IC RATED CANLESS SOLUTION

Black



SWIVEL LENS WITH 35° TILT FOR DIRECTIONAL LIGHT CONTROL



3 COLOR TEMPERATURE OPTIONS



SPRING-LOADED CLIPS ENSURE A SNUG FIT



IC RATED CANLESS SOLUTION

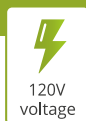

PRODUCT SIZES

3", 4", 6"



AVAILABLE POWER

6W, 12W, 15W



COLOR SELECTABLE

2 700K - 5 000K

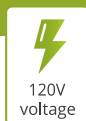

PRODUCT SIZES

4"



AVAILABLE POWER

9W



COLOR SELECTABLE

3 000K - 5 000K



LED TRIMLESS DOWNLIGHT

ASD-CD-TR ROUND
ASD-CD-TS SQUARE
ASD-CD-TG GIMBAL



SMOOTH TRIMLESS LOOK



5 COLOR TEMPERATURE OPTIONS

White



IC RATED CANLESS SOLUTION



CRI90+ RICH AND NATURAL COLORS

Black



120V voltage



Wet locations



Battery Back-up



120-277V voltage



PRODUCT SIZES

2", 3.5", 4", 6"



AVAILABLE POWER

8W - 24W



COLOR SELECTABLE

2 700K - 5 000K



LED TRIMLESS DOWNLIGHT GIMBAL

ASD-CD-TG



SWIVEL LENS WITH 30° TILT FOR DIRECTIONAL LIGHT CONTROL



5 COLOR TEMPERATURE OPTIONS



CRI90+ RICH AND NATURAL COLORS



IC RATED CANLESS SOLUTION

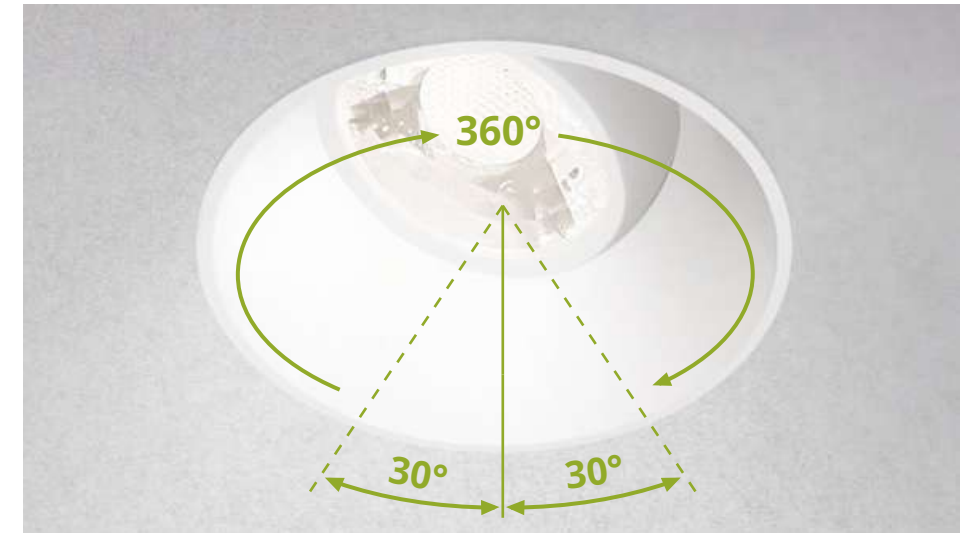

BATTERY BACK-UP KIT



AUTOMATIC SELF-CHECKING OPTION



FIELD INSTALLATION



PROTECTION: OVER-TEMPERATURE, OVER-CHARGE, OVER-DISCHARGE, SHORT-CIRCUIT



MUD FRAME



SMOOTH TRIMLESS LOOK



ROUND OR SQUARE SHAPES



MUD FRAME IS INCLUDED



LED TRIMLESS DOWNLIGHT COMBO GIMBAL

ASD-TCS

LED DOWNLIGHT 1 & 2 INCH

ASD-CD-P

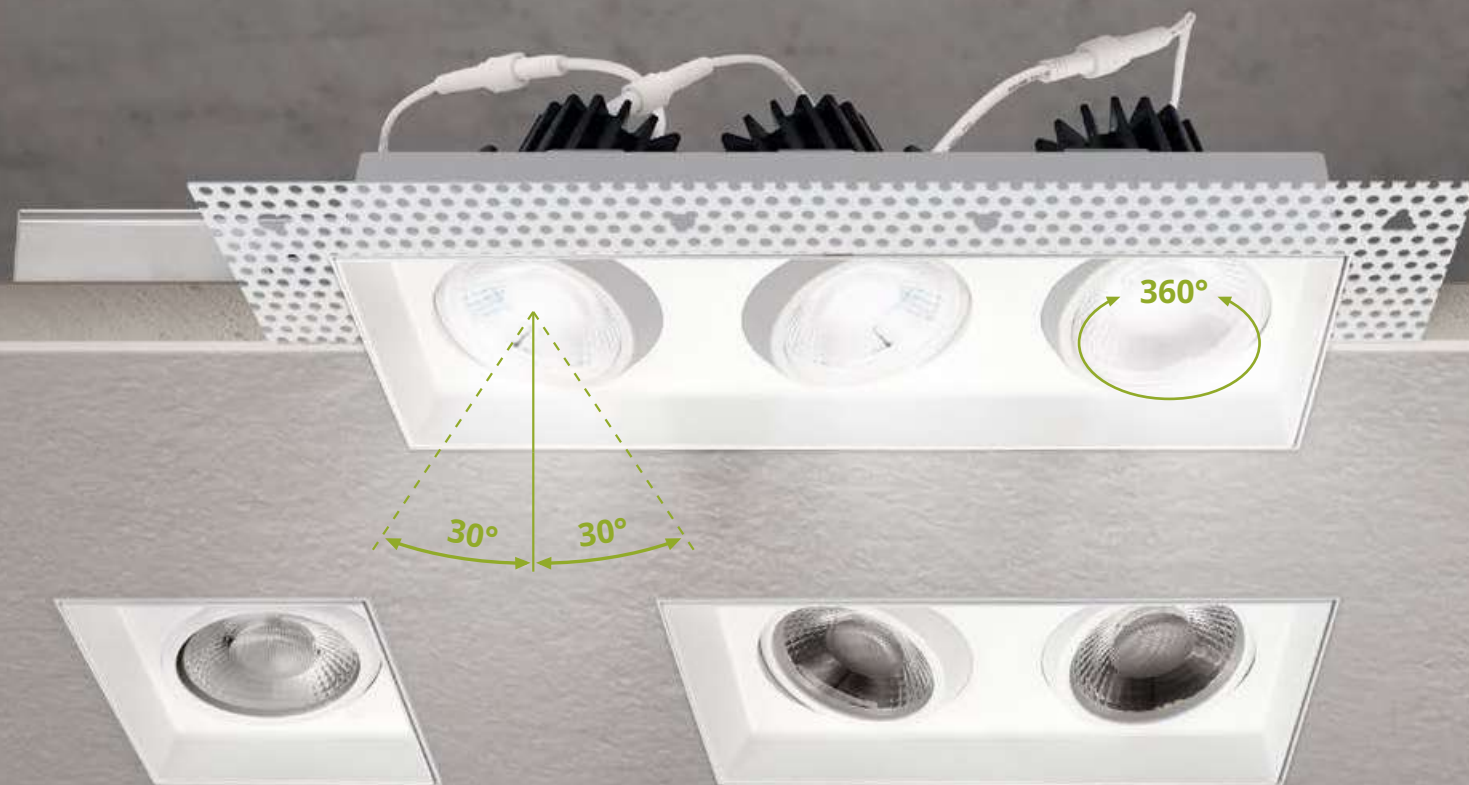

MULTI-DIRECTIONAL ADJUSTABLE SWIVEL HEADS

CRI90+ RICH AND NATURAL COLORS

5 COLOR TEMPERATURE OPTIONS

DURABLE AIRTIGHT ALUMINUM HOUSING WITH EXCELLENT HEAT DISSIPATION

REFLECTOR FINISH:
 White Chrome

5 COLOR TEMPERATURE OPTIONS

IC RATED CANLESS SOLUTION

IC RATED CANLESS SOLUTION

CRI90+ RICH AND NATURAL COLORS

TRIM FINISH:
 White Black

HEAD QUANTITY
1pc, 2 pcs, 3pcs

AVAILABLE POWER
15W, 30W, 45W

COLOR SELECTABLE
2 700K - 5 000K

120V voltage
 Wet locations
 Battery Back-up

PRODUCT SIZES
1", 2"

AVAILABLE POWER
7W, 8W, 15W

COLOR SELECTABLE
2 700K - 5 000K

120V voltage
 Wet locations
 Battery Back-up
 120-277V voltage

LED DOWNLIGHT 2 INCH WITH ROUND WASH TRIM

ASD-CD-PWR



5 COLOR TEMPERATURE OPTIONS

DURABLE AIRTIGHT ALUMINUM HOUSING WITH EXCELLENT HEAT DISSIPATION

IC RATED CANLESS SOLUTION

CRI90+ RICH AND NATURAL COLORS

PRODUCT SIZES
2"

AVAILABLE POWER
8W

COLOR SELECTABLE
2 700K - 5 000K

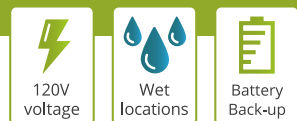

NEW CONSTRUCTION MOUNTING PLATE

ASD-MPL-FA WITH ASYMMETRIC HOLES

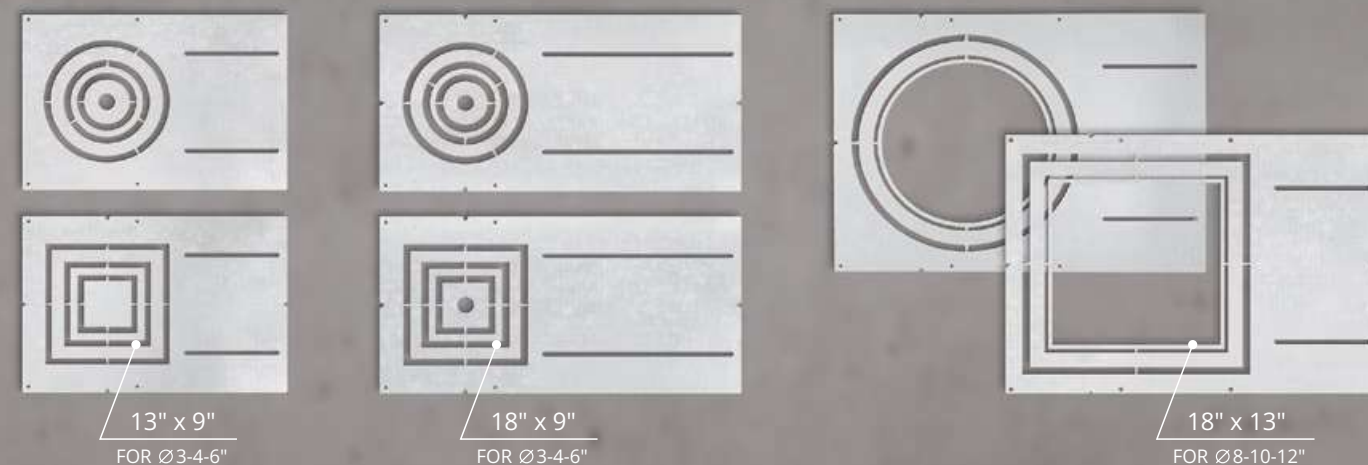

ASD-MPL-FS WITH SYMMETRIC HOLES

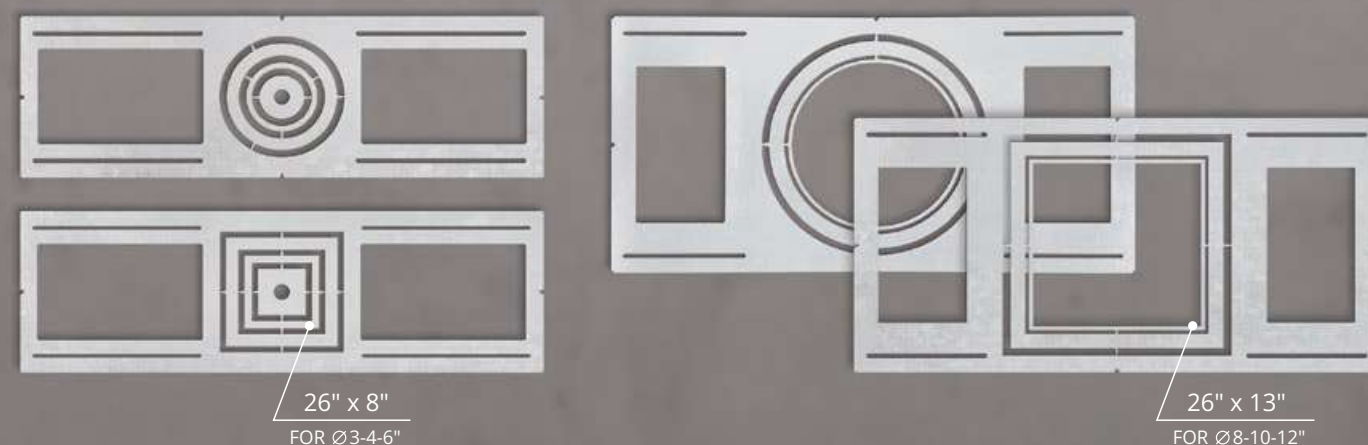

ASD-MPL-SC WITH SLIDING CLIPS

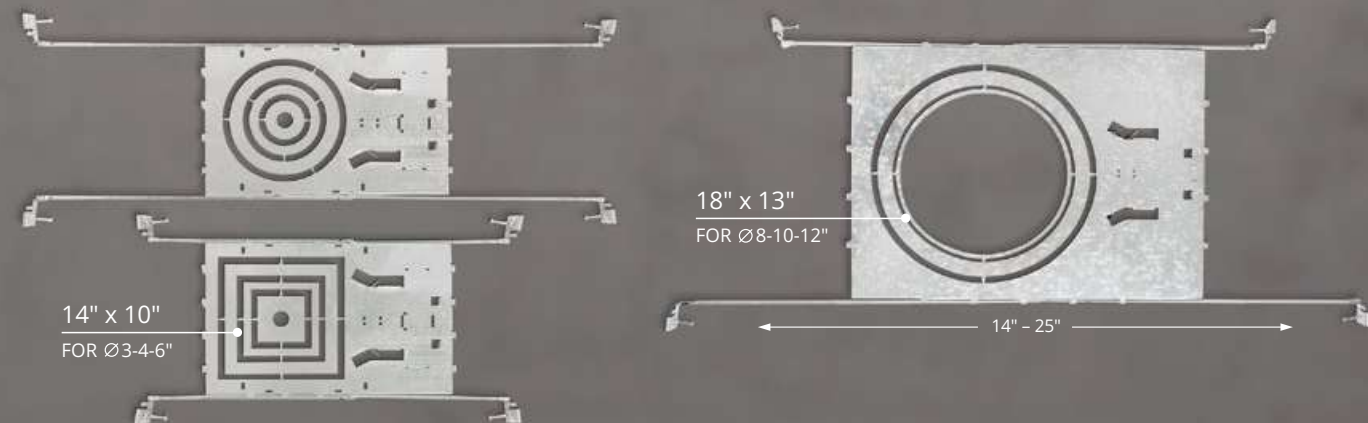

LED DOWNLIGHT RETROFIT KIT

ASD-LRKR ROUND
ASD-LRKS SQUARE



LED DOWNLIGHT RETROFIT KIT GIMBAL

ASD-LRK-GBR

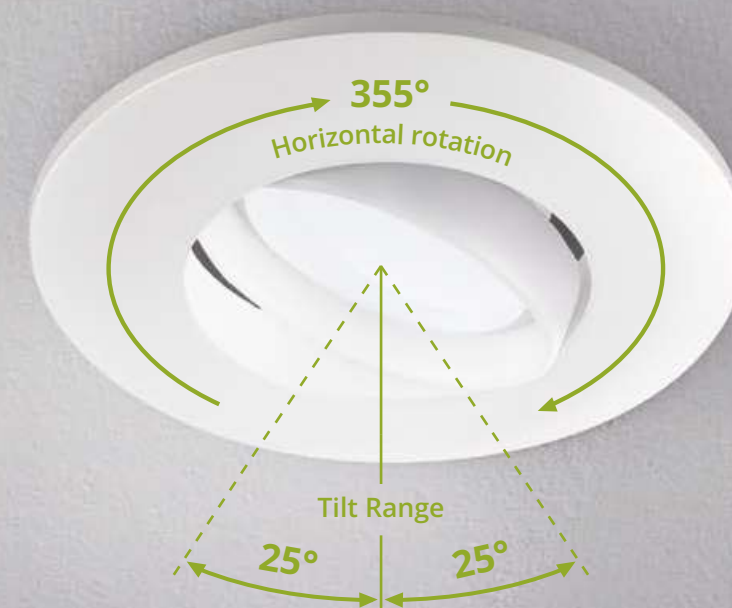

PREINSTALLED TP24 AND E26 CONNECTORS FOR EASY INSTALLATION



5 COLOR TEMPERATURE OPTIONS



CRI90+ RICH AND NATURAL COLORS



SEAMLESS DIMMING TO ADJUST BRIGHTNESS LEVEL AND SAVE ENERGY



SWIVEL LENS WITH 25° TILT FOR DIRECTIONAL LIGHT CONTROL



CRI90+ RICH AND NATURAL COLORS



PREINSTALLED TP24 AND E26 CONNECTORS FOR EASY INSTALLATION



5 COLOR TEMPERATURE OPTIONS



120V voltage



Wet locations



PRODUCT SIZES

4", 6"



AVAILABLE POWER

8.6W, 12W



COLOR SELECTABLE

2 700K - 5 000K



120V voltage



Damp locations



PRODUCT SIZES

4", 6"



AVAILABLE POWER

10W, 15W



COLOR SELECTABLE

2 700K - 5 000K



Wet locations



LED VANITY LINEAR LOFT

ASD-LOFT-LF

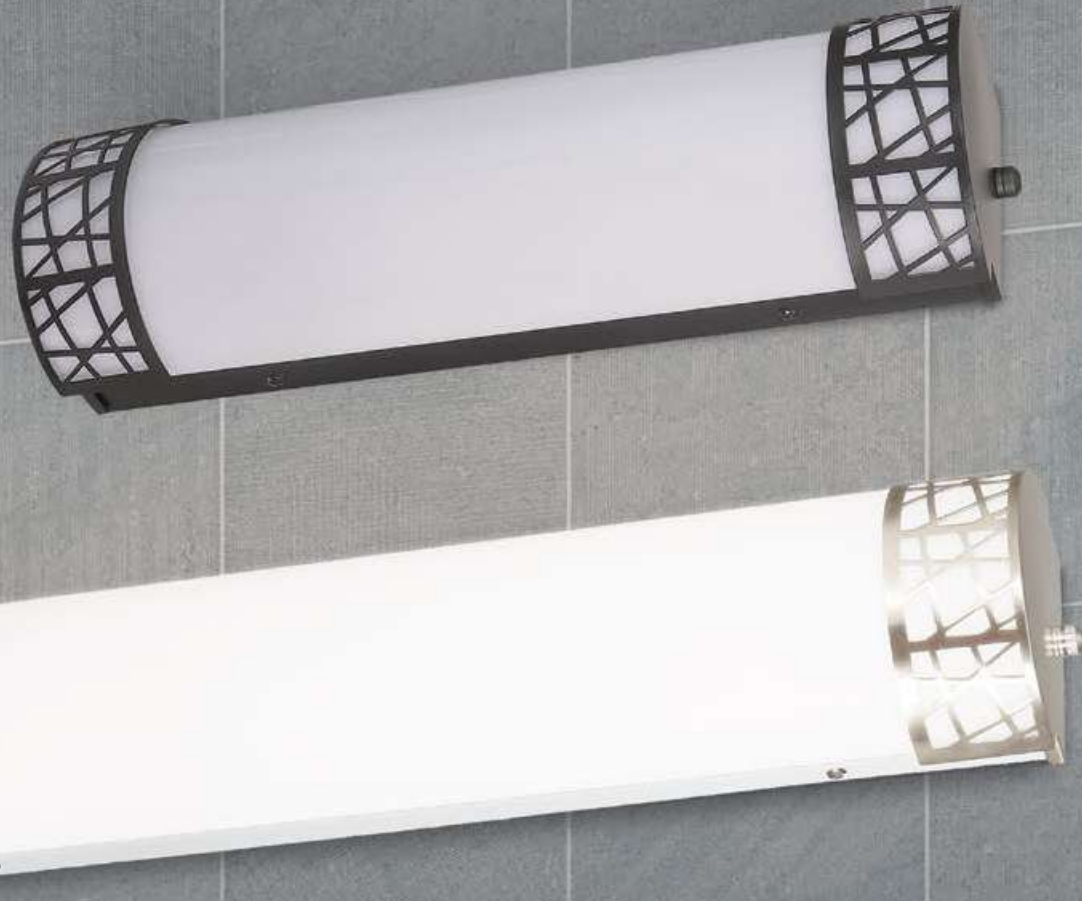

DURABLE HOUSING RESISTANT TO RUST AND IMPACT



5 COLOR TEMPERATURE OPTIONS



Nickel



ACRYLIC LENS WITH EVEN LIGHT DISTRIBUTION



VERTICAL OR HORIZONTAL INSTALLATION



Black

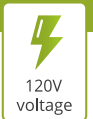

120V voltage



Damp locations



PRODUCT SIZES

18", 24", 36", 48"



AVAILABLE POWER

20W - 35W



COLOR SELECTABLE

2 700K - 5 000K



LED VANITY LINEAR LIGHT

ASD-LVF21



DURABLE HOUSING RESISTANT TO RUST AND IMPACT



3 COLOR TEMPERATURE OPTIONS



Nickel



Bronze



ACRYLIC LENS WITH EVEN LIGHT DISTRIBUTION



VERTICAL OR HORIZONTAL INSTALLATION



Black

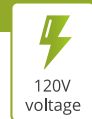

120V voltage



Damp locations



PRODUCT SIZES

18", 24", 36", 48"



AVAILABLE POWER

20W - 35W



COLOR SELECTABLE

3 000K - 5 000K



120-277V voltage



LED VANITY LINEAR LIGHT

ASD-LVF22



DURABLE HOUSING RESISTANT TO RUST AND IMPACT



3 COLOR TEMPERATURE OPTIONS



ACRYLIC LENS WITH EVEN LIGHT DISTRIBUTION



VERTICAL OR HORIZONTAL INSTALLATION



120V voltage



Damp locations



PRODUCT SIZES

18", 24"



AVAILABLE POWER

20W, 25W



COLOR SELECTABLE

3 000K - 5 000K



[i](#) 136 INFO PAGE

LED VANITY LINEAR LIGHT

ASD-LVF23



DURABLE HOUSING RESISTANT TO RUST AND IMPACT



3 COLOR TEMPERATURE OPTIONS



ACRYLIC LENS WITH EVEN LIGHT DISTRIBUTION



VERTICAL OR HORIZONTAL INSTALLATION



Nickel



Black



120V voltage



Damp locations



PRODUCT SIZES

18", 24", 36", 48"



AVAILABLE POWER

20W - 35W



COLOR SELECTABLE

3 000K - 5 000K



[i](#) 136 INFO PAGE

LED VANITY LIGHT

ASD-LVF24M



DURABLE HOUSING RESISTANT TO RUST AND IMPACT



3 COLOR TEMPERATURE OPTIONS



Chrome



ACRYLIC LENS WITH EVEN LIGHT DISTRIBUTION



QUICK AND EASY HARDWIRE INSTALLATION



Black



120V voltage



Damp locations



NUMBER OF LIGHTS

2, 3, 4, 5, 6



AVAILABLE POWER

12W - 35W



COLOR SELECTABLE

3 000K - 5 000K



i 136 INFO PAGE

LED VANITY LIGHT WITH ROTATABLE HEADS

ASD-LVF25M

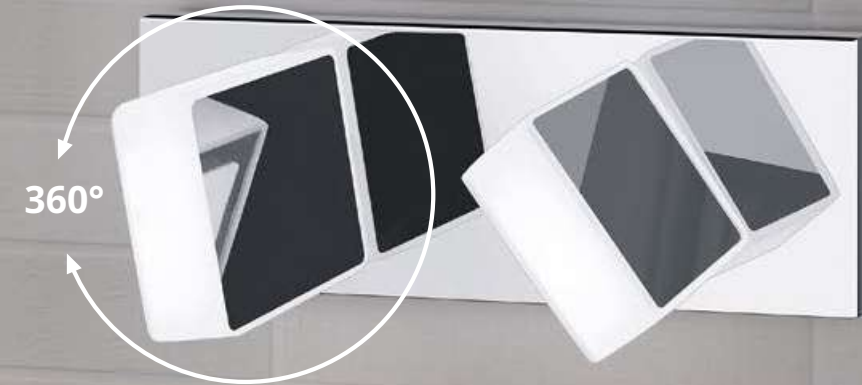

360° ADJUSTABLE LIGHT HEADS



ACRYLIC LENS WITH EVEN LIGHT DISTRIBUTION



Chrome



DURABLE HOUSING RESISTANT TO RUST AND IMPACT



5 COLOR TEMPERATURE OPTIONS



Black



120V voltage



Damp locations



NUMBER OF LIGHTS

2, 3, 4, 5



AVAILABLE POWER

12W - 28W



COLOR SELECTABLE

2 700K - 6 000K



i 137 INFO PAGE

LED VANITY LIGHT

ASD-LVF26M



DURABLE HOUSING RESISTANT TO RUST AND IMPACT



5 COLOR TEMPERATURE OPTIONS



Chrome



ACRYLIC LENS WITH EVEN LIGHT DISTRIBUTION



QUICK AND EASY HARDWIRE INSTALLATION



Black



120V voltage



Damp locations



NUMBER OF LIGHTS

2, 3, 4, 5



AVAILABLE POWER

12W - 28W



COLOR SELECTABLE

2 700K - 6 000K



VANITY LIGHT & MINI-PENDANT

ASD-VF27 VANITY LIGHT
ASD-MP27 MINI-PENDANT



DURABLE HOUSING RESISTANT TO RUST AND IMPACT



STANDARD E26 BASE IS COMPATIBLE WITH A VARIETY OF LED BULBS



CLEAR GLASS SHADES WITH EVEN LIGHT DISTRIBUTION



QUICK AND EASY HARDWIRE INSTALLATION



120V voltage



Damp locations



NUMBER OF BULBS

1, 2, 3, 4



STANDARD BASE

E26



BULB TYPE

A19



VANITY LIGHT & MINI-PENDANT

ASD-VF44 VANITY LIGHT
ASD-MP44 MINI-PENDANT



 DURABLE HOUSING RESISTANT TO RUST AND IMPACT

 STANDARD E26 BASE IS COMPATIBLE WITH A VARIETY OF LED BULBS

 Nickel

 OPAL GLASS SHADES WITH EVEN LIGHT DISTRIBUTION

 QUICK AND EASY HARDWIRE INSTALLATION

 Black

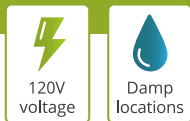

 NUMBER OF BULBS
1, 2, 3, 4

 STANDARD BASE
E26

 BULB TYPE
A19

VANITY LIGHT & MINI-PENDANT

ASD-VF45 VANITY LIGHT
ASD-MP45 MINI-PENDANT



 DURABLE HOUSING RESISTANT TO RUST AND IMPACT

 STANDARD E26 BASE IS COMPATIBLE WITH A VARIETY OF LED BULBS

 OPAL GLASS SHADES WITH EVEN LIGHT DISTRIBUTION

 QUICK AND EASY HARDWIRE INSTALLATION



 NUMBER OF BULBS
1, 2, 3

 STANDARD BASE
E26

 BULB TYPE
A19

LED WALL SCONCE LOFT

ASD-LOFT-WS



DURABLE HOUSING RESISTANT TO RUST AND IMPACT



5 COLOR TEMPERATURE OPTIONS



Nickel



ACRYLIC LENS WITH EVEN LIGHT DISTRIBUTION



SEAMLESS DIMMING TO ADJUST BRIGHTNESS LEVEL AND SAVE ENERGY



Black

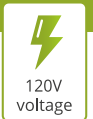

120V voltage



Damp locations



PRODUCT SIZES

12"



AVAILABLE POWER

15W



COLOR SELECTABLE

2 700K - 5 000K



[i](#) 138 INFO PAGE

LED WALL SCONCE

ASD-LWS-11



DURABLE HOUSING RESISTANT TO RUST AND IMPACT



3 COLOR TEMPERATURE OPTIONS



Nickel



Bronze



ACRYLIC LENS WITH EVEN LIGHT DISTRIBUTION



SEAMLESS DIMMING TO ADJUST BRIGHTNESS LEVEL AND SAVE ENERGY



Black

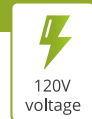

120V voltage



Damp locations



PRODUCT SIZES

10"



AVAILABLE POWER

15W



COLOR SELECTABLE

3 000K - 5 000K



[i](#) 138 INFO PAGE

LED WALL SCONCE

ASD-LWS12



IDEAL FOR APARTMENTS AND HOTELS



5 COLOR TEMPERATURE OPTIONS



Nickel



ACRYLIC LENS WITH EVEN LIGHT DISTRIBUTION



SEAMLESS DIMMING TO ADJUST BRIGHTNESS LEVEL AND SAVE ENERGY



Black



120V voltage



Damp locations



PRODUCT SIZES

12"



AVAILABLE POWER

12W



COLOR SELECTABLE

2 700K - 5 000K



LED UNDER CABINET BULLNOSE

ASD-UBN



ON/OFF SWITCH



5 COLOR TEMPERATURE OPTIONS



CRI90+ RICH AND NATURAL COLORS



QUICK AND EASY HARDWIRE AND PLUG-IN INSTALLATION



120V voltage



Damp locations



PRODUCT SIZES

9", 12", 18", 24",
32", 40", 48"



AVAILABLE POWER

4W - 24W



COLOR SELECTABLE

2 700K - 5 000K



LED UNDER CABINET LINEAR

ASD-UCL



End-to-end connector Linking Cord 6 inch Power Cord 6 ft

HI / LOW SWITCH PROVIDES 100% AND 50% BRIGHTNESS LEVELS

3 COLOR TEMPERATURE OPTIONS

CRI90+ RICH AND NATURAL COLORS

QUICK AND EASY HARDWARE AND PLUG-IN INSTALLATION



PRODUCT SIZES
9", 12", 18", 24", 32", 40", 48"

AVAILABLE POWER
3W - 24W

COLOR SELECTABLE
2 700K - 4 000K

LED UNDER CABINET SWIVEL

ASD-UCS



End-to-end connector Linking Cord 6 inch Power Cord 6 ft

SWIVEL LENS WITH 50° TILT FOR DIRECTIONAL LIGHT CONTROL

3 COLOR TEMPERATURE OPTIONS

CRI90+ RICH AND NATURAL COLORS

QUICK AND EASY HARDWARE AND PLUG-IN INSTALLATION

White

Bronze

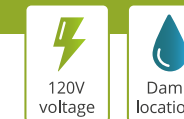

PRODUCT SIZES
9", 12", 18", 24", 32", 40", 48"

AVAILABLE POWER
3W - 24W

COLOR SELECTABLE
2 700K - 4 000K

LED STEP LIGHT HORIZONTAL

ASD-LSTL
ASD-STLA-RGB



 **LOW-PROFILE DESIGN WITH NO VISIBLE HARDWARE**

 **3 COLOR TEMPERATURE OPTIONS**

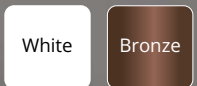

 **DURABLE HOUSING RESISTANT TO RUST AND IMPACT**

 **WATERPROOF FOR ALL WEATHER CONDITIONS**



 **AVAILABLE POWER**
3W

 **COLOR SELECTABLE**
3 000K - 5 000K



 **BUILT-IN PHOTOCELL**
ASD-LSTL-PC

 BUILT-IN DUSK TO DAWN PHOTOCELL

 AUTOMATICALLY SWITCHES ON/OFF DEPENDING ON THE TIME OF DAY

 **BUILT-IN MOTION SENSOR**
ASD-LSTL-MS

 AUTOMATICALLY SWITCHES ON/OFF

 FIELD INSTALLATION

 **BUILT-IN PHOTOCELL & MOTION SENSOR**
ASD-LSTL-PC-MS

 BUILT-IN DUSK TO DAWN PHOTOCELL

 AUTOMATICALLY SWITCHES ON/OFF

 FIELD INSTALLATION

 **RGBW LIGHTING**
ASD-STLA-RGB

 RGBW DESIGN WITH 16.7 MILLION COLORS

 CONTROLLED BY SMART APP ON YOUR SMARTPHONE

 COMPATIBLE WITH ALEXA AND GOOGLE ASSISTANT



LED SWIVEL HARDSCAPE LIGHT

ASD-HSLS



LED SWIVEL HARDSCAPE LIGHT WITH RGBW

ASD-HSLS-RGB



 12V
LOW-VOLTAGE DESIGN

 5 COLOR
TEMPERATURE OPTIONS

 CONTROLLED BY SMART APP
ON YOUR SMARTPHONE

 SWIVEL LIGHT HEAD
WITH 90° TILT

 CUTTABLE
MOUNTING PLATE

 CUTTABLE
MOUNTING PLATE



RGBW DESIGN
WITH 16.7 MILLION COLORS

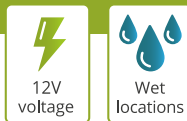

 PRODUCT
SIZES
4", 7", 12"

 AVAILABLE
POWER
2W, 4.5W, 5W

 COLOR
SELECTABLE
2 200K - 5 000K

 PRODUCT
SIZES
4", 7", 12"

 AVAILABLE
POWER
1.5W, 3W, 5W

 COLOR
SELECTABLE
2 700K - 6 500K





LED OUTDOOR WALL SCONCE

ASD-OLWS-21



 DURABLE HOUSING RESISTANT TO RUST AND IMPACT

 3 COLOR TEMPERATURE OPTIONS

 Nickel  Bronze

 UV RESISTANT PMMA LENS WITH EVEN LIGHT DISTRIBUTION

 WATERPROOF FOR ALL WEATHER CONDITIONS

 Black



 **PRODUCT SIZES**
10", 18", 24", 36"

 **AVAILABLE POWER**
15W, 20W, 25W, 30W

 **COLOR SELECTABLE**
3 000K - 5 000K

LED OUTDOOR WALL SCONCE

ASD-OLWS-22



 DURABLE HOUSING RESISTANT TO RUST AND IMPACT

 3 COLOR TEMPERATURE OPTIONS

 Bronze

 UV RESISTANT PMMA LENS WITH EVEN LIGHT DISTRIBUTION

 WATERPROOF FOR ALL WEATHER CONDITIONS

 Black

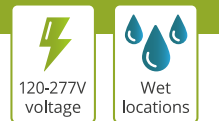

 **PRODUCT SIZES**
12", 18", 24", 36"

 **AVAILABLE POWER**
15W, 20W, 23W, 28W

 **COLOR SELECTABLE**
3 000K - 5 000K

LED OUTDOOR WALL SCONCE

ASD-OLWS-23



LED OUTDOOR WALL SCONCE

ASD-LWS26S
ASD-LWS26S-RGBWC
WITH RGBWC



DURABLE HOUSING RESISTANT TO RUST AND IMPACT



3 COLOR TEMPERATURE OPTIONS



UV RESISTANT PMMA LENS WITH EVEN LIGHT DISTRIBUTION



WATERPROOF FOR ALL WEATHER CONDITIONS



DURABLE HOUSING RESISTANT TO RUST AND IMPACT



RGBW DESIGN WITH RED, GREEN, BLUE, WARM WHITE AND DAYLIGHT WHITE COLORS



CLEAR SEEDED GLASS FOR LUXURIOUS GLOW



COLOR IS CONTROLLED BY A SIMPLE SWITCH ON THE BOTTOM OF THE FIXTURE



PRODUCT SIZES

8", 14"



AVAILABLE POWER

12W, 20W



COLOR SELECTABLE

3 000K - 5 000K



120V voltage



Wet locations



Photocell



PRODUCT SIZES

13", 18", 24"



AVAILABLE POWER

8.5W, 11.5W, 20W



COLOR SELECTABLE

3 000K - 5 000K



120V voltage



Wet locations



Photocell



120-277V voltage



RGB

LED OUTDOOR WALL SCONCE

ASD-LWS27A
ASD-LWS27A-RGB
WITH RGBW



LED OUTDOOR NARROW WALL SCONCE

ASD-LWS27N
ASD-LWS27N-RGB
WITH RGBW



 RGBW DESIGN WITH 16.7 MILLION COLORS

 OPERATE ON 120-277V CIRCUITS



 NARROW DESIGN

 OPERATE ON 120-277V CIRCUITS



 DURABLE HOUSING RESISTANT TO RUST AND IMPACT

 2.75" OR 3.5" MOUNTING HOLES FOR STANDARD OUTLET BOX INSTALLATION



 RGBW DESIGN WITH 16.7 MILLION COLORS

 2.75" OR 3.5" MOUNTING HOLES FOR STANDARD OUTLET BOX INSTALLATION



 **PRODUCT SIZES**
18", 24", 36", 48", 72"

 **AVAILABLE POWER**
18W - 40W

 **COLOR SELECTABLE**
3 000K - 5 000K

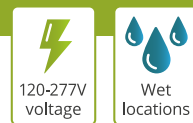

 **PRODUCT SIZES**
18", 24", 36", 48", 72"

 **AVAILABLE POWER**
18W - 40W

 **COLOR SELECTABLE**
3 000K - 5 000K

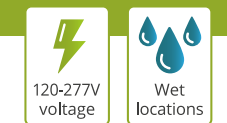

LED OUTDOOR BACK-LIGHT WALL SCONCE

ASD-LWS27B
ASD-LWS27B-RGB
WITH RGBW

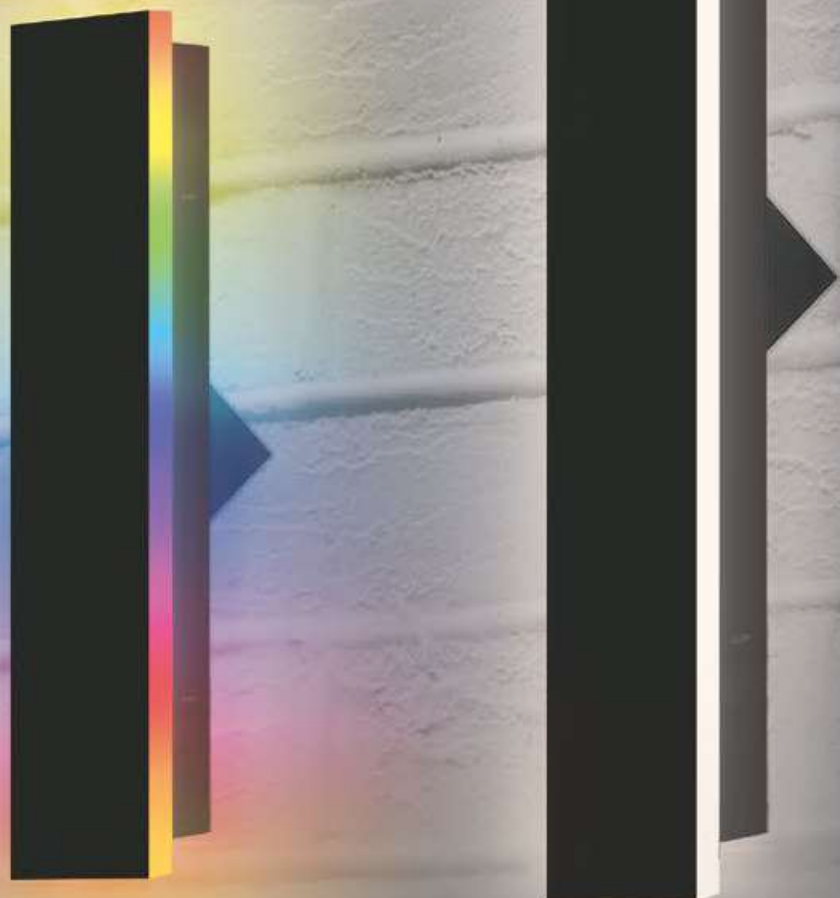

 BACK-LIGHT DESIGN

 OPERATE ON 120-277V CIRCUITS

 ASD APP

 RGBW DESIGN WITH 16.7 MILLION COLORS



 2.75" OR 3.5" MOUNTING HOLES FOR STANDARD OUTLET BOX INSTALLATION

works with 

 PRODUCT SIZES
18", 24", 36", 48", 72"

 AVAILABLE POWER
18W - 40W

 COLOR SELECTABLE
3 000K - 5 000K

 120-277V voltage
 Wet locations



LED OUTDOOR WALL SCONCE WITH CENTRAL LIGHT

ASD-LWS27C



 DURABLE HOUSING RESISTANT TO RUST AND IMPACT

 2.75" MOUNTING HOLES FOR STANDARD OUTLET BOX INSTALLATION



 OPERATE ON 120-277V CIRCUITS

 3 COLOR TEMPERATURE OPTIONS

 PRODUCT SIZES
18", 24", 36", 48", 72"

 AVAILABLE POWER
18W - 40W

 COLOR SELECTABLE
3 000K - 5 000K

 120-277V voltage
 Wet locations

LED OUTDOOR WALL SCONCE

ASD-LWS28S



MULTIDIRECTIONAL ILLUMINATION



3 COLOR TEMPERATURE OPTIONS



CLEAR SEEDED GLASS FOR LUXURIOUS GLOW



WATERPROOF FOR ALL WEATHER CONDITIONS

LED OUTDOOR WALL CYLINDER WITH RGBW

ASD-LCLR2-RGBW



CONTROLLED BY SMART APP ON YOUR SMARTPHONE



CUTTABLE MOUNTING PLATE



RGBW DESIGN WITH 16.7 MILLION COLORS



PRODUCT SIZES
12", 18", 24"



AVAILABLE POWER
22W



COLOR SELECTABLE
3 000K - 5 000K



120V voltage



Wet locations



120-277V voltage



LIGHT DIRECTION
2 sides



AVAILABLE POWER
30W



COLOR SELECTABLE
2 700K - 6 500K



120V voltage



Wet locations



RGBW

LED OUTDOOR WALL CYLINDER

ASD-LCLR ROUND
ASD-LCLS SQUARE



 EFFECTIVE UP / DOWN ILLUMINATION

 3 COLOR TEMPERATURE OPTIONS

Bronze

 DURABLE HOUSING RESISTANT TO RUST AND IMPACT

 WATERPROOF FOR ALL WEATHER CONDITIONS



Black

 LIGHT DIRECTION
1 side, 2 sides

 AVAILABLE POWER
9W, 18W

 COLOR TEMPERATURE
3CCT, 3 000K, 5 000K

 120V voltage
 Wet locations
 Battery Back-up

 120-277V voltage
 Photocell

 **BUILT-IN BATTERY BACK-UP**
ASD-OLCLR-EM

 90 MINUTES OF WORKING IN EMERGENCY MODE

 ILLUMINATED TEST SWITCH

 **BUILT-IN PHOTOCELL**
ASD-LCLR-PC, ASD-LCLS-PC

 BUILT-IN DUSK TO DAWN PHOTOCELL

 AUTOMATICALLY SWITCHES ON/OFF DEPENDING ON THE TIME OF DAY

 **CCT SELECTABLE**

 3CCT 3 COLOR TEMPERATURE OPTIONS

 EASILY ADJUSTABLE VIA DIP SWITCH



BULB OUTDOOR WALL CYLINDER

ASD-OCLR ROUND
ASD-OCLS SQUARE



 EFFECTIVE UP / DOWN ILLUMINATION

 STANDARD E26 BASE

 White

 DURABLE HOUSING RESISTANT TO RUST AND IMPACT

 WATERPROOF FOR ALL WEATHER CONDITIONS

 Black

 120V voltage  Wet locations  Photocell

 LIGHT DIRECTION
1 side, 2 sides

 MAXIMUM BULB WATTAGE
60W

 BULB TYPE
A19

BULB OUTDOOR WALL CYLINDER WITH DECORATIVE RINGS

ASD-OCLR-B ROUND
ASD-OCLS-B SQUARE



 DECORATIVE RINGS WITH SIDE-LIGHT EFFECT

 STANDARD E26 BASE

 EFFECTIVE UP / DOWN ILLUMINATION

 WATERPROOF FOR ALL WEATHER CONDITIONS

 120V voltage  Wet locations

 LIGHT DIRECTION
1 side, 2 sides

 MAXIMUM BULB WATTAGE
60W

 BULB TYPE
A19



LED LINEAR HIGH BAY WITH Q-BASE

ASD-WHB5B

Model	Size	Watts	Input Voltage	Dimmable	CCT	Lm	Dimensions LxWxH	Pcs. per Carton	Certification
ASD-WHB5B-100A50	14"	60/80/100	120-277	0-10 V	5,000	15,386	14-15/16" x 9-13/16" x 2-15/16"	1	UL / DLC PRM
ASD-WHB5B-160A50	14"	100/130/160	120-277	0-10 V	5,000	24,842	14-15/16" x 9-13/16" x 2-15/16"	1	UL / DLC PRM
ASD-WHB5B-220A50	17"	130/160/220	120-277	0-10 V	5,000	35,342	17-11/16" x 12-7/16" x 2-15/16"	1	UL / DLC PRM
ASD-WHB5B-320A50	20"	160/220/320	120-277	0-10 V	5,000	50,848	20-1/2" x 14-7/16" x 3-1/4"	1	UL / DLC PRM
ASD-WHB5B-500A50	35"	320/400/500	120-277	0-10 V	5,000	75,905	35-1/2" x 12-7/16" x 2-15/16"	1	UL / DLC PRM

ACCESSORIES

Infrared motion sensor 39ft 12V White	ASD-09IR-WH	2-1/8" x 2-1/8" x 1-11/16"	120	UL
Infrared motion sensor 50ft 12V White	ASD-09IR50-WH	2-1/8" x 2-1/8" x 1-11/16"	120	UL
Microwave motion sensor 49ft 12V White	ASD-09MW-WH	2-1/8" x 2-1/8" x 1-5/16"	120	UL
Remote control for Motion Sensor	ASD-06RC	5-11/16" x 1-3/4" x 13/16"	60	-
NLS Infrared motion sensor 39ft 12V White	ASD-09IR-NLS-WH	2-1/8" x 2-1/8" x 1-11/16"	120	UL
NLS Microwave motion sensor 49ft 12V White	ASD-09MW-NLS-WH	2-1/8" x 2-1/8" x 1-3/8"	120	UL
Remote control for Motion Sensor NLS	ASD-06RC-NLS	5-11/16" x 1-3/4" x 13/16"	60	-
Battery back-up kit 20W for 220-500W	ASD-EMK20W-WHB5B	9-5/8" x 4-5/8" x 1-7/8"	10	-
Battery back-up kit 30W for 220-500W	ASD-EMK30W-WHB5A	9-5/8" x 4-5/8" x 1-7/8"	10	-
Pendant Mounting Bracket for 100/160/220W	ASD-PMB1-WHB5	4" x 3-11/16" x 3-1/8"	50	-
Surface mount Bracket	ASD-SMB1-WHB5	4" x 3-11/16" x 3-1/16"	50	-



LED LINEAR HIGH BAY WITH Q-BASE PRO series

ASD-WHB5B-PRO

Model	Size	Watts	Input Voltage	Dimmable	CCT	Lm	Dimensions LxWxH	Pcs. per Carton	Certification
ASD-WHB5B-PRO-100	14"	60/80/100	120-277	0-10 V	3,500/4,000/5,000	16,366	14-15/16" x 9-13/16" x 2-15/16"	1	UL / DLC PRM
ASD-WHB5B-PRO-160	14"	100/130/160	120-277	0-10 V	3,500/4,000/5,000	25,521	14-15/16" x 9-13/16" x 2-15/16"	1	UL / DLC PRM
ASD-WHB5B-PRO-220	17"	130/160/220	120-277	0-10 V	3,500/4,000/5,000	36,274	17-11/16" x 12-7/16" x 2-15/16"	1	UL / DLC PRM
ASD-WHB5B-PRO-320	20"	160/220/320	120-277	0-10 V	3,500/4,000/5,000	52,194	20-1/2" x 14-7/16" x 3-1/4"	1	UL / DLC PRM
ASD-WHB5B-PRO-500	35"	320/400/500	120-277	0-10 V	3,500/4,000/5,000	76,668	35-1/2" x 12-7/16" x 2-15/16"	1	UL / DLC PRM

HIGH VOLTAGE

ASD-WHB5BHV-PRO-220	17"	130/160/220	277-480	0-10 V	3,500/4,000/5,000	36,031	17-11/16" x 12-7/16" x 2-15/16"	1	UL / DLC PRM
ASD-WHB5BHV-PRO-320	20"	160/220/320	277-480	0-10 V	3,500/4,000/5,000	51,322	20-1/2" x 14-7/16" x 3-1/4"	1	UL / DLC PRM

WITH BATTERY BACK-UP

ASD-WHB5B-PRO-160-40EM	14"	100/130/160	120-277	0-10 V	3,500/4,000/5,000	25,522	14-15/16" x 9-13/16" x 2-15/16"	1	UL / DLC PRM
ASD-WHB5B-PRO-220-40EM	17"	130/160/220	120-277	0-10 V	3,500/4,000/5,000	36,274	17-11/16" x 12-7/16" x 2-15/16"	1	UL / DLC PRM
ASD-WHB5B-PRO-320-40EM	20"	160/220/320	120-277	0-10 V	3,500/4,000/5,000	52,194	20-1/2" x 14-7/16" x 3-1/4"	1	UL / DLC PRM

ACCESSORIES

Infrared motion sensor 39ft 12V White	ASD-09IR-WH	2-1/8" x 2-1/8" x 1-11/16"	120	UL
Infrared motion sensor 50ft 12V White	ASD-09IR50-WH	2-1/8" x 2-1/8" x 1-11/16"	120	UL
Microwave motion sensor 49ft 12V White	ASD-09MW-WH	2-1/8" x 2-1/8" x 1-5/16"	120	UL
Remote control for Motion Sensor	ASD-06RC	5-11/16" x 1-3/4" x 13/16"	60	-
NLS Infrared motion sensor 39ft 12V White	ASD-09IR-NLS-WH	2-1/8" x 2-1/8" x 1-11/16"	120	UL
NLS Microwave motion sensor 49ft 12V White	ASD-09MW-NLS-WH	2-1/8" x 2-1/8" x 1-3/8"	120	UL
Remote control for Motion Sensor NLS	ASD-06RC-NLS	5-11/16" x 1-3/4" x 13/16"	60	-
Battery back-up kit 20W for 220-500W	ASD-EMK20W-WHB5B	9-5/8" x 4-5/8" x 1-7/8"	10	-
Battery back-up kit 30W for 220-500W	ASD-EMK30W-WHB5A	9-5/8" x 4-5/8" x 1-7/8"	10	-
Pendant Mounting Bracket for 100/160/220W	ASD-PMB1-WHB5	4" x 3-11/16" x 3-1/8"	50	-
Surface mount Bracket	ASD-SMB1-WHB5	4" x 3-11/16" x 3-1/16"	50	-



LED UFO HIGH BAY WITH Q-BASE

ASD-UHB2A

Model	Watts	Input Voltage	Dimmable	CCT	Lm	Finish	Dimensions DxH	Pcs. per Carton	Certification
ASD-UHB2A-150A50-BK	100/120/150	120-277	0-10V	5,000	23,013	Black	11" x 6-3/4"	1	UL / DLC PRM
ASD-UHB2A-200A50-BK	100/150/200	120-277	0-10V	5,000	30,978	Black	11" x 6-3/4"	1	UL / DLC PRM
ASD-UHB2A-200A50-WH	100/150/200	120-277	0-10V	5,000	30,978	White	11" x 6-3/4"	1	UL / DLC PRM
ASD-UHB2A-240A50-BK	150/200/240	120-277	0-10V	5,000	37,120	Black	12-5/8" x 6-3/4"	1	UL / DLC PRM
ASD-UHB2A-300A50-BK	200/240/300	120-277	0-10V	5,000	45,148	Black	12-5/8" x 7-15/16"	1	UL / DLC PRM

ACCESSORIES

Infrared motion sensor 39ft 12V	ASD-09IR-WH	White	2-1/8" x 2-1/8" x 1-11/16"	120	UL
Infrared motion sensor 39ft 12V	ASD-09IR-BK	Black	2-1/8" x 2-1/8" x 1-11/16"	120	UL
Infrared motion sensor 50ft 12V	ASD-09IR50-WH	White	2-1/8" x 2-1/8" x 1-11/16"	120	UL
Microwave motion sensor 49ft 12V	ASD-09MW-WH	White	2-1/8" x 2-1/8" x 1-5/16"	120	UL
Microwave motion sensor 49ft 12V	ASD-09MW-BK	Black	2-1/8" x 2-1/8" x 1-5/16"	120	UL
Remote control for Motion Sensor	ASD-06RC	-	5-11/16" x 1-3/4" x 13/16"	60	-
NLS Infrared motion sensor 39ft 12V	ASD-09IR-NLS-WH	White	2-1/8" x 2-1/8" x 1-11/16"	120	UL
NLS Microwave motion sensor 49ft 12V	ASD-09MW-NLS-WH	White	2-1/8" x 2-1/8" x 1-3/8"	120	UL
Remote control for Motion Sensor NLS	ASD-06RC-NLS	-	5-11/16" x 1-3/4" x 13/16"	60	-
Battery Back-up 40W for 120-277V & 100-300W	BLD-RM40R	-	15-11/16" x 15-11/16" x 5-9/16"	4	UL
Battery Back-up 60W with two hooks for 120-277V	BLD-RM60R	-	15-11/16" x 5-3/4" x 5-3/4"	4	UL
Remote Control for Battery Back-up	RN1	-	5-1/8" x 1-1/4" x 5/8"	50	-
NLS Battery back-up kit 40W for 120-277V	ASD-EMB40-NLS	-	8-3/8" x 5-3/16" x 4-13/16"	6	UL
NLS Gateway (Bluetooth, ZigBee, WiFi) for NLS sensors and EM Battery	ASD-G02-NLS	-	4-1/4" x 5-3/16" x 1-1/16"	4	UL
Spring Hook M10 for 100-240W	ASD-H-M10	-	3-5/16" x 2-1/16" x 7/8"	50	-
Spring Hook M12 for 300W	ASD-H-M12	-	3-1/2" x 2-5/16" x 1"	50	-
Screw-bolt Hook M10 for 100-240W	ASD-HS-M10	-	3-7/8" x 1-5/8" x 1-5/16"	50	-
Pendant Mount Bracket	ASD-PMB-UHB	Black	2-3/8" x 1-9/16" x 2-13/16"	50	-
Pendant Mount Bracket with J-box and Spring hook for 100/300 W	ASD-PMBJB-UHB	Black	4-3/4" x 5-1/16" x 7-3/16"	20	-
Surface mount Bracket for 150-300W	ASD-SMB-UHB2A-BK	Black	10-5/8" x 10-5/8" x 8-1/4"	20	-
Surface mount Bracket for 150-300W	ASD-SMB-UHB2A-WH	White	10-5/8" x 10-5/8" x 8-1/4"	20	-
Polycarbonate Reflector 16" 90° for 150-200W	ASD-DUHB2A-A16PC	Clear	16-5/16" x 16-5/16" x 6"	10	-
Polycarbonate Reflector 16" 90° for 240-300W	ASD-DUHB2A-B16PC	Clear	16-5/16" x 16-5/16" x 5-1/8"	10	-
Polycarbonate Bottom Conical Lens for 16"	ASD-BLUHB2A-AB	Clear	15-15/16" x 15-15/16" x 1-3/4"	20	-





LED UFO HIGH BAY WITH Q-BASE PRO series

ASD-UHB2A-PRO

Model	Watts	Input Voltage	Dimmable	CCT	Lm	Dimensions DxH	Pcs. per Carton	Certification
ASD-UHB2A-PRO-150-BK	100/120/150	120-277	0-10V	3,000/4,000/5,000	22,951	11" x 6-3/4"	1	UL / DLC PRM
ASD-UHB2A-PRO-200-BK	100/150/200	120-277	0-10V	3,000/4,000/5,000	29,648	11" x 6-3/4"	1	UL / DLC PRM
ASD-UHB2A-PRO-240-BK	150/200/240	120-277	0-10V	3,000/4,000/5,000	36,681	12-5/8" x 6-3/4"	1	UL / DLC PRM
ASD-UHB2A-PRO-300-BK	200/240/300	120-277	0-10V	3,000/4,000/5,000	44,273	12-5/8" x 7-15/16"	1	UL / DLC PRM
ASD-UHB2A-PRO-500-BK	300/400/500	120-277	0-10V	3,000/4,000/5,000	76,843	14-9/16" x 10-1/16"	1	UL / DLC PRM

HIGH VOLTAGE

ASD-UHB2AHV-PRO-150-BK	100/120/150	277-480	0-10V	3,000/4,000/5,000	22,951	11" x 6-7/8"	1	UL / DLC PRM
ASD-UHB2AHV-PRO-200-BK	100/150/200	277-480	0-10V	3,000/4,000/5,000	29,648	11" x 6-7/8"	1	UL / DLC PRM
ASD-UHB2AHV-PRO-240-BK	150/200/240	277-480	0-10V	3,000/4,000/5,000	36,681	12-5/8" x 6-7/8"	1	UL / DLC PRM
ASD-UHB2AHV-PRO-300-BK	200/240/300	277-480	0-10V	3,000/4,000/5,000	44,273	12-5/8" x 7-3/8"	1	UL / DLC PRM
ASD-UHB2AHV-PRO-500-BK	300/400/500	277-480	0-10V	3,000/4,000/5,000	76,843	14-9/16" x 10-1/16"	1	UL / DLC PRM

ACCESSORIES

Infrared motion sensor 39ft 12V	ASD-09IR-WH	White	2-1/8" x 2-1/8" x 1-11/16"	120	UL
Infrared motion sensor 39ft 12V	ASD-09IR-BK	Black	2-1/8" x 2-1/8" x 1-11/16"	120	UL
Infrared motion sensor 50ft 12V	ASD-09IR50-WH	White	2-1/8" x 2-1/8" x 1-11/16"	120	UL
Microwave motion sensor 49ft 12V	ASD-09MW-WH	White	2-1/8" x 2-1/8" x 1-5/16"	120	UL
Microwave motion sensor 49ft 12V	ASD-09MW-BK	Black	2-1/8" x 2-1/8" x 1-5/16"	120	UL
Remote control for Motion Sensor	ASD-06RC	-	5-11/16" x 1-3/4" x 13/16"	60	-
NLS Infrared motion sensor 39ft 12V	ASD-09IR-NLS-WH	White	2-1/8" x 2-1/8" x 1-11/16"	120	UL
NLS Microwave motion sensor 49ft 12V	ASD-09MW-NLS-WH	White	2-1/8" x 2-1/8" x 1-3/8"	120	UL
Remote control for Motion Sensor NLS	ASD-06RC-NLS	-	5-11/16" x 1-3/4" x 13/16"	60	-
Battery Back-up 40W for 120-277V & 100-300W	BLD-RM40R	-	15-11/16" x 15-11/16" x 5-9/16"	4	UL
Battery Back-up 60W with two hooks for 120-277V	BLD-RM60R	-	15-11/16" x 5-3/4" x 5-3/4"	4	UL
Battery Back-up 60W with Bracket, J-box, Ring, Hook for 277-480V	BLD-GM60R-HV	-	14-1/2" x 3-1/16" x 1-7/8"	5	UL
Remote Control for Battery Back-up	RN1	-	5-1/8" x 1-1/4" x 5/8"	50	-
NLS Battery back-up kit 40W for 120-277V	ASD-EMB40-NLS	-	8-3/8" x 5-3/16" x 4-13/16"	6	UL
NLS Gateway (Bluetooth, ZigBee, WiFi) for NLS sensors and EM Battery	ASD-G02-NLS	-	4-1/4" x 5-3/16" x 1-1/16"	4	UL
Spring Hook M10 for 100-240W	ASD-H-M10	-	3-5/16" x 2-1/16" x 7/8"	50	-
Spring Hook M12 for 300W	ASD-H-M12	-	3-1/2" x 2-5/16" x 1"	50	-
Screw-bolt Hook M10 for 100-240W	ASD-HS-M10	-	3-7/8" x 1-5/8" x 1-5/16"	50	-
Pendant Mount Bracket	ASD-PMB-UHB	Black	2-3/8" x 1-9/16" x 2-13/16"	50	-
Pendant Mount Bracket with J-box and Spring hook for 100/300 W	ASD-PMBJB-UHB	Black	4-3/4" x 5-1/16" x 7-3/16"	20	-
Surface mount Bracket for 150-300W	ASD-SMB-UHB2A-BK	Black	10-5/8" x 10-5/8" x 8-1/4"	20	-
Polycarbonate Reflector 16" 90° for 150-200W	ASD-DUHB2A-A16PC	Clear	16-5/16" x 16-5/16" x 6"	10	-
Polycarbonate Reflector 16" 90° for 240-300W	ASD-DUHB2A-B16PC	Clear	16-5/16" x 16-5/16" x 5-1/8"	10	-
Polycarbonate Bottom Conical Lens for 16"	ASD-BLUHB2A-AB	Clear	15-15/16" x 15-15/16" x 1-3/4"	20	-



NSF LED UFO HIGH BAY

ASD-UFS-PRO

Model	Watts	Input Voltage	Dimmable	CCT	Lm	Dimensions DxH	Pcs. per Carton	Certification
ASD-UFS-PRO-200	100/150/200	120-277	0-10 V	3,000/4,000/5,000	31,503	16-15/16" x 5-5/8"	1	NSF / UL / DLC PRM
ASD-UFS-PRO-300	200/240/300	120-277	0-10 V	3,000/4,000/5,000	45,444	16-15/16" x 5-5/8"	1	NSF / UL / DLC PRM

LED WRAP FIXTURE

ASD-WRL



Model	Size	Watts	Input Voltage	Dimmable	CCT	Lm	Dimensions LxWxH	Pcs. per Carton	Certification
ASD-WRL-4A48AC	4 ft	32/40/48	120-277	0-10 V	3,500/4,000/5,000	5,583	47-5/8" x 5-5/16" x 2-1/8"	4	UL / DLC STD

LED WRAP FIXTURE

ASD-WRL



Model	Size	Watts	Input Voltage	Dimmable	CCT	Lm	Dimensions LxWxH	Pcs. per Carton	Certification
ASD-WRL2-4A45AC	4 ft	34/38/45	120-277	0-10 V	3,500/4,000/5,000	6,312	46" x 9-3/4" x 3-7/16"	1	UL / DLC STD

LED SEAMLESS VAPOR PROOF FIXTURE

ASD-LVP2SM



Model	Size	Watts	Input Voltage	Dimmable	CCT	Lm	Dimensions LxWxH	Pcs. per Carton	Certification
ASD-LVP2SM-4A56AC	4 ft	32/48/56	120-277	0-10 V	3,500/4,000/5,000	7,253	48-1/8" x 3-9/16" x 3-1/8"	9	UL / DLC STD
ASD-LVP2SM-8A120AC	8 ft	64/96/120	120-277	0-10 V	3,500/4,000/5,000	17,359	94-3/4" x 3-9/16" x 3-1/8"	6	UL / DLC STD

WITH BATTERY BACK-UP

ASD-LVP2SM-4A56AC-EM	4 ft	32/48/56	120-277	0-10 V	3,500/4,000/5,000	7,140	48-1/8" x 3-9/16" x 3-1/8"	9	UL / DLC STD
ASD-LVP2SM-8A120AC-EM	8 ft	64/96/120	120-277	0-10 V	3,500/4,000/5,000	17,325	94-3/4" x 3-9/16" x 3-1/8"	6	UL / DLC STD

LED STRIPLIGHT FIXTURE

ASD-LSF5



Model	Size	Watts	Input Voltage	Dimmable	CCT	Lm	Dimensions LxWxH	Pcs. per Carton	Certification
ASD-LSF5-2A28AC-PRM	2 ft	20/24/28	120-277	0-10 V	3,500/4,000/5,000	3,890	26-3/16" x 2-5/8" x 2-11/16"	8	UL / DLC STD
ASD-LSF5-4A44AC-PRM	4 ft	22/28/36/44	120-277	0-10 V	3,500/4,000/5,000	5,853	46-5/8" x 2-5/8" x 2-11/16"	8	UL / DLC STD
ASD-LSF5-8A90AC-PRM	8 ft	48/68/90	120-277	0-10 V	3,500/4,000/5,000	12,534	92-13/16" x 2-5/8" x 2-11/16"	4	UL / DLC STD

WITH BATTERY BACK-UP

ASD-LSF5-2A28AC-4EM-PRM	2 ft	20/24/28	120-277	0-10 V	3,500/4,000/5,000	3,890	26-3/16" x 2-5/8" x 2-11/16"	8	UL / DLC STD
ASD-LSF5-4A44AC-12EM-PRM	4 ft	22/28/36/44	120-277	0-10 V	3,500/4,000/5,000	5,853	46-5/8" x 2-5/8" x 2-11/16"	8	UL / DLC STD
ASD-LSF5-8A90AC-EM-PRM	8 ft	48/68/90	120-277	0-10 V	3,500/4,000/5,000	12,534	92-13/16" x 2-5/8" x 2-11/16"	4	UL / DLC STD

STAIRWELL WITH MOTION SENSOR

ASD-LSF5-2A28AC-MS-SW	2 ft	20/24/28	120-277	0-10 V	3,500/4,000/5,000	3,890	26-3/16" x 2-5/8" x 2-11/16"	8	UL / DLC STD
ASD-LSF5-4A44AC-MS-SW	4 ft	22/28/36/44	120-277	0-10 V	3,500/4,000/5,000	5,853	46-5/8" x 2-5/8" x 2-11/16"	8	UL / DLC STD

Remote Control for Motion Sensor

ASD-RC-RC100	4-13/16" x 2-3/4" x 13/16"	50
--------------	----------------------------	----

STAIRWELL WITH MOTION SENSOR AND BATTERY BACK-UP

ASD-LSF5-4A44AC-12EM-MS-SW	4 ft	22/28/36/44	120-277	0-10 V	3,500/4,000/5,000	5,853	46-5/8" x 2-5/8" x 2-11/16"	8	UL / DLC STD
----------------------------	------	-------------	---------	--------	-------------------	-------	-----------------------------	---	--------------

Remote Control for Motion Sensor

ASD-RC-RC100	4-13/16" x 2-3/4" x 13/16"	50
--------------	----------------------------	----

ACCESSORIES

Connection bracket	ASD-CB-LSF5	5 1/4" x 2 3/4" x 11/16"	100
Wire Guard for 4 feet	ASD-WG4-LSF5	46-13/16" x 3-1/4" x 2-3/8"	8

LED STRIPLIGHT FIXTURE WITH Q-BASE

ASD-LSF7A



Model	Size	Watts	Input Voltage	Dimmable	CCT	Lm	Finish	Dimensions LxWxH	Pcs. per Carton	Certification
ASD-LSF7A-2A25	2 ft	15/20/25	120-277	0-10 V	3,500/4,000/5,000	3,137	White	22-3/16" x 2-13/16" x 3-1/16"	6	UL / DLC STD
ASD-LSF7A-4A40	4 ft	25/30/40	120-277	0-10 V	3,500/4,000/5,000	5,275	White	47-5/16" x 2-13/16" x 3-1/16"	6	UL / DLC STD
ASD-LSF7A-4A40-BK	4 ft	25/30/40	120-277	0-10 V	3,500/4,000/5,000	5,275	Black	47-5/16" x 2-13/16" x 3-1/16"	6	UL / DLC STD
ASD-LSF7A-8A90	8 ft	65/75/90	120-277	0-10 V	3,500/4,000/5,000	11,898	White	94-3/16" x 2-13/16" x 3-1/16"	4	UL / DLC STD
ASD-LSF7A-8A90-BK	8 ft	65/75/90	120-277	0-10 V	3,500/4,000/5,000	11,898	Black	94-3/16" x 2-13/16" x 3-1/16"	4	UL / DLC STD

HIGH VOLTAGE



ASD-LSF7AHV-4A40	4 ft	25/30/40	277-480	0-10 V	3,500/4,000/5,000	5,275	White	47-5/16" x 2-13/16" x 3-1/16"	6	UL / DLC STD
ASD-LSF7AHV-8A90	8 ft	65/75/90	277-480	0-10 V	3,500/4,000/5,000	12,020	White	94-3/16" x 2-13/16" x 3-1/16"	4	UL / DLC STD

WITH BATTERY BACK-UP



ASD-LSF7A-4A40-EM	4 ft	25/30/40	120-277	0-10 V	3,500/4,000/5,000	5,275	White	47-5/16" x 2-13/16" x 3-1/16"	6	UL / DLC STD
ASD-LSF7A-4A40-EM-BK	4 ft	25/30/40	120-277	0-10 V	3,500/4,000/5,000	5,275	Black	47-5/16" x 2-13/16" x 3-1/16"	6	UL / DLC STD
ASD-LSF7A-8A90-EM	8 ft	65/75/90	120-277	0-10 V	3,500/4,000/5,000	11,898	White	94-3/16" x 2-13/16" x 3-1/16"	4	UL / DLC STD
ASD-LSF7A-8A90-EM-BK	8 ft	65/75/90	120-277	0-10 V	3,500/4,000/5,000	11,898	Black	94-3/16" x 2-13/16" x 3-1/16"	4	UL / DLC STD

ACCESSORIES



Microwave Motion Sensor audio-jack base 12V	ASD-08MW-WH	2-5/8" x 3/4" x 1"	120
Remote Control for Motion Sensor	ASD-06RC	5-11/16" x 1-3/4" x 13/16"	60
Connection bracket	ASD-CB-LSF7	7-3/8" x 3-3/16" x 9/16"	24
Wire Guard for 4 feet	ASD-WG4-LSF7	47-1/16" x 3-3/8" x 2-1/16"	2

LED BACK-LIT FLAT PANEL

ASD-BLP



Model	Size	Watts	Input Voltage	Dimmable	CCT	Lm	Dimensions LxWxH	Pcs. per Carton	Certification
ASD-BLP-22A30-4P	2x2	20/25/30	120-277	0-10V	3,500/4,000/5,000	3,573	23-3/4" x 23-3/4" x 1-3/8"	1	UL / DLC PRM
ASD-BLP-24A40-4P	2x4	25/30/40	120-277	0-10V	3,500/4,000/5,000	5,025	47-3/4" x 23-3/4" x 1-3/8"	1	UL / DLC PRM
ASD-BLP-24A50-4P	2x4	30/40/50	120-277	0-10V	3,500/4,000/5,000	5,025	47-3/4" x 23-3/4" x 1-3/8"	1	UL / DLC PRM

WITH BATTERY BACK-UP

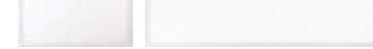

ASD-BLP-22A30-EM	2x2	20/25/30	120-277	0-10V	3,500/4,000/5,000	3,573	23-3/4" x 23-3/4" x 1-3/8"	4	UL / DLC PRM
ASD-BLP-24A40-EM	2x4	25/30/40	120-277	0-10V	3,500/4,000/5,000	5,025	47-3/4" x 23-3/4" x 1-3/8"	4	UL / DLC PRM

WITH MOTION SENSOR



ASD-BLP-22A30-MS	2x2	20/25/30	120-277	0-10V	3,500/4,000/5,000	3,573	23-3/4" x 23-3/4" x 1-3/8"	4	UL / DLC PRM
ASD-BLP-24A40-MS	2x4	25/30/40	120-277	0-10V	3,500/4,000/5,000	5,025	47-3/4" x 23-3/4" x 1-3/8"	4	UL / DLC PRM

NLS Microwave Motion Sensor magnet base 12V

ASD-M2MW-NLS	2-5/8" x 13/16" x 1/2"	120
--------------	------------------------	-----

ACCESSORIES



Surface mounting Low Frame for Panels 1x4	ASD-FELP14-L	48" x 12-1/8" x 1-15/16"	9
Surface mounting Low Frame for Panels 2x2	ASD-FELP22-L	24" x 23-15/16" x 1-15/16"	9
Surface mounting Low Frame for Panels 2x4	ASD-FELP24-L	48" x 23-15/16" x 1-15/16"	9

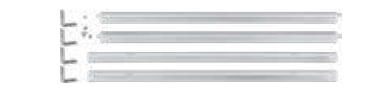

NLS LED BACK-LIT FLAT PANEL

ASD-BLP-SM, ASD-BLP-SM-RGBW

Model	Size	Watts	Input Voltage	Dimmable	CCT	Lm	Dimensions LxWxH	Pcs. per Carton	Certification
ASD-BLP-22D35SM-2P	2x2	35	120-277	WIFI	3,500-5,000	4,266	23-3/4" x 23-3/4" x 1-3/8"	1	UL / DLC PRM
ASD-BLP-24D40SM-2P	2x4	40	120-277	WIFI	3,500-5,000	4,924	47-3/4" x 23-3/4" x 1-3/8"	1	UL / DLC PRM

WITH RGBW

ASD-BLP-22D35SM-RGBW-2P	2x2	35	120-277	WIFI	2,700 - 6,500 + RGB	4,282	23-3/4" x 23-3/4" x 1-3/8"	1	UL
ASD-BLP-24D40SM-RGBW-2P	2x4	40	120-277	WIFI	2,700 - 6,500 + RGB	4,961	47-3/4" x 23-3/4" x 1-3/8"	1	UL

ACCESSORIES

Surface mounting Low Frame for Panels 1x4	ASD-FELP14-L	48" x 12-1/8" x 1-15/16"	9
Surface mounting Low Frame for Panels 2x2	ASD-FELP22-L	24" x 23-15/16" x 1-15/16"	9
Surface mounting Low Frame for Panels 2x4	ASD-FELP24-L	48" x 23-15/16" x 1-15/16"	9

LED TROFFER LIGHTS

ASD-LTR

Model	Size	Watts	Input Voltage	Dimmable	CCT	Lm	Dimensions LxWxH	Pcs. per Carton	Certification
ASD-LTR-22A30-2P	2x2	20/25/30	120-277	0-10V	3,500/4,000/5,000	3,909	23-3/4" x 23-3/4" x 2-1/8"	1	UL / DLC STD
ASD-LTR-24A45-2P	2x4	34/38/45	120-277	0-10V	3,500/4,000/5,000	6,028	47-3/4" x 23-3/4" x 2-1/8"	1	UL / DLC STD

WITH BATTERY BACK-UP

ASD-LTR-22A30-EM-2P	2x2	20/25/30	120-277	0-10V	3,500/4,000/5,000	3,909	23-3/4" x 23-3/4" x 2-1/8"	1	UL / DLC STD
ASD-LTR-24A45-EM-2P	2x4	34/38/45	120-277	0-10V	3,500/4,000/5,000	6,028	47-3/4" x 23-3/4" x 2-1/8"	1	UL / DLC STD

LED TROFFER KIT

ASD-LTRK

Model	Size	Watts	Input Voltage	Dimmable	CCT	Lm	Dimensions LxWxH	Pcs. per Carton	Certification
ASD-LTRK-22A30-2P	2x2	20/25/30	120-277	0-10V	3,500/4,000/5,000	3,909	23-7/8" x 23-7/8" x 3-1/8"	1	UL / DLC STD
ASD-LTRK-24A45-2P	2x4	34/38/45	120-277	0-10V	3,500/4,000/5,000	6,028	47-13/16" x 23-7/8" x 3-1/8"	1	UL / DLC STD

LED SQUARE COMMERCIAL DOWNLIGHT

ASD-CDL7S

Model	Size	Watts	Input Voltage	Dimmable	IC Rated	CCT	Lm	Finish	Dimensions DxH	Pcs. per Carton	Certification
ASD-CDL7S-6A30WH	6"	12/16/22/26/30	120-277	0-10 V	Yes	2,700/3,000/3,500/4,000/5,000	3,009	White	8-11/16" x 8-11/16" x 4-5/16"	8	ETL
ASD-CDL7S-8A35WH	8"	16/22/26/30/35	120-277	0-10 V	Yes	2,700/3,000/3,500/4,000/5,000	3,711	White	10-1/4" x 10-1/4" x 4-1/4"	4	ETL

ACCESSORIES

Battery back-up kit 8W	BLD-HM08D	10-7/16" x 1-15/16" x 15/16"	10	UL
Battery back-up kit 15W	BLD-HM15D	12-15/16" x 1-7/16" x 15/16"	10	UL
NLS Battery back-up kit 15W	ASD-EMA15-NLS	14-5/8" x 1-5/8" x 1-7/16"	10	UL
New Construction Flat Mounting Plate with Asymmetric Square holes 3-4-6"	ASD-MPLS-346-FA-6PACK	13-1/4" x 9-1/16" x 1/16"	4	-
New Construction Flat Mounting Plate with Asymmetric Square holes 8-10-12"	ASD-MPLS-81012-FA-6PACK	18-1/2" x 13-3/8" x 1/16"	4	-
New Construction Flat Mounting Plate with Symmetric Square holes 3-4-6"	ASD-MPLS-346-FS-6PACK	26" x 8-1/4" x 1/16"	4	-
New Construction Flat Mounting Plate with Symmetric Square holes 8-10-12"	ASD-MPLS-81012-FS-6PACK	26" x 13" x 1/16"	4	-
New Construction Mounting Plate with Square holes 3-4-6" and Sliding Clips	ASD-MPLS-346-SC-6PACK	14-3/8" x 10-9/16" x 1-5/8"	2	-



LED ROUND COMMERCIAL DOWNLIGHT

■ ASD-CDL7, ASD-CDL7R

Model	Size	Watts	Input Voltage	Dimmable	IC Rated	CCT	Lm	Finish	Dimensions DxH	Pcs. per Carton	Certification
ASD-CDL7-4DA13AC	4"	7/10/13	120-277	0-10 V	Yes	2,700/3,000/3,500/4,000/5,000	1,050	White	5-3/8" x 3-1/16"	8	UL / Energy Star
ASD-CDL7-6DA22AC	6"	10/15/22	120-277	0-10 V	Yes	2,700/3,000/3,500/4,000/5,000	1,850	White	8-1/4" x 4"	8	UL / Energy Star
ASD-CDL7-6DA22AC-BK	6"	10/15/22	120-277	0-10 V	Yes	2,700/3,000/3,500/4,000/5,000	1,850	Black	8-1/4" x 4"	8	UL / Energy Star
ASD-CDL7-6DA30AC	6"	20/25/30	120-277	0-10 V	No	2,700/3,000/3,500/4,000/5,000	2,487	White	8-1/4" x 4"	8	UL
ASD-CDL7R-6A30WH	6"	12/16/22/26/30	120-277	0-10 V	Yes	2,700/3,000/3,500/4,000/5,000	3,352	White	8-3/8" x 4-13/16"	8	ETL
ASD-CDL7-8DA30AC	8"	12/20/30	120-277	0-10 V	Yes	2,700/3,000/3,500/4,000/5,000	2,400	White	10-1/4" x 4-7/16"	4	UL / Energy Star
ASD-CDL7-8DA30AC-BK	8"	12/20/30	120-277	0-10 V	Yes	2,700/3,000/3,500/4,000/5,000	2,400	Black	10-1/4" x 4-7/16"	4	UL / Energy Star
ASD-CDL7R-8A35WH	8"	16/22/26/30/35	120-277	0-10 V	Yes	2,700/3,000/3,500/4,000/5,000	4,246	White	10-5/16" x 5-5/16"	4	ETL
ASD-CDL7-10DA40AC	10"	20/30/40	120-277	0-10 V	Yes	2,700/3,000/3,500/4,000/5,000	3,000	White	11-5/16" x 4-15/16"	4	UL / Energy Star
ASD-CDL7-10DA40AC-BK	10"	20/30/40	120-277	0-10 V	Yes	2,700/3,000/3,500/4,000/5,000	3,000	Black	11-5/16" x 4-15/16"	4	UL / Energy Star
ASD-CDL7R-10A40WH	10"	22/26/30/35/40	120-277	0-10 V	Yes	2,700/3,000/3,500/4,000/5,000	4,791	White	11-9/16" x 5-15/16"	4	ETL

WITH BATTERY BACK-UP

ASD-CDL7R-6A30WH-EM	6"	12/16/22/126/30	120-277	0-10 V	Yes	2,700/3,000/3,500/4,000/5,000	3,352	White	8-11/16" x 4-5/16"	8	ETL
ASD-CDL7R-8A35WH-EM	8"	16/22/26/30/35	120-277	0-10 V	Yes	2,700/3,000/3,500/4,000/5,000	4,246	White	10-1/4" x 4-5/16"	4	ETL

ACCESSORIES

Battery back-up kit 8W	BLD-HM08D	10-7/16" x 1-15/16" x 15/16"	10	UL
Battery back-up kit 15W	BLD-HM15D	12-15/16" x 1-7/16" x 15/16"	10	UL
NLS Battery back-up kit 15W	ASD-EMA15-NLS	14-5/8" x 1-5/8" x 1-7/16"	10	UL
New Construction Flat Mounting Plate with Asymmetric Round holes 3-4-6"	ASD-MPLR-346-FA-6PACK	13-1/4" x 9-1/16" x 1/16"	4	-
New Construction Flat Mounting Plate 18" with Asymmetric Round holes 3-4-6"	ASD-MPLR18-346-FA-6PACK	18" x 9-1/16" x 1/16"	4	-
New Construction Flat Mounting Plate with Asymmetric Round holes 8-10-12"	ASD-MPLR-81012-FA-6PACK	18-1/2" x 13-3/8" x 1/16"	4	-
New Construction Flat Mounting Plate with Symmetric Round holes 3-4-6"	ASD-MPLR-346-FS-6PACK	26" x 8-1/4" x 1/16"	4	-
New Construction Flat Mounting Plate with Symmetric Round holes 8-10-12"	ASD-MPLR-81012-FS-6PACK	26" x 13" x 1/16"	4	-
New Construction Mounting Plate with Round holes 3-4-6" and Sliding Clips	ASD-MPLR-346-SC-6PACK	14-3/8" x 10-9/16" x 1-5/8"	2	-
New Construction Mounting Plate with Round holes 8-10-12" and Sliding Clips	ASD-MPLR-81012-SC-6PACK	17-11/16" x 13" x 1-9/16"	2	-

LED ROUND RECESSED MINI PANEL WITH BAFFLE TRIM

■ ASD-JBRB-MV

Model	Size	Watts	Input Voltage	Dimmable	CCT	Lm	Finish	Dimensions DxH	Pcs. per Carton	Certification
ASD-JBRB-MV-4D12WH	4"	12	120-277 V	0-10V	2,700/3,000/3,500/4,000/5,000	886	White	5" x 2-3/16"	6	ETL
ASD-JBRB-MV-4D12BK	4"	12	120-277 V	0-10V	2,700/3,000/3,500/4,000/5,000	886	Black	5" x 2-3/16"	6	ETL
ASD-JBRB-MV-6D15WH	6"	15	120-277 V	0-10V	2,700/3,000/3,500/4,000/5,000	1,153	White	6-7/8" x 2-3/16"	6	ETL
ASD-JBRB-MV-6D15BK	6"	15	120-277 V	0-10V	2,700/3,000/3,500/4,000/5,000	1,153	Black	6-7/8" x 2-3/16"	6	ETL

ACCESSORIES

Battery back-up kit 8W	BLD-HM08D	10-7/16" x 1-15/16" x 15/16"	10	UL
Battery back-up kit 15W	BLD-HM15D	12-15/16" x 1-7/16" x 15/16"	10	UL
NLS Battery back-up kit 15W	ASD-EMA15-NLS	14-5/8" x 1-5/8" x 1-7/16"	10	UL



LED ROUND RECESSED MINI PANEL FIRE RATED

■ ASD-JFR, ASD-JFRB-MV

Model	Size	Watts	Input Voltage	Dimmable	CCT	Lm	Dimensions DxH	Pcs. per Carton	Certification
ASD-JFR-4D12AC-WH	4"	12	120 V	Triac	2,700/3,000/3,500/4,000/5,000	840	5" x 2"	6	ETL
ASD-JFR-6D15AC-WH	6"	15	120 V	Triac	2,700/3,000/3,500/4,000/5,000	1,119	6-7/8" x 2"	6	ETL

120-277V WITH BAFFLE TRIM

ASD-JFRB-MV-4D12WH	4"	12	120-277 V	0-10V	2,700/3,000/3,500/4,000/5,000	867	5" x 2-3/16"	6	ETL
ASD-JFRB-MV-6D15WH	6"	15	120-277 V	0-10V	2,700/3,000/3,500/4,000/5,000	1,148	6-7/8" x 2-1/4"	6	ETL

ACCESSORIES

Battery back-up kit 8W for 120-277V	BLD-HM08D	10-7/16" x 1-15/16" x 15/16"	10	UL
Battery back-up kit 15W	BLD-HM15D	12-15/16" x 1-7/16" x 15/16"	10	UL
NLS Battery back-up kit 15W	ASD-EMA15-NLS	14-5/8" x 1-5/8" x 1-7/16"	10	UL

LED AREA LIGHT

■ ASD-LSB5

Model	Watts	Input Voltage	Dimmable	CCT	Lm	Dimensions LxWxH	Pcs. per Carton	Certification
ASD-LSB5-150D50BR	150	120-277	0-10V	5,000	22,398	14-5/16" x 11" x 2-13/16"	1	UL / DLC PRM
ASD-LSB5-200D50BR	200	120-277	0-10V	5,000	30,071	14-5/16" x 11" x 2-13/16"	1	UL / DLC PRM
ASD-LSB5-240D50BR	240	120-277	0-10V	5,000	35,843	18-1/2" x 12-9/16" x 2-13/16"	1	UL / DLC PRM
ASD-LSB5-300D50BR	300	120-277	0-10V	5,000	44,069	18-1/2" x 12-9/16" x 2-13/16"	1	UL / DLC PRM

WITH ARM MOUNTING BRACKET

ASD-LSB5-150D50BR-AMR	150	120-277	0-10V	5,000	22,398	22-1/4" x 11" x 6-1/4"	1	UL / DLC PRM
ASD-LSB5-200D50BR-AMR	200	120-277	0-10V	5,000	30,071	22-1/4" x 11" x 6-1/4"	1	UL / DLC PRM
ASD-LSB5-300D50BR-AMR	300	120-277	0-10V	5,000	44,069	26-1/2" x 12-9/16" x 6-1/4"	1	UL / DLC PRM

WITH SLIP FITTER

ASD-LSB5-150D50BR-SF	150	120-277	0-10V	5,000	22,398	22-5/16" x 11" x 3-1/16"	1	UL / DLC PRM
ASD-LSB5-200D50BR-SF	200	120-277	0-10V	5,000	30,071	21-5/16" x 11" x 3-1/16"	1	UL / DLC PRM
ASD-LSB5-300D50BR-SF	300	120-277	0-10V	5,000	44,069	25-9/16" x 12-9/16" x 3-1/16"	1	UL / DLC PRM

ACCESSORIES

Arm Mounting Bracket for 100-300W	ASD-AM-LSB5-BR	6-13/16" x 6-1/4" x 2-5/16"	10
Adjustable Arm Mounting Bracket for 100-300W	ASD-AMR-LSB5-BR	7-1/4" x 4-15/16" x 6-1/4"	20
Floodlight Mounting Bracket for 100-200W	ASD-FM1-LSB5-BR	12-3/16" x 7-1/4" x 1-3/4"	10
Floodlight Mounting Bracket for 240-300W	ASD-FM2-LSB5-BR	13-3/4" x 8-5/8" x 1-15/16"	10
Slip fitter Mounting Bracket for 100-300W	ASD-SF-LSB5-BR	7-1/16" x 4-15/16" x 3-1/16"	20
Full Trunnion Mounting Bracket for 100-300W	ASD-TR-LSB5-BR	6-9/16" x 4-7/16" x 1-7/8"	20
Clear Lens Type II-M for 100-200W	ASD-L2A-LSB5	10-1/4" x 8-3/4" x 5/16"	50
Clear Lens Type II-M for 240-300W	ASD-L2B-LSB5	11-13/16" x 11-13/16" x 5/16"	25
Clear Lens Type IV-S for 100-200W	ASD-L4A-LSB5	10-1/4" x 8-3/4" x 5/16"	50
Clear Lens Type IV-S for 240-300W	ASD-L4B-LSB5	11-13/16" x 11-13/16" x 5/16"	25
Clear Lens Type V-S for 100-200W	ASD-L5A-LSB5	10-1/4" x 8-3/4" x 5/16"	50
Clear Lens Type V-S for 240-300W	ASD-L5B-LSB5	11-13/16" x 11-13/16" x 5/16"	25



LED AREA LIGHT WITH Q-BASE PRO series

ASD-LSB5A-PRO

Model	Watts	Input Voltage	Dimmable	CCT	Lm	Finish	Dimensions LxWxH	Pcs. per Carton	Certification
ASD-LSB5A-PRO-150BK	100/120/150	120-277	0-10V	3,000/4,000/5,000	25,823	Black	14-5/16" x 11" x 2-13/16"	1	UL / DLC PRM
ASD-LSB5A-PRO-150BR	100/120/150	120-277	0-10V	3,000/4,000/5,000	25,823	Bronze	14-5/16" x 11" x 2-13/16"	1	UL / DLC PRM
ASD-LSB5A-PRO-150SL	100/120/150	120-277	0-10V	3,000/4,000/5,000	25,823	Silver	14-5/16" x 11" x 2-13/16"	1	UL / DLC PRM
ASD-LSB5A-PRO-150WH	100/120/150	120-277	0-10V	3,000/4,000/5,000	25,823	White	14-5/16" x 11" x 2-13/16"	1	UL / DLC PRM
ASD-LSB5A-PRO-200BK	100/150/200	120-277	0-10V	3,000/4,000/5,000	33,511	Black	14-5/16" x 11" x 2-13/16"	1	UL / DLC PRM
ASD-LSB5A-PRO-200BR	100/150/200	120-277	0-10V	3,000/4,000/5,000	33,511	Bronze	14-5/16" x 11" x 2-13/16"	1	UL / DLC PRM
ASD-LSB5A-PRO-200SL	100/150/200	120-277	0-10V	3,000/4,000/5,000	33,511	Silver	14-5/16" x 11" x 2-13/16"	1	UL / DLC PRM
ASD-LSB5A-PRO-200WH	100/150/200	120-277	0-10V	3,000/4,000/5,000	33,511	White	14-5/16" x 11" x 2-13/16"	1	UL / DLC PRM
ASD-LSB5A-PRO-240BK	150/200/240	120-277	0-10V	3,000/4,000/5,000	40,372	Black	18-1/2" x 12-9/16" x 2-13/16"	1	UL / DLC PRM
ASD-LSB5A-PRO-240BR	150/200/240	120-277	0-10V	3,000/4,000/5,000	40,372	Bronze	18-1/2" x 12-9/16" x 2-13/16"	1	UL / DLC PRM
ASD-LSB5A-PRO-240SL	150/200/240	120-277	0-10V	3,000/4,000/5,000	40,372	Silver	18-1/2" x 12-9/16" x 2-13/16"	1	UL / DLC PRM
ASD-LSB5A-PRO-240WH	150/200/240	120-277	0-10V	3,000/4,000/5,000	40,372	White	18-1/2" x 12-9/16" x 2-13/16"	1	UL / DLC PRM
ASD-LSB5A-PRO-300BK	200/240/300	120-277	0-10V	3,000/4,000/5,000	52,440	Black	18-1/2" x 12-9/16" x 2-13/16"	1	UL / DLC PRM
ASD-LSB5A-PRO-300BR	200/240/300	120-277	0-10V	3,000/4,000/5,000	52,440	Bronze	18-1/2" x 12-9/16" x 2-13/16"	1	UL / DLC PRM
ASD-LSB5A-PRO-300SL	200/240/300	120-277	0-10V	3,000/4,000/5,000	52,440	Silver	18-1/2" x 12-9/16" x 2-13/16"	1	UL / DLC PRM
ASD-LSB5A-PRO-300WH	200/240/300	120-277	0-10V	3,000/4,000/5,000	52,440	White	18-1/2" x 12-9/16" x 2-13/16"	1	UL / DLC PRM
ASD-LSB5A-PRO-500BK	300/400/500	120-277	0-10V	3,000/4,000/5,000	84,732	Black	27-1/8" x 14-1/8" x 2-13/16"	1	UL / DLC PRM
ASD-LSB5A-PRO-500BR	300/400/500	120-277	0-10V	3,000/4,000/5,000	84,732	Bronze	27-1/8" x 14-1/8" x 2-13/16"	1	UL / DLC PRM
ASD-LSB5A-PRO-500SL	300/400/500	120-277	0-10V	3,000/4,000/5,000	84,732	Silver	27-1/8" x 14-1/8" x 2-13/16"	1	UL / DLC PRM
ASD-LSB5A-PRO-500WH	300/400/500	120-277	0-10V	3,000/4,000/5,000	84,732	White	27-1/8" x 14-1/8" x 2-13/16"	1	UL / DLC PRM

HIGH VOLTAGE

ASD-LSB5A-HV-PRO-150BR	100/120/150	277-480	0-10V	3,000/4,000/5,000	25,191	Bronze	14-5/16" x 11" x 2-13/16"	1	UL / DLC PRM
ASD-LSB5A-HV-PRO-200BR	100/150/200	277-480	0-10V	3,000/4,000/5,000	35,039	Bronze	14-5/16" x 11" x 2-13/16"	1	UL / DLC PRM
ASD-LSB5A-HV-PRO-240BR	150/200/240	277-480	0-10V	3,000/4,000/5,000	41,389	Bronze	18-1/2" x 12-9/16" x 2-13/16"	1	UL / DLC PRM
ASD-LSB5A-HV-PRO-300BR	200/240/300	277-480	0-10V	3,000/4,000/5,000	52,361	Bronze	18-1/2" x 12-9/16" x 2-13/16"	1	UL / DLC PRM
ASD-LSB5A-HV-PRO-500BR	300/400/500	277-480	0-10V	3,000/4,000/5,000	86,582	Bronze	27-1/8" x 14-1/8" x 2-13/16"	1	UL / DLC PRM

ACCESSORIES

Infrared motion sensor 39ft 12V	ASD-09IR-WH	White	2-1/8" x 2-1/8" x 1-11/16"	120
Infrared motion sensor 39ft 12V	ASD-09IR-BK	Black	2-1/8" x 2-1/8" x 1-11/16"	120
Infrared motion sensor 50ft 12V	ASD-09IR50-WH	White	2-1/8" x 2-1/8" x 1-11/16"	120
Microwave motion sensor 49ft 12V	ASD-09MW-WH	White	2-1/8" x 2-1/8" x 1-5/16"	120
Microwave motion sensor 49ft 12V	ASD-09MW-BK	Black	2-1/8" x 2-1/8" x 1-5/16"	120
Remote control for Motion Sensor	ASD-06RC	-	5-11/16" x 1-3/4" x 13/16"	60
NLS Infrared motion sensor 39ft 12V	ASD-09IR-NLS-WH	White	2-1/8" x 2-1/8" x 1-11/16"	120
NLS Microwave motion sensor 49ft 12V	ASD-09MW-NLS-WH	White	2-1/8" x 2-1/8" x 1-3/8"	120
Remote control for Motion Sensor NLS	ASD-06RC-NLS	-	5-11/16" x 1-3/4" x 13/16"	60
Arm Mounting Bracket for 100-300W	ASD-AM-LSB5-BR	Bronze	6-13/16" x 6-1/4" x 2-5/16"	10
Adjustable Arm Mounting Bracket for 100-300W	ASD-AMR-LSB5-BK	Black	7-1/4" x 4-15/16" x 6-1/4"	20
Adjustable Arm Mounting Bracket for 100-300W	ASD-AMR-LSB5-BR	Bronze	7-1/4" x 4-15/16" x 6-1/4"	20
Adjustable Arm Mounting Bracket for 100-300W	ASD-AMR-LSB5-SL	Silver	7-1/4" x 4-15/16" x 6-1/4"	20
Adjustable Arm Mounting Bracket for 100-300W	ASD-AMR-LSB5-WH	White	7-1/4" x 4-15/16" x 6-1/4"	20
Adjustable Arm Mounting Bracket for 400-500W	ASD-AMR2-LSB-BK	Black	9-5/8" x 6-1/4" x 4-5/16"	10
Adjustable Arm Mounting Bracket for 400-500W	ASD-AMR2-LSB-BR	Bronze	9-5/8" x 6-1/4" x 4-5/16"	10
Adjustable Arm Mounting Bracket for 400-500W	ASD-AMR2-LSB-SL	Silver	9-5/8" x 6-1/4" x 4-5/16"	10
Adjustable Arm Mounting Bracket for 400-500W	ASD-AMR2-LSB-WH	White	9-5/8" x 6-1/4" x 4-5/16"	10
Floodlight Mounting Bracket for 100-200W	ASD-FM1-LSB5-BK	Black	12-3/16" x 7-1/4" x 1-3/4"	10
Floodlight Mounting Bracket for 100-200W	ASD-FM1-LSB5-BR	Bronze	12-3/16" x 7-1/4" x 1-3/4"	10
Floodlight Mounting Bracket for 100-200W	ASD-FM1-LSB5-SL	Silver	12-3/16" x 7-1/4" x 1-3/4"	10
Floodlight Mounting Bracket for 100-200W	ASD-FM1-LSB5-WH	White	12-3/16" x 7-1/4" x 1-3/4"	10
Floodlight Mounting Bracket for 240-300W	ASD-FM2-LSB5-BK	Black	13-3/4" x 8-5/8" x 1-15/16"	10
Floodlight Mounting Bracket for 240-300W	ASD-FM2-LSB5-BR	Bronze	13-3/4" x 8-5/8" x 1-15/16"	10
Floodlight Mounting Bracket for 240-300W	ASD-FM2-LSB5-SL	Silver	13-3/4" x 8-5/8" x 1-15/16"	10
Floodlight Mounting Bracket for 240-300W	ASD-FM2-LSB5-WH	White	13-3/4" x 8-5/8" x 1-15/16"	10
Floodlight Mounting Bracket for 400-500W	ASD-FM3-LSB5-BK	Black	15-3/8" x 12-3/8" x 3-1/8"	5
Floodlight Mounting Bracket for 400-500W	ASD-FM3-LSB5-BR	Bronze	15-3/8" x 12-3/8" x 3-1/8"	5
Floodlight Mounting Bracket for 400-500W	ASD-FM3-LSB5-SL	Silver	15-3/8" x 12-3/8" x 3-1/8"	5
Floodlight Mounting Bracket for 400-500W	ASD-FM3-LSB5-WH	White	15-3/8" x 12-3/8" x 3-1/8"	5
Slip fitter Mounting Bracket for 100-300W	ASD-SF-LSB5-BK	Black	7-1/16" x 4-15/16" x 3-1/16"	20
Slip fitter Mounting Bracket for 100-300W	ASD-SF-LSB5-BR	Bronze	7-1/16" x 4-15/16" x 3-1/16"	20
Slip fitter Mounting Bracket for 100-300W	ASD-SF-LSB5-SL	Silver	7-1/16" x 4-15/16" x 3-1/16"	20
Slip fitter Mounting Bracket for 100-300W	ASD-SF-LSB5-WH	White	7-1/16" x 4-15/16" x 3-1/16"	20
Slip fitter Mounting Bracket for 400-500W	ASD-SF2-LSB-BK	Black	10-11/16" x 4-5/16" x 3-3/8"	10
Slip fitter Mounting Bracket for 400-500W	ASD-SF2-LSB-BR	Bronze	10-11/16" x 4-5/16" x 3-3/8"	10
Slip fitter Mounting Bracket for 400-500W	ASD-SF2-LSB-SL	Silver	10-11/16" x 4-5/16" x 3-3/8"	10
Slip fitter Mounting Bracket for 400-500W	ASD-SF2-LSB-WH	White	10-11/16" x 4-5/16" x 3-3/8"	10
Full Trunnion Mounting Bracket for 100-300W	ASD-TR-LSB5-BK	Black	6-9/16" x 4-7/16" x 1-7/8"	20
Full Trunnion Mounting Bracket for 100-300W	ASD-TR-LSB5-BR	Bronze	6-9/16" x 4-7/16" x 1-7/8"	20
Full Trunnion Mounting Bracket for 100-300W	ASD-TR-LSB5-SL	Silver	6-9/16" x 4-7/16" x 1-7/8"	20
Full Trunnion Mounting Bracket for 100-300W	ASD-TR-LSB5-WH	White	6-9/16" x 4-7/16" x 1-7/8"	20
Full Trunnion Mounting Bracket for 400-500W	ASD-TR2-LSB-BK	Black	7-1/16" x 5-7/8" x 2-11/16"	10
Full Trunnion Mounting Bracket for 400-500W	ASD-TR2-LSB-BR	Bronze	7-1/16" x 5-7/8" x 2-11/16"	10
Full Trunnion Mounting Bracket for 400-500W	ASD-TR2-LSB-SL	Silver	7-1/16" x 5-7/8" x 2-11/16"	10
Full Trunnion Mounting Bracket for 400-500W	ASD-TR2-LSB-WH	White	7-1/16" x 5-7/8" x 2-11/16"	10
Clear Lens Type II-M for 100-200W	ASD-L2A-LSB5	Clear	10-1/4" x 8-3/4" x 5/16"	50
Clear Lens Type II-M for 240-300W	ASD-L2B-LSB5	Clear	11-13/16" x 11-13/16" x 5/16"	25
Clear Lens Type IV-S for 100-200W	ASD-L4A-LSB5	Clear	10-1/4" x 8-3/4" x 5/16"	50
Clear Lens Type IV-S for 240-300W	ASD-L4B-LSB5	Clear	11-13/16" x 11-13/16" x 5/16"	25
Clear Lens Type V-S for 100-200W	ASD-L5A-LSB5	Clear	10-1/4" x 8-3/4" x 5/16"	50
Clear Lens Type V-S for 240-300W	ASD-L5B-LSB5	Clear	11-13/16" x 11-13/16" x 5/16"	25



LED AREA LIGHT WITH Q-BASE PRO series

ASD-LSB5B-PRO

Model	Watts	Input Voltage	Dimmable	CCT	Lm	Finish	Dimensions LxWxH	Pcs. per Carton	Certification
ASD-LSB5B-PRO-150BR	100/120/150	120-277	0-10V	3,000/4,000/5,000	24,221	Bronze	12-5/16" x 11-5/16" x 2-7/16"	1	UL / DLC PRM
ASD-LSB5B-PRO-200BR	100/150/200	120-277	0-10V	3,000/4,000/5,000	33,253	Bronze	12-5/16" x 11-5/16" x 2-7/16"	1	UL / DLC PRM
ASD-LSB5B-PRO-240BR	150/200/240	120-277	0-10V	3,000/4,000/5,000	39,533	Bronze	16-9/16" x 12-3/16" x 2-1/2"	1	UL / DLC PRM
ASD-LSB5B-PRO-300BR	200/240/300	120-277	0-10V	3,000/4,000/5,000	49,391	Bronze	16-9/16" x 12-3/16" x 2-1/2"	1	UL / DLC PRM
ASD-LSB5B-PRO-500BR	300/400/500	120-277	0-10V	3,000/4,000/5,000	82,894	Bronze	29-7/16" x 12-3/16" x 2-3/4"	1	UL / DLC PRM

HIGH VOLTAGE

ASD-LSB5BHV-PRO-150BR	100/120/150	200-480	0-10V	3,000/4,000/5,000	24,221	Bronze	12-5/16" x 11-5/16" x 2-7/16"	1	UL / DLC PRM
ASD-LSB5BHV-PRO-200BR	100/150/200	200-480	0-10V	3,000/4,000/5,000	33,253	Bronze	12-5/16" x 11-5/16" x 2-7/16"	1	UL / DLC PRM
ASD-LSB5BHV-PRO-240BR	150/200/240	200-480	0-10V	3,000/4,000/5,000	39,533	Bronze	16-9/16" x 12-3/16" x 2-1/2"	1	UL / DLC PRM
ASD-LSB5BHV-PRO-300BR	200/240/300	200-480	0-10V	3,000/4,000/5,000	49,391	Bronze	16-9/16" x 12-3/16" x 2-1/2"	1	UL / DLC PRM
ASD-LSB5BHV-PRO-300SL	200/240/300	200-480	0-10V	3,000/4,000/5,000	49,391	Silver	16-9/16" x 12-3/16" x 2-1/2"	1	UL / DLC PRM
ASD-LSB5BHV-PRO-300WH	200/240/300	200-480	0-10V	3,000/4,000/5,000	49,391	White	16-9/16" x 12-3/16" x 2-1/2"	1	UL / DLC PRM
ASD-LSB5BHV-PRO-500BR	300/400/500	200-480	0-10V	3,000/4,000/5,000	82,894	Bronze	29-7/16" x 12-3/16" x 2-3/4"	1	UL / DLC PRM

ACCESSORIES

Infrared motion sensor 39ft 12V	ASD-09IR-WH	White	2-1/8" x 2-1/8" x 1-11/16"	120
Infrared motion sensor 39ft 12V	ASD-09IR-BK	Black	2-1/8" x 2-1/8" x 1-11/16"	120
Infrared motion sensor 50ft 12V	ASD-09IR50-WH	White	2-1/8" x 2-1/8" x 1-11/16"	120
Microwave motion sensor 49ft 12V	ASD-09MW-WH	White	2-1/8" x 2-1/8" x 1-5/16"	120
Microwave motion sensor 49ft 12V	ASD-09MW-BK	Black	2-1/8" x 2-1/8" x 1-5/16"	120
Remote control for Motion Sensor	ASD-06RC	-	5-11/16" x 1-3/4" x 13/16"	60
NLS Infrared motion sensor 39ft 12V	ASD-09IR-NLS-WH	White	2-1/8" x 2-1/8" x 1-11/16"	120
NLS Microwave motion sensor 49ft 12V	ASD-09MW-NLS-WH	White	2-1/8" x 2-1/8" x 1-3/8"	120
Remote control for Motion Sensor NLS	ASD-06RC-NLS	-	5-11/16" x 1-3/4" x 13/16"	60
Arm Mounting Bracket for 100-300W	ASD-AM-LSB5-BR	Bronze	6-13/16" x 6-1/4" x 2-5/16"	10
Adjustable Arm Mounting Bracket for 100-300W	ASD-AMR-LSB5-BR	Bronze	7-1/4" x 4-15/16" x 6-1/4"	20
Adjustable Arm Mounting Bracket for 100-300W	ASD-AMR-LSB5-SL	Silver	7-1/4" x 4-15/16" x 6-1/4"	20
Adjustable Arm Mounting Bracket for 100-300W	ASD-AMR-LSB5-WH	White	7-1/4" x 4-15/16" x 6-1/4"	20
Adjustable Arm Mounting Bracket for 400-500W	ASD-AMR2-LSB-BR	Bronze	9-5/8" x 6-1/4" x 4-5/16"	10
Floodlight Mounting Bracket for 100-200W	ASD-FM1-LSB5-BR	Bronze	11-7/16" x 6-5/16" x 9-7/8"	10
Floodlight Mounting Bracket for 100-200W	ASD-FM1-LSB5-SL	Silver	11-7/16" x 6-5/16" x 9-7/8"	10
Floodlight Mounting Bracket for 240-300W	ASD-FM2-LSB5-BR	Bronze	12-9/16" x 6-1/16" x 9-5/16"	10
Floodlight Mounting Bracket for 240-300W	ASD-FM2-LSB5-SL	Silver	12-9/16" x 6-1/16" x 9-5/16"	10
Floodlight Mounting Bracket for 400-500W	ASD-FM3-LSB5-BR	Bronze	12-11/16" x 7-1/2" x 12-3/8"	5
Slip fitter Mounting Bracket for 100-300W	ASD-SF-LSB5-BR	Bronze	7-1/16" x 4-15/16" x 3-1/16"	20
Slip fitter Mounting Bracket for 100-300W	ASD-SF-LSB5-SL	Silver	7-1/16" x 4-15/16" x 3-1/16"	20
Slip fitter Mounting Bracket for 100-300W	ASD-SF-LSB5-W			



LED LOW-PROFILE CANOPY WITH Q-BASE

ASD-CAN07A

Model	Watts	Input Voltage	Dimmable	CCT	Lm	Finish	Dimensions LxWxH	Pcs. per Carton	Certification
ASD-CAN07A-45BK	45	120-277	1-10V	3,000/4,000/5,000	6,900	Black	10-9/16" x 9-13/16" x 2-15/16"	6	UL / DLC PRM
ASD-CAN07A-45WH	45	120-277	1-10V	3,000/4,000/5,000	6,900	White	10-9/16" x 9-13/16" x 2-15/16"	6	UL / DLC PRM
ASD-CAN07A-70BK	70	120-277	1-10V	3,000/4,000/5,000	8,945	Black	10-9/16" x 9-13/16" x 2-15/16"	6	UL / DLC PRM
ASD-CAN07A-70WH	70	120-277	1-10V	3,000/4,000/5,000	8,945	White	10-9/16" x 9-13/16" x 2-15/16"	6	UL / DLC PRM

WITH BATTERY BACK-UP

ASD-CAN07A-45BK-8EM	45	120-277	0-10V	3,000/4,000/5,000	6,900	Black	10-9/16" x 9-13/16" x 2-15/16"	6	UL / DLC PRM
ASD-CAN07A-45WH-8EM	45	120-277	0-10V	3,000/4,000/5,000	6,900	White	10-9/16" x 9-13/16" x 2-15/16"	6	UL / DLC PRM

ACCESSORIES

Infrared motion sensor 39ft 12V	ASD-09IR-WH	White	2-1/8" x 2-1/8" x 1-11/16"	120
Infrared motion sensor 39ft 12V	ASD-09IR-BK	Black	2-1/8" x 2-1/8" x 1-11/16"	120
Infrared motion sensor 50ft 12V	ASD-09IR50-WH	White	2-1/8" x 2-1/8" x 1-11/16"	120
Microwave motion sensor 49ft 12V	ASD-09MW-WH	White	2-1/8" x 2-1/8" x 1-5/16"	120
Microwave motion sensor 49ft 12V	ASD-09MW-BK	Black	2-1/8" x 2-1/8" x 1-5/16"	120
Remote control for Motion Sensor	ASD-06RC	-	5-11/16" x 1-3/4" x 13/16"	60
NLS Infrared motion sensor 12V White	ASD-09IR-NLS-WH	White	2-1/8" x 2-1/8" x 1-11/16"	120
NLS Microwave motion sensor 12V White	ASD-09MW-NLS-WH	White	2-1/8" x 2-1/8" x 1-3/8"	120
Remote control for Motion Sensor NLS	ASD-06RC-NLS	-	5-11/16" x 1-3/4" x 13/16"	60



LED EDGE-LIT CANOPY SQUARE WITH Q-BASE

ASD-CAN09S

Model	Watts	Input Voltage	Dimmable	CCT	Lm	Finish	Dimensions LxWxH	Pcs. per Carton	Certification
ASD-CAN09S-A70BK	40/60/70	120-277	0-10V	3,000/4,000/5,000	10,747	Black	10-1/16" x 10-1/16" x 2-3/4"	4	UL / DLC PRM
ASD-CAN09S-A70WH	40/60/70	120-277	0-10V	3,000/4,000/5,000	10,823	White	10-1/16" x 10-1/16" x 2-3/4"	4	UL / DLC PRM
ASD-CAN09S-A100BK	60/70/100	120-277	0-10V	3,000/4,000/5,000	14,448	Black	10-1/16" x 10-1/16" x 2-3/4"	4	UL / DLC PRM
ASD-CAN09S-A100WH	60/70/100	120-277	0-10V	3,000/4,000/5,000	14,820	White	10-1/16" x 10-1/16" x 2-3/4"	4	UL / DLC PRM

ACCESSORIES

Infrared motion sensor 39ft 12V	ASD-09IR-WH	White	2-1/8" x 2-1/8" x 1-11/16"	120
Infrared motion sensor 39ft 12V	ASD-09IR-BK	Black	2-1/8" x 2-1/8" x 1-11/16"	120
Infrared motion sensor 50ft 12V	ASD-09IR50-WH	White	2-1/8" x 2-1/8" x 1-11/16"	120
Microwave motion sensor 49ft 12V	ASD-09MW-WH	White	2-1/8" x 2-1/8" x 1-5/16"	120
Microwave motion sensor 49ft 12V	ASD-09MW-BK	Black	2-1/8" x 2-1/8" x 1-5/16"	120
Remote control for Motion Sensor	ASD-06RC	-	5-11/16" x 1-3/4" x 13/16"	60
NLS Infrared motion sensor 12V White	ASD-09IR-NLS-WH	White	2-1/8" x 2-1/8" x 1-11/16"	120
NLS Microwave motion sensor 12V White	ASD-09MW-NLS-WH	White	2-1/8" x 2-1/8" x 1-3/8"	120
Remote control for Motion Sensor NLS	ASD-06RC-NLS	-	5-11/16" x 1-3/4" x 13/16"	60



LED SECURITY LIGHT WITH MOTION SENSOR

ASD-LSR, ASD-LSR3

Model	Watts	Input Voltage	Dimmable	CCT	Lm	Finish	Dimensions LxWxH	Pcs. per Carton	Certification
ASD-LSR-20AC-WH	20	120-277 V	No	3,000/4,000/5,000	2,040	White	9-15/16" x 6-5/16" x 7-3/8"	8	ETL
ASD-LSR-20AC-BK	20	120-277 V	No	3,000/4,000/5,000	2,040	Black	9-15/16" x 6-5/16" x 7-3/8"	8	ETL
ASD-LSR3-25AC-WH	25	120 V	No	3,000/4,000/5,000	2,289	White	9-15/16" x 6-5/16" x 7-3/8"	8	ETL
ASD-LSR3-25AC-BK	25	120 V	No	3,000/4,000/5,000	2,289	Black	9-15/16" x 6-5/16" x 7-3/8"	8	ETL

LED SECURITY LIGHT WITH MOTION SENSOR

ASD-LSR2

Model	Watts	Input Voltage	Dimmable	CCT	Lm	Finish	Dimensions LxWxH	Pcs. per Carton	Certification
ASD-LSR2-25AC-WH	25	120-277 V	No	3,000/4,000/5,000	2,525	White	9-3/4" x 7-3/16" x 6-3/4"	8	ETL
ASD-LSR2-25AC-BK	25	120-277 V	No	3,000/4,000/5,000	2,525	Black	9-3/4" x 7-3/16" x 6-3/4"	8	ETL



LED SECURITY FLOODLIGHT WITH MOTION SENSOR

ASD-SFL

Model	Watts	Input Voltage	Dimmable	CCT	Lm	Finish	Dimensions LxWxH	Pcs. per Carton	Certification
ASD-SFL-20WH	20	120	No	2,700/3,000/3,500/4,000/5,000	2,204	White	10-1/4" x 4-7/16" x 6-13/16"	8	UL / DLC PRM
ASD-SFL-20BK	20	120	No	2,700/3,000/3,500/4,000/5,000	2,045	Black	10-1/4" x 4-7/16" x 6-13/16"	8	UL / DLC PRM

LED SECURITY FLOODLIGHT WITH CAMERA

ASD-SFL-SC

Model	Watts	Input Voltage	Dimmable	CCT	Lm	Finish	Dimensions LxWxH	Pcs. per Carton	Certification
ASD-SFL-20WH-SC	20	120	No	2,700/3,000/3,500/4,000/5,000	2,017	White	10-1/4" x 4-7/16" x 7-11/16"	6	UL / DLC PRM

LED FLOODLIGHT WITH ARM

ASD-FL01K

Model	Watts	Input Voltage	Dimmable	CCT	Lm	Dimensions LxWxH	Pcs. per Carton	Certification
ASD-FL01K-55BK	15/30/55	120-277 V	0-10V	3,000/4,000/5,000	8,379	9" x 2-15/16" x 11-11/16"	4	UL / DLC PRM
ASD-FL01K-75BK	30/55/75	120-277 V	0-10V	3,000/4,000/5,000	10,428	9" x 2-15/16" x 11-11/16"	4	UL / DLC PRM



LED SECURITY WALLPACK WITH PHOTOCELL

ASD-LSWP01

Model	Watts	Input Voltage	Dimmable	CCT	Lm	Dimensions LxWxH	Pcs. per Carton	Certification
ASD-LSWP01-18NCC-PC	18	120-277 V	No	3,000/4,000/5,000	2,187	8-3/16" x 5-3/8" x 2-13/16"	8	UL
ASD-LSWP01-26NCC-PC	26	120-277 V	No	3,000/4,000/5,000	3,385	8-3/16" x 5-3/8" x 2-13/16"	8	UL

WITH BATTERY BACK-UP

ASD-LSWP01-A26AC-PC-4EM	13/18/26	120-277 V	0-10V	3,000/4,000/5,000	3,857	5-1/2" x 4-1/16" x 8-3/16"	8	UL
-------------------------	----------	-----------	-------	-------------------	-------	----------------------------	---	----

LED SPORT LIGHT

ASD-SPFL7, ASD-SPFL7-DMX, ASD-SPFL7-RGBW-DMX

Model	Watts	Input Voltage	Dimmable	CCT	Lm	Beam angles	Dimensions LxWxH	Pcs. per Carton	Certification
ASD-SPFL7-300D50	300	120-277	0-10V	5,000	45,009	45°	17-5/8" x 16-1/8" x 16-1/16"	1	UL / DLC PRM
ASD-SPFL7-A500D50	300/400/500	120-277	0-10V	5,000	74,009	45°	17-5/8" x 16-1/8" x 16-1/16"	1	UL / DLC PRM

HIGH VOLTAGE

ASD-SPFL7-HV-A500D50	300/400/500	200-480	0-10V	5,000	74,009	45°	17-5/8" x 16-1/8" x 16-1/16"	1	UL / DLC PRM
ASD-SPFL7-HV-A750D50	600/680/750	200-480	0-10V	5,000	113,665	40°	31" x 17-7/8" x 17-3/4"	1	UL / DLC PRM
ASD-SPFL7-HV-A1000D50	600/750/1,000	200-480	0-10V	5,000	150,198	40°	23-1/4" x 20-13/16" x 21-3/8"	1	UL / DLC PRM
ASD-SPFL7-HV-A1300D50	1,000/1,200/1,300	200-480	0-10V	5,000	195,000	40°	23-1/4" x 20-13/16" x 21-3/8"	1	UL / DLC PRM

WITH DMX

ASD-SPFL7HV-500D50-DMX	500	200-480	DMX	5,000	75,057	45°	17-5/8" x 10-15/16" x 16-1/8"	1	UL / DLC PRM
------------------------	-----	---------	-----	-------	--------	-----	-------------------------------	---	--------------

WITH DMX & RGBW

ASD-SPFL7HV-450RGBW-DMX	450	200-480	DMX	2,700-6,500+RGB	33,619	45°	22-5/8" x 16-1/8" x 16"	1	UL / DLC PRM
-------------------------	-----	---------	-----	-----------------	--------	-----	-------------------------	---	--------------

ACCESSORIES

Slip-fitter bracket for 300-500W	ASD-SF1-SPFL7	15-1/4" x 17-11/16" x 3-1/16"	5
Slip-fitter bracket for 600-750W	ASD-SF2-SPFL7	17-3/8" x 19-7/8" x 3-1/16"	4
Slip-fitter bracket for 1000-1300W	ASD-SF3-SPFL7	21-11/16" x 20-1/4" x 3-1/8"	2
Laser Pointer for 300-500W	ASD-LSA-SPFL7	5-1/16" x 5-1/2" x 1-11/16"	10
Laser Pointer for 600-1300W	ASD-LSB-SPFL7	5-1/16" x 4-15/16" x 1-11/16"	10
Lens 20° NEMA2 for 600-800W	ASD-L20B-SPFL7	15-5/16" x 15-5/16" x 11/16"	10
Lens 20° NEMA2 for 1000-1300W	ASD-L20C-SPFL7	19-9/16" x 9-3/8" x 11/16"	20
Lens 30° NEMA4 for 300-500W	ASD-L30-SPFL7-300/500	14-5/16" x 14-5/16" x 1/2"	20





LED TRADITIONAL WALLPACK WITH PHOTOCELL

ASD-WLP01

Model	Watts	Input Voltage	Dimmable	CCT	Lm	Dimensions LxWxH	Pcs. per Carton	Certification
ASD-WLP01-50D50-PC	50	120-277 V	0-10V	5,000	7,692	14" x 9" x 7-1/8"	1	UL / DLC PRM
ASD-WLP01-50A-PC	30/40/50	120-277 V	0-10V	3,000/4,000/5,000	7,889	14" x 9" x 7-1/8"	1	UL / DLC PRM
ASD-WLP01-80D50-PC	80	120-277 V	0-10V	5,000	11,973	14" x 9" x 7-1/8"	1	UL / DLC PRM
ASD-WLP01-80A-PC	50/60/80	120-277 V	0-10V	3,000/4,000/5,000	12,213	14" x 9" x 7-1/8"	1	UL / DLC PRM
ASD-WLP01-120A-PC	80/100/120	120-277 V	1-10V	3,000/4,000/5,000	17,571	14" x 9" x 7-1/8"	1	UL / DLC PRM

WITH BATTERY BACK-UP

ASD-WLP01-50DAC-EM	50	120-277 V	1-10 V	3,000/4,000/5,000	7,773	14-1/4" x 9-5/16" x 7-9/16"	1	UL / DLC PRM
ASD-WLP01-80DAC-EM	80	120-277 V	1-10 V	3,000/4,000/5,000	12,174	14-1/4" x 9-5/16" x 7-9/16"	1	UL / DLC PRM

ACCESSORIES

Photocell	ASD-PC-WLP	7/8" x 7/8" x 3/4"	100
-----------	------------	--------------------	-----



Q-BASE MOTION SENSOR

Model	Type	Base	Input Voltage	Dimmable	IP	Installation Height	Finish	Dimensions LxWxH	Pcs. per Carton	Certification
ASD-09IR-WH	Infrared	3pin	12V	0-10 V	IP65	39ft	White	2-1/8" x 2-1/8" x 1-11/16"	120	UL
ASD-09IR-BK	Infrared	3pin	12V	0-10 V	IP65	39ft	Black	2-1/8" x 2-1/8" x 1-11/16"	120	UL
ASD-09IR50-WH	Infrared	3pin	12V	0-10 V	IP65	50ft	White	2-1/8" x 2-1/8" x 1-11/16"	120	UL
ASD-08MW-WH	Microwave	Audio-jack	12V	0-10 V	IP20	12ft	White	2-5/8" x 3/4" x 1"	120	UL
ASD-09MW-WH	Microwave	3pin	12V	0-10 V	IP65	49ft	White	2-1/8" x 2-1/8" x 1-5/16"	120	UL
ASD-09MW-BK	Microwave	3pin	12V	0-10 V	IP65	49ft	Black	2-1/8" x 2-1/8" x 1-5/16"	120	UL
Remote Control for Motion Sensor	ASD-06RC							5-11/16" x 1-3/4" x 13/16"	60	-

NLS

ASD-09IR-NLS-WH	Infrared	3pin	12V	0-10 V	IP65	39ft	White	2-1/8" x 2-1/8" x 1-11/16"	120	UL
ASD-09MW-NLS-WH	Microwave	3pin	12V	0-10 V	IP65	49ft	White	2-1/8" x 2-1/8" x 1-3/8"	120	UL
ASD-M2MW-NLS	Microwave	Magnet	12V	0-10 V	IP65	52ft	White	2-5/8" x 13/16" x 1/2"	120	-

Remote Control for NLS Motion Sensor ASD-06RC-NLS

NLS Gateway (Bluetooth, ZigBee, WiFi) for NLS Sensors and EM Battery ASD-G02-NLS

LED SLIM WALLPACK

ASD-WLP01SL

Model	Watts	Input Voltage	Dimmable	CCT	Lm	Dimensions LxWxH	Pcs. per Carton	Certification
ASD-WLP01SL-A60BR-PC	30/50/60	120-277 V	0-10 V	3,000/4,000/5,000	6,915	13-3/8" x 9-7/16" x 4-1/2"	1	UL / DLC PRM
ASD-WLP01SL-A80BR-PC	50/60/80	120-277 V	0-10 V	3,000/4,000/5,000	9,554	13-3/8" x 9-7/16" x 4-1/2"	1	UL / DLC PRM
ASD-WLP01SL-A120BR-PC	60/100/120	120-277 V	0-10 V	3,000/4,000/5,000	14,768	13-3/8" x 9-7/16" x 4-1/2"	1	UL / DLC PRM

ACCESSORIES

Photocell	ASD-PC-WLP	7/8" x 7/8" x 3/4"	100
-----------	------------	--------------------	-----



EMERGENCY BATTERY BACK-UP

Model	Watts	Input Voltage	IP	Dimensions LxWxH	Pcs. per Carton	Certification
BLD-HM08D	8	120-277 V	IP20	10-7/16" x 1-15/16" x 15/16"	10	UL
BLD-HM15D	15	120-277 V	IP40	12-15/16" x 1-7/16" x 15/16"	10	UL
ASD-EMK20W-WHB5A	20	120-277 V	IP40	9-5/8" x 4-5/8" x 1-7/8"	10	-
ASD-EMK20W-WHB5B	20	120-277 V	IP40	9-5/8" x 4-5/8" x 1-7/8"	10	-
ASD-EMK30W-WHB5A	30	120-277 V	IP40	9-5/8" x 4-5/8" x 1-7/8"	10	-

BLD-RM40R	40	120-277 V	IP65	15-11/16" x 15-11/16" x 5-9/16"	4	UL
BLD-RM60R	60	120-277 V	IP65	15-11/16" x 15-3/4" x 5-3/4"	4	UL
BLD-GM60R-HV	60	277-480 V	IP65	14-1/2" x 3-1/16" x 1-7/8"	5	UL

Remote Test Switch for Battery Back-up RN1

NLS

ASD-EMA15-NLS	15	120-277 V	IP20	14-5/8" x 1-5/8" x 1-7/16"	10	UL
ASD-EMB40-NLS	40	120-277 V	IP20	8-3/8" x 5-3/16" x 4-13/16"	6	UL

NLS Gateway (Bluetooth, ZigBee, WiFi) for NLS Sensors and EM Battery ASD-G02-NLS



LED ADJUSTABLE CUTOFF WALLPACK

ASD-WLP02A

Model	Watts	Input Voltage	Dimmable	CCT	Lm	Dimensions LxWxH	Pcs. per Carton	Certification
ASD-WLP02A-12DAC-PC-BK	12	120-277 V	0-10 V	3,000/4,000/5,000	1,686	5-7/8" x 5-1/16" x 3-9/16"	12	UL / DLC PRM
ASD-WLP02A-30DAC-PC-BK	30	120-277 V	0-10 V	3,000/4,000/5,000	4,058	9-1/8" x 7-5/8" x 4-5/8"	6	UL / DLC PRM
ASD-WLP02A-50DAC-PC-BK	50	120-277 V	0-10 V	3,000/4,000/5,000	7,047	9-1/8" x 7-5/8" x 4-5/8"	6	UL / DLC PRM

ACCESSORIES

Photocell	ASD-PC-WLP	7/8" x 7/8" x 3/4"	100
-----------	------------	--------------------	-----



LED DOUBLE RING FLUSHMOUNT

ASD-LFMDR

Model	Size	Watts	Input Voltage	Dimmable	CCT	Lm	Finish	Dimensions DxH	Pcs. per Carton	Certification
ASD-LFMDR-10D16CC-NK	10"	16	120	Triac	3,000/4,000/5,000	1,041	Nickel	10-5/16" x 3-1/2"	4	ETL / Energy Star
ASD-LFMDR-12D20CC-BK	12"	20	120	Triac	3,000/4,000/5,000	1,532	Black	11-13/16" x 3-1/8"	4	ETL / Energy Star
ASD-LFMDR-12D20CC-NK	12"	20	120	Triac	3,000/4,000/5,000	1,532	Nickel	11-13/16" x 3-1/8"	4	ETL / Energy Star
ASD-LFMDR-14D21CC-BK	14"	21	120	Triac	3,000/4,000/5,000	1,675	Black	14" x 3-9/16"	4	ETL / Energy Star
ASD-LFMDR-14D21CC-NK	14"	21	120	Triac	3,000/4,000/5,000	1,675	Nickel	14" x 3-9/16"	4	ETL / Energy Star
ASD-LFMDR-16D24CC-BK	16"	24	120	Triac	3,000/4,000/5,000	1,854	Black	15-3/4" x 3-3/4"	2	ETL / Energy Star
ASD-LFMDR-16D24CC-BZ	16"	24	120	Triac	3,000/4,000/5,000	1,854	Oil Rubbed Bronze	15-3/4" x 3-3/4"	2	ETL / Energy Star
ASD-LFMDR-16D24CC-NK	16"	24	120	Triac	3,000/4,000/5,000	1,854	Nickel	15-3/4" x 3-3/4"	2	ETL / Energy Star
ASD-LFMDR-18D28CC-BK	18"	28	120	Triac	3,000/4,000/5,000	2,230	Black	17-11/16" x 4-1/16"	2	ETL / Energy Star
ASD-LFMDR-18D28CC-BZ	18"	28	120	Triac	3,000/4,000/5,000	2,230	Oil Rubbed Bronze	17-11/16" x 4-1/16"	2	ETL / Energy Star
ASD-LFMDR-18D28CC-NK	18"	28	120	Triac	3,000/4,000/5,000	2,230	Nickel	17-11/16" x 4-1/16"	2	ETL / Energy Star

120-277 V

ASD-LFMDR-MV-12D20CC-NK	12"	20	120-277	Triac	3,000/4,000/5,000	1,580	Nickel	11-13/16" x 3-1/8"	4	ETL / Energy Star
ASD-LFMDR-MV-14D21CC-NK	14"	21	120-277	Triac	3,000/4,000/5,000	1,725	Nickel	14" x 3-9/16"	4	ETL / Energy Star
ASD-LFMDR-MV-16D24CC-NK	16"	24	120-277	Triac	3,000/4,000/5,000	2,118	Nickel	15-3/4" x 3-3/4"	2	ETL / Energy Star
ASD-LFMDR-MV-18D28CC-NK	18"	28	120-277	Triac	3,000/4,000/5,000	2,744	Nickel	17-11/16" x 4-1/16"	2	ETL / Energy Star

120-277 V WITH MOTION SENSOR

ASD-LFMDR-MV-12N15CC-MS-NK	12"	15	120-277	No	3,000/4,000/5,000	1,402	Brushed Nickel	12" x 3-1/8"	4	ETL / Energy Star
ASD-LFMDR-MV-14N21CC-MS-NK	14"	21	120-277	No	3,000/4,000/5,000	1,725	Brushed Nickel	14" x 3-1/2"	4	ETL / Energy Star

120-277 V WITH BATTERY BACK-UP

ASD-LFMDR-MV-12D20CC-EM-NK	12"	20	120-277	Triac	3,000/4,000/5,000	1,876	Nickel	11-13/16" x 4-5/16"	4	ETL
ASD-LFMDR-MV-14D21CC-EM-NK	14"	21	120-277	Triac	3,000/4,000/5,000	1,854	Nickel	13-3/4" x 4-11/16"	4	ETL
ASD-LFMDR-MV-16D24CC-EM-NK	16"	24	120-277	Triac	3,000/4,000/5,000	2,116	Nickel	15-3/4" x 4-3/4"	4	ETL



LED OVAL DOUBLE RING FLUSHMOUNT

ASD-LFMOV, ASD-FMOV

Model	Size	Watts	Input Voltage	Dimmable	CCT	Lm	Finish	Dimensions LxWxH	Pcs. per Carton	Certification
ASD-FMOV-24D38BK	24"	38	120	Triac	2,700/3,000/3,500/4,000/5,000	3,289	Black	24" x 13-9/16" x 4-5/16"	2	ETL
ASD-FMOV-24D38NK	24"	38	120	Triac	2,700/3,000/3,500/4,000/5,000	3,289	Nickel	24" x 13-9/16" x 4-5/16"	2	ETL
ASD-FMOV-32D50BK	32"	50	120	Triac	2,700/3,000/3,500/4,000/5,000	4,195	Black	32-5/16" x 18-1/8" x 4-5/16"	2	ETL
ASD-FMOV-32D50NK	32"	50	120	Triac	2,700/3,000/3,500/4,000/5,000	4,195	Nickel	32-5/16" x 18-1/8" x 4-5/16"	2	ETL

120-277 V

ASD-LFMOV-MV-32D45CC-BK	32"	45	120-277	Triac	3,000/4,000/5,000	3,750	Black	32-7/16" x 18-1/8" x 4-13/16"	2	ETL / Energy Star
ASD-LFMOV-MV-32D45CC-BZ	32"	45	120-277	Triac	3,000/4,000/5,000	3,750	Bronze	32-7/16" x 18-1/8" x 4-13/16"	2	ETL / Energy Star
ASD-LFMOV-MV-32D45CC-NK	32"	45	120-277	Triac	3,000/4,000/5,000	3,750	Nickel	32-7/16" x 18-1/8" x 4-13/16"	2	ETL / Energy Star

LOFT LED FLUSHMOUNT

ASD-LOFT-FM

Model	Size	Watts	Input Voltage	Dimmable	CCT	Lm	Finish	Dimensions DxH	Pcs. per Carton	Certification
ASD-LOFT-FM-12D20BK	12"	20	120	Triac	2,700/3,000/3,500/4,000/5,000	1,130	Black	11-13/16" x 3-1/2"	4	ETL
ASD-LOFT-FM-12D20NK	12"	20	120	Triac	2,700/3,000/3,500/4,000/5,000	1,130	Nickel	11-13/16" x 3-1/2"	4	ETL
ASD-LOFT-FM-14D24BK	14"	24	120	Triac	2,700/3,000/3,500/4,000/5,000	1,534	Black	14" x 3-3/4"	4	ETL
ASD-LOFT-FM-14D24NK	14"	24	120	Triac	2,700/3,000/3,500/4,000/5,000	1,534	Nickel	14" x 3-3/4"	4	ETL
ASD-LOFT-FM-16D28BK	16"	28	120	Triac	2,700/3,000/3,500/4,000/5,000	1,752	Black	15-5/16" x 3-11/16"	4	ETL
ASD-LOFT-FM-16D28NK	16"	28	120	Triac	2,700/3,000/3,500/4,000/5,000	1,752	Nickel	15-5/16" x 3-11/16"	4	ETL
ASD-LOFT-FM-18D35BK	18"	35	120	Triac	2,700/3,000/3,500/4,000/5,000	1,992	Black	17-5/16" x 3-15/16"	4	ETL
ASD-LOFT-FM-18D35NK	18"	35	120	Triac	2,700/3,000/3,500/4,000/5,000	1,992	Nickel	17-5/16" x 3-15/16"	4	ETL
ASD-LOFT-FM-20D42BK	20"	42	120	Triac	2,700/3,000/3,500/4,000/5,000	2,475	Black	19-1/8" x 4-1/8"	4	ETL
ASD-LOFT-FM-20D42NK	20"	42	120	Triac	2,700/3,000/3,500/4,000/5,000	2,475	Nickel	19-1/8" x 4-1/8"	4	ETL

LED FLUSHMOUNT COMFORT 5CCT

ASD-LFC

Model	Name	Size	Watts	Input Voltage	Dimmable	CCT	Lm	Dimensions DxH	Pcs. per Carton	Certification
ASD-LFC-AF-20D42-AC	AFINA	20"	42	120 V	Triac	2,700/3,000/3,500/4,000/5,000	2,638	19-1/8" x 3-9/16"	4	ETL
ASD-LFC-DD-20D42-AC	DIAMOND	20"	42	120 V	Triac	2,700/3,000/3,500/4,000/5,000	3,430	19-5/16" x 3-9/16"	4	ETL
ASD-LFC-HN-20D42-AC	HONEY	20"	42	120 V	Triac	2,700/3,000/3,500/4,000/5,000	2,544	18-7/8" x 4-3/4"	4	ETL
ASD-LFC-MY-20D42-AC	MYSTERY	20"	42	120 V	Triac	2,700/3,000/3,500/4,000/5,000	3,430	19-1/2" x 3-1/8"	4	ETL
ASD-LFC-SN-16D28-AC	STONE	16"	28	120 V	Triac	2,700/3,000/3,500/4,000/5,000	2,126	16-15/16" x 16-15/16" x 3-3/4"	4	ETL
ASD-LFC-SN-20D42-AC	STONE	20"	42	120 V	Triac	2,700/3,000/3,500/4,000/5,000	3,430	20-13/16" x 19-5/16" x 4-1/8"	4	ETL

LED FLUSHMOUNT COMFORT-SMART

ASD-LFC-RGB-SMART

Model	Name	Size	Watts	Input Voltage	Dimmable	CCT	Lm	Dimensions DxH	Pcs. per Carton	Certification
ASD-LFC-GX-20D42S-RGB-SMART	GALAXY	20"	42	120 V	Triac	2,700 - 6,500 + RGB	3,327	21-7/8" x 3-1/4"	4	ETL
ASD-LFC-MY-20D42S-RGB-SMART	MYSTERY	20"	42	120 V	Triac	2,700 - 6,500 + RGB	3,386	19-1/2" x 3-3/16"	4	ETL



LED ROUND SURFACE MINI PANEL

ASD-MPR

Model	Size	Watts	Input Voltage	Dimmable	CCT	Lm	Finish	Dimensions DxH	Pcs. per Carton	Certification
ASD-MPR-5D10BK	5"	10	120	Triac	2,700/3,000/4,000/5,000/6,000	692	Black	5-5/16" x 1"	6	ETL
ASD-MPR-5D10WH	5"	10	120	Triac	2,700/3,000/4,000/5,000/6,000	692	White	5-5/16" x 1"	6	ETL
ASD-MPR-7D15BK	7"	15	120	Triac	2,700/3,000/4,000/5,000/6,000	1,262	Black	7-1/16" x 1"	6	ETL
ASD-MPR-7D15WH	7"	15	120	Triac	2,700/3,000/4,000/5,000/6,000	1,262	White	7-1/16" x 1"	6	ETL
ASD-MPR-9D18BK	9"	18	120	Triac	2,700/3,000/4,000/5,000/6,000	1,664	Black	8-7/8" x 1-3/4"	6	ETL
ASD-MPR-9D18WH	9"	18	120	Triac	2,700/3,000/4,000/5,000/6,000	1,664	White	8-7/8" x 1-3/4"	6	ETL
ASD-MPR-12D24BK	12"	24	120	Triac	2,700/3,000/4,000/5,000/6,000	2,145	Black	11-13/16" x 1"	4	ETL
ASD-MPR-12D24WH	12"	24	120	Triac	2,700/3,000/4,000/5,000/6,000	2,145	White	11-13/16" x 1"	4	ETL
ASD-MPR-15D28WH	15"	28	120	Triac	2,700/3,000/4,000/5,000/6,000	2,500	White	15" x 1-1/4"	2	ETL
ASD-MPR-18D32WH	18"	32	120	Triac	2,700/3,000/4,000/5,000/6,000	2,700	White	18" x 1-1/4"	2	ETL
ASD-MPR-24D38WH	24"	38	120	Triac	2,700/3,000/4,000/5,000/6,000	3,100	White	24" x 1-1/4"	2	ETL
ASD-MPR-32D45WH	32"	45	120	Triac	2,700/3,000/4,000/5,000/6,000	4,100	White	32" x 1-1/4"	2	ETL

120-277 V

ASD-MPR-MV-12D24BK	12"	24	120-277	Triac	2,700/3,000/4,000/5,000/6,000	2,145	Black	11-13/16" x 1"	4	ETL
ASD-MPR-MV-12D24WH	12"	24	120-277	Triac	2,700/3,000/4,000/5,000/6,000	2,145	White	11-13/16" x 1"	4	ETL

WITH MOTION SENSOR

ASD-MPR-9N18CC-MS-WH	9"	18	120	No	3,000/4,000/5,000	1,430	White	8-3/4" x 3/4"	12	ETL / Energy Star
----------------------	----	----	-----	----	-------------------	-------	-------	---------------	----	-------------------

WITH BATTERY BACK-UP

ASD-MPR-7D15WH-EM	7"	15	120	Triac	2,700/3,000/4,000/5,000/6,000	1,267	White	7-1/16" x 1-3/4"	12	ETL
ASD-MPR-9D18WH-EM	9"	18	120	Triac	2,700/3,000/4,000/5,000/6,000	1,664	White	8-3/4" x 3/4"	12	ETL

ACCESSORIES

Sub-plate 7" for 7"	ASD-SP7-MPR-WH	White	7-1/16" x 1-3/4"	12
Retrofit Kit with E26 base and TP24 connector for 5"	ASD-RK4-MPR	-	-	48
Retrofit Kit with E26 base and TP24 connector for 7/9/12"	ASD-RK6-MPR	-	-	48

LED SQUARE SURFACE MINI PANEL

ASD-MPS

Model	Size	Watts	Input Voltage	Dimmable	CCT	Lm	Finish	Dimensions LxWxH	Pcs. per Carton	Certification
ASD-MPS-5D10CC-BK-6PACK	5"	10	120	Triac	3,000/4,000/5,000	744	Black	5-5/16" x 5-5/16" x 1-1/8"	2	ETL
ASD-MPS-5D10CC-WH-6PACK	5"	10	120	Triac	3,000/4,000/5,000	744	White	5-5/16" x 5-5/16" x 1-1/8"	2	ETL
ASD-MPS-7D12CC-WH-6PACK	7"	12	120	Triac	3,000/4,000/5,000	1,094	White	7-1/16" x 7-1/16" x 1-1/8"	2	ETL
ASD-MPS-7D15CC-BK-6PACK	7"	15	120	Triac	3,000/4,000/5,000	1,094	Black	7-1/16" x 7-1/16" x 1-1/8"	2	ETL
ASD-MPS-7D15CC-WH-6PACK	7"	15	120	Triac	3,000/4,000/5,000	1,094	White	7-1/16" x 7-1/16" x 1-1/8"	2	ETL
ASD-MPS-9D18CC-BK-6PACK	9"	18	120	Triac	3,000/4,000/5,000	1,452	Black	8-7/8" x 8-7/8" x 1-1/8"	2	ETL
ASD-MPS-9D18CC-WH-6PACK	9"	18	120	Triac	3,000/4,000/5,000	1,452	White	8-7/8" x 8-7/8" x 1-1/8"	2	ETL
ASD-MPS-12D24CC-BK	12"	24	120	Triac	3,000/4,000/5,000	1,824	Black	11-13/16" x 11-13/16" x 1-1/8"	4	ETL
ASD-MPS-12D24CC-WH	12"	24	120	Triac	3,000/4,000/5,000	1,824	White	11-13/16" x 11-13/16" x 1-1/8"	4	ETL

ACCESSORIES

Retrofit Kit with E26 base and TP24 connector for 5"	ASD-RK4-MPR	-	-	48
Retrofit Kit with E26 base and TP24 connector for 7/9/12"	ASD-RK6-MPR	-	-	48





LED DISK LIGHT

ASD-LDS

Model	Size	Watts	Input Voltage	Dimmable	CCT	Lm	Finish	Dimensions DxH	Pcs. per Carton	Certification
ASD-LDS-4D10BK	4"	10	120	Triac	2,700/3,000/3,500/4,000/5,000	685	Black	5-7/8" x 7/8"	6	UL
ASD-LDS-4D10AC-BK-12PACK	4"	10	120	Triac	2,700/3,000/3,500/4,000/5,000	685	Black	5-7/8" x 7/8"	1	UL / Energy Star
ASD-LDS-4D10WH	4"	10	120	Triac	2,700/3,000/3,500/4,000/5,000	685	White	5-7/8" x 7/8"	6	UL
ASD-LDS-4D10AC-WH-12PACK	4"	10	120	Triac	2,700/3,000/3,500/4,000/5,000	685	White	5-7/8" x 7/8"	1	UL / Energy Star
ASD-LDS-6D15BK	6"	15	120	Triac	2,700/3,000/3,500/4,000/5,000	1,245	Black	7-5/16" x 15/16"	6	UL
ASD-LDS-6D15MB	6"	15	120	Triac	2,700/3,000/3,500/4,000/5,000	1,293	Matte Black	7-5/16" x 15/16"	6	ETL
ASD-LDS-6D15AC-BK-12PACK	6"	15	120	Triac	2,700/3,000/3,500/4,000/5,000	1,245	Black	7-5/16" x 15/16"	1	UL / Energy Star
ASD-LDS-6D15BR	6"	15	120	Triac	2,700/3,000/3,500/4,000/5,000	1,245	Bronze	7-5/16" x 15/16"	6	UL
ASD-LDS-6D15NK	6"	15	120	Triac	2,700/3,000/3,500/4,000/5,000	1,245	Nickel	7-5/16" x 15/16"	6	UL
ASD-LDS-6D15WH	6"	15	120	Triac	2,700/3,000/3,500/4,000/5,000	1,245	White	7-5/16" x 15/16"	6	UL
ASD-LDS-6D15MW	6"	15	120	Triac	2,700/3,000/3,500/4,000/5,000	1,293	Matte White	7-5/16" x 15/16"	6	ETL
ASD-LDS-6D15AC-WH-12PACK	6"	15	120	Triac	2,700/3,000/3,500/4,000/5,000	1,245	White	7-5/16" x 15/16"	1	UL / Energy Star

WITH MOTION SENSOR

ASD-LDS-6N15WH-MS	6"	15	120	No	2,700/3,000/3,500/4,000/5,000	1,149	White	7-5/16" x 1-1/4"	6	UL
-------------------	----	----	-----	----	-------------------------------	-------	-------	------------------	---	----

ACCESSORIES

Retrofit Kit with E26 base and TP24 connector for 4"	ASD-RK4-LDS-6PACK	8	
Retrofit Kit with E26 base and TP24 connector for 6"	ASD-RK6-LDS-6PACK	8	



LED ROUND RECESSED MINI PANEL

ASD-JBR, ASD-LMPJBR, ASD-JBR-RGBW

Model	Size	Watts	Input Voltage	Dimmable	CCT	Lm	Finish	Dimensions DxH	Pcs. per Carton	Certification
ASD-JBR-3D6AC-BK	3"	6	120	Triac	2,700/3,000/3,500/4,000/5,000	460	Black	3-1/4" x 5/8"	6	UL / Energy Star
ASD-JBR-3D6AC-BK-12PACK	3"	6	120	Triac	2,700/3,000/3,500/4,000/5,000	460	Black	3-1/4" x 5/8"	1	UL / Energy Star
ASD-JBR-3D6AC-BR	3"	6	120	Triac	2,700/3,000/3,500/4,000/5,000	460	Bronze	3-1/4" x 5/8"	6	UL / Energy Star
ASD-JBR-3D6AC-NK	3"	6	120	Triac	2,700/3,000/3,500/4,000/5,000	460	Nickel	3-1/4" x 5/8"	6	UL / Energy Star
ASD-JBR-3D6AC-WH	3"	6	120	Triac	2,700/3,000/3,500/4,000/5,000	460	White	3-1/4" x 5/8"	6	UL / Energy Star
ASD-JBR-3D6AC-WH-12PACK	3"	6	120	Triac	2,700/3,000/3,500/4,000/5,000	460	White	3-1/4" x 5/8"	1	UL / Energy Star
ASD-JBR-4D12AC-BK	4"	12	120	Triac	2,700/3,000/3,500/4,000/5,000	893	Black	4-11/16" x 5/8"	6	UL
ASD-JBR-4D12AC-BK-12PACK	4"	12	120	Triac	2,700/3,000/3,500/4,000/5,000	893	Black	4-11/16" x 5/8"	1	UL / Energy Star
ASD-JBR-4D12AC-BR	4"	12	120	Triac	2,700/3,000/3,500/4,000/5,000	893	Bronze	4-11/16" x 5/8"	6	UL / Energy Star
ASD-JBR-4D12AC-WH	4"	12	120	Triac	2,700/3,000/3,500/4,000/5,000	893	White	4-11/16" x 5/8"	6	UL
ASD-JBR-4D12AC-WH-12PACK	4"	12	120	Triac	2,700/3,000/3,500/4,000/5,000	893	White	4-11/16" x 5/8"	1	UL / Energy Star
ASD-JBR-6D15AC-BK	6"	15	120	Triac	2,700/3,000/3,500/4,000/5,000	1,225	Black	6-5/8" x 5/8"	6	UL / Energy Star
ASD-JBR-6D15AC-BK-12PACK	6"	15	120	Triac	2,700/3,000/3,500/4,000/5,000	1,225	Black	6-5/8" x 5/8"	1	UL / Energy Star
ASD-JBR-6D15AC-BR	6"	15	120	Triac	2,700/3,000/3,500/4,000/5,000	1,225	Bronze	6-5/8" x 5/8"	6	UL
ASD-JBR-6D15AC-WH	6"	15	120	Triac	2,700/3,000/3,500/4,000/5,000	1,225	White	6-5/8" x 5/8"	6	UL / Energy Star
ASD-JBR-6D15AC-WH-12PACK	6"	15	120	Triac	2,700/3,000/3,500/4,000/5,000	1,225	White	6-5/8" x 5/8"	1	UL / Energy Star
ASD-JBR-8D20AC-BK	8"	20	120	Triac	2,700/3,000/3,500/4,000/5,000	1,746	Black	8-11/16" x 5/8"	4	UL / Energy Star
ASD-JBR-8D20AC-WH	8"	20	120	Triac	2,700/3,000/3,500/4,000/5,000	1,746	White	8-11/16" x 5/8"	4	UL / Energy Star
ASD-JBS-12D24AC-BK	12"	24	120	Triac	2,700/3,000/3,500/4,000/5,000	2,169	Black	11-9/16" x 9/16"	4	UL / Energy Star
ASD-JBS-12D24AC-WH	12"	24	120	Triac	2,700/3,000/3,500/4,000/5,000	2,169	White	11-9/16" x 9/16"	4	UL / Energy Star

WITH RGBW

ASD-JBR-6D15SM-RGBW-WH	6"	15	120	WiFi	2,700 - 6,500 + RGB	1,135	White	6-3/4" x 1-1/4"	6	ETL
------------------------	----	----	-----	------	---------------------	-------	-------	-----------------	---	-----

ACCESSORIES

Extension Cord 3PIN 10"	ASD-EC-10A-6PACK	10	UL
Extension Cord 3PIN 20"	ASD-EC-20A-6PACK	10	UL



LED SQUARE RECESSED MINI PANEL

ASD-JBS

Model	Size	Watts	Input Voltage	Dimmable	CCT	Lm	Finish	Dimensions LxWxH	Pcs. per Carton	Certification
ASD-JBS-3D6AC-BK-6PACK	3"	6	120	Triac	2,700/3,000/3,500/4,000/5,000	456	Black	3-1/4" x 3-1/4" x 9/16"	2	UL / Energy Star
ASD-JBS-3D6AC-BZ-6PACK	3"	6	120	Triac	2,700/3,000/3,500/4,000/5,000	456	Bronze	3-1/4" x 3-1/4" x 9/16"	2	UL / Energy Star
ASD-JBS-3D6AC-NK-6PACK	3"	6	120	Triac	2,700/3,000/3,500/4,000/5,000	456	Nickel	3-1/4" x 3-1/4" x 9/16"	2	UL / Energy Star
ASD-JBS-3D6AC-WH-6PACK	3"	6	120	Triac	2,700/3,000/3,500/4,000/5,000	456	White	3-1/4" x 3-1/4" x 9/16"	2	UL / Energy Star
ASD-JBS-4D12AC-BK-6PACK	4"	12	120	Triac	2,700/3,000/3,500/4,000/5,000	784	Black	4-5/8" x 4-5/8" x 9/16"	2	UL / Energy Star
ASD-JBS-4D12AC-BZ-6PACK	4"	12	120	Triac	2,700/3,000/3,500/4,000/5,000	784	Bronze	4-5/8" x 4-5/8" x 9/16"	2	UL / Energy Star
ASD-JBS-4D12AC-NK-6PACK	4"	12	120	Triac	2,700/3,000/3,500/4,000/5,000	784	Nickel	4-5/8" x 4-5/8" x 9/16"	2	UL / Energy Star
ASD-JBS-4D12AC-WH-6PACK	4"	12	120	Triac	2,700/3,000/3,500/4,000/5,000	784	White	4-5/8" x 4-5/8" x 9/16"	2	UL / Energy Star
ASD-JBS-6D15AC-BK-6PACK	6"	15	120	Triac	2,700/3,000/3,500/4,000/5,000	1,197	Black	6-9/16" x 6-9/16" x 9/16"	2	UL / Energy Star
ASD-JBS-6D15AC-BZ-6PACK	6"	15	120	Triac	2,700/3,000/3,500/4,000/5,000	1,197	Bronze	6-9/16" x 6-9/16" x 9/16"	2	UL / Energy Star
ASD-JBS-6D15AC-NK-6PACK	6"	15	120	Triac	2,700/3,000/3,500/4,000/5,000	1,197	Nickel	6-9/16" x 6-9/16" x 9/16"	2	UL / Energy Star
ASD-JBS-6D15AC-WH-6PACK	6"	15	120	Triac	2,700/3,000/3,500/4,000/5,000	1,197	White	6-9/16" x 6-9/16" x 9/16"	2	UL / Energy Star
ASD-JBS-8D20AC-BK	8"	20	120	Triac	2,700/3,000/3,500/4,000/5,000	1,743	Black	8-11/16" x 8-11/16" x 9/16"	4	UL / Energy Star
ASD-JBS-8D20AC-WH	8"	20	120	Triac	2,700/3,000/3,500/4,000/5,000	1,743	White	8-11/16" x 8-11/16" x 9/16"	4	UL / Energy Star
ASD-JBS-12D24AC-BK	12"	24	120	Triac	2,700/3,000/3,500/4,000/5,000	2,152	Black	11-9/16" x 11-9/16" x 9/16"	4	UL / Energy Star
ASD-JBS-12D24AC-WH	12"	24	120	Triac	2,700/3,000/3,500/4,000/5,000	2,152	White	11-9/16" x 11-9/16" x 9/16"	4	UL / Energy Star

ACCESSORIES

Extension Cord 3PIN 10"	ASD-EC-10A-6PACK	10	UL
Extension Cord 3PIN 20"	ASD-EC-20A-6PACK	10	UL



LED ROUND RECESSED MINI PANEL GIMBAL

ASD-JBR-GB

Model	Size	Watts	Input Voltage	Dimmable	Air Tight	CCT	Lm	Finish	Dimensions DxH	Pcs. per Carton	Certification
ASD-JBR-GB-3D6AC-WH-6PACK	3"	6	120	Triac	No	2,700/3,000/3,500/4,000/5,000	463	White	3-15/16" x 1"	2	UL / Energy Star
ASD-JBR-GB-4D12AC-WH-6PACK	4"	12	120	Triac	No	2,700/3,000/3,500/4,000/5,000	842	White	5-1/8" x 1"	2	UL / Energy Star
ASD-JBR-GB-6D15AC-WH-6PACK	6"	15	120	Triac	No	2,700/3,000/3,500/4,000/5,000	1,232	White	7-5/16" x 1-1/4"	2	UL / Energy Star

ACCESSORIES

Extension Cord 3PIN 10"	ASD-EC-10A-6PACK	10	UL
Extension Cord 3PIN 20"	ASD-EC-20A-6PACK	10	UL

LED ROUND RECESSED MINI PANEL GIMBAL AIRTIGHT

ASD-JBR-GBA

Model	Size	Watts	Input Voltage	Dimmable	Air Tight	CCT	Lm	Finish	Dimensions DxH	Pcs. per Carton	Certification
ASD-JBR-GBA-3D6AC-BK-6PACK	3"	6	120	Triac	Yes	2,700/3,000/3,500/4,000/5,000	463	Black	3-15/16" x 1-1/2"	2	UL
ASD-JBR-GBA-3D6AC-WH-6PACK	3"	6	120	Triac	Yes	2,700/3,000/3,500/4,000/5,000	463	White	3-15/16" x 1-1/2"	2	UL
ASD-JBR-GBA-4D12AC-BK-6PACK	4"	12	120	Triac	Yes	2,700/3,000/3,500/4,000/5,000	842	Black	5-1/8" x 1-11/16"	2	UL
ASD-JBR-GBA-4D12AC-WH-6PACK	4"	12	120	Triac	Yes	2,700/3,000/3,500/4,000/5,000	842	White	5-1/8" x 1-11/16"	2	UL
ASD-JBR-GBA-6D15AC-BK-6PACK	6"	15	120	Triac	Yes	2,700/3,000/3,500/4,000/5,000	1,232	Black	7-5/16" x 1-7/8"	2	UL
ASD-JBR-GBA-6D15AC-WH-6PACK	6"	15	120	Triac	Yes	2,700/3,000/3,500/4,000/5,000	1,232	White	7-5/16" x 1-7/8"	2	UL

ACCESSORIES

Extension Cord 3PIN 10"	ASD-EC-10A-6PACK	10	UL
Extension Cord 3PIN 20"	ASD-EC-20A-6PACK	10	UL

LED ROUND RECESSED MINI PANEL GIMBAL

ASD-LMPJBR-GB

Model	Size	Watts	Input Voltage	Dimmable	Air Tight	CCT	Lm	Finish	Dimensions DxH	Pcs. per Carton	Certification
ASD-LMPJBR-GB-4D9CC-WH	4"	9	120	Triac	No	3,000/4,000/5,000	630	White	5-1/8" x 1-1/8"	12	ETL
ASD-LMPJBR-GB-4D9CC-WH-6PACK	4"	9	120	Triac	No	3,000/4,000/5,000	630	White	5-1/8" x 1-1/8"	1	ETL

ACCESSORIES

Extension Cord 3PIN 10'	ASD-EC-10A-6PACK	10	UL
Extension Cord 3PIN 20'	ASD-EC-20A-6PACK	10	UL

LED ROUND TRIMLESS DOWNLIGHT

ASD-CD-TR

Model	Size	Watts	Input Voltage	Dimmable	CCT	Lm	Finish	Dimensions DxH	Pcs. per Carton	Certification
ASD-CD-TR-2D8AC-WH	2"	8	120	Triac	2,700/3,000/3,500/4,000/5,000	640	White	2-3/8" x 2-7/16"	18	ETL / Energy Star
ASD-CD-TR-2D15AC-BK	2"	15	120	Triac	2,700/3,000/3,500/4,000/5,000	1,029	Black	3-9/16" x 5-1/16"	18	ETL / Energy Star
ASD-CD-TR-2D15AC-WH	2"	15	120	Triac	2,700/3,000/3,500/4,000/5,000	1,029	White	3-9/16" x 5-1/16"	18	ETL / Energy Star
ASD-CD-TR-3D12AC-BK	3.5"	12	120	Triac	2,700/3,000/3,500/4,000/5,000	933	Black	5-7/8" x 2-15/16"	18	ETL / Energy Star
ASD-CD-TR-3D12AC-WH	3.5"	12	120	Triac	2,700/3,000/3,500/4,000/5,000	933	White	5-7/8" x 2-15/16"	18	ETL / Energy Star
ASD-CD-TR-4D15AC-BK	4"	15	120	Triac	2,700/3,000/3,500/4,000/5,000	1,055	Black	5-7/8" x 3-1/8"	18	ETL / Energy Star
ASD-CD-TR-4D15AC-WH	4"	15	120	Triac	2,700/3,000/3,500/4,000/5,000	1,055	White	5-7/8" x 3-1/8"	18	ETL / Energy Star
ASD-CD-TR-6D24AC-BK	6"	24	120	Triac	2,700/3,000/3,500/4,000/5,000	2,075	Black	8-11/16" x 3-9/16"	12	ETL / Energy Star
ASD-CD-TR-6D24AC-WH	6"	24	120	Triac	2,700/3,000/3,500/4,000/5,000	2,075	White	8-11/16" x 3-9/16"	12	ETL / Energy Star

120-277 V

ASD-CD-TR-MV-2D15AC-WH	2"	15	120-277	0-10V	2,700/3,000/3,500/4,000/5,000	1,077	White	2-3/8" x 4-15/16"	18	ETL / Energy Star
ASD-CD-TR-MV-4D15AC-WH	4"	15	120-277	0-10V	2,700/3,000/3,500/4,000/5,000	1,082	White	3-1/8" x 2-13/16"	18	ETL / Energy Star
ASD-CD-TR-MV-6D24AC-WH	6"	24	120-277	0-10V	2,700/3,000/3,500/4,000/5,000	2,023	White	5-5/16" x 3-5/8"	12	ETL / Energy Star

ACCESSORIES

Battery back-up kit 8W	BLD-HM08D	10-7/16" x 1-15/16" x 15/16"	10	UL
Battery back-up kit 15W	BLD-HM15D	12-15/16" x 1-7/16" x 15/16"	10	UL
NLS Battery back-up kit 15W	ASD-EMA15-NLS	14-5/8" x 1-5/8" x 1-7/16"	10	UL

LED SQUARE TRIMLESS DOWNLIGHT

ASD-CD-TS

Model	Size	Watts	Input Voltage	Dimmable	CCT	Lm	Finish	Dimensions LxWxH	Pcs. per Carton	Certification
ASD-CD-TS-2D8AC-WH	2"	8	120	Triac	2,700/3,000/3,500/4,000/5,000	640	White	2-3/4" x 2-3/4" x 3-3/8"	18	ETL / Energy Star
ASD-CD-TS-2D15AC-BK	2"	15	120	Triac	2,700/3,000/3,500/4,000/5,000	1,029	Black	4-1/8" x 4-1/8" x 5-9/16"	18	ETL / Energy Star
ASD-CD-TS-2D15AC-WH	2"	15	120	Triac	2,700/3,000/3,500/4,000/5,000	1,029	White	4-1/8" x 4-1/8" x 5-9/16"	18	ETL / Energy Star
ASD-CD-TS-3D12AC-BK	3.5"	12	120	Triac	2,700/3,000/3,500/4,000/5,000	933	Black	5-11/16" x 5-11/16" x 3-1/16"	18	ETL
ASD-CD-TS-3D12AC-WH	3.5"	12	120	Triac	2,700/3,000/3,500/4,000/5,000	933	White	5-11/16" x 5-11/16" x 3-1/16"	18	ETL
ASD-CD-TS-4D15AC-BK	4"	15	120	Triac	2,700/3,000/3,500/4,000/5,000	1,055	Black	6-5/16" x 6-5/16" x 4"	18	ETL / Energy Star
ASD-CD-TS-4D15AC-WH	4"	15	120	Triac	2,700/3,000/3,500/4,000/5,000	1,055	White	6-5/16" x 6-5/16" x 4"	18	ETL / Energy Star
ASD-CD-TS-6D24AC-BK	6"	24	120	Triac	2,700/3,000/3,500/4,000/5,000	2,075	Black	8-1/8" x 8-1/8" x 3-11/16"	12	ETL
ASD-CD-TS-6D24AC-WH	6"	24	120	Triac	2,700/3,000/3,500/4,000/5,000	2,075	White	8-1/8" x 8-1/8" x 3-11/16"	12	ETL

ACCESSORIES

Battery back-up kit 8W	BLD-HM08D	10-7/16" x 1-15/16" x 15/16"	10	UL
Battery back-up kit 15W	BLD-HM15D	12-15/16" x 1-7/16" x 15/16"	10	UL
NLS Battery back-up kit 15W	ASD-EMA15-NLS	14-5/8" x 1-5/8" x 1-7/16"	10	UL



LED ROUND TRIMLESS DOWNLIGHT GIMBAL

ASD-CD-TG

Model	Size	Watts	Input Voltage	Dimmable	CCT	Lm	Shape	Finish	Dimensions DxH	Pcs. per Carton	Certification
ASD-CD-TG-2D8AC-WH	2"	8	120	Triac	2,700/3,000/3,500/4,000/5,000	717	Round	White	2-3/4" x 2-3/8"	18	ETL / Energy Star
ASD-CD-TGR-2D8AC-BK	2"	8	120	Triac	2,700/3,000/3,500/4,000/5,000	717	Round	Black	2-3/4" x 2-11/16"	18	ETL
ASD-CD-TGR-3D12AC-WH	3.5"	12	120	Triac	2,700/3,000/3,500/4,000/5,000	1,043	Round	White	4-1/16" x 5-9/16"	18	ETL
ASD-CD-TGR-4D17AC-WH	4"	17	120	Triac	2,700/3,000/3,500/4,000/5,000	1,623	Round	White	6-11/16" x 4"	18	ETL

ASD-CD-TGS-2D8AC-BK	2"	8	120	Triac	2,700/3,000/3,500/4,000/5,000	672	Square	Black	3-1/16" x 3-1/16" x 2-3/4"	18	ETL
ASD-CD-TGS-2D8AC-WH	2"	8	120	Triac	2,700/3,000/3,500/4,000/5,000	672	Square	White	3-1/16" x 3-1/16" x 2-3/4"	18	ETL

ACCESSORIES

Battery back-up kit 8W	BLD-HM08D	10-7/16" x 1-15/16" x 15/16"	10	UL
Battery back-up kit 15W	BLD-HM15D	12-15/16" x 1-7/16" x 15/16"	10	UL
NLS Battery back-up kit 15W	ASD-EMA15-NLS	14-5/8" x 1-5/8" x 1-7/16"	10	UL

LED TRIMLESS DOWNLIGHT COMBO GIMBAL

ASD-TCS

Model	Head Quantity	Watts	Input Voltage	Dimmable	CCT	Lm	Finish	Dimensions LxWxH	Pcs. per Carton	Certification
ASD-TCS-1D15WH	1 pc	15	120	Triac	2,700/3,000/3,500/4,000/5,000	1,234	White	6-3/8" x 6-3/8" x 3-1/8"	18	ETL
ASD-TCS-2D30WH	2 pcs	30	120	Triac	2,700/3,000/3,500/4,000/5,000	2,112	White	10-1/8" x 6-3/8" x 3-1/8"	8	ETL
ASD-TCS-3D45WH	3 pcs	45	120	Triac	2,700/3,000/3,500/4,000/5,000	3,308	White	13-15/16" x 6-3/8" x 3-1/8"	4	ETL

ACCESSORIES

Battery back-up kit 15W for 15W	BLD-HM15D	12-15/16" x 1-7/16" x 15/16"	10	UL
NLS Battery back-up kit 15W for 15W	ASD-EMA15-NLS	14-5/8" x 1-5/8" x 1-7/16"	10	UL

LED ROUND DOWNLIGHT 1 & 2 INCH

ASD-CD-PR, ASD-CD-CR

Model	Size	Watts	Input Voltage	Dimmable	CCT	Lm	Reflector finish	Trim finish	Dimensions DxH	Pcs. per Carton	Certification
ASD-CD-PR-1D7AC-BK	1"	7	120	Triac	2,700/3,000/3,500/4,000/5,000	550	Black	Black	2-3/8" x 3-3/8"	24	ETL
ASD-CD-PR-1D7AC-WH	1"	7	120	Triac	2,700/3,000/3,500/4,000/5,000	550	White	White	2-3/8" x 3-3/8"	24	ETL
ASD-CD-CR-2D8AC-CH/BK	2"	8	120	Triac	2,700/3,000/3,500/4,000/5,000	609	Chrome	Black	3-1/8" x 2-15/16"	18	ETL / Energy Star
ASD-CD-CR-2D8AC-CH/WH	2"	8	120	Triac	2,700/3,000/3,500/4,000/5,000	609	Chrome	White	3-1/8" x 2-15/16"	18	ETL / Energy Star
ASD-CD-PR-2D8AC-BK	2"	8	120	Triac	2,700/3,000/3,500/4,000/5,000	649	Black	Black	3-1/8" x 2-15/16"	18	ETL / Energy Star
ASD-CD-PR-2D8AC-WH	2"	8	120	Triac	2,700/3,000/3,500/4,000/5,000	649	White	White	3-1/8" x 2-15/16"	18	ETL / Energy Star
ASD-CD-CR-2D15AC-CH/BK	2"	15	120	Triac	2,700/3,000/3,500/4,000/5,000	1,011	Chrome	Black	3-1/8" x 4-15/16"	18	ETL / Energy Star
ASD-CD-CR-2D15AC-CH/WH	2"	15	120	Triac	2,700/3,000/3,500/4,000/5,000	1,011	Chrome	White	3-1/8" x 4-15/16"	18	ETL / Energy Star
ASD-CD-PR-2D15AC-BK	2"	15	120	Triac	2,700/3,000/3,500/4,000/5,000	1,110	Black	Black	3-1/8" x 4-15/16"	18	ETL / Energy Star
ASD-CD-PR-2D15AC-WH	2"	15	120	Triac	2,700/3,000/3,500/4,000/5,000	1,110	White	White	3-1/8" x 4-15/16"	18	ETL / Energy Star

120-277 V

ASD-CD-PR-MV-2D15AC-WH	2"	15	120-277	0-10V	2,700/3,000/3,500/4,000/5,000	1,087	White	White	3-1/8" x 4-15/16"	18	ETL / Energy Star
------------------------	----	----	---------	-------	-------------------------------	-------	-------	-------	-------------------	----	-------------------

ACCESSORIES

Battery back-up kit 8W	BLD-HM08D	10-7/16" x 1-15/16" x 15/16"	10	UL
Battery back-up kit 15W	BLD-HM15D	12-15/16" x 1-7/16" x 15/16"	10	UL
NLS Battery back-up kit 15W	ASD-EMA15-NLS	14-5/8" x 1-5/8" x 1-7/16"	10	UL



LED SQUARE DOWNLIGHT 1 & 2 INCH

ASD-CD-PS

Model	Size	Watts	Input Voltage	Dimmable	CCT	Lm	Reflector finish	Trim finish	Dimensions LxWxH	Pcs. per Carton	Certification
ASD-CD-PS-1D7AC-BK	1"	7	120	Triac	2,700/3,000/3,500/4,000/5,000	560	Black	Black	2-3/8" x 2-3/8" x 3-3/8"	24	ETL
ASD-CD-PS-1D7AC-WH	1"	7	120	Triac	2,700/3,000/3,500/4,000/5,000	560	White	White	2-3/8" x 2-3/8" x 3-3/8"	24	ETL
ASD-CD-PS-2D8AC-BK	2"	8	120	Triac	2,700/3,000/3,500/4,000/5,000	615	Black	Black	3-1/8" x 3-1/8" x 2-15/16"	18	ETL / Energy Star
ASD-CD-PS-2D8AC-WH	2"	8	120	Triac	2,700/3,000/3,500/4,000/5,000	615	White	White	3-1/8" x 3-1/8" x 2-15/16"	18	ETL / Energy Star
ASD-CD-PS-2D15AC-BK	2"	15	120	Triac	2,700/3,000/3,500/4,000/5,000	1,103	Black	Black	3-1/8" x 3-1/8" x 4-15/16"	18	ETL / Energy Star
ASD-CD-PS-2D15AC-WH	2"	15	120	Triac	2,700/3,000/3,500/4,000/5,000	1,103	White	White	3-1/8" x 3-1/8" x 4-15/16"	18	ETL / Energy Star

ACCESSORIES

Battery back-up kit 8W	BLD-HM08D	10-7/16" x 1-15/16" x 15/16"	10	UL
Battery back-up kit 15W	BLD-HM15D	12-15/16" x 1-7/16" x 15/16"	10	UL
NLS Battery back-up kit 15W	ASD-EMA15-NLS	14-5/8" x 1-5/8" x 1-7/16"	10	UL



LED DOWNLIGHT 2 INCH WITH ROUND WASH TRIM

ASD-CD-PWR

Model	Size	Watts	Input Voltage	Dimmable	CCT	Lm	Finish	Dimensions DxH	Pcs. per Carton	Certification
ASD-CD-PWR-2D8AC-WH	2"	8	120	Triac	2,700/3,000/3,500/4,000/5,000	416	White	3-1/8" x 2-13/16"	18	ETL

ACCESSORIES

Battery back-up kit 8W	BLD-HM08D	10-7/16" x 1-15/16" x 15/16"	10	UL
Battery back-up kit 15W	BLD-HM15D	12-15/16" x 1-7/16" x 15/16"	10	UL
NLS Battery back-up kit 15W	ASD-EMA15-NLS	14-5/8" x 1-5/8" x 1-7/16"	10	UL

NEW CONSTRUCTION MOUNTING PLATE

ASD-MPL-FA, ASD-MPL-FS, ASD-MPL-SC

Description	Model	Holes	Size	Dimensions LxWxH	Pcs. per Carton
New Construction Flat Mounting Plate with Asymmetric holes	ASD-MPLR-346-FA-6PACK	Round	3-4-6"	13-1/4" x 9-1/16" x 1/16"	4
New Construction Flat Mounting Plate with Asymmetric holes	ASD-MPLR18-346-FA-6PACK	Round	3-4-6"	18" x 9-1/16" x 1/16"	4
New Construction Flat Mounting Plate with Asymmetric holes	ASD-MPLR-81012-FA-6PACK	Round	8-10-12"	18-1/2" x 13-3/8" x 1/16"	4
New Construction Flat Mounting Plate with Asymmetric holes	ASD-MPLS-346-FA-6PACK	Square	3-4-6"	13-1/4" x 9-1/16" x 1/16"	24
New Construction Flat Mounting Plate with Asymmetric holes	ASD-MPLS-346-FA-6PACK	Square	3-4-6"	13-1/4" x 9-1/16" x 1/16"	4
New Construction Flat Mounting Plate with Asymmetric holes	ASD-MPLS-81012-FA-6PACK	Square	8-10-12"	18-1/2" x 13-3/8" x 1/16"	4
New Construction Flat Mounting Plate with Symmetric holes	ASD-MPLR-346-FS-6PACK	Round	3-4-6"	26" x 8-1/4" x 1/16"	4
New Construction Flat Mounting Plate with Symmetric holes	ASD-MPLR-81012-FS-6PACK	Round	8-10-12"	26" x 13" x 1/16"	4
New Construction Flat Mounting Plate with Symmetric holes	ASD-MPLS-346-FS-6PACK	Square	3-4-6"	26" x 8-1/4" x 1/16"	24
New Construction Flat Mounting Plate with Symmetric holes	ASD-MPLS-346-FS-6PACK	Square	3-4-6"	26" x 8-1/4" x 1/16"	4
New Construction Flat Mounting Plate with Symmetric holes	ASD-MPLS-81012-FS-6PACK	Square	8-10-12"	26" x 13" x 1/16"	4
New Construction Mounting Plate with holes and Sliding Clips	ASD-MPLR-346-SC-6PACK	Round	3-4-6"	14-3/8" x 10-9/16" x 1-5/8"	2
New Construction Mounting Plate with holes and Sliding Clips	ASD-MPLR-81012-SC-6PACK	Round	8-10-12"	17-11/16" x 13" x 1-9/16"	2
New Construction Mounting Plate with holes and Sliding Clips	ASD-MPLS-346-SC-6PACK	Square	3-4-6"	14-3/8" x 10-9/16" x 1-5/8"	2



LED ROUND DOWNLIGHT RETROFIT KIT

ASD-LRKR

Model	Size	Watts	Input Voltage	Dimmable	CCT	Lm	Finish	Dimensions DxH	Pcs. per Carton	Certification
ASD-LRKR-4D9AC-BK	4"	8.6	120	Triac	2,700/3,000/3,500/4,000/5,000	702	Black	5-1/16" x 2"	6	UL
ASD-LRKR-4D9AC-BK-12PACK	4"	8.6	120	Triac	2,700/3,000/3,500/4,000/5,000	702	Black	5-1/16" x 2"	1	UL
ASD-LRKR-4D9AC-BR	4"	8.6	120	Triac	2,700/3,000/3,500/4,000/5,000	702	Bronze	5-1/16" x 2"	6	UL
ASD-LRKR-4D9AC-BR-12PACK	4"	8.6	120	Triac	2,700/3,000/3,500/4,000/5,000	702	Bronze	5-1/16" x 2"	1	UL
ASD-LRKR-4D9AC-WH	4"	8.6	120	Triac	2,700/3,000/3,500/4,000/5,000	702	White	5-1/16" x 2"	6	UL
ASD-LRKR-4D9AC-WH-12PACK	4"	8.6	120	Triac	2,700/3,000/3,500/4,000/5,000	702	White	5-1/16" x 2"	1	UL
ASD-LRKR-6D12AC-BK	6"	12	120	Triac	2,700/3,000/3,500/4,000/5,000	1,009	Black	7-5/16" x 3-7/16"	6	UL
ASD-LRKR-6D12AC-BK-12PACK	6"	12	120	Triac	2,700/3,000/3,500/4,000/5,000	1,009	Black	7-5/16" x 3-7/16"	1	UL
ASD-LRKR-6D12AC-BR	6"	12	120	Triac	2,700/3,000/3,500/4,000/5,000	1,009	Bronze	7-5/16" x 3-7/16"	6	UL
ASD-LRKR-6D12AC-BR-12PACK	6"	12	120	Triac	2,700/3,000/3,500/4,000/5,000	1,009	Bronze	7-5/16" x 3-7/16"	1	UL
ASD-LRKR-6D12AC-WH	6"	12	120	Triac	2,700/3,000/3,500/4,000/5,000	1,009	White	7-5/16" x 3-7/16"	6	UL
ASD-LRKR-6D12AC-WH-12PACK	6"	12	120	Triac	2,700/3,000/3,500/4,000/5,000	1,009	White	7-5/16" x 3-7/16"	1	UL



LED SQUARE DOWNLIGHT RETROFIT KIT

ASD-LRKS

Model	Size	Watts	Input Voltage	Dimmable	CCT	Lm	Finish	Dimensions LxWxH	Pcs. per Carton	Certification
ASD-LRKS-4D9AC-BK-6PACK	4"	8.6	120	Triac	2,700/3,000/3,500/4,000/5,000	709	Black	5" x 5" x 2-1/16"	2	UL
ASD-LRKS-4D9AC-BZ-6PACK	4"	8.6	120	Triac	2,700/3,000/3,500/4,000/5,000	709	Bronze	5" x 5" x 2-1/16"	2	UL
ASD-LRKS-4D9AC-WH-6PACK	4"	8.6	120	Triac	2,700/3,000/3,500/4,000/5,000	709	White	5" x 5" x 2-1/16"	2	UL
ASD-LRKS-6D12AC-BK-6PACK	6"	12	120	Triac	2,700/3,000/3,500/4,000/5,000	1,023	Black	7-5/16" x 7-5/16" x 1-7/8"	2	UL
ASD-LRKS-6D12AC-BZ-6PACK	6"	12	120	Triac	2,700/3,000/3,500/4,000/5,000	1,023	Bronze	7-5/16" x 7-5/16" x 1-7/8"	2	UL
ASD-LRKS-6D12AC-WH-6PACK	6"	12	120	Triac	2,700/3,000/3,500/4,000/5,000	1,023	White	7-5/16" x 7-5/16" x 1-7/8"	2	UL



LED DOWNLIGHT RETROFIT KIT GIMBAL

ASD-LRK-GBR

Model	Size	Watts	Input Voltage	Dimmable	CCT	Lm	Finish	Dimensions DxH	Pcs. per Carton	Certification
ASD-LRK-GBR-4D10AC-BK-6PACK	4"	10	120	Triac	2,700/3,000/3,500/4,000/5,000	860	Black	5-3/8" x 2-13/16"	2	UL
ASD-LRK-GBR-4D10AC-BZ-6PACK	4"	10	120	Triac	2,700/3,000/3,500/4,000/5,000	860	Bronze	5-3/8" x 2-13/16"	2	UL
ASD-LRK-GBR-4D10AC-WH-6PACK	4"	10	120	Triac	2,700/3,000/3,500/4,000/5,000	860	White	5-3/8" x 2-13/16"	2	UL / Energy Star
ASD-LRK-GBR-6D15AC-BK-6PACK	6"	15	120	Triac	2,700/3,000/3,500/4,000/5,000	1,310	Black	7-11/16" x 3-1/16"	2	UL
ASD-LRK-GBR-6D15AC-BZ-6PACK	6"	15	120	Triac	2,700/3,000/3,500/4,000/5,000	1,310	Bronze	7-11/16" x 3-1/16"	2	UL
ASD-LRK-GBR-6D15AC-WH-6PACK	6"	15	120	Triac	2,700/3,000/3,500/4,000/5,000	1,310	White	7-11/16" x 3-1/16"	2	UL / Energy Star



LED VANITY LINEAR LOFT

ASD-LOFT-LF

Model	Size	Watts	Input Voltage	Dimmable	CCT	Lm	Finish	Dimensions LxWxH	Pcs. per Carton	Certification
ASD-LVF-LF-18D20AC-BK	18"	20	120	Triac	2,700/3,000/3,500/4,000/5,000	1,462	Black	19-1/16" x 5-1/4" x 3-11/16"	4	ETL
ASD-LVF-LF-18D20AC-NK	18"	20	120	Triac	2,700/3,000/3,500/4,000/5,000	1,462	Nickel	19-1/16" x 5-1/4" x 3-11/16"	4	ETL
ASD-LVF-LF-24D25AC-BK	24"	25	120	Triac	2,700/3,000/3,500/4,000/5,000	1,939	Black	25-1/2" x 5-1/4" x 3-11/16"	4	ETL
ASD-LOFT-VF-24D25NK	24"	25	120	Triac	2,700/3,000/3,500/4,000/5,000	1,939	Nickel	25-1/2" x 5-1/4" x 3-11/16"	4	ETL
ASD-LVF-LF-36D30AC-BK	36"	30	120	Triac	2,700/3,000/3,500/4,000/5,000	2,515	Black	37-1/16" x 5-1/4" x 3-11/16"	4	ETL
ASD-LOFT-VF-36D30NK	36"	30	120	Triac	2,700/3,000/3,500/4,000/5,000	2,515	Nickel	37-1/16" x 5-1/4" x 3-11/16"	4	ETL
ASD-LVF-LF-48D35AC-BK	48"	35	120	Triac	2,700/3,000/3,500/4,000/5,000	3,098	Black	49" x 5-1/4" x 3-11/16"	4	ETL
ASD-LOFT-VF-48D35NK	48"	35	120	Triac	2,700/3,000/3,500/4,000/5,000	3,098	Nickel	49" x 5-1/4" x 3-11/16"	4	ETL



LED LINEAR VANITY LIGHT

ASD-LVF21

Model	Size	Watts	Input Voltage	Dimmable	CCT	Lm	Finish	Dimensions LxWxH	Pcs. per Carton	Certification
ASD-LVF21-18D20CC-BK	18"	20	120	Triac	3,000/4,000/5,000	1,620	Black	19-1/8" x 5-7/8" x 4"	4	ETL / Energy Star
ASD-LVF21-18D20CC-BZ	18"	20	120	Triac	3,000/4,000/5,000	1,620	Bronze	19-1/8" x 5-7/8" x 4"	4	ETL / Energy Star
ASD-LVF21-18D20CC-NK	18"	20	120	Triac	3,000/4,000/5,000	1,570	Nickel	19-1/8" x 5-7/8" x 4"	4	ETL / Energy Star
ASD-LVF21-18D20CC-NK-2PACK	18"	20	120	Triac	3,000/4,000/5,000	1,570	Nickel	19-1/8" x 5-7/8" x 4"	2	ETL / Energy Star
ASD-LVF21-24D25CC-BK	24"	25	120	Triac	3,000/4,000/5,000	1,950	Black	25-9/16" x 5-7/8" x 4"	4	ETL / Energy Star
ASD-LVF21-24D25CC-BZ	24"	25	120	Triac	3,000/4,000/5,000	1,950	Bronze	25-9/16" x 5-7/8" x 4"	4	ETL / Energy Star
ASD-LVF21-24D25CC-NK	24"	25	120	Triac	3,000/4,000/5,000	1,950	Nickel	25-9/16" x 5-7/8" x 4"	4	ETL / Energy Star
ASD-LVF21-24D25CC-NK-2PACK	24"	25	120	Triac	3,000/4,000/5,000	1,950	Nickel	25-9/16" x 5-7/8" x 4"	2	ETL / Energy Star
ASD-LVF21-36D30CC-BK	36"	30	120	Triac	3,000/4,000/5,000	2,640	Black	37-3/16" x 5-7/8" x 4"	4	ETL / Energy Star
ASD-LVF21-36D30CC-NK	36"	30	120	Triac	3,000/4,000/5,000	2,640	Nickel	37-3/16" x 5-7/8" x 4"	4	ETL / Energy Star
ASD-LVF21-48D35CC-NK	48"	35	120	Triac	3,000/4,000/5,000	3,205	Nickel	49" x 5-7/8" x 4"	4	ETL / Energy Star

120-277 V

ASD-LVF21-MV-18D20NK	18"	20	120-277	Triac	3,000/4,000/5,000	2,259	Nickel	19-1/8" x 5-7/8" x 4"	4	ETL
ASD-LVF21-MV-24D25NK	24"	25	120-277	Triac	3,000/4,000/5,000	2,598	Nickel	25-9/16" x 5-7/8" x 4"	4	ETL



LED LINEAR VANITY LIGHT

ASD-LVF22

Model	Size	Watts	Input Voltage	Dimmable	CCT	Lm	Finish	Dimensions LxWxH	Pcs. per Carton	Certification
ASD-LVF22-18D20CC-NK	18"	20	120	Triac	3,000/4,000/5,000	1,730	Nickel	18-1/16" x 4-1/2" x 4-3/4"	4	ETL / Energy Star
ASD-LVF22-24D25CC-NK	24"	25	120	Triac	3,000/4,000/5,000	2,105	Nickel	24-3/8" x 4-1/2" x 4-3/4"	4	ETL / Energy Star

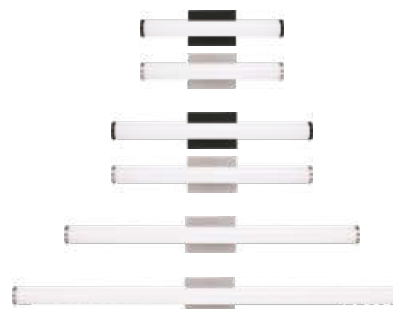

LED LINEAR VANITY LIGHT

ASD-LVF23

Model	Size	Watts	Input Voltage	Dimmable	CCT	Lm	Finish	Dimensions LxWxH	Pcs. per Carton	Certification
ASD-LVF23-18D20CC-BK	18"	20	120	Triac	3,000/4,000/5,000	1,789	Black	18" x 4-1/2" x 3"	4	ETL / Energy Star
ASD-LVF23-18D20CC-NK	18"	20	120	Triac	3,000/4,000/5,000	1,789	Nickel	18" x 4-1/2" x 3"	4	ETL / Energy Star
ASD-LVF23-24D25CC-BK	24"	25	120	Triac	3,000/4,000/5,000	2,574	Black	24" x 4-1/2" x 3"	4	ETL / Energy Star
ASD-LVF23-24D25CC-NK	24"	25	120	Triac	3,000/4,000/5,000	2,574	Nickel	24" x 4-1/2" x 3"	2	ETL / Energy Star
ASD-LVF23-36D30CC-NK	36"	30	120	Triac	3,000/4,000/5,000	3,141	Nickel	36" x 4-1/2" x 3"	4	ETL / Energy Star
ASD-LVF23-48D35CC-NK	48"	35	120	Triac	3,000/4,000/5,000	3,812	Nickel	47-5/16" x 4-1/2" x 3"	4	ETL

LED VANITY LIGHT

ASD-LVF24M

Model	Number of lights	Watts	Input Voltage	Dimmable	CCT	Lm	Finish	Dimensions LxWxH	Pcs. per Carton	Certification
ASD-LVF24M-2D12CC-BK	2	12	120	Triac	3,000/4,000/5,000	652	Black	15" x 5-1/8" x 3-3/16"	4	ETL
ASD-LVF24M-2D12CC-CH	2	12	120	Triac	3,000/4,000/5,000	996	Chrome	15" x 5-1/8" x 3-3/16"	4	ETL
ASD-LVF24M-3D15CC-BK	3	15	120	Triac	3,000/4,000/5,000	843	Black	18-1/8" x 5-1/8" x 3-3/16"	4	ETL
ASD-LVF24M-3D15CC-CH	3	15	120	Triac	3,000/4,000/5,000	1,211	Chrome	18-1/8" x 5-1/8" x 3-3/16"	4	ETL
ASD-LVF24M-4D23CC-BK	4	23	120	Triac	3,000/4,000/5,000	1,297	Black	24" x 5-1/8" x 3-3/16"	2	ETL
ASD-LVF24M-4D23CC-CH	4	23	120	Triac	3,000/4,000/5,000	1,869	Chrome	24" x 5-1/8" x 3-3/16"	2	ETL
ASD-LVF24M-5D28CC-BK	5	28	120	Triac	3,000/4,000/5,000	1,604	Black	29-15/16" x 5-1/8" x 3-3/16"	2	ETL
ASD-LVF24M-5D28CC-CH	5	28	120	Triac	3,000/4,000/5,000	2,308	Chrome	29-15/16" x 5-1/8" x 3-3/16"	2	ETL
ASD-LVF24M-6D35CC-BK	6	35	120	Triac	3,000/4,000/5,000	2,025	Black	36" x 5-1/8" x 3-3/16"	2	ETL
ASD-LVF24M-6D35CC-CH	6	35	120	Triac	3,000/4,000/5,000	2,768	Chrome	36" x 5-1/8" x 3-3/16"	2	ETL

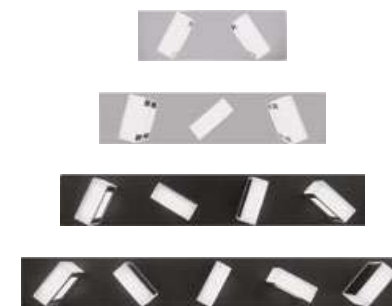

LED VANITY LIGHT WITH ROTATABLE HEADS

ASD-LVF25M

Model	Number of lights	Watts	Input Voltage	Dimmable	CCT	Lm	Finish	Dimensions LxWxH	Pcs. per Carton	Certification
ASD-LVF25M-2D12BK	2	12	120	Triac	2,700/3,000/4,000/5,000/6,000	825	Black	13-3/16" x 4-13/16" x 4-5/16"	4	ETL
ASD-LVF25M-2D12CH	2	12	120	Triac	2,700/3,000/4,000/5,000/6,000	825	Chrome	13-3/16" x 4-13/16" x 4-5/16"	4	ETL
ASD-LVF25M-3D15BK	3	15	120	Triac	2,700/3,000/4,000/5,000/6,000	857	Black	19-11/16" x 4-13/16" x 4-5/16"	4	ETL
ASD-LVF25M-3D15CH	3	15	120	Triac	2,700/3,000/4,000/5,000/6,000	857	Chrome	19-11/16" x 4-13/16" x 4-5/16"	4	ETL
ASD-LVF25M-4D23BK	4	23	120	Triac	2,700/3,000/4,000/5,000/6,000	1,316	Black	26-3/16" x 4-13/16" x 4-5/16"	2	ETL
ASD-LVF25M-4D23CH	4	23	120	Triac	2,700/3,000/4,000/5,000/6,000	1,316	Chrome	26-3/16" x 4-13/16" x 4-5/16"	2	ETL
ASD-LVF25M-5D28BK	5	28	120	Triac	2,700/3,000/4,000/5,000/6,000	1,618	Black	32-7/8" x 4-13/16" x 4-5/16"	2	ETL
ASD-LVF25M-5D28CH	5	28	120	Triac	2,700/3,000/4,000/5,000/6,000	1,618	Chrome	32-7/8" x 4-13/16" x 4-5/16"	2	ETL

LED VANITY LIGHT

ASD-LVF26M

Model	Number of lights	Watts	Input Voltage	Dimmable	CCT	Lm	Finish	Dimensions LxWxH	Pcs. per Carton	Certification
ASD-LVF26M-2D12BK	2	12	120	Triac	2,700/3,000/4,000/5,000/6,000	1,043	Black	13-3/16" x 3-3/4" x 4-5/16"	4	ETL
ASD-LVF26M-2D12CH	2	12	120	Triac	2,700/3,000/4,000/5,000/6,000	1,043	Chrome	13-3/16" x 3-3/4" x 4-5/16"	4	ETL
ASD-LVF26M-3D15BK	3	15	120	Triac	2,700/3,000/4,000/5,000/6,000	1,229	Black	19-11/16" x 3-3/4" x 4-5/16"	4	ETL
ASD-LVF26M-3D15CH	3	15	120	Triac	2,700/3,000/4,000/5,000/6,000	1,229	Chrome	19-11/16" x 3-3/4" x 4-5/16"	4	ETL
ASD-LVF26M-4D23BK	4	23	120	Triac	2,700/3,000/4,000/5,000/6,000	2,102	Black	26-3/16" x 3-3/4" x 4-5/16"	2	ETL
ASD-LVF26M-4D23CH	4	23	120	Triac	2,700/3,000/4,000/5,000/6,000	2,102	Chrome	26-3/16" x 3-3/4" x 4-5/16"	2	ETL
ASD-LVF26M-5D28BK	5	28	120	Triac	2,700/3,000/4,000/5,000/6,000	2,517	Black	32-7/8" x 3-3/4" x 4-5/16"	2	ETL
ASD-LVF26M-5D28CH	5	28	120	Triac	2,700/3,000/4,000/5,000/6,000	2,517	Chrome	32-7/8" x 3-3/4" x 4-5/16"	2	ETL



VANITY LIGHT & MINI-PENDANT

ASD-VF27, ASD-MP27

Model	Type	Bulb Type	Voltage	Finish	Shade	Dimensions LxWxH	Pcs. per Carton	Certification
ASD-VF27-2I-2660-NK	Vanity Light	2 x E26 60W max	120 V	Nickel	Clear Glass	15-5/16" x 7-7/8" x 10-11/16"	2	ETL
ASD-VF27-3I-2660-NK	Vanity Light	3 x E26 60W max	120 V	Nickel	Clear Glass	22-5/8" x 7-7/8" x 10-11/16"	2	ETL
ASD-VF27-4I-2660-NK	Vanity Light	4 x E26 60W max	120 V	Nickel	Clear Glass	31-1/4" x 7-7/8" x 10-11/16"	2	ETL
ASD-MP27-1I-2660-NK	Mini-Pendant	1 x E26 60W max	120 V	Nickel	Clear Glass	5-1/2" x 5-1/2" x 46-3/4"	4	ETL

VANITY LIGHT & MINI-PENDANT

ASD-VF44, ASD-MP44

Model	Type	Bulb Type	Voltage	Finish	Shade	Dimensions LxWxH	Pcs. per Carton	Certification
ASD-VF44-2I-2660-NK	Vanity Light	2 x E26 60W max	120 V	Nickel	Opal Glass	12-5/8" x 6-3/8" x 7-13/16"	6	ETL
ASD-VF44-3I-2660-BK	Vanity Light	3 x E26 60W max	120 V	Black	Opal Glass	20-1/2" x 6-3/8" x 7-13/16"	4	ETL
ASD-VF44-3I-2660-NK	Vanity Light	3 x E26 60W max	120 V	Nickel	Opal Glass	20-1/2" x 6-5/16" x 7-1/2"	4	ETL
ASD-VF44-4I-2660-NK	Vanity Light	4 x E26 60W max	120 V	Nickel	Opal Glass	28-3/8" x 6-3/8" x 7-13/16"	4	ETL
ASD-MP44-1I-2660-BK	Mini-Pendant	1 x E26 60W max	120 V	Black	Opal Glass	4-3/4" x 4-3/4" x 51-3/16"	12	ETL
ASD-MP44-1I-2660-NK	Mini-Pendant	1 x E26 60W max	120 V	Nickel	Opal Glass	4-3/4" x 4-3/4" x 51-3/16"	12	ETL



VANITY LIGHT & MINI-PENDANT

ASD-VF45, ASD-MP45

Model	Type	Bulb Type	Voltage	Finish	Shade	Dimensions LxWxH	Pcs. per Carton	Certification
ASD-VF45-2I-2660-NK	Vanity Light	2 x E26 60W max	120 V	Nickel	Opal Glass	12-7/16" x 6-1/8" x 7-9/16"	6	ETL
ASD-VF45-3I-2660-NK	Vanity Light	3 x E26 60W max	120 V	Nickel	Opal Glass	20-1/2" x 6-1/8" x 7-9/16"	4	ETL
ASD-MP45-1I-2660-NK	Mini-Pendant	1 x E26 60W max	120 V	Nickel	Opal Glass	4-3/4" x 4-3/4" x 10-1/4"	12	ETL





LED WALL SCONCE LOFT

ASD-LOFT-WS

Model	Size	Watts	Input Voltage	Dimmable	CCT	Lm	Finish	Dimensions LxWxH	Pcs. per Carton	Certification
ASD-LWS-LF-12D15AC-BK	12"	15	120 V	Triac	2,700/3,000/3,500/4,000/5,000	1,124	Black	5-1/4" x 3-11/16" x 12-11/16"	4	ETL
ASD-LWS-LF-12D15AC-NK	12"	15	120 V	Triac	2,700/3,000/3,500/4,000/5,000	1,124	Nickel	5-1/4" x 3-11/16" x 12-11/16"	4	ETL



LED WALL SCONCE

ASD-LWS-11

Model	Size	Watts	Input Voltage	Dimmable	CCT	Lm	Finish	Dimensions LxWxH	Pcs. per Carton	Certification
ASD-LWS-11-D15CC-BK	10"	15	120	Triac	3,000/4,000/5,000	1,107	Black	7" x 3-5/16" x 9-13/16"	4	ETL / Energy Star
ASD-LWS-11-D15CC-BZ	10"	15	120	Triac	3,000/4,000/5,000	1,107	Bronze	7" x 3-5/16" x 9-13/16"	4	ETL / Energy Star
ASD-LWS-11-D15CC-NK	10"	15	120	Triac	3,000/4,000/5,000	1,107	Nickel	7" x 3-5/16" x 9-13/16"	4	ETL / Energy Star
ASD-LWS-11-D15CC-NK-2PACK	10"	15	120	Triac	3,000/4,000/5,000	1,107	Nickel	7" x 3-5/16" x 9-13/16"	2	ETL / Energy Star



LED WALL SCONCE

ASD-LWS12

Model	Size	Watts	Input Voltage	Dimmable	CCT	Lm	Finish	Dimensions LxWxH	Pcs. per Carton	Certification
ASD-LWS12-D12AC-BK	12"	12	120 V	Triac	2,700/3,000/3,500/4,000/5,000	855	Black	11-7/16" x 4-3/4" x 1-3/4"	4	UL
ASD-LWS12-D12AC-NK	12"	12	120 V	Triac	2,700/3,000/3,500/4,000/5,000	855	Nickel	11-7/16" x 4-3/4" x 1-3/4"	4	UL



LED UNDER CABINET BULLNOSE

ASD-UBN

Model	Size	Watts	Input Voltage	Dimmable	CCT	Lm	Finish	Dimensions LxWxH	Pcs. per Carton	Certification
ASD-UBN-9WH	9"	4	120	Triac	2,700/3,000/3,500/4,000/5,000	337	White	9" x 3-1/2" x 1-1/8"	20	UL
ASD-UBN-12WH	12"	5	120	Triac	2,700/3,000/3,500/4,000/5,000	442	White	12" x 3-1/2" x 1-1/8"	20	UL
ASD-UBN-12WH-2P	12"	5	120	Triac	2,700/3,000/3,500/4,000/5,000	442	White	12" x 3-1/2" x 1-1/8"	10	UL
ASD-UBN-18WH	18"	10	120	Triac	2,700/3,000/3,500/4,000/5,000	807	White	18" x 3-1/2" x 1-1/8"	20	UL
ASD-UBN-18WH-2P	18"	10	120	Triac	2,700/3,000/3,500/4,000/5,000	807	White	18" x 3-1/2" x 1-1/8"	10	UL
ASD-UBN-24WH	24"	12	120	Triac	2,700/3,000/3,500/4,000/5,000	1,051	White	24" x 3-1/2" x 1-1/8"	12	UL
ASD-UBN-24WH-2P	24"	12	120	Triac	2,700/3,000/3,500/4,000/5,000	1,051	White	24" x 3-1/2" x 1-1/8"	6	UL
ASD-UBN-32WH	32"	16	120	Triac	2,700/3,000/3,500/4,000/5,000	1,436	White	32-1/4" x 3-1/2" x 1-1/8"	12	UL
ASD-UBN-40WH	40"	20	120	Triac	2,700/3,000/3,500/4,000/5,000	1,814	White	40" x 3-1/2" x 1-1/8"	6	UL
ASD-UBN-48WH	48"	24	120	Triac	2,700/3,000/3,500/4,000/5,000	2,087	White	48-1/16" x 3-1/2" x 1-1/8"	6	UL



LED UNDER CABINET LINEAR

ASD-UCL

Model	Size	Watts	Input Voltage	Dimmable	CCT	Lm	Finish	Dimensions LxWxH	Pcs. per Carton	Certification
ASD-UCL-9D3CC-WH	9"	3	120	Triac	2,700/3,000/4,000	214	White	9" x 3-11/16" x 1"	20	ETL / Energy Star
ASD-UCL-12D5CC-WH	12"	5	120	Triac	2,700/3,000/4,000	406	White	12" x 3-11/16" x 1"	20	ETL / Energy Star
ASD-UCL-18D8CC-WH	18"	8	120	Triac	2,700/3,000/4,000	548	White	18" x 3-11/16" x 1"	20	ETL / Energy Star
ASD-UCL-24D12CC-WH	24"	12	120	Triac	2,700/3,000/4,000	874	White	24" x 3-11/16" x 1"	12	ETL / Energy Star
ASD-UCL-32D16CC-WH	32"	16	120	Triac	2,700/3,000/4,000	1,131	White	32" x 3-11/16" x 1"	12	ETL / Energy Star
ASD-UCL-40D20CC-WH	40"	20	120	Triac	2,700/3,000/4,000	1,532	White	40" x 3-11/16" x 1"	12	ETL / Energy Star
ASD-UCL-48D24CC-WH	48"	24	120	Triac	2,700/3,000/4,000	1,781	White	48" x 3-11/16" x 1"	6	ETL / Energy Star



LED UNDER CABINET SWIVEL

ASD-UCS

Model	Size	Watts	Input Voltage	Dimmable	CCT	Lm	Finish	Dimensions LxWxH	Pcs. per Carton	Certification
ASD-UCS-9D3CC-WH	9"	3	120	Triac	2,700/3,000/4,000	191	White	9" x 3-5/8" x 1"	20	ETL / Energy Star
ASD-UCS-12D5CC-BZ	12"	5	120	Triac	2,700/3,000/4,000	396	Bronze	12" x 3-5/8" x 1"	20	ETL / Energy Star
ASD-UCS-12D5CC-WH	12"	5	120	Triac	2,700/3,000/4,000	396	White	12" x 3-5/8" x 1"	20	ETL / Energy Star
ASD-UCS-18D8CC-BZ	18"	8	120	Triac	2,700/3,000/4,000	613	Bronze	18" x 3-5/8" x 1"	20	ETL / Energy Star
ASD-UCS-18D8CC-WH	18"	8	120	Triac	2,700/3,000/4,000	613	White	18" x 3-5/8" x 1"	20	ETL / Energy Star
ASD-UCS-24D12CC-BZ	24"	12	120	Triac	2,700/3,000/4,000	933	Bronze	24" x 3-5/8" x 1"	20	ETL / Energy Star
ASD-UCS-24D12CC-WH	24"	12	120	Triac	2,700/3,000/4,000	933	White	24" x 3-5/8" x 1"	12	ETL / Energy Star
ASD-UCS-32D16CC-BZ	32"	16	120	Triac	2,700/3,000/4,000	1,328	Bronze	31-7/8" x 3-5/8" x 1"	12	ETL / Energy Star
ASD-UCS-32D16CC-WH	32"	16	120	Triac	2,700/3,000/4,000	1,328	White	31-7/8" x 3-5/8" x 1"	12	ETL / Energy Star
ASD-UCS-40D20CC-WH	40"	20	120	Triac	2,700/3,000/4,000	1,567	White	40-3/16" x 3-5/8" x 1"	6	ETL / Energy Star
ASD-UCS-48D24CC-WH	48"	24	120	Triac	2,700/3,000/4,000	1,744	White	48" x 3-5/8" x 1"	6	ETL / Energy Star

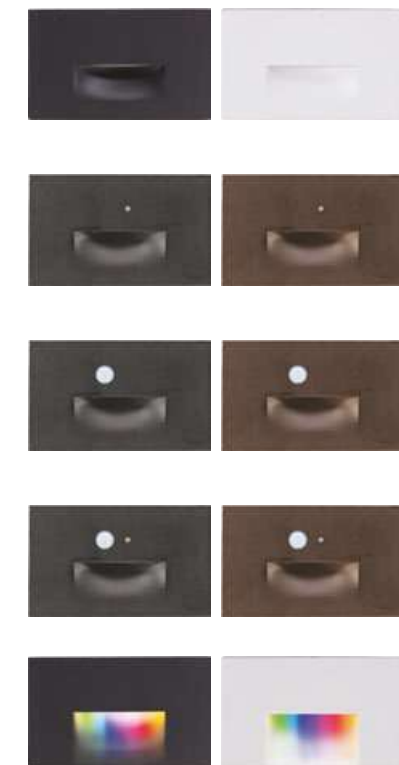

LED STEP LIGHT HORIZONTAL

ASD-LSTL, ASD-STLA-RGB

Model	Watts	Input Voltage	Dimmable	CCT	Lm	Finish	Dimensions LxWxH	Pcs. per Carton	Certification
ASD-LSTL-H01W-D3CC-BK-4PACK	3	120	Triac	3,000/4,000/5,000	114	Black	4-3/4" x 1-9/16" x 2-13/16"	3	ETL
ASD-LSTL-H01W-D3CC-BZ-4PACK	3	120	Triac	3,000/4,000/5,000	114	Oil Rubbed Bronze	4-3/4" x 1-9/16" x 2-13/16"	3	ETL
ASD-LSTL-H01W-D3CC-BZ	3	120	Triac	3,000/4,000/5,000	114	Oil Rubbed Bronze	4-3/4" x 1-9/16" x 2-13/16"	12	ETL
ASD-LSTL-H01W-D3CC-WH-4PACK	3	120	Triac	3,000/4,000/5,000	114	White	4-3/4" x 1-9/16" x 2-13/16"	3	ETL

WITH PHOTOCELL

ASD-LSTL-H01W-N3CC-PC-BK	3	120	No	3,000/4,000/5,000	114	Black	4-3/4" x 1-9/16" x 2-13/16"	4	ETL
ASD-LSTL-H01W-N3CC-PC-BZ	3	120	No	3,000/4,000/5,000	114	Oil Rubbed Bronze	4-3/4" x 1-9/16" x 2-13/16"	4	ETL
ASD-LSTL-H01W-N3CC-PC-WH	3	120	No	3,000/4,000/5,000	114	White	4-3/4" x 1-9/16" x 2-13/16"	4	ETL

WITH MOTION SENSOR

ASD-LSTL-H01W-N3CC-MS-BK	3	120	No	3,000/4,000/5,000	114	Black	4-3/4" x 1-3/4" x 2-13/16"	4	ETL
ASD-LSTL-H01W-N3CC-MS-BZ	3	120	No	3,000/4,000/5,000	114	Oil Rubbed Bronze	4-3/4" x 1-3/4" x 2-13/16"	4	ETL
ASD-LSTL-H01W-N3CC-MS-WH	3	120	No	3,000/4,000/5,000	114	White	4-3/4" x 1-3/4" x 2-13/16"	4	ETL

WITH PHOTOCELL AND MOTION SENSOR

ASD-LSTL-H01W-N3CC-PC-MS-BK	3	120	No	3,000/4,000/5,000	114	Black	4-3/4" x 1-3/4" x 2-13/16"	4	ETL
ASD-LSTL-H01W-N3CC-PC-MS-BZ	3	120	No	3,000/4,000/5,000	114	Oil Rubbed Bronze	4-3/4" x 1-3/4" x 2-13/16"	4	ETL
ASD-LSTL-H01W-N3CC-PC-MS-WH	3	120	No	3,000/4,000/5,000	114	White	4-3/4" x 1-3/4" x 2-13/16"	4	ETL

WITH RGB

ASD-STLA-3SM-RGB-BK-6P	3	120	WIFI	2,700 - 6,500 + RGB	114	Black	4-3/4" x 1-3/4" x 2-13/16"	4	ETL
ASD-STLA-3SM-RGB-WH-6P	3	120	WIFI	2,700 - 6,500 + RGB	114	White	4-3/4" x 1-3/4" x 2-13/16"	4	ETL



LED SWIVEL HARDSCAPE LIGHT

ASD-HSL5, ASD-HSL5-RGB

Model	Size	Watts	Input Voltage	Dimmable	CCT	Lm	Finish	Dimensions LxWxH	Pcs. per Carton	Certification
ASD-HSL5-4N2BR-4P	4"	2	12	No	2,200/2,700/3,000/4,000/5,000	135	Bronze	4-1/8" x 2-15/16" x 7/8"	2	ETL
ASD-HSL5-7N5BR-4P	7"	4.5	12	No	2,200/2,700/3,000/4,000/5,000	301	Bronze	6-15/16" x 2-15/16" x 7/8"	2	ETL
ASD-HSL5-12N5BR-2P	12"	5	12	No	2,200/2,700/3,000/4,000/5,000	333	Bronze	12-3/16" x 2-15/16" x 7/8"	2	ETL

WITH RGBW

ASD-HSL54-2SM-RGB-BR-8P	4"	1.5	12	WiFi	2,700 – 6,500 + RGB	50	Bronze	4-1/2" x 1" x 3"	2	ETL
ASD-HSL57-3SM-RGB-BR-8P	7"	3	12	WiFi	2,700 – 6,500 + RGB	105	Bronze	7" x 1" x 3"	2	ETL
ASD-HSL512-5SM-RGB-BR-8P	12"	5	12	WiFi	2,700 – 6,500 + RGB	158	Bronze	12-1/2" x 1" x 3"	1	ETL



LED OUTDOOR WALL SCONCE

ASD-OLWS-21

Model	Size	Watts	Input Voltage	Dimmable	CCT	Lm	Finish	Dimensions LxWxH	Pcs. per Carton	Certification
ASD-OLWS-21-MV-10D15CC-BK	10"	15	120-277	Triac	3,000/4,000/5,000	1,228	Black	7" x 3-1/4" x 9-15/16"	2	ETL
ASD-OLWS-21-MV-10D15CC-BZ	10"	15	120-277	Triac	3,000/4,000/5,000	1,228	Bronze	7" x 3-1/4" x 9-15/16"	2	ETL
ASD-OLWS-21-MV-10D15CC-NK	10"	15	120-277	Triac	3,000/4,000/5,000	1,228	Nickel	7" x 3-1/4" x 9-15/16"	2	ETL
ASD-OLWS-21-MV-18D20CC-BK	18"	20	120-277	Triac	3,000/4,000/5,000	2,457	Black	7" x 3-1/4" x 17-15/16"	2	ETL
ASD-OLWS-21-MV-18D20CC-BZ	18"	20	120-277	Triac	3,000/4,000/5,000	2,457	Bronze	7" x 3-1/4" x 17-15/16"	2	ETL
ASD-OLWS-21-MV-18D20CC-NK	18"	20	120-277	Triac	3,000/4,000/5,000	2,457	Nickel	7" x 3-1/4" x 17-15/16"	2	ETL
ASD-OLWS-21-MV-24D25CC-BK	24"	25	120-277	Triac	3,000/4,000/5,000	3,017	Black	7" x 3-1/4" x 23-13/16"	2	ETL
ASD-OLWS-21-MV-24D25CC-BZ	24"	25	120-277	Triac	3,000/4,000/5,000	3,017	Bronze	7" x 3-1/4" x 23-13/16"	2	ETL
ASD-OLWS-21-MV-24D25CC-NK	24"	25	120-277	Triac	3,000/4,000/5,000	3,017	Nickel	7" x 3-1/4" x 23-13/16"	2	ETL
ASD-OLWS-21-MV-36D30CC-BK	36"	30	120-277	Triac	3,000/4,000/5,000	3,268	Bronze	7" x 3-1/4" x 36"	2	ETL
ASD-OLWS-21-MV-36D30CC-NK	36"	30	120-277	Triac	3,000/4,000/5,000	3,268	Nickel	7" x 3-1/4" x 36"	2	ETL

WITH PHOTOCELL

ASD-OLWS-21-MV-10N15BK-PC	10"	15	120-277	No	3,000/4,000/5,000	1,098	Black	7" x 3-1/4" x 10-7/16"	2	ETL
ASD-OLWS-21-MV-10N15NK-PC	10"	15	120-277	No	3,000/4,000/5,000	1,098	Nickel	7" x 3-1/4" x 10-7/16"	2	ETL

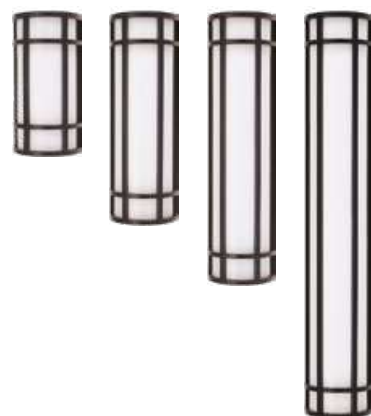

LED OUTDOOR WALL SCONCE

ASD-OLWS-22

Model	Size	Watts	Input Voltage	Dimmable	CCT	Lm	Finish	Dimensions LxWxH	Pcs. per Carton	Certification
ASD-OLWS-22-MV-12N15CC-BZ	12"	15	120-277	No	3,000/4,000/5,000	1,010	Oil Rubbed Bronze	12" x 6-1/8" x 4"	4	ETL / Energy Star
ASD-OLWS-22-MV-18N20CC-BK	18"	20	120-277	No	3,000/4,000/5,000	1,515	Black	17-15/16" x 6-1/8" x 4"	4	ETL / Energy Star
ASD-OLWS-22-MV-18N20CC-BZ	18"	20	120-277	No	3,000/4,000/5,000	1,515	Oil Rubbed Bronze	17-15/16" x 6-1/8" x 4"	4	ETL / Energy Star
ASD-OLWS-22-MV-24N23CC-BK	24"	23	120-277	No	3,000/4,000/5,000	1,970	Black	24-1/16" x 6-1/8" x 4"	4	ETL / Energy Star
ASD-OLWS-22-MV-24N23CC-BZ	24"	23	120-277	No	3,000/4,000/5,000	1,970	Oil Rubbed Bronze	24-1/16" x 6-1/8" x 4"	4	ETL / Energy Star
ASD-OLWS-22-MV-36N28CC-BK	36"	28	120-277	No	3,000/4,000/5,000	2,690	Matte Black	36-1/16" x 6-1/8" x 4"	4	ETL / Energy Star



LED OUTDOOR WALL SCONCE

ASD-OLWS-23

Model	Size	Watts	Input Voltage	Dimmable	CCT	Lm	Finish	Dimensions LxWxH	Pcs. per Carton	Certification
ASD-OLWS-23-8D12CC-BK	8"	12	120	Triac	3,000/4,000/5,000	909	Black	8" x 6" x 3-1/8"	4	ETL
ASD-OLWS-23-14D20CC-BK	14"	20	120	Triac	3,000/4,000/5,000	1,909	Black	14" x 6" x 3-1/8"	4	ETL

WITH PHOTOCELL

ASD-OLWS-23-14N20CC-PC-BK	14"	20	120	No	3,000/4,000/5,000	1,909	Black	14-5/8" x 6" x 3-1/8"	4	ETL
---------------------------	-----	----	-----	----	-------------------	-------	-------	-----------------------	---	-----



LED OUTDOOR WALL SCONCE

ASD-LWS26S, ASD-LWS26S-RGBWC

Model	Size	Watts	Input Voltage	Dimmable	CCT	Lm	Finish	Glass	Dimensions LxWxH	Pcs. per Carton	Certification
ASD-LWS26S-13D12BK	13"	11.5	120	Triac	3,000/4,000/5,000	566	Black	Clear Seeded	13-3/4" x 4-3/4" x 2-1/2"	2	ETL
ASD-LWS26S-18D12BK	18"	11.5	120	Triac	3,000/4,000/5,000	495	Black	Clear Seeded	17-15/16" x 4-3/4" x 2-1/2"	2	ETL
ASD-LWS26S-18D12WH	18"	11.5	120	Triac	3,000/4,000/5,000	495	White	Clear Seeded	17-15/16" x 4-3/4" x 2-1/2"	2	ETL

120-277 V

ASD-LWS26S-MV-24D20CC-BK	24"	20	120-277	Triac	3,000/4,000/5,000	581	Black	Clear Seeded	24" x 4-3/4" x 2-15/16"	2	ETL
--------------------------	-----	----	---------	-------	-------------------	-----	-------	--------------	-------------------------	---	-----

WITH PHOTOCELL

ASD-LWS26S-13N12BK-PC	13"	11.5	120	No	3,000/4,000/5,000	566	Black	Clear Seeded	13-7/8" x 4-3/4" x 2-1/2"	2	ETL
ASD-LWS26S-18N12BK-PC	18"	11.5	120	No	3,000/4,000/5,000	495	Black	Clear Seeded	18" x 4-3/4" x 2-1/2"	2	ETL

WITH RGBWC

ASD-LWS26-13N9AC-RGBW-BK	13"	8.5	120-277	No	3,000/5,000/RGB	211	Black	Clear Seeded	13-7/8" x 4-3/4" x 2-7/8"	2	ETL
ASD-LWS26-18N9AC-RGBW-BK	18"	8.5	120-277	No	3,000/5,000/RGB	189	Black	Clear Seeded	17-15/16" x 4-3/4" x 2-7/8"	2	ETL

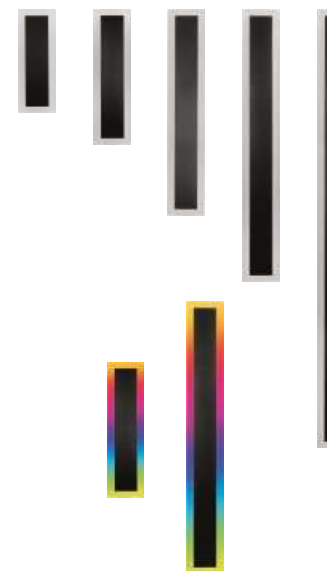

LED OUTDOOR WALL SCONCE

ASD-LWS27A, ASD-LWS27A-RGB

Model	Size	Watts	Input Voltage	Dimmable	CCT	Lm	Dimensions LxWxH	Pcs. per Carton	Certification
ASD-LWS27A-18D18BK	18"	18	120-277	Triac	3,000/4,000/5,000	1,573	18" x 5-7/8" x 1-13/16"	2	ETL
ASD-LWS27A-24D24BK	24"	24	120-277	Triac	3,000/4,000/5,000	2,001	24" x 5-7/8" x 1-13/16"	2	ETL
ASD-LWS27A-36D30BK	36"	30	120-277	Triac	3,000/4,000/5,000	2,356	36" x 5-7/8" x 1-13/16"	2	ETL
ASD-LWS27A-48D36BK	48"	36	120-277	Triac	3,000/4,000/5,000	2,980	48" x 5-7/8" x 1-13/16"	1	ETL
ASD-LWS27A-72D40BK	72"	40	120-277	Triac	3,000/4,000/5,000	3,620	72" x 5-7/8" x 1-13/16"	1	ETL

WITH RGBW

ASD-LWS27A-24D18SM-RGB-BK	24"	18	120-277	WiFi	2,700 – 6,500 + RGB	860	24" x 5-7/8" x 1-13/16"	2	ETL
ASD-LWS27A-48D36SM-RGB-BK	48"	36	120-277	WiFi	2,700 – 6,500 + RGB	1,530	48" x 5-7/8" x 1-13/16"	1	ETL



LED OUTDOOR NARROW WALL SCONCE

ASD-LWS27N, ASD-LWS27N-RGB

Model	Size	Watts	Input Voltage	Dimmable	CCT	Lm	Dimensions LxWxH	Pcs. per Carton	Certification
ASD-LWS27N-18D18BK	18"	18	120-277	Triac	3,000/4,000/5,000	1,260	18" x 3-1/7" x 2-1/4"	2	ETL
ASD-LWS27N-24D24BK	24"	24	120-277	Triac	3,000/4,000/5,000	1,680	24" x 3-1/7" x 2-1/4"	2	ETL
ASD-LWS27N-36D30BK	36"	30	120-277	Triac	3,000/4,000/5,000	2,100	36" x 3-1/7" x 2-1/4"	2	ETL
ASD-LWS27N-48D36BK	48"	36	120-277	Triac	3,000/4,000/5,000	2,466	48" x 3-1/7" x 2-1/4"	1	ETL
ASD-LWS27N-72D40BK	72"	40	120-277	Triac	3,000/4,000/5,000	2,800	72" x 3-1/7" x 2-1/4"	1	ETL

WITH RGBW

ASD-LWS27N-24D18SM-RGB-BK	24"	18	120-277	Triac	2,700 – 6,500 + RGB	815	24" x 3-1/7" x 2-1/4"	2	ETL
ASD-LWS27N-48D36SM-RGB-BK	48"	36	120-277	Triac	2,700 – 6,500 + RGB	1,513	48" x 3-1/7" x 2-1/4"	1	ETL

LED OUTDOOR BACK-LIGHT WALL SCONCE

ASD-LWS27B, ASD-LWS27B-RGB

Model	Size	Watts	Input Voltage	Dimmable	CCT	Lm	Dimensions LxWxH	Pcs. per Carton	Certification
ASD-LWS27B-18D18BK	18"	18	120-277	Triac	3,000/4,000/5,000	1,059	18" x 3-1/7" x 2-1/4"	2	ETL
ASD-LWS27B-24D24BK	24"	24	120-277	Triac	3,000/4,000/5,000	1,312	24" x 3-1/7" x 2-1/4"	2	ETL
ASD-LWS27B-36D30BK	36"	30	120-277	Triac	3,000/4,000/5,000	1,639	36" x 3-1/7" x 2-1/4"	2	ETL
ASD-LWS27B-48D36BK	48"	36	120-277	Triac	3,000/4,000/5,000	1,951	48" x 3-1/7" x 2-1/4"	1	ETL
ASD-LWS27B-72D40BK	72"	40	120-277	Triac	3,000/4,000/5,000	2,118	72" x 3-1/7" x 2-1/4"	1	ETL

WITH RGBW

ASD-LWS27B-24D18SM-RGB-BK	24"	18	120-277	WiFi	2,700 – 6,500 + RGB	815	24" x 3-1/7" x 2-1/4"	2	ETL
ASD-LWS27B-48D36SM-RGB-BK	48"	36	120-277	WiFi	2,700 – 6,500 + RGB	1,513	48" x 3-1/7" x 2-1/4"	1	ETL

LED OUTDOOR WALL SCONCE WITH CENTRAL LIGHT

ASD-LWS27C

Model	Size	Watts	Input Voltage	Dimmable	CCT	Lm	Dimensions LxWxH	Pcs. per Carton	Certification
ASD-LWS27C-18D18BK	18"	18	120-277	Triac	3,000/4,000/5,000	1,186	18" x 5-7/8" x 1-13/16"	2	ETL
ASD-LWS27C-24D24BK	24"	24	120-277	Triac	3,000/4,000/5,000	1,637	24" x 5-7/8" x 1-13/16"	2	ETL
ASD-LWS27C-36D30BK	36"	30	120-277	Triac	3,000/4,000/5,000	1,856	36" x 5-7/8" x 1-13/16"	2	ETL
ASD-LWS27C-48D36BK	48"	36	120-277	Triac	3,000/4,000/5,000	2,108	48" x 5-7/8" x 1-13/16"	1	ETL
ASD-LWS27C-72D40BK	72"	40	120-277	Triac	3,000/4,000/5,000	2,338	72" x 5-7/8" x 1-13/16"	1	ETL



LED OUTDOOR WALL SCONCE

ASD-LWS28S

Model	Size	Watts	Input Voltage	Dimmable	CCT	Lm	Finish	Glass	Dimensions LxWxH	Pcs. per Carton	Certification
ASD-LWS28S-12D22CC-BK	12"	22	120	Triac	3,000/4,000/5,000	485	Black	Clear Seeded	11-13/16" x 5-1/2" x 2-3/16"	4	ETL
120-277 V											
ASD-LWS28S-MV-18D22CC-BK	18"	22	120-277	Triac	3,000/4,000/5,000	520	Black	Clear Seeded	18-1/8" x 5-1/2" x 2-3/16"	2	ETL
ASD-LWS28S-MV-24D22CC-BK	24"	22	120-277	Triac	3,000/4,000/5,000	531	Black	Clear Seeded	24" x 5-1/2" x 2-3/16"	2	ETL

LED ROUND OUTDOOR WALL CYLINDER

ASD-OLCLR, ASD-LCLR2-RGB

Model	Light Direction	Watts	Input Voltage	Dimmable	CCT	Lm	Finish	Dimensions LxWxH	Pcs. per Carton	Certification
ASD-LCLR-1A-9BK	1	9	120	Triac	3,000/4,000/5,000	1,002	Black	4-3/8" x 6-7/16" x 7-7/8"	2	ETL
ASD-LCLR-2A-18BK	2	18	120	Triac	3,000/4,000/5,000	1,859	Black	4-3/8" x 6-7/16" x 11-13/16"	2	ETL

WITH PHOTOCELL

ASD-LCLR-1A-9BK-PC	1	9	120	No	3,000/4,000/5,000	1,002	Black	4-3/8" x 6-7/16" x 7-7/8"	2	ETL
ASD-LCLR-2A-18BK-PC	2	18	120	No	3,000/4,000/5,000	1,859	Black	4-3/8" x 6-7/16" x 11-13/16"	2	ETL

120-277 V WITH BATTERY BACK-UP

ASD-OLCLR-MV-2D18CC-EM-BK	2	18	120-277	Triac	3,000/4,000/5,000	1,676	Black	4-3/8" x 6-5/8" x 11-13/16"	6	ETL
---------------------------	---	----	---------	-------	-------------------	-------	-------	-----------------------------	---	-----

WITH RGBW

ASD-LCLR2-30SM-RGBW-BK-2P	2	30	120	Triac	2,700 – 6,500	920	Black	4-7/8" x 12-1/8" x 6-1/8"	3	ETL
---------------------------	---	----	-----	-------	---------------	-----	-------	---------------------------	---	-----

LED SQUARE OUTDOOR WALL CYLINDER

ASD-OLCLS

Model	Light Direction	Watts	Input Voltage	Dimmable	CCT	Lm	Finish	Dimensions LxWxH	Pcs. per Carton	Certification
ASD-OLCLS-1D9CC-BK	1	9	120	Triac	3,000/4,000/5,000	983	Black	4-3/8" x 5-13/16" x 7-7/8"	6	ETL
ASD-OLCLS-1D9CC-BZ	1	9	120	Triac	3,000/4,000/5,000	983	Oil Rubbed Bronze	4-3/8" x 5-13/16" x 7-7/8"	6	ETL
ASD-OLCLS-2D18CC-BK	2	18	120	Triac	3,000/4,000/5,000	1,974	Black	4-3/8" x 5-13/16" x 10-3/16"	6	ETL
ASD-OLCLS-2D18CC-BZ	2	18	120	Triac	3,000/4,000/5,000	1,974	Oil Rubbed Bronze	4-3/8" x 5-13/16" x 10-3/16"	6	ETL

WITH PHOTOCELL

ASD-OLCLS-1N9CC-PC-BK	1	9	120	No	3,000/4,000/5,000	983	Black	4-3/8" x 5-13/16" x 7-7/8"	6	ETL
ASD-OLCLS-2N18CC-PC-BK	2	18	120	No	3,000/4,000/5,000	1,974	Black	4-3/8" x 5-13/16" x 10-3/16"	6	ETL



BULB ROUND OUTDOOR WALL CYLINDER

■ ASD-OCLR, ASD-OCLR-B

Model	Light Direction	Bulb Type	Voltage	Finish	Dimensions LxWxH	Pcs. per Carton	Certification
ASD-OCLR-1A-BK	1	1 x E26 60W max	120	Black	4-3/8" x 6-7/16" x 7-7/8"	2	ETL
ASD-OCLR-1A-WH	1	1 x E26 60W max	120	White	4-3/8" x 6-7/16" x 7-7/8"	2	ETL
ASD-OCLR-2A-BK	2	2 x E26 60W max	120	Black	4-3/8" x 6-7/16" x 11-13/16"	2	ETL
ASD-OCLR-2A-WH	2	2 x E26 60W max	120	White	4-3/8" x 6-7/16" x 11-13/16"	2	ETL

WITH PHOTOCELL

ASD-OCLR-1A-PC-BK	1	1 x E26 60W max	120	Black	4-3/8" x 6-7/16" x 7-7/8"	2	ETL
ASD-OCLR-2A-PC-BK	2	2 x E26 40W max	120	Black	4-3/8" x 6-7/16" x 11-13/16"	2	ETL

WITH DECORATIVE RINGS

ASD-OCLR-1B-BK	1	1 x E26 60W max	120	Black	4-3/8" x 6-7/16" x 7-7/8"	2	ETL
ASD-OCLR-2B-BK	2	2 x E26 60W max	120	Black	4-3/8" x 6-7/16" x 11-13/16"	2	ETL



BULB SQUARE OUTDOOR WALL CYLINDER

■ ASD-OCLS, ASD-OCLS-B

Model	Light Direction	Bulb Type	Voltage	Finish	Dimensions LxWxH	Pcs. per Carton	Certification
ASD-OCLS-1A-BK	1	1 x E26 60W max	120	Black	4-3/8" x 5-13/16" x 7-7/8"	2	ETL
ASD-OCLS-2A-BK	2	2 x E26 60W max	120	Black	4-3/8" x 5-13/16" x 11-13/16"	2	ETL

WITH PHOTOCELL

ASD-OCLS-1A-PC-BK	1	1 x E26 60W max	120	Black	4-3/8" x 5-13/16" x 7-7/8"	2	ETL
ASD-OCLS-2A-PC-BK	2	2 x E26 40W max	120	Black	4-3/8" x 5-13/16" x 11-13/16"	2	ETL

WITH DECORATIVE RINGS

ASD-OCLS-1B-BK	1	1 x E26 60W max	120	Black	4-3/8" x 5-13/16" x 7-15/16"	2	ETL
ASD-OCLS-2B-BK	2	2 x E26 60W max	120	Black	4-3/8" x 5-13/16" x 11-13/16"	2	ETL