

Single Wall Pipe and Fittings



Small diameter N-12® pipe injection molded fittings



Pipe Advantages

Our advantages extend beyond the field! Call our customer support number: 800-821-6710 for more information. We can also be found at adspipe.com

Easy to Install

Lightweight and easy to carry. Saves time and labor. No special tools or fittings needed. No waste; just cut to required length.

Assured Effluent Flow

(Leach Bed Pipe) Uniformly sized and spaced drilled holes for effective outflow of effluent.

Flexible

Easily adjusted for line and grade. Reduces the need for fittings and maximizes potential for field adjustments.

Long Life

Will not deteriorate. Rust resistant. Not affected by acidic soil content or other problem soils or by freezing or thawing.

Strong-Tough-Durable

Won't crack or break under normal handling and installation procedures. Tough enough to withstand the heaviest loads.

Unrestricted Water Intake

(Drainage Pipe) Uniform slots in the corrugated valleys for unrestricted, rapid water intake. Quicker drainage to handle heavy rains.

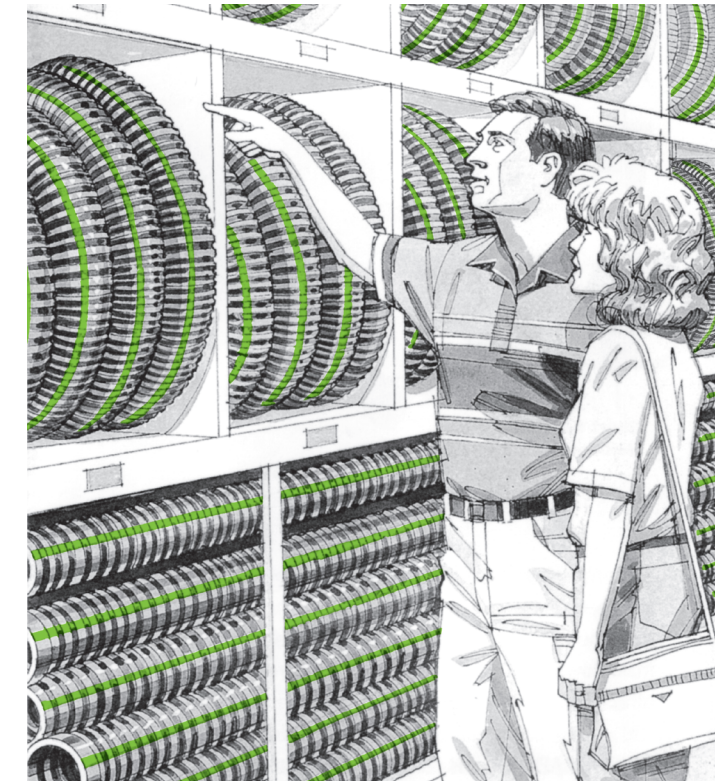

For quick, easy fix-ups of drainage problems around the house, rely on lightweight ADS polyethylene pipe.

Downspout Run-off

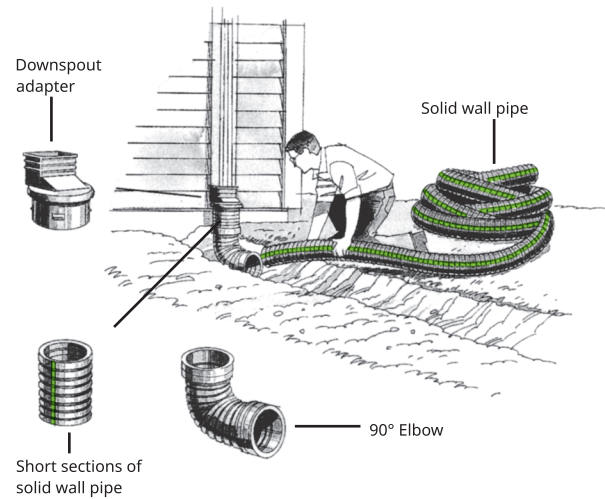

To carry rainwater away from the house and avoid water seeping down basement walls and creating wet basement problems, use solid wall pipe from downspout to storm drain inlet, street curb or other disposal area.

Place a downspout adapter on the end of the downspout, snap the solid wall pipe into the snap coupling end of adapter and run solid wall pipe to the disposal area. If a shallow line is needed from the downspout, an ADS 90° elbow can be used. ADS tees, wyes and other fittings are available for connecting two or more downspouts to the same line.

Window Wells

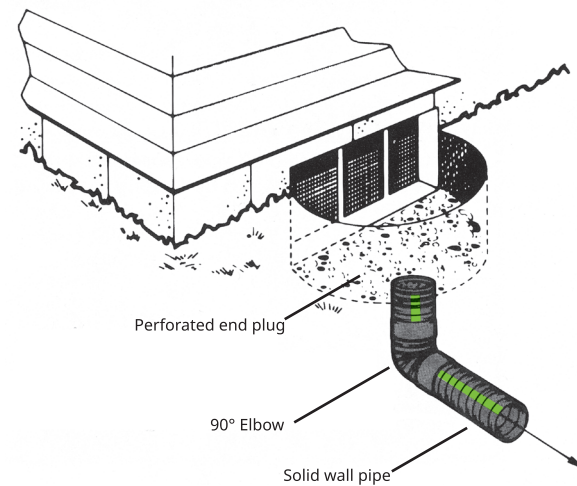

Basement window wells should be drained to prevent water from seeping down to the foundation wall and entering the basement.

The window well can be easily drained by running a line of solid wall pipe from a drain in the bottom of the well to a disposal area. The flexibility of ADS pipe will be helpful in making grade changes and curves away from the well. 90° elbows are available for extremely sharp curves.

Foundation Drains

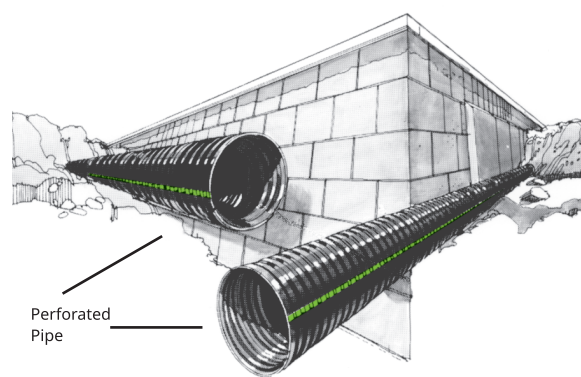

Wet basements are generally caused by ground water being either adjacent to or higher than the basement floor. To prevent the water from entering either the basement wall or the footings, install perforated pipe in a gravel envelope completely around the house. The bottom of the line should be as low as the bottom of the wall or footing course with a minimum slope. It should run to a storm sewer or other disposal area. Although ADS pipe will bend around corners, 90° elbows with snap couplings are available where local codes require them. A tee will tie together the ends of the foundation drain at the line leading to the disposal area.

Low Spots

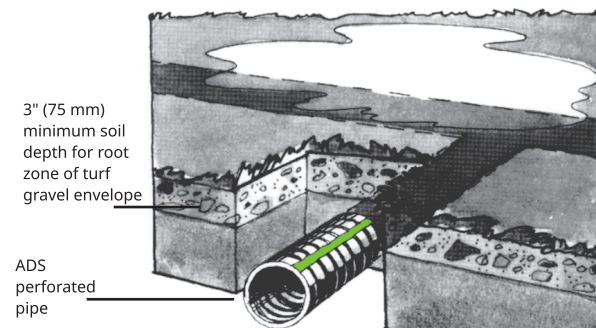

Use perforated pipe, installed in gravel, to collect and carry water to catch basin/disposal area. In heavy clay soils, several lines of perforated pipe may be needed to speed drainage.

Driveway Culverts

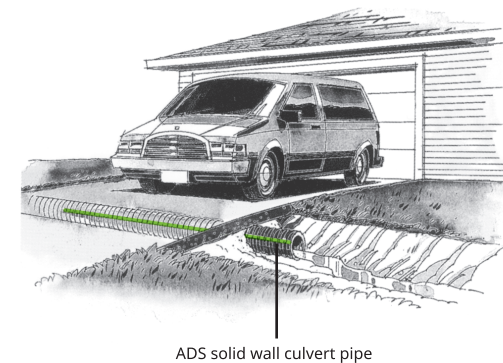

To carry water beneath your driveway, use solid wall pipe. Crushed stone, gravel or compacted soil backfill material should be used as the bedding material around the culvert, with aggregate size not exceeding 1" (25 mm). Minimum recommended cover is 12" (300 mm). For driveway culverts with less than 12" (300 mm) of cover see ADS Pocket Installation Guide.

Pipe Installation Guidelines

By carefully following these installation guidelines, you will achieve an easy-to-install, safe, permanent and efficient ADS drainage system.

- CARE DURING INSTALLATION**
 Care should be taken to prevent damage to the pipe during the backfilling operation. Avoid dropping large clods or rocks directly on pipe. Impact loads of all types should be avoided until pipe is properly bedded.
- BEDDING**
 Pipe should be bedded in gravel. However, selected soil backfill material may also be used with satisfactory results, provided it is compacted. The bedding material should be placed around the pipe to a depth at least 2" (50 mm) over the top of pipe. When selected soil bedding material from the trench excavation is used, choose small, loose particles of soil that will flow around the pipe and minimize soil settling. Avoid large rocks that may damage the pipe or large clods of soil that cause voids and subsequent excessive settling.
- DEPTH OF COVER**
 If vehicular traffic is expected over pipe, there should be a minimum of 12" (300 mm) of cover. Typical recommended gravel materials would be 6A stone, or pit-run coarse sand and gravel mixes.
- PROPER GRADE**
 The grade, or fall, on which pipe is laid is critical in that reversals in grade will greatly reduce the system's effectiveness. Best drainage results are achieved with continuous downhill fall, or grade, over the entire length of the drain line. A fall of 0.2" (5 mm) per 10' (3 m) of length is generally considered adequate. Greater fall will promote more rapid drainage.
- PROPER SELECTION OF MATERIALS**
 Choose your materials according to application. If absorption and drainage are required, perforated pipe should be used. If pipe serves only to move water away from an area (such as downspout runoffs etc.) solid wall pipe is best because it will not dissipate water into the surrounding area. Solid wall pipe should also be used if the line runs close to trees where root penetration may be a problem. If the soil being drained is sandy or silty, then either a geotextile wrap or gravel should be used to prevent the soils from entering and blocking the drainage line.

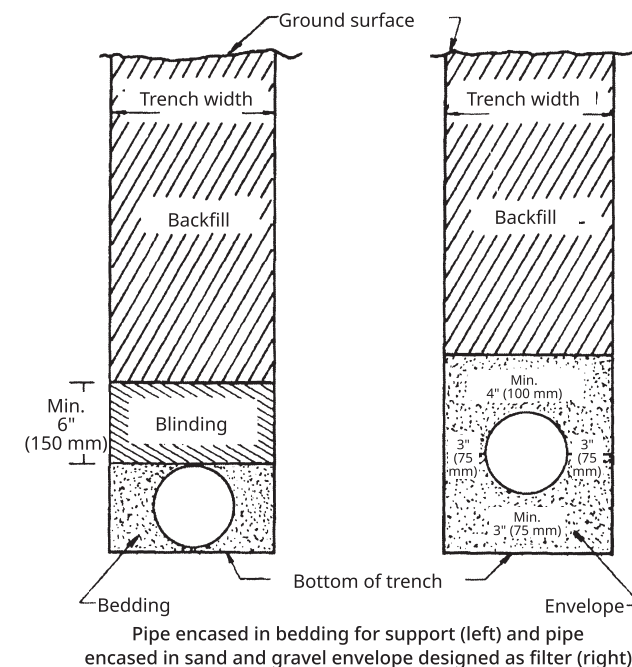

When you install ADS pipe, you can be sure it will provide dependable drainage for many years to come. Problems that often surface with other drainage materials simply don't occur with ADS pipe.