

ADS Mega Green® WT

Submittal Package



Package Contents

1. Sell Sheet
2. Specification
3. Technical notes
4. Corrugated plastic pipe installation guide



adspipe.com

800-821-6710

N-12[®] Mega Green[®] WT IB Pipe (per ASTM F2648)

N-12 Mega Green WT IB pipe (per ASTM F2648) has recycled content and provides material properties to meet or exceed the demands of the market.

N-12 WT IB contains a superior built-in bell-and-spigot joint. An exterior bell wrap provides a quick visual indicator to customers and inspectors that a watertight product is being used. A patented gasket, that meets all requirements of ASTM F477, increases its sealing forces as temporary internal or external hydrostatic pressure increases. The flared bell and spigot significantly improve ease of installation.

Applications

- Storm sewers
- Retention/Detention
- Roof drainage
- Culverts & cross drains
- Slope/edge drains
- Mining, Forestry & Industrial

Features

- 4"-60" (100-1500 mm) diameters available
- Nominal 20' (6 m) and 13' (4 m) lengths available
- Integral bell and factory-installed gasket
- Joint meets or exceeds ASTM D3212 lab test as well as ASTM F2487 and ASTM F1417 watertight field test
- Light weight for fast installation times
- Structural strength will support H-25 or HL-93 live loads with 12" (300 mm) minimum cover; 60" (1500 mm) requires 24" (600 mm) cover for H-25 or HL-93 live loads

Benefits

- Variety of diameters and lengths that will fit any project
- Pipe requires no extra couplers, grout or other sealants for installation due to built-in bell and factory-installed gasket.
- Installation cost savings from lower shipping costs, reduced labor and less heavy equipment
- Hydraulic efficiency from smooth interior
- Long-term durability of HDPE

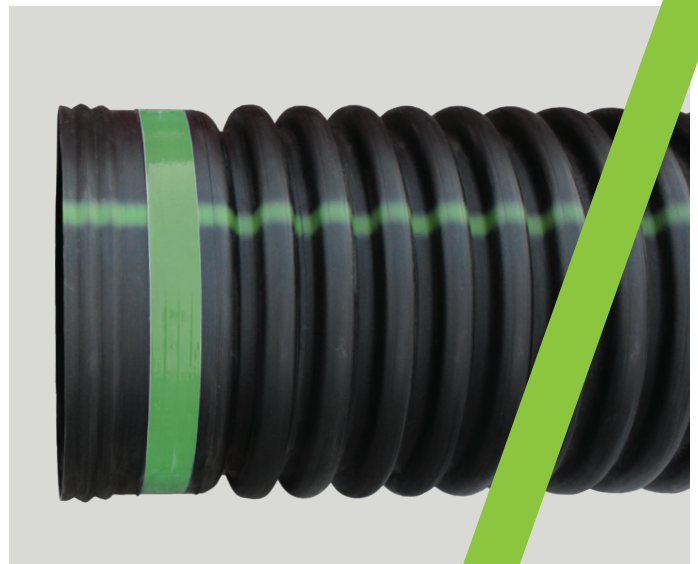
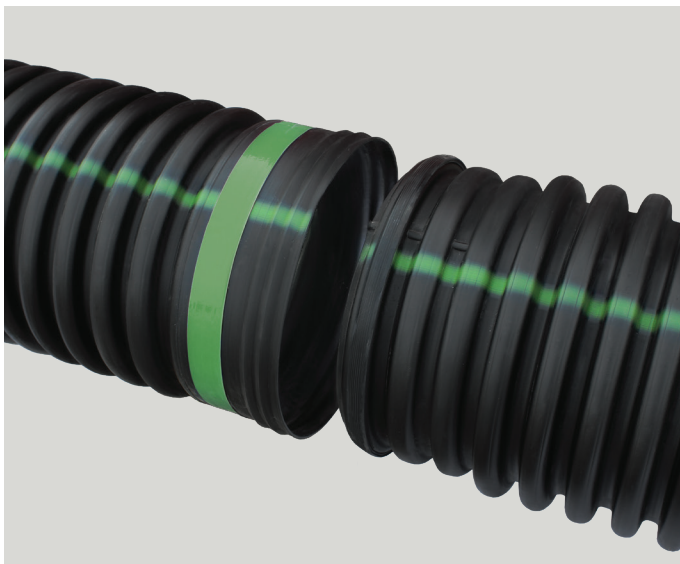

ADS N-12 Mega Green WT IB Pipe (per ASTM F2648) Specification

Scope

This specification describes 4- through 60-inch (100 to 1500 mm) ADS N-12 Mega Green WT IB pipe for use in gravity-flow land drainage applications.

Pipe Requirements

ADS N-12 Mega Green WT IB pipe shall have a smooth interior and annular exterior corrugations.

- 4- through 60-inch (100 to 1500 mm) shall meet ASTM F2648
- Manning's "n" value for use in design shall be 0.012.

Joint Performance

Pipe shall be joined using a bell & spigot joint meeting ASTM F2648. The joint shall be watertight according to the requirements of ASTM D3212. Gaskets shall meet the requirements of ASTM F477. Gaskets shall be installed by the pipe manufacturer and covered with a removable, protective wrap to ensure the gasket is free from debris. A joint lubricant available from the manufacturer shall be used on the gasket and bell during assembly. 12- through 60-inch (300 to 1500 mm) diameters shall have an exterior bell wrap installed by the manufacturer.

Fittings

Fittings shall conform to ASTM F2306. Bell and spigot connections shall utilize a welded bell and valley or saddle gasket meeting the watertight joint performance requirements of ASTM F2306.

Field Pipe and Joint Performance

To assure watertightness, field performance verification may be accomplished by testing in accordance with ASTM F2487. Appropriate safety precautions must be used when field testing any pipe material. Contact the manufacturer for recommended leakage rates.

Material Properties

Material for pipe production shall be an engineered compound of virgin and recycled high-density polyethylene conforming with the minimum requirements of cell classification 424420C, (ESCR Test Condition B) for 4- through 10-inch (100 to 250 mm) diameters, and 435420C, (ESCR Test Condition B) for 12- through 60-inch (300 to 1500 mm) diameters, as defined and described in the latest version of ASTM D3350, except that carbon black content should not exceed 4%. The design engineer shall verify compatibility with overall system including structural, hydraulic, material and installation requirements for a given application.

Installation

Installation shall be in accordance with ASTM D2321 and ADS' published installation guidelines, with the exception that minimum cover in trafficked areas for 4- through 48-inch (100 to 1200 mm) diameters shall be one foot (0.3 m) , and for 60-inch (1500 mm) diameters, the minimum cover shall be two feet (0.6 m) in single run applications. Backfill for minimum cover situations shall consist of Class 1 (compacted), or Class 2 (minimum 90% SPD) material. Maximum fill heights depend on embedment material and compaction level; please refer to Technical Note 2.02. Contact your local ADS representative or visit our website adspipe.com for a copy of the latest installation guidelines.

Pipe Dimensions*

Nominal Diameter													
Pipe I.D. in (mm)	4 (100)	6 (150)	8 (200)	10 (250)	12 (300)	15(375)	18 (450)	24 (600)	30 (750)	36 (900)	42 (1050)	48 (1200)	60 (1500)
Pipe O.D. in (mm)	4.8 (122)	6.9 (175)	9.1 (231)	11.4 (290)	14.5 (368)	18 (457)	22 (559)	28(711)	36 (914)	42 (1067)	48 (1219)	54 (1372)	67 (1702)

*Check with sales representative for availability by region. **Pipe O.D. values are provided for reference purposes only, values stated for 12- through 60-inch are ±1 inch. Contact a sales representative for exact values.



adspipe.com

800-821-6710

ADS N-12® MEGA GREEN™ WT IB PIPE SPECIFICATION

Scope

This specification describes 4- through 60-inch (100 to 1500 mm) ADS N-12 MEGA GREEN™ WT IB pipe for use in gravity-flow land drainage applications.

Pipe Requirements

ADS N-12 MEGA GREEN WT IB pipe shall have a smooth interior and annular exterior corrugations.

- 4- through 60-inch (100 to 1500 mm) pipe shall meet ASTM F2648.
- Manning’s “n” value for use in design shall be 0.012.

Joint Performance

Pipe shall be joined using a bell & spigot joint meeting ASTM F2648. The joint shall be watertight according to the requirements of ASTM D3212. Gaskets shall meet the requirements of ASTM F477. Gaskets shall be installed by the pipe manufacturer and covered with a removable, protective wrap to ensure the gasket is free from debris. A joint lubricant available from the manufacturer shall be used on the gasket and bell during assembly. 12- through 60-inch (300 to 1500 mm) diameters shall have an exterior bell wrap installed by the manufacturer.

Fittings

Fittings shall conform to ASTM F2306. Bell and spigot connections shall utilize a welded bell and valley or saddle gasket meeting the watertight joint performance requirements of ASTM F2306.

Field Pipe and Joint Performance

To assure watertightness, field performance verification may be accomplished by testing in accordance with ASTM F2487. Appropriate safety precautions must be used when field-testing any pipe material. Contact the manufacturer for recommended leakage rates.

Material Properties

Material for pipe production shall be an engineered compound of virgin and recycled high density polyethylene conforming with the minimum requirements of cell classification 424420C (ESCR Test Condition B) for 4- through 10-inch (100 to 250 mm) diameters, and 435420C (ESCR Test Condition B) for 12- through 60-inch (300 to 1500 mm) diameters, as defined and described in the latest version of ASTM D3350, except that carbon black content should not exceed 4%. The design engineer shall verify compatibility with overall system including structural, hydraulic, material, and installation requirements for a given application.

Installation

Installation shall be in accordance with ASTM D2321 and ADS recommended installation guidelines, with the exception that minimum cover in trafficked areas for 4- through 48-inch (100 to 1200 mm) diameters shall be one foot. (0.3 m) and for 60-inch (1500 mm) diameter the minimum cover shall be 2 ft. (0.6 m) in single run applications. Backfill for minimum cover situations shall consist of Class 1 (compacted) or Class 2 (minimum 90% SPD) material. Maximum fill heights depend on embedment material and compaction level; please refer to Technical Note 2.02. Contact your local ADS representative or visit our website at www.adspipe.com for a copy of the latest installation guidelines.

Pipe Dimensions

	Nominal Diameter, in (mm)												
Pipe I.D. in (mm)	4 (100)	6 (150)	8 (200)	10 (250)	12 (300)	15 (375)	18 (450)	24 (600)	30 (750)	36 (900)	42 (1050)	48 (1200)	60 (1500)
Pipe O.D.* in (mm)	4.8 (122)	6.9 (175)	9.1 (231)	11.4 (290)	14.5 (368)	18 (457)	22 (559)	28 (711)	36 (914)	42 (1067)	48 (1219)	54 (1372)	67 (1702)

*Pipe O.D. values are provided for reference purposes only, values stated for 12 through 60-inch are ±1 inch. Contact a sales representative for exact values

Technical Note

TN 1.07 Manhole Adapter Guide - SaniTite® HP, HP Storm, N-12® HDPE Pipe

Manhole Connection Basics

Compression Connections

- Gasket is cast into the wall of the manhole at the precaster's facility. Gasket cannot be field installed.
- A-LOK® Premium™ is recommended for all connections. The Premium gasket has higher compression than the A-LOK STM standard gasket, which aids in sealing against the outer wall of SaniTite HP triple wall pipe and the SaniTite HP manhole adapter sleeve for dual wall pipe.
- A-LOK gaskets always need to connect to a smooth surface of pipe – Nyloplast® adapter or ADS adapter sleeves are required when using dual wall pipe. Triple wall pipe requires no adapter.



Boot Connections:

- Gasket can be installed by the precaster or field-installed by the contractor. The precaster will form the required hole in the structure and either the precaster or contractor will install the boot.
- Preferred manufacturers are Press Seal® (PSX Direct Drive) and Trelleborg (Kor-n-Seal®).
- Boots always need to connect to a smooth surface. You can connect to a dual wall pipe with an installed corrugated pipe adapter (valley fill gasket) or a Manhole adapter sleeve.

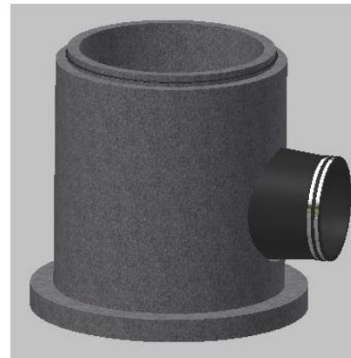

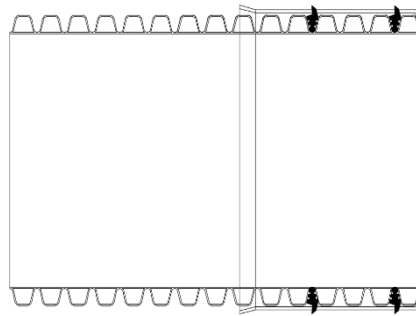
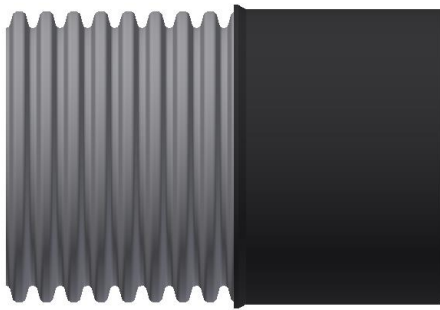

Sleeve Manhole Adapter

Boot or Compression Connection

For HP & HDPE
12" - 24" (XX22AAPP)
Sanitary or Storm Joint

Not Available for 21"

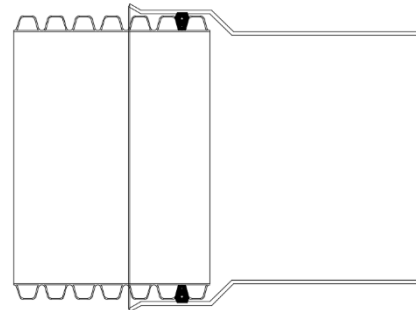
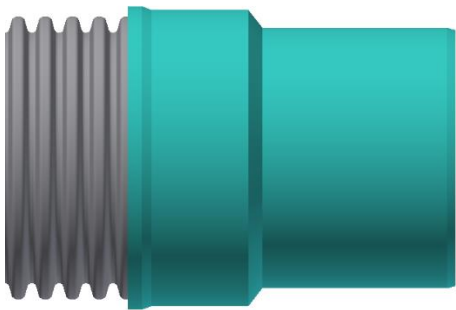

Nyloplast® PVC Manhole Adapter

Same OD as SDR35

Boot or Compression Connection

HP { 12" - 24" (XX57AGHPU2) Sanitary Joint
12" - 30" (XX57AGHPU) Storm Joint

HDPE { 12" - 30" (XX77AGU) Storm Joint

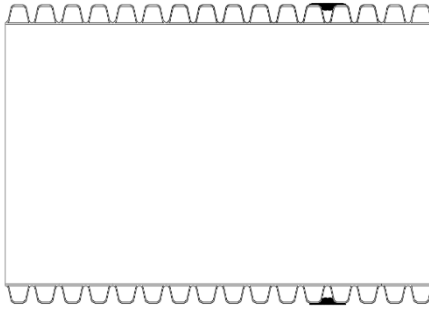
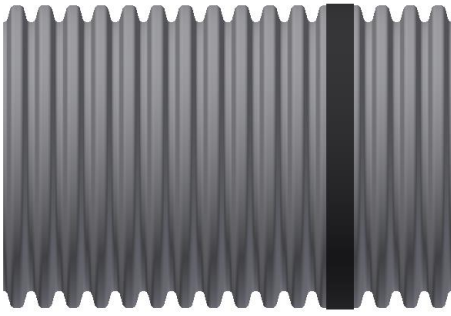

Corrugated Pipe Adapter Gasket

Boot Connection Only
(XX50PS)

12" – 30" Sanitary or Storm Joint
36" – 60" Storm Joint

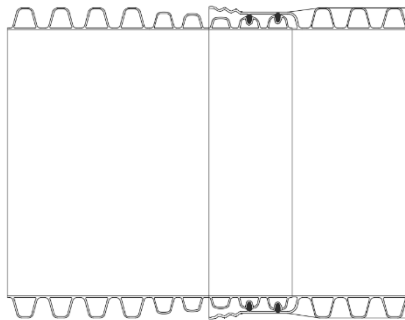
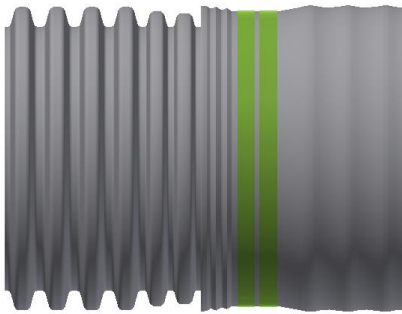

SaniTite HP TW to HP Storm DW

Boot or Compression Connection

30" – 60" Dual Wall

Storm Joint

Coordinate with plant to ensure correct gasket
for compatibility is installed prior to shipment.

CONSULT ADS SERIES 200 STANDARD DETAILS



The ADS logo, SaniTite HP, N-12 and the Green Stripe are registered trademarks of Advanced Drainage Systems, Inc.
Nyloplast® is a registered trademark of Nyloplast, Inc.
© 2022 Advanced Drainage Systems, Inc. TN 1.07 April 2022

adspipe.com
1-800-821-6710

Technical Note

TN 2.02 Minimum and Maximum Cover Heights for Corrugated HDPE Pipe (per ASTM F2648)

Introduction

The information in this document is designed to provide answers to general cover height questions; the data provided is not intended to be used for project design. The design procedure described in the *Structures* section (Section 2) of the Drainage Handbook provides detailed information for analyzing most common installation conditions. This procedure should be utilized for project specific designs.

The two common cover height concerns are minimum cover in areas exposed to vehicular traffic and maximum cover heights. Either may be considered “worst case” scenario from a loading perspective, depending on the project conditions.

Minimum Cover in Traffic Applications

Pipe diameters from 4- through 48-inch (100-1200 mm) installed in traffic areas (AASHTO H-25 or HS-25 loads) must have at least one foot (0.3m) of cover over the pipe crown, while 60-inch (1500 mm) pipe must have at least 24 inches (0.6m) of cover. The backfill envelope must be constructed in accordance with the *Installation* section (Section 5) of the Drainage Handbook and the requirements of ASTM D2321. The backfill envelope must be of the type and compaction listed in Appendix A-5, Table A-5-2A of the Drainage Handbook. In Table 1 below, this condition is represented by a Class II material compacted to 90% standard Proctor density, although other material can provide similar strength at slightly lower levels of compaction. Structural backfill material should extend to the crown of the pipe; the remaining cover should be appropriate for the installation and as specified by the design engineer. If settlement or rutting is a concern, it may be appropriate to extend the structural backfill to grade. Where pavement is involved, sub-base material can be considered in the minimum burial depth. While rigid pavements can be included in the minimum cover, the thickness of flexible pavements should not be included in the minimum cover.

Additional information that may affect the cover requirements is included in the *Installation* section (Section 5) of the Drainage Handbook. Some examples of what may need to be considered are temporary heavy equipment, construction loading, paving equipment and similar loads that are less than the design load, the potential of pipe flotation, and the type of surface treatment which will be installed over the pipe zone. Please note that Table 1 and 3 are based on the installation of N-12 and MEGA GREEN (per ASTM F2648) pipe under pavement using a uniform backfill type and compaction level, as depicted in Figure 1.

Table 1
Minimum Cover Requirements for N-12® and MEGAGREEN™ Pipes (per ASTM F2648)
with AASHTO H-25 or HS-25 Load

Inside Diameter, ID, inches (mm)	Minimum Cover feet (m)
4 (100) – 48 (1200)	1 (0.3)
60 (1500)	2 (0.6)

Note: Minimum covers presented here were calculated assuming Class II backfill material compacted to 90% standard Proctor density around the pipe and structural backfill to the crown of the pipe, as recommended in Section 5 of the Drainage Handbook, with an additional layer of compacted traffic lane sub-base for a total cover as required. In shallow traffic installations, especially where pavement is involved, a good quality compacted material to grade is required to prevent surface settlement and rutting.

Maximum Cover

Wall thrust generally governs the maximum cover a pipe can withstand and conservative maximum cover heights will result when using the information presented in the Structures section (Section 2) of the Drainage Handbook.

The maximum burial depth is highly influenced by the type of backfill and level of compaction around the pipe. General maximum cover limits for N-12 and MEGA GREEN (per ASTM F2648) pipe are shown in Table 3 for a variety of backfill conditions.

Table 3 was developed assuming pipe is installed in accordance with ASTM D2321 and the Installation section (Section 5) of the Drainage Handbook. Additionally, the calculations assume no hydrostatic load around the pipe, incorporate the maximum safety factors represented in Structures section of the Drainage Handbook, use material properties consistent with the expected performance characteristics for N-12 and MEGA GREEN (per ASTM F2648) materials as shown in Table 2 below, and assume the native soil (in-situ) is of adequate strength and is suitable for installation. For applications requiring fill heights greater than those shown in Table 3 or where hydrostatic pressure due to groundwater is present, contact an ADS engineering representative.

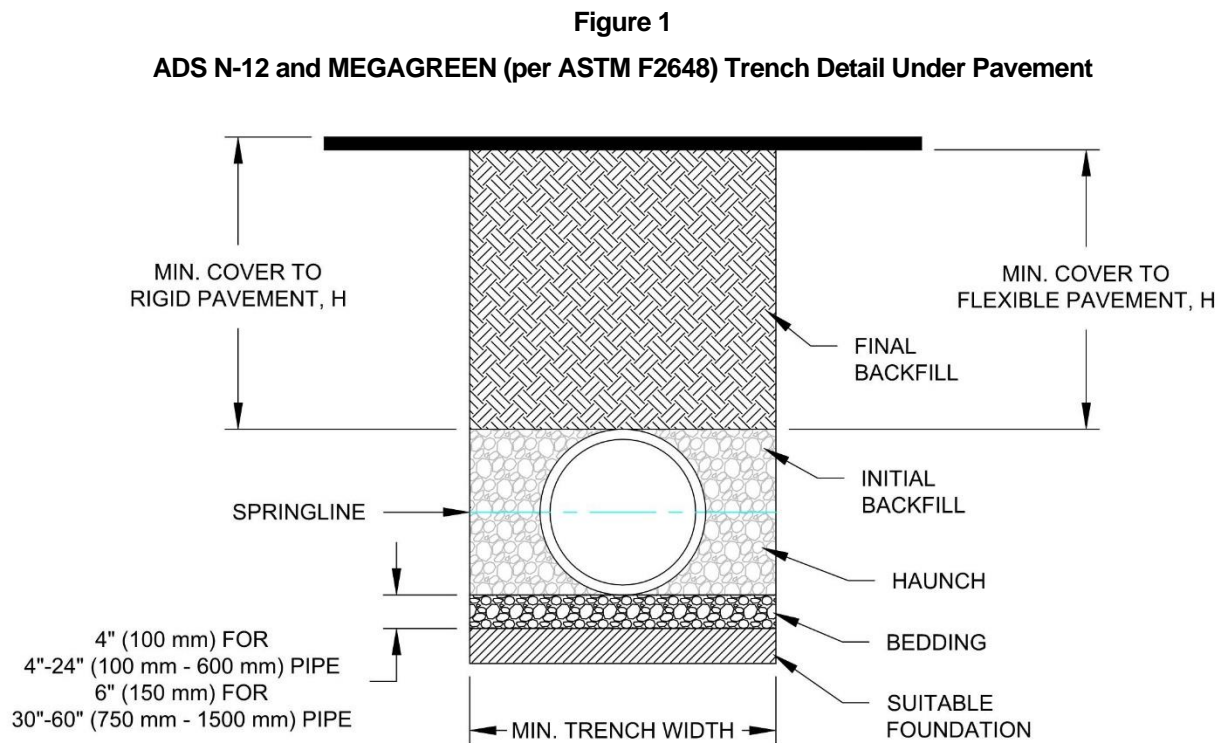

Table 2
ADS N-12 and MEGAGREEN (per ASTM F2648) Mechanical Properties

Cell Class	Design Compressive Strain (%)	Design Tensile Strain (%)	Initial		50-Year	
			Fu (psi)	E (psi)	Fu (psi)	E (psi)
ASTM D3350 424420C – 4-10" 435420C – 12-60"	3.7	4.0	3,000	110,000	800	21,000

Table 3
Maximum Cover for ADS N-12 and MEGAGREEN Pipes (per ASTM F2648), ft (m)

Diameter in. (mm)	Class 1				Class 2				Class 3	
	Compacted		Dumped		95%		90%		95%	
4 (100)	34	(10.4)	16	(4.9)	23	(7.0)	16	(4.9)	17	(5.2)
6 (150)	40	(12.2)	19	(5.8)	27	(8.2)	19	(5.8)	20	(6.1)
8 (200)	30	(9.1)	14	(4.3)	21	(6.4)	14	(4.3)	15	(4.6)
10 (250)	34	(10.4)	16	(4.9)	23	(7.0)	16	(4.9)	17	(5.2)
12 (300)	35	(10.7)	17	(5.2)	24	(7.3)	17	(5.2)	18	(5.5)
15 (375)	37	(11.3)	18	(5.5)	25	(7.6)	18	(5.5)	19	(5.8)
18 (450)	32	(9.8)	15	(4.6)	22	(6.7)	15	(4.6)	16	(4.9)
24 (600)	27	(8.2)	13	(4.0)	19	(5.8)	13	(4.0)	14	(4.3)
30 (750)	22	(6.7)	11	(3.4)	16	(4.9)	11	(3.4)	11	(3.4)
36 (900)	26	(7.9)	12	(3.7)	18	(5.5)	12	(3.7)	13	(4.0)
42 (1050)	24	(7.3)	11	(3.4)	17	(5.2)	11	(3.4)	12	(3.7)
48 (1200)	23	(7.0)	11	(3.4)	16	(4.9)	11	(3.4)	12	(3.7)
60 (1500)	26	(7.9)	12	(3.7)	18	(5.5)	12	(3.7)	13	(4.0)

Notes:

1. Results based on calculations shown in the Structures section of the ADS Drainage Handbook(v20.6). Calculations assume no hydrostatic pressure and a density of 120 pcf (1926 kg/m³) for overburden material.
2. Installation assumed to be in accordance with ASTM D2321 and the Installation section of the Drainage Handbook.
3. Material must be adequately “knifed” into haunch and in between corrugations. Compaction and backfill material is assumed uniform throughout entire backfill zone.
4. Compaction levels shown are for standard Proctor density.
5. Installations of pipe manufactured per ASTM F2648 are only applicable to the fill heights, type of embedment materials and compaction levels listed above.
6. For projects where cover exceeds the maximum values listed above, contact ADS for specific design considerations.
7. Calculations assume no hydrostatic pressure. Hydrostatic pressure will result in a reduction in allowable fill height. Reduction in allowable fill height must be assessed by the design engineer for the specific field conditions.



Technical Note

TN 5.02 Flowable Fill Backfill for Thermoplastic Pipe

Introduction

The use of flowable fill, also known as controlled low strength material (CLSM), controlled density fill (CDF), and slurry fill, as pipe bedding and backfill material has steadily been increasing. The term “flowable fill” encompasses a variety of fill materials that are used as alternates to compacted granular fill. The materials are comprised of mixtures of sand, Portland cement, Class C or Class F fly ash, and water. In addition, the mix is typically flowable and self-leveling at the time of placement.

Flowable fill is an alternative to conventional soil or stone backfill and has been used for unique applications and installations of pipe for some time. It has the advantage of providing adequate strength quickly, while providing an easy and efficient placement system. Flowable fill has proven to be a viable alternative when stone, sand, or other backfills have limited availability or cost prohibits their use. Even with these advantages it is necessary that the fill be controlled and care taken to provide for the proper installation.

Use of Flowable Fill

The following provides some advantages and disadvantages when deciding whether flowable fill should be specified or recommended on a project.

Advantages

- Allows for narrower trench and less disturbance to the native material.
- Eliminates the need for backfill compaction.
- Ensured proper distribution of support around the pipe.
- Reduces the amount of material excavated on a project.
- Time, personnel and equipment required to install flowable fill are typically less than that required for proper placement and compaction of conventional backfill materials, particularly fine-grained soils.
- Flowable fill may be made on-site using native soil as part of the mix where sands or silty sands exist.
- Time and equipment required for compressive strength testing is often less than that required to test soil compaction.



Disadvantages

- More costly than granular backfill due to the many components required and specialized delivery.
- Improper mix components can cause difficult future excavation if taps or extensions are required.
- Cannot be stockpiled on site like granular backfill. Time saved during the placement of the flowable fill can be wasted waiting on ready-mix delivery.
- Unless precaution is taken, the potential for pipe flotation is high during the installation process.

Mix Design

The mix design of flowable fill can vary widely. The flowable fill mix should be designed to meet all strength and flowability requirements. A suggested strength ranges between 50 psi and 100 psi for the 28 day strength; mixes that have 28-day compressive strengths greater than 100 psi should be avoided due to increased difficulty in future excavation, if needed. The flowable fill should be able to flow into all voids between the pipe and the trench walls. The mix design should be laboratory tested prior to installation ensure that the proper results are obtained during field batching. The field mix may also require monitoring and adjustments to maintain the proper mix and properties. These variations in the field mix can be due to many factors including water content, temperature and humidity during placement.

Installation Considerations

Environment

Flowable fill cannot be used in all temperature and weather conditions. It is recommended that the temperature be at least 40°F and that the soil exposed to the flowable fill be unfrozen. There should be no appreciable precipitation during placement to initial set. Flowable fill should be protected from freezing temperatures.

Joints

For flowable fill applications, the use of a watertight joint is recommended. For soiltight joints, precautionary measures should be taken to prevent infiltration of flowable fill mix material. This will depend nearly entirely on the consistency of the mix design.

Placement of Flowable Fill

Trench excavation should follow normal procedures and meet all OSHA safety regulations. Trench width will be dictated by the native material strength. When acceptable in-situ material exists in the trench, like rock or other high-bearing soils, the trench widths may be reduced to within 6-in along each side of the pipe, provided there is enough space to properly place the flowable fill in the pipe haunch areas. Table 1 depicts typical trench widths for a flowable fill installation. Once the trench is excavated to the proper line and grade, placement of pipe may begin. The pipe should be laid in the trench and joined in accordance with publish recommended installation guidelines.

Table 1
Recommended Trench Widths for Flowable Fill Backfill

Nominal Pipe Diam, in. (mm)	Minimum Trench in. (m)	Nominal Pipe Diam, in. (mm)	Minimum Trench in. (m)
12 (300)	22 (0.6)	36 (900)	59 (1.5)
15 (375)	27 (0.7)	42 (1050)	66 (1.7)
18 (450)	33 (0.8)	48 (1200)	74 (1.9)
24 (600)	42 (1.0)	54 (1350)	82 (2.0)
30 (750)	51 (1.3)	60 (1500)	90 (2.3)

*AASHTO LRFD Section C12.6.6.1, 2006

It is recommended that both an anchoring system and incremental lifts be utilized during installation. Refer to Figure 1 below for lift recommendations and corresponding recommended anchoring forces. Keep in mind that the fill should be brought up evenly on both sides to prevent unbalanced forces from acting on the pipe. Each lift should be allowed to reach initial set, prior to placing the next lift. Time to initial set is dependent on the mix design as well as ambient temperature and moisture. The mix supplier should be contacted to determine the site-specific waiting period recommended between lifts. NOTE: The use of plasticizers or other admixtures can greatly affect cure time and final compressive strength. While it is recommended to place the flowable fill in incremental lifts, it should be noted, one continuous lift may be used provided flotation restraints have been properly designed and installed, see Table 2 for recommendations.

If additional backfill is to be placed over the flowable fill to reach final grade, it should not be placed until the flowable fill has reached a minimum compressive strength, as determined by the design engineer. If minimum strength is not specified or time constraints do not allow for testing of cylinders, ASTM C403 and ASTM D6024 can be referenced to determine if flowable fill has gained adequate strength.

Since moisture is beneficial to curing it may be desirable to place a thin layer of soil (6 inches) on top of the flowable fill section for enhanced curing.

Figure 1
Hold Down Force for Incremental Lifts

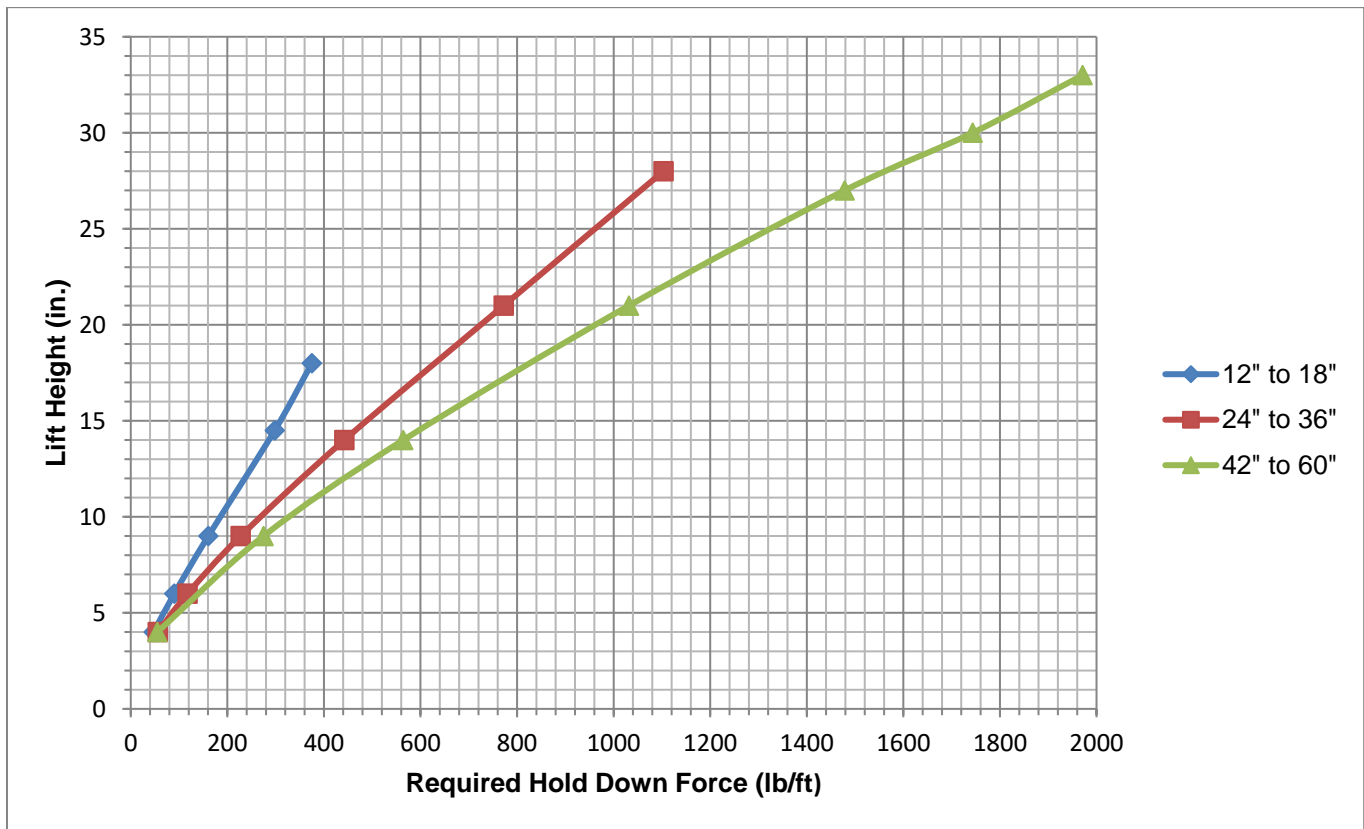

*Assumes a unit weight of flowable fill of 150 pcf and no water in the pipe at time of placement

Anchoring Systems

Probably the greatest concern associated with flowable fill during installation is its tendency to float the pipe. Flotation and misalignment issues are extremely critical and should not be ignored. When backfilling with flowable fill, the absence of soil overburden will cause the pipe to float since the pipe weight does not offset the flowable fill uplift. Therefore, the pipe must be anchored to keep the intended alignment and grade. There are a number of acceptable methods for anchoring the pipe in the trench. It may be assumed that flowable fill acts as a fluid with a density of 140 - 150 lb/cu ft. prior to stiffening. When properly designed, pipe restraints should account for buoyant forces exerted by the fluid.

Common methods include placing bags of soil or cement or heaping native material at intervals along the pipe, rebar placed in an "X" pattern above the pipe and anchored into the trench sidewall, or use of on-site construction equipment that can be left in place while curing (e.g. boom/bucket of excavator). Additional methods may include a pre-cast concrete swamp weight, or a commercially available screw anchor assembly. Anchor design and spacing shall be determined by the project design engineer. For other restraint options and additional technical information related to floatation, refer to Technical Note 5.05: *Pipe Flotation*.

Table 2
Hold Down Force, One Continuous Lift

Full Depth Placement of Flowable Fill Backfill		
Nominal Pipe Diam, in. (mm)	Lift Height (Pipe OD), in. (mm)	Required Hold Down Force, lb/ft (kg/m)
12 (300)	14.5 (368)	186 (276)
15 (375)	18 (457)	287 (426)
18 (450)	22 (559)	429 (638)
24 (600)	28 (711)	693 (1032)
30 (750)	36 (914)	1149 (1710)
36 (900)	42 (1067)	1566 (2330)
42 (1050)	48 (1219)	2044 (3042)
48 (1200)	54 (1372)	2590 (3854)
54 (1350)	61 (1549)	3311 (4927)
60 (1500)	67 (1702)	3990 (5938)



Technical Note

TN 5.04 HDPE and HP Storm Connections to Manholes and Structures for Storm Sewer Applications

Introduction

A full line of pipe jointing options is available to fit the requirements of nearly any storm drain or gravity flow project specifications. The joints available range from soil tight split couplers to gasketed soil-tight (ST) and watertight (WT) pipe. When connecting pipe to drainage structures it is important to make those connections with a joint performance at least equal to that of the piping system.

Connection Options

Soil-Tight Performance

When using soil-tight pipe in non-watertight applications, it may be acceptable to grout the void space between the pipe and drainage structure.

Watertight Performance

When using watertight pipe for testable systems, requiring some degree of watertight performance, it is necessary to provide additional measures to insure a watertight connection between the pipe and structure. ASTM F2510/F 2510M, "Standard Specification for Resilient Connectors Between Reinforced Concrete Manhole Structures and Corrugated High Density Polyethylene Drainage Pipes," is the governing standard for corrugated HDPE pipe-manhole connections, but specific performance/installation requirements should be verified for each specific project. Along with a full line of adapter fittings available, including the Waterstop® Gasket, are flexible boot fittings provided by other manufactures. Fitting dimensions should be supplied to the manufacturer to insure the proper fitting size and manhole boot connector are supplied.

Installation Recommendations

When installing a manhole adapter on the upstream end, the fitting may be over inserted into the structure temporarily while the adjoining pipe is laid. The spigot piece is then pushed back through the structure and connected to the bell end when pushing the joint together, as shown to the right.

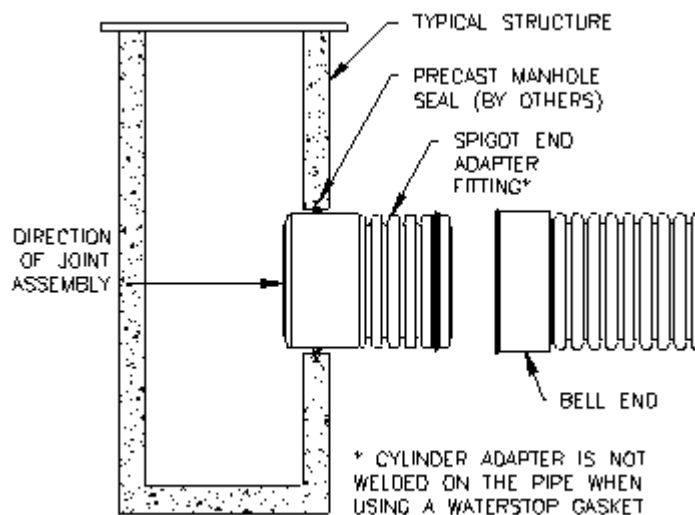

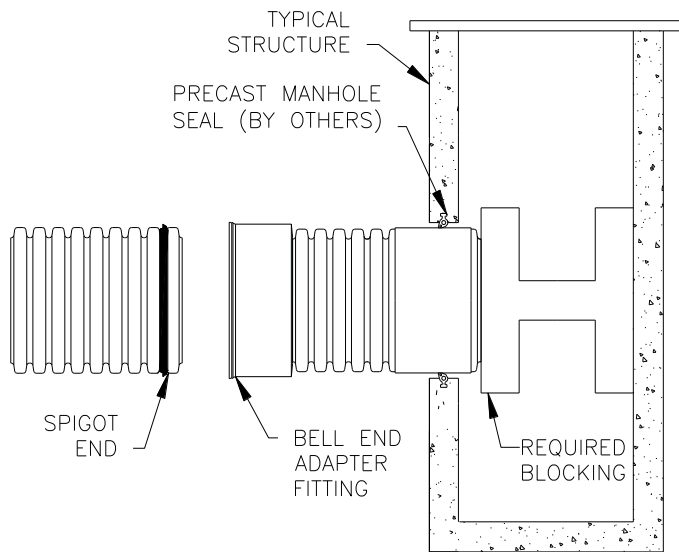

Alternately, when using the adapter fitting in the downstream end of the structure, before pushing the bell and spigot together from inside the structure, it is necessary to provide blocking at the structure to prevent the fitting from moving in the structure, as shown to the left.

Summary

The selection of which manhole connection is best suited for a project is based on the joint and connection requirements along with preferred manhole connection method for the region. It is imperative that prevailing regulations be consulted before selecting a manhole connection. Other options may be available for watertight manhole connections. Refer to 200 Series Standard Details for installation and connection-specific details. Contact your Regional Engineer or Application Engineering for further assistance.



Technical Note

TN 5.06 Culvert Sliplining with HDPE Pipe

Introduction

An abrasive or corrosive environment can cause premature deterioration of some types of pipe. In lieu of a total replacement, sliplining the existing pipe with a durable material may be an economical method to significantly extend the service life. Polyethylene pipe, because of its resistance to aggressive environments, is often the product of choice to slipline deteriorated pipes. This technical bulletin describes the site and installation considerations that must be evaluated before using HDPE pipe in these applications.

Access to the Host Pipe

The “host” pipe may be open on both ends, as in a culvert application, or it may be accessible only through a manhole opening, as in a storm sewer application. Open-ended applications are more appropriate for HDPE pipe products, provided they do not require the pipe to be bent in order to enter the host pipe. If access can only be made through a manhole, HDPE pipe products may not be acceptable because they cannot be bent sufficiently.

Diameter of the Host Pipe

The greater of either the outside diameter of the HDPE pipe or coupler should be compared to the inside diameter of the host pipe. This may be accomplished by attempting to pull a short section (~2 feet in length) through the host pipe as a trial run. The host pipe should be clean; free from sediment and debris so as to not interfere with the installation of the liner pipe. Sliplining installations may be subject to thermal length changes of 0.07-inches per 100 feet of pipe per change in degree F. One should design to allow for these changes during installation. To allow for proper grout placement and clearance, the relined pipe should have a maximum outside diameter no greater than 90% of the inside diameter of the host pipe. The maximum outside diameters of ADS products are shown in Table 1.

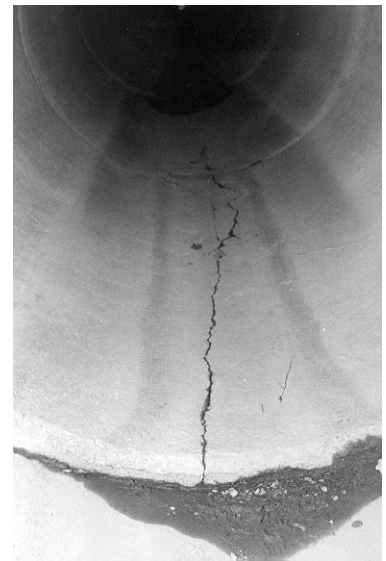

Table 1
HDPE Pipe Dimensions

Nominal Inside Diam. in (mm)	Max Outside Diam. in (mm)	Nominal Inside Diam. in (mm)	Max Outside Diam. in (mm)
4 (100)	4.8 (122)	24 (600)	28.4 (721)
6 (150)	7.0 (178)	30 (750)	35.6 (904)
8 (200)	9.5 (241)	36 (900)	41.4 (1052)
10 (250)	12.0 (305)	42 (1050)	48.0 (1219)
12 (300)	14.5 (367)	48 (1200)	55.0 (1397)
15 (375)	17.8 (452)	54 (1350)	61.0 (1549)
18 (450)	21.5 (546)	60 (1500)	67.3 (1709)

Length of Installation

HDPE pipe joints are not designed to withstand large pulling forces. Furthermore, pushing the liner pipe in through the host pipe may damage the corrugations at the pipe ends as they butt up against each other. The method of installation will affect, in large part, the maximum length that can be slip lined without damaging the pipe. Using skids, especially in a corrugated host pipe, will help minimize resistance between the two surfaces. Skids could be as simple as a pair of 2X4's placed near the invert. A push-and-pull technique keeps stress on the joints to a minimum. Projects in excess of 100 ft (30 m) between access points are addressed in Technical Note 5.11: *Sliplining Extended Lengths with HDPE Pipe*.

Hydraulic Considerations

Original design calculations may be referenced, however careful attention should be given to changes in land use which would change the calculated runoff tributary to the culvert. Once a discharge has been determined, the required size of the HDPE pipe may be established. If original design calculations are not available, the project engineer should complete a thorough drainage study. A culvert size can be selected based on watershed attributes, design storm, allowable headwater, culvert entrance conditions and any other related design factors.

In many cases, where culverts are too deep to make replacement practical, slightly reduced hydraulics may be an acceptable tradeoff to an expensive replacement. Typically, gravity flow systems are designed using Manning's Equation with a conservative 'n' value of 0.012 for HDPE. It should be noted that culverts in need of relining do not have Manning's 'n' values typical of original design values. Relining with smooth interior HDPE pipe may actually increase the capacity of the deteriorated culvert.

Structural Requirements

Failing culverts in need of relining may eventually deteriorate into a conduit with no structural integrity at all. For this reason, it is important to reline with a culvert capable of handling the loads based on its installation assuming no load reduction from the host pipe. Loading for Highway and pavement tunnels shall be based upon a continuous load carrying structure for the height of cover under HS-25 loading. Voids between the surrounding soil and the host pipe shall be pressure grouted to ensure structural integrity and resistance to thermal effects. For more information for determining the structural capacity of HDPE, refer to the Structures section of the *Drainage Handbook*.

Installation of HDPE in Host Pipe

Before the HDPE pipe is inserted into an existing culvert for relining, it is critical to inspect the existing culvert for any objects or obstructions, which may be extending into the barrel of the existing culvert to be relined. Failure to do this may result in a damaged reline.

Insertion Forces

Once the culvert is clear, the new material may be pushed through. It is important to determine the maximum insertion force that can be applied to the culvert. This will prevent the pipe wall profile from buckling in the axial direction under excessive insertion loading.

In cases where the new culvert will be two or more sizes smaller than the existing culvert, it is possible to construct mechanisms to transport the new material along the existing culvert without sliding across the invert. Although ideal for construction, many times there is insufficient room to allow this technique.

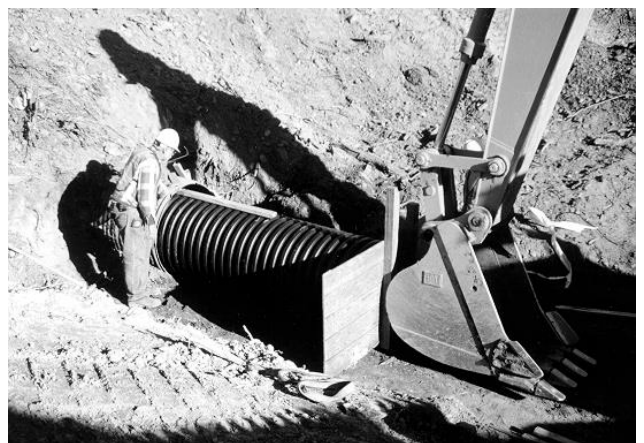

Grouting Procedures

When relining a culvert with HDPE pipe, it is recommended to fill the void space between the existing culvert and the new material with a grout material. The grout material is often a controlled low strength material – controlled density fill (CLSM-CDF). A CLSM or flowable fill material will help provide uniform support on the sides of the pipe, maintain a consistent soil density, provide lateral support for the pipe, and eliminate point loads. For more information on flowable fill mix, refer to Technical Note: *Flowable Fill Backfill for Thermoplastic Pipe*.

It is common for aging metal culverts to have deteriorated or completely destroyed inverts. This allows the fluid carried through the culvert to create void space under the pipe, creating an undesired design consideration. The grout material will help plug and fill any fractures or holes in the existing culvert along with structurally stabilizing the system from thermal, hydrostatic pressure, point loads, and function as a water barrier.



To ensure proper alignment and prevent joint separation, the pipe should be anchored against flotation when placing the grout material. Grouting in layers thin enough such that they don't float the pipe helps tremendously. Each layer should be allowed to set up between pours. Contractors may have other techniques that will also prevent flotation such as the use of deadweight inside the pipe. Regardless of the method used, it is also important to avoid applying point loads to the pipe. For more information on flotation and anchoring methods, refer to Technical Note: *Pipe Flotation*.

When HDPE pipe, or any flexible pipe, is used as a liner, it is very important not to use excessive grout pressure. In most circumstances, the joint, not the wall strength, will be the limiting factor for maximum allowable grouting pressure. Including a factor of safety, the recommended maximum grouting pressure for water tight pipe products is 5 psi; this

value may vary based on specific site conditions and specific products used. Due to the application method of grout, water tight pipe is recommended for sliplining applications. During the grouting operation, gauges should be used to monitor the grout pressure exerted on the pipe system. For some applications, hydrostatic head pressure may increase the expected pressure on the pipe from the grouting. Additional pressure may be a result of the slope and/or diameter of the pipe, elevation changes between the pipe and the gauge, and other conditions that should be considered during the design. The sum of all pressures that will be exerted on the pipe should not exceed the recommended maximum pressure for the application.



Technical Note

TN 5.07 Post Installation Testing for HDPE Pipe

Introduction

HDPE pipe is often tested after or during installation to ensure a sound installation was accomplished. Types of post installation field testing include deflection testing and joint testing. Specific testing required for the project will be found in the project specifications. This technical note is not meant to supersede any project specification, but should be used in conjunction with the project specification and national testing standards as it relates specifically to HDPE pipe.

Deflection Testing

An important feature of any flexible pipe is its ability to deflect, or oval, under load without structural distress. Flexible pipe *must* deflect in order to mobilize the strength of the surrounding backfill. Deflection allows the load to be transferred from the pipe to the surrounding backfill. As a result, flexible pipe can withstand very high loads as a relatively light structure.

According to current thermoplastic design procedures, deflection is defined as a service limit. The designer, considering all site conditions, will set this service limit in order to perform a proper design evaluation. Deflection in excess of this service limit does not necessarily result in strength limits being exceeded, i.e. system failure. For more information on service and strength limit states, see the *Structures* section of the Drainage Handbook. HDPE can be expected to perform satisfactorily in most applications with 5% or 7.5% deflection and so it is typical of designers to choose a service limit in this range.

When testing for allowable deflection limits, the minimum inside diameter should be used when establishing mandrel sizing. The minimum inside diameter accounts for the allowable manufacturing tolerances. Table 1 lists the inside diameters that result from 5% and 7.5% deflection from the minimum inside diameter. Values listed in Table 1 should be used for sizing mandrels for deflection testing. Mandrels may be obtained from a variety of commercial suppliers.

Table 1
Base Inside Diameters for HDPE Pipe

Nominal Pipe Diameter (in.)	Base Inside Diameter (in.)	Base Inside Diameter with 5% Deflection (in.)	Base Inside Diameter with 7.5% Deflection (in.)
4	3.88	3.68	3.59
6	5.82	5.53	5.38
8	7.76	7.37	7.17
10	9.69	9.21	8.97
12	11.63	11.05	10.76
15	14.54	13.82	13.45
18	17.45	16.58	16.14
24	23.27	22.10	21.52
30	29.08	27.63	26.90
36	34.90	33.16	32.28
42	40.72	38.68	37.66
48	46.54	44.21	43.05
54	52.35	49.73	48.43
60	58.17	55.26	53.81

*Value is per AASHTO M252¹ (4"-10" dia.) and AASHTO M294² (12" – 60" dia.).
If designing to a specific standard, please review allowable minimum diameter.

It is important to understand that mandrel testing is a go/no-go test. If any line were to not pass a mandrel, it is important to determine the cause. Obstructions in the line, not associated with deflection, may influence the test. Visual inspection is recommended in the event of a no-go result.

Joint Testing

Joint testing is an important part of any gravity sewer system, both in testing for infiltration and exfiltration. Infiltration aids to estimate the amount of sewer water that will be conveyed to, and ultimately treated by, the waste water treatment plant. Exfiltration aids to estimate the loss of sewage water into the surrounding soil. The two primary ways of testing sewer pipe joints for infiltration and/or exfiltration is using air or water to create a constant pressure within the system.

Exfiltration Testing with Air

Air is a compressible gas and so it is extremely important one adheres to the appropriate safety regulations outlined in OSHA and project specifications. There are two primary national testing standards that may be applied to joint testing HDPE: ASTM F1417 *Standard Test Method for Installation Acceptance of Plastic Gravity Sewer Lines Using Low-Pressure Air*, and ASTM F3058 *Preliminary Field Testing of Thermoplastic Pipe Joints for Gravity Flow (Non-Pressure) Sewer Lines*. When either standard is specified by the project plans, one should review the standards carefully and follow the testing procedure and safety precautions outlined. The below commentary on the ASTM testing procedures should be considered a summary and does not replace the testing procedures outlined in their respective specifications.

ASTM F1417 entails testing a run of pipe from one manhole to the next adjacent manhole. Inflatable plugs are positioned into the manholes and secured. Air is introduced into the pipe line and gradually builds pressure. Once the line has been pressurized and is stable at 4.0-psi, the pressure is decreased to 3.5-psi at which time the line must not lose more than 0.5- or 1.0-psi (whichever is specified by the design engineer) in the specified amount of time. Table 2 below summarizes the minimum time that must be reached for less than 0.5- or 1.0-psi of pressure drop, depending on the diameter and length of pipe being tested.

Table 2
Time to Pressure Drop for HDPE (per ASTM F1417)

Pipe Diameter	Pressure Drop (psi)	Minimum Test Time (min:sec)	Length for Minimum Time, (ft)	Time for Longer Lengths, (sec)	Time for Length Shown, (min:sec)							
					100 ft	150 ft	200 ft	250 ft	300 ft	350 ft	400 ft	450 ft
12	0.5	5:40	199	1.709 L	5:40	5:40	5:42	7:08	8:33	9:58	11:24	12:50
	1.0	11:20		3.418 L	11:20	11:20	11:24	14:15	17:05	19:56	22:47	25:38
15	0.5	7:05	159	2.671 L	7:05	7:05	8:54	11:08	13:21	15:35	17:48	20:02
	1.0	14:10		5.342 L	14:10	14:10	17:48	22:15	26:42	31:09	35:36	40:04
18	0.5	8:30	133	3.846 L	8:30	9:37	12:49	16:01	19:14	22:26	25:38	28:51
	1.0	17:00		7.692 L	17:00	19:13	25:38	32:03	38:27	44:52	51:16	57:41
24	0.5	11:20	99	6.837 L	11:24	17:57	22:48	28:30	34:11	39:53	45:35	51:17
	1.0	22:40		13.764 L	22:47	34:11	43:34	56:58	68:22	79:46	91:10	102:33
30	0.5	14:10	80	10.683 L	17:48	26:43	35:37	44:31	53:25	62:19	71:13	80:07
	1.0	28:20		21.366 L	35:37	53:25	71:13	89:02	106:50	124:38	142:26	160:15

Data taken from ASTM F 1417³ and Uni-Bell, Uni-B-6-98⁵.

It may not be necessary to hold the test for the entire time period listed above when it is evident that the rate of air loss is zero or less than the allowable pressure drop and authorized by the approving authority¹.

When the pipe is large enough to be physically accessed, it may be desirable to test individual joints for safety reasons. In these cases, one may consider joint testing in accordance with ASTM F3058, also known as a joint isolation test. ADS recommends a joint isolation test, in lieu of a full line test, for testing pipe diameters 36" and larger for safety reasons. This test is typically done with air, though water may also be used, and involves the use of special testing equipment. The equipment consists of two inflatable bladders, placed on each side of the joint, creating an open center cavity between them. The bladders are inflated and then the center cavity is pressurized to 3.5 psi. The joint passes the test if the pressure is held for 5 seconds without dropping more than 1.0-psi. For all practical purposes, this is a go/no-go test. Final acceptance of the pipeline per this testing method shall be at the discretion of the Design Engineer. One advantage of this type of test is the ability for the installer to quickly test the joint immediately after installation, allowing for any corrective measures to be taken early on in the project.

Infiltration/Exfiltration with Water

Testing gravity sewer joints via water infiltration or exfiltration is a common practice. For HDPE, this testing should be conducted in accordance with ASTM F2487 *Standard Practice for Infiltration and Exfiltration Acceptance Testing of Installed Corrugated High Density Polyethylene Pipelines*. These standards entail first observing the ground water conditions and, if applicable, measuring the infiltration rate of the ground water through the joints. If ground water is not applicable, then the line is filled with water and the leakage is observed through exfiltration.

Manholes shall be tested separately and independently of the pipe line to the requirements established in the project specifications. When water level is measured in the manhole for the exfiltration test, the leakage associated with the manhole shall be subtracted from the overall leakage of the test section to establish a pass or fail grade for the pipe.

Allowable Leakage

The allowable leakage rate for HDPE is 200 gallons/in-dia/mi-pipe/day for both infiltration and exfiltration when tested in accordance with ASTM F2487

Conclusion

HDPE pipe is intended for gravity flow drainage applications and may be tested for deflection and joint tightness as discussed in this technical document. It is important to note that the testing procedures are no different than for other gravity flow drainage products currently being used in the market. This document does not purport to address the safety concerns associated with testing HDPE pipe. Any questions associated with testing HDPE pipe can be directed to your local representative.

References

1. AASHTO M252, *Standard Specification for Corrugated Polyethylene Pipe Drainage Pipe*, AASHTO, 2012
2. AASHTO M294, *Standard Specification for Corrugated Polyethylene Pipe, 300 to 1500 mm (12 to 60 in.) Diameter*, AASHTO, 2015
3. ASTM F1417, *Standard Test Method for Installation Acceptance of Plastic Gravity Sewer Lines Using Low-Pressure Air*, ASTM, 2005
4. F3058, *Preliminary Field Testing of Thermoplastic Pipe Joints for Gravity Flow (non-Pressure) Sewer Lines*, ASTM, 2016.
5. Uni-B-6-98, *Recommended Practice for Low-Pressure Air Testing of Installed Sewer Pipe*, Uni-Bell PVC Pipe Association, 1998
6. ASTM F2487, *Standard Practice for Infiltration and Exfiltration Acceptance Testing of Installed Corrugated High Density Polyethylene Pipelines*, ASTM, 2006



Technical Note

TN 5.10 Integral Bell Transition for HDPE Pipe

ADS offers a variety of joints to the market place. Corrugated HDPE pipe can be cut at any corrugation allowing a great degree of flexibility in making field cuts. Plain end pipe can be connected using split couplers, cleated bell-bell couplers, or bell end couplers and gaskets. The standard pipe joint ADS offers is the Integral Bell (IB) joint which requires field cuts when transitioning to plain end pipe, fittings or other materials.

ADS N-12[®] IB pipe has an integral bell which maintains a constant pipe outside diameter (OD). This constant OD eliminates the need for bell holes and makes it easier to maintain line and grade during installation. The gasketed bell and spigot design, with an elastomeric rubber gasket meeting ASTM F477, is intended for soil-tight (ST) or watertight (WT), gravity-flow storm sewer applications, as defined in ASTM F 2306 and ASTM D 3212..

Connections for Integral Bell Pipe

With the variety of couplers available, connecting to existing pipe runs or to fabricated fittings may necessitate a transition to other ADS joints. ADS fittings come as either plain end or bell end; which makes it necessary to transition from an IB joint to either a plain end connection or a bell end connection. This technical note will give guidance in selecting the proper method of making these connections.

Integral Bell Pipe to Plain End Pipe (12" – 60") (Plain End Pipe/Fitting Connections)

Remove the bell or spigot end of the pipe. The spigot end on 12"-60" pipe will have mini or reduced-size corrugations; for smaller diameter pipe, 4"-10", there will be no mini corrugations to remove. Utilize a split coupler or cleated bell-bell coupler (snap coupler) to make the connection. Refer to Figure 1 for common configurations. This connection is considered soil-tight in most embedment soil conditions.

Figure 1
Integral Bell Pipe to Plain End Pipe Connection

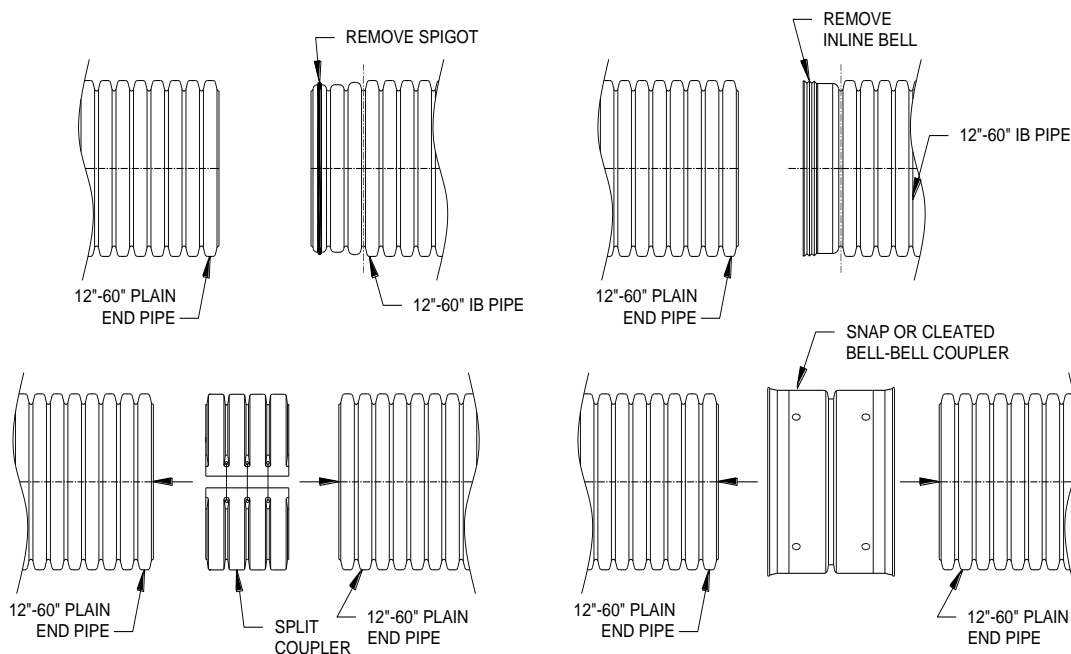

Integral Bell Pipe to a Welded Bell (Welded Bell End Pipe/Fitting Connections)

To connect pipe or fittings, which already have a welded bell, remove the mini corrugations from the spigot end of pipe or the IB bell from the bell end. The welded bell can be identified easily compared to the integral bell, because a weld seam will be present where the bell and corrugations meet. In addition to the weld seam, the OD of the welded bell is slightly larger than the OD of the adjacent corrugations. Refer to the pictures in Figure 2. Once the mini corrugations or IB bell have been removed, install a valley gasket (12"-36") or saddle gasket (42"-60") provided by ADS. Valley gaskets are to be placed in the valley behind the first corrugation crown. Saddle gaskets are placed on the crown of the first corrugation. Lettering printed on the gasket will face the joining bell. Lube gasket and the inside of the welded bell, be sure to lube the bells leading edge, and insert the spigot into the welded bell. This connection is considered soil-tight or watertight based on the type of gasket used. Consult an ADS representative to ensure the correct gasket is ordered to meet connection performance requirements.

Figure 2
Welded Bell Connection

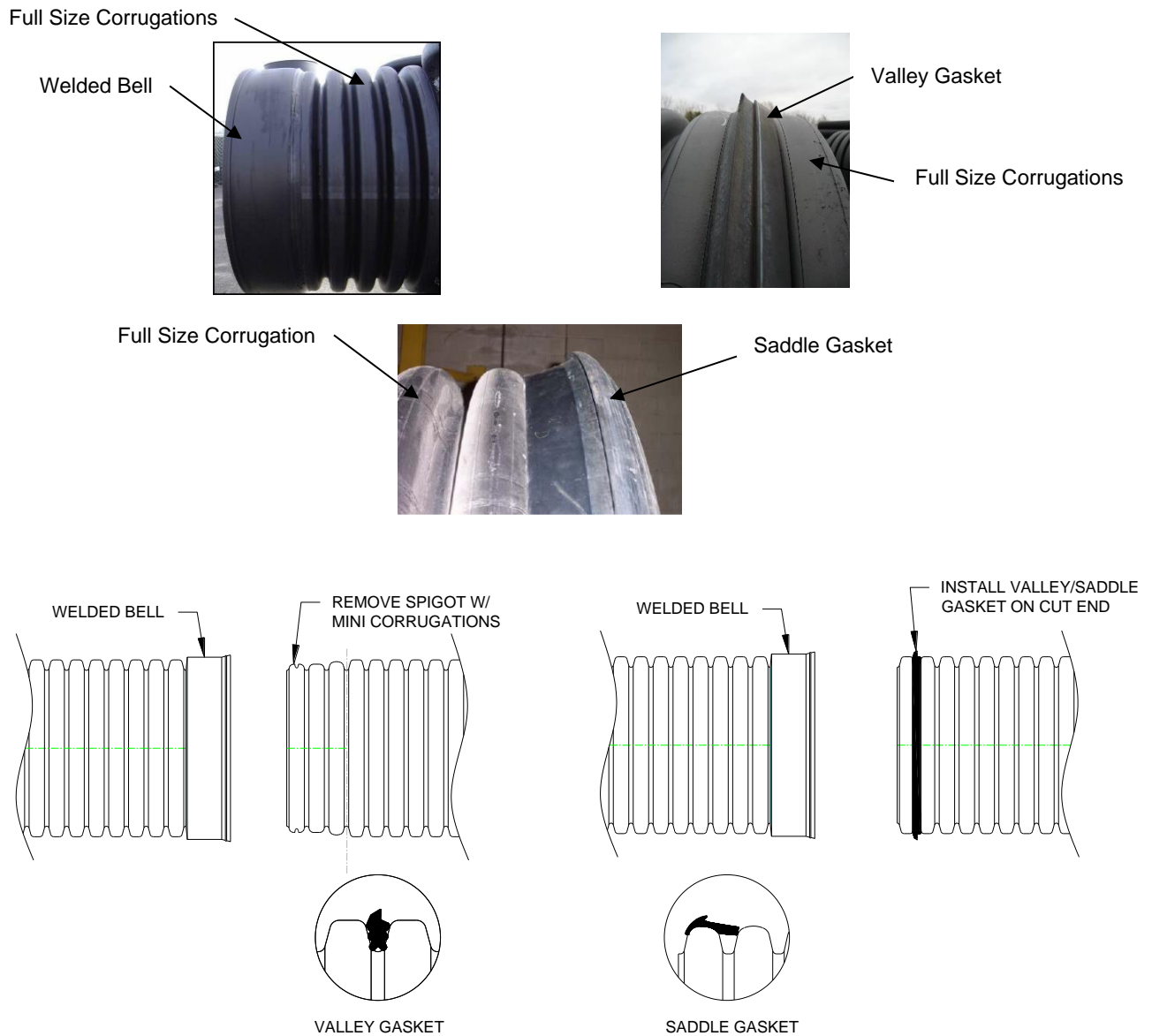

Integral Bell Pipe to Bell-Bell Coupler Connection

Some field modification will require the use of a bell-bell coupler in conjunction with a valley or saddle gasket. This field joint configuration follows very similarly to that described above for welded bell pipe/fitting connections. Remove the inline bell, spigot and/or the appropriate number of corrugations needed to make the connection and install a valley gasket (12"-36") or saddle gasket (42"-60") provided by ADS. Valley gaskets are to be placed in the valley behind the first corrugation crown. Saddle gaskets are placed on the crown of the first corrugation. Lettering printed on the gasket will face the joining bell. The joint will now consist of two pipes/fittings which each have a valley or saddle gasket installed as shown in Figure 3. Lubricate the interior and leading edge of a bell-bell coupler and the valley/saddle gaskets. Connect the pipes by inserting the valley/saddle gasket end of the pipes into the bell-bell coupler. This connection is considered soil-tight or watertight based on the type of gasket used. Consult an ADS representative to ensure the correct bell-bell coupler with accompanying gasket is ordered to meet connection performance requirements. If a non-gasketed connection is allowed, a split coupler or cleated bell-bell coupler (snap coupler) can be used in place of the bell-bell coupler for a soil-tight joint.

Figure 3
Bell-Bell Coupler Connection

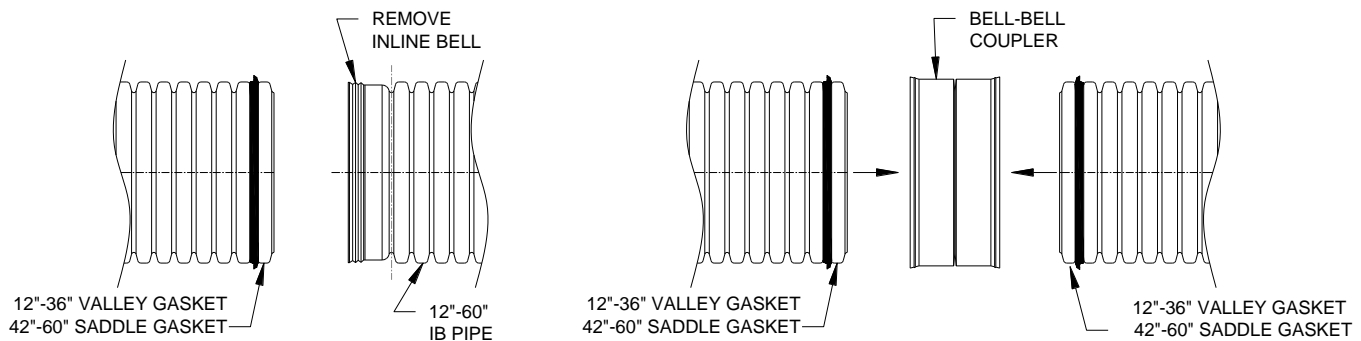

Vent Tube Sealing

The manufacturing process of corrugated plastic pipe requires the release of hot air from inside the corrugations in order to properly form the corrugations. This hot air is allowed to escape from the corrugations during the extrusion process via vent tubes that run the length of the pipe. Vent tubes become exposed when the pipe is cut in the field to install a fitting, connect to a manhole, or otherwise adjust the length of a pipe run. Exposed vent tubes may result in a leak path, and therefore is recommended that they be sealed. It is important that these vent tubes be sealed whenever the pipe is cut in the field. Please see Technical Note 5.16: *Methods for Sealing Vent Tubes* for instructions on sealing the vent tubes.



Corrugated Plastic Pipe Storm **Installation Guide**



Table of Contents

Job Site Handling and Receiving	5
Job Site Pipe Storage	8
Trench Construction	9
Trench Boxes	11
Bell & Spigot Joint Assembly	13
• Bar & Block Method	14
• Backhoe Method	15
• Backhoe and Sling Method.....	15
Installation Stub Fabrication	16
Joining Different Pipe Types or Sizes	17
Manholes and Catch Basin/ Connections	18
Field Gasket Assembly	20
Fittings Assembly	21
Backfill Recommendations	22
• Backfill Material Selection	23
• Groundwater or Surface Runoff.....	25
• Backfill Envelope Construction.....	25

Table of Contents

Other Installation Considerations	26
• Construction and Paving Traffic	27
• Maximum Cover	29
• Vertical Installations.....	32
• Flotation.....	33
• Bending Radius.....	35
Repair Methods	35
• Soil-tight:	
– Option 1: Split Band Coupler	35
– Option 2: Concrete Collar.....	36
– Option 3: Mastic Banding.....	36
• Watertight:	
– Option 1: PVC Slip Coupling.....	37
– Option 2: Concrete Collar.....	37
– Option 3: Chemical Grouting.....	38
– Option 4: Internal Sealing	38
Recommendations for In-Field Testing	39
• Leakage Testing.....	39
• Deflection Testing.....	39
Appendix	BC

Job Site Handling and Receiving

Receiving Recommendations

Our distributors and customer service personnel make service and customer satisfaction their highest priority. If your order is incorrect, contact your distributor or our customer service personnel.

- Direct driver to a smooth, flat area, free of rocks and debris.

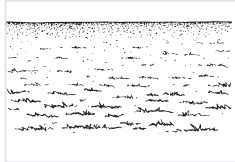

- Examine load quantities and quality immediately after unloading.

Inspect pipe carefully for possible damage from transportation or unloading.



- Note damaged or missing items on delivery receipt.
- Shortages and damaged material are not automatically reshipped. Reorder replacement material.
- Do not dispose of damaged items. Check with driver for proper return method. If driver is unsure, contact our customer service personnel.

Handling Recommendations

To avoid damage to the pipe and fittings the following handling recommendations should be followed:

- OSHA safety requirements.

- Do not drop pipe.
- Avoid any impact to the bell or spigot.
- 18" (450 mm) and smaller pipe can be moved by hand. Larger pipe requires a backhoe with a nylon sling.
- Lift 36" (900 mm) and larger diameter pipe with a sling at two points, spaced approximately 10 feet (3 m) apart. Smaller diameters can use one lift point. Refer to Table 1 for recommended handling methods.

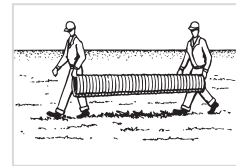

≤18" (450mm)

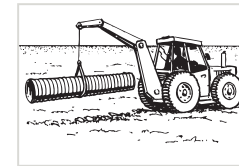

24"-30" (600-750mm)

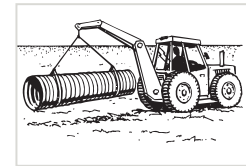

≥36" (900mm)

- Contractor assistance is required to unload palletized pipe.
- Do not use a loading boom or forklift directly on or inside pipe.

Table 1: Recommended Pipe Handling Method

Diameter in (mm)	HDPE Approx. lb/ft (kg/m)	HP DW Approx. lb/ft (kg/m)	Handling Method
4" (100)	0.44 (.65)	n/a	Labor
6" (150)	0.85 (1.3)	n/a	Labor
8" (200)	1.5 (2.2)	n/a	Labor
10" (250)	2.1 (3.1)	n/a	Labor
12" (300)	3.2 (4.8)	3.6 (5.4)	Labor
15" (375)	4.6 (6.9)	5.3 (7.9)	Labor
18" (450)	6.4 (9.6)	7.1 (10.5)	Labor
24" (600)	11.0 (16.4)	11.9 (17.7)	Sling (1 point)
30" (750)	15.2 (22.6)	16.8 (24.9)	Sling (1 point)
36" (900)	19.8 (29.5)	20.3 (30.2)	Sling (2 points)
42" (1050)	24.3 (36.1)	25.1 (37.4)	Sling (2 points)
48" (1200)	30.9 (45.9)	32.4 (48.2)	Sling (2 points)
60" (1500)	44.5 (66.3)	49.6 (73.8)	Sling (2 points)

**Recommended handling methods are based on two laborers per pipe length, neither of which is carrying more than 100 lb. (45kg).*

Job Site Pipe Storage

Storage Recommendations

To ensure that your delivered pipe products do not become damaged during job site storage, follow these simple guidelines:

- Non-palletized pipe may be temporarily stockpiled on a flat, clear area.
- Use securing timbers (or blocks) to ensure the stockpile does not collapse.
- Failure to block pipe may result in stack collapsing, pipe damage, or personal injury.

- Stack pipe no higher than approximately 6 feet (1.8 m).

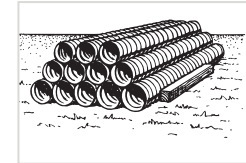

- While supporting lengths of pipe evenly, alternate bells for each row of pipe.

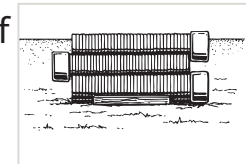

- To prevent damage to the bell or spigot when moving pipe sections, do not drag or strike pipe ends against anything.

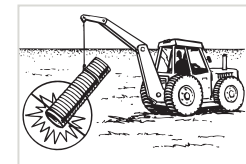

Trench Construction

- Information provided in this pocket installation guide is intended as a quick reference only and does not supersede requirements specified on project plans.
- The trench or ditch should be wide enough to place and compact backfill around the entire pipe.
- Refer to Table 2 for recommended minimum trench widths. The design engineer may modify the trench width based on site specific conditions.

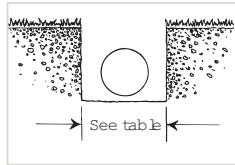

Table 2: Minimum Trench Widths

Pipe Diameter in (mm)	Trench Width in (mm)
4"-8" (100-200)	*
10" (250)	28" (711)
12" (300)	30" (762)
15" (375)	34" (863)
18" (450)	39" (990)
24" (600)	48" (1219)
30" (750)	56" (1422)
36" (900)	64" (1625)
42" (1050)	72" (1828)
48" (1200)	80" (2032)
60" (1500)	96" (2438)

**Usually dependent on smallest bucket size available.*

- For parallel pipe installations, allow space between pipes for proper compaction. Refer to Figure 1 for minimum pipe spacing. Spacing will differ for retention/detention systems due to the intended use of this product.

Figure 1: Parallel Pipe Installation

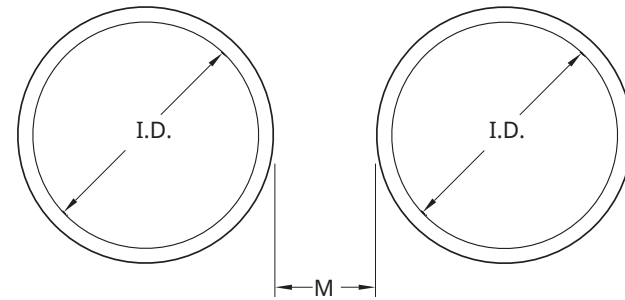

UP TO 24" (600MM) I.D.: M=12" (300MM)
 MORE THAN 24" (600 mm) I.D.: M=1/2 I.D.

- Trench or ditch bottoms containing bedrock, soft muck or refuse, or other material unable to provide long-term uniform pipe support are **unacceptable**.
- All unsuitable foundation shall be excavated before pipe installation proceeds.
- Where the trench bottom is unstable, the contractor shall excavate to a depth required by the engineer and replace with suitable material as is specified by the engineer.

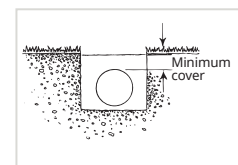
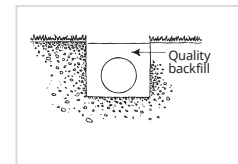
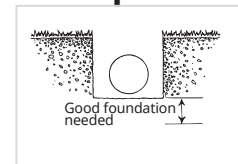

- If native soil can migrate into backfill, use synthetic fabric (geotextile) to separate native soil from backfill.

Trench Boxes

Trench boxes provide a safe work area to install pipe in deep trenches or in soils that have insufficient stability. **Always** follow OSHA requirements when using a trench box.

The length of the trench box should be suitable for the pipe length. Nominal length for pipe is 20 ft. (6.1 m) although shorter lengths can be supplied.

The most effective way to maintain a sound system is to provide a 'subtrench' within which to place the pipe and backfill. The subtrench shall not be greater than 24" (600 mm) above the bottom on the trench as shown in Figure 2. Backfill and compact according to the design specifications within the subtrench. The trench box can be pulled along the top edge of the subtrench without affecting the backfill in the pipe embedment zone.

Figure 2: Subtrench Installation

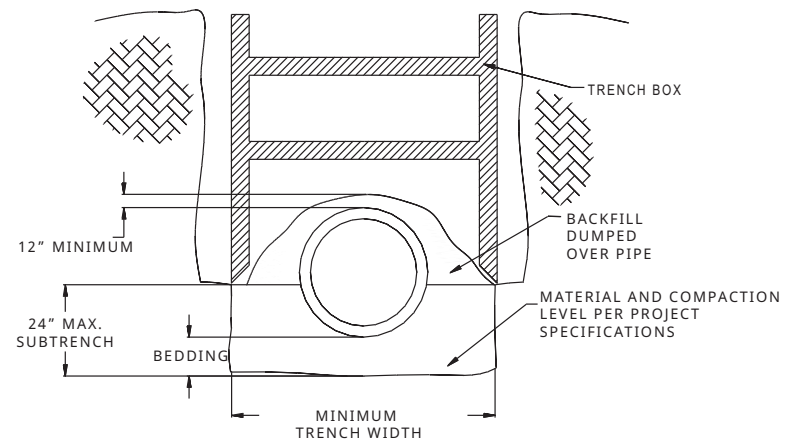

In installations not involving a subtrench, dragging a trench box should only be done if it does not damage the pipe or disrupt the backfill; otherwise, the box should be lifted vertically into its new position, again taking great care not to disturb the pipe or backfill.

Bell & Spigot Joint Assembly

For pipe with a bell-and-spigot connection, it is imperative that the joint be assembled properly to ensure that the product performs to expectations. The steps that must be followed to obtain a quality joint are provided below. Failure to follow these instructions may cause the joint quality to be severely compromised.

- Lower pipe into trench by hand, or use nylon straps and excavating equipment.
- Begin by inspecting the bell and remove any foreign matter.
- Use a clean rag or brush to lubricate bell of pipe lubricant.
- Clean spigot end of pipe.
- Remove protective wrap from gasket.
- Using clean rag or brush, lubricate exposed gasket with pipe lubricant.
- Do not allow lubricated section to touch dirt or backfill. Foreign matter could adhere to surface and compromise joint integrity.
- Place spigot into bell and align.
Note: It is recommended that one always lay pipe starting at the down stream end, pushing spigots into bells with the bells facing upstream. Always push spigot ends into bell, **not** bell end into spigot.

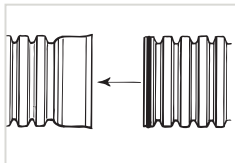
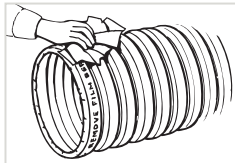
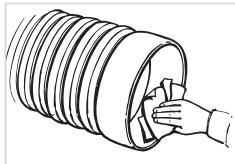

Assemble joint using one of the following methods. (For smaller diameters, pipe may be joined manually.)

- For all methods, ensure bell and spigot are adequately “homed” for proper installation and tight joining seal. If no homing mark is present, measure the depth of the bell and use a crayon or other material to place a homing mark on appropriate corrugation of the spigot end. Care should be taken to not over home the pipe during assembly.
- Installation stubs, mentioned in the assembly instructions, can be purchased or made following the information on page 15.
- Some high joint performance applications may require the joint to be held in place for a short time, immediately after insertion, to properly set the gasket.

Bar & Block Method

- Place installation stub into bell end of pipe.
- Place wooden block horizontally across end of installation stub.
- With a bar, push against wooden block until pipe is fully inserted into bell.

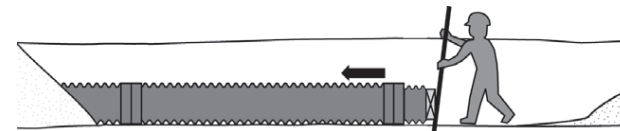

NOTE: This method requires use of installation stub. DO NOT push directly against pipe.

Backhoe Method

- Place installation stub into bell end of pipe.
- Place wooden block horizontally across installation stub.
- Carefully push back of backhoe bucket against block until pipe is fully inserted into bell.

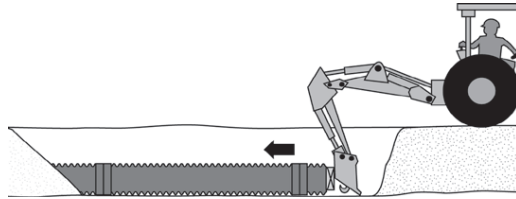

NOTE: This method requires use of installation stub. DO NOT push backhoe directly against pipe.

Backhoe and Sling Method

- Wrap nylon sling around pipe. Pipe 36" (900 mm) or larger should be picked up at two points approximately 10' (3m) apart.
- Hook other end of nylon sling to backhoe bucket.
- Operator should carefully push strap tight toward bell of downstream pipe until spigot is fully inserted into bell.
- Ensure pipe slides **squarely** into bell to avoid misalignment.
- **Keep pipe level.**

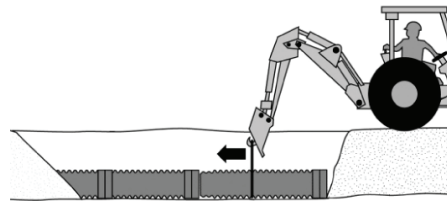

NOTE: Distance from bedding to bottom of pipe not to exceed 6" (150mm) for a 20' (6m) pipe.

Installation Stub Fabrication

To push "home" bell-and-spigot pipe, an installation stub can be used to prevent accidental damage to the bell. Installation stubs are not required if the bell is not pushed on directly. Installation stubs in all sizes are available from your distributor, or you can fabricate your own on site by following the proceeding steps:

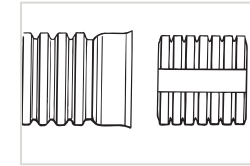

- Cut a section of pipe five corrugations long in the center of the corrugation valley.
- Using a saw, remove a strip of pipe wall from the short stub of pipe (Figure 3). Note: Strip width depends on pipe size. See Table 3 for recommended widths.

Figure 3: Installation Stub

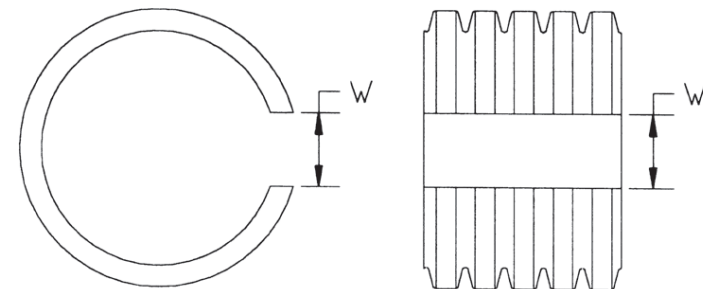

Table 3: Strip Width for Installation Stub

Pipe Diameter in (mm)	Trench Width in (mm)
4"-6" (100-150)	2 (51)
8" (200)	2.5" (64)
10"-12" (250-300)	4" (102)
15" (375)	5" (127)
18" (450)	6" (152)
24" (600)	7.5" (191)
30"-42" (750-1050)	10" (254)
48"-60" (1200-1500)	12" (305)

- To use stub, push on pipe walls to change O.D. of stub to I.D. of bell to be installed.

Joining Different Pipe Types or Sizes

Drainage systems often involve connecting pipes of different materials or sizes. Options to make these transitions are often limited by the joint quality required. One very common method of connecting different types of pipe of the same size, and in some cases different sizes, is through the use of a concrete collar. This generally provides a minimum silt-tight joint quality but the resulting quality ultimately depends on workmanship.

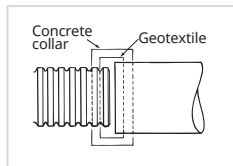

- A concrete collar is formed by butting the two pipe ends tightly together, wrapping the junction with a geotextile to keep out most soil and concrete, and then pouring a concrete collar that covers both pipe ends.

Another option may be using fittings or adapters specifically designed for this application. A selection of fittings designed to make the transition from one material directly to another is available. In other cases a fitting may need to be used in combination with another manufacturer's gasket or coupler to complete the transition. Transitions made in this manner may provide for a higher performance joint than a concrete collar.

Manholes and Catch Basin/Connections

Manholes or catch basins can be used at changes in pipe material, size, grade, direction and elevation. Manholes and catch basins can be more costly than other alternatives but also allow grade and directional changes in addition to changes in pipe material and size.

- Local regulations should be consulted to determine if manholes or catch basins are required at any or all pipe changes.
- Refer to Figure 4 for the acceptable methods of connecting plastic pipe to manholes or basins.
- See appendix for references to additional product specific resources applicable to connecting pipe to manholes.

**Figure 4: Manhole Connection
Product Details**

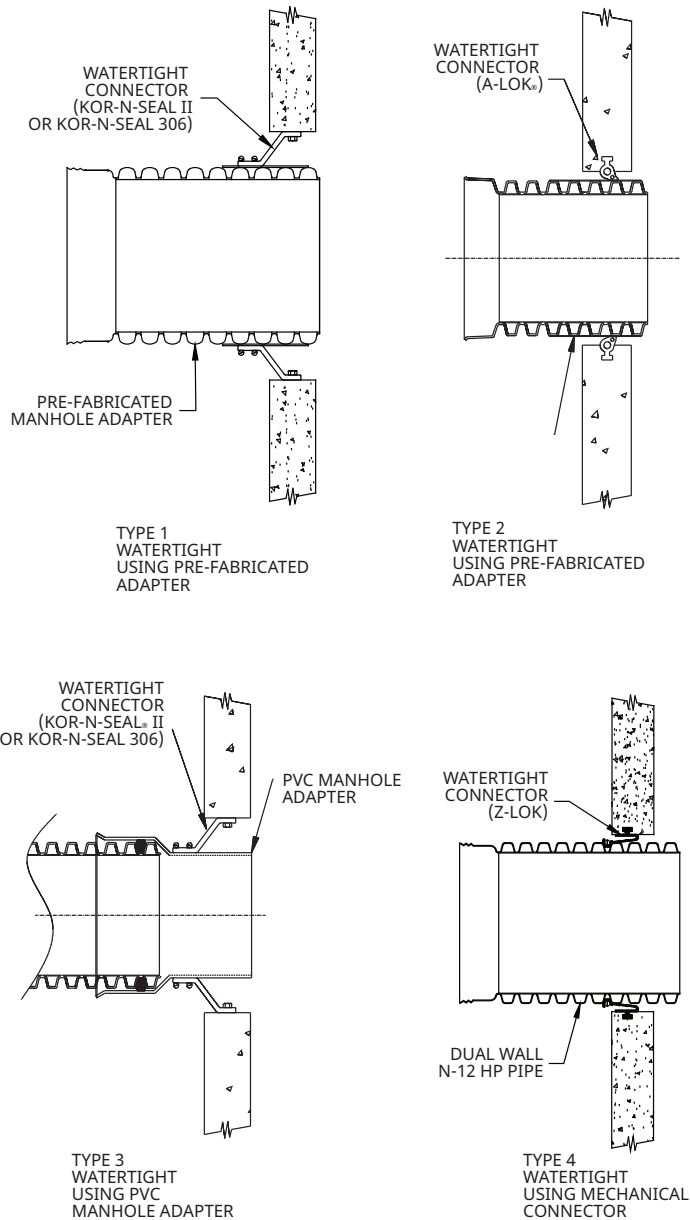

Field Gasket Assembly

When standard lengths of pipe must be cut to fit in a field application, the following instructions will ensure proper performing joints:

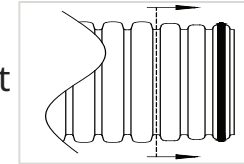

- For reduced spigot pipe **ONLY**, reducing spigot must be removed.
- Using a saw, cut in the center of the valley of the first full corrugation.
- Trim remaining plastic burrs from saw cut. *Note: Failure to smoothly trim burrs may compromise joint integrity.*
- Wipe clean first valley from end of pipe. *This is where gasket will be placed.*
- Hold gasket with both hands so printing is facing you.
- With printing on gasket face-up and toward spigot end of pipe, slide gasket into first corrugation valley, starting at bottom. *Note: It is easier to pull gasket up to conform to valley.*
- Slide gasket into first corrugation valley by hand.
- Ensure printing on gasket is face-up and toward spigot end of pipe.
- Vent tubes shall be appropriately scaled at joint where applicable, see *Technical Note 5.10: Integral Bell Transition for HDPE.*

Gasket printing should be visible in this location when properly installed.

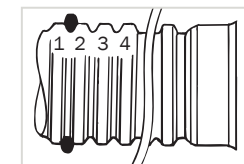

Fittings Assembly

This section includes information necessary for:

1. Soil-tight belled fittings
 2. Watertight fittings
 3. Repair couplers
- Cut pipe to desired length in the center of the corrugation valley before placing in trench.
 - Trim remaining polyethylene burrs from saw cut. Note: Failure to smoothly trim burrs may compromise joint integrity.
 - Excavate bedding from around spigot end where fitting shall be used. A bell hole will help prevent dirt and debris from contaminating joint during assembly.
 - Install gasket in accordance with gasket assembly procedure (page 19).
 - Measure the depth of the bell and use a crayon or other material to place a homing mark on appropriate corrugation of the spigot end.
 - Vent tubes shall be appropriately sealed at joint where applicable, see *Technical Note 5.10: Integral Bell Transition for HDPE*.
 - Using clean rag or brush, lubricate exposed gasket with pipe lubricant.
 - Do not let lubricated section touch dirt or backfill, as foreign material could adhere to surface and compromise joint integrity.

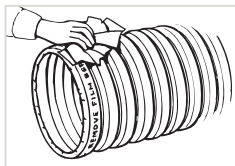

- Inspect fitting and remove any foreign matter.
- Align and center pipe.
- Lubricate inside of bell.
- Align fitting with pipe end.
- Use installation stub or blocking where required.
- Take care not to damage pipe or fittings.
- Ensure pipe is straight and bell reaches homing mark.
- Assemble other end of pipe or fitting as described in the pipe assembly section on page 12.
- Special care should be taken to replace and compact bedding material in bell hole to provide adequate support under the joint.

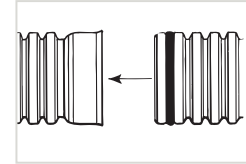

Backfill Recommendations

Plastic pipe and a well-constructed backfill envelope work together to support soil and traffic loads. Correct installation will ensure long-term trouble-free service for all types of pipe systems.

Backfill Material Selection

- Provided the plans meet minimum recommendations as stated in Table 4, they should take precedence.
- Locally available materials may be acceptable for backfill use, but must meet one of the acceptable soil classifications outlined in Table 4.
- Class I materials can be dumped around pipe. Voids must be eliminated by knifing under and around pipe or by some other technique.
- Non-cohesive sand, sand/gravel mixes and other Class II and III materials must be compacted to a minimum of 85% and 90% standard Proctor density, respectively.
- Inorganic silts, and gravelly, sandy or silty clays, and other Class IV materials are not permitted.
- Flowable fill is another acceptable backfill material. Misalignment or flotation may occur unless added precautions are taken, such as anchoring the pipe or pouring the flowable fill in lifts.
- See appendix for references to additional product specific resources that may be used when installing corrugated plastic pipe.

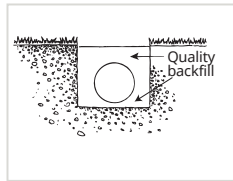
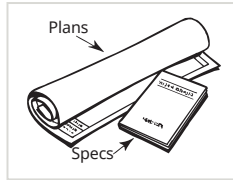

Table 4: Acceptable Backfill Material and Compaction Requirements

Description	Soil Classification			Minimum Standard Proctor Density %
	ASTM D2321	ASTM D2487	AASHTO M43	
Graded or crushed, crushed stone, gravel	Class I	-	5 56	Dumped
Well-graded sand, gravels and gravel/sand mixtures; poorly graded sand, gravels and gravel/sand mixtures; little or no fines	Class II	GW GP SW SP	57 6	85%
Silty or clayey gravels, gravel/sand/silt or gravel and clay mixtures; silty or clayey sands, sand/clay or sand/silt mixtures	Class III	GM GC SM SC	Gravel and sand (<10% fines)	90%

* Layer heights should not exceed 1/2 the pipe diameter. Layer heights may also need to be reduced to accommodate compaction method.

Groundwater or Surface Runoff

When groundwater or surface runoff is present in the work area, dewater to maintain stability of native and imported materials. Maintain water level below pipe foundation to provide a stable trench bottom.

Backfill Envelope Construction

- If native soil cannot carry load, import, compact and level adequate bedding material as in Figure 5.
- Figure 5 represents typical trench construction applicable to all products. See appendix for references to additional product specific resources.

Figure 5:

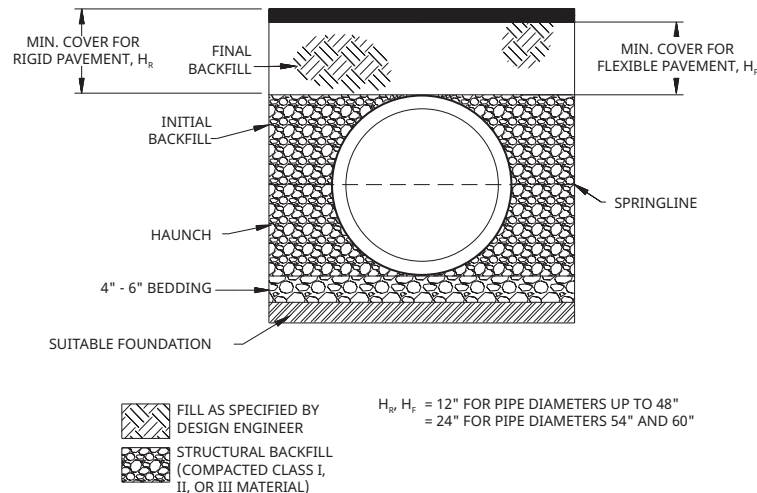

- Place and compact backfill in layers to meet requirements of Table 4 and project requirements. Note that the large diameter pipes may require layer heights less than those indicated in the table to achieve proper compaction.
- Avoid impacting pipe with compaction equipment.
- 4" - 48" (100-1200 mm) single pipe runs receiving H-25 traffic requires final backfill 12" (0.3 m) above initial backfill to provide at least 12" (0.3 m) of total cover as measured from the top of pipe to bottom of flexible pavement or to top of rigid pavement.
- 60" (1500 mm) single pipe runs receiving H-25 traffic require final backfill 24" (0.6 m) above initial backfill to provide at least 24" (0.6 m) of total cover as measured from top of the pipe to the bottom of flexible pavement or to top of rigid pavement.
- Minimum cover may be reduced in areas with no or infrequent light traffic. These situations must first be reviewed by the pipe manufacturer.

Other Installation Considerations

All unique situations cannot be anticipated; however, several common questions are answered in the following material.

Construction and Paving Traffic

- Some construction vehicles, such as many types of paving equipment, are not as heavy as the design load.
- For situations with relatively light construction vehicles, the 12" (0.3 m) and 24" (0.6 m) minimum covers criteria discussed earlier can be decreased during the construction phase.
- Table 5 presents the surface applied loads and the corresponding minimum cover that can be permitted on a temporary basis. *These criteria should only be employed during construction; finished projects should always have a minimum*

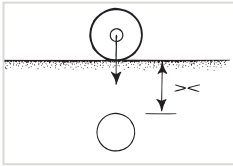

cover of at least 12" (0.3 m) for 4" - 48" (100-1200 mm) diameters and minimum cover of at least 24" (0.6 m) for 60" (1500 mm) diameters.

- Vehicles exceeding these criteria must not be permitted to drive over the installation.
- Areas receiving heavy construction equipment traffic between 30 and 60 tons require at least 3 feet (0.9 m) of cover. Higher loads require cover greater than 3 feet (0.9 m), depending on the load.
- If sufficient cover is not provided, mound and compact material over pipe to provide minimum cover needed for load during construction.
- For heavy duty compaction equipment, such as a hoe-pack or equivalent type compactor, a minimum of 3 feet (0.9 m) of compacted backfill shall separate the pipe from the equipment.

Table 5: Temporary Cover Requirements for Light Construction Traffic

Type of Vehicle	Vehicular Load at Surface psi (kPa) ASTM D2321	Temporary Minimum Cover in (mm) for:	
		4"-48" (100-1200) Diameter Pipe	54"-60" (1350-1500) Diameter Pipe
Semi-tractor ¹	75 (517)	9 (230)	12 (300)
Loaded pick-up truck ²	50 (345)	6 (150)	9 (230)
Skid steer loader ³	25 (172)	3 (80)	6 (15)

1. Based on typical 3-axel day-trip tractor without trailer.

2. Chevy® 3500 series, fully loaded.

3. Bobcat® T180 model skid steer loader.

Table 6: Maximum Cover for ADS N-12, N-12 ST & N-12 WT Pipe (per AASHTO) ft (m)

Diameter in (mm)	Class 1		Class 2			Class 3	
	Compacted	Dumped	95%	90%	85%	95%	90%
4" (100)	37 (11.3)	18 (5.5)	25 (7.6)	18 (5.5)	12 (3.7)	18 (5.5)	13 (4.0)
6" (150)	44 (13.4)	20 (6.1)	29 (8.8)	20 (6.1)	14 (4.3)	21 (6.4)	15 (4.6)
8" (200)	32 (9.8)	15 (4.6)	22 (6.7)	15 (4.6)	10 (3.0)	16 (4.9)	11 (3.4)
10" (250)	38 (11.6)	18 (5.5)	26 (7.9)	18 (5.5)	12 (3.7)	18 (5.5)	13 (4.0)
12" (300)	35 (10.7)	17 (5.2)	24 (7.3)	17 (5.2)	8 (2.4)	17 (5.2)	11 (3.4)
15" (375)	38 (11.6)	17 (5.2)	25 (7.6)	17 (5.2)	8 (2.4)	18 (5.5)	11 (3.4)
18" (450)	36 (11.0)	17 (5.2)	24 (7.3)	17 (5.2)	8 (2.4)	17 (5.2)	11 (3.4)
24" (600)	28 (8.5)	13 (4.0)	20 (6.1)	13 (4.0)	7 (2.1)	14 (4.3)	10 (3.0)
30" (750)	28 (8.5)	13 (4.0)	20 (6.1)	13 (4.0)	7 (2.1)	14 (4.3)	9 (2.7)
36" (900)	26 (7.9)	12 (3.7)	18 (5.5)	12 (3.7)	7 (2.1)	13 (4.0)	9 (2.7)
42" (1050)	23 (7.0)	11 (3.4)	16 (4.9)	11 (3.4)	7 (2.1)	11 (3.4)	7 (2.1)
48" (1200)	25 (7.6)	11 (3.4)	17 (5.2)	11 (3.4)	7 (2.1)	12 (3.7)	7 (2.1)
60" (1500)	25 (7.6)	11 (3.4)	17 (5.2)	11 (3.4)	6 (1.8)	12 (3.7)	7 (2.1)

Maximum Cover

The maximum burial depth is highly influenced by the type of backfill installed around the pipe. Maximum cover limits for dual wall HDPE pipe made to the requirements of AASHTO M252, M294 and ASTM F2306 are shown in Table 6 for a variety of backfill conditions. Maximum cover limits for HP pipe made to the requirements of ASTM F2881 and AASHTO M330 are shown in Table 7. Greater cover heights may be possible but should be reviewed by the Engineering Department.

Notes:

- 1) Results based on calculations shown in the Structures section of the Drainage Handbook (N20.2). Calculations assume no hydrostatic pressure and a density of 120 pcf (1926 kg/m³) for overburden material.
- 2) Installation assumed to be in accordance with ASTM D2321 and the installation section of the Drainage Handbook.
- 3) For installations using lower quality backfill materials or lower compaction efforts, pipe deflection may exceed the 5% design limit; however controlled deflection may not be a structurally limiting factor for the pipe. For installations where deflection is critical, pipe placement techniques or periodic deflection measurements may be required to ensure satisfactory pipe installation.
- 4) Backfill materials and compaction levels not shown in the table may also be acceptable. Contact ADS for further detail.
- 5) Material must be adequately "knifed" into haunch and in between corrugations. Compaction and backfill material is assumed uniform throughout entire backfill zone.
- 6) Compaction levels shown are for standard Proctor density.
- 7) For projects where cover exceeds the maximum values listed above, contact ADS for specific design considerations.
- 8) Calculations assume no hydrostatic pressure. Hydrostatic pressure will result in a reduction in allowable fill height. Reduction in allowable fill height must be assessed by the design engineer for the specific field conditions.
- 9) Fill height for dumped Class 1 material incorporate an additional degree of conservatism that is difficult to assess due to the large degree of variation in the consolidation of this material as it is dumped. There is limited analytical data on its performance. For this reason, values as shown are estimated to be conservatively equivalent to Class 2, 90% SPD.

Vertical Installations

- Corrugated plastic pipe is sometimes installed vertically for use as catch basins or manholes, meter pits, and similar applications.
- Backfill should extend a minimum of 12" (300 mm) completely around the vertical structure.
- Backfill material recommendations are identical to those for a horizontal installation; compaction levels and maximum lift requirements must be strictly followed (refer to Table 4 for material selection).
- Height of the vertical structure must not exceed 8' (2.4 m), unless the Engineering Department reviews the design.
- If traffic will be driving over a vertical structure, a concrete collar similar to that shown in Figure 6 shall be used to transfer the load into the ground.
- Cast iron frames holding grates or lids must be seated on a concrete collar or similar structure so that the weight of the frame and grate or lid is transferred into the ground, *not* to the vertical pipe.
- There may also be other product performance limits depending on the application. Contact Engineering for further information.

Table 7: Maximum Cover for ADS HP Storm Pipe with Uniform Backfill ft (m)

Diameter in (mm)	Class 1	Class 2			Class 3		Class 4
	Compacted	95%	90%	85% ³	95%	90% ³	95% ³
12" (300)	41 (12.5)	28 (8.5)	21 (6.4)	16 (4.9)	20 (6.1)	16 (4.9)	16 (4.9)
15" (375)	42 (12.8)	29 (8.8)	21 (6.4)	16 (4.9)	21 (6.4)	16 (4.9)	16 (4.9)
18" (450)	44 (13.4)	30 (9.1)	21 (6.4)	16 (4.9)	22 (6.7)	17 (5.2)	16 (4.9)
24" (600)	37 (11.3)	26 (7.9)	18 (5.5)	14 (4.3)	19 (5.8)	14 (4.3)	14 (4.3)
30" (750)	39 (11.9)	27 (8.2)	19 (5.8)	14 (4.3)	19 (5.8)	15 (4.6)	14 (4.3)
36" (900)	28 (8.5)	20 (6.1)	14 (4.3)	10 (3.0)	14 (4.3)	11 (3.4)	10 (3.0)
42" (1050)	30 (9.1)	21 (6.4)	14 (4.3)	10 (3.0)	15 (4.6)	11 (3.4)	10 (3.0)
48" (1200)	29 (8.8)	20 (6.1)	14 (4.3)	9 (2.7)	14 (4.3)	10 (3.0)	10 (3.0)
60" (1500)	29 (8.8)	20 (6.1)	14 (4.3)	9 (2.7)	14 (4.3)	10 (3.0)	9 (2.7)

Notes:

- 1) Results based on calculations shown in the Structures section of the Drainage Handbook (v20.7). Calculations assume no hydrostatic pressure and a density of 120 pcf (1926 kg/m³) for overburden material.
- 2) Installation assumed to be in accordance with ASTM D2321 and the installation section of the Drainage Handbook.
- 3) For installations using lower quality backfill materials or lower compaction efforts, pipe deflection may exceed the 5% design limit; however controlled deflection may not be a structurally limiting factor for the pipe. For installation where deflection is critical, pipe placement techniques or periodic deflection measurements may be required to ensure satisfactory pipe installation.
- 4) Backfill materials and compaction levels not shown in the table may also be acceptable. Contact ADS for further detail.
- 5) Material must be adequately "knifed" into haunch and in between corrugations. Compaction and backfill material is assumed uniform throughout entire backfill zone.
- 6) Compaction levels shown are for standard Proctor density.
- 7) For projects where cover exceeds the maximum values listed above, contact ADS for specific design considerations.
- 9) See ADS Standard Detail STD-101D for additional details.

Figure 6: Vertical Riser

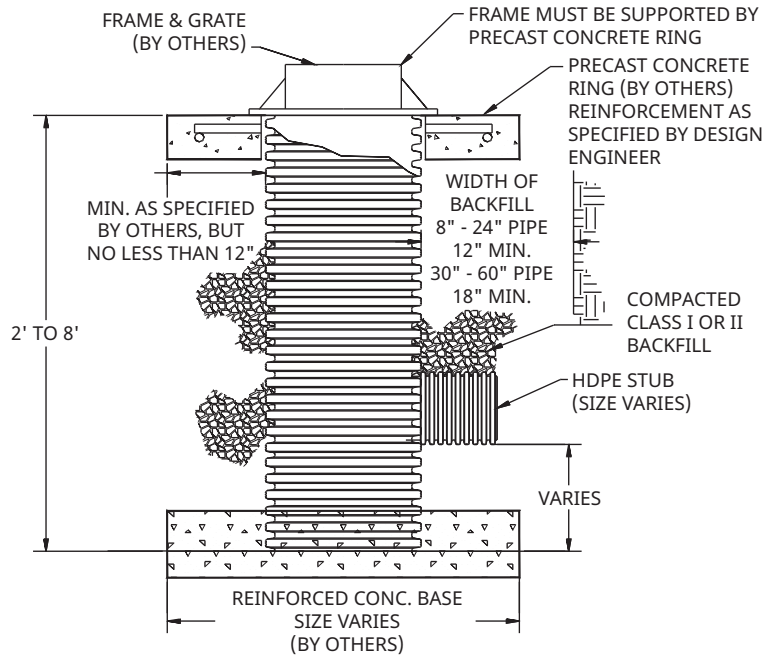

Flotation

Table 8 shows minimum cover heights for various plastic pipe sizes to prevent flotation.

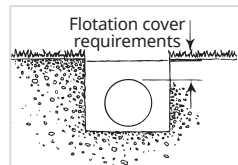

Table 8: Required Minimum Cover* to Prevent Flotation

Pipe Type	Nominal Diameter in (mm)	Minimum Cover in (mm)
Dual Wall HDPE & HP	4" (100)	3" (77)
	6" (150)	4" (102)
	8" (200)	5" (127)
	10" (250)	7" (178)
	12" (300)	9" (228)
	15" (375)	11" (280)
	18" (450)	13" (330)
	24" (600)	17" (432)
	30" (750)	22" (559)
	36" (900)	25" (635)
Single Wall HDPE	42" (1050)	29" (737)
	48" (1200)	33" (838)
	60" (1500)	40" (1016)
	3" (75)	2" (50)
	4" (100)	3" (77)
	6" (150)	4" (102)
	8" (200)	6" (152)
	10" (250)	7" (178)
12" (300)	9" (228)	
15" (375)	11" (280)	
18" (450)	13" (330)	
24" (600)	17" (432)	

*Based on the pipe being completely empty, water table at the ground surface, soil density of 130 pcf (2083 kg/m³), and a soil friction angle appropriate for most sand/gravel mixtures. The average of the inside and outside diameters was used to determine soil and water displacement.

Bending Radius

A curved pipe alignment is sometimes desired in pipe systems so that they can be installed around buildings or utilities without the use of fittings. Plastic pipe can be angled slightly at the joints to create this curvature. Coupling bands allow approximately 3° of angular misalignment at each joint, while each bell-and-spigot joint can accommodate 1-1.5° and remain at its specified joint quality. Additional information can be obtained through your Sales Representative or the Engineering Department.

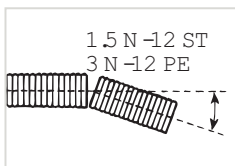

Soil Tight Repair Methods

Option 1: Split Band Coupler

For repairs of 4" - 30" (100-750 mm) pipe with a damaged area less than 10% of the diameter of pipe in a non-trafficked area, use a split band coupler as described in the following steps:

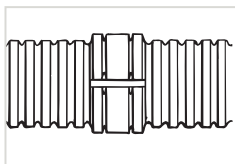

- Center split band coupler around damaged section of pipe.
- Wrap the coupler around the pipe and tighten nylon straps.
- Carefully replace and compact bedding and backfill to provide proper support for pipe and coupler.

Option 2: Concrete Collar

For repairs of 4" - 60" (100-1500 mm) pipe with a damaged area less than 25% the diameter of pipe, use a concrete collar as described in the following steps:

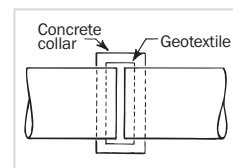

- Excavate area beneath damaged section of pipe about 6" (0.15 m).
- Wrap the damaged area with a geotextile to completely cover the area to be repaired.
- Strut or brace damaged section as necessary.
- Encase damaged section of pipe with a concrete collar.
- Carefully replace bedding and backfill to provide proper support for pipe.

Option 3: Mastic Banding

Typically with external sealing of 4" - 60" (100-1500 mm) pipe, a mastic material is used to wrap a small section of pipe. The use of the Mar-Mac® Polyseal Pipe Coupler by Mar-Mac Construction Products, Inc., or a comparable equal is recommended. This band is a self-adhering rubberized mastic that wraps around the damaged section or joint. A protective peelable paper is removed from the back of the band to expose a tacky mastic surface. The band is then adhered to the entire circumference of the pipe. Straps on the band tighten for a positive seal.

*Note: Mar-Mac bands shall be installed in accordance with manufacturer's recommendations.

Watertight Repair Methods

Option 1: PVC Slip Coupling

For repairs of 12" - 24" (300-600 mm) pipe, a PVC slip coupling is recommended. The PVC slip coupling is typically used when a damaged section of pipe is cut and removed in an existing line. Couplings provide a bell-bell connection to join the existing pipe to a replacement section of pipe or other end of the existing pipe. Installation of PVC slip coupling should follow recommendations listed on page 20.

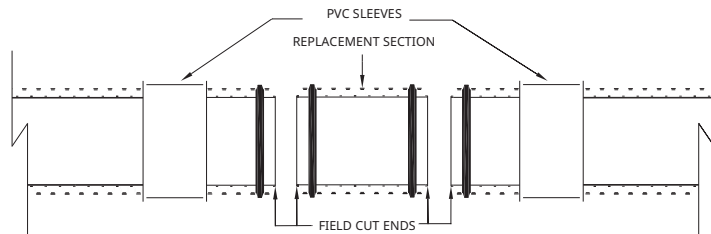

Option 2: Concrete Collar

For 12" - 60" (300-1500 mm) pipe, a concrete collar can provide a water tight repair testable to most hydrostatic test with an appropriate leakage requirement. Installing a concrete collar involves building a form around the area to be repaired and encasing it in concrete. A *Mar Mac*[®] *Polyseal Pipe Coupler* is wrapped around the repair area or joint prior to pouring the collar to keep the concrete from seeping into the pipe. *WaterStop* gaskets are installed outside of the *Polyseal* coupler towards the outside edge of the concrete collar. Typically, approximately

6" (150 mm) is excavated beneath the pipe to allow for proper application of the *Polyseal* coupler and a concrete encasement. If the pipe itself is damaged, the damaged area shall be removed and a replacement pipe section spliced in prior to pouring the collar.

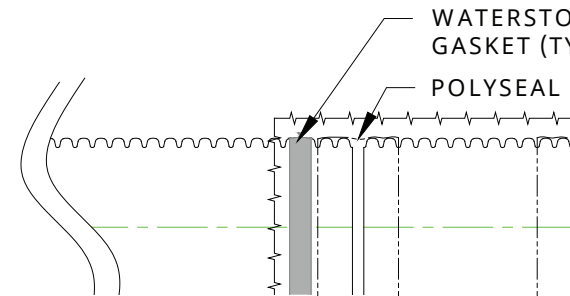

Option 3: Chemical Grouting

For repairs of 4" - 60" (100-1500 mm) pipe with improperly assembled joints, chemical grouting can be considered an optional repair method. Chemical grout creates a waterproof collar around leaking pipes and joints.

Option 4: Internal Sealing

For repairs of 18"-60" (450-1500 mm) pipe with a damaged area on the interior, a repair with internal sealing methods may be used. Internal mechanical sealing is usually comprised of a metal band with a rubber gasket, which expands to conform to the inner wall of the pipe. The feasibility of this repair method depends on the size of the damaged section or joint and available access into the pipe.

Recommendations for In-Field Testing

Normally, a visual inspection is all that is necessary to identify proper line and excessive deflection. If it is determined that additional in-field testing is necessary, the following criteria or methods should be used:



Leakage Testing (where applicable):

After watertight pipe has been installed, sections of pipe may be tested for leakage. When required, pipe shall be tested by water infiltration or by air pressure. The test method must be in accordance with ASTM F2487 for water and F1417 or F3058 for air.

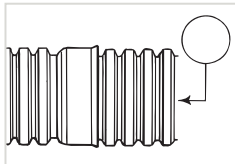

Deflection Testing:

If considered necessary, pipe deflection can be tested within 30 days of installation by pulling a mandrel through the installed pipe. Testing 10% of the overall project should provide a reasonable indication of installation quality. Table 8 lists the inside diameters that result from common testing limits of 5% and 7.5% deflection. Mandrel tests yield only pass/fail results and can provide misleading results. Before excavating, further investigate to make sure the problem is not being caused by foreign material in the pipe, a slightly offset joint, or some other similar situation.

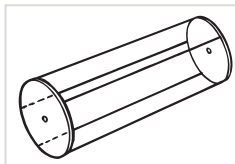

Table 9: HDPE Pipe Base Inside Diameters

Nominal Pipe Diameter in (mm)	Base Inside Diameter in (mm)	Base Inside Diameter with 5% Deflection in (mm)	Base Inside Diameter with 7.5% Deflection in (mm)
4" (100)	3.88 (99)	3.68 (93)	3.59 (91)
6" (150)	5.82 (148)	5.53 (140)	5.38 (137)
8" (200)	7.76 (197)	7.37 (187)	7.17 (182)
10" (250)	9.69 (246)	9.21 (234)	8.97 (228)
12" (300)	11.63 (295)	11.05 (281)	10.76 (273)
15" (375)	14.54 (369)	13.82 (351)	13.45 (342)
18" (450)	17.45 (443)	16.58 (421)	16.14 (410)
24" (600)	23.27 (591)	22.10 (561)	21.52 (547)
30" (750)	29.08 (739)	27.63 (702)	26.90 (683)
36" (900)	34.90 (886)	33.16 (842)	32.28 (820)
42" (1050)	40.72 (1034)	38.68 (982)	37.66 (957)
48" (1200)	46.54 (1182)	44.21 (1123)	43.05 (1093)
60" (1500)	58.17 (1478)	55.26 (1404)	53.81 (1367)

* Value is per AASHTO M252¹ (4"-10" diameter) and AASHTO M294² (12"-60" diameter). If designing to a specific standard, please review allowable minimum diameter.

All sales of our product are subject to a limited warranty and purchasers are solely responsible for installation and use of our products and determining whether a product is suited for any specific needs. Please consult a full copy of the Terms and Conditions of Sale at adspipe.com.

Appendix

All product specific resources are available from the manufacturer's web site: adspipe.com

- Drainage Handbook
- Technical Note 2.01 Minimum and Maximum Burial Depths for HDPE Pipe per AASHTO
- Technical Note 2.02 Minimum and Maximum Burial Depths for ASTM F2648 Pipe
- Technical Note 2.03 Minimum and Maximum Burial Depths for Single Wall HDPE
- Technical Note 2.04 Minimum and Maximum Burial Depths for HP Storm for Storm Drainage
- Technical Note 5.01 Recommended Use for Trench Boxes
- Technical Note 5.02 Flowable Fill Backfill for Thermoplastic Pipe
- Technical Note 5.03 HDPE Pipe Repair Options
- Technical Note 5.04 HDPE and HP Storm Connections to Manholes and Structures
- Technical Note 5.05 Pipe Flotation
- Technical Note 5.06 Culvert Sliplining with HDPE Pipe
- Technical Note 5.07 Post-Installation Testing for HDPE
- Technical Note 5.10 Integral Bell Transition
- Technical Note 5.11 Sliplining Extended Lengths with HDPE Pipe
- Technical Note 5.12 HP Storm Drainage Pipe Repair Options
- Technical Note 5.14 Culvert Sliplining with HP Pipe
- STD-100 series, Trench Installation Details for N-12, HP Storm and SaniTite HP
- STD-200 series, Manhole Connection Details for N-12, HP Storm and SaniTite HP
- STD-600 series, Adapting to Dissimilar Materials



adspipe.com

800-821-6710

ADS "Terms and Conditions of Sale" are available on the ADS website, www.ads-pipe.com.

Advanced Drainage Systems and the Green Stripe are registered trademarks of Advanced Drainage Systems, Inc. Mar-Mac[®] is a registered trademark of Mar-Mac[®] Construction Products, Inc. Chevy[®] is a registered trademark of General Motors Corporation. Bobcat[®] is a registered trademark of Bobcat Company. A-LOK[®] is a registered trademark of A-LOK Products, Inc. Kor-N-Seal[®] is a registered trademark of NPC, Inc.
© 2022 Advanced Drainage Systems, Inc. #10607 06/22 MH