



HTK02

CAR-DE-ASADA™



**GET INSTRUCTIONS ONLINE
INSTRUCTIONS DISPONIBLES
EN LIGNE**

CONSULTA LAS INSTRUCCIONES EN LÍNEA
OBTER INSTRUÇÕES ONLINE
ANWEISUNGEN ONLINE ERHÄLTICH
ИНСТРУКЦИИ ДОСТУПНЫ ОНЛАЙН

megaunboxed.com

1

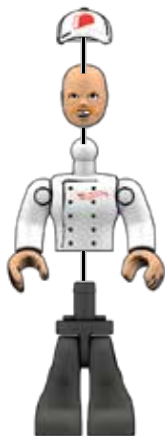

1



2

2



2x

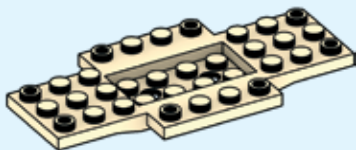

1x

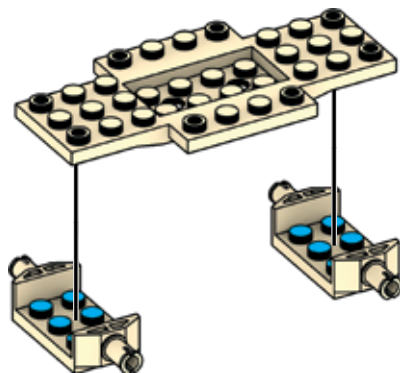

3



1x

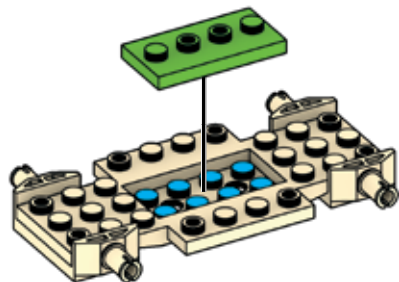

4



1x



2x

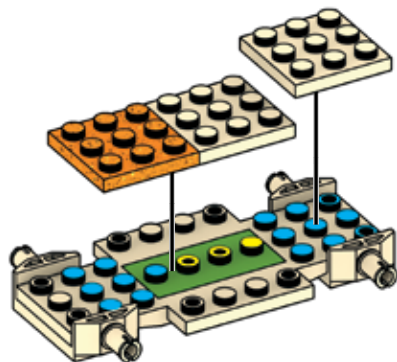

5



1x



2x

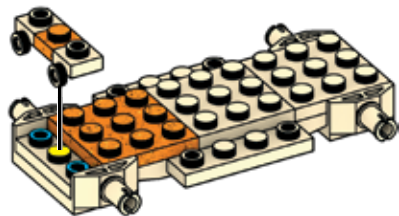

6



1x



1x



2x

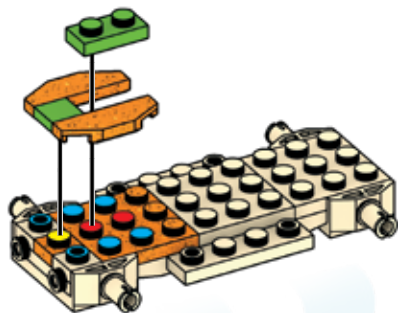

7



1x



1x



1x

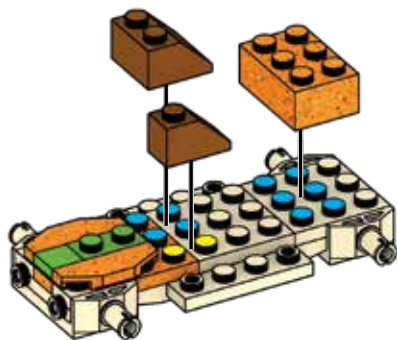

1

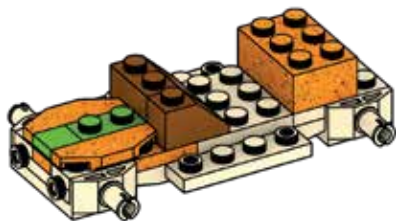

2

8



1x



1x

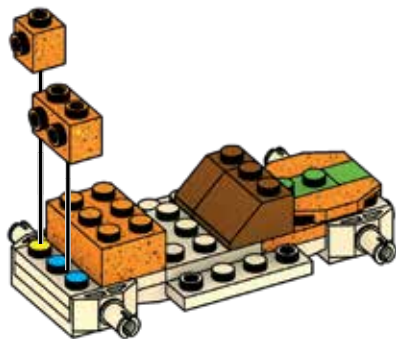

9



1x



1x

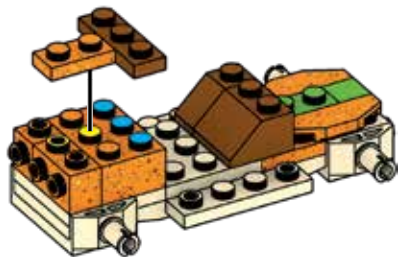

1

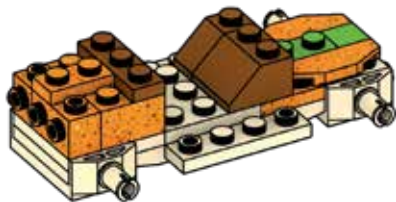

2

10

2x

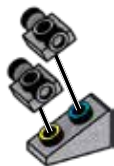

1x

**11**

1x



1x

**12**

1x



1x

**13**

2x



14

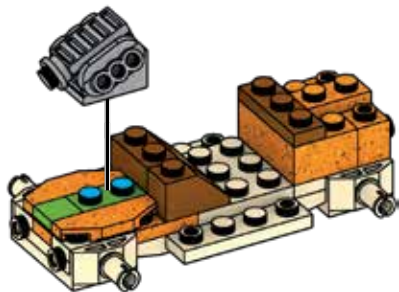

15

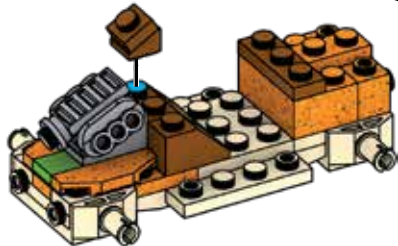

16

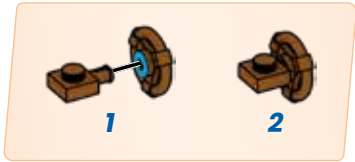
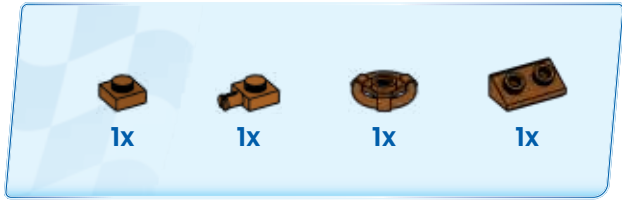

17

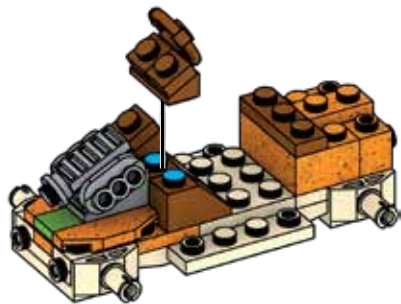

18

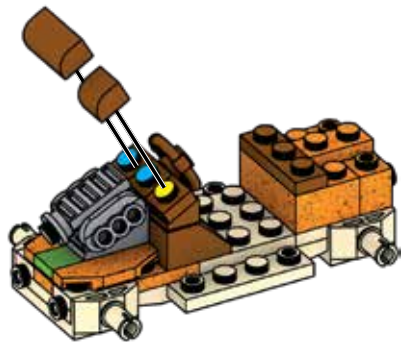

19



1x



2x

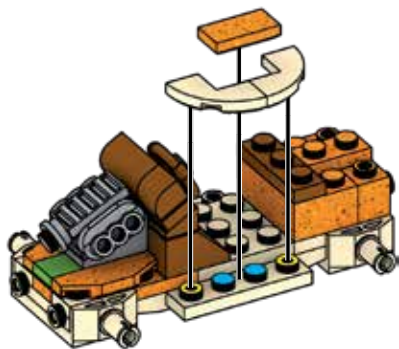

1

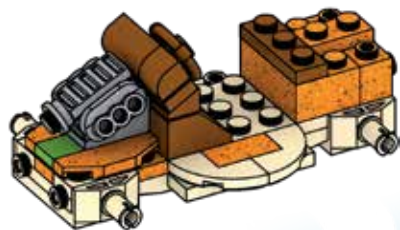

2

20



1x



2x

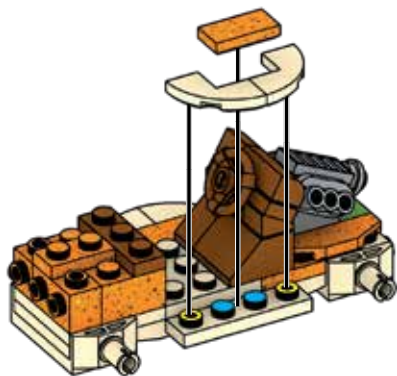

1

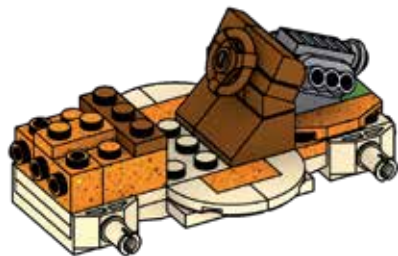

2

21



2x

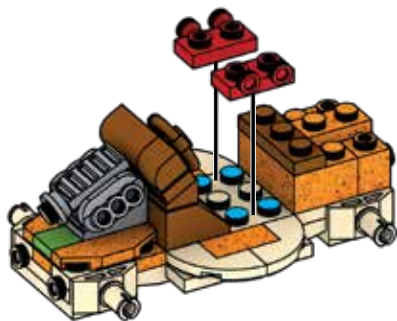

22



2x

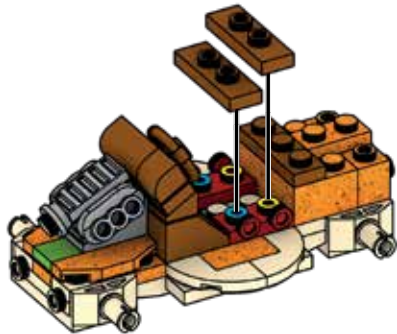

1

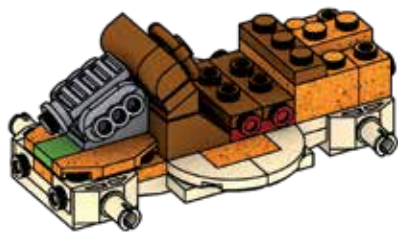

2

23



1x



2x



2x



1x

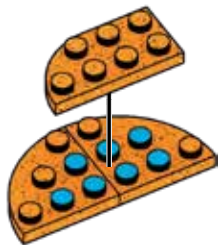

1



2



3

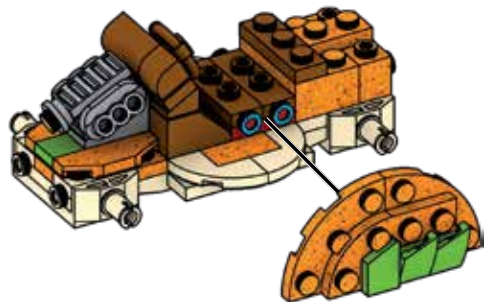

25

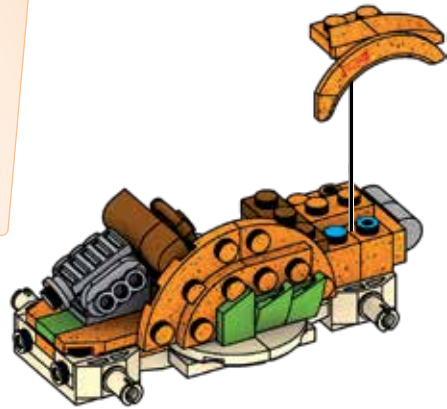
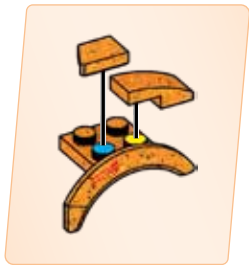
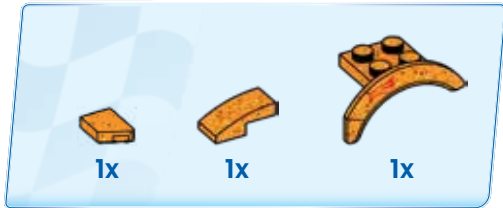

1



2

26



1x



2x



2x



1x

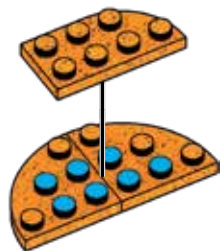

1



2



3

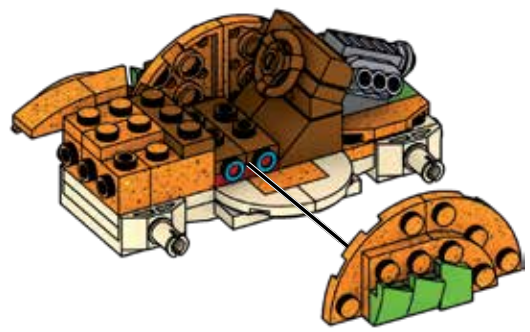

28



1x



1x



1x

29



1x

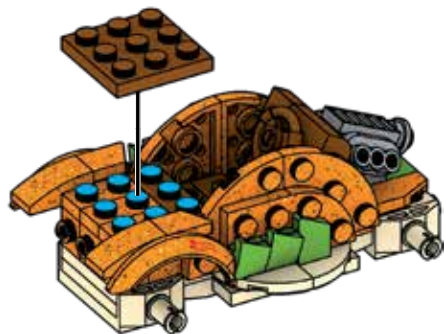
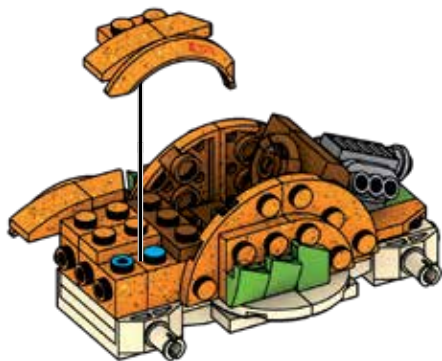

30



2x



1x



1



2



31

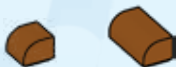

1x

1x

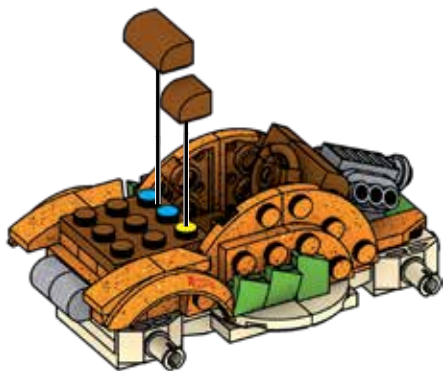

1

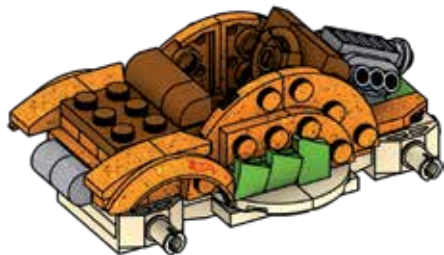

2

32



1x



1x

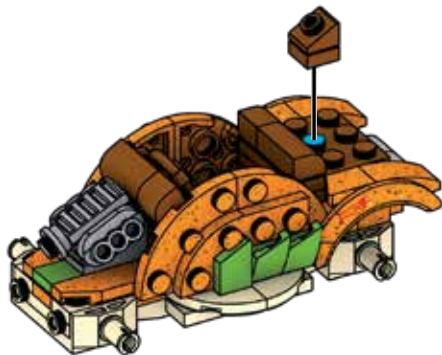

33



1x

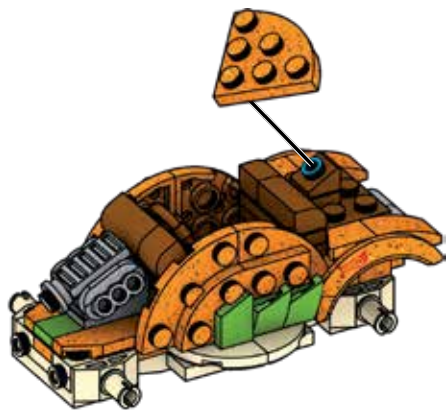

34



2x

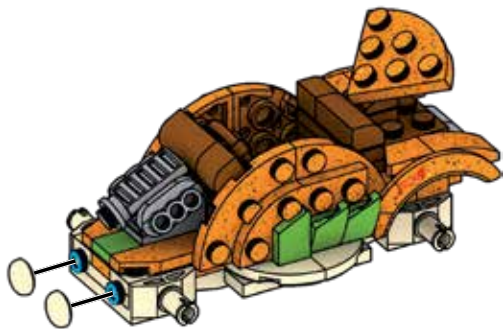

35



2x



2x

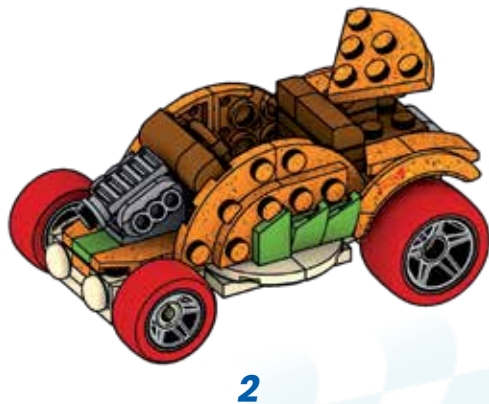
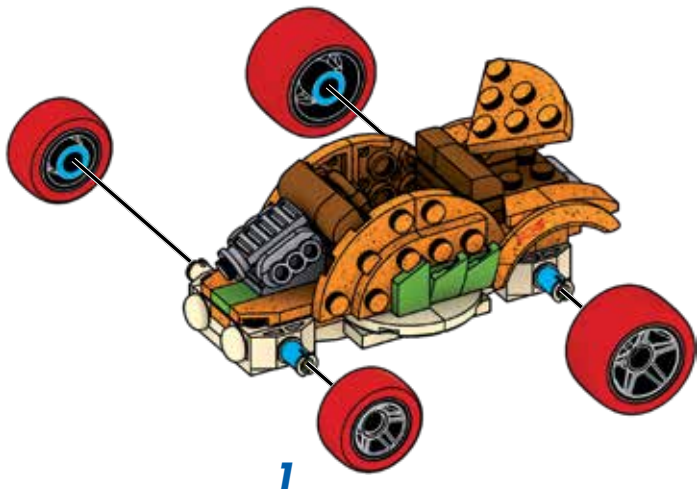

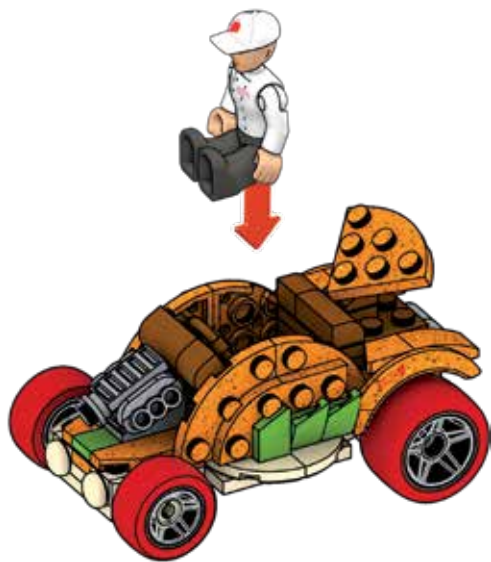

1



2



2x
AM75332WC



1x
AM01113APG



1x
AM07223JS



1x
AM03328AVE



3x
AM03328MY



1x
AM03328APG



2x
AM77574WC



1x
AM79590APG

2x
AM80120APG



1x
AM80546MY



1x
AM74300AVE



1x
AM74300JS



1x
AM74299JS



1x
AM74299AVE



2x
AM72001MY



2x
AM16980APG



2x
AM17787MY

2x
AM81545JS



2x
AM81546JS



1x
AM07629AVE



2x
AM76469APG



1x
AM81383MY



2x
AM22501AVE



1x
AM09198APG



1x
AM09393AVE



1x
AM09393JS

2x
AM79070AMC



2x
AM03017MY



1x
AM18272MY



1x
AM01322MY



1x
AM04429APG



1x
AM17502AVE



2x
AM78486AVE



4x
AM18667WC



2x
AM76450AVE



1x
AM74298AVE



2x
AM74298MY



1x
AM01314MY



1x
AM10273MY



1x
AM03873AVE



2x
AS-HTK02-03



2x
AS-HTK02-04



1x
AS-HTK02-01



1x
AS-HTK02-02



1x
AM01531JS



2x
AM81163WC



1x
AM81163MY



1x
AM81163AVE



1x
AM03324AVE



1x
AM03323AVE



1x
AM03323AVE



5x
AM17056AVE





1



2

⚠ WARNING:
CHOKING HAZARD – Small parts.
Not for children under 3 years.

ATTENTION :
DANGER D'ÉTOUFFEMENT –
PETITS ÉLÉMENTS. NE
CONVIENT PAS AUX ENFANTS
DE MOINS DE 36 MOIS.

ATENÇÃO: NÃO INDICADO / NÃO RECOMENDÁVEL PARA CRIANÇAS MENORES DE 3 (TRÊS) ANOS POR CONTER PARTE(S) PEQUENA(S) QUE PODE(M) SER ENGOLIDA(S) OU ASPIRADA(S) PODENDO PROVOCAR ASFIXIA.

WARNING: Small parts, **ATTENTION :** PETITS ÉLÉMENTS, **ACHTUNG:** Kleine Teile, **AVVERTENZA:** Piccole parti, **WAARSCHUWING:** Kleine onderdelen, **ADVERTENCIA:** PELIGRO DE ATRAGANTAMIENTO. Juguete no recomendado para menores de 3 años, porque contiene piezas pequeñas que podrían provocar asfixia en caso de ser ingeridas o inhaladas por el/la niño/a, **WARNING:** Små delar, **VAROITUS:** Pieniä osia, **ADVASEL:** Små dele, **ADVASEL:** Små deler, **OSTRZEŻENIE:** Małe części, **UPOZORNĚNÍ:** Malé části, **UPOZORNENIE:** Malé části, **FIGYELMEZTETÉS:** Kis alkatrészek, **ПРЕДУПРЕЖДЕНИЕ:** Мелкие детали, **ΠΡΟΕΙΔΟΠΟΙΗΣΗ:** Μικρά κομμάτια, **UYARI:** Küçük parçalar.
تحذير: قطع صغيرة.
のどにつまる危険 小さな部品が含まれています 3歳以下の子供には与えないで下さい。



0-3

警告! 不适合3岁以下儿童使用。内含小零件。



1x
FIG-HTK02-A

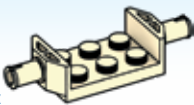

2x
AM80971WC

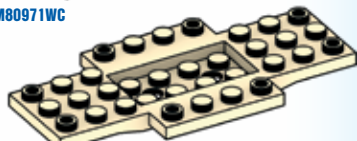

1x
AM80537WC

Missing pieces?
Pièces manquantes?

¿Partes faltantes? • Perdeu peças?
Fehlen Teile? • Не хватает деталей?



support.megabrand.com

Mattel Europa B.V. Gondel 1, 1186 MJ Amstelveen, Nederland. Mattel U.K. Limited, The Porter Building, 1Brunel Way, Slough SL1 1FQ, UK. Mattel France, Parc de la Cerisaie, 1/3/5 allée des Fleurs, 94260 Fresnes Cedex. N° Cristal 0969 36 99 99 (Numéro non surtaxé) ou www.lesjouetsmattel.fr Mattel Belgium N.V. De Kleetlaan 4, 1831 Machelen (Diegem) Belgium. Deutschland : Mattel GmbH, Solmsstraße 83, D-60486 Frankfurt am Main. Schweiz: Mattel AG, Kirchstrasse 24, CH-3097 Liebfeld, Österreich: Mattel Ges.m.b.H., Campus 21, Liebermannstraße A01 404, A- 2345 Brunn/Gebirge, Mattel Italy Srl, Via Turati 4, 20121 Milano, Italy. Servizio assistenza clienti: CustomerServiceItalia@mattel.com - Numero verde 800 11 37 11. Mattel España, S.A. Anibaú 200 pl. 9, 08036 Barcelona, c.servicio.spain@mattel.com Tel.: +34 933 06 79 00 <http://www.service.mattel.com/es>. Hong Kong: Kids Kingdom Limited, Room 1908-9, Galle Place, 56 Dundas Street, Mongkok, Kowloon, Hong Kong. Customer Care line: (852)2/82-0766. Taiwan: Chickabiddy Company Limited, 5/F, No. 186, Section 4, Nanjing East Road, Taipei 10595, Taiwan. Customer Care line: (02)2578-1188. Mainland China: Mattel Barbie (Shanghai) Trading Co., Ltd. Units 4701-4711, 47F, 2 Grand Gateway, 3 Hong Qiao Road, Shanghai, 200030, P.R.C. Customer Care line: 400-819-8658. Diimport & Diedarkan Oleh: Mattel Continental Asia Sdn Bhd. Level 19, Tower 3, Avenue 12, No. 8 Jalan Kerinchi, Bangsar South, 59200 Kuala Lumpur, Malaysia. Mattel South Africa (PTY) LTD, Office 102 B, 30 Melrose Boulevard, Johannesburg 2196. Dystrybutor: Mattel Poland Sp. z o.o., Budynek Skyliner 31 p., ul. Prosta 67, 00-838 Warszawa, Polska. Mattel Australia Pty. Ltd., 658 Church St., Richmond, Victoria, 3121. Consumer Advisory Service - 1300 135 312. Mattel AEBE, Εθνάρχου Μακαρίου 1, Κτήριο Κ-2, ΤΚ 17561, Πλατεία Φόληρου, Mattel Oyuncakçılık Tic. Ltd. Şti. İçerenköy Mah., Umut Sokak No: 10 - 12, Quick Tower kat:2 İcari no:15 Ataşehir 34752, İstanbul, Türkiye. Tel: 0216 570 75 00. Импортер/Уполномоченная организация: ООО "МАТТЕЛ" Российская Федерация, 105120 Москва, 2-й Сыроматинский переулок 1; +7 495 287 79 39. Mattel Czech Republic s.r.o., The Forum, Václavské nám. 19, 11000 Praha 1, Mattel, 333 Continental Boulevard, El Segundo, CA 90245, USA. Consumer Services: 1-800-465-MEGA (6342). Mattel Canada Inc., Mississauga, Ontario L5R 3W2. Consumer Services: You may call us free at/ Composez sans frais le 1-800-524-8697. Importado e distribuído por Mattel de México, S.A. de C.V., Miguel de Cervantes Saavedra No. 193, Pisos 10 y 11, Col. Granada, Alcaldía Miguel Hidalgo, C.P. 11520, México, Ciudad de México, R.F.C. MME-920701-NB3. Tels: 59-05-51-00 Ext. 5206 6 01- 800-463-59-89. Mattel Chile S.A., Pte. Risco 5561, Of. 203-204 PS2, Las Condes, Santiago. Servicio al consumidor Venezuela: Tel.: 0-800-100-9123. Mattel Argentina S.A., Av. Libertador 1000, Piso 11 – Oficinas 109 y 111, Vicente López - Prov. Buenos Aires. Tel.: 0800-666-3373. Mattel Colombia, S.A., Calle 123# 07 P5, Bogotá. Mattel Perú, S.A., Av. Juan de Arona N° 151, Centro Empresarial Juan de Arona, Torre C, Piso 7, Oficina 704, San Isidro, Lima 27, Perú. RUC: 20425853865. Reg. Importador: 02350-12-JUE-DIGESA. Tel.: 0800-547444. E-mail Latinoamérica: servicio.clientes@mattel.com. Mattel do Brasil Ltda. - CNPJ: 54.558.002/0001-20 - Rua Verbo Divino, 1488 - 2º. Andar - 04719-904 - Chácara Santo Antônio - São Paulo - SP - Brasil. Serviço de Atendimento ao Consumidor: Contato: <https://faleconosco.mattel.com.br/Contato>. E-mail: sac.matteldobrazil@mattel.com.

BUILD YOUR WAY CONSTRUIS TON UNIVERS



HTK01



HTK02



HTJ98



HTJ99

Crea tu camino | Constrói à tua maneira
Bauen, wie es dir gefällt! | Построй мир гонок

Set(s) sold separately and subject to availability. / Ensemble(s) vendu(s) séparément. Certains produits peuvent ne pas être commercialisés.
Se vende(n) por separado y está(n) sujeto(s) a disponibilidad. / Conjunto(s) vendido(s) em separado e sujeito(s) à disponibilidade. / Set in vendita separatamente, secondo disponibilità.
/ Das/Die Set(s) sind separat erhältlich. / Zestaw(y) sprzedawany(e) oddzielnie w zależności od dostępności. / Set(s) apart verkrijgbaar en afhankelijk van beschikbaarheid. / Набор(-ы) продаются отдельно, при наличии. / Sæt sælges separat og så længe lager haves. / Seten säljs separat så länge lagret räcker. / Settet/settene selges separat så langt lageret rekker. / Pakkaus/pakkaukset myydään erikseen, saatavuus voi vaihdella. / Το(α) σετ πωλούνται ξεχωριστά και ανάλογα με τη διαθεσιμότητα. / Setler ayrı olarak satılır ve stoklarla sınırlıdır. / Set (sety) se prodává (prodávají) samostatně dle aktuální nabídky. / Súprava/-y sa predáva(jú) samostatne a podľa dostupnosti. / A készlet(ek) külön kapható(k), az elérhetőség változhat. / セット商品は別売りになります。在庫状況は別途ご確認お願いします。 / تباع المجموعة أو المجموعات على حدة وتخضع لتوافرها. / 每套单独发售，按供货情况决定。



1186 MJ, 1, NL

HOT WHEELS®, MATTEL and associated trademarks and trade dress are owned by, and used under license from Mattel. ©2023 Mattel.

P D714,887, D781,964, D797,203, D841,101

MEGAUNBOXED.com

Mattel Canada Inc. Mississauga, Ontario L5R 3W2.

MADE IN CHINA. FABRIQUÉ EN CHINE. FABRICADO NA CHINA.
HECHO EN CHINA. ИЗГОТОВЛЕНО В КИТАЕ. ÇIN'DE ÜRETİLMİŞTİR.

صنع في الصين

©2023 MEGA Brands &™ MEGA Brands.
Printed in China / Imprimé en Chine

AD-HTK02-01



Inspirer les futures générations par le jeu.