

# Confocal Fiber Displacement Sensor ZW-8000/7000/5000 Series

## Reliable measurements for any material and surface types



- Measuring shiny objects with an inclination of  $\pm 25^\circ$
- $\pm 0.3 \mu\text{m}$  or less linearity for various materials
- Sampling rate as fast as  $20 \mu\text{s}$
- Small spot diameter of  $4 \mu\text{m}$  or less

Note: Angle characteristic, linearity, sampling period and spot diameter given in the cover differ among models. Please ask OMRON sales representative for details.



## System Configuration

### EtherCAT connections

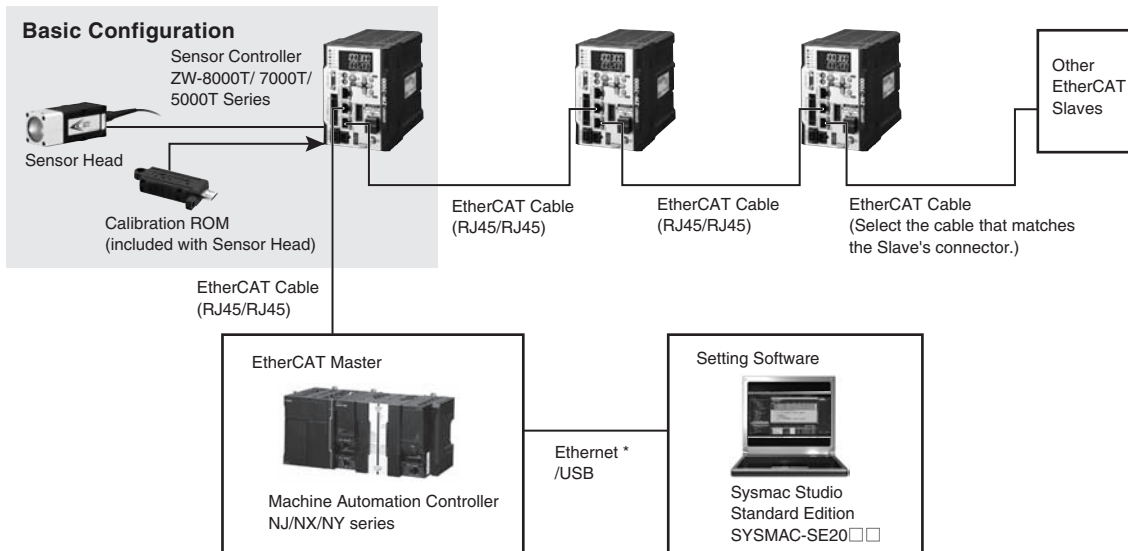

### Analog, EtherNet/IP, Ethernet, RS-232C and Parallel connections

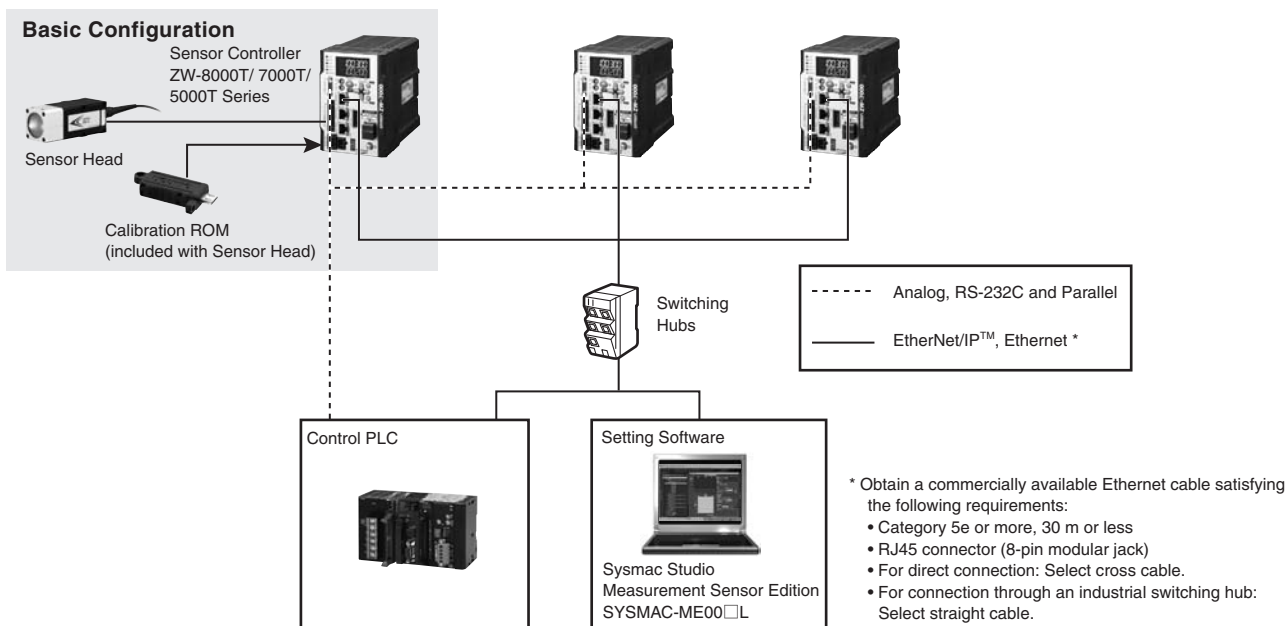

# ZW-8000/7000/5000 Series

## Order Information

### ZW-8000

#### ●Sensor Head

#### Square-shaped straight type

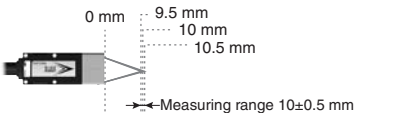
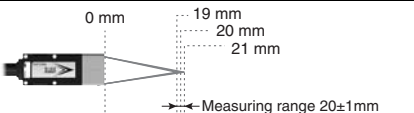
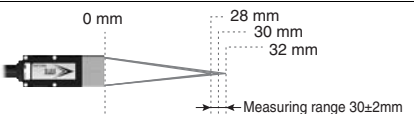
Appearance	Measuring range	Spot diameter	Static resolution *	Cable length	Model
	 0 mm, 9.5 mm, 10 mm, 10.5 mm ← Measuring range 10±0.5 mm	4 μm dia.	0.25 μm	2 m	ZW-S8010 2M
				0.3 m	ZW-S8010 0.3M
	 0 mm, 19 mm, 20 mm, 21 mm ← Measuring range 20±1mm	7 μm dia.	0.25 μm	2 m	ZW-S8020 2M
				0.3 m	ZW-S8020 0.3M
	 0 mm, 28 mm, 30 mm, 32 mm ← Measuring range 30±2mm	10 μm dia.	0.25 μm	2 m	ZW-S8030 2M
				0.3 m	ZW-S8030 0.3M

\* Values when the Sensor Controller ZW-8000T is used.

#### Pen-shaped straight type

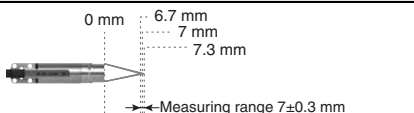
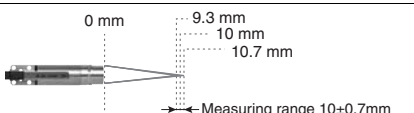
Appearance	Measuring range	Spot diameter	Static resolution *	Cable length	Model
	 0 mm, 6.7 mm, 7 mm, 7.3 mm ← Measuring range 7±0.3 mm	7 μm dia.	0.25 μm	2 m	ZW-SP8007 2M
				0.3 m	ZW-SP8007 0.3M
	 0 mm, 9.3 mm, 10 mm, 10.7 mm ← Measuring range 10±0.7mm	10 μm dia.	0.25 μm	2 m	ZW-SP8010 2M
				0.3 m	ZW-SP8010 0.3M

\* Values when the Sensor Controller ZW-8000T is used.

#### Pen-shaped right angle type

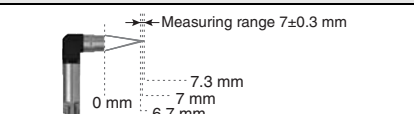
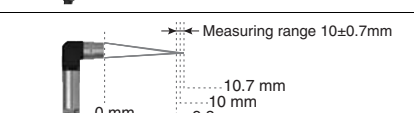

Appearance	Measuring range	Spot diameter	Static resolution *	Cable length	Model
	 ← Measuring range 7±0.3 mm 0 mm, 7.3 mm, 7 mm, 6.7 mm	8 μm dia.	0.25 μm	2 m	ZW-SPR8007 2M
				0.3 m	ZW-SPR8007 0.3M
	 ← Measuring range 10±0.7mm 0 mm, 10.7 mm, 10 mm, 9.3 mm	11 μm dia.	0.25 μm	2 m	ZW-SPR8010 2M
				0.3 m	ZW-SPR8010 0.3M

\* Values when the Sensor Controller ZW-8000T is used.

#### ●Sensor Controller with EtherCAT

Appearance	Power supply	Output type	Model
	24 VDC	NPN/PNP	ZW-8000T

#### ●Cable

Appearance	Item	Cable length	Model
	Extension Fiber Cable (from Sensor Head to Sensor Controller), (Fiber Adapter ZW-XFCS is included)	2 m	ZW-XF8002R
		5 m	ZW-XF8005R
		10 m	ZW-XF8010R
		20 m	ZW-XF8020R
		30 m	ZW-XF8030R
	Fiber Adapter (used between Sensor Head pre-wired cable and Extension Fiber Cable)	—	ZW-XFCS

**Note:** Extension Fiber Cable ZW-XF80□□R can be used with the firmware version 3.000 or later. If you have an old version Sensor Controller, register as a Sysmac member and download the latest firmware and tools to update your Sensor Controller. Refer to the Sysmac member registration sheet that is enclosed with the Sensor Controller for details on member registration and firmware download.

**ZW-7000**

● **Sensor Head**

**Square-shaped straight type**

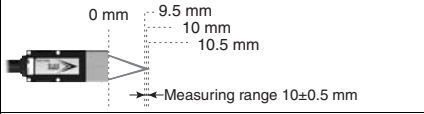
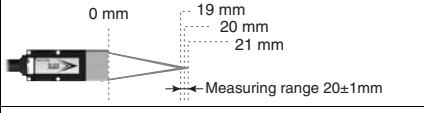
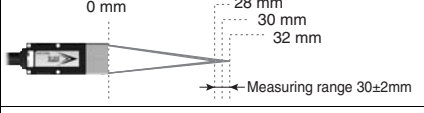
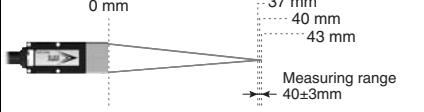
Appearance	Measuring range	Spot diameter	Static resolution *	Cable length	Model
	 0 mm, 9.5 mm, 10 mm, 10.5 mm Measuring range 10±0.5 mm	50 µm dia.	0.25 µm	2 m	ZW-S7010 2M
				0.3 m	ZW-S7010 0.3M
	 0 mm, 19 mm, 20 mm, 21 mm Measuring range 20±1mm	70 µm dia.	0.25 µm	2 m	ZW-S7020 2M
				0.3 m	ZW-S7020 0.3M
	 0 mm, 28 mm, 30 mm, 32 mm Measuring range 30±2mm	100 µm dia.	0.25 µm	2 m	ZW-S7030 2M
				0.3 m	ZW-S7030 0.3M
	 0 mm, 37 mm, 40 mm, 43 mm Measuring range 40±3mm	120 µm dia.	0.25 µm	2m	ZW-S7040 2M
				0.3m	ZW-S7040 0.3M

\* Values when the Sensor Controller ZW-7000T is used.

**Pen-shaped straight type**

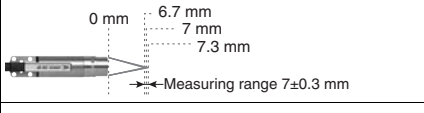
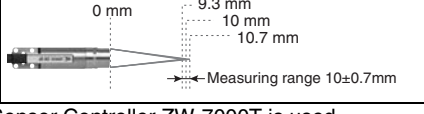
Appearance	Measuring range	Spot diameter	Static resolution *	Cable length	Model
	 0 mm, 6.7 mm, 7 mm, 7.3 mm Measuring range 7±0.3 mm	130 µm dia.	0.25 µm	2 m	ZW-SP7007 2M
				0.3 m	ZW-SP7007 0.3M
	 0 mm, 9.3 mm, 10 mm, 10.7 mm Measuring range 10±0.7mm	170 µm dia.	0.25 µm	2 m	ZW-SP7010 2M
				0.3 m	ZW-SP7010 0.3M

\* Values when the Sensor Controller ZW-7000T is used.

**Pen-shaped right angle type**

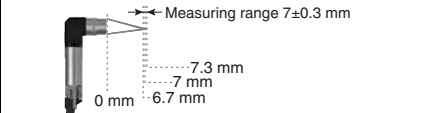
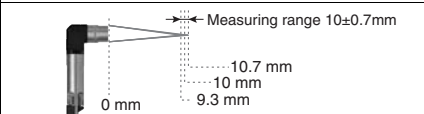

Appearance	Measuring range	Spot diameter	Static resolution *	Cable length	Model
	 Measuring range 7±0.3 mm 0 mm, 7.3 mm, 7 mm, 6.7 mm	150 µm dia.	0.25 µm	2 m	ZW-SPR7007 2M
				0.3 m	ZW-SPR7007 0.3M
	 Measuring range 10±0.7mm 0 mm, 10.7 mm, 10 mm, 9.3 mm	190 µm dia.	0.25 µm	2 m	ZW-SPR7010 2M
				0.3 m	ZW-SPR7010 0.3M

\* Values when the Sensor Controller ZW-7000T is used.

● **Sensor Controller with EtherCAT**

Appearance	Power supply	Output type	Model
	24 VDC	NPN/PNP	ZW-7000T

● **Cable**

Appearance	Item	Cable length	Model
	Extension Fiber Cable (from Sensor Head to Sensor Controller), (Fiber Adapter ZW-XFCM is included)	2 m	ZW-XF7002R
		5 m	ZW-XF7005R
		10 m	ZW-XF7010R
		20 m	ZW-XF7020R
	Fiber Adapter (used between Sensor Head pre-wired cable and Extension Fiber Cable)	30 m	ZW-XF7030R
		—	ZW-XFCM

**Note:** Cables of 10, 20, and 30 m can be used with the firmware version 2.100 or later. If you have an old version Sensor Controller, register as a Sysmac member and download the latest firmware and tools to update your Sensor Controller. Refer to the Sysmac member registration sheet that is enclosed with the Sensor Controller for details on member registration and firmware download.

# ZW-8000/7000/5000 Series

## ZW-5000

### ●Sensor Head

#### Square-shaped straight type

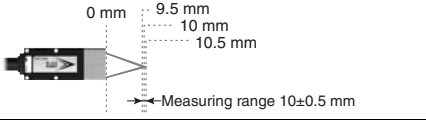
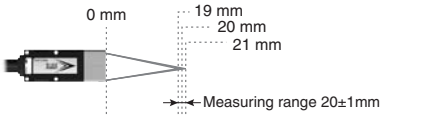
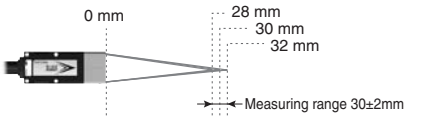
Appearance	Measuring range	Spot diameter	Static resolution *	Cable length	Model
	 0 mm, 9.5 mm, 10 mm, 10.5 mm Measuring range 10±0.5 mm	9 μm dia.	0.25 μm	2 m	ZW-S5010 2M
				0.3 m	ZW-S5010 0.3M
	 0 mm, 19 mm, 20 mm, 21 mm Measuring range 20±1mm	13 μm dia.	0.25 μm	2 m	ZW-S5020 2M
				0.3 m	ZW-S5020 0.3M
	 0 mm, 28 mm, 30 mm, 32 mm Measuring range 30±2mm	18 μm dia.	0.25 μm	2 m	ZW-S5030 2M
				0.3 m	ZW-S5030 0.3M

\* Values when the Sensor Controller ZW-5000T is used.

#### Pen-shaped straight type

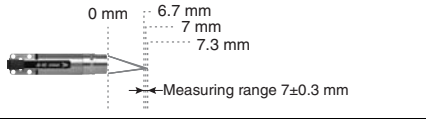
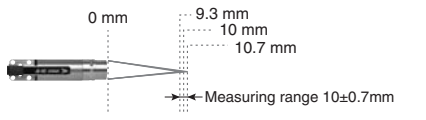
Appearance	Measuring range	Spot diameter	Static resolution *	Cable length	Model
	 0 mm, 6.7 mm, 7 mm, 7.3 mm Measuring range 7±0.3 mm	13 μm dia.	0.25 μm	2 m	ZW-SP5007 2M
				0.3 m	ZW-SP5007 0.3M
	 0 mm, 9.3 mm, 10 mm, 10.7 mm Measuring range 10±0.7mm	18 μm dia.	0.25 μm	2 m	ZW-SP5010 2M
				0.3 m	ZW-SP5010 0.3M

\* Values when the Sensor Controller ZW-5000T is used.

#### Pen-shaped right angle type

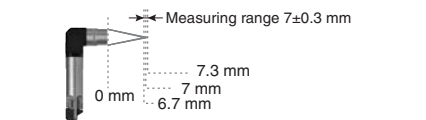
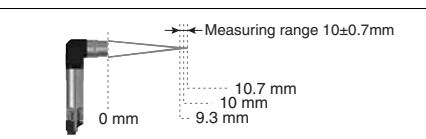

Appearance	Measuring range	Spot diameter	Static resolution *	Cable length	Model
	 Measuring range 7±0.3 mm 0 mm, 7.3 mm, 7 mm, 6.7 mm	15 μm dia.	0.25 μm	2 m	ZW-SPR5007 2M
				0.3 m	ZW-SPR5007 0.3M
	 Measuring range 10±0.7mm 0 mm, 10.7 mm, 10 mm, 9.3 mm	20 μm dia.	0.25 μm	2 m	ZW-SPR5010 2M
				0.3 m	ZW-SPR5010 0.3M

\* Values when the Sensor Controller ZW-5000T is used.

### ●Sensor Controller with EtherCAT



Appearance	Power supply	Output type	Model
	24 VDC	NPN/PNP	ZW-5000T

### ●Cable

Appearance	Item	Cable length	Model
	Extension Fiber Cable (from Sensor Head to Sensor Controller), (Fiber Adapter ZW-XFC2 is included)	2 m	ZW-XF5002R
		5 m	ZW-XF5005R
		10 m	ZW-XF5010R
		20 m	ZW-XF5020R
		30 m	ZW-XF5030R
	Fiber Adapter (used between Sensor Head pre-wired cable and Extension Fiber Cable)	—	ZW-XFC2

**Note:** Extension Fiber Cable ZW-XF50□□R can be used with the firmware version 2.100 or later. If you have an old version Sensor Controller, register as a Sysmac member and download the latest firmware and tools to update your Sensor Controller. Refer to the Sysmac member registration sheet that is enclosed with the Sensor Controller for details on member registration and firmware download.





●Common cables

Appearance	Item	Cable length	Model
	Parallel caable for ZW-8000T/7000T/5000T 32-pole (included with Sensor Controller ZW-8000T/7000T/5000T)	2 m	ZW-XCP2E
	RS-232C Cable for personal computer	2 m	ZW-XRS2
	RS-232C Cable for PLC/programmable terminal	2 m	ZW-XPT2

●Recommended EtherCAT Communications Cables

Use Straight STP (shielded twisted-pair) cable of category 5 or higher with double shielding (braiding and aluminum foil tape) for EtherCAT.

●Cable with Connectors

Item	Appearance	Recommended manufacturer	Cable length(m) *1	Model
Standard type Cable with Connectors on Both Ends (RJ45/RJ45) Wire Gauge and Number of Pairs: AWG26, 4-pair Cable Cable Sheath material: LSZH *2 Cable color: Yellow *3		OMRON	0.3	XS6W-6LSZH8SS30CM-Y
			0.5	XS6W-6LSZH8SS50CM-Y
			1	XS6W-6LSZH8SS100CM-Y
			2	XS6W-6LSZH8SS200CM-Y
			3	XS6W-6LSZH8SS300CM-Y
			5	XS6W-6LSZH8SS500CM-Y
Rugged type Cable with Connectors on Both Ends (RJ45/RJ45) Wire Gauge and Number of Pairs: AWG22, 2-pair Cable		OMRON	0.3	XS5W-T421-AMD-K
			0.5	XS5W-T421-BMD-K
			1	XS5W-T421-CMD-K
			2	XS5W-T421-DMD-K
			5	XS5W-T421-GMD-K
			10	XS5W-T421-JMD-K
Rugged type Cable with Connectors on Both Ends (M12 Straight/RJ45) Wire Gauge and Number of Pairs: AWG22, 2-pair Cable		OMRON	0.3	XS5W-T421-AMC-K
			0.5	XS5W-T421-BMC-K
			1	XS5W-T421-CMC-K
			2	XS5W-T421-DMC-K
			5	XS5W-T421-GMC-K
			10	XS5W-T421-JMC-K
Rugged type Cable with Connectors on Both Ends (M12 Right-angle/RJ45) Wire Gauge and Number of Pairs: AWG22, 2-pair Cable		OMRON	0.3	XS5W-T422-AMC-K
			0.5	XS5W-T422-BMC-K
			1	XS5W-T422-CMC-K
			2	XS5W-T422-DMC-K
			5	XS5W-T422-GMC-K
			10	XS5W-T422-JMC-K

Note: For details, refer to Cat.No.G019.

\*1. Standard type cables length 0.2, 0.3, 0.5, 1, 1.5, 2, 3, 5, 7.5, 10, 15 and 20m are available.

Rugged type cables length 0.3, 0.5, 1, 2, 3, 5, 10 and 15m are available.

\*2. The lineup features Low Smoke Zero Halogen cables for in-cabinet use and PUR cables for out-of-cabinet use.

\*3. Cables colors are available in blue, yellow, or Green

●Cables / Connectors

Wire Gauge and Number of Pairs: AWG24, 4-pair Cable

Item	Appearance	Recommended manufacturer	Model
Cables	—	Hitachi Metals, Ltd.	NETSTAR-C5E SAB 0.5 × 4P *
	—	Kuramo Electric Co.	KETH-SB *
	—	SWCC Showa Cable Systems Co.	FAE-5004 *
RJ45 Connectors	—	Panduit Corporation	MPS588-C *

\* We recommend to use above cable and connector together.

Wire Gauge and Number of Pairs: AWG22, 2-pair Cable



Item	Appearance	Recommended manufacturer	Model
Cables	—	Kuramo Electric Co.	KETH-PSB-OMR *
	—	JMACS Japan Co.,Ltd.	PNET/B *
RJ45 Assembly Connector		OMRON	XS6G-T421-1 *

Note: Connect both ends of cable shielded wires to the connector hoods.

\* We recommend to use above cable and connector together.



# ZW-8000/7000/5000 Series

## ●Industrial switching hubs for Ethernet

Appearance	Number of ports	Failure detection	Current consumption	Model
	3	None	0.22A	W4S1-03B
	5	None	0.22A	W4S1-05B
		Supported		W4S1-05C

**Note:** Industrial switching hubs are cannot be used for EtherCAT.

## ●EtherCAT junction slaves

Appearance	Number of ports	Power supply voltage	Current consumption	Model
	3	20.4 to 28.8 VDC (24 VDC -15 to 20%)	0.08A	GX-JC03
	6		0.17A	GX-JC06

**Note:** 1. Please do not connect EtherCAT junction slave with OMRON position control unit, Model CJ1W-NC□81/□82.  
2. EtherCAT junction slaves cannot be used for EtherNet/IP™ and Ethernet.

## ●Automation Software Sysmac Studio

**Please purchase a DVD and required number of licenses the first time you purchase the Sysmac Studio. DVDs and licenses are available individually.**

**Each model of licenses does not include DVD.**

Item	Specifications	Number of licenses		Media	Model	Standards
		Number of licenses	Media			
Sysmac Studio Standard Edition Ver.1□□ *2	The Sysmac Studio is the software that provides an integrated environment for setting, programming, debugging and maintenance of machine automation controllers including the NJ/NX-series CPU Units, NY-series Industrial PC, EtherCat Slave, and the HMI. Sysmac Studio runs on the following OS. Windows 7 (32-bit/64-bit version)/Windows 8 (32-bit/64-bit version)/Windows 8.1 (32-bit/64-bit version)/Windows 10 (32-bit/64-bit version) This software provides functions of the Measurement Sensor Edition. Refer to your OMRON website for details.	— (Media only)	DVD		SYSMAC-SE200D	—
		1 license*1	—		SYSMAC-SE201L	—
Sysmac Studio Measurement Sensor Edition Ver.1.□□	Sysmac Studio Measurement Sensor Edition is a limited license that provides selected functions required for ZW-series Displacement Sensor settings. Because this product is a license only, you need the Sysmac Standard Edition DVD media to install it.	1 license	—		SYSMAC-ME001L	—
		3 license	—		SYSMAC-ME003L	—

\*1. Multiple licenses are available for the Sysmac Studio (3, 10, 30, or 50 licenses).

\*2. ZW-8000/7000/5000 is supported by Sysmac Studio version 1.22 or higher.

## ●Fiber Cleaner

Item	Recommended manufacturer	Model	Applicable Model			Contacts
			ZW-8000	ZW-7000	ZW-5000	
Fiber Connector Cleaner *1	OMRON	ZW-XCL	Yes	Yes	Yes	OMRON
NEOCLEAN-M	NTT Advanced Technology Corporation	ATC-NE-M1	No	Yes	No	*2
OPTIPOP R1		ATC-RE-01	Yes (Sensor Head only)	No	Yes (Sensor Head only)	

\*1. Place orders in units of boxes (contacting 10 units).

\*2. Contacts

Japan: NTT Advanced Technology Corporation TEL: 0422-47-7888  
China: GUANGZHOU LI CHENG OPTOELECTRONIC CO.,LTD. TEL: 020-8165 0508  
Hong Kong: ComStar Communications Ltd. TEL: +852 2536 9737  
Taiwan: Global Science Instruments Co., Ltd. TEL: +886-2-8913-2737 Ext. 33  
India: Aishwarya Telecom Ltd. TEL: +91 40 2753 1324  
Singapore: Masstron Pte Ltd TEL: (65) 6763 0309  
Malaysia: Masstron Communication Solutions Sdn Bhd TEL: (603) 8061 0309  
Thailand: Masstron (Thailand) Co.,Ltd TEL: (66-2) 319-9375/6  
Vietnam: Masstron Pte Ltd (Singapore) TEL: (65) 6763 0309  
Germany: AMS Technologies AG TEL: +49 (0)89 895 77 0  
France: AMS Technologies S.A.R.L. TEL: +33 (0)1 64 86 46 00  
Italy: AMS Technologies S.r.l. TEL: +39 0331 596 693  
Spain: AMS Technologies S.L. TEL: +34 93 380 84 20  
Netherlands: AMS Technologies AG (Germany) TEL: +49 (0)89 895 77 0  
USA: AFL Telecommunications TEL: +1 (800) 235-3423



## Specifications

### ● Sensor Head

ZW-S8010/S8020/S8030/SP8007/SP8010/SPR8007/SPR8010

Item	Specifications						
	ZW-S8010	ZW-S8020	ZW-S8030	ZW-SP8007	ZW-SP8010	ZW-SPR8007	ZW-SPR8010
Sensor controller	ZW-8000T						
Sensor head type	Square-shaped straight type			Pen-shaped straight type		Pen-shaped right angle type	
Measurement center distance *1	10 mm	20 mm	30 mm	7 mm	10 mm	7 mm	10 mm
Measuring range *2	±0.5 mm	±1mm	±2mm	±0.3 mm	±0.7 mm	±0.3 mm	±0.7 mm
Static resolution *3	0.25 μm						
Linearity *4	±0.3 μm	±0.6 μm	±1.3 μm	±0.3 μm	±0.45 μm	±0.45 μm	±0.7 μm
Spot diameter (Total measurement range) *5	4 μm dia.	7 μm dia.	10 μm dia.	7 μm dia.	10 μm dia.	8 μm dia.	11 μm dia.
Measurement cycle *6	60 μs to 7,500 μs						
Operating ambient illumination	Illumination on object surface max.30000 Lx: (incandescent light)						
Ambient temperature range	Operation: 0 to 50°C, Storage: -15 to +60°C (No freezing and condensation)						
Ambient humidity range	Operation/storage: 35 or 85%RH (No condensation)						
Degree of protection	IP40 (IEC60529)						
Vibration resistance (destructive)	10 to 150 Hz (half amplitude 0.35 mm), 80 mins in each of X/Y/Z directions						
Shock resistance (destructive)	150 m/s <sup>2</sup> , 6 direction, 3 times each (up/down, left/right, forward/backward)						
Temperature characteristic *7	0.6 μm/°C (0.2 μm/°C)	1.1 μm/°C (0.5 μm/°C)	1.8 μm/°C (1.0 μm/°C)	0.8 μm/°C (0.4 mm/°C)	0.8 μm/°C (0.4 mm/°C)	0.8 μm/°C (0.4 mm/°C)	0.8 μm/°C (0.4 mm/°C)
LED Safety	Risk Group 3 (IEC62471)						
Material	Chassis: aluminum die cast Fiber cable sheath: PVC Calibration ROM: PC			Chassis: SUS Fiber cable sheath: PVC Calibration ROM: PC Mounting Plate: Aluminum		Chassis: SUS, aluminum Fiber cable sheath: PVC Calibration ROM: PC Mounting Plate: Aluminum	
Fiber cable length	0.3 m, 2 m (flex-resistant cable)						
Fiber cable minimum bend radius	20 mm						
Insulation resistance (Calibration ROM)	Between case and all terminals: 20 MΩ (by 250 VDC)						
Dielectric strength (Calibration ROM)	Between case and all terminals: 1000 VAC, 50/60 Hz, 1 min						
Weight	Fiber cable length 0.3m Approx. 170g Fiber cable length 2m Approx. 180g			Fiber cable length 0.3m Approx. 27 g Fiber cable length 2m Approx. 37 g		Fiber cable length 0.3m Approx. 31 g Fiber cable length 2m Approx. 41 g	
Accessories	Calibration ROM fixing screw (M2×5mm) × 1, Fiber cable protective cap × 1, Strap × 1, Instruction Manual, Precautions			Installation plate × 1, Unit fixing screws (M2 × 10 mm) × 4, Calibration ROM fixing screw (M2 × 5 mm) × 1, Fiber cable protective cap × 1, Strap × 1, Instruction Manual, Precautions			

\*1. Indicates the distance from the front of the sensor head. The pen-shaped right angle type has a maximum individual difference of ±0.15 mm in the distance from the front of the sensor head.

\*2. The measurement range is higher 100 μs than measurement cycle.

\*3. Capacity value when OMRON standard mirror surface target is measured at the measurement center distance as the average of 16,384 times. The value when the Sensor Controller ZW-8000T is connected.

\*4. Material setting for the OMRON standard mirror surface target: Error from an ideal straight line when measuring on mirror surface.

\*5. Capacity value defined by  $1/e^2$  (13.5%) of the peak optical intensity of the measurement wavelength.

\*6. When an extension fiber cable of 2 m or longer is connected, the setting range of the measurement cycle (exposure time) changes. For details, refer to *Setting Measurement Cycle* in the *ZW-8000/7000/5000 User's Manual (Cat. No. Z362)*.

\*7. Actual value of the change in measurement value at the measurement center distance when fastened with an aluminum jig between the Sensor Head and the target, and with the Sensor Head and the Sensor Controller set in the same temperature environment.

The value in parentheses is the actual value when using an SUS304 jig.

When measuring the thickness, the value is calculated from the difference between the heights of the surface and rear surface, so there is no effect on the temperature change.

# ZW-8000/7000/5000 Series

## ZW-S7010/S7020/S7030/S7040/SP7007/SP7010/SPR7007/SPR7010

Item	Specifications							
	ZW-S7010	ZW-S7020	ZW-S7030	ZW-S7040	ZW-SP7007	ZW-SP7010	ZW-SPR7007	ZW-SPR7010
<b>Sensor controller</b>	ZW-7000T							
<b>Sensor head type</b>	Square-shaped straight type				Pen-shaped straight type		Pen-shaped right angle type	
<b>Measurement center distance *1</b>	10 mm	20 mm	30 mm	40 mm	7 mm	10 mm	7 mm	10 mm
<b>Measuring range *2</b>	±0.5 mm	±1 mm	±2 mm	±3 mm	±0.3 mm	±0.7 mm	±0.3 mm	±0.7 mm
<b>Static resolution *3</b>	0.25 μm							
<b>Linearity *4</b>	±0.45 μm	±0.9 μm	±2.0 μm	±3.0 μm	±0.45 μm	±0.7 μm	±0.7 μm	±1.1 μm
<b>Spot diameter (Total measurement range) *5</b>	50 μm dia.	70 μm dia.	100 μm dia.	120 μm dia.	130 μm dia.	170 μm dia.	150 μm dia.	190 μm dia.
<b>Measurement cycle *6</b>	20 μs to 400 μs							
<b>Operating ambient illumination</b>	Illumination on object surface max.30000 Lx: (incandescent light)							
<b>Ambient temperature range</b>	Operation: 0 to 50°C, Storage: -15 to +60°C (No freezing and condensation)							
<b>Ambient humidity range</b>	Operation/storage: 35 or 85%RH (No condensation)							
<b>Degree of protection</b>	IP40 (IEC60529)							
<b>Vibration resistance (destructive)</b>	10 to 150 Hz (half amplitude 0.35 mm), 80 mins in each of X/Y/Z directions							
<b>Shock resistance (destructive)</b>	150 m/s <sup>2</sup> , 6 direction, 3 times each (up/down, left/right, forward/backward)							
<b>Temperature characteristic *7</b>	0.6 μm/°C (0.2 μm/°C)	1.1 μm/°C (0.5 μm/°C)	1.8 μm/°C (1.0 μm/°C)	2.1 μm/°C (1.2 μm/°C)	0.8 μm/°C (0.4 μm/°C)	0.8 μm/°C (0.4 μm/°C)	0.8 μm/°C (0.4 μm/°C)	0.8 μm/°C (0.4 μm/°C)
<b>LED Safety</b>	Risk Group 3 (IEC62471)							
<b>Material</b>	Chassis: aluminum die cast Fiber cable sheath: PVC Calibration ROM: PC				Chassis: SUS Fiber cable sheath: PVC Calibration ROM: PC Mounting Plate: Aluminum		Chassis: SUS, aluminum Fiber cable sheath: PVC Calibration ROM: PC Mounting Plate: Aluminum	
<b>Fiber cable length</b>	0.3 m, 2 m (flex-resistant cable)							
<b>Fiber cable minimum bend radius</b>	20 mm							
<b>Insulation resistance (Calibration ROM)</b>	Between case and all terminals: 20 MΩ (by 250 VDC)							
<b>Dielectric strength (Calibration ROM)</b>	Between case and all terminals: 1000 VAC, 50/60 Hz, 1 min							
<b>Weight</b>	Fiber cable length 0.3m Approx. 170g Fiber cable length 2m Approx. 180g				Fiber cable length 0.3m Approx. 27 g Fiber cable length 2m Approx. 37 g		Fiber cable length 0.3m Approx. 31 g Fiber cable length 2m Approx. 41 g	
<b>Accessories</b>	Calibration ROM fixing screw (M2×5mm) × 1, Fiber cable protective cap × 1, Strap × 2, Instruction Manual, Precautions				Installation plate × 1, Unit fixing screws (M2 × 10 mm) × 4, Calibration ROM fixing screw (M2 × 5 mm) × 1, Fiber cable protective cap × 1, Strap × 2, Instruction Manual, Precautions			

\*1. Indicates the distance from the front of the sensor head. The pen-shaped right angle type has a maximum individual difference of ±0.15 mm in the distance from the front of the sensor head.

\*2. The measurement range is higher 28 μs than measurement cycle.

\*3. Capacity value when OMRON standard mirror surface target is measured at the measurement center distance as the average of 16,384 times.  
The value when the Sensor Controller ZW-7000T is connected.

\*4. Material setting for the OMRON standard mirror surface target: Error from an ideal straight line when measuring on mirror surface.

\*5. Capacity value defined by 1/e<sup>2</sup> (13.5%) of the peak optical intensity of the measurement wavelength.

\*6. When an extension fiber cable of 10 m or longer is connected, the setting range of the measurement cycle (exposure time) changes. For details, refer to *Setting Measurement Cycle* in the *ZW-8000/7000/5000 User's Manual (Cat. No. Z362)*.

\*7. Actual value of the change in measurement value at the measurement center distance when fastened with an aluminum jig between the Sensor Head and the target, and with the Sensor Head and the Sensor Controller set in the same temperature environment.

The value in parentheses is the actual value when using an SUS304 jig.

When measuring the thickness, the value is calculated from the difference between the heights of the surface and rear surface, so there is no effect on the temperature change.



## ZW-S5010/S5020/S5030/SP5007/SP5010/SPR5007/SPR5010

Item	Specifications						
	ZW-S5010	ZW-S5020	ZW-S5030	ZW-SP5007	ZW-SP5010	ZW-SPR5007	ZW-SPR5010
Sensor controller	ZW-5000T						
Sensor head type	Square-shaped straight type			Pen-shaped straight type		Pen-shaped right angle type	
Measurement center distance *1	10 mm	20 mm	30 mm	7 mm	10 mm	7 mm	10 mm
Measuring range	±0.5 mm	±1 mm	±2 mm	±0.3 mm	±0.7 mm	±0.3 mm	±0.7 mm
Static resolution *2	0.25 μm						
Linearity *3	±0.45 μm	±0.9 μm	±2.0 μm	±0.45 μm	±0.7 μm	±0.7 μm	±1.1 μm
Spot diameter (Total measurement range) *4	9 μm dia.	13 μm dia.	18 μm dia.	13 μm dia.	18 μm dia.	15 μm dia.	20 μm dia.
Measurement cycle *5	80 μs to 1,600 μs						
Operating ambient illumination	Illumination on object surface max.30000 Lx: (incandescent light)						
Ambient temperature range	Operation: 0 to 50°C, Storage: -15 to +60°C (No freezing and condensation)						
Ambient humidity range	Operation/storage: 35 or 85%RH (No condensation)						
Degree of protection	IP40 (IEC60529)						
Vibration resistance (destructive)	10 to 150 Hz (half amplitude 0.35 mm), 80 mins in each of X/Y/Z directions						
Shock resistance (destructive)	150 m/s <sup>2</sup> , 6 direction, 3 times each (up/down, left/right, forward/backward)						
Temperature characteristic *6	0.6 μm/°C (0.2 μm/°C)	1.1 μm/°C (0.5 μm/°C)	1.8 μm/°C (1.0 μm/°C)	0.8 μm/°C (0.4 μm/°C)	0.8 μm/°C (0.4 μm/°C)	0.8 μm/°C (0.4 μm/°C)	0.8 μm/°C (0.4 μm/°C)
LED Safety	Risk Group 3 (IEC62471)						
Material	Chassis: aluminum die cast Fiber cable sheath: PVC Calibration ROM: PC			Chassis: SUS Fiber cable sheath: PVC Calibration ROM: PC Mounting Plate: Aluminum		Chassis: SUS, aluminum Fiber cable sheath: PVC Calibration ROM: PC Mounting Plate: Aluminum	
Fiber cable length	0.3 m, 2 m (flex-resistant cable)						
Fiber cable minimum bend radius	20 mm						
Insulation resistance (Calibration ROM)	Between case and all terminals: 20 MΩ (by 250 VDC)						
Dielectric strength (Calibration ROM)	Between case and all terminals: 1000 VAC, 50/60 Hz, 1 min						
Weight	Fiber cable length 0.3m Approx. 170g Fiber cable length 2m Approx. 180g			Fiber cable length 0.3m Approx. 29 g Fiber cable length 2m Approx. 39 g		Fiber cable length 0.3m Approx. 33g Fiber cable length 2m Approx. 43g	
Accessories	Calibration ROM fixing screw (M2×5mm) × 1, Fiber cable protective cap × 1, Strap × 1, Instruction Manual, Precautions			Installation plate × 1, Unit fixing screws (M2 × 10 mm) × 4, Calibration ROM fixing screw (M2 × 5 mm) × 1, Fiber cable protective cap × 1, Strap × 1, Instruction Manual, Precautions			

- \*1. Indicates the distance from the front of the sensor head. The pen-shaped right angle type has a maximum individual difference of ±0.15 mm in the distance from the front of the sensor head.
- \*2. Capacity value when OMRON standard mirror surface target is measured at the measurement center distance as the average of 16,384 times.  
The value when the Sensor Controller ZW-5000T is connected.
- \*3. Material setting for the OMRON standard mirror surface target: Error from an ideal straight line when measuring on mirror surface.
- \*4. Capacity value defined by 1/e<sup>2</sup> (13.5%) of the peak optical intensity of the measurement wavelength.
- \*5. When an extension fiber cable of 5 m or longer is connected, the setting range of the measurement cycle (exposure time) changes. For details, refer to *Setting Measurement Cycle* in the *ZW-8000/7000/5000 User's Manual (Cat. No. Z362)*.
- \*6. Actual value of the change in measurement value at the measurement center distance when fastened with an aluminum jig between the Sensor Head and the target, and with the Sensor Head and the Sensor Controller set in the same temperature environment.  
The value in parentheses is the actual value when using an SUS304 jig.  
When measuring the thickness, the value is calculated from the difference between the heights of the surface and rear surface, so there is no effect on the temperature change.

# ZW-8000/7000/5000 Series

## ● Sensor Controller

Item	Specifications			
	ZW-8000T	ZW-7000T	ZW-5000T	
Input/output type	NPN/PNP dual type			
Number of connected sensor heads	1			
Sensor head compatibility	ZW-S80□□/ ZW-SP80□□/ ZW-SPR80□□	ZW-S70□□/ ZW-SP70□□/ ZW-SPR70□□	ZW-S50□□/ ZW-SP50□□/ ZW-SPR50□□	
LED Safety	Risk Group 3 (IEC62471)			
Segment Display	Main display	11-segment white display, 6 digits		
	Sub-display	11-segment green display, 6 digits		
LED display	Status indicators	HIGH (orange), PASS (green), LOW (orange), STABILITY (green), ZERO (green), ENABLE (green), THRESHOLD-H (orange), THRESHOLD-L (orange), RUN (green)		
	EtherCAT indicator	ECAT RUN (green), L/A IN (Link/Activity IN) (green), L/A OUT (Link/Activity OUT) (green), ECAT ERR (red)		
External I/F	Ethernet	100BASE-TX/10BASE-T, Non-procedure (TCP/UDP), EtherNet/IP		
	EtherCAT	EtherCAT exclusive protocol 100BASE-TX		
	RS-232C	Max. 115,200 bps		
	Analog output terminal block	Analog voltage output (OUT V)	-10 V to +10 V, output impedance: 100 Ω	
		Analog current output (OUT A)	4 mA to 20 mA, max. load resistance: 300 Ω	
	32-pole expansion connector	Judgment output (HIGH/PASS/LOW)	Transistor output system Output voltage: 21.6 to 30 VDC Load current: 50 mA or less Residual voltage when turning ON: 2 V or less Leakage voltage when turning OFF: 0.1 mA or less	
		Busy output (BUSY)		
		Alarm output (ALARM)		
		Enable output (ENABLE)		
		Sync flag output (SYNFLG)		
		Trigger busy output (TRIGBUSY)		
		Logging state output (LOGSTAT)		
		Logging error output (LOGERR)		
		Stability output (STABILITY)		
		Task state output (TASKSTAT)		
		LIGHT OFF input (LIGHT OFF)		
		Zero reset input (ZERO)		
Timing input (TIMING)				
Reset input (RESET)	DC input system Input voltage: 24 VDC ± 10% (21.6 to 26.4 VDC) Input current: 7 mA Type. (24 VDC) ON voltage/ON current: 19 V/3 mA or less ON voltage/ON current: 5 V/1 mA or less			
Sync input (SYNC)				
Trigger input (TRIG)				
Logging input (LOGGING)				
Bank				
Bank	Currently selected bank output (BANK_OUT 1 to 3)	Transistor output system Output voltage: 21.6 to 30 VDC Load current: 50 mA or less Residual voltage when turning ON: 2 V or less Leakage voltage when turning OFF: 0.1 mA or less		
	Bank Selection input (BANK_SEL 1 to 3)	DC input system Input voltage: 24 VDC ± 10% (21.6 to 26.4 VDC) Input current: 7 mA Type. (24 VDC) ON voltage/ON current: 19 V/3 mA or more OFF voltage/OFF current: 5 V/1 mA or less		

# ZW-8000/7000/5000 Series

Item	Specifications			
	ZW-8000T	ZW-7000T	ZW-5000T	
Main functions	Exposure time	Automatic/Fixed		
	Measuring cycle *1	60 μs to 7,500 μs	20 μs to 400 μs	80 μs to 1,600 μs
	Material setting	Standard/Mirror/Rough surfaces		
	Measurement item	Height/Thickness of transparent object/Calculation		
	Filtering	Median/Average/Differentiation/High pass/Low pass/Band pass		
	Output	Scaling/Different holds/Zero reset/Logging for a measured value/Keep, Clamp		
	Display	Measured value/Threshold value/Analog output voltage or current value/Judgment result/Resolution/Light power/Internal logging condition/Peak amount of received light		
	Number of configurable banks	NORMAL mode: Max. 8 banks JUDGMENT mode: Max. 32 banks		
	Task process	Multi-task (up to 4 tasks per bank)		
	System	Save/Initialization/Display measured information/Communication settings/Sensor head calibration/Key-lock/Zero reset memory/Timing input		
Rating	Power supply voltage	21.6 to 26.4 VDC (including ripple)		
	Current consumption	700 mA or less	800 mA or less	
	Insulation resistance	Across all lead wires and FG terminal: 20 MΩ (by 250 VDC)		
	Dielectric strength	Between all lead wires and FG terminal: 500 VAC, 50/60 Hz, 1 minute		
Environmental resistance	Degree of protection	IP20 (IEC60529)		
	Vibration resistance (destructive)	10 to 55 Hz (half amplitude 0.35 mm), 50 mins in each of X/Y/Z directions		
	Shock resistance (destructive)	150 m/s <sup>2</sup> , 6 direction, 3 times each (up/down, left/right, forward/backward)		
	Ambient temperature range	Operation: 0 to 40°C, Storage: -15 to +60°C (No freezing and condensation)		
	Ambient humidity range	Operation/storage: 35 to 85%RH (No condensation)		
Grounding	D-type grounding (grounding resistance of 100 Ω or less) Note: For conventional Class D grounding			
Material	Chassis: PC			
Weight	Approx. 950g (main unit only), Approx. 150 g (Parallel cable)	Approx. 900g (main unit only), Approx. 150 g (Parallel cable)		
Accessories	Parallel cable (ZW-XCP2E) × 1 10 Fiber cleaners (ZW-XCL) × 1 Instruction Manual Member registration sheet Precautions		Parallel cable (ZW-XCP2E) × 1 10 Fiber cleaners (ZW-XCL) × 1 Fiber adapter cap × 1 Strap × 1 Instruction Manual Member registration sheet Precautions	

**Note:** The Export Trade Control Order compatible Sensor Controller (ZW-8000T/7000T/5000T) is available.

When using this Controller, the minimum resolution is 0.25 μm regardless of the connected Sensor Head and setting conditions.

\*1. When an extension fiber cable of 2 m or longer (on the ZW-8000 series), 10 m or longer (on the ZW-7000 series) or 5 m or longer (on the ZW-5000 series) is connected, the setting range of the measurement cycle (exposure time) changes. For details, refer to *Setting Measurement Cycle* in the *ZW-8000/7000/5000 User's Manual* (Cat. No. Z362).

# ZW-8000/7000/5000 Series

## ●EtherCAT Communications Specifications

Item	Specification
Communications standard	IEC61158 Type12
Physical layer	100BASE-TX(IEEE802.3)
Connectors	RJ45 × 2 ECAT IN: EtherCAT input ECAT OUT: EtherCAT output
Communications media	Category 5 or higher (cable with double, aluminum tape and braided shielding) is recommended.
Communications distance	Distance between nodes: 100 m max.
Process data	Variable PDO mapping
Mailbox (CoE)	Emergency messages, SDO requests, SDO responses, and SDO information
Distributed clock	Synchronization in DC mode.
LED display	L/A IN (Link/Activity IN) × 1, AL/A OUT (Link/Activity OUT) × 1, AECAT RUN × 1, AECAT ERR × 1

## ●Automation Software Sysmac Studio

Item	Operating environment *3
Operating system (OS) *1	Windows 7 (32-bit/64-bit version)/Windows 8 (32-bit/64-bit version)/Windows 8.1 (32-bit/64-bit version)/Windows 10(32-bit/64-bit version)
CPU	Windows computers with Intel® Celeron® processor 540 (1.8 GHz) or faster CPU. Intel® Core™ i5 M520 processor (2.4 GHz) or equivalent or faster recommended.
Main memory	2 GB min. 4 GB min. recommended
Hard disk	Minimum 4.6 GB of Hard disk space is required to install. *2
Display	XGA 1024 × 768, 16,000,000 colors WXGA 1280 × 800 dots or higher resolution is recommended.
Disk drive	DVD-ROM drive
Communications ports	USB port corresponded to USB 2.0, or Ethernet port *4
Supported languages	Japanese, English, German, French, Italian, Spanish, simplified Chinese, traditional Chinese, Korean

\*1. Note about Sysmac Studio compatible operating systems: The required system and hard disk capacity differs according to the system environment.

\*2. Separate logging memory is required to use the file logging function.

\*3. Describes System Requirements and notes of Sysmac Studio Measurement Sensor Edition.

For details on System Requirements and notes of Sysmac Studio Measurement Sensor Edition, refer to Sysmac Studio Version 1 Operation Manual.

\*4. For information on how to connect a personal computer with the controller or other hardware and information on required cables, refer to manuals for each hardware.

## ●Version Information

### Sensor Head/Cable, Sensor Controller, and Sysmac Studio

The applicable version of the Sensor Controller varies depending on the Sensor Head or Cable. The versions are listed below.

Use the latest version of Sysmac Studio Standard Edition/Measurement Sensor Edition.

Sensor head/Cable		ZW Series	Version of Sensor Controller	Corresponding version of Sysmac Studio Standard Edition/Measurement Sensor Edition
Type	Model			
Square-shaped straight type	ZW-S80□□ □M	ZW-8000□	Version 3.000 or later	Version 1.22 or higher
Pen-shaped straight type	ZW-SP8007 □M ZW-SP8010 □M			
Pen-shaped right-angle type	ZW-SPR8007 □M ZW-SPR8010 □M			
Extension Fiber Cable	ZW-XF80□□R			
Square-shaped straight type	ZW-S70□□ □M	ZW-7000□	Version 2.030 or later	Version 1.15 or higher
Pen-shaped straight type	ZW-SP7007 □M ZW-SP7010 □M		Version 2.110 or later	
Pen-shaped right-angle type	ZW-SPR7007 □M ZW-SPR7010 □M		Version 2.030 or later	
Extension Fiber Cable	ZW-XF7002R ZW-XF7010R ZW-XF7020R ZW-XF7030R		Version 2.100 or later	
Square-shaped straight type	ZW-S50□□ □M	ZW-5000□	Version 2.100 or later	Version 1.18 or higher
Pen-shaped straight type	ZW-SP5007 □M ZW-SP5010 □M		Version 2.110 or later	
Pen-shaped right-angle type	ZW-SPR5007 □M ZW-SPR5010 □M		Version 2.100 or later	
Extension Fiber Cable	ZW-XF50□□R		Version 2.100 or later	

**Note:** Refer to the *Firmware Update* in the *ZW-8000/7000/5000 User's Manual* (Cat. No. Z362) for how to update the Sensor Controller.

External Dimensions

(Unit: mm)

Sensor Head

Square-shaped straight type

ZW-S8010 □M/S8020 □M/S8030 □M

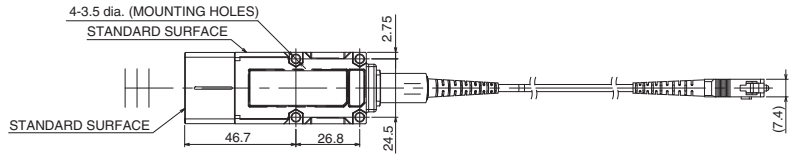
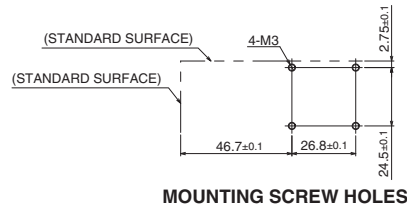

\*1.

Type	W.D.	M
ZW-S8010	10	0.5
ZW-S8020	20	1
ZW-S8030	30	2

\*2.

Length	L
0.3 m	(300)
2 m	(2000)

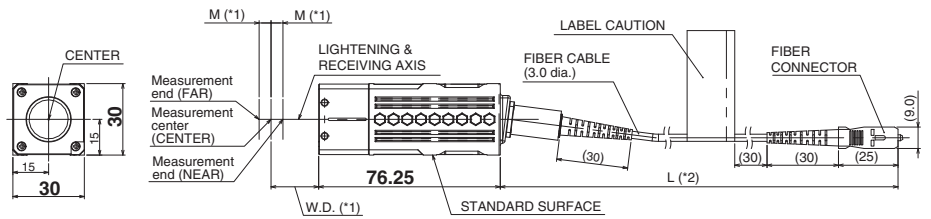

Pen-shaped straight type

ZW-SP8007 □M

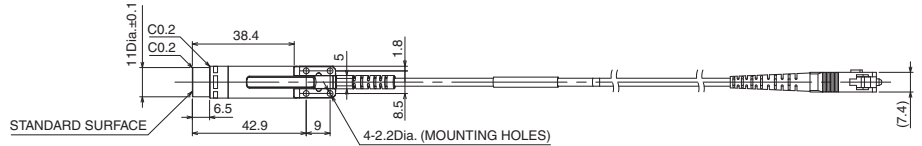
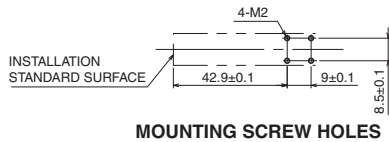

\*1.

Length	L
0.3 m	(300)
2 m	(2000)

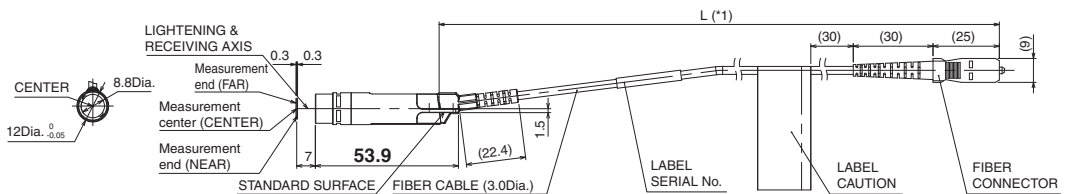

<MOUNTING PLATE>  
MATERIAL: ALUMINUM

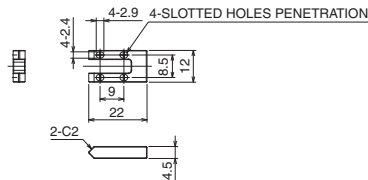

<USE SITUATION OF MOUNTING PLATE>  
SENSOR HEAD IS FASTENED WITH MOUNTING PLATE BY USING THE ACCESSORY SCREWS

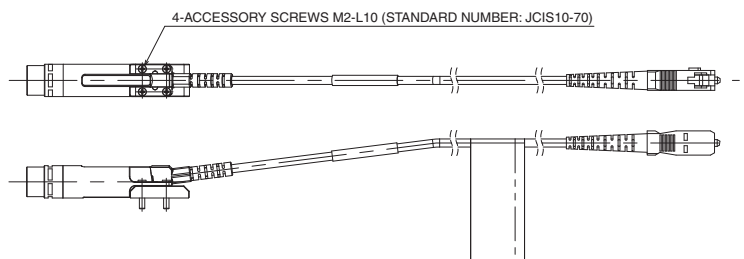

# ZW-8000/7000/5000 Series

ZW-SP8010 □M

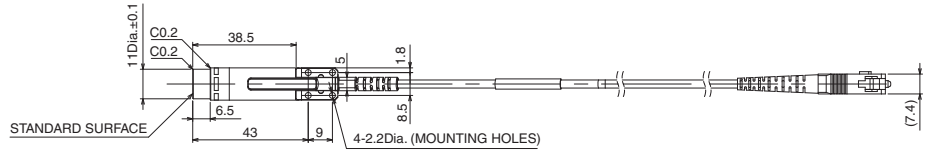
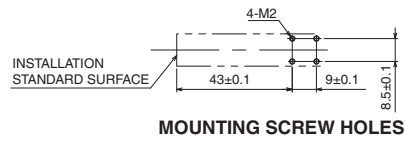

\*1.

Length	L
0.3 m	(300)
2 m	(2000)

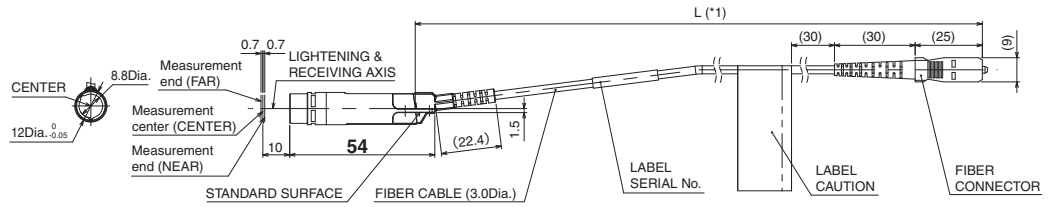

<MOUNTING PLATE>  
MATERIAL: ALUMINUM

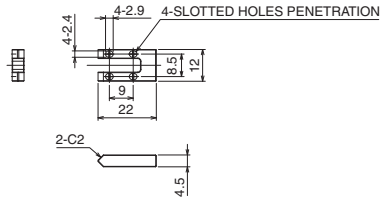

<USE SITUATION OF MOUNTING PLATE>  
SENSOR HEAD IS FASTENED WITH MOUNTING PLATE BY USING THE ACCESSORY SCREWS

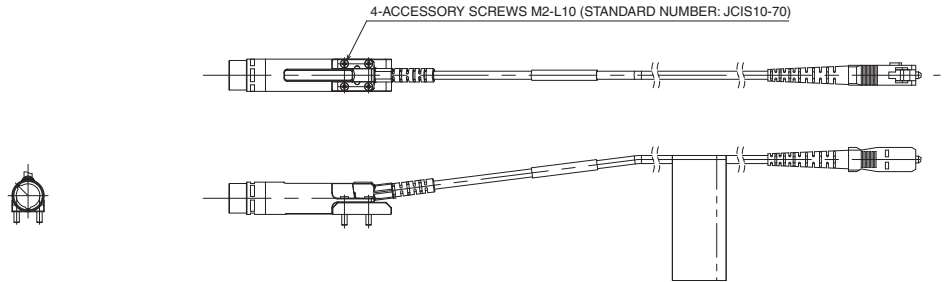



Pen-shaped right angle type  
ZW-SPR8007 □M

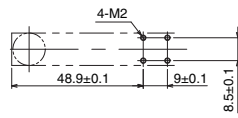

MOUNTING SCREW HOLES

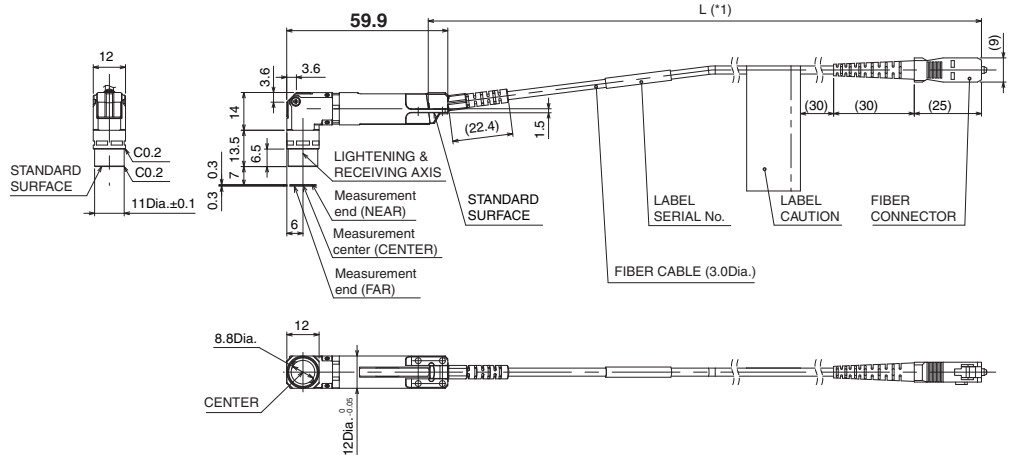
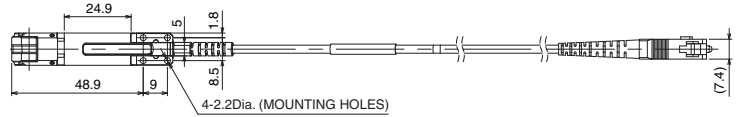

\*1.

Length	L
0.3 m	(300)
2 m	(2000)

<MOUNTING PLATE>  
MATERIAL: ALUMINUM

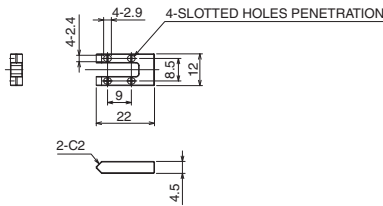

<USE SITUATION OF MOUNTING PLATE>  
SENSOR HEAD IS FASTENED WITH MOUNTING PLATE BY USING THE ACCESSORY SCREWS

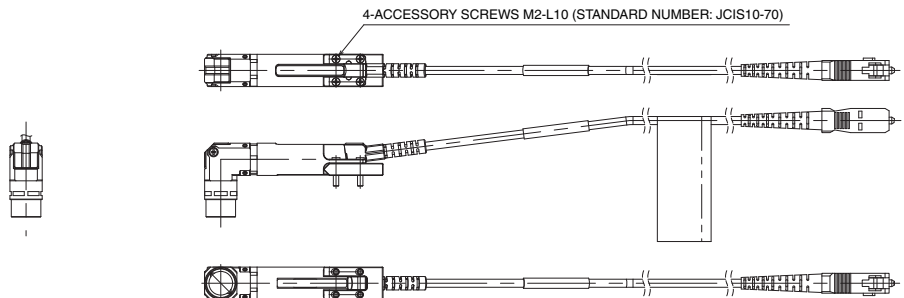

# ZW-8000/7000/5000 Series

## ZW-SPR8010 □M

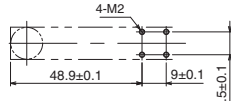

MOUNTING SCREW HOLES

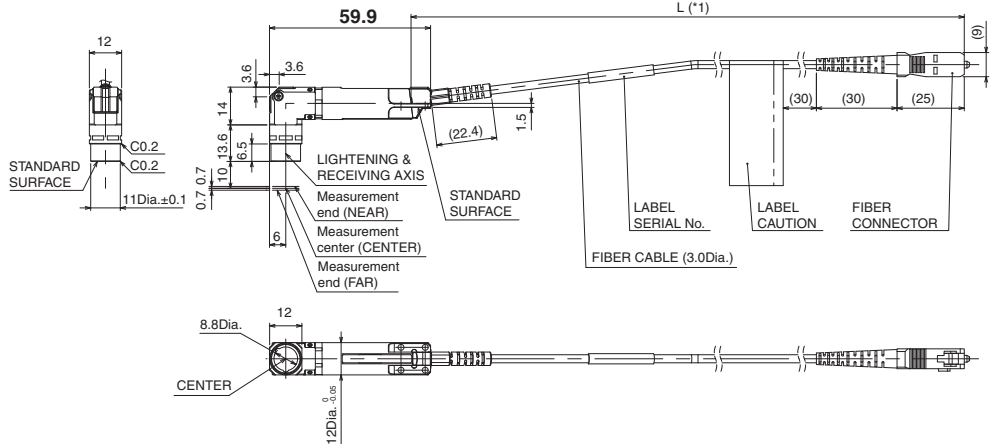
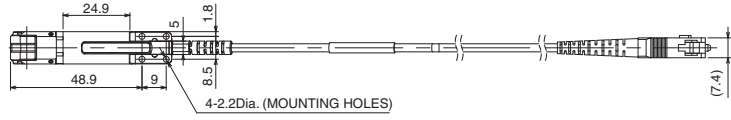

\*1.

Length	L
0.3 m	(300)
2 m	(2000)

<MOUNTING PLATE>  
MATERIAL: ALUMINUM

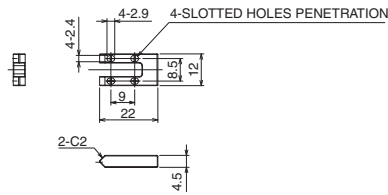

<USE SITUATION OF MOUNTING PLATE>  
SENSOR HEAD IS FASTENED WITH MOUNTING PLATE BY USING THE ACCESSORY SCREWS

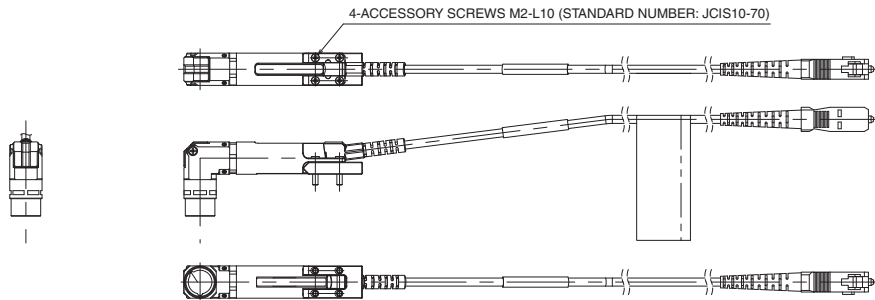



# ZW-8000/7000/5000 Series

## ZW-SP7010 □M

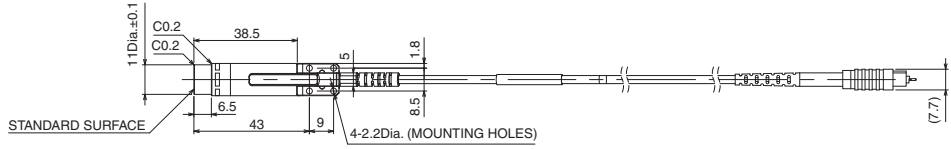
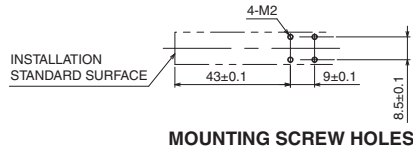

\*1.

Length	L
0.3 m	(300)
2 m	(2000)

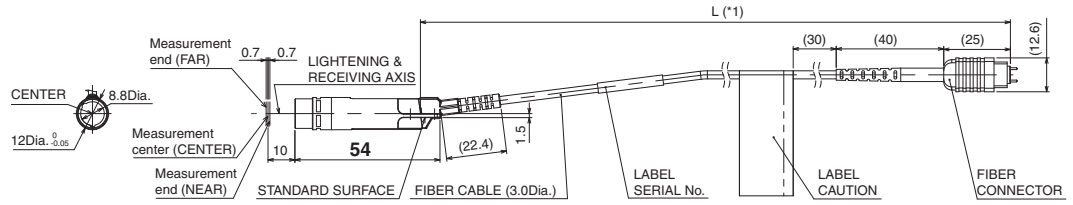

<MOUNTING PLATE>  
MATERIAL: ALUMINUM

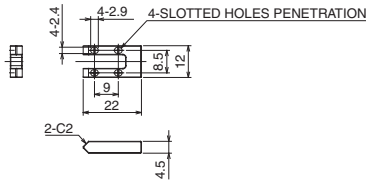

<USE SITUATION OF MOUNTING PLATE>  
SENSOR HEAD IS FASTENED WITH MOUNTING PLATE BY USING THE ACCESSORY SCREWS

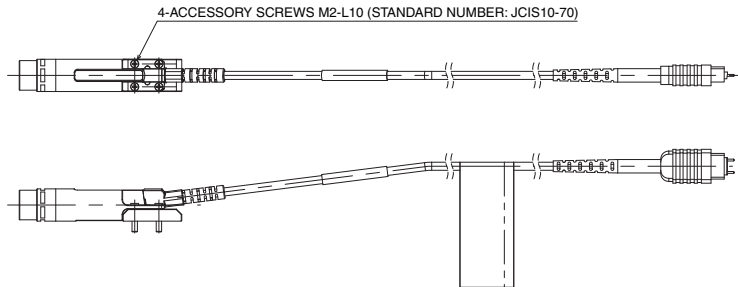

## Pen-shaped right angle type ZW-SPR7007 □M



\*1.

Length	L
0.3 m	(300)
2 m	(2000)

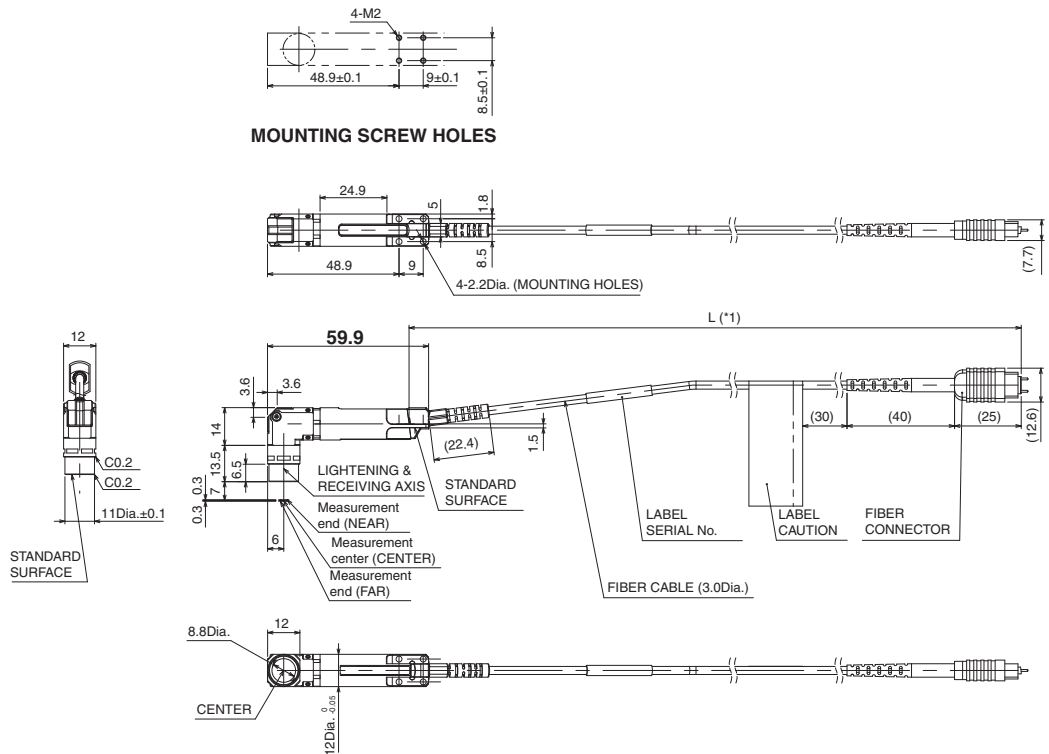

<MOUNTING PLATE>  
MATERIAL: ALUMINUM

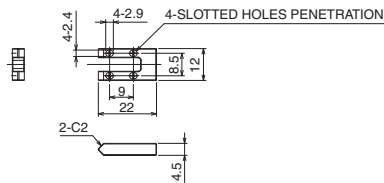

<USE SITUATION OF MOUNTING PLATE>

SENSOR HEAD IS FASTENED WITH MOUNTING PLATE BY USING THE ACCESSORY SCREWS

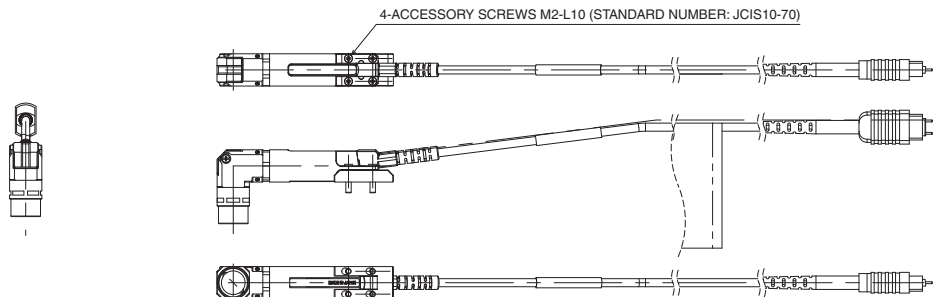

# ZW-8000/7000/5000 Series

## ZW-SPR7010 □M

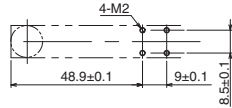

MOUNTING SCREW HOLES

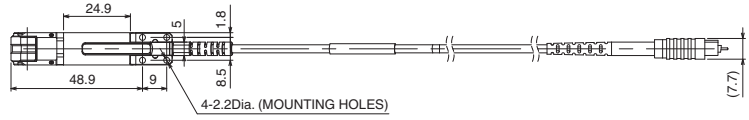

\*1.

Length	L
0.3 m	(300)
2 m	(2000)

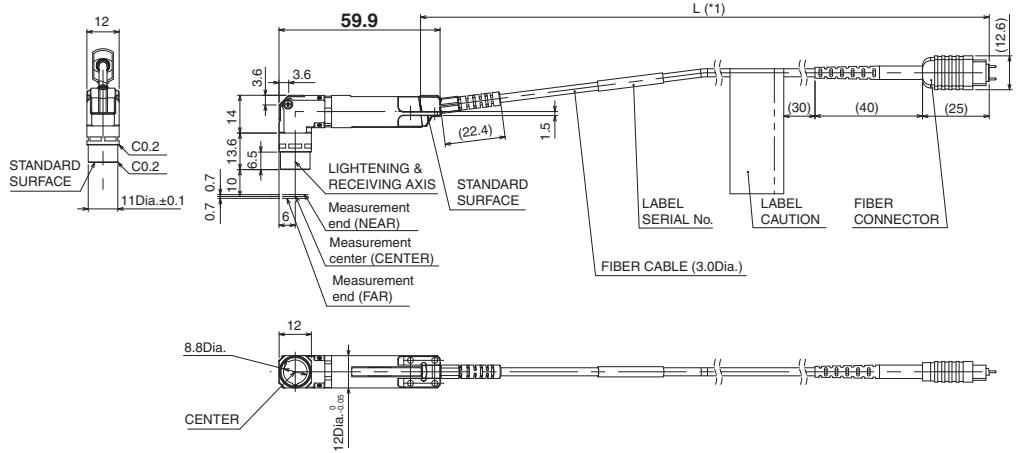

<MOUNTING PLATE>  
MATERIAL: ALUMINUM

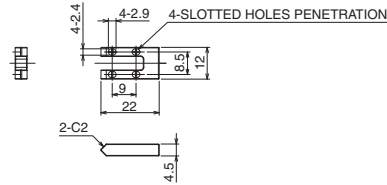

<USE SITUATION OF MOUNTING PLATE>  
SENSOR HEAD IS FASTENED WITH MOUNTING PLATE BY USING THE ACCESSORY SCREWS

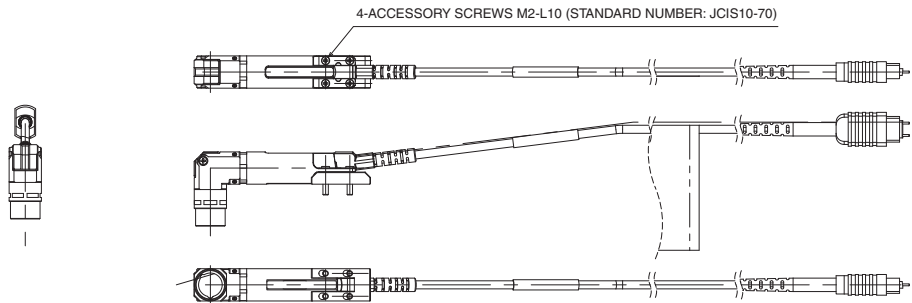



## Square-shaped straight type

ZW-S5010 □M/S5020 □M/S5030 □M

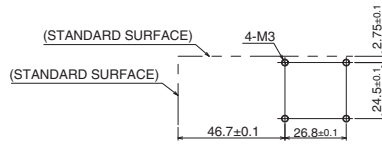

MOUNTING SCREW HOLES

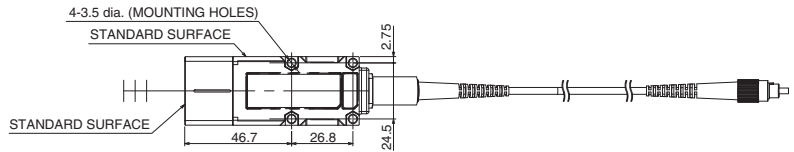

\*1.

Type	W.D.	M
ZW-S5010	10	0.5
ZW-S5020	20	1
ZW-S5030	30	2

\*2.

Length	L
0.3 m	(300)
2 m	(2000)

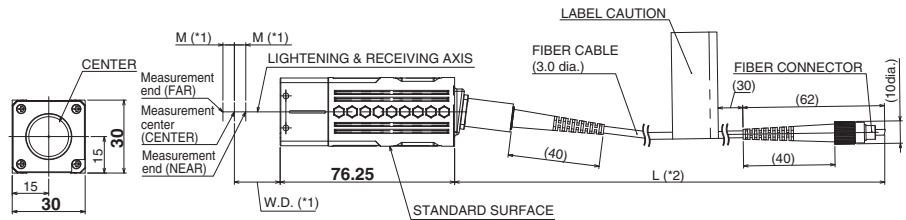

## Pen-shaped straight type

ZW-SP5007 □M

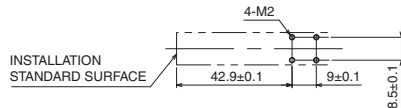

MOUNTING SCREW HOLES

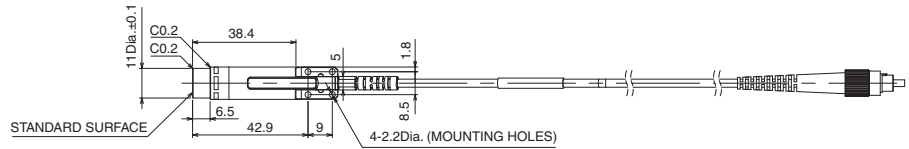

\*1.

Length	L
0.3 m	(300)
2 m	(2000)

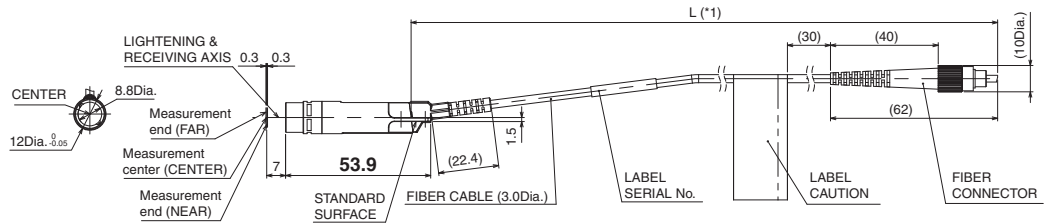

<MOUNTING PLATE>  
MATERIAL: ALUMINUM

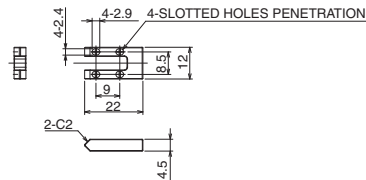

<USE SITUATION OF MOUNTING PLATE>

SENSOR HEAD IS FASTENED WITH MOUNTING PLATE BY USING THE ACCESSORY SCREWS

4-ACCESSORY SCREWS M2-L10 (STANDARD NUMBER: JCS10-70)

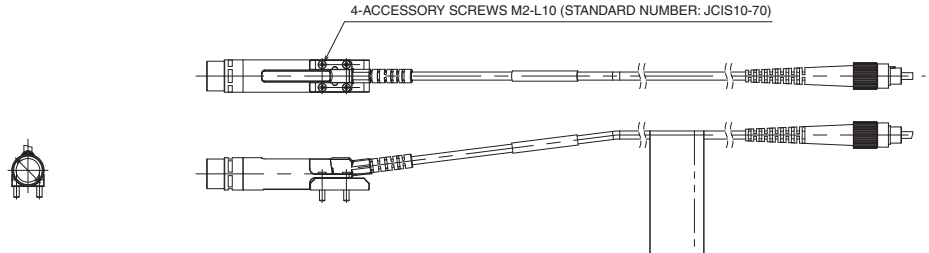

# ZW-8000/7000/5000 Series

## ZW-SP5010 □M

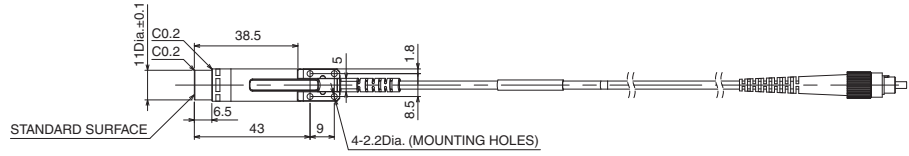
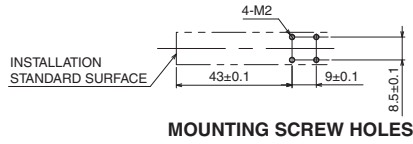

\*1.

Length	L
0.3 m	(300)
2 m	(2000)

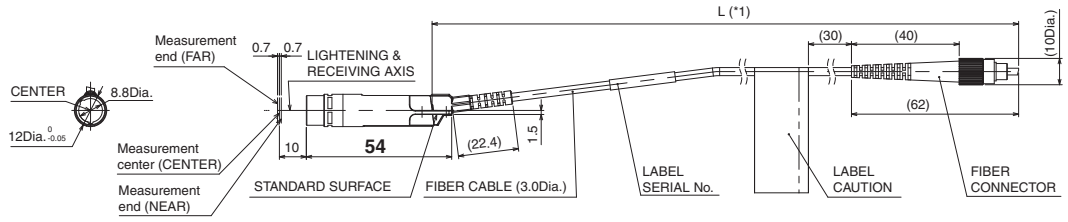

<MOUNTING PLATE>  
MATERIAL: ALUMINUM

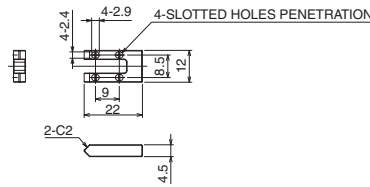

<USE SITUATION OF MOUNTING PLATE>  
SENSOR HEAD IS FASTENED WITH MOUNTING PLATE BY USING THE ACCESSORY SCREWS

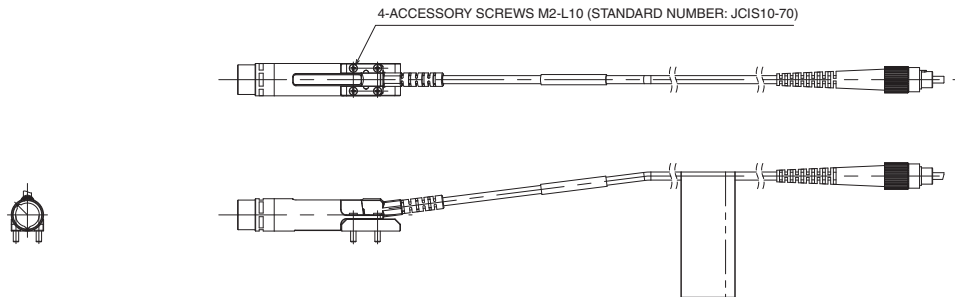

## Pen-shaped right angle type ZW-SPR5007 □M



\*1.

Length	L
0.3 m	(300)
2 m	(2000)

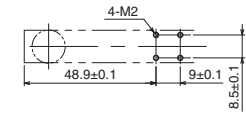

MOUNTING SCREW HOLES

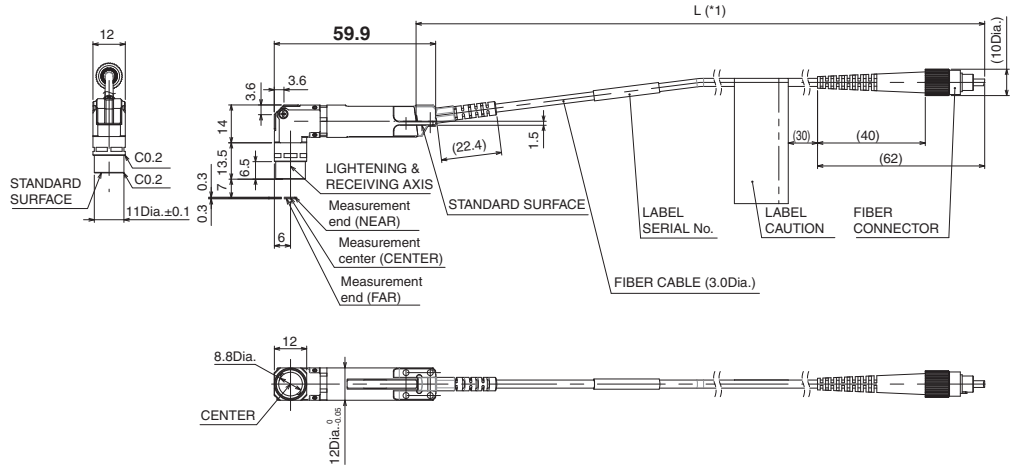
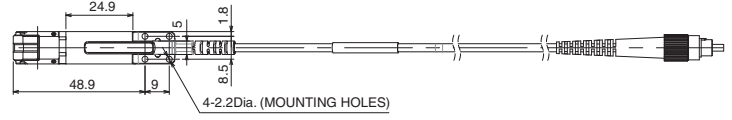

<MOUNTING PLATE>  
MATERIAL: ALUMINUM

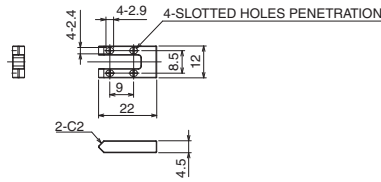

<USE SITUATION OF MOUNTING PLATE>  
SENSOR HEAD IS FASTENED WITH MOUNTING PLATE BY USING THE ACCESSORY SCREWS

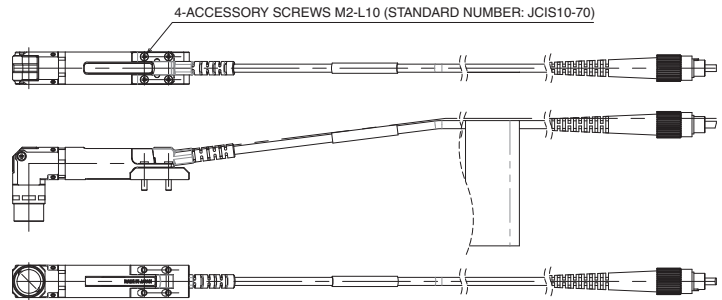

# ZW-8000/7000/5000 Series

## ZW-SPR5010 □M

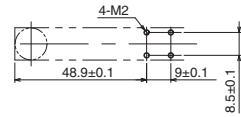

MOUNTING SCREW HOLES

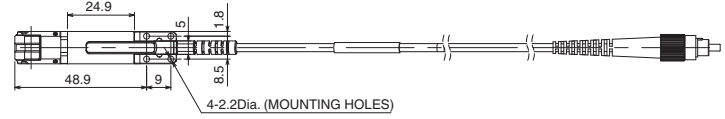

\*1.

Length	L
0.3 m	(300)
2 m	(2000)

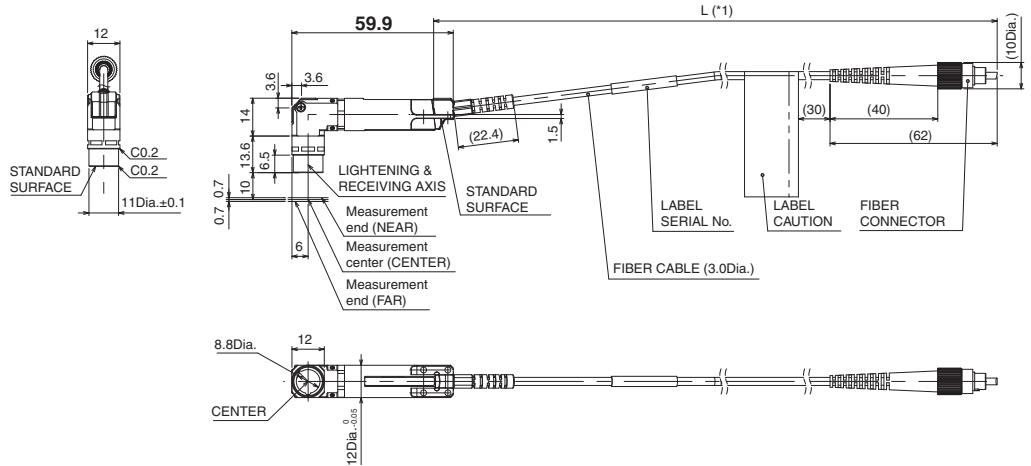

<MOUNTING PLATE>  
MATERIAL: ALUMINUM

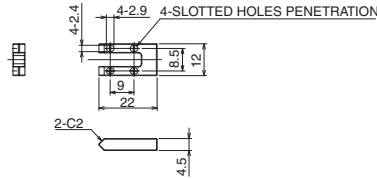

<USE SITUATION OF MOUNTING PLATE>  
SENSOR HEAD IS FASTENED WITH MOUNTING PLATE BY USING THE ACCESSORY SCREWS

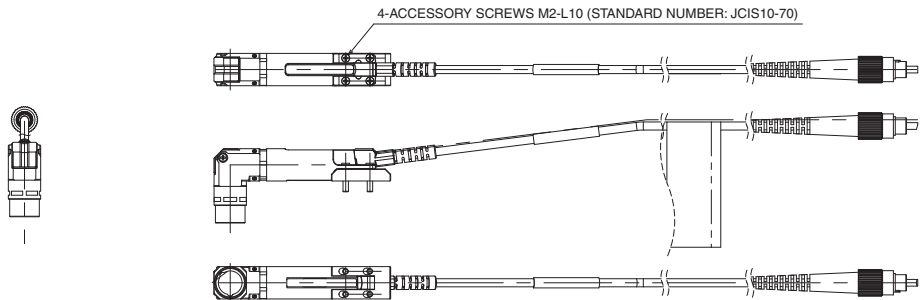

Sensor Controller

ZW-8000T

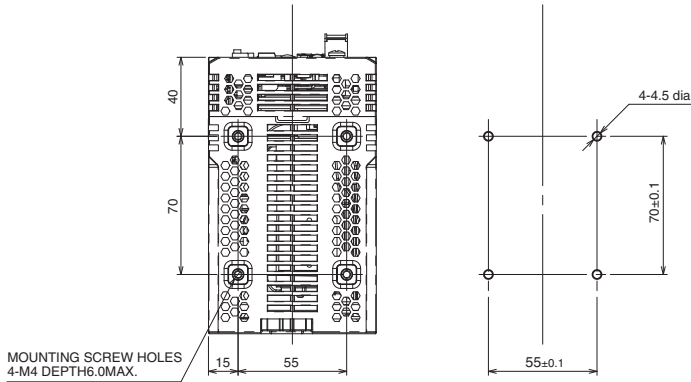
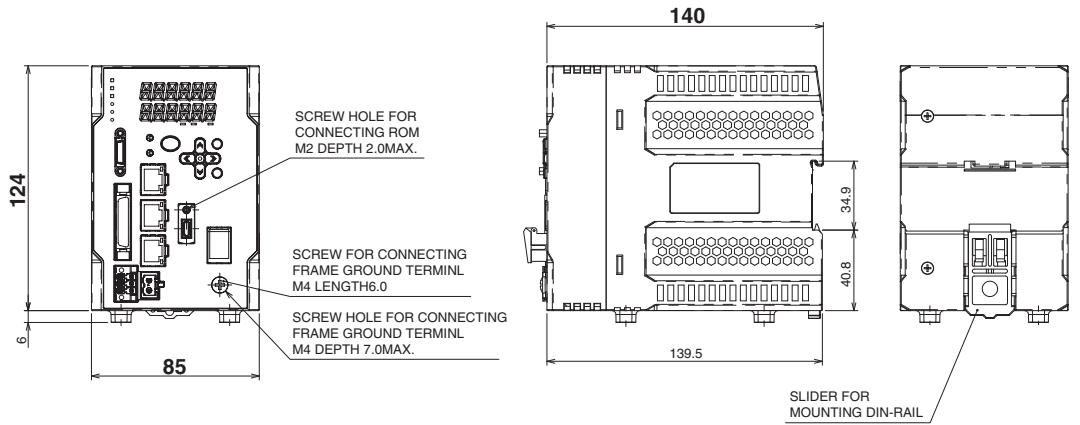

MOUNTING SCREW HOLES

ZW-7000T

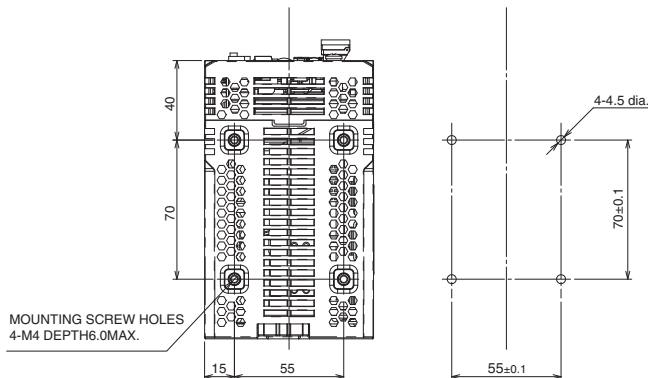
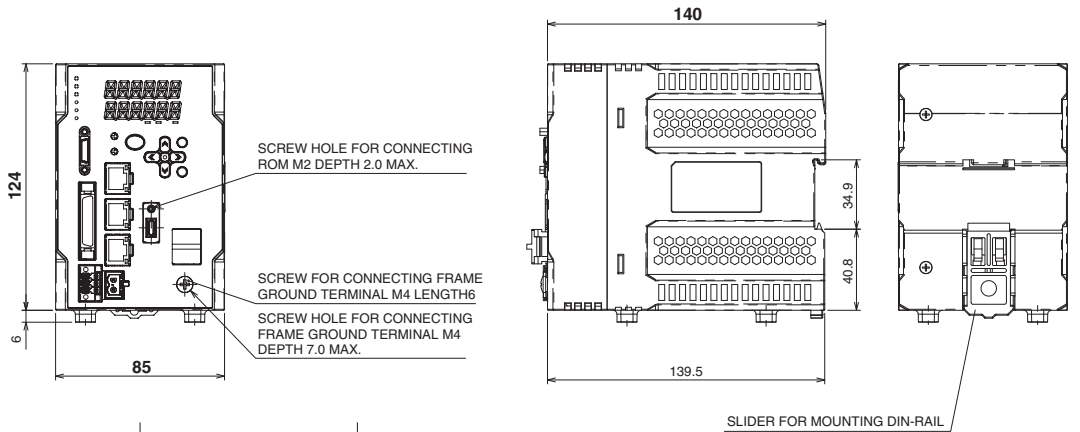

MOUNTING SCREW HOLES

# ZW-8000/7000/5000 Series

## ZW-5000T

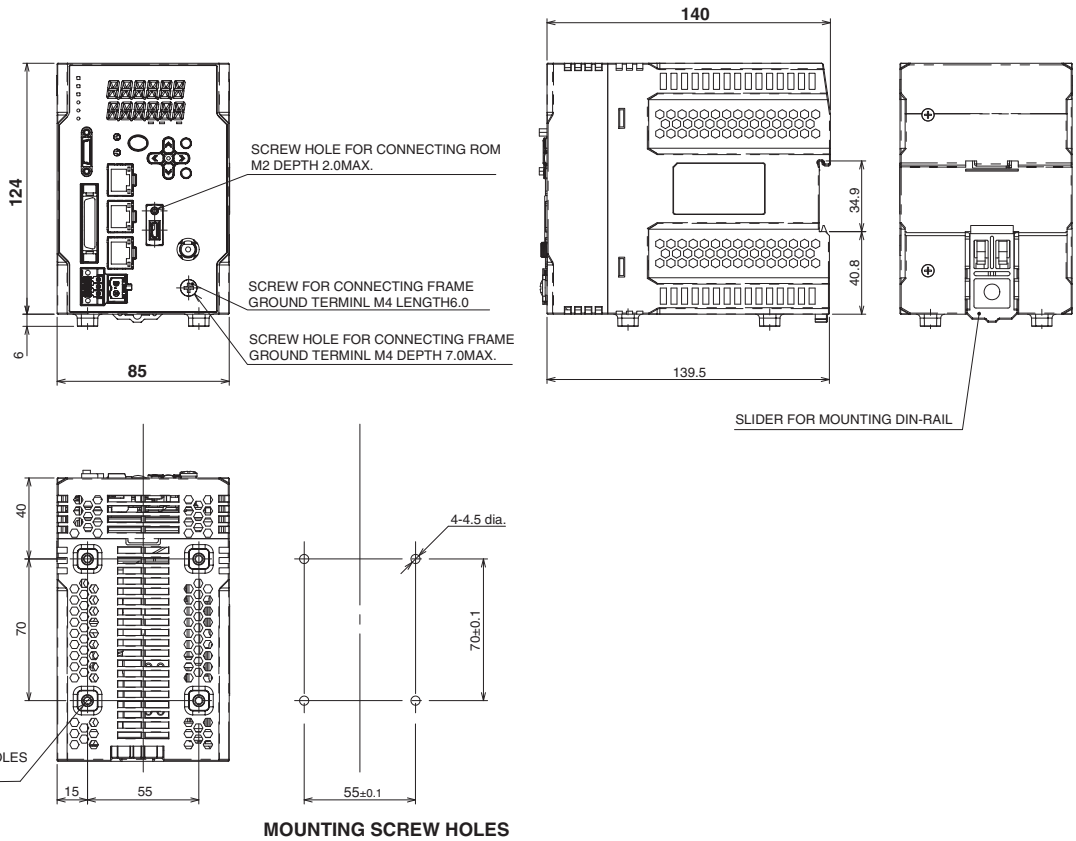

## Extension Fiber Cable

### ZW-XF8002R/XF8005R/XF8010R/XF8020R/XF8030R

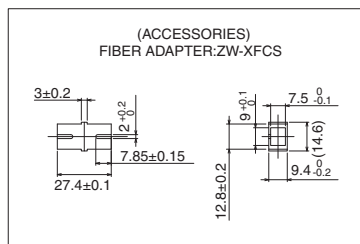
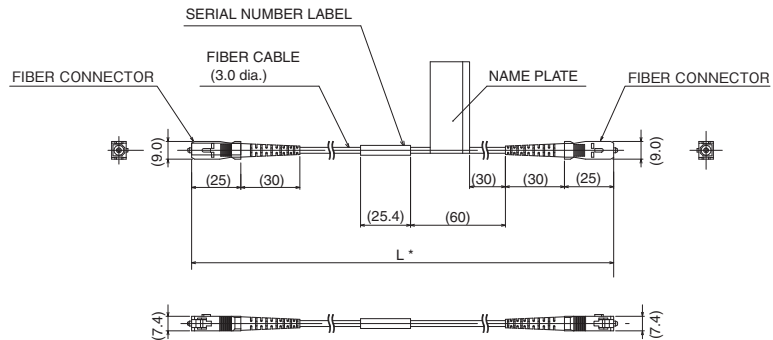

\* The following table lists cable lengths per models.

Type	Specification	L
ZW-XF8002R	2 m	2000+40/0
ZW-XF8005R	5 m	5000+100/0
ZW-XF8010R	10 m	10000+200/0
ZW-XF8020R	20 m	20000+400/0
ZW-XF8030R	30 m	30000+600/0



## ZW-XF7002R/XF7005R/XF7010R/XF7020R/XF7030R

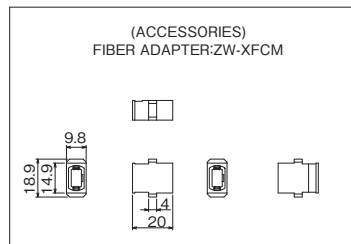
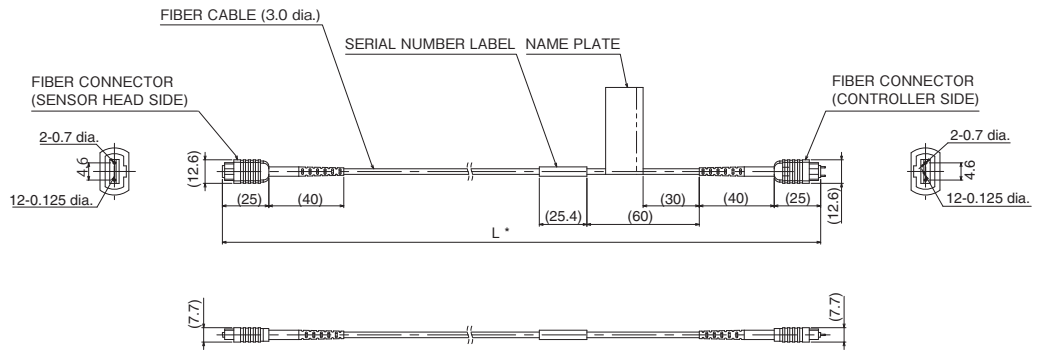

\* The following table lists cable lengths per models.

Type	Specification	L
ZW-XF7002R	2 m	2000+40/0
ZW-XF7005R	5 m	5000+100/0
ZW-XF7010R	10 m	10000+200/0
ZW-XF7020R	20 m	20000+400/0
ZW-XF7030R	30 m	30000+600/0

## ZW-XF5002R/XF5005R/XF5010R/XF5020R/XF5030R

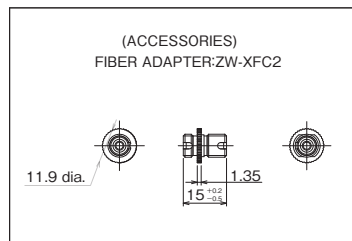
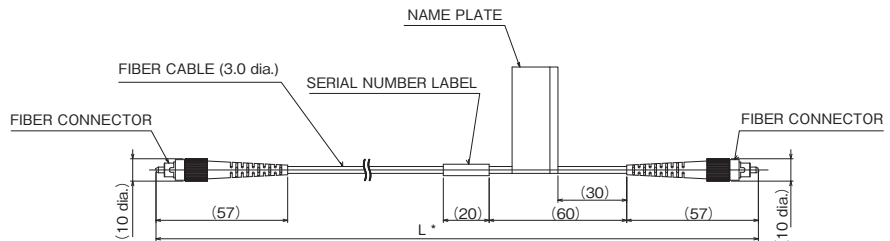

\* The following table lists cable lengths per models.

Type	Specification	L
ZW-XF5002R	2 m	2000+200/0
ZW-XF5005R	5 m	5000+200/0
ZW-XF5010R	10 m	10000+200/0
ZW-XF5020R	20 m	20000+500/0
ZW-XF5030R	30 m	30000+500/0

## Related Manuals

Man.No.	Model number	Manual
Z362	ZW-8000□/7000□/5000□	Displacement Sensor ZW-8000/7000/5000 User's Manual
Z363	ZW-8000□/7000□/5000□	Displacement Sensor ZW-8000/7000/5000 User's Manual for Communications Settings
W504	SYSMAC-SE2	Sysmac Studio Version 1 Operation Manual



# Terms and Conditions Agreement

## **Read and understand this catalog.**

Please read and understand this catalog before purchasing the products. Please consult your OMRON representative if you have any questions or comments.

## **Warranties.**

- (a) Exclusive Warranty. Omron's exclusive warranty is that the Products will be free from defects in materials and workmanship for a period of twelve months from the date of sale by Omron (or such other period expressed in writing by Omron). Omron disclaims all other warranties, express or implied.
- (b) Limitations. OMRON MAKES NO WARRANTY OR REPRESENTATION, EXPRESS OR IMPLIED, ABOUT NON-INFRINGEMENT, MERCHANTABILITY OR FITNESS FOR A PARTICULAR PURPOSE OF THE PRODUCTS. BUYER ACKNOWLEDGES THAT IT ALONE HAS DETERMINED THAT THE PRODUCTS WILL SUITABLY MEET THE REQUIREMENTS OF THEIR INTENDED USE.

Omron further disclaims all warranties and responsibility of any type for claims or expenses based on infringement by the Products or otherwise of any intellectual property right. (c) Buyer Remedy. Omron's sole obligation hereunder shall be, at Omron's election, to (i) replace (in the form originally shipped with Buyer responsible for labor charges for removal or replacement thereof) the non-complying Product, (ii) repair the non-complying Product, or (iii) repay or credit Buyer an amount equal to the purchase price of the non-complying Product; provided that in no event shall Omron be responsible for warranty, repair, indemnity or any other claims or expenses regarding the Products unless Omron's analysis confirms that the Products were properly handled, stored, installed and maintained and not subject to contamination, abuse, misuse or inappropriate modification. Return of any Products by Buyer must be approved in writing by Omron before shipment. Omron Companies shall not be liable for the suitability or unsuitability or the results from the use of Products in combination with any electrical or electronic components, circuits, system assemblies or any other materials or substances or environments. Any advice, recommendations or information given orally or in writing, are not to be construed as an amendment or addition to the above warranty.

See <http://www.omron.com/global/> or contact your Omron representative for published information.

## **Limitation on Liability; Etc.**

OMRON COMPANIES SHALL NOT BE LIABLE FOR SPECIAL, INDIRECT, INCIDENTAL, OR CONSEQUENTIAL DAMAGES, LOSS OF PROFITS OR PRODUCTION OR COMMERCIAL LOSS IN ANY WAY CONNECTED WITH THE PRODUCTS, WHETHER SUCH CLAIM IS BASED IN CONTRACT, WARRANTY, NEGLIGENCE OR STRICT LIABILITY.

Further, in no event shall liability of Omron Companies exceed the individual price of the Product on which liability is asserted.

## **Suitability of Use.**

Omron Companies shall not be responsible for conformity with any standards, codes or regulations which apply to the combination of the Product in the Buyer's application or use of the Product. At Buyer's request, Omron will provide applicable third party certification documents identifying ratings and limitations of use which apply to the Product. This information by itself is not sufficient for a complete determination of the suitability of the Product in combination with the end product, machine, system, or other application or use. Buyer shall be solely responsible for determining appropriateness of the particular Product with respect to Buyer's application, product or system. Buyer shall take application responsibility in all cases.

NEVER USE THE PRODUCT FOR AN APPLICATION INVOLVING SERIOUS RISK TO LIFE OR PROPERTY OR IN LARGE QUANTITIES WITHOUT ENSURING THAT THE SYSTEM AS A WHOLE HAS BEEN DESIGNED TO ADDRESS THE RISKS, AND THAT THE OMRON PRODUCT(S) IS PROPERLY RATED AND INSTALLED FOR THE INTENDED USE WITHIN THE OVERALL EQUIPMENT OR SYSTEM.

## **Programmable Products.**

Omron Companies shall not be responsible for the user's programming of a programmable Product, or any consequence thereof.

## **Performance Data.**

Data presented in Omron Company websites, catalogs and other materials is provided as a guide for the user in determining suitability and does not constitute a warranty. It may represent the result of Omron's test conditions, and the user must correlate it to actual application requirements. Actual performance is subject to the Omron's Warranty and Limitations of Liability.

## **Change in Specifications.**

Product specifications and accessories may be changed at any time based on improvements and other reasons. It is our practice to change part numbers when published ratings or features are changed, or when significant construction changes are made. However, some specifications of the Product may be changed without any notice. When in doubt, special part numbers may be assigned to fix or establish key specifications for your application. Please consult with your Omron's representative at any time to confirm actual specifications of purchased Product.

## **Errors and Omissions.**

Information presented by Omron Companies has been checked and is believed to be accurate; however, no responsibility is assumed for clerical, typographical or proofreading errors or omissions.

- Angle characteristic, linearity, sampling period and spot diameter given in the cover differ among models. Please ask Omron sales representative for details.
- EtherCAT® is registered trademark and patented technology, licensed by Beckhoff Automation GmbH, Germany.
- EtherNet/IP™ is a trademark of ODVA.
- Sysmac is a trademark or registered trademark of OMRON Corporation in Japan and other countries for OMRON factory automation products.
- Windows is a registered trademark of Microsoft Corporation in the USA and other countries.
- Other company names and product names mentioned in this document are the trademarks or registered trademarks of their respective companies.

Note: Do not use this document to operate the Unit.

**OMRON Corporation Industrial Automation Company**  
Kyoto, JAPAN

Contact: [www.ia.omron.com](http://www.ia.omron.com)

**Regional Headquarters**

**OMRON EUROPE B.V.**

Wegalaan 67-69, 2132 JD Hoofddorp  
The Netherlands  
Tel: (31)2356-81-300/Fax: (31)2356-81-388

**OMRON ELECTRONICS LLC**

2895 Greenspoint Parkway, Suite 200  
Hoffman Estates, IL 60169 U.S.A.  
Tel: (1) 847-843-7900/Fax: (1) 847-843-7787

**OMRON ASIA PACIFIC PTE. LTD.**

No. 438A Alexandra Road # 05-05/08 (Lobby 2),  
Alexandra Technopark,  
Singapore 119967  
Tel: (65) 6835-3011/Fax: (65) 6835-2711

**OMRON (CHINA) CO., LTD.**

Room 2211, Bank of China Tower,  
200 Yin Cheng Zhong Road,  
PuDong New Area, Shanghai, 200120, China  
Tel: (86) 21-5037-2222/Fax: (86) 21-5037-2200

**Authorized Distributor:**

© OMRON Corporation 2018 All Rights Reserved.  
In the interest of product improvement,  
specifications are subject to change without notice.

CSM\_1\_2\_0618

Cat. No. Q261-E1-02

0618 (0518)