

BUSTER+PUNCH
LONDON



KITCHEN

2024 EDIT



FREESTANDING KITCHEN BY BUSTER + PUNCH

New from Buster + Punch – a beautifully designed and engineered freestanding kitchen, packed with charisma and attention to detail. The kitchen's unique framing system and knurled metal feet are available in a range of finishes, to complement the brand's iconic solid metal cabinet hardware and kitchen accessories.

page 6-19:	THE KITCHEN
page 20-21:	HARDWARE
page 22-23:	KITCHEN TAPS
page 24-24:	APPLIANCES
page 26-31:	CURATED LOOKS
page 34-35:	SHELVING
page 36-41:	LIGHTING
page 42-43:	ELECTRICITY
page 44-45:	OUR DESIGNER

THE KITCHEN

HARDWARE

KITCHEN TAPS

APPLIANCES

CURATED LOOKS

SHELVING

LIGHTING

ELECTRICITY

OUR DESIGNER





fronts: **SCRAMBLER GREEN**
hardware: **CAST / GUN METAL**
frame: **BLACK / STEEL**
worktop: **STAINLESS STEEL**

category: **KITCHEN**
page: **6**



fronts: **STONE GREY**
hardware: **LINEAR / BRASS**
frame: **STONE / BRASS**
worktop: **DEKTON ARGENTINIUM**

category: **KITCHEN**
page: **7**

BASE CABINETS



BUSTER + PUNCH KITCHENS ARE AVAILABLE IN A WIDE RANGE OF FORMATS TO SUIT ANY SPACE.

ISLANDS



TALL CABINETS



EXPLORE THE SIGNATURE LOOKS AND FINISHES OF BUSTER + PUNCH AS YOU DESIGN YOUR KITCHEN.



kitchen taps:

22-23



worktops:

18-19



fronts:

14-15



hardware:

20-21



frame:

16-17



YOUR CHOICES

custom: **DETAILS**

fronts: **STONE GREY**

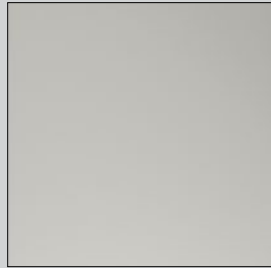

SCRAMBLER GREEN



OFF-BLACK

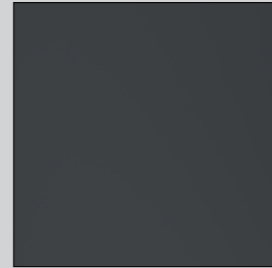

frame: **STONE / STEEL**



STONE / BRASS



BLACK / STEEL



BLACK / BRASS



worktop: **13 MM DEKTON ARGENTINIUM**



13 MM DEKTON BROMO



4 MM STAINLESS STEEL



hardware: **CAST**



CROSS



LINEAR

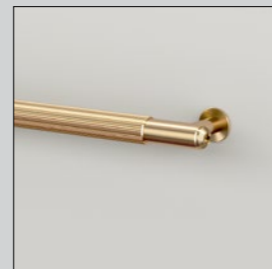

kitchen: **ACCESSORIES**

taps: **CROSS**



LINEAR



shelf: **HANGER**



GIRDER

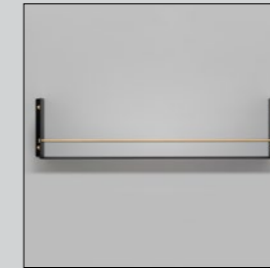

fyi:

- 18mm fascia painted in your choice of colour from our three options.
- Durable and fingerprint resistant finish.
- Signature B+P coin screws.
- Blumotion soft-close hinges by Blum, onyx black, 100 degree opening with anti-slam.
- Full extension Legrabox runners by Blum, matt grey, slimline profile with anti-slam.
- Drawer liners by Blum, soft touch matt rubber.
- Adjustable solid metal feet, with diamond-cut knurling.

FRONTS

material: **18MM FASCIA PAINTED IN YOUR CHOICE OF COLOUR FROM OUR THREE OPTIONS. DURABLE AND FINGERPRINT RESISTANT FINISH.**

edges: **2 MM RADIUS
SOLID EDGE**

finish: **STONE GREY** ●
SCRAMBLER GREEN ●
OFF-BLACK ●

care & cleaning: **FRONTS:**
We recommend using a soft cloth to wipe the surface. If necessary, use a delicate cleaning agent that is recommended for wooden surfaces. Do not use agents containing ammonia, alcohol, bleach, or substances with abrasive properties. If, by accident, something spills, immediately wipe clean to avoid stains.

product image:

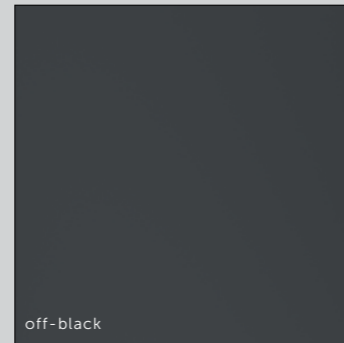
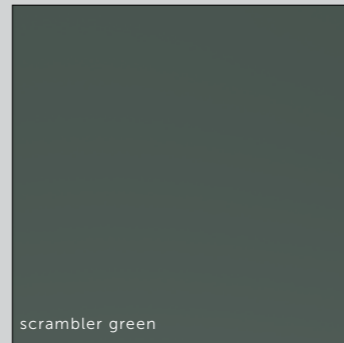

fronts:
hardware:
worktop

**SCRAMBLER GREEN
CAST / GUN METAL
STAINLESS STEEL**

FRAME

frame: **STONE** 
BLACK 

material: **POWDER COATED EXTRUDED ALUMINIUM AND STEEL**

detail: **COIN SCREWS**
CROSS KNURL
CORNER RADIUS

feet: **STEEL** 
BRASS 

care & cleaning: **FRAME:**
Damp cloth with mild detergent.

FEET & COIN SCREWS:
Wipe with a damp cloth with no loose hairs, avoid using chemicals. Please note all finishes are prone to ageing.



fyi: Thick walled extruded aluminium and steel frame brought together with precision by engineered corner pieces. It's finished with an ultra durable, double layer of textured powder coat to give the frame a sharp look that's underscored by an unrivalled choice of robust materials.



fronts: **OFF-BLACK**
frame: **BLACK / BRASS**

WORKTOP

thickness: **4 MM STAINLESS STEEL**
13MM DEKTON PORCELAIN

corner: **RADIUSED TO MATCH FRAME**

shadow gap: **3 MM**

finish: **STAINLESS STEEL** 
DEKTON ARGENTINIUM 
DEKTON BROMO 

care & cleaning: **STAINLESS STEEL:**
Please note, due to the directional brushing, stainless steel is prone to scratch marks initially.

DEKTON PORCELAIN:
For everyday, routine cleaning, simply wipe the surface with a damp cloth and warm soapy water, a mild detergent, or a quality spray to maintain its lustre. Thoroughly dry with a soft cloth or paper towel. For consistent shine, wipe worktops in a broad circular motion.

product image:

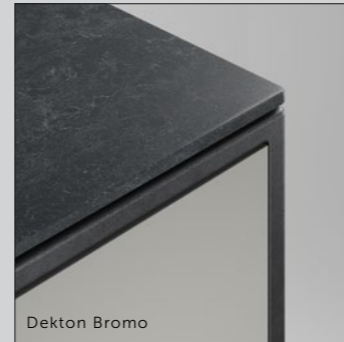
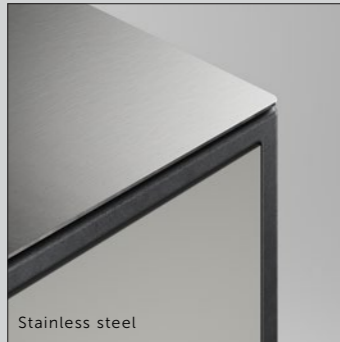

fyi: Dekton is a carbon neutral ultra compact porcelain surface, chosen for its unrivalled quality, durability and strength over time. The aesthetics of natural stone that goes beyond nature achieving the highest product performance.



HARDWARE

collection: **CAST**

finish: **STEEL**
BRASS
GUN METAL
WELDERS BLACK

dimensions:



CARE: Wipe with a damp cloth with no loose hairs, avoid using chemicals.

collection: **CROSS**

finish: **STEEL**
BRASS
SMOKED BRONZE
BLACK

dimensions:

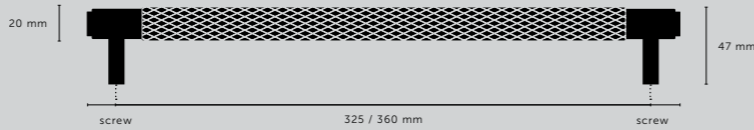

CARE: Wipe with a damp cloth with no loose hairs, avoid using chemicals.

collection: **LINEAR**

finish: **STEEL**
BRASS
GUN METAL
BLACK

dimensions:

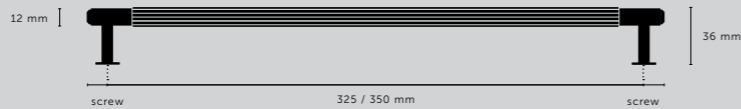

CARE: Wipe with a damp cloth with no loose hairs, avoid using chemicals.



CAST

Our rough-cast process uses solid and molten metal to create an aesthetic that's truly original. Thanks to the nature of the casting process, no two pieces are the same.

SCRAMBLER GREEN

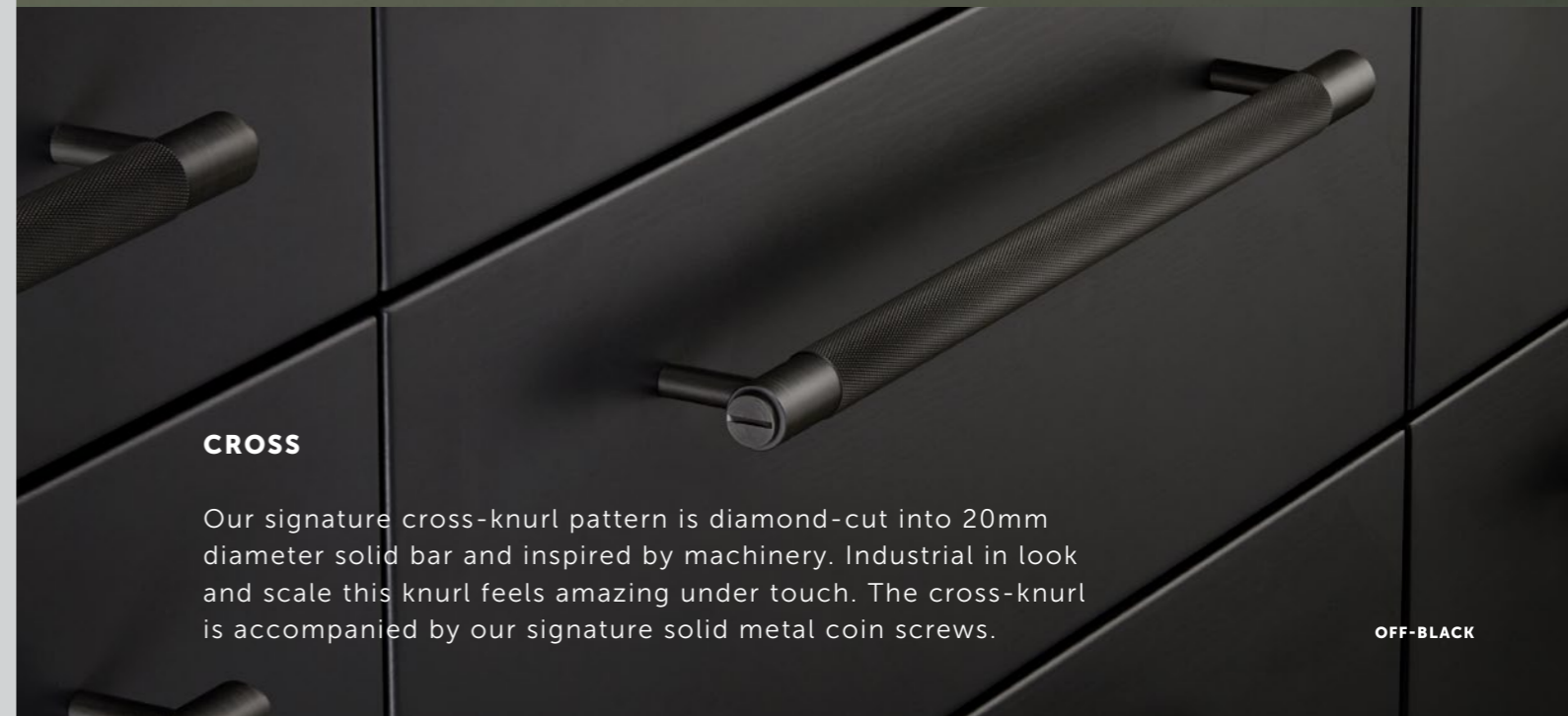

CROSS

Our signature cross-knurl pattern is diamond-cut into 20mm diameter solid bar and inspired by machinery. Industrial in look and scale this knurl feels amazing under touch. The cross-knurl is accompanied by our signature solid metal coin screws.

OFF-BLACK



LINEAR

Our linear-knurl pattern is machined into 12mm diameter solid bar and inspired by fashion accessory hardware. Elegant in look and scale this knurl is beautifully refined. The linear-knurl is accompanied by machined torx screws.

STONE GREY

KITCHEN TAP

knurl: **LINEAR CROSS**

material: **SOLID METAL**

types: **MIXER TAP
MIXER WITH PULL OUT SPRAY**

process: **DIAMOND CNC LATHE**

action: **SINGLE LEVER MIXER**

finish: **STEEL
BRASS
GUN METAL
WELDERS BLACK**



water: **WARM + COLD**

dimensions:

feature: **PULL OUT SPRAY**

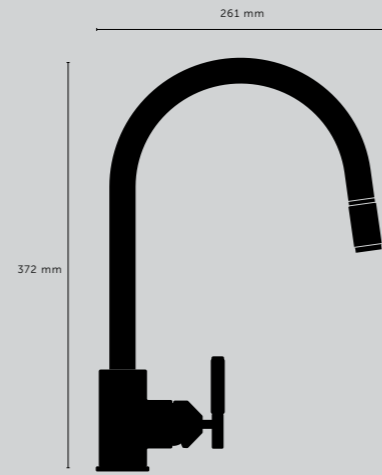
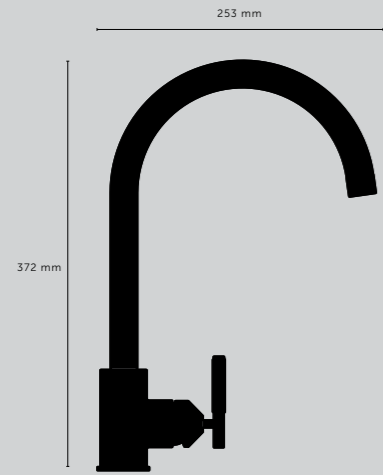

product image:

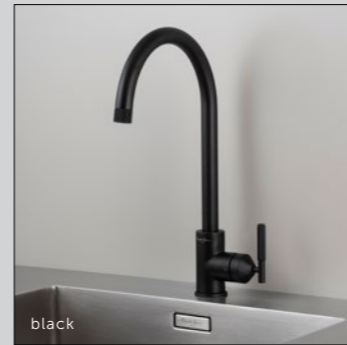

Mixer taps are tested to work with a max. pressure of 10 bar (1000 kPa) and recommended working pressure range is 1.0 – 5.0 bar (100 kPa – 500 kPa). All Buster + Punch mixer taps conform to standard EN817. In some cases, local housing regulations may require mixer taps to be of a higher minimum water pressure standard. In this instance we would recommend consulting with a certified plumber about installing a pressure regulator or similar device.



The Buster + Punch kitchen tap is a monument piece that incorporates all we stand for. Solid metals, signature knurls, enhanced function and unique styling.

APPLIANCES

choose from:

MIELE
GAGGENAU
SIEMENS
FISHER & PAYKEL
BORA
VZUG

Our specialist kitchen designers will help select the best appliance arrangement for your kitchen. Selected from a carefully curated range of appliances, designed to integrate perfectly into Buster + Punch's kitchen cabinetry.

Miele GAGGENAU SIEMENS
FISHER & PAYKEL BORA



fronts: **OFF-BLACK**
hardware: **CROSS / SMOKED BRONZE**

OFF-BLACK

CURATED LOOK BY MASSIMO BUSTER MINALE

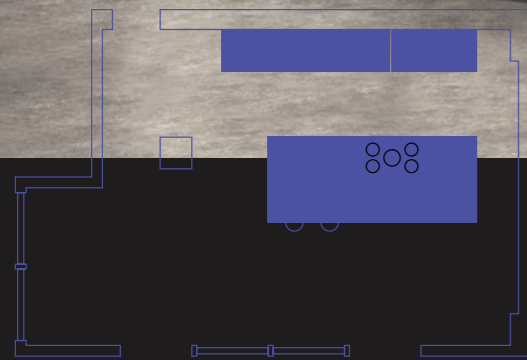

tone: **DARK**

A kitchen designed around Buster + Punch's hardware. With the style and attitude to match.

We've taken inspiration from professional chefs' kitchens for a freestanding design that opens up a space and lets it breathe. The flexibility of this design means it will adapt to how you live now and in the years to come.

In this curated look, Massimo Buster Minale, founder and creative director of Buster + Punch, runs with a black monotone theme. The result is a dramatic space with timeless modernity.



"THE BUSTER + PUNCH KITCHEN IS ADAPTABLE, USABLE, AND FEELS LIKE IT'S BEEN MACHINED FROM ONE SOLID PIECE OF METAL AND STONE."



hardware: **CROSS**
finish: **SMOKED BRONZE**

Smoked bronze hardware in cross-knurl creates a dramatic, deeply nuanced look.



fronts: **OFF-BLACK**

Off-black cabinet fronts are slightly matt to the touch, coated with five layers of super-hardwearing fingermark-resistant lacquer.



frame: **BLACK / STEEL**

The extruded aluminium and steel frame has an identical corner radius to the worktop, a detail that's incredibly hard to execute and rarely seen in kitchen design.



worktop: **DEKTON BROMO**

Edge-to-edge porcelain worktop with soft bevelled edges, 3 mm shadow gap, and matching corner radius.

SCRAMBLER GREEN

CURATED LOOK BY MASSIMO BUSTER MINALE

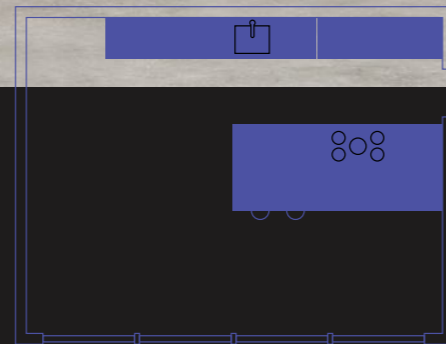

tone: **MID**

Off-beat and enthralling from every angle, this kitchen look explores the soft, mid-tone Scrambler Green.

Experiencing a stellar chef in the kitchen is a poetry of motion, knowledge and skill. Larger spaces like this are the perfect arena to don your chef's hat, sharpen your knives and play to an audience.

This curated look has wide expansive worktops, plus vast storage options to put condiments, seasonings, utensils and tools close to hand when needed. Details definitely make this dish.

"THE RIGHT DETAILS
SET THE FOUNDATION
FOR A COHERENT AND
STRONG AESTHETIC."



hardware: **CAST**
finish: **GUN METAL**

Using a rough-casting process, every piece of hardware in the cast range is unique and original.

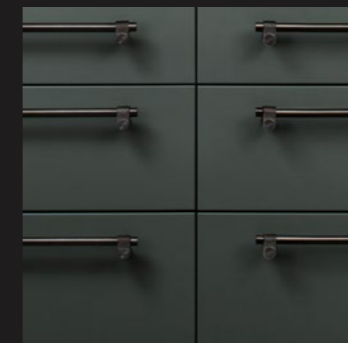

fronts: **SCRAMBLER GREEN**

Scrambler green is a real chameleon hue. Under an array of spotlights it's bright and airy, yet tone the lights down low and it takes on a dramatic feel. Never a dull moment with this colourway.

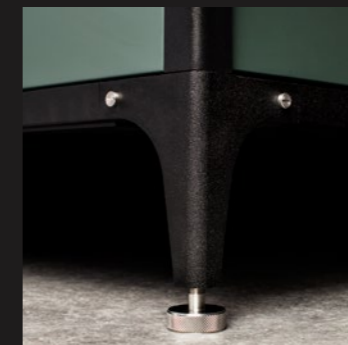

frame: **BLACK / STEEL**

Sharp stainless steel details against the matt black frame. A powerful combination.



worktop: **STAINLESS STEEL**

A gently brushed stainless steel worktop any chef would be proud to square up to.

STONE GREY

CURATED LOOK BY MASSIMO BUSTER MINALE

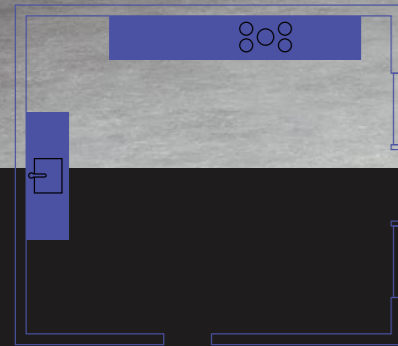

tone: **LIGHT**

Refined and elegant, marrying function with rich, warm detailing to balance out the white colour palette.

This curated look is perfect for a slimline floor plan, with the freestanding units in a simple row giving the impression of being in a much larger space.



“CLEAN AND CRISP WITH THE GLOWING TACTILITY OF OUR BRASS HARDWARE. A LOOK THAT LINGERS IN THE MIND AND LIGHTS THE SOUL.”



hardware: **LINEAR**
finish: **BRASS**

It's impossible to ignore the warm glow of brass hardware. Here in a linear-knurl with its elegant proportions.

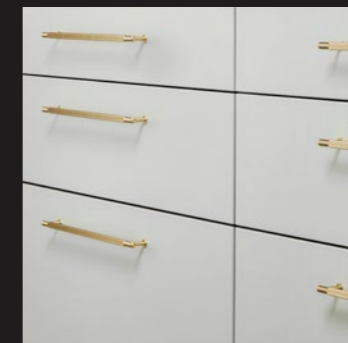

fronts: **STONE GREY**

A vibrant grey with a positive, infectious personality. Contemporary yet classic and very adaptable to different styling intentions.



frame: **STONE / BRASS**

The extruded aluminium and steel frame, capped with our custom-turned, diamond-cut adjustable feet.



worktop: **DEKTON ARGENTINIUM**

High durability and incredibly tactile.

COMPLETE YOUR KITCHEN

ADD BUSTER + PUNCH'S LIGHTING, SHELVING, SWITCHES AND SOCKETS FOR A SEAMLESS LOOK.



task lighting:

36-37

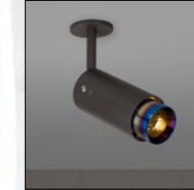

decorative lighting:

38-41

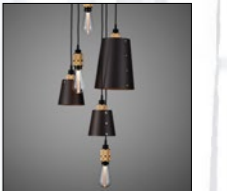
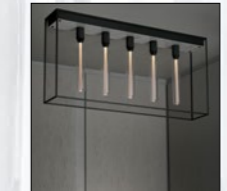
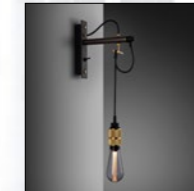

kitchen shelves:

34-35



electricity:

42-43

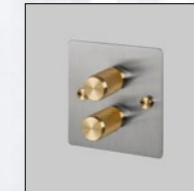
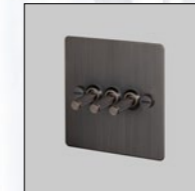

KITCHEN SHELF / HANGER

function: **STORAGE**

finish details: **STEEL**
BRASS
GUN METAL



max load: **30KG**

finish body: **STONE**
BLACK



material: **SOLID METAL**

details: **COIN CAPS**
GUARD RAIL
PAN RAIL

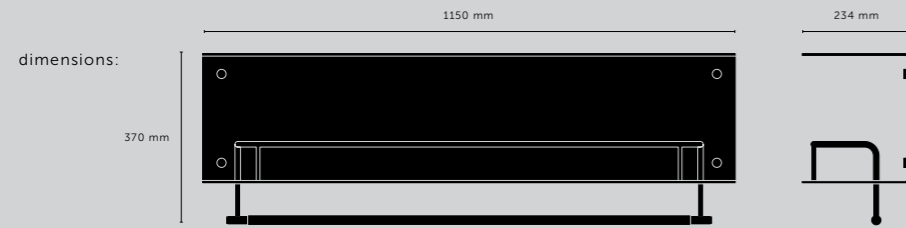

product image:



TASK LIGHTING

EXHAUST

category: **TRACK SPOTLIGHTS***
ADJUSTABLE SPOTLIGHTS
FIXED SPOTLIGHTS
PENDANTS

range: **EXHAUST**

knurl: **LINEAR**

details: **SOLID METAL**
TORX SCREWS
LOW-GLARE HONEYCOMB FILTER

socket: **GU10**
voltage: **220-240V**
classification: **CB/CE CERTIFIED, CLASS 1 & IP20**

finish details: **STEEL**
BURNT STEEL
BRASS
GUN METAL

finish body: **STONE**
GRAPHITE

fyi: **COMPLETE FITTING COMPRISES OF BODY + DETAIL KIT**
GU10 BULB REQUIRED AND SOLD SEPARATELY

compatibility:* **THE TRACK FITTING WORKS WITH GLOBAL, POWERGEAR,**
EUTRAC, NORDIC AND UNIPRO 3-CIRCUIT TRACK*

product image:

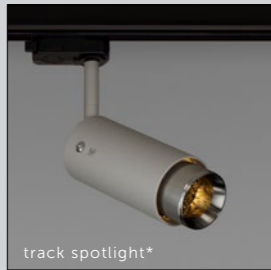
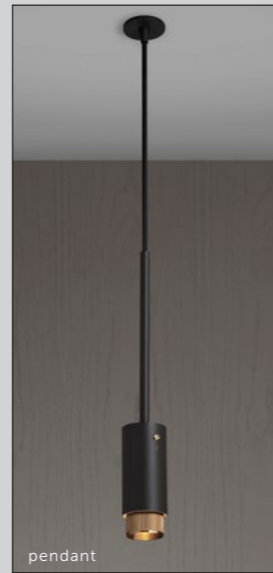

scale:

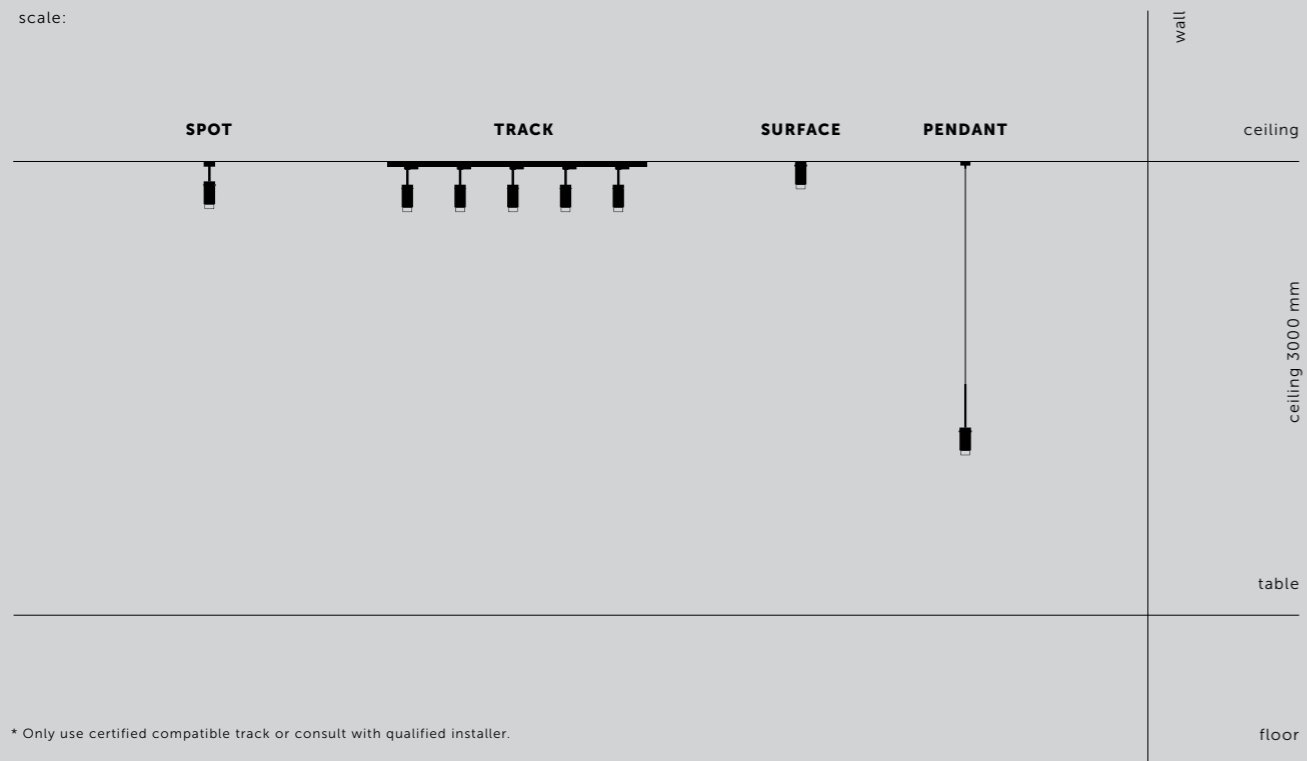

* Only use certified compatible track or consult with qualified installer.



type: **EXHAUST / TRACK**
finish: **GRAPHITE / GUN METAL**

DECORATIVE LIGHTING

HOOKED

category: **PENDANTS
WALL LIGHTS**

range: **HOOKED**

knurl: **CROSS**

socket: **E27**

voltage: **220-240V**

classification: **CB/CE CERTIFIED, CLASS 1 & IP20**

finish details: **STEEL**
BRASS
SMOKED BRONZE

finish shade: **STONE**
GRAPHITE

cable length: **UP TO 2.6M (PENDANT)**
UP TO 0.5M (WALL LIGHT)

details: **SOLID METAL**
CUSTOMISING HOOKS

product image:

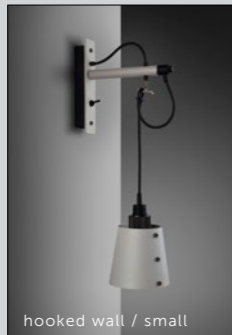
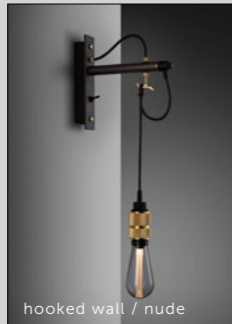

scale:

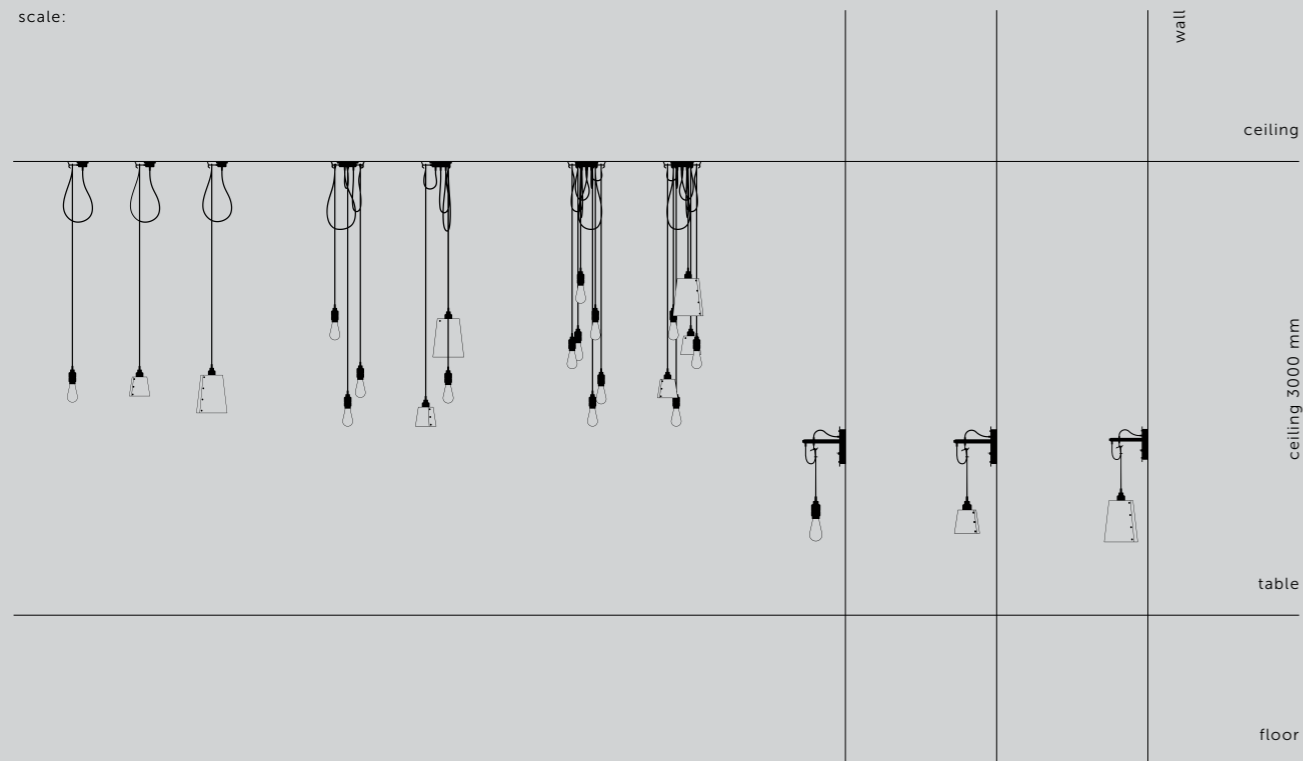

DECORATIVE LIGHTING

CAGED

category: **CEILING LIGHTS
WALL LIGHTS**

socket: **E27**
voltage: **220-240V**
classification: **CB/CE CERTIFIED, CLASS 1 & IP20**

range: **CAGED**

knurl: **CROSS**

details: **MATT BLACK METAL CAGE
MATT BLACK KNURLED PENDANT
MATT BLACK COIN SCREWS**

finish: **POLISHED WHITE MARBLE
SATIN BLACK MARBLE**

product image:

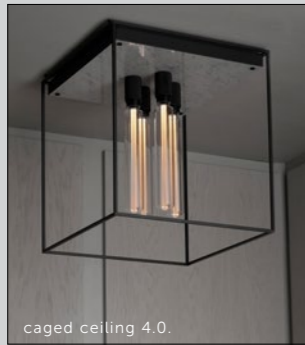
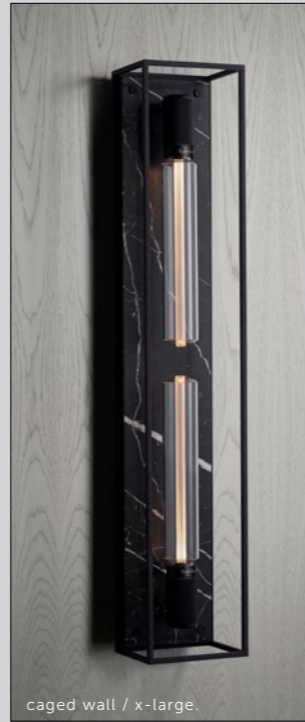
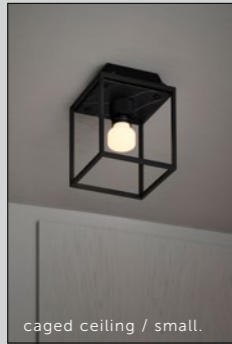

scale:



type: **CAGED WALL / LARGE**
finish: **BLACK MARBLE**

ELECTRICITY

knurl: **CROSS**

finish: **WHITE**

type: **TOGGLE SWITCH
DIMMER SWITCH
UK SOCKETS
EURO SOCKETS
COOKER SWITCH
DP SWITCH
SWITCHED FUSED SPUR
FAN SWITCH
COOKER CONTROL UNIT
SHAVER SOCKET**

**WHITE + STEEL
WHITE + BRASS
STEEL
STEEL + BRASS
BRASS
SMOKED BRONZE
SMOKED BRONZE + STEEL
SMOKED BRONZE + BRASS
BLACK
BLACK + STEEL
BLACK + BRASS**



details: **SOLID METAL
COIN SCREWS**

product image:



1G toggle



2G toggle



3G toggle



4G toggle



1G dimmer



2G dimmer



3G dimmer



4G dimmer



1G UK plug socket



cooker switch



1G USB socket



2G UK plug socket



OUR DESIGNER

The Buster + Punch Kitchen and its accessories range are designed by renowned London architect, Massimo Buster Minale. His mission with Buster + Punch is to transform ordinary design and interior detailing into extraordinary pieces that change the way you connect with your home.



"WE'VE DESIGNED THE ENTIRE KITCHEN PROCESS FROM BEGINNING TO END TO GIVE YOU CONTROL AND OWNERSHIP AS YOU CREATE YOUR DREAM KITCHEN. EVERY SINGLE DETAIL HAS BEEN CONSIDERED, WITH ZERO COMPROMISE ANYWHERE, TO MAKE THE BUSTER + PUNCH KITCHEN A SPACE THAT EXCEEDS ALL EXPECTATIONS."

**VISIT US AT ONE OF OUR LONDON
SHOWROOMS TO EXPERIENCE THE
BUSTER + PUNCH KITCHEN.**



