



**From start
to finish,
we're here
when you
need us.**



**Phone (800) 328-0953
Fax (800) 334-8823
www.reeseusa.com
info@reeseusa.com**

GENERAL INFORMATION

All Reese products comply with the Buy American Act (BAA) and the American Reinvestment and Recovery Act (ARRA).



FIRE RATED — UL10B Tested. See page 5.



POSITIVE PRESSURE — UL10C Positive Pressure Test. See page 5.



SMOKE AND DRAFT CONTROL TEST — Category H Listed, UL-1784. For use on “S” labeled doors. See page 6.



SOUND TEST — ASTM standard E90-75. See page 7.



AIR INFILTRATION TEST — E283-73 AND SDI 116 Air. See page 7.



EDGE SEAL TESTED — UL10C Category G. See page 29.



ADA COMPLIANT THRESHOLDS — These thresholds have less than 1/4” vertical rise, beveled rise slope no greater than 1:2 up to 1/2”, and ramps with slope less than 1:12. They meet ANSI spec. A117.1.

MATERIAL DESIGNATIONS

A – Mill finish aluminum

B – Architectural brass

BLK – Black anodized aluminum

C – Clear anodized aluminum

D – Dark bronze anodized aluminum

G – Gold anodized

SS – Stainless steel

V – Vinyl insert

N – Neoprene insert

U – Polyurethane insert

P – Pile insert

PR – Polypropylene insert

S – Silicone insert

Material Finishes

Aluminum extrusions shown are alloy 6063-T5. They are available in mill finish, clear, gold and duranodic bronze finish as noted.

Bronze extrusions are alloy 385 architectural bronze. They are furnished in mill finish, which is a light brass color.

Spring bronze weatherstrips are roll-formed from 85/15 red brass strip.

All vinyl weatherstrips are extruded from “cold weather” vinyl, which remains flexible down to -30°F and is in compliance with commercial standard CS230-60, as published by the U.S. Department of Commerce and ASTM D-2287-81.

Polyurethane is an ether-based elastomeric thermoplastic, resin especially developed for low temperature flexibility, abrasion resistance and durability. See page 23 for more attributes.

All expanded (sponge) neoprene is closed cell, and extruded with a tough outer skin for extra abrasion resistance or slitted without outer skin. It is black in color for maximum weatherability. See page 25 for more attributes.

Silicone rubber is a synthetic polymer able to withstand a wide range of temperature extremes. See page 24 for more attributes.

Polypropylene is a thermoplastic rubber compound developed by Reese that has excellent low temperature flexibility and weather resisting qualities. See page 24 for more attributes.

c/c — Code Acceptability, Certification

All Reese products are guaranteed for two years against defects in material or workmanship. Defective goods will be replaced or repaired, at our option. No claims for damage incurred or work done thereon will be allowed. Reese does not assume liability for consequential damages or delays, and claims for labor will not be allowed.

pp — Product Presentations

Product drawings in this catalog are full size cross-section profiles, unless noted, and are designed to illustrate the uses and applications of the products. Dimensions not shown may be obtained by scaling the drawings. Catalog illustrations are sufficiently accurate to use as templates.

a/c — Availability, Costs

All products in this catalog are stocked for prompt shipment at our Rosemount, Minnesota plant. Catalogs and price lists are available from our plant.

STANDARD SCREWS FURNISHED WITH THRESHOLDS: No. 10 Phillips Flat Head Wood Screws in appropriate length.

STANDARD SCREWS FURNISHED WITH WEATHERSTRIP: 6 x 5/8” pan screws (furnished for most weatherstrips)

Fire Rated Weatherstrips and Thresholds

All fire rated weatherstrips and thresholds listed on this page have been tested and have pass **THE POSITIVE PRESSURE REQUIREMENTS UL10C AND MEETS CAN4-S104-2010. CATEGORY J LISTED GASKETING.** UL rated materials cover the fire test of door assemblies for **UL10B.**



The "F" prefix designates that the product has been fire tested and that each piece has the UL label attached*. Materials are not shipped with the UL label unless specified by ordering with the prefix "F-".

*Fire rated labels at no extra charge

WEATHERSTRIPS

<u>Adjustable Door Stop</u>	33, 59, 95, 99, 399, 599, 633, 659	Drawing on Page 28
<u>Astragal</u>	M35, DS75, 92, 93, 95P, 95V, 103, 129P, 129V, 203, 276, 678, 688, 792, 804, 807, 954, 955, 959, 961, 964, 967	Drawing on Page 32
<u>Hardware Compatible Perimeter Gasket</u>	653, 655, 657, 754, 755, 757, 758, 759, 775, 786, 854, 855, 856, 858, 859, 875	Drawing on Page 27
<u>Perimeter Seal</u>	39, 49, DS62, DS63, DS69, DS70, DS75, DS76, DS77, DS78, DS79, 93, DS106, 128V, 129P, 129V, 364, 373, 612, 619, 669, 678, 688, 769, 770, 778, 779, 788, 795, 804, 807, 815, 818, 822, 863, 884, 888, 918, 934, 954, 955, 956, 958, 959, 961, 962, 964, 965, 967, 968, 970, 973	Drawing on Page 23
<u>Self-Adhesive Weatherstrip</u>	588, 608, 628, 629, 631, 632, 638, 793, 797, 798	Drawing on Page 29

DOOR BOTTOMS

<u>Automatic Door Bottom</u>	320, 321, 330, 370, 372, 430, 521, 933, 934	Drawing on Page 38
<u>Door Shoe/Extender</u>	DB591F, DB591U, DB592F, DB592U, DB593F, DB593U, DB594F, DB594U, DB595F, DB595U, DB596F, DB596U, DB600F, DB600U, 1030, 1031, 1032, 1033	Drawing on Page 37
<u>Door Sweep</u>	M15, M35, 64, 323, 353, 354, 362, 377, DB469, 602, 603, 701, 772, 773, 805, 806, 810, 825 954, 955, 960, 962, 963, 964, 965, 966, 967, 968, 969, 970, 971, 973, 977, 978, 979, 984, 985, 986	Drawing on Page 36 Drawing on Page 30

THRESHOLDS

<u>All Aluminum, Brass, and Stainless-Steel</u>	Drawing on Page 8-22
<u>Hospitality Thresholds</u>	Drawing on Page 41

UL 10 C – Category J Listed

Intended for application to/with listed steel frames and/or classified hollow metal or steel covered composite type fire doors rated up to 3 hours; wood composite and plastic covered type fire doors rated up to 1-1/2 hours; and wood core type 20 minutes.

UL 10 B

Intended for application to/with listed steel frames and/or classified hollow metal or steel covered composite type fire doors rated up to 3 hours; wood composite type fire doors rated up to 1-1/2 hours; and wood core type 20 minutes w/o hose stream.

Smoke and Draft Control Gasketing

For Use on ‘S’ Labeled Doors. Category H Listed Smoke and Draft Control Gasket. Complying with UL 1784 Standard for Air Leakage Tests of Door Assemblies and Other Openings Protectives. S

Tested for The Following Applications:

Wood Core Door Rated Up to 20 Minutes with Hose Stream		
Wood and Plastic Covered Composite Fire Doors Rated Up to 1-1/2 Hours		
Steel Covered Composite and Hollow-Metal Doors Rated Up to 3 Hours		
<u>Adjustable Door Stop</u>		
Neoprene	33, 59, 99, 399, 599	Drawing on Page 28
Silicone	633 and 659	Drawing on Page 28
<u>Astragal</u>		
Neoprene	93	Drawing on Page 32
Nylon Brush	959, 964, 967	Drawing on Page 33
Polyprene	92, 103, 792, 793(with 183), 797(with 183), 798(with 183)	Drawing on Page 32
Silicone	638(with 183)	Drawing on Page 32
Vinyl	M35	Drawing on Page 32
<u>Hardware Compatible Perimeter Seal</u>		
Neoprene	757	Drawing on Page 27
Polyprene	755 and 855	Drawing on Page 27
Polyurethane	775 and 875	Drawing on Page 27
Silicone	653, 655, 657	Drawing on Page 27
<u>Perimeter Seal</u>		
Neoprene	39, 49, DS69, DS70, DS76, DS77, DS78, DS79, 364, 373	Drawing on Page 25
Nylon Brush	918, 934, 956, 958, 959, 961, 964, 967	Drawing on Page 30
Polyprene	815 and 818	Drawing on Page 24
Polyurethane	769, 770, 778, 779, 788, 795	Drawing on Page 23
Silicone	612, 619, 669, 678, 688	Drawing on Page 24
<u>Self-Adhesive Perimeter Seal</u>		
Intumescent*	588	Drawing on Page 29
Polyprene	793, 797, 798	Drawing on Page 29
Silicone	638	Drawing on Page 29

*588 Also Rated as Category G, Edge Sealing System. See Page 29 for More Information.

Note: Any UL 10C Classified Threshold, Automatic Door Bottom, Door Sweep, or Door Shoe May Be Installed (Although Not Required) on a ‘S’ Label Door Without Affecting the Label.

Offset Saddle Thresholds

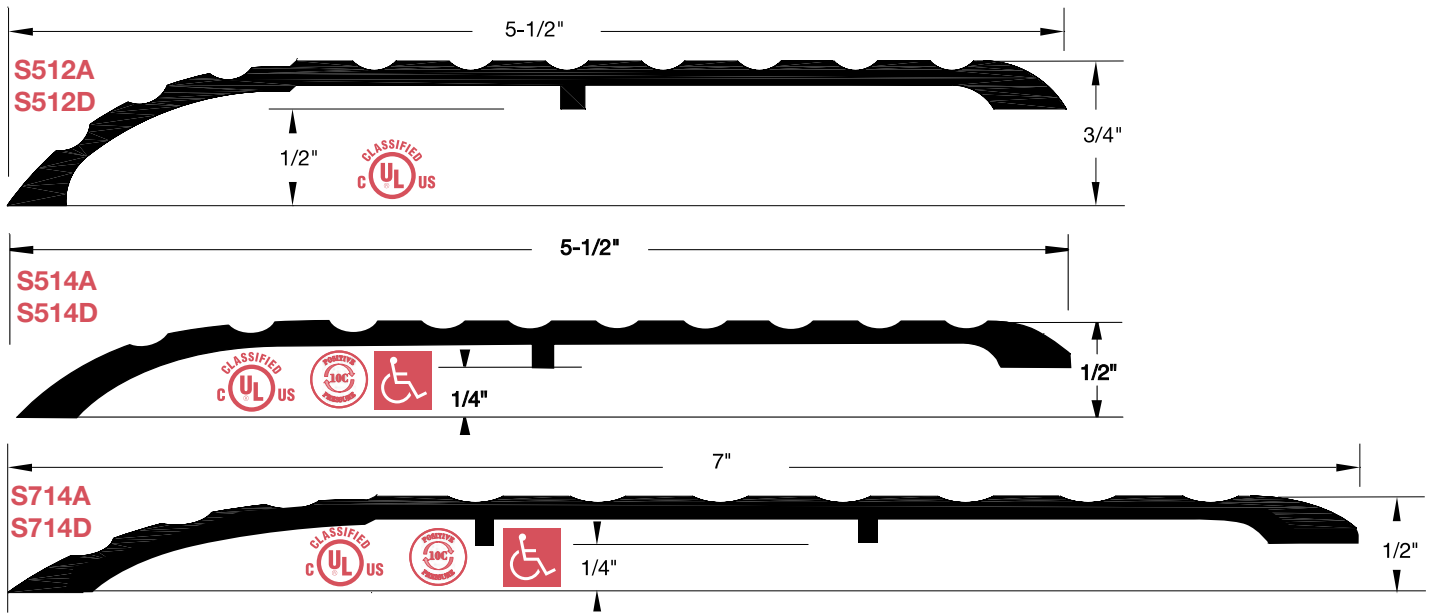

Stainless Steel Thresholds

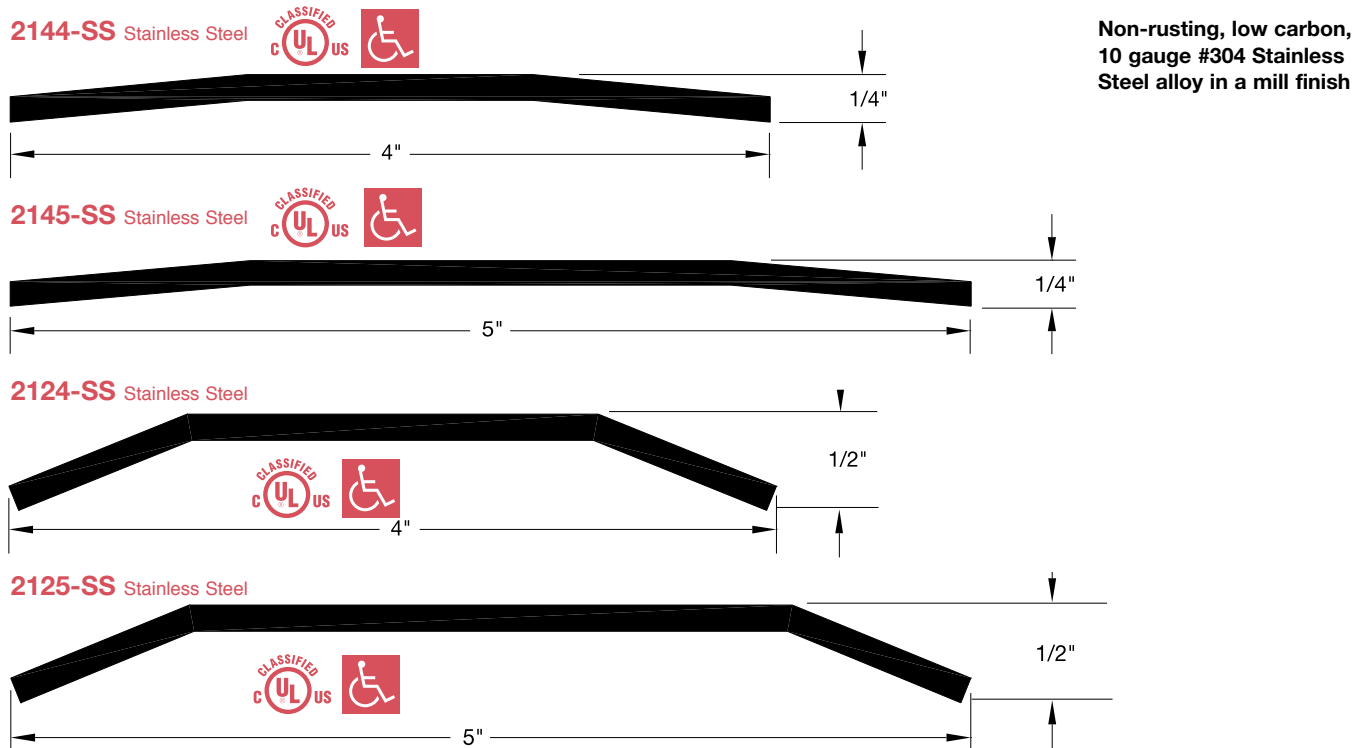

Fiberglass Thresholds

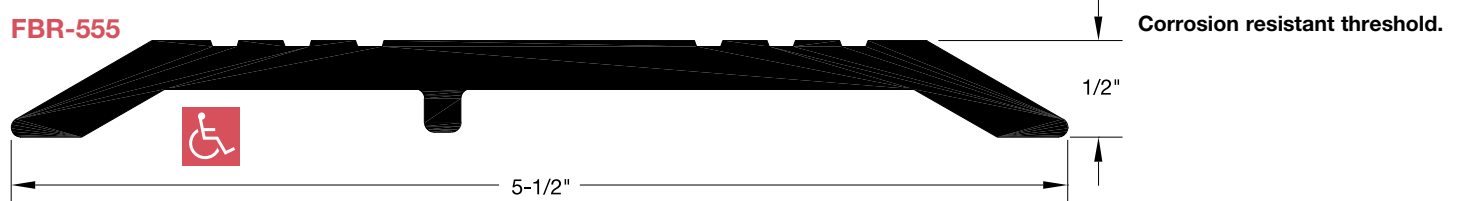

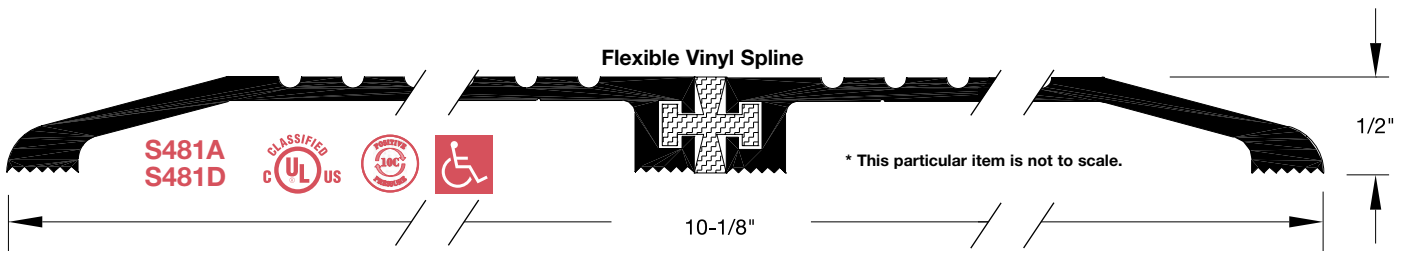

Offset Thermal Break Thresholds

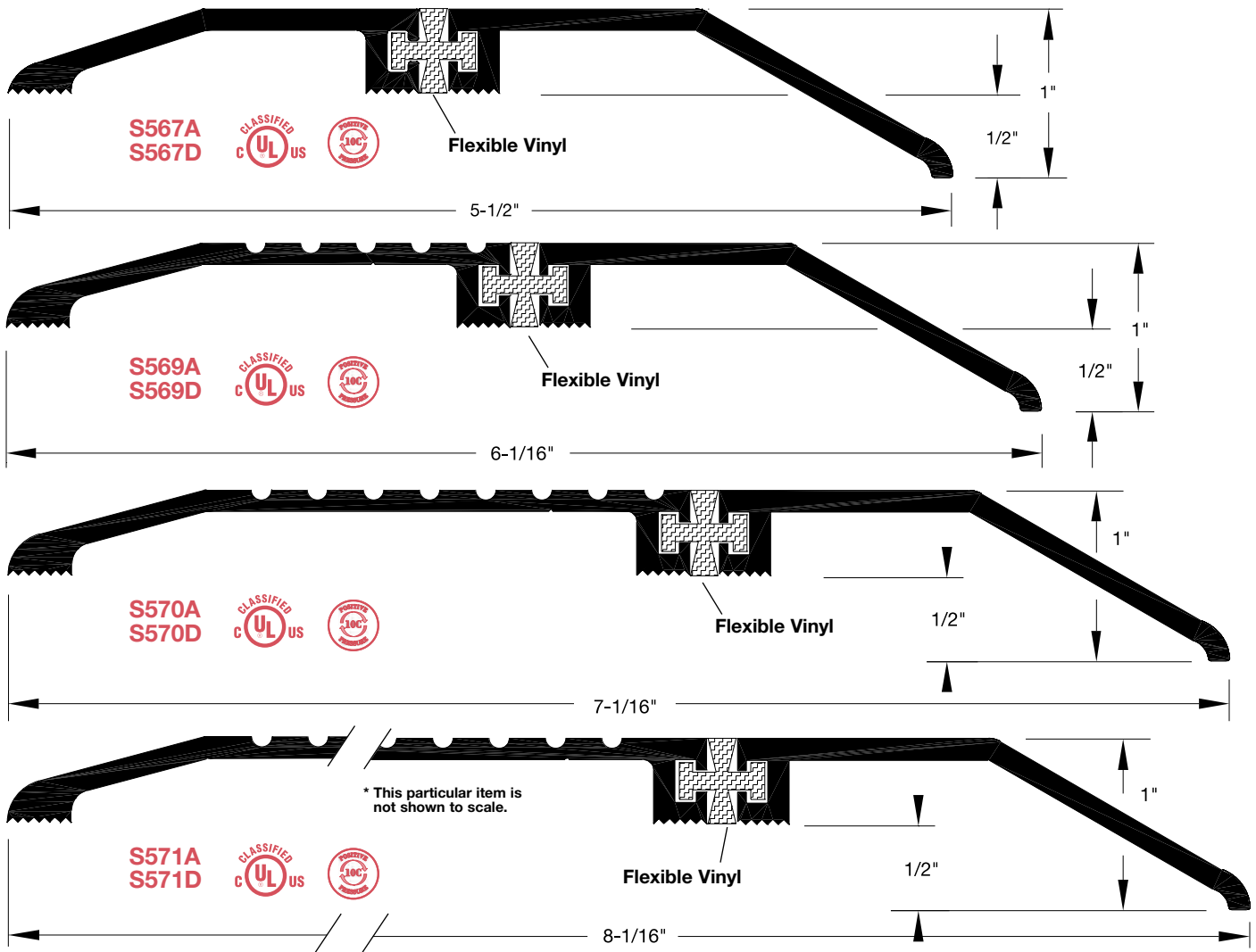

Beveled Aluminum Plates

These plates are fabricated to customer specifications. Templates for factory hole drilling

should be furnished. If no template is furnished, they will be supplied undrilled. Minimum width 2".

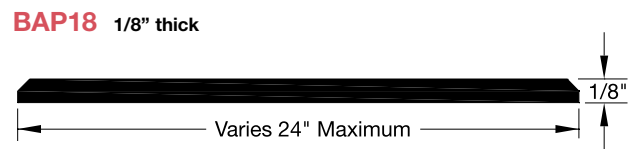
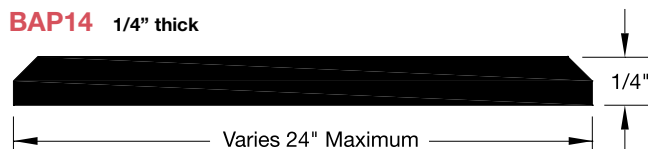

S239A
S239B*
S239D

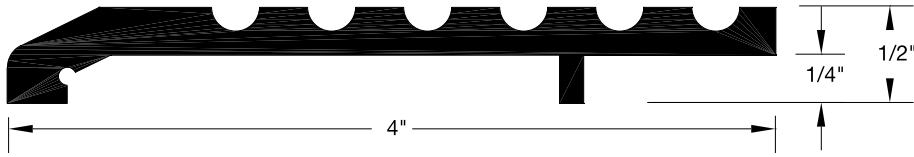

S245A
S245B*
S245D

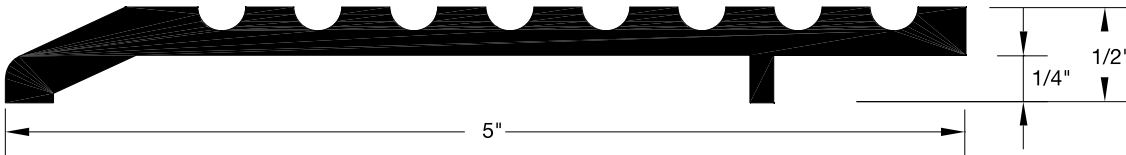

S243A
S243D

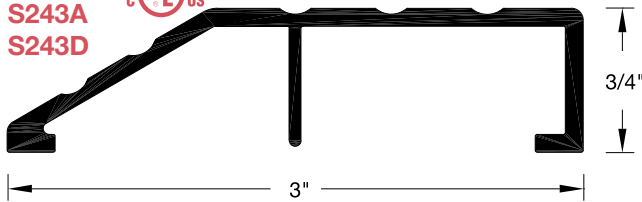

Offset Panic Thresholds

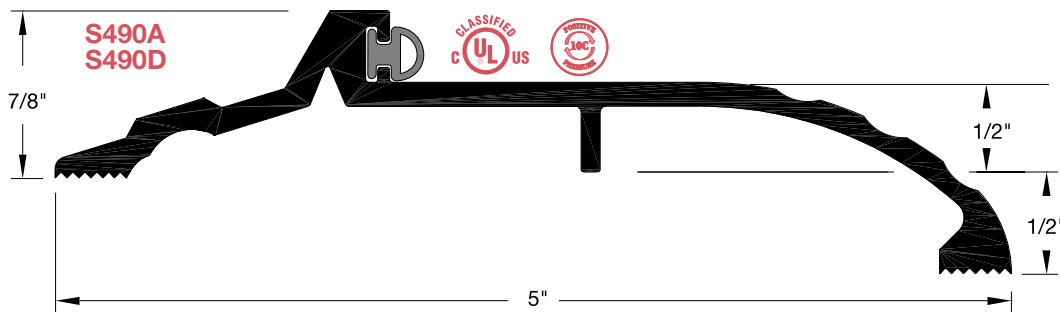
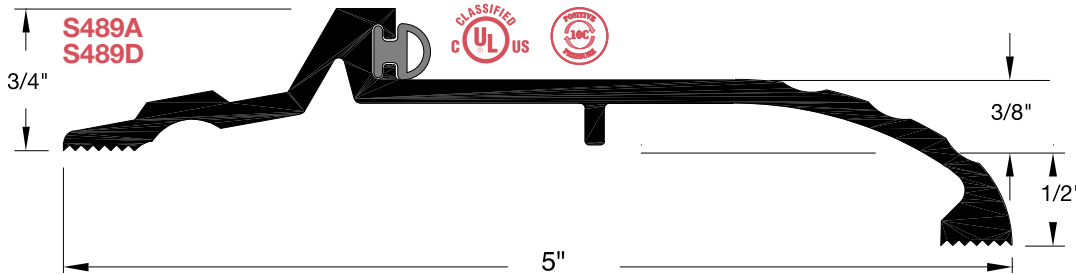

Vinyl insert shipped if no insert specified

* Brass equivalent may differ slightly from the aluminum profile in images.

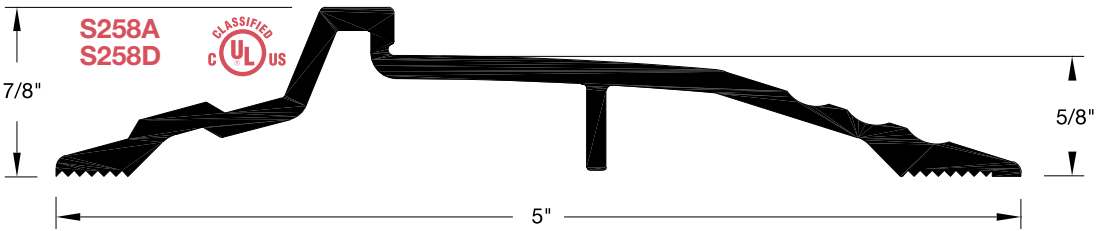
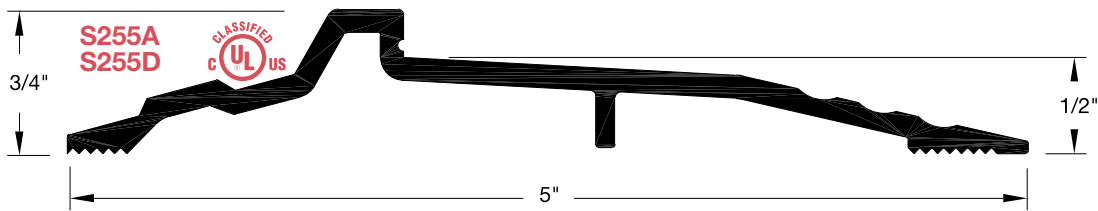
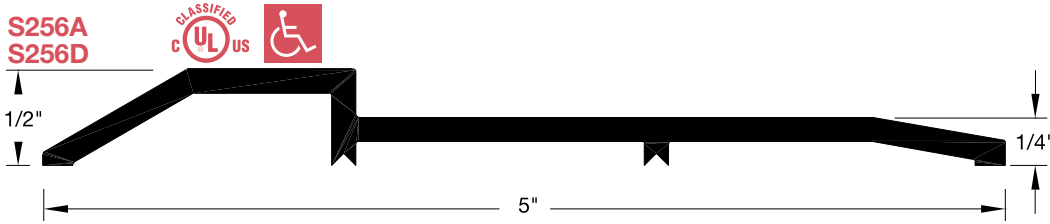
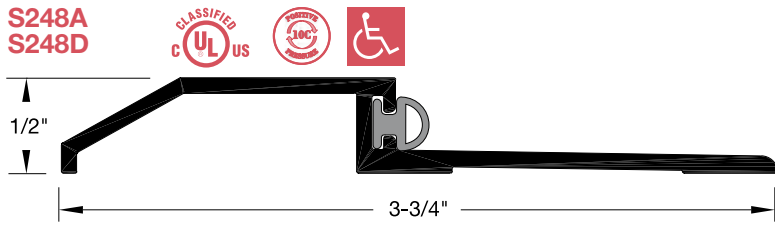

Offset Thermal Break Panic Thresholds

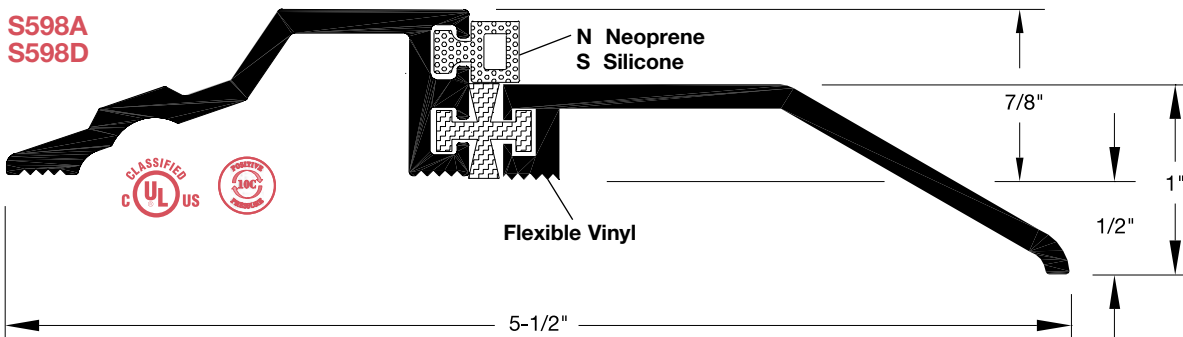
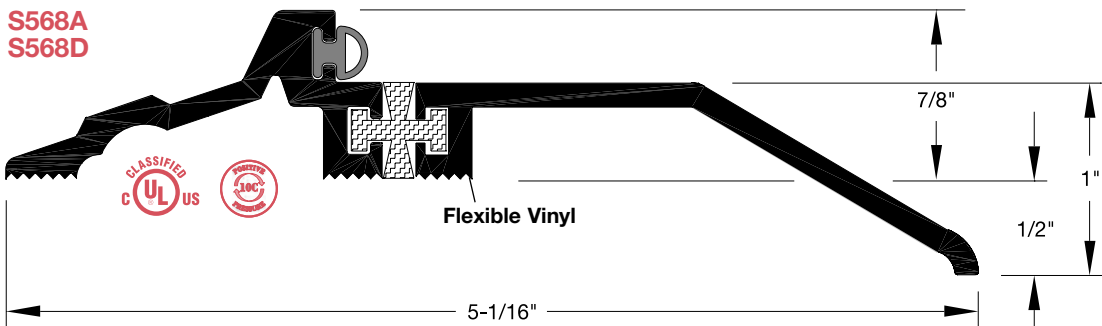

Neoprene insert shipped if no insert specified

Reese Enterprises



Reese Enterprises is a family owned business that has been designing American made door hardware and entrance floor mats and grates since 1918.

We pride ourselves in reducing stress and headaches by providing one of the best customer service teams in the industry, along with quality products, great order packaging, and fast lead times.

Post Office Box 459

Rosemount, MN 55068-0459

Phone (800) 328-0953

Fax (800) 334-8823

www.reeseusa.com

info@reeseusa.com



NEW HOSPITALITY LINE

Vinyl Thresholds, Quick Seal Adhesives, Dark-AN Door Bottoms



SEE PAGES 41-43