

WeatherTech® AlloyCover™



INSTALLATION INSTRUCTIONS AND OWNER'S MANUAL

Thank you for purchasing the AlloyCover™ from WeatherTech®. Manufactured with pride using superior quality materials and workmanship. With proper care, your cover will provide years of service and enjoyment.

NOTICE TO INSTALLER: Even if familiar with cover, read instructions prior to installation as improvements may be made without notice. Always handle cover and components with care. If you have questions or problems, have serial number ready and call customer service. When done, these instructions must be given to the consumer.

NOTICE TO CONSUMER: Before using cover, read operating, maintenance, and safety sections and save owner's manual for future reference.

Questions? (800) 441-6287

WeatherTech®.com

1 MacNeil Ct, Bolingbrook, IL 60440

PREPARATION

Unpack cover components and clean truck box if dirty.

COMPONENTS

- (8) Clamps
- (2) Safety straps
- Driver side rail
- Passenger side rail
- Pre-folded cover assembly

TOOLS NEEDED

- 1/2" Wrench
- Optional - 7/16" Wrench
- Torque wrench with 1/2" socket
- Tape measure or ruler
- Protective eyewear
- Spring clamp (optional)

NOTE: With an under the rail drop-in bed liner, installation is possible with minimal trimming/cutting of bed liner at front corner of box and back by tailgate to allow side rail to install properly. Considerable trimming/cutting is required with an over the rail drop-in bed liner.

NOTE: For additional protection against the elements, locate and seal miscellaneous factory holes, crevices, stake pockets, etc. that may be in box (sealant not included).

NOTE: Tonneau cover and side rail appearance may vary. Typically a vehicle with a 6' or longer box is provided with two multi-piece side rails.

▲ CAUTION: Over torquing hardware may damage components.

PARTS DIAGRAM

Front (closest to cab)

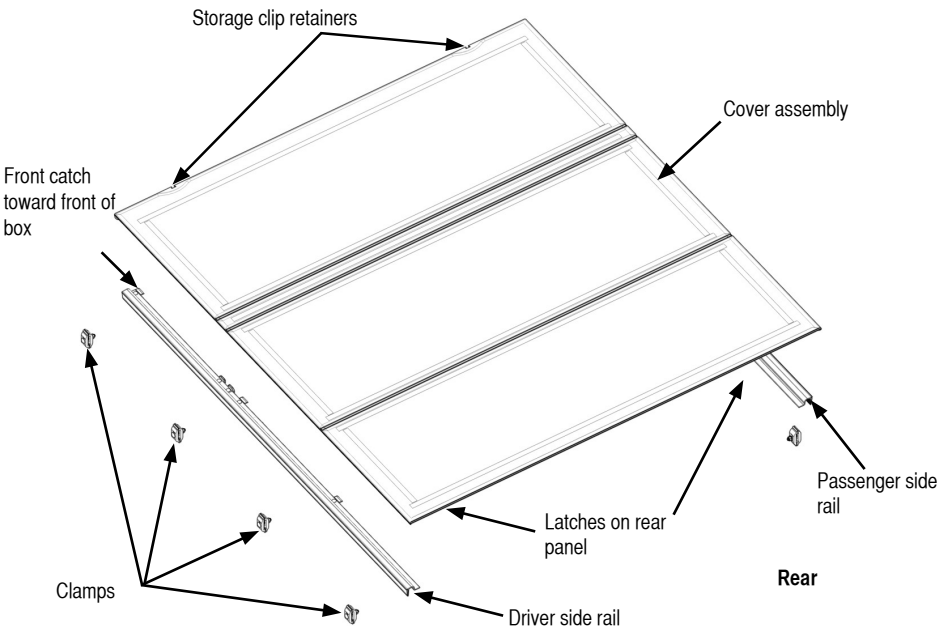

1: INSTALLING SIDE RAILS

NOTE: Some installs require special instructions. If required, follow special instructions for side rail attachment along with these standard instructions.

A. Position side rail with weather strip against inside lip of box and front catch toward front of box. Push side rail forward until it touches front of box.

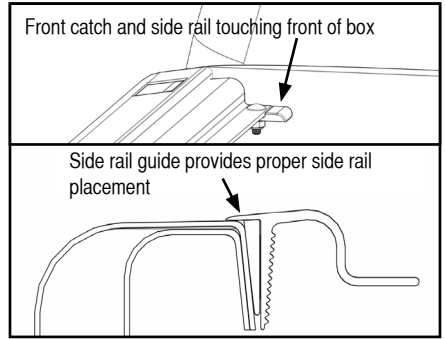

B. Ensure each clamp half has a wide and narrow offset positioned at top and bottom. Adjust top of side rail until flush with top of box, hold with assistance of another person or spring clamp. Install first clamp as close to front as possible and use 1/2" wrench to tighten.

IMPORTANT: To keep side rail secured on truck, ensure clamp teeth engage grooves on side rail, turn nut finger tight, then use wrench to finish tightening.

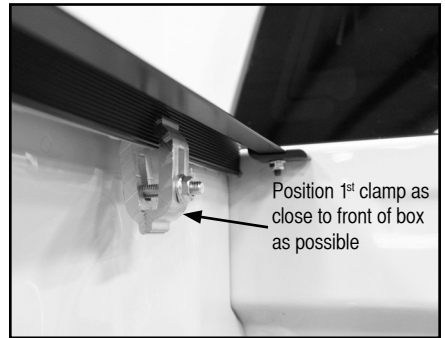

NOTE: Images below illustrate clamping options. Option A depicts standard clamping orientation lower on the side rail. Option B depicts alternate clamping orientation with half of clamp assembly rotated 180° to provide better grip at top of side rail.

C. Verify side rail is level. If side rail is not level, perform one of the following:

If side rail tilts up: loosen and lower clamp, engage teeth and then retighten clamp.

If side rail tilts down: loosen and raise clamp, engage teeth and then retighten clamp.

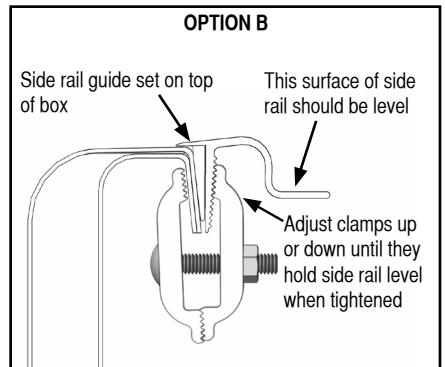
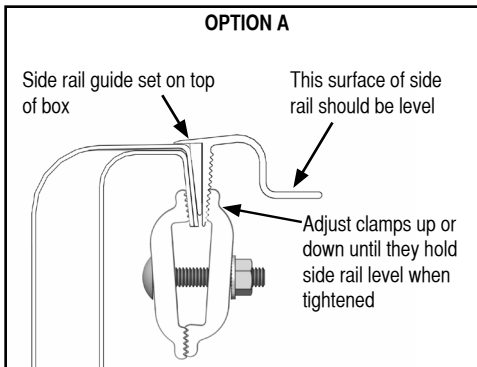

1: INSTALLING SIDE RAILS (Continued)

- D. With side rail guide set on top of box, install second clamp on side rail $1/3^{\text{rd}}$ from front of box. Repeat clamping procedure.
- E. With side rail guide set on top of box, install third clamp $2/3^{\text{rds}}$ from front of box. Repeat clamping procedure.
- F. At rear of box, place rear clamp as close to tailgate as possible. Repeat clamping procedure.

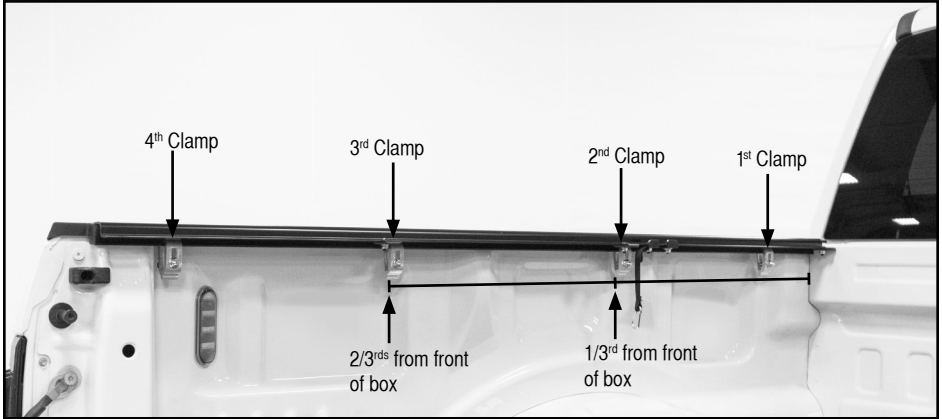

NOTE: For trucks with electric tailgates, typically side rail must be installed slightly higher to eliminate interference.

- G. Repeat Step 1 to install side rail on opposite side.
- H. Torque all clamps to 20 ft-lbs or value specified in special instructions (if supplied).

2: APPLYING SEAL

NOTE: For best adhesion, ensure air and surface temperatures are above 60°F.

NOTE: With a spray-in bed liner, better adhesion is possible by smoothing surface and applying an adhesion promoter.

A. Ensure bulkhead is clean, wipe top surface with alcohol pad (if needed wash and dry surface first).

NOTE: If replacing previous seal, ensure previous seal, debris and remaining adhesive residue are completely removed.

IMPORTANT: Ensure tall side of seal faces cab.

B. Starting at one end, peel protective backing as you go. Align and adhere seal against front of side rail and inside edge of box to opposite corner and cut to length.

C. Firmly press adhesive along seal.

NOTE: Trim tall side of seal if necessary to ensure proper seal.

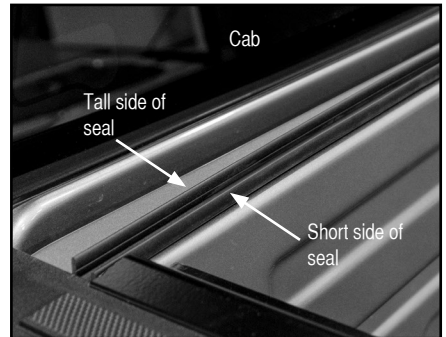

3: INSTALLING COVER

A. At front of box, lift folded cover above side rails and place leading edge of front panel on front rails.

B. Hold cover rear edge 1" above side rails and slide cover hooks underneath front rail catch on each side.

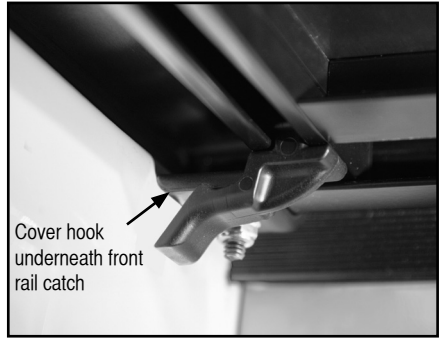

C. With cover hooks engaged underneath front catches, lower cover to engage latches in retainment brackets on each side.

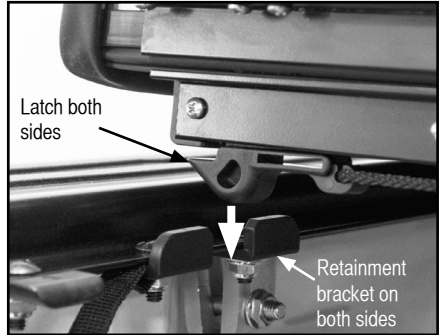

D. Attach safety straps to safety strap brackets on each side.

IMPORTANT: Always ensure safety straps are attached to cover and side rails.

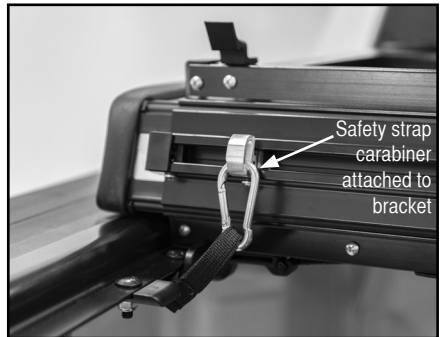

3: INSTALLING COVER (Continued)

E. Unhook storage clips at front of cover and unfold middle panel toward tailgate.

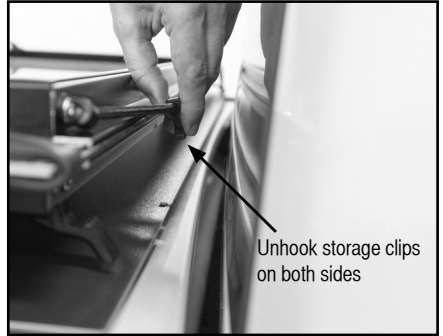

F. Unfold rear panel toward tailgate.

IMPORTANT: Always ensure hooks and latches fully engaged catches and side rails.

NOTE: After installation, cover should remain on truck box in closed position for at least 48 hours. During this time period the cover typically conforms to truck box.

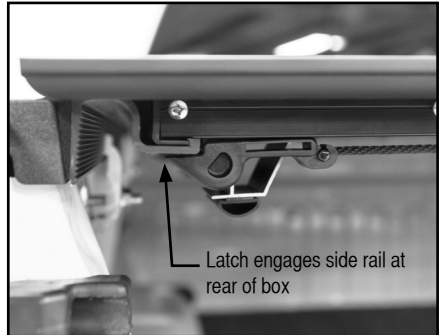

TROUBLESHOOTING

PROBLEM

SOLUTION

Top of tailgate hits cover when attempting to close.

Verify top of side rail guide is set on top of box. Side rails are set too low at rear of cover, raise rails at rear of box until cover no longer interferes with tailgate operation (see Step 1).

Gap between cover and truck box or tailgate.

Verify top of side rail guide is set on top of box. Side rails are set too high (see Step 1).

Seal on edge of cover is not sealing tight with top of side rail and truck box.

Verify top of side rail guide is set on top of box. Side rails are set too high (see Step 1).

Latch doesn't engage.

Check side rails for height and level (see Step 1). Inspect latches for jammed or broken parts.

Cover is not parallel with side rails.

With cover installed on box, loosen hardware on both retainment brackets with 7/16" wrench (DO NOT REMOVE HARDWARE). Unfold cover to closed position and square up with box. Carefully fold cover back to open position and retighten retainment bracket hardware.

OPENING TRI-FOLD COVER

IMPORTANT: To avoid damage or misalignment of hinge points, open cover in a smooth, fluid manner. Avoid dropping or slamming cover.

IMPORTANT: Remove debris or snow from hinges before opening cover.

A. Open tailgate, pull release latch.



B. Fold panels toward the cab.



C. Fasten storage clips on both sides to store the cover.



CLOSING TRI-FOLD COVER

IMPORTANT: To avoid damage or misalignment of hinge points, close cover in a smooth, fluid manner. Avoid dropping or slamming cover.

IMPORTANT: Remove debris or snow from hinges before closing cover.

A. Open tailgate, unfasten storage clips on both sides.

B. Unfold panels toward tailgate.

C. Always ensure hooks and latches fully engage catches and side rails. Close tailgate.

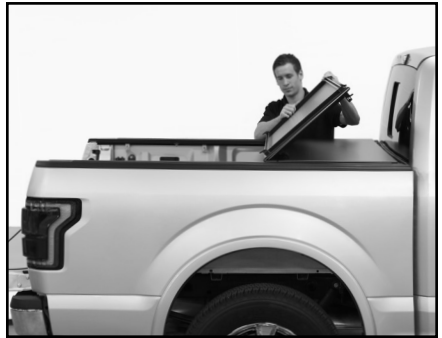

REMOVING AND REINSTALLING COVER

REMOVE COVER

- A. With cover open and storage clips secured, detach safety straps from safety brackets.
- B. Pull tab on front panel and lift rear edge of cover 1" above side rails (Figure 1).
- C. Slide cover back to disengage hooks, then lift to remove (Figure 2).
- D. Attach safety strap carabiner to retaining loop.

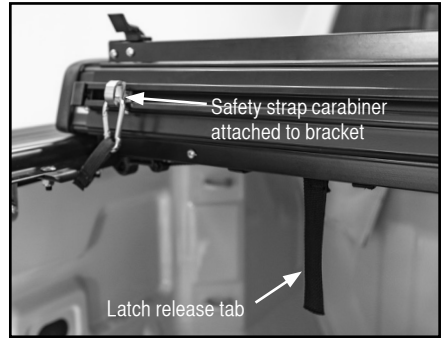

REINSTALL COVER

- A. At front of box, set front edge of cover on side rails and hold rear edge 1" above rails (Figure 1).
- B. Slide cover forward to engage hooks underneath catches (Figure 2).
- C. Lower cover to engage latches in retainment brackets.
- D. Secure safety straps to safety brackets

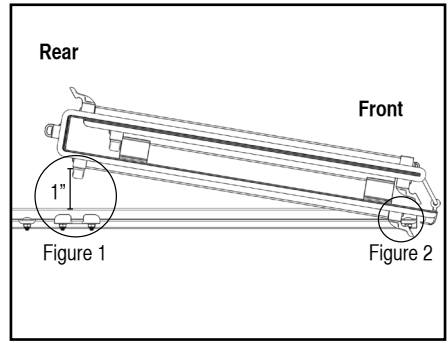

▲ WARNING: ALWAYS PROPERLY SECURE COVER.

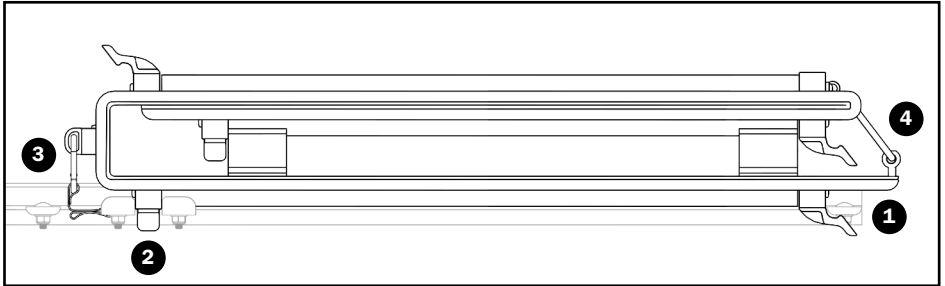

Failure to execute these steps may result in severe damage and will void your warranty.

1. Cover hooks engaged underneath rail catches.
2. Latches engaged in retainment brackets.
3. Safety straps attached to safety brackets.
4. Fasten storage clips if open.

SAFETY INFORMATION

- Always ensure hooks and latches fully engage catches and side rails.
- Ensure safety straps are attached to safety brackets when cover is installed on vehicle.
- Do not tow vehicle backward with cover on your truck.
- Do not cover cargo that is higher than the cover.
- Do not place object(s) on or against the cover or its framework at any time.
- Always secure cargo to ensure it does not damage cover or framework.
- Remove debris or snow from top of cover and hinges before opening or closing cover.
- Do not use the cover's framework to tie down cargo.
- Never stand, sit or ride on the cover or allow others to do so.
- The cover does not eliminate moisture and dust from entering the truck box. Special wrappings or packaging of the cargo may be necessary.
- Due to poor ventilation, if you allow a pet/animal in the box, leave cover open. Do not allow people or animals to occupy box with the cover closed.
- Use caution when operating cover in windy conditions.
- Keep cover completely closed or open and secured with storage clips. Do not attempt to drive with the rear panel in the partially open position.
- Use caution when cleaning cover and components with a pressure washer. Using a pressure washer too close to the cover may damage paint, hinge or seal.
- Keep cover closed when going through automatic car washes.
- Keep hands and fingers away from all pinch points.
- Never use latch cord to lift or fold cover.

TIPS FOR A LONGER LASTING COVER

- Keep cover closed when not in use.
- Avoid storing cover in its folded position for long periods of time.
- Avoid dropping or slamming cover into closed position.
- Ensure cover is properly latched while traveling and before entering automatic drive-through car washes.
- When cleaning, use mild liquid soap and water. Never clean with petroleum or citrus based products. Petroleum based products may dry out and damage cover seal.

INSPECTION AND MAINTENANCE

The operator can perform most of inspection and maintenance. It may be necessary to review the installation and operating instructions.

- Periodically check and retighten safety strap hardware. If safety straps or brackets are damaged, replace with new hardware.
- Periodically check and retighten clamps as needed.
- Periodically check synthetic cord to ensure latches fully engage side rails.
- Periodically inspect cover assembly and the condition of all parts. Check for loose bolts and parts, tighten if needed. Test the operation to ensure parts are functioning properly and cover is in top operational condition.
- If latch has been damaged, replace with new one.

NOTE: Inspection and maintenance should also be performed anytime a malfunction is observed or suspected. If you need assistance inspecting or servicing your cover, or if you want to order a replacement part, call the customer service number on the back page. Always use original equipment replacement parts for your cover.

Serial Number can be located under rear panel on driver side.

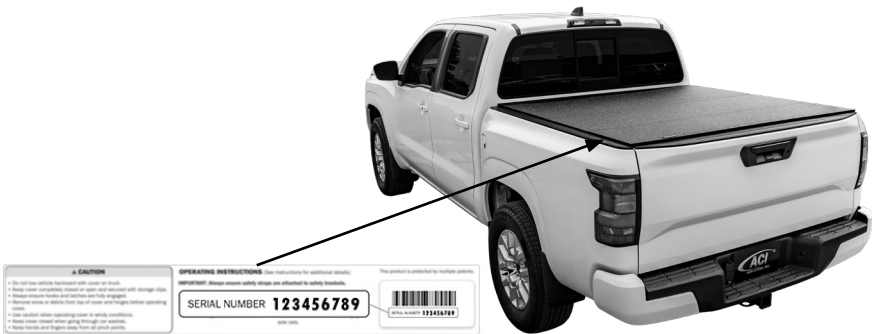

3 YEAR WARRANTY

WeatherTech® extends the following 3 year warranty to the original retail purchaser of this AlloyCover™:

WeatherTech® warrants its covers to be free from defects in material and workmanship, as long as the original purchaser owns the truck on which the cover was originally installed and as long as the cover remains properly installed on said truck.

WeatherTech®'s sole obligation under this warranty is limited to the repair or replacement, at its option, of defective parts only. No labor or service allowance is given or implied. **IN NO EVENT SHALL WEATHERTECH® BE LIABLE FOR INCIDENTAL, CONSEQUENTIAL, OR SPECIAL DAMAGES. WEATHERTECH® EXPRESSLY DISCLAIMS ANY AND ALL IMPLIED WARRANTIES OF MERCHANTABILITY, AND THERE ARE NO WARRANTIES WHICH EXTEND BEYOND THE 3 YEAR WARRANTY DESCRIPTION CONTAINED HEREIN.**

For warranty call our Customer Service Department at 800-441-6287 to determine if only a replacement part is needed or if the cover needs to be returned for inspection and repair. **Goods to be returned must have a pre-authorized RA # (Return Authorization Number) - obtained by calling the number above.** Mark the number on the package and ship it freight prepaid to address on the back page. WeatherTech® will pay freight to return goods to sender.

This warranty does not cover any damage due to accident, abuse, misuse, alteration, neglect, improper installation, or ordinary wear and tear.

This warranty gives you specific legal rights and you may have other rights, which vary, from state to state.

This product is protected by multiple patents. Product subject to change without notice.

WeatherTech® AlloyCover™



FOR YOUR RECORDS _____

Date Purchased: _____

Location of Purchase: _____

Serial Number: _____

(Located on decal under rear panel by tailgate)

Questions? (800) 441-6287

WeatherTech.com

1 MacNeil Ct, Bolingbrook, IL 60440

©2024 MacNeil IP LLC.



0124 2000096_K