

# Air Curtains: Energy Savings & Occupant Comfort



**Berner International**  
Shenango Commerce Park  
111 Progress Avenue  
New Castle, PA 16101  
Tel: (724) 658-3551  
Fax: (724) 652-0682  
Toll-Free: (800) 245-4455  
Email: [sales@berner.com](mailto:sales@berner.com)  
Web: [www.berner.com](http://www.berner.com)



**We share,  
we support,  
we inspire.**

FCSI Education Provider Program has approved this course for 1.0 (60 minutes) Continuing Education Units (CEUs).

# Purpose and Learning Objectives

---

**Purpose:** An air curtain, also known as an air door, employs a controlled stream of air aimed across an opening to create an air seal. This seal separates different environments while allowing a smooth, unhindered flow of traffic and unobstructed vision through the opening. This course discusses how air curtains work and why they can contribute to occupant comfort, energy efficiency, and indoor air quality when the door is open. It also reviews how air curtains improve whole-building energy efficiency versus conventional methods.

**Learning Objectives:** At the end of this program, participants will be able to:

- describe air curtains in terms of their components, function, and operation
- discuss how air curtains enhance the safety of an entrance or opening by evaluating air curtain design criteria to determine the correct size and placement of an air curtain for a specific application
- explore the benefits of air curtains to determine how they improve occupant thermal comfort levels and reduce whole-building energy use
- recognize why it is necessary to specify the right air curtain and controls to achieve optimal air curtain effects for environmental separation, to reduce dust, fume, and insect infiltration, and to maintain air movement control
- identify industry building codes and testing standards relevant to air curtains, and
- refer to case studies to illustrate the efficiency of air curtains for energy savings, climate separation, and comfortable air temperature.

# Introduction

---



# What Is an Air Curtain?

---

An air curtain, also known as an air door, generates an engineered stream of air that is aimed across an opening to create an air seal. This seal separates two different environments (outdoor/indoor, hot room/cold room) and maintains temperature separation while allowing a smooth, unhindered flow of traffic (people or vehicles) and unobstructed vision through the opening.

Because air curtains help to contain heated or conditioned air when the door is open, they provide sizeable energy savings while protecting indoor air comfort. In addition to protecting indoor air temperatures, air curtains are also used to keep flying insects, fumes (such as tobacco smoke and vehicle exhaust), and dust out.



# How Does an Air Curtain Work?

Typically, air curtain technology uses a cabinet to house a fan, plenum, and nozzle system to produce a stream of air that is strategically engineered to strike the floor with a particular balance of velocity, volume, and uniformity. The airstream must reach the threshold in order to create the barrier.

Once the unit is activated, air is brought into the air curtain through the intake, enters the fan housing, and is accelerated by the fan. This fast-moving air enters the plenum which allows for an even distribution of air along the full length of the discharge nozzle. Aerofoil-shaped directional vanes in the nozzle help to create and direct a uniform airstream with minimal turbulence.

## HOW AN AIR CURTAIN WORKS



# How Does an Air Curtain Work?

---

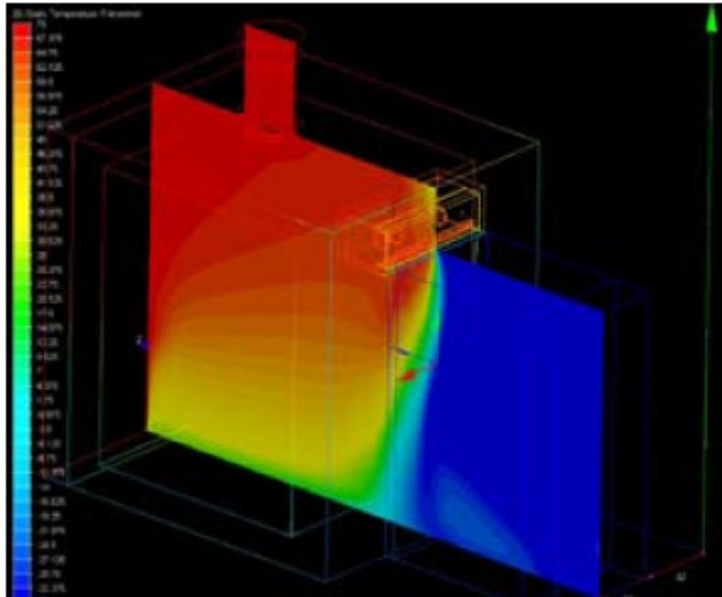

**Temperature**

In this simulation, color depicts temperature. The air curtain is providing a barrier, keeping the warm air (red, orange, yellow) inside of the building and the cold air (blue) outside of the building.

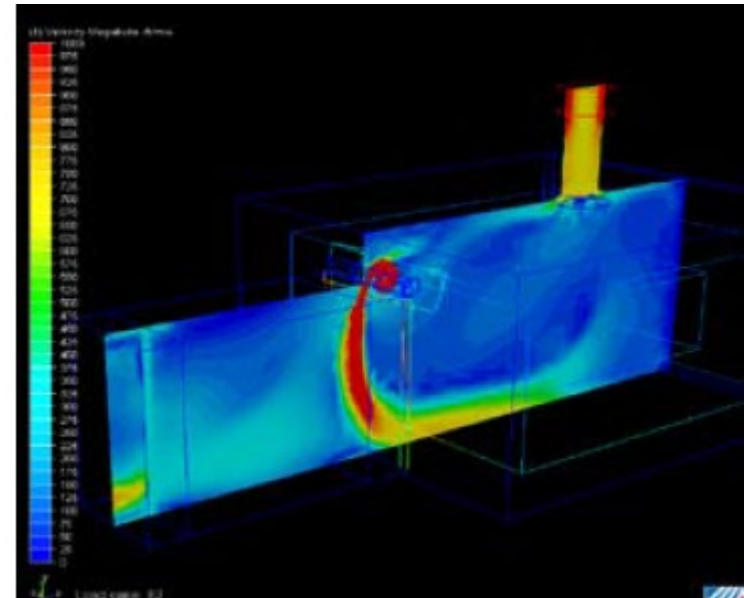

**Velocity**

In this simulation, color depicts velocity. The air curtain is providing a high-velocity (red) airstream that is able to bend and resist thermal exchange.

# Importance of Velocity, Volume, & Uniformity

---

Velocity, volume, and uniformity work together to deliver a controlled stream of air to create a barrier of air across an opening; therefore, relying on only one or two of these forces could skew performance results.

## **Velocity** (speed the air is moving)

The airstream must hit the floor with enough velocity to create a split, but not so much that it creates turbulence and cannot form the split. The split, which creates stability, strength, and direction for the air entrained on each side of the airstream, should occur right at the doorway's threshold. Once an air curtain activates and creates a split, it creates a "skin" over the building's volume of indoor air and uses this internal pressure to resist wind. The split then rolls the entrained conditioned and unconditioned air back to their respective areas.

## **Volume** (how much air is moving)

Volume is the building block that allows a properly designed and pressurized discharge plenum to generate a high-velocity laminar jet stream. The taller the opening, the more volume that is required to generate a thicker, higher velocity airstream to resist wind loads up to as much as 10 mph. An air curtain for a fast food restaurant's drive-thru window does not need as strong a volume as a 16-foot-high door in a shipping area.

# Importance of Velocity, Volume, & Uniformity

---

**Uniformity** (the “evenness” of the thickness of the airstream)

Uniformity begins to impact the airstream effectiveness when it drops below 60 percent. An air curtain that focuses too much energy on generating a high uniformity loses velocity, thereby reducing its effective wind resistance.

**In summary...**

To create the barrier, the airstream needs to reach the threshold, i.e., the floor. The velocity, volume, and uniformity combination of the air blowing from the air curtain must be sufficient to resist the penetration of air and other contaminants trying to enter the space from the other side.



# Why Use an Air Curtain?

---

- Energy savings
- Climate control/occupant comfort
- Chemical-free insect control
- Odor, fume, dust control

Air curtains work to control air transfer across two independent temperature zones when there is no physical barrier, such as a door, between the two. By helping to contain heated or conditioned air when the door is open, air curtains:

- Provide energy savings
- Help to reduce building energy consumption due to shorter and/or less frequent run times of the building's air handler or compressor, and
- Keep people more comfortable

Whether it is hot or cold air that is to be kept inside when the door is open, an air curtain is designed to provide efficient, effective separation with low energy consumption.



# Why Use an Air Curtain?

---

Air curtains have other uses, as well:

- Provide protection against flying insects, particularly in the food service market
- Many health codes require an air curtain over the back door of kitchens as part of insect control
- The FDA recognizes that air curtains help protect against the intrusion of flying insects in food processing plants and other facilities
- Reduce the infiltration of airborne dust, idling vehicle fumes, tobacco smoke, and unpleasant odors
- Reduce fog and the buildup of ice in cold storage areas



# Types of Air Curtains

---

Air curtains can be categorized into two types, recirculating and nonrecirculating. Both are available with supplemental heat. This course focuses on nonrecirculating air curtains, as the nonrecirculating air curtain is what most people think of when they think of an air curtain.



Nonrecirculating air curtain



Recirculating air curtain

# Recirculating Air Curtain

---

A recirculating air curtain (also known as an air entrance system) generates and discharges a low-velocity, thick, high-volume airstream that is sent from a discharge grill across the opening towards a receiving grill and is then recirculated using an air handler. It works by entraining large volumes of air into a barrier to counteract thermal exchange and wind loading.

Recirculating air curtains are mainly used in places with nonstop foot traffic (i.e., the door never closes) such as supermarket or retail entrances, to provide both indoor air comfort and energy conservation while allowing for the unhindered flow of people. Because this type of air curtain is built into the entrance, it is usually selected for new construction or a major renovation. The unobtrusive wide stream of low-velocity air created by recirculating air curtains is less noticeable than the higher velocity air movement of the nonrecirculating, and thus is often more desirable for separating environments in key main entrances.

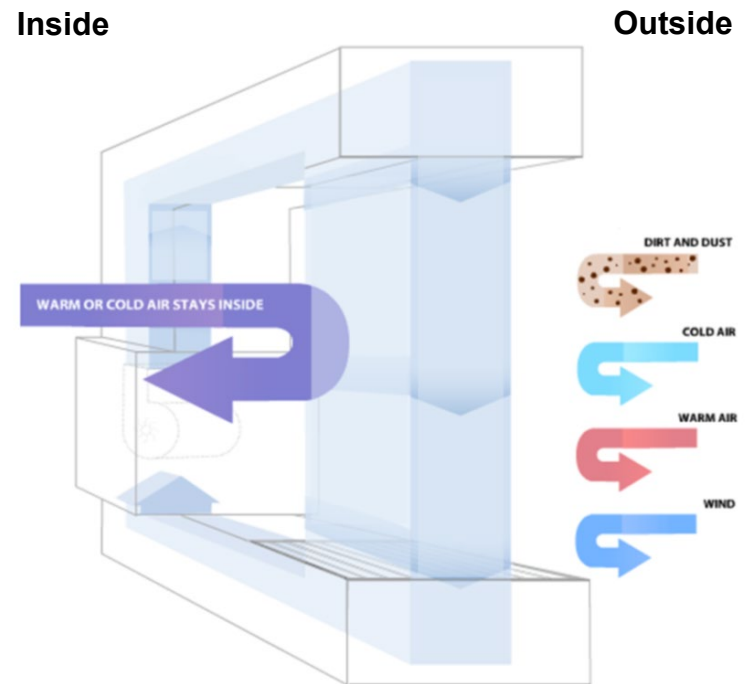

# Nonrecirculating Air Curtain

---

A nonrecirculating air curtain is defined as a device that generates and discharges a high-velocity, thin, low-volume airstream that splits at the threshold (i.e., floor) and is not recirculated back to the intake. This thin, high-velocity airstream works by entraining air into a barrier to counteract thermal exchange and wind loading.

The nonrecirculating air curtain is what most people think of when they think of an air curtain.

Nonrecirculating air curtains are used in both new construction and existing buildings. They are used with all types of door (opening) sizes—from drive-thru windows to bay doors, with all types of door traffic. They are mounted on the wall or from the ceiling.

## HOW AN AIR CURTAIN WORKS



# Where Is an Air Curtain Installed?

---

## **Retail**

Retailers of all sizes use air curtains to contribute to a comfortable selling and buying environment while saving energy. When both aesthetics and protection of the interior space is a consideration, an air curtain can be designed to integrate into the architectural design of the space as well as to meet the functional needs of the application in:

- Customer entryways
- Service/employee entrances
- Shipping and receiving doors
- Shopping cart storage areas
- Walk-in coolers

Air curtains can also replace vestibules to save energy and maintain comfortable interiors. Air curtains are in the International Energy Conservation Code (IECC), International Green Construction Code (IgCC), and ASHRAE Standard 90.1-2019 as alternatives to vestibules; however, studies show the most effective combination for indoor comfort is to have both an air curtain and a vestibule.

# Where Is an Air Curtain Installed?

---

## Retail



# Where Is an Air Curtain Installed?

---

## **Institutions and Facilities**

Schools, universities, hospitals and clinics, hotels, elder care facilities, etc. use air curtains to create comfortable environments for students, patients, guests, and residents. Air curtains effectively create a barrier between indoor and outdoor temperature conditions while enhancing safety and welcoming people to enter freely, or providing open access through:

- Main entrances
- Concession windows
- Kitchen doorways
- Service entrances
- Shipping and receiving doors



# Where Is an Air Curtain Installed?

---

## Institutions and Facilities



# Where Is an Air Curtain Installed?

---

## **Restaurants**

Air curtains are chosen by restaurant owners and kitchen designers to comply with food service standards and health department codes such as NSF 37 for insect control. Sanitation certified air curtains are designed to meet the functional needs of the application, to integrate into the space, and to keep installation costs to a minimum. Air curtains are also used over customer entrances to keep waiting and seating areas comfortable. Whether they are quick-service, fast-casual, cafeteria, bar-centric, or white tablecloth, restaurants use air curtains in the front or the back of the house on:

- Customer entryways
- Drive-thru windows
- Indoor/outdoor bar openings
- Patio doors
- Kitchen service entryways
- Shipping and receiving doors
- Walk-in coolers

# Where Is an Air Curtain Installed?

---

## Restaurants



# Where Is an Air Curtain Installed?

---

## **Manufacturing and Warehouse**

Air curtains are used to protect openings in automotive plants, warehouses, distribution centers, food processing plants, cold storage warehouses, pharmaceutical facilities, and other types of manufacturing facilities.

Designed to keep interior temperatures stable and flying insects out when the doors are open, air curtains create an effective barrier for:

- Shipping and receiving doors
- Service entrances
- Cold storage rooms
- Conveyor doors
- Train bays

Air curtains can also be engineered to perform in hazardous environments (as defined by ANSI/NFPA-70 National Electrical Code (NEC) for Electrical Equipment) in manufacturing and pharmaceutical plants, and in corrosive environments such as wastewater treatment plants (odor control).

# Where Is an Air Curtain Installed?

---

## Manufacturing and Warehouse

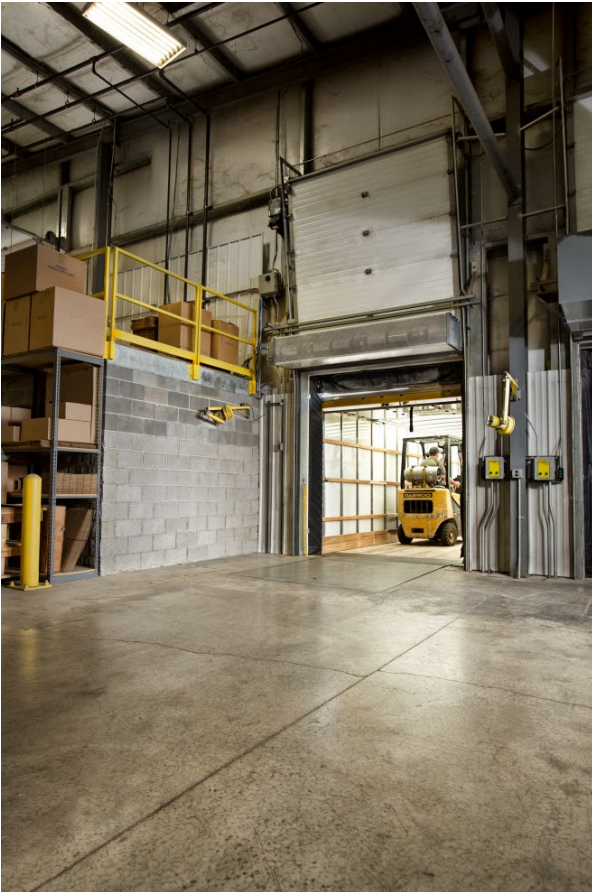

# Where Is an Air Curtain Installed?

---

## **Transportation**

Airports, train stations, bus stations, and bus and truck garages use air curtains to create comfortable environments for travellers, baggage handlers, mechanics, and others working near the door. Air curtains effectively create a barrier between indoor and outdoor temperature conditions while enhancing safety and welcoming people and vehicles to enter freely through:

- Passenger drop-off and pick-up doors
- Doors that lead to the tracks, tarmac, or bus stop
- Baggage loading/unloading doors
- Garages

Air curtains can also be engineered and built for installation in various hazardous locations, as defined by the ANSI/NFPA-70 National Electrical Code (NEC) for Electrical Equipment, such as CNG (compressed natural gas) bus garages. Check with the manufacturer for limitations.

# Where Is an Air Curtain Installed?

## Transportation

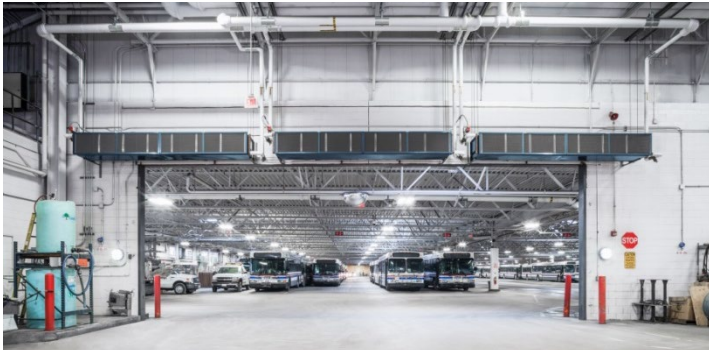

# Air Curtains Are Effective & Efficient

---

With the increased focus on occupant comfort and energy conservation, air curtain manufacturers continue to develop architectural, commercial, and industrial products that can be specified to accommodate a wide variety of industries and applications. Air curtains are specified as both part of new construction and major renovations, and additions to doorways in existing buildings.

The remainder of this course provides an overview of:

- Air curtain product selection considerations, including design criteria and control options
- Relevant industry codes and standards that have led to air curtains being included as alternatives to vestibules.



# Review Question



Why use an air curtain?

# Answer

Air curtains have many benefits. They:

- provide energy savings
- help to reduce building energy consumption
- keep people more comfortable
- reduce the infiltration of airborne dust, fumes, smoke, and unpleasant odors
- reduce fog and the buildup of ice in cold storage areas, and
- provide protection against flying insects.

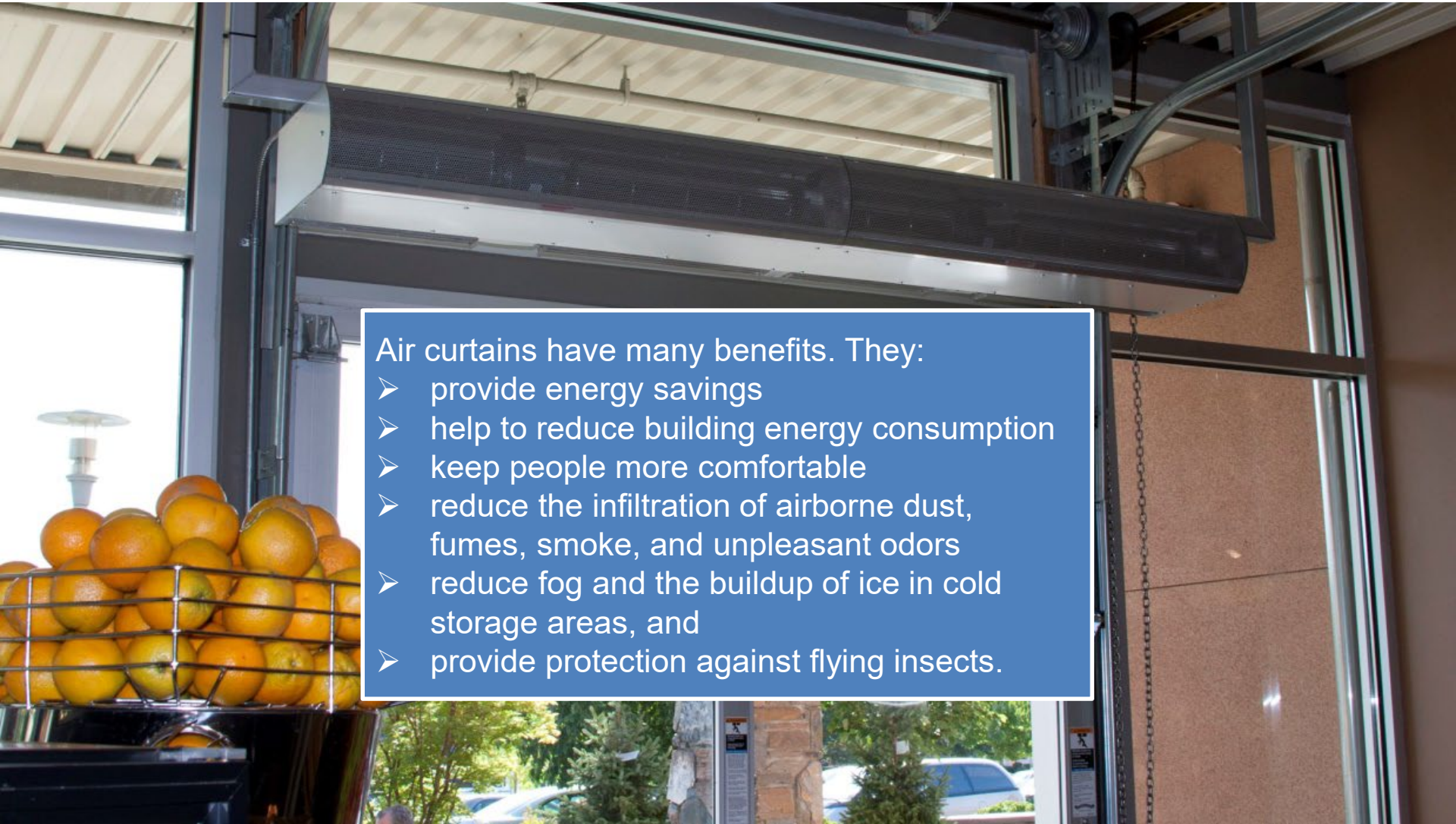

# Design Criteria

---



# Air Curtain Selection Considerations

---

Selecting an air curtain to meet the design requirements of a specific application requires considering the:

- Type of application
- Location of the opening
- Airflow through an opening
- Mounting height and space
- Characteristics of the doorway
- Door traffic
- Climate
- Supplemental heat requirements
- Materials
- Fans and motor type
- Power
- Mounting type
- Installation
- Controls
- Sequence of operations
- Maintenance and service



# Type of Application

---

Today's air curtains are engineered to meet the performance requirements of a specific application: industrial, light industrial, commercial, retail, food service, sanitation, cold storage, etc. An air curtain installed above a high-traffic retail entrance has different operational and aesthetic requirements than one installed above a large opening in an industrial warehouse or the back door to a commercial kitchen.

Air curtains are designed for a particular use, so it is necessary to determine the purpose of the air curtain. Air curtains may have a primary purpose, e.g., insect control, and one or more secondary purposes, e.g., energy savings and indoor air protection.

# Location of the Opening

---

The purpose and frequency of use of the opening in relation to the interior space and other doorways must also be taken into consideration when selecting an air curtain.

- What type of opening is it?
  - A main entrance, a kitchen/service door, or a loading dock?
- What is the primary purpose?
  - Indoor environmental separation and energy savings?
  - Flying insect control?
  - Fume control?
- What are the dimensions of the opening?
- What is the mounting space (clearance) above the opening?
- When is the physical door open?
  - Frequently? How frequently?
- What type of traffic will use the door?
  - Customers, employees, fork trucks, carts, etc.?
- Is the space under negative pressure?

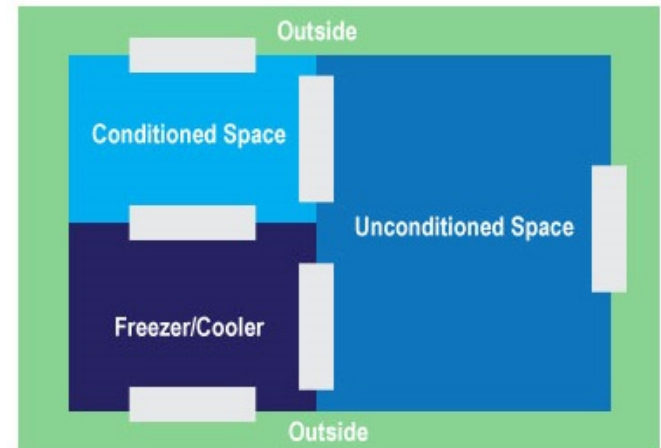

# Airflow Through an Opening: The Basics

---

Air will flow into, out of, or within a building through any sized opening if the driving force—pressure—exists. The amount of airflow is determined by the size of the opening, the extent of the pressure (force), and the length of time a pressure differential (difference in pressure between two environments) exists.

Pressure differentials are influenced by:

1. Temperature differences

- Warm air is less dense and lighter than cold air; as such, it rises and escapes through the top portion of an opening as cold air is drawn in and across the bottom of the opening

2. Pressure differences

- To equalize differences in air pressure between two environments, air will flow from a high-pressure area to a low-pressure area and will always choose the path of least resistance (the biggest hole)

3. Wind or drafts

- The speed and direction of wind running along a building or drafts in a tall building with open stairwells will cause a negative pressure on one side of an opening or side of a building

4. Poorly balanced ventilation systems and air leakage

- Interior spaces will experience negative pressure if the supply and return of air is not balanced or if the duct system leaks air to the interior or exterior

# Airflow Through an Opening

---

An air curtain cannot operate well if the building is under negative pressure. Therefore, exterior conditions, interior space configurations, and the location of the air curtain doorway in relation to other openings within a facility must also be taken into account when selecting an air curtain.

Things to consider when checking for potential negative pressure situations:

- Is there potential for a wind tunnel effect to occur?
  - A wind tunnel effect occurs when two exterior doors on opposite sides of a space are open at the same time
- Are any exhaust fans causing negative pressure within the building?
- Stack effect
  - Are escalators or stairs nearby? How tall is the building?
- Is it an open floor plan?



# Mounting Height & Space

---

When selecting an air curtain, it is necessary to know the opening width, the mounting height, and the clearance (mounting space) above the opening.

In order for an air curtain to work properly, it is designed to discharge air across the entire width and height of the opening.

For proper function, the airstream has to be strong enough to reach the target surface (ground) and to split at the floor, but not so strong that it creates turbulence and cannot form the split.

The minimum clearance required to mount an air curtain varies based on the model selected.

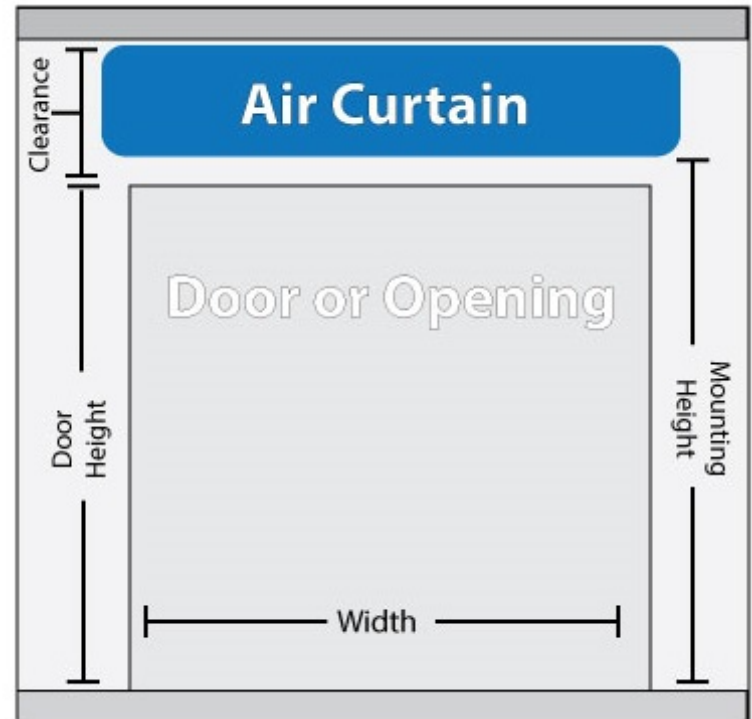

# Characteristics of the Doorway

---

The physical characteristics of the actual door or window must be taken into account, as well as the configuration of multiple doors or windows.

- What type of door is being installed, and is it automatic or manual?
  - Roll-up
  - High-speed roll-up
  - Swinging (single or double)
  - Automated sliding
  - Revolving
- Single doors side by side?
- Revolving door next to a single door?
- Pedestrian entry next to a wide roll-up door?



# Door Traffic

---

When selecting activation devices and controls, it is important to consider:

- How often does the door open? For how long?
- Is the air curtain supplying supplemental heat to the space?
- Should employees have limited ability to adjust the operation of the air curtain?



# Climate

---

The location and orientation of a building and its external and internal climate conditions are important considerations, along with the dimensions of the doorway.

In applications where openings are exposed to seasonal climate conditions, winds, and fluctuating pressure differentials, supplemental heat is often added to the air curtain for occupant comfort.

In smaller contained spaces such as vestibules, heated air curtains can provide the same supplemental heat as a cabinet unit heater, while also protecting against the loss of conditioned air.

Heated air curtains are designed to work with the building unitary heating systems to minimize run time that would normally occur with drafts and therefore reduce whole-building energy consumption.

Heat is sized only to be supplemental and to temper the air pulled from the interior space to make the airstream comfortable for persons passing through it, not to temper infiltrating cold air in extreme weather conditions.

# Supplemental Heat Requirements

---

The most common supplemental heating types for an air curtain are:

- Electric heat
  - Most common, suitable for most commercial applications and available in a variety of wattages/voltages
- Steam heat
  - Clean and effective but not readily available in most applications
- Hot water heat
  - Clean and affordable, but high temperatures may not be generated
- Direct gas heat
  - Utilizes a burner that fires directly into the airstream; its use may require a permit—always check local code
  - industrial applications
- Indirect gas heat
  - Utilizes a burner that indirectly heats the airstream; special venting required for exhaust gases
  - Industrial, heavy commercial applications

# Materials

---

The housing of an air curtain may be a single unit or multi-piece construction and manufactured from plastic or metals such as aluminum, stainless steel, or steel. The housing may be painted or powder-coated.

Special coatings of the housing may be required to provide corrosion resistance or spark resistance, or more commonly, to meet color/architectural design requirements.

The materials used in air curtain construction are equally as important as the components. For example, an air curtain installed in a hazardous location needs to be spark-resistant; an air curtain going into a wet environment would need wash-down duty motors.

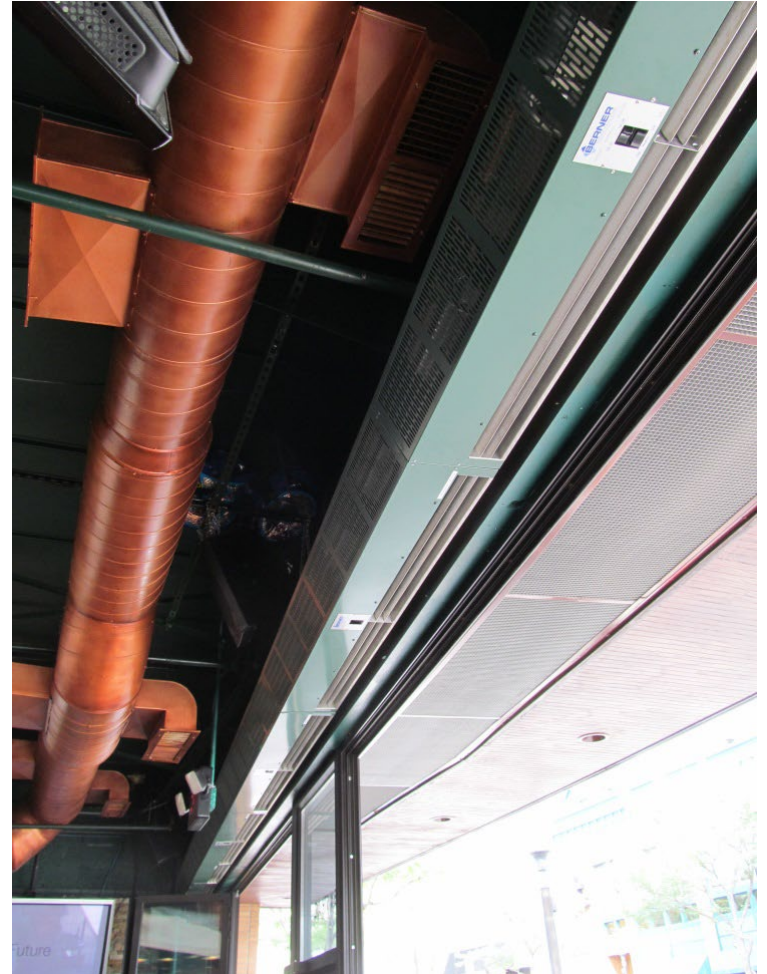

# Fans & Motors

---

The fan in an air curtain is responsible for pressurizing, accelerating, and moving the air into the discharge plenum and nozzle. The proper size and power rating of the fan and motor will depend on the selection considerations previously discussed, dimension of opening, air curtain location, environmental conditions, etc. Fans may be direct or belt driven—centrifugal, axial, and cross-flow.

An air curtain may utilize one or more motors. Variable speed or multi-speed motors are preferable since they allow a building owner to adjust the performance of the air curtain to compensate for environmental conditions.

Air curtains for a hazardous location (HL) must be constructed with explosion-proof motors and spark-resistant fans, electrical components, and materials. The air curtain must also comply with electrical codes that dictate special requirements for HL sites as defined by ANSI/NFPA-70 National Electrical Code (NEC) for Electrical Equipment.

# Power

---

Once the model, length, and heat type of the air curtain has been selected, the next thing to decide is the type of power. This includes considering the:

- Power rating of the selected air curtain
- Quantity of electrical circuits needed to power the air curtain (motors and any electric heat or other electrical device powered by the electrical circuit)
- Amps per electrical circuit to power the air curtain
- Breaker rating per circuit to power the air curtain

Voltages range from 120v single-phase to 600v three-phase. Check a manufacturer's data sheet for power options.



# Mounting

---

## **Horizontal mounting**

- Horizontal mounting is the most efficient and is recommended for most applications. It reduces the chances that it will be damaged and lessens the concerns that the physical door and items placed next to it will block the airstream. For optimum performance, the air curtain should be installed directly to the wall, at the top, flush and level with the opening.

## **Vertical mounting**

- Vertical mounting an air curtain on either or both sides of an opening is typically used in industrial applications when horizontal mounting of the air curtain is not possible. Vertical mounting is not usually recommended for commercial applications.

# Mounting

---



**Mount inside, over the opening:** provides environmental separation and occupant comfort by using the interior conditioned air to create the airstream.



**Mount outside, over the opening:** recommended for insect control.

# Mounting

---



Recessed mount



Wall mount



Suspended mount

# Installation: Discharge Nozzle

---

An air curtain's discharge nozzle is responsible for providing the required volume and uniform velocity of air across the width of the air curtain. The length, width, and angle of the discharge nozzle will impact the effectiveness of the air curtain.

Depending on the model, an air curtain's discharge may be adjusted via an adjustable nozzle that can be pivoted within the unit or adjustable directional vanes within the nozzle. The nozzle should be adjustable to aim inward or outward up to 20 degrees from the opening.

# Installation: Discharge Nozzle

---

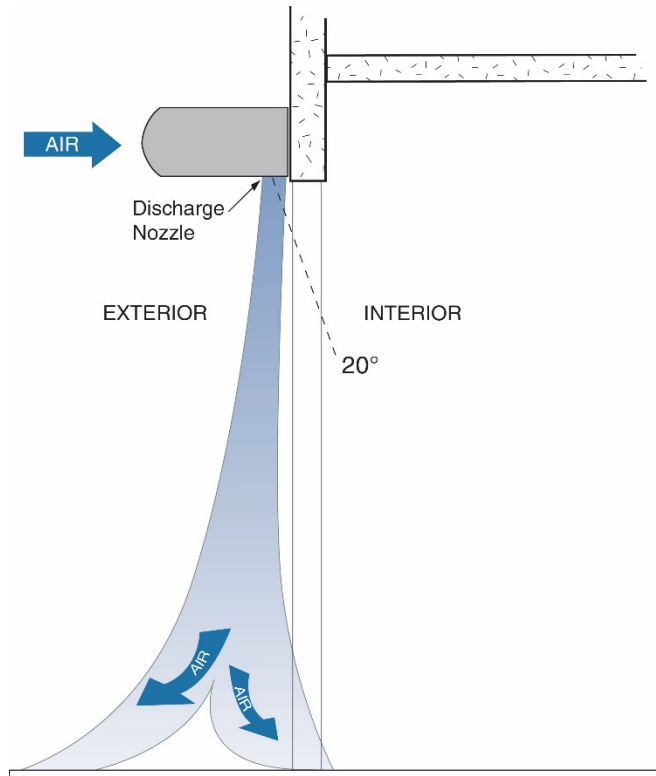

Air curtain profile exterior mount

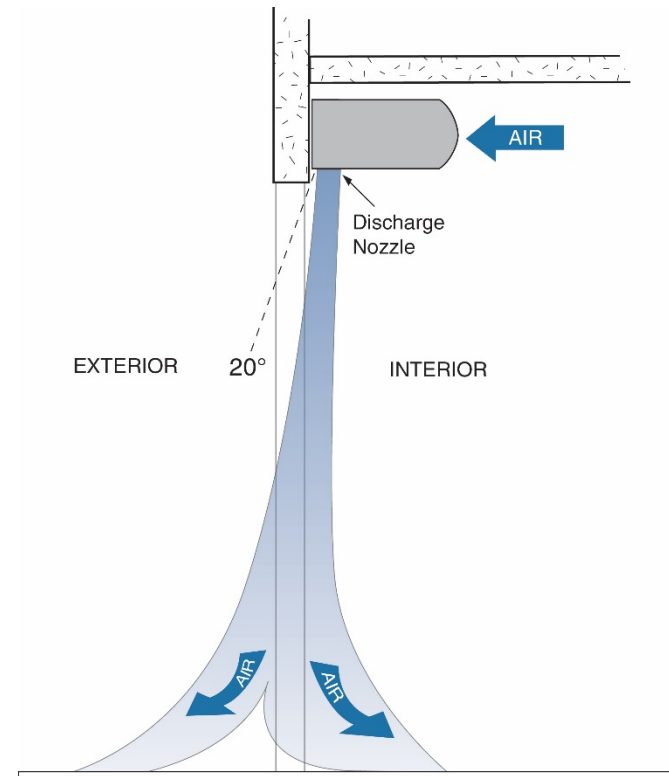

Air curtain profile interior mount

# Controls

---

Some air curtains come with built-in switches, some do not. Some require control panels, some do not. Depending on the application, different controls will be desired.

When selecting controls, it is important to think about the:

- Sequence of operations desired
- Air curtain model selected
- Power available and the power needed
- Location of the switches
- Type of door

# Controls

---

Here are some of the most common operational sequences and how they work:

For when the door stays open for an extended period of time or does not have a lot of traffic

- The door opens, the air curtain turns on. The door closes, the air curtain turns off. To do this, a door switch is installed as the activation device for the air curtain.

For high-traffic openings

- The door opens, the air curtain turns on. The door closes, the air curtain continues to run for 60 seconds. If the door opens again, before the 60 seconds is up, then the air curtain continues to run and will turn off when the door remains closed for longer than 60 seconds. To do this, a door switch and a time delay are installed.

For high-traffic openings, air curtain with heater

- The door opens, the air curtain turns on. The thermostat calls for heat, so the heat also turns on. The door closes, the air curtain and the heat continue to run until the time delay expires. Once the time delay expires, the air curtain and the heat both turn off. To do this, a door switch, a thermostat, and a time delay are installed.

# Controls

---

For high-traffic openings that require supplemental heat when the door is closed

- The door opens, the air curtain turns on. The thermostat calls for heat, so the heat also turns on. The door closes, the air curtain switches to a lower setting and both the heat and air curtain continue to run until the thermostat is satisfied. If the door does not open, but the thermostat calls for heat, the air curtain and the heat will turn back on with the air curtain operating at the lower setting. To do this, a door switch, a time delay, and a thermostat are required.

## Digital controls

- With digital (electronic) controls, the air curtain can be programmed to follow various operational sequences depending on the day of the week and time of day. To do this, an activation device, such as a door switch, is installed along with the digital controller.

## Building management systems

- An air curtain may also be tied into the building management system using a low-voltage circuit.



# Controls: Activation Devices

---



Magnetic reed door switch



Plunger door switch



Roller arm door switch

# Controls: Electrical Accessories

## NOTE:

A magnetic reed switch requires low voltage and cannot be operated on any other line voltage power. A transformer converts single- or three-phase power from the air curtain to 24V.

## NOTE:

For an automatic electric sliding door or an automatic electric bi-parting door, only one magnetic reed limit switch is needed. But if it is a double manual swing door, two switches are needed, one for each side of the door.

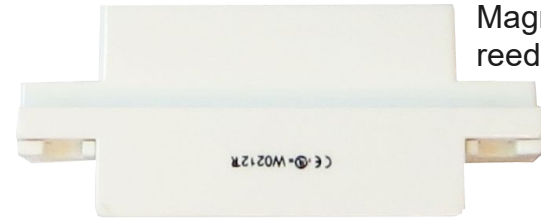

Magnetic reed switch

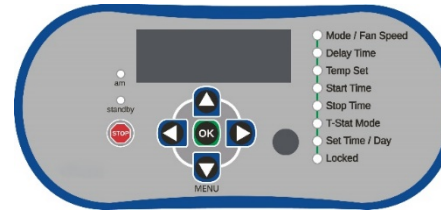

Digital controller



Thermostat

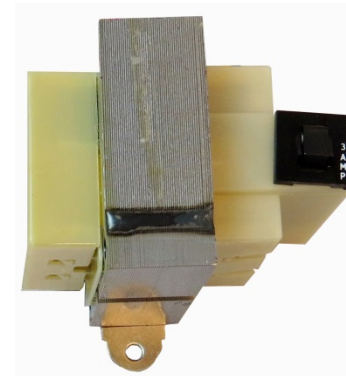

Transformer



Time delay

# Maintenance & Service

---

Depending on the environment of the air curtain, maintenance and cleaning may be needed monthly, but if the environment is fairly dust- and grease-free, then every six months is a good rule of thumb. It is recommended to do a cleaning at the start of heating season.

Many air curtains have removable access panels to make accessing the fans and motors easier. For dusty, dirty, or greasy environments, filters may be available depending on the model selected.

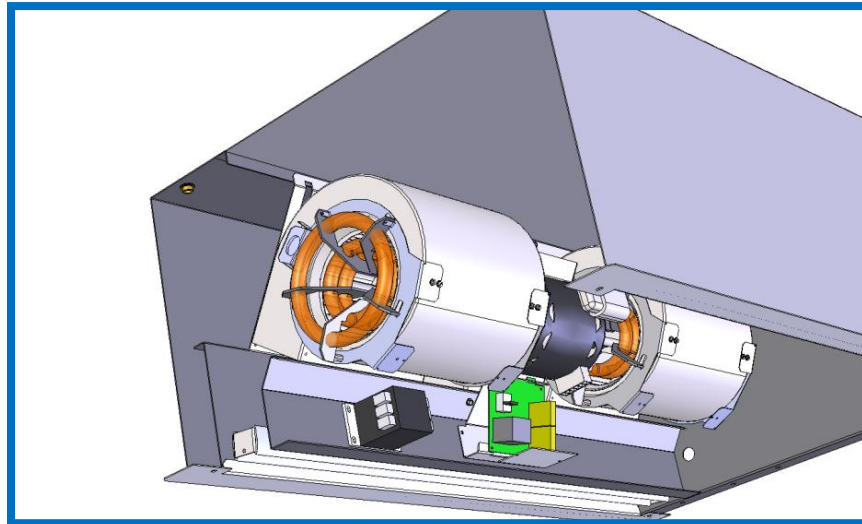

# Review Question

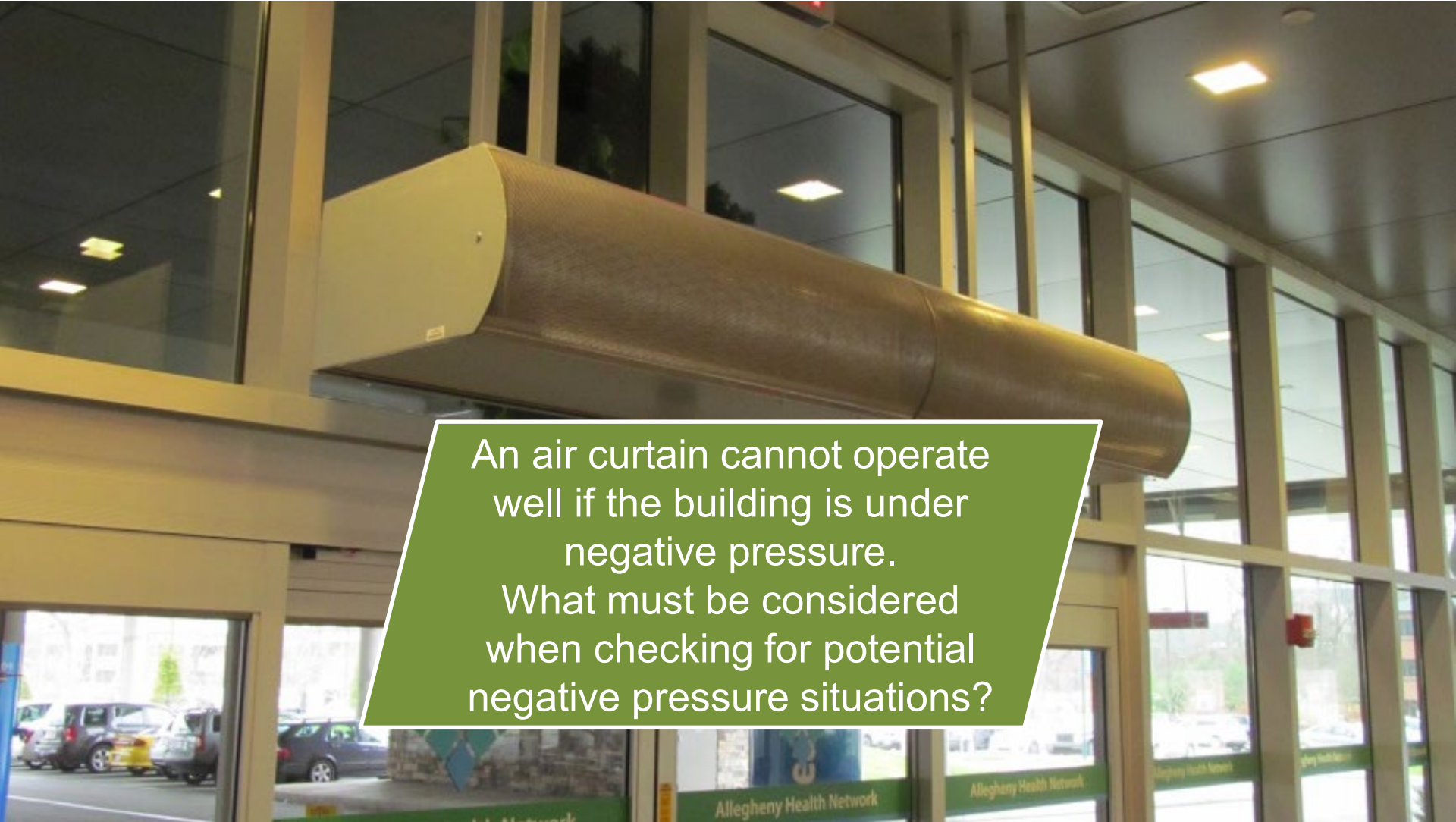

An air curtain cannot operate well if the building is under negative pressure. What must be considered when checking for potential negative pressure situations?

# Answer



When checking for potential negative pressure situations, consider:

- the exterior conditions
- the interior space configurations and the location of the air curtain doorway in relation to other openings within a facility
- the potential for a wind tunnel effect to occur
- if exhaust fans are causing negative pressure within the building, and
- if the stack effect exists (a pressure difference that causes uncontrolled airflow).

# Energy Performance

---



# Air Curtains vs. Vestibules

---

By definition, a vestibule is a permanent fixture within a building frame. The typical air curtain is a removable or add-on fixture that does not change the existing structure, and can be easily upgraded, if necessary. Air curtains can be installed along with any style of door (self-closing, automatic, revolving, rapid roll-up, etc.), and they eliminate the need for two sets of doors, additional lighting, and the space that is being consumed to create the vestibule.

When used to prevent air leakage, air curtains achieve the same goal of vestibules. However, because air curtains provide a continuous environmental barrier, they prevent the entry of unconditioned, outdoor air more effectively than vestibules.

As floor space is very valuable in commercial buildings, vestibules are often designed to be so narrow that even single-person traffic causes both internal and external doors to be open simultaneously. For this reason, vestibules allow unconditioned air to enter the building unhindered, if for only a brief period of time. As the interior door(s) open, the unconditioned air will enter the facility.

# Air Curtains vs. Vestibules

---

Eliminating a vestibule saves construction costs.

- The estimated cost of a vestibule is anywhere from \$20,000 to \$60,000, while an air curtain for a single six-foot-wide entrance/exit opening plus installation labor costs less than \$6,000.
- A vestibule consumes anywhere from 50 square feet at a small retail store on up to 2,000 square feet at a large home center retailer.
- A conservative estimate of today's construction costs per square foot is \$125. Multiply that by 50 and 2,000 square feet and the cost savings of eliminating a vestibule can amount to \$6,250 for a small retail store to \$250,000 per project at a large home center.

A 2008 research study, “Air Curtains: A Proven Alternative to Vestibule Design,” confirmed that air curtains (air doors) provide a better environmental separation and save more energy than vestibules. Prior to the study, architects and engineers never knew for certain if air curtains were a viable energy-saving substitute for vestibules, because there had not been any organized research comparing the two entryway methodologies. The fact that air curtains were not listed at the time on some codes as viable vestibule alternatives also limited them as commercial building specification choices by consulting engineers and architects.



# Air Curtains vs. Vestibules

---

A three-month-long study performed using computational fluid dynamics (CFD) analysis, verified by Blue Ridge Numerics, and validated by a full-scale laboratory test, concluded that air curtains:

- Clearly outperformed vestibules in energy savings by 10 percent
- Are an effective solution to air leakage in the building envelope
- Are more effective than vestibules in providing environmental separation
- When used in conjunction with a vestibule, increase the efficiency of the vestibule by adding additional protection against climate loss and infiltration of flying insects
- Provide protection when one or more of the vestibule doors are open
- Provide protection with unobstructed access, both physical and visual, to the building envelope space
- Cost up to 75 percent less in labor and materials compared to vestibule installation costs
- Conserve 50–2,000 square feet of entryway floor space typically consumed by vestibule designs

# Air Curtains vs. Vestibules

---

The study's researchers used vestibule construction dimensions and statistics from three leading pharmacy chains as a model. Using a typical pharmacy chain entrance, the study CFD-modeled three scenarios: 1) air curtain with automatic door; 2) vestibule; and 3) air curtain with vestibule. Each scenario was subjected to wind loads of up to four mph and different frequencies of traffic. Under all of the same loads and timing conditions, the air curtain in the left figure maintained a higher interior temperature (represented by yellow, orange, and red) than the vestibule in the right figure.

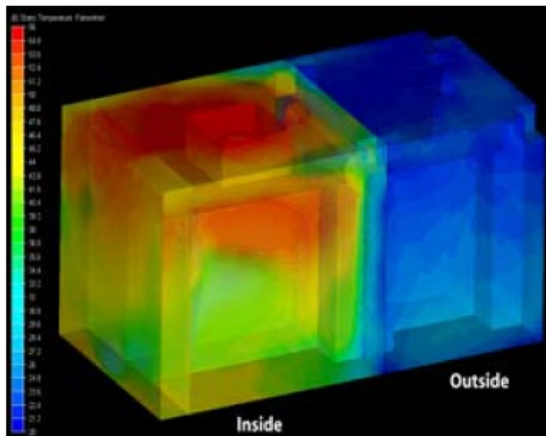

Air Curtain

*\*Color represents temperature*

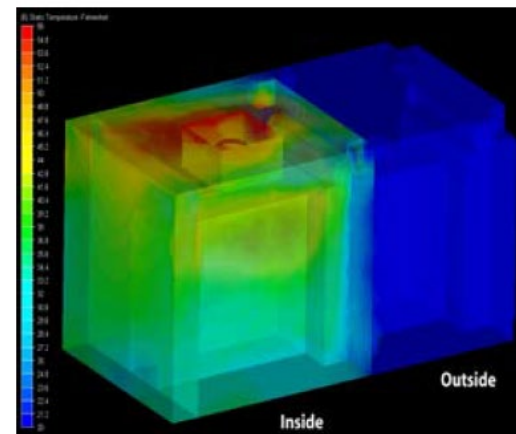

Vestibule

*\*Color represents temperature*

# Impact on Whole-Building Energy Use

---

A 2013 study, “Investigation of the Impact of Building Entrance Air Curtain on Whole-Building Energy Use,” conducted by Liangzhu (Leon) Wang, Ph.D., assistant professor at the Department of Building, Civil, and Environmental Engineering of Concordia University, Montreal, Canada, and published by the Air Movement and Control Association (AMCA), used an integration of three types of modeling software to compare the energy performance of an air curtain mounted over a single-entry door to that of a vestibule.

The study used computational fluid dynamics (CFD) software and a building simulation model to examine whole-building energy use at hourly intervals during an entire year for multiple climate zones for the following types of door configurations:

- Single door without vestibule or air curtain
- Single door equipped with air curtain
- A vestibule with two sets of doors

# Impact on Whole-Building Energy Use

---

The study found:

- An air curtain allowed less infiltration than a vestibule for a given building
- An air curtain reduced air infiltration significantly across a building entrance door under various pressure conditions
- Whole-building annual energy use in all climate zones was less when an air curtain was installed
- Heating efficiency accounted for the air curtain door's major savings
- In all of the climate zones where the IECC required vestibules, an air curtain was equally effective or better at energy savings

The study also found building entrance orientation, building pressure, and frequency of door usage affect air infiltration/exfiltration, and the resultant energy performance of the air curtain door. In particular, the effects of building entrance orientation and the balance of the HVAC system were shown to be as important as door usage frequency.

# Research Leads to Code Changes

---

The research studies have led to the addition of air curtain language in the:

- 2019 ASHRAE Standard 90.1
- 2015 International Energy Conservation Code (IECC), and
- 2015 International Green Construction Code (IgCC).

The code provisions require that air curtains be tested in accordance to ANSI/AMCA 220, be installed according to the manufacturer's instructions, and be interlocked to the door to be in compliance.



# Industry Codes & Standards

---



# Air Movement & Control Association Certification

---

In a perfect world, all air curtains would perform to their manufacturer's specifications, but this is not always the case. The Air Movement and Control Association International (AMCA) tests air curtains for power (consumption), air volume, air velocity projection, and uniformity. Under their Certified Ratings Program (CRP), AMCA tests products and product lines for performance data. The program has test standards and rating requirements for testing products consistently and accurately. Performance data is confirmed by this testing.

An uncertified air curtain can result in a product that might not operate up to expectations. Consequently, this tarnishes the reputation of air curtain technology, not to mention the engineer or architect who specified it. Air curtain technology does work, but proper sizing is critical. AMCA certification is also invaluable because air curtain manufacturers must biannually check test each certified model, which assures any modifications or redesigns are also updated.



The AMCA seal assures consumers that a product or product line has been tested and rated in conformance with AMCA's test standards and rating requirements. The AMCA CRP Air Performance Seal must be present on the data sheet.

# ASHRAE Standard 90.1-2019

---

Effective in the fall of 2019, the ASHRAE Standard 90.1, “Energy Standard for Buildings Except Low Rise Residential Buildings,” allows AMCA certified air curtains as exceptions to vestibules.

Section 5.4.3.3 Vestibules and Revolving Doors states:

- Vestibules and revolving doors shall be installed in accordance with this section. The new list of exceptions includes air curtains complying with mandatory provisions and can be found in Section 10.4.5:
  - “Air curtain units shall be tested in accordance with ANSI/AMCA 220 or ISO 27327-1 and installed and commissioned in accordance with the manufacturer’s instructions to ensure proper operation and shall have a jet velocity of not less than 6.6 feet per second (2.0 m/s) at 6.0 in (15 cm) above the floor and direction not less than 20 degrees toward the opening. Automatic controls shall be provided that will operate the air curtain with the opening and closing of the door.”



# International Energy Conservation Code (IECC)

---

The 2015 IECC includes AMCA certified air curtains as an exception to a vestibule.

Section C402 Building Envelope, Subsection 402.4 Air Leakage, item C402.4.7 Vestibules code reads:

- Exceptions: Vestibules are not required for the following:
  - Item 6. Doors that have an air curtain with a minimum velocity of 2 m/s at the floor, have been tested in accordance with ANSI/AMCA 220 and installed in accordance with manufacturer's instructions. Manual or automatic controls shall be provided that will operate the air curtain with the opening and closing of the door. Air curtains and their controls shall comply with Section C408.2.3.

# International Green Construction Code (IgCC)

---

AMCA certified air curtains were approved as an alternative to vestibules in the 2012 IgCC.

- “Where a building entrance is required to be protected with a vestibule in accordance with the International Energy Conservation Code, an air curtain tested in accordance with ANSI/AMCA 220 is permitted to be used as an alternative to separate conditioned space from the exterior.”

The 2015 IgCC has been modified to include the performance requirement of the 2015 IECC and now permits the use of air curtains in conjunction with vestibules. As it is an overlay code, it is now harmonized with the IECC.

- 605.1.2.3 Where air curtains are provided at building entrances or building entrance vestibules, the curtain shall have a minimum velocity of 2 m/s at the floor, be tested in accordance with ANSI/AMCA 220 and installed in accordance with manufacturer’s instructions. Manual or automatic controls shall be provided that will operate the air curtain with the opening and closing of the door. Air curtains and their controls shall comply with Section C408.2.3 of the IECC.

# Food & Food Service Establishments

---

NSF International is an independent, not-for-profit organization dedicated to public health safety and protection of the environment.

- ANSI/NSF Standard 37, “Air Curtains for Entrances in Food and Food Service Establishments,” is the certification for air curtains for entrance ways in food and food service establishments, e.g., service and customer entries, service windows, and cooler and cold storage entries, to control flying insects at customer entry doors, service windows, and delivery doors.

The mission of the United States Food and Drug Administration (FDA) is to promote and protect the public health by helping safe and effective products reach the market in a timely way, to monitor products for continued safety after they are in use, and to help the public get the accurate, science-based information needed to improve health.

- The 2000 Food Establishment Plan Review Guide recommends controlled air currents for insect control at all openings, and specifically recommends air curtains for loading docks and delivery doors.
- The 2001 Food Code, Chapter 6, Section 6-202.15 Outer Openings Protected, properly designed and installed air curtains are specified as a method to protect openings of food establishments against the entry of flying insects.

# Overview: LEED® Certification

---

The U.S. Green Building Council (USGBC) developed the LEED (Leadership in Energy and Environmental Design) program. LEED® is the preeminent program for the design, construction, maintenance and operations of high-performance green buildings.



LEED credit requirements cover the performance of materials in aggregate, not the performance of individual products or brands. Therefore, products that meet the LEED performance criteria can only contribute toward earning points needed for LEED certification; they cannot earn points individually toward LEED certification.

For detailed information about the council, their principles and programs, please visit [www.usgbc.org](http://www.usgbc.org).

# Air Curtains & LEED®

---

The contributions of air curtains are not as easily captured for projects that require commissioning and energy modeling (i.e., new construction and major renovations). This is because commissioning and energy modeling are done with the building's doors and windows closed.

LEED v4 for Building Operations and Maintenance projects are where air curtains can contribute to earning LEED credit, as the overall energy performance of the building is measured for a year.

While no single product can earn a point or meet all of the prerequisite requirements, air curtains can be part of an overall strategy for lowering energy consumption, protecting occupant comfort, and improving air quality, regardless of the LEED certification a project is aiming for.

# Air Curtains & LEED®

<b>LEED v4 for Building Operations and Maintenance</b> <b>Potential Applicable Prerequisite and Credits</b>	<b>Intent</b>
Energy and Atmosphere Prerequisite: Minimum Energy Performance	To reduce the environmental and economic harms of excessive energy use by achieving a minimum level of energy efficiency for the building and its systems
Energy and Atmosphere EA Credit: Optimize Energy Performance	To achieve increasing levels of energy performance beyond the prerequisite standard to reduce environmental and economic harms associated with excessive energy use
Indoor Environmental Quality EQ Credit: Thermal Comfort	To promote occupants' productivity, comfort, and well-being by providing quality thermal comfort
Innovation IN Credit: Innovation	To encourage projects to achieve exceptional or innovative performance

# ASHRAE

---

Air curtains can be found in the following American Society of Heating, Refrigerating, and Air-Conditioning Engineers (ASHRAE) handbooks:

- “HVAC Applications”
- “HVAC Systems and Equipment”
- “Fundamentals”

# Review Question

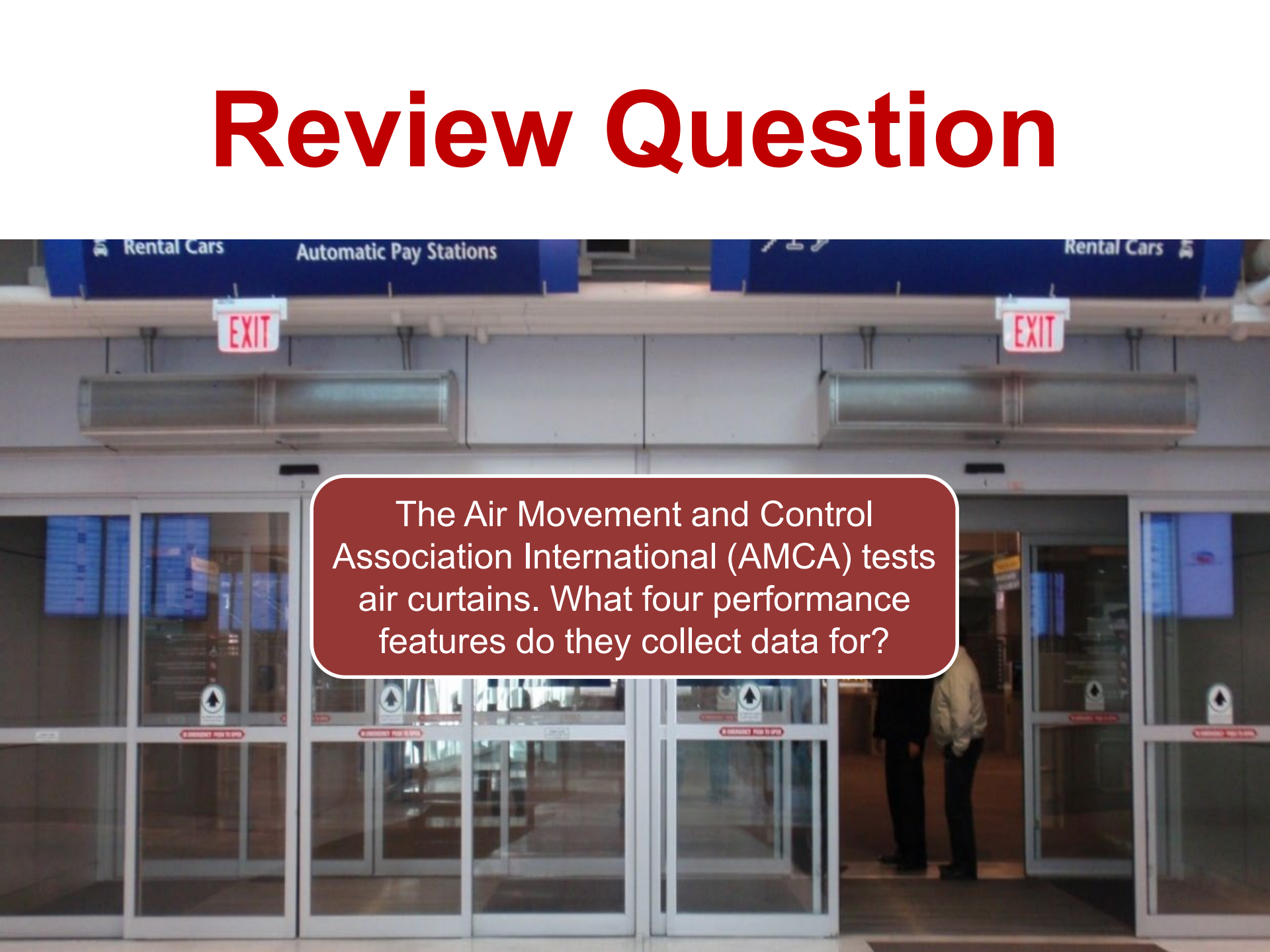

The Air Movement and Control Association International (AMCA) tests air curtains. What four performance features do they collect data for?



# Answer

The Air Movement and Control Association International (AMCA) tests air curtains for:

1. power (consumption)
2. air volume
3. air velocity projection, and
4. uniformity.

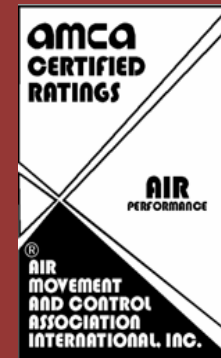

# Case Studies

---



# Market of Choice

---

Location: Market of Choice, Eugene, Oregon

This eight-store grocery chain's operational strategy is a supermarket role model of environmental and energy conservation. It employs energy-saving air curtains on front and back doorways, sells power generated from its own 130.0 kW solar photovoltaic (PV) electric rooftop system, and even composts its own food waste. The 32-year-old, family-owned chain is also amidst an ambitious energy-saving light bulb change-out program from overhead high-intensity discharge (HID) and reach-in cooler/freezer fluorescent light bulbs to LED lighting.

Since 2008 when both check-out employees and customers were feeling chilled from westerly wind drafts through the front door at one Market of Choice's store, air curtains have been installed on seven of eight stores' front end and shipping doors. Originally aimed at indoor air comfort, the stores have since experienced additional air curtain benefits of increased energy savings and flying insect infiltration reduction.

# Market of Choice

---

Most stores use an aesthetic stainless steel air curtain to match the modern interior automatic door entrances. The air curtains are activated by a limit switch triggered when the door opens and deactivated on a five-second delay setting via a digital, programmable controller. Store managers are trained by the installing electrical engineer to clean reusable filters and adjust the air curtain's 10-speed fan to suit patrons and weather conditions.



# Boston Rail Station

---

Location: TD Garden North Rail Station, Boston, Massachusetts

Architect firm: Sasaki Associates, Inc.

Engineering firm: Cosentini Associates, Cambridge, Massachusetts

Extending North Station's commuter foot traffic area 100 feet into the adjacent train shed relieved congestion; however, it took innovative HVAC engineering and architecture to make the retrofit an energy-saving and aesthetic solution.

Previously, the narrow 30-foot-wide lobby/walkway area's traffic spilled over into the automatic entry door sensor zones. Thus, exterior sliding double doors remained open continuously during rush hours, resulting in significant energy losses into the open-ended train shed.

While the renovation's main objective was better traffic flow and a roomier waiting area, controlling energy losses through more efficient doorways was also a major concern. In the redesign, the existing 12 sliding commuter doors were moved out 100 feet and incorporated into a new curtain wall.

# Boston Rail Station

---

The curtain wall's soffits became perfect receptacles for housing 12 high-efficiency in-ceiling mount air curtains. The air curtains are completely recessed into the bottom of the soffit and appear only as decorative white aluminum grilles. Each 3,624-cfm air door distributes a maximum 3,500-f/min. stream of air angled directly down toward the floor; thus cold (or hot in the summer) train shed air and fumes cannot infiltrate the receiving area.

The in-ceiling mount units all have coils that tap into the soffit's heating supply loop. The 95,600-Btu/h coils supplement the new entrance area's main HVAC system by providing thermostatically controlled heating near the door areas, when needed.



# Resources

---



# Resources

---

- “Air Curtains Save More Energy.” *The News*. BNP Media, October 6, 2008. Web. Accessed January 2016. <http://www.achrnews.com/articles/108338-air-curtains-save-more-energy>
- *AMCA International*. Air Movement and Control Association International, Inc. (AMCA), 2015. Web. Accessed January 2016. [www.amca.org](http://www.amca.org)
- “AMCA Publication 222-08. (R2012) Application Manual for Air Curtains.” AMCA International, February 2012. Web. Accessed January 2016  
[https://www.amca.org/assets/document/amca\\_222-08\\_\(R2012\).pdf](https://www.amca.org/assets/document/amca_222-08_(R2012).pdf)
- Benes, Stephen. “Air Curtains Go Beyond Industrial Uses.” *Construction Canada*. Construction Canada, September 14, 2013. Web. Accessed January 2016.  
<http://www.constructioncanada.net/air-curtains-go-beyond-industrial-uses/>
- *Berner International*. Berner International, 2014. Web. Accessed January 2016.  
<http://www.berner.com/>
- Johnson, David, Philip Thomas, and Leah Kordecki. “Air Curtains: a Proven Alternative to Vestibule Design.” Berner International, 2008. Web. Accessed January 2016.  
<http://cdn.thomasnet.com/ccp/00164277/35841.pdf>



# Resources

---

- Johnson, David A., Frank R. Cuaderno, and Brian Jones. “Air Curtains as Alternatives to Vestibules.” *Building Safety Journal Online*. ICC, June 2015. Web. Accessed January 2016. <http://www.berner.com/wp-content/uploads/2015/07/Berner-Press-Release-Air-Curtains-as-Alternative-to-Vestibules-Build-Safety-Journal-June-2015.pdf>
- Nagy, Bruce. “Favourable Winds for Air Curtains.” *Plumbing and HVAC*. Newcom Business Media Inc., April 2015. Web. Accessed January 2016. <http://wasserresources.com/wp-content/uploads/2015/07/Favourable-Winds-for-Air-Curtains-Bruce-Nagy-Plumbing-HVAC-Magazine-April-2015-1.pdf>
- NSF. NSF International, 2016. Web. Accessed January 2016. <http://www.nsf.org/>
- Wang, Liangzhu (Leon), Ph.D. “Investigation of the Impact of Building Entrance Air Curtain on Whole-Building Energy Use.” AMCA International, 2013. Web. Accessed January 2016. [http://www.amca.org/UserFiles/file/Energy%20Initiative%20Web%20Pages/Air%20Curtain%20Study\(1\).pdf](http://www.amca.org/UserFiles/file/Energy%20Initiative%20Web%20Pages/Air%20Curtain%20Study(1).pdf)

# Conclusion

---



©2016, 2020 Bernier International. The material contained in this course was researched, assembled, and produced by Bernier International and remains its property.