



Decarbonizing Building Thermal Systems:

A How-to Guide for Heat Pump Systems and Beyond

In conjunction with



Design and Construction Allies



DECARBONIZING BUILDING THERMAL SYSTEMS: A How-to Guide for Heat Pump Systems and Beyond

AUTHORS

Sammy Houssainy, National Renewable Energy Laboratory
Landan Taylor, National Renewable Energy Laboratory
Paul Torcellini, National Renewable Energy Laboratory
Sugirdhalakshmi Ramaraj, National Renewable Energy Laboratory

SUGGESTED CITATION:

Houssainy, Sammy, Landan Taylor, Paul Torcellini, and Sugirdhalakshmi Ramaraj. 2024. Decarbonizing Building Thermal Systems: A How-to Guide for Heat Pump Systems and Beyond. Golden, CO: National Renewable Energy Laboratory. BK-5500-87812. www.nrel.gov/docs/fy24ost/87812.pdf.

NOTICE

This manuscript has been authored by employees of the Alliance for Sustainable Energy, LLC (“Alliance”) under Contract No. DE-AC36-08GO28308 with the U.S. Department of Energy (“DOE”). Funding provided by the U.S. Department of Energy Building Technologies Office.

This report was prepared as an account of work sponsored by an agency of the United States government. Neither the United States government nor any agency thereof, nor any of their employees, makes any warranty, express or implied, or assumes any legal liability or responsibility for the accuracy, completeness, or usefulness of any information, apparatus, product, or process disclosed, or represents that its use would not infringe privately owned rights. Reference herein to any specific commercial product, process, or service by trade name, trademark, manufacturer, or otherwise does not necessarily constitute or imply its endorsement, recommendation, or favoring by the United States government or any agency thereof. The views and opinions of authors expressed herein do not necessarily state or reflect those of the United States government or any agency thereof.

This report is available at no cost from the National Renewable Energy Laboratory (NREL) at www.nrel.gov/publications.

U.S. Department of Energy (DOE) reports produced after 1991 and a growing number of pre-1991 documents are available free via www.OSTI.gov.

NREL is a national laboratory of the
U.S. Department of Energy
Office of Energy Efficiency & Renewable Energy
Operated by the Alliance for Sustainable Energy, LLC

Contract No. DE-AC36-08GO28308

Publication Number
NREL/BK-5500-87812

September 2024

National Renewable Energy Laboratory
15013 Denver West Parkway
Golden, CO 80401
303-275-3000 • www.nrel.gov

Cover photograph: ASHRAE's new
Global Headquarters in Peachtree
Corners, Georgia. The building
uses six water-source heat pumps.

Photo from ASHRAE

CONTRIBUTORS

David Traxler, Burns & McDonnell
Stet Sanborn, SmithGroup
Karina Hershberg, PAE Engineers
Mark Frankel, Ecotope
Drake Wahlers, Leopardo Energy

Shawn Oram, Ecotope
Anna Morton Rivera, Databased+
Peter Luttk, Copeland
Keith Boswell, Skidmore, Owings & Merrill

ACKNOWLEDGMENTS

The authors would like to thank Marjorie Schott from NREL for technical illustration, chart design, and document layout. The authors would like to thank Carol Marriott, Mark MacCracken, Michael Blunsch, Kim Trenbath, Ron Judkoff, Sasha de Frondeville, and Rois Langner for their detailed technical review and feedback. In addition, the authors would like to thank Nathaniel Allen and Hannah Debelius for their support, and acknowledge the guidance, review, and feedback received from the Better Buildings – Design and Construction Allies, the ASHRAE Heat Pump Application Guide Committee, and the ASHRAE Task Force for Building Decarbonization members listed below:

BETTER BUILDINGS - DESIGN AND CONSTRUCTION ALLIES:

John Hickey, Jacobs
Keith Boswell, Skidmore, Owings & Merrill
Gwen Fuertes, Leddy Maytum Stacy Architects
Stet Sanborn, SmithGroup
Kent Peterson, P2S Inc.
Paul Hutton, Cuningham Group Architecture
Ariane Laxo, HGA
David Kaneda, IDEAs Consulting
Ryan Poole, DPR Construction

Scott Williams,
Williams Building Systems Engineering
Christopher Baker, Willdan
Misha Semënov-Leiva, Centerbrook
Kiersten Washle, CMTA, Inc.
Lauren Blas, CPL Architects and Engineers
Adam MicMillen, IMEG Corp
Karina Hershberg, PAE Engineers
John Andary, Introba

Anna Morton Rivera, DataBased+
Lindsey Morris, Moody Nolan
Thomas Phoenix, MCI Mechanical Contractors
Drake Wahlers, Leopardo Companies, Inc.
Kristy Walson, BranchPattern
Mark Perepelitza, SeraDesign
Patricia Lozano, CookFox
Vedyun Mishra, Gensler
Michael Do, McKinstry

ASHRAE HEAT PUMP APPLICATION GUIDE COMMITTEE:

Mark Frankel, Ecotope
Carmen Cejudo, Pacific Northwest National Laboratory
Vrushali Mendon, Pacific Northwest National Laboratory
Frédéric Genest, NRCan
Steve Guttman, Guttman & Blaevoet
Steven Clark, ICF
Kashif Nawaz, Oak Ridge National Laboratory
Zach Alderman, Opechee

ASHRAE TASK FORCE FOR BUILDING DECARBONIZATION:

Kent Peterson, P2S Inc.
Donald Colliver, University of Kentucky
Carrie Brown, Resource Refocus
Blake Ellis, Burns & McDonnell
Luke Leung, Skidmore, Owings and Merrill
Bing Liu, Pacific Northwest National Laboratory
William McQuade, Baltimore Aircoil
Clay Nesler, The Nesler Group
Stet Sanborn, SmithGroup
Ginger Scoggins, Engineered Designs, Inc.
Stephanie Reiniche, ASHRAE
Jeff Littleton, ASHRAE

TABLE OF CONTENTS

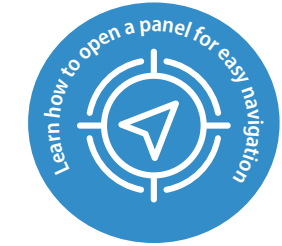

LIST OF ACRONYMS 5

CHAPTER 1: INTRODUCTION 6

- Heating Systems in New and Existing Buildings 8
 - Reduce Building Loads and Heating System Capacity 8
 - Use One System for Heating and Cooling 9
 - Select Equipment and Design Systems to Mitigate Short Cycling 10
 - Minimize Electric Resistance Backup Heat 10
 - Use a Phased Approach to Deployment 10
- Refrigerants 10
- Codes and Standards 10
- References 12

CHAPTER 2: SELECTING THE RIGHT HEAT PUMP FOR YOUR PROJECT 13

- Step 1:** Determine Building Heating and Cooling Loads 14
- Step 2:** Identify and Quantify Energy Recovery Potential 16
- Step 3:** Identify Heat Sources 19
 - Air Source 19
 - Water/Ground Source 23
- Step 4:** Choose Central or Distributed Architectures 25
 - Central Plant 25
 - Distributed System 25
 - Advantages and Disadvantages of Central vs. Distributed Architectures 26

- Step 5:** Choose Distribution Medium (Air, Water, Refrigerant) 27
- Step 6:** Choose Ventilation Control 28
 - Distributed Systems + DOAS Architectures 28
- Step 7:** Assess Backup Heat Requirements .. 29
 - How To Design Without Backup Heat 30
 - Electric Resistance Auxiliary Heat 32
 - Air-to-Water Heat Pumps for Auxiliary Heat 32
 - Existing Gas Equipment as Backup 32
- Heat Pump Configurations 33
 - Ductless Split Air-to-Air Heat Pumps 33
 - Heat Recovery (or Reclaim) Chiller 34
 - Water-Source Heat Pumps With Ambient Water Loop 37
 - Ground-Source Heat Pumps With Ambient Water Loop 39
 - Variable Refrigerant Flow Systems 40
- References 41

CHAPTER 3: DESIGNING AND SIZING HEAT PUMPS 42

- Determine the General System Configuration 43
 - New Construction 43
 - Retrofit 43
- Run a Load Calculation for the Building 44
 - Measured Data and Existing System Capacity ... 44
- Map Hourly Loads for Heating and Cooling ... 45
- Select Equipment Size Based on Load Profiles 47

- Backup Heat 49
- Thermal Energy Storage 49
 - Dedicated Outdoor Air Systems 52
- Simulate System Performance 53
- Iterate on Design (Repeat Steps 1-5) 53
- Design for Minimum Supply Temperature 54
 - Options for Reducing Supply Water Temperature 55
- Risks of Oversizing Equipment 59
 - Operational Issues 59
 - Cost Issues 60
- References 60

CHAPTER 4: RETROFIT APPLICATIONS 61

- Use a Phased Approach 62
- Collect Project-Level Information 63
- Evaluate Existing Building Conditions 63
 - Envelope 63
 - Lighting 64
 - Plug and Process Loads 64
 - Thermal Energy Storage 64
 - On-Site Renewables and Battery Storage 64
- CASE STUDY: Sitka Public Library 65
- Evaluate Existing Mechanical Systems 67
 - Existing HVAC and Domestic Hot Water Systems 67
 - Distribution Systems 67
 - System Operation 68
 - Usage and Load Profiles 68

- Identify Space for New Heat Pump and Distribution Equipment 68
 - Existing Equipment Location 68
 - Air-Source Heat Pumps 68
 - Ground- and Water-Source Heat Pumps 69
 - Distribution Systems 69
- Thermal Stress Test the Building 69
 - What Is a Building Stress Test? 69
- Building Electrical Capacity Considerations for Heat Pump Retrofits 71
 - Determine Remaining Electrical Capacity in an Existing Building 71
 - PV Considerations on Electrical Capacity 74
 - Energy Storage Considerations on Electrical Capacity 74
 - Energy Efficiency Measure Considerations Re: Electrical Capacity 74
 - Key Takeaway Concepts 74
- Retrofit Scenarios 75
 - Scenario 1:** Steam Radiators with Split System Air Conditioning 76
 - Scenario 2:** Single Zone Direct Expansion RTUs with Natural Gas Heat 78
 - Scenario 3:** Variable Air Volume Direct Expansion Air Handling Unit with Natural Gas Reheat 80
 - Scenario 4:** Single Duct VAV Direct Expansion Air Handling Unit with Electric Reheat 82
 - Scenario 5:** Existing Central Plant (Chilled Water and Hot Water) 84
- References 85

**CHAPTER 5: ENSURING SUCCESS, RELIABILITY,
AND LONGEVITY: BEST PRACTICES IN HEAT
PUMP SYSTEM INSTALLATION86**

Eliminate Refrigerant Leaks 87
Submeter 87
If Possible, Preserve the Existing
Heating System 87
Avoid Unnecessary Electrical Upgrades 87
Prioritize Air Sealing 87
Internal Condensate Drainage 87

APPENDIX90

Heat Pump Basics 91
Heat Pump Working Principles91
Basic Components of Heat Pump Equipment
and Their Operation94
Measures of Efficiency96
Heat Pump Controls96
Defrost System and Controls97
Other Types of Heat Pump Cycles99
Building Internal Load Reduction102
Lighting102
Plug and Process Loads107
PPL Control Strategies109
References112
How to Use Bookmarks/Table of Contents
to Navigate This Document.....113

Inside ASHRAE's new Global Headquarters is an example of how a building can undergo retrofits and become a modern, high-performance building.

Photo from ASHRAE

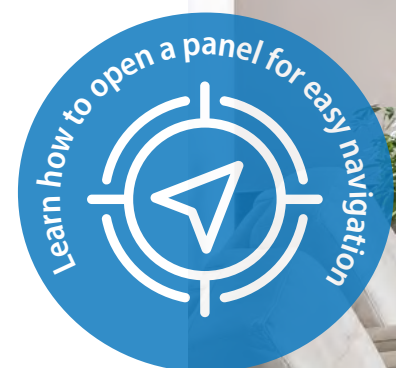

LIST OF ACRONYMS

AHRI	American Heating and Refrigeration Institute
ASHRAE	American Society of Heating, Refrigerating and Air-Conditioning Engineers
COP	coefficient of performance
DOAS	dedicated outdoor air system
DOE	U.S. Department of Energy
ERV	energy recovery ventilator
EVI	enhanced vapor injection
HRV	heat recovery ventilator
HVAC	heating, ventilating, and air conditioning
LPD	lighting power density
NEEA	Northwest Energy Efficiency Alliance
NEEP	Northeast Energy Efficiency Partnership
NREL	National Renewable Energy Laboratory
PPL	plug and process loads
PV	photovoltaics
RTU	rooftop unit
SEER	seasonal energy efficiency ratio
TES	thermal energy storage
VAV	variable air volume
VRF	variable refrigerant flow



VRF Condensing Unit

Photo from P2S Inc.

CHAPTER 1: INTRODUCTION



The heat exchangers in the integrated control room underneath the high performance computing data center at NREL's Energy Systems Integration Facility.
Photo by Dennis Schroeder, NREL 24637

Space heating and hot water systems represent approximately one-third of the total energy consumed by commercial buildings in the United States (EIA 2023). Much of this energy is from fossil fuels or electric resistance heating. Ultimately, this large energy expenditure has environmental impacts, whether it is pollution and emissions from the direct consumption of fossil fuels or from the electrical grid.

There are many pathways to reduce the environmental impact of building cooling, heating, and hot water systems, referred to as thermal systems in this guide. Some of these strategies are independent of the type of thermal system; building energy efficiency, for example, is core to reducing environmental impacts. Design strategies, such as better envelopes and better management of outside air, also have positive impacts. Improving the distribution of heat to the building is another core solution that often yields better control and comfort. Heat pumps, high efficiency boilers, heat recovery, and combined heat and power are additional strategies for increasing the energy efficiency of the system to reduce fossil fuel consumption and the associated emissions.

Heat pumps deliver heating and cooling to buildings at a high level of efficiency. If the electricity powering the heat pump is from renewable energy sources, these devices can be a pathway for substantially reducing the emissions associated with commercial building thermal systems. Heat pumps move heat into the building from a source such as the air, ground, and water. The source for a particular heat pump installation depends on local conditions. The heat pump can extract heat from outside air (air-source heat pumps), but there can be advantages to pulling the heat from the ground (ground-source heat pumps) or waste heat from the building such as sewer water or exhaust air.

Aside from the impact of using energy for heating systems, other environmental impacts of heating systems include resource extraction, transportation, carbon emissions, non-carbon-based emissions, and refrigerant release, as shown in Figure 1. This guide focuses on the impacts of the operation of the heating system as shown by the green arrows. These combustion emissions accounted for 73% of building emissions and 27% of global emissions in 2020 (ASHRAE

2022a). The guide excludes the flows shown in gray, including the embodied carbon of the equipment, but all these emissions should be considered as part of the design when pursuing emissions reductions. Although this guide aims to reduce barriers to deploying heat pumps for heating, cooling system strategies are also discussed to improve overall efficiency and further reduce the energy and environmental impact of buildings. This is especially important in buildings that require simultaneous heating and cooling.

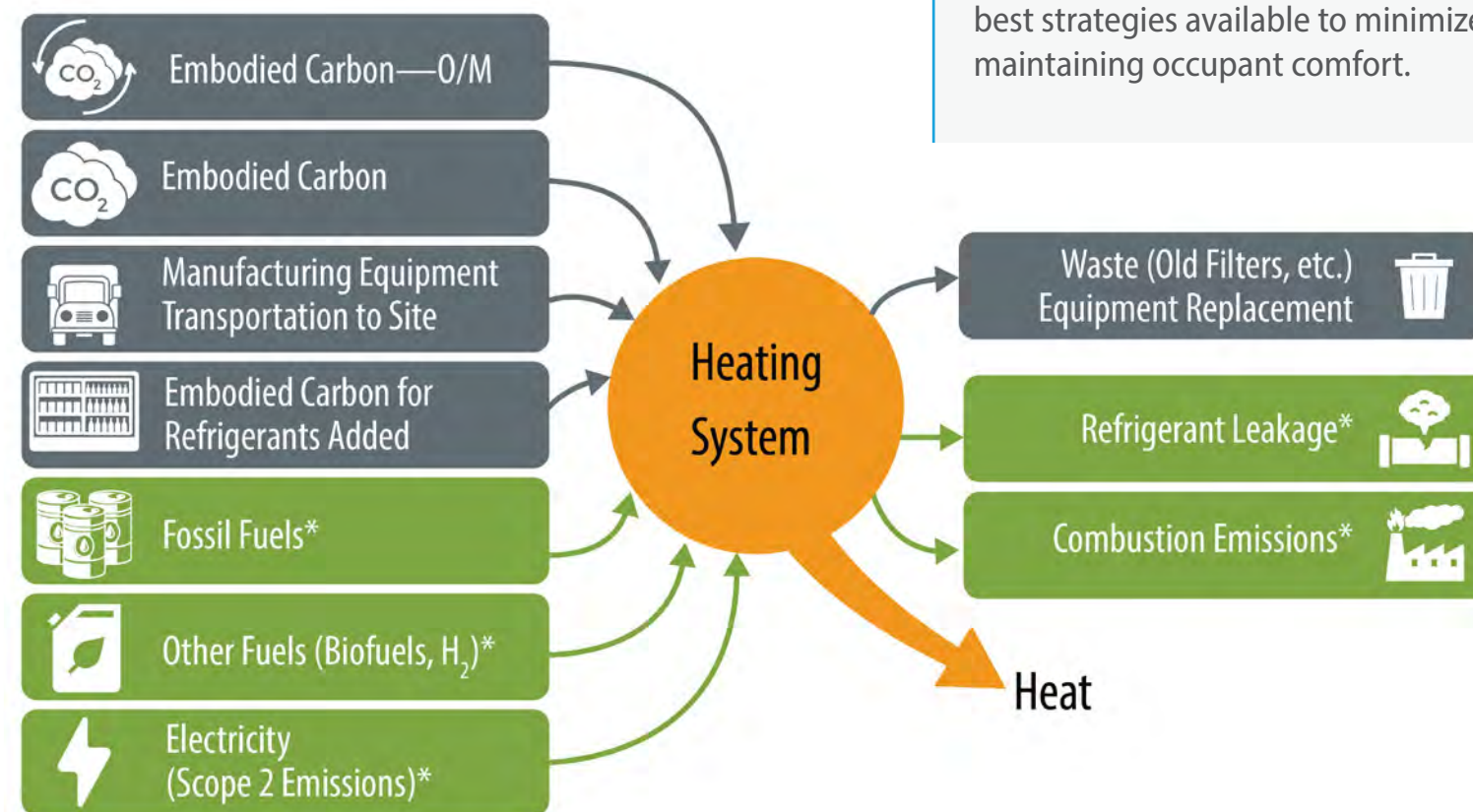

Figure 1. Building heating typically requires many inputs and outputs that can produce emissions. Inputs include the fuels used to operate the system and the manufacture, transportation, and maintenance of the equipment. Outputs include refrigerant leakage, combustion emissions, and emissions resulting from the use and eventual demolition and disposal of the system. Green items with an asterisk are included in this guide.

All figures in this guide are by NREL, unless otherwise noted

ABOUT THIS GUIDE

Decarbonizing Building Thermal Systems is the first in a broad suite of resources focused on increasing energy efficiency and reducing the environmental impact of space conditioning in commercial buildings. It focuses on the design of heat pump systems and complements forthcoming guidance on combined heat and power, district energy, ground-source heat pump design, high-temperature heat pumps, and other emerging technologies. Commercial buildings use a variety of heating and hot water systems, and reducing the impact of these thermal systems requires a variety of technologies. The basic principle in all these strategies is that the process requires a systems approach—looking at the building as an integrated system. The key is to first reduce the need for heating and then to find efficient ways to deliver that heat by evaluating waste heat streams and taking advantage of local site conditions. The objective is to use the best strategies available to minimize environmental impact while maintaining occupant comfort.

The design and construction community plays a pivotal role in implementing building heating systems. This resource was developed for architects, engineers, and contractors in response to an industry need for a technical resource that provides guidance on the intricacies of designing, installing, and maintaining commercial heat pump systems. It includes detailed information on sizing and selecting an appropriate configuration for heat pump systems, determining the heat source (such as air, ground, or water), and integrating the heat pump into new or existing commercial building systems. Moreover, it emphasizes best practices for ensuring operational efficiency, system longevity, and reliability.

The design and construction community plays a pivotal role in implementing building heating systems.

Heating Systems in New and Existing Buildings

Reducing the emissions impact of heating systems requires an integrated approach that is important in both new and existing buildings. Heat pumps operate best in a well-insulated and energy-efficient building. For new construction, code and beyond code envelopes result in many buildings that are ideal for heat pumps. Existing buildings that are less energy-efficient, however, pose unique challenges. The most effective system upgrades begin with improving envelope performance and updating distribution systems in addition to augmenting or replacing central equipment. It is also important to consider appropriate capacity for any heating system. Oversized heat pumps can result in poor performance and reduced life expectancy due to short cycling of motors and compressors. By considering the heating system as part of the whole heating, ventilating, and air conditioning (HVAC) system, projects can be designed and implemented to optimize system performance and mitigate any perceived barriers to decarbonizing the heating system.

Reduce Building Loads and Heating System Capacity

There are several key strategies for a successful heating system upgrade. The first and often the most cost-effective is to reduce building loads and thus heating system capacity, which also saves on operating costs. Reducing building loads can reduce the requirements for supplemental heating and improve heating system performance. In addition, occupants' thermal comfort could be compromised if the HVAC system cannot meet the load. Other building loads such as lighting and plug and process loads can also increase equipment size requirements.

When designing a heat pump system, first review the existing envelope to determine whether it could be improved and examine other loads for reduction opportunities. Buildings with inefficient envelopes require more energy to heat and cool, resulting in the need for larger equipment to manage the loads. Without envelope improvements, the need for larger equipment can increase heating system costs.

To reduce building loads:

- **Improve the building envelope.** Think of the building envelope as part of the heating system. In both new and existing buildings, a tight, well-insulated envelope reduces building loads and enables the heating system to operate at higher efficiency. In existing buildings, improving the envelope allows for lower supply temperatures to better maintain occupant comfort and reduces the cost of the heating system by reducing equipment size. Upgrading envelope components such as windows, wall insulation, and roof insulation improves system performance and can mitigate thermal bridging and infiltration, which will also reduce building loads. This becomes more important in the cooler climates where heating loads are higher. The **Envelope** section includes more detail on envelope improvements.
- **Reduce internal loads.** Internal loads such as lighting and plug and process loads increase the need for building cooling. If the building uses a heat pump for heating

and cooling, the increased cooling requirement could result in a heat pump that is oversized in heating mode. Installing newer and more energy-efficient equipment and improving the lighting design can allow the designer to reduce internal loads as well as the size of the components required to meet them. The **Lighting** and **Plug and Process Loads** sections provide further detail on how to reduce these loads in existing buildings.

- **Reduce ventilation heating and cooling loads.** Ventilation loads typically account for 20% to 40% or more of a building's heating load, depending on the building type and operation requirements (DLC 2024). Strategies that can help reduce heating loads include using energy recovery, reducing ventilation rates to match occupancy and building changes, and separating building loads from ventilation loads by using a dedicated outdoor air system (DOAS). Moreover, in addition to ASHRAE Standard 62.1 (ASHRAE 2022b) on ventilation and acceptable indoor air quality, designers need to also consider ASHRAE Standard 241 (ASHRAE 2023) on the control of infectious aerosols and minimum equivalent clean air requirements to reduce airborne diseases in commercial buildings. **Step 6: Choose Ventilation Control** and the subsection **Reduce Ventilation Loads** (within **Options for Reducing Supply Water Temperature**) include further discussions of these strategies.
- **Recover heat from simultaneous heating and cooling loads.** Heat pumps move heat from one location to another, which gives buildings using them for heating and cooling an advantage over buildings with separate heating and cooling systems. Heat pumps can recover waste heat from other sources in a building, and that ability can allow designers to reduce equipment size and improve system efficiency. For example, cooling condenser water can be used to provide heating for zone-level reheat or domestic hot water in the building. This helps improve system efficiency, reduce loads, and improve overall project return on investment. **Step 2: Identify and Quantify Energy Recovery Potential** includes a discussion of heat recovery and different strategies for analyzing heat recovery.

- **Investigate reduced nighttime setbacks.** Many buildings use nighttime setbacks to reduce heating or cooling requirements during nonoperating hours. In the mornings before occupants arrive, the systems operate at peak capacity to bring the building temperature back to normal occupied set points. Conventional guidelines suggest that building warm-up requirements can add 20% to the overall capacity of the equipment to meet these loads. In some cases, reducing or eliminating these nighttime setbacks or extending warm-up duration can reduce building peak loads, which in turn reduces equipment size and cost and makes it possible for the equipment to be sized for more typical building loads. Not sizing for morning warm-up can increase overall system efficiency—something that is unique to heat pump designs compared with fossil fuel-based systems. **Chapter 3: Designing and Sizing Heat Pumps** discusses this concept in more detail.

Use One System for Heating and Cooling

For a building with a heat pump as part of its HVAC system, it may be possible to provide both heating and cooling from one piece of equipment. This strategy can reduce costs, simplify installation, save space, and reduce the need for additional electrical capacity. For these reasons, using heat pumps for both heating and cooling rather than replacing the existing heating equipment with a dedicated heating-only unit may be the most cost-effective solution.

If, however, occupant comfort requires supplementary heating, it could make sense to meet that need by leaving the existing heating system in place. This strategy allows the designer to reduce equipment size and still gain many of the benefits of installing a heat pump for both heating and cooling. **Chapter 5: Ensuring Success, Reliability, and Longevity: Best Practices in Heat Pump System Installation** discusses design considerations and strategies to address these issues.

HEAT PUMPS

Heat pumps are an efficient, readily available technology to provide space heating, space cooling, and water heating in buildings while supporting efforts to decarbonize. Heat pump technology has improved significantly over the last 15 years, and the latest air-source heat pumps are capable of providing the sole source of heat in cold climates with little to no assistance from auxiliary heat. Although heat pumps currently account for only about 11% of commercial building space heating (representing about 15% of the total floor area) (CBECS 2018), that percentage is expected to grow as heat pumps become more common.

Heat pump technology has been in development for more than 170 years. British mathematician Lord Kelvin (née William Thomson) described the theory behind heat pumps in the early 1850s. Later that decade, Austrian engineer Peter von Rittinger built the first practical heat pump, using the latent heat in water vapor to evaporate liquid from salt brine. Likely inspired by Rittinger's work, Antoine-Paul Piccard of the University of Lausanne and engineer J.H. Weibel of the Weibel-Briquet in Geneva developed the first vapor-compression salt plant in 1876, which was installed in the salt works at Bex, Switzerland, in 1877. By 1938, the City Hall of Zurich replaced wood stove heating with a water-source (from Lake Geneva) heat pump system, which was in use until 2001 when it was replaced by a new, more efficient heat pump (Zogg 2008).

Being able to easily switch between heating and cooling with the same unit makes heat pumps distinct from traditional HVAC systems, which typically provide either heating or cooling. Understanding how heat pumps operate is important when making decisions about how to deploy them as a building's primary heating and cooling source.

Heat pumps are more efficient than electric resistance or fossil fuel-fired equipment. The operating coefficient of performance for heat pumps typically ranges from 2 to 5, meaning that for every one unit of energy the system consumes, it provides 2 to 5 units of heating energy to the space. The coefficient of performance for electric resistance equipment is approximately 1, while gas furnaces always have efficiencies less than 1 because fossil fuel combustion is not 100% efficient at turning fossil fuels (chemical energy) into heat and always exhausts some heat from the combustion process

through the stack. Heat pumps can be ducted or ductless and can be integrated with existing HVAC equipment or designed into new construction.

Heat pumps generally deliver lower temperature air or water (in heating mode) than conventional combustion equipment. This means that air coils in distribution systems must be sized for lower supply temperatures. Envelope loads should also be minimized, which can enhance occupant comfort by increasing the surface temperature of the walls.

Heat pumps can heat and cool. Often a reversing valve is used to effectively swap the evaporator and condenser coils, which allows the same heat pump outlet to be used for heating or cooling. This component is the primary difference between a heat pump and a typical air conditioner or refrigerator. Not all heat pumps have reversing valves, however. Some heat pumps, especially those designed for hot water production, only produce heat.

Because of their high efficiency, use of electricity, and range of available configurations, heat pumps are a valuable option for achieving building decarbonization goals. **Appendix: Heat Pump Basics** includes a more detailed discussion of the operation of the heat pump and its components.

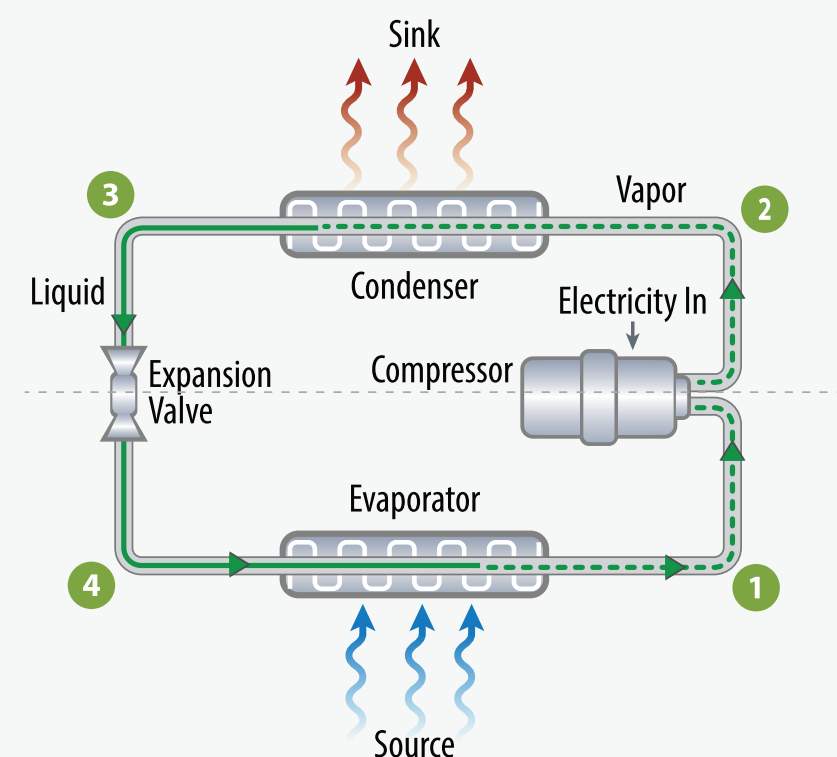

Figure 2. Basic operation of a heat pump system

Select Equipment and Design Systems to Mitigate Short Cycling

Heat pumps ideally provide both heating and cooling, so they operate at least twice as long as a stand-alone heating- or cooling-only system would. As a result of this increased run time and the varied loads the heat pump must meet, it is imperative to design the system to mitigate short cycling—cycling on and off too frequently—and ensure the equipment will reach the end of its expected useful life. This can be achieved by using energy storage, selecting variable-speed equipment with sufficient ability to vary loads, sizing equipment properly for the anticipated load and run time, staging equipment to increase turndown ratios, and providing backup heating systems to manage short-lived peak loads. The **Select Equipment Size Based on Load Profiles** section discusses design strategies to mitigate short cycling issues.

Minimize Electric Resistance Backup Heat

Buildings with new heat pump equipment that can operate at high capacity and high efficiency down to very cold outdoor air temperatures will not need backup heat in many climates. In the coldest climates, these heat pumps can still operate at efficiencies better than electric resistance, although total heating capacity will be reduced. To help reduce costs and enable efficient operation, backup heat should be minimized in existing buildings and 100% electric resistance backup heat should be considered only in a limited number of cases (see **Step 7: Assess Backup Heat Requirements** for more information). Strategies to avoid or minimize backup heat include selecting equipment with sufficient cold weather performance, using ground-source heat pumps, providing sufficient thermal storage, and using existing heating systems as backup heat for short-lived building load peaks. The **Backup Heat** section discusses these strategies in more detail.

Use a Phased Approach to Deployment

For many buildings, equipment upgrades are driven by necessity, such as equipment failures that require quick replacements to prevent building downtime and lost costs for the tenant/

owner. In these instances, deep analysis, engineering, and retrofits might not be achievable in the available time frame. It can make sense to develop a plan that anticipates these failures and follows a phased approach that moves the building on a path to decarbonization and gives the building owner more time to pursue the deeper strategies that result in an optimized and fully decarbonized solution. In this approach, the focus should be on solving the current building problems with electrified solutions that significantly reduce fossil fuel consumption on-site and can provide a pathway for full decarbonization in the future as time and budget permits. The section **Use a Phased Approach** discusses strategies to implement this phased approach in greater detail.

Refrigerants

Refrigerants are central to heat pump operation. Different refrigerants have different thermal properties that impact heat pump configuration, capabilities, and performance. Refrigerants determine how well heat pump systems perform in colder climates; how high an output temperature can be delivered by the heat pump; how much temperature differential can be delivered by the heat pump; and a host of other details that affect system configuration, control, and operation. Designers must carefully review system performance characteristics for each building application to select the right type of heat pump equipment with the right type of refrigerant.

Many refrigerants have very high global warming potential, and refrigerant leakage into the atmosphere is a major contributor to the building sector's carbon impacts.

Many refrigerants have very high global warming potential, and refrigerant leakage into the atmosphere is a major contributor to the building sector's carbon impacts. Because of the global warming impacts of refrigerants, the international community is transitioning the HVAC industry to refrigerants with lower global warming potential. Just as ozone-depleting refriger-

ants were phased out, refrigerants with high global warming potential will be replaced by refrigerants with lower impacts. These may consist of new refrigerant chemical designs or the adoption of natural refrigerants like CO₂, propane, ammonia, and others.

Designers should be aware that this transition to low global warming potential refrigerants may make some current equipment obsolete or may require a refrigerant change-out as older refrigerants are phased out. Designers should also pay careful attention to specifying systems and construction strategies that allow for transitions to new refrigerants when equipment becomes available. This is the beginning of an effective refrigerant management strategy that can be used throughout the lifetime of the building.

Codes and Standards

The American Heating and Refrigeration Institute (AHRI) maintains a database of testing standards and testing performance metrics for a wide variety of heat pumps (AHRI 2024a). Performance data using third-party testing organizations provide a means to objectively compare heat pumps and are also used to define minimum requirements to meet energy codes based on ASHRAE 90.1 Energy Standard for Buildings Except Low-Rise Residential (ASHRAE 2022c). **Table 1** includes a sample list of various heat pump testing standards. **Figure 3** shows an example AHRI certificate template (AHRI 2024b) that describes performance tested under protocol AHRI 1230 at outdoor air temperatures of 95°F and 47°F. Additional data under other conditions, such as outdoor or indoor temperature and compressor loading, may be available in manufacturers' data tables.

Other resources list heat pumps that meet specific performance criteria:

- **Northeast Energy Efficiency Partnership** lists air-source heat pumps that meet performance criteria under cold conditions (NEEP 2024). Small air-source heat pumps must have a coefficient of performance of more than 1.7 at 5°F. Currently, the Northeast Energy Efficiency Partnership list includes more than 100,000 models.
- **ENERGY STAR® Light Commercial** lists efficiency minimums for variable refrigerant flow, ground-source heat pumps, and large unitary commercial heat pumps that exceed minimums specified in ASHRAE 90.1 (ENERGY STAR 2024).
- **Northwest Energy Efficiency Alliance** shows system coefficients of performance (COPs) for central heat pump water heating for commercial and multifamily systems (NEEA 2024).

Figure 3. AHRI certificate template depicting AHRI 1230

Figure from AHRI



Table 1. Heat Pump Type and Associated Testing Standard

Heat Pump Type	Test Standard	Notes
Smaller split and unitary air source	AHRI 210/240	For air-to-air heat pumps with less than 64,000 Btu/hr capacity
Commercial and industrial unitary air source	AHRI 340/360	For air-to-air heat pumps greater than 64,000 Btu/hr capacity
Variable refrigerant flow	AHRI 1230	For capacities greater than 65,000 Btu/h
Ground source	ISO 13256-1 and 13256-2	
Heat pump chillers, heat recovery chillers	AHRI 550/590	
Dedicated outdoor air system	AHRI 920	

References

- AHRI. 2024a. "AHRI Certification." The Air-Conditioning, Heating, and Refrigeration Institute. www.ahrinet.org/certification. Accessed 14 Feb. 2024.
- AHRI. 2024b. "Standards & Guidelines." The Air-Conditioning, Heating, and Refrigeration Institute. www.ahrinet.org/standards. Accessed 14 Feb. 2024.
- ASHRAE. 2022a. "ASHRAE Position Document on Building Decarbonization." 26 June 2022. https://www.ashrae.org/file%20library/about/ashrae_building_decarbonization_pd_2022.pdf.
- ASHRAE. 2022b. ANSI/ASHRAE/IES Standard 62.1-2022 Ventilation and Acceptable Air Quality. Peachtree Corners, GA: ASHRAE. <https://www.ashrae.org/technical-resources/standards-and-guidelines/read-only-versions-of-ashrae-standards>.
- ASHRAE. 2022c. ANSI/ASHRAE/IES Standard 90.1-2022 Energy Standard for Sites and Buildings Except Low-Rise Residential Buildings. Peachtree Corners, GA: ASHRAE. <https://www.ashrae.org/technical-resources/standards-and-guidelines/read-only-versions-of-ashrae-standards>.
- ASHRAE. 2023. ASHRAE Standard 241-2023 Control of Infectious Aerosols. Peachtree Corners, GA: ASHRAE. <https://www.ashrae.org/technical-resources/standards-and-guidelines/read-only-versions-of-ashrae-standards>.
- DLC. 2024. "Commercial Energy Library: Ventilation." Duquesne Light Co. (DLC). <https://c03.apogee.net/mvc/home/hes/land/el?utilityname=duquesnelight&spc=cel&id=1314>.
- EIA. 2023. "Use of energy explained—energy use in commercial buildings." U.S. Energy Information Administration (EIA). www.eia.gov/energyexplained/use-of-energy/commercial-buildings.php.
- ENERGY STAR. 2024. "Light Commercial Heating & Cooling." www.energystar.gov/products/light_comm_heating_cooling. Accessed 14 Feb. 2024.
- NEEA. 2024. "Heat Pump Water Heaters." Northwest Energy Efficiency Alliance. <https://neea.org/search?query=Heat+Pump+Water+Heaters>. Accessed 14 Feb. 2024.
- NEEP. 2024. "CcASHP Specification & Product List." Northeast Energy Efficiency Partnerships. <https://neep.org/heating-electrification/ccashp-specification-product-list>. Accessed 14 Feb. 2024.
- Zogg, Martin. 2008. "History of Heat Pumps: Swiss Contributions and International Milestones." Swiss Federal Office of Energy. www.zogg-engineering.ch/publi/HistoryHP.pdf.



5 ton rooftop heat pump.

Photo from P2S

CHAPTER 2: SELECTING THE RIGHT HEAT PUMP FOR YOUR PROJECT

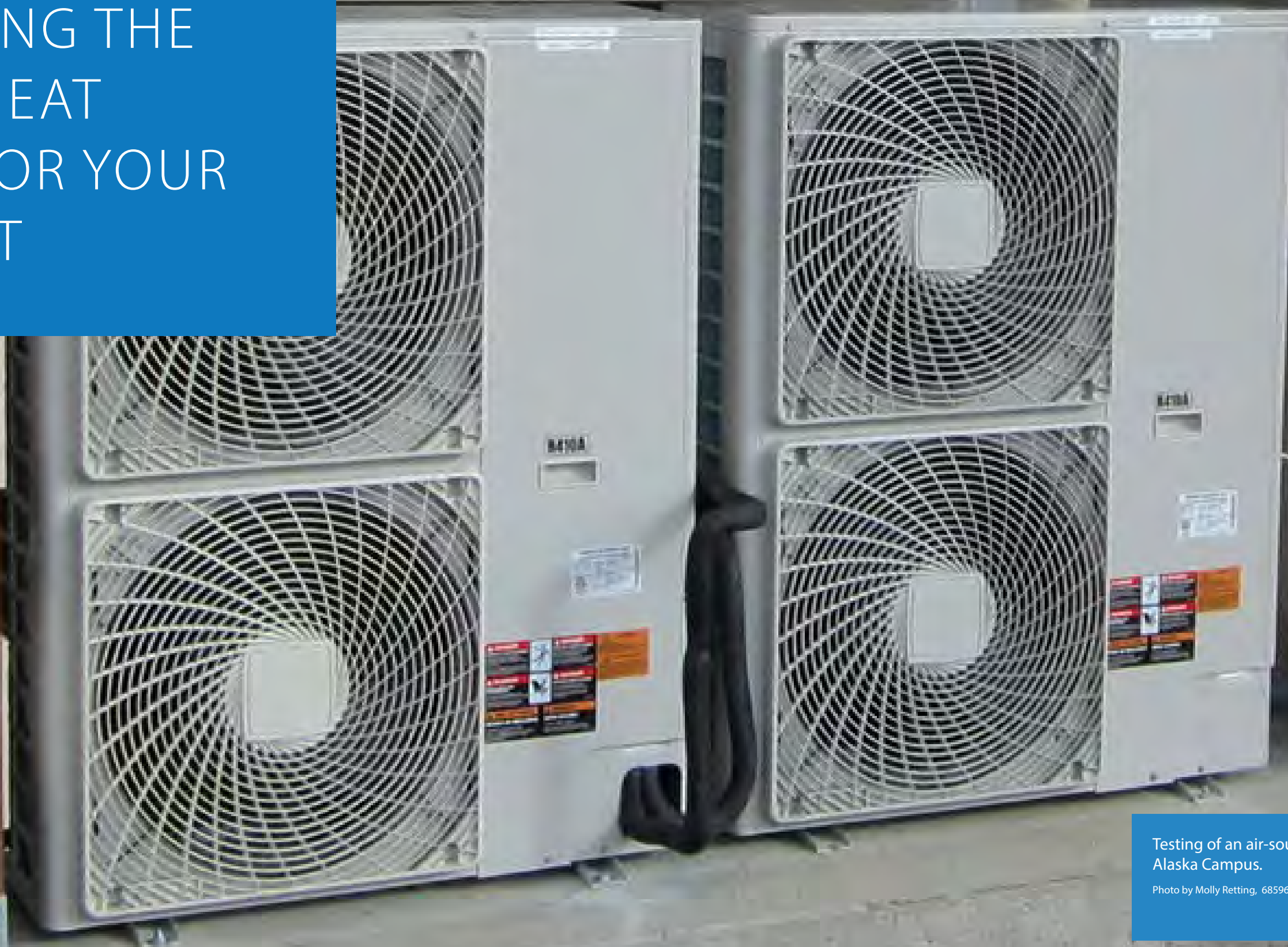

Testing of an air-source heat pump at NREL's
Alaska Campus.

Photo by Molly Retting, 68596 NREL

This section provides a process that can be deployed by engineers to select heating system configurations for a building or campus for retrofit or for new building projects. Heat pump solutions should not be thought of as drop-in replacements for fossil fuel equipment. In contrast to fossil fuel-based heating designs, holistic building design processes should be considered that investigate heating loads, cooling loads, and energy streams within and outside of the building when considering heat pump solutions. Heat pumps benefit from integration into the building. The following sections will outline a process for effective integration in a streamlined, cost-effective manner. The steps are depicted in **Figure 4**.

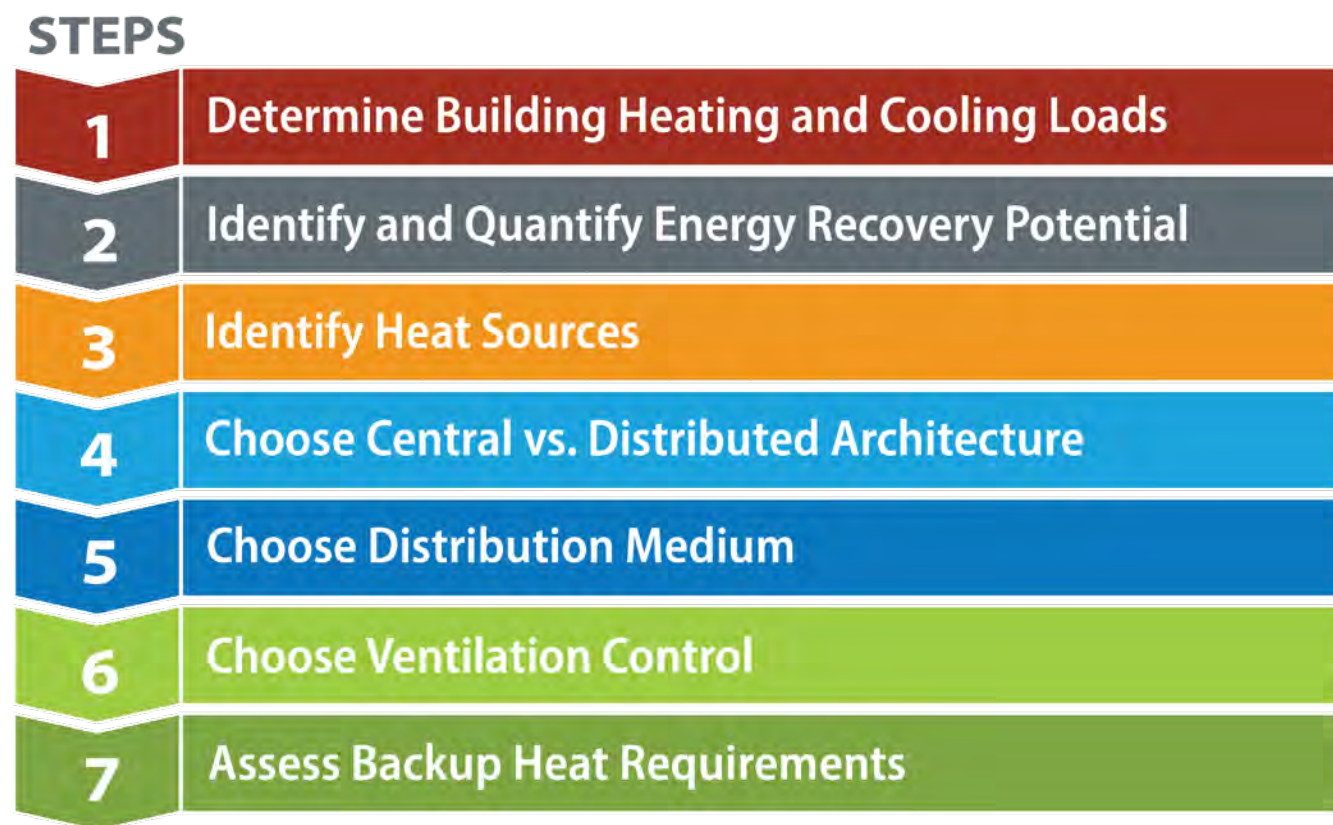

Figure 4. Sample process steps that can be deployed by engineers to select all-electric heating system configurations for a building or campus in a retrofit application or for new construction projects

Step 1: Determine Building Heating and Cooling Loads

The first step to selecting an appropriate heat pump is determining the amount of heating and cooling the building needs. While cooling systems have not historically run on fossil fuels in the same way heating systems have, designers must analyze loads for both, given that heat pumps should deliver heating and cooling. This can be done by analyzing existing building heating and cooling data from a building automation system, using portable data loggers to collect run times or fuel consumption, or by calculating the heating and cooling needs through building energy modeling software. Ideally these data would be presented in 60-minute time intervals or less.

Once heating and cooling loads are determined, heating and cooling load curves can be created based on outdoor temperature for each time interval. Ideally, morning warmup (or cooldown in the summer) would not be included as that artificially increases the peak loads. **Figure 5** shows fictitious curves of heating and cooling loads as functions of outdoor air temperature, for demonstration purposes. Real plots of this data will have a lot of scatter. A key piece of data includes the oversizing of the existing equipment both on the heating and cooling side. In the example shown below, there is a switchover from heating to cooling and a range of temperatures where minimal heating and cooling are needed. In many buildings there is a crossover showing that both heating and cooling are needed. This concept will be examined more in **Chapter 3: Designing and Sizing Heat Pumps**. Because heat pumps can provide heating and cooling at the same time in some applications, this translates to either free heating or free cooling compared to fossil fuel-based systems with separate air conditioning.

When designing for the use of heat pumps, the heating and cooling loads **must be compared** to each other to determine which load is higher, and a heat pump rated for the greatest load should be considered. For example, if the cooling load is 5 tons and the heating load is 72,000 Btu/hr (6 tons), then a 6-ton heat pump will need to be selected with capacity sufficient for the design heating temperature. Particularly for air-source heat pumps, outdoor air conditions at peak heating and cooling loads should be noted to ensure that heat pump systems are selected with operational ranges that encompass peak operating conditions. Designers should aim to design the heat pump for the purpose of meeting all heating and cooling needs and to refrain from relying on separate, lower efficiency, backup heat sources when possible. (**Step 7: Assess Backup Heat Requirements** outlines backup heat considerations in more detail.)

A caution here: when heating loads are significantly higher than cooling loads in humid climates, care must be taken to select a heat pump that can provide sufficient heat and also reduce the capacity output for the summer cooling loads for proper humidity control. This can be done by selecting variable-speed inverter-driven compressors with variable-speed fans, which will modulate the airflow and compressor speed to provide adequate cooling and dehumidification in the summer, without frequent short cycling. This can also be done by using staged equipment or providing sufficient thermal storage to prevent short cycling and provide sufficient part-load performance. These considerations will ensure sufficient run times that are needed to properly dehumidify the space. A key point here is that thermal energy storage can be advantageous in helping heat pumps meet a wide range of loads.

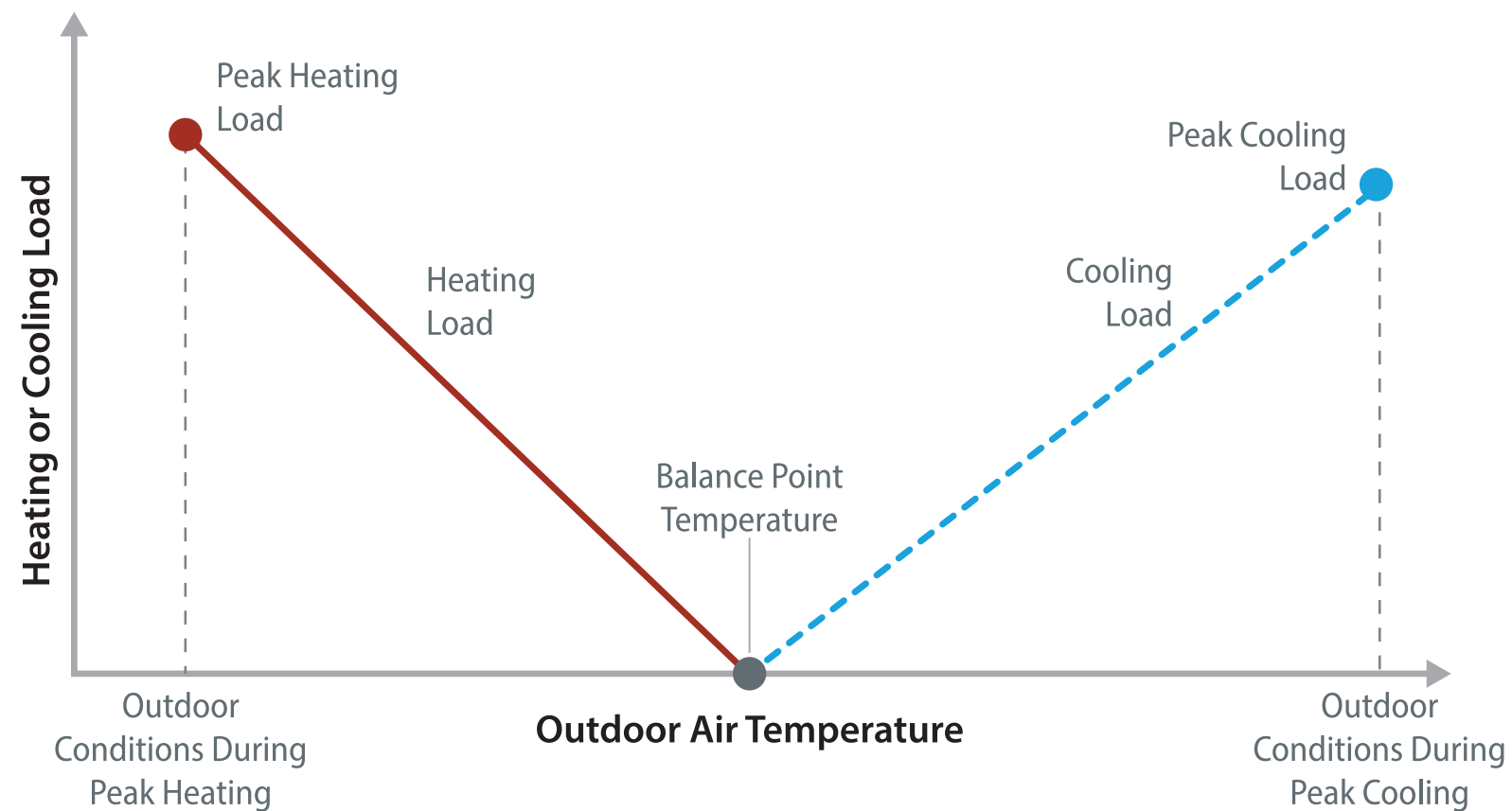

Figure 5. Fictitious curves of weather-normalized heating and cooling load curves as functions of outdoor air temperature, for demonstration purposes, where peak heating and peak cooling is identified along with associated outdoor air conditions



The City Hall building in Greensburg, Kansas, includes solar panels and a ground-source heat pump system that provides heating and cooling.

Photo by Lynn Billman, NREL 17597

THERMAL BALANCING

For constant-speed heat pumps, the heat pump will cycle on and off to meet the heating load at outdoor air temperatures below the thermal balance point temperature.

In variable-speed heat pumps, the system can vary its capacity to match the heating or cooling load within a certain capacity range dictated by the compressor turndown ratio. In a two-stage, multi-stage, or variable-capacity heat pump, this is the ratio of maximum capacity to minimum capacity (e.g., 3:1). Heat pumps with higher turndown ratios will operate without cycling for a greater proportion of the heating season, increasing their seasonal efficiency (NRC 2020).

Figure 6 demonstrates an example of two heat pump options with differing turndown ratios by overlaying the

heating load (red line) and heat pump capacity curves as functions of outdoor air conditions. Each heat pump option has the same maximum capacity, but the lower capacity is different for these two example heat pumps. The length of the heating load line that is between the two maximum and minimum intersecting points indicates the amount of the heating load that the heat pump will operate without cycling. Designers should aim for heat pump selections that maximize operational outdoor air temperature between these two intersection points. It is important to note that cycling degrades performance and results in zone temperature swings, poor humidity control, and associated comfort degradation. Designers should aim to minimize cycling by selecting equipment with adequate turndown ratios. This is one area where heat pumps are different than fossil fuel boilers and furnaces—often these equipment have large turndown ratios.

Step 2: Identify and Quantify Energy Recovery Potential

Energy recovery can take on many forms. In general, energy recovery refers to capturing the heat or cold that is normally a waste stream and reintroducing it into the building. The benefit is less overall energy needed. In addition to energy efficiency, energy recovery has the potential to substantially reduce peak heating and cooling loads, which in turn reduces the size of the heating and cooling systems and thus the size of the heat pump and any backup heat, if necessary.

In the winter, warm air leaving the building preheats required ventilation air entering the building.

The first form of energy recovery is capturing conditioned air leaving the space and moving that energy to the inlet air stream. In the winter, warm air leaving the building preheats required ventilation air entering the building. These systems can be somewhat passive—in other words, this can be a heat exchanger that moves the heat between the airflow streams, or a more active approach where a heat pump evaporator is located in the outlet air stream and the condenser is in the supply air. This system allows for more control and for warmer supply air temperatures than provided by a heat exchanger alone. The heat pump operates more efficiently than when the evaporator is exposed to the outdoor temperatures and is thus more efficient. Hybrid solutions can use both a heat pump and a heat exchanger. While we have just described heating the outlet air stream, the opposite can be used for cooling the ventilation air; this also has the advantage of removing outside moisture before it enters the building either with an enthalpy exchanger or by cooling the air below the dewpoint with a heat pump. All these systems reduce the heating and cooling loads. Conditioning outside air is a significant portion of the building load, especially in new construction where loads are minimized because of better envelopes and solar load manage-

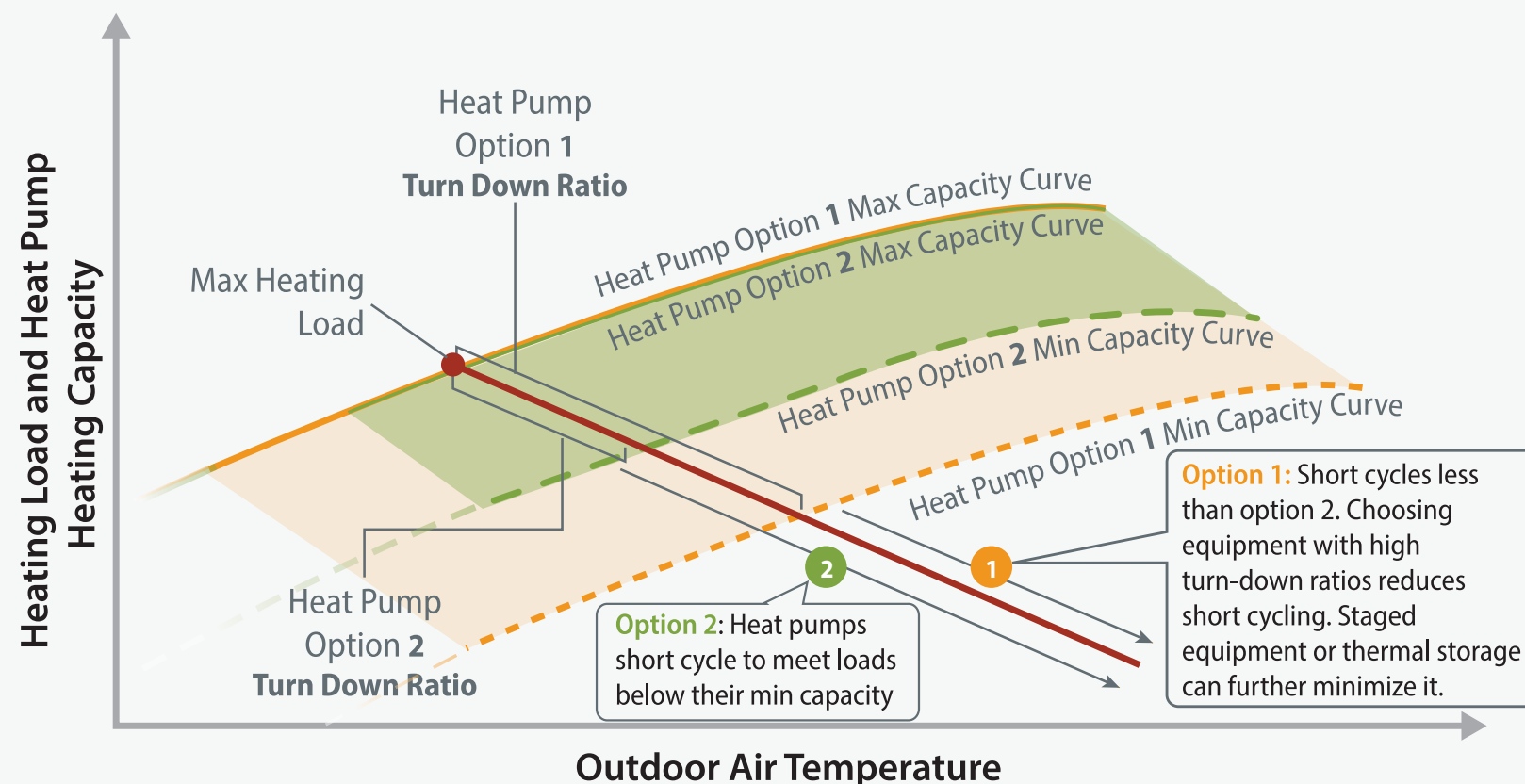

Figure 6. Thermal balance point temperature in variable-capacity heat pump systems and a demonstration of turndown ratio for two heat pump options

ment during the cooling season. A caution here: some heat recovery systems that only use heat or enthalpy exchangers also use electric resistance elements to raise the ventilation air temperature in the winter. This can be a significant load (both a peak design and an energy burden) to the building.

The second form of energy recovery is when simultaneous heating and cooling loads are required in the building. For example, large buildings in the winter require heating for zones against exterior walls. Internal spaces have no means to remove heat from the space due to internal loads such as plug loads and lights—in this case these interior zones need cooling. Designers would commonly use fossil fuels or electric resistance systems to heat the perimeter of the building while using a separate cooling system to condition the center of the building. Heat pump designs should use heat from the center of the building to condition the building perimeter. To design for this, hourly heating and cooling load data or calculations are needed to predict simultaneous heating and cooling needs and to quantify the energy recovery potential for the building and its impacts on heat pump system design, selection, and sizing.

The following metrics offer insights into the potential for energy recovery and its associated impacts on system selection and sizing:

1. Peak simultaneous heating and cooling load
2. Minimum simultaneous heating and cooling load
3. Maximum heating load minus simultaneous load
4. Maximum cooling load minus simultaneous load
5. Minimum cooling load
6. Minimum heating load

Simultaneous load, or overlapping load, is calculated at each hour of the year through the following equation:

$$OL(t)=\min[HL(t),CL(t)]$$

Where OL(t) is the overlapping or simultaneous load at hour “t”, HL(t) is the hourly heating load, CL(t) is the hourly cooling load, and “min” indicates that the overlapping load is the lesser of the heating and cooling loads at each hour of the year.

Table 2 summarizes the key metrics to calculate, how to calculate them, and explains why each of these data points is useful for determining energy recovery possibilities that ultimately inform heat pump selection and sizing.

Heat pump designs should use heat from the center of the building to condition the building perimeter.

ENERGY RECOVERY POTENTIAL AND BUILDING SIZE

Energy recovery potential is typically correlated with building size. Smaller buildings such as residences or small offices (roughly less than 10,000 ft²) are less likely to have simultaneous needs for heating and cooling, hence in smaller buildings calculating the peak heating and cooling loads is typically sufficient for heat pump selection and sizing purposes. This includes large multifamily buildings that are a collection of smaller units that operate independently.

For larger buildings (roughly larger than 10,000 ft²), the potential for load diversity throughout building zones becomes higher. Therefore, one key consideration of heat pump selection in larger buildings is the need **for hourly heating and cooling load data (modeled or measured) for an entire year**. Hourly heating and cooling loads enable the designer to investigate and consider energy recovery possibilities and design options.

Table 2. Key Metrics That Inform Energy Recovery Possibilities and Heat Pump Selection and Sizing Consideration

Key Metrics To Calculate	How the Metric Influences Design Decisions	How To Calculate the Metric
Peak simultaneous heating and cooling load	Use to calculate how much energy recovery is possible for sizing the energy recovery system.	$\max(\text{OL}(t))$
Minimum simultaneous heating and cooling load	Use to calculate and ensure the energy recovery equipment can turn down to the lowest loads encountered. This can be especially important for making sure that reheat can be provided in the summer or a small amount of cooling can be provided in the winter through the energy recovery equipment. This is likely the optimal selection point for heat recovery chillers as it is theoretically the point at which the unit would operate continuously at full load (its most efficient point). If either load is less, the unit may short cycle, leading to inefficient operation and a high level of strain on the unit.	$\min(\text{OL}(t))$
Maximum heating load minus corresponding simultaneous load	Use the energy recovery to reduce peak heating load.	$\text{HL}(t_{\max}) - \text{OL}(t_{\max})$ where t_{\max} is the hour of the year corresponding to the maximum heating load
Maximum cooling load minus corresponding simultaneous load	Use the energy recovery to reduce peak cooling load.	$\text{CL}(t_{\max}) - \text{OL}(t_{\max})$ where t_{\max} is the hour of the year corresponding to the maximum cooling load
Minimum cooling load	Use to select a cooling system with adequate turndown capability.	$\min(\text{CL}(t))$
Minimum heating load	Use to select a heating system with adequate turndown capability.	$\min(\text{HL}(t))$

Figure 7 provides a visual demonstration of the key metrics to calculate and determine energy recovery potential, which are outlined in **Table 2**. Note that the metrics should be calculated using annual hourly data, however **Figure 7** reflects typical building load curves over diurnal timeframe, for demonstration purposes only.

QUANTIFY ENERGY RECOVERY POTENTIAL

Energy recovery potential (ERP) could also be explicitly quantified using the equation below, where Q_h is the hourly heating load, Q_c is the hourly cooling load, and $\text{COP}_{\text{cooling}}$ is the hourly coefficient of performance of the heat pump system in cooling mode.

$$\text{ERP} = \frac{\int \min \left(Q_h, \left(1 + \frac{1}{\text{COP}_{\text{cooling}}} \right) Q_c \right) dt}{\int Q_h dt}$$

One hundred percent ERP means the condenser heat of a heat pump system can satisfy the heating load of the building at all hours of the year, while 0% means the lack of any overlap in condenser heat availability and heating load at any instant of time throughout the year.

Step 3: Identify Heat Sources

Air Source

For an air-source heat pump, heat is extracted from the outdoor air. As the outdoor ambient air gets colder, the ability to extract the heat and move it indoors gets harder. This results in either more input power, reduced capacity for the same input power (fixed speed units) or a combination of both. This reduced capacity must be accounted for in the design. As the building load goes up because of a drop in outdoor tempera-

ture the heat pump operational capacity also goes down. Another consideration is frost buildup. Often, water vapor in the air will condense and freeze on the evaporator coils, reducing airflow and further reducing heat transfer. Periodically, the heat pump must defrost or melt off this ice—during this time and depending on the type of defrost cycle, heat could be taken from the building to defrost, or no heat may be added to the building, which further reduces its capacity. Defrost cycles are an important consideration in regions near large bodies of water (e.g., Buffalo, NY) which may experience periods of high winter humidity as well as regions that are humid year-round.

Despite the concerns of capacity degradation and defrost cycles caused by lower ambient temperatures, air-source heat pumps are very attractive, as they are easy to install and often replace the traditional outdoor unit of an air-conditioning system.

Air-source heat pumps have been used for many years to provide heating and cooling to small commercial buildings, multifamily residential, and single-family residential buildings

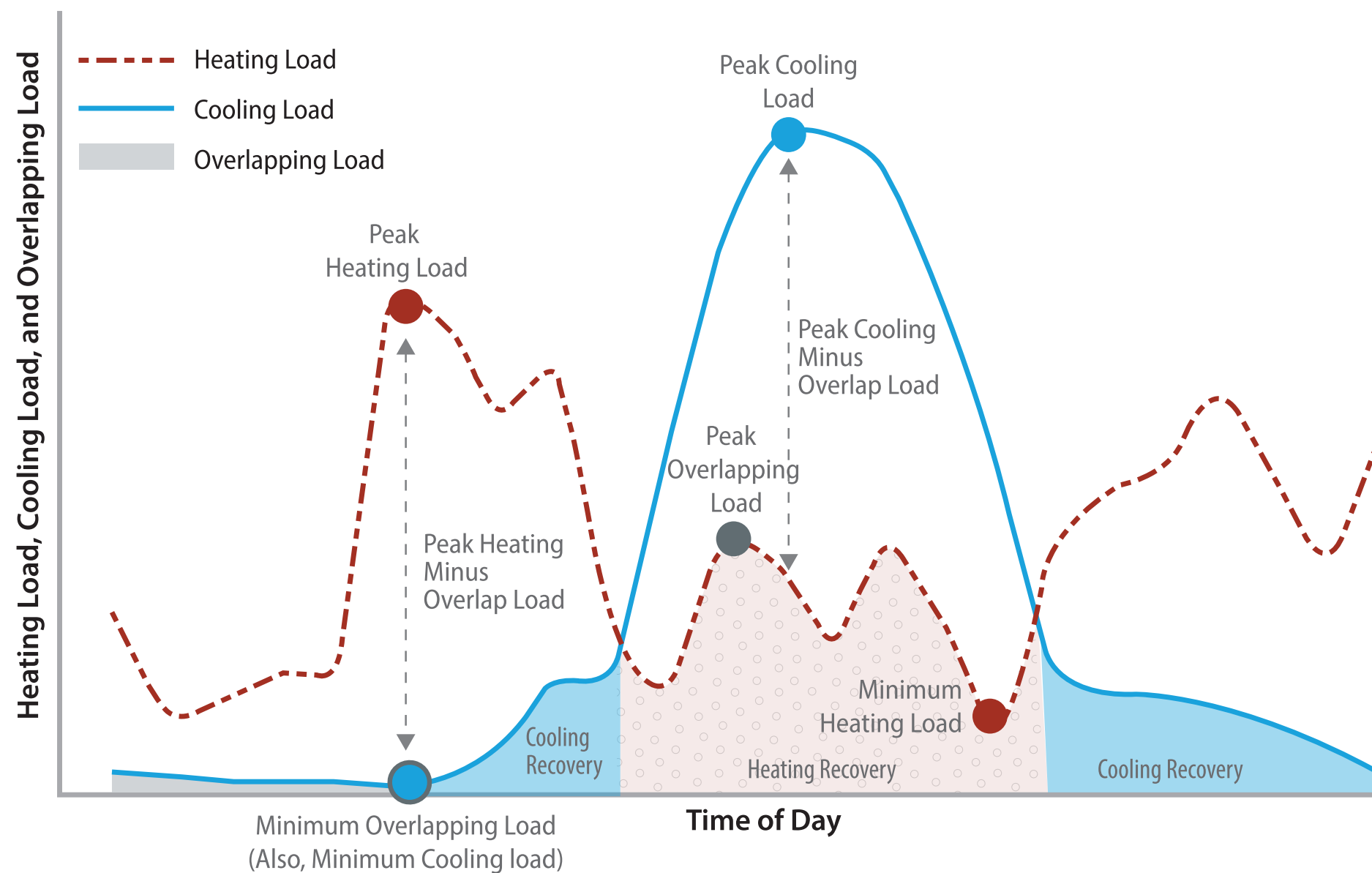

Figure 7. A visual demonstration of the key metrics to calculate that allude to energy recovery possibilities, adequate turndown ratios, and potential for reducing heat pump capacity

Air-source heat pumps have been used for many years to provide heating and cooling to small commercial buildings, multifamily residential, and single-family residential buildings. Traditionally, these heat pumps have included auxiliary heating because the ability for the heat pump to extract heat from the outside air at low temperatures was limited. The auxiliary systems can be electric resistance or a fossil fuel-based heating system that is redundant. Recent advances in heat pump design, including variable-speed inverter-driven compressors and enhanced vapor injection, have enabled air-source heat pumps to provide more heat at lower outside air temperatures than previous designs, as is outlined in **Chapter 2: Selecting the Right Heat Pump for Your Project**. However, air-source heat pumps still have reduced heating capacity at extremely low outside air temperatures, and this should be considered when selecting and sizing heating equipment.

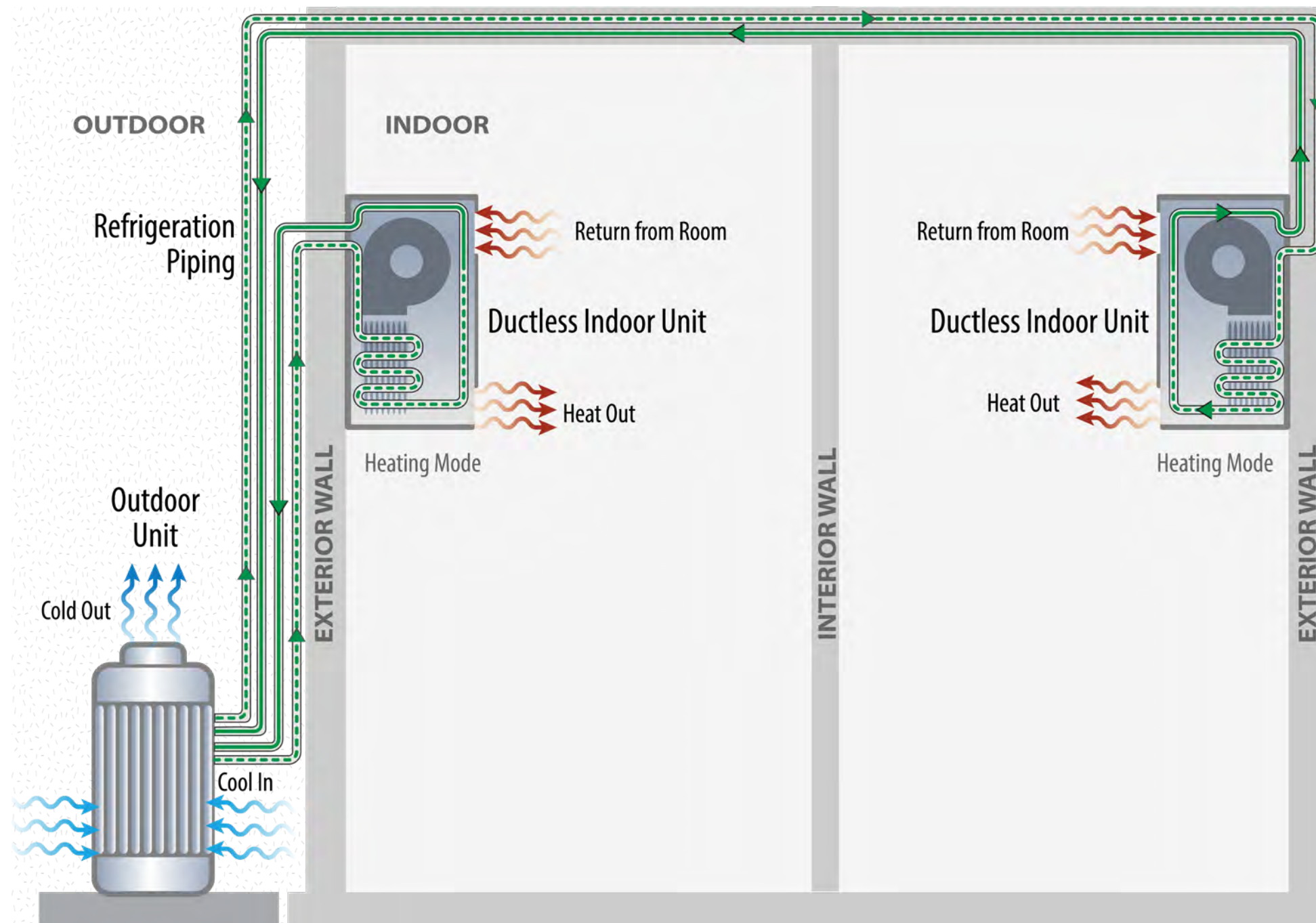

Figure 8. Ductless split air-to-air heat pump and component-level placement in a building in heating mode¹

¹ Designers should consider choosing a location for the outdoor unit that minimizes refrigerant lines.

There are different types of air-source heat pumps, namely air-to-air and air-to-water. Air-to-air heat pumps operate much like a direct expansion air conditioner but can operate in reverse. Air-to-air heat pumps extract heat out of air and transfer it into an airstream that heats the building, as shown in **Figure 8**. Air-to-water heat pumps are much like an air-source chiller that can operate in reverse. Air-to-water heat pumps extract heat out of the air and transfer it into water, which is pumped through the building. Air-to-air heat pumps are more common but air-to-water systems are rapidly progressing in technology and application (DOE 2024). Air-to-air heat pumps are typically made in smaller sizes—less than 25 tons. Air-to-water heat pumps can exceed 200 tons of capacity.

Air-to-air heat pumps extract heat out of air and transfer it into an airstream

Most heat pumps use outside air to extract heat for space heating. However, this is not the only source of heat for an air-source heat pump. Some heat pump technologies use condenser/evaporator coils in the exhaust air stream to recover heat from the building air, as shown in **Figure 9**. This principle is similar to an energy recovery ventilator or heat recovery ventilators but with the added benefit of active control of the supply air. This heat source is typically only applicable in dedicated outdoor air systems (DOAS) that exhaust nearly the same amount of air as provided. This configuration provides the ability to recover more heat from the exhaust air as well as reduce the capacity and efficiency losses of the air-source heat pumps in cold conditions because the heat pump only sees the warmer building exhaust air. These systems are typically coupled with a passive heat recovery system like an energy recovery ventilator (ERV) to maximize recovered heat and overall system efficiency.

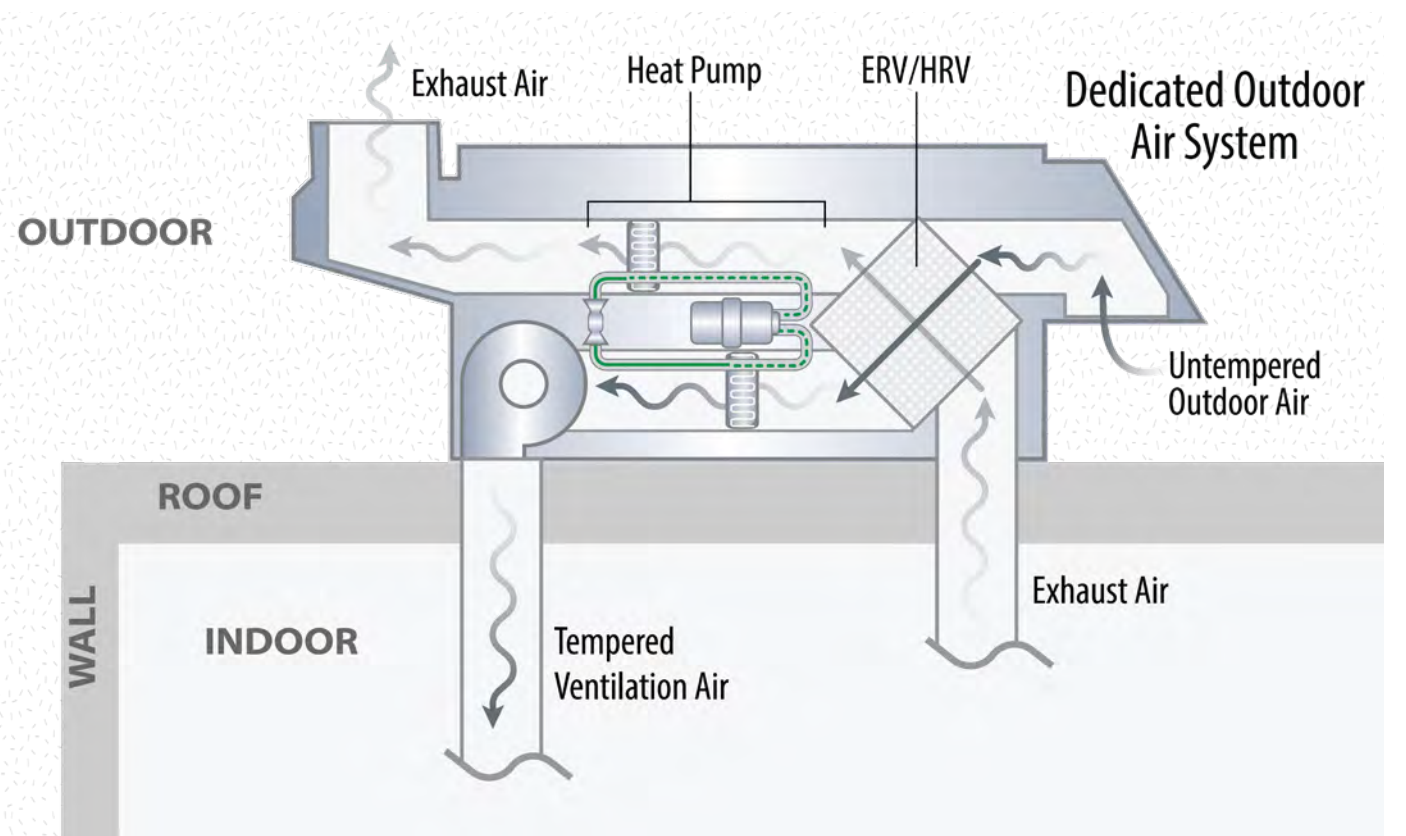

Figure 9. DOAS ERV with coil in exhaust air stream

ENHANCED VAPOR INJECTION

Enhanced vapor injection (EVI) is a compressor technology that is designed to increase the heating capacity and improve the energy efficiency of heat pump systems (ECT 2024). The EVI method operates by diverting a portion of the refrigerant that exits the condenser and heating it via a refrigerant-to-refrigerant economizer until it reaches a vapor state. This vaporized refrigerant is subsequently reintroduced into the compressor suction line with the remaining refrigerant exiting the evaporator. This technique optimizes the overall efficiency of the system, enabling it to operate more effectively in colder temperatures.

By introducing the refrigerant vapor into the compressor suction line, EVI can help to increase the compressor's capacity and efficiency, resulting in a higher COP for a heat pump system. This means that the system can achieve the same

level of heating with less energy consumption, or it can provide a higher level of heating with the same amount of energy.

EVI is used in commercial refrigeration systems, such as those in supermarkets and food processing facilities, where large loads necessitate the prioritization of energy efficiency. It is also used in heat pump systems, where it can help to increase the system's heating capacity and efficiency, particularly at lower evaporating temperatures where heat extraction from conventional heat pump cycles may struggle to maintain loads. Therefore, EVI is particularly suited to operate in colder climates, as it can offer a higher operating temperature range (higher condensing temperature at lower evaporator temperatures) compared to conventional heat pump systems.

Thermodynamic cycles and major component schematics for a conventional single-stage heat pump cycle and a heat pump cycle with EVI is shown in Figure 10.

A comparison of the thermodynamic cycles that reflect the conventional heat pump system and the enhance vapor injection system is depicted in the pressure-enthalpy (P-h) diagram shown in Figure 11. This figure shows both heat pump cycles operating under the same condensing and evaporating temperature ranges. As shown in Figure 11, the EVI heat pump system extracts more heat through the evaporator, which is enabled by subcooling a portion of the refrigerant exiting the condenser. The P-h diagram also demonstrates the lower work required by the EVI compressor to operate under the same suction and discharge pressure.

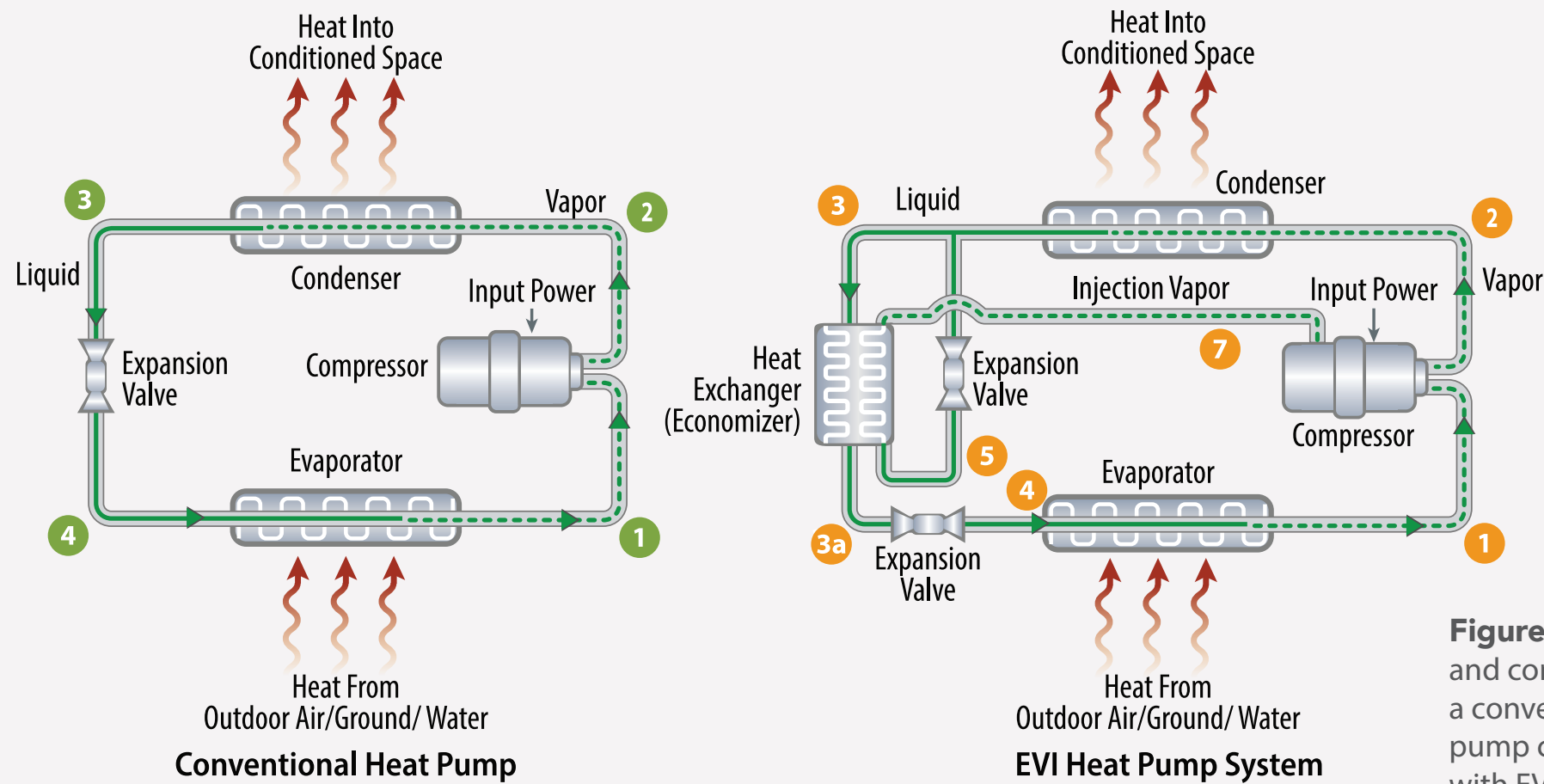

Figure 10. Thermodynamic cycle and component schematics for a conventional single-stage heat pump cycle and a heat pump cycle with EVI

ENHANCED VAPOR INJECTION CONTINUED

Leveraging the definition of the COP and a simple energy balance surrounding the heat pump system, the expression for COP as a function of the heat extracted by the evaporator and the work performed by the compressor is shown in Equation 1. As illustrated by in the equation, the higher heat extraction capability combined with the lower compressor work in the EVI system contributes to a higher COPs compared with conventional single-stage heat pump systems.

Equation 1:

$$COP = \frac{Q_{condenser}}{W_{compressor}} = \frac{Q_{evaporator} + W_{compressor}}{W_{compressor}} = 1 + \frac{Q_{evaporator}}{W_{compressor}}$$

The diagram shown in **Figure 11** compares both systems under the same condensing and evaporating temperatures from the range. Alternatively, comparing both systems over the same compressor power can show that the heat provided by the condenser is larger in the EVI system compared with the conventional system due to the higher COP. This is depicted by Equation 2.

The EVI heat pump cycle is typically used in systems that operate at low evaporation temperatures, where the compression ratio is high, and the efficiency of the conventional vapor compression cycle is low.

Equation 2:

$$Q_{condenser} = W_{compressor} COP$$

The EVI cycle consists of the following main components and associated stages:

- **Compressor and Vapor Injection:** The process starts with compression of the low-pressure refrigerant vapor exiting the evaporator (state 1 in **Figure 11**) to the intermediate injection pressure (state 8). Injection ports within the compressor introduce the bypassed vapor refrigerant inside the compressor (state 7). The injected vapor (state 7) and the compressed vapor (state 8) mix and cool the refrigerant to an intermediate value (state 9). The compressor continues to compress and discharge the high-pressure vapor into the condenser (state 2).
- **Condenser:** The high-pressure refrigerant vapor enters the condenser and condenses the refrigerant into a high-pressure liquid (state 3). The heat released during this process is typically rejected to the building heat distribution fluid (i.e., water) through a heat exchanger. The condenser can typically subcool the liquid slightly under normal operations.

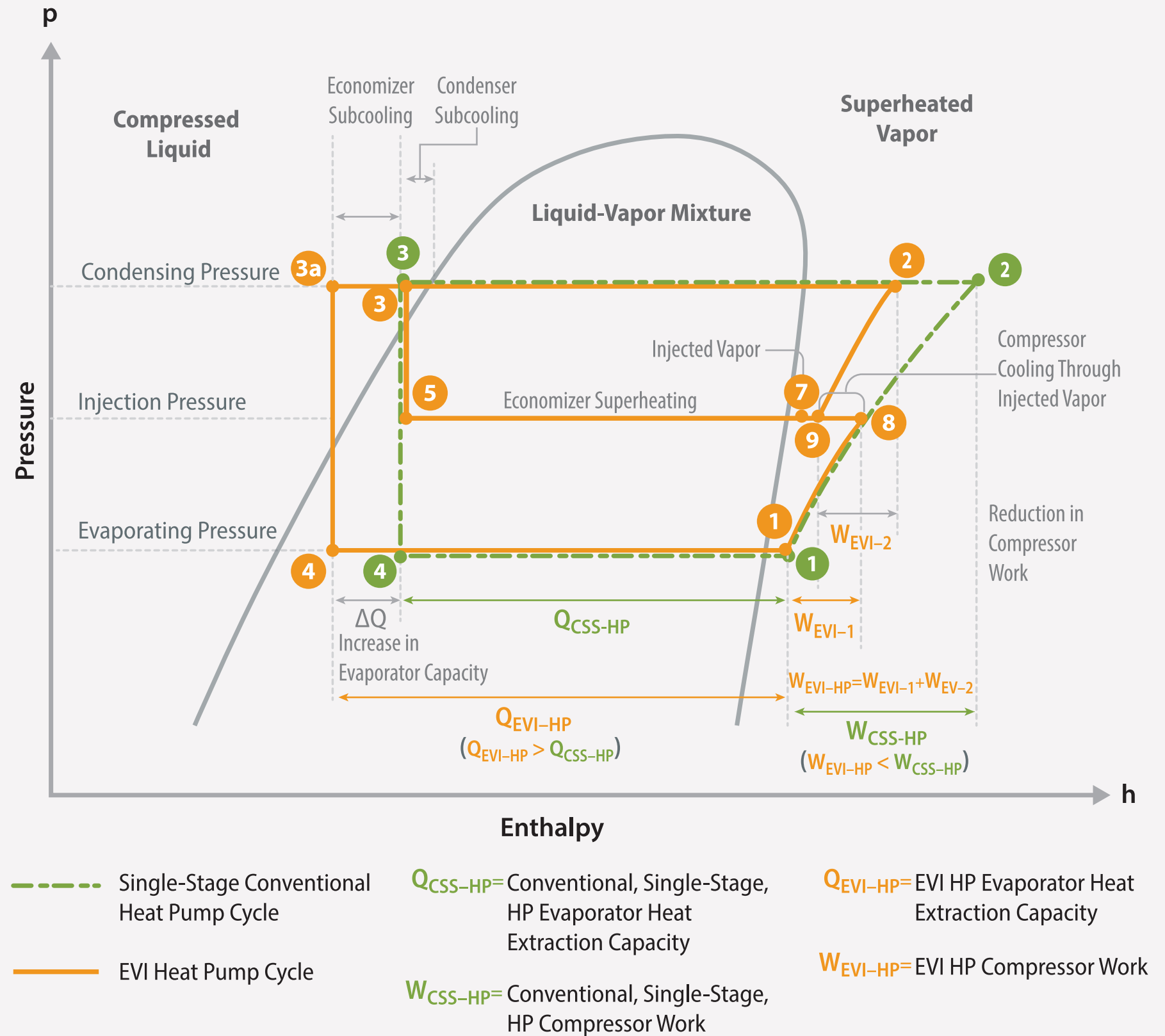

Figure 11. Comparison of thermodynamic states, through a pressure-enthalpy (P-h) diagram, for a conventional single-stage heat pump system and an enhance vapor injection system operating over the same condensing and evaporating temperature range.

ENHANCED VAPOR INJECTION CONTINUED

- **Economizer:** The compressed refrigerant liquid exiting the condenser is separated into two streams. The first stream enters a secondary expansion valve, which throttles the refrigerant to a mixed vapor-liquid state at lower pressure and temperature (state 5) and enters the economizer. The remaining high-pressure liquid stream enters the economizer and is subcooled (state 3a), while the colder stream (state 5) is superheated at the intermediate pressure (state 7).
- **Expansion Valve:** The high-pressure liquid exiting the economizer (state 3a) is then passed through an expansion valve, which reduces the pressure and causes the liquid to evaporate. This process is known as throttling, and it results in a mixture of low-pressure liquid and vapor.
- **Evaporator:** The vapor and liquid mixture (state 4) is then passed through an evaporator, where it absorbs heat from the surroundings and evaporates into low-pressure vapor (state 1).

The system's COP is maximized when an intermediate vapor injection pressure is used at an optimal level. It is also important to note that there is a maximum allowable injection refrigerant flow rate. If too much refrigerant is bypassed, the economizer will be unable to adequately superheat the liquid-vapor mixture entering it. This could result in a liquid-vapor state entering the compressor, which could potentially cause damage.

The refrigerant economizer works by subcooling a portion of the condenser outlet while superheating the remaining portion, which is then introduced into the compressor. As a result, the compressor is cooled, reducing its power consumption, and boosting its overall efficiency. The process of subcooling via the economizer enhances the capacity of the evaporator beyond what a typical heat pump cycle would allow, thereby increasing the overall heat extraction potential of the system. The increase in evaporator capacity and the reduction in compressor power result in higher COPs as compared with conventional systems.

Water/Ground Source

Water-source heat pumps have also been used for many years. Water-source heat pumps extract energy out of water and transfer it to either air or water, referred to as water-to-air and water-to-water heat pumps, respectively. Water-to-air heat pumps remove energy from a water loop and reject this energy into air. Water-to-water heat pumps are much like a water-cooled chiller that can operate in reverse. In turn, heat must be added to the water loop—this happens from a number of different heat sources:

- **Ground water:** Water wells can provide energy for water-source heat pumps where the water is extracted out of wells and injected back into wells. This ground water is typically about the same temperature as the average yearly air temperature for a location. This application is historically done, but in many jurisdictions the application is limited by concerns of potential contamination of ground water. Similarly, sometimes water is pulled from wells and then discharged to either storm water systems or sanitary sewer systems—these systems are also not allowed in many areas. This quantity of well water can come with minerals that can pollute waterways. These systems are referred to as open systems.
- **Ground source:** Ground source is where water is circulated from the ground to extract or reject energy. These can be closed loops in deep wells or horizontal loops in the ground.
- **Surface water:** This includes lakes, rivers, ocean water, or sea water.
- **Exhaust air (energy recovery):** Water can be circulated through coils mounted in exhaust ducts, data centers, or other heat source to provide energy for the water-source heat pumps.
- **Boiler:** Electric or fossil fuel boilers can add heat to the water (such as an ambient loop) that is used by water-source heat pumps to heat a building.
- **Cooling tower/fluid cooler:** A cooling tower or fluid cooler can remove heat from the water.

- **Sewer thermal:** Sewer thermal is where energy is extracted out of a sewer system and passes through a heat exchanger, which provides energy to the water-source heat pump water.

The following table provides a comparison of different heat sources and sinks. This table aims to provide high-level information to help designers select different heat sources and sinks based on their applicability to project requirements.



Multiple 4-pipe air-to-water heat pumps stacked together for 480 tons of cooling and 240 tons of heating.

Photo from P2S

Table 3. Heat Pump Heat Source and Sink Comparison Table (ASHRAE 2020, ASHRAE 2021) Key: ● Poor ● Fair ● Good ● Excellent \$ Low \$\$ Moderate \$\$\$ High \$\$\$\$ Extremely High

Medium	Suitability		Availability		Cost		Temperature		Common Practice	
	Heat Source (Heating Mode)	Heat Sink (Cooling Mode)	Location Relative to Need	Coincidence with Need	Installed	Operation and Maintenance	Level	Variation	Use	Limitation
Air										
Outdoor (i.e., ambient air)	● But efficiency and capacity in heating mode decrease with decreasing outdoor air temperatures	● But efficiency and capacity in cooling mode decrease with increasing outdoor air temperatures	●	●	\$	\$\$	Moderate	Variable	Most common, many standard products	Defrosting and supplemental heat usually required
Exhaust (i.e., building ventilation)	●	●	● If planned for in building design	●	\$\$-	\$\$-	Low unless exhaust is laden with dirt or grease	Excellent	Excellent as energy-conservation and load reduction measure	Insufficient for typical loads
Water										
Groundwater well	●	●	●●●● Practical depth varies by location	●	\$ If existing well used or shallow wells suitable; can be high otherwise	\$ But periodic maintenance required	Generally excellent; varies by location	Extremely stable	Common practice	Water disposal and required permits may limit; may require double-wall exchangers; may foul or scale
Condensing (i.e., cooling towers or refrigeration systems)	●●●	●	●●●●	●●●● Varies with cooling loads	\$ Usually	\$\$	Favorable as heat source	Depends on source	Available	Suitable on if heating need is coincident with heat rejection
Closed loops (i.e., building water loop)	● Loop may need supplemental heat	● May need loop heat rejection	● If designed as such	●	\$	\$\$-	As designed	As designed	Very common	Most suitable for medium or large buildings
Waste (i.e., gray water or sewage)	●●●	●●●● With source	●●●●	●●●● May be adequate	\$\$\$\$- High for raw sewage	\$\$\$\$- May be high for raw sewage	Excellent	Usually, low	Uncommon practical only in large systems	Usually regulated may clog, foul, scale, or corrode
Ground										
Ground-coupled (i.e., buried fluid loops)	●● If ground is moist; otherwise fair	●● If ground is moist; otherwise fair	●●●● Depends on soil suitability	●	\$\$-\$\$\$	\$	Low to moderate	Low, particularly for vertical systems	Rapidly increasing	Most suitable for medium or large buildings
Solar Energy										
Direct or heated water	●●●	● Usually unacceptable	●	● Night use requires storage	\$\$	\$\$-\$\$\$	Varies by design	Extreme	Very limited	Supplemental source or storage required
Industrial Process										
Process heat or exhaust	●●●	●●●● Often impractical	●●●●	●●●●	\$\$-	\$ Generally	Varies	Varies	Varies	May be costly unless heat need is near rejected source

Step 4: Choose Central or Distributed Architectures

Central Plant

A central system architecture has a central location in the building where heating and/or cooling are generated and distributed throughout the building. In most cases, central systems consist of water heat distribution, but can also include air- or refrigerant-based systems as well. Some equipment commonly located in a central plant are hot water boilers, chillers, heat pumps, and water pumps. Central plant architecture is typically found in medium to large buildings with higher cooling and heating loads.

The advantage of a central heating and cooling system is that it provides a dedicated space for some of the heating and cooling equipment. This system architecture reduces the amount of equipment needed, making maintenance and asset management easier. It reduces the number of compressors in the building, and the compressors can be located close to the building's main electrical room. This reduced number of compressors and equipment results in single points of maintenance. However, this reduced amount of equipment can result in complicated controls and operation as well as increased difficulty when scheduling downtime for maintenance compared to distributed equipment.

The advantage of a central heating and cooling system is that it provides a dedicated space for some of the heating and cooling equipment. This system architecture reduces the amount of equipment needed, making maintenance and asset management easier

In the past, central architecture selection was driven by steam or hot water being commonly used to heat buildings and

chilled water being used to cool buildings, which allowed a central point for heating and cooling production. With a central architecture, there are typically air handlers or fan coils located throughout the building that still require maintenance, such as replacing filters and cleaning coils. There is also the need for hot and chilled water piping throughout the building.

Recirculation Losses

Recirculation loss is heat lost throughout the distribution network of a system. As the heat is distributed throughout the building, heat is lost through the pipe or duct and this heating or cooling energy is lost. There are also friction losses in the piping or ductwork. Recirculation losses are a major concern of central systems, especially with the distribution of hot water (Raftery, 2018). If centralized systems are selected for a project, care should be taken to mitigate recirculation losses through adequate insulation levels that meet or exceed energy code, pipe sizing, scheduling, and controls.

Distributed System

A distributed system architecture is where the heating and cooling equipment is located throughout the building closer to the point of use of the energy. This is commonly done with air-source heat pumps where the condensers/compressors will be located outside, and the fan and duct system will be throughout the building. Water-source heat pumps work similarly where water pipes and pumps circulate water throughout the building and deliver the energy to heat pumps that serve the spaces. Distributed architectures are commonly used in smaller buildings but can be used in larger buildings. For example, in larger buildings with multiple tenants (e.g., multifamily buildings, large office buildings), distributed equipment can allow for different heating and cooling priorities to be handled in each space by specific equipment, reducing losses due to part-load operation of centralized equipment managing competing loads.

The advantage of distributed system architecture is using smaller, easy-to-obtain equipment and reduced distribution losses, which typically results in lower building energy consumption. With smaller distributed equipment there is less space required for each piece of equipment and they can be placed in smaller spaces or outside of the building. With smaller equipment, lower voltage service can be used, resulting in cheaper electrical infrastructure (note: lower voltage service is more common in smaller buildings). The other primary advantage of distributed systems is the increased number of equipment provides greater redundancy in the event of equipment failure. If one small piece of equipment fails, the other equipment will still operate and maintain comfort in adjoining spaces.

The advantage of distributed system architecture is using smaller, easy-to-obtain equipment and reduced distribution losses, which typically results in lower building energy consumption.

Zone-Level Metering

For buildings with multiple tenants, such as multifamily residential, office buildings, strip malls, etc., metering tenant energy consumption can be important. Zone-level metering is when utility meters are placed to measure the amount of energy consumed in different areas of the building. Both central and distributed systems can be metered. With a central system, distributing hot water and chilled water throughout the building, Btu meters are needed for zones along with electrical meters. With zone-level heat pumps, there is no need for Btu meters, so all energy can be monitored with electric meters for each piece of equipment. Maintaining distributed energy meters is additional maintenance for property owners and can lead to incorrect billing to customers, whereas utility managed meters are easier for property managers. When deciding between central or distributed architectures, care should be taken to determine metering requirements and which architecture is best for the project.

Advantages and Disadvantages of Central vs. Distributed Architectures

The following table highlights a non-exhaustive list of advantages and disadvantages pertaining distributed and central systems for comparison purposes and to help aid designers in their selection depending on project requirements and circumstances.

Table 4. Key Advantages and Disadvantages Pertaining to Distributed and Central Systems (ASHRAE 2021)

Distributed		Central	
Advantages	Disadvantages	Advantages	Disadvantages
Only one zone temperature is affected if equipment malfunctions.	Larger total building installed capacity is usually required because diversity factors used for moving heating/cooling needs do not apply to multiple dedicated packages.	A centralized location minimizes restrictions on service accessibility.	Equipment may be more complicated than decentralized equipment, and thus require a more knowledgeable equipment operator.
System operation is simple. Trained operators are not usually required.	Operating sound levels can be high, and noise-producing machinery is often closer to building occupants than with central systems.	Energy-efficient design strategies, energy recovery, thermal storage, and energy management can be simpler and more cost-effective to implement.	A central location within or adjacent to the building is needed.
Less mechanical and electrical room space is required compared to central systems.	Equipment's effect on building appearance can be unappealing.	Load diversity can substantially reduce the total equipment capacity requirements.	Multiple equipment manufacturers might be required when combining primary and ancillary equipment.
Initial cost is usually relatively lower, and energy can be metered directly to each tenant.	Condensate drains can be required with each unit.	Multiple energy sources can be applied to a central plant, providing flexibility. A central plant and its distribution can be economically expanded to accommodate future growth. In addition, it could be modified in the future to adapt to new technologies. Changing equipment at the central plant is easier than changing multiple pieces of equipment throughout the spaces served by the central plant.	Special permitting may be required.
Smaller equipment provides more ability for turndown to handle part-load operation and prevent short cycling.	Heat recovery and thermal storage can be difficult or not possible.	Staged equipment or energy storage can provide sufficient part-load operation to prevent short cycling.	Single, large-capacity equipment might not provide sufficient turndown and result in short cycling in low-load conditions.

Step 5: Choose Distribution Medium (Air, Water, Refrigerant)

Air, water, and refrigerant can be used as heat transfer mediums to transport heating or cooling from where it is generated to building spaces. The amount of energy that a medium can deliver to a space is based on its physical properties. In the case of refrigerant distribution, such as variable refrigerant flow (VRF) systems, refrigerant is delivered to a space in one phase and it changes phase as it exchanges heat with the space (from vapor to liquid or liquid to vapor depending on whether it is in heating or cooling mode, respectively). Through phase change, refrigerant distribution systems rely on the relatively higher amounts of energy transfer associated with latent heat of vaporization compared with sensible heat transfer mechanism. In contrast, air and water transport systems do not change phase (they remain in vapor and liquid) throughout the transport and heat exchange at the space. Therefore, air and water systems rely largely on sensible heat transfer at the zone. As a result of leveraging the heat of vaporization for heat exchange at the zone, refrigerant pipes are smaller than water pipes and air ducts.

Even when refrigerant or water pipes are used on projects, ducts are normally required to distribute outside air to the spaces. Also, when refrigerant and water pipes are used to transport energy, there will still often be air distribution equipment in the spaces. A notable exception is radiant heating and cooling, where the heat transfer pipes are embedded in the floor or mounted overhead. Even with these systems, outside air is normally transported via a duct system.

Figure 12 shows a visual comparison of refrigerant, air, and water distribution piping sizes that are required to meet the same load, for demonstration purposes (MEP 2024).

In summary, air ducts are the largest energy transport system used in buildings but are useful for delivering outside air to spaces and distributing heating and cooling to zones from air handlers or fan coils.

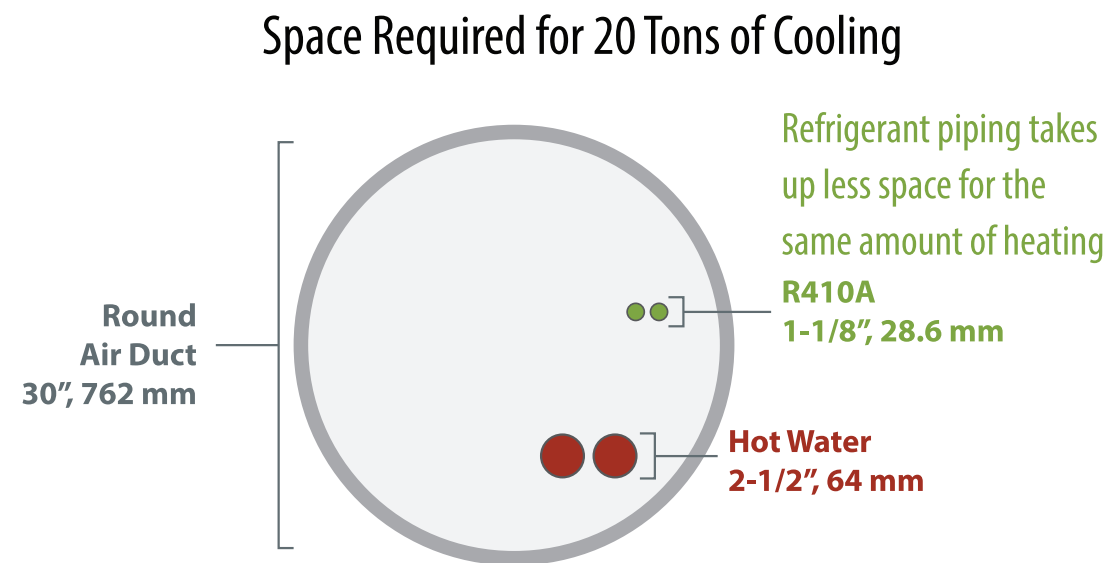

Figure 12. Comparing refrigerant, air, and water distribution piping sizes required to meet the same load.

Water pipes are smaller than air ducts and can transport energy over the longest distances. Additionally, water is a relatively inert substance and can be adapted to many different system types. Water pipes provide cooling or heating to air handling units, fan coils, or to water-source heat pumps in the building.

Water pipes are smaller than air ducts and can transport energy over the longest distances. Additionally, water is a relatively inert substance and can be adapted to many different system types.

Refrigerant pipes are the smallest but are limited in the distance they can carry energy. The size, configuration, and pressure rating of the piping is specific to the refrigerant being transported, so future retrofits of existing buildings may require new piping. At present, the refrigerants commonly used have a high global warming potential and thus refrigerant leaks are of major concern. Refrigerant leaks can also be hard to detect.

For high-volume refrigerant systems, such as VRF, additional monitoring devices or limiting the number of evaporator units on a single condensing unit system may be required to meet requirements from ASHRAE 15—*Safety Standard for Refrigeration Systems* (ASHRAE 2019a) and ASHRAE 34—*Designation and Safety Classification of Refrigerants* (ASHRAE 2019b). Additionally, the flammability of certain low-global warming potential refrigerants may require piping to be firestopped and/or routed through fire-rated chases. While VRF and other distributed refrigerant-based equipment can have high efficiency it is not recommended to use these systems with large amounts of installed refrigerant on-site. In many cases the added efficiency and subsequent carbon reduction can be offset or exceeded by leaking these high global warming potential refrigerants. **Table 5** summarizes key differences and tradeoffs associated with water, air (ducts), and refrigerant distribution systems.

Table 5. Comparison of Different Distribution Systems for HVAC

Type	Distribution Network	Relative Size	Efficiency	Complexity	Building Size Applicability
Distributed	None	Small	High	Low	Small-Large ^a
Centralized	Ducts	Large	Low-Medium	Low-High	Small-Large
	Water Pipe	Medium	Medium	Medium	Medium-Large
	Refrigerant Pipe	Small	High	High	Small-Large

a. In this table, small buildings are roughly less than 10,000 ft², large buildings are roughly greater than 25,000 ft².

Step 6: Choose Ventilation Control

Distributed Systems + DOAS Architectures

Distributed systems normally only recirculate air to heat and cool the space. To meet the ventilation code requirements a separate system, commonly referred to as a dedicated outdoor air system (DOAS), is used to provide outside air directly to the spaces throughout the building. DOAS have several advantages compared to traditional mixed air systems:

1. Improved humidity control because ventilation air is directly controlled by a single system and is not mixed before being cooled.
2. Reduced energy use due to direct control of the ventilation air being able to shut the unit down when the building is unoccupied and being able to shut down return air only when building load is satisfied and providing tempered outdoor air in an occupied scenario, eliminating the need for reheat.
3. Simplified ventilation control by controlling outdoor air with a decoupled piece of equipment.

4. The ability to use systems that don't provide ventilation air (e.g., radiant panels, chilled beam, VRF, minisplits).
5. Reduced installation cost as a result of reduced equipment load downsizing primary and secondary equipment (e.g., ductwork, piping, electrical).

DOAS have these many advantages and should be considered as a means to reduce building loads, save energy, and provide better part-load performance for equipment. When selecting and designing these systems, many different resources are available to help make these decisions for the project. The *ASHRAE Design Guide for Dedicated Outdoor Air Systems* (ASHRAE 2017) provides engineers and contractors information for how to design, select, install, operate, and maintain these systems for high efficiency and consistent operation. When designing and selecting systems is recommended to follow the guidance in this guide. The Northwest Energy Efficiency Alliance (NEEA) has outlined guidance for load calculations of these systems in their "Energy Modeling Guide for Very High Efficiency DOAS," which can help designers maximize efficiency in these system types (BetterBricks 2024).

When designing DOAS, designers should consider designing the DOAS equipment to dehumidify the supply air low enough to prevent the need for return air equipment to dehumidify as well. This has many advantages such as eliminating the need for local condensate drains from return air units and reducing return air equipment capacity. If a heat pump is needed to provide this additional dehumidification, the additional capacity to handle this latent load also provides additional heating capabilities by the DOAS system. It should be noted that DOAS equipment often reduces the ability for economizing due to the lower outdoor air supply rates compared to mixed air economizer systems. There will be a slight energy penalty for this reduced economizing but this can be offset by the improved efficiency of the DOAS.

When compared to code-minimum equipment, systems following these requirements reduce commercial building energy use by an average of 36% and HVAC energy use by an average of 65% (NEEA 2024).

To help simplify system selection to ensure high-efficiency operation, NEEA has outlined guidance and recommendations on "Very High Efficiency (VHE) DOAS for Commercial Buildings" (NEEA 2024). This document provides prescriptive recommendations to ensure DOAS equipment is designed and selected to optimize efficiency. Systems that meet these requirements use energy recovery ventilator (ERV) or heat recovery ventilator (HRV) systems to temper the outdoor air with exhaust air and high-efficiency heating and cooling systems to meet additional ventilation or building loads. When compared to code-minimum equipment, systems following these requirements reduce commercial building energy use by an average of 36% and HVAC energy use by an average of 65% (NEEA 2024).

Step 7: Assess Backup Heat Requirements

The thermal balance point temperature is an important design parameter when selecting, sizing, and designing the controls for a heat pump system. The thermal balance point temperature occurs at the intersection of the heating load line and the heat pump capacity curve as a function of outdoor air temperature. At outdoor air temperatures below the thermal balance point temperature, the heating system will require the operation of auxiliary heat, at least in part, to meet the heating load of the building. At temperatures above the thermal balance point, a selected heat pump will have sufficient capacity to meet the entirety of the heating load. Thermal balance point temperature is important for sizing, backup heat planning, and controls for air-source heat pumps, as well as visualizing the operation of a heat pump at various outdoor air temperatures.

Choosing backup heat requirements is dependent on several factors, including whether existing systems will remain operational, the heat pump cut-off temperature (outdoor air temperature below which the heat pump turns off), the selected heat pump capacity, and whether the heat pump can operate simultaneously with backup heat. A sample decision tree for selecting backup heat requirements for air-source heat pumps is shown in **Figure 14**. Designs with full-capacity electric backup heat may result in necessary electrical capacity upgrades and associated added costs for the electrical upgrades, in addition to inefficiencies associated with backup heat operations. Therefore, designers should aim to avoid requiring full-capacity backup heat by choosing a heat pump with either sufficiently low cut-off temperature limit (depends on project climate region and associated extreme outdoor air temperature) and/or ensuring the system can operate the heat pump simultaneously with the backup heat to avoid excessively large backup heat requirements. Optimally, designers should aim to avoid backup heat requirements by selecting heat pumps with capacities greater than the heating load at the design temperature, and hence requiring no backup

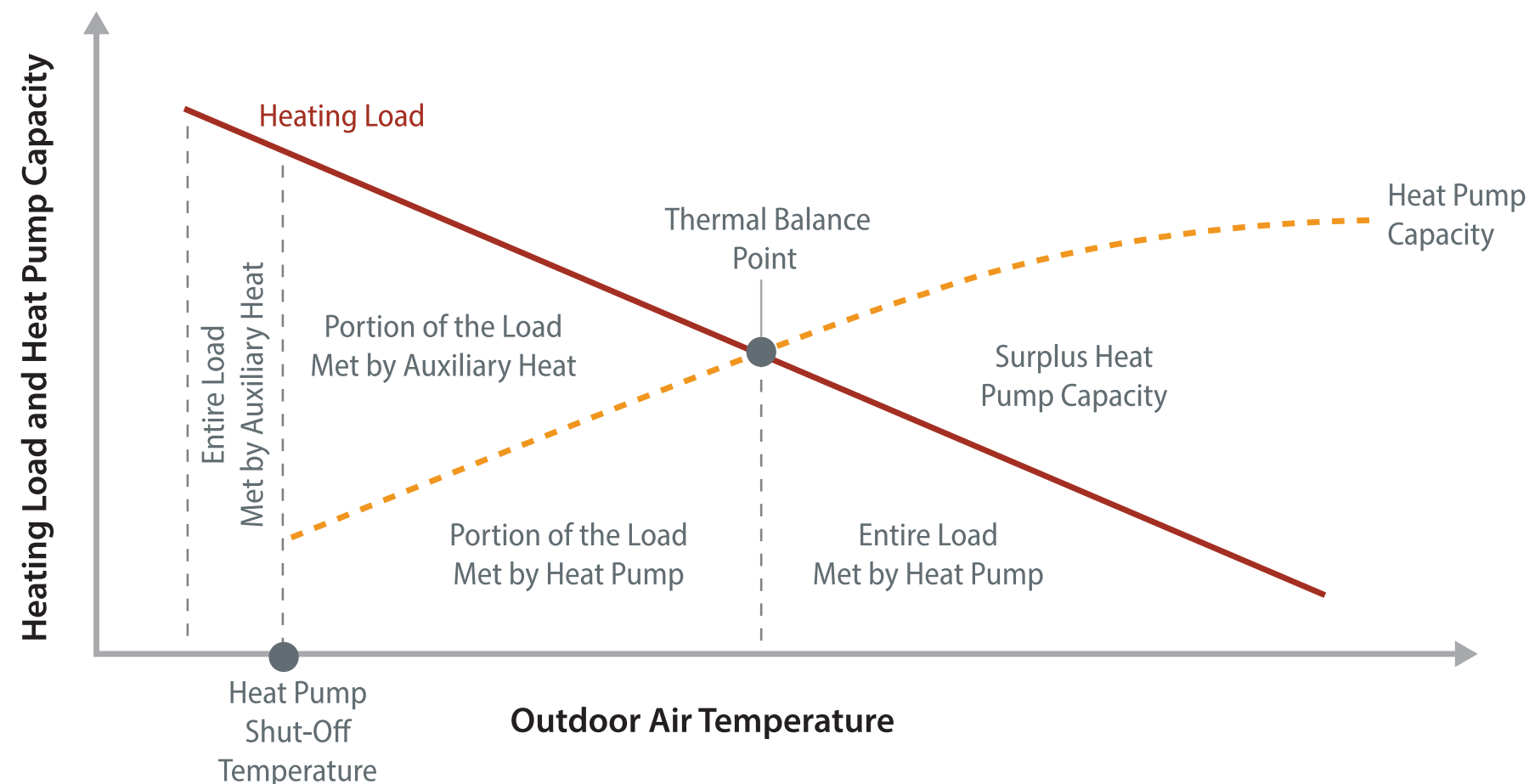
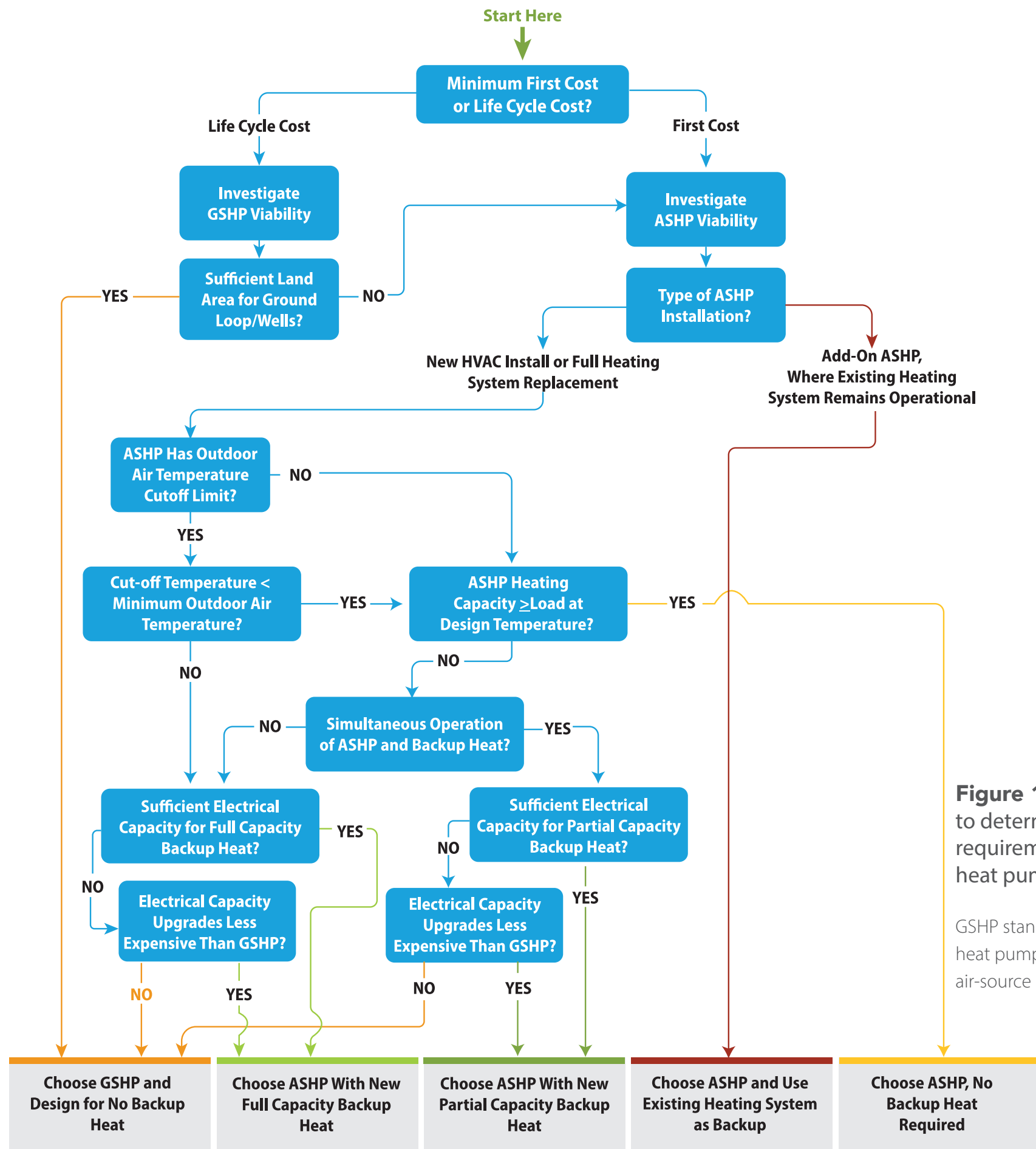

Figure 13. Thermal balance point temperature definition and its importance for sizing and backup heat planning and controls for air-source heat pumps

heating system while balancing required turndown ratios and/or modularity of heat pumps to avoid frequent on/off cycling during non-peak heating hours. **Figure 14** is a sample decision tree that can be used to determine backup heat requirements depending on project requirements and heat pump system sizing, modes of operation, and selections. It is imperative that designer have a discussion with the building owner regarding the consideration of backup heat for zones that could not tolerate a complete loss of heating capacity in the event of a compressor failure.



CONTROL BACKUP HEAT OPERATIONS

There is an opportunity to control backup heat operations in such a way that minimizes operational costs in scenarios where existing gas heating is leveraged for backup. This is primarily determined by identifying and controlling the heat pump to shut off below the minimum required COP that ensures cost competitiveness with gas heat and/or gas backup. The minimum required cost-competitive COP depends on the local cost of electricity, cost of gas, and the efficiency of the gas system through the following equation: (NRC 2020)

$$COP_{min} = (\text{Cost of Electricity} \times \text{Efficiency of Gas}) / \text{Cost of Gas}$$

How To Design Without Backup Heat

A challenge, particularly in air-source heat pumps, is that when heat is needed the most, such as very cold winter days, there is the least amount of heat available in the outside air and heat pump capacity is reduced.

The designer should aim to identify a heat pump that can meet the required building heating capacity at the design heating temperatures and the cooling capacity at the design cooling temperatures. In some applications this works well because the heating and cooling peak loads are similar to equipment heating and cooling capacities. In colder climates, careful attention must be given to how the equipment operates throughout the course of the year. Choosing equipment for the cooling peak will often result in inadequate heating, and choosing equipment for the heating peak will result in oversized cooling and problems with humidity control during the cooling season from short system run times. This does not mean that heat pumps are not suitable in cold climates, rather that careful attention should be offered to designs in colder climates. The following sample strategies can be considered

Figure 14. Decision tree to determine backup heat requirements for air-source heat pumps

GSHP stands for ground-source heat pump; ASHP stands for air-source heat pump

when the building has a large difference between the peak heating and peak cooling load:

1. Size the heat pump system for peak heating (the larger load), at the associated design outdoor air temperature, while ensuring variable-speed capability for compressors and fans.

Variable-speed capability ensures that the heat pump system can modulate its capacity to accommodate lower loads without frequent on/off cycling of the compressor, which can hinder performance, comfort, and equipment longevity.

2. Design for multiple smaller heat pumps instead of a single large heat pump.

Designs that leverage multiple smaller heat pumps would be most applicable to larger buildings with water-based heating and cooling systems, but the principles could be applied to many different building types. The principles are similar to a variable-speed compressor heat pump, albeit in a more discrete manner. However, with larger systems, there are still limits to the amount of capacity reduction of a piece of equipment that may affect the year-round operation of the system. Having multiple smaller units also offers some redundancy and flexibility in system operation. **Figure 15** demonstrates an example where multiple heat pumps are used and exemplifies operational flexibility that can be leveraged during winter and summer months. In this example, summer operation may only leverage two of the three heat pump systems, while winter operation may leverage all heat pumps systems. Moreover, one or more of the heat pumps may operate in heat recovery mode to meet simultaneous heating and cooling loads, as needed.

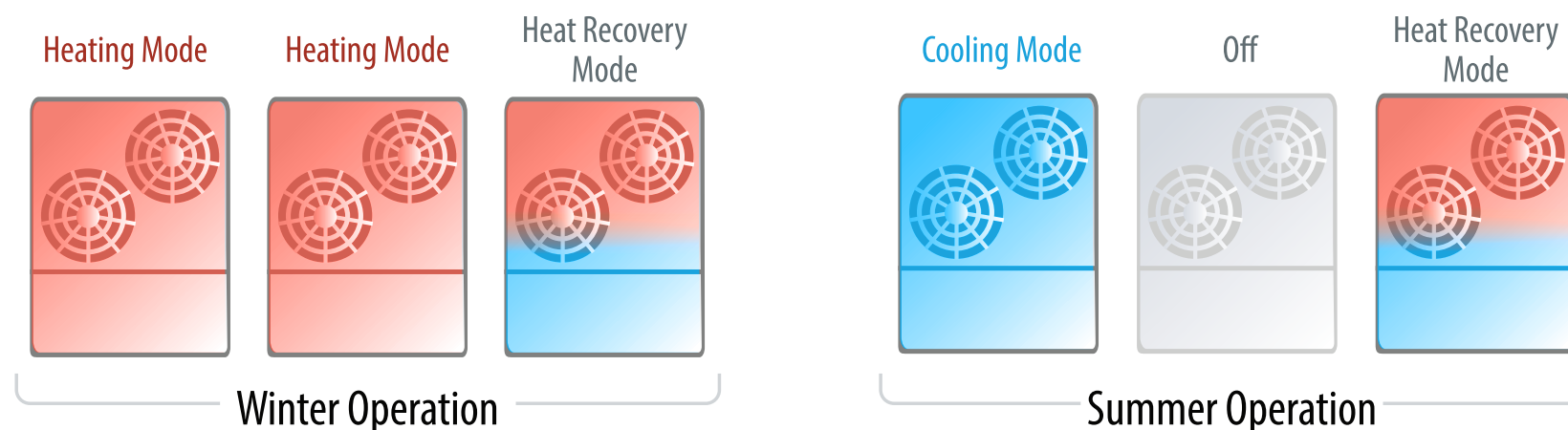

Figure 15. Demonstration of modular heat pump system operations during summer and winter months

3. Explore the use of ground-source heat pumps.

Ground-source heat pumps use the relatively stable ground temperature to provide heating and cooling to buildings. This reduces the impact of cold outside temperature on the performance of the heat pump equipment. The ground can also perform like a large heat storage device because it can store the heat rejected to it in the summer, which can be extracted in the winter.

4. Explore the use of energy storage.

Large commercial buildings typically have a high internal heat gain from people and computers, but these higher heat gains typically happen in the middle of the day, whereas the largest heating loads are during building morning warmup. Building warmup loads also happen when there is the least amount of heat available from air-source heat pumps because of cold weather capacity reduction and defrost capacity reduction. The problem is that the most heat is needed when the least heat is available, and the least heat is needed when the most heat is available. Energy storage can be used to store the heat from the afternoon via water or ice storage and use it the following morning.

5. Reduce nighttime temperature setback.

Reducing the nighttime setback will reduce the amount of heat that is needed to warm the building in the morning and reduce the need for heat when the outside is coldest. The building materials will also remain at a higher temperature, which reduces the morning warmup heat needed. Retrofitting heat pumps poses additional barriers when compared to new construction, as existing buildings tend to be less efficient as well as have existing architecture and systems not designed around heat pump operation.

6. Decouple ventilation and return air.

Decoupling ventilation air from the return by utilizing DOAS can help reduce overall building load. In a decoupled ventilation system, ventilation air only needs to be tempered to near room temperature, which reduces overall load compared to mixed-air systems that cool or heat ventilation air to the supply air temperature to offset building loads. In humid climates, the discharge air temperature may need to be subcooled (to dewpoint) and then reheated to maintain building relative humidity requirements. Coupling DOAS equipment with an ERV or HRV also reduces building load by recovering heat from the exhaust air to help temper the incoming ventilation air, reducing load on any required heating or cooling equipment.

This reduced load can provide further room for additional heat pump capacity to cover building loads, especially when coupled with cold climate heat pumps. For more information on DOAS, see (ASHRAE 2017).

Electric Resistance Auxiliary Heat

Depending on the capacity and design of the heat pump and the climate, electric resistance auxiliary heat may be needed. As noted in **Figure 13**, air-source heat pumps can provide more heat at higher outside air temperatures. As the outside air temperature decreases, the heat output of the heat pump significantly decreases, and auxiliary heat can be used to offset the reduction in heat pump capacity. Auxiliary or supplemental heat can be provided with electric resistance heating or gas heating.

In some designs, electric resistance auxiliary heat can be leveraged by maintaining existing electric baseboards or VAV boxes in building retrofit applications. Electric resistance can also be paired with water-source heat pumps in the form of an electric boiler. Water-source heat pumps get their energy from water, typically between 45°F and 90°F, that circulates through a building, and when the water temperature drops below the desired range, an electric resistance boiler can be used to heat the water.

Air-to-Water Heat Pumps for Auxiliary Heat

A relatively new application is to use air-to-water heat pumps as an auxiliary heat source along with distributed water-source heat pumps. The air-to-water heat pump acts much like an auxiliary boiler, but instead of using electric resistance to heat the water loop, it uses heat from the outside air to inject energy into the condenser water loop. A thermal storage tank can also be part of the system so that the air-to-water heat pump can operate during the warmest part of the day for greatest efficiency and heating capacity, and this heat can be stored and extracted the following morning. HVAC system air-to-water heat pumps are usually located outdoors. In cold climates, the water loop should contain a sufficient level of glycol for freeze protection.

Existing Gas Equipment as Backup

When replacing existing gas heating equipment with a heat pump, there may be advantages to keeping gas heat as a backup or auxiliary heating source. A couple example scenarios where this would be helpful include:

- When there isn't enough existing electrical capacity to power auxiliary electric heat
- For backup heat purposes so that during a power outage, the electrical load is limited to the fans
- When the life cycle carbon of keeping the gas equipment is lower.

Most manufacturers offer heat pumps packaged with a gas furnace. In addition, some control systems will allow the user to specify when the gas heat will turn on, limiting its operation to emergency events only or for backup heating purposes.

Water-to-air heat pumps fed off a geothermal loop in a commercial ski resort.

Photo from Kristy Walson, BranchPattern

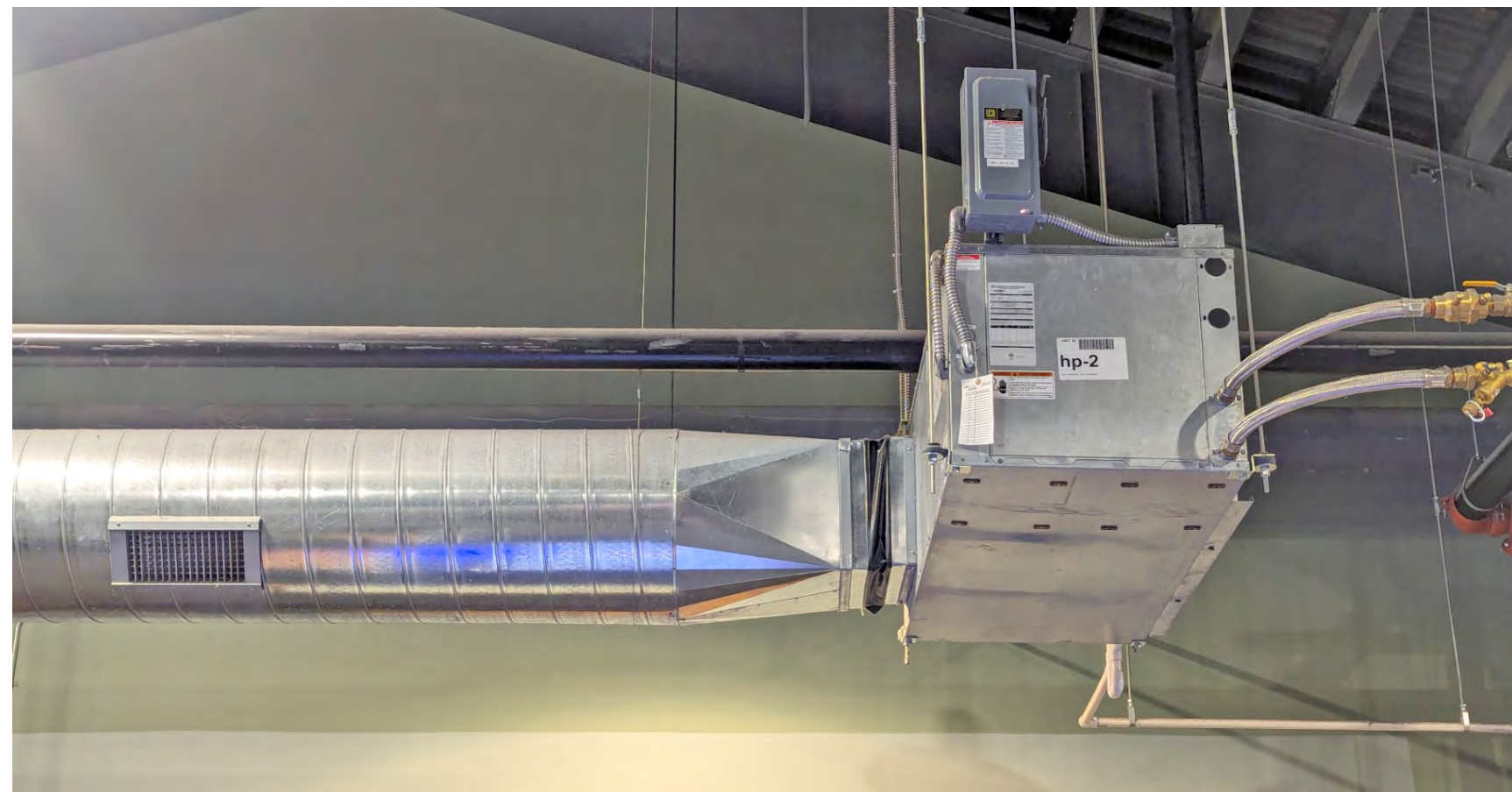

Heat Pump Configurations

This section outlines a few common heat pump configurations and considerations for commercial buildings.

Ductless Split Air-to-Air Heat Pumps

Ductless minisplit air-to-air heat pump systems, as shown in **Figure 16**, are best suited for projects containing or planned for “non-ducted” heating systems. In retrofit applications, typical existing non-ducted heating systems may include hydronic systems, radiant panels, and space heaters. Minisplits are composed of two primary components—an outdoor unit, which encompasses the compressor and refrigerant-air heat exchanger, and an indoor unit containing a supply fan and a refrigerant-air heat exchanger. In heating mode, the outdoor unit acts as a refrigerant evaporator where cool outside air is warm enough to evaporate the refrigerant at its suction pressure. The evaporator refrigerant is compressed, and the hot superheated vapor is distributed to the indoor units to exchange heat with the indoor air. In heating mode, the indoor units act as condensers, where the refrigerant is condensed back to a liquid and distributed back to the outdoor unit for the process to repeat.

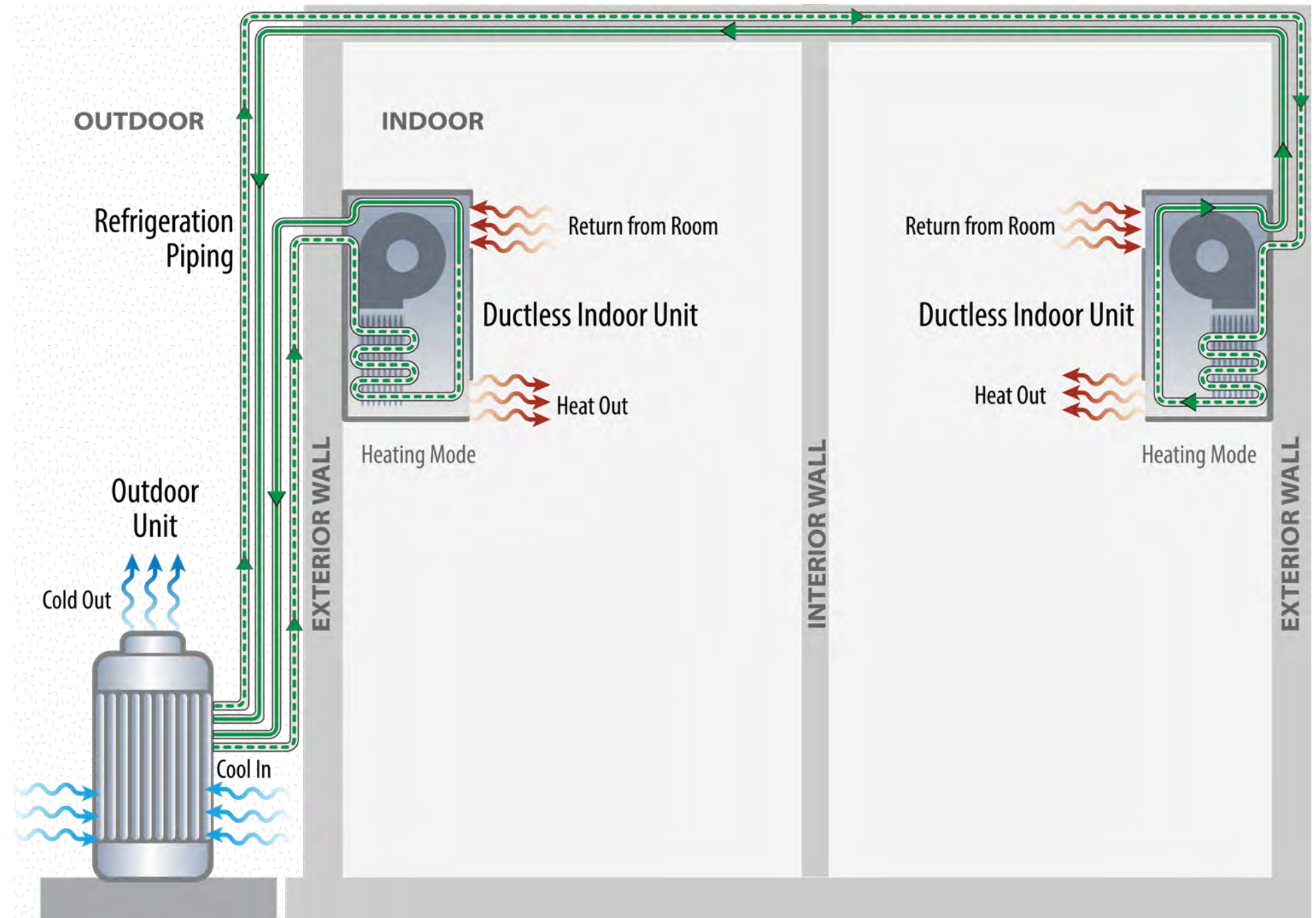

Figure 16. Example piping configuration of a ductless minisplit air-to-air heat pump.

Some advantages and disadvantages of minisplit heat pumps are outlined in **Table 6**.

Heat Recovery (or Reclaim) Chiller

Prior to covering heat reclaim chillers, it's important to understand the principles of operation of a basic chiller, as depicted in **Figure 17**. Chillers can be water-cooled or air-cooled.

Figure 17 illustrates a basic piping diagram of a water-cooled chiller. Chillers are used to create cold water that is distributed throughout the building to provide air conditioning. Chillers are most suitable for use in large buildings, typically with cooling loads on the order of hundreds of tons. Chillers are typically the largest, most expensive, and most energy-consuming component of a central plant. While not depicted in **Figure 17**, it is often effective to stack chillers in parallel to efficiently meet the variations in seasonal cooling loads while building in system redundancy, rather than relying on one oversized chiller to meet the entire building's cooling load.

Water-cooled chillers are typically located in a mechanical room on a lower floor within the building (i.e., basement). Chilled water (~42°F) leaving the evaporator of the chiller is distributed throughout the building to air handling units, or fan coil units, located within various spaces to absorb the heat within the building. The heat is returned in the form of warmer water (~57°F) back to the chiller for the cycle to repeat. Within the chiller, the heat absorbed by the water is transferred through a refrigerant via a vapor compression cycle to the condenser side of the chiller. The water-cooled condenser has its own and separate water circuit that rejects heat through a cooling tower, typically located on the roof of the building. Hot water leaving the chiller condenser at around 95°F is distributed to the cooling tower for heat rejection and returns to the chiller at around 85°F for the cycle to repeat.

Table 6. Advantages and Disadvantages of Ductless Minisplit Air-to-Air Heat Pump Systems

Advantages	Disadvantages
Small in physical size	Water condensate drains are required for the outdoor unit.
Flexibility for zoning through the design and application of multiple indoor units	Performance is sensitive to sizing errors of each indoor unit. Oversized or incorrectly located indoor units can result in short cycling, inefficiency, and lack of proper temperature and humidity control.
Relatively easy to install. For example, the hookup between the outdoor and indoor units generally requires only a 3-inch hole through a wall for the conduit.	Appearance of the indoor unit may not be as seamless as central systems
No duct work required, and avoided energy losses associated ductwork of central forced air systems.	Not suitable for large spaces, given the smaller nature of these system and associated limited heating and cooling capacities. Therefore, multiple minisplits would need to be installed to meet larger space loads.
Interior design flexibility. The indoor air units can be suspended from a ceiling, mounted flush into a drop ceiling, or hung on a wall. Floor-standing models are also commercially available.	

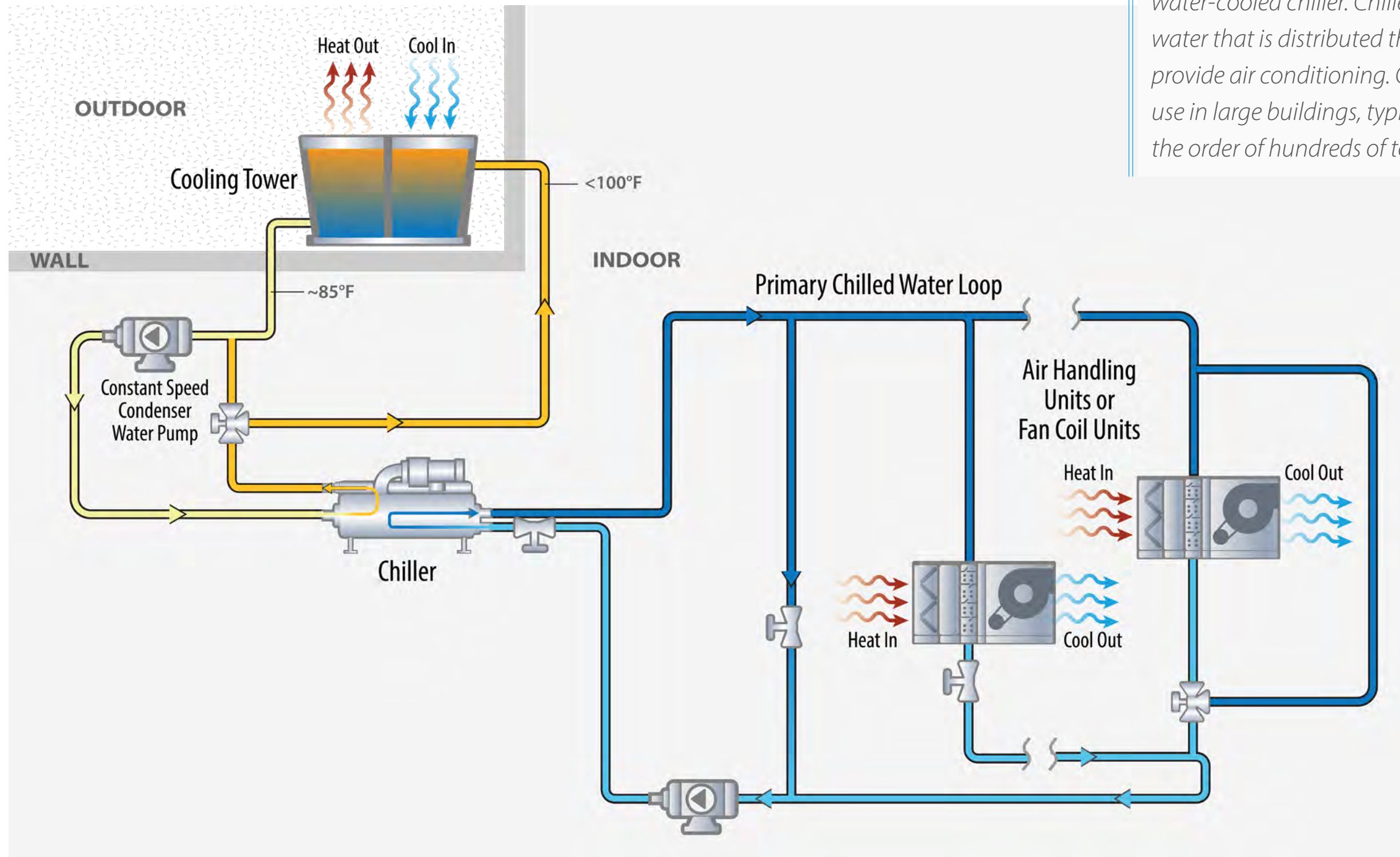

Figure 17 illustrates a basic piping diagram of a water-cooled chiller. Chillers are used to create cold water that is distributed throughout the building to provide air conditioning. Chillers are most suitable for use in large buildings, typically with cooling loads on the order of hundreds of tons.

Figure 17. Example chiller piping diagram

There are two main categories of chillers used in buildings:

- **Vapor compression chillers** use mechanical work with a working fluid (the refrigerant) to move thermal energy and are categorized as dynamic (centrifugal) or positive displacement (reciprocating, rotary, and orbital).
- **Absorption chillers** use thermal energy to drive the refrigeration cycle and have two working fluids—the sorbent and the refrigerant.

Absorption chillers have a lower efficiency compared to vapor compression chillers and are best suited in places where waste heat is generated; for example, in a campus with a cogeneration plant.²

Adding a heat reclaim chiller will enable the system to capture thermal energy that would otherwise be lost into the atmosphere in a basic chiller operation. Heat reclaim chillers can be placed in series or in parallel to chiller plants, sized to match the heating load, and controlled to a chilled water setpoint exiting the heat recovery chiller evaporator (to control to a common leaving water temperature setpoint) or hot water temperature setpoint leaving the heat reclaim chiller condenser. Heat reclaim chillers are best suited for buildings with a high amount of simultaneous heating and cooling load, or energy recovery potential. **Figure 18** demonstrates a heat recovery chiller that is integrated in parallel to the cooling chiller.

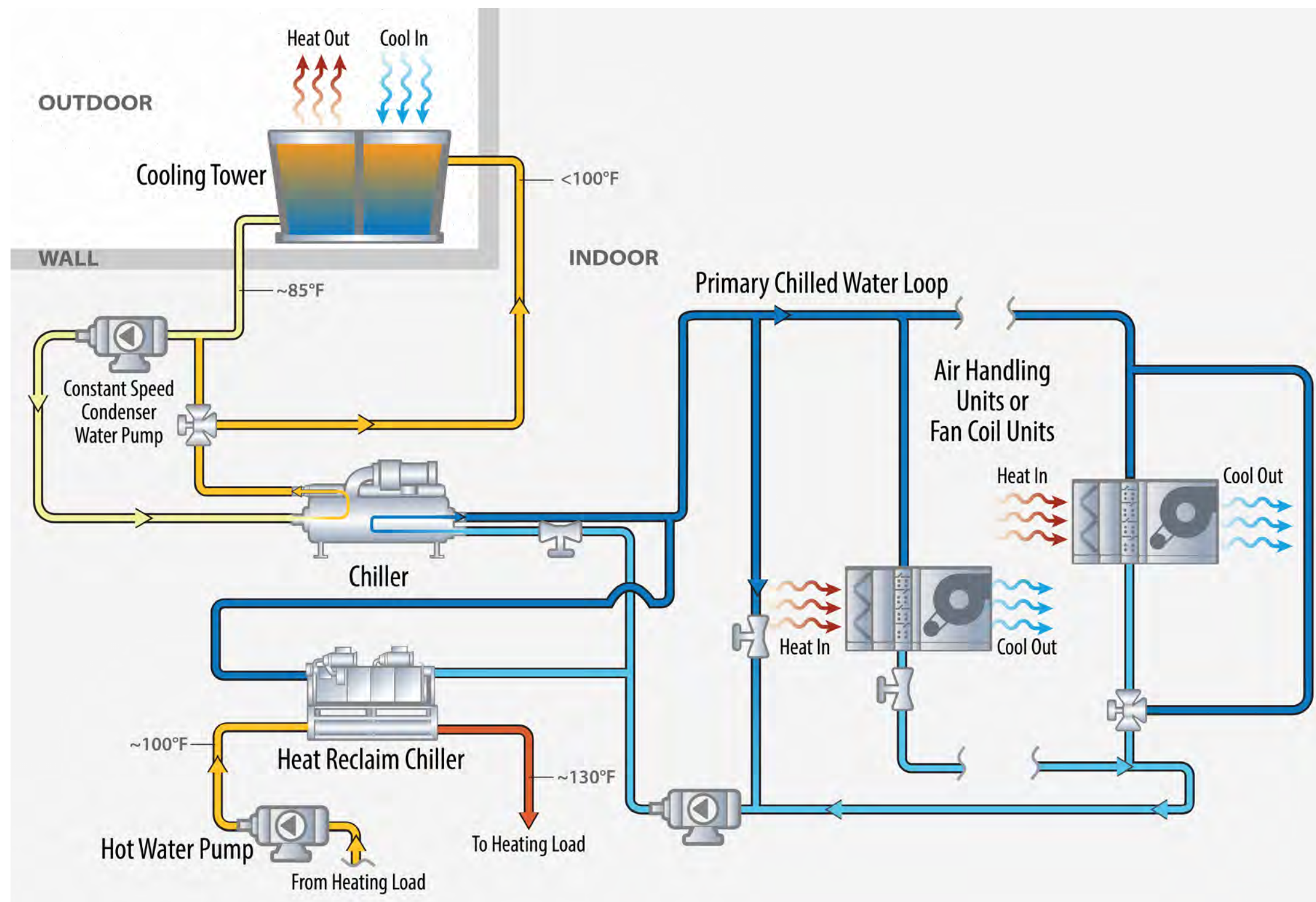

Figure 18. Example heat reclaim chiller piping diagram

² For additional information about using low-grade waste steam to for absorption chiller, refer to the [Energy Tip Sheet for Steam](#) fact sheet (DOE 2012).

COP OF HEAT RECOVERY CHILLER SYSTEMS

The COP of heat recovery chiller systems are typically determined and reported by manufacturers as the sum of heating plus cooling COPs for the unit, as shown below.

Where:

$$\text{COP}_{\text{HRC}} = \text{COP}_{\text{heating}} + \text{COP}_{\text{cooling}}$$

$$\text{COP}_{\text{heating}} = \text{Heat}_{\text{out}} / \text{Work}_{\text{in}}$$

$$\text{COP}_{\text{cooling}} = \text{Heat}_{\text{in}} / \text{Work}_{\text{in}}$$

Water-Source Heat Pumps With Ambient Water Loop

Larger buildings (roughly larger than 10,000 ft²) with high amounts of simultaneous heating and cooling loads may benefit from the use of water-source heat pumps connected to a common water loop (ambient loop typically 45°F–90°F). Water-source heat pumps connected to a common water loop can move heat from warmer areas to colder areas within the building. Doing so results in higher performance efficiencies as compared with meeting heating and cooling loads through separate dedicated heating and cooling systems. The architecture of water-source heat pumps connected to an ambient loop is shown in **Figure 19**. This configuration consists of several water-to-air heat pumps, each containing a reversing valve that allows the unit to operate in heating or cooling modes as demanded by the zone conditions. Water-source heat pumps operating in heating mode extract heat through the ambient water loop while heat pumps operating in cooling

mode reject heat into the same water loop. This architecture allows heat from unwanted areas within the building to be leveraged in other areas within the building where it is needed. In the ideal operational scenario, the building would require an equivalent amount of heating and cooling. In such balanced scenarios the ambient loop temperatures will remain relatively constant, however for most parts of the year this may or may not be the case. As a result, the need for supplemental heating and/or cooling may be required to maintain ambient loop water temperatures within a certain range. In water-source heat pump configurations, the ambient water loop temperature is commonly maintained at roughly 45°F to 90°F, depending on the instantaneous loads extracted or dissipated through the operational heat pumps at any given time. Water loop piping may require insulation for condensation control.

In circumstances where insufficient amounts of simultaneous heating and cooling are present, ambient water loop temperatures during heating-dominated seasons may drop to well below 45°F and the need for supplemental heating may be required. **Figure 19** illustrates the location of possible supplemental heating that may be integrated with the water loop. Similarly, in cooling dominated seasons the ambient loop may rise to temperatures above 90°F. In such circumstances, a heat rejection mechanism (closed loop wet cooling tower or dry cooling tower) may be required to effectively reduce the ambient loop temperatures. The cooling tower is typically placed outside of the building, and is connected to the water loop as shown in **Figure 19**. In humid climates, a common heat rejection system includes an open loop wet cooling tower that is isolated from the building's condenser water loop with a plate and frame heat exchanger. It is best practice to install a redundant plate and frame heat exchanger to allow cleaning of plates which often suffer "fouling" due to the open water loop. Terminal water-source heat pumps should include a motorized condenser water isolation valve. This will allow flow reduction and significant loop pump energy savings.

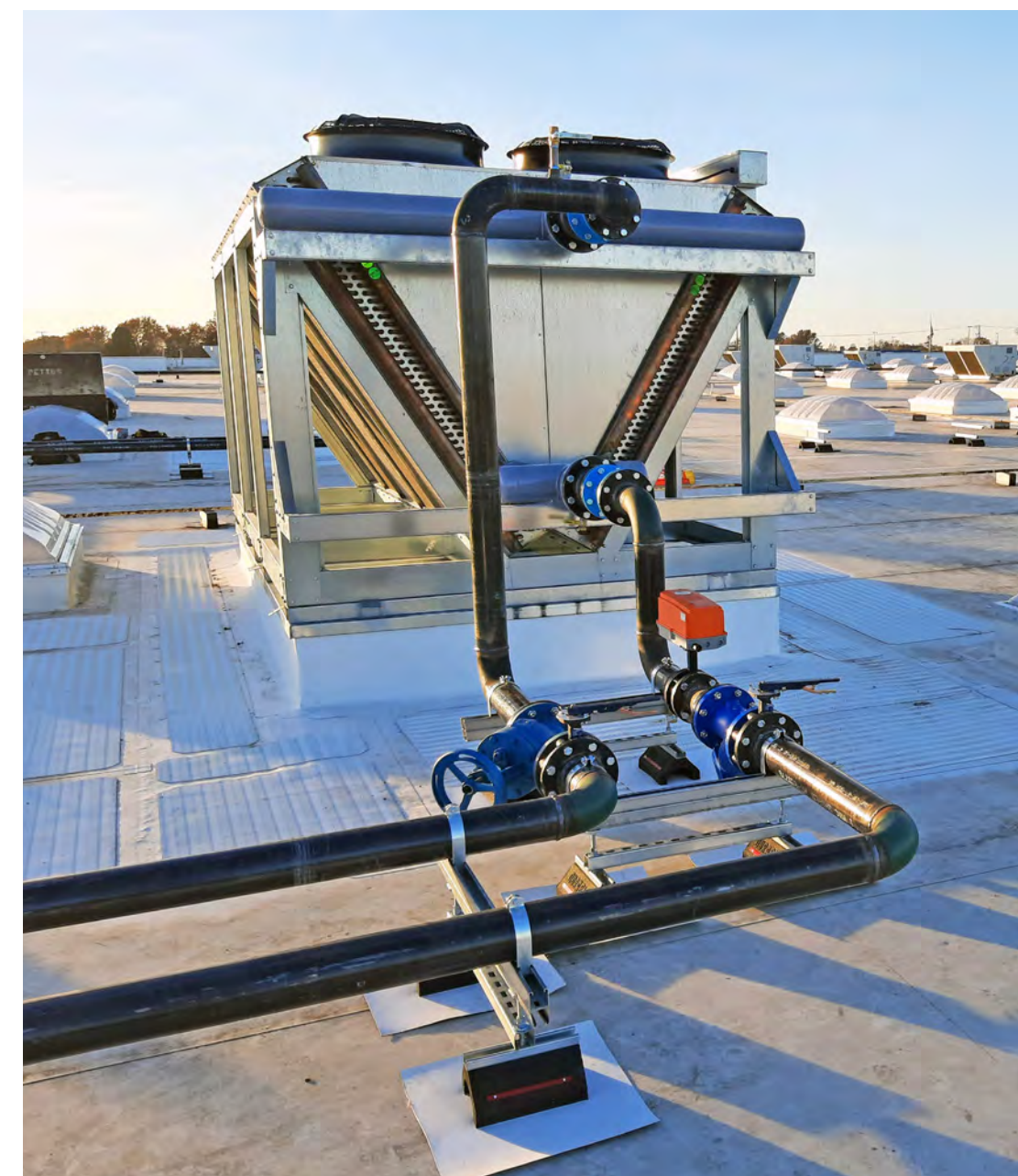

Dry cooler used to reject heat from a water-source heat pump using glycol as the fluid

Photo from Walmart

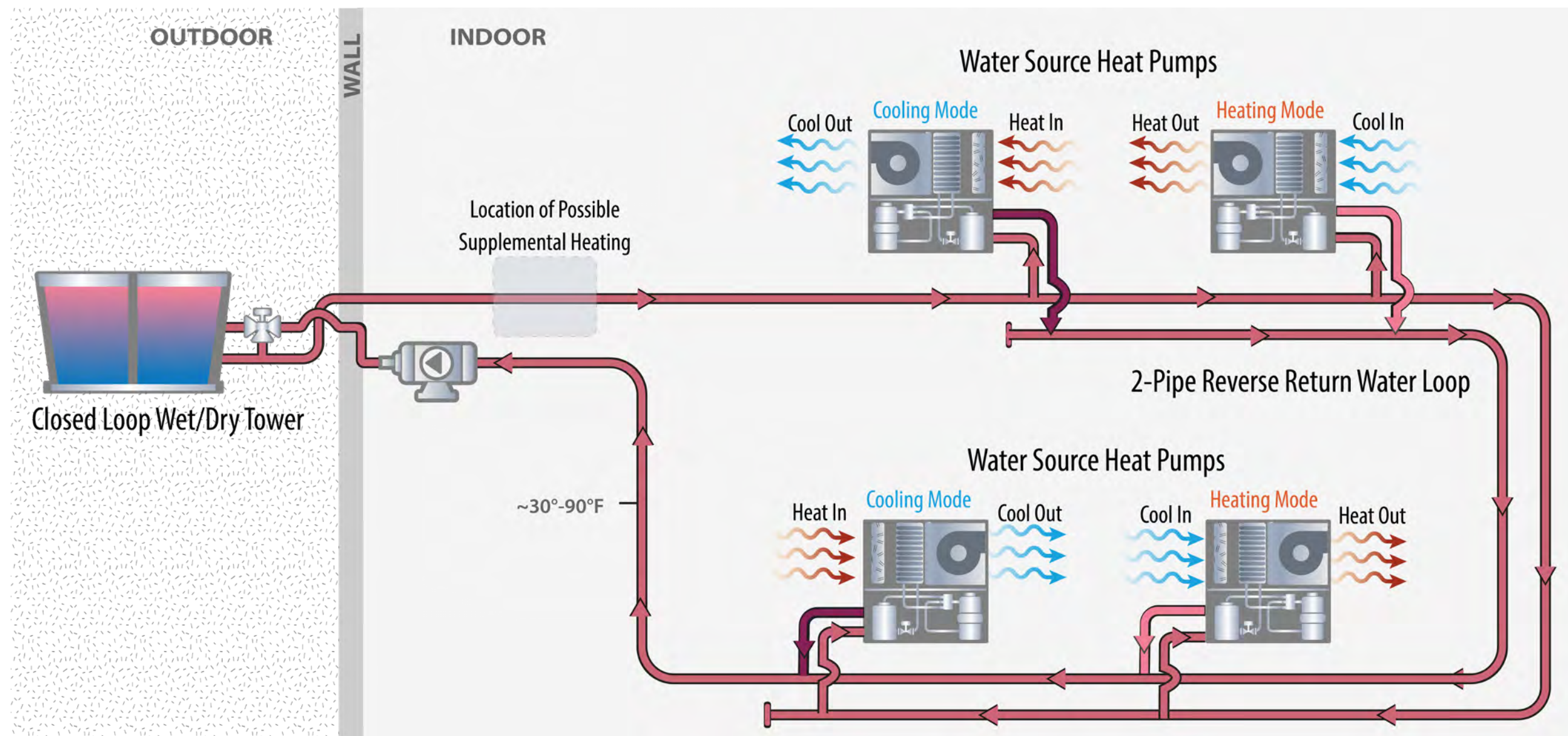

Figure 19. Example water-source heat pump piping diagram with ambient water loop

This figure illustrates the location of possible supplemental heating that may be integrated with the water loop. Similarly, in cooling dominated seasons the ambient loop may rise to temperatures above 90°F. In such circumstances, a heat rejection mechanism (closed loop wet cooling tower or dry cooling tower) may be required to effectively reduce the ambient loop temperatures. The cooling tower is typically placed outside of the building, and is connected to the water loop as shown.

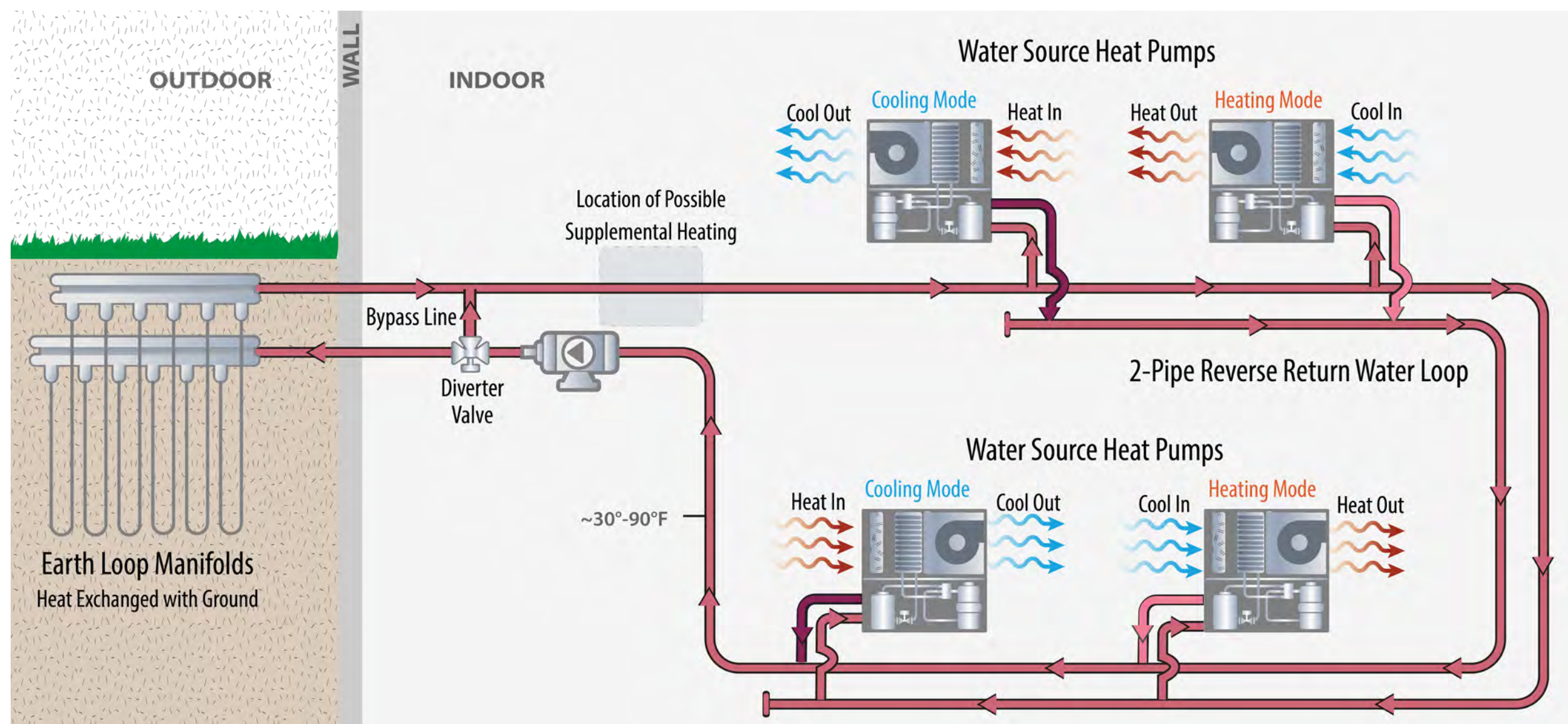

Figure 20. Example ground-source configuration with ambient water loop and water-source heat pumps

Ground-Source Heat Pumps With Ambient Water Loop

Ground-source configurations could also leverage an ambient water loop design with several integrated water-source heat pumps serving each zone or area in a building. The earth loop in a ground-source configuration serves as a heat rejection or heat source for the ambient water loop. Therefore, ground-source configurations can eliminate the need for a cooling tower and supplementary heating in the water loop. In addition, earth loop ground-source configurations have other operational differences compared with water loop configurations that rely on a cooling tower and possibly a supplementary

heating mechanism. For example, a ground-source configuration typically operates over a wider ambient loop temperature range. Depending on the earth loop design, site location, and building loads, earth loop temperatures could operate across temperature ranges that span 30°F to 90°F. Therefore, it is important to select water-source heat pumps that are capable of operating within the expected water loop design temperature ranges. If temperatures are anticipated to operate at or below freezing, antifreeze solution should be included in the water loop. Moreover, strategies such as proper insulation should be considered to prevent surface condensation on ambient loop piping when anticipated to operate below interior air dew point temperatures.

When water-source heat pumps are used for heating and cooling through a water loop, the ventilation air is typically provided by a DOAS. During cooling-dominated periods, the DOAS cools and dehumidifies the outside air. During heating-dominated seasons the DOAS heats the ventilation air.

Variable Refrigerant Flow Systems

Variable refrigerant flow (VRF) systems are all-electric heating and cooling solutions that are configured to recirculate refrigerant to and from indoor units serving numerous spaces within a building and an outdoor unit. VRF systems can be configured to meet simultaneous heating and cooling loads using branch selectors (as shown in **Figure 21**) or using three-pipe VRF architectures. VRF systems are typically ductless and are better suited for large buildings. VRF systems typically rely on variable-speed inverter-based compressors that can modulate their capacity to match and save energy at part-load conditions. As described in **Chapter 2: Selecting the Right Heat Pump for Your Project**, the use of refrigerant as a distribution medium enables the use of smaller piping, hence deeming VRF technology more favorable in some building retrofit applications. VRF systems can be air cooled, water cooled, two pipes, three pipe, and may or may not include heat recovery capabilities.

VRF systems require separate ventilation equipment to supply each zone to satisfy ASHRAE Standard 62.1 *Ventilation for Acceptable Indoor Air Quality*. Furthermore, designers should minimize the refrigerant pipe runs to the extent possible to reduce initial and operational costs, while being cognizant of the maximum allowable refrigerant pipe between the indoor and outdoor units as specified by the manufacturer.

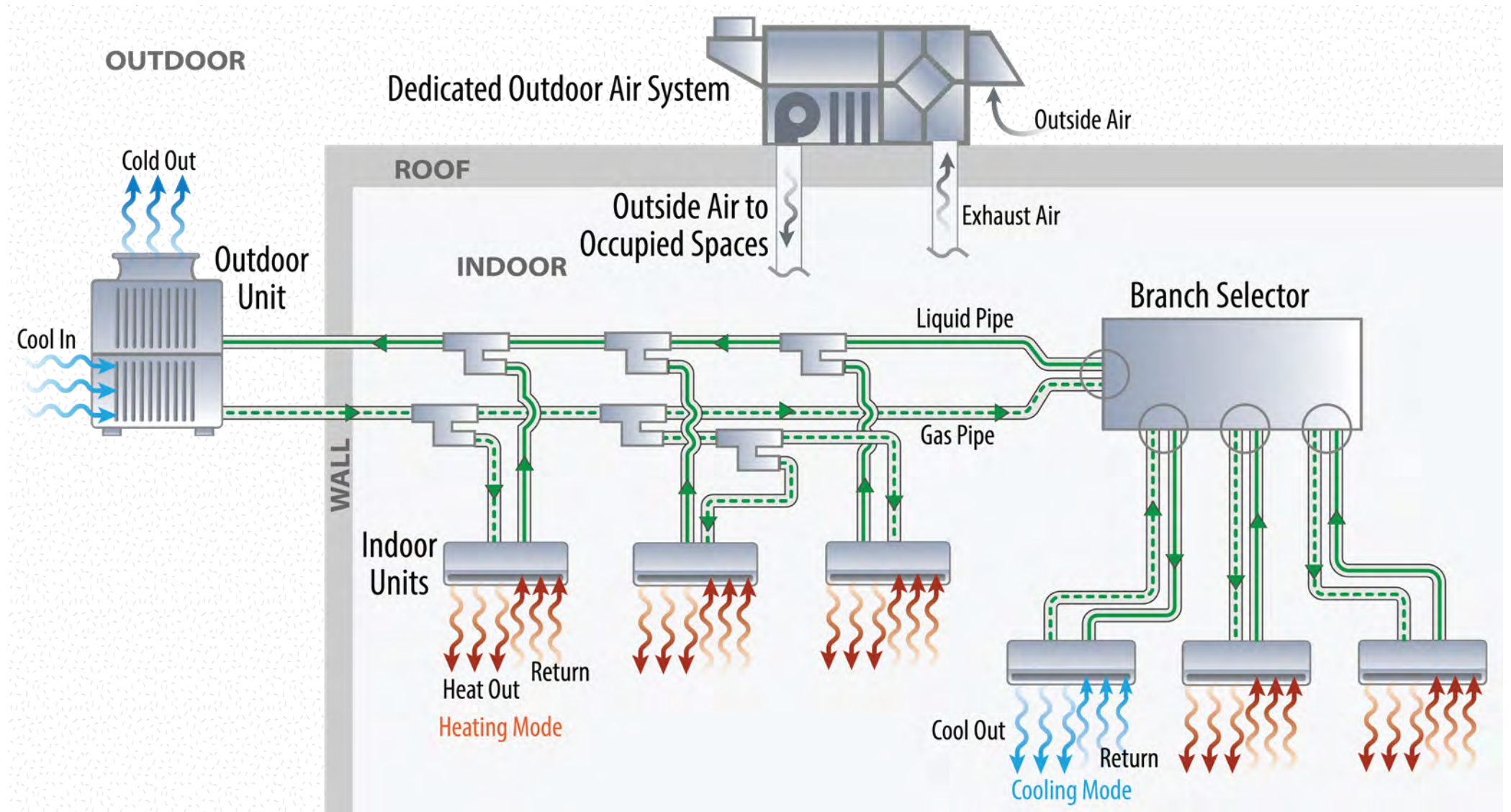

Figure 21. Example VRF system piping diagram

*VRF systems can be configured to meet simultaneous heating and cooling loads using branch selectors (as shown in **Figure 21**) or using three-pipe VRF architectures.*

References

- ASHRAE. 2017. *ASHRAE Design Guide for Dedicated Outdoor Air Systems*. American Society of Heating, Refrigerating and Air-Conditioning Engineers.
- ASHRAE. 2019a. *ASHRAE 15 – Safety Standard for Refrigeration Systems*. American Society of Heating, Refrigerating and Air-Conditioning Engineers.
- ASHRAE. 2019b. *ASHRAE 34 – Designation and Safety Classification of Refrigerants*. American Society of Heating, Refrigerating and Air-Conditioning Engineers.
- ASHRAE. 2020. *ASHRAE Handbook—HVAC Systems and Equipment*. American Society of Heating, Refrigerating and Air-Conditioning Engineers.
- ASHRAE. 2021. *ASHRAE Handbook—Fundamentals*. American Society of Heating, Refrigerating and Air-Conditioning Engineers.
- BetterBricks. 2024. “Energy Modeling Guide for Very High Efficiency DOAS.” <https://betterbricks.com/resources/energy-modeling-guide-for-very-high-efficiency-doas>. Accessed 15 Feb. 2024.
- DOE. 2012. “Use Low-Grade Waste Steam to Power Absorption Chillers.” U.S. Department of Energy, Advanced Manufacturing Office. DOE/GO-102012-3413. https://www1.eere.energy.gov/manufacturing/tech_assistance/pdfs/steam14_chillers.pdf
- DOE. 2023. “Heat Pump Systems.” U.S. Department of Energy. www.energy.gov/energysaver/heat-pump-systems.
- DOE. 2024. “Air-Source Heat Pumps.” U.S. Department of Energy. www.energy.gov/energysaver/air-source-heat-pumps.
- ECT. 2024. Emerson Climate Technologies. Technical Information, Enhanced Vapor Injection. <https://www.copeland.com/documents/enhanced-vapour-injection-for-zh-copeland-scroll-compressors-technical-information-en-gb-4215484.pdf>
- MEP. 2024. MEPAcademy: Mechanical, Electrical, Plumbing. <https://mepacademy.com/wp-content/uploads/2022/10/Piping-vs-Ductwork-Space-Requirements.png>. Accessed 15 Feb. 2024.
- NEEA. 2024. “Very High Efficiency DOAS Requirements.” Northwest Energy Efficiency Alliance (NEEA), <https://neea.org/our-work/very-high-efficiency-doas-requirements>. Accessed 15 Feb. 2024.
- NRC. 2020. “Air-Source Heat Pump Sizing And Selection Guide, Version 1.0, 2020-12-21.” National Resources Canada. [https://natural-resources.canada.ca/sites/nrcan/files/canmetenergy/pdf/ASHP%20Sizing%20and%20Selection%20Guide%20\(EN\).pdf](https://natural-resources.canada.ca/sites/nrcan/files/canmetenergy/pdf/ASHP%20Sizing%20and%20Selection%20Guide%20(EN).pdf)
- Raftery, P. 2018. “Quantifying energy losses in hot water reheat systems.” *Energy and Buildings Volume 179*, 183-199.

CHAPTER 3: DESIGNING AND SIZING HEAT PUMPS

The visitor center at Lassen Volcanic National Park uses a whole-building, sustainable design approach that includes a high efficiency 10-ton ground-source heating and cooling system; a 30 kW photovoltaic system; automated daylight controls; super insulation; and incandescent-free lighting throughout. The building achieved a LEED™ Platinum certification and is the first year-round LEED Platinum building in the National Park System as well as the first Platinum Federal building in the State of California.

Photo from Boeckman, Gabriel, NREL 17252

Proper sizing of heating and cooling systems is important, as it affects the performance and control of the system. If systems are oversized, then there is potential for the system to short cycle in low-load scenarios, leading to poor temperature and humidity control as well as decreased equipment life and reduced COP. If the system is undersized, this can lead to space temperatures falling out of the acceptable comfort ranges, resulting in reduced occupant comfort. These two points emphasize the importance of sizing the HVAC system properly. For many applications, heat pumps provide both heating and cooling to the system, and this further complicates the sizing because heating and cooling loads in many buildings are not equal and air-source heat pumps can have reduced capacity with very cold outdoor air temperatures. Based on the need for proper sizing from an operational perspective and the added complexity of heat pumps, intentional sizing decisions should be made. Considering the heating and cooling load profiles throughout the year is critical, not just looking at peak sizing conditions.

When sizing any heating or cooling system, performing the following steps is recommended.

1. Determine the general system configuration

- › Determine the general system requirements
 - Space temperature setpoints
 - Space humidity setpoints
 - Ventilation requirements
- › Zoning pattern
 - Single zone
 - Multi zone
- › Controls Strategies
 - Setbacks
 - Ventilation

2. Run a load calculation for the building

- › Measured building loads
- › ANSI/ASHRAE/ACCA Standard 183 Compliant Model
- › Ideally a yearly analysis

3. Map hourly loads for heating and cooling

4. Select equipment size based on load profiles (this may include a combination of equipment, such as heat pump and electric resistance heating coil)

5. (Optional) Simulate system performance

6. (Optional) Iterate on design to optimize performance (repeat steps 1–5).

In this section, we will discuss these steps and lay out a strategy for sizing heat pump systems.

Determine the General System Configuration

New Construction

When beginning sizing of the system, it is ideal to understand the general system configurations that are being designed because this will affect the load calculations for the system. For example, if you have a distributed system of individual single room systems such as a packaged terminal heat pump, the load calculations will need to account for the peak load of each room. However, if the system is configured as a central system with multiple zones, the load calculations will determine both the peak loads of each zone or space but also the peak “block” load of the entire building. Similarly, understanding the system requirements such as ventilation and setpoints will also affect the load calculations of the building. Finally, understanding any proposed controls strategies such as setbacks can influence the load calculations because building warmup and cooldown can impact peak loads in a space significantly.

Retrofit

For retrofit projects, calculating or measuring the performance of the existing system can help inform the sizing of the new mechanical systems as well as allow the design team to understand building performance issues that can be addressed with the new design. Also, analyzing building performance under real-world conditions can provide a more accurate load analysis for the building because measured load data shows how the building is actually performing and does not rely on accurately quantifying all building loads required in a software-based approach. The section on **Measured Data and Existing System Capacity** discusses this measured data approach in detail. If further building improvements are going to be made as part of the project, an energy model might be used in tandem with measured data to inform the expected reduction in building load due to envelope improvements, plug and process load reductions, light improvements, occupancy changes, etc. See **Chapter 4: Retrofit Applications** for more information on investigation of existing systems in a building and how to identify load reduction strategies.

Run a Load Calculation for the Building

Once the general system configuration has been determined, either existing or new, a load calculation should be performed. In the case of an existing building, if possible measured building load data should be used in place of load calculation to determine the building loads; this is discussed further in the section **Measured Data and Existing System Capacity**. For commercial buildings, we recommend that load calculations be performed by automated systems that are compliant with ANSI/ASHRAE/ACCA Standard 183. This involves utilizing the equipment configurations determined in Step 1, the building layout/construction/occupancy patterns of the building being analyzed, and the weather data for this location to run a load calculation for the building. For heat pumps, we recommend that this calculation be a full year hourly load calculation, as having this hourly data will inform proper heat pump sizing. For many engineers in the past, system sizing looked at peak cooling and peak heating load, and heating and cooling equipment was selected to meet these loads. This methodology has potential pitfalls in sizing as many buildings only operate at peak loads for a short period, leaving the system grossly oversized for most of the operating conditions throughout the year. For this reason, an 8760 analysis (hourly over a year) is recommended. The subsequent sizing methodology is covered in this section using an 8760 analysis.

While 8760 analysis provides more information to help reduce oversizing, the assumptions that are used for the model play a significant role in reducing potential oversizing pitfalls. Assumptions such as design day, internal loads, and schedules influence a building model significantly. In general it is recommended to perform design day calculations with information that is compliant with ASHARE Standard 169. This standard includes ASHRAE recommended design day information which can be found in online resources (ASHRAE, ASHRAE CLIMATIC DESIGN CONDITIONS 2009/2013/2017/2021, 2021). Future climate may be something the project manager would like to factor into the sizing. Codes may also impact the sizing condi-

tions and any calculations should factor in local code requirements. Using more extreme design conditions can cause additional oversizing. Assumptions in terms of occupancy, equipment usage, and schedules should be carefully considered to avoid layering conservative assumptions and introducing unintended oversizing.

When applying load calculations, internal loads should be accurately evaluated and quantified. These loads can include things like lighting, plug and process loads, people, etc. Each of these loads should be determined via reasonable design intents as well as schedules. For example, occupancy should account for diversity and not assume that each space is completely full at all times, and plug and process loads should be accurately accounted for and not be assumed at an average density. Schedules should also be applied to these loads to ensure that calculations account for changes in operation throughout the day and loads are not assumed to be 100% operational 24/7. By establishing accurate quantities and schedules, loads can be calculated closer to actual operation and reduce the risk of oversizing the equipment.

Measured Data and Existing System Capacity

Load calculation software uses heat transfer physics to calculate the heat load for the facility. These methods have been tested and verified to be accurate and provide a basis for new buildings and existing buildings' heating loads. When the required information for these methods is available, the software are powerful tools to understand the heating loads and design requirements. When critical building information is not available or the operation of the building is unclear, measured data can be an effective way to monitor the actual operation of the equipment and determine the heating requirements for the space.

CALCULATING THE HEATING LOADS

When calculating the heating loads for a facility, the primary equation that will be used is as follows:

$$q = \dot{m} C_p \Delta T$$

$$q = \text{Heat (Btu/hr)}$$

$$\dot{m} = \text{Mass flow rate (lb/s)}$$

$$C_p = \text{Specific heat capacity of the liquid or air}$$

$$\Delta T = \text{Change in temperature of the fluid}$$

If we assume the fluid type and atmospheric pressure at sea level of the working fluids, we can simplify these equations down to the following forms.

For air at sea level :

$$q_{\text{sensible}} = 1.08 \text{ CFM } \Delta T$$

$$q_{\text{latent}} = 4840 \text{ CFM } \Delta W_{\text{lb}}$$

$$q_{\text{total}} = 4.5 \text{ CFM } \Delta h$$

For water without glycol:

$$q = 500 \text{ GPM } \Delta T$$

Where:

$$\text{CFM} = \text{cubic feet per minute ((ft}^3\text{)/min)}$$

$$\Delta W_{\text{lb}} = \text{change in humidity ratio ((lb.H}_2\text{O)/(lb dry air))}$$

$$\Delta h = \text{change in enthalpy (Btu/(lb dry air))}$$

$$\text{GPM} = \text{gallons per minute (gal/min)}$$

These equations help show the information that needs to be gathered from the equipment. The specific heat of the fluid, whether air or water or a glycol mixture, is available through textbooks and other technical publications. The mass flow rate of the fluid can either be directly measured by a sensor or can be inferred by using fan or pump speed compared to the rated flow of the fan or pump. When inferring flow rate take the percent speed or percent open position of the damper/valve and scale it by the maximum flow of the system. The inferred approach can result in inaccurate assumptions for flow, as dampers and valves are not always linear in their volume control depending on the equipment type. If this approach is used caution should be taken to determine accurate assumptions for flow through valves and damper. Finally, the change in temperature of the fluid can be measured before and after the specific heating coil in question or between the supply air and the room temperature. This methodology can be applied to determine the load on the equipment as well as the space itself.

Ideally, when applying this method for establishing building loads, data is available from the building automation system. Many modern building automation systems have the capability to store data trends over different time spans and different sampling rates. These trends might need to be set up during on-site investigation and exported later. If the system does not have this capability, then data loggers will need to be deployed to gather this data. Utilizing data loggers to measure and trend both the change in temperature and flow of the heating equipment, the load can be determined. When utilizing either the data logger or building automation system components to gather data, it is crucial to understand the accuracy of the measurement devices and adjust the data as needed to account for any variance in the calibration of the devices. For both data loggers and the building automation system components, calibration should be verified before logging or recent calibration reports should be reviewed. By adjusting the trended data to account for calibration issues, the heating load calculations will be more accurate and a higher confidence in the results will be established.

For both data loggers and the building automation system components, calibration should be verified before logging or recent calibration reports should be reviewed.

When utilizing measured data, it is ideal to be able to take these measurements during a peak load situation that is happening during normal operation. This is to say, don't take the heating load measurements during the coldest night when occupancy is zero and no equipment is on at the occupied setpoint. By performing the measurements during realistic peak heat load scenarios, oversizing can be reduced, and optimal equipment performance can be achieved. If it's not feasible to measure the system during a peak cooling or heating load operation, multiple measurements can be taken, and a regression of the peak heating or cooling load can be established. This regression should be normalized to weather, occupancy, or other significant building characteristic at the time measurements were taken. Utilizing this regression, apply the design day weather condition and other normalizing characteristics for this facility and extrapolate the expected peak heating load for this facility.

For the measured data approach, it is recommended that if peak load conditions cannot be directly measured that the investigation team follow the International Performance Measurement and Verification Protocol (IPMVP) Option A recommendation for weather-dependent systems (DOE 2002). This option recommends trending for a long enough period to adequately characterize the load pattern of the facility. This is facility-dependent but for many offices, multifamily, or other cyclical occupancy buildings a good rule of thumb is a minimum of two weeks of measured data to establish the normalized building load regression. Two weeks is recommended because this will capture two cycles of occupancy with weekday and weekend occupancy as well as provide two sets (weeks) of data with similar occupancy in case of abnormal operation during the measured period. This additional set can be used to help calibrate a regression to remove or eliminate

the abnormal operation that occurred during data measurement. Along with the length of time, measurement sampling should be established. The sample rate of the data should be enough to capture variances in the system but not too high as to capture instantaneous anomalies in the system. A rule of thumb is to capture 1-minute to 15-minute data and create 15-minute or hourly averages for the data collected. By averaging the measured data, instantaneous anomalies will be leveled out and a typical peak and average heating load will be calculated, resulting in a system that is better sized to meet expected loads in the space.

The primary goal in this exercise is to understand the building load for design calculations. However, understanding the loads on the existing equipment can help inform the design team what would be required of the new heat pump system if they used existing distribution equipment.

The primary goal in this exercise is to understand the building load for design calculations. However, understanding the loads on the existing equipment can help inform the design team what would be required of the new heat pump system if they used existing distribution equipment. To determine this, equipment should be tested following the "Stress Test" procedure detailed in section titled **Identify Space for New Heat Pump and Distribution Equipment**.

Map Hourly Loads for Heating and Cooling

After determining the hourly load profiles for the building and general system configuration, mapping and analyzing this load profile is recommended. When mapping the hourly load profile to outdoor air dry-bulb temperature ("dry-bulb" refers to ambient air temperature, not accounting for humidity), you get a graph that looks like **Figure 22**.

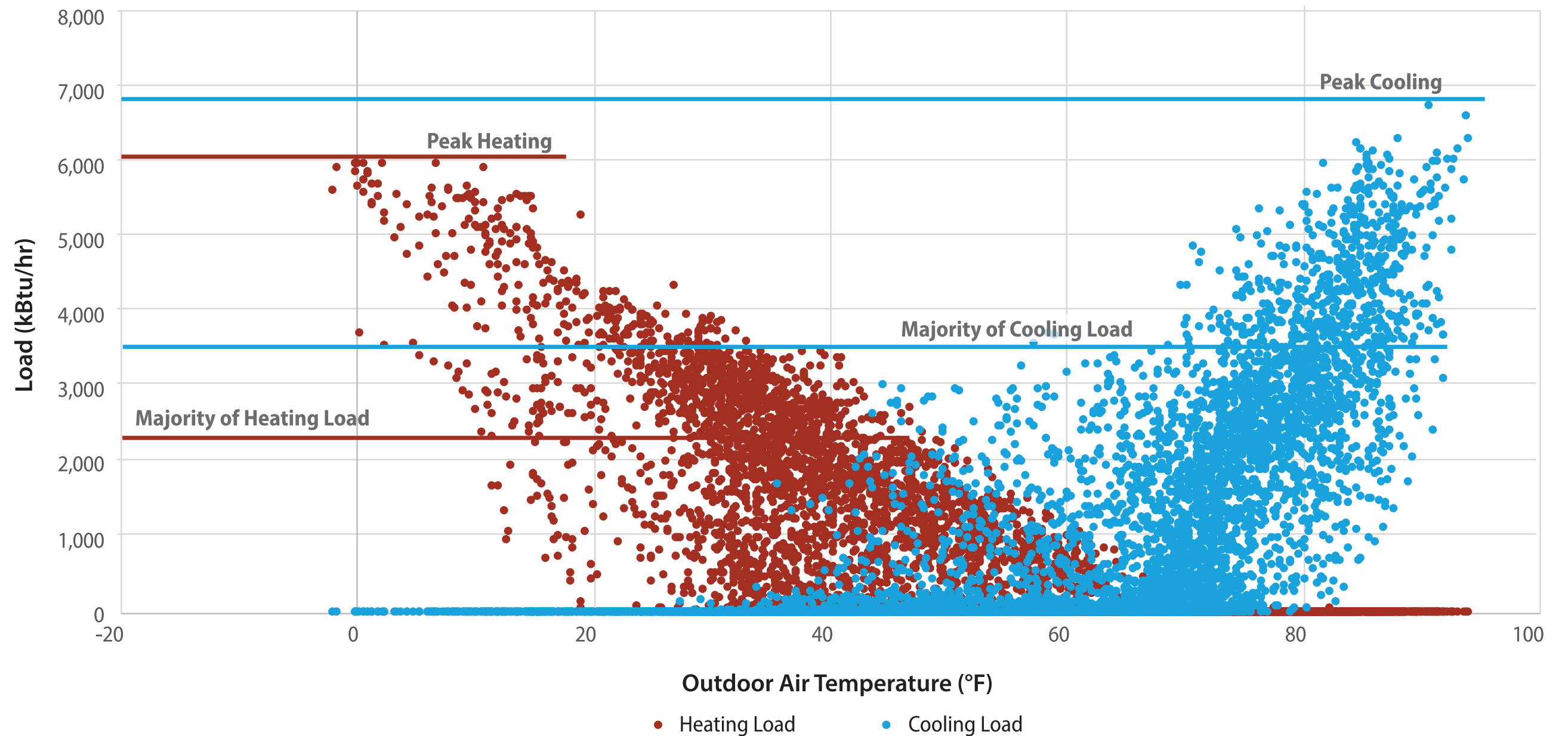

Figure 22. Example hourly building load vs. outdoor air temperature

Each circle in this graph represents the load at a given hour for each dry-bulb temperature. Looking at the graph, we can see that peak cooling and heating loads for the building are different, with the heating load being less than the cooling load. We can also see that the peak cooling and heating loads are much greater than the loads of the building that occur most of the time. This illustrates further that peak load sizing will leave equipment operating at part-load capacity most of the year, potentially resulting in the performance issues mentioned earlier. This can also be analyzed further by producing a load duration curve for both heating and cooling, shown in **Figure 23**.

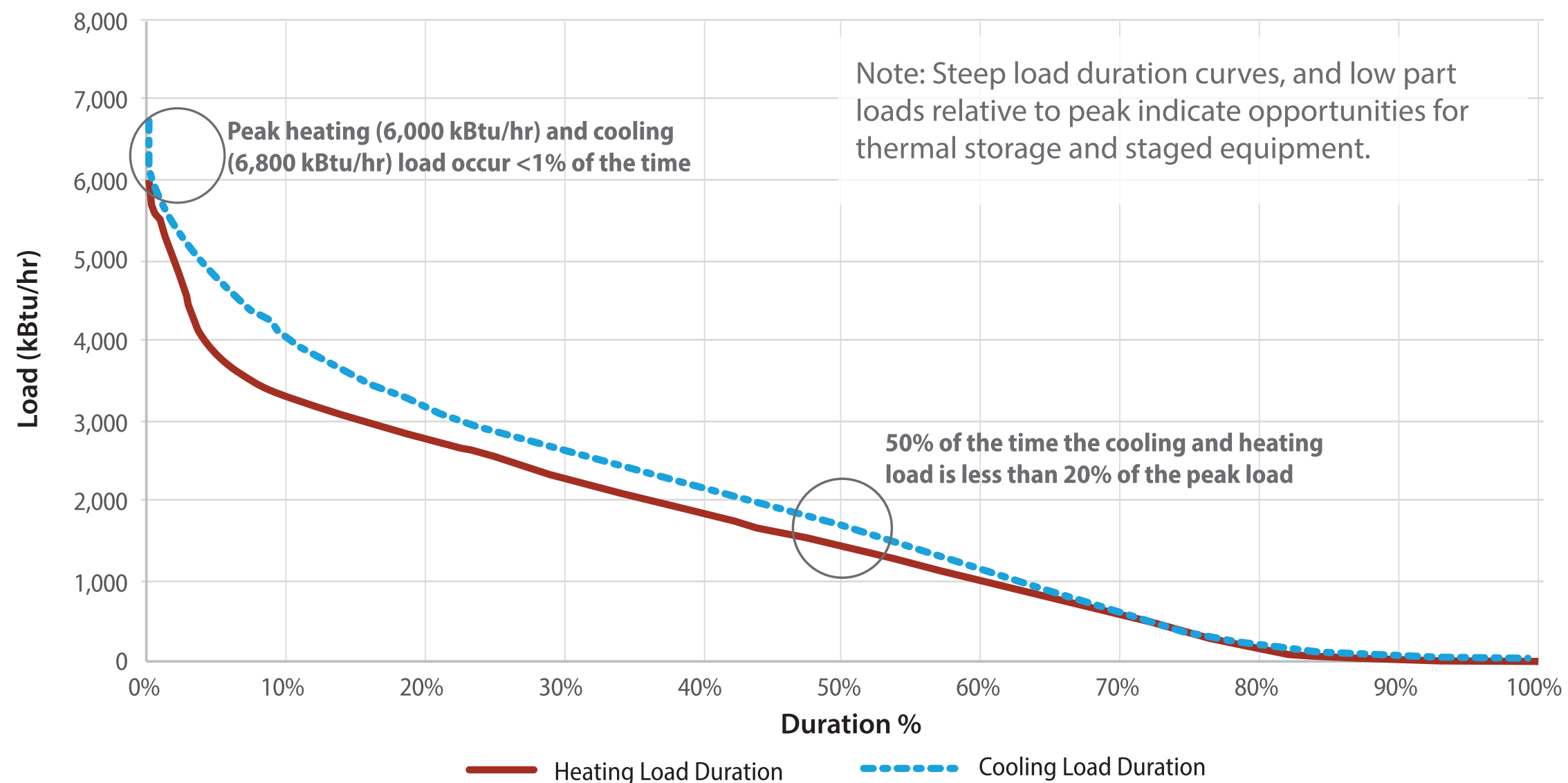

Figure 23. Example heating and cooling load duration

The load duration curves in **Figure 23** show the percentage of time a certain amount of load occurs. For this example we see that as the load increases, the percentage of time that load occurs reduces. As the load approaches peak, the curve becomes steeper, indicating that the peak or near peak load occurs for a short amount of time, in this case <1%. We can see in this example that for 50% of the time the load is less <25% of the peak load for both heating and cooling. For many buildings this type of duration curve is common. Understanding the profile of the building emphasizes the importance of sizing equipment not just for peak operation but also for part-load operation to help eliminate oversizing and short cycling issues discussed previously.

Select Equipment Size Based on Load Profiles

The next step in sizing a heat pump is to select the heat pump size and general system configuration. Utilizing the example above, the peak heating and cooling load ratio shows that the cooling load is the larger load in both peak scenarios and for most of the load hours. In this scenario, the heat pump could be selected to match the peak cooling of the system, but this would lead the heat pump to be potentially oversized in heating mode. If the heat pump is sized to provide peak heating load this could result in a unit that is undersized in cooling mode, potentially resulting in the building not meeting

comfort setpoints in peak load scenarios. Similarly, if the unit is sized for loads that cover the majority of the building loads, the unit will operate more efficiently during those partial load hours but could struggle during peak load scenarios.

To mitigate the tradeoffs between peak load sizing and partial load sizing, options including DOAS, staged equipment, and energy storage should be explored. Utilizing multiple pieces of equipment to provide heating and cooling has advantages. For example, if one piece of equipment is sized to meet most of the loads and a second auxiliary piece of equipment is used in tandem to cover the peak load scenarios, both efficiency and operation can be optimized for most of the year while having

the ability to meet peak loads without the drawbacks of an oversized heat pump. Similarly, thermal storage can be used to the same effect (more details on thermal storage are covered in section titled **Thermal Energy Storage**). If a piece of equipment is sized to meet 80% of the loads in the building, thermal storage can be used to cover the peak load scenarios as well as provide demand shifting capabilities. Further analysis should be performed to determine if energy storage will provide the ability to meet load hours based on the number of consecutive hours the building experiences above the equipment's capacity.

A useful example analysis is shown in **Figure 24**. By utilizing the peak heating load of the building at different outdoor air temperatures, the heat pump performance (in this case, air source) can be mapped as well as bin hours for the building loads. In this analysis, we can quickly compare the performance of heat pumps and different configurations as well as the amount of time a building operates at each outdoor air temperature and load. For this case, we are looking at multiple heat pumps, starting with one heat pump as the solid green line. Each further line represents an additional heat pump operating in parallel. In this configuration, all loads that cannot be met by the heat pump will be picked up by backup heat in the form of electric resistance, the existing natural gas system, or thermal storage. In this scenario utilizing two heat pumps will have the backup heat operating at ~25°F outside air temperature due to the capacity degradation of the air-source heat pumps. However, if a third unit is added, the heat pumps can cover all the heating load until ~15°F outside air temperature. Additional equipment increases cost and should be weighed against performance. Similarly, this type of analysis can be performed for the cooling system as well.

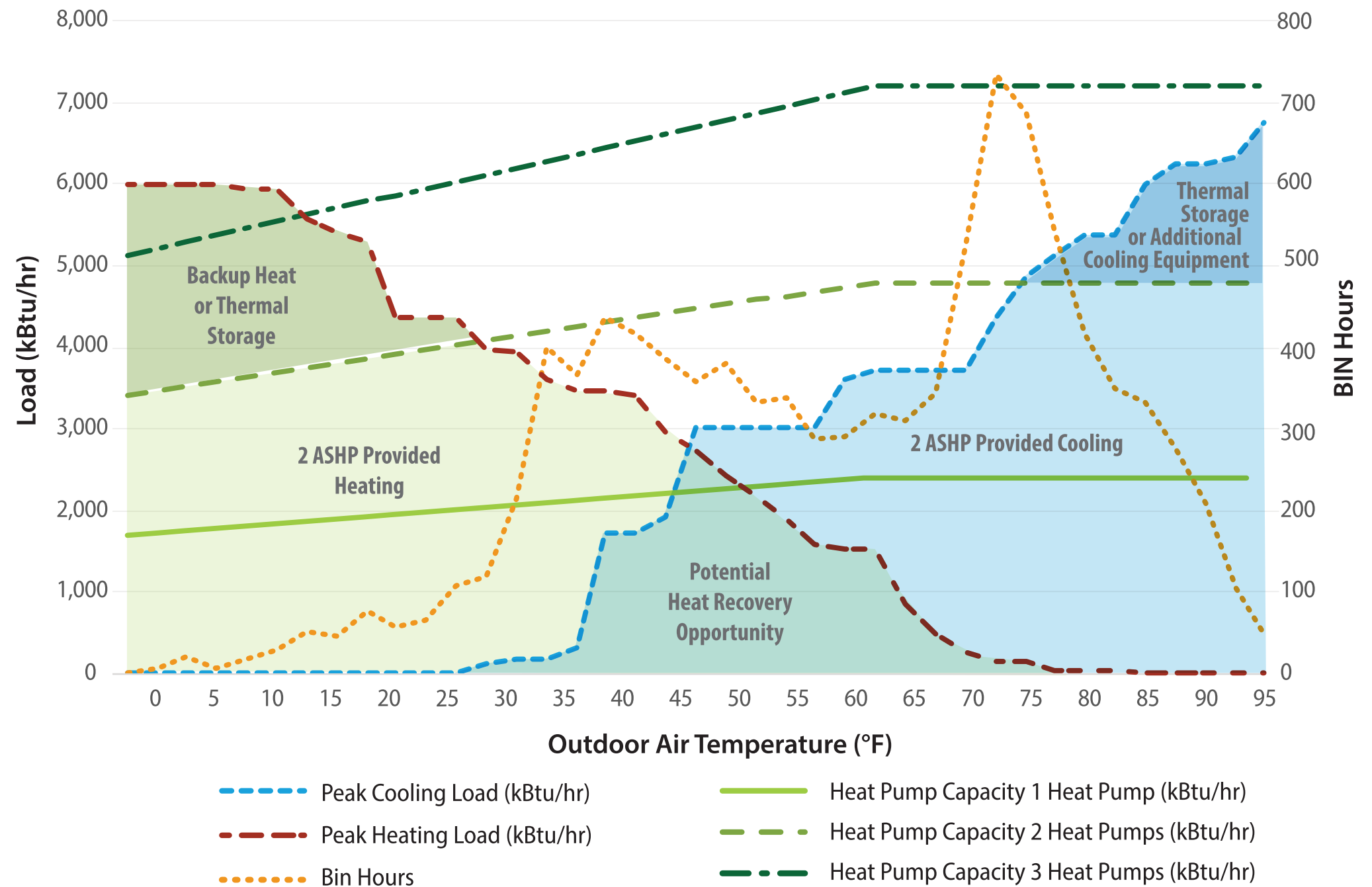

Figure 24. Example air-source heat pump sizing analysis

Backup Heat

Figure 24 illustrates how backup heat interacts with air-source heat pumps. In this example, two air-source heat pumps can provide ~3,300 kBtu/hr of load at -2°F outside air temp. In this case the backup heat or thermal energy storage only needs to provide ~2,700 kBtu/hr of capacity to meet the building loads at peak conditions. Looking at the bin hour line, <10% of the hours are spent at less than 10°F. This illustrates how for heat pumps that can operate at partial capacity at low outside temperatures, full backup heat sizing is not required and is a short-lived event. Similarly, given the relatively low operating hours of the backup equipment, utilizing existing natural gas equipment can help alleviate electrical capacity constraints and still significantly reduce on-site emissions.

Backup heat is an important part of air-source heat pump design, and a balance should be struck between costs, emissions, and additional equipment to meet the backup load requirements. For the above example, most of the heating load could be handled by three heat pumps, but this increases heat pump cost and footprint requirements significantly. By installing all-electric backup to meet 100% of the peak heating load a (~6,000 kBtu/hr) this would require ~1,760 kW of electric heaters. This would likely exceed existing electric capacity and make the project cost prohibitive, as well as be less efficient than a heat pump operating at a COP of greater than 1.

Water-source heat pumps have an advantage of not being subject to outdoor air temperatures but rather the water loop temperature they are connected to. In some cases this is an ambient loop that uses ground water or the soil to move heat into and out of the building. This water loop temperature is relatively stable and therefore does not result in the capacity degradation that we see for air-source heat pumps in the example above. By utilizing water-source equipment, backup heat becomes less of a concern. Assuming a flat performance curve of the heat pumps shown above, three heat pumps would be able to handle the entire building's heating load without any need for backup heat. When designing and sizing equipment, cost increase should be weighed against the

potential cost of additional equipment or backup systems and the performance and energy costs associated with each.

Thermal Energy Storage

Thermal energy storage is an approach that has been used for many years as a means to shift or level building loads. This can result in reduced primary equipment size and reduced building peak energy loads, resulting in cost savings for time-of-use or demand rate structures. Thermal energy storage for building comfort typically uses either water stored in a tank (like a domestic hot water heater) or ice. These storage vessels hold energy, and this energy is released in a controlled manner to effectively shift the energy load of the equipment.

For heat pumps, thermal energy storage can help mitigate performance issues at very cold outside air temperatures. By taking advantage of warmer outside air temperatures during the day, a heat pump can fill a thermal energy storage tank during periods of higher performance and capacity, and discharge the tank during colder periods when performance and capacity are lower. As mentioned above, this strategy can help reduce heat pump size as well as reduce the need for backup systems for heating. Thermal energy storage also has the added benefit of reducing short cycling of the equipment. By utilizing a thermal storage tank, the heat pump can operate at full capacity to charge the tank and then turn off during low load periods and use just the tank to provide heating or cooling to the building. This can help reduce the number of start cycles on the compressors, increasing the equipment life.¹

Sizing thermal storage is based on the goal of having thermal storage. Namely, is the goal to prevent short cycling, reduce equipment size and level out the building loads, or is the goal to shift building loads during on and off-peak hours? We will discuss these approach below. These approaches are not an exhaustive list; they provide a starting point for designers to implement energy storage. All designs should investigate optimal solutions based on size constraints, electricity rates,

carbon emissions, and equipment sizing. Given the incrementally low cost of additional storage tank capacity, oversizing storage tank capacity can also provide further flexibility in the event of future changes to building loads.

Minimum Tank Size for Short Cycling

The following equation discusses how to size thermal storage for a piece of equipment to prevent short cycling and improve equipment life. This is the minimum size of any thermal storage tank that should be used. This approach does not maximize any other benefits of thermal storage discussed or necessarily enable load shifting or load leveling strategies by itself.

HOW TO SIZE THERMAL STORAGE

Minimum Load_(TES Tank) (Btu)

=Minimum Equipment Load (Btu/hr)

*Minimum Equipment Cycle Time (hrs)

Assuming water (adjust if glycol or other medium is used)

$$lb_{\text{water}} = \frac{\text{Minimum Load}_{(\text{TES Tank})} (\text{Btu}) C_p (\text{Btu}/(\text{lb}\cdot^{\circ}\text{F}))}{\Delta T_{\text{System}} (^{\circ}\text{F})}$$

Where: $C_p = 1 \text{ Btu}/(\text{lb}\cdot^{\circ}\text{F})$

$$\text{Minimum Volume (Gal)} = (lb_{\text{water}}) / (8.34 \text{ lb/gal})$$

¹ More info on the use of thermal storage in energy-efficient buildings can be found at [NREL \(2023\)](#).

Load Leveling

Load leveling uses thermal energy storage to allow the heating or cooling equipment to provide a constant amount of heating or cooling throughout the day. Load leveling averages out the load in a building, both reducing peaks and valleys in building heating or cooling requirements and allowing for reduced equipment capacity. **Figure 25** shows the concept of building load leveling. The orange bars represent the building load over the course of a design day. For this particular example, the peak building load is ~6,000 kBtu/hr. If we use a thermal energy storage system sized to level the load of the building, the peak load of this building is ~4,750 kBtu/hr. This 4,750 kBtu/hr would be the capacity that the equipment would run at 24/7 on a similar design day. By utilizing thermal energy storage in this example, the equipment size can be reduced to 80% of a piece of equipment sized to meet the peak load. During days of lower load, the equipment can either run 24/7 at partial load or charge the tank and shutoff intermittently.

Figure 25. Thermal energy storage (TES) building load leveling approach

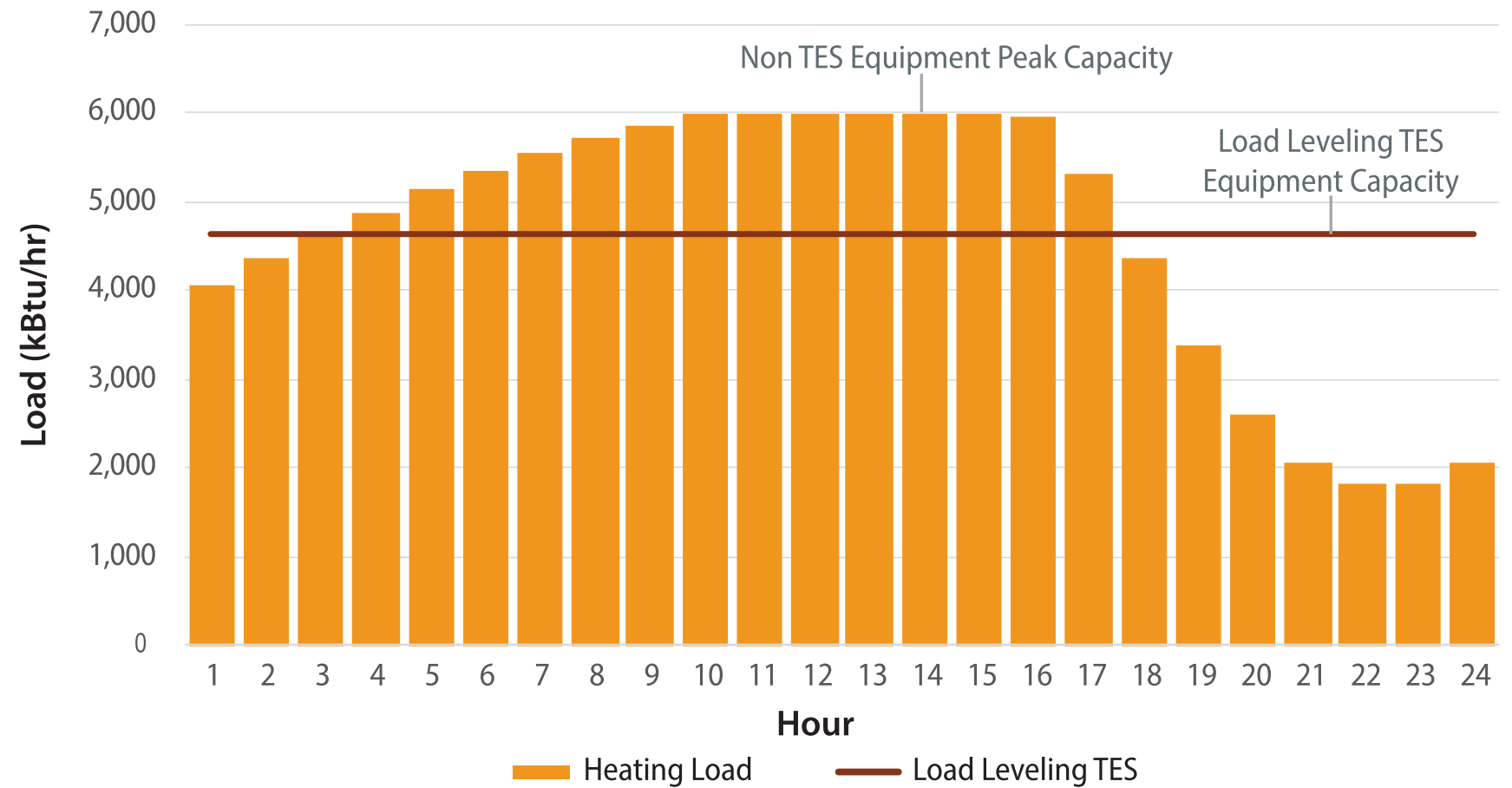

Load Shifting

Figure 26 show an example of the building load shifting approach of building energy storage. In this example the peak load of the building is also 6,000 kBtu/hr. The thermal energy storage is designed to allow the equipment to turn off completely during peak load hours, which is 12 hours per day, to help reduce peak demand of the equipment. In this configuration the equipment capacity is ~5,250 kBtu/hr. This approach does reduce the equipment size but not as much as the load leveling approach. However, this approach does allow the equipment to turn off each day even in a peak load scenario, which helps reduce runtime of the equipment compared to the load leveling approach even on design days.

Figure 26. Thermal energy storage building load shifting approach

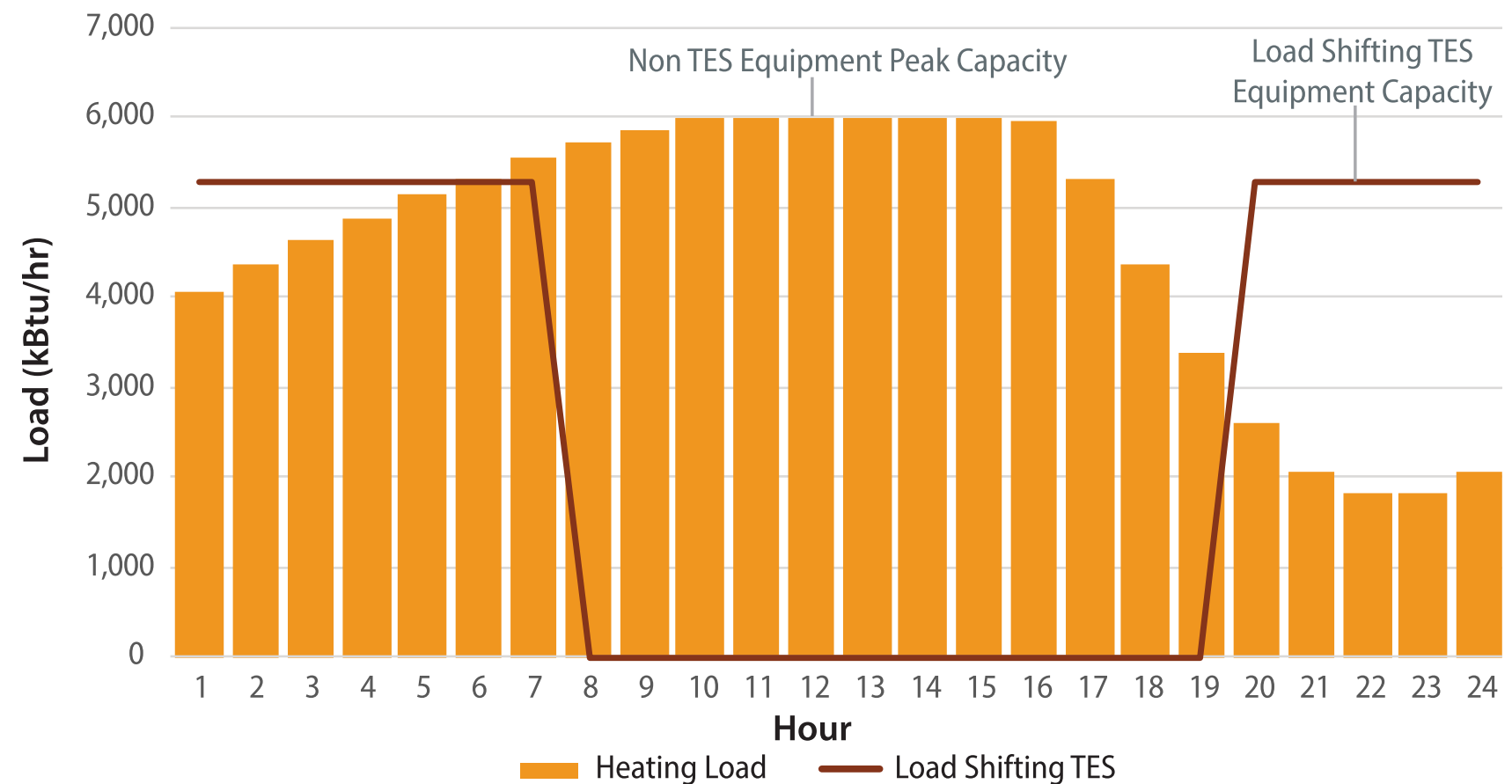

TANK SIZING

To size a tank to the load leveling or load shifting approach, the building load on a design day should be modeled like **Figure 26** illustrates. Once this has been done the total energy for the day should be summed as follows.

$$\text{Total Load Hours} = \sum \text{Load}_{\text{@Each Hour}}$$

Utilizing this Total Load Hours for the day should be averaged out over the period the equipment operates to get the average tons required for the building.

$$\text{Required Equipment Load}_{\text{Load Leveling}} = (\text{Total Load Hours}) / (24 \text{ Hours})$$

$$\text{Required Equipment Load}_{\text{Load Shifting}} = (\text{Total Load Hours}) / (\text{Total Hours Equipment Operates (HR)})$$

This required load is the load that the equipment will run during operating hour on a peak design day. The heat pump should be sized to provide this load for the full day. Next the thermal energy storage tank needs to be sized to hold this amount of energy. To size a tank to meet this load the following equations can be used:

$$\text{Total Load}_{\text{TES Tank}} \text{ (Btu)} = \text{Total Load}_{\text{Not Handled By Equipment}} \text{ Hours}_{\text{TES is needed}}$$

Assuming water (adjust if glycol or other medium is used)

$$m(\text{lb}_{\text{water}}) = \text{Total Load}_{\text{TES Tank}} \text{ (Btu)} / (C_p \text{ (Btu/(lb}\cdot\text{°F)}) \cdot \Delta T_{\text{System}} \text{ (°F)})$$

Where: $C_p = 1 \text{ Btu/(lb}\cdot\text{°F)}$

$$\text{Volume (Gal)} = m(\text{lb}_{\text{water}}) / (8.34 \text{ lb/gal})$$

This calculated volume is the volume of the tank needed to store the required energy for the building for either approach discussed above or for another approach that fits the project's needs.

Based on footprint constraints and load profile of the building, these approaches can be effective strategies to pursue. If needed, the thermal energy storage tank can be reevaluated to reduce the tank size at the penalty of larger equipment. If smaller tank sizes are selected the equipment will need to operate for more hours or at a higher load. Iterating on the tank size can help balance footprint and cost between tank and heat pump sizes as well as optimize performance requirements.

Intersection Tank Sizing

An approach that can be used when determining the tank size for a building is shown in **Figure 27**. If the heat pump and tank are designed to operate in tandem, much like the load leveling approach the analysis below can be used to help size both the tank and heat pumps with thermal energy storage. The red line represents a water storage tank heating capacity in (kBtu/hr) at a specified delta T (°F) of the water loop (18°F for this example). The green line represents the size of heat pump required to meet the designed point building load, assuming the thermal energy storage tank operates in parallel with the heat pump. In this example the reduced tank design meant installing a 5,000-gallon tank, which required ~5,250 kBtu/hr of heat pump capacity to meet the building load at the design point. The new design looked at balancing the energy between both the thermal energy storage and heat pump equally. This increased the tank size to ~18,000 gallons but reduced heat pump capacity requirements by 3,000 kBtu/hr. The slope of the minimum heat pump capacity line should be adjusted based on specific building loads on a design day, as the amount of flow required will adjust based on the load profile of each building. Final tank size and operation should be modeled to ensure building loads can be met with the proposed tank design.

The red line represents a water storage tank heating capacity in (kBtu/hr) at a specified delta T ($^{\circ}F$) of the water loop ($18^{\circ}F$ for this example). The green line represents the size of heat pump required to meet the designed point building load, assuming the thermal energy storage tank operates in parallel with the heat pump. In this example the reduced tank design meant installing a 5,000-gallon tank, which required $\sim 5,250$ kBtu/hr of heat pump capacity to meet the building load at the design point.

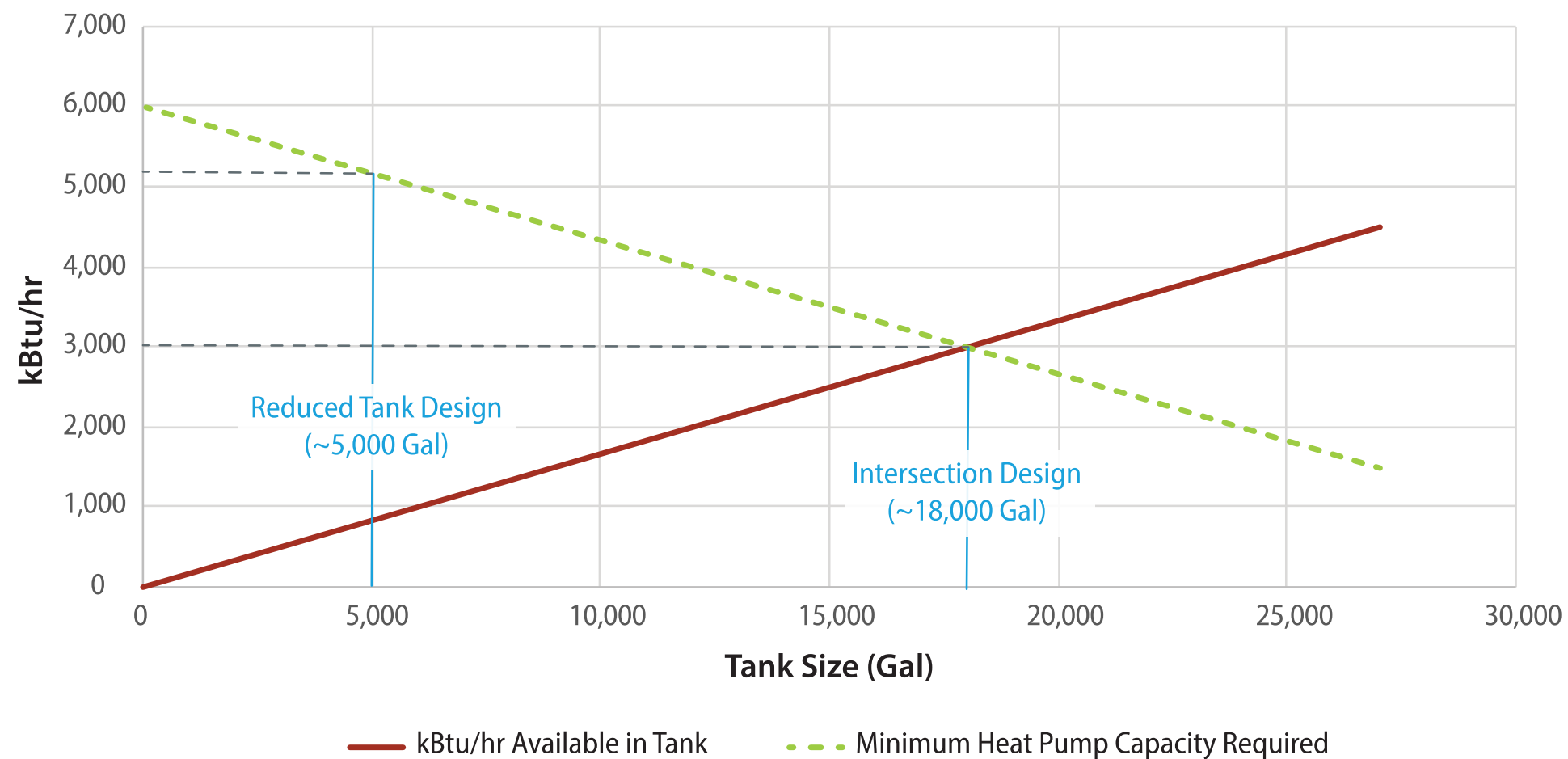

Figure 27. Heat pump size vs. thermal energy storage tank size example

Dedicated Outdoor Air Systems

DOAS are air handling equipment that temper and control outdoor air to a building. This system type is discussed in detail in **Distributed Systems + DOAS Architectures**. In the context of designing and selecting equipment, DOAS provides several benefits to system designers that should be considered. The primary advantage of DOAS equipment is that outdoor air can be controlled to the precise temperature that is needed. For mixed air systems, outdoor air is mixed with return air and tempered to the supply air temperature. In a DOAS, outdoor air is typically tempered to near space temperatures. This reduces the load on the equipment due to ventilation air not being cooled or heated past what is needed. Having a DOAS also provides the ability for return air equipment to turn off when cooling or heating is not needed. This eliminates the need for reheat in the HVAC system as outdoor air is supplied close to room temperature, which helps eliminate additional loads in the building. Another benefit DOAS systems provide is the ability to reduce equipment size. By splitting the ventilation and return air equipment, two pieces of equipment can be used which can provide the ability to have equipment that can handle lower turndowns and can reduce overall installed equipment capacity for the reasons mentioned above. This becomes even more beneficial for air-based equipment due to air-based equipment not being able to use energy storage or staged equipment like water-based equipment.

While DOAS systems have some advantages over mixed air systems there are some disadvantages to DOAS systems as well. DOAS system architecture can result in higher first costs and added system complexity because there can be more pieces of equipment to purchase and install. Similarly, for DOAS equipment care should be taken to ensure the unit can provide proper dehumidification because terminal equipment must be sized to manage the remaining dehumidification required for the space.

Simulate System Performance

Once the system size and general configuration have been determined, simulating the system's performance with this configuration is optional but recommended. Simulation should be performed utilizing an energy modeling software or other spreadsheet-based tool. By performing this simulation we can determine if the configuration can meet load requirements of the building and if setpoints can be maintained within an acceptable tolerance. This simulation can also provide information on the energy impact of the selected equipment and configuration as well as provide further confidence in the ability of the equipment to meet the building's load requirements.

Iterate on Design (Repeat Steps 1-5)

After completing the system selection and simulation, it is optional but recommended to iterate on the design to optimize the performance of the system. The iterative process may include repeating steps 1–5 as outlined in the previous sections, namely:

1. Determine the general system configuration
2. Run a load calculation for the building
3. Map hourly loads for heating and cooling
4. Select equipment size based on load profiles
5. Simulate system performance.

Further configurations should be explored, including but not limited to:

- Load assumptions, including design conditions and internal loads
- Weather data, e.g., projected climate data, ASHRAE Design Conditions
- Different equipment
- Equipment sizes

- Equipment quantity
- Equipment configuration
- Controls strategies to mitigate load (e.g., reduced setbacks, thermal energy storage, lighting)
- Building efficiency strategies to mitigate load (e.g., infiltration, envelope, lighting).

By analyzing multiple scenarios, system performance can be compared across multiple options, providing comparison and benchmarking points to determine which system type meets both the building load requirements but also other project-level constraints such as first cost, energy costs, space requirements, etc.



NREL researcher Matt Mitchell works with the new EnergyPlus API. EnergyPlus is a whole building energy simulation program that engineers, architects, and researchers use to model both energy consumption—for heating, cooling, ventilation, lighting and plug and process loads—and water use in buildings.

Photo by Dennis Schroeder, NREL 64223

Design for Minimum Supply Temperature

Supply temperature has a significant impact on heat pump efficiency, capacity, and equipment availability. Space heating systems installed prior to the 1980s typically prioritized lower building heat distribution system costs over operational costs, given the lower costs of heating fuels used in boiler systems at the time of construction (coal, fuel oil, and/or natural gas). Therefore, heat emitters distributed throughout pre-1980 building zones typically exhibit relatively small heat transfer emitter areas (poor heat transfer efficiency), while instead relying on high-temperature (>200°F) distribution networks to adequately meet loads.

Heat pump capacities and COPs are highly dependent on supply temperatures and heat source temperatures (outdoor air in air-source heat pumps, ground in ground-source, etc.).

Figure 28 demonstrates the general relationship between the COP, outdoor air temperature, and delivered supply water temperature in a typical air-source heat pump. As the outdoor air temperature drops, heat extraction by the heat pump becomes more challenging, and the efficiency of an air-source heat pump decreases. Moreover, increasing the delivered supply water temperature by the heat pump requires a larger temperature lift, which also decreases the heat pump efficiency. It is also important to note that the capacity of a heat pump is proportional to its COP, therefore the same relationships between outdoor and supply temperatures shown in **Figure 28** apply to the overall capacity of a heat pump.

In addition, heat pumps system availability typically becomes more limited as design supply temperatures increase. **Figure 29** qualitatively demonstrates the heating capacity, efficiency, and equipment availability of heat pumps as a function of supply water temperatures.

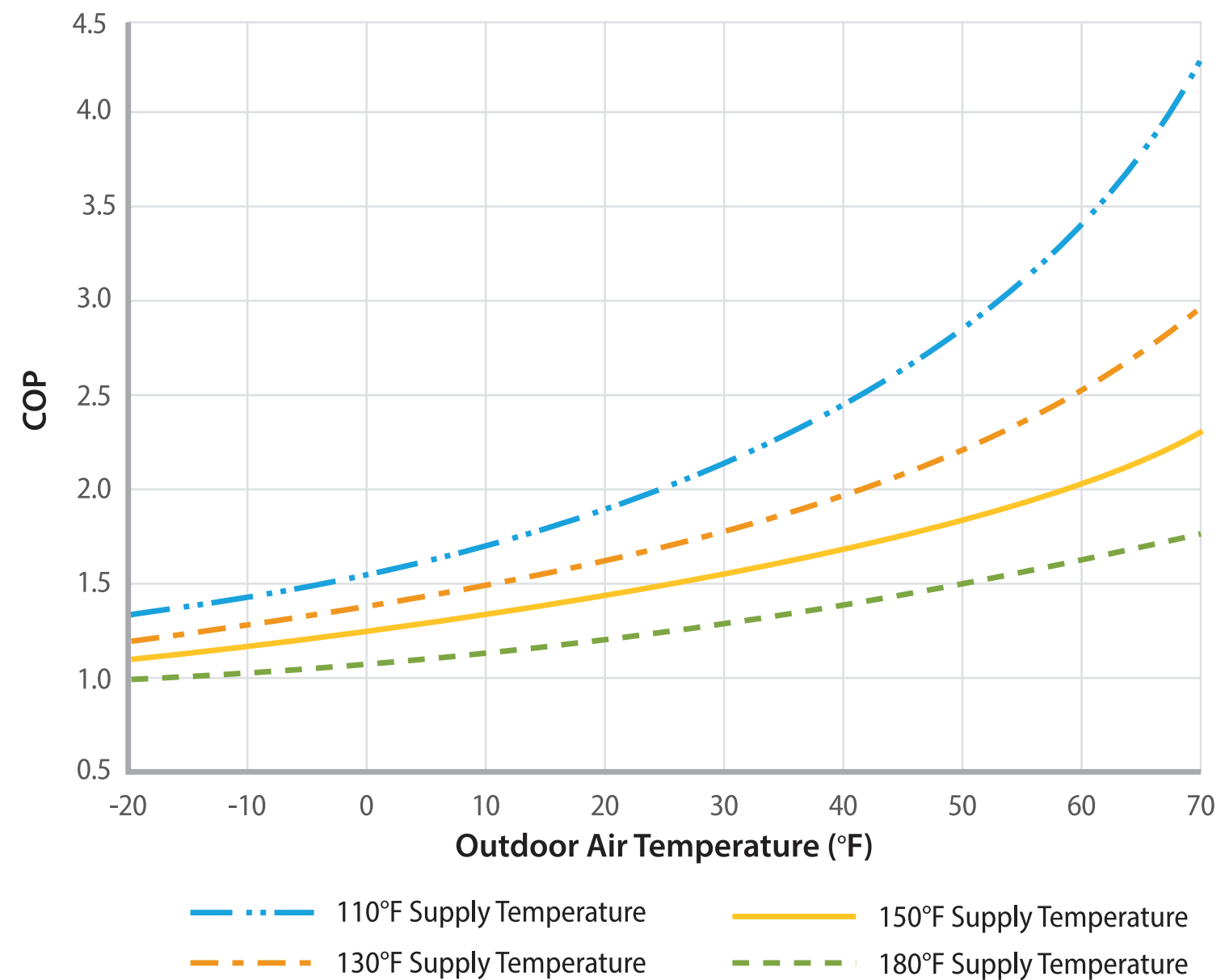

Figure 28. Typical relationship between outdoor air temperature, supply temperature, and heat pump COP

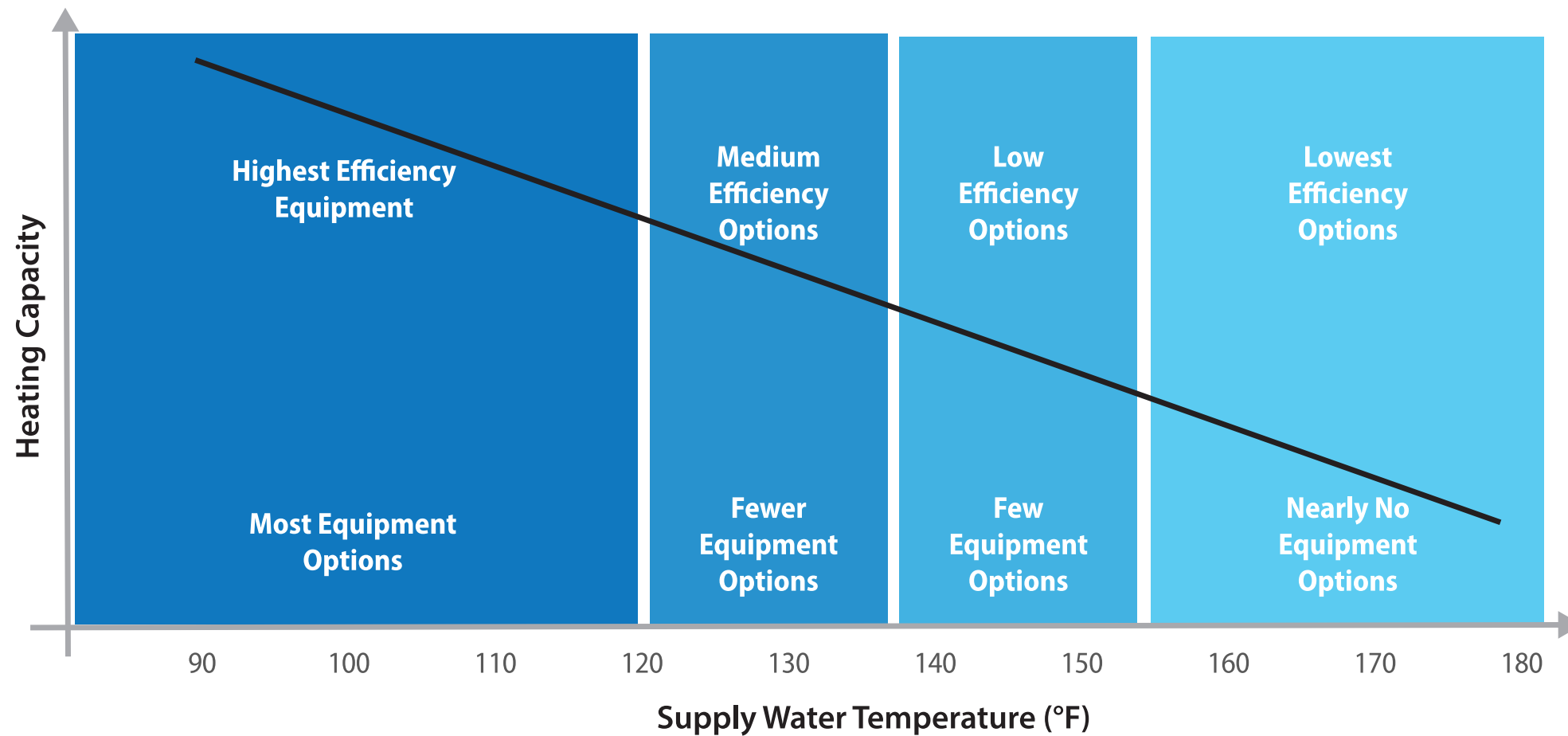

Figure 29. General relationship between heat pump heating capacity, efficiency, and equipment availability as a function of supply temperature

In summary, designing for minimum supply temperature is key to ensuring successful operation and mass adoption of heat pump systems. Minimizing the design supply temperature ensures higher operational efficiency, higher heating capacities, and results in more equipment options and availability to designers and building owners.

Options for Reducing Supply Water Temperature

Given the critical need to minimize supply temperature for maximizing heat pump operation efficiency, in the next few sections we describe approaches that can be used to minimize supply temperatures in building. The approaches are summarized in **Figure 30**, and include stress tests, building retrofits, adding more heat emitters, upgrading and/or adding fan coil units, integrating outdoor air reset controls, configuring heat emitters to operate in parallel relative to the heat source (if this is not the case already), and considering a combination of all the methods that maximum heat pump performance while minimizing cost.

Thermally Stress Test the Building

Many existing heating systems are oversized for the loads in the space and can have their supply temperatures reduced while still meeting building loads. By stress testing a building, the actual building loads and minimum supply temperature of the existing systems can be determined, leading to efficiency gains in the short term and inform potential heat pump retrofit solutions. For more information on thermal stress testing and the procedure for effectively stress testing a building please see section **Thermal Stress Test the Building**.

Reduce Building Load

Building thermal envelope enhancements, such as reducing air leakages (infiltration rates) and improving insulation (R-values) for exterior walls, roofs, windows, and doors can reduce the heating load and the required heating supply temperatures to maintain occupant comfort. To demonstrate the impact of envelope improvements on heat capacity requirements,

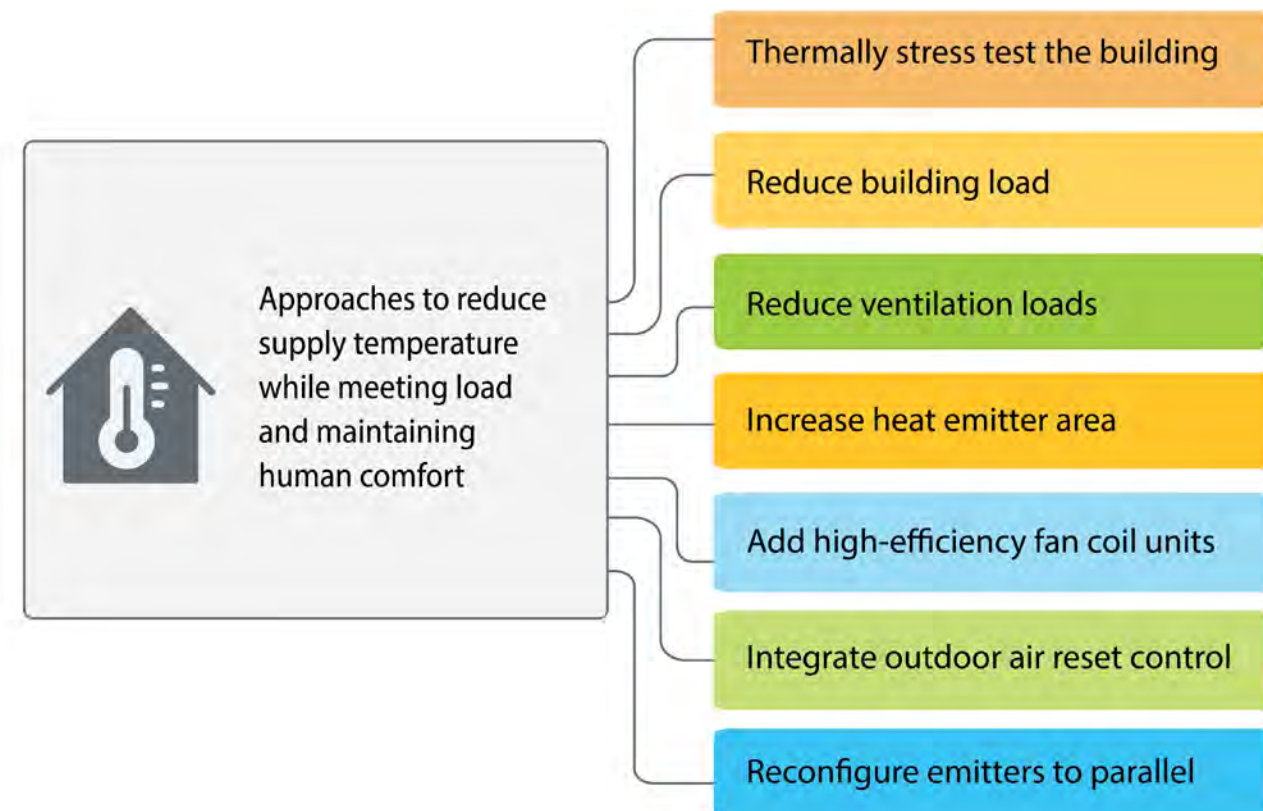

Figure 30. Options for reducing supply temperature

we used the 2010 vintage, DOE Office Prototype office building model. For this model, heating capacity reduction was parametrically calculated for various exterior wall R-values. The results of the parametric analysis are shown in **Figure 31**.

Upon envelope improvements and/or building energy efficiency measure implementations, several heating load calculation approaches could be leveraged to calculate the new heating load of the building. Options include the heat balance method, the radiant time series method, and the ACCA manual J for residential applications (ASHRAE, ASHRAE Handbook - Fundamentals, 2021).

**Heating Capacity Reduction vs. Exterior Wall R-Value
2010 Medium Office Prototype, Climate Zone 5B**

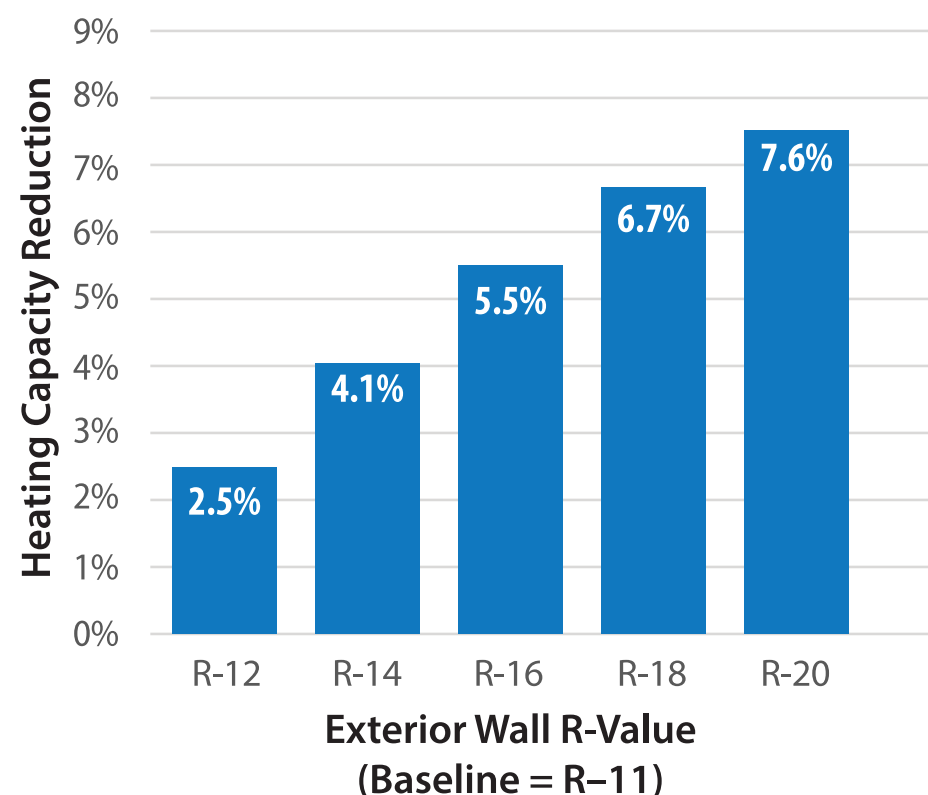

Figure 31. Impact of envelope improvements on heat capacity reduction on the 2010 vintage DOE Office Prototype building model

operational changes have reduced the number of occupants, thereby reducing the required ventilation and associated building load. Most exhaust air has historically been exhausted to the atmosphere. The exhaust air is typically close to the building internal temps and provides a source of useful heat or cooling for the incoming ventilation air. By utilizing energy recovery ventilators (ERV) or heat recovery ventilators (HRV), this heating or cooling energy can be recovered for tempering the incoming ventilation air, reducing ventilation loads and equipment size. Where possible, ventilation loads should be separated from heating and cooling loads by deploying a DOAS. This will reduce the capacity needed by heat pump systems to meet heating and cooling loads. Similarly, using

demand control ventilation to adjust ventilation rates in response to occupancy will also help reduce ventilation loads in the building. By reducing ventilation loads, heat pumps can operate at a lower temperature, improving the efficiency of the heat pump and reducing equipment size.

Increasing Heat Emitter Area

If the existing building leverages radiant heating emitters, then adding additional surface area will increase the heat output supplied by the emitter, and hence reduce the needed supply temperature at design load.

ESTIMATE REDUCED DESIGN SUPPLY WATER TEMPERATURE

The reduced design supply water temperature at design conditions can be estimated through an energy balance, assuming no change in heat emitter area, piping, and configuration, through the equation below (Caleffi, 2019):

$$T_{\text{new supply}} = T_{\text{indoor}} + Q_{\text{new}} / Q_{\text{existing}} (T_{\text{existing supply}} - T_{\text{indoor}})$$

This could be used as a starting point to understand reduced design supply temperature needs as a function of building load reductions through energy efficiency measures. For more detailed assessments, the manufacturer’s heat emitter specifications should be leveraged in the design process.

Reduce Ventilation Loads

As discussed in **Chapter 1: Introduction**, ventilation loads in buildings account for large portion of the overall load. When looking at existing buildings, occupancy type and operation might have changed, resulting in less required ventilation air per building codes. For example, a building might have originally been designed for large occupancy but renovation or

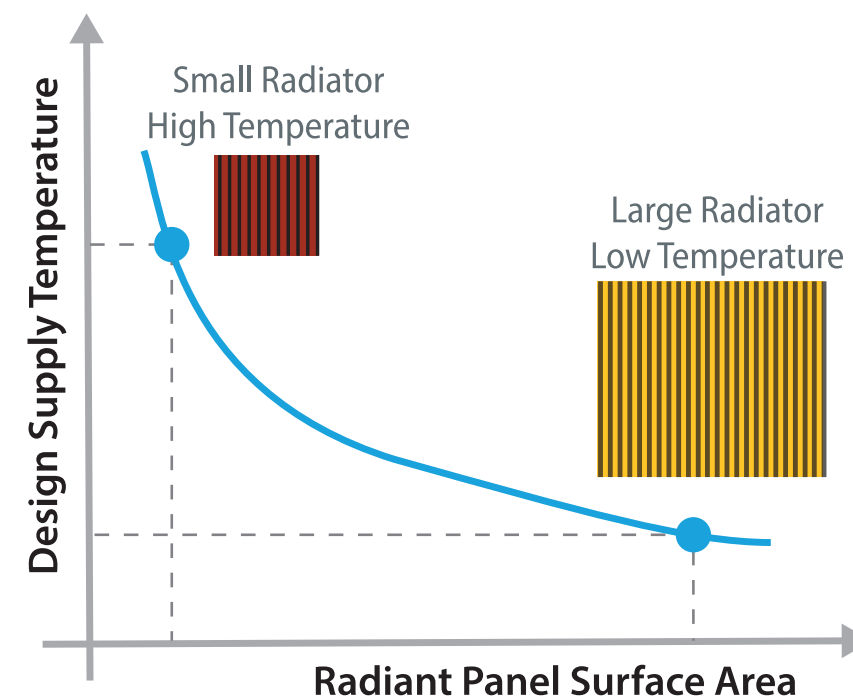

Figure 32. Qualitative relationship between design supply temperature requirements and radiant panel surface area to meet design loads

RADIATION AND NATURAL CONVECTION

The primary modes of heat transfer from radiant heat emitters are radiation and natural convection. An empirical equation for the heat flux from thermal radiation is shown in the equation below.

$$q_r = 0.15 \times 10^{-8} [(t_p + 459.67)^4 - (AUST + 459.67)^4]$$

Where,

$$t_p = \text{effective panel surface temperature, } ^\circ\text{F}$$

AUST = area weighted average temperature for all indoor surfaces (excluding panel surface)

Natural convection heat flux between a heated floor or cooled ceiling surface and indoor air can be estimated using the heat flux equation below:

$$q_c = 0.26 |t_p - t_a|^{0.32} (t_p - t_a)$$

We can approximate the total heat flux from a radiant panel by combining both natural convection and radiation heat flux, as shown below:

$$q_{\text{total}} = q_r + q_c$$

Equating the total heat delivered by the panel with the building design load, using the equations above, one can solve for the required design supply temperature that satisfies the design load of the zone. A parametric plot of the combined equation is shown in **Figure 33** and can be leveraged to approximate the design supply temperature at design conditions, and the tradeoffs between design load reductions, emitter area, and supply temperatures that are needed to meet the heating load and maintain occupant comfort within a zone. Several curves are plotted that reflect multiple increases in emitter area compared to a baseline case. As shown, increasing emitter area and reducing heating load can both contribute to a lower supply temperature, and can be used in combination to meet design requirements that align with heat pump availability, maximum heat pump COP, and minimum total building retrofit costs.

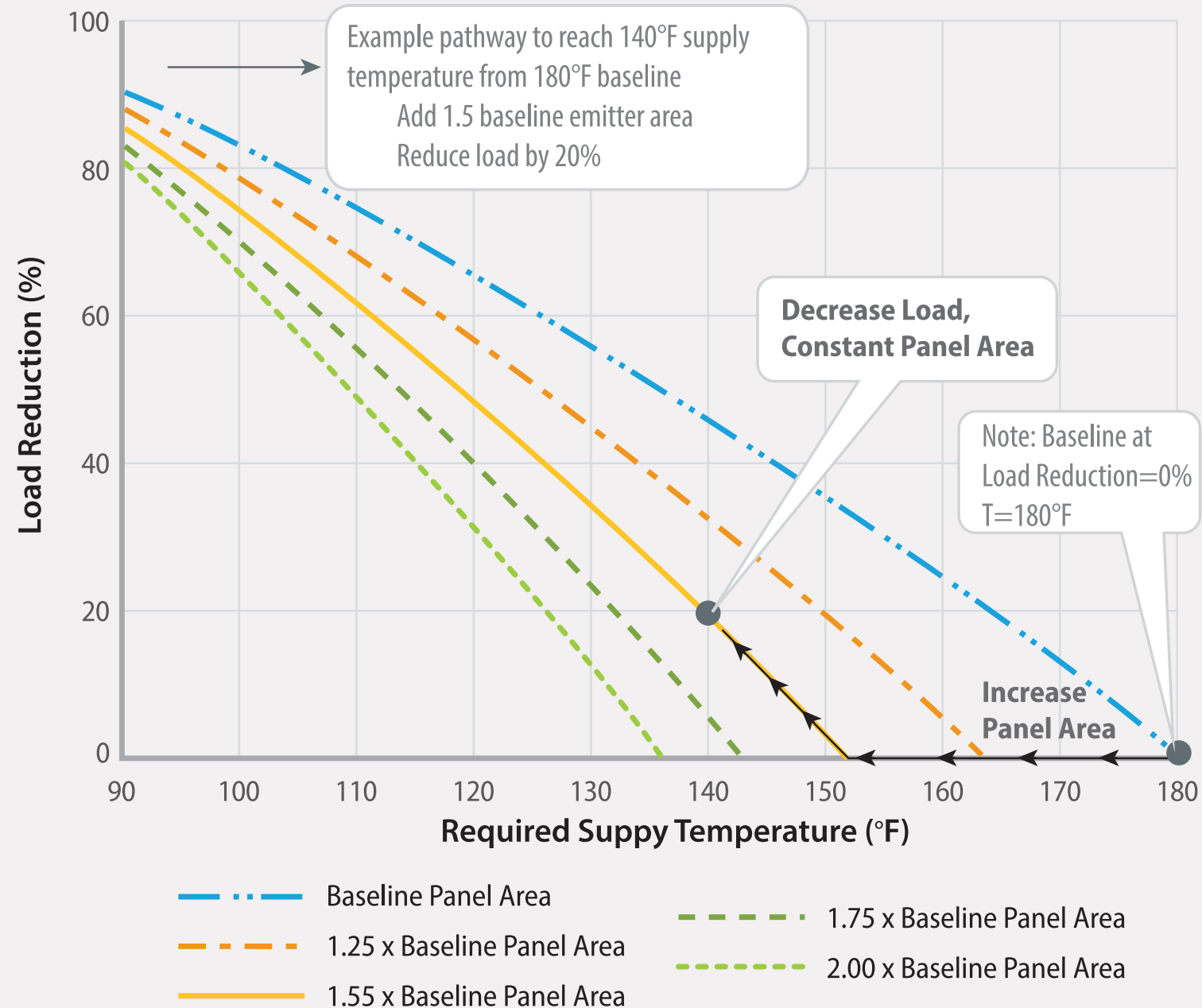

Figure 33. Example of combined impact of load reduction and increases in emitter area on supply temperature requirements to meet load for a baseline building with 180°F supply temperature

Add High-Efficiency Fan Coil Units

Fan coil units leverage forced convection heat transfer to increase the heat output of an emitter, and are especially useful when available space is limited. Fan coil units can output as much as 20 times the heat output per area compared with fin-tube baseboard heaters. Similar to the relation of supply temperature to heat emitter area for a radiator, the supply temperature of a fan coil can be reduced, while maintaining the same heat output, by increasing the number of tube passes, and hence the total surface area of the coil. Fan coil manufacturers typically offer specs and a variety of options on the number of coil passes for designers to choose from. Designers should generally aim to maximize the number of coil passes to reduce required supply temperature needs, resulting in higher heat pump performance, while minimizing the total cost of the system upgrade. Designers should closely review the potential increase in pressure losses and associated pumping power when considering the optimal design that minimizes overall system energy consumption. A schematic illustrating the relationship between number of coil passes and supply temperature is shown in **Figure 34**.

Implement Outdoor Air Reset Controls

Outdoor air reset controls are a type of control system used in heating and cooling systems. They work by adjusting the temperature of the heating or cooling supply based on the outdoor air temperature. Implementing outdoor air reset controls enables heat pump systems to operate at lower supply heating temperatures at partial heating load conditions, which can increase the system's efficiency and reduce overall energy and power consumption.

At partial heating load conditions, the heat pump system doesn't need to work as hard to maintain the desired indoor temperature. By implementing outdoor air reset controls, the supply heating temperature can be lowered, which reduces the temperature difference between the outdoor air and the supply heating temperature.

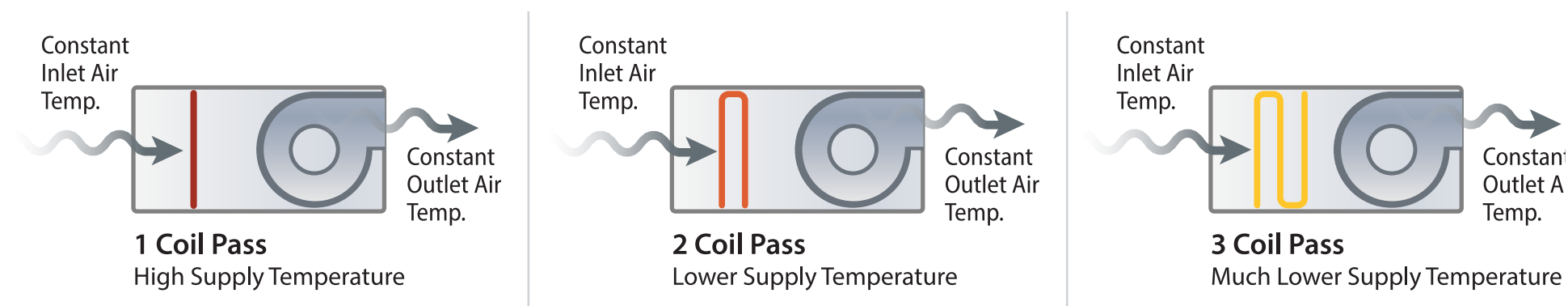

Figure 34. Schematic illustrating the relationship between number of coil passes and supply temperature

This means that the heat pump system can operate at lower temperatures and still provide enough heat to maintain the desired indoor temperature. Operating at lower temperatures can increase the efficiency of the heat pump system, as it reduces the amount of work required to extract heat from the outdoor air.

In summary, implementing outdoor air reset controls helps to lower supply heating temperatures at partial heating load conditions, which enables heat pump systems to operate at lower temperatures, increases efficiency, and saves overall energy and power consumption.

Ensure Parallel Distribution to Heat Source

Connecting a hot water distribution system in a building to meet heating loads through radiators and/or fan coil units in parallel to the hot water tank supplied by a heat pump is more effective and efficient than connecting them in series because:

- 1. Parallel connection increases heat transfer:** When radiators and/or fan coil units are connected in series, the exit temperature of one radiator is the inlet of the next. Therefore, downstream radiators/fan coils will receive lower temperature inlet conditions, reducing the overall the heat output of the system. In contrast, when connected in parallel, each unit receives the same temperature, allowing for greater heat output.

- 2. Parallel connection allows for independent control:**

When connected in series, the entire system must be controlled as a single unit, making it difficult to adjust the output of individual radiators or fan coil units. In contrast, when connected in parallel, each unit can be independently controlled, allowing for more precise temperature control and energy savings.

- 3. Parallel connection increases system reliability:**

When radiators and/or fan coil units are connected in series, if one unit fails or becomes clogged, it can impact the entire system, resulting in a loss of heating. In contrast, when connected in parallel, if one unit fails or becomes clogged, it only affects that specific unit, allowing the rest of the system to continue functioning.

Overall, connecting radiators and/or fan coil units in parallel to the hot water tank supplied by a heat pump is a more effective and efficient configuration due to its ability maximize heat transfer by the distribution system, allow for independent control, and increase system reliability.

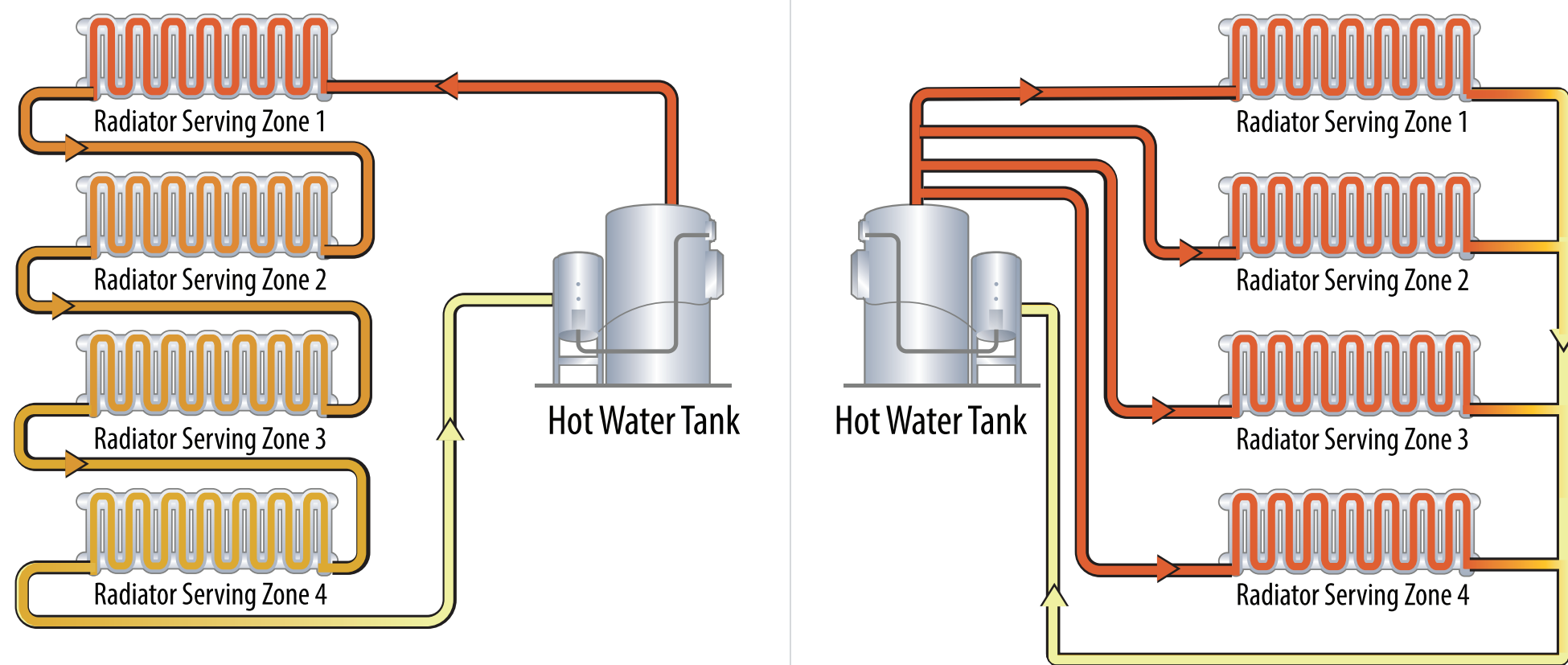

Figure 35. Illustration of series (left) vs. parallel (right) hot water distribution system in a building to meet heating loads through radiators and/or fan coil units

Risks of Oversizing Equipment

When sizing a heat pump, oversizing is a serious concern. Oversizing occurs when equipment is selected at a capacity that is greater than the building peak cooling/heating load or does not have sufficient ability to manage part-load operation that occurs during the majority of the year. The risks associated with oversizing of equipment can be divided into operational issues and cost issues.

Operational Issues

When equipment is oversized, building loads can be below the minimum operating capacities of the equipment, resulting in issues that impact the operation of the equipment. The

primary issues include low load cycling, purge cycling, reduced temperature control, and reduced dehumidification.

Low Load Cycling (i.e., Short Cycling)

Low load cycling (short cycling) occurs when minimum capacity of the heat pump exceeds the heat and cooling load of the building. The heat pump is providing or removing more heat than is required at that time which causes the heat pump to start and stop to prevent overcooling/overheating the space. This constant cycling of the compressors results in reduced energy performance, and increased wear and tear on equipment due to increased number of starts. This constant cycling is exacerbated by the fact that heat pumps operate

both during heating and cooling seasons which can increase the amount of time equipment short cycles throughout the year.

Purge Cycling

Frequent low load cycling can result in a purge cycle being required by the compressor. When there is low load in the building an oversized system can't turndown properly, which can result in refrigerant that does not completely evaporate. This liquid can damage the compressor of the heat pump. To prevent this damage, the equipment will enter a purge cycle to move this liquid to prevent it infiltrating the compressor. During this cycle the equipment cannot provide any heating or cooling, which can result in reduced occupant comfort. Additionally, the equipment uses energy for this purge cycle that does not result in cooling or heating, which reduces the overall efficiency of the equipment.

Reduced Temperature Control

When a unit is experiencing low load cycling, temperature control is reduced. When the unit turns on to meet setpoint at low loads, the unit is providing more cooling or heating than is required due to improper turndown. This can result in the unit overcooling or overheating the space before it shuts off again. This can result in poor occupant comfort, which is experienced at the low loads during much of the year.

Reduced Dehumidification

During cooling mode, heat pumps dehumidify the air. This process requires the equipment to operate for an extended period of time to sufficiently dry out the air and maintain indoor air humidity requirements. Due to the reduced runtime of oversized systems, as a result of low load cycling, the air will not sufficiently dehumidify and indoor air quality will be reduced.

Cost Issues

Cost issues that arise from oversizing impact both the first cost of the project but also the ongoing operational costs of running the equipment. By properly designing and sizing equipment the following costs can be mitigated, and overall project return on investment can be improved.

Equipment Cost

Larger capacity heat pumps are more expensive than lower capacity heat pumps, which means unnecessarily higher first costs. Larger equipment can also result in increased installed cost due to additional equipment, increased structural requirements, larger building penetrations, etc. By rightsizing equipment, upfront costs can be reduced.

Energy Consumption and Cost

Oversizing equipment can result in higher operational costs and increased energy consumption. Like most equipment, heat pumps are least efficient during first starting up. Similarly, each time a heat pump stops there is refrigerant/water/air in the distribution systems that does not reach the terminal point, resulting in wasted energy. When oversized short cycling results in more frequent starts and stops, this means reduced equipment efficiency and increased energy consumption and costs.

Shorter Equipment Life

Start cycles for most equipment, including heat pumps, is rough on equipment and should be minimized. Short cycling increases the number of starts on a heat pump, which increases wear and tear on the equipment and can lead to premature failure of equipment. This means increased maintenance costs or potentially replacement sooner than rightsized equipment.

References

ASHRAE. 2021. *ASHRAE CLIMATIC DESIGN CONDITIONS 2009/2013/2017/2021*. <http://ashrae-meteo.info/v2.0/>.

ASHRAE. 2021. *ASHRAE Handbook - Fundamentals*. <https://www.ashrae.org/technical-resources/ashrae-handbook/description-2021-ashrae-handbook-fundamentals>

Caleffi. 2019. "Lowering Water Temperature in Existing Hydronic Heating Systems." *Journal of Design Innovation For Hydronic And Plumbing Professionals*. <https://idronics.caleffi.com/magazine/25-lowering-water-temperature-existing-hydronic-systems>

DOE. 2002. International Measurement and Verification Protocol, Concept and Options for Determining Energy and Water Savings. DOE/GO-102002-1554. <https://www.nrel.gov/docs/fy02osti/31505.pdf>.

NREL. 2023. "Exploring Thermal Energy Storage Solutions for Energy-Efficient Buildings." National Renewable Energy Laboratory. <https://www.nrel.gov/news/program/2023/exploring-thermal-energy-storage-solutions-for-energy-efficient-buildings.html>.

CHAPTER 4: RETROFIT APPLICATIONS



The Kiowa County Courthouse was one of the few buildings to survive the tornado in Greensburg, Kansas. The renovation includes several energy-efficient strategies, such as daylighting and ground-source heat pumps.

Photo by Lynn Billman, NREL 17554

When looking at retrofitting a building's existing mechanical system, many designers and owners will follow the path of least resistance and look for like-for-like replacements with new code-minimum equipment, or newer technologies that follow the same sizing. This poses risks for heat pumps and overall building performance. Sizing a heat pump solely based on existing equipment sizes can compound issues with existing designs such as oversized cooling, poor controls schemes, inefficient equipment layout, and heating that will perform poorly in the winter, resulting in excessive backup heat. These issues can lead to worse performance and inefficient operation of the building. When looking at retrofitting a building with a heat pump, a whole-building perspective and a detailed analysis will allow for integrated solutions that will optimize heat pump performance and create a successful heat pump project. In this section, we discuss the steps in evaluating an existing building for heat pump retrofits, strategies to explore to help implement heat pumps effectively, and some sample building retrofit scenarios.

Use a Phased Approach

For smaller buildings, or those without the necessary resources to prepare for a longer-term solution, decarbonization may start with a significant equipment failure or end-of-life in the heating or cooling system that requires a replacement. Given time pressure constraints to bring the system back online, and the lack of data and/or engineering support to holistically look at a robust decarbonization strategy, a phased approach may be more appropriate. The goal of this approach is to move buildings on a pathway that starts toward decarbonization and enables future upgrades that result in full decarbonization. The first step in the phased approach is important, because selecting equipment types that help move the building toward decarbonization helps eliminate a large portion of on-site emissions in the short term, but also enables deeper retrofits and decarbonization strategies in the future to further decarbonize the building. Examples of the first step in this phased strategy may include:

- For smaller buildings, focus on solutions that sufficiently solve the initial problem (air conditioning, heating, hot water, etc.) to give time to do the full optimization to the building (such as envelope improvements or evaluation of

solar options to minimize system requirements) and fully leverage available utility rebates and grants.

- › This can look like replacing the equipment with heat pump equivalent technology. For example, if the existing air conditioner breaks, install a heat pump that can provide both heating and cooling, reducing runtime and reliance on fossil fuel systems.
- Use off-the-shelf solutions where possible to reduce engineering and other costs, especially in smaller buildings and residential structures. A mix of a smart, central DOAS heat pump with energy recovery and decentralized heat pumps and/or cooling units tends to be a very efficient and cost-effective solution for many building types. See the section on **Distributed Systems + DOAS Architectures** for more information on this system type.
- Optimize the central system capacity and overall system efficiency by separating air quality/ventilation/humidity control from sensible control (i.e., DOAS with return air-only equipment). This allows for some splitting of loads between equipment by delivering preconditioned air with an energy recovery-coupled heat pump and return air equipment operating at conditions that still require

some sensible heating or cooling, and can result in overall smaller equipment sizing.

- Use existing heating systems temporarily for peak demand while their replacement is being planned.
- Prepare for central heating system replacement with decentralized split systems. This may allow for use of the new heat pumps for the majority of the year and existing fossil fuel-based central systems used for peak heating demand control only. In time, optimizations to the building (such as envelope improvements) or controls may preclude the need for the carbon-based peak system, which can then be decommissioned.
- If existing distribution systems (radiators, heating coils, etc.) are sized for a high-temperature hot water (>160°F), replace these systems with equivalents that are sized for lower-temperature supply temperatures (<140°F) to enable future heat pump replacements.
 - › These replacements can happen periodically as equipment failure, routine replacement, or maintenance is required without impacting existing heating equipment.

When looking at retrofitting a building with a heat pump, a whole-building perspective and a detailed analysis will allow for integrated solutions that will optimize heat pump performance and create a successful heat pump project.

A phased replacement strategy gives time for decision makers to plan the next steps and review options for load reduction, ventilation management, smart controls, and optimal system choices without having to fully replace all systems at once. Additionally, during this time multiple bids can be reviewed regarding the full replacement of the current carbon-based heating system, providing more insight into what capital expenses would be required in the future and how best to

leverage utility and federal incentive programs to offset those costs. The next steps can also be phased in a way to spread project costs over a longer period. For example, envelope or other load reduction upgrades can be timed to coincide with larger building changes. For example, when normal maintenance such as roof replacements occur, additional insulation can be added, which can combine project costs as well as not prematurely remove things like roof membranes before the end of their useful life. This could also be done at times of deeper renovations to interiors such as tenant changeover to minimize detrimental downtime from improvements such as additional wall insulation, window replacements, lighting, etc. By installing a partially decarbonized solution in the first step of this phased approach, these deeper load reductions will improve the capability of the decarbonized solutions to cover more of the building loads and improve the overall system efficiency.

Collect Project-Level Information

When evaluating a building it is helpful to work top down, from high-level project information down to the detailed information about how the building operates. Before any on-site/ detailed investigation occurs, the team should collect information about the building type and overall size. This will give the team a general understanding of what kinds of things they can expect to see in the building in terms of level of effort during the investigation phase, as well as establish an energy use intensity benchmark, such as ENERGY STAR Portfolio Manager, for the building to compare the building's efficiency to similar buildings. This benchmark can inform the project team as to how poorly the building is currently performing and determine if deep energy retrofits will be necessary. Next the team should understand the climate of the building. This will include understanding typical winter temperatures as well as design extremes to better understand the importance of cold weather design for the heat pump. Finally, the team, if possible, should gather building electrical information including energy use, peak load, advanced metering infrastructure data for electrical trends, as well as the capacity of the existing electrical infra-

structure on-site. Having this electrical information will inform the project team of any electrical constraints upfront from an installation perspective, as well as inform the team of the building performance and trends.

When evaluating a building it is helpful to work top down, from high-level project information down to the detailed information about how the building operates.

Evaluate Existing Building Conditions

After determining high-level information about the site, deeper investigation should be performed to understand the existing non-mechanical systems at the site. Accurate evaluation of building systems can avoid oversizing pitfalls, and result in reduced cost and improved performance of proposed heat pumps. Through investigation, deficiencies and measures can be identified that will allow the team to reduce the heating and cooling loads in the facility, resulting in smaller heat pumps and less electrical consumption and demand. The areas to be investigated further are the building's envelope, lighting, plug and process loads, energy storage, and on-site renewables. In this section we discuss each of these areas and their importance/ applicability to successful heat pump deployment. For further information on strategies to assess and reduce these different loads, see the Appendix: **Building Internal Load Reduction**.

Envelope

A building's envelope is the main thermal barrier between the inside and outside of a building. It includes windows, walls, roof, and foundation. The envelope in existing buildings is an important area to be investigated and improved. As mentioned in the introduction, older buildings can have lower insulation values, high infiltration rates, and other deficiencies that are not present in newer buildings due to improved construction techniques and improvements in energy codes. With these

less efficient envelopes, existing heating systems have been designed to overcome the deficiencies seen in envelopes by providing high-temperature water or air and "washing" the exterior walls to prevent drafts and improve occupant comfort. As discussed, heat pumps are not well suited to this operation strategy due to most equipment operating at lower supply temperature than traditional heating equipment. To enable a successful heat pump installation, the envelope should be investigated and improved to improve insulation values, reduce infiltration, and in some cases increase thermal mass of the building.

Envelope upgrades can be costly to pursue but can be strategically phased to coincide with other upgrades to reduce overall cost. Windows are an accessible envelope system that can provide significant load reduction and be retrofit and improved at a relatively lower cost than other systems, such as wall or roof. Windows can be an accessible upgrade for many projects and can have a decent return depending on the condition of the existing system. Roofs are a more expensive upgrades compared to windows but have regular replacement cycles for parts of the system, which provide optimal times for upgrades. For example, when a roof needs to be replaced, additional insulation can be added and the envelope can be tightened to help improve performance, which shares the project cost of necessary replacements and can pay back the overall project through load reduction and energy savings. Building walls are some of the most costly and disruptive upgrades for a building due to demolition requirements to access most wall systems, which necessitate in many cases having the building or space be unoccupied. Much like the roof during a scheduled building remodel or retrofit, building envelope upgrades can be deployed as building operation will already be impacted and other remodels might expose existing insulation and envelope, easing in the installation and retrofit of these systems.

Infiltration in older, or even in newly constructed buildings, can be significant. It is not uncommon to discover failed exterior door seals, gaps in general construction where walls meet roofs, and plenum-to-exterior relief dampers that do not fully close. At minimum, the designer should walk through

the building to search for such easy-to-identify problems. Designers should consider utilizing tests such as a thermal scan and/or building pressure test to identify deficiencies in the building envelope.

While complete envelope upgrades might not be accessible for all projects, planning for the upgrades can enable heat pumps that are installed today, as well as enable heat pumps for future projects. Planning designs for future envelope upgrades should be considered, especially when dual-fuel systems are used to provide a pathway for future full decarbonization of the building's thermal systems.

Lighting

Lighting poses a large internal building load for buildings. In the last two decades lighting technology has seen significant increases in efficiency, reducing both the cooling load on building mechanical equipment as well as reducing building electrical requirements. When evaluating an existing building, original mechanical equipment and electrical infrastructure was potentially sized for less efficient lighting. By understanding what new lighting systems have been implemented or what system can be implemented, load reduction can be captured. This load reduction can reduce both new equipment size but also provide additional electrical panel capacity that can help handle additional electrical load from a new heat pump if needed (see **Building Electrical Capacity Considerations for Heat Pump Retrofits** for more info). Both benefits can help reduce project costs, which can help offset any additional cost incurred from lighting upgrades as part of the project. Mechanical cooling load reduction can also help align building cooling and heating loads, potentially easing design considerations. See the Appendix: **Building Internal Load Reduction** for more information.

Plug and Process Loads

Plug and process loads consist of the systems on-site that use electricity for things other than lighting or HVAC. Common plug and process loads include computers, personal heaters,

battery charging, servers, air compressors, TVs, etc. These systems consume electricity and admit heat into the space. This additional heat will result in greater cooling requirements for the space in the cooling season but will reduce heating requirements for the space in the heating season, as well as reducing the amount of reheat. Plug and process loads are components of a building that can be significantly oversized during design, resulting in oversized electrical and HVAC systems. For example, in some office lease agreements plug and process loads are requested at 5 to 10 W/ft², but based on studies performed by NREL, the average and peak plug and process loads for an office building is between 0.28 W/ft² and 0.88 W/ft² (Sheppy, 2014). This shows the necessity of accurately quantifying the plug and process loads in the space and provides opportunities, in some cases, to reduce the original design load and free up existing electrical infrastructure. As discussed in the lighting section above, this reduced cooling and electrical load can help reduce project costs by reducing mechanical equipment size and freeing up electrical capacity. This reduced project cost can potentially offset any additional costs of reducing plug and process loads. See the Appendix: **Building Internal Load Reduction**.

Common plug and process loads include computers, personal heaters, battery charging, servers, air compressors, TVs, etc.

Thermal Energy Storage

Thermal energy storage provides expanded options for heat pump retrofits because it allows for smaller equipment sizes, reduced short cycling, improved demand flexibility, and in some cases lower-temperature operations. Energy storage allows the units to store heat or cooling energy, during low load or low energy cost periods, in a medium such as ice, water, phase change material, etc. and use this energy later during a higher load or energy cost period. This has the potential to add additional cost savings and provide a more robust system to the facility. While on-site the team should investigate any

existing energy storage systems for proper function as well as identify locations for installing energy storage systems. By understanding the current systems and footprint available for installing a new storage system, the design team can analyze and quantify potential storage system solutions for the facility. The section titled **Thermal Energy Storage** describes how to design and implement energy storage in a building and the advantages of utilizing thermal energy storage when possible.

On-Site Renewables and Battery Storage

Renewable electricity generation (e.g., solar panels) provides the facility a means of offsetting electricity consumption, which reduces operating cost, operational carbon emissions, and potentially offsets load on the electrical grid. When building electrification is the goal, renewables help offset this increased load and become more financially attractive as energy costs shift to electricity. If there are renewables on-site, the investigator should review the on-site installation to determine the condition of the renewables as well as the operation of any controls for battery storage, load shedding, etc. Along with the existing equipment, the team should also investigate the potential for expanding the existing system to any free roof area or open space on-site to improve the capacity or areas to implement energy storage.

In many facilities, on-site generation is not present. The investigation team should identify locations for on-site renewable generation including but not limited to the roof structure of the facility, parking lots/structure, open space owned by the facility, etc. Utilizing information gathered for either existing or new installations' potential capacity can be modeled, and potential electricity storage options can be investigated and quantified as part of the overall project scope.

On-site renewables and battery storage have the potential to help offset potential building electrical capacity constraints as a result of a heat pump retrofit. The potential benefits and uses for these systems are detailed in section titled **Building Electrical Capacity Considerations for Heat Pump Retrofits**.



Case study and images/figures are provided by Ecotope

HVAC Overview Pre and Post Retrofit

Before the retrofit, all heating was done with an oil boiler at 80% efficiency. The retrofit added envelope insulation and heat recovery ventilation that greatly reduces the heating energy requirement, while the high-efficiency VRF heat pump system provides hydronic radiant and airside space heat and cooling as needed. Efficient fans, which are turned off when there is no call for heat/cool, and LED lights further reduce the daily electrical use. The library computer is cooled using the VRF heat pump, and waste heat from the computer lab is recovered into the radiant floor heating system.

The heat recovery ventilators were configured as DOAS, with the ventilation ducted separately from the heating and cooling systems. This design approach significantly reduces duct sizing and fan energy since only the ventilation fans need to run for most hours of the day. Typical designs coupling ventilation with heating and cooling equipment must rely on the much larger HVAC fans to run continuously to deliver the ventilation air.

Energy Efficiency Measures

Envelope	Super Insulation: R-30 walls, R-50 roof, R-20 slab, triple-glazed windows
Space Heating	Variable refrigerant flow (VRF) heat pumps with radiant floor distribution in large open space and wall cassettes in smaller rooms
Ventilation	Dedicated outdoor air system (DOAS) with 80+% sensible energy recovery from the exhausted indoor air
Lighting	100% LED fixtures with dimming
Water Heating	Heat pump water heater for domestic hot water production
Water Fixtures	Low-flow plumbing fixtures

CASE STUDY: Sitka Public Library

Overview

The city of Sitka had a target of reducing its reliance on expensive imported oil while maintaining the same electrical use. To accomplish the goal, the team relied on energy efficiency measures with a focus on reducing the heating load while remaining within the existing available electrical capacity for the building. The Sitka public library also underwent a 63% floor area expansion.



High-Level Building Information

Building name: Sitka Public Library ¹	Building floor area: 12,322 ft ² (original size: 8,000 ft ² , space was added in this remodel)
Building type: Public Library	
Building location: Sitka, Alaska	Number of floors: 1
Building occupancy date: 2016	

¹<https://www.cityofsitka.com/departments/SitkaPublicLibrary>

CASE STUDY: Sitka Public Library Continued

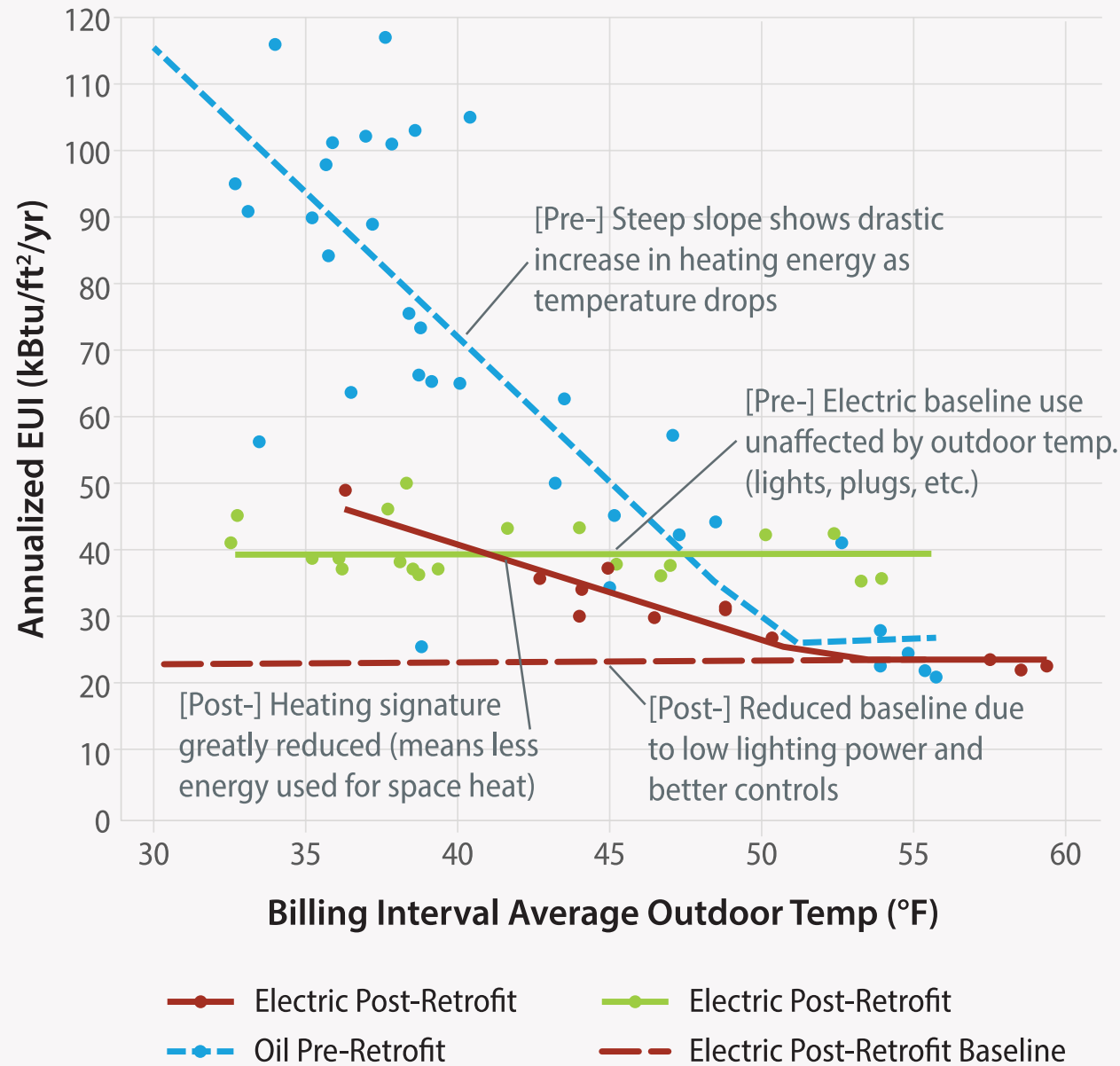

Figure 36. Weather-normalized building energy use intensity (EUI): pre and post retrofit

Figure from Ecotope

Annual Energy Use

	Area (ft ²)	Oil Use (Gallon/yr)	Electrical Use (kWh/yr)	Actual Energy Use Intensity (kBtu/ft ² -yr)
Pre-retrofit	7,567	3,234	87,689	99.1
Post-retrofit	12,366	0	115,909	32.0

Main Takeaways

- Oil—60% of the preliminary energy use—has been eliminated.
- Despite the team’s goal to maintain the same electrical use, it increased by 32% because of adding space heat to the electric load and increasing the heated floor area by 63%.
- Utility costs were nearly cut in half, with money staying in the community rather than paying for imported fuel.
- Carbon emissions eliminated, from a previous amount of 72,377 lb/yr of CO₂.
- Annual energy use normalized by total square footage (energy use intensity) cut by factor of three, from 99 to 32 kBtu/ft²-yr. This puts it at one-third the national average for libraries.

Lessons Learned

- Specify a separate subcontractor and bidding for a data collection system. This is a place where contractors will offer building owners credits for doing something less than spec.
- Existing building electrical infrastructure is typically conservative in capacity; explore the existing capacity and understand how much space heating ampacity is available in electrification projects.
- Heat pumps do work in cold climates. Installation needs to follow manufacturer’s requirements for colder climates. Size so that the heat pump meets 100% of the load at design condition.

Utility costs were nearly cut in half, with money staying in the community rather than paying for imported fuel.

Evaluate Existing Mechanical Systems

Understanding the existing mechanical systems is essential to understand how the building is operating, deficiencies in current design, equipment that can be repurposed for heat pump installations, and provide data to inform heat pump designs via the building automation system or testing. A thorough investigation of the mechanical systems will provide a strong foundation for designing a heat pump retrofit solution.

Existing HVAC and Domestic Hot Water Systems

The first step when assessing the existing mechanical equipment is to understand what main pieces of equipment are present for the HVAC and domestic hot water systems (“domestic” simply meaning any water that is delivered to people, like via kitchens and bathrooms). These systems have many types and permutations, making it imperative to document the existing system well. Thinking about the systems in terms of the needs of the building will help identify all the pertinent pieces of equipment. In other words, think about the building’s cooling, heat, ventilation, and domestic hot water systems. What equipment is providing each of these building requirements? Sometimes one piece of equipment will serve multiple functions, but thinking in this approach will ensure if multiple systems serve the same function they will be captured in the investigation.

Once the major pieces of equipment are identified, certain criteria should be noted. **Table 7** illustrates the major categories that need to be investigated with example notes.

Table 7. Example Mechanical Equipment Inventory

Item	HVAC	Domestic Hot Water
System Type	Make, Model, Mixed Air Direct Expansion, Direct Fired Natural Gas, Economizer Air Handling Unit with Electric Reheat	Make, Model, Natural Gas Hot Water Boiler Condensing
Rated Capacities	20 Ton Cooling, 1000 MBH Heating, 40 kW Reheat, 10 HP Fan, 8000 CFM	200 MBH
Condition of Equipment	15 Years, Damaged Housing, Dirty Filters, New Motor	10 Years No Major Issues
Equipment Efficiencies	10 EER, 14 SEER, 80% Natural Gas Efficiency	90% Efficiency
Capacity Control Options	Two Stage Scroll Compressor, Modulating Gas Burner, Variable Frequency Drive Fan	4 Stage Burner
Control Systems	Direct Digital Controls – Manufacturer	Local Unit Mounted Controller

Distribution Systems

After these pieces of information have been noted for each of the equipment, the next step is to understand how the heating, cooling, or hot water is distributed throughout the building. For example, is the system a centralized or distributed system type? This can be thought of as a central air handling unit being ducted to each space, or distributed single unitary window-mounted air conditioners. With a centralized system it is important to understand how the systems move either the air or water in the building. Are these systems ducted or piped? If so, assessing the condition of these distribution systems will provide insight into any deficiencies and options to use in a heat pump retrofit. For example, if the ductwork system is already present, a heat pump could potentially use this existing system for air distribution, reducing cost. Understanding any deficiencies in these systems will inform if further retrofits are necessary to use existing distribution systems for a heat pump retrofit as well as any improvements to the existing system that can make a new heat pump system even more efficient.

When assessing the distribution system of the equipment, certain pieces of information should be noted, such as:

- Ductwork and pipe sizes
- Distribution system pressure classification
- Existing distribution system material
- Existing damage or leaks
- Existing condition and R value of insulation
- Condition and operation of control actuators
- Maintenance access distribution components.

By gathering the above information the design team will have the required information to determine opportunities for utilizing the existing distribution system, if present, and be able to analyze required or suggested improvements to optimize a new heat pump system. Some of these improvements can include increasing the insulation value of the distribution system, or increasing pipe or ductwork sizes to reduce pressure loss or increase flow in the system.

System Operation

The next step after investigating the distribution system, if any, of the equipment is to understand the operating conditions of the equipment. Understanding the existing operating conditions of the equipment provides insight into the design and what is required to make the building operate under the existing conditions. The operating conditions that need to be understood include supply air setpoints, supply water setpoints, airflows, and water flows to the equipment for both cooling and heating systems. Understanding these operating conditions allows the design team to determine loads on the equipment and conditioning capacities provided to the space, as well as what might be required from the new heat pump system.

Usage and Load Profiles

Usage profiles can tell the investigation team a lot about how the existing building operates and provide insight into optimal solutions for the team to investigate. When looking at usage profiles the team ideally should gather a year's worth of granular (≤ 1 hour) usage profiles such as electricity data, and operation trends of the mechanical equipment including:

- On/off operation
- Fan speed
- Pump speed
- Supply temperatures
- Heating/cooling operation.

By having both the electrical and mechanical usage trends for the building the design team can identify the building peak load, operational deficiencies in the existing building, potential oversizing of the existing equipment, and controls schemes for mechanical equipment. By having these data, options for reducing the load through control or improved design practices can be investigated, as well as understanding options for “controlling” out the peak electrical demand through load shifting, thermal storage, or other method. By analyzing these

data, we can identify the maximum heating capacity required by the current equipment. This information will help the team understand the requirements for a new heat pump system, assuming the building's operations remain unchanged.

By having both the electrical and mechanical usage trends for the building the design team can identify the building peak load, operational deficiencies in the existing building, potential oversizing of the existing equipment, and controls schemes for mechanical equipment.

Identify Space for New Heat Pump and Distribution Equipment

When assessing the existing conditions of a space, thought and discussion should be put into determining a location for the new heat pump. This decision has many variables. Heat pumps generally fall into two different categories based on their compressor types being either an air-source heat pump or water/ground-sourced heat pump. Both types have specific considerations that need to be investigated for locating the new equipment. Similar to traditional direct expansion air handlers, factors such as equipment size, weight, distribution types, configuration, etc. affect where the equipment can be located given the facility configuration. This section details the variables and decision points surrounding this decision.

Existing Equipment Location

The typical first identified location for installing a new heat pump is in the location of the existing direct expansion air handler. In many cases this location is already designed structurally to handle mechanical equipment and has existing penetrations for the distribution system. Understanding the parameters such as max allowable equipment size and weight as well as the information already discussed about assessing

the distribution system will inform the team during design if this location will work for the new equipment, as well as if the equipment can use the existing distribution system. These parameters can also influence system type selection discussed in **Chapter 2: Selecting the Right Heat Pump for Your Project** of the guide. It should be noted that by reducing building loads, mechanical equipment size and weight can be reduced to reduce potential structural or size constraints.

Air-Source Heat Pumps

When investigating locations for air-source heat pumps, care needs to be taken. The heat pump location and orientation needs to maintain proper clearance to ensure required airflow to the condensing unit. In areas of high wind, the unit should be installed near proper wind breaks because winds can cause issues with defrost control during cold weather. These wind breaks can be a wall, foliage, or other structure that can reduce the wind effect on the unit. For air-source heat pumps the primary location for many units is on the roof of the facility. This installation maintains the ground space and real estate, and prevents considerations around protecting the unit from vehicles or vandalism. Furthermore, for many facilities any distribution systems will penetrate the roof directly into a mechanical chase, or above-ceiling plenum. Mounting the equipment on the ground is the next primary option but this requires care in locating the unit near mechanical chases or thoughts around how distribution equipment will enter the building. For both installation areas, noise is another requirement that needs to be determined because the fans and compressors for the equipment produce considerable noise and need to be mitigated if there are sound requirements for the space.

With air-source heat pumps the heat is rejected or pulled from the ambient air, typically outdoors. A strategic location for an air-source heat pump can be in an underground parking structure, if it exists on-site. Underground structures maintain a consistent air temperature in the space due to the consistent ground soil temperature surrounding the structure, similar to a cave. This consistent temperature provides ideal temperatures for the heat pump to operate at high efficiency throughout the

year, as well as eliminate concerns about cold weather operation for the heat pump. For installation in these locations, often the equipment is housed in an enclosed mechanical room. If this location is deemed acceptable for locating the equipment, a strategy for providing proper airflow to that room would be necessary to maintain the requirements for the heat pump.

Ground- and Water-Source Heat Pumps

For a ground-source heat pump, soil is used as the source for heat capture. This system uses piped water or refrigerant and submerged or vertically bored pipes in the ground to move the heat between the heat pump and the soil and maintain a high efficiency for the heat pump year-round. These installations require enough area to properly space the pipe and enough area to meet the heat rejection requirements of the heat pump. Common locations for these systems are underneath parking lots or open space near the building. New technology has allowed for angled drilling to locate bore holes underneath existing buildings or parking lots without disturbing the existing structures. Once suitable locations have been identified, engineering calculations should be performed to determine if locations have enough area or thermal conductivity for a ground-source installation.

For both ground-source and water-source heat pumps, added flexibility is provided for installation since there is no longer the requirement for airflow directly to the heat pump.

A water-source heat pump uses water for heat capture. This system uses piped refrigerant installed in a body of water at a depth that does not freeze in the winter or get too hot in the summer. The refrigerant rejects or captures heat for the heat pump from the water. This installation maintains a high efficiency for the heat pump year-round similar to ground-source systems. For water-source systems, the bodies of water need to be identified and evaluated for suitability. Common

sources are lakes, ponds, aquifers, or wells, but each water source needs to be verified for a stable temperature and enough water to handle the added or removed heat from the water. If enough water does not exist to handle the added or removed heat, heat rejection by the heat pump system may constitute thermal pollution, which negatively impacts aquatic ecosystems. Increased water temperature may not be tolerable for aquatic biota and can decrease dissolved oxygen (DO).² These water sources must also be allowed per local regulations, as some jurisdictions don't allow water sources to be used for this application.

For both ground-source and water-source heat pumps, added flexibility is provided for installation since there is no longer the requirement for airflow directly to the heat pump. Areas discussed for air-source heat pumps are still viable locations for a water- or ground-source heat pump, however installing the equipment indoors is further enabled. Ground-source or water-source heat pumps both have the benefit of being smaller than air-source counterparts, as well as being quieter in operation primarily due to the lack of condenser fans.

Distribution Systems

Distribution systems allow for heating and cooling to be supplied to spaces within a building. This distribution is handled via terminal units, air through ductwork, water in a piping network, refrigerant in a piping network, radiant systems, or with many distributed heat pump units. When evaluating the existing space for distribution systems, the investigator needs to understand the space available to install new distribution systems and align with the interior architecture of the facility. If the facility is multiple stories, mechanical chases need to be understood or a route for the ductwork or piping needs to be determined as well as max allowable size. Similarly, it is important to understand any plenum space in the ceiling or if no plenum is available, understand the allowable distribution types and sizes to fit in those areas. This will require coordination with the on-site staff and architect to ensure proposed distribution systems are acceptable from an interior architecture perspective.

² <https://www.sciencedirect.com/topics/earth-and-planetary-sciences/thermal-pollution>

While investigating the distribution system, the team needs to identify major obstacles that will influence how the distribution system will be routed. This includes things like structural beams, fire protection piping, electrical wires, and other installed systems. These obstacles should be noted and located on design documents to ensure proposed distribution routing is coordinated with these pieces. By understanding the areas that distribution systems can be located and the max allowable size of these systems, decisions about the distribution system types can be made and will influence the heat pump technology selected.

Thermal Stress Test the Building

Heat pumps as a system provide an effective way to heat and cool a space, decarbonize buildings, and improve source energy efficiency. However, in an air-source application the heat pump will have lower supply temperatures, reduced capacity, and efficiency at extremely cold temperatures. Given these qualities of heat pump technologies today, it is imperative to size and design the system to the correct load in the space. Along with rightsizing the heat pump, design supply temperatures affect the heat pumps capacity, efficiency, and market availability. Many existing heating systems are oversized for the loads in the space and can have their supply temperatures reduced while still meeting the building loads. By stress testing a building, the actual building loads and minimum supply temperature of the existing systems can be determined, leading to efficiency gains in the short term and inform potential heat pumps retrofit solutions.

What Is a Building Stress Test?

A building stress test is taking an existing building and adjusting the current heating operation by reducing supply temperatures and existing equipment capacity to see how the building operates at reduced operating conditions. By performing these tests, the minimum supply temperatures and minimum capacity needed to maintain the space can be accurately determined as well as inform if the existing distribution system can be used in the heat pump retrofit. Many

of the techniques discussed in **Measured Data and Existing System Capacity** will be employed as part of this stress testing to collect data about the system capacity and verify supply air temperatures. This building stress test differs from the measured data approach in that this stress test will test different operating setpoints to determine minimum heating requirements and loads, whereas the methodology discussed in **Run a Load Calculation for the Building** is measuring the load at current system operation, which could include issues with equipment operation influencing calculated loads and does not inform retrofit potential of the existing distribution system.

Prior to performing the stress test, verify proper heating system performance and investigate any existing problems.

This process systematically lowers the heating supply setpoint of the building and allows the building to respond both in terms of its thermal mass but also any time-of-day controls strategies of the existing equipment. This method will provide the design team with data to inform design of the new equipment, capability of utilizing the existing distribution system, and improvements that need to be made to the existing distribution system. For example, if the supply temperature is able to be reduced to a lower setpoint that is achievable with current heat pump technology, the existing distribution system can be used, which in turn reduces cost and construction timeline and improves the payback and feasibility of the retrofit.

Prior to performing the stress test, verify proper heating system performance and investigate any existing problems. First, check maintenance records and ensure all components of the heating system have been regularly serviced. If service has not been performed, service all equipment or functionally test the equipment to ensure proper function. Next, all heating equipment should be visually inspected, and any damage, maintenance, or issues should be noted and addressed. By confirming proper function of the heating equipment, any alarms that arise during the testing procedure can be attributed to

the reduced supply temperature and not any mechanical deficiency in the existing system.

Unoccupied setbacks are a control strategy implemented by many buildings to reduce space setpoint requirements during unoccupied times. This reduces the heating load on the building and provides reduced energy consumption during unoccupied times. Given that the lowest outdoor air temperature and subsequent peak heating loads occur during traditional unoccupied times, setbacks need to be removed during the testing period to be able to accurately determine peak heating requirements and really test the new supply temperature during a worst-case scenario.

After lowering the supply temperature, there are several points that need to be monitored to determine if the lower supply water temperature is effectively meeting the load requirements of the building. The following points should be monitored and alarmed at these conditions:

- When ambient room temperature falls out of acceptable range. The minimum expected acceptable temperature is generally considered to be 70°F. If expanded comfort range is allowable, such as in a sanctuary where occupants can be expected to bring coats, the allowable temperature range may drop to as low as 65°F.
- When heating pump or fan speed reaches 100%.
- When pipe main velocity reaches 8 feet per second (if it is possible for an ultrasound flow meter to be installed, maintaining correct straight pipe lengths).
- When building occupants complain about thermal comfort.

If any of these alarms are raised, the heating water temperature should be set back up to the previous increment. The status of each of the above alarms should be monitored over the course of 1 week, or if speeding up the process is possible in unoccupied buildings, for 3 to 4 days at a time. If there are no alarms during the week, the temperature can be lowered by another 10°F. This incremental reduction in supply temperature should proceed until one or more of the above alarms are raised.

STRESS TEST APPROACH

The process for stress testing the building generally follows the following process:

1. Confirm the current supply temperature setpoint
2. Confirm heating system is functioning properly
3. Disable nighttime setback
4. Lower supply temperature by 10°F
5. Monitor alarms and cold calls for a few days (~4 days) to one full week
6. If no issues, repeat steps 4 and 5 until alarms are raised or cold calls are received
7. Make note of the last satisfactory supply temperature
8. Reset supply temperature to either lowest satisfactory temperature or original setpoint.

This test is expected to be ongoing for a few weeks to a few months and, if necessary, more than one heating season. At the conclusion of the test, and at the building owner's discretion, the heating hot water supply setpoint can remain in its lowered supply temperature state, which can yield energy savings, or can be reset back to its original setpoint.

For stress testing the building, this test ideally needs to occur during the peak heating season. This will vary by location but should be tested near the times of typical winter extreme conditions to accurately determine if lower supply temperatures are viable during periods of high heating loads. Outside air temperatures should be trended and monitored during the test to understand how the building performed compared to outside air temperature. If tests were performed during non-peak heating conditions, then this outdoor air temperature compared to load can help inform regressions to predict peak heating loads for the system and adjust the required hot water supply temperature accordingly.

Building Electrical Capacity Considerations for Heat Pump Retrofits

Since heat pumps are an electric-based heating and cooling system, care must be taken when evaluating existing buildings for heat pump retrofits. Electrical engineers should be engaged early on in the project to help evaluate the building's current electrical capacity to determine what is available for heat pump and backup heating equipment. The electrical engineer can help set the bounds for the mechanical engineer to avoid oversizing and excessive backup heat to meet the building electrical constraints. This section discusses the approach to determine the building electrical capacity as well as potential scenarios that can occur in building electrical systems.

Determine Remaining Electrical Capacity in an Existing Building

When adding a heat pump to an existing building electrical system, there are two levels that need to be evaluated for electrical capacity. The first is the main service to confirm there is enough supply to the building from the utility to support the new load. The second is the point of interconnection within the facility to confirm there is capacity in the local panel to support the new equipment.

It is important to note that the short-term metering does not provide insight into possible seasonal variations. One risk with this approach is that as buildings switch heating and cooling to electric heat pumps, the seasonal variation becomes a more important variable to consider.

If the facility utility meter is a smart meter, it is often possible to get whole-building meter data directly from the utility. The risk with whole-building meter data is it will only show whether the overall system can handle additional loads. In many scenarios, the utility service and building main distribution board can take on additional loads. Yet the challenge is that often a sub-distribution panel downstream of the main distribution board is the one best suited to feed a new heat pump, and yet that panel does not have adequate capacity.

Consider the scenario outlined in **Figure 38**: A historic building with multiple updates over the years is adding a new 60A heat pump. While the overall building service has plenty of available capacity, the sub-distribution boards near the location of the heat pump are at full capacity. Therefore, metering at a whole-building level informs the designer that the electrical service and main distribution board have capacity, yet without meter data on that specific panel, the whole building data doesn't confirm if the preferred location for the electrical connection has capacity.

EVALUATE ELECTRICAL CAPACITY

There are two methods for evaluating whether points have sufficient electrical capacity to accommodate heat pumps:

- The first is to calculate the worst-case condition for the existing loads based on breaker and equipment calculations. This is often the quicker and least expensive option, yet doesn't provide a detailed look at the actual operating conditions.
- The more detailed approach, especially with an existing building, is to collect meter data. If the building does not have existing meters, a meter can be added (meter rentals are often for 30-day periods) to provide a better understanding of base consistent loads. The 30-day meter data is often adequate to meet the requirements of the National Electrical Code for adding loads to an existing system. The project electrical engineer can provide guidance on how meter data can be used to demonstrate adequate capacity in compliance with National Electrical Code for review by an authority having jurisdiction.

Scenarios 2–4 (Figure 38–Figure 40) outline similar cases where the building may have adequate capacity at building service but not in the distribution riser serving the heat pump, or not in the area where the heat pump is located, or where no physical capacity is available in the panel.

Figure 37. Electrical capacity scenario 1: Adequate electrical capacity at building service but not in any sub-distribution panel

SCENARIO 1

Adequate electrical capacity at building service but not in any sub-distribution panel

The building service and main distribution board have adequate capacity to support the new heat pump.

Yet none of the branch panels, including the dedicated mechanical panel, are able to support the new unit. To accommodate the new equipment, upgrades will be required, such as a new electrical panel connected to the main transformer

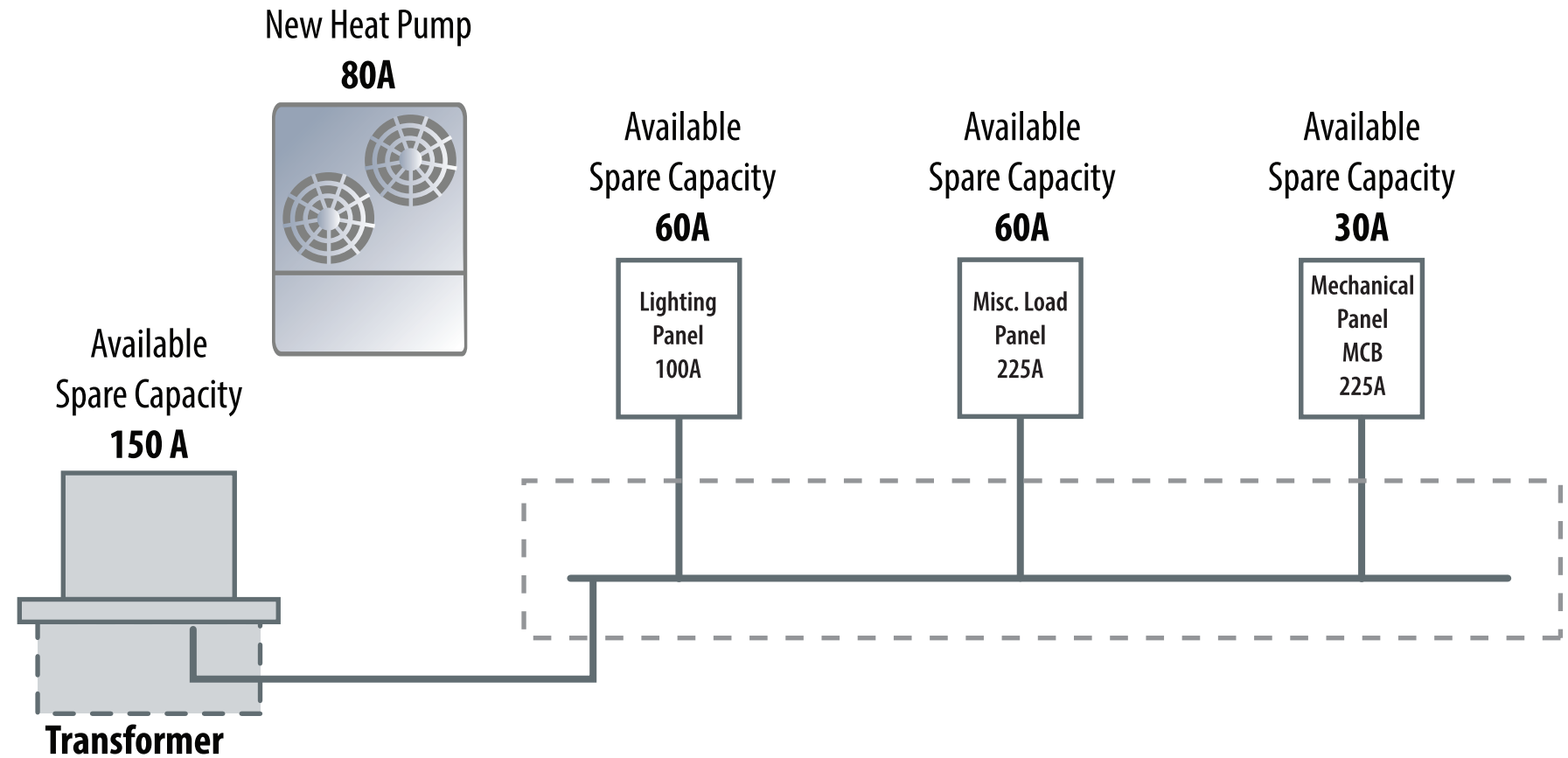
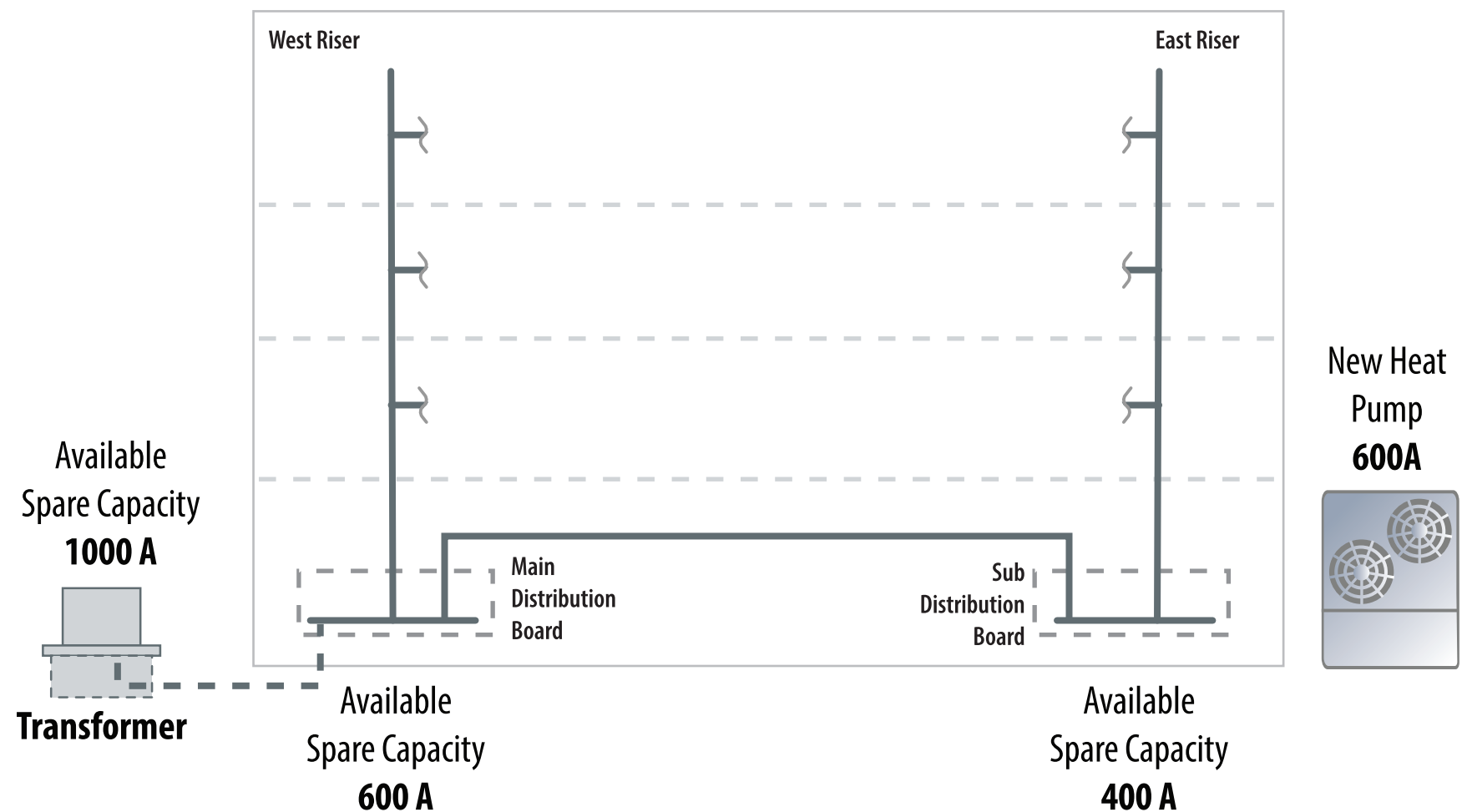

Figure 38. Electrical capacity scenario 2: Adequate electrical capacity at building service but not in the distribution riser serving the heat pump

SCENARIO 2

Adequate capacity at building service but not in the distribution riser serving the heat pump

The building service is split into essentially two (or more) sub-services within the building, each with its own riser. The main service to the building has adequate capacity for the heat pump, but the sub-service near the heat pump doesn't have adequate capacity.



SCENARIO 3

Adequate capacity at building service but not in the area where the heat pump is located

The building floorplate is large enough to require a sub-electrical room to serve areas far from the main electrical room. The building service and main distribution board has adequate capacity, but the sub-electrical room nearest to the heat pump location does not.

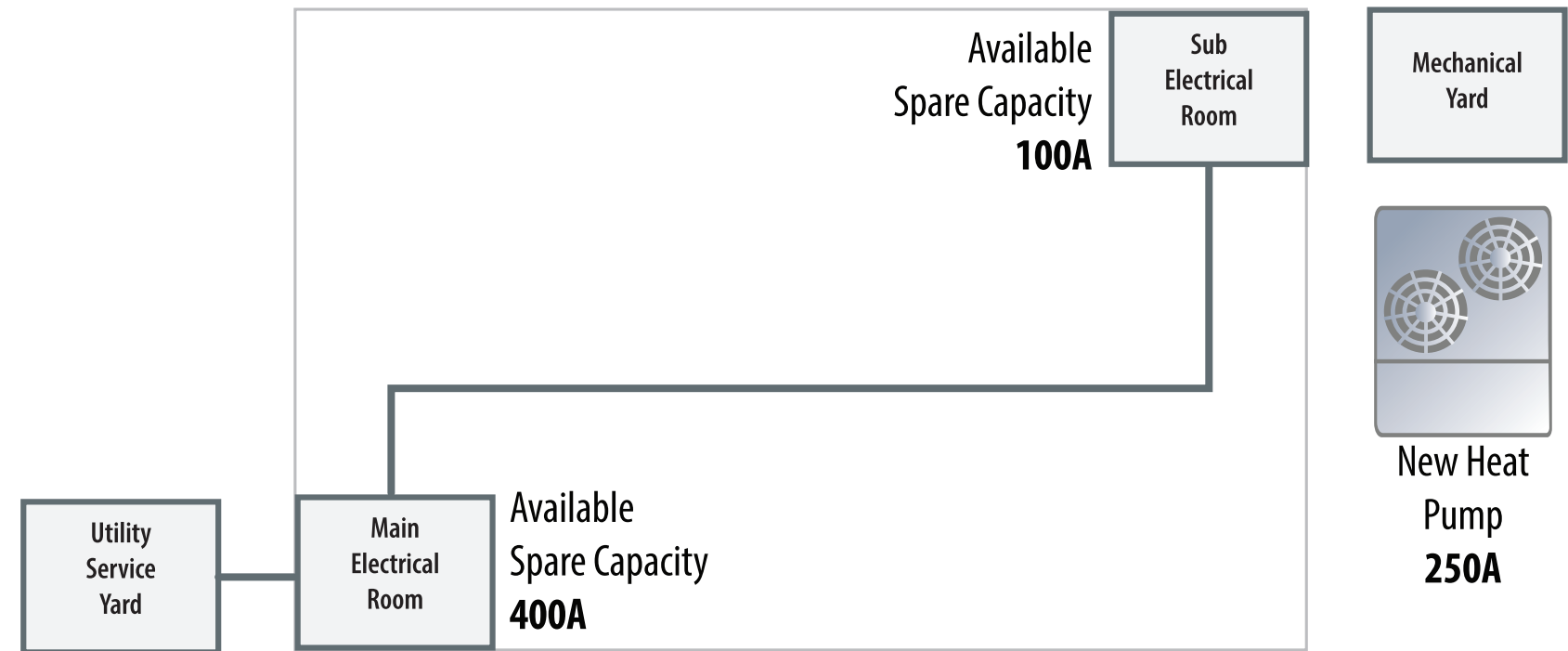

Figure 39. Electrical capacity scenario 3: Adequate electrical capacity at building service but not in the area where the heat pump is located

SCENARIO 4

Adequate electrical capacity at building service but no physical capacity in the panel

The building service and the main distribution board have adequate capacity to support the new heat pump. Yet the main distribution board doesn't have adequate physical capacity to support the new breakers needed for the equipment. Expansion or replacement of existing equipment to increase the space capacity can be expensive and disruptive to building operations.

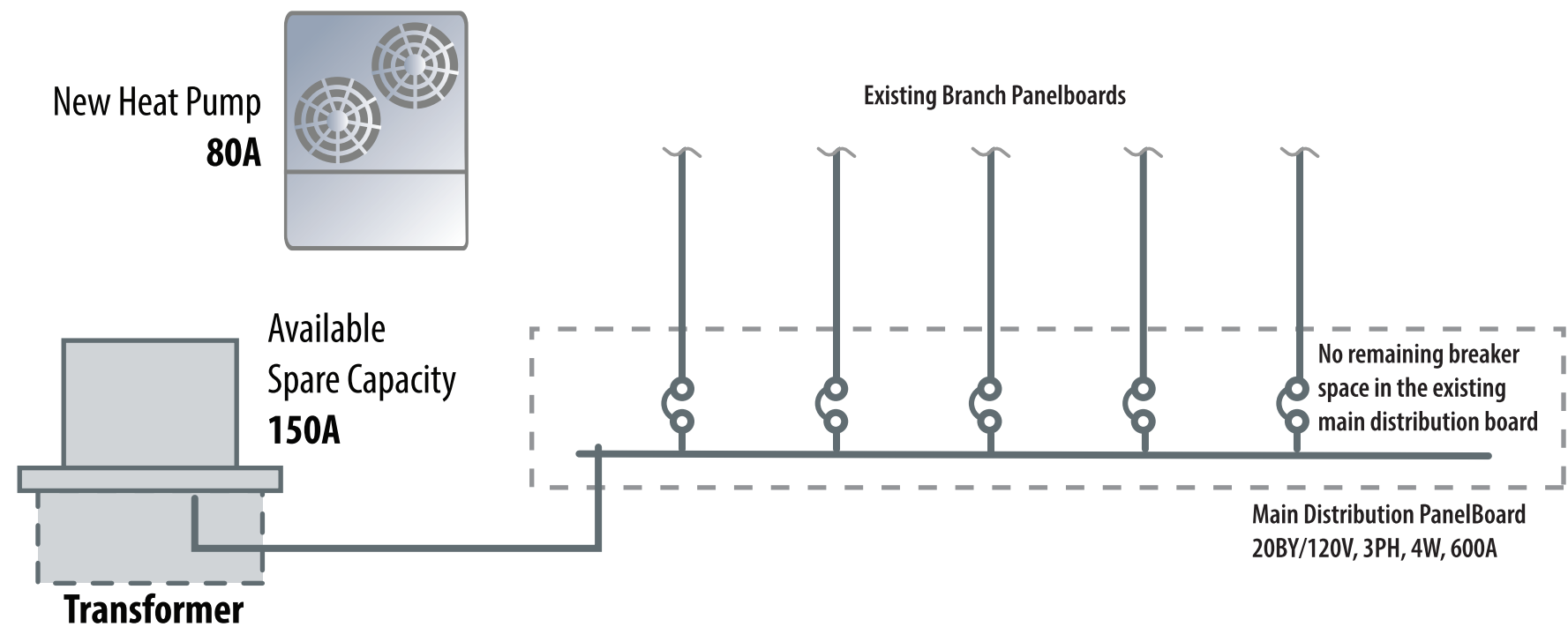

Figure 40. Electrical capacity scenario 4: Adequate electrical capacity at building service but no physical space capacity in the panel

PV Considerations on Electrical Capacity

On-site photovoltaics (PV) can provide multiple benefits to a project. However, in the context of adding a heat pump to the existing electrical system, PV can offset electric consumption from the heat pump, but care must be taken to deploy PV correctly to maximize benefit. It is important to consider that the National Electrical Code is generally focused on power, not energy. From this perspective, although the PV might reduce the overall utility energy use of the building, it doesn't necessarily reduce the power design requirements. Since PV isn't a consistent generation source, the electrical system must be designed to support the heat pump even when PV isn't producing. Therefore, PV can help reduce energy use, but designers must not assume any reduction in the power requirements for the overall infrastructure. Additionally, the National Electrical Code has specific requirements for how the electrical system must be sized to support the incorporation of PV. These requirements could potentially complicate the space and capacity considerations outlined in some of the examples in this section.

Energy Storage Considerations on Electrical Capacity

Battery energy storage systems can potentially be used to address capacity issues with adding a heat pump to an existing electrical distribution. If co-located with the heat pump, the battery energy storage system can be used to ensure the power needs, as seen by the service (i.e. electrical panel, utility transformer, etc.), stay below a certain threshold. However, this is not yet a common design solution and will need to be reviewed with an authority having jurisdiction for acceptance. Designers also need to consider that battery energy storage systems come with some additional coordination discussions such as space and fire protection, which needs to be evaluated within the larger design.

Energy Efficiency Measure Considerations Re: Electrical Capacity

Building energy efficiency measures can be a viable option for creating capacity to support new loads, but need to be applied in a strategic manner. If loads are reduced, but not eliminated, this can create electrical capacity in the overall system, but may not provide physical space in a panel if the circuit is still needed for the remaining loads. If entire circuits can be made available, this can help create both electrical and physical space within a distribution panel.

The location of the reductions are still critical when evaluating the potential benefit to the heat pump addition. If the efficiency improvements don't add capacity in the portion of the distribution identified for the heat pump, although the overall building still benefits, the improvements might not apply to the heat pump design. For example, if efficiency improvements are made to the lighting system, this will reduce the overall electrical load of the building. But if the heat pump is being added to a fully loaded mechanical panel, then the lighting improvements don't solve the issue of capacity on the mechanical system electrical capacity. In buildings with limited remaining physical and electrical capacity, the design team may need to evaluate redistribution of existing loads so the panel closest to the heat pump location has enough space and capacity to support its operation.

This highlights the need for reducing the primary heat pump size and backup heating requirements. By reducing the equipment electrical loads we can reduce the requirements of the existing electrical capacity. This is to say instead of making the existing electrical capacity work for the heat pump, make the heat pump electrical requirements work with the existing electrical if possible. Ways to mitigate equipment size and backup heating requirements are covered in **Chapter 1: Introduction** and **Chapter 3: Designing and Sizing Heat Pumps**.

Key Takeaway Concepts

The following summarizes key takeaway concepts from this section:

- Electrical distribution equipment can often have remaining electrical capacity due to differences between National Electrical Code requirements and actual operating conditions. But consideration must be given to the specific location of the available capacity throughout the entire distribution system, not just the main service switchboard.
- Even if the main distribution board has capacity, if the new equipment is not physically near and connecting directly to that main board, there may be downstream capacity bottlenecks that make the addition of new equipment more difficult and expensive.
- Both electrical and physical capacity are important. Expanding the physical capacity of a distribution board can be difficult and costly, so understanding this need early in a project design is critical.
- Reducing or eliminating backup heat, and reducing equipment size, helps alleviate the potential electrical capacity constraints that might be present in a building and should be considered before electrical infrastructure upgrades.

In summary, electrical studies evaluating options for adding new equipment need to consider three factors:

- **Electrical capacity**
- **Physical capacity**—i.e., breaker space in the board
- **Location**—i.e., capacity in the local infrastructure nearest to the equipment.

Retrofit Scenarios

Buildings come in many different vintages, sizes, types, and operation. However, for all commercial buildings there will likely be some form of mechanical HVAC equipment present on-site. In this section we cover several scenarios that include existing mechanical equipment on-site. We will discuss potential options for retrofitting these systems and some of their relative advantages and disadvantages. The recommendations will range from total replacement to “80% solutions” that replace most of the fossil fuel load with heat pumps. As this downsizes the heat pumps, it can substantially reduce the first cost of the heat pump solution. This 80% solution is offered as an interim pathway to provide lower first cost as well as a pathway that can enable a partial heat pump solution in buildings that cannot perform further retrofits necessary to enable heat pump operation. The recommendations in this section are to be used as a guide for engineers to create a first pass selection, and provide ideas for engineers to investigate for their specific project site. The solution pathways discussed in this section will follow configurations that are discussed in the **Heat Pump Configurations** section.

This section includes a total of five retrofit scenarios that apply to many existing buildings and their mechanical systems. Each of these scenarios is intended to stand alone for reference by the user and act as a guide for engineers, architects, and owners. The scenarios in this section include:

- **Scenario 1: Steam Radiators with Split System Air Conditioning**
- **Scenario 2: Single Zone Direct Expansion RTUs with Natural Gas Heat**
- **Scenario 3: Variable Air Volume Direct Expansion Air Handling Unit with Natural Gas Reheat**
- **Scenario 4: Single Duct VAV Direct Expansion Air Handling Unit with Electric Reheat**
- **Scenario 5: Existing Central Plant (Chilled Water and Hot Water)**



With help from the Geothermal Heat Pump (GHP) Consortium's Design Assistance Program, the National Park Service installed a GeoExchange system in the Longfellow House in Cambridge, Massachusetts, as part of its preservation. The system includes 10 geothermal heat pumps, with a total capacity of 40 to 50 tons. It will be an open-loop system, with two 1,500 ft. deep wells. The system will heat and cool both the house and its carriage house for a total of around 20,000 square feet. In addition to providing the necessary climate control for historical preservation, the system eliminates the risks of a ignition/combustion heating source.

Photo by Theresa Waggoner, NREL 07947

Scenario 1: Steam Radiators with Split System Air Conditioning

This scenario involves single/double pipe steam systems (often common for pre-1970s heating-only systems) with an oil or gas boiler. Steam is generated in a boiler and typically services radiators in the zones. Air conditioning, if present, was often added later for portions of the building. As the cooling systems were often retrofit into the building and are used seasonally, outdoor air is probably not provided through this system.

Commentary

Steam systems are difficult to electrify as there are no commercially available heat pump systems that can produce steam to serve as a drop-in replacement. Electric steam systems require excessive electrical capacity and are not an efficient alternative to steam systems. There are options for replacing the entire system with baseboard electric heat. However, this is not a recommended strategy for strategic electrification/decarbonization.

Cautions: Steam radiator-based systems provided comfort with a high radiant source (radiator). This was often to offset a lack of wall insulation often found in older buildings, especially those with masonry wall construction. Heat pumps systems do not deliver heat at this high temperature. As a result, it is typically necessary to replace windows and insulate the walls. This not only achieves energy savings, but also reduces the burden on the heat pump system as discussed in the **Envelope** section. The key to a strategic retrofit of these systems is to improve the building's envelope, remove the steam pipe and equipment, and use hot water or refrigerant-based equipment to heat and cool spaces.

SOLUTION PATHWAY 1: Maintain Existing Air-Conditioning Units; Replace Steam with New Air-to-Water Heat Pump

In this pathway the existing air-conditioning units will be maintained to provide cooling to the space. Units should be controlled to provide tempered outdoor air during the heating season to the space and to not burden the heat pump system further. If the existing air-conditioning system does not have heating elements for tempering air, a heat recover ventilator or energy recovery ventilator should be used to recover heat and reduce primary heating equipment size. Then, install an air-to-water heat pump system that supplies water at less than 140°F with radiant heaters sized for this temperature. The system should be selected for appropriate cold weather performance for the location with a sufficient turndown to meet seasonal variations in load. If cold weather performance cannot be achieved to provide 100% of the heat, energy storage or staged heat pumps should be considered. Electric resistance backup heat can be explored, however this will likely exceed existing building panel capacity, hence requiring electrical capacity expansion that may increase project costs.

Design Discussion

- This pathway provides the ability to maintain existing air-conditioning systems that are currently in place and electrify the heating system.
- Backup heat in this scenario can be a major concern for many reasons. First, utilizing existing steam can be costly and difficult to control. Electric backup heat can exceed existing building electrical capacity, increasing project cost. The recommended options for backup heat are to use energy storage or additional staged heat pumps in the new air-to-water heat pump system.
- This scenario looks at installing additional equipment to replace the existing heating system and supplement the existing air conditioning. This may add additional load on the building's electrical infrastructure and care should be taken to ensure additional capacity is available.

- Locating the air-to-water heat pump will require a location that does not have noise concerns from the outdoor fans. Existing steam equipment will likely be in a mechanical room, providing the ability for an indoor unit to be housed in this location with the outdoor unit mounted on the ground or the roof.
- New hot water piping can be located in similar routing to existing steam pipe. New radiators can be installed in place of existing steam radiators.

SOLUTION PATHWAY 2: Replace Existing Air Conditioning and Steam with Air-to-Air Heat Pumps and DOAS System

This pathway replaces all existing air-conditioning equipment and steam with air-to-air heat pump equipment. These can be in the form of packaged rooftop units, a multi-head split system, VRF, or local minisplits. Ventilation air should be provided with a DOAS system equipped with an ERV or HRV that provides tempered air in both the heating and cooling season. In humid climates, ventilation air is ideally treated to reduce the latent load on return air equipment and eliminate the need for condensate drains at zone level equipment. This DOAS system can also include an air-to-air heat pump to provide additional ventilation control if needed in extreme climates; generally, ERV or HRV can provide tempered air in mild climates. All air-to-air heat pumps should be selected with appropriate cold weather performance and turndown for the spaces that are served. If backup heat is needed, a separate air-to-water heat pump with radiators, a dual-fuel option for the air-to-air heat pumps, or electric resistance backup heat can be added.

Design Discussion

- This pathway replaces all existing equipment for the building. This is a large expense, but can still be cost-competitive compared to maintaining the existing air conditioning due to improved efficiency of replacing air-conditioning units, or reduced piping costs by eliminating the need for hot water piping.

- In certain colder climates, heat pumps might need to be upsized relative to the existing air-conditioning units. This should be mitigated by treating outdoor air with the DOAS or improving the envelope. This could result in exceeding the electrical capacity of existing panels. Utilizing a separate air-to-water heat pump can allow the air-to-air heat pumps to be sized for a lower capacity and any additional electrical upgrades can be mitigated or lumped to this new equipment.
- The new heat pumps can be located either in the existing location of the air-conditioning units or in each room with an indoor unit and a roof, ground, or wall mounted outdoor unit based on owner requirements. The DOAS system can be located on the roof, in the attic, or in the appropriate mechanical room if duct routing makes sense. Routing duct will likely be the biggest challenge for the DOAS equipment because the existing building might not have been designed to accommodate ductwork. Care must be taken to identify new ductwork location, or use existing ductwork if available to provide ventilation air.
- If a multi-head split system or VRF system is chosen, refrigerant lines can likely be run in the same location as existing steam pipes.

SOLUTION PATHWAY 3: Replace Existing Air Conditioning and Steam Ambient Loop with Water-Source Heat Pumps

If sufficient land is available, install a ground-source ambient loop. If land area is not available, a hybrid ground-source system can be installed utilizing a cooling tower or air-to-water heat pump to provide additional heating and cooling to the loop. This ambient loop can be run throughout the building with local water-source heat pumps providing heating and cooling to each zone or space in place of the existing air-conditioning units. If centralized equipment is desired, a water-to-water heat pump can provide hot and cold water to radiators or fan coils in each zone or space. Outdoor air can be treated utilizing a DOAS with an ERV/HRV or by the water-source heat pumps. Backup heat will not be necessary in this configuration as the water-source heat pumps are not affected by reduced

capacity at very cold outdoor air temperatures due to the ground-source loop ambient temperature. Ambient loop systems have increased efficiency in buildings or campuses that have simultaneous heating and cooling because heat from one space can be moved into the ambient loop and into another space as needed, maintaining optimal loop temperatures and therefore higher heat pump efficiency.

Design Discussion

- This pathway will likely have a higher first cost than other pathways due to the ground heat exchanger installation. However, this may eliminate the need for additional backup heat and can have a higher overall efficiency that can offset additional cost.
- This pathway provides many of the benefits of VRF systems in terms of efficiency and heat recovery but minimizes the amount of installed refrigerant in the building.
- The DOAS system can be located on the roof, in an attic, or in an appropriate mechanical room. Ducting for a DOAS system can prove to be a challenge in existing buildings not designed around ductwork. If this proves to be a challenge, water-source heat pumps or fan coils can condition the ventilation air, and any outdoor air duct can be done via local unit building penetrations to reduce ducting.
- Locations for new water-source heat pumps can be the existing air-conditioning locations or the existing location of the steam radiator. If a centralized system is needed, the water-to-water heat pump can be located in the existing steam mechanical room or can be ground-mounted outside.
- Ambient loop piping can follow the path of the existing steam pipe as well.
- Electrical capacity constraints are less likely to be a problem due to lack of required backup heat. However, care should be taken to determine if distributed or centralized equipment can be handled based on the differing panel infrastructure.

Scenario 2: Single Zone Direct Expansion RTUs with Natural Gas Heat

Single zone rooftop units (RTUs) with natural gas heat are a common system for medium to small buildings, especially for buildings with large open areas such as a warehouse or large retail building. This system type can either be one unit that serves the whole building or multiple units for each zone. These systems provide both heating and cooling to the space. Most installations are packaged systems that have the outdoor air intake, natural gas burner, fan, compressor, condenser, and evaporator in the same box and are ducted through the roof of the building to the space. These systems have integrated controls and are typically controlled via a single thermostat in the space they are serving. This scenario will consider roof-mounted equipment that has condensate that drains to the roof or is piped to the sewer.

Commentary

These packaged systems are common across the commercial building stock but can pose a challenge to electrify the heating system. Since the building's electric infrastructure was already sized for electric cooling, a similarly sized heat pump can be installed in its place. However, electric backup heat can lead to increased electrical load and costly electrical upgrades. In all replacement scenarios, backup heat should be eliminated or mitigated if possible.

SOLUTION PATHWAY 1: Replace Existing RTU with Heat Pump RTUs

This pathway replaces existing RTUs with heat pump RTUs. These units will serve the same single zone locations. If possible, these units should include HRV or ERV to recover heat from the exhaust air to pretreat the outdoor air for load reduction. Heat pumps should be selected for appropriate cold climate applications to mitigate backup heat.

Design Discussion

- This pathway provides ease of installation. New heat pumps can be located where existing RTUs were located, and existing ductwork can be used if existing ductwork is large enough to handle any potential increase in airflow from the new heat pump. If new airflows exceed the ability of existing ductwork, this will need to be replaced or upsized to accommodate new airflows which can pose routing constraints.
- Backup heat should be mitigated via cold climate heat pump selection. If extreme temperatures result in the need for backup heat, designers can consider utilizing a dual-fuel heat pump to provide backup heat via natural gas to reduce electrical capacity and cost constraints that might arise with electric backup heat. Any backup natural gas should be designed and controlled to operate only in extreme cold weather scenarios.

SOLUTION PATHWAY 2: Replace Existing RTU with Heat Pump RTUs and DOAS

This solution replaces the existing RTU with heat pump RTUs (return air-only rooftop units). The new RTUs will provide cooling and heating to the space and no ventilation control. A DOAS should be added to provide tempered outdoor air to the space. This DOAS should include an ERV or HRV to recover heat from the exhaust air. A heat pump can also be used in the DOAS to provide additional heating or cooling in climates where the ERV or HRV is not sufficient to treat the outdoor air. All heat pumps should be selected for appropriate cold climate applications to minimize backup heat.

Design Discussion

- This configuration decouples ventilation air from the heat pumps, reducing the primary heat pump sizes. The DOAS ERV or HRV eliminates or reduces the size of the ventilation heat pump, reducing installed capacity.
- Given the reduced size of the return air, only heat pumps' existing rooftop unit locations can potentially be used,

with minor modification. This reduced unit size can also enable the use of existing ductwork because airflow will be reduced as equipment size is reduced. These systems should be investigated to ensure feasibility.

- The new DOAS system can be located either on the roof or ground mounted. New ducting will need to be routed to and from the DOAS, and sufficient locations for this ductwork should be investigated.
- Backup heat is a concern in this pathway. Backup heat should be managed by appropriate cold climate heat pump selection, or a minimal natural gas backup. Given the reduced heat pump sizes, electric resistance backup might be feasible without electrical capacity constraints, but care should be taken to ensure this is not the case and electric resistance heat is minimized to improve overall system efficiency.

SOLUTION PATHWAY 3: Replace Existing RTUs with VRF or Minisplit Heat Pumps and DOAS

This pathway replaces all existing RTUs with a VRF or multi-head split system to manage return air only. This system either uses a single outdoor unit serving multiple indoor units or distributed split systems throughout the building to serve differing zones. A DOAS should be added to provide tempered outdoor air to space. This DOAS should include an ERV or HRV to recover heat from the exhaust air. A heat pump can also be used in the DOAS to provide additional heating or cooling in climates where the ERV or HRV is not sufficient to treat the outdoor air. All heat pumps should be selected for appropriate cold climate applications to minimize backup heat.

Design Discussion

- This configuration decouples ventilation air from the heat pumps, reducing the primary heat pump sizes. The DOAS ERV or HRV eliminates or reduces the size of the ventilation heat pump, reducing installed capacity.
- Utilizing split systems or VRF removes the need for ductwork from rooftop units and allows for the DOAS

to use this existing ductwork or for this ductwork to be demolished, opening up space for new DOAS ductwork routing.

- Distributed minisplits or VRF systems also provide the advantage of improved control over spaces, allowing for heating and cooling of spaces at the same time based on specific loading requirements.
- Outdoor units can be roof mounted, wall, or ground mounted.
- Minisplits or VRF might not be appropriate for large open spaces, and care should be taken to design to maintain space comfort.

Buckley Elementary School in Manchester, Connecticut recently underwent an extensive renovation. The 67,357 square foot school was originally built in 1952 and had a natural gas boiler and no air central conditioning. The upgrade included shifting the building to all-electric using a well-field connected to a series of zone level heat pumps adjacent to each zone.

Photos from Robert Benson Photography and TSKP



Scenario 3: Variable Air Volume Direct Expansion Air Handling Unit with Natural Gas Reheat

Variable air volume (VAV) air handling units are a common system type used in medium to large buildings. These units have a central fan, cooling coil, heating coil, and compressor inside the equipment. Depending on whether the equipment is mounted in a mechanical room or outside, condenser coils will also be included with the equipment. In this configuration the equipment provides heating and cooling to multiple zones via a single duct. Each zone is typically controlled via a VAV box that has a damper or other method of controlling airflow to space and responds to a thermostat in the zone. These VAV boxes are equipped with heating coils—heated by either hot water or electric resistance—to reheat the air for dehumidification purposes, and to heat the air to the desired temperature at the zone level. These systems tend to have complex controls to adjust fan speed, damper positions, and supply air temperatures. For this scenario, we consider rooftop-mounted air-conditioning equipment with a natural gas hot water boiler serving reheat.

Commentary

These systems are common across the commercial building stock but can pose a challenge to electrify the heating system as well as efficiently control. Since the building electric infrastructure was already sized for electric cooling, a similarly sized heat pump can be installed in its place for backup electric heat. Considering options that minimize new electric backup heat and use existing equipment can greatly reduce the cost for retrofitting these systems. For this scenario, utilizing equipment load data can inform new sizing of equipment. It is also recommended that for these systems a building stress test be performed to identify opportunities to use existing hot water coils at lower supply temperatures, as many coils might have been oversized. If existing distribution or terminal equipment is to be used, any existing controls or equipment deficiencies should be remedied to ensure proper function of the new system as a whole.

SOLUTION PATHWAY 1: Replace the Existing Hot Water Boiler with an Air-to-Water Heat Pump

This pathway electrifies only the heating system in order to maintain the existing air-conditioning unit and reduce first cost. The hydronic boiler can be replaced with an air-source heat pump to provide hot water for the RTU heating coil and reheat at the VAV boxes. Single and double row VAV coils will likely need to be replaced with coils that are designed for a lower entering water temperature (approximately less than 140°F). Backup heat is still the primary challenge in both configurations. If the return air unit needs backup heat, two options should be investigated. Backup heat should be mitigated by selecting appropriate cold climate heat pumps. If backup heat is still required, energy storage or staged heat pumps should be investigated to reduce backup heat.

Design Discussion

- New coils in the VAV boxes and RTU might require modifications or not be feasible based on specific equipment requirements. Investigation should focus on identifying room for these upgrades.
- A new air-to-water heat pump will pose the biggest potential for exceeding electrical capacity of the existing building by adding new electric heating equipment. The heat pump RTU should be used to provide as much heat as possible to minimize the size of the air-to-water heat pump. Backup heat, if needed for this system, can also use the existing natural gas boiler to minimize newly installed electric resistance backup.

SOLUTION PATHWAY 2: Replace Existing VAV Air Handling Unit with VAV Heat Pump RTU

This pathway replaces the existing air handling unit with an air-source heat pump. This system is a return air only system coupled with an ERV/heat pump DOAS for treating outdoor air. By utilizing an ERV to pretreat the incoming air, ventilation load is reduced, reducing the size of heat pump required to further treat the outdoor air. In this configuration, outdoor air

and return air can be controlled separately, allowing the return air unit to be sized for the internal loads only, which in turn keeps both units sized to their respective loads and reduces the risk of having the units oversized for part-load operation. The hydronic boiler can be replaced with an air-source heat pump to provide hot water for reheat and secondary heating at the VAV utilizing existing piping if unit is not direct fired. Single and double row VAV coils will likely need to be replaced with coils that are designed for a lower entering water temperature (approximately less than 140°F). Backup heat is still the primary challenge in both configurations. Backup heat should be mitigated by selecting appropriate cold climate heat pumps. If backup heat is still required, energy storage or staged heat pumps should be investigated to reduce backup heat.

Design Discussion

- The new air-source heat pump can be installed in the same location as the existing VAV air handling unit if feasible.
- New coils in the VAV boxes might require modifications or not be feasible based on specific equipment requirements. Investigation should focus on identifying room for these upgrades.
- With a decoupled ventilation system, the return air heat pump can be sized for a smaller load. This smaller system can likely use existing ductwork for heating and cooling.
- Ductwork will need to be routed for the DOAS system but can follow similar routing path of existing VAV ductwork.
- DOAS can be roof-mounted similar to the existing air handling unit if feasible.
- A new air-to-water heat pump will pose the biggest potential for exceeding electrical capacity of the existing building by adding new electric heating equipment. The heat pump RTU should be used to provide as much heat as possible to minimize the size of the air-to-water heat pump. Backup heat, if needed for this system, can also use the existing natural gas boiler to minimize newly installed electric resistance backup.

SOLUTION PATHWAY 3: Replace Existing RTUs with VRF or Minisplit Heat Pumps and DOAS

This pathway replaces all existing RTUs with a VRF or multi-head split system to manage return air only. This system either uses a single outdoor unit serving multiple indoor units or distributed split systems throughout the building to serve differing zones. A DOAS should be added to provide tempered outdoor air to space. This DOAS should include an ERV or HRV to recover heat from the exhaust air. A heat pump can also be used in the DOAS to provide additional heating or cooling in climates where the ERV or HRV is not sufficient to treat the outdoor air. All heat pumps should be selected for appropriate cold climate applications to minimize backup heat.

Design Discussion

- This configuration decouples ventilation air from the heat pumps, reducing the primary heat pump sizes. The DOAS ERV or HRV eliminates or reduces the size of the ventilation heat pump, which reduces installed capacity.
- The DOAS can be roof mounted at or near the location of the original RTU.
- Utilizing split systems or VRF removes the need for ductwork from rooftop units and allows the DOAS to use this existing ductwork or for existing ductwork to be demolished, opening up space for new DOAS ductwork routing. If existing ductwork is used, VAV boxes should be removed to reduce pressure drop on the system.
- Distributed minisplits or VRF systems also provide the advantage of improved control over spaces, allowing for heating and cooling of spaces at the same time based on specific loading requirements.
- Outdoor units can be roof mounted, wall, or ground mounted.
- Minisplits or VRF might not be appropriate for large open spaces and care should be taken to design to maintain space comfort.

SOLUTION PATHWAY 4: Replace Existing RTU with Ambient Loop and Water-Source Heat Pumps

If sufficient land is available, install a ground-source ambient loop. If land area is not available, a hybrid ground-source system can be installed that uses a cooling tower or air-to-water heat pump to provide additional heating and cooling to the loop. This ambient loop can be run throughout the building with local water-source heat pumps providing heating and cooling to each zone or space in place of the existing air-conditioning units. If centralized equipment is desired, a single water-to-water heat pump can provide hot and cold water to radiators or fan coils in each zone or space. Outdoor air can be treated utilizing a DOAS with an ERV/HRV or by the water-source heat pumps. Backup heat will not be necessary in this configuration as the water-source heat pumps are not affected by reduced capacity at very cold outdoor air temperatures due to the ground source loop ambient temperatures.

Design Discussion

- This pathway will likely have a higher first cost than other pathways due to the ground heat exchanger installation. However, this will eliminate the need for additional backup heat and can have a higher overall efficiency that can offset additional cost.
- This pathway provides many of the benefits of VRF systems in terms of efficiency and heat recovery but minimizes the amount of installed refrigerant in the building.
- The DOAS system can be located on the roof, in an attic, or in an appropriate mechanical room. Ducting for a DOAS system can use existing ductwork in buildings or following routing of old ductwork if applicable.
- Locations for new water-source heat pumps can be the existing RTU location or the existing location of the VAV boxes if possible. New water-source heat pumps can be ducted to serve multiple zones and in some cases could use existing ductwork from VAV boxes if they are sized appropriately.

- Ambient loop piping can follow the path of the existing ductwork if code allows such routing.
- Electrical capacity constraints are less likely to be a problem due to lack of required backup heat. However, care should be taken to determine if distributed or centralized equipment can be handled based on the differing panel infrastructure.

Scenario 4: Single Duct VAV Direct Expansion Air Handling Unit with Electric Reheat

VAV air handling units are a common system type used in medium to large buildings. These units have a central fan, a cooling coil, a heating coil, and a compressor inside the equipment. Depending on if the equipment is mounted in a mechanical room or outside, the condenser coils will also be included with the equipment. In this configuration, the equipment provides heating and cooling to multiple zones via a single duct. Each zone is typically controlled via a VAV box that has a damper or other method of controlling airflow to space and responds to a thermostat in the zone. These VAV boxes are equipped with heating coils—heated by either hot water or electric resistance—to reheat the air for dehumidification, and to heat the air to the desired temperature over the primary heating coil. These systems tend to have complex controls to adjust fan speed, damper positions, and supply air temperatures. This scenario will consider a single duct VAV unit with electric reheat and natural gas-fired primary heating.

Commentary

These systems are common across the commercial building stock but can pose a challenge to electrify the heating system as well as efficiently control. Since the building electric infrastructure was already sized for electric cooling, a similarly sized heat pump can be installed in its place. Similarly with systems that were sized for electric reheat, these system can be used to provide backup heat if necessary without exceeding electrical capacity constraints because the system was already sized to use electric heaters. Considering options that minimize new electric backup heat and use existing equipment can greatly reduce the cost for retrofitting these systems. For this scenario, utilizing equipment load data can inform new sizing of equipment. It is also recommended that for these systems a building stress test be performed to identify opportunities to use existing hot water coils at lower supply temperatures, as

many coils might have been oversized. If existing distribution or terminal equipment is to be used, any existing controls or equipment deficiencies should be remedied to ensure proper function of the new system as a whole.

SOLUTION PATHWAY 1: Replace Existing VAV Air Handling Unit with VAV Heat Pump RTU

This pathway replaces the existing air handling unit with an air-source heat pump. This system is a return air-only system coupled with an ERV/heat pump DOAS for treating outdoor air. By utilizing an ERV to pretreat the incoming air ventilation, load is reduced, reducing the size of heat pump required to further treat the outdoor air. In this configuration, outdoor air and return air can be controlled separately, which allows the return air unit to be sized for the internal loads only, which in turn keeps both units sized to their respective loads and reduces the risk of having the units oversized for part-load operation. Backup heat should be mitigated by selecting appropriate cold climate heat pumps. If backup heat is still required, utilizing existing VAV electric reheat can minimize new installed electrical as well as reduce project cost.

Design Discussion

- The new air-source heat pump can be installed in the same location as the existing VAV air handling unit if feasible.
- With a decoupled ventilation system, the return air heat pump can be sized for a smaller load. This smaller system can likely use existing ductwork for heating and cooling.
- Ductwork will need to be routed for the DOAS system but can follow similar routing path of existing VAV ductwork.
- DOAS can be roof mounted similar to the existing air handling unit if feasible.
- Electric VAV reheat should be controlled to minimize the operation of the electric heaters to improve overall system efficiency.

SOLUTION PATHWAY 2: Replace Existing RTUs with VRF or Minisplit Heat Pumps and DOAS

This pathway replaces all existing RTUs with a VRF or multi-head split system to manage return air only. This system either uses a single outdoor unit serving multiple indoor units or distributed split systems throughout the building to serve differing zones. A DOAS should be added to provide tempered outdoor air to space. This DOAS should include an ERV or HRV to recover heat from the exhaust air. A heat pump can also be used in the DOAS to provide additional heating or cooling in climates where the ERV or HRV is not sufficient to treat the outdoor air. All heat pumps should be selected for appropriate cold climate applications to minimize backup heat.

Design Discussion

- This configuration decouples ventilation air from the heat pumps, reducing the primary heat pump sizes. The DOAS ERV or HRV eliminates or reduces the size of the ventilation heat pump, reducing installed capacity.
- The DOAS can be roof mounted at or near the location of the original RTU.
- Utilizing split systems or VRF removes the need for ductwork from rooftop units and allow for the DOAS to use this existing ductwork or for existing ductwork to be demolished, opening up space for new DOAS ductwork routing. If existing ductwork is used VAV boxes should be removed to reduce pressure drop on the system.
- Distributed minisplits or VRF systems also provide the advantage of improved control over spaces allowing for heating and cooling of spaces at the same time based on specific loading requirements.
- Outdoor units can be roof mounted, wall, or ground mounted.
- Minisplits or VRF might not be appropriate for large open spaces and care should be taken to design to maintain space comfort.

SOLUTION PATHWAY 3: Replace Existing RTU with Ambient Loop and Water-Source Heat Pumps

If sufficient land is available, install a ground source ambient loop. If land area is not available, a hybrid ground source system can be installed, utilizing a cooling tower or air-to-water heat pump to provide additional heating and cooling to the loop. This ambient loop can be run throughout the building with local water-source heat pumps providing heating and cooling to each zone or space in place of the existing air-conditioning units. If centralized equipment is desired, a single water-to-water heat pump can provide hot and cold water to radiators or fan coils in each zone or space. Outdoor air can be treated utilizing a DOAS with an ERV/HRV or by the water-source heat pumps. Backup heat will not be necessary in this configuration as the water-source heat pumps are not affected by reduced capacity at very cold outdoor air temperatures due to the ground source loop ambient temperature. Ambient loop systems have increased efficiency in buildings or campuses that have simultaneous heating and cooling as heat from one space can be moved into the ambient loop and into another space as needed maintaining optimal loop temperatures and therefore higher heat pump efficiency.

Design Discussion

- This pathway will likely have a higher first cost than other pathways due to the ground heat exchanger installation. However, this will eliminate the need for additional backup heat and can have a higher overall efficiency that can offset additional cost.
- This pathway provides many of the benefits of VRF systems in terms of efficiency and heat recovery but minimizes the amount of installed refrigerant in the building.
- The DOAS system can be located on the roof, in an attic, or in an appropriate mechanical room. Ducting for a DOAS system can use existing ductwork or following routing of ductwork if applicable.

- Locations for new water-source heat pumps can be the existing RTU location or the existing location of the VAV boxes if possible. New water-source heat pumps can be ducted to serve multiple zones and in some cases could use existing ductwork from VAV boxes if they are sized appropriately.
- Ambient loop piping can follow the path of the existing ductwork if code allows such routing.
- Electrical capacity constraints are less likely to be a problem due to lack of required backup heat. However, care should be taken to determine if distributed or centralized equipment can be handled based on the differing panel infrastructure.

Scenario 5: Existing Central Plant (Chilled Water and Hot Water)

Central plants are common in medium to large commercial buildings. Hot water and chilled water are produced at a central piece of equipment and then pumped to equipment throughout the building. This equipment can be air based or radiant based systems such as air handling units or radiant panels. This equipment uses the energy produced by the central plant to heat and cool the building or group of buildings. Central plants typically consist of a chiller and boiler to cool and heat the water for the building. This scenario will consider an air-source chiller and natural gas boiler serving equipment in the buildings.

Commentary

These systems are common across the commercial building stock. The equipment is large and electric backup heat is not feasible for many of these systems due to the large demands this would cause. Since the building electric infrastructure was already sized for electric cooling, a similarly sized heat pump can be installed in its place. For these large systems, opportunities for heat recovery and equipment staging should be prioritized to maximize system efficiency, provide proper part load operation, and minimize electric backup. For this scenario, utilizing equipment load data can inform new sizing of equipment. It is also recommended that for these systems a building stress test be performed to identify opportunities to use existing hot water coils at lower supply temperatures as many coils might have been oversized. If existing distribution or terminal equipment is to be used, any existing controls or equipment deficiencies should be remedied to ensure proper function of the new system as a whole.

SOLUTION PATHWAY 1: Replace Existing Chiller and Boiler with Air-to-Water Heat Pumps

This pathway replaces the existing chiller with an air-to-water heat pump to produce chilled and hot water. If there are significant simultaneous heating and cooling loads, a heat recovery chiller should be selected. This could be as part of modular multitask chiller, a second staged chiller with a secondary heat recovery condenser bundle, or as a separate heat recovery chiller. This heat recovery can be used to serve simultaneous loads such as reheat in VAV boxes, hot water, or cooling loads in the heating season. This effectively allows the chiller to serve the roll of two pieces of equipment and serve multiple loads with one compressor improving overall efficiency. In this configuration, existing terminal equipment will need to be retrofit with coils or redesigned for lower entering water temperatures (<140°F). When considering backup heat, large electric resistance coils will most likely result in electrical capacity constraints. Some solutions for backup heat can be utilizing the existing natural gas boiler to provide heating during cold weather operation. Another solution is installing a second heat pump to help provide the additional capacity needed in cold temperatures. Another solution is to use existing reheat in the terminal equipment such as VAV boxes to make up the reduced capacity during cold weather operation.

Design Discussion

- New heat pump equipment can be installed in place of existing air-source equipment. Split systems can also be explored to use indoor units in an existing mechanical room with remote condensers located outside.
- As discussed, piping and hot water coils will need to be able to handle lower water temperatures.
- Sources of waste heat should be investigated to provide waste heat recovery (sewage, industrial, etc.)
- Part-load capacity is especially important for large systems that serve multiple pieces of equipment because diversity in loads can result in low load operation much of the time.

SOLUTION PATHWAY 2: Replace Existing RTU with Ambient Loop and Water-Source Heat Pumps

If sufficient land is available, install a ground source ambient loop. If land area is not available a hybrid ground source system can be installed, utilizing a cooling tower or air-to-water heat pump to provide additional heating and cooling to the loop. This ambient loop can be run throughout the building with local water-source heat pumps providing heating and cooling to each zone or space in place of the existing air-conditioning units. If centralized equipment is desired, a single water-to-water heat pump can provide hot and cold water to radiators or fan coils in each zone or space. Outdoor air can be treated utilizing a DOAS with an ERV/HRV or by the water-source heat pumps. Backup heat will not be necessary in this configuration as the water-source heat pumps are not affected by reduced capacity at very cold outdoor air temperatures due to the ground source loop ambient temperatures. Ambient loop systems have increased efficiency in buildings or campuses that have simultaneous heating and cooling as heat from one space can be moved into the ambient loop and into another space as needed maintaining optimal loop temperatures and therefore higher heat pump efficiency.

Design Discussion

- This pathway will likely have a higher first cost than other pathways due to the ground heat exchanger installation. However, this will eliminate the need for additional backup heat and can have a higher overall efficiency that can offset additional cost.
- This pathway will require all buildings that is a part of the existing campus loop to have mechanical equipment redesigned and should be considered in project phasing.
- This pathway provides many of the benefits of VRF systems in terms of efficiency and heat recovery but minimizes the amount of installed refrigerant in the building.
- The DOAS system can be located on the roof, in an attic, or in an appropriate mechanical room. Ducting for a

DOAS system can use existing ductwork in buildings or following routing of old ductwork if applicable.

- Locations for new water-source heat pumps can be the existing RTU location or the existing location of the VAV boxes if possible. New water-source heat pumps can be ducted to serve multiple zones and in some cases could use existing ductwork from VAV boxes if they are sized appropriately.
- Ambient loop piping can follow the path of the existing piping.
- Electrical capacity constraints are less likely to be a problem due to lack of required backup heat. However, care should be taken to determine if distributed or centralized equipment can be handled based on the differing panel infrastructure.

References

Sheppy, Michael, Luigi Gentile-Polese, and Scott Gould. 2014. *Plug and Process Loads Capacity and Power Requirements Analysis*. National Renewable Energy Laboratory. DOE/GO-102014-4277. <https://www.nrel.gov/docs/fy14osti/60266.pdf>.



The Heritage is a mixed-use development in Manhattan's East Harlem neighborhood. It is set to undergo improvements to the envelope and the integration of high efficiency heat pumps.

Photo from NYSERDA

CHAPTER 5:
ENSURING
SUCCESS,
RELIABILITY,
AND
LONGEVITY:
BEST PRACTICES
IN HEAT
PUMP SYSTEM
INSTALLATION



Water-to-air heat pump located above an office area in a commercial building
Photo from Brian Boylson, Lendlease

The installation of heat pump systems is a critical step in ensuring their successful operation, reliability, and longevity. Proper installation not only enhances the performance of these systems but also contributes to energy efficiency and reduced maintenance costs. This section covers key installation best practices to pave the pathway for successful heat pump operation. These practices include eliminating refrigerant leaks, incorporating submetering, preserving the existing heating system (if possible), avoiding unnecessary electrical upgrades, prioritizing air sealing, and internal condensate drainage.

Eliminate Refrigerant Leaks

One of the foremost considerations during heat pump installation is the prevention of refrigerant leaks. Refrigerant leaks not only harm the environment but also compromise the efficiency and performance of the system. To eliminate leaks, it is crucial to:

- 1. Use proper materials and techniques:** Ensure that qualified technicians use appropriate materials and follow industry standard techniques for connecting refrigerant lines. Leak testing should be carried out meticulously to detect and rectify any issues before commissioning the system.
- 2. Regular maintenance:** Implement a maintenance schedule that includes routine inspections for leaks. Address any leaks promptly to prevent them from escalating into more significant problems.

Submeter

Submetering of heat pumps and central plant systems—including tower side and building side pumps, plate and frame heat exchangers, and cooling tower fan and heat transfer performance—is an invaluable tool for assessing overall system performance and optimizing energy usage. A feedback loop ensures that the system operates efficiently over time:

- 1. Real-time monitoring:** Install meters to measure the electrical and thermal performance of the heat pump system. These data can be used to identify any

deviations from expected efficiency levels, enabling timely adjustments and improvements.

- 2. Feedback for optimization:** A feedback loop enables system optimization by providing information about energy consumption patterns. This information can guide decisions regarding system operation and maintenance to achieve optimal efficiency.

If Possible, Preserve the Existing Heating System

Retaining the existing heating system can serve as a future demand limiter, ensuring that the heat pump operates efficiently even in extreme conditions:

- 1. Dual-system compatibility:** Install the heat pump in conjunction with the existing heating system to provide a backup during extreme cold or system downtime.
- 2. Efficient hybrid operation:** Use controls and thermostats that can switch between the heat pump and the existing heating system as needed, optimizing energy use and comfort.

Avoid Unnecessary Electrical Upgrades

It is essential not to assume that an electrical upgrade is necessary when installing a heat pump system:

- **Load analysis:** Conduct a thorough electrical load analysis to determine if the existing electrical system can accommodate the heat pump. In many cases, heat pump installations can be integrated into the current electrical infrastructure without significant upgrades.
- **Efficient design:** Work with a qualified electrician or electrical engineer to design the electrical connections efficiently, minimizing the need for costly upgrades while ensuring safety and compliance with local codes.

Prioritize Air Sealing

Air sealing is integral to heat pump system performance and should never be treated as optional:

- **Seal ducts and enclosures:** Seal all ducts and enclosures to prevent air leaks. This ensures that the heat pump system operates at peak efficiency and minimizes energy losses.
- **Air quality considerations:** Air sealing also enhances indoor air quality by reducing the infiltration of pollutants, allergens, and outdoor contaminants.

Internal Condensate Drainage

Efficient internal condensate drainage minimizes the need to drill holes in the building's exterior, preserving its integrity:

- 1. Condensate management:** Install internal condensate drainage systems to safely and efficiently remove condensate from the heat pump. This reduces the risk of water damage and the need for additional penetrations in the building envelope.
- 2. Aesthetic and structural considerations:** Avoiding unnecessary holes in the building's exterior also preserves its aesthetics and structural integrity while maintaining energy efficiency.

The following table summarizes key installation considerations and best practices.

Table 8. Heat Pump Installation Considerations

Consideration	Additional Notes
Ensure adequate power capacity	Verify if the existing amperage can handle the new heat pump equipment. An electrical engineer or qualified electrical contractor should be consulted because installing heat pumps may increase required electrical capacity.
Review supplied system voltage	Power feed can sometimes creep over the tolerance for the heat pumps, causing compressor and board failures. The fix is a transformer specific to the heat pumps. Installing a power monitoring tool to verify the existing conditions can help. In most cases, installing surge protectors on each unit alleviates power quality issues.
For VRF systems, having more, smaller-capacity outdoor units is better practice than fewer, larger-capacity units	This provides better redundancy in case of equipment failure.
Outside air and conditioned ventilation are always concerns to be examined	Often this needs to be handled by a separate system.
Condensate drains need to be addressed early in the design to ensure good piping practices	Proper condensate drain designs ensure high efficiency and reliability. Manufacturers have specific installation and operation instructions that detail minimum equipment mounting height and spacing.
Service with filter changes/wash needs to be planned	The fine mesh filters in the cassettes and wall units can lint over and restrict air quickly.
VRF systems, specifically ceiling cassette or wall mounted units, are not ideal for larger spaces	It's better to separate larger spaces and use larger-capacity rooftop units.
Good piping practices are key to a successful leak-free system	Primarily a consideration for VRF systems. Keep accurate track of the piping distances to stay under maximum design criteria. Do not use 45-degree fittings. All pipe bends should be long radius 90-degree fittings. Consult with the VRF manufacturer as design requirements vary.

Consideration	Additional Notes
In VRF systems, the edges of refrigerant pipes need to be sealed. Nitrogen gas must be used during welding to prevent oxidation of the interiors of refrigerant pipes.	A detailed installation manual must be followed.
The installer should be familiar with the system control options	For example, in VRF systems each individual indoor unit can be controlled by a programmable thermostat or multiple indoor units serving the same zone can be controlled by the same thermostat.
Submeter the heat pump system	Submetering of heat pumps is an invaluable tool for assessing system performance and optimizing energy usage. A feedback loop ensures that the system operates efficiently over time.
If possible, keep existing system in place	Retaining the existing heating system can serve as a future demand limiter, ensuring that the heat pump operates efficiently even in extreme conditions.
Prioritize air sealing	Air sealing is integral to heat pump system performance and should never be treated as optional.
Correct VRF refrigerant piping installation is critical	It is not uncommon for (even new) systems to malfunction if the refrigerant piping is not installed to meet the exact requirements of the manufacturer, such as pipe sizes, pipe lengths, and number of elbows. These variables can have a profound impact on the system pressures, and the system can malfunction if pipe configuration is incorrect. Best practices include having a specification requirement that the VRF equipment vendor provide a complete refrigerant piping submittal, with the requirement that the contractor must install the piping system per the manufacturer’s layout drawings.
Add redundancy	<p>The external heat rejection system can be the weakest link in a heat pump system. This is because the cooling towers are usually “open loop wet” systems. Accordingly, best practices include:</p> <ol style="list-style-type: none"> 1. Providing a fully redundant plate and frame heat exchanger to allow operation of the lag unit while the plates are removed/cleaned in the lead unit. 2. Providing a reasonable safety margin in the sizing of the cooling tower in consideration of capacity reduction when the cooling tower heat transfer surfaces are affected by biological growth, dirt/dust/cottonwood, etc. 3. Consider multiple cell cooling towers to allow (at least partial) capacity during motor maintenance or failure.

Proper installation of heat pump systems is a crucial step in ensuring their successful operation, reliability, and longevity. By adhering to best practices, such as eliminating refrigerant leaks, submetering, preserving the existing heating system, avoiding unnecessary electrical upgrades, prioritizing air sealing, and internal condensate drainage, stakeholders can enjoy the benefits of energy-efficient, eco-friendly, and

cost-effective heating and cooling solutions. These practices not only contribute to reduced operational costs but also promote sustainability and environmental responsibility in the HVAC industry.

APPENDIX



Dry cooling tower for water-source heat pump on the rooftop of a Walmart store.

Photo from Walmart

Heat Pump Basics

Heat Pump Working Principles

A heat pump works on the principle of the vapor compression refrigeration cycle, similar to that in a refrigerator or an air conditioner. Naturally, heat flows from high temperature to low temperature, but while in this system, heat is moved from a lower temperature level to higher temperature level. As this is against the natural flow, energy input is required to move the heat from the low temperature location to a high temperature location. Some systems, such as refrigerators, only move heat in one direction. For the refrigerator, heat is removed from the inside of the refrigerator (cold location) and moved to the outside of the refrigerator (warm location, which is often the room). Heat pumps often have the ability to move heat in two directions, depending on whether the building needs heating or cooling. A reversing valve is used to effectively reverse the refrigerant flow through the heat exchangers. When it is cold outside, the heat pump extracts heat from the outdoor environment and transfers it to the indoor space, providing warmth. When it is warm outside, it reverses the direction and removes heat from inside and dumps outside, cooling the indoor space. The cooling is the same as traditional air-conditioning systems. Heating with a heat pump is basically an air conditioner in reverse.

The heat pump extracts energy from the environment which can be air, a body of water, or the ground. They are classified accordingly based on their heat source as an air-source heat pump, water-source heat pump, or ground-source heat pump. Sometimes a ground-source heat pump is also called a geothermal heat pump. Air-source heat pumps dissipate or extract heat from the outdoor air, whereas water-source heat pump from a water source, such as surface water, ground water, sea, sewage water, or cooling tower loop, and ground-source heat pumps take advantage of ambient heat several feet below ground. Heat is distributed to the conditioned space via air or water. Heat pumps are further categorized based on distribution fluid type along with heat source as air-to-air,

air-to-water, water-to-air, water-to-water, ground-to-air, and ground-to-water heat pumps.

The efficiency of the heat pump is highly dependent on the difference in temperature between the cold and hot temperature reservoirs. The smaller the temperature difference, the more efficient the heat pump.

The efficiency of the heat pump is highly dependent on the difference in temperature between the cold and hot temperature reservoirs. The smaller the temperature difference, the more efficient the heat pump. Often ground temperatures are closer to indoor temperatures in the wintertime, and therefore a ground-source heat pump is typically more efficient. In the summer, the ground temperature is often cooler than the desired inside temperature, making it easy to move heat from the building into the ground (at very high efficiencies). Availability of outdoor space for drilling boreholes or digging trenches is a major prerequisite while choosing ground-source heat pump.

The heat pump exploits the physical properties of refrigerant which undergoes phase change from liquid to gas and back again, as the heat is absorbed from heat source and released to heat sink. As the refrigerant changes its state, heat is absorbed and dissipated by the heat pump system, thus enabling cooling or heating operations. Most heat pumps have electrically driven compressors that circulate the refrigerant continually through a closed system of coils and pipes. The parts of the heat pump are similar to that of a refrigerator or an air conditioner with four key components: compressor; expansion valve; heat exchangers, which include an evaporator and condenser; and a reversing valve which helps in switching the direction of refrigerant flow to change between heating and cooling modes.

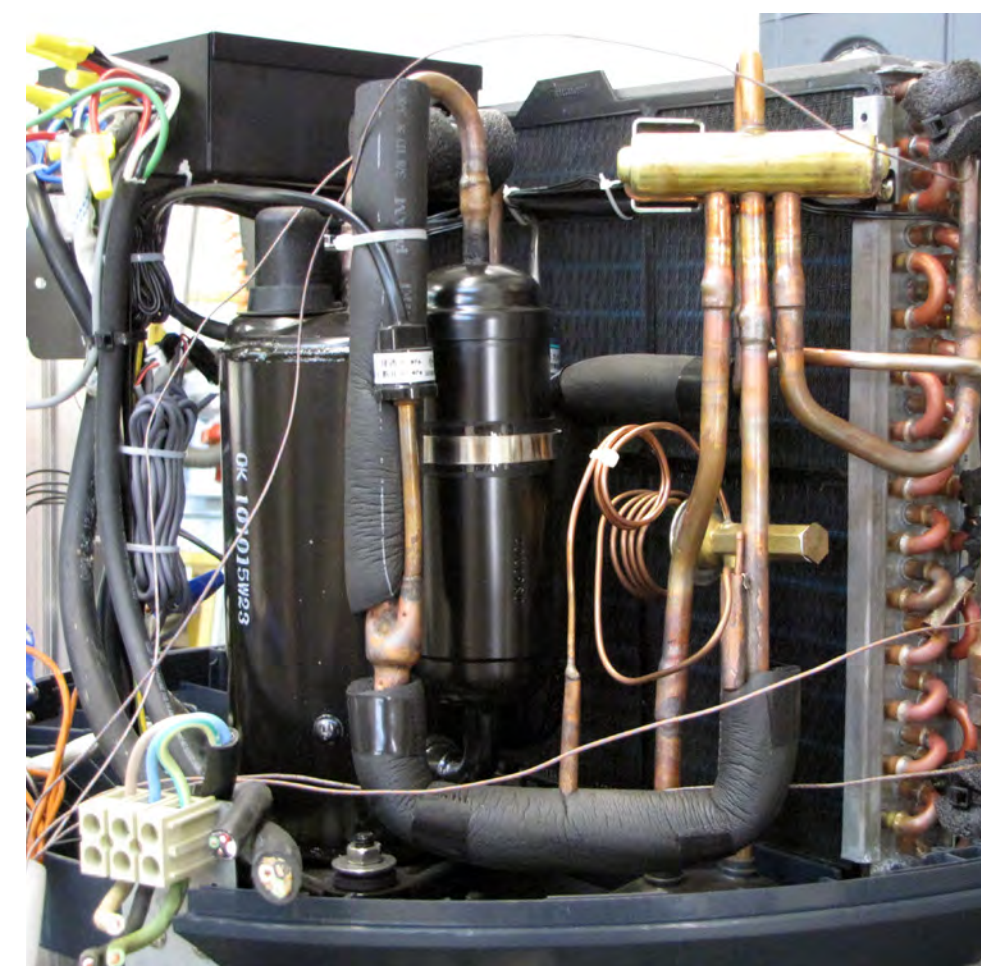

Interior components of a packaged heat pump.

Photo by Kate Hudonn, NREL 19462

Figure 41(a) shows the schematic of vapor compression refrigeration cycle with the main components of a heat pump system, and **Figure 41(b)** shows the corresponding thermodynamic cycle of the vapor compression refrigeration system. The refrigerant enters the compressor in a gaseous state at low pressure (1). It is then pumped by the compressor, which increases the pressure and temperature of the refrigerant vapor. The resulting hot, high-pressure refrigerant vapor (2) enters the condenser where heat is transferred to the sink, which is at a lower temperature. Inside the condenser, the refrigerant condenses into a liquid. This liquid refrigerant (3) then flows from the condenser to the expansion device. The expansion device creates a pressure drop of the refrigerant to that of the evaporator and is cooled to the desired evaporator temperature. The cool mixture of liquid and vapor refrigerant at low pressure (4) travels to the evaporator to repeat the cycle. Refrigerant enters the evaporator coil as cold, low-pressure liquid and vapor mixture (4). Heat is transferred to the refrigerant from the source, causing the liquid refrigerant to boil.

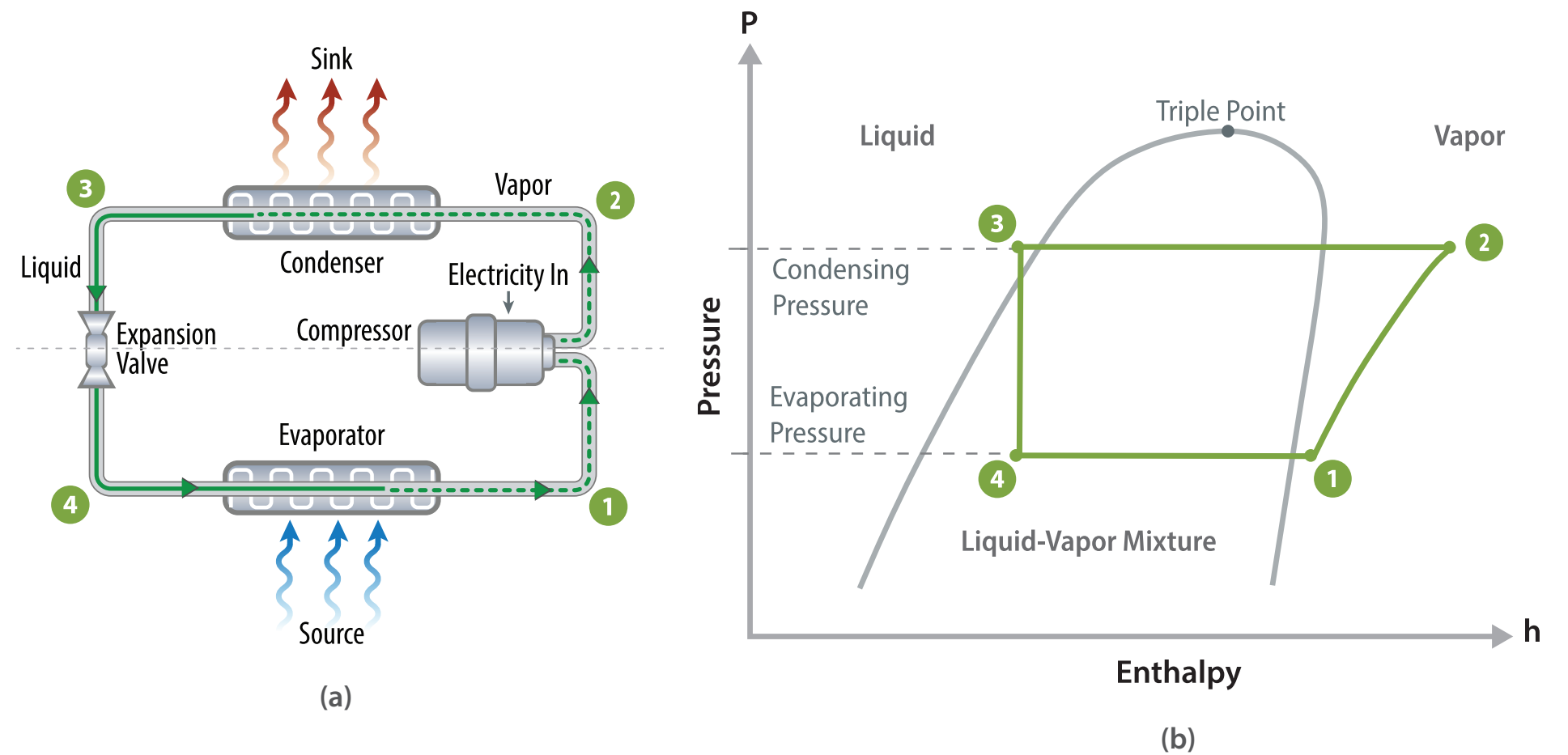

Figure 41. (a) Schematic of a standard vapor compression refrigeration system (b) Thermodynamic cycle of a standard vapor compression refrigeration system

Heat Pumps Operate in Two Modes

Cooling mode: In cooling mode, the heat pump operates the same as the refrigeration cycle mentioned above. **Figure 42** shows a heat pump that transfers heat from air to air and vice versa working in cooling mode. Hot, high-pressure refrigerant vapor is pumped from the compressor to the outdoor coil that functions as the condenser in cooling mode. Inside this heat exchanger, heat is transferred from the refrigerant vapor to the ambient air, and the refrigerant condenses into a liquid. The liquid refrigerant then flows through an expansion device that reduces the pressure and temperature of the refrigerant. The resulting mixture of cool liquid and vapor travels to the indoor coil that functions as the evaporator in the cooling mode. Inside this heat exchanger, the refrigerant absorbs heat from the relatively warm air, cooling the air and causing the liquid refrigerant to boil. The resulting refrigerant vapor is then pumped back to the compressor, which increases its pressure and temperature to repeat the cycle.

Heating mode: A heat pump includes a reversing valve that allows it to also function in heating mode. **Figure 43** shows the same air-to-air heat pump operating in heating mode. In heating mode, hot, high-pressure refrigerant vapor is pumped from the compressor, and is diverted by this reversing valve to the indoor coil. In the heating mode, this indoor coil functions as the condenser, and heat is transferred from the refrigerant vapor to the lower temperature air. The air is heated, and the refrigerant condenses into a liquid. The liquid refrigerant then flows through the expansion device and travels to the outdoor coil, that in the heating mode, now functions as the evaporator. Inside this heat exchanger, the refrigerant absorbs heat from the ambient air, causing the liquid refrigerant to boil. The refrigerant vapor travels back through the reversing valve to the compressor to repeat the cycle.

The reversing valve, piping, and controls inside the heat pump allow it to perform both cooling and heating functions.

Though there are different heat pump cycles, most heat pumps operate using the vapor compression refrigeration cycle to transfer heat energy from one location to another.

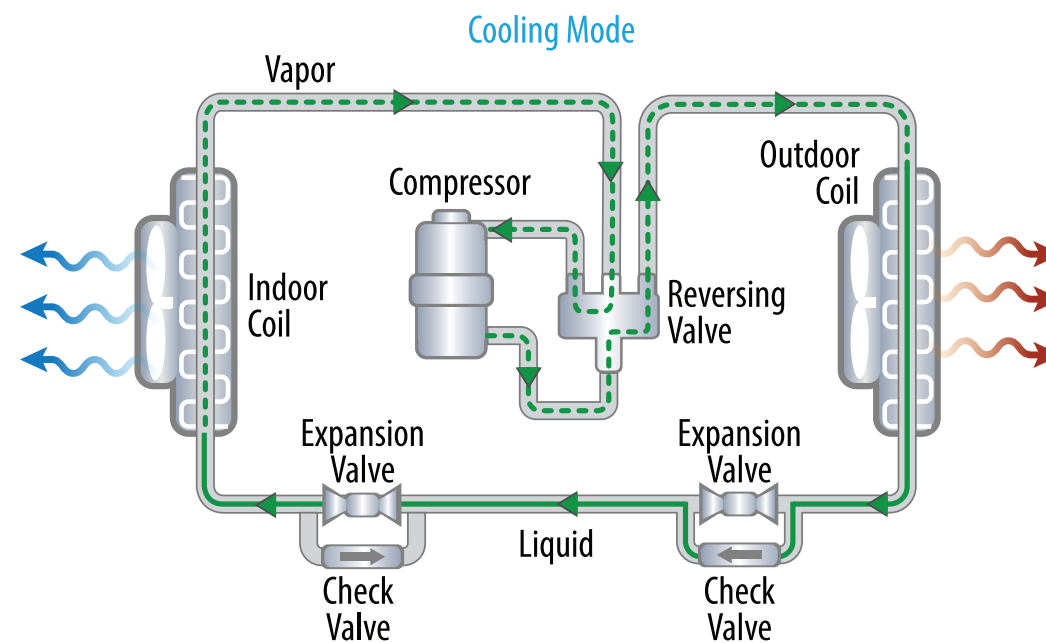

Figure 42. Air-to-air heat pump operating in cooling mode

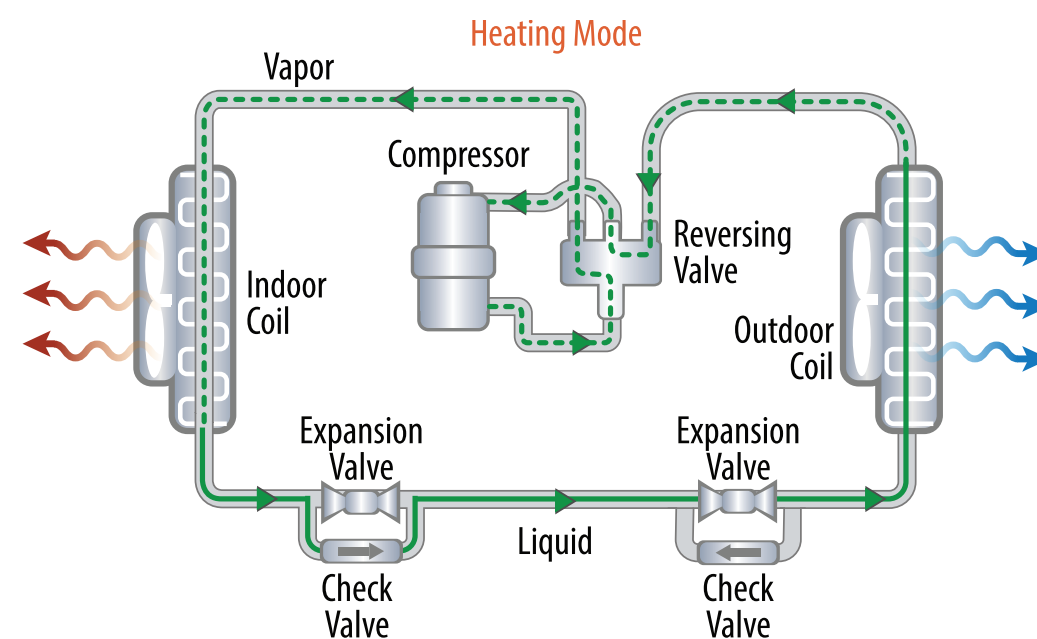

Figure 43. Air-to-air heat pump operating in heating mode

Basic Components of Heat Pump Equipment and Their Operation

As noted, the main components of the heat pump are compressor, heat exchanger coils, expansion valve, and reversing valve. The heat exchanger coils are placed as indoor and outdoor coils in the heat pump system and their functions are swapped as condenser or evaporator between heating and cooling operation using the reversing valve.

Compressor

A compressor is the central component of the heat pump system. The compressor pumps and circulates refrigerant through the evaporator and condenser coils to transfer heat. Within the compressor, the refrigerant is compressed to very high pressures while its temperature also increases significantly. This compression is achieved through the mechanical action of the compressor. The gaseous refrigerant enters the suction pipe of the compressor at low pressure and low temperature, and it is compressed and discharged at high pressure and high temperature, still in a gaseous state. The compressor is typically driven by electric power, but it can also be powered by other sources.

Compressors are classified into two basic types—positive displacement compressors and dynamic type compressors—depending on pressure, compressible medium, environmental conditions, structure, and type. In positive displacement compressor, a constant volume of the fluid is compressed from suction to discharge of the compressor while dynamic compressors work at constant pressure. Positive displacement compressors are further classified into reciprocating and rotary compressors, and dynamic compressors are categorized based on their axial or radial design. Most heat pump compressors are positive displacement units. In the reciprocating compressors, the piston reciprocates inside the cylinder to produce compression of the working fluid. The pistons can be single acting, double acting, or diaphragm type. Rotary compressors have two revolving elements between which the working fluid is compressed in a closed chamber. Lobe, liquid ring, vane, scroll,

screw, and centrifugal compressors are the types of rotary compressors. Most heat pump manufacturers have switched to scroll compressors because they consume less power and generates less noise compared to other reciprocating compressors. Compressors can be installed in either single or multistage configuration and can be connected to each other in series or in parallel.

Heat Exchanger Coils

Heat pump systems incorporate two coil components: the evaporator and the condenser to transfer heat. These coils absorb or reject heat between two mediums that possess different temperatures. Most heat exchangers either have coil or plate design and these designs are applied to different heat exchanger types. Fin and tube heat exchangers are commonly used in heat pump systems. In these heat exchangers, refrigerant flows through inside the coils and air flows outside through the fins. Each heat exchanger coil becomes an evaporator or a condenser depending on heating or cooling operation. A heat pump has two different coils, one indoor and one outdoor. During heating mode, the outdoor coil functions as the evaporator, drawing in heat, while the indoor coil functions as condenser and disperses heat into the indoors. Conversely, in cooling mode, the indoor coil serves as the evaporator, absorbing heat, while the outdoor coil expels heat to the environment to maintain a cool indoor environment. The functions of evaporator and condenser are described below.

Evaporator

The evaporator is a low-temperature heat exchanger. Its primary function is to absorb heat from its surroundings, which can be the outdoor environment (in heating mode) or the indoor space (in cooling mode). The refrigerant enters the evaporator from the expansion valve in liquid form at low temperature and pressure, which then absorbs heat from surroundings through evaporation and leaves as low-temperature vapor. Due to the lower temperature of the refrigerant inside the evaporator, it tends to absorb the heat from the surroundings. During this process, its pressure remains constant

and becomes a gas. The low-pressure refrigerant vapor exiting from the evaporator in gaseous form is directed into the compressor for the compression process.

Condenser

The condenser in the heat pump system is responsible for releasing heat collected from indoor space to outdoor environment in cooling mode or from outdoor environment to indoor in heating mode. The high-temperature, high-pressure vaporized refrigerant from the compressor enters the condenser coil. As the refrigerant flows through the condenser coil, it begins to release the heat it has absorbed from the indoor space or outdoor environment. Due to the heat release and cooling, the refrigerant undergoes a phase change from vapor to high-pressure liquid state. The refrigerant exiting the condenser enters the expansion valve. The condenser and evaporator are typically made of copper tubing with aluminum fins or all-aluminum tubing.

Expansion Valve

The expansion valve acts as a metering device regulating the flow of refrigerant and controlling its pressure and temperature as it passes from the high-pressure side of the system to the low-pressure side. It is located in the liquid line between the condenser and evaporator. Refrigerant enters the expansion valve from the condenser at high pressure. As the refrigerant passes through the expansion valve, it encounters a narrow passage or orifice. This constriction causes a significant reduction in pressure and temperature, which then enables it to absorb heat in the evaporator. Refrigerant exits the expansion valve in partially liquid and partially gaseous states when pressure and temperature are low. There are several types of expansion valves commonly used in heat pump systems: thermostatic expansion valve, electronic expansion valve, capillary tube, manual valve, float valve and automatic expansion valve. The choice of expansion valve type depends on factors like system size, complexity, efficiency requirements, and cost considerations. Thermostatic expansion valve are prevalent in many heat pump systems due to their reliability and cost-effec-

tiveness, while electronic expansion valve are favored in more advanced and precise applications.

Reversing Valve

The reversing valve in a heat pump system serves a critical function—it allows for the reversal of the refrigerant flow direction within the system. This valve enables the heat pump to switch between heating and cooling modes as needed to maintain the desired indoor temperature by altering the refrigerant's path through the system. When the heat pump is in heating mode, the reversing valve is positioned so that it directs the flow of pressurized refrigerant from the outdoor coil (evaporator) to the indoor coil (condenser). This allows the indoor coil to absorb heat from the outdoor environment and releases it to the indoor space to warm the building. When the heat pump switches to cooling mode, the reversing valve reverses the flow of refrigerant in the system. It redirects the refrigerant flow from the indoor coil (evaporator) to the outdoor coil (condenser) so that it absorbs heat from the indoor space and releases it outdoors. This is the opposite of what happens in heating mode. This valve is typically controlled by the thermostat or the system's control board to ensure that the heat pump operates in the appropriate mode based on the heating or cooling requirements of the space. A four-way reversing valve is the most common type of reversing valve used in heat pumps. It has four ports, allowing it to change the direction of refrigerant flow between the indoor and outdoor coils and transitioning between heating and cooling modes.

Check Valve

Check valves ensure that refrigerant flows in the correct direction through the heat pump system components while preventing it from flowing in the opposite direction. For example, they prevent the refrigerant from backflowing into the compressor, which could lead to inefficient operation and potential damage to the compressor. Check valves are important for maintaining the proper operation, efficiency, and safety of the heat pump.

A check valve consists of a valve body with an internal mechanism, often a spring-loaded poppet or disk. When the pressure on the inlet side (the side where refrigerant enters) is greater than the pressure on the outlet side (the side where refrigerant exits), the valve remains open, allowing refrigerant to flow through. When the pressure on the outlet side becomes greater than the pressure on the inlet side (indicating a reverse flow or backflow), the internal mechanism of the check valve closes, preventing refrigerant from flowing in the reverse direction. Some check valves have a cracking pressure, which is the minimum pressure differential required to open the valve. This ensures that the valve only opens when the pressure on the inlet side exceeds a certain threshold.

Spring-loaded check valves, swing check valves, and inline check valves are the most commonly used check valves in heat pump systems. Spring-loaded check valves are the most common type of check valve and use a spring-loaded mechanism to control the valve's opening and closing based on pressure differentials.

Refrigerant

Refrigerant is a central component of heat pump system, and its utilization is essential for the heat transfer process that allows the heat pump to provide heating and cooling functions efficiently. They play a vital role by enabling the absorption and release of heat through changes in their physical state (from liquid to vapor and vice versa) and by facilitating heat exchange between different environments. They absorb heat when they evaporate (change from liquid to vapor) and release heat when they condense (change from vapor to liquid), making them essential for cooling and heating applications. All major components within the heat pump system are connected together by refrigerant lines. As a result, they can work efficiently together when transferring heat energy between indoors and outdoors simultaneously. Refrigerants flow through refrigerant lines and pipes that connect the inside and outside equipment.

Refrigerants are excellent heat transfer mediums. They are selected based on their specific thermodynamic properties that allow them to efficiently absorb heat at low temperatures and release it at higher temperatures. The choice of refrigerant significantly impacts the efficiency of cooling and heating systems. The most common types of refrigerants currently in use are hydrochlorofluorocarbons (HCFCs), hydrofluorocarbons (HFCs), hydrofluoroolefins (HFOs), hydrocarbons (HCs), carbon dioxide (CO₂ or R-744), and ammonia (NH₃ or R-717). The environmental impact of refrigerants has become a critical concern due to their potential contribution to global warming and ozone depletion. As a result, there is a growing emphasis on using refrigerants with low environmental impact. Low-global warming potential refrigerants, including HFOs and certain HCs, are being adopted to replace high global warming potential refrigerants in various applications. HCFCs were widely used but are being phased out due to their ozone-depleting potential. HFCs replaced HCFCs in many applications but have high global warming potential, which has led to efforts to transition away from them. HFOs are designed to have lower global warming potential than HFCs and are considered a transition option to reduce environmental impact. HCs such as propane (R-290) and isobutane (R-600a) along with natural refrigerants such as CO₂ and NH₃ have low global warming potentials and are gaining popularity due to their minimal environmental impact.

Other Components

In addition to the main components, heat pump systems often include several other key components to facilitate their operation and enhance efficiency. These components may vary depending on the specific design and type of heat pump (air-source, water-source, or ground-source) and the intended application (residential, commercial, or industrial), but some common additional components include:

Thermostat: A thermostat is used to control the heat pump's operation by setting the desired temperature in the building. It includes an interface panel or digital display for users to monitor and adjust the heat pump's settings. Modern thermo-

stats may include programmable features, Wi-Fi connectivity, and advanced control options.

Sensors: Various sensors are employed to monitor conditions and optimize the heat pump's performance. These sensors can include temperature sensors, pressure sensors, and humidity sensors.

Backup heating elements: Some heat pump systems, especially in colder climates, include electric heating elements as a backup heat source. These elements provide occasional supplemental heating.

Control board or control system: The control board or control system manages the overall operation of the heat pump. It receives input from sensors and the thermostat, controls the operation of the compressor and other components, and ensures that the system operates efficiently and safely.

Defrost control: When the outdoor temperature is relatively cool, a defrost control system is used to prevent frost buildup on the outdoor coil. This system may include a defrost timer or sensors that trigger defrost cycles when needed.

Measures of Efficiency

Efficiency measures for heat pumps are important in assessing their performance and determining their effectiveness in providing heating and cooling. Several key measures are commonly used to evaluate the efficiency of heat pumps.

Coefficient of Performance

Coefficient of performance (COP) is one of the fundamental measures of heat pump efficiency. It represents the ratio of the heat output (in the form of heating or cooling) to the electrical power input at a specified set of operating temperatures. In heating mode, COP is expressed as:

$$\text{COP} = Q_{\text{condenser}} / W_{\text{compressor}}$$

In cooling mode, COP is expressed as:

$$\text{COP} = Q_{\text{evaporator}} / W_{\text{compressor}}$$

where,

Q– heat output (heating delivered by condenser in heating mode or cooling delivered by evaporator in cooling mode)

W– compressor electrical power input

The higher the COP, the more efficient the heat pump. A higher COP signifies lower energy consumption for the same heating output.

Seasonal Energy Efficiency Ratio

Seasonal energy efficiency ratio (SEER) is a metric primarily used to assess the cooling efficiency of heat pumps and air conditioners. It measures the cooling output over an entire cooling season (usually in Btu) divided by the total electrical energy input (in watt-hours) during the same period. Higher SEER ratings indicate more efficient cooling. SEER is expressed as a numerical value, with higher values indicating greater efficiency.

Heating Seasonal Performance Factor

Heating seasonal performance factor (HSPF) is a metric used to evaluate the heating efficiency of heat pumps. Similar to SEER, it measures the heating output (in Btu) divided by the total electrical energy input (in watt-hours) over an entire heating season. Higher HSPF ratings indicate greater heating efficiency.

Heat Pump Controls

Heat pump controls are essential components that manage and optimize the operation of heat pump systems to ensure efficient heating and cooling. Various control systems and components work together to regulate the heat pump's performance. The following subsections describe some common heat pump controls.

Thermostat Control

The thermostat is the user interface that allows building occupants to set and control the desired temperature and operating mode (heating, cooling, or fan-only). It falls under the category of user interface control because it provides a means for users to interact with and control the heat pump system. These controls serve distinct purposes within a heat pump system, contributing to efficient operation, user comfort, and system performance. Properly configuring and coordinating these controls is essential for optimizing the heat pump's operation and energy efficiency.

Speed Control

Inverter-based heat pump systems, often referred to as inverter heat pumps, represent an advanced and highly efficient technology used in HVAC systems. These systems incorporate inverter technology to modulate the speed and output of the heat pump's compressor and other components. The key feature of inverter-based heat pumps is the use of an inverter-driven compressor. Traditional heat pumps use fixed-speed compressors that operate at a constant speed, either at full capacity or switched off. In contrast, inverter-based heat pumps use a variable-speed compressor, which can adjust its speed and output continuously based on the heating or cooling demand. The variable-speed compressor in an inverter heat pump can operate at various speeds within a wide range. It can slow down or speed up depending on the indoor temperature, outdoor conditions, and the desired setpoint on the thermostat. Inverter control involves the use of sophisticated electronics to adjust the compressor's speed. Sensors continuously monitor temperature and load conditions, sending feedback to the inverter controller. The controller then modulates the compressor's speed to maintain the desired temperature while minimizing energy consumption. Usually heat pumps come as single stage, two stage and variable stage.

Single-stage or one-stage heat pumps run at full capacity all the time, and they are more affordable and best for mild climates. They don't remove as much humidity during air-con-

ditioning cycles, and they create slight temperature swings. In other words, climate control is a weak point. Two-stage heat pumps have a low- and high-capacity level. Low is usually 65% or 70% of capacity. Two-stage heat pumps have a good blend of efficiency, performance, and reasonable cost, although they cost more than single-stage units and are not as efficient as variable capacity. Variable-capacity heat pumps, also known as modulating heat pumps, run at a range of capacities from either 25% to 100% or 40% to 100%. They deliver the best climate control.

Defrost System and Controls

In an air-source heat pump, it is possible for the outdoor (evaporator) coil to accumulate frost or ice under certain conditions of cold outdoor air temperature and relative humidity when it is operating in heating mode. This leads to reduced airflow and decrease in heat transfer between air and refrigerant, which in turn reduces the heating capacity and efficiency of the heat pump. The defrost cycle is designed to address this issue and ensure the heat pump continues to operate efficiently and effectively. Defrosting systems are very important for air-source heat pumps, particularly in regions where winter temperatures drop below freezing and locations with high relative humidity.

Defrost Cycle Components

Defrost control board: The defrost cycle is typically controlled by a specialized defrost control board or timer within the heat pump system. This control board monitors the outdoor and coil temperatures. When it detects that the outdoor coils have accumulated a sufficient amount of frost or ice, it initiates the defrost cycle.

Sensors: Heat pumps are equipped with temperature sensors, such as outdoor air temperature sensors and coil temperature sensors, to monitor the conditions of the outdoor unit.

Reversing valve: A key component of the defrost cycle is the reversing valve. During the defrost cycle, the reversing

valve switches the heat pump from heating mode to cooling mode temporarily. This causes the outdoor coil to become hot, melting the frost or ice.

Defrost heater: Sometimes inside the outdoor unit there is a defrost heater, which is often a series of electric heating elements that warms the coils to melt ice buildup. The defrost heater provides additional heat to the outdoor coil, aiding in the defrosting process.

Fan control: The fan inside the outdoor unit is controlled during the defrost cycle. It may be turned off or run at a reduced speed to prevent cold air from being blown into the conditioned space during defrosting.

Once the defrost control board determines that the defrosting process is complete (usually based on time or temperature sensors), it reverses the reversing valve back to heating mode. The heat pump resumes normal heating operation.

Frequency of Defrost Cycles

The frequency of defrost cycles can vary depending on several factors, including outdoor temperature, humidity levels, and the amount of frost or ice accumulation. Modern heat pump systems are designed to minimize the frequency of defrost cycles to maintain energy efficiency. However, defrosting frequency should be no more than roughly every 35 minutes. Although the length of time the heat pump defrosts will vary, ordinarily it shouldn't take longer than 10 minutes.

Efficient defrost control is essential for maintaining the heat pump's performance during the winter months. Properly functioning defrost cycles ensure that the outdoor unit remains free of ice, allowing it to operate efficiently and provide consistent heating even in cold weather.

Methods of Defrost

Heat pumps use several methods for defrosting the outdoor coil to address frost and ice buildup during cold weather.

These methods are essential for maintaining the heat pump's efficiency and ensuring it can continue to provide effective heating. Following are the primary methods of defrost used in heat pumps:

Electric resistance defrost: Electric resistance defrost is a common method in which electric heating elements within the outdoor unit are activated to generate heat. This heat is used to melt frost and ice on the outdoor coil. This method is reliable and effective but can be energy-intensive, as it uses electricity to generate heat.

Reverse-cycle defrost: Reverse-cycle defrost is a method where the heat pump temporarily reverses its operation. It briefly switches from heating mode to cooling mode. During this process, the indoor coil becomes a heat source, warming the refrigerant. Simultaneously, the outdoor coil acts as a heat sink, allowing the frost and ice to melt. Reverse-cycle defrost can be more energy efficient than using electric resistance heating elements for defrosting. Reverse-cycle defrost is commonly used in more advanced and efficient heat pump systems.

Hot gas defrost: Hot gas defrost is a variation of reverse-cycle defrost. In this method, hot refrigerant gas from the compressor is directed to the outdoor coil. The high-temperature gas heats the outdoor coil, melting the frost and ice. Once the defrost cycle is complete, the refrigerant returns to its normal cycle. Hot gas defrost is efficient and can be faster than other methods.

Natural defrost: Very few heat pumps rely on natural defrost methods, where they pause the heating operation and allow the accumulated frost and ice to melt gradually just by running the outdoor coil fan. This approach can be less energy efficient and may result in a temporary decrease in heating capacity during the defrosting process.

The choice of defrost method depends on the heat pump's design, manufacturer, and model. More advanced and energy-efficient heat pumps often incorporate methods like

reverse-cycle defrost or hot gas defrost to reduce energy consumption during defrost cycles.

Types of Defrost Cycles

Heat pumps use various types of defrost cycles to address the issue of frost or ice buildup on the outdoor coil during cold weather. The specific type of defrost cycle employed can vary depending on the heat pump model and manufacturer. Following are some common types of defrost cycles in heat pumps:

Time-initiated defrost cycle: In this type of defrost cycle, the heat pump's defrost control board activates the defrost cycle at predetermined time intervals, regardless of the actual frost or ice buildup on the outdoor coil. While this method is straightforward, it may not always be the most energy-efficient option, as it can result in unnecessary defrost cycles when frost buildup is minimal.

Temperature-sensing defrost cycle: Temperature-sensing defrost cycles rely on sensors, typically outdoor air temperature sensors and coil temperature sensors, to initiate defrost cycles. The control board monitors these temperature sensors and activates the defrost cycle when it detects that the outdoor coil's temperature has dropped to a certain predetermined point (indicating frost or ice buildup) and outdoor conditions support the need for defrosting. This type of defrost cycle is more responsive to actual frost conditions, reducing unnecessary defrost cycles compared to time-based controls.

Demand-initiated defrost cycle: Demand-initiated defrost cycles are a more advanced approach to defrost control. They take into account a combination of factors, including outdoor temperature, humidity levels, and coil conditions to determine when a defrost cycle is needed. These systems may use algorithms that analyze multiple inputs to make defrost cycle decisions, optimizing energy efficiency while effectively preventing excessive ice buildup.

Adaptive defrost cycle: Adaptive defrost is a modern, intelligent defrost control method. It continuously analyzes real-time conditions, such as outdoor temperature, humidity, and frost buildup to determine when and how to initiate the defrost cycle. This method aims to minimize the frequency of defrost cycles during periods of light frost and maximize energy efficiency.

Pressure-based defrost: Some advanced heat pump systems use pressure-based defrost control. They monitor the pressure levels within the refrigerant system to detect frost buildup. When the pressure indicates reduced heat transfer efficiency due to frost or ice, the system initiates the defrost cycle.

The choice of defrost cycle type can impact the efficiency and performance of a heat pump in cold weather. Modern heat pumps often incorporate advanced control strategies, such as adaptive defrost and demand-initiated defrost, to optimize defrost cycles and minimize energy consumption while effectively addressing frost and ice buildup on the outdoor coil.

Other Types of Heat Pump Cycles

Transcritical Heat Pumps

Transcritical heat pumps operate in a thermodynamic cycle where the working fluid (refrigerant) goes through subcritical and supercritical states. Transcritical heat pumps have the same basic configuration as any vapor compression heat pump but typically use environmentally friendly natural working fluid, carbon dioxide (CO_2 , also known as R-744), as the refrigerant and include a gas cooler instead of a condenser to dissipate heat. The heat rejection takes place in the supercritical regimes due to very low critical temperature (31.1°C) of CO_2 . Due to the unique thermodynamic properties of CO_2 , a much larger temperature difference across the heat distribution system is necessary. Thus, transcritical heat pumps require a low return temperature and can supply high temperatures. These heat pumps are suitable for providing space heating and cooling, domestic hot water, thermal storage, or other high temperature applications. They can be used as booster systems. A system using a transcritical heat pump needs to be designed to ensure that the return temperature is always within the acceptable range and the heat pump components are designed to handle the high pressure of supercritical CO_2 .

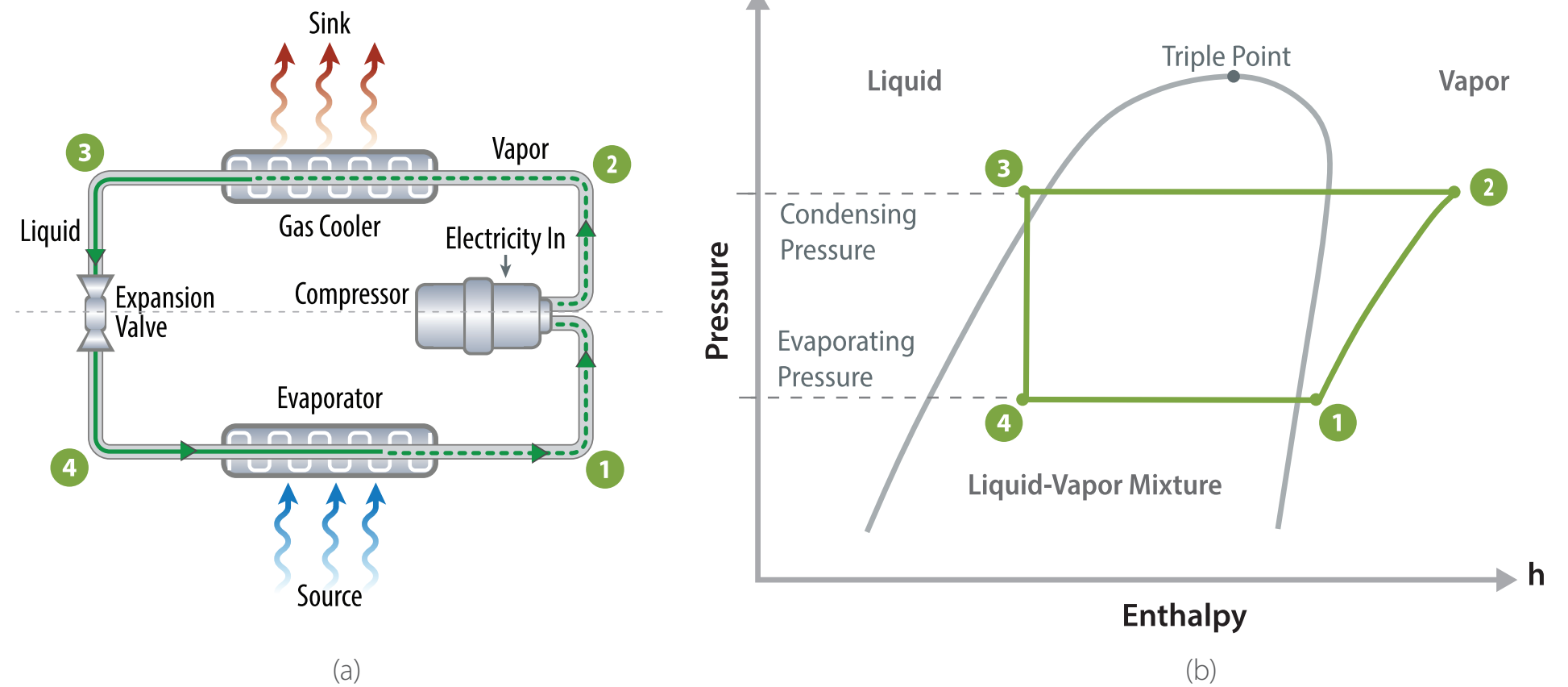

Figure 44. (a) Schematic of a Transcritical CO_2 heat pump (b) Thermodynamic cycle of a Transcritical CO_2 heat pump

Absorption Heat Pumps

Absorption heat pumps use alternative thermal energy sources such as natural gas, propane, or renewable heat sources such as ground, water, or solar waste heat to power the heat pump rather than an electric compressor. Usually, vapor compression refrigeration systems provide the basis for the operation of heat pumps. Heat pumps that operate on the absorption process are used less frequently. Since natural gas is the most widely used energy source, absorption heat pumps are frequently referred to as gas-fired heat pumps. Absorption heat pumps operate on the principle of dissolving two chemicals in one another, usually water and ammonia. Heat is applied to the generator (also known as the desorber) which contains the solution of ammonia and water at high pressure. The solution is boiled, and ammonia is separated from the water due to vaporization (1). The high-temperature ammonia vapor then passes through the condenser where it rejects heat to the indoor space and condenses to liquid (4). Next, a throttle valve is used to lower the pressure of the high-temperature liquid ammonia (5). The low-pressure, low-temperature liquid ammonia is passed through an evaporator (6) and absorbs ambient heat to evaporate to vapor. Meanwhile, the separated high-pressure water in the generator is also evaporated and is then passed through a throttle valve where it is reduced in pressure (2). The low-pressure ammonia vapor is absorbed into water in the absorber and turns into liquid (3). The combined solution is then pumped to high pressure by an electrically driven low-power pump (7) starting the cycle again. The absorber, generator and pump can be regarded as a thermal compressor because the energy required to pump the liquid mixture is small compared with the heat supplied to the generator.

Absorption heat pumps are sometimes integrated as part of cogeneration and trigeneration systems, where the residue heat from these systems is used to vaporize the ammonia. The absorption heat pump employed is used to meet the building's heating and cooling needs.

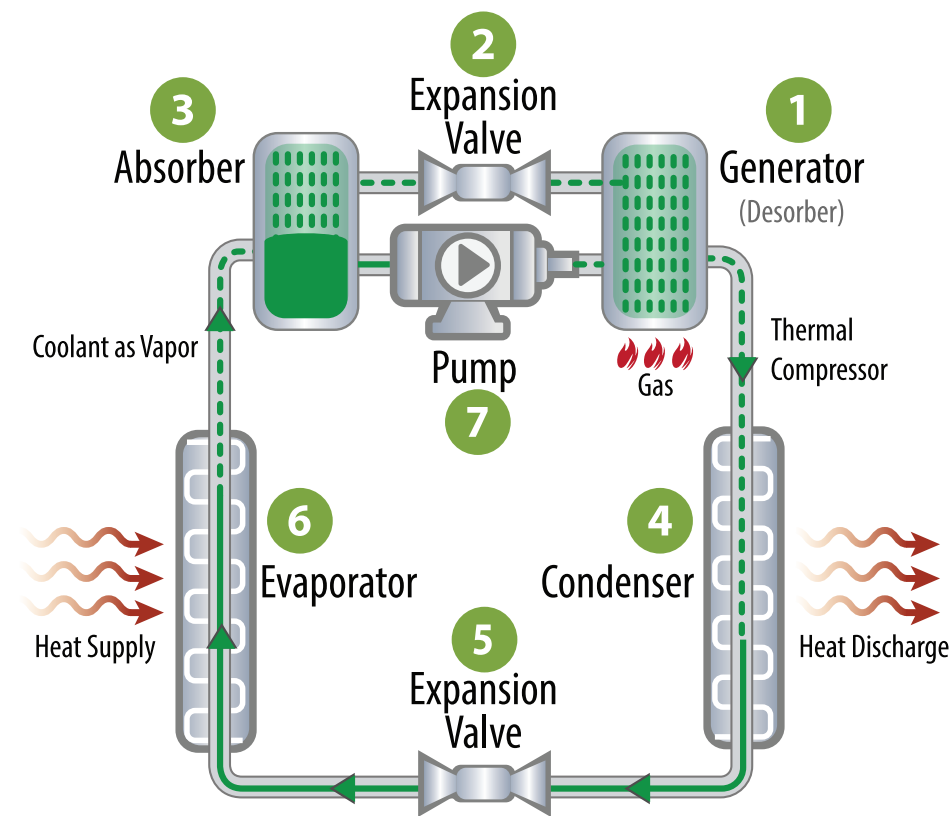

Figure 45. Gas-absorption heat pump cycle

Liquid Desiccant Heat Pump

Liquid desiccants have been used for dehumidification for decades, but primarily in the food industry and other industrial applications where precise humidity control is critical. Advances in membranes and plastic technology have resulted in a new generation of equipment that differs significantly from earlier generations and solid desiccants.

One example of a newer liquid desiccant dehumidifier is a system that simultaneously cools and dehumidifies the air using a three-way heat exchanger that uses a concentrated desiccant, which itself is cooled using a heat transfer fluid from the evaporator of the heat pump. The moist air when in contact with the liquid desiccant is dehumidified due to the liquid/air vapor pressure difference. Panels are covered with a membrane, behind which the desiccant flows over sheets that are cooled internally. The desiccant is regenerated using condenser heat from heat pump, which lowers condenser airflows and temperatures.

The equipment controls cooling capacity by adjusting compressor capacity to change the water temperature used for cooling, and controls dehumidification capacity by varying the desiccant concentration via adjusting the water flow rate through the condenser. This provides independent control of both humidity and temperature.

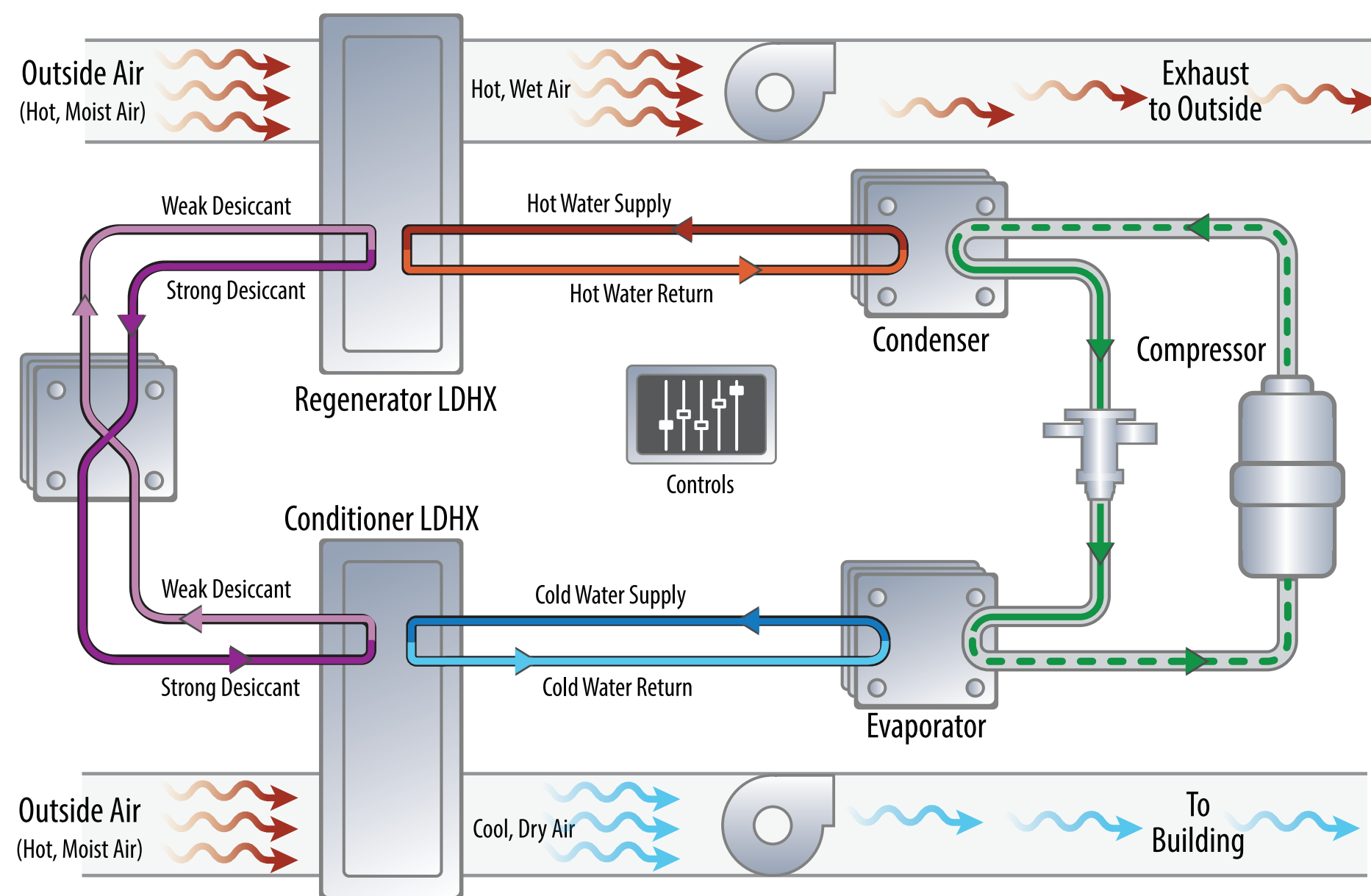

Figure 46. An example liquid desiccant dehumidification system

Note that LDHX stands for liquid desiccant heat exchanger

Building Internal Load Reduction

Building internal load reductions provide opportunities for buildings to reduce heating and cooling loads that can help enable heat pump deployment which is discussed in **Chapter 2: Selecting the Right Heat Pump for Your Project** and **Chapter 3: Designing and Sizing Heat Pumps**. In this appendix we discuss in-depth strategies to help reduce internal loads for a building. The guidance in this section is meant to be a guide for projects but should be evaluated for each project.

Lighting

Lighting in commercial buildings uses approximately 20% of all the energy consumed by commercial buildings in the United States. Given this large use, lighting as a system poses a significant area of focus for reducing energy in a building. This equipment directly consumes electricity and produces heat that must be mitigated by the HVAC equipment. By reducing energy consumption of the lighting system, the required cooling by the HVAC systems is also reduced. So, by optimizing lighting energy, savings can be obtained as well as reduced HVAC equipment sizes. In this section we will discuss assessing the lighting systems in a building and strategies to optimize and reduce energy costs.

Lighting Assessment

When evaluating lighting systems for energy savings, it is recommended to perform a robust lighting assessment. This assessment provides the proper information to determine the lighting baseline. By establishing a baseline, design and efficiency strategies can be determined and evaluated. When performing this assessment, minimal equipment is recommended. A digital camera/cell phone, measuring equipment for dimensions, and an illuminance meter is all the equipment needed to perform the assessment detailed in this section.

LIGHTING ASSESSMENT

The recommended assessment procedure is as follows:

- **Inventory the existing lighting in each room**
 - ▶ Note the number of fixtures, ballasts, and lamps
 - Numbers can be approximated from electrical drawings
 - Record ballasts types (if applicable)
 - Use a phone camera to determine if ballasts are magnetic or electronic
 - If possible gather ballast information and determine specifications such as ballast factor, instant start, rapid start, and program
 - Determine the color temperature of the existing fixtures (Kelvin)
 - Determine the wattage of existing lighting equipment
 - Fixture wattage = Lamp wattage x Number of lamps x Ballast factor
 - Determine the existing lighting power density (LPD) for each space type.
 - $LPD = \text{total fixture wattage} / \text{floor area (W/ft}^2\text{)}$
- **Record the layout of the existing light fixtures**
 - ▶ This can be a schematic drawing or photo for reference
- **Record illuminance (foot candles or lux) in the spaces**
 - ▶ Use the illuminance meter and takes measurements throughout the room
 - ▶ Measurements in offices should be taken at the desk level
 - ▶ Hallway measurements should be taken at floor level
 - ▶ Restrooms should be taken at counter height
 - ▶ Ideally measurements are recorded in a grid pattern
 - Measure between 2 ft on the center or 10 ft on the center for small or large spaces, respectively
 - Note min, max, and mean light levels per space
 - ▶ Take measurements during daytime and nighttime operation
 - This will show the influence of daylight on light levels in the space
 - Having these data can inform daylighting measures or design changes in each space
- **Determine the operational hours per year**
 - ▶ This can be calculated from daily operation and anticipated schedule
- **Identify and note control systems and wiring layouts**
 - ▶ Identify control systems, local occupancy sensors, dimmers, etc.
 - ▶ Create a zoning map of the existing lighting systems
 - Map out how each lighting zone is controlled and the number of fixtures per zone (e.g., 50% of fixtures in room x are controlled by occupancy sensors, 50% are controlled by user operated switch)
 - ▶ Evaluate controls systems for user overrides, broken sensors, and incorrect operation
 - Note differences and locations
 - If user overrides are in place interview on-site staff to determine why overrides are in place, and determine strategies to negate these in the future.

The above assessment should be summarized in a report or other concise documentation for review. By creating this report, a clear baseline for the buildings lighting systems can be established. This baseline is the foundation for the analysis and investigation for improvements to the lighting systems.

Evaluate Lighting Replacements

The most common form of lighting upgrades is a direct replacement of existing technology to more efficient technology. Direct replacements are the cheapest option for lighting improvements as they do not require detailed design or major renovation of existing lighting fixtures. Most direct replacements either use existing fixtures with new bulbs or replace the fixture in place with a similarly sized replacement. These replacements depend on budget, level of efficiency desired, and existing fixtures in place. For lighting, light-emitting diode (LED) is the gold standard for efficient lighting. This technology is efficient being upwards of 7 times more efficient than incandescent bulbs.

There are many lighting technologies on the market. These different technologies will be present in different locations depending on installed location and use of that space. Some of the primary lighting technologies that are present in existing buildings include:

- Metal halide
- High pressure sodium
- Incandescent
- Fluorescent
- LED.

Each of these lighting technologies types have different options based on fixture type, architectural look, and application. For example for many office building fluorescent fixtures can be in the form of fluorescent tubes (T-5, T-8, etc.) or smaller compact fluorescent lights. Each of these permutations of fluorescent technology fit into specific fixture types for different applications. Based on the specific technology, there

are different options for retrofitting these systems. Looking at the two different options mentioned above, a few options for LED replacement are shown below.

- **Fluorescent tubes**
 - › LED tube replacements
 - Ballast will need to be removed and LEDs will be wired to line voltage
 - › LED fixture replacement
 - Removes the entire existing fixture and replaces with an LED option that fits the existing ceiling penetration
- **Compact fluorescent light bulb**
 - › Replacement with LED bulb
 - Maintains existing fixture and look
 - › Full fixture replacement
 - Replaces the entire fixture and changes the architectural look.

Each technology and fixture will have different options for energy savings and costs, which need to be balanced with architectural look when deciding between different LED replacements. While cost and aesthetics are project dependent, calculating the energy savings of the replacement is a relatively simple calculation. Utilizing the information from the lighting assessment and the new fixture anticipated savings can be calculated for lighting replacements. See below for calculating energy savings for lighting replacements:

$$\text{kWh Savings: } ((\text{Fixture Wattage}_{\text{existing}} - \text{Fixture Wattage}_{\text{new}}) \text{ Hours of Operation}_{\text{yearly}}) / 1000$$

While direct replacements can be a cost-effective and simple solution for reducing lighting load, there are some pitfalls and drawbacks to this approach. For LED replacements this technology has higher light output (lumens) per bulb or fixture than other technologies. This light also tends to come standard in a higher color temperature than other technologies, resulting in a whiter, more sterile light. With increased light output and a whiter light direct, one-for-one replacement without design considerations can result in an overlit and

unpleasant aesthetic from these lights. When replacing lights, doing some pre-planning or on-site testing of the new fixtures can result in a better overall project and improve savings. It is recommended that the anticipated and measured illuminance of the new fixtures at a minimum match the existing measured lighting levels or match ASHRAE 90.1 Illuminance recommendations, and color temperature be selected to meet the preference of the occupants. By not over-lighting the space, smaller fixtures can be used and reduce the fixture wattage further and lighting aesthetics can be maintained. Further detail on lighting design considerations for further improvements can be found in the **Lighting Design Evaluation** subsection below.

Another metric to evaluate lighting retrofits outside of illuminance is lighting power density (LPD). LPD is measured as the total lighting power in watts divided by the area served by the lights (watts/ft²). This metric provides an overall performance metric to compare the current lighting system to other systems. When looking at lighting replacements it is recommended to evaluate proposed technologies and their anticipated LPD to determine future energy. It is recommended when evaluating light replacement options that at a minimum LPD meet the most recent ASHRAE 90.1 recommended values and aim to achieve the values recommended in the ASHRAE Advanced Energy Design Guides for zero energy. By aiming to achieve the targets set by the Advanced Energy Design Guides, the building's lighting systems' base consumption will be minimized and set up for zero energy operation in the future. **Table 8** outlining these recommended LPDs can be found in the **Lighting Design Evaluation** subsection below.

As mentioned, LED lighting is the most popular efficient lighting technology used in the market today. LED lighting has been used and popularized since the mid-2000s and has become the dominant technology in the last decade. Around 2010, LED technology had efficiencies close to 75 lumens/watts which was more efficient than many other technologies at that time. Advances in manufacturing and technology have improved LED efficiencies to an average of 110 lumens/watt, with the highest efficiencies reaching 200 lumens/watt (Lane, 2023). This is an average increase in efficiency by ~46% (IEA 2023). For many early adopters of LED technology there are

opportunities to replace their existing LED lighting with newer, more efficient LEDs. To evaluate LED-to-LED replacements, the same steps and process detailed above should be used to determine if there are viable and cost-effective solutions available

Lighting Design Evaluation

Direct bulb and fixture replacement is typically the lowest first cost measure to reduce lighting loads in a building. For many buildings a detailed evaluation of the lighting design can inform potential design changes that can result in even further energy savings beyond just reducing the fixture consumption. Detailed design evaluations can inform measures such as reducing the number of fixtures, advanced controls, and task lighting to help reduce the consumption of the lighting system overall. Lighting design can also result in improvements in indoor lighting quality, architecture, and occupant comfort.

The first task in assessing a lighting design is evaluating the illuminance measurements taken during the lighting assessment. Illuminance values that exceed the recommended levels in **Table 9** or in the most recent ASHRAE 90.1 should be flagged for redesign. We recommend also evaluating these values during both nighttime and daytime to assess the effect of daylight on the space illuminance. If the space illuminance is flagged during nighttime operation, this indicates that the current lighting system is oversized and should be investigated for redesign options. If the space illuminance is flagged during daytime operation, this indicates the potential for space to use daylighting controls to reduce lighting power when sunlight is available.

Table 9. Recommended Illuminance Levels

ROOM TYPE	LIGHT LEVEL (FOOT CANDLES)	LIGHT LEVEL (LUX)	COLOR RENDERING INDEX	CORRELATED COLOR TEMPERATURE (K)
Cafeteria – Eating	20-30 FC	200-300 lux	85+	3000K-4000K
Classroom – General	30-50 FC	300-500 lux	85+	3000K-4000K
Conference Room	30-50 FC	300-500 lux	85+	3000K-4000K
Corridor – General	5-10 FC	50-100 lux	85+	3000K-4000K
Corridor – Hospital	5-10 FC	50-100 lux	85+	3000K-4000K
Dormitory – Living Quarters	20-30 FC	200-300 lux	85+	3000K-4000K
Exhibit Space (Museum)	30-50 FC	300-500 lux	85+	3000K-4000K
Gymnasium – Exercise / Workout	20-30 FC	200-300 lux	85+	3000K-4000K
Gymnasium – Sports / Games	30-50 FC	300-500 lux	85+	3000K-4000K
Kitchen / Food Prep	30-75 FC	300-750 lux	85+	3000K-4000K
Laboratory (Classroom)	50-75 FC	500-750 lux	85+	3000K-4000K
Laboratory (Professional)	75-120 FC	750-1200 lux	85+	3000K-4000K
Library – Stacks	20-50 FC	200-500 lux	85+	3000K-4000K
Library – Reading / Studying	30-50 FC	300-500 lux	85+	3000K-4000K
Loading Dock	10-30 FC	100-300 lux	85+	3000K-4000K
Lobby – Office/General	20-30 FC	200-300 lux	85+	3000K-4000K
Locker Room	10-30 FC	100-300 lux	85+	3000K-4000K
Lounge / Breakroom	10-30 FC	100-300 lux	85+	3000K-4000K
Mechanical / Electrical Room	20-50 FC	200-500 lux	85+	3000K-4000K
Office – Open	30-50 FC	300-500 lux	85+	3000K-4000K
Office – Private / Closed	30-50 FC	300-500 lux	85+	3000K-4000K
Parking – Interior	5-10 FC	50-100 lux	85+	3000K-4000K
Restroom / Toilet	10-30 FC	100-300 lux	85+	3000K-4000K
Retail Sales	20-50 FC	200-500 lux	85+	3000K-4000K
Stairway	5-10 FC	50-100 lux	85+	3000K-4000K
Storage Room – General	5-20 FC	50-200 lux	85+	3000K-4000K
Workshop	30-75 FC	300-750 lux	85+	3000K-4000K

To evaluate design options, the primary goal of any design should be to reduce the existing LPD to a minimum level. Recommended values for LPD can be found in the Advanced Energy Design Guides, and summarized in the table below.

By designing an existing building's lighting systems to achieve LPDs at or below the values in **Table 10**, this system will meet requirements identified for zero energy operation determined in the Advanced Energy Design Guides. These low lighting power densities will also help achieve significantly reduced load on the mechanical systems through reduced heat gain from the lights.

Table 10. Recommended LPDs Based on Zero Energy Advanced Energy Design Guides

INTERIOR SPACE	LPD, W/FT ²
Open-plan office	0.31
Private office	0.42
Conference room/meeting room	0.77
Corridor	0.34
Storage area	0.34
Restroom	0.50
Breakroom	0.47
Electrical/mechanical room	0.42
Stairway	0.49
Lobby	0.70
Other spaces	0.49
Gymnasium/multipurpose room—primary school	0.50
Gymnasium/multipurpose room—secondary school	0.80
Cafeteria	0.40
Classroom	0.40

INTERIOR SPACE	LPD, W/FT ²
Mechanical	0.40
Restroom	0.40
Auditorium	0.50
Office	0.50
Art room	0.60
Kitchen	0.60
Corridor	0.25
Library/media center—primary school	0.40
Library/media center—secondary school	0.50
Lobby	0.70
Whole building—office	0.40
Whole building—primary school	0.40
Whole building—secondary school	0.45

Lighting Controls

The last area to evaluate is lighting controls. Lighting controls are systems that allow you to control the operation of lights. Lighting controls in their simplest form are light switches to control whether the lights are on or off. Advances in technology have provided lighting controls that are automated and have advanced capabilities to respond to preset schedules, occupancy, and daylight. Newer lighting technology and controls have also allowed for dimming capabilities on lighting fixtures. By evaluating lighting controls, lighting power can be reduced even further through reduced runtime.

The type of controls strategies that will be viable for a given building will be heavily dependent on the layout of the building, especially in relation to the wiring of the existing lighting system. Different controls strategies that require different banks of lights to be turned off and on at different times might require significant wiring changes if all the lights are currently controlled by one switch. This wiring adjustment will increase cost and should be considered when evaluating lighting controls. Utilizing the wiring layouts that were found during the on-site investigation will help inform the viable controls strategies for the space.

The primary lighting control strategies to evaluate are as follows:

- Daylighting
- Occupancy/vacancy sensors
- Dimmer controls
- Task tuning
- Exterior.

Daylighting

Daylighting control means utilizing the light from the sun to help illuminate spaces. This control strategy uses a light sensor that measures the illuminance in a space and dims the lights in response to an increase in daylighting, and vice versa as

daylight levels decrease. Utilizing the measured illuminance during daytime operation of the building, spaces with overlit areas should be evaluated for daylighting controls. If possible, skylights or added windows should be evaluated in conjunction with the daylighting controls to improve the effectiveness of the control. Daylight from windows in most spaces will not provide uniform light throughout the space and therefore will require independent control of the lights to maintain proper illuminance throughout the space. For instance, in a space with a window, generally it is recommended to control the bank of lights closest to the window, and in each segment of the room moving away from the window independently to maintain adequate light levels. Daylighting also has the added benefit of providing natural rhythms of light in response to the sun resulting in improved occupant comfort and health.

Occupancy and Vacancy Sensors

Occupancy and vacancy sensors detect occupancy via a sensor and control the lights based on this occupancy. These sensors use various technologies to detect occupancy such as ultrasonic frequency, passive infrared, or dual technologies. The technologies are integrated into equipment that is mounted either on the wall, ceiling, lights, workstations, or most typically in a wall-mounted switch. Occupancy sensors have many forms such as automatic on/off where the lights turn on or off based on occupancy, and partial on/off based on a dimmer switch to set the on lighting levels and turn off when the space is unoccupied. Vacancy sensors work just like an occupancy sensor except the on control is controlled via a manual switch and the light turns off when occupancy is no longer detected. Vacancy sensors tend to reduce lighting energy more than occupancy sensors because in some cases the occupants will want to leave the lights off, reducing the light's run time while still having the same automatic off benefit.

Occupancy and vacancy sensors make sense in many applications, especially in spaces of intermittent occupancy like conference rooms. This control type can be implemented in some spaces by just replacing the existing lighting switch with a wall mounted occupancy or vacancy sensor. Occupancy

sensors can also be used in a zone-controlled manner, such as a large open office via controlling certain banks of lights with individual occupancy sensors.

Dimmer Controls

Dimmer controls are controls that allow you to change the light output of fixtures via a switch. Dimming the lights results in less energy consumed by the lights and heat added to the space. Dimmer controls are manually operated by occupants to adjust the lighting levels to a preferred setting. This control strategy has mixed savings potential as occupants might not use the dimmer setting and always opt for the highest output of light. This control strategy should be used in tandem with occupant education to ensure proper use of the control.

Task Tuning

Task tuning is a control strategy that adjusts levels to Illuminating Engineering Society (IES)-recommended task light levels or user preference for individual spaces. This strategy requires dimmer control for lights and detailed information on each space and required tasks. For many spaces even with efficient lighting power densities and designs, light levels might still be too high for required tasks or occupant preference. By reducing light levels and providing supplemental fixtures in required area, light levels can be reduced and therefore energy saved. Based on a meta-analysis by the Lawrence Berkeley National Laboratory in 2011, task tuning results in an average of 36% savings. This strategy does require buy-in from occupants, and light levels should be tested with occupants present to ensure the levels provided are adequate for occupant comfort and productivity.

Exterior Lighting

Exterior lighting controls primarily consist of an astronomical clock or photocell control. Astronomical clock controls turn the lights on and off based on sunrise and sunset. The astronomical timer performs automatic sunrise and sunset calculations and turns exterior lights on between sunset and sunrise and off during the day. Photocell control uses a photo sensor

that detects whether there is daylight. If there is no daylight detected the light is turned on, and turned off when light is present. Both control strategies control the lights to only be on when required and save energy during daylight hours. In many cases astronomical clocks are used to control several exterior lights at once. Photocells typically are integrated into a single fixture and only control that fixture.

Plug and Process Loads

Plug and process loads consist of the systems on-site that use electricity for end uses other than lighting or HVAC. Common plug and process loads include computers, personal heaters, battery charging, servers, air compressors, TVs, etc. These systems consume electricity as well as provide added thermal load to the space. Plug and process loads are components of a building that can be significantly oversized during design, resulting in oversized electrical and HVAC systems. For example, in some office lease agreements plug and process loads are requested at 5 to 10 W/ft², but based on studies performed by NREL the average and peak plug and process loads for an office building is between 0.28 W/ft² and 0.88 W/ft² (Sheppy 2014). This shows the necessity of accurately quantifying the plug and process loads in the space and provides opportunities in some cases to reduce the original design load and free up existing electrical infrastructure.

Inventory Plug and Process Loads

To accurately determine the plug and process loads (PPL), a detailed inventory of the PPLs on-site should be completed. A detailed inventory should include information pertaining to the PPLs' schedules, controls, types, uses, quantity, and age. As part of the inventory, each device or a sample of devices should be tested to determine if the device is functioning properly and any deficiencies can be noted to be addressed as part of PPL load reduction strategies. There are many tools that can be used to assist in creating and inventory of PPLs; NREL has created PPL inventory workbooks for both **offices** and **retail** spaces. By properly inventorying the PPLs in a building, a baseline can begin to be developed.

When inventorying the devices in a facility, PPLs should be identified by their type of device such as computers, cooking equipment, heaters, washing equipment, etc. How the devices are used in the facility should also be noted. This will help adjust PPL strategies to ensure facility operations are not negatively affected. Next, the devices' consumption should be noted both during full operation and standby operation to be able to model the energy use for the equipment. Age is a characteristic that should be noted to inform when devices might fail and to prioritize equipment for upgrades. Finally, the quantity of each device should be noted as well.

When inventorying the PPL, schedules should be noted for the equipment. These schedules should include both the scheduled operation of the equipment as it's currently operating and scheduled operation based on when the device is actually needed. Understanding both of these schedules can inform the baseline of the device for energy modeling as well as inform potential scheduling measures to improve the device operation. Device schedules can be determined by analyzing control systems for programmed schedules, operator interviews, or through measured data. To determine what the scheduled operation should be, operator interviews will inform how the device is intended to be used and what its ideal schedule should be. For example, a computer might be scheduled to operate from 7am to 6pm but the typical work schedule for the office is 8am to 5pm. This provides an opportunity for schedule reduction and load reduction.

Once the inventory has been completed, the baseline PPL usage can be calculated. The PPL usage can be calculated utilizing energy modeling software or by hand. Utilizing an energy modeling software will allow modeling interactive effects of plug loads, HVAC, and other building system more effectively but requires more effort. Calculating the plug load energy consumption can be done with the following equation.

$$\text{PPL kWh} = \frac{(\text{Watts}_{\text{Full Operation}} \text{Hours}_{\text{Full Operation}} + \text{Watts}_{\text{Standby Operation}} \text{Hours}_{\text{Standby Operation}})}{1000}$$

This equation can be used to estimate energy consumption of the PPLs as well as estimate future usage by utilizing proposed PPL watts and hours of operation. This method does simplify the calculation process but can overestimate usage compared to the actual consumption on-site. This discrepancy can occur due to lack of visibility of operating schedules, and inaccurate data on energy consumption of the equipment. To truly determine the PPLs in the space, measured data should be used.

Measuring the actual consumption of the PPL devices in the space can inform the actual load in the space, which will inform heating loads, and electrical capacity requirements of the equipment as well as inform more detailed PPL strategies. It is recommended to measure the PPLs individually to desegregate their usage from the building's overall consumption. This can be done at each device or within the electrical panels. Installing a data logger and trending the consumption over a week or more will show usage patterns of the devices and inform the actual PPL density in the space. As part of a study, measured PPL densities in the space were as shown in **Table 11** (Sheppy 2014).

Table 11. Measured Average and Measured Peak PPL Density

Building Type	Average (W/ft ²)	Peak (W/ft ²)
Office – Single Government Tenant	0.24	0.52
Office – Single Government Tenant	0.16	0.55
Office – Single Government Tenant w/ Data Center	0.34	0.51
Office – Single Government Tenant W/ Data Center	0.77	1.25
Data Center Only	0.57	0.82
Higher Education – Classrooms, Meeting Areas, and Faculty Offices	0.23	0.41
Higher Education – Classrooms, Meeting Areas, and Faculty Offices	0.30	0.64
Higher Education – Classrooms, Meeting Areas, and Faculty Offices	0.16	0.42
Higher Education – Classrooms, Meeting Areas, and Faculty Offices	0.40	1.08
Higher Education – Classrooms, Meeting Areas, and Faculty Offices	0.28	0.63
Office – Multitenant w/ Data Center	1.17	Data Not Available
Office – Multitenant w/ Data Center	0.19	Data Not Available
Office – Multitenant w/ Data Center	0.37	Data Not Available
Office – Multitenant	0.49	Data Not Available
Office – Municipal	0.40	Data Not Available
Office – Single Tenant w/ Warehouse	0.19	Data Not Available
Office – Single Corporate Tenant w/ Data Center	0.58	Data Not Available
Office – Single Corporate Tenant	0.36	Data Not Available
Office – Single Corporate Tenant w/ Kitchen	0.64	Data Not Available
Office – Single Corporate Tenant w/ Laboratories	2.27	Data Not Available

The data to the left show low PPL loads for many buildings, especially compared to the 5 to 10 W/ft² typically requested and designed around for most buildings. Assuming 5 W/ft² as the design and 1 W/ft² in a 100,000 ft² building results in a design load to actual of 400 kW. By establishing the actual load in the building design, cooling loads can be reduced, allowing for properly sized mechanical equipment to be installed. This also shows the ability to free up electrical panel capacity for electrifying the building's heating system.

General PPL Load Reduction Strategies

Once the PPLs have been inventoried and the building's load density has been established, load reduction strategies can be investigated. For several strategies that reduce PPL energy consumption and do not require infrastructure changes, refer to the Better Building Solution Center's "Decision Guides for PPL Controls" (DOE n.d) and "Assessing and Reducing Plug and Process Loads" (NREL 2020). These strategies can be implemented along with control strategies to maximize energy savings without capital investment in electrical infrastructure. Some of the general strategies in this guide include:

- **Replace inefficient appliances.** Older models can use more energy, so replacing them with their ENERGY STAR (ENERGY STAR n.d.) or EPEAT (EPEAT n.d.) approved equivalent can provide energy savings.
- **Incorporate low-power/power-off settings.** Many devices have sleep settings or can be manually powered off without affecting the building functionality—computers, for example.
- **Consolidate loads.** Replace redundant loads with one larger load, such as purchasing a large, shared printer rather than having individual printers.
- **Time software updates.** Ensure that updates occur close to business hours to allow equipment to be shut off during nonbusiness hours.

PPL Control Strategies

PPL controls strategies help reduce both power consumption and thermal load in a facility. This is done by automating the various PPLs found in a facility to reduce runtime and power consumption. This automation includes basic on/off functionality, monitoring, or integrating the control of PPLs with HVAC and lighting to align operation. By optimizing the control of PPLs, overall efficiency can be optimized as well as reduced thermal load on HVAC equipment will enable heat pump deployment. **Table 12** details the following PPL control strategies (NREL 2020):

- Wireless Meter and Control Systems
- Advanced Power Strips
- Automatic Receptacle Controls
- Integrated Controls

For more information on these control strategies refer to the publication "Assessing and Reducing Plug and Process Loads" (NREL 2020).

NREL's Commercial Buildings Group measures plug loads and verifies lighting measurements at the Best Buy Store in Lakewood, CO.

Photo by Dennis Schroeder, NREL 22091



Table 12. Plug and Process Load Control Strategies

From NREL (2020)

Control Strategies	Wireless Meter and Control Systems	Advanced Power Strips	Automatic Receptacle Controls	Integrated Controls
Description	System of smart outlets that measure energy usage and turn devices on/off	Power strips that can be controlled to shut off power to specific appliances	Outlets that are installed in the building and can be controlled to turn devices on/off	Connects lighting, HVAC, and PPL systems to monitor and control them together
PPL Reduction Goal	Control PPLs using a device schedule and understand the PPL energy usage of the entire building	Control the energy usage of specific devices	Control PPLs using a device schedule or occupancy sensors and meet code requirements	Control PPLs alongside lighting controls and understand the PPL energy usage of the entire building
Characteristics	<ul style="list-style-type: none"> • Wireless control • Automated system • Full picture of energy use • Device health monitoring 	<ul style="list-style-type: none"> • Shared control of multiple devices • Focus on specific devices 	<ul style="list-style-type: none"> • Wireless control • Automated system • Required for ASHRAE standard 90.1-2019 compliance 	<ul style="list-style-type: none"> • Wireless control • Automated system • Full picture of energy use • Device health monitoring • Connecting multiple systems • Interoperability
Metering	Use smart outlets	Use separate plug-in metering devices	Use separate plug-in metering devices	Use building management system
Load Analysis to Determine Device Attributes	Determine loads that: <ul style="list-style-type: none"> • Are high energy, especially in low-power modes (e.g., audio-visual systems) • Can be turned off or set to low power modes • Are used according to a building/ device schedule 	Determine: <ul style="list-style-type: none"> • Devices that could be connected • What controls (schedule, load-based, occupancy) are relevant 	Determine loads that: <ul style="list-style-type: none"> • Are high energy, especially in low-power modes (e.g., audio-visual systems) • Can be turned off or set to low power modes • Are used according to a building/ device schedule or according to occupancy 	Determine loads that: <ul style="list-style-type: none"> • Are high energy, especially in low-power modes (e.g., audio-visual systems) • Can be turned off or set to low power modes • Can be connected to lighting/HVAC controls and sensors
Applying Controls	Program the smart outlets according to schedule	See NREL Guidance: How to Use Advanced Power Strips (NREL n.d.)	Program the controlled receptacles to be schedule-based or occupancy-based	PPLs are controlled by the building management system and lighting controls
Strategy Maintenance	<ul style="list-style-type: none"> • Reprogram plug-load management system to accommodate changes • Education and training • Check up on the plug load management dashboard/energy usage and provide feedback 	<ul style="list-style-type: none"> • Check up on APS usage by occupants • Education and training 	<ul style="list-style-type: none"> • Reprogram controlled receptacles system to accommodate changes • Education and training 	<ul style="list-style-type: none"> • Education and training • Check up on the building management system dashboard/energy usage and provide feedback

Appliance-Specific Strategies

The general strategies noted above apply to most buildings and are recommended to be implemented to help reduce PPL loads. When investigating further savings strategies for PPLs, each strategy is appliance-specific. Each device should be investigated to find applicable strategies for that device or efficient replacements to reduce PPL loads. In this section we will cover several appliance-specific strategies to help reduce PPL.

Vertical Transport

- Elevators
 - › Elevator car lighting and ventilation are typically powered whether or not the car is occupied.
 - › Control elevator lighting and ventilation with occupancy sensors.
 - › Building occupants should be encouraged to use stairs to reduce energy use and improve health.
- Escalators
 - › Escalators operate continuously during business hours, and in some cases continuously during nonbusiness hours.
 - › Control escalators so that they operate only during business hours or when needed to save as much as \$900/year/escalator.

Computing Facilities (Data Centers/Server Room Equipment)

- Implement an uninterruptible power supply that has the following features:
 - › At least 95% energy efficiency
 - › Scalable design
 - › Built-in redundancy
 - › End user serviceable

- › Sufficient uptime until the backup generator starts
- › Meets the efficiency guidelines of the Server System Infrastructure initiative, which sets open industry specifications for server power supplies and electronic bays.
- Load the uninterruptible power supply so it operates at peak efficiency.
- Use energy-efficient power distribution units.
- Use blade servers with variable-speed fans and energy-efficient power supplies.
- Implement virtualization software.
- Implement a hot aisle/cold aisle configuration.
- Implement hot aisle containment.
- Depending on climate zone, implement economizers and evaporative cooling.
- Capture waste heat from the servers for use in other areas of the building.

NREL and Sheppy et al. (2011) provide more details about energy reduction strategies in server rooms and data centers.

Small-Scale Food Service Areas

As with other areas of the building, replacing aging and inefficient equipment with the most efficient ENERGY STAR equipment will save energy. Food service areas present unique challenges because they are often outfitted and operated by outside vendors. It is important to work with the vendor to supply energy-efficient PPLs that meet their needs.

- Refrigerators
 - › Remove underused refrigerators
 - › Replace aging, inefficient refrigerators with the most efficient compliant refrigerators
 - › Consolidate multiple mini refrigerators into a full-size refrigerator

- › Replace glass-door refrigerators with similarly sized solid-door refrigerators
- › Set contractual requirements for vendors to use only the most efficient commercial refrigerators.
- Nonrated Equipment
 - › For equipment that is not rated by ENERGY STAR, or similar organizations, those responsible for specification and procurement should work directly with manufacturers to determine the most efficient option. Many manufacturers offer low-energy equipment options.
- Small Kitchen Appliances
 - › Upgrade items such as coffee pots, toasters, and microwaves with units that have limited parasitic loads from status LED lights or displays.
 - › Control these items with electrical outlet timers so they are powered down during nonbusiness hours.
 - › Set contractual requirements for vendors to use only the most energy-efficient items.
- Parasitic Loads
 - › Food service equipment can have large parasitic loads during nonbusiness hours.
 - › Control equipment with electrical switches, or a similar method, to easily disconnect power to all nonessential equipment during nonbusiness hours.
 - › Set contractual requirements for vendors that will ensure that the equipment is disconnected and powered down during nonbusiness hours.

Natatorium

Natatoriums are facilities that include pools, either indoors or outdoors. These facilities provide unique PPL and typically are large energy consumers on-site. We primarily seen them in hospitality, higher education, or multifamily facilities. These systems can include pumps, pool heaters, lights, or pool cover systems. To reduce energy consumption from these PPLs the following measures should be investigated and implemented.

- **Pick the right finish**
 - › Darker colored pool finishes absorb the sun's rays, and that energy helps heat your pool.
- **Create a natural windbreak**
 - › Wind can increase the rate of evaporation and heat loss from a pool, increasing heating energy and water consumption. Installing wind breaks such as a hedge, berm, wall, or other form can help reduce this heat loss and evaporation.
- **Install a variable-speed pool pump**
 - › Utilizing variable speed pumps can allow the speed of the pump to be reduced, resulting in energy savings. New pumps installed should be variable speed and high efficiency such as ENERGY STAR rated pool pumps.
- **Optimize your pool's plumbing**
 - › Restrictive pool plumbing such as narrow pipes can result in increased pumping energy to overcome the losses through the pipes.
- **Use advanced heating technology**
 - › There are many different heating technologies available for heating the pool. Technologies like solar water heating or heat pumps will improve heating efficiency and reduce heating energy. Other configurations can also improve heating efficiency such as bottom up heating systems to optimally heat the pool.

- **Install an automatic pool cover**
 - › Automated pool covers should be used to cover the pool when not in use. These covers will help reduce heat loss and evaporation and are more effective than wind breaks.
- **Use larger pool filters**
 - › Much like optimizing the pool plumbing, using larger pool filters will reduce the pressure required by the pump, reducing pumping energy.
- **Maintain your cleaning system**
 - › Dirty pool systems result in increased pressure drops and reduced heating efficiency. Cleaning pool systems regularly will reduce pumping energy and improve heating efficiency.
- **Install LED lighting**
 - › LED lights can save 80% or more over incandescent lights, and last three times as long. Utilizing LED lights when possible is recommended for energy savings
- **Automate your pool operations**
 - › Automated pool systems can optimize pool operation, improving energy efficiency. Controlling things like heating setpoints, schedules, pool covers, and lights can reduce human error and allow for timing pool systems to reduce energy or take advantage of time of use rates.

References

- DOE. n.d. Better Building Solution Center. "Decision Guides for PPL Controls." https://betterbuildingsolutioncenter.energy.gov/sites/default/files/attachments/Decision_Guides_for_PPL_Controls_0.pdf.
- Earle, L., and B. Sparn. 2012. "Results of Laboratory Testing of Advanced Power Strips." National Renewable Energy Laboratory. www.osti.gov/biblio/1219753. Accessed 15 Feb. 2024.
- ENERGY STAR. 2024. "What Makes a Product ENERGY STAR?" www.energystar.gov, www.energystar.gov/products/what_makes_product_energy_star.
- EPEAT Registry. www.epeat.net.
- Lobato, Chad, et al. 2012. *Selecting a Control Strategy for Plug and Process Loads*. <https://www.nrel.gov/docs/fy12osti/51708.pdf>.
- NREL. 2015. Advanced Power Strips (APS). <https://www.nrel.gov/docs/gen/fy15/63800.pdf>.
- NREL. 2020. *Assessing and Reducing Plug and Process Loads in Retail Buildings*. NREL/BR-5500-76998. <https://www.nrel.gov/docs/fy20osti/76998.pdf>.
- Sheppy, Michael, et al. 2011. Reducing Data Center Loads for a Large-Scale, Low-Energy Office Building: NREL's Research Support Facility. National Renewable Energy Laboratory. NREL/BK-7A40-52785. <https://www.nrel.gov/docs/fy12osti/52785.pdf>.
- Sheppy, Michael, Luigi Gentile-Polese, and Scott Gould. 2014. *Plug and Process Loads Capacity and Power Requirements Analysis*. National Renewable Energy Laboratory. DOE/GO-102014-4277. <https://www.nrel.gov/docs/fy14osti/60266.pdf>.

How to Use Bookmarks/Table of Contents to Navigate This Document

When viewing using Adobe Acrobat and Acrobat Reader (also if using the Adobe Acrobat Extension in Chrome)

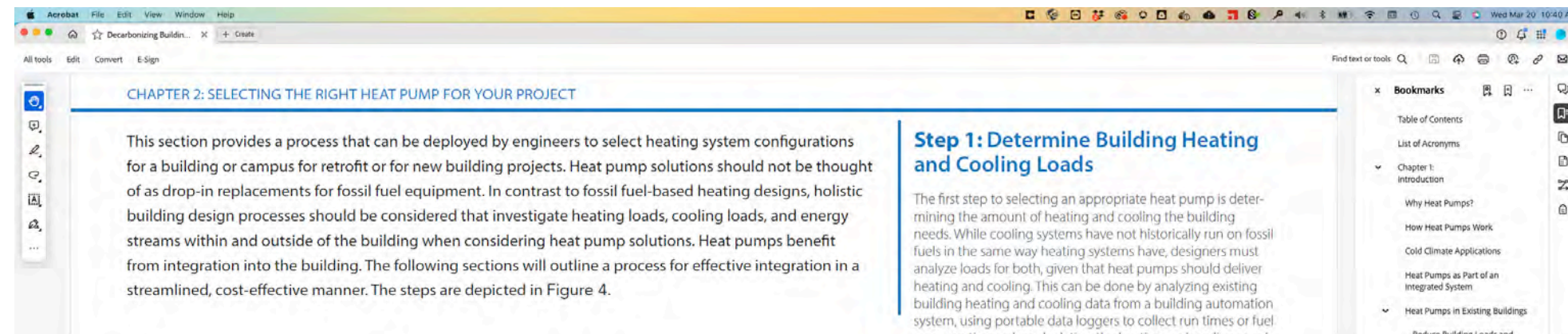

Click on this icon to open and close the bookmarks and the click on a bookmark to move through document.



When viewing using Chrome without the Adobe Acrobat Extension

Click on this icon to open a panel that shows page thumbnails and bookmarks. Click on the bookmark icon.

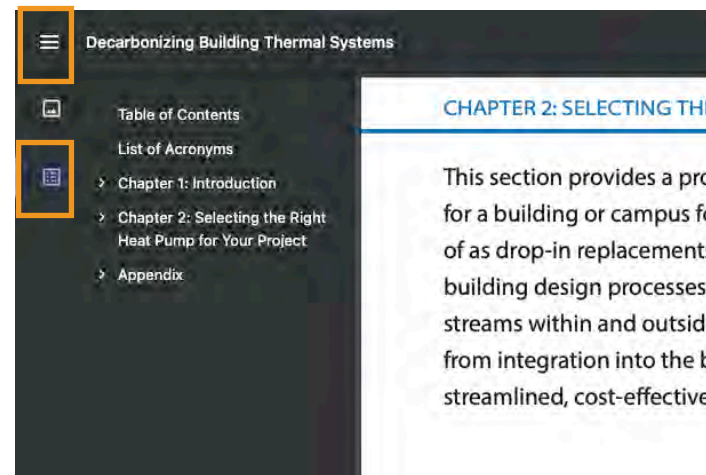

When viewing using Firefox

Click on this icon to open a panel that shows page thumbnails and bookmarks. Click on the bookmark icon.

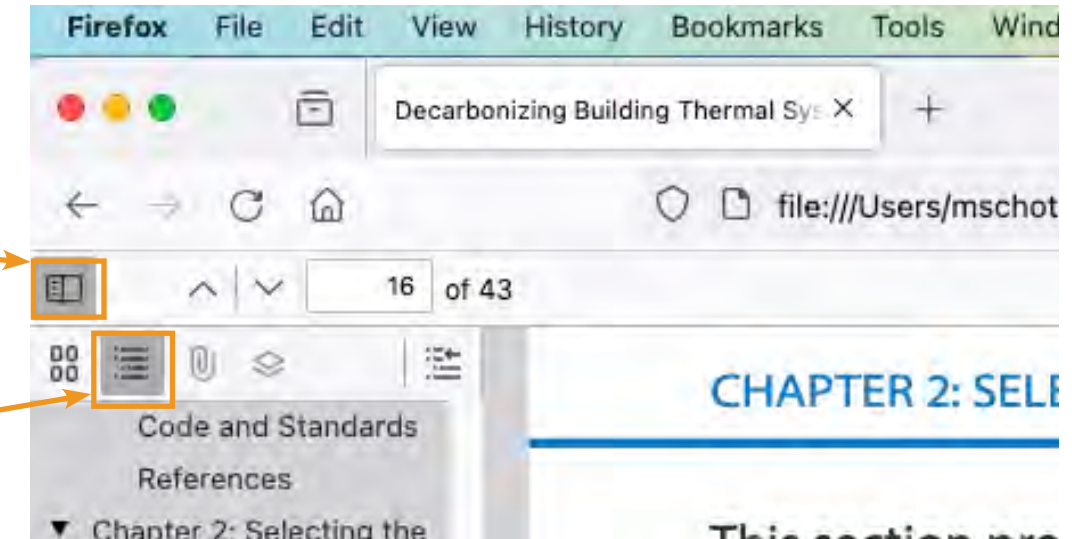

When viewing using Safari

Right click on the PDF and select "Open with Preview" and then go to "View" and then select "Table of Contents"

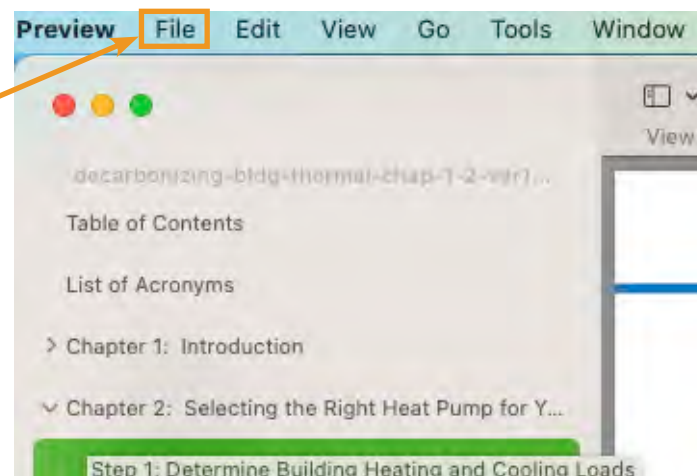

When viewing using Edge

Click on this icon to open a panel that shows page thumbnails and bookmarks. Click on the bookmark icon.

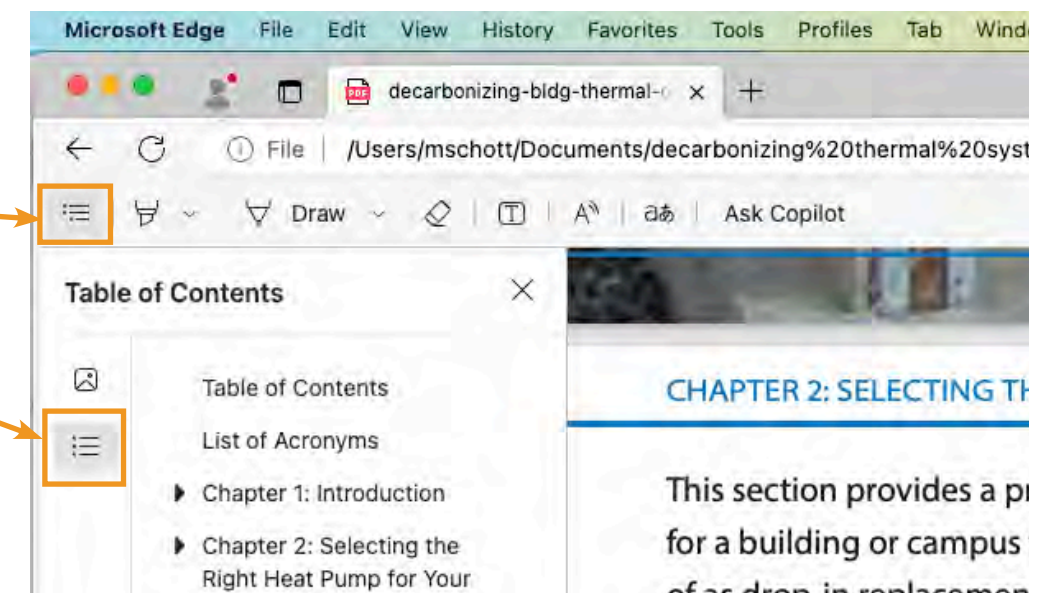



National Renewable Energy Laboratory
15013 Denver West Parkway
Golden, CO 80401
303-275-3000 • www.nrel.gov

NREL is a national laboratory of the U.S. Department of Energy, Office of Energy Efficiency and Renewable Energy, operated by the Alliance for Sustainable Energy, LLC.

NREL/BK-5500-87812 • September 2024

Photo of mechanical room in ASHRAE's Global Headquarters

Photo from ASHRAE