



PRODUCT GUIDE

C.A. Baldwin & Co Ltd

Quality is our strength

INDEX

Expansion / Anti-vibration Couplings	Pages 1 – 7
Repair Bandage	Page 8
Fixing and Repair Clamps	Pages 9 – 19
Compression Fittings for Steel	Pages 20 – 22
Quick Branch fittings / Exploding Tees	Page 23
Malleable Pipe Fittings	Pages 24 – 51
Steel Pipe Fittings to BS1740 (Wrought Iron)	Pages 52 – 59
Steel Tubular Fittings to BS1387	Page 60 – 62
Welded Pipe Fittings	Pages 63 – 68
Pipe Flanges to BS10 / BS 4504 Weld / Screwed	Pages 69 – 77
Valves (Commercial & Domestic)	Pages 78 – 107
Conversion Tables	Page 108

Click on a heading to go to that section.

EXPANSION / ANTIVIBRATION COUPLINGS

RUBBER BELLOWS

Rubber bellows - Compensators - Expansion Joints

Eliminate	Pipe Stress & Water Hammer
Reduce	Pump & Fluid Borne Noise
Isolate	Vibration & Start Up Deflections
Absorb	Pipe Work Expansion & Contraction
Compensate	Small Misalignment of Pipes

EPDM	20°C to +120°C	High temperature capability and ozone resistance. Weak acids, alkalis, esters and ketones
NITRILE	40°C to + 90°C	Mineral and vegetable oils, butane, propane, acetylene, weak acids, demineralised water and natural gas.
NEOPRENE	40°C to + 90°C	Light oil contamination. Good ozone and sunlight resistance.
NATURAL	20°C to + 80°C	Excellent abrasion resistance. Suitable for use with acid and alkalis
BUTYL	40°C to +120°C	Good chemical resistance and high temperature capability.
FOOD GRADES		Available in natural, Neoprene and Nitrile elastomers

Control Rods - Tie Bars

The pressure applied to a pipeline bellows generates a force which tends to extend the bellows - the pressure reaction force. If this force is not controlled by the main anchors securing the pipeline, it must be contained by control rods or tie bars.

Tie bars are required when pressures exceed :

Vacuum Rings

Must be fitted inside the bellows convolutions when the pressure is below 400mm.

NB	P Bar
25-100mm	10
125-250mm	9
300-350mm	6
400-600mm	2

INSTALLATION GUIDELINES

Pipe Supports and Anchors

Only one bellows should be installed between two anchors and the anchors must be strong enough to take the force generated by pressure in an untied bellows.

Pipe guides must be used either side of the bellows. The first guide should be as close as possible to the bellows and the second spaced at approximately 14 pipe diameters.

Bolting

Flange bolts must be inserted with the bolt heads adjacent to the bellows arch.

Bolts should be tightened evenly around the flange to the following torque values:

Size NB	Torque Rating
-80mm	6 KPM
+80mm	8-10KPM

Alignment

Ensure that the pipe work is aligned and that the gap in which the bellows is to fit does not exceed the rated movement. Do not apply torsion to the bellows.

Flanges

Mating flanges must be clean and free from burrs or irregularities. They must be flat in the seating area, slip-on flanges require to be welded flush with the pipe end.

Storage

Bellows should be stored in cool dry conditions away from direct sunlight. Avoid contamination by oil or grease.

On Placing Order :

Please Specify the Following :

Type Rubber / SS Convolute

Flange Type / Table

Length (Dimension taken with Cool / Hot System, please specify)

Tied / Untied

Application

EXPANSION / ANTIVIBRATION COUPLINGS

SINGLE SPHERE BELLOWS

Swivel Flanges Galvanized
Flange Ratings BS10 Table E or F
 BS4504, PN10 an PN16
 ANSI B16.5 150lbs



Pressure Ratings : 25 - 200 NB 16 Bar @ 100°C
 250 - 300 NB 10 Bar @ 100°C

Product Group Code Group P030	Nominal Bore Size Ins mm	Available Lengths F/F mm	Axial Comp/Extn mm mm	Lateral Deflection mm	Angle of Deflection Deg
10000032	1.1/4" 32	125/130/150	12.5 10	12.5	15
10000040	1.1/2 40	125/130/150	12.5 10	12.5	15
10000050	2 50	125/130/150	12.5 10	12.5	15
10000065	2.1/2 65	125/130/150	12.5 10	12.5	15
10000080	3 80	125/130/150	12.5 10	12.5	15
10000100	4 100	125/130/150	16 10	12.5	15
10000125	5 125	125/130/150	16 10	12.5	15
10000150	6 150	125/130/150	16 10	12.5	15
10000200	8 200	125/130/150	16 10	12.5	15

SINGLE SPHERE BELLOWS with TIE BARS

Swivel Flanges Galvanized
Flange Ratings BS10 Table E or F
 BS4504, PN10 an PN16
 ANSI B16.5 150lbs



Pressure Ratings : 25 - 200 NB 16 Bar @ 100°C
 250 - 300 NB 10 Bar @ 100°C

Product Group Code Group P030	Nominal Bore Size Ins mm	Available Lengths F/F mm	Axial Comp/Extn mm mm	Lateral Deflection mm	Angle of Deflection Deg
10002032	1.1/4" 32	125/130/150	12.5 10	12.5	15
10002040	1.1/2 40	125/130/150	12.5 10	12.5	15
10002050	2 50	125/130/150	12.5 10	12.5	15

EXPANSION / ANTIVIBRATION COUPLINGS

SINGLE SPHERE BELLOWS with TIE BARS

Product Group Code Group P030	Nominal Bore Size		Available Lengths F/F mm	Axial Comp/Extn		Lateral Deflection mm	Angle of Deflection Deg
	Ins	mm		mm	mm		
10002065	1.1/2"	65	125/130/150	12.5	10	12.5	15
10002080	3	80	125/130/150	12.5	10	12.5	15
10002100	4	100	125/130/150	16	10	12.5	15
10002125	5	125	125/130/150	16	10	12.5	15
10002150	6	150	125/130/150	16	10	12.5	15
10002200	8	200	125/130/150	16	10	12.5	15

SINGLE SPHERE BELLOWS Type: BB Untied

Chlorobutyl rubber membrane with untied flanges suitable for use with hot water and chilled water at 4 Bar working pressure with a maximum temperature of up to 105 Degrees.



Product Group Code Group P030	Nominal Bore Size		Available Lengths F/F mm	Axial Comp/Extn		Lateral Deflection mm	Angle of Deflection Deg
	Ins	mm		mm	mm		
10025032	1.1/4"	32	95	8	4	8	15
10025040	1.1/2	40	95	8	4	8	15
10025050	2	50	105	8	4	8	15
10025065	2.1/2	65	115	12	6	8	15
10025080	3	80	130	12	6	10	15
10025100	4	100	135	18	10	10	15
10025125	5	125	170	18	10	12	15
10025150	6	150	180	18	10	12	15

EXPANSION / ANTIVIBRATION COUPLINGS

SINGLE SPHERE BELLOWS with TIE BARS

Type: BB Untied

Chlorobutyl rubber membrane with untied flanges suitable for use with hot water and chilled water at 4 Bar working pressure with a maximum temperature of up to 105 Degrees.



Product Group Code Group P030	Nominal Bore Size Ins mm	Available Lengths F/F mm	Axial Comp/Extn mm mm	Lateral Deflection mm	Angle of Deflection Deg
10025032	1.1/4" 32	95	8 4	8	15
10025040	1.1/2 40	95	8 4	8	15
10025050	2 50	105	8 4	8	15
10025065	2.1/2 65	115	12 6	8	15
10025080	3 80	130	12 6	10	15
10025100	4 100	135	18 10	10	15
10025125	5 125	170	18 10	12	15
10025150	6 150	180	18 10	12	15

TYPE AU-BSP UNION ENDS

- Construction :** Bellows Membrane - AISI 321 Stainless Steel
BSP Union Ends - Malleable iron, gunmetal or stainless steel
- Performance :** Pressure Max Working 6 Bar. Test Pressure 9 Bar
Temperature 150°C
- Installation :** Take to avoid applying torsion on the bellows. Ensure pipework is adequately anchored and guided. All AU are supplied pre-extended, and do not require cold pull.

Product Group Code Group P031	Nominal Bore Size mm	Available Lengths F/F mm	Movement Comp mm
10054015	15	125	25
10054020	20	135	25
10054025	25	150	25
10054032	32	165	25
10054040	42	190	25
10054050	50	210	25

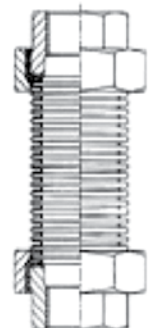

EXPANSION / ANTIVIBRATION COUPLINGS

TYPE AU-CPR SPIGOT ENDS

- Construction :** Bellows Membrane - AISI 321 Stainless Steel
Copper Spigot Ends Table X Copper Ends
- Performance :** Pressure Max Working 6 Bar. Test Pressure 9 Bar
Temperature 150°C
- Installation :** Take to avoid applying torsion on the bellows.
Ensure pipework is adequately anchored and guided. All AU are supplied pre-extended, and do not require cold pull.

Product Group Code	Nominal Bore Size mm	Available Lengths F/F mm	Movement Comp mm
10054415	15	200	25
10054422	22	210	25
10054428	28	215	25
10054435	35	225	25
10054442	42	230	25
10054454	54	230	25

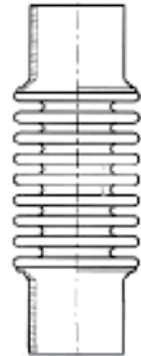

SS CONVOLUTED BELLOWS FLANGED / WELD ENDS AX RANGE

Standard Construction :

- 316 Stl/Stl membranes
- 316 Stl/Stl Flow Sleeves
- M/Stl Pipe
- M/Stl flanges

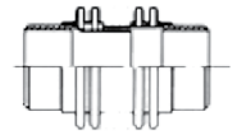
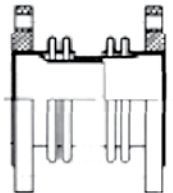

The AX range of expansion joints are designed to absorb the thermal expansion in straight pipelines.

Suitable for LTHW, MTHW, HTHW, steam and many other gases and liquids. The multiply construction and modern production techniques of the bellows membranes results in longer life span and lower spring rates. Supplied as standard with internal flow sleeves and fixed M/Stl flanges, they can also be custom made from different materials and to specific dimensions especially to suit each application, be it replacement of existing expansion joints or brand new systems.

EXPANSION / ANTIVIBRATION COUPLINGS

Please note the although these details give specific lengths, bellows of a specific requirement can be manufactured on request. The available range is not limited to ranges detailed but extends to products of a much higher specification. The standard working conditions and material options are as follows

Working Conditions: PN: 10
 Design Pressure 10 Bar
 Design Temp 350C

Options: Membranes in special alloys ie incoloy 825, 310 stl/stl
 Flanges to suit ie BS, JIS, DIN, A.S.A
 External Covers/ insulation
 Limit rod swivel flanges
 Higher pressure/Temperature Rating

Requirements for Ordering

Medium being Transported
 Pipe Bore Size
 Flange Table
 Operating Temperature/Pressure
 Hot Length/Cold Length
 Existing Face To Face
 Tied /Untied

DN		Short Movement			Medium Movement			Long Movement		
ins	mm	Movement +/-	Length Flanged	Length Plain	Movement +/-	Length Flanged	Length Plain	Movement +/-	Length Flanged	Length Plain
½	15	13	185	185	25	300	300	40	340	340
¾	20	13	185	185	25	330	330	40	340	340
1	25	13	185	185	25	330	330	40	340	340
1¼	32	13	185	185	25	325	325	40	340	340
1½	40	13	185	185	25	325	325	40	340	340
2	50	13	185	185	25	310	310	40	340	340
2½	65	15	135	245	25	210	320	40	390	390
3	80	15	135	245	25	210	320	50	390	390
4	100	15	135	245	25	210	320	50	460	460
5	125	15	180	300	35	210	320	50	460	460
6	150	15	180	300	40	210	360	50	460	460
8	200	20	180	300	40	240	390	60	480	480

POWER WRAP REPAIR BANDAGE

There are 100's of
different
pipes and hoses...

...only 1 product
can repair them all!



POWER
WRAP

PERMANENTLY REPAIRS ALMOST ANY MATERIAL
COPPER • STEEL • GALVANIZED PIPE • ALL PLASTIC PIPES • RUBBER • CEMENT
MEETS EPA REQUIREMENTS FOR DRINKING WATER
WATER ACTIVATED FIBERGLASS TAPE SETS LIKE STEEL

FIXING AND REPAIR CLAMPS

TEEKAY AXIFLEX COUPLING

Casing Standard Type 1 Stainless Steel AISI304

Internal Components: Stainless Steel AISI304

Lock Parts: Fasteners High Tensile Steel, Zinc & PTFE coated

OD mm	OD +/- Tolerance	Length mm	Nominal P Bar
48.3	1	85	16
60.3	1.5	87	16
76.1	1.5	87	16
88.9	1.5	87	16
114.3	2	87	16
139.7	2	112	16
168.3	2	112	16
219.1	2	112	16

Group P028 Code	Description	Clamp Size
10200040	Axiflex Coupling. EPDM 48.3od	40mm
10200050	Axiflex Coupling. EPDM 60.3od	50mm
10200065	Axiflex Coupling. EPDM 76.1od	65mm
10200080	Axiflex Coupling. EPDM 88.9od	80mm
10200100	Axiflex Coupling. EPDM 114.3od	100mm
10200125	Axiflex Coupling. EPDM 139.7od	125mm
10200150	Axiflex Coupling. EPDM 168.3od	150mm
10200200	Axiflex Coupling. EPDM 219.1od	200mm
10200250	Axiflex Coupling. EPDM 323.9od	250mm

EPDM Sealing Sleeves -40°C to +100°C

Is suitable for most effluents and is available in WRC approved compounds for potable water. Has outstanding resistance to ageing, weathering, ozone, oxygen and many chemicals.

NBR Sealing Sleeves -30°C to +80°C

Is suitable for use with petroleum products and gas as well as general services such as water, sewage etc.



FIXING AND REPAIR CLAMPS

TEEKAY AXIREP COUPLING

Casing Standard Type 1 Stainless Steel AISI304

Internal Components: Stainless Steel AISI304

Lock Parts: Fasteners High Tensile Steel, Zinc & PTFE coated

OD mm	OD +/- Tolerance	Length mm	Nominal P Bar
48.3	1	86	16
60.3	1.5	87	16
76.1	1.5	111	16
88.9	1.5	113	16
114.3	2	114	16
139.7	2	114	16
168.3	2	114	16
219.1	2	115	16

Group P028 Code	Description	Clamp Size
10205040	Axirep Repair Coupling. EPDM 48.3od	40mm
10205050	Axirep Repair Coupling. EPDM 60.3od	50mm
10205065	Axirep Repair Coupling. EPDM 76.1od	65mm
10205080	Axirep Repair Coupling. EPDM 88.9od	80mm
10205100	Axirep Repair Coupling. EPDM 114.3od	100mm
10205125	Axirep Repair Coupling. EPDM 139.7od	125mm
10205150	Axirep Repair Coupling. EPDM 168.3od	150mm
10205200	Axirep Repair Coupling. EPDM 219.1od	200mm

EPDM Sealing Sleeves -40°C to +100°C

Is suitable for most effluents and is available in WRC approved compounds for potable water. Has outstanding resistance to ageing, weathering, ozone, oxygen and many chemicals.

NBR Sealing Sleeves -30°C to +80°C

Is suitable for use with petroleum products and gas as well as general services such as water, sewage etc.



FIXING AND REPAIR CLAMPS

TEEKAY AXILOCK COUPLING

Casing Standard Type 1 Stainless Steel AISI304

Internal Components: Stainless Steel AISI304

Lock Parts: Fasteners High Tensile Steel, Zinc & PTFE coated

OD mm	OD +/- Tolerance	Length mm	Nominal P Bar
48.3	1	65	16
60.3	1.5	85	16
76.1	1.5	85	16
88.9	1.5	85	16
114.3	2	85	16
139.7	2	110	16
168.3	2	110	13
219.1	2	110	6

Group P028 Code	Description	Clamp Size
10215032	Axilock S Coupling. EPDM. 42.2od	32mm
10215040	Axilock S Coupling. EPDM. 48.3od	40mm
10215050	Axilock S Coupling. EPDM. 60.3od	50mm
10215065	Axilock S Coupling. EPDM. 76.1od	65mm
10215080	Axilock S Coupling. EPDM. 88.9od	80mm
10215100	Axilock S Coupling. EPDM. 114.3od	100mm
10215125	Axilock S Coupling. EPDM. 139.7od	125mm
10215150	Axilock S Coupling. EPDM. 168.3od	150mm
10215200	Axilock S Coupling. EPDM. 219.1od	200mm

EPDM Sealing Sleeves -40°C to +100°C

Is suitable for most effluents and is available in WRC approved compounds for potable water. Has outstanding resistance to ageing, weathering, ozone, oxygen and many chemicals.

NBR Sealing Sleeves -30°C to +80°C

Is suitable for use with petroleum products and gas as well as general services such as water, sewage etc.



FIXING AND REPAIR CLAMPS

MAXIDAPTOR

Flange adaptors designed to accommodate plain ended pipes with different outside diameters. For use on steel ductile iron, cast iron, PVCu and asbestos cement.

Finish: Black Rilsan Coat
Nuts & Bolts: Rilsan Coat
Gasket: E.P.D.M ("E" Grade)
Options: British Gas LC6 approved gaskets



Group P026 Code	Description	Clamp Size
10480050	Maxidaptor (range 59.2– 72mm) NP16/DE	50mm
10480065	Maxidaptor (range 72.2-85mm) NP16/DE	65mm
10480080	Maxidaptor (range 88.1-102.4mm) NP16/DE	80mm
10480100	Maxidaptor (range 109.6-127.8mm) NP16/DE	100mm
10480125	Maxidaptor (range 132.2-146mm) NP16/DE	125mm
10480150	Maxidaptor (range 159.2-181.6mm) NP16/DE	150mm
10480200	Maxidaptor (range 218.1-235mm) NP16/DE	200mm

HANDBAND

A range of small bore stainless steel repair clamps.

Nuts & Bolts: Mild Steel
Gasket: E.P.D.M ("E" Grade)
Options: British Gas LC6 approved gaskets



Group P026 Code	Description	Clamp Size & Length
10500015	Handiband (15-22mm)	15x75mm
10500020	Handiband (26-30mm)	20x75mm
10500025	Handiband (33-37mm)	25x75mm
10500032	Handiband (42-45mm)	32x75mm
10500040	Handiband (48-54mm)	40x75mm
10500050	Handiband (60-64mm)	50x75mm

FIXING AND REPAIR CLAMPS

EASI CLAMP / EASITAP

A range of high strength repair clamps for use on steel, ductile iron, cast iron PVCu (up to 200mm/8") and PE pipes (up to 220/8"). The easitap identical in specification other than the availability of a threaded boss, either tapped or proud on the coupling. Each product has a tolerance designed to accommodate the outside diameters of different pipe materials.

Finish: Black Rilsan Coat
Nuts & Bolts: Rilsan Coat
Gasket: E.P.D.M ("E" Grade)
Options: British Gas LC6 approved gaskets



Group P026 Code	Description	Clamp Size
10450050	Easiclump with Boss (range 66-75mm)- 2"	50mm
10450065	Easiclump with Boss (range 75-84mm) - 2"	65mm
10450080	Easitap with Boss (range 92.3-103mm) - 2"	80mm
10450100	Easitap with Boss (range 115-125.6) - 2"	100mm
10450125	Easitap with Boss (range 141-153.9mm) -2"	125mm
10450150	Easitap with Boss (range 166-181.2mm) .2"	150mm
10450200	Easitap with Boss (range 216.5-226mm) .2"	200mm

MAXIFIT COUPLING

Couplings Designed to accommodate plain ended pipes with different outside diameters. For use on steel, ductile iron, cast iron, PVCu and asbestos cement.

Finish: Black Rilsan Coat
Nuts & Bolts: Rilsan Coat
Gasket: E.P.D.M ("E" Grade)
Options: British Gas LC6 approved gaskets



Group P026 Code	Description	Clamp Size
10460050	Maxifit Coupling (range 59.5-72mm)	50mm
10460065	Maxifit Coupling (range 72.2- 85mm)	65mm
10460080	Maxifit Coupling (range 88.1- 102.4mm)	80mm

FIXING AND REPAIR CLAMPS

MAXIFIT COUPLING

Group P026 Code	Description	Clamp Size
10460100	Maxifit Coupling (range 109.6-127.8mm)	100mm
10460101	Maxifit Coupling (range 120-141mm)	100mm
10460125	Maxifit Coupling (range 132.2-146mm)	125mm
10460126	Maxifit Coupling (range 138.9-153.2)	125mm
10460150	Maxifit Coupling (range 159.2-181.6)	150mm
10460200	Maxifit Coupling (range 218.1-235mm)	200mm
10460201	Maxifit Coupling (range 230-247mm)	200mm

MAXISTEP COUPLING

Couplings Designed to accommodate plain ended pipes with different outside diameters. For use on steel, ductile iron, cast iron, PVCu and asbestos cement.

Finish:	Black Rilsan Coat
Nuts & Bolts:	Rilsan Coat
Gasket:	E.P.D.M ("E" Grade)
Options:	British Gas LC6 approved gaskets

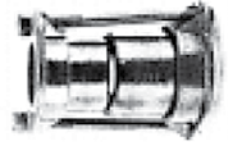

Group P026 Code	Description	Clamp Size
10470040	Maxistep (range 47.9-59.5 to 72.2/85mm)	40/65mm
10470050	Maxistep (range 59.5-72.2 to 72.2-85mm)	50/65mm
10470051	Maxistep (range 59.5-72.2 to 88.1-102.4mm)	50/80mm
10470081	Maxistep (range 88.1-102.4 to 109.6-127.8mm)	80/100mm
10470100	Maxistep (range 107.2-115 to 109.6-127.8mm)	100mm
10470101	Maxistep (range 109.6-127to8 /118/131.5mm)	100mm
10470102	Maxistep (range 109.6-127.8 to 132.2-146mm)	125mm
10470125	Maxistep (range 132.2-146 to 138.9-153.2mm)	125mm
10470126	Maxistep (range 132.2-146to 159.2-181.6)	125/150mm
10470127	Maxistep (range 138.9-153 to 159.2-181.6)	125/150mm
10470150	Maxistep (range 159.2-181.6 to 171.5-193)	150mm

FIXING AND REPAIR CLAMPS

GEBO PIPE REPAIR CLAMP

Galvanised Cast Iron Sealing Clamps for Sealing Holes, cracks and other porous areas. For steel pipes according to DIN2440, 2441, 2442, 2448 & 2458 Series 1

Media: Water
Pressure Ranges: PN16
Temperatures: Water up to 90°C

Group P021 Code	Description	Clamp Size
10519015	GEBO Pipe Repair Clamp	15mm
10519020	GEBO Pipe Repair Clamp	20mm
10519025	GEBO Pipe Repair Clamp	25mm
10519032	GEBO Pipe Repair Clamp	32mm
10519040	GEBO Pipe Repair Clamp	40mm
10519050	GEBO Pipe Repair Clamp	50mm
10519065	GEBO Pipe Repair Clamp	65mm
10519080	GEBO Pipe Repair Clamp	80mm
10519100	GEBO Pipe Repair Clamp	100mm



FIXING AND REPAIR CLAMPS

MULTI JOINT SYSTEMS PRESSURE CLASS PN16/PN10



VARIOFIKS END LOAD FIXING SYSTEM

These special rings were built up from segments which are conical in all directions, free to move independently and connected to each other at the same time. This ensures their stability.

The Varioseal rubber ring is fixed. Its dimensions are such that 100% tightness is assured. The ring has a tested theoretical life of 50 years.

Tests

The Multijoint system with the Variofiks ring is exhaustively tested according to the international standards ISO 2531 - EN 545 - EN 969.

This means that the multi-joint system fully meets the requirements of the EU standards.

Little time needed for assembly. Dismantling not required.

Angular setting 8° Pressure Class PN16. Resicoat Plastic Coating.



Tests Performed

Pressure : Water 25 Bar/Time : 15 mins

Vacuum : 0.2Bar/Time:120mins, 0.8Bar/Time:120mins

Gas : Air 6 Bar/Time: 10 Mins
for Gas the system is tested up to 8 bar working pressure.

Flexibility : Water 20Bar,whereby the coupling and pipe are subjected to the maximum turn angle Time 60mins.

FIXING AND REPAIR CLAMPS

MULTI JOINT SYSTEMS PRESSURE CLASS PN16/PN10

END LOAD COUPLINGS

Advantages of the Type 3000 Waga Range

One size fits and grips all per nominal size. Quick and reliable. Replaces complicated fitting methods. No need for additional support where elbows are build-in. For placing Valves , elbows, fire hydrants and pipes end-loaded in the piping system. With special end caps (blind or with a threaded hole) Environmentally friendly.



Material Specification

Body	Ductile Cast Iron GGG40
Coating	Resicoat synthetic coating Meets requirements of WRC, KTW & KIWA for use in drinking water pipelines
Vario Seal	NBR (Nitrilic butadiene rubber) temperature:-5°C up to +50°C
Flekscores	Nakan GPM
Fiksers	Stainless Steel quality A4 (316)
Bolts & nuts	Standard bolt steel quality 8.8 and nuts quality 8. Bolts nuts coated with Delta magni coating. The combination of these layers guarantees corrosion resistance according to : Salt spray test DIN50021:750h Kesternich test SFW 2.0: 12cycli
Washers	Stainless steel A2 (304)
Flanges	DN50 to 150mm flange drilling PN10/16 DN200 to 300mm flange drilling PN10
Pressures	Multi/joint 3000 system PN16. Multi/joint 3007 system up to PN16 depending on nominal diameter (indicated where appropriate)
Patent Nr	Patented under number 1002514

The Multi/joint system is manufactured in accordance with the quality assurance standard ISO 9001.

FIXING AND REPAIR CLAMPS

MULTI JOINT SYSTEMS PRESSURE CLASS PN16/PN10

TYPE 3007

End load
Spigot to
Spigot
coupling



Product Code	DN	Size Range	Fixing	Weight KG	Working Pressure
10306050	50	46-70	3xM12	5	PN16
10306065	65	70-88	3xM12	5.2	PN16
10306080	80	84-105	3xM12	6.2	PN16
10306100	100	104-132	3xM16	9.6	PN16
10306125	125	132-155	3xM16	12.9	PN16
10306150	150	154-192	4xM16	13.2	PN16
10306200	200	198-230	4xM20	23.2	PN16
10306225	225	232-257	6xM20	32.1	PN16
10306250	250	267-310	6xM20	46	PN16
10306300	300	315-356	8xM20	55.4	PN16

TYPE 3057

End load
Spigot to
Flange
coupling



Product Code	DN	Size Range	Fixing	Weight KG	Working Pressure
10308050	50	46-70	3xM12	5.4	PN16
10308065	65	70-88	3xM12	8.1	PN16
10308080	80	84-105	3xM12	7.9	PN16
10308100	100	104-132	3xM16	9.8	PN16
10308125	125	132-155	3xM16	12.8	PN16
10308150	150	154-192	4xM16	15.3	PN16
10308200	200	198-230	4xM20	22	PN10
10308250	250	267-310	6xM20	38.5	PN10
10308300	300	315-356	8xM20	53	PN10

FIXING AND REPAIR CLAMPS

MULTI JOINT SYSTEMS PRESSURE CLASS PN16/PN10

TYPE 3207

End load cap
end tapped
BSP or plain.



Product Code	DN	Size Range	Fixing	Weight KG	Working Pressure
10307050	50	46-70	3xM12	3.7	PN16
10307065	65	70-88	3xM12	4	PN16
10307080	80	84-105	3xM12	4.6	PN16
10307100	100	104-132	3xM16	6	PN16
10307125	125	132-155	3xM16	8.2	PN16
10307150	150	154-192	4xM16	11	PN16
10307200	200	198-230	4xM20	15.9	PN10
10307225	225	232-257	6xM20	23.7	PN10
10307250	250	267-310	6xM20	30.7	PN10
10307300	300	315-356	8xM20	34.9	PN10

The above range of cap ends are drilled & tapped either 1" or 2" BSP.
Blind end caps are also available.

COMPRESSION FITTINGS FOR STEEL

Seal	Medium	Steel Pipe Maximum Temperature	Steel Pipe Maximum Working Pressure @ 20C	PE Pipe Maximum Temperature	PE Pipe Maximum Working Pressure @ 20C
Nitrile	Gas	70C	10 Bar	40C	5 Bar
	Water	80C	16 Bar	40C	16 Bar
	Air	80C	16 Bar	/	/
	Oil	80C	16 Bar	/	/
EPDM	Water	40C	16 Bar	40C	16 Bar
FPM	Water	95C	10 Bar	/	/

Product Group PO20

Product Code	Description	Fitting Size
10100015	Primofit Coupling . StlxStl. Galv. NBR	15x15mm
10100020	Primofit Coupling . StlxStl. Galv. NBR	20x20mm
10100025	Primofit Coupling . StlxStl. Galv. NBR	25x25mm
10100032	Primofit Coupling . StlxStl. Galv. NBR	32x32mm
10100040	Primofit Coupling . StlxStl. Galv. NBR	40x40mm
10100050	Primofit Coupling . StlxStl. Galv. NBR	50x50mm



Product Code	Description	Fitting Size
10100115	Primofit x Male Bsp Adaptor. Galv. NBR	15mm
10100120	Primofit x Male Bsp Adaptor. Galv. NBR	20mm
10100125	Primofit x Male Bsp Adaptor. Galv. NBR	25mm
10100132	Primofit x Male Bsp Adaptor. Galv. NBR	32mm
10100140	Primofit x Male Bsp Adaptor. Galv. NBR	40mm
10100150	Primofit x Male Bsp Adaptor. Galv. NBR	50mm

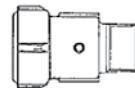

Product Code	Description	Fitting Size
10100215	Primofit x Female Bsp Adaptor. Galv. NBR	15mm
10100220	Primofit x Female Bsp Adaptor. Galv. NBR	20mm
10100225	Primofit x Female Bsp Adaptor. Galv. NBR	25mm
10100232	Primofit x Female Bsp Adaptor. Galv. NBR	32mm
10100240	Primofit x Female Bsp Adaptor. Galv. NBR	40mm
10100250	Primofit x Female Bsp Adaptor. Galv. NBR	50mm



COMPRESSION FITTINGS FOR STEEL

Product Group PO20

Product Code	Description	Fitting Size
10100315	Primofit Elbow 90.deg. Galv.NBR	15mm
10100320	Primofit Elbow 90.deg. Galv.NBR	20mm
10100325	Primofit Elbow 90.deg. Galv.NBR	25mm
10100332	Primofit Elbow 90.deg. Galv.NBR	32mm
10100340	Primofit Elbow 90.deg. Galv.NBR	40mm
10100350	Primofit Elbow 90.deg. Galv.NBR	50mm

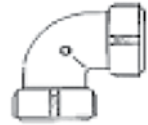

Product Code	Description	Fitting Size
10100415	Primofit Cap.Galv.NBR	15mm
10100420	Primofit Cap.Galv.NBR	20mm
10100425	Primofit Cap.Galv.NBR	25mm
10100432	Primofit Cap.Galv.NBR	32mm
10100440	Primofit Cap.Galv.NBR	40mm
10100450	Primofit Cap.Galv.NBR	50mm



Product Code	Description	Fitting Size
10100515	Primofit Equal Tee.StlxStlxStl.Galv.NBR	15mm
10100520	Primofit Equal Tee.StlxStlxStl.Galv.NBR	20mm
10100525	Primofit Equal Tee.StlxStlxStl.Galv.NBR	25mm
10100532	Primofit Equal Tee.StlxStlxStl.Galv.NBR	32mm
10100540	Primofit Equal Tee.StlxStlxStl.Galv.NBR	40mm
10100550	Primofit Equal Tee.StlxStlxStl.Galv.NBR	50mm



Product Code	Description	Fitting Size
10100615	Primofit x Bsp Tee.StlxStlxBsp.Galv.NBR	15mm
10100620	Primofit x Bsp Tee.StlxStlxBsp.Galv.NBR	20mm
10100625	Primofit x Bsp Tee.StlxStlxBsp.Galv.NBR	25mm
10100632	Primofit x Bsp Tee.StlxStlxBsp.Galv.NBR	32mm
10100640	Primofit x Bsp Tee.StlxStlxBsp.Galv.NBR	40mm
10100650	Primofit x Bsp Tee.StlxStlxBsp.Galv.NBR	50mm



COMPRESSION FITTINGS FOR STEEL

Product Group PO20

Product Code	Description	Fitting Size
10100701	Primofit FPM Seal Kit	15mm
10100702	Primofit FPM Seal Kit	20mm
10100703	Primofit FPM Seal Kit	25mm
10100704	Primofit FPM Seal Kit	32mm
10100705	Primofit FPM Seal Kit	40mm
10100750	Primofit FPM Seal Kit	50mm



Product Code	Description	Fitting Size
10100815	Primofit NBR Replacement Kit	15mm
10100820	Primofit NBR Replacement Kit	20mm
10100825	Primofit NBR Replacement Kit	25mm
10100832	Primofit NBR Replacement Kit	32mm
10100840	Primofit NBR Replacement Kit	40mm
10100850	Primofit NBR Replacement Kit	50mm



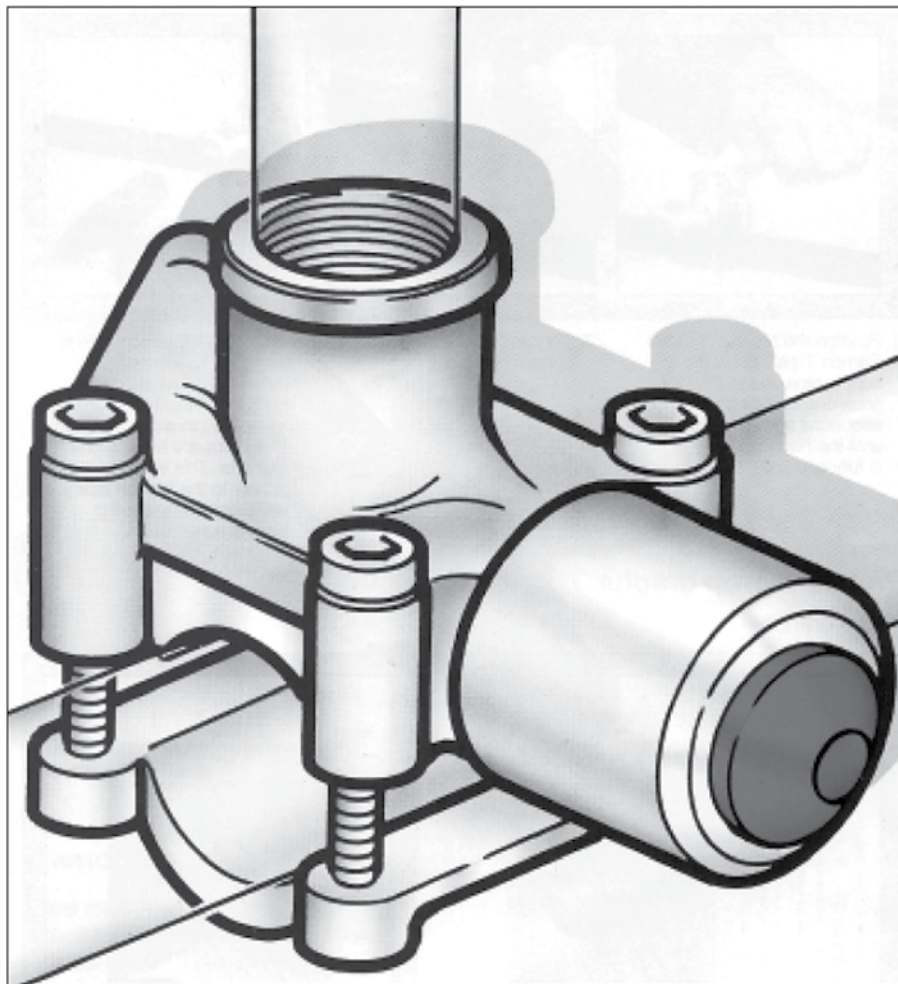

MALLEABLE PIPE FITTINGS

Product Code	Description	Size mm
11311015	Malleable Return Bend 213	15
11311020	Malleable Return Bend 213	20
11311025	Malleable Return Bend 213	25
11311032	Malleable Return Bend 213	32
11311040	Malleable Return Bend 213	40
11311050	Malleable Return Bend 213	50
11312015	Malleable Return Bend Galv 213G	15
11312020	Malleable Return Bend Galv 213G	20
11312025	Malleable Return Bend Galv 213G	25
11312032	Malleable Return Bend Galv 213G	32
11312040	Malleable Return Bend Galv 213G	40
11312050	Malleable Return Bend Galv 213G	50



Product Code	Description	Size mm
11331020	Malleable Round Floor Plate	20
11331025	Malleable Round Floor Plate	25
11332020	Malleable Round Floor Plate Galv	20
11332025	Malleable Round Floor Plate Galv	25



Product Code	Description	Size mm
11401081	Malleable Hexagon Reducing Bush 140	8x6
11401101	Malleable Hexagon Reducing Bush 140	10x6
11401102	Malleable Hexagon Reducing Bush 140	10x8
11401151	Malleable Hexagon Reducing Bush 140	15x6
11401152	Malleable Hexagon Reducing Bush 140	15x8
11401153	Malleable Hexagon Reducing Bush 140	15x10
11401221	Malleable Hexagon Reducing Bush 140	20x6
11401222	Malleable Hexagon Reducing Bush 140	20x8
11401223	Malleable Hexagon Reducing Bush 140	20x10
11401224	Malleable Hexagon Reducing Bush 140	20x15
11401252	Malleable Hexagon Reducing Bush 140	25x8
11401253	Malleable Hexagon Reducing Bush 140	25x10
11401254	Malleable Hexagon Reducing Bush 140	25x15
11401255	Malleable Hexagon Reducing Bush 140	25x20
11401322	Malleable Hexagon Reducing Bush 140	32x8
11401323	Malleable Hexagon Reducing Bush 140	32x10
11401324	Malleable Hexagon Reducing Bush 140	32x15
11401325	Malleable Hexagon Reducing Bush 140	32x20



Continued

MALLEABLE PIPE FITTINGS

Product Code	Description	Size mm
11401326	Malleable Hexagon Reducing Bush 140	32x25
11401402	Malleable Hexagon Reducing Bush 140	40x8
11401403	Malleable Hexagon Reducing Bush 140	40x10
11401404	Malleable Hexagon Reducing Bush 140	40x15
11401405	Malleable Hexagon Reducing Bush 140	40x20
11401406	Malleable Hexagon Reducing Bush 140	40x25
11401407	Malleable Hexagon Reducing Bush 140	40x32
11401503	Malleable Hexagon Reducing Bush 140	50x10
11401504	Malleable Hexagon Reducing Bush 140	50x15
11401505	Malleable Hexagon Reducing Bush 140	50x20
11401506	Malleable Hexagon Reducing Bush 140	50x25
11401507	Malleable Hexagon Reducing Bush 140	50x32
11401508	Malleable Hexagon Reducing Bush 140	50x40
11401654	Malleable Hexagon Reducing Bush 140	65x15
11401655	Malleable Hexagon Reducing Bush 140	65x20
11401656	Malleable Hexagon Reducing Bush 140	65x25
11401657	Malleable Hexagon Reducing Bush 140	65x32
11401658	Malleable Hexagon Reducing Bush 140	65x40
11401659	Malleable Hexagon Reducing Bush 140	65x50
11401804	Malleable Hexagon Reducing Bush 140	80x15
11401805	Malleable Hexagon Reducing Bush 140	80x20
11401806	Malleable Hexagon Reducing Bush 140	80x25
11401807	Malleable Hexagon Reducing Bush 140	80x32
11401808	Malleable Hexagon Reducing Bush 140	80x40
11401809	Malleable Hexagon Reducing Bush 140	80x50
11401810	Malleable Hexagon Reducing Bush 140	80x65
11401901	Malleable Hexagon Reducing Bush 140	100x25
11401902	Malleable Hexagon Reducing Bush 140	100x32
11401903	Malleable Hexagon Reducing Bush 140	100x40
11401904	Malleable Hexagon Reducing Bush 140	100x50
11401905	Malleable Hexagon Reducing Bush 140	100x65
11401906	Malleable Hexagon Reducing Bush 140	100x80
11401911	Malleable Hexagon Reducing Bush 140	125x100
11401922	Malleable Hexagon Reducing Bush 140	150x50
11401923	Malleable Hexagon Reducing Bush 140	150x80
11401924	Malleable Hexagon Reducing Bush 140	150x100
11402081	Malleable Hexagon Reducing Bush Galv	8x6
11402101	Malleable Hexagon Reducing Bush Galv	10x6
11402102	Malleable Hexagon Reducing Bush Galv	10x8
11402151	Malleable Hexagon Reducing Bush Galv	15x6



Continued

MALLEABLE PIPE FITTINGS

Product Code	Description	Size mm
11402152	Malleable Hexagon Reducing Bush Galv	15x8
11402153	Malleable Hexagon Reducing Bush Galv	15x10
11402221	Malleable Hexagon Reducing Bush Galv	20x6
11402222	Malleable Hexagon Reducing Bush Galv	20x8
11402223	Malleable Hexagon Reducing Bush Galv	20x10
11402224	Malleable Hexagon Reducing Bush Galv	20x15
11402252	Malleable Hexagon Reducing Bush Galv	25x8
11402253	Malleable Hexagon Reducing Bush Galv	25x10
11402254	Malleable Hexagon Reducing Bush Galv	25x15
11402255	Malleable Hexagon Reducing Bush Galv	25x20
11402322	Malleable Hexagon Reducing Bush Galv	32x8
11402323	Malleable Hexagon Reducing Bush Galv	32x10
11402324	Malleable Hexagon Reducing Bush Galv	32x15
11402325	Malleable Hexagon Reducing Bush Galv	32x20
11402326	Malleable Hexagon Reducing Bush Galv	32x25
11402402	Malleable Hexagon Reducing Bush Galv	40x8
11402403	Malleable Hexagon Reducing Bush Galv	40x10
11402404	Malleable Hexagon Reducing Bush Galv	40x15
11402405	Malleable Hexagon Reducing Bush Galv	40x20
11402406	Malleable Hexagon Reducing Bush Galv	40x25
11402407	Malleable Hexagon Reducing Bush Galv	40x32
11402503	Malleable Hexagon Reducing Bush Galv	50x10
11402504	Malleable Hexagon Reducing Bush Galv	50x15
11402505	Malleable Hexagon Reducing Bush Galv	50x20
11402506	Malleable Hexagon Reducing Bush Galv	50x25
11402507	Malleable Hexagon Reducing Bush Galv	50x32
11402508	Malleable Hexagon Reducing Bush Galv	50x40
11402654	Malleable Hexagon Reducing Bush Galv	65x15
11402655	Malleable Hexagon Reducing Bush Galv	65x20
11402656	Malleable Hexagon Reducing Bush Galv	65x25
11402657	Malleable Hexagon Reducing Bush Galv	65x32
11402658	Malleable Hexagon Reducing Bush Galv	65x40
11402659	Malleable Hexagon Reducing Bush Galv	65x50
11402804	Malleable Hexagon Reducing Bush Galv	80x15
11402805	Malleable Hexagon Reducing Bush Galv	80x20
11402806	Malleable Hexagon Reducing Bush Galv	80x25
11402807	Malleable Hexagon Reducing Bush Galv	80x32
11402808	Malleable Hexagon Reducing Bush Galv	80x40
11402809	Malleable Hexagon Reducing Bush Galv	80x50
11402810	Malleable Hexagon Reducing Bush Galv	80x65



Continued

MALLEABLE PIPE FITTINGS

Product Code	Description	Size mm
11402901	Malleable Hexagon Reducing Bush Galv	100x25
11402902	Malleable Hexagon Reducing Bush Galv	100x32
11402903	Malleable Hexagon Reducing Bush Galv	100x40
11402904	Malleable Hexagon Reducing Bush Galv	100x50
11402905	Malleable Hexagon Reducing Bush Galv	100x65
11402906	Malleable Hexagon Reducing Bush Galv	100x80
11402911	Malleable Hexagon Reducing Bush Galv	125x100
11402922	Malleable Hexagon Reducing Bush Galv	150x50
11402923	Malleable Hexagon Reducing Bush Galv	150x80
11402924	Malleable Hexagon Reducing Bush Galv	150x100



Product Code	Description	Size mm
11441008	Malleable Hexagon Nipple	8
11441010	Malleable Hexagon Nipple	10
11441015	Malleable Hexagon Nipple	15
11441020	Malleable Hexagon Nipple	20
11441025	Malleable Hexagon Nipple	25
11441032	Malleable Hexagon Nipple	32
11441040	Malleable Hexagon Nipple	40
11441050	Malleable Hexagon Nipple	50
11441065	Malleable Hexagon Nipple	65
11441080	Malleable Hexagon Nipple	80
11441100	Malleable Hexagon Nipple	100
11441150	Malleable Hexagon Nipple	150
11442008	Malleable Hexagon Nipple Galv	8
11442010	Malleable Hexagon Nipple Galv	10
11442015	Malleable Hexagon Nipple Galv	15
11442020	Malleable Hexagon Nipple Galv	20
11442025	Malleable Hexagon Nipple Galv	25
11442032	Malleable Hexagon Nipple Galv	32
11442040	Malleable Hexagon Nipple Galv	40
11442050	Malleable Hexagon Nipple Galv	50
11442065	Malleable Hexagon Nipple Galv	65
11442080	Malleable Hexagon Nipple Galv	80
11442100	Malleable Hexagon Nipple Galv	100
11442150	Malleable Hexagon Nipple Galv	150



MALLEABLE PIPE FITTINGS



Product Code	Description	Size mm
11451081	Malleable Hexagon Reducing Nipple	8x6
11451102	Malleable Hexagon Reducing Nipple	10x8
11451152	Malleable Hexagon Reducing Nipple	15x8
11451153	Malleable Hexagon Reducing Nipple	15x10
11451203	Malleable Hexagon Reducing Nipple	20x10
11451204	Malleable Hexagon Reducing Nipple	20x15
11451254	Malleable Hexagon Reducing Nipple	25x15
11451255	Malleable Hexagon Reducing Nipple	25x20
11451324	Malleable Hexagon Reducing Nipple	32x15
11451325	Malleable Hexagon Reducing Nipple	32x20
11451326	Malleable Hexagon Reducing Nipple	32x25
11451406	Malleable Hexagon Reducing Nipple	40x25
11451407	Malleable Hexagon Reducing Nipple	40x32
11451506	Malleable Hexagon Reducing Nipple	50x25
11451507	Malleable Hexagon Reducing Nipple	50x32
11451508	Malleable Hexagon Reducing Nipple	50x40
11451659	Malleable Hexagon Reducing Nipple	65x50
11451809	Malleable Hexagon Reducing Nipple	80x50
11451810	Malleable Hexagon Reducing Nipple	80x65
11452081	Malleable Hexagon Reducing Nipple Galv	8x6
11452102	Malleable Hexagon Reducing Nipple Galv	10x8
11452152	Malleable Hexagon Reducing Nipple Galv	15x8
11452153	Malleable Hexagon Reducing Nipple Galv	15x10
11452203	Malleable Hexagon Reducing Nipple Galv	20x10
11452204	Malleable Hexagon Reducing Nipple Galv	20x15
11452254	Malleable Hexagon Reducing Nipple Galv	25x15
11452255	Malleable Hexagon Reducing Nipple Galv	25x20
11452324	Malleable Hexagon Reducing Nipple Galv	32x15
11452325	Malleable Hexagon Reducing Nipple Galv	32x20
11452326	Malleable Hexagon Reducing Nipple Galv	32x25
11452406	Malleable Hexagon Reducing Nipple Galv	40x25
11452407	Malleable Hexagon Reducing Nipple Galv	40x32
11452506	Malleable Hexagon Reducing Nipple Galv	50x25
11452507	Malleable Hexagon Reducing Nipple Galv	50x32
11452508	Malleable Hexagon Reducing Nipple Galv	50x40
11452659	Malleable Hexagon Reducing Nipple Galv	65x50
11452809	Malleable Hexagon Reducing Nipple Galv	80x50
11452810	Malleable Hexagon Reducing Nipple Galv	80x65

MALLEABLE PIPE FITTINGS

Product Code	Description	Size mm
11471006	Malleable Plug	6
11471008	Malleable Plug	8
11471010	Malleable Plug	10
11471015	Malleable Plug	15
11471020	Malleable Plug	20
11471025	Malleable Plug	25
11471032	Malleable Plug	32
11471040	Malleable Plug	40
11471050	Malleable Plug	50
11471065	Malleable Plug	65
11471080	Malleable Plug	80
11471100	Malleable Plug	100
11471125	Malleable Plug	125
11471150	Malleable Plug	150
11472006	Malleable Plug Galv	6
11472008	Malleable Plug Galv	8
11472010	Malleable Plug Galv	10
11472015	Malleable Plug Galv	15
11472020	Malleable Plug Galv	20
11472025	Malleable Plug Galv	25
11472032	Malleable Plug Galv	32
11472040	Malleable Plug Galv	40
11472050	Malleable Plug Galv	50
11472065	Malleable Plug Galv	65
11472080	Malleable Plug Galv	80
11472100	Malleable Plug Galv	100
11472125	Malleable Plug Galv	125
11472150	Malleable Plug Galv	150



Product Code	Description	Size mm
11501006	Malleable Elbow 90deg FF	6
11501008	Malleable Elbow 90deg FF	8
11501010	Malleable Elbow 90deg FF	10
11501015	Malleable Elbow 90deg FF	15
11501020	Malleable Elbow 90deg FF	20
11501025	Malleable Elbow 90deg FF	25
11501161	Malleable Elbow 90deg FF (reducing)	20x15
11501032	Malleable Elbow 90deg FF	32
11501040	Malleable Elbow 90deg FF	40



Continued

MALLEABLE PIPE FITTINGS



Product Code	Description	Size mm
11501050	Malleable Elbow 90deg FF	50
11501065	Malleable Elbow 90deg FF	65
11501080	Malleable Elbow 90deg FF	80
11501100	Malleable Elbow 90deg FF	100
11501125	Malleable Elbow 90deg FF	125
11501150	Malleable Elbow 90deg FF	150
11502006	Malleable Elbow 90deg FF Galv	6
11502008	Malleable Elbow 90deg FF Galv	8
11502010	Malleable Elbow 90deg FF Galv	10
11502015	Malleable Elbow 90deg FF Galv	15
11502020	Malleable Elbow 90deg FF Galv	20
11502025	Malleable Elbow 90deg FF Galv	25
11502161	Malleable Elbow 90deg FF Galv (reducing)	20x15
11502032	Malleable Elbow 90deg FF Galv	32
11502040	Malleable Elbow 90deg FF Galv	40
11502050	Malleable Elbow 90deg FF Galv	50
11502065	Malleable Elbow 90deg FF Galv	65
11502080	Malleable Elbow 90deg FF Galv	80
11502100	Malleable Elbow 90deg FF Galv	100
11502125	Malleable Elbow 90deg FF Galv	125
11502150	Malleable Elbow 90deg FF Galv	150

Product Code	Description	Size mm
11521006	Malleable Elbow 90deg MF	6
11521008	Malleable Elbow 90deg MF	8
11521010	Malleable Elbow 90deg MF	10
11521015	Malleable Elbow 90deg MF	15
11521020	Malleable Elbow 90deg MF	20
11521025	Malleable Elbow 90deg MF	25
11521032	Malleable Elbow 90deg MF	32
11521040	Malleable Elbow 90deg MF	40
11521050	Malleable Elbow 90deg MF	50
11521065	Malleable Elbow 90deg MF	65
11521080	Malleable Elbow 90deg MF	80
11521100	Malleable Elbow 90deg MF	100
11522006	Malleable Elbow 90deg MF Galv	6
11522008	Malleable Elbow 90deg MF Galv	8
11522010	Malleable Elbow 90deg MF Galv	10
11522015	Malleable Elbow 90deg MF Galv	15



Continued

MALLEABLE PIPE FITTINGS

Product Code	Description	Size mm
11522020	Malleable Elbow 90deg MF Galv	20
11522025	Malleable Elbow 90deg MF Galv	25
11522032	Malleable Elbow 90deg MF Galv	32
11522040	Malleable Elbow 90deg MF Galv	40
11522050	Malleable Elbow 90deg MF Galv	50
11522065	Malleable Elbow 90deg MF Galv	65
11522080	Malleable Elbow 90deg MF Galv	80
11522100	Malleable Elbow 90deg MF Galv	100



Product Code	Description	Size mm
11551008	Malleable Elbow 45deg FF	8
11551010	Malleable Elbow 45deg FF	10
11551015	Malleable Elbow 45deg FF	15
11551020	Malleable Elbow 45deg FF	20
11551025	Malleable Elbow 45deg FF	25
11551032	Malleable Elbow 45deg FF	32
11551040	Malleable Elbow 45deg FF	40
11551050	Malleable Elbow 45deg FF	50
11551065	Malleable Elbow 45deg FF	65
11551080	Malleable Elbow 45deg FF	80
11551100	Malleable Elbow 45deg FF	100
11551150	Malleable Elbow 45deg FF	150
11552010	Malleable Elbow 45deg FF Galv	10
11552015	Malleable Elbow 45deg FF Galv	15
11552020	Malleable Elbow 45deg FF Galv	20
11552025	Malleable Elbow 45deg FF Galv	25
11552032	Malleable Elbow 45deg FF Galv	32
11552040	Malleable Elbow 45deg FF Galv	40
11552050	Malleable Elbow 45deg FF Galv	50
11552065	Malleable Elbow 45deg FF Galv	65
11552080	Malleable Elbow 45deg FF Galv	80
11552100	Malleable Elbow 45deg FF Galv	100
11552150	Malleable Elbow 45deg FF Galv	150



MALLEABLE PIPE FITTINGS



Product Code	Description	Size mm
11561008	Malleable Elbow 45deg MF	8
11561010	Malleable Elbow 45deg MF	10
11561015	Malleable Elbow 45deg MF	15
11561020	Malleable Elbow 45deg MF	20
11561025	Malleable Elbow 45deg MF	25
11561032	Malleable Elbow 45deg MF	32
11561040	Malleable Elbow 45deg MF	40
11561050	Malleable Elbow 45deg MF	50
11561065	Malleable Elbow 45deg MF	65
11561080	Malleable Elbow 45deg MF	80
11561100	Malleable Elbow 45deg MF	100
11562008	Malleable Elbow 45deg MF Galv	8
11562010	Malleable Elbow 45deg MF Galv	10
11562015	Malleable Elbow 45deg MF Galv	15
11562020	Malleable Elbow 45deg MF Galv	20
11562025	Malleable Elbow 45deg MF Galv	25
11562032	Malleable Elbow 45deg MF Galv	32
11562040	Malleable Elbow 45deg MF Galv	40
11562050	Malleable Elbow 45deg MF Galv	50
11562065	Malleable Elbow 45deg MF Galv	65
11562080	Malleable Elbow 45deg MF Galv	80
11562100	Malleable Elbow 45deg MF Galv	100

Product Code	Description	Size mm
11611006	Malleable Equal Tee	6
11611008	Malleable Equal Tee	8
11611010	Malleable Equal Tee	10
11611015	Malleable Equal Tee	15
11611020	Malleable Equal Tee	20
11611025	Malleable Equal Tee	25
11611032	Malleable Equal Tee	32
11611040	Malleable Equal Tee	40
11611050	Malleable Equal Tee	50
11611065	Malleable Equal Tee	65
11611080	Malleable Equal Tee	80
11611100	Malleable Equal Tee	100
11611125	Malleable Equal Tee	125
11611150	Malleable Equal Tee	150
11612006	Malleable Equal Tee Galv	6



Continued

MALLEABLE PIPE FITTINGS

Product Code	Description	Size mm
11612008	Malleable Equal Tee Galv	8
11612010	Malleable Equal Tee Galv	10
11612015	Malleable Equal Tee Galv	15
11612020	Malleable Equal Tee Galv	20
11612025	Malleable Equal Tee Galv	25
11612032	Malleable Equal Tee Galv	32
11612040	Malleable Equal Tee Galv	40
11612050	Malleable Equal Tee Galv	50
11612065	Malleable Equal Tee Galv	65
11612080	Malleable Equal Tee Galv	80
11612100	Malleable Equal Tee Galv	100
11612125	Malleable Equal Tee Galv	125
11612150	Malleable Equal Tee Galv	150



Product Code	Description	Size mm
11621151	Malleable Tee RB 161RB	15x15x8
11621152	Malleable Tee RB 161RB	15x15x10
11621201	Malleable Tee RB 161RB	20x20x8
11621202	Malleable Tee RB 161RB	20x20x10
11621203	Malleable Tee RB 161RB	20x20x15
11621251	Malleable Tee RB 161RB	25x25x8
11621252	Malleable Tee RB 161RB	25x25x10
11621253	Malleable Tee RB 161RB	25x25x15
11621254	Malleable Tee RB 161RB	25x25x20
11621321	Malleable Tee RB 161RB	32x32x15
11621322	Malleable Tee RB 161RB	32x32x20
11621323	Malleable Tee RB 161RB	32x32x25
11621401	Malleable Tee RB 161RB	40x40x15
11621402	Malleable Tee RB 161RB	40x40x20
11621403	Malleable Tee RB 161RB	40x40x25
11621404	Malleable Tee RB 161RB	40x40x32
11621501	Malleable Tee RB 161RB	50x50x15
11621502	Malleable Tee RB 161RB	50x50x20
11621503	Malleable Tee RB 161RB	50x50x25
11621504	Malleable Tee RB 161RB	50x50x32
11621505	Malleable Tee RB 161RB	50x50x40
11621651	Malleable Tee RB 161RB	65x65x15
11621652	Malleable Tee RB 161RB	65x65x20
11621653	Malleable Tee RB 161RB	65x65x25



Continued

MALLEABLE PIPE FITTINGS



Product Code	Description	Size mm
11621654	Malleable Tee RB 161RB	65x65x32
11621655	Malleable Tee RB 161RB	65x65x40
11621656	Malleable Tee RB 161RB	65x65x50
11621801	Malleable Tee RB 161RB	80x80x15
11621802	Malleable Tee RB 161RB	80x80x20
11621803	Malleable Tee RB 161RB	80x80x25
11621804	Malleable Tee RB 161RB	80x80x32
11621805	Malleable Tee RB 161RB	80x80x40
11621806	Malleable Tee RB 161RB	80x80x50
11621807	Malleable Tee RB 161RB	80x80x65
11621808	Malleable Tee RB 161RB	100x100x25
11621809	Malleable Tee RB 161RB	100x100x32
11621810	Malleable Tee RB 161RB	100x100x40
11621811	Malleable Tee RB 161RB	100x100x50
11621812	Malleable Tee RB 161RB	100x100x65
11621813	Malleable Tee RB 161RB	100x100x80
11621814	Malleable Tee RB 161RB	150x150x80
11621815	Malleable Tee RB 161RB	150x150x100
11622101	Malleable Tee RB Galv 161RBG	10x10x8
11622151	Malleable Tee RB Galv 161RBG	15x15x8
11622152	Malleable Tee RB Galv 161RBG	15x15x10
11622201	Malleable Tee RB Galv 161RBG	20x20x8
11622202	Malleable Tee RB Galv 161RBG	20x20x10
11622203	Malleable Tee RB Galv 161RBG	20x20x15
11622251	Malleable Tee RB Galv 161RBG	25x25x8
11622252	Malleable Tee RB Galv 161RBG	25x25x10
11622253	Malleable Tee RB Galv 161RBG	25x25x15
11622254	Malleable Tee RB Galv 161RBG	25x25x20
11622321	Malleable Tee RB Galv 161RBG	32x32x15
11622322	Malleable Tee RB Galv 161RBG	32x32x20
11622323	Malleable Tee RB Galv 161RBG	32x32x25
11622401	Malleable Tee RB Galv 161RBG	40x40x15
11622402	Malleable Tee RB Galv 161RBG	40x40x20
11622403	Malleable Tee RB Galv 161RBG	40x40x25
11622404	Malleable Tee RB Galv 161RBG	40x40x32
11622501	Malleable Tee RB Galv 161RBG	50x50x15
11622502	Malleable Tee RB Galv 161RBG	50x50x20
11622503	Malleable Tee RB Galv 161RBG	50x50x25
11622504	Malleable Tee RB Galv 161RBG	50x50x32
11622505	Malleable Tee RB Galv 161RBG	50x50x40

Continued

MALLEABLE PIPE FITTINGS



Product Code	Description	Size mm
11622651	Malleable Tee RB Galv 161RBG	65x65x15
11622652	Malleable Tee RB Galv 161RBG	65x65x20
11622653	Malleable Tee RB Galv 161RBG	65x65x25
11622654	Malleable Tee RB Galv 161RBG	65x65x32
11622655	Malleable Tee RB Galv 161RBG	65x65x40
11622656	Malleable Tee RB Galv 161RBG	65x65x50
11622801	Malleable Tee RB Galv 161RBG	80x80x15
11622802	Malleable Tee RB Galv 161RBG	80x80x20
11622803	Malleable Tee RB Galv 161RBG	80x80x25
11622804	Malleable Tee RB Galv 161RBG	80x80x32
11622805	Malleable Tee RB Galv 161RBG	80x80x40
11622806	Malleable Tee RB Galv 161RBG	80x80x50
11622807	Malleable Tee RB Galv 161RBG	80x80x65
11632100	Malleable Tee RB Galv 161RBG	100x100x25
11632101	Malleable Tee RB Galv 161RBG	100x100x32
11632102	Malleable Tee RB Galv 161RBG	100x100x40
11632103	Malleable Tee RB Galv 161RBG	100x100x50
11632104	Malleable Tee RB Galv 161RBG	100x100x65
11632105	Malleable Tee RB Galv 161RBG	100x100x80
11632150	Malleable Tee RB Galv 161RBG	150x150x80
11632151	Malleable Tee RB Galv 161RBG	150x150x100



Product Code	Description	Size mm
11641151	Malleable Tee REE 161IB	15x15x20
11641201	Malleable Tee REE 161IB	20x20x25
11641251	Malleable Tee REE 161IB	25x25x32
11641252	Malleable Tee REE 161IB	25x25x40
11641321	Malleable Tee REE 161IB	32x32x50
11641401	Malleable Tee REE 161IB	40x40x50
11641501	Malleable Tee REE 161IB	50x50x65
11642151	Malleable Tee REE Galv 161IBG	15x15x20
11642201	Malleable Tee REE Galv 161IBG	20x20x25
11642251	Malleable Tee REE Galv 161IBG	25x25x32
11642252	Malleable Tee REE Galv 161IBG	25x25x40
11642321	Malleable Tee REE Galv 161IBG	32x32x50
11642401	Malleable Tee REE Galv 161IBG	40x40x50
11642501	Malleable Tee REE Galv 161IBG	50x50x65

MALLEABLE PIPE FITTINGS

Product Code	Description	Size mm
11651151	Malleable Tee REB161RBE	15x10x10
11651201	Malleable Tee REB161RBE	20x15x15
11651251	Malleable Tee REB161RBE	25x15x20
11651252	Malleable Tee REB161RBE	25x20x20
11651253	Malleable Tee REB161RBE	25x20x15
11651321	Malleable Tee REB161RBE	32x15x25
11651322	Malleable Tee REB161RBE	32x25x20
11651323	Malleable Tee REB161RBE	32x25x25
11651401	Malleable Tee REB161RBE	40x25x25
11651402	Malleable Tee REB161RBE	40x32x15
11651403	Malleable Tee REB161RBE	40x32x25
11651404	Malleable Tee REB161RBE	40x32x32
11651501	Malleable Tee REB161RBE	50x40x20
11651502	Malleable Tee REB161RBE	50x40x25
11651503	Malleable Tee REB161RBE	50x40x32
11651504	Malleable Tee REB161RBE	50x40x40
11652151	Malleable Tee REB Galv 161RBEG	15x10x10
11652201	Malleable Tee REB Galv 161RBEG	20x15x15
11652251	Malleable Tee REB Galv 161RBEG	25x20x15
11652252	Malleable Tee REB Galv 161RBEG	25x20x20
11652321	Malleable Tee REB Galv 161RBEG	32x25x15
11652322	Malleable Tee REB Galv 161RBEG	32x25x20
11652323	Malleable Tee REB Galv 161RBEG	32x25x25
11652401	Malleable Tee REB Galv 161RBEG	40x25x25
11652402	Malleable Tee REB Galv 161RBEG	40x32x15
11652403	Malleable Tee REB Galv 161RBEG	40x32x25
11652404	Malleable Tee REB Galv 161RBEG	40x32x32
11652501	Malleable Tee REB Galv 161RBEG	50x40x20
11652502	Malleable Tee REB Galv 161RBEG	50x40x25
11652503	Malleable Tee REB Galv 161RBEG	50x40x32
11652504	Malleable Tee REB Galv 161RBEG	50x40x40



Product Code	Description	Size mm
11661201	Malleable Tee RE 161RE	20x15x20
11661251	Malleable Tee RE 161RE	25x15x25
11661252	Malleable Tee RE 161RE	25x20x25
11661321	Malleable Tee RE 161RE	32x15x32
11661322	Malleable Tee RE 161RE	32x20x32
11661323	Malleable Tee RE 161RE	32x25x32



Continued

MALLEABLE PIPE FITTINGS

Product Code	Description	Size mm
11661400	Malleable Tee RE 161RE	40x15x40
11661401	Malleable Tee RE 161RE	40x20x40
11661402	Malleable Tee RE 161RE	40x25x40
11661501	Malleable Tee RE 161RE	50x15x50
11661502	Malleable Tee RE 161RE	50x20x50
11661503	Malleable Tee RE 161RE	50x25x50
11661504	Malleable Tee RE 161RE	50x40x50
11661201	Malleable Tee RE 161RE	20x15x20
11661251	Malleable Tee RE 161RE	25x15x25
11661252	Malleable Tee RE 161RE	25x20x25
11661321	Malleable Tee RE 161RE	32x15x32
11661322	Malleable Tee RE 161RE	32x20x32
11661323	Malleable Tee RE 161RE	32x25x32
11661400	Malleable Tee RE 161RE	40x15x40
11661401	Malleable Tee RE 161RE	40x20x40
11661402	Malleable Tee RE 161RE	40x25x40
11661501	Malleable Tee RE 161RE	50x15x50
11661502	Malleable Tee RE 161RE	50x20x50
11661503	Malleable Tee RE 161RE	50x25x50
11661504	Malleable Tee RE 161RE	50x40x50



Product Code	Description	Size mm
11711010	Malleable Cross	10
11711015	Malleable Cross	15
11711020	Malleable Cross	20
11711025	Malleable Cross	25
11711032	Malleable Cross	32
11711040	Malleable Cross	40
11711050	Malleable Cross	50
11711065	Malleable Cross	65
11711080	Malleable Cross	80
11711100	Malleable Cross	100
11712010	Malleable Cross Galv	10
11712015	Malleable Cross Galv	15
11712020	Malleable Cross Galv	20
11712025	Malleable Cross Galv	25
11712032	Malleable Cross Galv	32
11712040	Malleable Cross Galv	40
11712050	Malleable Cross Galv	50
11712065	Malleable Cross Galv	65
11712080	Malleable Cross Galv	80
11712100	Malleable Cross Galv	100



MALLEABLE PIPE FITTINGS



Product Code	Description	Size mm
11791101	Malleable Concentric Socket	10x8
11791151	Malleable Concentric Socket	15x8
11791152	Malleable Concentric Socket	15x10
11791201	Malleable Concentric Socket	20x8
11791202	Malleable Concentric Socket	20x10
11791203	Malleable Concentric Socket	20x15
11791252	Malleable Concentric Socket	25x10
11791253	Malleable Concentric Socket	25x15
11791254	Malleable Concentric Socket	25x20
11791321	Malleable Concentric Socket	32x15
11791322	Malleable Concentric Socket	32x20
11791323	Malleable Concentric Socket	32x25
11791401	Malleable Concentric Socket	40x15
11791402	Malleable Concentric Socket	40x20
11791403	Malleable Concentric Socket	40x25
11791404	Malleable Concentric Socket	40x32
11791501	Malleable Concentric Socket	50x15
11791502	Malleable Concentric Socket	50x20
11791503	Malleable Concentric Socket	50x25
11791504	Malleable Concentric Socket	50x32
11791505	Malleable Concentric Socket	50x40
11791652	Malleable Concentric Socket	65x25
11791653	Malleable Concentric Socket	65x32
11791654	Malleable Concentric Socket	65x40
11791655	Malleable Concentric Socket	65x50
11791801	Malleable Concentric Socket	80x25
11791802	Malleable Concentric Socket	80x50
11791803	Malleable Concentric Socket	80x65
11791901	Malleable Concentric Socket	100x50
11791902	Malleable Concentric Socket	100x65
11791903	Malleable Concentric Socket	100x80
11791912	Malleable Concentric Socket	150x100
11792101	Malleable Concentric Socket Galv	10x8
11792151	Malleable Concentric Socket Galv	15x8
11792152	Malleable Concentric Socket Galv	15x10
11792201	Malleable Concentric Socket Galv	20x8
11792202	Malleable Concentric Socket Galv	20x10
11792203	Malleable Concentric Socket Galv	20x15
11792252	Malleable Concentric Socket Galv	25x10
11792253	Malleable Concentric Socket Galv	25x15

Continued

MALLEABLE PIPE FITTINGS

Product Code	Description	Size mm
11792254	Malleable Concentric Socket Galv	25x20
11792321	Malleable Concentric Socket Galv	32x15
11792322	Malleable Concentric Socket Galv	32x20
11792323	Malleable Concentric Socket Galv	32x25
11792401	Malleable Concentric Socket Galv	40x15
11792402	Malleable Concentric Socket Galv	40x20
11792403	Malleable Concentric Socket Galv	40x25
11792404	Malleable Concentric Socket Galv	40x32
11792501	Malleable Concentric Socket Galv	50x15
11792502	Malleable Concentric Socket Galv	50x20
11792503	Malleable Concentric Socket Galv	50x25
11792504	Malleable Concentric Socket Galv	50x32
11792505	Malleable Concentric Socket Galv	50x40
11792652	Malleable Concentric Socket Galv	65x25
11792653	Malleable Concentric Socket Galv	65x32
11792654	Malleable Concentric Socket Galv	65x40
11792655	Malleable Concentric Socket Galv	65x50
11792801	Malleable Concentric Socket Galv	80x25
11792802	Malleable Concentric Socket Galv	80x50
11792803	Malleable Concentric Socket Galv	80x65
11792901	Malleable Concentric Socket Galv	100x50
11792902	Malleable Concentric Socket Galv	100x65
11792903	Malleable Concentric Socket Galv	100x80
11792912	Malleable Concentric Socket Galv	150x100



Product Code	Description	Size mm
11801201	Malleable Eccentric Socket	20x15
11801251	Malleable Eccentric Socket	25x15
11801252	Malleable Eccentric Socket	25x20
11801321	Malleable Eccentric Socket	32x15
11801322	Malleable Eccentric Socket	32x20
11801323	Malleable Eccentric Socket	32x25
11801401	Malleable Eccentric Socket	40x15
11801402	Malleable Eccentric Socket	40x20
11801403	Malleable Eccentric Socket	40x25
11801404	Malleable Eccentric Socket	40x32
11801501	Malleable Eccentric Socket	50x15
11801502	Malleable Eccentric Socket	50x20
11801503	Malleable Eccentric Socket	50x25



Continued

MALLEABLE PIPE FITTINGS

Product Code	Description	Size mm
11801504	Malleable Eccentric Socket	50x32
11801505	Malleable Eccentric Socket	50x40
11801651	Malleable Eccentric Socket	65x15
11801655	Malleable Eccentric Socket	65x40
11801656	Malleable Eccentric Socket	65x50
11801801	Malleable Eccentric Socket	80x50
11801802	Malleable Eccentric Socket	80x65
11802201	Malleable Eccentric Socket Galv	20x15
11802251	Malleable Eccentric Socket Galv	25x15
11802252	Malleable Eccentric Socket Galv	25x20
11802321	Malleable Eccentric Socket Galv	32x15
11802322	Malleable Eccentric Socket Galv	32x20
11802323	Malleable Eccentric Socket Galv	32x25
11802401	Malleable Eccentric Socket Galv	40x15
11802402	Malleable Eccentric Socket Galv	40x20
11802403	Malleable Eccentric Socket Galv	40x25
11802404	Malleable Eccentric Socket Galv	40x32
11802501	Malleable Eccentric Socket Galv	50x15
11802502	Malleable Eccentric Socket Galv	50x20
11802503	Malleable Eccentric Socket Galv	50x25
11802504	Malleable Eccentric Socket Galv	50x32
11802505	Malleable Eccentric Socket Galv	50x40
11802651	Malleable Eccentric Socket Galv	65x15
11802655	Malleable Eccentric Socket Galv	65x40
11802656	Malleable Eccentric Socket Galv	65x50
11802801	Malleable Eccentric Socket Galv	80x50
11802802	Malleable Eccentric Socket Galv	80x65



Product Code	Description	Size mm
11851008	Malleable Cap	8
11851010	Malleable Cap	10
11851015	Malleable Cap	15
11851020	Malleable Cap	20
11851025	Malleable Cap	25
11851032	Malleable Cap	32
11851040	Malleable Cap	40
11851050	Malleable Cap	50
11851065	Malleable Cap	65
11851080	Malleable Cap	80



Continued

MALLEABLE PIPE FITTINGS

Product Code	Description	Size mm
11851100	Malleable Cap	100
11852008	Malleable Cap Galv	8
11852010	Malleable Cap Galv	10
11852015	Malleable Cap Galv	15
11852020	Malleable Cap Galv	20
11852025	Malleable Cap Galv	25
11852032	Malleable Cap Galv	32
11852040	Malleable Cap Galv	40
11852050	Malleable Cap Galv	50
11852065	Malleable Cap Galv	65
11852080	Malleable Cap Galv	80
11852100	Malleable Cap Galv	100



Product Code	Description	Size mm
11891015	Malleable Equal Sweep Tee	15
11891020	Malleable Equal Sweep Tee	20
11891025	Malleable Equal Sweep Tee	25
11891032	Malleable Equal Sweep Tee	32
11891040	Malleable Equal Sweep Tee	40
11891050	Malleable Equal Sweep Tee	50
11891065	Malleable Equal Sweep Tee	65
11891080	Malleable Equal Sweep Tee	80
11891100	Malleable Equal Sweep Tee	100
11892015	Malleable Equal Sweep Tee Galv	15
11892020	Malleable Equal Sweep Tee Galv	20
11892025	Malleable Equal Sweep Tee Galv	25
11892032	Malleable Equal Sweep Tee Galv	32
11892040	Malleable Equal Sweep Tee Galv	40
11892050	Malleable Equal Sweep Tee Galv	50
11892065	Malleable Equal Sweep Tee Galv	65
11892080	Malleable Equal Sweep Tee Galv	80
11892100	Malleable Equal Sweep Tee Galv	100



MALLEABLE PIPE FITTINGS



Product Code	Description	Size mm
11901201	Malleable Sweep Tee RB	20x20x15
11901251	Malleable Sweep Tee RB	25x25x15
11901252	Malleable Sweep Tee RB	25x25x20
11901321	Malleable Sweep Tee RB	32x32x15
11901322	Malleable Sweep Tee RB	32x32x20
11901323	Malleable Sweep Tee RB	32x32x25
11901401	Malleable Sweep Tee RB	40x40x15
11901402	Malleable Sweep Tee RB	40x40x20
11901403	Malleable Sweep Tee RB	40x40x25
11901404	Malleable Sweep Tee RB	40x40x32
11901501	Malleable Sweep Tee RB	50x50x15
11901502	Malleable Sweep Tee RB	50x50x20
11901503	Malleable Sweep Tee RB	50x50x25
11901504	Malleable Sweep Tee RB	50x50x32
11901505	Malleable Sweep Tee RB	50x50x40
11901651	Malleable Sweep Tee RB	65x65x15
11901652	Malleable Sweep Tee RB	65x65x20
11901653	Malleable Sweep Tee RB	65x65x25
11901654	Malleable Sweep Tee RB	65x65x32
11901655	Malleable Sweep Tee RB	65x65x40
11901656	Malleable Sweep Tee RB	65x65x50
11901803	Malleable Sweep Tee RB	80x80x40
11901804	Malleable Sweep Tee RB	80x80x50
11901901	Malleable Sweep Tee RB	100x100x65
11901902	Malleable Sweep Tee RB	100x100x80
11902201	Malleable Sweep Tee RB Galv	20x20x15
11902251	Malleable Sweep Tee RB Galv	25x25x15
11902252	Malleable Sweep Tee RB Galv	25x25x20
11902321	Malleable Sweep Tee RB Galv	32x32x15
11902322	Malleable Sweep Tee RB Galv	32x32x20
11902323	Malleable Sweep Tee RB Galv	32x32x25
11902401	Malleable Sweep Tee RB Galv	40x40x15
11902402	Malleable Sweep Tee RB Galv	40x40x20
11902403	Malleable Sweep Tee RB Galv	40x40x25
11902404	Malleable Sweep Tee RB Galv	40x40x32
11902501	Malleable Sweep Tee RB Galv	50x50x15
11902502	Malleable Sweep Tee RB Galv	50x50x20
11902503	Malleable Sweep Tee RB Galv	50x50x25
11902504	Malleable Sweep Tee RB Galv	50x50x32
11902505	Malleable Sweep Tee RB Galv	50x50x40

Continued

MALLEABLE PIPE FITTINGS

Product Code	Description	Size mm
11902651	Malleable Sweep Tee RB Galv	65x65x15
11902652	Malleable Sweep Tee RB Galv	65x65x20
11902653	Malleable Sweep Tee RB Galv	65x65x25
11902654	Malleable Sweep Tee RB Galv	65x65x32
11902655	Malleable Sweep Tee RB Galv	65x65x40
11902656	Malleable Sweep Tee RB Galv	65x65x50
11902801	Malleable Sweep Tee RB Galv	80x80x20
11902802	Malleable Sweep Tee RB Galv	80x80x25
11902803	Malleable Sweep Tee RB Galv	80x80x40
11902804	Malleable Sweep Tee RB Galv	80x80x50
11902901	Malleable Sweep Tee RB Galv	100x100x65
11902902	Malleable Sweep Tee RB Galv	100x100x80



Product Code	Description	Size mm
11921008	Malleable Bend 90deg MF	8
11921010	Malleable Bend 90deg MF	10
11921015	Malleable Bend 90deg MF	15
11921020	Malleable Bend 90deg MF	20
11921025	Malleable Bend 90deg MF	25
11921032	Malleable Bend 90deg MF	32
11921040	Malleable Bend 90deg MF	40
11921050	Malleable Bend 90deg MF	50
11921065	Malleable Bend 90deg MF	65
11921080	Malleable Bend 90deg MF	80
11921100	Malleable Bend 90deg MF	100
11921150	Malleable Bend 90deg MF	150
11922008	Malleable Bend 90deg MF Galv	8
11922010	Malleable Bend 90deg MF Galv	10
11922015	Malleable Bend 90deg MF Galv	15
11922020	Malleable Bend 90deg MF Galv	20
11922025	Malleable Bend 90deg MF Galv	25
11922032	Malleable Bend 90deg MF Galv	32
11922040	Malleable Bend 90deg MF Galv	40
11922050	Malleable Bend 90deg MF Galv	50
11922065	Malleable Bend 90deg MF Galv	65
11922080	Malleable Bend 90deg MF Galv	80
11922100	Malleable Bend 90deg MF Galv	100
11922150	Malleable Bend 90deg MF Galv	150



MALLEABLE PIPE FITTINGS

Product Code	Description	Size mm
11931008	Malleable Bend 90deg FF	8
11931010	Malleable Bend 90deg FF	10
11931015	Malleable Bend 90deg FF	15
11931020	Malleable Bend 90deg FF	20
11931025	Malleable Bend 90deg FF	25
11931032	Malleable Bend 90deg FF	32
11931040	Malleable Bend 90deg FF	40
11931050	Malleable Bend 90deg FF	50
11931065	Malleable Bend 90deg FF	65
11931080	Malleable Bend 90deg FF	80
11931100	Malleable Bend 90deg FF	100
11931125	Malleable Bend 90deg FF	125
11931150	Malleable Bend 90deg FF	150
11932008	Malleable Bend 90deg FF Galv	8
11932010	Malleable Bend 90deg FF Galv	10
11932015	Malleable Bend 90deg FF Galv	15
11932020	Malleable Bend 90deg FF Galv	20
11932025	Malleable Bend 90deg FF Galv	25
11932032	Malleable Bend 90deg FF Galv	32
11932040	Malleable Bend 90deg FF Galv	40
11932050	Malleable Bend 90deg FF Galv	50
11932065	Malleable Bend 90deg FF Galv	65
11932080	Malleable Bend 90deg FF Galv	80
11932100	Malleable Bend 90deg FF Galv	100
11932125	Malleable Bend 90deg FF Galv	125
11932150	Malleable Bend 90deg FF Galv	150



Product Code	Description	Size mm
11971015	Malleable Twin Elbow	15
11971020	Malleable Twin Elbow	20
11971025	Malleable Twin Elbow	25
11971032	Malleable Twin Elbow	32
11971040	Malleable Twin Elbow	40
11971050	Malleable Twin Elbow	50
11971065	Malleable Twin Elbow	65
11971080	Malleable Twin Elbow	80
11972015	Malleable Twin Elbow Galv	15
11972020	Malleable Twin Elbow Galv	20
11972025	Malleable Twin Elbow Galv	25



Continued

MALLEABLE PIPE FITTINGS

Product Code	Description	Size mm
11972032	Malleable Twin Elbow Galv	32
11972040	Malleable Twin Elbow Galv	40
11972050	Malleable Twin Elbow Galv	50
11972065	Malleable Twin Elbow Galv	65
11972080	Malleable Twin Elbow Galv	80



Product Code	Description	Size mm
12561008	Malleable Union.Cone Seat.FF	8
12561010	Malleable Union.Cone Seat.FF	10
12561015	Malleable Union.Cone Seat.FF	15
12561020	Malleable Union.Cone Seat.FF	20
12561025	Malleable Union.Cone Seat.FF	25
12561032	Malleable Union.Cone Seat.FF	32
12561040	Malleable Union.Cone Seat.FF	40
12561050	Malleable Union.Cone Seat.FF	50
12561065	Malleable Union.Cone Seat.FF	65
12561080	Malleable Union.Cone Seat.FF	80
12561100	Malleable Union.Cone Seat.FF	100
12562008	Malleable Union.Cone Seat.FF Galv	8
12562010	Malleable Union.Cone Seat.FF Galv	10
12562015	Malleable Union.Cone Seat.FF Galv	15
12562020	Malleable Union.Cone Seat.FF Galv	20
12562025	Malleable Union.Cone Seat.FF Galv	25
12562032	Malleable Union.Cone Seat.FF Galv	32
12562040	Malleable Union.Cone Seat.FF Galv	40
12562050	Malleable Union.Cone Seat.FF Galv	50
12562065	Malleable Union.Cone Seat.FF Galv	65
12562080	Malleable Union.Cone Seat.FF Galv	80
12562100	Malleable Union.Cone Seat.FF Galv	100



Product Code	Description	Size mm
12571008	Malleable Union.Cone Seat.MF	8
12571010	Malleable Union.Cone Seat.MF	10
12571015	Malleable Union.Cone Seat.MF	15
12571020	Malleable Union.Cone Seat.MF	20
12571025	Malleable Union.Cone Seat.MF	25
12571032	Malleable Union.Cone Seat.MF	32
12571040	Malleable Union.Cone Seat.MF	40



Continued

MALLEABLE PIPE FITTINGS

Product Code	Description	Size mm
12571050	Malleable Union.Cone Seat.MF	50
12571065	Malleable Union.Cone Seat.MF	65
12571080	Malleable Union.Cone Seat.MF	80
12572010	Malleable Union.Cone Seat.MF Galv	10
12572015	Malleable Union.Cone Seat.MF Galv	15
12572020	Malleable Union.Cone Seat.MF Galv	20
12572025	Malleable Union.Cone Seat.MF Galv	25
12572032	Malleable Union.Cone Seat.MF Galv	32
12572040	Malleable Union.Cone Seat.MF Galv	40
12572050	Malleable Union.Cone Seat.MF Galv	50
12572065	Malleable Union.Cone Seat.MF Galv	65
12572080	Malleable Union.Cone Seat.MF Galv	80



Product Code	Description	Size mm
12611015	Malleable Union Elbow.Cone Seat.FF	15
12611020	Malleable Union Elbow.Cone Seat.FF	20
12611025	Malleable Union Elbow.Cone Seat.FF	25
12611032	Malleable Union Elbow.Cone Seat.FF	32
12611040	Malleable Union Elbow.Cone Seat.FF	40
12611050	Malleable Union Elbow.Cone Seat.FF	50
12612015	Malleable Union Elbow.Cone Seat.FF Galv	15
12612020	Malleable Union Elbow.Cone Seat.FF Galv	20
12612025	Malleable Union Elbow.Cone Seat.FF Galv	25
12612032	Malleable Union Elbow.Cone Seat.FF Galv	32
12612040	Malleable Union Elbow.Cone Seat.FF Galv	40
12612050	Malleable Union Elbow.Cone Seat.FF Galv	50



Product Code	Description	Size mm
12621015	Malleable Union Elbow.Cone Seat.MF	15
12621020	Malleable Union Elbow.Cone Seat.MF	20
12621025	Malleable Union Elbow.Cone Seat.MF	25
12621032	Malleable Union Elbow.Cone Seat.MF	32
12621040	Malleable Union Elbow.Cone Seat.MF	40
12621050	Malleable Union Elbow.Cone Seat.MF	50
12622015	Malleable Union Elbow.Cone Seat.MF Galv	15
12622020	Malleable Union Elbow.Cone Seat.MF Galv	20
12622025	Malleable Union Elbow.Cone Seat.MF Galv	25
12622032	Malleable Union Elbow.Cone Seat.MF Galv	32
12622040	Malleable Union Elbow.Cone Seat.MF Galv	40
12622050	Malleable Union Elbow.Cone Seat.MF Galv	50



MALLEABLE PIPE FITTINGS

Product Code	Description	Size mm
12711008	Malleable 1BS Union FF	8
12711010	Malleable 1BS Union FF	10
12711015	Malleable 1BS Union FF	15
12711020	Malleable 1BS Union FF	20
12711025	Malleable 1BS Union FF	25
12711032	Malleable 1BS Union FF	32
12711040	Malleable 1BS Union FF	40
12711050	Malleable 1BS Union FF	50
12711065	Malleable 1BS Union FF	65
12711080	Malleable 1BS Union FF	80
12711100	Malleable 1BS Union FF	100
12712008	Malleable 1BS Union FF.Galv	8
12712010	Malleable 1BS Union FF.Galv	10
12712015	Malleable 1BS Union FF.Galv	15
12712020	Malleable 1BS Union FF.Galv	20
12712025	Malleable 1BS Union FF.Galv	25
12712032	Malleable 1BS Union FF.Galv	32
12712040	Malleable 1BS Union FF.Galv	40
12712050	Malleable 1BS Union FF.Galv	50
12712065	Malleable 1BS Union FF.Galv	65
12712080	Malleable 1BS Union FF.Galv	80
12712100	Malleable 1BS Union FF.Galv	100



Product Code	Description	Size mm
12721015	Malleable 1BS Union MF	15
12721020	Malleable 1BS Union MF	20
12721025	Malleable 1BS Union MF	25
12721032	Malleable 1BS Union MF	32
12721040	Malleable 1BS Union MF	40
12721050	Malleable 1BS Union MF	50
12722015	Malleable 1BS Union MF Galv	15
12722020	Malleable 1BS Union MF Galv	20
12722025	Malleable 1BS Union MF Galv	25
12722032	Malleable 1BS Union MF Galv	32
12722040	Malleable 1BS Union MF Galv	40
12722050	Malleable 1BS Union MF Galv	50



MALLEABLE PIPE FITTINGS



Product Code	Description	Size mm
12891008	Malleable 2BS Navy Union.FF	8
12891010	Malleable 2BS Navy Union.FF	10
12891015	Malleable 2BS Navy Union.FF	15
12891020	Malleable 2BS Navy Union.FF	20
12891025	Malleable 2BS Navy Union.FF	25
12891032	Malleable 2BS Navy Union.FF	32
12891040	Malleable 2BS Navy Union.FF	40
12891050	Malleable 2BS Navy Union.FF	50
12891065	Malleable 2BS Navy Union.FF	65
12891080	Malleable 2BS Navy Union.FF	80
12892008	Malleable 2BS Navy Union FF.Galv.	8
12892010	Malleable 2BS Navy Union FF.Galv.	10
12892015	Malleable 2BS Navy Union FF.Galv.	15
12892020	Malleable 2BS Navy Union FF.Galv.	20
12892025	Malleable 2BS Navy Union FF.Galv.	25
12892032	Malleable 2BS Navy Union FF.Galv.	32
12892040	Malleable 2BS Navy Union FF.Galv.	40
12892050	Malleable 2BS Navy Union FF.Galv.	50
12892065	Malleable 2BS Navy Union FF.Galv.	65
12892080	Malleable 2BS Navy Union FF.Galv.	80

Product Code	Description MW HRL	Size mm
13861008	Barrel BS1387 MW.S/S.HRL.(3.24M)Black	8
13861010	Barrel BS1387 MW.S/S.HRL.(3.24M)Black	10
13861015	Barrel BS1387 MW.S/S.HRL.(3.24M)Black	15
13861020	Barrel BS1387 MW.S/S.HRL.(3.24M)Black	20
13861025	Barrel BS1387 MW.S/S.HRL.(3.24M)Black	25
13861032	Barrel BS1387 MW.S/S.HRL.(3.24M)Black	32
13861040	Barrel BS1387 MW.S/S.HRL.(3.24M)Black	40
13861050	Barrel BS1387 MW.S/S.HRL.(3.24M)Black	50
13861065	Barrel BS1387 MW.S/S.HRL.(3.24M)Black	65
13861080	Barrel BS1387 MW.S/S.HRL.(3.24M)Black	80
13861100	Barrel BS1387 MW.S/S.HRL.(3.24M)Black	100
13861125	Barrel BS1387 MW.S/S.HRL.(3.24M)Black	125
13861150	Barrel BS1387 MW.S/S.HRL.(3.24M)Black	150
13862008	arrel BS1387 MW.S/S.HRL.(3.24M)Galv	8
13862010	Barrel BS1387 MW.S/S.HRL.(3.24M)Galv	10
13862015	Barrel BS1387 MW.S/S.HRL.(3.24M)Galv	15
13862020	Barrel BS1387 MW.S/S.HRL.(3.24M)Galv	20

Continued

MALLEABLE PIPE FITTINGS

Product Code	Description MW HRL	Size mm
13862025	Barrel BS1387 MW.S/S.HRL.(3.24M)Galv	25
13862032	Barrel BS1387 MW.S/S.HRL.(3.24M)Galv	32
13862040	Barrel BS1387 MW.S/S.HRL.(3.24M)Galv	40
13862050	Barrel BS1387 MW.S/S.HRL.(3.24M)Galv	50
13862065	Barrel BS1387 MW.S/S.HRL.(3.24M)Galv	65
13862080	Barrel BS1387 MW.S/S.HRL.(3.24M)Galv	80
13862100	Barrel BS1387 MW.S/S.HRL.(3.24M)Galv	100
13862125	Barrel BS1387 MW.S/S.HRL.(3.24M)Galv	125
13862150	Barrel BS1387 MW.S/S.HRL.(3.24M)Galv	150

Product Code	Description MW LRL	Size mm
13871008	Barrel BS1387 MW.S/S.LRL.(6.4M)Black	8
13871010	Barrel BS1387 MW.S/S.LRL.(6.4M)Black	10
13871015	Barrel BS1387 MW.S/S.LRL.(6.4M)Black	15
13871020	Barrel BS1387 MW.S/S.LRL.(6.4M)Black	20
13871025	Barrel BS1387 MW.S/S.LRL.(6.4M)Black	25
13871032	Barrel BS1387 MW.S/S.LRL.(6.4M)Black	32
13871040	Barrel BS1387 MW.S/S.LRL.(6.4M)Black	40
13871050	Barrel BS1387 MW.S/S.LRL.(6.4M)Black	50
13871065	Barrel BS1387 MW.S/S.LRL.(6.4M)Black	65
13871080	Barrel BS1387 MW.S/S.LRL.(6.4M)Black	80
13871100	Barrel BS1387 MW.S/S.LRL.(6.4M)Black	100
13871125	Barrel BS1387 MW.S/S.LRL.(6.4M)Black	125
13871150	Barrel BS1387 MW.S/S.LRL.(6.4M)Black	150
13872008	Barrel BS1387 MW.S/S.LRL.(6.4M)Galv	8
13872010	Barrel BS1387 MW.S/S.LRL.(6.4M)Galv	10
13872015	Barrel BS1387 MW.S/S.LRL.(6.4M)Galv	15
13872020	Barrel BS1387 MW.S/S.LRL.(6.4M)Galv	20
13872025	Barrel BS1387 MW.S/S.LRL.(6.4M)Galv	25
13872032	Barrel BS1387 MW.S/S.LRL.(6.4M)Galv	32
13872040	Barrel BS1387 MW.S/S.LRL.(6.4M)Galv	40
13872050	Barrel BS1387 MW.S/S.LRL.(6.4M)Galv	50
13872065	Barrel BS1387 MW.S/S.LRL.(6.4M)Galv	65
13872080	Barrel BS1387 MW.S/S.LRL.(6.4M)Galv	80
13872100	Barrel BS1387 MW.S/S.LRL.(6.4M)Galv	100
13872125	Barrel BS1387 MW.S/S.LRL.(6.4M)Galv	125
13872150	Barrel BS1387 MW.S/S.LRL.(6.4M)Galv	150

MALLEABLE PIPE FITTINGS

Product Code	Description HW HRL/LRL	Size mm
13881015	Barrel BS1387 HW.S/S.HRL.(3.24M)Black	15
13881020	Barrel BS1387 HW.S/S.HRL.(3.24M)Black	20
13881025	Barrel BS1387 HW.S/S.HRL.(3.24M)Black	25
13881032	Barrel BS1387 HW.S/S.HRL.(3.24M)Black	32
13881040	Barrel BS1387 HW.S/S.HRL.(3.24M)Black	40
13881050	Barrel BS1387 HW.S/S.HRL.(3.24M)Black	50
13881065	Barrel BS1387 HW.S/S.HRL.(3.24M)Black	65
13881080	Barrel BS1387 HW.S/S.HRL.(3.24M)Black	80
13881100	Barrel BS1387 HW.S/S.HRL.(3.24M)Black	100
13881125	Barrel BS1387 HW.S/S.HRL.(3.24M)Black	125
13881150	Barrel BS1387 HW.S/S.HRL.(3.24M)Black	150
13882015	Barrel BS1387 HW.S/S.HRL.(3.24M)Galv	15
13882020	Barrel BS1387 HW.S/S.HRL.(3.24M)Galv	20
13882025	Barrel BS1387 HW.S/S.HRL.(3.24M)Galv	25
13882032	Barrel BS1387 HW.S/S.HRL.(3.24M)Galv	32
13882040	Barrel BS1387 HW.S/S.HRL.(3.24M)Galv	40
13882050	Barrel BS1387 HW.S/S.HRL.(3.24M)Galv	50
13882065	Barrel BS1387 HW.S/S.HRL.(3.24M)Galv	65
13882080	Barrel BS1387 HW.S/S.HRL.(3.24M)Galv	80
13882100	Barrel BS1387 HW.S/S.HRL.(3.24M)Galv	100
13882125	Barrel BS1387 HW.S/S.HRL.(3.24M)Galv	125
13882150	Barrel BS1387 HW.S/S.HRL.(3.24M)Galv	150
13891015	Barrel BS1387 HW.S/S.LRL.(6.4M)Black	15
13891020	Barrel BS1387 HW.S/S.LRL.(6.4M)Black	20
13891025	Barrel BS1387 HW.S/S.LRL.(6.4M)Black	25
13891032	Barrel BS1387 HW.S/S.LRL.(6.4M)Black	32
13891040	Barrel BS1387 HW.S/S.LRL.(6.4M)Black	40
13891050	Barrel BS1387 HW.S/S.LRL.(6.4M)Black	50
13891065	Barrel BS1387 HW.S/S.LRL.(6.4M)Black	65
13891080	Barrel BS1387 HW.S/S.LRL.(6.4M)Black	80
13891100	Barrel BS1387 HW.S/S.LRL.(6.4M)Black	100
13891125	arrel BS1387 HW.S/S.LRL.(6.4M)Black	125
13891150	Barrel BS1387 HW.S/S.LRL.(6.4M)Black	150
13892015	Barrel BS1387 HW.S/S.LRL.(6.4M)Galv	15
13892020	Barrel BS1387 HW.S/S.LRL.(6.4M)Galv	20
13892025	Barrel BS1387 HW.S/S.LRL.(6.4M)Galv	25
13892032	Barrel BS1387 HW.S/S.LRL.(6.4M)Galv	32
13892040	Barrel BS1387 HW.S/S.LRL.(6.4M)Galv	40
13892050	Barrel BS1387 HW.S/S.LRL.(6.4M)Galv	50
13892065	Barrel BS1387 HW.S/S.LRL.(6.4M)Galv	65

MALLEABLE PIPE FITTINGS

Product Code	Description HW HRL/LRL	Size mm
13881015	Barrel BS1387 HW.S/S.HRL.(3.24M)Black	15
13881020	Barrel BS1387 HW.S/S.HRL.(3.24M)Black	20
13881025	Barrel BS1387 HW.S/S.HRL.(3.24M)Black	25
13881032	Barrel BS1387 HW.S/S.HRL.(3.24M)Black	32
13881040	Barrel BS1387 HW.S/S.HRL.(3.24M)Black	40
13881050	Barrel BS1387 HW.S/S.HRL.(3.24M)Black	50
13881065	Barrel BS1387 HW.S/S.HRL.(3.24M)Black	65
13881080	Barrel BS1387 HW.S/S.HRL.(3.24M)Black	80
13881100	Barrel BS1387 HW.S/S.HRL.(3.24M)Black	100
13881125	Barrel BS1387 HW.S/S.HRL.(3.24M)Black	125
13881150	Barrel BS1387 HW.S/S.HRL.(3.24M)Black	150
13882015	Barrel BS1387 HW.S/S.HRL.(3.24M)Galv	15
13882020	Barrel BS1387 HW.S/S.HRL.(3.24M)Galv	20
13882025	Barrel BS1387 HW.S/S.HRL.(3.24M)Galv	25
13882032	Barrel BS1387 HW.S/S.HRL.(3.24M)Galv	32
13882040	Barrel BS1387 HW.S/S.HRL.(3.24M)Galv	40
13882050	Barrel BS1387 HW.S/S.HRL.(3.24M)Galv	50
13882065	Barrel BS1387 HW.S/S.HRL.(3.24M)Galv	65
13882080	Barrel BS1387 HW.S/S.HRL.(3.24M)Galv	80
13882100	Barrel BS1387 HW.S/S.HRL.(3.24M)Galv	100
13882125	Barrel BS1387 HW.S/S.HRL.(3.24M)Galv	125
13882150	Barrel BS1387 HW.S/S.HRL.(3.24M)Galv	150
13891015	Barrel BS1387 HW.S/S.LRL.(6.4M)Black	15
13891020	Barrel BS1387 HW.S/S.LRL.(6.4M)Black	20
13891025	Barrel BS1387 HW.S/S.LRL.(6.4M)Black	25
13891032	Barrel BS1387 HW.S/S.LRL.(6.4M)Black	32
13891040	Barrel BS1387 HW.S/S.LRL.(6.4M)Black	40
13891050	Barrel BS1387 HW.S/S.LRL.(6.4M)Black	50
13891065	Barrel BS1387 HW.S/S.LRL.(6.4M)Black	65
13891080	Barrel BS1387 HW.S/S.LRL.(6.4M)Black	80
13891100	Barrel BS1387 HW.S/S.LRL.(6.4M)Black	100
13891125	Barrel BS1387 HW.S/S.LRL.(6.4M)Black	125
13891150	Barrel BS1387 HW.S/S.LRL.(6.4M)Black	150
13892015	Barrel BS1387 HW.S/S.LRL.(6.4M)Galv	15
13892020	Barrel BS1387 HW.S/S.LRL.(6.4M)Galv	20
13892025	Barrel BS1387 HW.S/S.LRL.(6.4M)Galv	25
13892032	Barrel BS1387 HW.S/S.LRL.(6.4M)Galv	32
13892040	Barrel BS1387 HW.S/S.LRL.(6.4M)Galv	40
13892050	Barrel BS1387 HW.S/S.LRL.(6.4M)Galv	50
13892065	Barrel BS1387 HW.S/S.LRL.(6.4M)Galv	65
13892080	Barrel BS1387 HW.S/S.LRL.(6.4M)Galv	80
13892100	Barrel BS1387 HW.S/S.LRL.(6.4M)Galv	100
13892125	Barrel BS1387 HW.S/S.LRL.(6.4M)Galv	125
13892150	Barrel BS1387 HW.S/S.LRL.(6.4M)Galv	150

STEEL PIPE FITTINGS TO BS1740

Product Code	Description	Size mm
11161008	Steel Elbow MF.BS1740/1971	8
11161010	Steel Elbow MF.BS1740/1971	10
11161015	Steel Elbow MF.BS1740/1971	15
11161020	Steel Elbow MF.BS1740/1971	20
11161025	Steel Elbow MF.BS1740/1971	25
11161032	Steel Elbow MF.BS1740/1971	32
11161040	Steel Elbow MF.BS1740/1971	40
11161050	Steel Elbow MF.BS1740/1971	50
11161065	Steel Elbow MF.BS1740/1971	65
11161080	Steel Elbow MF.BS1740/1971	80
11162008	Steel Elbow MF.BS1740/1971 Galv	8
11162010	Steel Elbow MF.BS1740/1971 Galv	10
11162015	Steel Elbow MF.BS1740/1971 Galv	15
11162020	Steel Elbow MF.BS1740/1971 Galv	20
11162025	Steel Elbow MF.BS1740/1971 Galv	25
11162032	Steel Elbow MF.BS1740/1971 Galv	32
11162040	Steel Elbow MF.BS1740/1971 Galv	40
11162050	Steel Elbow MF.BS1740/1971 Galv	50
11162065	Steel Elbow MF.BS1740/1971 Galv	65
11162080	Steel Elbow MF.BS1740/1971 Galv	80

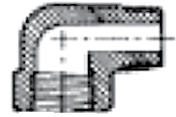

Product Code	Description	Size mm
11171006	Steel Elbow FF.BS1740/1971	6
11171008	Steel Elbow FF.BS1740/1971	8
11171010	Steel Elbow FF.BS1740/1971	10
11171015	Steel Elbow FF.BS1740/1971	15
11171020	Steel Elbow FF.BS1740/1971	20
11171025	Steel Elbow FF.BS1740/1971	25
11171032	Steel Elbow FF.BS1740/1971	32
11171040	Steel Elbow FF.BS1740/1971	40
11171050	Steel Elbow FF.BS1740/1971	50
11171065	Steel Elbow FF.BS1740/1971	65
11171080	Steel Elbow FF.BS1740/1971	80
11172006	Steel Elbow FF.BS1740/1971 Galv	6
11172008	Steel Elbow FF.BS1740/1971 Galv	8
11172010	Steel Elbow FF.BS1740/1971 Galv	10
11172015	Steel Elbow FF.BS1740/1971 Galv	15
11172020	Steel Elbow FF.BS1740/1971 Galv	20
11172025	Steel Elbow FF.BS1740/1971 Galv	25
11172032	Steel Elbow FF.BS1740/1971 Galv	32
11172040	Steel Elbow FF.BS1740/1971 Galv	40
11172050	Steel Elbow FF.BS1740/1971 Galv	50
11172065	Steel Elbow FF.BS1740/1971 Galv	65
11172080	Steel Elbow FF.BS1740/1971 Galv	80



STEEL PIPE FITTINGS TO BS1740

Product Code	Description	Size mm
11181006	Steel Equal Tee FF.BS1740/1971	6
11181008	Steel Equal Tee FF.BS1740/1971	8
11181010	Steel Equal Tee FF.BS1740/1971	10
11181015	Steel Equal Tee FF.BS1740/1971	15
11181020	Steel Equal Tee FF.BS1740/1971	20
11181025	Steel Equal Tee FF.BS1740/1971	25
11181032	Steel Equal Tee FF.BS1740/1971	32
11181040	Steel Equal Tee FF.BS1740/1971	40
11181050	Steel Equal Tee FF.BS1740/1971	50
11181065	Steel Equal Tee FF.BS1740/1971	65
11181080	Steel Equal Tee FF.BS1740/1971	80
11182006	Steel Equal Tee FF.BS1740/1971 Galv	6
11182008	Steel Equal Tee FF.BS1740/1971 Galv	8
11182010	Steel Equal Tee FF.BS1740/1971 Galv	10
11182015	Steel Equal Tee FF.BS1740/1971 Galv	15
11182020	Steel Equal Tee FF.BS1740/1971 Galv	20
11182025	Steel Equal Tee FF.BS1740/1971 Galv	25
11182032	Steel Equal Tee FF.BS1740/1971 Galv	32
11182040	Steel Equal Tee FF.BS1740/1971 Galv	40
11182050	Steel Equal Tee FF.BS1740/1971 Galv	50
11182065	Steel Equal Tee FF.BS1740/1971 Galv	65
11182080	Steel Equal Tee FF.BS1740/1971 Galv	80



Product Code	Description	Size mm
11191006	Steel.Union Flatface BS1740 Blk	6
11191008	Steel.Union Flatface BS1740 Blk	8
11191010	Steel.Union Flatface BS1740 Blk	10
11191015	Steel.Union Flatface BS1740 Blk	15
11191020	Steel.Union Flatface BS1740 Blk	20
11191025	Steel.Union Flatface BS1740 Blk	25
11191032	Steel.Union Flatface BS1740 Blk	32
11191040	Steel.Union Flatface BS1740 Blk	40
11191050	Steel.Union Flatface BS1740 Blk	50
11191065	Steel.Union Flatface BS1740 Blk	65
11191080	Steel.Union Flatface BS1740 Blk	80
11192006	Steel.Union Flatface BS1740 Galv	6
11192008	Steel.Union Flatface BS1740 Galv	8
11192010	Steel.Union Flatface BS1740 Galv	10
11192015	Steel.Union Flatface BS1740 Galv	15



Continued

STEEL PIPE FITTINGS TO BS1740

Product Code	Description	Size mm
11192020	Steel.Union Flatface BS1740 Galv	20
11192025	Steel.Union Flatface BS1740 Galv	25
11192032	Steel.Union Flatface BS1740 Galv	32
11192040	Steel.Union Flatface BS1740 Galv	40
11192050	Steel.Union Flatface BS1740 Galv	50
11192065	Steel.Union Flatface BS1740 Galv	65
11192080	Steel.Union Flatface BS1740 Galv	80



Product Code	Description	Size mm
11201006	Steel Equal Socket.BS1740/1971	6
11201008	Steel Equal Socket.BS1740/1971	8
11201010	Steel Equal Socket.BS1740/1971	10
11201015	Steel Equal Socket.BS1740/1971	15
11201020	Steel Equal Socket.BS1740/1971	20
11201025	Steel Equal Socket.BS1740/1971	25
11201032	Steel Equal Socket.BS1740/1971	32
11201040	Steel Equal Socket.BS1740/1971	40
11201050	Steel Equal Socket.BS1740/1971	50
11201065	Steel Equal Socket.BS1740/1971	65
11201080	Steel Equal Socket.BS1740/1971	80
11201100	Steel Equal Socket.BS1740/1971	100
11201125	Steel Equal Socket.BS1740/1971	125
11201150	Steel Equal Socket.BS1740/1971	150
11202006	Steel Equal Socket.BS1740/1971 Galv	6
11202008	Steel Equal Socket.BS1740/1971 Galv	8
11202010	Steel Equal Socket.BS1740/1971 Galv	10
11202015	Steel Equal Socket.BS1740/1971 Galv	15
11202020	Steel Equal Socket.BS1740/1971 Galv	20
11202025	Steel Equal Socket.BS1740/1971 Galv	25
11202032	Steel Equal Socket.BS1740/1971 Galv	32
11202040	Steel Equal Socket.BS1740/1971 Galv	40
11202050	Steel Equal Socket.BS1740/1971 Galv	50
11202065	Steel Equal Socket.BS1740/1971 Galv	65
11202080	Steel Equal Socket.BS1740/1971 Galv	80
11202100	Steel Equal Socket.BS1740/1971 Galv	100
11202125	Steel Equal Socket.BS1740/1971 Galv	125
11202150	Steel Equal Socket.BS1740/1971 Galv	150



STEEL PIPE FITTINGS TO BS1740

Product Code	Description	Size mm
11231006	Steel Plug. BS1740/1971	6
11231008	Steel Plug. BS1740/1971	8
11231010	Steel Plug. BS1740/1971	10
11231015	Steel Plug. BS1740/1971	15
11231020	Steel Plug. BS1740/1971	20
11231025	Steel Plug. BS1740/1971	25
11231032	Steel Plug. BS1740/1971	32
11231040	Steel Plug. BS1740/1971	40
11231050	Steel Plug. BS1740/1971	50
11231065	Steel Plug. BS1740/1971	65
11231080	Steel Plug. BS1740/1971	80
11231100	Steel Plug. BS1740/1971	100
11232006	Steel Plug.BS1740/1971 Galv	6
11232008	Steel Plug.BS1740/1971 Galv	8
11232010	Steel Plug.BS1740/1971 Galv	10
11232015	Steel Plug.BS1740/1971 Galv	15
11232020	Steel Plug.BS1740/1971 Galv	20
11232025	Steel Plug.BS1740/1971 Galv	25
11232032	Steel Plug.BS1740/1971 Galv	32
11232040	Steel Plug.BS1740/1971 Galv	40
11232050	Steel Plug.BS1740/1971 Galv	50
11232065	Steel Plug.BS1740/1971 Galv	65
11232080	Steel Plug.BS1740/1971 Galv	80
11232100	Steel Plug.BS1740/1971 Galv	100



Product Code	Description	Size mm
11241006	Steel Backnut.BS1740/1971	6
11241008	Steel Backnut.BS1740/1971	8
11241010	Steel Backnut.BS1740/1971	10
11241015	Steel Backnut.BS1740/1971	15
11241020	Steel Backnut.BS1740/1971	20
11241025	Steel Backnut.BS1740/1971	25
11241032	Steel Backnut.BS1740/1971	32
11241040	Steel Backnut.BS1740/1971	40
11241050	Steel Backnut.BS1740/1971	50
11241065	Steel Backnut.BS1740/1971	65
11241080	Steel Backnut.BS1740/1971	80
11241100	Steel Backnut.BS1740/1971	100
11242006	Steel Backnut.BS1740/1971 Galv	6



Continued

STEEL PIPE FITTINGS TO BS1740

Product Code	Description	Size mm
11242008	Steel Backnut.BS1740/1971 Galv	8
11242010	Steel Backnut.BS1740/1971 Galv	10
11242015	Steel Backnut.BS1740/1971 Galv	15
11242020	Steel Backnut.BS1740/1971 Galv	20
11242025	Steel Backnut.BS1740/1971 Galv	25
11242032	Steel Backnut.BS1740/1971 Galv	32
11242040	Steel Backnut.BS1740/1971 Galv	40
11242050	Steel Backnut.BS1740/1971 Galv	50
11242065	Steel Backnut.BS1740/1971 Galv	65
11242080	Steel Backnut.BS1740/1971 Galv	80
11242100	Steel Backnut.BS1740/1971 Galv	100



Product Code	Description	Size mm
11243004	Steel Hexagon Bush to BS 1740/1971	20x15
11243005	Steel Hexagon Bush to BS 1740/1971	25x15
11243006	Steel Hexagon Bush to BS 1740/1971	25x20
11243007	Steel Hexagon Bush to BS 1740/1971	32x15
11243008	Steel Hexagon Bush to BS 1740/1971	32x20
11243009	Steel Hexagon Bush to BS 1740/1971	32x25
11243010	Steel Hexagon Bush to BS 1740/1971	40x15
11243011	Steel Hexagon Bush to BS 1740/1971	40x20
11243012	Steel Hexagon Bush to BS 1740/1971	40x25
11243013	Steel Hexagon Bush to BS 1740/1971	40x32
11243016	Steel Hexagon Bush to BS 1740/1971	50x15
11243017	Steel Hexagon Bush to BS 1740/1971	50x20
11243018	Steel Hexagon Bush to BS 1740/1971	50x25
11243019	Steel Hexagon Bush to BS 1740/1971	50x32
11243020	Steel Hexagon Bush to BS 1740/1971	50x40
11243025	Steel Hexagon Bush to BS 1740/1971	65x15
11243026	Steel Hexagon Bush to BS 1740/1971	65x20
11243027	Steel Hexagon Bush to BS 1740/1971	65x25
11243028	Steel Hexagon Bush to BS 1740/1971	65x32
11243029	Steel Hexagon Bush to BS 1740/1971	65x40
11243030	Steel Hexagon Bush to BS 1740/1971	65x50
11243036	Steel Hexagon Bush to BS 1740/1971	80x15
11243037	Steel Hexagon Bush to BS 1740/1971	80x20
11243038	Steel Hexagon Bush to BS 1740/1971	80x25
11243039	Steel Hexagon Bush to BS 1740/1971	80x32
11243040	Steel Hexagon Bush to BS 1740/1971	80x40



Continued

STEEL PIPE FITTINGS TO BS1740

Product Code	Description	Size mm
11243041	Steel Hexagon Bush to BS 1740/1971	80x50
11243042	Steel Hexagon Bush to BS 1740/1971	80x65
11243081	Steel Hexagon Bush to BS 1740/1971	8x6
11243101	Steel Hexagon Bush to BS 1740/1971	10x6
11243151	Steel Hexagon Bush to BS 1740/1971	15x10
11243201	Steel Hexagon Bush to BS 1740/1971 Galv	8x6
11243202	Steel Hexagon Bush to BS 1740/1971 Galv	10x6
11243203	Steel Hexagon Bush to BS 1740/1971 Galv	20x15
11243204	Steel Hexagon Bush to BS 1740/1971 Galv	25x15
11243205	Steel Hexagon Bush to BS 1740/1971 Galv	25x20
11243206	Steel Hexagon Bush to BS 1740/1971 Galv	32x10
11243207	Steel Hexagon Bush to BS 1740/1971 Galv	32x15
11243208	Steel Hexagon Bush to BS 1740/1971 Galv	32x20
11243209	Steel Hexagon Bush to BS 1740/1971 Galv	32x25
11243210	Steel Hexagon Bush to BS 1740/1971 Galv	40x15
11243211	Steel Hexagon Bush to BS 1740/1971 Galv	40x20
11243212	Steel Hexagon Bush to BS 1740/1971 Galv	40x25
11243213	Steel Hexagon Bush to BS 1740/1971 Galv	40x32
11243215	Steel Hexagon Bush to BS 1740/1971 Galv	50x10
11243216	Steel Hexagon Bush to BS 1740/1971 Galv	50x15
11243217	Steel Hexagon Bush to BS 1740/1971 Galv	50x20
11243218	Steel Hexagon Bush to BS 1740/1971 Galv	50x25
11243219	Steel Hexagon Bush to BS 1740/1971 Galv	50x32
11243220	Steel Hexagon Bush to BS 1740/1971 Galv	50x40
11243225	Steel Hexagon Bush to BS 1740/1971 Galv	65x15
11243226	Steel Hexagon Bush to BS 1740/1971 Galv	65x20
11243227	Steel Hexagon Bush to BS 1740/1971 Galv	65x25
11243228	Steel Hexagon Bush to BS 1740/1971 Galv	65x32
11243229	Steel Hexagon Bush to BS 1740/1971 Galv	65x40
11243230	Steel Hexagon Bush to BS 1740/1971 Galv	65x50
11243236	Steel Hexagon Bush to BS 1740/1971 Galv	80x15
11243237	Steel Hexagon Bush to BS 1740/1971 Galv	80x20
11243238	Steel Hexagon Bush to BS 1740/1971 Galv	80x25
11243239	Steel Hexagon Bush to BS 1740/1971 Galv	80x32
11243240	Steel Hexagon Bush to BS 1740/1971 Galv	80x40
11243241	Steel Hexagon Bush to BS 1740/1971 Galv	80x50
11243242	Steel Hexagon Bush to BS 1740/1971 Galv	80x65



STEEL PIPE FITTINGS TO BS1740

Product Code	Description	Size mm
11245000	Steel Hexagon Nipple.BS1740/1971	20x15
11245001	Steel Hexagon Nipple.BS1740/1971	6
11245002	Steel Hexagon Nipple.BS1740/1971	8
11245003	Steel Hexagon Nipple.BS1740/1971	10
11245004	Steel Hexagon Nipple.BS1740/1971	15
11245005	Steel Hexagon Nipple.BS1740/1971	20
11245006	Steel Hexagon Nipple.BS1740/1971	25
11245007	Steel Hexagon Nipple.BS1740/1971	32
11245008	Steel Hexagon Nipple.BS1740/1971	40
11245009	Steel Hexagon Nipple.BS1740/1971	50
11245010	Steel Hexagon Nipple.BS1740/1971	65
11245011	Steel Hexagon Nipple.BS1740/1971	80
11245012	Steel Hexagon Nipple.BS1740/1971	100
11245201	Steel Hexagon Nipple.BS1740/1971 Galv	6
11245202	Steel Hexagon Nipple.BS1740/1971 Galv	8
11245203	Steel Hexagon Nipple.BS1740/1971 Galv	10
11245204	Steel Hexagon Nipple.BS1740/1971 Galv	15
11245205	Steel Hexagon Nipple.BS1740/1971 Galv	20
11245206	Steel Hexagon Nipple.BS1740/1971 Galv	25
11245207	Steel Hexagon Nipple.BS1740/1971 Galv	32
11245208	Steel Hexagon Nipple.BS1740/1971 Galv	40
11245209	Steel Hexagon Nipple.BS1740/1971 Galv	50
11245210	Steel Hexagon Nipple.BS1740/1971 Galv	65
11245211	Steel Hexagon Nipple.BS1740/1971 Galv	80

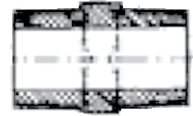

Product Code	Description	Size mm
11250001	Steel Cap.BS1740/1971	8
11250002	Steel Cap.BS1740/1971	10
11250003	Steel Cap.BS1740/1971	15
11250004	Steel Cap.BS1740/1971	20
11250005	Steel Cap.BS1740/1971	25
11250006	Steel Cap.BS1740/1971	32
11250007	Steel Cap.BS1740/1971	40
11250008	Steel Cap.BS1740/1971	50
11250009	Steel Cap.BS1740/1971	65
11250201	Steel Cap BS 1740/1971.Galv	8
11250202	Steel Cap BS 1740/1971.Galv	10
11250203	Steel Cap BS 1740/1971.Galv	15
11250204	Steel Cap BS 1740/1971.Galv	20

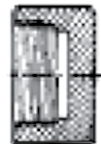

Continued

STEEL PIPE FITTINGS TO BS1740

Product Code	Description	Size mm
11250205	Steel Cap BS 1740/1971.Galv	25
11250206	Steel Cap BS 1740/1971.Galv	32
11250207	Steel Cap BS 1740/1971.Galv	40
11250208	Steel Cap BS 1740/1971.Galv	50
11250209	Steel Cap BS 1740/1971.Galv	65

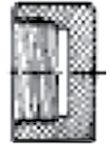

Product Code	Description	Size mm
12901015	Steel Socket Union FF	15
12901020	Steel Socket Union FF	20
12901025	Steel Socket Union FF	25
12901032	Steel Socket Union FF	32
12901040	Steel Socket Union FF	40
12901050	Steel Socket Union FF	50
12902015	Steel Socket Union FF Galv.	15
12902020	Steel Socket Union FF Galv.	20
12902025	Steel Socket Union FF Galv.	25
12902032	Steel Socket Union FF Galv.	32
12902040	Steel Socket Union FF Galv.	40
12902050	Steel Socket Union FF Galv.	50



STEEL TUBULAR FITTINGS TO BS1387

Product Code	Description	Size mm
11021006	Connector c/w Socket & B/nut BS1387 Hvy	6
11021008	Connector c/w Socket & B/nut BS1387 Hvy	8
11021010	Connector c/w Socket & B/nut BS1387 Hvy	10
11021015	Connector c/w Socket & B/nut BS1387 Hvy	15
11021020	Connector c/w Socket & B/nut BS1387 Hvy	20
11021025	Connector c/w Socket & B/nut BS1387 Hvy	25
11021032	Connector c/w Socket & B/nut BS1387 Hvy	32
11021040	Connector c/w Socket & B/nut BS1387 Hvy	40
11021050	Connector c/w Socket & B/nut BS1387 Hvy	50
11021065	Connector c/w Socket & B/nut BS1387 Hvy	65
11021080	Connector c/w Socket & B/nut BS1387 Hvy	80
11021100	Connector c/w Socket & B/nut BS1387 Hvy	100
11021150	Connector c/w Socket & B/nut BS1387 Hvy	150
11022008	Connector c/w Socket & B/nut.Hvy.Galv	8
11022010	Connector c/w Socket & B/nut.Hvy.Galv	10
11022015	Connector c/w Socket & B/nut.Hvy.Galv	15
11022020	Connector c/w Socket & B/nut.Hvy.Galv	20
11022025	Connector c/w Socket & B/nut.Hvy.Galv	25
11022032	Connector c/w Socket & B/nut.Hvy.Galv	32
11022040	Connector c/w Socket & B/nut.Hvy.Galv	40
11022050	Connector c/w Socket & B/nut.Hvy.Galv	50
11022065	Connector c/w Socket & B/nut.Hvy.Galv	65
11022080	Connector c/w Socket & B/nut.Hvy.Galv	80
11022100	Connector c/w Socket & B/nut.Hvy.Galv	100
11022125	Connector c/w Socket & B/nut.Hvy.Galv	125
11022150	Connector c/w Socket & B/nut.Hvy.Galv	150



Product Code	Description	Size mm
11091006	Barrel Nipple to BS 1387.Hvy	6
11091008	Barrel Nipple to BS 1387.Hvy	8
11091010	Barrel Nipple to BS 1387.Hvy	10
11091015	Barrel Nipple to BS 1387.Hvy	15
11091020	Barrel Nipple to BS 1387.Hvy	20
11091025	Barrel Nipple to BS 1387.Hvy	25
11091032	Barrel Nipple to BS 1387.Hvy	32
11091040	Barrel Nipple to BS 1387.Hvy	40
11091050	Barrel Nipple to BS 1387.Hvy	50
11091065	Barrel Nipple to BS 1387.Hvy	65
11091080	Barrel Nipple to BS 1387.Hvy	80



Continued

STEEL TUBULAR FITTINGS TO BS1387

Product Code	Description	Size mm
11091100	Barrel Nipple to BS 1387.Hvy	100
11091125	Barrel Nipple to BS 1387.Hvy	125
11091150	Barrel Nipple to BS 1387.Hvy	150
11092006	Barrel Nipple to BS 1387.Hvy.Galv	6
11092008	Barrel Nipple to BS 1387.Hvy.Galv	8
11092010	Barrel Nipple to BS 1387.Hvy.Galv	10
11092015	Barrel Nipple to BS 1387.Hvy.Galv	15
11092020	Barrel Nipple to BS 1387.Hvy.Galv	20
11092025	Barrel Nipple to BS 1387.Hvy.Galv	25
11092032	Barrel Nipple to BS 1387.Hvy.Galv	32
11092040	Barrel Nipple to BS 1387.Hvy.Galv	40
11092050	Barrel Nipple to BS 1387.Hvy.Galv	50
11092065	Barrel Nipple to BS 1387.Hvy.Galv	65
11092080	Barrel Nipple to BS 1387.Hvy.Galv	80
11092100	Barrel Nipple to BS 1387.Hvy.Galv	100
11092125	Barrel Nipple to BS 1387.Hvy.Galv	125
11092150	Barrel Nipple to BS 1387.Hvy.Galv	150



Product Code	Description	Size mm
11101008	Close Taper Nipple to BS1387 Hvy	8
11101010	Close Taper Nipple to BS1387 Hvy	10
11101015	Close Taper Nipple to BS1387 Hvy	15
11101020	Close Taper Nipple to BS1387 Hvy	20
11101025	Close Taper Nipple to BS1387 Hvy	25
11101032	Close Taper Nipple to BS1387 Hvy	32
11101040	Close Taper Nipple to BS1387 Hvy	40
11101050	Close Taper Nipple to BS1387 Hvy	50
11101065	Close Taper Nipple to BS1387 Hvy	65
11101080	Close Taper Nipple to BS1387 Hvy	80
11101100	Close Taper Nipple to BS1387 Hvy	100
11101125	Close Taper Nipple to BS1387 Hvy	125
11101150	Close Taper Nipple to BS1387 Hvy	150
11102006	Close Taper Nipple to BS1387 Hvy Galv	6
11102008	Close Taper Nipple to BS1387 Hvy Galv	8
11102010	Close Taper Nipple to BS1387 Hvy Galv	10
11102015	Close Taper Nipple to BS1387 Hvy Galv	15
11102020	Close Taper Nipple to BS1387 Hvy Galv	20
11102025	Close Taper Nipple to BS1387 Hvy Galv	25
11102032	Close Taper Nipple to BS1387 Hvy Galv	32



Continued

STEEL TUBULAR FITTINGS TO BS1387

Product Code	Description	Size mm
11102040	Close Taper Nipple to BS1387 Hvy Galv	40
11102050	Close Taper Nipple to BS1387 Hvy Galv	50
11102065	Close Taper Nipple to BS1387 Hvy Galv	65
11102080	Close Taper Nipple to BS1387 Hvy Galv	80
11102100	Close Taper Nipple to BS1387 Hvy Galv	100
11102125	Close Taper Nipple to BS1387 Hvy Galv	125
11102150	Close Taper Nipple to BS1387 Hvy Galv	150



Product Code	Description	Size mm
11111006	Steel Bend 90deg c/w Socket.BS1387.Hvy	6
11111008	Steel Bend 90deg c/w Socket.BS1387.Hvy	8
11111010	Steel Bend 90deg c/w Socket.BS1387.Hvy	10
11111015	Steel Bend 90deg c/w Socket.BS1387.Hvy	15
11111020	Steel Bend 90deg c/w Socket.BS1387.Hvy	20
11111025	Steel Bend 90deg c/w Socket.BS1387.Hvy	25
11111032	Steel Bend 90deg c/w Socket.BS1387.Hvy	32
11111040	Steel Bend 90deg c/w Socket.BS1387.Hvy	40
11111050	Steel Bend 90deg c/w Socket.BS1387.Hvy	50
11111065	Steel Bend 90deg c/w Socket.BS1387.Hvy	65
11111080	Steel Bend 90deg c/w Socket.BS1387.Hvy	80
11111100	Steel Bend 90deg c/w Socket.BS1387.Hvy	100
11111125	Steel Bend 90deg c/w Socket.BS1387.Hvy	125
11111150	Steel Bend 90deg c/w Socket.BS1387.Hvy	150
11112006	Steel Bend 90deg & Socket.BS1387.HW.Galv	6
11112008	Steel Bend 90deg & Socket.BS1387.HW.Galv	8
11112010	Steel Bend 90deg & Socket.BS1387.HW.Galv	10
11112015	Steel Bend 90deg & Socket.BS1387.HW.Galv	15
11112020	Steel Bend 90deg & Socket.BS1387.HW.Galv	20
11112025	Steel Bend 90deg & Socket.BS1387.HW.Galv	25
11112032	Steel Bend 90deg & Socket.BS1387.HW.Galv	32
11112040	Steel Bend 90deg & Socket.BS1387.HW.Galv	40
11112050	Steel Bend 90deg & Socket.BS1387.HW.Galv	50
11112065	Steel Bend 90deg & Socket.BS1387.HW.Galv	65
11112080	Steel Bend 90deg & Socket.BS1387.HW.Galv	80
11112100	Steel Bend 90deg & Socket.BS1387.HW.Galv	100
11112125	Steel Bend 90deg & Socket.BS1387.HW.Galv	125
11112150	Steel Bend 90deg & Socket.BS1387.HW.Galv	150



WELDED PIPE FITTINGS

Product Code	Description	Size mm
10800015	Weld Elbow 45deg BS1965 Hvy	15
10800020	Weld Elbow 45deg BS1965 Hvy	20
10800025	Weld Elbow 45deg BS1965 Hvy	25
10800032	Weld Elbow 45deg BS1965 Hvy	32
10800040	Weld Elbow 45deg BS1965 Hvy	40
10800050	Weld Elbow 45deg BS1965 Hvy	50
10800065	Weld Elbow 45deg BS1965 Hvy	65
10800080	Weld Elbow 45deg BS1965 Hvy	80
10800100	Weld Elbow 45deg BS1965 Hvy	100
10800125	Weld Elbow 45deg BS1965 Hvy	125
10800150	Weld Elbow 45deg BS1965 Hvy	150
10800200	Weld Elbow 45deg BS1965 (5.38mm)	200
10800201	Weld Elbow 45deg BS1965 (6.35mm)	200
10800202	Weld Elbow 45deg BS1965 (7.14mm)	200



Product Code	Description	Size mm
10820015	Weld Branch Bend BS1965 Hvy	15
10820020	Weld Branch Bend BS1965 Hvy	20
10820025	Weld Branch Bend BS1965 Hvy	25
10820032	Weld Branch Bend BS1965 Hvy	32
10820040	Weld Branch Bend BS1965 Hvy	40
10820050	Weld Branch Bend BS1965 Hvy	50
10820065	Weld Branch Bend BS1965 Hvy	65
10820080	Weld Branch Bend BS1965 Hvy	80
10820100	Weld Branch Bend BS1965 Hvy	100
10820125	Weld Branch Bend BS1965 Hvy	125
10820150	Weld Branch Bend BS1965 Hvy	150



Product Code	Description	Size mm
10830040	Weld Short Radius Elbow.BS1965 Hvy	40
10830050	Weld Short Radius Elbow.BS1965 Hvy	50
10830065	Weld Short Radius Elbow.BS1965 Hvy	65
10830080	Weld Short Radius Elbow.BS1965 Hvy	80
10830100	Weld Short Radius Elbow.BS1965 Hvy	100
10830125	Weld Short Radius Elbow.BS1965 Hvy	125
10830150	Weld Short Radius Elbow.BS1965 Hvy	150
10830200	Weld Short Radius Elbow.BS1965 Hvy	200



WELDED PIPE FITTINGS

Product Code	Description	Size mm
10840015	Weld Equal Tee BS1965 Hvy	15
10840020	Weld Equal Tee BS1965 Hvy	20
10840025	Weld Equal Tee BS1965 Hvy	25
10840032	Weld Equal Tee BS1965 Hvy	32
10840040	Weld Equal Tee BS1965 Hvy	40
10840050	Weld Equal Tee BS1965 Hvy	50
10840065	Weld Equal Tee BS1965 Hvy	65
10840080	Weld Equal Tee BS1965 Hvy	80
10840100	Weld Equal Tee BS1965 Hvy	100
10840125	Weld Equal Tee BS1965 Hvy	125
10840150	Weld Equal Tee BS1965 Hvy	150
10850501	Weld Reducing Tee BS1965 Hvy	50
10850651	Weld Reducing Tee BS1965 Hvy	65
10850802	Weld Reducing Tee BS1965 Hvy	80
10851003	Weld Reducing Tee BS1965 Hvy	100
10851254	Weld Reducing Tee BS1965 Hvy	125
10851504	Weld Reducing Tee BS1965 Hvy	150



Product Code	Description	Size mm
10870015	Weld Cap BS1965 Hvy	25
10870032	Weld Cap BS1965 Hvy	32
10870040	Weld Cap BS1965 Hvy	40
10870050	Weld Cap BS1965 Hvy	50
10870065	Weld Cap BS1965 Hvy	65
10870080	Weld Cap BS1965 Hvy	80
10870100	Weld Cap BS1965 Hvy	100
10870125	Weld Cap BS1965 Hvy	125
10870150	Weld Cap BS1965 Hvy	150



Product Code	Description	Size mm
10880201	Weld Concentric Reducer BS1965 Hvy	20x15
10880251	Weld Concentric Reducer BS1965 Hvy	25x15
10880252	Weld Concentric Reducer BS1965 Hvy	25x20
10880321	Weld Concentric Reducer BS1965 Hvy	32x15
10880322	Weld Concentric Reducer BS1965 Hvy	32x20
10880323	Weld Concentric Reducer BS1965 Hvy	32x25
10880401	Weld Concentric Reducer BS1965 Hvy	40x15
10880402	Weld Concentric Reducer BS1965 Hvy	40x20



WELDED PIPE FITTINGS

Product Code	Description	Size mm
10880403	Weld Concentric Reducer BS1965 Hvy	40x25
10880404	Weld Concentric Reducer BS1965 Hvy	40x32
10880501	Weld Concentric Reducer BS1965 Hvy	50x15
10880502	Weld Concentric Reducer BS1965 Hvy	50x20
10880503	Weld Concentric Reducer BS1965 Hvy	50x25
10880504	Weld Concentric Reducer BS1965 Hvy	50x32
10880505	Weld Concentric Reducer BS1965 Hvy	50x40
10880651	Weld Concentric Reducer BS1965 Hvy	65x20
10880652	Weld Concentric Reducer BS1965 Hvy	65x25
10880653	Weld Concentric Reducer BS1965 Hvy	65x32
10880654	Weld Concentric Reducer BS1965 Hvy	65x40
10880655	Weld Concentric Reducer BS1965 Hvy	65x50
10880801	Weld Concentric Reducer BS1965 Hvy	80x25
10880802	Weld Concentric Reducer BS1965 Hvy	80x32
10880803	Weld Concentric Reducer BS1965 Hvy	80x40
10880804	Weld Concentric Reducer BS1965 Hvy	80x50
10880805	Weld Concentric Reducer BS1965 Hvy	80x65
10881001	Weld Concentric Reducer BS1965 Hvy	100x40
10881002	Weld Concentric Reducer BS1965 Hvy	100x50
10881003	Weld Concentric Reducer BS1965 Hvy	100x65
10881004	Weld Concentric Reducer BS1965 Hvy	100x80
10881251	Weld Concentric Reducer BS1965 Hvy	125x65
10881252	Weld Concentric Reducer BS1965 Hvy	125x80
10881253	Weld Concentric Reducer BS1965 Hvy	125x100
10881501	Weld Concentric Reducer BS1965 Hvy	150x65
10881502	Weld Concentric Reducer BS1965 Hvy	150x80
10881503	Weld Concentric Reducer BS1965 Hvy	150x100
10881504	Weld Concentric Reducer BS1965 Hvy	150x125



Product Code	Description	Size mm
10890201	Weld Eccentric Reducer BS1965 Hvy	20x15
10890251	Weld Eccentric Reducer BS1965 Hvy	25x15
10890252	Weld Eccentric Reducer BS1965 Hvy	25x20
10890321	Weld Eccentric Reducer BS1965 Hvy	32x15
10890322	Weld Eccentric Reducer BS1965 Hvy	32x20
10890323	Weld Eccentric Reducer BS1965 Hvy	32x25
10890401	Weld Eccentric Reducer BS1965 Hvy	40x15
10890402	Weld Eccentric Reducer BS1965 Hvy	40x20



Continued

WELDED PIPE FITTINGS

Product Code	Description	Size mm
10890403	Weld Eccentric Reducer BS1965 Hvy	40x25
10890404	Weld Eccentric Reducer BS1965 Hvy	40x32
10890501	Weld Eccentric Reducer BS1965 Hvy	50x20
10890502	Weld Eccentric Reducer BS1965 Hvy	50x25
10890503	Weld Eccentric Reducer BS1965 Hvy	50x32
10890504	Weld Eccentric Reducer BS1965 Hvy	50x40
10890651	Weld Eccentric Reducer BS1965 Hvy	65x25
10890652	Weld Eccentric Reducer BS1965 Hvy	65x32
10890653	Weld Eccentric Reducer BS1965 Hvy	65x40
10890654	Weld Eccentric Reducer BS1965 Hvy	65x50
10890801	Weld Eccentric Reducer BS1965 Hvy	80x40
10890802	Weld Eccentric Reducer BS1965 Hvy	80x50
10890803	Weld Eccentric Reducer BS1965 Hvy	80x65
10891001	Weld Eccentric Reducer BS1965 Hvy	100x40
10891002	Weld Eccentric Reducer BS1965 Hvy	100x50
10891003	Weld Eccentric Reducer BS1965 Hvy	100x65
10891004	Weld Eccentric Reducer BS1965 Hvy	100x80
10891251	Weld Eccentric Reducer BS1965 Hvy	125x65
10891252	Weld Eccentric Reducer BS1965 Hvy	125x80
10891253	Weld Eccentric Reducer BS1965 Hvy	125x100
10891501	Weld Eccentric Reducer BS1965 Hvy	150x65
10891502	Weld Eccentric Reducer BS1965 Hvy	150x80
10891503	Weld Eccentric Reducer BS1965 Hvy	150x100
10891504	Weld Eccentric Reducer BS1965 Hvy	150x125



Product Code	Description	Size mm
10810015	Weld Long Radius Elbow 90deg BS1965 Hvy	15
10810020	Weld Long Radius Elbow 90deg BS1965 Hvy	20
10810025	Weld Long Radius Elbow 90deg BS1965 Hvy	25
10810032	Weld Long Radius Elbow 90deg BS1965 Hvy	32
10810040	Weld Long Radius Elbow 90deg BS1965 Hvy	40
10810050	Weld Long Radius Elbow 90deg BS1965 Hvy	50
10810065	Weld Long Radius Elbow 90deg BS1965 Hvy	65
10810080	Weld Long Radius Elbow 90deg BS1965 Hvy	80
10810100	Weld Long Radius Elbow 90deg BS1965 Hvy	100
10810125	Weld Long Radius Elbow 90deg BS1965 Hvy	125
10810150	Weld Long Radius Elbow 90deg BS1965 Hvy	150
10810200	Weld Long Radius Elbow.BS1965(5.4mm)	200
10810201	Weld Long Radius Elbow.BS1965(6.3mm)	200
10810202	Weld Long Radius Elbow.BS1965(8.0mm)	200



WELDED PIPE FITTINGS

Product Code	Description MW PE HRL/LRL	Size mm
13911008	Barrel BS1387 MW.P/E.HRL.(3.24M)Black	8
13911010	Barrel BS1387 MW.P/E.HRL.(3.24M)Black	10
13911015	Barrel BS1387 MW.P/E.HRL.(3.24M)Black	15
13911020	Barrel BS1387 MW.P/E.HRL.(3.24M)Black	20
13911025	Barrel BS1387 MW.P/E.HRL.(3.24M)Black	25
13911032	Barrel BS1387 MW.P/E.HRL.(3.24M)Black	32
13911040	Barrel BS1387 MW.P/E.HRL.(3.24M)Black	40
13911050	Barrel BS1387 MW.P/E.HRL.(3.24M)Black	50
13911065	Barrel BS1387 MW.P/E.HRL.(3.24M)Black	65
13911080	Barrel BS1387 MW.P/E.HRL.(3.24M)Black	80
13911100	Barrel BS1387 MW.P/E.HRL.(3.24M)Black	100
13911125	Barrel BS1387 MW.P/E.HRL.(3.24M)Black	125
13911150	Barrel BS1387 MW.P/E.HRL.(3.24M)Black	150
13900008	Barrel BS1387 MW.P/E.LRL.(6.4M)Black	8
13900010	Barrel BS1387 MW.P/E.LRL.(6.4M)Black	10
13900015	Barrel BS1387 MW.P/E.LRL.(6.4M)Black	15
13900020	Barrel BS1387 MW.P/E.LRL.(6.4M)Black	20
13900025	Barrel BS1387 MW.P/E.LRL.(6.4M)Black	25
13900032	Barrel BS1387 MW.P/E.LRL.(6.4M)Black	32
13900040	Barrel BS1387 MW.P/E.LRL.(6.4M)Black	40
13900050	Barrel BS1387 MW.P/E.LRL.(6.4M)Black	50
13900065	Barrel BS1387 MW.P/E.LRL.(6.4M)Black	65
13900080	Barrel BS1387 MW.P/E.LRL.(6.4M)Black	80
13900100	Barrel BS1387 MW.P/E.LRL.(6.4M)Black	100
13900125	Barrel BS1387 MW.P/E.LRL.(6.4M)Black	125
13900150	Barrel BS1387 MW.P/E.LRL.(6.4M)Black	150

Product Code	Description HW PE HRL/LRL	Size mm
13912015	Barrel BS1387 HW.P/E.HRL.(3.24M)Black	15
13912020	Barrel BS1387 HW.P/E.HRL.(3.24M)Black	20
13912025	Barrel BS1387 HW.P/E.HRL.(3.24M)Black	25
13912032	Barrel BS1387 HW.P/E.HRL.(3.24M)Black	32
13912040	Barrel BS1387 HW.P/E.HRL.(3.24M)Black	40
13912050	Barrel BS1387 HW.P/E.HRL.(3.24M)Black	50
13912065	Barrel BS1387 HW.P/E.HRL.(3.24M)Black	65
13912080	Barrel BS1387 HW.P/E.HRL.(3.24M)Black	80
13912100	Barrel BS1387 HW.P/E.HRL.(3.24M)Black	100
13912125	Barrel BS1387 HW.P/E.HRL.(3.24M)Black	125
13912150	Barrel BS1387 HW.P/E.HRL.(3.24M)Black	150

WELDED PIPE FITTINGS

Product Code	Description HW PE HRL/LRL	Size mm
13901015	Barrel BS1387 HW,P/E.LRL.(6.4M)Black	15
13901020	Barrel BS1387 HW,P/E.LRL.(6.4M)Black	20
13901025	Barrel BS1387 HW,P/E.LRL.(6.4M)Black	25
13901032	Barrel BS1387 HW,P/E.LRL.(6.4M)Black	32
13901040	Barrel BS1387 HW,P/E.LRL.(6.4M)Black	40
13901050	Barrel BS1387 HW,P/E.LRL.(6.4M)Black	50
13901065	Barrel BS1387 HW,P/E.LRL.(6.4M)Black	65
13901080	Barrel BS1387 HW,P/E.LRL.(6.4M)Black	80
13901100	Barrel BS1387 HW,P/E.LRL.(6.4M)Black	100
13901125	Barrel BS1387 HW,P/E.LRL.(6.4M)Black	125
13901150	Barrel BS1387 HW,P/E.LRL.(6.4M)Black	150

PIPE FLANGES TO BS10/BS4504 WELD / SCREWED

FLANGE DATA

The following flange data is given as an extract from BS10: part 1: 1962 and BS4504: part 2: 1969 Tables. Dimensions of all BS10 flanges are in imperial (inches) and BS4504 in metric (mm).



Flanges To BS 10: part 1:1962

PIPE SIZE	MM INCHES	15 1/2	20 3/4	25 1	32 1 1/4	40 1 1/2	50 2	65 2 1/2	80 3	100 4	125 5	150 6	200 8
Table D Rated 100Psi @ 200.deg.C	Flange OD PCD Thickness Bolts Bolt Size	3 3/4 2 5/8 3/16 4 M12x25	4 2 7/8 3/16 4 M12x25	4 1/2 3 1/4 3/16 4 M12x25	4 3/4 3 7/16 1/4 4 M12x30	5 1/4 3 3/8 1/4 4 M12x30	6 4 1/2 5/16 4 M16x40	6 1/2 5 5/16 4 M16x40	7 1/4 5 3/4 3/8 4 M16x45	8 1/4 7 3/8 4 M16x50	10 8 1/4 1/2 8 M16x50	11 9 1/4 1/2 8 M16x50	13 1/4 11 1/2 1/2 8 M16x50
Table D Rated 200Psi @ 200.deg.C	Flange OD PCD Thickness Bolts Bolt Size	3 3/4 2 5/8 1/4 4 M12x30	4 2 7/8 1/4 4 M12x30	4 1/2 3 1/4 9/32 4 M12x30	4 3/4 3 7/16 5/16 4 M12x40	5 1/4 3 3/8 1 1/32 4 M12x40	6 4 1/2 3/8 4 M16x45	6 1/2 5 13/32 4 M16x45	7 1/4 5 3/4 7/16 4 M16x45	8 1/4 7 1/2 8 M16x50	10 8 1/4 9/16 8 M16x50	11 9 1/4 1 1/16 8 M20x65	13 1/4 11 1/2 1/2 8 M16x50
Table D Rated 300Psi @ 200.deg.C	Flange OD PCD Thickness Bolts Bolt Size	3 3/4 2 5/8 3/8 4 M12x40	4 2 7/8 3/8 4 M12x40	4 3/4 3 7/16 3/8 4 M16x45	5 1/4 3 3/8 1/2 4 M16x45	5 1/2 4 1/8 1/2 4 M16x50	6 1/2 5 5/8 4 M16x55	7 1/4 5 3/4 5/8 8 M16x55	8 6 1/2 5/8 8 M16x55	9 7 1/2 3/4 8 M16x65	11 9 1/4 7/8 8 M20x70	12 10 1/4 7/8 8 M20x70	14 1/2 12 3/4 1 12 M20x75
Table D Rated 500Psi @ 200.deg.C	Flange OD PCD Thickness Bolts Bolt Size	3 1/2 3 1/4 1/2 4 M16x50	4 1/2 3 3/4 1/2 4 M16x50	4 3/4 3 7/16 9/16 4 M16x50	5 1/4 3 3/8 1 1/16 4 M16x55	5 1/2 4 1/8 1 1/16 4 M16x55	6 1/2 5 3/4 4 M16x55	7 1/4 5 3/4 3/4 8 M16x65	8 6 1/2 7/8 8 M16x70	9 7 1/2 1 8 M16x75	11 9 1/4 1 1/8 8 M20x80	12 10 1/4 1 1/8 12 M20x80	14 1/2 12 3/8 1 1/4 12 M20x90

Flanges to BS4504: part 2:1969

PN6 Rated 6 Bar @ 200.deg.C	Flange OD PCD Thickness Bolts Bolt Size	80 55 12 4 M10x45	90 65 14 4 M10x50	100 75 14 4 M10x50	120 90 16 4 M12x55	130 100 16 4 M12x55	140 110 16 4 M12x55	160 130 16 4 M12x55	190 150 18 4 M16x65	210 170 18 4 M16x70	240 200 20 8 M16x75	265 225 20 8 M16x75	320 280 22 8 M20x75	
PN10 Rated 10 Bar @ 200.deg.C	Flange OD PCD Thickness Bolts Bolt Size	95 65 14 4 M12x50	105 75 16 4 M12x55	115 85 16 4 M12x55	140 100 16 4 M16x55	150 110 16 4 M16x55	150 125 18 4 M16x65	165 145 18 4 M16x65	185 160 20 8 M16x70	200 180 20 8 M16x70	220 210 22 8 M16x75	250 240 22 8 M20x70	285 295 24 8 M20x75	340 340 24 8 M20x75
PN16 Rated 16 Bar @ 200.deg.C	Flange OD PCD Thickness Bolts Bolt Size	95 65 14 4 M12x50	105 75 16 4 M12x55	115 85 16 4 M12x55	140 100 16 4 M16x55	150 110 16 4 M16x55	165 125 18 4 M16x65	185 145 18 4 M16x65	200 160 20 8 M16x70	220 180 20 8 M16x70	250 210 22 8 M16x75	285 240 22 8 M20x70	340 295 24 8 M20x75	

PIPE FLANGES TO BS10/BS4504 WELD / SCREWED

Slip On Weld Flanges T/E

Product Code	Description	Size mm
10711015	Weld Flange Slip-on Boss BS10:D/E	15
10711020	Weld Flange Slip-on Boss. BS10:D/E	20
10711025	Weld Flange Slip-on Boss. BS10:D/E	25
10711032	Weld Flange Slip-on Boss. BS10:D/E	32
10711040	Weld Flange Slip-on Boss. BS10:D/E	40
10711050	Weld Flange Slip-on Boss. BS10:D/E	50
10711065	Weld Flange Slip-on Boss. BS10:D/E	65
10711080	Weld Flange Slip-on Boss. BS10:D/E	80
10711100	Weld Flange Slip-on Boss. BS10:D	100
10711101	Weld Flange Slip-on Boss. BS10:E	100
10711125	Weld Flange Slip-on Boss. BS10:D/E	125
10711150	Weld Flange Slip-on Boss. BS10:D	150
10711151	Weld Flange Slip-on Boss. BS10:E	150
10711200	Weld Flange Slip-on Boss. BS10:E	200



Slip On Weld Flanges T/F

Product Code	Description	Size mm
10712015	Weld Flange Slip-on Boss BS10F	15
10712020	Weld Flange Slip-on Boss BS10F	20
10712025	Weld Flange Slip-on Boss BS10F	25
10712032	Weld Flange Slip-on Boss BS10F	32
10712040	Weld Flange Slip-on Boss BS10F	40
10712050	Weld Flange Slip-on Boss BS10F	50
10712065	Weld Flange Slip-on Boss BS10F	65
10712080	Weld Flange Slip-on Boss BS10F	80
10712100	Weld Flange Slip-on Boss BS10F	100
10712125	Weld Flange Slip-on Boss BS10F	125
10712150	Weld Flange Slip-on Boss BS10F	150
10712200	Weld Flange Slip-on Boss BS10F	200

Slip On Weld Flanges T/H

Product Code	Description	Size mm
10713015	Weld Flange Slip-on Boss BS10H	15
10713020	Weld Flange Slip-on Boss BS10H	20
10713025	Weld Flange Slip-on Boss BS10H	25
10713032	Weld Flange Slip-on Boss BS10H	32
10713040	Weld Flange Slip-on Boss BS10H	40
10713050	Weld Flange Slip-on Boss BS10H	50

PIPE FLANGES TO BS10/BS4504 WELD / SCREWED

Slip On Weld Flanges T/H

Product Code	Description	Size mm
10751065	Weld Flange Slip-on Boss.BS4504:6/5(112)	65
10751080	Weld Flange Slip-on Boss.BS4504:6/5(112)	80
10751100	Weld Flange Slip-on Boss.BS4504:6/5(112)	100
10751125	Weld Flange Slip-on Boss.BS4504:6/5(112)	125
10751150	Weld Flange Slip-on Boss.BS4504:6/5(112)	150
10751200	Weld Flange Slip-on Boss.BS4504:6/5(112)	200



Slip On Weld Flanges PN16

Product Code	Description	Size mm
10781015	Weld Flange Slip Boss.BS4504:16/5(112)	15
10781020	Weld Flange Slip Boss.BS4504:16/5(112)	20
10781025	Weld Flange Slip Boss.BS4504:16/5(112)	25
10781032	Weld Flange Slip Boss.BS4504:16/5(112)	32
10781040	Weld Flange Slip Boss.BS4504:16/5(112)	40
10781050	Weld Flange Slip Boss.BS4504:16/5(112)	50
10781065	Weld Flange Slip Boss.BS4504:16/5(112)	65
10781080	Weld Flange Slip Boss.BS4504:16/5(112)	80
10781100	Weld Flange Slip Boss.BS4504:16/5(112)	100
10781125	Weld Flange Slip Boss.BS4504:16/5(112)	125
10781150	Weld Flange Slip Boss.BS4504:16/5(112)	150
10781200	Weld Flange Slip Boss.BS4504:16/5(112)	200

Slip On Weld Flanges Stainless Steel PN16

Product Code	Description	Size mm
18105025	Stainless Steel 316 SO Weld Flange PN16	25
18105032	Stainless Steel 316 SO Weld Flange PN16	32
18105040	Stainless Steel 316 SO Weld Flange PN16	40
18105050	Stainless Steel 316 SO Weld Flange PN16	50
18105065	Stainless Steel 316 SO Weld Flange PN16	65
18105080	Stainless Steel 316 SO Weld Flange PN16	80
18105100	Stainless Steel 316 SO Weld Flange PN16	100
18105150	Stainless Steel 316 SO Weld Flange PN16	150

PIPE FLANGES TO BS10/BS4504 WELD / SCREWED

Screwed Flanges Table D/E

Product Code	Description	Size mm
10714015	S/D Bossed Flange BS10:D/E	15
10714020	S/D Bossed Flange BS10:D/E	20
10714025	S/D Bossed Flange BS10:D/E	25
10714032	S/D Bossed Flange BS10:D/E	32
10714040	S/D Bossed Flange BS10:D/E	40
10714050	S/D Bossed Flange BS10:D/E	50
10714065	S/D Bossed Flange BS10:D/E	65
10714080	S/D Bossed Flange BS10:D/E	80
10714100	S/D Bossed Flange BS10:D	100
10714101	S/D Bossed Flange BS10:E	100
10714125	S/D Bossed Flange BS10:D/E	125
10714150	S/D Bossed Flange BS10:D/E	150
10724015	S/D Bossed Flange BS10:D/E.Galvanised	15
10724020	S/D Bossed Flange BS10:D/E.Galvanised	20
10724025	S/D Bossed Flange BS10:D/E.Galvanised	25
10724032	S/D Bossed Flange BS10:D/E.Galvanised	32
10724040	S/D Bossed Flange BS10:D/E.Galvanised	40
10724050	S/D Bossed Flange BS10:D/E.Galvanised	50
10724065	S/D Bossed Flange BS10:D/E.Galvanised	65
10724080	S/D Bossed Flange BS10:D/E.Galvanised	80
10724100	S/D Bossed Flange BS10:D.Galvanised	100
10724101	S/D Bossed Flange BS10:E.Galvanised	100
10724125	S/D Bossed Flange BS10:E.Galvanised	125
10724150	S/D Bossed Flange BS10:E.Galvanised	150



Screwed Flanges Table F/H

Product Code	Description	Size mm
10715015	S/D Bossed Flange BS10:F	15
10715020	S/D Bossed Flange BS10:F	20
10715025	S/D Bossed Flange BS10:F	25
10715032	S/D Bossed Flange BS10:F	32
10715040	S/D Bossed Flange BS10:F	40
10715050	S/D Bossed Flange BS10:F	50
10715065	S/D Bossed Flange BS10:F	65
10715080	S/D Bossed Flange BS10:F	80
10715100	S/D Bossed Flange BS10:F	100
10716015	S/D Bossed Flange BS10:H	15
10716020	S/D Bossed Flange BS10:H	20

Continued

PIPE FLANGES TO BS10/BS4504 WELD / SCREWED

Screwed Flanges Table F/H

Product Code	Description	Size mm
10716025	S/D Bossed Flange BS10:H	25
10716032	S/D Bossed Flange BS10:H	32
10716040	S/D Bossed Flange BS10:H	40
10716050	S/D Bossed Flange BS10:H	50
10716065	S/D Bossed Flange BS10:H	65
10716080	S/D Bossed Flange BS10:H	80
10716100	S/D Bossed Flange BS10:H	100
10725015	S/D Bossed Flange BS10:F.Galvanised	15
10725020	S/D Bossed Flange BS10:F.Galvanised	20
10725025	S/D Bossed Flange BS10:F.Galvanised	25
10725032	S/D Bossed Flange BS10:F.Galvanised	32
10725040	S/D Bossed Flange BS10:F.Galvanised	40
10725050	S/D Bossed Flange BS10:F.Galvanised	50
10725065	S/D Bossed Flange BS10:F.Galvanised	65
10725080	S/D Bossed Flange BS10:F.Galvanised	80
10725100	S/D Bossed Flange BS10:F.Galvanised	100
10726015	S/D Bossed Flange BS10:H.Galvanised	15
10726020	S/D Bossed Flange BS10:H.Galvanised	20
10726025	S/D Bossed Flange BS10:H.Galvanised	25
10726032	S/D Bossed Flange BS10:H.Galvanised	32
10726040	S/D Bossed Flange BS10:H.Galvanised	40
10726050	S/D Bossed Flange BS10:H.Galvanised	50
10726065	S/D Bossed Flange BS10:H.Galvanised	65
10726080	S/D Bossed Flange BS10:H.Galvanised	80
10726100	S/D Bossed Flange BS10:H.Galvanised	100



Screwed Flanges PN6

Product Code	Description	Size mm
10741015	S/D Bossed Flange BS4504:6/4(113)	15
10741020	S/D Bossed Flange BS4504:6/4(113)	20
10741025	S/D Bossed Flange BS4504:6/4(113)	25
10741032	S/D Bossed Flange BS4504:6/4(113)	32
10741040	S/D Bossed Flange BS4504:6/4(113)	40
10741050	S/D Bossed Flange BS4504:6/4(113)	50
10741065	S/D Bossed Flange BS4504:6/4(113)	65
10741080	S/D Bossed Flange BS4504:6/4(113)	80
10741100	S/D Bossed Flange BS4504:6/4(113)	100
10741125	S/D Bossed Flange BS4504:6/4(113)	125

Continued

PIPE FLANGES TO BS10/BS4504 WELD / SCREWED

Screwed Flanges PN6

Product Code	Description	Size mm
10741150	S/D Bossed Flange BS4504:6/4(113)	150
10742015	S/D Bossed Flange BS4504:6/4(113)Galv	15
10742020	S/D Bossed Flange BS4504:6/4(113)Galv	20
10742025	S/D Bossed Flange BS4504:6/4(113)Galv	25
10742032	S/D Bossed Flange BS4504:6/4(113)Galv	32
10742040	S/D Bossed Flange BS4504:6/4(113)Galv	40
10742050	S/D Bossed Flange BS4504:6/4(113)Galv	50
10742065	S/D Bossed Flange BS4504:6/4(113)Galv	65
10742080	S/D Bossed Flange BS4504:6/4(113)Galv	80
10742100	S/D Bossed Flange BS4504:6/4(113)Galv	100
10742125	S/D Bossed Flange BS4504:6/4(113)Galv	125
10742150	S/D Bossed Flange BS4504:6/4(113)Galv	150



Screwed Flanges PN16

Product Code	Description	Size mm
10771015	S/D Bossed Flange BS4504:16/4 (113)	15
10771020	S/D Bossed Flange BS4504:16/4 (113)	20
10771025	S/D Bossed Flange BS4504:16/4 (113)	25
10771032	S/D Bossed Flange BS4504:16/4 (113)	32
10771040	S/D Bossed Flange BS4504:16/4 (113)	40
10771050	S/D Bossed Flange BS4504:16/4 (113)	50
10771065	S/D Bossed Flange BS4504:16/4 (113)	65
10771080	S/D Bossed Flange BS4504:16/4 (113)	80
10771100	S/D Bossed Flange BS4504:16/4 (113)	100
10771125	S/D Bossed Flange BS4504:16/4 (113)	125
10771150	S/D Bossed Flange BS4504:16/4 (113)	150
10772015	S/D Bossed Flange BS4504:16/4 (113)Galv	15
10772020	S/D Bossed Flange BS4504:16/4 (113)Galv	20
10772025	S/D Bossed Flange BS4504:16/4 (113)Galv	25
10772032	S/D Bossed Flange BS4504:16/4 (113)Galv	32
10772040	S/D Bossed Flange BS4504:16/4 (113)Galv	40
10772050	S/D Bossed Flange BS4504:16/4 (113)Galv	50
10772065	S/D Bossed Flange BS4504:16/4 (113)Galv	65
10772080	S/D Bossed Flange BS4504:16/4 (113)Galv	80
10772100	S/D Bossed Flange BS4504:16/4 (113)Galv	100
10772125	S/D Bossed Flange BS4504:16/4 (113)Galv	125
10772150	S/D Bossed Flange BS4504:16/4 (113)Galv	150

PIPE FLANGES TO BS10/BS4504 WELD / SCREWED

Blind Plate Flanges Table D/E

Product Code	Description	Size mm
10717015	Blind Plate Flange. BS10:D/E	15
10717020	Blind Plate Flange. BS10:D/E	20
10717025	Blind Plate Flange. BS10:D/E	25
10717032	Blind Plate Flange. BS10:D/E	32
10717040	Blind Plate Flange. BS10:D/E	40
10717050	Blind Plate Flange. BS10:D/E	50
10717065	Blind Plate Flange. BS10:D/E	65
10717080	Blind Plate Flange. BS10:D/E	80
10717100	Blind Plate Flange. BS10:D	100
10717101	Blind Plate Flange. BS10:E	100
10717125	Blind Plate Flange. BS10:D	125
10717126	Blind Plate Flange. BS10:E	125
10717150	Blind Plate Flange. BS10:D	150
10717151	Blind Plate Flange. BS10:E	150
10717200	Blind Plate Flange. BS10:E	200
10717201	Blind Plate Flange. BS10:E	200
10717250	Blind Plate Flange. BS10:D	250
10717251	Blind Plate Flange. BS10:E	250
10717300	Blind Plate Flange. BS10:E	300
10720050	Blind Plate Flange. BS10:D/E Galvanised	50
10720080	Blind Plate Flange. BS10:D/E Galvanised	80
10720100	Blind Plate Flange. BS10:D/E Galvanised	100
10720101	Blind Plate Flange. BS10:E Galvanised	100

Blind Plate Flanges PN6

Product Code	Description	Size mm
10718015	Blind Plate Flange. BS10:F	15
10718020	Blind Plate Flange. BS10:F	20
10718025	Blind Plate Flange. BS10:F	25
10718032	Blind Plate Flange. BS10:F	32
10718040	Blind Plate Flange. BS10:F	40
10718050	Blind Plate Flange. BS10:F	50
10718065	Blind Plate Flange. BS10:F	65
10718080	Blind Plate Flange. BS10:F	80
10718100	Blind Plate Flange. BS10:F	100
10718125	Blind Plate Flange. BS10:F	125
10718150	Blind Plate Flange. BS10:F	150
10718200	Blind Plate Flange. BS10:F	200

Continued

PIPE FLANGES TO BS10/BS4504 WELD / SCREWED

Blind Plate Flanges PN6

Product Code	Description	Size mm
10719015	Blind Plate Flange. BS10:H	15
10719020	Blind Plate Flange. BS10:H	20
10719025	Blind Plate Flange. BS10:H	25
10719032	Blind Plate Flange. BS10:H	32
10719040	Blind Plate Flange. BS10:H	40
10719050	Blind Plate Flange. BS10:H	50
10719065	Blind Plate Flange. BS10:H	65
10719080	Blind Plate Flange. BS10:H	80
10719100	Blind Plate Flange. BS10:H	100
10719125	Blind Plate Flange. BS10:H	125
10719150	Blind Plate Flange. BS10:H	150
10719200	Blind Plate Flange. BS10:H	200



Blind Plate Flanges PN6

Product Code	Description	Size mm
10731015	Blind Plate Flange BS4504:6/8	15
10731020	Blind Plate Flange BS4504:6/8	20
10731025	Blind Plate Flange BS4504:6/8	25
10731032	Blind Plate Flange BS4504:6/8	32
10731040	Blind Plate Flange BS4504:6/8	40
10731050	Blind Plate Flange BS4504:6/8	50
10731065	Blind Plate Flange BS4504:6/8	65
10731080	Blind Plate Flange BS4504:6/8	80
10731100	Blind Plate Flange BS4504:6/8	100
10731125	Blind Plate Flange BS4504:6/8	125
10731150	Blind Plate Flange BS4504:6/8	150
10731200	Blind Plate Flange BS4504:6/8	200

Blind Plate Flanges PN16

Product Code	Description	Size mm
10761015	Blind Plate Flange BS4504:16/8	15
10761020	Blind Plate Flange BS4504:16/8	20
10761025	Blind Plate Flange BS4504:16/8	25
10761032	Blind Plate Flange BS4504:16/8	32
10761040	Blind Plate Flange BS4504:16/8	40
10761050	Blind Plate Flange BS4504:16/8	50
10761065	Blind Plate Flange BS4504:16/8	65
10761080	Blind Plate Flange BS4504:16/8	80

Continued

PIPE FLANGES TO BS10/BS4504 WELD / SCREWED

Blind Plate Flanges PN16

Product Code	Description	Size mm
10761100	Blind Plate Flange BS4504:16/8	100
10761125	Blind Plate Flange BS4504:16/8	125
10761150	Blind Plate Flange BS4504:16/8	150
10761200	Blind Plate Flange BS4504:16/8	200
10761300	Blind Plate Flange BS4504:16/8	300

Blind Plate Flanges Stainless Steel Table D/E

Product Code	Description	Size mm
18101025	Stainless Steel 316 Blind Flange D/E	25
18101032	Stainless Steel 316 Blind Flange D/E	32
18101040	Stainless Steel 316 Blind Flange D/E	40
18101050	Stainless Steel 316 Blind Flange D/E	50
18101065	Stainless Steel 316 Blind Flange D/E	65
18101080	Stainless Steel 316 Blind Flange D/E	80
18101100	Stainless Steel 316 Blind Flange D	100
18101101	Stainless Steel 316 Blind Flange E	100
18101150	Stainless Steel 316 Blind Flange D	150

Blind Plate Flanges Stainless Steel Table PN16

Product Code	Description	Size mm
18106025	Stainless Steel 316 Blind Flange PN16	25
18106032	Stainless Steel 316 Blind Flange PN16	32
18106040	Stainless Steel 316 Blind Flange PN16	40
18106050	Stainless Steel 316 Blind Flange PN16	50
18106065	Stainless Steel 316 Blind Flange PN16	65
18106080	Stainless Steel 316 Blind Flange PN16	80
18106100	Stainless Steel 316 Blind Flange PN16	100
18106150	Stainless Steel 316 Blind Flange PN16	150



VALVES

Product Code	Description	Size mm
80010515	Pegler M59 Compression Brass Stopcock	15
80010522	Pegler M59 Compression Brass Stopcock	22
80010528	Pegler M59 Compression Brass Stopcock	28
80010615	Pegler GM59 Compression Stopcock	15
80010622	Pegler GM59 Compression Stopcock	22
80010628	Pegler GM59 Compression Stopcock	28
80010635	Pegler GM59 Compression Stopcock	35
80010642	Pegler GM59 Compression Stopcock	42
80010654	Pegler GM59 Compression Stopcock	54
80010715	Pegler GM59LS Compression Stopcock	15
80010722	Pegler GM59LS Compression Stopcock	22
80010728	Pegler GM59LS Compression Stopcock	28
80010735	Pegler GM59LS Compression Stopcock	35
80010742	Pegler GM59LS Compression Stopcock	42
80010754	Pegler GM59LS Compression Stopcock	54



Product Code	Description	Size mm
80010815	Pegler 59ECCP Compression Stopcock	15
80010822	Pegler 59ECCP Compression Stopcock	22



Product Code	Description	Size mm
80020315	Pegler 744FPIW Wheelhead Stopcock FF Bsp	15
80020320	Pegler 744FPIW Wheelhead Stopcock FF Bsp	20
80020325	Pegler 744FPIW Wheelhead Stopcock FF Bsp	25
80020332	Pegler 744FPIW Wheelhead Stopcock FF Bsp	32
80020340	Pegler 744FPIW Wheelhead Stopcock FF Bsp	40
80020350	Pegler 744FPIW Wheelhead Stopcock FF Bsp	50



Product Code	Description	Size mm
80020415	Pegler 744ECCP Stopcock FF Bsp	15

Product Code	Description	Size mm
80020015	Pegler 744F Stopcock FxF Bsp.	15
80020020	Pegler 744F Stopcock FxF Bsp.	20
80020025	Pegler 744F Stopcock FxF Bsp.	25



VALVES

Product Code	Description	Size mm
80020032	Pegler 744F Stopcock FxF Bsp.	32
80020040	Pegler 744F Stopcock FxF Bsp.	40
80020050	Pegler 744F Stopcock FxF Bsp.	50
80020080	Pegler 744F Stopcock FxF Bsp.	80
80020115	Pegler 744FGK Lockshield Stopcock FF Bsp	15
80020120	Pegler 744FGK Lockshield Stopcock FxFBsp	20
80020125	Pegler 744FGK Lockshield Stopcock FxFBsp	25
80020132	Pegler 744FGK Lockshield Stopcock FxFBsp	32
80020140	Pegler 744FGK Lockshield Stopcock FxFBsp	40
80020150	Pegler 744FGK Lockshield Stopcock FxFBsp	50



Product Code	Description	Size mm
81140115	Pegler M63 Compression Gatevalve	15
81140122	Pegler M63 Compression Gatevalve	22
81140128	Pegler M63 Compression Gatevalve	28
81140135	Pegler M63 Compression Gatevalve	35
81140242	Pegler GM63 Compression Gatevalve	42
81140254	Pegler GM63 Compression Gatevalve	54
81140315	Pegler M63LS Compression Gatevalve	15
81140322	Pegler M63LS Compression Gatevalve	22
81140328	Pegler M63LS Compression Gatevalve	28
81140335	Pegler M63LS Compression Gatevalve	35
81140442	Pegler GM63LS Compression Gatevalve	42
81140454	Pegler GM63LS Compression Gatevalve	54



Product Code	Description	Size mm
81142015	Petronelli GV0115 Compression Gatevalve	15
81142022	Petronelli GV0122 Compression Gatevalve	22
81142028	Petronelli GV0128 Compression Gatevalve	28
81142035	Petronelli GV0135 Compression Gatevalve	35
81142042	Petronelli GV0142 Compression Gatevalve	42
81142054	Petronelli GV0154 Compression Gatevalve	54



VALVES

Product Code	Description	Size mm
81225008	Cimberio 70BS PN20 Gatevalve WH	8
81225010	Cimberio 70BS PN20 Gatevalve WH	10
81225015	Cimberio 70BS PN20 Gatevalve WH	15
81225020	Cimberio 70BS PN20 Gatevalve WH	20
81225025	Cimberio 70BS PN20 Gatevalve WH	25
81225032	Cimberio 70BS PN20 Gatevalve WH	32
81225040	Cimberio 70BS PN20 Gatevalve WH	40
81225050	Cimberio 70BS PN20 Gatevalve WH	50
81225065	Cimberio 70BS PN20 Gatevalve WH	65
81225080	Cimberio 70BS PN20 Gatevalve WH	80



Product Code	Description	Size mm
81200008	Crane D151 PN20 Gatevalve WH	8
81200010	Crane D151 PN20 Gatevalve WH	10
81200015	Crane D151 PN20 Gatevalve WH	15
81200020	Crane D151 PN20 Gatevalve WH	20
81200025	Crane D151 PN20 Gatevalve WH	25
81200032	Crane D151 PN20 Gatevalve WH	32
81200040	Crane D151 PN20 Gatevalve WH	40
81200050	Crane D151 PN20 Gatevalve WH	50
81200065	Crane D151 PN20 Gatevalve WH	65
81200080	Crane D151 PN20 Gatevalve WH	80
81200100	Crane D151 PN20 Gatevalve WH	100
81201015	Crane D237 PN20 Gatevalve LS	15
81201020	Crane D237 PN20 Gatevalve LS	20
81201025	Crane D237 PN20 Gatevalve LS	25
81201032	Crane D237 PN20 Gatevalve LS	32
81201040	Crane D237 PN20 Gatevalve LS	40
81201050	Crane D237 PN20 Gatevalve LS	50
81201065	Crane D237 PN20 Gatevalve LS	65
81201080	Crane D237 PN20 Gatevalve LS	80



VALVES

Product Code	Description	Size mm
81202008	Crane D159 PN32 Gatevalve WH	8
81202010	Crane D159 PN32 Gatevalve WH	10
81202015	Crane D159 PN32 Gatevalve WH	15
81202020	Crane D159 PN32 Gatevalve WH	20
81202025	Crane D159 PN32 Gatevalve WH	25
81202032	Crane D159 PN32 Gatevalve WH	32
81202040	Crane D159 PN32 Gatevalve WH	40
81202050	Crane D159 PN32 Gatevalve WH	50
81202065	Crane D159 PN32 Gatevalve WH	65
81202080	Crane D159 PN32 Gatevalve WH	80
81202115	Crane D235 PN32 Gatevalve LS	15
81202120	Crane D235 PN32 Gatevalve LS	20
81202125	Crane D235 PN32 Gatevalve LS	25
81202132	Crane D235 PN32 Gatevalve LS	32
81202140	Crane D235 PN32 Gatevalve LS	40
81202150	Crane D235 PN32 Gatevalve LS	50
81202165	Crane D235 PN32 Gatevalve LS	65
81202180	Crane D235 PN32 Gatevalve LS	80



Product Code	Description	Size mm
81211008	Hattersley 33X Bronze Gate Valve.PN20	8
81211010	Hattersley 33X Bronze Gate Valve.PN20	10
81211015	Hattersley 33X Bronze Gate Valve.PN20	15
81211020	Hattersley 33X Bronze Gate Valve.PN20	20
81211025	Hattersley 33X Bronze Gate Valve.PN20	25
81211032	Hattersley 33X Bronze Gate Valve.PN20	32
81211040	Hattersley 33X Bronze Gate Valve.PN20	40
81211050	Hattersley 33X Bronze Gate Valve.PN20	50
81211108	Hattersley 33XLS Bronze Gate Valve.PN20	8
81211110	Hattersley 33XLS Bronze Gate Valve.PN20	10
81211115	Hattersley 33XLS Bronze Gate Valve.PN20	15
81211120	Hattersley 33XLS Bronze Gate Valve.PN20	20
81211125	Hattersley 33XLS Bronze Gate Valve.PN20	25
81211132	Hattersley 33XLS Bronze Gate Valve.PN20	32
81211140	Hattersley 33XLS Bronze Gate Valve.PN20	40
81211150	Hattersley 33XLS Bronze Gate Valve.PN20	50



INDEX

Product Code	Description	Size mm
84005006	Crane D71 Needle Valve	6
84005008	Crane D71 Needle Valve	8
84005010	Crane D71 Needle Valve	10
84005015	Crane D71 Needle Valve	15
84005020	Crane D71 Needle Valve	20



Product Code	Description	Size mm
84003008	Crane D15 Globe Valve PN32	8
84003010	Crane D15 Globe Valve PN32	10
84003015	Crane D15 Globe Valve PN32	15
84003020	Crane D15 Globe Valve PN32	20
84003025	Crane D15 Globe Valve PN32	25
84003032	Crane D15 Globe Valve PN32	32
84003040	Crane D15 Globe Valve PN32	40
84003050	Crane D15 Globe Valve PN32	50
84003065	Crane D15 Globe Valve PN32	65



Product Code	Description	Size mm
81230020	Crane D160 Bronze Gatevalve BS10/E	20
81230025	Crane D160 Bronze Gatevalve BS10/E	25
81230032	Crane D160 Bronze Gatevalve BS10/E	32
81230040	Crane D160 Bronze Gatevalve BS10/E	40
81230050	Crane D160 Bronze Gatevalve BS10/E	50
81230065	Crane D160 Bronze Gatevalve BS10/E	65
81230080	Crane D160 Bronze Gatevalve BS10/E	80



Product Code	Description	Size mm
82002050	Crane F52-D/E Gatevalve	50
82002065	Crane F52-D/E Gatevalve	65
82002080	Crane F52-D/E Gatevalve	80
82002100	Crane F52-D Gatevalve	100
82002101	Crane F52-E Gatevalve	100
82002125	Crane F52-E Gatevalve	125
82002150	Crane F52-E Gatevalve	150
82002200	Crane F52-E Gatevalve	200



VALVES

Product Code	Description	Size mm
82007050	Crane F63-CL150 Gatevalve	50
82007065	Crane F63-CL150 Gatevalve	65
82007080	Crane F63-CL150 Gatevalve	80
82007100	Crane F63-CL150 Gatevalve	100
82007125	Crane F63-CL150 Gatevalve	125
82007150	Crane F63-CL150 Gatevalve	150



Product Code	Description	Size mm
82003050	Crane FM52-PN6 Gatevalve	50
82003065	Crane FM52-PN6 Gatevalve	65
82003080	Crane FM52-PN6 Gatevalve	80
82003100	Crane FM52-PN6 Gatevalve	100
82003125	Crane FM52-PN6 Gatevalve	125
82003150	Crane FM52-PN6 Gatevalve	150



Product Code	Description	Size mm
82005050	Crane FM63-PN16 Gatevalve	50
82005065	Crane FM63-PN16 Gatevalve	65
82005080	Crane FM63-PN16 Gatevalve	80
82005100	Crane FM63-PN16 Gatevalve	100
82005125	Crane FM63-PN16 Gatevalve	125
82005150	Crane FM63-PN16 Gatevalve	150



Product Code	Description	Size mm
82011050	Hattersley 541-E CI Gate Valve	50
82011065	Hattersley 541-E CI Gate Valve	65
82011080	Hattersley 541-E CI Gate Valve	80
82011100	Hattersley 541-E CI Gate Valve	100
82011125	Hattersley 541-E CI Gate Valve	125
82011150	Hattersley 541-E CI Gate Valve	150



Product Code	Description	Size mm
82013050	Hattersley 544 - E CI Gate Valve	50
82013065	Hattersley 544 - E CI Gate Valve	65
82013080	Hattersley 544 - E CI Gate Valve	80
82013100	Hattersley 544 - E CI Gate Valve	100
82013125	Hattersley 544 - E CI Gate Valve	125
82013150	Hattersley 544 - E CI Gate Valve	150
82013200	Hattersley 544 - E CI Gate Valve	200



VALVES

Product Code	Description	Size mm
82015050	Hattersley 549-E CI Gate Valve	50
82015065	Hattersley 549-E CI Gate Valve	65
82015080	Hattersley 549-E CI Gate Valve	80
82015100	Hattersley 549-E CI Gate Valve	100
82015125	Hattersley 549-E CI Gate Valve	125
82015150	Hattersley 549-E CI Gate Valve	150



Product Code	Description	Size mm
82017050	Hattersley 599-E CI Gate Valve	50
82017065	Hattersley 599-E CI Gate Valve	65
82017080	Hattersley 599-E CI Gate Valve	80
82017100	Hattersley 599-E CI Gate Valve	100
82017125	Hattersley 599-E CI Gate Valve	125
82017150	Hattersley 599-E CI Gate Valve	150



Product Code	Description	Size mm
82012050	Hattersley M541-PN16 CI Gate Valve	50
82012065	Hattersley M541-PN16 CI Gate Valve	65
82012080	Hattersley M541-PN16 CI Gate Valve	80
82012100	Hattersley M541-PN16 CI Gate Valve	100
82012125	Hattersley M541-PN16 CI Gate Valve	125
82012150	Hattersley M541-PN16 CI Gate Valve	150



Product Code	Description	Size mm
82014050	Hattersley M544 PN16 CI Gate Valve	50
82014065	Hattersley M544 PN16 CI Gate Valve	65
82014080	Hattersley M544 PN16 CI Gate Valve	80
82014100	Hattersley M544 PN16 CI Gate Valve	100
82014125	Hattersley M544 PN16 CI Gate Valve	125
82014150	Hattersley M544 PN16 CI Gate Valve	150
82014200	Hattersley M544 PN16 CI Gate Valve	200



Product Code	Description	Size mm
82016050	Hattersley M549-PN6 CI Gate Valve	50
82016065	Hattersley M549-PN6 CI Gate Valve	65
82016080	Hattersley M549-PN6 CI Gate Valve	80
82016100	Hattersley M549-PN6 CI Gate Valve	100
82016125	Hattersley M549-PN6 CI Gate Valve	125
82016150	Hattersley M549-PN6 CI Gate Valve	150



VALVES

Product Code	Description	Size mm
82018050	Hattersley M599-PN16 CI Gate Valve	50
82018065	Hattersley M599-PN16 CI Gate Valve	65
82018080	Hattersley M599-PN16 CI Gate Valve	80
82018100	Hattersley M599-PN16 CI Gate Valve	100
82018125	Hattersley M599-PN16 CI Gate Valve	125
82018150	Hattersley M599-PN16 CI Gate Valve	150



Product Code	Description	Size mm
83101050	Burcim Lever 3000 S/Lug Butterfly Valve	50
83101065	Burcim Lever 3000 S/Lug Butterfly Valve	65
83101080	Burcim Lever 3000 S/Lug Butterfly Valve	80
83101100	Burcim Lever 3000 S/Lug Butterfly Valve	100
83101125	Burcim Lever 3000 S/Lug Butterfly Valve	125
83101150	Burcim Lever 3000 S/Lug Butterfly Valve	150
83101200	Burcim Lever 3000 S/Lug Butterfly Valve	200



Product Code	Description	Size mm
83102050	Burcim 3010 Geared Wafer Valve.EPDM/RIL	50
83102065	Burcim 3010 Geared Wafer Valve.EPDM/RIL	65
83102080	Burcim 3010 Geared Wafer Valve.EPDM/RIL	80
83102100	Burcim 3010 Geared Wafer Valve.EPDM/RIL	100
83102125	Burcim 3010 Geared Wafer Valve.EPDM/RIL	125
83102150	Burcim 3010 Geared Wafer Valve.EPDM/RIL	150
83102200	Burcim 3010 Geared Wafer Valve.EPDM/RIL	200



Product Code	Description	Size mm
83102050	Burcim 3010 Geared Wafer Valve.EPDM/RIL	50
83102065	Burcim 3010 Geared Wafer Valve.EPDM/RIL	65
83102080	Burcim 3010 Geared Wafer Valve.EPDM/RIL	80
83102100	Burcim 3010 Geared Wafer Valve.EPDM/RIL	100
83102125	Burcim 3010 Geared Wafer Valve.EPDM/RIL	125
83102150	Burcim 3010 Geared Wafer Valve.EPDM/RIL	150
83102200	Burcim 3010 Geared Wafer Valve.EPDM/RIL	200



Product Code	Description	Size mm
83108050	Burcim 3111 Geared Lugged Valve EPDM/RIL	50
83108065	Burcim 3111 Geared Lugged Valve EPDM/RIL	65
83108080	Burcim 3111 Geared Lugged Valve EPDM/RIL	80
83108100	Burcim 3111 Geared Lugged Valve EPDM/RIL	100



VALVES

Product Code	Description	Size mm
83108125	Burcim 3111 Geared Lugged Valve EPDM/RIL	125
83108150	Burcim 3111 Geared Lugged Valve EPDM/RIL	150
83108200	Burcim 3111 Geared Lugged Valve EPDM/RIL	200
83109050	Burcim 3110 Geared Lugged Valve EPDM/SS	50
83109065	Burcim 3110 Geared Lugged Valve EPDM/SS	65
83109080	Burcim 3110 Geared Lugged Valve EPDM/SS	80
83109100	Burcim 3110 Geared Lugged Valve EPDM/SS	100
83109125	Burcim 3110 Geared Lugged Valve EPDM/SS	125
83109150	Burcim 3110 Geared Lugged Valve EPDM/SS	150
83109200	Burcim 3110 Geared Lugged Valve EPDM/SS	200



Product Code	Description	Size mm
85800020	Brandoni CP02.000 CI Ballvalve PN16	20
85800025	Brandoni CP02.000 CI Ballvalve PN16	25
85800032	Brandoni CP02.000 CI Ballvalve PN16	32
85800040	Brandoni CP02.000 CI Ballvalve PN16	40
85800050	Brandoni CP02.000 CI Ballvalve PN16	50
85800065	Brandoni CP02.000 CI Ballvalve PN16	65
85800080	Brandoni CP02.000 CI Ballvalve PN16	80
85800100	Brandoni CP02.000 CI Ballvalve PN16	100
85800125	Brandoni CP02.000 CI Ballvalve PN16	125
85800150	Brandoni CP02.000 CI Ballvalve PN16	150
85800200	Brandoni CP02.000 CI Ballvalve PN16	200



Product Code	Description	Size mm
85801020	Brandoni HP2.100 CI Ballvalve PN16	20
85801025	Brandoni HP2.100 CI Ballvalve PN16	25
85801032	Brandoni HP2.100 CI Ballvalve PN16	32
85801040	Brandoni HP2.100 CI Ballvalve PN16	40
85801050	Brandoni HP2.100 CI Ballvalve PN16	50
85801065	Brandoni HP2.100 CI Ballvalve PN16	65
85801080	Brandoni HP2.100 CI Ballvalve PN16	80
85801100	Brandoni HP2.100 CI Ballvalve PN16	100
85801125	Brandoni HP2.100 CI Ballvalve PN16	125
85801150	Brandoni HP2.100 CI Ballvalve PN16	150
85801200	Brandoni HP2.100 CI Ballvalve PN16	200



VALVES

Product Code	Description	Size mm
85110008	Cim 10 Ballvalve.FF	8
85110010	Cim 10 Ballvalve.FF	10
85110015	Cim 10 Ballvalve.FF	15
85110020	Cim 10 Ballvalve.FF	20
85110025	Cim 10 Ballvalve.FF	25
85110032	Cim 10 Ballvalve.FF	32
85110040	Cim 10 Ballvalve.FF	40
85110050	Cim 10 Ballvalve.FF	50
85110065	Cim 10 Ballvalve.FF	65
85110080	Cim 10 Ballvalve.FF	80
85110100	Cim 10 Ballvalve.FF	100



Product Code	Description	Size mm
85110108	Cim 10G Gas Ballvalve.FF	8
85110110	Cim 10G Gas Ballvalve.FF	10
85110115	Cim 10G Gas Ballvalve.FF	15
85110120	Cim 10G Gas Ballvalve.FF	20
85110125	Cim 10G Gas Ballvalve.FF	25
85110132	Cim 10G Gas Ballvalve.FF	32
85110140	Cim 10G Gas Ballvalve.FF	40
85110150	Cim 10G Gas Ballvalve.FF	50



Product Code	Description	Size mm
85111008	Cim 11G Gas Ballvalve.FF	8
85111010	Cim 11G Gas Ballvalve.FF	10
85111015	Cim 11G Gas Ballvalve.FF	15
85111020	Cim 11G Gas Ballvalve.FF	20
85111025	Cim 11G Gas Ballvalve.FF	25
85111032	Cim 11G Gas Ballvalve.FF	32
85111040	Cim 11G Gas Ballvalve.FF	40
85111050	Cim 11G Gas Ballvalve.FF	50
85111065	Cim 11G Gas Ballvalve.FF	65
85111080	Cim 11G Gas Ballvalve.FF	80
85111100	Cim 11G Gas Ballvalve.FF	100



VALVES

Product Code	Description	Size mm
85112008	Cim 12 FBBV.Non leak Stem.FxF	8
85112010	Cim 12 FBBV.Non leak Stem.FxF	10
85112015	Cim 12 FBBV.Non leak Stem.FxF	15
85112020	Cim 12 FBBV.Non leak Stem.FxF	20
85112025	Cim 12 FBBV.Non leak Stem.FxF	25
85112032	Cim 12 FBBV.Non leak Stem.FxF	32
85112040	Cim 12 FBBV.Non leak Stem.FxF	40
85112050	Cim 12 FBBV.Non leak Stem.FxF	50
85112065	Cim 12 FBBV.Non leak Stem.FxF	65
85112080	Cim 12 FBBV.Non leak Stem.FxF	80
85112100	Cim 12 FBBV.Non leak Stem.FxF	100



Product Code	Description	Size mm
85130915	Cim 309T Ballvalve CxC NPtd	15
85130922	Cim 309T Ballvalve CxC NPtd	22
85130928	Cim 309T Ballvalve CxC NPtd	28
85130932	Cim 309T Ballvalve CxC NPtd	35
85130942	Cim 309T Ballvalve CxC NPtd	42
85130954	Cim 309T Ballvalve CxC.NPtd	54



Product Code	Description	Size mm
85120915	Cim 209L Ballvalve CxC NPtd	15
85120922	Cim 209L Ballvalve CxC NPtd	22
85120928	Cim 209L Ballvalve CxC NPtd	28
85120932	Cim 209L Ballvalve CxC NPtd	35
85120942	Cim 209L Ballvalve CxC NPtd	42
85120954	Cim 209L Ballvalve CxC.NPtd	54



Product Code	Description	Size mm
85111210	Cim 209G Compression Gas Ballvalve.	10
85111212	Cim 209G Compression Gas Ballvalve.	12
85111215	Cim 209G Compression Gas Ballvalve.	15
85111222	Cim 209G Compression Gas Ballvalve.	22
85111228	Cim 209G Compression Gas Ballvalve.	28
85111235	Cim 209G Compression Gas Ballvalve.	35
85111242	Cim 209G Compression Gas Ballvalve.	42
85111254	Cim 209G Compression Gas Ballvalve.	54



VALVES

Product Code	Description	Size mm
85136415	Cim 346 MI Union x FI Bsp Ballvalve.Tbar	15
85136422	Cim 346 MI.Union x FI Bsp Ballvalve.Tbar	20
85136428	Cim 364 MI.Union x FI Bsp.Ballvalve.Tbar	25
85136435	Cim 364 MI.Union x FI.Bsp Ballvalve.Tbar	32



Product Code	Description	Size mm
85162015	Cim 620 Ballvalve/Strainer.FxF Bsp.T bar	15
85162020	Cim 620 Ballvalve/Strainer.FxF Bsp.Tbar	20
85162025	Cim 620 Ballvalve/Strainer.FxF Bsp.Tbar	25
85162032	Cim 620 Ballvalve/Strainer.FxF Bsp.Tbar	32
85162040	Cim 620 Ballvalve/Strainer.FxF Bsp.Tbar	40
85162050	Cim 620 Ballvalve/Strainer.FxF Bsp.Tbar	50



Product Code	Description	Size mm
85162315	Cim 621 Ballvalve/Strainer/Checkvalve.FF	15
85162320	Cim 621 Ballvalve/Strainer/Checkvalve.FF	20
85162325	Cim 621 Ballvalve/Strainer/Checkvalve.FF	25



Product Code	Description	Size mm
85230115	CP301 Carbon Steel 3pc Ballvalve.PN60.Bsp	15
85230120	CP301 Carbon Steel 3pc Ballvalve.PN60.Bsp	20
85230125	CP301 Carbon Steel 3pc Ballvalve.PN60.Bsp	25
85230132	CP301 Carbon Steel 3pc Ballvalve.PN60.Bsp	32
85230140	CP301 Carbon Steel 3pc Ballvalve.PN60.Bsp	40
85230150	CP301 Carbon Steel 3pc Ballvalve.PN60.Bsp	50



Product Code	Description	Size mm
85232015	CP301 S/S 3 piece Ballvalve.1000/PN60.WOG	15
85232020	CP301 S/S 3 Piece Ballvalve.1000/PN60.WOG	20
85232025	CP301 S/S 3 Piece Ballvalve.1000/PN60.WOG	25
85232032	CP301 S/S 3 Piece Ballvalve.1000/PN60.WOG	32
85232040	CP301 S/S 3 Piece Ballvalve.1000/PN60.WOG	40
85232050	CP301 S/S 3 Piece Ballvalve.1000/PN60.WOG	50



VALVES

Product Code	Description	Size mm
85323015	CP 2000 3 Port BallValve. T/L port	15
85323020	CP 2000 3 Port BallValve. T/L port	20
85323025	CP 2000 3 Port BallValve. T/L port	25
85323032	CP 2000 3 Port BallValve. T/L port	32
85323040	CP 2000 3 Port BallValve. T/L port	40
85323050	CP 2000 3 Port BallValve. T/L port	50



Product Code	Description	Size mm
85322015	CP34SL S/S 3 Port BallValve.L port	15
85322020	CP34SL S/S 3 Port BallValve.L port	20
85322025	CP34SL S/S 3 Port BallValve.L port	25
85322032	CP34SL S/S 3 Port BallValve.L port	32
85322040	CP34SL S/S 3 Port BallValve.L port	40
85322050	CP34SL S/S 3 Port BallValve.L port	50
85322115	CP34ST S/S 3 Port BallValve.T port	15
85322120	CP34ST S/S 3 Port BallValve.T port	20
85322125	CP34ST S/S 3 Port BallValve.T port	25
85322132	CP34ST S/S 3 Port BallValve.T port	32
85322140	CP34ST S/S 3 Port BallValve.T port	40
85322150	CP34ST S/S 3 Port BallValve.T port	50



Product Code	Description	Size mm
85324015	Nabic 503 Boiler Escape Valve	15
85324020	Nabic 503 Boiler Escape Valve	20
85324025	Nabic 503 Boiler Escape Valve	25
85324032	Nabic 503 Boiler Escape Valve	32
85324040	Nabic 503 Boiler Escape Valve	40
85324050	Nabic 503 Boiler Escape Valve	50
85324065	Nabic 503 Boiler Escape Valve	65



Product Code	Description	Size mm
85001008	Ballofix 3200 YA MF	8
85001010	Ballofix 3210 YA MF	10
85001015	Ballofix 3310 YA MF	15
85001020	Ballofix 3410 YA MF	20
85001025	Ballofix 3510 YA MF	25
85001032	Ballofix 3610 BA MF	32
85001110	Ballofix 3210 ZA MF Valve	10
85001115	Ballofix 3310 ZA MF Valve	15
85001120	Ballofix 3410 ZA MF Valve	20



Continued

VALVES

Product Code	Description	Size mm
85001125	Ballofix 3510 ZA MF Valve	25
85001132	Ballofix 3610 CA MF Valve	32
85001208	Ballofix 3205 YA Valve FF	8
85001210	Ballofix 3250 YA Valve FF	10
85001215	Ballofix 3350 YA Valve FF	15
85001220	Ballofix 3450 YA Valve FF	20
85001225	Ballofix 3550 YA Valve FF	25
85001308	Ballofix 3205 ZA Valve FF	8
85001310	Ballofix 3250 ZA Valve FF	10
85001315	Ballofix 3350 ZA Valve FF	15
85001320	Ballofix 3450 ZA Valve FF	20
85001325	Ballofix 3550 ZA Valve FF	25
85001415	Ballofix 3480 CP Angle Valve.CxC	15
85001422	Ballofix 3480 CP Angle Valve.CxC	22
85001515	Ballofix 3375 YA Valve MlxC	15x1/2
85001522	Ballofix 3475 YA Valve MlxC	22x3/4
85001528	Ballofix 3575 YA Valve MlxC	28x1
85001535	Ballofix 3675 BA Valve MlxC	35x1.1/4
85001615	Ballofix 3375 ZA MlxC	15x1/2
85001622	Ballofix 3475 ZA MlxC	22x3/4
85001628	Ballofix 3575 ZA MlxC	28x1
85001635	Ballofix 3675 CA MlxC	32x1.1/4
85001812	Ballofix 3331 YA Valve FlxC	15x1/2
85001822	Ballofix 3431 YA Valve FlxC	22x3/4
85001828	Ballofix 3531 YA Valve FlxC	28x1
85001835	Ballofix 3631 BA Valve FlxC	35x1.1/4
85001915	Ballofix 3331 ZA Valve FlxCu	15x1/2
85001922	Ballofix 3431 ZA Valve FlxCu	22/3/4
85001928	Ballofix 3531 ZA Valve FlxCu	28x1
85001935	Ballofix 3631 CA Valve FlxCu	35x1.1/4
85002015	Ballofix 5045 BA Angle Radiator Valve	15x1/2
85002022	Ballofix 5075 BA Angle Radiator Valve	22x3/4
85002115	Ballofix 5045 CA Angle Radiator Valve	15x1/2
85002122	Ballofix 5075 CA Angle Radiator Valve	22x3/4
85002215	Ballofix 5035 BA Strt.Radiator Valve	15x1/2
85002222	Ballofix 5065 BA Strt.Radiator Valve	22x3/4
85002315	Ballofix 5035 CA Strt.Radiator Valve	15x1/2
85002322	Ballofix 5065 CA Strt.Radiator Valve	22x3/4
85002412	Ballofix 3381 YA Valve CxC	12
85002415	Ballofix 3381 YA Valve CxC	15
85002422	Ballofix 3481 YA Valve CxC	22
85002428	Ballofix 3481 YA Valve CxC	28
85002435	Ballofix 3681 BA Valve CxC	35



Continued

VALVES

Product Code	Description	Size mm
85002515	Ballofix 3381 ZA Valve CxC	15
85002522	Ballofix 3481 ZA Valve CxC	22
85002528	Ballofix 3581 ZA Valve CxC	28
85002535	Ballofix 3681 CA Valve CxC	35
85002615	Ballofix 3380 YA CxC. Angle	15
85002715	Ballofix 3380 ZA CxC. Angle	15
85002815	Ballofix 3140 YA Service Valve CxSwivel	15
85002915	Ballofix 3140 ZA Service Valve CxSwivel	15
85003015	Ballofix 3160 YA Angle Service Valve.CxSw.	15
85003115	Ballofix 3160 ZA Angle Service Valve.CxSw.	15



Product Code	Description	Size mm
87001020	D901 Flow Orifice with PT84 test points	20
87001025	D901 Flow Orifice with PT84 test points	25
87001032	D901 Flow Orifice with PT84 test points	32
87001040	D901 Flow Orifice with PT84 test points	40
87001050	D901 Flow Orifice with PT84 test points	50
87001115	D902 Flow Orifice (Low flow)	15



Product Code	Description	Size mm
87020015	D920 Double Regulating Valve	15
87020020	D920 Double Regulating Valve	20
87020025	D920 Double Regulating Valve	25
87020032	D920 Double Regulating Valve	32
87020040	D920 Double Regulating Valve	40
87020050	D920 Double Regulating Valve	50
97020115	D923 Double Regulating Valve.(low flow)	15



Product Code	Description	Size mm
87030015	D930 Dble Regulation Valve/Test points	15
87030020	D930 Dble Regulation Valve/Test points	20
87030025	D930 Dble Regulation Valve/Test points	25
87030032	D930 Dble Regulation Valve/Test points	32
87030040	D930 Dble Regulation Valve/Test points	40
87030050	D930 Dble Regulation Valve/Test points	50
87030115	D932 Dble Regulation Valve/Test points	15
87031015	D931 DR Commissioning Valve/Test points	15
87031020	D931 DR Commissioning Valve/Test points	20
87031025	D931 DR Commissioning Valve/Test points	25
87031032	D931 DR Commissioning Valve/Test points	32
87031040	D931 DR Commissioning Valve/Test points	40



VALVES

Product Code	Description	Size mm
87074050	Crane DM900 Measuring Orifice PN16	50
87074065	Crane DM900 Measuring Orifice PN16	65
87074080	Crane DM900 Measuring Orifice PN16	80
87074100	Crane DM900 Measuring Orifice PN16	100
87074125	Crane DM900 Measuring Orifice PN16	125
87074150	Crane DM900 Measuring Orifice PN16	150



Product Code	Description	Size mm
87075050	Crane DM920 CI Dbl.Reg.Valve PN16	50
87075065	Crane DM920 CI Dbl.Reg.Valve PN16	65
87075080	Crane DM920 CI Dbl.Reg.Valve PN16	80
87075100	Crane DM920 CI Dbl.Reg.Valve PN16	100
87075125	Crane DM920 CI Dbl.Reg.Valve PN16	125
87075150	Crane DM920 CI Dbl.Reg.Valve PN16	150



Product Code	Description	Size mm
87076050	Crane DM930 Commissioning Valve PN16	50
87076065	Crane DM930 Commissioning Valve PN16	65
87076080	Crane DM930 Commissioning Valve PN16	80
87076100	Crane DM930 Commissioning Valve PN16	100
87076125	Crane DM930 Commissioning Valve PN16	125
87076150	Crane DM930 Commissioning Valve PN16	150



Product Code	Description	Size mm
87065015	Hattersley 1000 Bronze Metering Station	15
87065020	Hattersley 1000 Bronze Metering Station	20
87065025	Hattersley 1000 Bronze Metering Station	25
87065032	Hattersley 1000 Bronze Metering Station	32
87065040	Hattersley 1000 Bronze Metering Station	40
87065050	Hattersley 1000 Bronze Metering Station	50



Product Code	Description	Size mm
87066015	Hattersley 1432 Bronze D/Reg.Valve.Bsp	15
87066020	Hattersley 1432 Bronze D/Reg.Valve.Bsp	20
87066025	Hattersley 1432 Bronze D/Reg.Valve.Bsp	25
87066032	Hattersley 1432 Bronze D/Reg.Valve.Bsp	32
87066040	Hattersley 1432 Bronze D/Reg.Valve.Bsp	40
87066050	Hattersley 1432 Bronze D/Reg.Valve.Bsp	50



VALVES

Product Code	Description	Size mm
87067015	Hattersley 1700 Bronze Commissioning Valve	15
87067020	Hattersley 1700 Bronze Commissioning Valve	20
87067025	Hattersley 1700 Bronze Commissioning Valve	25
87067032	Hattersley 1700 Bronze Commissioning Valve	32
87067040	Hattersley 1700 Bronze Commissioning Valve	40
87067050	Hattersley 1700 Bronze Commissioning Valve	50



Product Code	Description	Size mm
87068050	Hattersley 2000 CI Metering Station	50
87068065	Hattersley 2000 CI Metering Station	65
87068080	Hattersley 2000 CI Metering Station	80
87068100	Hattersley 2000 CI Metering Station	100
87068125	Hattersley 2000 CI Metering Station	125
87068150	Hattersley 2000 CI Metering Station	150



Product Code	Description	Size mm
87069065	Hattersley 733DR-PN16 CI DRV	65
87069080	Hattersley 733DR-PN16 CI DRV	80
87069100	Hattersley 733DR-PN16 CI DRV	100
87069125	Hattersley 733DR-PN16 CI DRV	125
87069150	Hattersley 733DR-PN16 CI DRV	150



Product Code	Description	Size mm
87070050	Hattersley 737-PN16CI Commissioning Valve	50
87070065	Hattersley 737-PN16CI Commissioning Valve	65
87070080	Hattersley 737-PN16CI Commissioning Valve	80
87070100	Hattersley 737-PN16CI Commissioning Valve	100
87070125	Hattersley 737-PN16CI Commissioning Valve	125
87070150	Hattersley 737-PN16CI Commissioning Valve	150



Product Code	Description	Size mm
87050015	Cim 721 DZR Metering Station	15
87050020	Cim 721 DZR Metering Station	20
87050025	Cim 721 DZR Metering Station	25
87050032	Cim 721 DZR Metering Station	32
87050040	Cim 721 DZR Metering Station	40
87050050	Cim 721 DZR Metering Station	50



VALVES

Product Code	Description	Size mm
87060015	Cim 727 DZR Double Regulating Valve	15
87060020	Cim 727 DZR Double Regulating Valve	20
87060025	Cim 727 DZR Double Regulating Valve	25
87060032	Cim 727 DZR Double Regulating Valve	32
87060040	Cim 727 DZR Double Regulating Valve	40
87060050	Cim 727 DZR Double Regulating Valve	50



Product Code	Description	Size mm
87061015	Cim 737 DZR Commissioning Set	15
87061020	Cim 737 DZR Commissioning Set	20
87061025	Cim 737 DZR Commissioning Set	25
87061032	Cim 737 DZR Commissioning Set	32
87061040	Cim 737 DZR Commissioning Set	40
87061050	Cim 737 DZR Commissioning Set	50



Product Code	Description	Size mm
87063065	Cim 3727 Double Regulating Valve.4504/16	65
87063080	Cim 3727 Double Regulating Valve.4504/16	80
87063100	Cim 3727 Double Regulating Valve.4504/16	100
87063125	Cim 3727 Double Regulating Valve.4504/16	125
87063150	Cim 3727 Double Regulating Valve.4504/16	150



Product Code	Description	Size mm
86000115	Beta 870 Single Check Valve.CxC	15
86000122	Beta 871 Single Check Valve.CxC	22
86000128	Beta 872 Single Check Valve.CxC	28



Product Code	Description	Size mm
86000215	Beta 873 DZR Double Check Valve.CxC	15
86000222	Beta 874 DZR Double Check Valve.CxC	22



Product Code	Description	Size mm
86005115	Yorkshire 4426 Double Check Valve.FxF	15
86005120	Yorkshire 4426 Double Check Valve.FxF	20
86005125	Yorkshire 4426 Double Check Valve.FxF	25
86005132	Yorkshire 4426 Double Check Valve.FxF	32
86005140	Yorkshire 4426 Double Check Valve.FxF	40
86005150	Yorkshire 4426 Double Check Valve.FxF	50



VALVES

Product Code	Description	Size mm
86031025	CIM 30A foot Valve Screen	25
86031032	CIM 30A foot Valve Screen	32
86031040	CIM 30A foot Valve Screen	40
86031050	CIM 30A foot Valve Screen	50
86031065	CIM 30A foot Valve Screen	65
86031080	CIM 30A foot Valve Screen	80



Product Code	Description	Size mm
86030010	CIM 30 Check Valve	10
86030015	CIM 30 Check Valve	15
86030020	CIM 30 Check Valve	20
86030025	CIM 30 Check Valve	25
86030032	CIM 30 Check Valve	32
86030040	CIM 30 Check Valve	40
86030050	CIM 30 Check Valve	50
86030065	CIM 30 Check Valve	65
86030080	CIM 30 Check Valve	80
86030100	CIM 30 Check Valve	100



Product Code	Description	Size mm
86032015	CIM 32 MF Check Valve	15
86032020	CIM 32 MF Check Valve	20
86032025	CIM 32 MF Check Valve	25
86032032	CIM 32 MF Check Valve	32
86032040	CIM 32 MF Check Valve	40
86032050	CIM 32 MF Check Valve	50



Product Code	Description	Size mm
86033015	CIM 33 Check Valve FF	15
86033020	CIM 33 Check Valve FF	20
86033025	CIM 33 Check Valve FF	25
86033032	CIM 33 Check Valve FF	32
86033040	CIM 33 Check Valve FF	40
86033050	CIM 33 Check Valve FF	50



VALVES

Product Code	Description	Size mm
86007015	Pegler 1060A Bronze Non-return Valve	15
86007020	Pegler 1060A Bronze Non-return Valve	20
86007025	Pegler 1060A Bronze Non-return Valve	25
86007032	Pegler 1060A Bronze Non-return Valve	32
86007040	Pegler 1060A Bronze Non-return Valve	40
86007050	Pegler 1060A Bronze Non-return Valve	50
86007065	Pegler 1060A Bronze Non-return Valve	65
86007080	Pegler 1060A Bronze Non-return Valve	80



Product Code	Description	Size mm
86013810	Crane D138 Bronze Non-return Valve	10
86013815	Crane D138 Bronze Non-return Valve	15
86013820	Crane D138 Bronze Non-return Valve	20
86013825	Crane D138 Bronze Non-return Valve	25
86013832	Crane D138 Bronze Non-return Valve	32
86013840	Crane D138 Bronze Non-return Valve	40
86013850	Crane D138 Bronze Non-return Valve	50
86013865	Crane D138 Bronze Non-return Valve	65
86013880	Crane D138 Bronze Non-return Valve	80



Product Code	Description	Size mm
86013915	Crane D140 Bronze Non-return Valve.WRC	15
86013920	Crane D140 Bronze Non-return Valve.WRC	20
86013925	Crane D140 Bronze Non-return Valve.WRC	25
86013932	Crane D140 Bronze Non-return Valve.WRC	32
86013940	Crane D140 Bronze Non-return Valve.WRC	40
86013950	Crane D140 Bronze Non-return Valve.WRC	50



Product Code	Description	Size mm
86015050	Crane F491-CL 50/100 CI Non Return Valve	50
86015065	Crane F491-CL 50/100 CI Non Return Valve	65
86015080	Crane F491-CL 50/100 CI Non Return Valve	80
86015100	Crane F491-CL 50/100 CI Non Return Valve	100
86015125	Crane F491-CL 50/100 CI Non Return Valve	125
86015150	Crane F491-CL 50/100 CI Non Return Valve	150



VALVES

Product Code	Description	Size mm
86016050	Crane F492 CL 190 CI Non Return Valve	50
86016065	Crane F492 CL 190 CI Non Return Valve	65
86016080	Crane F492 CL 190 CI Non Return Valve	80
86016100	Crane F492 CL 190 CI Non Return Valve	100
86016125	Crane F492 CL 190 CI Non Return Valve	125
86016150	Crane F492 CL 190 CI Non Return Valve	150



Product Code	Description	Size mm
86017050	Crane FM490 PN6 CI Non Return Valve	50
86017065	Crane FM490 PN6 CI Non Return Valve	65
86017080	Crane FM490 PN6 CI Non Return Valve	80
86017100	Crane FM490 PN6 CI Non Return Valve	100
86017125	Crane FM490 PN6 CI Non Return Valve	125
86017150	Crane FM490 PN6 CI Non Return Valve	150



Product Code	Description	Size mm
86018050	Crane FM469 PN16 CI Non Return Valve	50
86018065	Crane FM469 PN16 CI Non Return Valve	65
86018080	Crane FM469 PN16 CI Non Return Valve	80
86018100	Crane FM469 PN16 CI Non Return Valve	100
86018125	Crane FM469 PN16 CI Non Return Valve	125
86018150	Crane FM469 PN16 CI Non Return Valve	150



Product Code	Description	Size mm
86020050	Hattersley 651-E CI Non Return Valve	50
86020065	Hattersley 651-E CI Non Return Valve	65
86020080	Hattersley 651-E CI Non Return Valve	80
86020100	Hattersley 651-E CI Non Return Valve	100
86020125	Hattersley 651-E CI Non Return Valve	125
86020150	Hattersley 651-E CI Non Return Valve	150



Product Code	Description	Size mm
86021050	Hattersley M651 PN6 CI Non Return Valve	50
86021065	Hattersley M651 PN6 CI Non Return Valve	65
86021080	Hattersley M651 PN6 CI Non Return Valve	80
86021100	Hattersley M651 PN6 CI Non Return Valve	100
86021125	Hattersley M651 PN6 CI Non Return Valve	125
86021150	Hattersley M651 PN6 CI Non Return Valve	150



VALVES

Product Code	Description	Size mm
86022050	Hattersley M651 PN16 CI Non Return Valve	50
86022065	Hattersley M651 PN16 CI Non Return Valve	65
86022080	Hattersley M651 PN16 CI Non Return Valve	80
86022100	Hattersley M651 PN16 CI Non Return Valve	100
86022125	Hattersley M651 PN16 CI Non Return Valve	125
86022150	Hattersley M651 PN16 CI Non Return Valve	150



Product Code	Description	Size mm
86028065	Burcim 3950 Wafer Check Valve.BS4504	65
86028080	Burcim 3950 Wafer Check Valve.BS4504	80
86028100	Burcim 3950 Wafer Check Valve.BS4504	100
86028125	Burcim 3950 Wafer Check Valve.BS4504	125
86028150	Burcim 3950 Wafer Check Valve.BS4504	150



Product Code	Description	Size mm
86023032	Gestra RK41 Wafer Non Return Valve	32
86023040	Gestra RK41 Wafer Non Return Valve	40
86023050	Gestra RK41 Wafer Non Return Valve	50
86023065	Gestra RK41 Wafer Non Return Valve	65
86023100	Gestra RK41 Wafer Non Return Valve	100
86023125	Gestra RK41 Wafer Non Return Valve	125



Product Code	Description	Size mm
86300015	Spirax Fig 12 SG Iron Y Strainer	15
86300020	Spirax Fig 12 SG Iron Y Strainer	20
86300025	Spirax Fig 12 SG Iron Y Strainer	25
86300032	Spirax Fig 12 SG Iron Y Strainer	32
86300040	Spirax Fig 12 SG Iron Y Strainer	40
86300050	Spirax Fig 12 SG Iron Y Strainer	50
86300065	Spirax Fig 12 SG Iron Y Strainer	65



Product Code	Description	Size mm
86301015	Spirax Fig 12 Brass Y Strainer	15
86301020	Spirax Fig 12 Brass Y Strainer	20
86301025	Spirax Fig 12 Brass Y Strainer	25
86301032	Spirax Fig 12 Bronze Y Strainer	32
86301040	Spirax Fig 12 Bronze Y Strainer	40
86301050	Spirax Fig 12 Bronze Y Strainer	50
86301065	Spirax Fig 12 Bronze Y Strainer	65



VALVES

Product Code	Description	Size mm
86304015	Cimberio 74A Brass Y Strainer.FxF Bsp	15
86304020	Cimberio 74A Brass Y Strainer.FxF Bsp	20
86304025	Cimberio 74A Brass Y Strainer.FxF Bsp	25
86304032	Cimberio 74A Brass Y Strainer.FxF Bsp	32
86304040	Cimberio 74A Brass Y Strainer.FxF Bsp	40
86304050	Cimberio 74A Brass Y Strainer.FxF Bsp	50
86304065	Cimberio 74A Brass Y Strainer.FxF Bsp	65
86304080	Cimberio 74A Brass Y Strainer.FxF Bsp	80
86304100	Cimberio 74A Brass Y Strainer.FxF Bsp	100



Product Code	Description	Size mm
86306050	Hattersley 810-PN16 Strainer.BS4504-PN16	50
86306065	Hattersley 810-PN16 Strainer.BS4504-PN16	65
86306080	Hattersley 810-PN16 Strainer.BS4504-PN16	80
86306100	Hattersley 810-PN16 Strainer.BS4504-PN16	100
86306125	Hattersley 810-PN16 Strainer.BS4504-PN16	125
86306150	Hattersley 810-PN16 Strainer.BS4504-PN16	150



Product Code	Description	Size mm
86700050	Burcim 3900 Y Strainer.PN16	50
86700065	Burcim 3900 Y Strainer.PN16	65
86700080	Burcim 3900 Y Strainer.PN16	80
86700100	Burcim 3900 Y Strainer.PN16	100
86700125	Burcim 3900 Y Strainer.PN16	125
86700150	Burcim 3900 Y Strainer.PN16	150



Product Code	Description	Size mm
88054215	Nabic 542 Pressure Relief Valve	15
88054220	Nabic 542 Pressure Relief Valve.	20
88054225	Nabic 542 Pressure Relief Valve.	25
88054232	Nabic 542 Pressure Relief Valve.	32
88054240	Nabic 542 Pressure Relief Valve	40
88054250	Nabic 542 Pressure Relief Valve	50
88054300	Nabic Test Certificate	



Product Code	Description	Size mm
88057115	Temperature/pressure Relief Valve.7 bar.MF	15
88057120	Temperature/pressure Relief Valve.7 bar.MF	20



INDEX

Product Code	Description	Size mm
88050015	Nabic 500 High Lift Safety Valve	15
88050020	Nabic 500 High Lift Safety Valve	20
88050025	Nabic 500 High Lift Safety Valve	25
88050032	Nabic 500 High Lift Safety Valve	32
88050040	Nabic 500 High Lift Safety Valve	40
88050050	Nabic 500 High Lift Safety Valve	50
88050065	Nabic 500 High Lift Safety Valve	65



Product Code	Description	Size mm
88200015	Tundish.Copper	15
88200022	Tundish.Copper	22
88200028	Tundish.Copper	28
88200035	Tundish.Copper	35
88200042	Tundish.Copper	42
88200054	Tundish.Copper	54



Product Code	Description	Size mm
88200120	Tundish.Galvanised	20
88200125	Tundish.Galvanised	25
88200132	Tundish.Galvanised	32
88200140	Tundish.Galvanised	40
88200150	Tundish.Galvanised	50



Product Code	Description	Size mm
87202032	RWC 315 Dial Up PRV.Mbsp.(1.5-6bar)	32
87202040	RWC 315 Dial Up PRV.Mbsp.(1.5-6bar)	40
87202050	RWC 315 Dial Up PRV.Mbsp. (1.5-6bar)	50
87203015	RWC 312C Dial UP PRV.CxC. range:0,5-5bar	15
87203022	RWC 312C Dial Up PRV.CxC.range 0,5-5bar	22
87204015	RWC 312F PRV.FxF.Bsp range 0,5-5bar	15
87204020	RWC 312F PRV.FxF.Bsp.range 0,5-5bar	20
87204025	RWC 312F PRV.FxF Bsp.range 1,5-6bar	25
87204100	RWC 312 PRV Replacement Cartridge	10 & 15
87204101	RWC 312 PRV Replacement Cartridge	20
87204115	RWC 6243.1 Adj.PRV.Temp 90.C(1.5-5bar)	15
87204150	RWC Rinox Pressure Reducing Valve.Bsp	50



VALVES

Product Code	Description	Size mm
87205015	809T Pressure Reducing Valve	15
87205020	809T Pressure Reducing Valve	20
87205025	809T Pressure Reducing Valve	25
87205032	809T Pressure Reducing Valve	32
87205040	809T Pressure Reducing Valve	40
87205050	809T Pressure Reducing Valve	50
87205065	809T Pressure Reducing Valve	65



Product Code	Description	Size mm
84100015	1832 GM Hose Union D.O Cock & lever	15
84100020	1832 GM Hose Union D.O Cock & lever	20
84100025	1832 GM Hose Union D.O Cock & lever	25
84100032	1832 GM Hose Union D.O Cock & lever	32
84100040	1832 GM Hose Union D.O Cock & lever	40



Product Code	Description	Size mm
84100115	Conex S742 Brass DO.Cock. Male BSP	15
84100215	Conex S746 DZR DO.Cock. Plain Inlet	15



Product Code	Description	Size mm
84100315	Pegler 832 Brass HU.DO Cock.BSP	15
84100320	Pegler 832 Brass HU.DO Cock.BSP	20



Product Code	Description	Size mm
88100006	Manual Air Vent	6
88100008	Manual Air Vent	8
88100010	Manual Air Vent	10
88100015	Manual Air Vent	15



Product Code	Description	Size mm
88300015	RWC AV50A Anti Vacuum Valve	15



Product Code	Description	Size mm
88500015	Spirax BPT13x Steam Trap. Angle	15
88500020	Spirax BPT13x Steam Trap. Angle	20
88500115	Spirax BPT13x Steam Trap.Straight	15
88500120	Spirax BPT13x Steam Trap.Straight	20



VALVES

Product Code	Description	Size mm
88100106	Automatic Radiator Air Vent	6
88100115	Radiator CP Air Cock	15
88100206	Honeywell Automatic Air Vent	6
88100208	Honeywell adaptor Q122A.101 for EA122 AAV	
88100307	Comap 3081 Bottle AAV + shutoff valve	10
88100310	Varia Bottle A.A.V with shutoff valve	10
88100315	Varia Bottle A.A.V with shutoff valve	15
88100350	Supervent Bottle A.A.V with 90.outlet	10
88100400	Spirax AE30A AAV. Inbuilt check Valve	15
88100401	Spirax AE30B AAV. C/W L/S Valve	15
88100402	Spirax AE30C AAV. check & LS Valves	15
88100405	Spirax AE14 AAV. (AE550)	15
88100600	Winns Type B AAV c/w LS Valve	15



Product Code	Description	Size mm
88500215	Spirax TDL42H Steam Trap.Straight	15
88500220	Spirax TDL42H Steam Trap.Straight	20
88500225	Spirax TDL42H Steam Trap.Straight	25



Product Code	Description	Size mm
88500320	Spirax HM10/7 Inverted Bucket Steam Trap.	20
88500325	Spirax HM12/7 Inverted Bucket Steam Trap.	25



Product Code	Description	Size mm
88500415	Spirax FT14 Float Steam Trap.	15
88500420	Spirax FT14 Float Steam Trap.	20
88500425	Spirax FT14 Float Steam Trap.	25

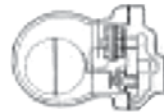

Product Code	Description	Size mm
87120550	Terrier Extension Tail ETP 21mm.brass	15
87120553	Terrier Extension Tail ETP 21mm.CP	15
87120555	Terrier Wheelhead Handle.Grey	8/10/15
87120556	Terrier Lockshield handle.Grey	8/10/15
87120558	Terrier Wheelhead Handle.White	8/10/15
87120559	Terrier Wheelhead Screw	8/ 10/15
87120561	Terrier Lockshield Head.White	8/10/15



INDEX

Product Code	Description	Size mm
87120015	Terrier 367WHMB angle Radiator Valve	15
87120016	Terrier 367LSMB Angle Radiator Valve	15
87120115	Terrier 367WHCP Angle Radiator Valve	15
87120116	Terrier 367LSCP Angle Radiator Valve	15
87120215	Terrier 368WHMB Straight Radiator Valve	15
87120216	Terrier 368LSMB Straight Radiator Valve	15
87120315	Terrier 368WHCP Straight Radiator Valve	15
87120316	Terrier 368LSCP Straight Radiator Valve	15
87120415	Terrier 369WHMB Angle Radiator Valve	15
87120416	Terrier 369LSMB Angle Radiator Valve	15
87120515	Terrier 369WHCP Angle Radiator Valve	15
87120516	Terrier 369LSCP Angle Radiator Valve	15



Product Code	Description	Size mm
87120615	Belmont 97WHMB Angle Radiator Valve	15x15
87120620	Belmont 97WHMB Angle Radiator Valve	20x22
87120625	Belmont 97WHMB Angle Radiator Valve	25x28
87120715	Belmont 97LSMB Angle Radiator Valve	15x15
87120720	Belmont 97LSMB Angle Radiator Valve	20x22
87120725	Belmont 97LSMB Angle Radiator Valve	25x28
87120815	Belmont 97WHCP Angle Radiator Valve	15x15
87120820	Belmont 97WHCP Angle Radiator Valve	20x22
87120825	Belmont 97WHCP Angle Radiator Valve	25x28
87120915	Belmont 97LSCP Angle Radiator Valve	15x15
87120920	Belmont 97LSCP Angle Radiator Valve	20x22
87120925	Belmont 97LSCP Angle Radiator Valve	25x28
87121115	Belmont 98WHMB Straight Radiator Valve	15x15
87121120	Belmont 98WHMB Straight Radiator Valve	20x22
87121125	Belmont 98WHMB Straight Radiator Valve	25x28
87121215	Belmont 98WHCP Straight Radiator Valve	15x15
87121220	Belmont 98WHCP Straight Radiator Valve	20x22
87121225	Belmont 98WHCP Straight Radiator Valve	25x28
87121315	Belmont 98LSMB Straight Radiator Valve	15x15
87121320	Belmont 98LSMB Straight Radiator Valve	20x22
87121325	Belmont 98LSMB Straight Radiator Valve	25x28
87121415	Belmont 98LSCP Straight Radiator Valve	15x15
87121420	Belmont 98LSCP Straight Radiator Valve	20x22
87121425	Belmont 98LSCP Straight Radiator Valve	25x28



VALVES

Product Code	Description	Size mm
87121470	Belmont Red O Ring	
87121474	Belmont Green O Ring	
87121480	Belmont Wheelhead handle.Grey.Pld pattern	1/2
87121481	Belmont Wheelhead handle.Grey.Pld pattern	3/4
87121482	Belmont Lockshieldhandle.Grey.old pattern	1/2
87121483	Belmont Lockshieldhandle.Grey.old pattern	3/4
87121485	Belmont SICP Screw	
87121490	Belmont Wheelhandle.White	1/2 & 3/4
87121491	Belmont Wheelhandle.White	1
87121492	Belmont Lockshield top. White	1/2 & 3/4
87121493	Belmont Lockshield top.White	1



Product Code	Description	Size mm
87121515	Crane D201WH Angle Radiator Valve MB	15
87121516	Crane D203LS Angle Radiator Valve MB	15
87121520	Crane D201WH Angle Radiator Valve MB	20
87121521	Crane D203LS Angle Radiator Valve MB	20
87121525	Crane D201WH Angle Radiator Valve MB	25
87121526	Crane D203LS Angle Radiator Valve MB	25
87121615	Crane D221WH Straight Radiator Valve MB	1/2
87121616	Crane D223LS Straight Radiator Valve MB	1/2
87121620	Crane D221WH Straight Radiator Valve MB	3/4
87121621	Crane D223LS Straight Radiator Valve MB	3/4
87121625	Crane D221WH Straight Radiator Valve MB	1.0
87121626	Crane D223LS Straight Radiator Valve MB	1.0



Product Code	Description	Size mm
87121715	Crusader D880WH Angle Radiator Valve MB	15
87121720	Crusader D880WH Angle Radiator Valve MB	20
87121725	Crusader D880WH Angle Radiator Valve MB	25
87121815	Crusader D881LS Angle Radiator Valve MB	15
87121820	Crusader D881LS Angle Radiator Valve MB	20
87121825	Crusader D881LS Angle Radiator Valve MB	25
87121915	Crusader D890WH Str. Radiator Valve MB	15
87121920	Crusader D890WH Str. Radiator Valve MB	20
87121925	Crusader D890WH Str. Radiator Valve MB	25
87122015	Crusader D891LS Str. Radiator Valve MB	15
87122020	Crusader D891LS Str. Radiator Valve MB	20
87122025	Crusader D891LS Str. Radiator Valve MB	25



VALVES

Product Code	Description	Size mm
87130100	Drayton TRV4 Integral Sensor	
87130101	Drayton TRV4/TRV3 Integral Sensor	
87130110	Drayton TRV4 Remote Sensor	2 Metre
87130115	Drayton TRV4 Complete.Angle.Compression	15
87130215	Drayton TRV4 Complete.Strt.Compression	15
87130315	Drayton TRV4 Complete.Angle. Bsp	1/2
87130320	Drayton TRV4 Complete.Angle.Bsp	3/4
87130321	Drayton TRV4 Complete.Straight.BSP	3/4
87130415	Drayton TRV4 Complete.Straight.Bsp	1/2
87130515	Drayton TRV4 with remote sensor.Angle.	15
87130615	Drayton TRV4 with remote sensor.Straight.	15
87130715	Drayton TRV4 with remote sensor.Angle.Bsp.	1/2
87130815	Drayton TRV4 with remote sensor.Str.Bsp	1/2
87130900	Drayton TRV4 Single Pipe Body.Angle.Bsp	1/2
87130902	Drayton TRV4 Single Pipe Body.Str.Bsp	1/2
87130903	Drayton TRV4 Single Pipe Body.Angle.Bsp	3/4
87130904	Drayton TRV4 Single Pipe Body.Str.Bsp	3/4
87130905	Drayton TRV4 Single Pipe Body.Angle Bsp	1.0
87130906	Drayton TRV4 Single Pipe Body.Str.Bsp	1.0
87130920	Drayton Tamperproof Cover	
87130950	RT212 Thermostatic Radiator Valve.Angle	15



Product Code	Description	Size mm
87131013	Danfoss 013G0149 RAFN A Bdy	15
87131014	Danfoss 013G0084 RAFN Str.Body	1/2-15
87131015	Danfoss 13G5050 RAS-Contract TRV.Angle	15
87131016	Danfoss 13G5146 RAS-D Straight TRV	15
87131018	Danfoss 13G5150 RAS-D Reversible TRV.Angle	15
87131033	Danfoss 13G0023AA RAFN A Body	15
87131034	Danfoss 13G0025/6 RAFN 3/4 TRV Body	3/4
87131035	Danfoss 13G0027/8 RAFN 1" TRV Body	1
87131050	Danfoss 13G2022 RAD-S Remote Sensor	.2M cap.
87131051	Danfoss 13G5022 RAD-S Remote Sensor	.2M cap
87131052	Danfoss 13G5120 RAD-S Sensor.new style	
87131053	Danfoss 13G2070 RA TRV Sensor.LT lock & limit	
87131054	Danfoss 13G2310 TRV Service Head (Old RAVL)	
87131056	Danfoss 13G2010 RA TRV Sensor Head	
87131057	Danfoss 13G2020 RA-2020 Tamperproof Sensor	
87131058	Danfoss 13G5062 RA-2M Remote Adj.Sensor	
87131060	Danfoss 13G2072 RAG.2M Remote Sensor	
87131062	Danfoss 13G2312 RAV.2M Remote Sensor(old.pat)	
87131064	Danfoss 013G2210 TRV Head (Old Ravl Pat.)	
87131066	Danfoss 013G1234 SP,Str TRV with sensor	1/2



VALVES

Product Code	Description	Size mm
87133000	Herz 7260-06 TS Standard Model Sensor	
87133004	Herz 7430-08 Remote Sensor 2 metre Cap.	
87133005	Herz 7330-05 Remote Adjustable Control.2 Mtr	
87133007	Herz 7734-33 Reversible TRV & Sensor	15
87133009	Herz 7724 Angle TRV with 7260 Sensor.Bsp	15
87133015	Herz 7724-91 TRV Body.Angle.BSP	15
87133016	Herz 7224-92 Angle TRV Body. Bsp	20
87133017	Herz 7224-93 Angle TRV Body. Bsp	25
87133018	Herz 7228-91 Reverse Angle TRV Body.Bsp	15
87133019	Herz 7228-97 Reverse Angle TRV Body.Bsp	20
87133021	Herz 7223-91 Straight TRV Body.Bsp	15
87133022	Herz 7223-93 Straight TRV Body.Bsp	25
87133023	Herz 5524-20 Angle WH Radiator Valve	10
87133024	Herz 5524-10 Angle LS Radiator Valve	10
87133026	Herz 5524-21 Angle WH Radiator Valve	15
87133027	Herz 5524-11 Angle LS Radiator Valve	15
87133028	Herz 5524-22 Angle LS Radiator Valve	20
87133029	Herz 5524-12 Angle WH Radiator Valve	20
87133032	Herz 5523-21 Straight WH Radiator Valve	20
87133033	Herz 5523-11 Straight LS Radiator Valve	20
87133034	Herz 5523-22 Straight WH Radiator Valve	20
87133035	Herz 5523-12 Straight LS Radiator Valve	20
87133040	Herz 6292-01 Nut & Olive for Copper Conn.	15
87133099	Herz 3724-41 RL1 LS Angle Valve	15
87133100	Herz 3924-01 RL5 LS Angle Valve	15



Product Code	Description	Size mm
87160000	Drayton Tapstat.HW Control.2 way	15
87160002	Drayton Tapstat.HW Control.3 Way	15



Product Code	Description	Size mm
87161315	Peglertherm 402H In-line Mixing Valve	22/15
87161415	Peglertherm 402U In-line Mixing Valve	22/15



Product Code	Description
87160100	Spirax DHF2 Hot Water Temperature Control

(When stocks are exhausted this item will be withdrawn)



CONVERSION TABLES

Temperature

Celcius x 1.8 + 32 = Fahrenheit

Fahrenheit - 32 + 1.8 = Celcius

Length

MM x 0.0393 = Inches

Metre x 3.28 = Feet

Metre x 1.0936 = Yard

Inch x 25.4 = MM

Feet x 0.3048 = Meter

Yard x 0.9144 = Metre

Flow Rate

Litres/Sec x 2.12 = CFM

M3/Sec x 2199 = CFM

CFM x 0.472 = Litres/Sec

CFM x 0.00047 = M3/Sec

Area

Sq mm x 0.00155 = Sq Inch

Sq Metre x 10.76 = Sq Ft

Sq Yard x 0.8361 = Sq Metre

Volume

Cubic Metre x 35.31 = Cubic Feet

Litre x 0.0353 = Cubic Feet

Litre x 1.7598 = Pint

Litre x 0.22 = Imp Gallon

Cubic Feet x 0.0283 = Cubic Metre

Cubic Feet x 28.318 = Litre

Pint x 0.5683 = Litre

Imp Gallon x 4.546 = Litre

Velocity

Metres/Sec x 196.85 = Feet/Min

Feet/Min x 0.0051 = Metres/Sec

Speed

Km/Hr x 0.625 = Mph

Mph x 1.6 = Km/Hr

Pressures

Pascals x 0.004 = Inches WG

Millimetres x 0.039 = Inches WG

Kilopascals x 4.016 = Inches WG

Kilopascals x 0.145 = Psi

Kg/cm sq x 0.981 = Bar

Atmosphere x 33.93 = Ft Water

Atmosphere x 14.7 = Lbs/Sq Inch

Atmosphere x 29.92 = Inch Mercury

Lbs/Sq Inch x 2.294 = Ft Water

Lbs/Sq Ft x 0.016 = Ft Water

Inch Mercury x 1.135 = Ft Water

Inches WG x 249 = Pascals

Inches WG x 0.249 = Kilopascals

Psi x 6.89 = Kilopascals

Bar x 1.02 = Kg/Cm Sq

Lbs/Sq Inch x 0.068 = Atmosphere

Ft Water x 0.029 = Atmosphere

Ft Water x 0.436 = Lbs/Sq Inch

Ft Water 62.35 = Lbs/Sq Ft

Ft Water x 0.881 = Inch Mercury

Weight

Kg x 2.205 = Pounds

g x 0.0353 = Ounce

Heat

Kw x 3411.8 = Btu/Hr

Kw x 0.284 = Ton Ref

Ton Ref x 12.000 = Btu/Hr

Kcal/Hr x 3.958 = Btu/Hr

Btu/Hr x 0.0002931 = Kw

Ton Ref x 3.52 = Kw

Btu/Hr x 0.000083 = Ton Ref

Btu/Hr x 0.252 = Kcal/Hr

Power

Kw x 1.33 = Hp

Hp x 0.75 = Kw

Diameter

Circ 3.142 = Overall Diameter

Please note the above conversions are a guide only and are taken from various reputable sources and C. A. Baldwins do not take responsibility for any errors or omissions.



C.A. Baldwin & Co Ltd

Valan House, 146-154 Wells Way, Camberwell, London SE5 7SY

T: 020 7703 2138 F: 020 7701 8436

email: info@cabaldwin.com www.cabaldwin.com

Quality is our strength