

# IFAB<sup>®</sup>

THE  
INTERNATIONAL  
FOOTBALL  
ASSOCIATION  
BOARD



FIFA



THEIFAB.COM  
SINCE 1886

# Laws of the Game

# 2016/17



**The International Football Association Board**

Münstergasse 9, 8001 Zurich, Switzerland  
T: +41 (0)44 245 1886, F: +41 (0)44 245 1887  
[www.theifab.com](http://www.theifab.com)

**This booklet may not be reproduced or translated in whole or in part in any manner without the permission of The International Football Association Board.**

Effective from 1st June 2016

# **Laws of the Game**

2016/17

# Contents

## **8 Introduction**

- 8 History of The IFAB
- 10 Structure and working of The IFAB
- 12 Background to the current Law revision

## **14 Notes on the Laws of the Game**

### **16 Laws of the Game 2016/17**

- 18 01 The Field of Play
- 28 02 The Ball
- 32 03 The Players
- 40 04 The Players' Equipment
- 44 05 The Referee
- 52 06 The Other Match Officials
- 60 07 The Duration of the Match
- 64 08 The Start and Restart of Play
- 68 09 The Ball In and Out of Play
- 70 10 Determining the Outcome of a Match
- 76 11 Offside
- 80 12 Fouls and Misconduct
- 90 13 Free Kicks
- 94 14 The Penalty Kick
- 98 15 The Throw-in
- 102 16 The Goal Kick
- 106 17 The Corner Kick

**110 Law changes 2016/17**

- 111 Outline summary of Law changes
- 116 Details of all Law changes

**158 Glossary**

- 159 Football bodies
- 160 Football terms
- 169 Referee terms

**170 Practical Guidelines for Match Officials**

- 171 Introduction
- 172 Positioning, Movement and Teamwork
- 186 Body language, Communication and Whistle
- 192 Other advice
  - Advantage
  - Allowance for time lost
  - Holding an opponent
  - Offside
  - Treatment /assessment after a caution / sending-off offence

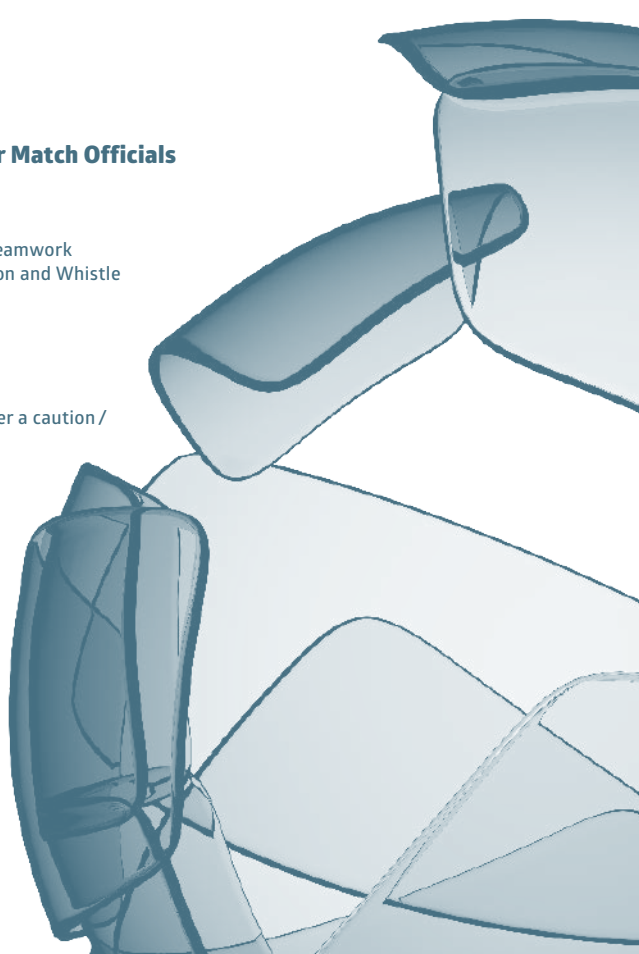

# History of The IFAB

The IFAB is the universal decision-making body for the Laws of the Game of association football. Its objectives are to safeguard, compile and amend the Laws as they apply within the scope of world football as organised by FIFA, which includes ensuring that the Laws are uniformly applied worldwide and monitored accordingly, and that organised football is practised consistently.

The IFAB was formed when two representatives from each of the football associations of England, Scotland, Wales and Northern Ireland met on 2 June 1886. The brainchild of the English FA, the new body was created to draw up a uniform set of Laws at a time when each country applied different rules. Once established as the guardians of the Laws of the Game, The IFAB's role was and remains to preserve, monitor, study and where appropriate improve the Laws.

The game of football spread rapidly and in 1904 seven nations met in Paris to form FIFA, Fédération Internationale de Football Associations, which joined The IFAB in 1913.

The IFAB has overseen many Law changes since the creation of the first set of official Laws in 1863. For example, offside is probably the most amended Law e.g. originally a player in front of the ball was offside. The goal area first appeared in 1869, followed by corner kicks in 1872, and the first penalty kick was awarded in 1891 - until 1902 it could be taken from any point along a line 12 yards from the goal. The 1912 decision to prohibit goalkeepers from handling the ball outside the penalty area led to an increase in the number of goals and from 1920 players could not be offside from throw-ins.

Steadily, The IFAB changed the game and the mind-set of those who played and watched it. The change prohibiting goalkeepers from handling deliberate 'back-passes', introduced after the 1990 FIFA World Cup Italy™, and the 1998 ruling that red cards be awarded for serious tackles from behind are good examples of that shift in attitude.

In October 2010 The IFAB reconsidered the introduction of goal line technology (GLT) and agreed to a two-year period of comprehensive testing. In July 2012 The IFAB made the historic decisions to approve GLT and the use of Additional Assistant Referees.

March 2016 was also an historic AGM when a testing phase for Video Assistant Referees was approved along with the most comprehensive revision of the Laws of the Game in The IFAB's history.

# Structure and working of The IFAB

In 2012 The IFAB started a reform process which concluded on 13 January 2014 when The IFAB became an autonomous association under Swiss Law and approved the statutes that define the purpose, structure and responsibilities of The IFAB and its bodies. To ensure the work of The IFAB is transparent, democratic and modern, an executive secretariat, led by the Secretary of The IFAB, was introduced.

Whilst The IFAB composition remained unchanged, the reform saw the formation of the Football Advisory Panel and Technical Advisory Panel consisting of experts from across the world of football. These panels aim to improve the consultation process and foster a more proactive approach to the development of the Laws.

## **Annual General Meeting (AGM)**

The AGM takes place in February or March in England, Scotland, Wales and Northern Ireland in strict rotation, as well as a location decided by FIFA in FIFA World Cup™ years. AGM decisions on the Laws of the Game are binding on confederations and national football associations as from 1 June. However, confederations and national football associations whose current season or competition has not ended by 1 June may delay the change(s) until the beginning of their next season or end of the competition; those which start before 1 June may apply them once The IFAB has issued the official circular announcing any changes.

***No alteration to the Laws of the Game can be made by any confederation or national football association (including competitions) unless it has been passed by The IFAB.***



**Annual Business Meeting (ABM)**

The ABM is the preparatory meeting for the AGM and is held in November. The ABM can consider items submitted by any confederation or national football association and may approved experiments and trials. However, changes to the Laws must be approved at the AGM.

**Technical Subcommittee (TSC)**

The IFAB TSC consists of experts from the four British FAs, FIFA and The IFAB and is responsible for considering potential Law changes and overseeing trials approved by the ABM and AGM.

**Advisory Panels**

The Football Advisory Panel (FAP) and Technical Advisory Panel (TAP) consist of experts from across the world of football, who support The IFAB's work on the Laws of the Game. They include former players, coaches and referees from different confederations and football bodies . FAP provides perspectives from players and coaches while TAP assesses technical details and possible impacts on refereeing of any Law changes.

# Background to the current Law revision

The authority for the current revision of the Laws of the Game is found in the minutes of the 127th, 128th and 129th AGMs. The TSC started work in autumn 2014 and the minutes of the 129th AGM on 28th February 2015 record that:

**“...the aim of the revision is to make the Laws of the Game more accessible and more easily understood by everyone in football and increase consistency of understanding, interpretation and application.”**

The revision has focussed on making the Laws appropriate for the modern game at all levels. The major areas of change are:

- **More simple structure** – Law and Law Interpretation have been combined so all the information for each Law is in the same place
- **Updated titles** – some Laws have been renamed to reflect their content and allow inclusion of text not previously assigned to a Law e.g. Law 6: ‘The Assistant Referees’ has become ‘The Other Match Officials’ to allow inclusion of Fourth Officials, Additional Assistant Referees etc.
- **English and phraseology** – unnecessary words have been removed and a more consistent use of words and phrases makes the Laws more readable, helps translation and reduces confusion and misunderstandings. Contradictions and unnecessary repetitions have been removed. The Laws are now ‘gender neutral’, reflecting the importance of women in football today
- **Updated content** – some changes bring the Laws up to date with modern football e.g. the increased number of substitutes

Two important ‘new’ sections have been introduced:

- **Law changes explained** – this section gives the ‘old’ text, the ‘new’ text and an explanation for each Law change
- **Glossary** – this is a list of definitions of important words/phrases which are sometimes misunderstood and/or difficult to translate

The IFAB believes that this revision makes the Laws of the Game more accessible and more easily understood by everyone involved or interested in football. This should lead to increased consistency of understanding, interpretation and application so there are fewer disputes and controversies resulting from conflicting interpretations.

The IFAB acknowledges with grateful thanks the work on this revision by the Technical Subcommittee:

- David Elleray (Project lead, The IFAB)
- Neale Barry (The FA)
- Jean-Paul Brigger (FIFA)
- Massimo Busacca (FIFA)
- William Campbell (Irish FA)
- Ray Ellingham (FA of Wales)
- John Fleming (Scottish FA)
- Fernando Tresaco Gracia (FIFA)

# Notes on the Laws of the Game

## **Modifications**

Subject to the agreement of the national football association concerned and provided the principles of these Laws are maintained, the Laws may be modified in their application for matches for players of under 16 years of age, for women footballers, for veteran footballers (over 35 years of age) and for players with disabilities, in any or all of the following ways:

- size of the field of play
- size, weight and material of the ball
- width between the goalposts and height of the crossbar from the ground
- duration of the periods of play
- substitutions

Further modifications are only allowed with the consent of The IFAB.

## **Official languages**

The IFAB publishes the Laws of the Game in English, French, German and Spanish. If there is any divergence in the wording, the English text is authoritative.

## **Key**

The main Law changes are underlined and highlighted in the margin.





# **Laws of the Game**

2016/17

**Law**

01



# The Field of Play

## 1. Field surface

The field of play must be a wholly natural or, if competition rules permit, a wholly artificial playing surface except where competition rules permit an integrated combination of artificial and natural materials (hybrid system).

The colour of artificial surfaces must be green.

Where artificial surfaces are used in competition matches between representative teams of national football associations affiliated to FIFA or international club competition matches, the surface must meet the requirements of the FIFA Quality Programme for Football Turf or the International Match Standard, unless special dispensation is given by The IFAB.

## 2. Field markings

The field of play must be rectangular and marked with continuous lines which must not be dangerous. These lines belong to the areas of which they are boundaries.

Only the lines indicated in Law 1 are to be marked on the field of play.

The two longer boundary lines are touchlines. The two shorter lines are goal lines.

The field of play is divided into two halves by a halfway line, which joins the midpoints of the two touchlines.

The centre mark is at the midpoint of the halfway line. A circle with a radius of 9.15 m (10yds) is marked around it.

Marks may be made off the field of play 9.15 m (10 yds) from the corner arc at right angles to the goal lines and the touchlines.

All lines must be of the same width, which must not be more than 12 cm (5 ins). The goal lines must be of the same width as the goalposts and the crossbar.

Where artificial surfaces are used, other lines are permitted provided they are a different colour and clearly distinguishable from the football lines.

A player who makes unauthorised marks on the field of play must be cautioned for unsporting behaviour. If the referee notices this being done during the match, the player is cautioned when the ball next goes out of play.

### 3. Dimensions

The touchline must be longer than the goal line.

- |                         |                        |
|-------------------------|------------------------|
| • Length (touchline):   | • Length (goal line):  |
| minimum 90 m (100 yds)  | minimum 45 m (50 yds)  |
| maximum 120 m (130 yds) | maximum 90 m (100 yds) |

### 4. Dimensions for international matches

- |                         |                       |
|-------------------------|-----------------------|
| • Length (touchline):   | • Length (goal line): |
| minimum 100 m (100 yds) | minimum 64 m (70 yds) |
| maximum 110 m (120 yds) | maximum 75 m (80 yds) |

Competitions may determine the length of the goal line and touchline within the above dimensions.



## 5. The goal area

Two lines are drawn at right angles to the goal line, 5.5 m (6 yds) from the inside of each goalpost. These lines extend into the field of play for 5.5 m (6 yds) and are joined by a line drawn parallel with the goal line. The area bounded by these lines and the goal line is the goal area.

## 6. The penalty area

Two lines are drawn at right angles to the goal line, 16.5 m (18 yds) from the inside of each goalpost. These lines extend into the field of play for 16.5 m (18 yds) and are joined by a line drawn parallel with the goal line. The area bounded by these lines and the goal line is the penalty area.

Within each penalty area, a penalty mark is made 11 m (12 yds) from the midpoint between the goalposts.

An arc of a circle with a radius of 9.15 m (10 yds) from the centre of each penalty mark is drawn outside the penalty area.

## 7. The corner area

The corner area is defined by a quarter circle with a radius of 1 m (1 yd) from each corner flagpost drawn inside the field of play.



## 8. Flagposts

A flagpost, at least 1.5 m (5 ft) high, with a non-pointed top and a flag must be placed at each corner.

Flagposts may be placed at each end of the halfway line, at least 1 m (1 yd) outside the touchline.

## 9. The technical area

The technical area relates to matches played in stadiums with a designated seated area for team officials and substitutes as outlined below:

- the technical area should only extend 1 m (1 yd) on either side of the designated seated area and up to a distance of 1 m (1 yd) from the touchline
- markings should be used to define the area
- the number of persons permitted to occupy the technical area is defined by the competition rules
- the occupants of the technical area:
  - > are identified before the start of the match in accordance with the competition rules
  - > must behave in a responsible manner
  - > must remain within its confines except in special circumstances, e.g. a physiotherapist/doctor entering the field of play, with the referee's permission, to assess an injured player
- only one person at a time is authorised to convey tactical instructions from the technical area

## **10. Goals**

A goal must be placed on the centre of each goal line.

A goal consists of two vertical posts equidistant from the corner flagposts and joined at the top by a horizontal crossbar. The goalposts and crossbar must be made of approved material. They must be square, rectangular, round or elliptical in shape and must not be dangerous.

The distance between the inside of the posts is 7.32 m (8yds) and the distance from the lower edge of the crossbar to the ground is 2.44 m (8ft).

The position of the goalposts in relation to the goal line must be in accordance with the graphics.

The goalposts and the crossbar must be white and have the same width and depth, which must not exceed 12 cm (5 ins).

If the crossbar becomes displaced or broken, play is stopped until it has been repaired or replaced in position. If it can not be repaired the match must be abandoned. A rope or any flexible or dangerous material may not replace the crossbar. Play is restarted with a dropped ball.

Nets may be attached to the goals and the ground behind the goal; they must be properly supported and must not interfere with the goalkeeper.

### **Safety**

Goals (including portable goals) must be firmly secured to the ground.

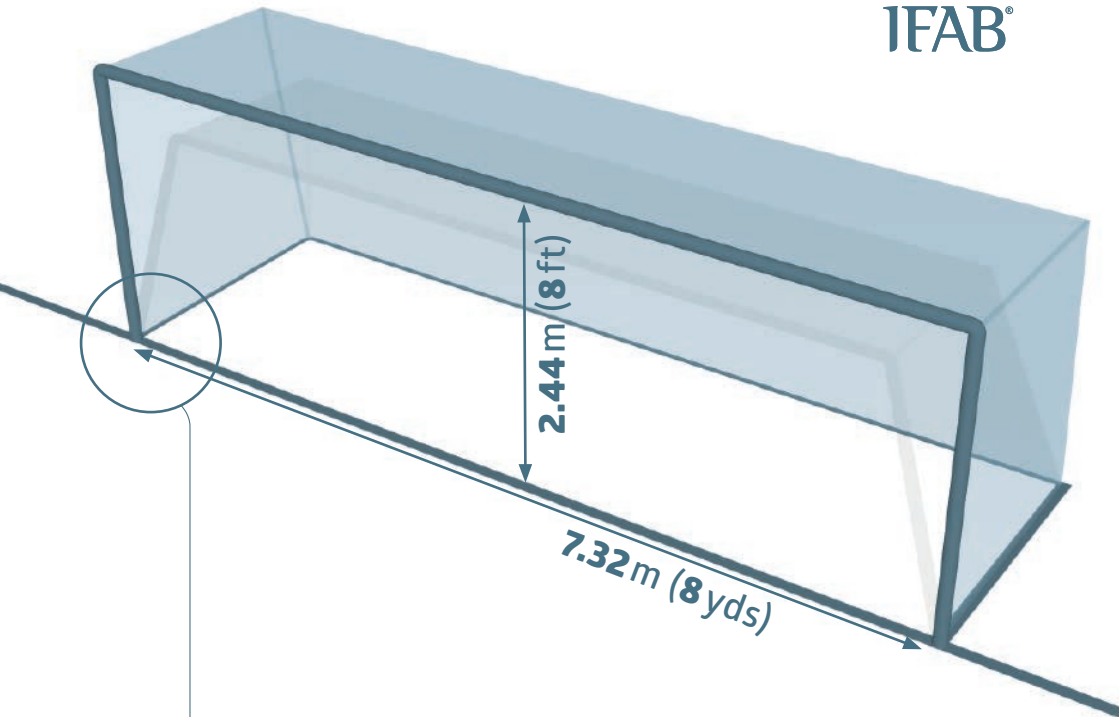

The position of the goalposts in relation to the goal line must be in accordance with the graphics below.

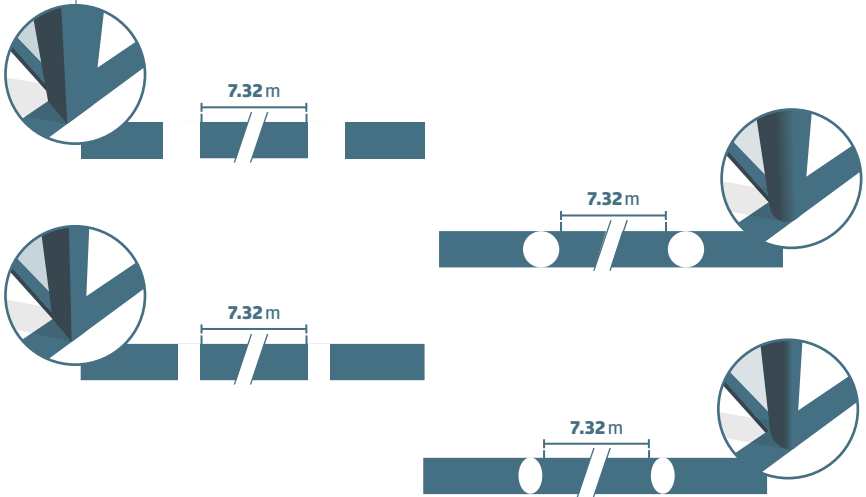

## **11. Goal Line Technology (GLT)**

GLT systems may be used to verify whether a goal has been scored to support the referee's decision.

Where GLT is used, modifications to the goal frame may be permitted in accordance with the specifications stipulated in the FIFA Quality Programme for GLT and with the Laws of the Game. The use of GLT must be stipulated in the competition rules.

### **Principles of GLT**

GLT applies solely to the goal line and is only used to determine whether a goal has been scored.

The indication of whether a goal has been scored must be immediate and automatically confirmed within one second by the GLT system only to the match officials (via the referee's watch, by vibration and visual signal).

### **Requirements and specifications of GLT**

If GLT is used in competition matches, the competition organisers must ensure that the system is certified according to one of the following standards:

- FIFA Quality PRO
- FIFA Quality
- IMS - INTERNATIONAL MATCH STANDARD

An independent testing institute must verify the accuracy and functionality of the different technology providers' systems in accordance with the Testing Manual. If the technology does not function in accordance with the Testing Manual, the referee must not use the GLT system and must report this to the appropriate authority.

Where GLT is used, the referee must test the technology's functionality before the match as set out in the FIFA Quality Programme for GLT Testing Manual.



## 12. Commercial advertising

No form of commercial advertising, whether real or virtual, is permitted on the field of play, on the ground within the area enclosed by the goal nets or the technical area, or on the ground within 1 m (1 yd) of the boundary lines from the time the teams enter the field of play until they have left it at half-time and from the time the teams re-enter the field of play until the end of the match. Advertising is not permitted on the goals, nets, flagposts or their flags and no extraneous equipment (cameras, microphones, etc.) may be attached to these items.

In addition, upright advertising must be at least:

- 1 m (1 yd) from the touchlines of the field of play
- the same distance from the goal line as the depth of the goal net
- 1 m (1 yd) from the goal net

## 13. Logos and emblems

The reproduction, whether real or virtual, of representative logos or emblems of FIFA, confederations, national football associations, competitions, clubs or other bodies is forbidden on the field of play, the goal nets and the areas they enclose, the goals, and the flagposts during playing time. They are permitted on the flags on the flagposts.

**Law**

02

# The Ball

## 1. Qualities and measurements

All balls must be:

- spherical
- made of suitable material
- of a circumference of between 70 cm (28 ins) and 68 cm (27 ins)
- between 450 g (16 oz) and 410 g (14 oz) in weight at the start of the match
- of a pressure equal to 0.6 – 1.1 atmosphere (600 – 1,100 g/cm<sup>2</sup>) at sea level (8.5 lbs/sq in – 15.6 lbs/sq in)

All balls used in matches played in an official competition organised under the auspices of FIFA or confederations must bear one of the following:



- FIFA Quality PRO



- FIFA Quality



- IMS - INTERNATIONAL MATCH STANDARD

Balls carrying previous quality marks such as “FIFA Approved”, “FIFA Inspected” or “International Matchball Standard” may be used in aforementioned competitions until 31 July 2017.

Each mark indicates that it has been officially tested and meets the specific technical requirements for that mark which are additional to the minimum specifications stipulated in Law 2 and must be approved by The IFAB. The institutes conducting the tests are subject to the approval of FIFA.

Where goal line technology (GLT) is used, balls with integrated technology must carry one of the above listed quality marks.

National football association competitions may require the use of balls bearing one of these marks.

In matches played in an official competition organised under the auspices of FIFA, confederations or national football associations, no form of commercial advertising is permitted on the ball, except for the logo/emblem of the competition, the competition organiser and the authorised manufacturer's trademark. The competition regulations may restrict the size and number of such markings.

## **2. Replacement of a defective ball**

If the ball becomes defective:

- play is stopped and
- restarted by dropping the replacement ball where the original ball became defective

If the ball becomes defective at a kick-off, goal kick, corner kick, free kick, penalty kick or throw-in the restart is re-taken.

If the ball becomes defective during a penalty kick or kicks from the penalty mark as it moves forward and before it touches a player, crossbar or goalposts the penalty kick is retaken.

The ball may not be changed during the match without the referee's permission.

## **3. Additional balls**

Additional balls which meet the requirements of Law 2 may be placed around the field of play and their use is under the referee's control.

TEFAB®



**Law**

03

# The Players

## 1. Number of players

A match is played by two teams, each with a maximum of eleven players; one must be the goalkeeper. A match may not start or continue if either team has fewer than seven players.

If a team has fewer than seven players because one or more players has deliberately left the field of play, the referee is not obliged to stop play and the advantage may be played, but the match must not resume after the ball has gone out of play if a team does not have the minimum number of seven players.

If the competition rules state that all players and substitutes must be named before kick-off and a team starts a match with fewer than eleven players, only the players and substitutes named in the starting line-up may take part in the match upon their arrival.

## 2. Number of substitutions

### Official competitions

A maximum of three substitutes may be used in any match played in an official competition organised under the auspices of FIFA, confederations or national football associations.

The competition rules must state how many substitutes may be named, from three to a maximum of twelve.

### **Other matches**

In national “A” team matches, a maximum of six substitutes may be used.

In all other matches, a greater number of substitutes may be used provided that:

- the teams reach agreement on a maximum number
- the referee is informed before the match

If the referee is not informed, or if no agreement is reached before the match, each team is allowed a maximum of six substitutes.

### **Return substitutions**

The use of return substitutions is only permitted in the lowest levels (grassroots/recreational) of football, subject to the agreement of the national football association.

## **3. Substitution procedure**

The names of the substitutes must be given to the referee before the start of the match. Any substitute not named by this time may not take part in the match.

To replace a player with a substitute, the following must be observed:

- the referee must be informed before any substitution is made
- the player being substituted receives the referee’s permission to leave the field of play, unless already off the field
- the player being replaced is not obliged to leave at the halfway line and takes no further part in the match, except where return substitutions are permitted
- if a player who is to be replaced refuses to leave, play continues

The substitute only enters:

- during a stoppage in play
- at the halfway line
- after the player being replaced has left
- after receiving a signal from the referee



The substitution is completed when a substitute enters the field of play; from that moment, the substitute becomes a player and the replaced player becomes a substituted player.

Substitutes can take any restart provided they first enter the field of play.

If a substitution is made during the half-time interval or before extra time, the procedure must be completed before the match restarts.

All substituted players and substitutes are subject to the referee's authority whether they play or not.

#### **4. Changing the goalkeeper**

Any of the players may change places with the goalkeeper if:

- the referee is informed before the change is made
- the change is made during a stoppage in play

#### **5. Infringements and sanctions**

If a named substitute starts a match instead of a named player and the referee is not informed of this change:

- the referee allows the named substitute to continue playing
- no disciplinary sanction is taken against the named substitute
- the named player can become a named substitute
- the number of substitutions is not reduced
- the referee reports the incident to the appropriate authorities

If a player changes places with the goalkeeper without the referee's permission, the referee:

- allows play to continue
- cautions both players when the ball is next out of play

For any other infringements of this Law:

- the players are cautioned
- play is restarted with an indirect free kick, from the position of the ball when play was stopped

## 6. Players and substitutes sent off

A player who is sent off:

- before submission of the team list can not be named on the team list in any capacity
- after being named on the team list and before kick-off may be replaced by a named substitute, who can not be replaced; the number of substitutions the team can make is not reduced
- after the kick-off can not be replaced

A named substitute who is sent off before or after the kick-off may not be replaced.

## 7. Extra persons on the field of play

The coach and other officials named on the team list (with the exception of players or substitutes) are team officials. Anyone not named on the team list as a player, substitute or team official is an outside agent.

If a team official, substitute, substituted or sent off player or outside agent enters the field of play the referee must:

- only stop play if there is interference with play
- have the person removed when play stops
- take appropriate disciplinary action

If play is stopped and the interference was by:

- a team official, substitute, substituted or sent off player, play restarts with a direct free kick or penalty kick
- an outside agent, play restarts with a dropped ball

If a ball is going into the goal and the interference does not prevent a defending player playing the ball, the goal is awarded if the ball enters the goal (even if contact was made with the ball) unless the ball enters the opponents' goal.

## 8. Player outside the field of play

If, after leaving the field of play with the referee's permission, a player re-enters without the referee's permission, the referee must:

- stop play (not immediately if the player does not interfere with play or if the advantage can be applied)
- caution the player for entering the field of play without permission
- order the player to leave the field of play

If the referee stops play, it must be restarted:

- with an indirect free kick from the position of the ball when play was stopped or
- in accordance with Law 12 if the player infringes this Law

A player who crosses a boundary line as part of a playing movement, does not commit an infringement.

## 9. Goal scored with an extra person on the field of play

If, after a goal is scored, the referee realises, before play restarts, an extra person was on the field of play when the goal was scored:

- the referee must disallow the goal if the extra person was:
  - > a player, substitute, substituted player, sent off player or team official of the team that scored the goal
  - > an outside agent who interfered with play unless a goal results as outlined above in 'extra persons on the field of play'

Play is restarted with a goal kick, corner kick or dropped ball.

- the referee must allow the goal if the extra person was:
  - > a player, substitute, substituted player, sent off player or team official of the team that conceded the goal
  - > an outside agent who did not interfere with play

In all cases, the referee must have the extra person removed from the field of play.

If, after a goal is scored and play has restarted, the referee realises an extra person was on the field of play when the goal was scored, the goal can not be disallowed. If the extra person is still on the field the referee must:

- stop play
- have the extra person removed
- restart with a dropped ball or free kick as appropriate

The referee must report the incident to the appropriate authorities.

## **10. Team captain**

The team captain has no special status or privileges but has a degree of responsibility for the behaviour of the team.

IFAB®



**Law**

04

# The Players' Equipment

## 1. Safety

A player must not use equipment or wear anything that is dangerous.

All items of jewellery (necklaces, rings, bracelets, earrings, leather bands, rubber bands, etc.) are forbidden and must be removed. Using tape to cover jewellery is not permitted.

The players must be inspected before the start of the match and substitutes before they enter the field of play. If a player is wearing or using unauthorised/dangerous equipment or jewellery the referee must order the player to:

- remove the item
- leave the field of play at the next stoppage if the player is unable or unwilling to comply

A player who refuses to comply or wears the item again must be cautioned.

## 2. Compulsory equipment

The compulsory equipment of a player comprises the following separate items:

- a shirt with sleeves
- shorts
- socks – tape or any material applied or worn externally must be the same colour as that part of the sock it is applied to or covers
- shinguards – these must be made of a suitable material to provide reasonable protection and covered by the socks
- footwear

Goalkeepers may wear tracksuit bottoms.

A player whose footwear or shinguard is lost accidentally must replace it as soon as possible and no later than when the ball next goes out of play; if before doing so the player plays the ball and/or scores a goal, the goal is awarded.

### 3. Colours

- The two teams must wear colours that distinguish them from each other and the match officials
- Each goalkeeper must wear colours that are distinguishable from the other players and the match officials
- If the two goalkeepers' shirts are the same colour and neither has another shirt, the referee allows the match to be played

Undershirts must be the same colour as the main colour of the shirt sleeve; undershorts/tights must be the same colour as the main colour of the shorts or the lowest part of the shorts – players of the same team must wear the same colour.

### 4. Other equipment

Non-dangerous protective equipment, for example headgear, facemasks and knee and arm protectors made of soft, lightweight padded material is permitted as are goalkeepers' caps and sports spectacles.

Where head covers are worn, they must:

- be black or the same main colour as the shirt (provided that the players of the same team wear the same colour)
- be in keeping with the professional appearance of the player's equipment
- not be attached to the shirt
- not be dangerous to the player wearing it or any other player (e.g. opening/closing mechanism around neck)
- not have any part(s) extending out from the surface (protruding elements)

The use of any form of electronic communication between players (including substitutes/substituted and sent off players) and/or technical staff is not permitted.



Where electronic performance and tracking systems (EPTS) are used (subject to the agreement of the national football association/competition organiser):

- they must not be dangerous
- information and data transmitted from the devices/systems is not permitted to be received or used in the technical area during the match

Equipment must not have any political, religious or personal slogans, statements or images. Players must not reveal undergarments that show political, religious, personal slogans, statements or images, or advertising other than the manufacturer's logo. For any infringement the player and/or the team will be sanctioned by the competition organiser, national football association or to be justified by FIFA.

## 5. Infringements and sanctions

For any infringement of this Law play need not be stopped and the player:

- is instructed by the referee to leave the field of play to correct the equipment
- leaves when play stops, unless the equipment has already been corrected

A player who leaves the field of play to correct or change his equipment must:

- have the equipment checked by a match official before being allowed to re-enter
- only re-enter with the referee's permission (which may be given during play)

A player who enters without permission must be cautioned and if play is stopped to issue the caution, an indirect free kick is awarded from the position of the ball when play was stopped.

**Law**

05

# The Referee

## 1. The authority of the referee

Each match is controlled by a referee who has full authority to enforce the Laws of the Game in connection with the match.

## 2. Decisions of the referee

Decisions will be made to the best of the referee's ability according to the Laws of the Game and the 'spirit of the game' and will be based on the opinion of the referee who has the discretion to take appropriate action within the framework of the Laws of the Game.

The decisions of the referee regarding facts connected with play, including whether or not a goal is scored and the result of the match, are final.

The referee may not change a decision on realising that it is incorrect or on the advice of another match official if play has restarted or the referee has signalled the end of the first or second half (including extra time) and left the field of play or terminated the match.

If a referee is incapacitated, play may continue under the supervision of the other match officials until the ball is next out of play.

## 3. Powers and duties

The referee:

- enforces the Laws of the Game
- controls the match in cooperation with the other match officials
- acts as timekeeper, keeps a record of the match and provides the appropriate authorities with a match report, including information on disciplinary action and any other incidents that occurred before, during or after the match
- supervises and/or indicates the restart of play

## Advantage

- allows play to continue when an infringement or offence occurs and the non-offending team will benefit from the advantage and penalises the infringement or offence if the anticipated advantage does not ensue at that time or within a few seconds

## Disciplinary action

- punishes the more serious offence, in terms of sanction, restart, physical severity and tactical impact, when more than one offence occurs at the same time
- takes disciplinary action against players guilty of cautionable and sending-off offences
- has the authority to take disciplinary action from entering the field of play for the pre-match inspection until leaving the field of play after the match ends (including kicks from the penalty mark). If, before entering the field of play at the start of the match, a player commits a sending-off offence, the referee has the authority to prevent the player taking part in the match (see Law 3.6); the referee will report any other misconduct
- has the power to show yellow or red cards from entering the field of play at the start of the match until after the match has ended, including during the half-time interval, extra time and kicks from the penalty mark
- takes action against team officials who fail to act in a responsible manner and may expel them from the field of play and its immediate surrounds
- acts on the advice of other match officials regarding incidents that the referee has not seen

## Injuries

- allows play to continue until the ball is out of play if a player is only slightly injured
- stops play if a player is seriously injured and ensures that the player is removed from the field of play. An injured player may not be treated on the field of play and may only re-enter after play has restarted; if the ball is in play, re-entry must be from the touchline but if the ball is out of play, it may be from any boundary line. Exceptions to the requirement to leave the field of play are only when:

- > a goalkeeper is injured
  - > a goalkeeper and an outfield player have collided and need attention
  - > players from the same team have collided and need attention
  - > a severe injury has occurred
  - > a player is injured as the result of a physical offence for which the opponent is cautioned or sent off (e.g. reckless or serious foul challenge), if the assessment/treatment is completed quickly
- ensures that any player bleeding leaves the field of play. The player may only re-enter on receiving a signal from the referee, who must be satisfied that the bleeding has stopped and there is no blood on the equipment
  - if the referee has authorised the doctors and /or stretcher bearers to enter the field of play, the player must leave on a stretcher or on foot. A player who does not comply, must be cautioned for unsporting behaviour
  - if the referee has decided to caution or send off a player who is injured and has to leave the field of play for treatment, the card must be shown before the player leaves
  - if play has not been stopped for another reason, or if an injury suffered by a player is not the result of an infringement of the Laws of the Game, play is restarted with a dropped ball

### Outside interference

- stops, suspends or abandons the match for any infringements of the Laws or because of outside interference e.g. if:
  - > the floodlights are inadequate
  - > an object thrown by a spectator hits a match official, a player or team official, the referee may allow the match to continue, or stop, suspend or abandon it depending on the severity of the incident
  - > a spectator blows a whistle which interferes with play - play is stopped and restarted with a dropped ball
  - > an extra ball, other object or animal enters the field of play during the match, the referee must:

- stop play (and restart with a dropped ball) only if it interferes with play unless the ball is going into the goal and the interference does not prevent a defending player playing the ball, the goal is awarded if the ball enters the goal (even if contact was made with the ball) unless the ball enters the opponents' goal
  - allow play to continue if it does not interfere with play and have it removed at the earliest possible opportunity
- allows no unauthorised persons to enter the field of play

#### 4. Referee's equipment

##### Compulsory equipment:

- Whistle(s)
- Watch(es)
- Red and yellow cards
- Notebook (or other means of keeping a record of the match)

##### Other equipment

Referees may be permitted to use:

- Equipment for communicating with other match officials – buzzer/beep flags, headsets etc.
- EPTS or other fitness monitoring equipment

Referees and other match officials are prohibited from wearing jewellery or any other electronic equipment.

#### 5. Referee signals

Refer to graphics for approved referee signals.

In addition to the current 'two armed' signal for an advantage, a similar 'one arm' signal is now permitted as it is not always easy for referees to run with both arms extended.

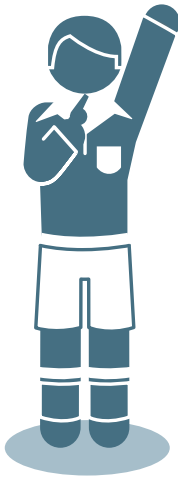

**Indirect** free kick



**Direct** free kick



**Advantage (1)**

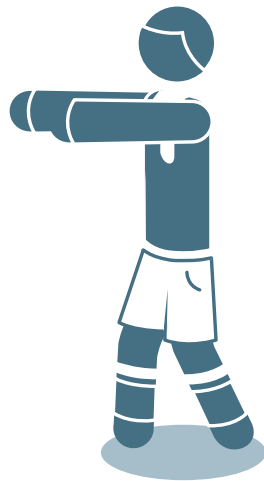

**Advantage (2)**



**Penalty** kick



**Red** and **Yellow** card



**Corner** kick



**Goal** kick



## 6. Liability of Match Officials

A referee or other match official is not held liable for:

- any kind of injury suffered by a player, official or spectator
- any damage to property of any kind
- any other loss suffered by any individual, club, company, association or other body, which is due or which may be due to any decision taken under the terms of the Laws of the Game or in respect of the normal procedures required to hold, play and control a match.

Such decisions may include a decision:

- that the condition of the field of play or its surrounds or that the weather conditions are such as to allow or not to allow a match to take place
- to abandon a match for whatever reason
- as to the suitability of the field equipment and ball used during a match
- to stop or not to stop a match due to spectator interference or any problem in spectator areas
- to stop or not to stop play to allow an injured player to be removed from the field of play for treatment
- to require an injured player to be removed from the field of play for treatment
- to allow or not to allow a player to wear certain clothing or equipment
- where the referee has the authority, to allow or not to allow any persons (including team or stadium officials, security officers, photographers or other media representatives) to be present in the vicinity of the field of play
- any other decision taken in accordance with the Laws of the Game or in conformity with their duties under the terms of FIFA, confederation, national football association or competition rules or regulations under which the match is played

**Law**

06

# The Other Match Officials

Other match officials (two assistant referees, fourth official, two additional assistant referees and reserve assistant referee) may be appointed to matches. They will assist the referee in controlling the match in accordance with the Laws of the Game but the final decision will always be taken by the referee.

The match officials operate under the direction of the referee. In the event of undue interference or improper conduct, the referee will relieve them of their duties and make a report to the appropriate authorities.

With the exception of the reserve assistant referee, they assist the referee with offences and infringements when they have a clearer view than the referee and they must submit a report to the appropriate authorities on any serious misconduct or other incident that occurred out of the view of the referee and the other match officials. They must advise the referee and other match officials of any report being made.

The match officials assist the referee with inspecting the field of play, the balls and players' equipment (including if problems have been resolved) and maintaining records of time, goals, misconduct etc.

Competition rules must state clearly who replaces a match official who is unable to start or continue and any associated changes. In particular, it must be clear whether, if the referee is unable to continue, the fourth official or the senior assistant referee or senior additional assistant referee takes over.

## 1. Assistant referees

They indicate when:

- the whole of the ball leaves the field of play and which team is entitled to a corner kick, goal kick or throw-in
- a player in an offside position may be penalised
- a substitution is requested
- at penalty kicks, the goalkeeper moves off the goal line before the ball is kicked and if the ball crosses the line; if additional assistant referees have been appointed the assistant referee takes a position in line with the penalty mark

The assistant referee's assistance also includes monitoring the substitution procedure.

The assistant referee may enter the field of play to help control the 9.15m (10 yards) distance.

## 2. Fourth official

The fourth official's assistance also includes:

- supervising the substitution procedure
- checking a player's/substitute's equipment
- the re-entry of a player following a signal/approval from the referee
- supervising the replacement balls
- indicating the minimum amount of additional time the referee intends to play at the end of each half (including extra time)
- informing the referee of irresponsible behaviour by any technical area occupant

## 3. Additional assistant referees

The additional assistant referees may indicate:

- when the whole of the ball passes over the goal line, including when a goal is scored
- which team is entitled to a corner kick or goal kick
- whether, at penalty kicks, the goalkeeper moves off the goal line before the ball is kicked and if the ball crosses the line

**4. Reserve assistant referee**

The only duty of a reserve assistant referee is to replace an assistant referee or fourth official who is unable to continue.



**5. Assistant referee signals**

**Substitution**

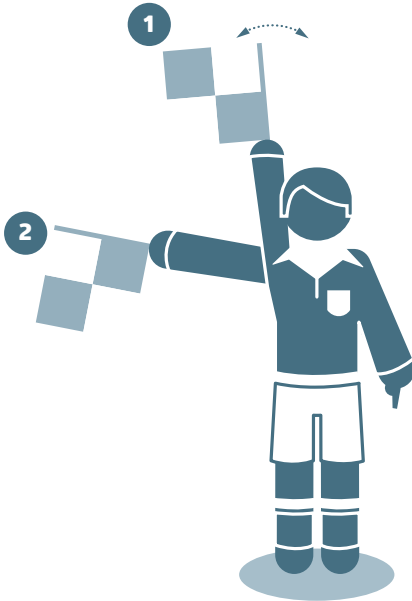

**Attacking** free kicks



**Defending** free kicks

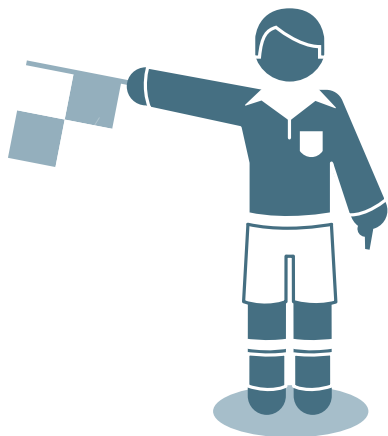

**Throw-in** for **attacker**

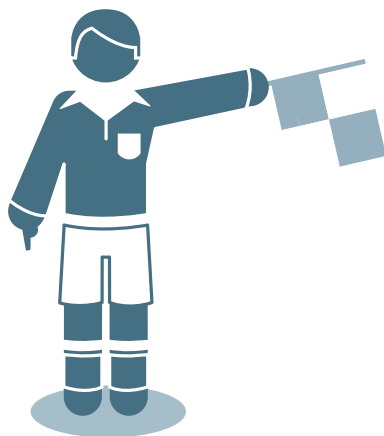

**Throw-in** for **defender**

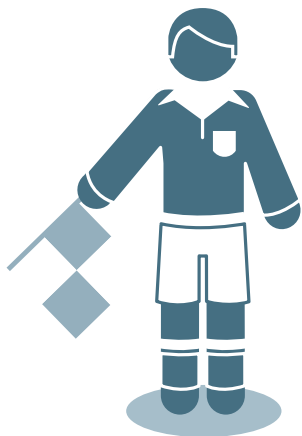

**Corner** kick

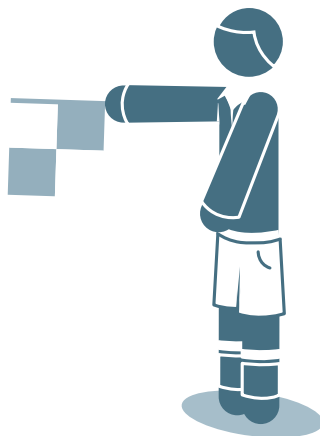

**Goal** kick



**Offside**



**Offside** on the  
**near side** of the field

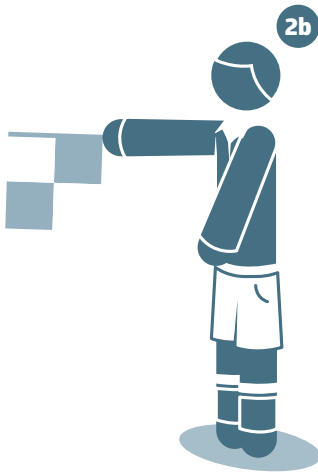

**Offside** in the  
**middle** of the field



**Offside** on the  
**far side** of the field

## 6. Additional assistant referee signals



**goal**  
(unless the ball has very clearly  
passed over the goal line)



IFAB®



**Law**

07

# The Duration of the Match

## 1. Periods of play

A match lasts for two equal halves of 45 minutes which may only be reduced if agreed between the referee and the two teams before the start of the match and is in accordance with competition rules.

## 2. Half-time interval

Players are entitled to an interval at half-time, not exceeding 15 minutes. Competition rules must state the duration of the half-time interval and it may be altered only with the referee's permission.

## 3. Allowance for time lost

Allowance is made by the referee in each half for all time lost in that half through:

- substitutions
- [assessment and/or removal of injured players](#)
- wasting time
- disciplinary sanctions
- [stoppages for drinks or other medical reasons permitted by competition rules](#)
- any other cause, including any significant delay to a restart (e.g. goal celebrations)

The fourth official indicates the minimum additional time decided by the referee at the end of the final minute of each half. The additional time may be increased by the referee but not reduced.

The referee must not compensate for a timekeeping error during the first half by changing the length of the second half.

#### **4. Penalty kick**

If a penalty kick has to be taken or retaken, the half is extended until the penalty kick is completed.

#### **5. Abandoned match**

An abandoned match is replayed unless the competition rules or organisers determine otherwise.

IFAB®



**Law**

08

# The Start and Restart of Play

A kick-off starts both halves of a match, both halves of extra time and restarts play after a goal has been scored. Free kicks (direct or indirect), penalty kicks, throw-ins, goal kicks and corner kicks are other restarts (see Laws 13–17).

A dropped ball is the restart when the referee stops play and the Law does not require one of the above restarts.

If an infringement occurs when the ball is not in play this does not change how play is restarted.

## 1. Kick-off

### Procedure

- the team that wins the toss of a coin decides which goal it will attack in the first half
- their opponents take the kick-off
- the team that wins the toss takes the kick-off to start the second half
- for the second half, the teams change ends and attack the opposite goals
- after a team scores a goal, the kick-off is taken by their opponents

For every kick-off:

- all players must be in their own half of the field of play
- the opponents of the team taking the kick-off must be at least 9.15 m (10 yds) from the ball until it is in play
- the ball must be stationary on the centre mark
- the referee gives a signal
- the ball is in play when it is kicked and clearly moves
- a goal may be scored directly against the opponents from the kick-off

### **Infringements and sanctions**

If the player taking the kick-off touches the ball again before it has touched another player an indirect free kick, or for deliberate handball a direct free kick, is awarded.

In the event of any other infringement of the kick-off procedure the kick-off is retaken.

## **2. Dropped ball**

### **Procedure**

The referee drops the ball at the position where it was when play was stopped, unless play was stopped inside the goal area in which case the ball is dropped on the goal area line which is parallel to the goal line at the point nearest to where the ball was when play was stopped.

The ball is in play when it touches the ground.

Any number of players may contest a dropped ball (including the goalkeepers); the referee cannot decide who may contest a dropped ball or its outcome.

### **Infringements and sanctions**

The ball is dropped again if it:

- touches a player before it touches the ground
- leaves the field of play after it touches the ground, without touching a player

If a dropped ball enters the goal without touching at least two players play is restarted with:

- a goal kick if it enters the opponents' goal
- a corner kick if it enters the team's goal



IFAB®



# Law

09

# The Ball in and out of Play

## 1. Ball out of play

The ball is out of play when:

- it has wholly passed over the goal line or touchline on the ground or in the air
- play has been stopped by the referee

## 2. Ball in play

The ball is in play at all other times, including when it rebounds off a match official, goalpost, crossbar or corner flagpost and remains in the field of play.

**Law**

10

# Determining the Outcome of a Match

## 1. Goal scored

A goal is scored when the whole of the ball passes over the goal line, between the goalposts and under the crossbar, provided that no offence or infringement of the Laws of the Game has been committed by the team scoring the goal.

If a referee signals a goal before the ball has passed wholly over the goal line, play is restarted with a dropped ball.

## 2. Winning team

The team scoring the greater number of goals is the winner. If both teams score no goals or an equal number of goals the match is drawn.

When competition rules require a winning team after a drawn match or home-and-away tie, the only permitted procedures to determine the winning team are:

- away goals rule
- extra time
- kicks from the penalty mark

## 3. Kicks from the penalty mark

Kicks from the penalty mark are taken after the match has ended and unless otherwise stated, the relevant Laws of the Game apply.

### Procedure

#### Before kicks from the penalty mark start

- Unless there are other considerations (e.g. ground conditions, safety etc.), the referee tosses a coin to decide the goal at which the kicks will be taken which may only be changed for safety reasons or if the goal or playing surface becomes unusable

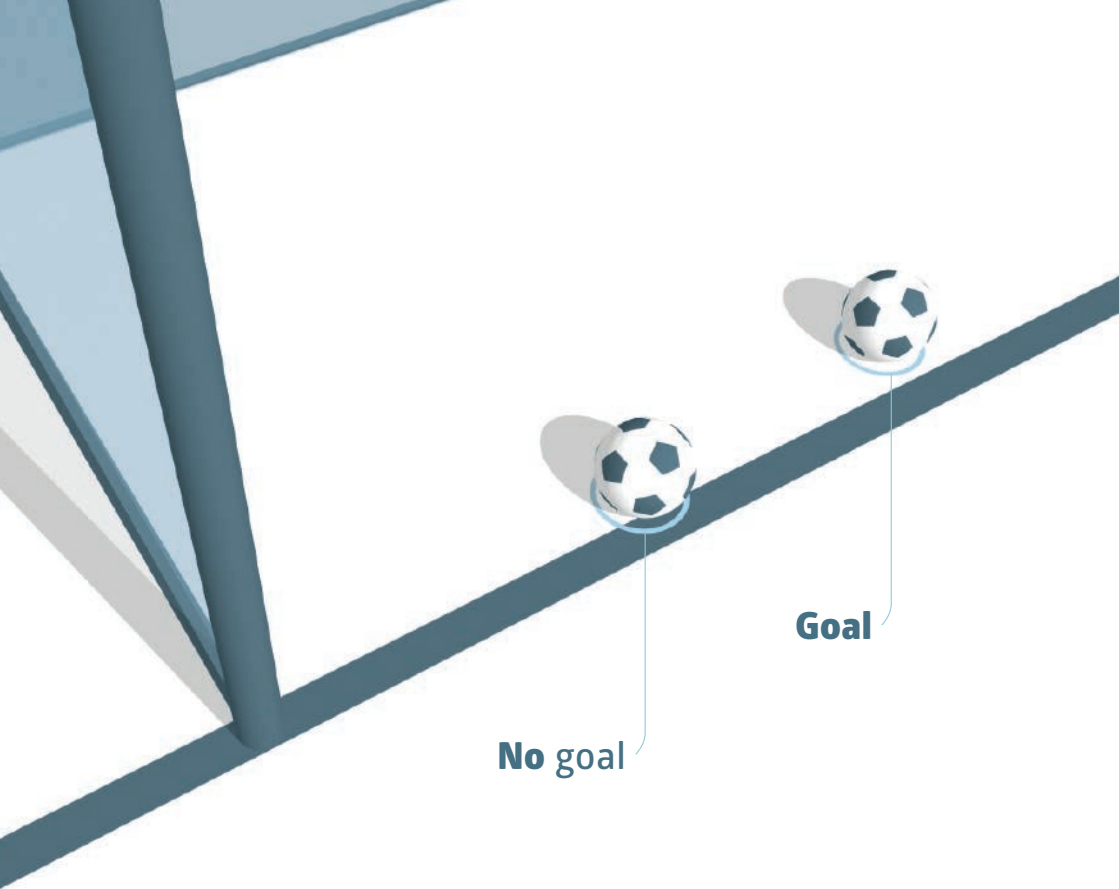

**No goal**

**Goal**

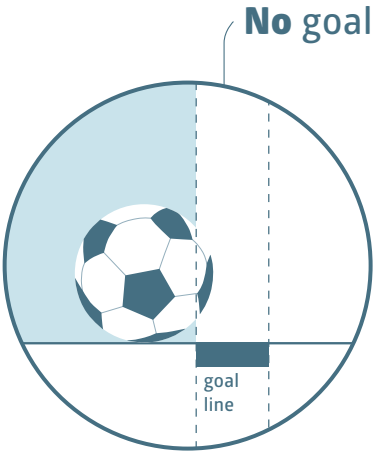

**No goal**

goal  
line

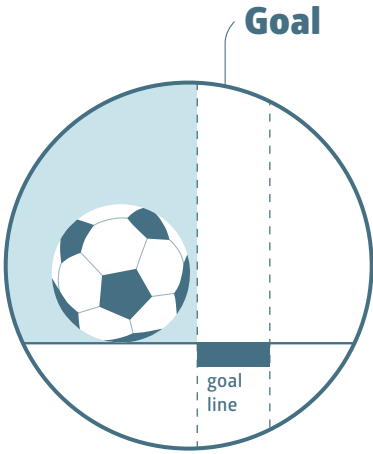

**Goal**

goal  
line

- The referee tosses a coin again and the team that wins the toss decides whether to take the first or second kick
- With the exception of a substitute for an injured goalkeeper, only players who are on the field of play or are temporarily off the field of play (injury, adjusting equipment etc.) at the end of the match are eligible to take kicks
- Each team is responsible for selecting from the eligible players the order in which they will take the kicks. The referee is not informed of the order
- If at the end of the match and before or during the kicks one team has a greater number of players than its opponents, it must reduce its numbers to the same number as its opponents and the referee must be informed of the name and number of each player excluded. Any excluded player is not eligible to take part in the kicks (except as outlined below)
- A goalkeeper who is unable to continue before or during the kicks and whose team has not used its maximum permitted number of substitutes, may be replaced by a named substitute, or a player excluded to equalise the number of players, but takes no further part and may not take a kick

#### **During kicks from the penalty mark**

- Only eligible players and match officials are permitted to remain on the field of play
- All eligible players, except the player taking the kick and the two goalkeepers, must remain within the centre circle
- The goalkeeper of the kicker must remain on the field of play, outside the penalty area, on the goal line where it meets the penalty area boundary line
- An eligible player may change places with the goalkeeper
- The kick is completed when the ball stops moving, goes out of play or the referee stops play for any infringement of the Laws
- The referee keeps a record of the kicks

#### **Subject to the conditions explained below, both teams take five kicks**

- The kicks are taken alternately by the teams
- If, before both teams have taken five kicks, one has scored more goals than the other could score, even if it were to complete its five kicks, no more kicks are taken

- If, after both teams have taken five kicks, the scores are level kicks continue until one team has scored a goal more than the other from the same number of kicks
- Each kick is taken by a different player and all eligible players must take a kick before any player can take a second kick
- The above principle continues for any subsequent sequence of kicks but a team may change the order of kickers
- Kicks from the penalty mark must not be delayed for a player who leaves the field of play. The player's kick will be forfeited (not scored) if the player does not return in time to take a kick

#### **Substitutions and send offs during kicks from the penalty mark**

- A player, substitute or substituted player may be cautioned or sent off
- A goalkeeper who is sent off must be replaced by an eligible player
- A player other than the goalkeeper who is unable to continue may not be replaced
- The referee must not abandon the match if a team is reduced to fewer than seven players



IFAB®

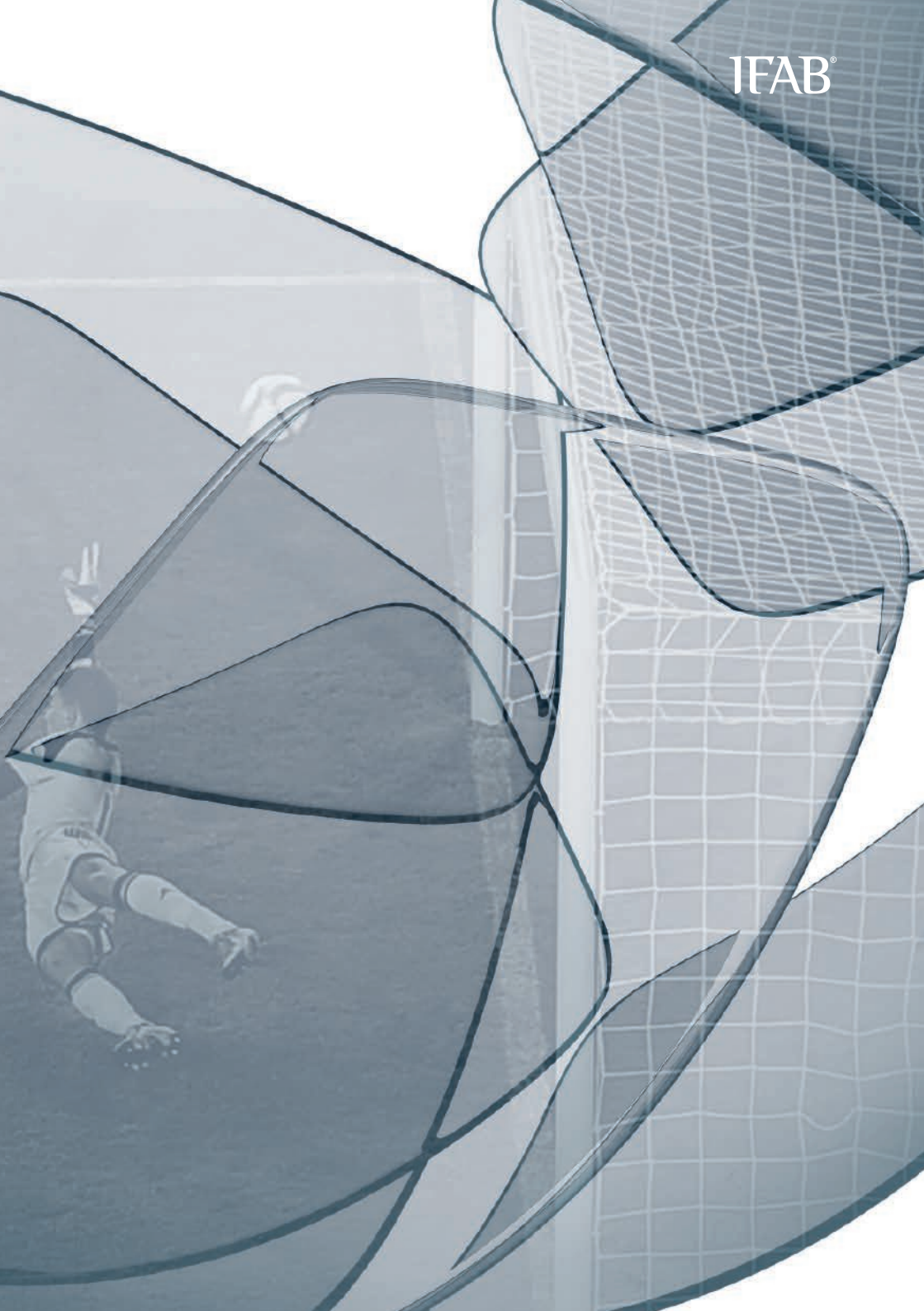

**Law**

11

# Offside

## 1. Offside position

It is not an offence to be in an offside position.

A player is in an offside position if:

- any part of the head, body or feet is in the opponents' half (excluding the halfway line) and
- any part of the head, body or feet is nearer to the opponents' goal line than both the ball and the second-last opponent

The hands and arms of all players, including the goalkeepers, are not considered.

A player is not in an offside position if level with the:

- second-last opponent or
- last two opponents

## 2. Offside offence

A player in an offside position at the moment the ball is played or touched by a team-mate is only penalised on becoming involved in active play by:

- interfering with play by playing or touching a ball passed or touched by a team-mate or
- interfering with an opponent by:

- preventing an opponent from playing or being able to play the ball by clearly obstructing the opponent's line of vision or
- challenging an opponent for the ball or
- clearly attempting to play a ball which is close to him when this action impacts on an opponent or
- making an obvious action which clearly impacts on the ability of an opponent to play the ball

or

- gaining an advantage by playing the ball or interfering with an opponent when it has:
  - rebounded or been deflected off the goalpost, crossbar or an opponent
  - been deliberately saved by any opponent

A player in an offside position receiving the ball from an opponent who deliberately plays the ball (except from a deliberate save by any opponent) is not considered to have gained an advantage.

A 'save' is when a player stops a ball which is going into or very close to the goal with any part of the body except the hands (unless the goalkeeper within the penalty area).

### 3. No offence

There is no offside offence if a player receives the ball directly from:

- a goal kick
- a throw-in
- a corner kick

#### 4. Infringements and sanctions

If an offside offence occurs, the referee awards an indirect free kick where the offence occurred, including if it is in the player's own half of the field of play.

A defending player who leaves the field of play without the referee's permission shall be considered to be on the goal line or touchline for the purposes of offside until the next stoppage in play or until the defending team has played the ball towards the halfway line and it is outside their penalty area. If the player left the field of play deliberately, the player must be cautioned when the ball is next out of play.

An attacking player may step or stay off the field of play not to be involved in active play. If the player re-enters from the goal line and becomes involved in play before the next stoppage in play, or the defending team has played the ball towards the halfway line and it is outside their penalty area, the player shall be considered to be positioned on the goal line for the purposes of offside.

A player who deliberately leaves the field of play and re-enters without the referee's permission and is not penalised for offside and gains an advantage, must be cautioned.

If an attacking player remains stationary between the goalposts and inside the goal as the ball enters the goal, a goal must be awarded unless the player commits an offside offence or Law 12 offence in which case play is restarted with an indirect or direct free kick.

# Law

12

# Fouls and Misconduct

Direct and indirect free kicks and penalty kicks can only be awarded for offences and infringements committed when the ball is in play.

## 1. Direct free kick

A direct free kick is awarded if a player commits any of the following offences against an opponent in a manner considered by the referee to be careless, reckless or using excessive force:

- charges
- jumps at
- kicks or attempts to kick
- pushes
- strikes or attempts to strike (including head-butt)
- tackles or challenges
- trips or attempts to trip

If an offence involves contact it is penalised by a direct free kick or penalty kick.

- Careless is when a player shows a lack of attention or consideration when making a challenge or acts without precaution. No disciplinary sanction is needed
- Reckless is when a player acts with disregard to the danger to, or consequences for, an opponent and must be cautioned
- Using excessive force is when a player exceeds the necessary use of force and endangers the safety of an opponent and must be sent off

A direct free kick is awarded if a player commits any of the following offences:

- handles the ball deliberately (except for the goalkeeper within their penalty area)
- holds an opponent
- impedes an opponent with contact
- spits at an opponent

See also offences in Law 3

### **Handling the ball**

Handling the ball involves a deliberate act of a player making contact with the ball with the hand or arm.

The following must be considered:

- the movement of the hand towards the ball (not the ball towards the hand)
- the distance between the opponent and the ball (unexpected ball)
- the position of the hand does not necessarily mean that there is an infringement
- touching the ball with an object held in the hand (clothing, shinguard, etc.) is an infringement
- hitting the ball with a thrown object (boot, shinguard, etc.) is an infringement

The goalkeeper has the same restrictions on handling the ball as any other player outside the penalty area. Inside their penalty area, the goalkeeper cannot be guilty of a handling offence incurring a direct free kick or any related sanction but can be guilty of handling offences that incur an indirect free kick.

## **2. Indirect free kick**

An indirect free kick is awarded if a player:

- plays in a dangerous manner
- impedes the progress of an opponent without any contact being made
- prevents the goalkeeper from releasing the ball from the hands or kicks or attempts to kick the ball when the goalkeeper is in the process of releasing it
- commits any other offence, not mentioned in the Laws, for which play is stopped to caution or send off a player



An indirect free kick is awarded if a goalkeeper, inside their penalty area, commits any of the following offences:

- controls the ball with the hands for more than six seconds before releasing it
- touches the ball with the hands after:
  - > releasing it and before it has touched another player
  - > it has been deliberately kicked to the goalkeeper by a team-mate
  - > receiving it directly from a throw-in taken by a team-mate

A goalkeeper is considered to be in control of the ball when:

- the ball is between the hands or between the hand and any surface (e.g. ground, own body) or by touching it with any part of the hands or arms except if the ball rebounds accidentally from the goalkeeper or the goalkeeper has made a save
- holding the ball in the outstretched open hand
- bouncing it on the ground or throwing it in the air

A goalkeeper cannot be challenged by an opponent when in control of the ball with the hands.

### **Playing in a dangerous manner**

Playing in a dangerous manner is any action that, while trying to play the ball, threatens injury to someone (including the player themselves) and includes preventing a nearby opponent from playing the ball for fear of injury.

A scissors or bicycle kick is permissible provided that it is not dangerous to an opponent.

### **Impeding the progress of an opponent without contact**

Impeding the progress of an opponent means moving into the opponent's path to obstruct, block, slow down or force a change of direction when the ball is not within playing distance of either player.

All players have a right to their position on the field of play; being in the way of an opponent is not the same as moving into the way of an opponent.

A player may shield the ball by taking a position between an opponent and the ball if the ball is within playing distance and the opponent is not held off with the arms or body. If the ball is within playing distance, the player may be fairly charged by an opponent.

### 3. Disciplinary action

The referee has the authority to take disciplinary action from entering the field of play for the pre-match inspection until leaving the field of play after the match ends (including kicks from the penalty mark).

If, before entering the field of play at the start of the match, a player commits a sending-off offence, the referee has the authority to prevent the player taking part in the match (see Law 3.6); the referee will report any other misconduct.

A player who commits a cautionable or sending-off offence, either on or off the field of play, against an opponent, a team-mate, a match official or any other person or the Laws of the Game, is disciplined according to the offence.

The yellow card communicates a caution and the red card communicates a sending-off.

Only a player, substitute or substituted player may be shown the red or yellow card.

#### **Delaying the restart of play to show a card**

Once the referee has decided to caution or send off a player, play must not be restarted until the sanction has been administered.

#### **Advantage**

If the referee plays the advantage for an offence for which a caution / send off would have been issued had play been stopped, this caution / send off must be issued when the ball is next out of play, except when the denial of an obvious goal-scoring opportunity results in a goal the player is cautioned for unsporting behaviour.

Advantage should not be applied in situations involving serious foul play, violent conduct or a second cautionable offence unless there is a clear opportunity to score a goal. The referee must send off the player when the ball

is next out of play but if the player plays the ball or challenges/interferes with an opponent, the referee will stop play, send off the player and restart with an indirect free kick.

If a defender starts holding an attacker outside the penalty area and continues holding inside the penalty area, the referee must award a penalty kick.

### Cautionable offences

A player is cautioned if guilty of:

- delaying the restart of play
- dissent by word or action
- entering, re-entering or deliberately leaving the field of play without the referee's permission
- failing to respect the required distance when play is restarted with a corner kick, free kick or throw-in
- persistent infringement of the Laws of the Game (no specific number or pattern of infringements constitutes "persistent")
- unsporting behaviour

A substitute or substituted player is cautioned if guilty of:

- delaying the restart of play
- dissent by word or action
- entering or re-entering the field of play without the referee's permission
- unsporting behaviour

### Cautions for unsporting behaviour

There are different circumstances when a player must be cautioned for unsporting behaviour including if a player:

- attempts to deceive the referee e.g. by feigning injury or pretending to have been fouled (simulation)
- changes places with the goalkeeper during play or without the referee's permission
- commits in a reckless manner a direct free kick offence
- commits a foul or handles the ball to interfere with or stop a promising attack

- handles the ball in an attempt to score a goal (whether or not the attempt is successful) or in an unsuccessful attempt to prevent a goal
- makes unauthorised marks on the field of play
- plays the ball when leaving the field of play after being given permission to leave
- shows a lack of respect for the game
- uses a deliberate trick to pass the ball (including from a free kick) to the goalkeeper with the head, chest, knee etc. to circumvent the Law, whether or not the goalkeeper touches the ball with the hands
- verbally distracts an opponent during play or at a restart

### **Celebration of a goal**

Players can celebrate when a goal is scored, but the celebration must not be excessive; choreographed celebrations are not encouraged and must not cause excessive time-wasting.

Leaving the field of play to celebrate a goal is not a cautionable offence but players should return as soon as possible.

A player must be cautioned for:

- climbing onto a perimeter fence
- gesturing in a provocative, derisory or inflammatory way
- covering the head or face with a mask or other similar item
- removing the shirt or covering the head with the shirt

### **Delaying the restart of play**

Referees must caution players who delay the restart of play by:

- appearing to take a throw-in but suddenly leaving it to a team-mate to take
- delaying leaving the field of play when being substituted
- excessively delaying a restart
- kicking or carrying the ball away, or provoking a confrontation by deliberately touching the ball after the referee has stopped play
- taking a free kick from the wrong position to force a retake

### **Sending-off offences**

A player, substitute or substituted player who commits any of the following offences is sent off:

- denying the opposing team a goal or an obvious goal-scoring opportunity by deliberately handling the ball (except a goalkeeper within their penalty area)
- denying an obvious goal-scoring opportunity to an opponent moving towards the opponents' goal by an offence punishable by a free kick (unless as outlined below)
- serious foul play
- spitting at an opponent or any other person
- violent conduct
- using offensive, insulting or abusive language and/or gestures
- receiving a second caution in the same match

A player, substitute or substituted player who has been sent off must leave the vicinity of the field of play and the technical area.

### **Denying a goal or an obvious goal-scoring opportunity**

Where a player denies the opposing team a goal or an obvious goal-scoring opportunity by a deliberate handball offence the player is sent off wherever the offence occurs.

Where a player commits an offence against an opponent within their own penalty area which denies an opponent an obvious goal-scoring opportunity and the referee awards a penalty kick, the offending player is cautioned unless:

- The offence is holding, pulling or pushing or
- The offending player does not attempt to play the ball or there is no possibility for the player making the challenge to play the ball or
- The offence is one which is punishable by a red card wherever it occurs on the field of play (e.g. serious foul play, violent conduct etc.)

In all the above circumstances the player is sent off.

The following must be considered:

- distance between the offence and the goal
- general direction of the play
- likelihood of keeping or gaining control of the ball
- location and number of defenders

### **Serious foul play**

A tackle or challenge that endangers the safety of an opponent or uses excessive force or brutality must be sanctioned as serious foul play.

Any player who lunges at an opponent in challenging for the ball from the front, from the side or from behind using one or both legs, with excessive force or endangers the safety of an opponent is guilty of serious foul play.

### **Violent conduct**

Violent conduct is when a player uses or attempts to use excessive force or brutality against an opponent when not challenging for the ball, or against a team-mate, team official, match official, spectator or any other person, regardless of whether contact is made.

In addition, a player who, when not challenging for the ball, deliberately strikes an opponent or any other person on the head or face with the hand or arm, is guilty of violent conduct unless the force used was negligible.

### **Offences where an object (or the ball) is thrown**

If while the ball is in play, a player, substitute or substituted player throws an object (including the ball) at an opponent or any other person the referee must stop play and if the offence was:

- reckless – caution the offender for unsporting behaviour
- using excessive force – send off the offender for violent conduct.

## **4. Restart of play after fouls and misconduct**

- If the ball is out of play, play is restarted according to the previous decision
- If the ball is in play and a player commits an offence inside the field of play against:
  - > an opponent – indirect or direct free kick or penalty kick
  - > a team-mate, substitute, substituted player, team official or a match official – a direct free kick or penalty kick
  - > any other person – a dropped ball

- If the ball is in play and a player commits an offence outside the field of play:
  - if the player is already off the field of play, play is restarted with a dropped ball
  - if the player leaves the field of play to commit the offence, play is restarted with an indirect free kick from the position of the ball when play was stopped. However, if a player leaves the field of play as part of play and commits an offence against another player, play is restarted with a free kick taken on the boundary line nearest to where the offence occurred; for direct free kick offences a penalty kick is awarded if this is within the offender's penalty area
- If a player standing on or off the field of play throws an object at an opponent on the field of play, play is restarted with a direct free kick or penalty kick from the position where the object struck or would have struck the opponent
- Play is restarted with an indirect free kick if a:
  - player standing inside the field of play throws an object at any person outside the field of play
  - substitute or substituted player throws an object at an opponent standing inside the field of play

# Law

13



# Free Kicks

## 1. Types of free kick

Direct and indirect free kicks are awarded to the opposing team of a player guilty of an offence or infringement.

### Indirect free kick signal

The referee indicates an indirect free kick by raising the arm above the head; this signal is maintained until the kick has been taken and the ball touches another player or goes out of play.

An indirect free kick must be retaken if the referee fails to signal that the kick is indirect and the ball is kicked directly into the goal.

### Ball enters the goal

- if a direct free kick is kicked directly into the opponents' goal, a goal is awarded
- if an indirect free kick is kicked directly into the opponents' goal, a goal kick is awarded
- if a direct or indirect free kick is kicked directly into the team's own goal, a corner kick is awarded

## 2. Procedure

All free kicks are taken from the place where the infringement occurred, except:

- indirect free kicks to the attacking team for an offence inside the opponents' goal area are taken from the nearest point on the goal area line which runs parallel to the goal line
- free kicks to the defending team in their goal area may be taken from anywhere in that area

- free kicks for offences involving a player entering, re-entering or leaving the field of play without permission are taken from the position of the ball when play was stopped. However, if a player leaves the field of play as part of play and commits an offence against another player, play is restarted with a free kick taken on the boundary line nearest to where the offence occurred; for direct free kick offences a penalty kick is awarded if this is within the offender's penalty area
- the Law designates another position (see Laws 3, 11, 12)

The ball:

- must be stationary and the kicker must not touch the ball again until it has touched another player
- is in play when it is kicked and clearly moves except for a free kick to the defending team in their penalty area where the ball is in play when it is kicked directly out of the penalty area

Until the ball is in play all opponents must remain:

- at least 9.15 m (10 yds) from the ball, unless they are on their own goal line between the goalposts
- outside the penalty area for free kicks inside the opponents' penalty area

A free kick can be taken by lifting the ball with a foot or both feet simultaneously.

Feinting to take a free kick to confuse opponents is permitted as part of football.

If a player, while correctly taking a free kick, intentionally kicks the ball at an opponent in order to play the ball again but not in a careless or reckless manner or using excessive force, the referee allows play to continue.

### 3. Infringements and sanctions

If, when a free kick is taken, an opponent is closer to the ball than the required distance, the kick is retaken unless the advantage can be applied; but if a player takes a free kick quickly and an opponent who is less than 9.15 m (10 yds) from the ball intercepts it, the referee allows play to continue. However, an opponent who deliberately prevents a free kick being taken quickly must be cautioned for delaying the restart of play.

If, when a free kick is taken quickly by the defending team from inside its penalty area, any opponents are inside the penalty area because they did not have time to leave, the referee allows play to continue.

If, when a free kick is taken by the defending team inside its penalty area, the ball is not kicked directly out of the penalty area the kick is retaken.

If, after the ball is in play, the kicker touches the ball again before it has touched another player an indirect free kick is awarded, if the kicker deliberately handles the ball:

- a direct free kick is awarded
- a penalty kick is awarded if the infringement occurred inside the kicker's penalty area unless the kicker was the goalkeeper in which case an indirect free kick is awarded

# Law

14

# The Penalty Kick

A penalty kick is awarded if a player commits a direct free kick offence inside their penalty area or off the field as part of play as outlined in Laws 12 and 13.

A goal may be scored directly from a penalty kick.

## 1. Procedure

The ball must be stationary on the penalty mark.

The player taking the penalty kick must be properly identified.

The defending goalkeeper must remain on the goal line, facing the kicker, between the goalposts until the ball has been kicked.

The players other than the kicker and goalkeeper must be:

- at least 9.15 m (10 yds) from the penalty mark
- behind the penalty mark
- inside the field of play
- outside the penalty area

After the players have taken positions in accordance with this Law, the referee signals for the penalty kick to be taken.

The player taking the penalty kick must kick the ball forward; backheeling is permitted provided the ball moves forward.

The ball is in play when it is kicked and clearly moves.

The kicker must not play the ball again until it has touched another player.

The penalty kick is completed when the ball stops moving, goes out of play or the referee stops play for any infringement of the Laws.

Additional time is allowed for a penalty kick to be taken and completed at the end of each half of the match or extra time.

## 2. Infringements and sanctions

Once the referee has signalled for a penalty kick to be taken, the kick must be taken. If, before the ball is in play, one of the following occurs:

the player taking the penalty kick or a team-mate infringes the Laws of the Game:

- if the ball enters the goal, the kick is retaken
- if the ball does not enter the goal, the referee stops play and restarts with an indirect free kick

except for the following when play will be stopped and restarted with an indirect free kick, regardless of whether or not a goal is scored:

- a penalty kick is kicked backwards
- a team-mate of the identified kicker takes the kick; the referee cautions the player who took the kick
- feinting to kick the ball once the kicker has completed the run-up (feinting in the run-up is permitted); the referee cautions the kicker

the goalkeeper or a team-mate infringes the Laws of the Game:

- if the ball enters the goal, a goal is awarded
- if the ball does not enter the goal, the kick is retaken; the goalkeeper is cautioned if responsible for the infringement

a player of both teams infringes the Laws of the Game, the kick is retaken unless a player commits a more serious offence (e.g. illegal feinting)

**If, after the penalty kick has been taken:**

the kicker touches the ball again before it has touched another player:

- an indirect free kick (or direct free kick for deliberate hand ball) is awarded

the ball is touched by an outside agent as it moves forward:

- the kick is retaken

the ball rebounds into the field of play from the goalkeeper, the crossbar or the goalposts and is then touched by an outside agent:

- the referee stops play
- play is restarted with a dropped ball at the position where it touched the outside agent

### 3. Summary table

	Outcome of the penalty kick	
	Goal	No Goal
<b>Encroachment by attacking player</b>	Penalty is retaken	Indirect free kick
<b>Encroachment by defending player</b>	Goal	Penalty is retaken
<b>Offence by goalkeeper</b>	Goal	Penalty is retaken and <u>caution for goalkeeper</u>
<b>Ball kicked backwards</b>	Indirect free kick	Indirect free kick
<b>Illegal feinting</b>	<u>Indirect free kick and caution for kicker</u>	<u>Indirect free kick and caution for kicker</u>
<b>Wrong kicker</b>	<u>Indirect free kick and caution for wrong kicker</u>	<u>Indirect free kick and caution for wrong kicker</u>

**Law**

15



# The Throw-in

A throw-in is awarded to the opponents of the player who last touched the ball when the whole of the ball passes over the touchline, on the ground or in the air.

A goal cannot be scored directly from a throw-in:

- if the ball enters the opponents' goal – a goal kick is awarded
- if the ball enters the thrower's goal – a corner kick is awarded

## 1. Procedure

At the moment of delivering the ball, the thrower must:

- face the field of play
- have part of each foot on the touchline or on the ground outside the touchline
- throw the ball with both hands from behind and over the head from the point where it left the field of play

All opponents must stand at least 2 m (2 yds) from the point at which the throw-in is taken.

The ball is in play when it enters the field of play. If the ball touches the ground before entering, the throw-in is retaken by the same team from the same position. If the throw-in is not taken correctly it is retaken by the opposing team.

If a player, while correctly taking a throw-in, intentionally throws the ball at an opponent in order to play the ball again but neither in a careless nor a reckless manner nor using excessive force, the referee allows play to continue.

The thrower must not touch the ball again until it has touched another player.

## 2. Infringements and sanctions

If, after the ball is in play, the thrower touches the ball again before it has touched another player an indirect free kick is awarded; if the thrower deliberately handles the ball:

- a direct free kick is awarded
- a penalty kick is awarded if the infringement occurred inside the thrower's penalty area unless the ball was handled by the defending team's goalkeeper in which case an indirect free kick is awarded

An opponent who unfairly distracts or impedes the thrower (including moving closer than 2 m (2 yds) to the place where the throw-in is to be taken) is cautioned for unsporting behaviour and if the throw-in has been taken an indirect free kick is awarded.

For any other infringement of this Law the throw-in is taken by a player of the opposing team.

IFAB®



**Law**

16

# The Goal Kick

A goal kick is awarded when the whole of the ball passes over the goal line, on the ground or in the air, having last touched a player of the attacking team, and a goal is not scored.

A goal may be scored directly from a goal kick, but only against the opposing team; if the ball directly enters the kicker's goal a corner kick is awarded to the opponents if the ball left the penalty area.

## 1. Procedure

- The ball must be stationary and is kicked from any point within the goal area by a player of the defending team
- The ball is in play when it leaves the penalty area
- Opponents must be outside the penalty area until the ball is in play

## 2. Infringements and sanctions

If the ball does not leave the penalty area or is touched by a player before it leaves the penalty area the kick is retaken.

If, after the ball is in play, the kicker touches the ball again before it has touched another player an indirect free kick is awarded; if the kicker deliberately handles the ball:

- a direct free kick is awarded
- a penalty kick is awarded if the infringement occurred inside the kicker's penalty area unless the kicker was the goalkeeper in which case an indirect free kick is awarded

If an opponent who is in the penalty area when the goal kick is taken touches or challenges for the ball before it has touched another player, the goal kick is retaken.

If a player enters the penalty area before the ball is in play and fouls or is fouled by an opponent, the goal kick is retaken and the offender may be cautioned or sent off depending on the offence.

For any other infringement of this Law the kick is retaken.

IFAB®



# Law

17



# The Corner Kick

A corner kick is awarded when the whole of the ball passes over the goal line, on the ground or in the air, having last touched a player of the defending team, and a goal is not scored.

A goal may be scored directly from a corner kick, but only against the opposing team; if the ball directly enters the kicker's goal a corner kick is awarded to the opponents.

## 1. Procedure

- The ball must be placed in the corner area nearest to the point where the ball passed over the goal line
- The ball must be stationary and is kicked by a player of the attacking team
- The ball is in play when it is kicked and clearly moves; it does not need to leave the corner area
- The corner flagpost must not be moved
- Opponents must remain at least 9.15 m (10 yds) from the corner arc until the ball is in play

## 2. Infringements and sanctions

If, after the ball is in play, the kicker touches the ball again before it has touched another player an indirect free kick is awarded; if the kicker deliberately handles the ball:

- a direct free kick is awarded
- a penalty kick is awarded if the infringement occurred inside the kicker's penalty area unless the kicker was the goalkeeper in which case an indirect free kick is awarded

If a player, while correctly taking a corner kick, intentionally kicks the ball at an opponent in order to play the ball again but not in a careless or reckless manner or using excessive force, the referee allows play to continue.

For any other infringement of this Law the kick is retaken.

IFAB®



# **Law changes**

2016/17

# Outline summary of Law changes

Herewith a simple outline of the main changes/clarifications.

## **Law 01 – The Field of Play**

- Artificial and natural surfaces may not be combined on the field
- Competitions may determine field size for their competitions (within Law)
- All commercial advertising on the ground must be at least 1 m (1yd) from boundary lines
- Logos/emblems of FAs, competitions etc... allowed on corner flags (no advertising)

## **Law 02 – The Ball**

None

## **Law 03 – The Players (new title)**

- A match may not start/continue if a team has fewer than 7 players
- Substitutes may take a restart but must first step onto the field
- Clarifies situation when a player is sent off before/after kick-off
- Direct FK (or penalty) if a substitute/team official interferes with play
- If something/someone (other than a player) touches a ball as it goes into the goal the referee can award the goal if the touch had no impact on the defenders
- If a goal is scored with an extra person on the field and referee has restarted play the goal stands and match continues

#### **Law 04 – The Players' Equipment**

- Any tape or other material on/covering socks must be same colour as the sock
- Player losing footwear/shinguard accidentally can play on until next stoppage
- Undershorts must be colour of shorts or hem; team must all wear same colour
- Electronic communication with substitutes is forbidden
- Player can return during play after changing/correcting equipment, once equipment has been checked (by referee, fourth official or AR) and referee signals

#### **Law 05 – The Referee**

- Decision can not be changed if play restarted or referee has left the field (HT+FT)
- If several offences occur at the same time the most serious is punished
- Referee can send a player off from pre-match pitch inspection onwards
- Referee can only use RC + YC after entering the field at start of the match
- Player injured by RC/YC foul can be quickly assessed/ treated and stay on field
- The equipment a referee can or may be allowed to use
- Diagrams of referee signals included (from Guidelines section)

#### **Law 06 – The Other Match Officials (new title)**

- More details about the duties of the assistants, AARs, fourth official
- Diagrams of assistant referee signals included (from Guidelines section)

#### **Law 07 – The Duration of the Match**

- More reasons for additional time (e.g. medical drinks breaks)

#### **Law 08 – The Start and Restart of Play**

- All restarts included (previously only kick-off and dropped ball)
- Ball must clearly move to be in play for all kicked restarts
- Ball can be kicked in any direction at kick-off (previously had to go forward)
- Referee can not 'manufacture' outcome of a dropped ball

**Law 09 – The Ball in and out of Play**

- If a ball rebounds off a match official it is in play unless it has wholly passed over a boundary line

**Law 10 – Determining the Outcome of a Match (new title)**

Kicks from the penalty mark:

- Referee will toss a coin to choose the goal (unless weather, safety, etc.)
- Player temporarily off the field (e.g. injured) at final whistle can take part
- Both teams must have same number of players before and during the kicks
- Clear statement of when a kick is over
- Kicks not delayed if player leaves the field; if not back in time kick is forfeited

**Law 11 – Offside**

- Halfway line ‘neutral’ for offside; player must be in opponents’ half
- Players’ arms not considered when judging offside position (including goalkeeper)
- Offside FK always taken where offence occurs (even in own half)
- Defender off the field only ‘active’ until defending team clear ball or play stops
- As above for attacker returning; before that re-entry point is the offside position

**Law 12 – Fouls and Misconduct**

- Foul with contact is a direct FK
- Advantage for a RC – indirect FK if offender then gets involved in play
- Change of wording for handball so that not every handball is a YC
- Some DOGSO offences in the penalty area are punished with a YC
- Attempted violent conduct is a RC, even if no contact
- Striking on head/face when not challenging an opponent is a RC (unless negligible)
- Offence against substitutes, team officials, match officials etc. is now a direct FK
- Foul off the field penalised with a direct FK on boundary line (penalty in own penalty area)

### **Law 13 – Free Kicks**

- Difference between ‘stopping’ a FK and ‘intercepting’ the ball after FK taken

### **Law 14 –The Penalty Kick**

- Indirect FK + YC if wrong player deliberately takes the penalty
- Indirect FK if ball kicked backwards
- If ‘illegal’ feinting occurs it is always an indirect FK (and YC)
- Goalkeeper YC if infringes and PK is retaken

### **Law 15 – The Throw-in**

- New wording makes it clear that ball must be thrown with both hands

### **Law 16 – The Goal Kick**

- If GK kicked into own goal it is a corner kick to opponents
- An opponent in the penalty area when the goal kick is taken can not play the ball first

### **Law 17 – The Corner Kick**

- If CK kicked into own goal it is a corner kick to opponents



IFAB®



# Details of all Law changes (in Law order)

The following are the main changes to the Laws of the Game which are not related to English/phraseology. For each change the old wording (where appropriate) and the new/changed wording are given followed by an explanation for the change.

The text shown in the 'old text' boxes may be the exact previous text or a more general outline of the meaning of the previous text.

## Law 01 – The Field of Play

### 01.1 Artificial and natural surfaces may not be combined

#### Old text

Matches may be played on natural or artificial surfaces, according to competition rules.

#### New text

The field of play must be a wholly natural or, if competition rules permit, a wholly artificial playing surface, except where competition rules permit an integrated combination of artificial and natural materials (hybrid system).

#### Explanation

Clarifies that for safety reasons mixing natural and artificial surfaces is not permitted on the field of play. A different surface is permitted on the surrounding areas e.g. artificial turf for the assistant referees' patrol area. An integrated mix of natural and artificial material is permitted.

**01.2** Competitions may determine length of boundary lines  
(within Law 1 parameters)

**Additional text**

Competitions may determine the length of the goal line and touchline within the above dimensions.

**Explanation**

Clarifies that competitions have the authority to determine the length of the touchlines and goal lines for their matches within the dimensions of Law 1.

**01.3** The technical area

**Explanation**

Technical area information moved from end of Laws section

**01.4** Goal Line Technology (GTL)

**Explanation**

Goal Line Technology (GLT) moved from Law 10

**01.5** Commercial advertising on the ground

**Old text**

No form of commercial advertising, whether real or virtual, is permitted on the field of play, on the ground within the area enclosed by the goal nets or the technical area, or within 1 m (1 yd) of the touchline from the time the teams enter the field of play...

**New text**

No form of commercial advertising, whether real or virtual, is permitted on the field of play, on the ground within the area enclosed by the goal nets or the technical area, or on the ground within 1 m (1 yd) of the boundary lines from the time the teams enter the field of play...

**Explanation**

Clarifies that restrictions on commercial advertising on the ground relate to the area behind the goal lines as well as the touchlines.

## 01.6 Logos and emblems on corner flags

### Old text

The reproduction, whether real or virtual, of representative logos or emblems of FIFA, confederations, member associations, leagues, clubs or other bodies is forbidden on the field of play, the goal nets and the areas they enclose, the goals, the flagposts and their flags during playing time.

### New text

The reproduction, whether real or virtual, of representative logos or emblems of FIFA, confederations, national football associations, competitions, clubs or other bodies is forbidden on the field of play, the goal nets and the areas they enclose, the goals, and the flagposts during playing time. They are permitted on the flags on the flagposts.

### Explanation

- **National football associations** replaces **member associations**
- **competitions** replaces **leagues** as cup competitions are not covered by the current wording.
- These logos are already widely used and allowing them on the flags is consistent with Law 2 which permits them on the ball.

## Law 02 – The Ball

None

## Law 03 – The Players

### 03.1 Title change

#### Old title

The Number of Players

#### New title

The Players

### Explanation

New title reflects that the content includes reference to substitutes etc.

**03.2** Minimum number of players**Old text**

A match may not start if either team consists of fewer than seven players. (...)although a match may not START if either team consists of fewer than seven players, the minimum number of players in a team required for a match to CONTINUE is left to the discretion of member associations. However, it is the opinion of the International F.A. Board that a match should not continue if there are fewer than seven players in either team.

**New text**

A match may not start or continue if either team has fewer than seven players.

**Explanation**

The IFAB recommendation of the minimum number of players for a match to continue becomes Law. This is consistent with the minimum to start the match.

**03.3** Restarts by substitutes**Old text**

A substitute who has not completed the substitution procedure by entering the field of play cannot restart play by taking a throw-in or corner kick.

**New text**

Substitutes can take any restart provided they first enter the field of play.

**Explanation**

Clarifies that a substitute who steps onto the field of play can then take any restart, including a corner kick or throw-in; some wrongly interpreted the 'old' wording as requiring play to be restarted before a substitute can take a restart.

### 03.4 Named substitute starts instead of named player

#### Old text

If a named substitute enters the field of play instead of a named player at the start of the match and the referee is not informed of this change:

- the referee allows the named substitute to continue the match(...)

#### New text

If a named substitute starts the match instead of a named player and the referee is not informed of this change:

- the referee allows the named substitute to continue the match(...)

#### Explanation

Clarifies that if a named player is 'replaced' by a substitute before the match, the player can be a substitute on arrival. More logical that this takes effect when the match kicks off rather than when the substitute enters the field.

### 03.5 Extra persons on the field of play – status of sent off player

#### Old text

Anyone not indicated on the team list as a player, substitute or team official is deemed to be an outside agent, as is a player who has been sent off.

#### New text

Anyone not named on the team list as a player, substitute or team official is deemed to be an outside agent.

#### Explanation

It is more logical to treat a sent off player like a substitute so that a player who returns to the field (having been sent off) is penalised with a free kick.

### 03.6 Infringements by substitutes and team officials

#### Old text

If a substitute or substituted player enters the field of play without the referee's permission:

- if the referee has stopped play, it is restarted with an indirect free kick (...).

#### New text

If play is stopped and the interference was by:

- a team official, substitute, substituted or sent off player, play restarts with a direct free kick or penalty kick

If a team official enters the field of play:

- if the referee stops the match, he must restart play with a dropped ball(...).

**Explanation**

There is a growing problem of substitutes/team officials entering the field to interfere with play or an opponent, e.g. stopping a goal. This is clearly 'unfair' and a direct free kick (or penalty kick if in own penalty area) is more appropriate.

**03.7** Player who is sent off before or after kick-off

**Additional text**

A player who is sent off:

- before submission of the team list can not be named on the team list in any capacity
- after being named on the team list and before kick-off may be replaced by a named substitute (who can not be replaced)
- after the kick-off can not be replaced

**Explanation**

Clarifies whether a sent off player can be replaced.

**03.8** Impact of substitute/team official/outside agent touching a ball which is going into the goal

**Old text**

In the situations outlined in 3.6 above the referee must stop play if the 'intruder' interferes with play or touches the ball  
 If an outside agent enters the field of play:  
 • the referee must stop play (although not immediately if the outside agent does not interfere with play)

**New text**

If a ball is going into the goal and the interference does not prevent a defending player playing the ball, the goal is awarded if the ball enters the goal (even if contact was made with the ball) unless the ball enters the opponents' goal.

---

## Explanation

---

This **'fair play'** change means the referee can apply the advantage principle so that if the attempt to stop a goal is unsuccessful the referee can award the goal (See 3.9)

---

### 03.9 Goal scored with an extra person on the field of play

---

#### Old text

If, after a goal is scored, the referee realises, before play restarts, that there was an extra person on the field of play when the goal was scored:

- the referee must disallow the goal if:
  - the extra person was an outside agent and he interfered with play
  - the extra person was a player, substitute, substituted player or team official associated with the team that scored the goal

#### New text

If, after a goal is scored, the referee realises, before play restarts, that there was an extra person(s) on the field of play when the goal was scored:

- the referee must disallow the goal if the extra person was:
  - a player, substitute, substituted player, sent off player or team official of the team that scored the goal
  - an outside agent who interfered with play unless a goal results as outlined above in 'extra persons on the field of play';

Play is restarted with a goal kick or a corner kick.

If, after a goal is scored and play has restarted, the referee realises an extra person was on the field of play when the goal was scored, the goal can not be disallowed. If the extra person is still on the field the referee must:

- stop play
- have the extra person removed
- restart with a dropped ball or indirect free kick as appropriate

The referee must report the incident to the appropriate authorities.

---



**Explanation**

- Incorporates principle outlined in 3.8 (above)
- Clarifies how to restart if a goal is scored when there is an extra person on the field and play has not restarted.
- Clarifies that if a goal was scored when there was an extra person on the field and play has restarted the referee has to allow the game to continue; the referee can not disallow the goal or 'nullify' the period between the goal and the discovery of the extra person.

**03.10** Reference to team captain (from Law 12)

**Additional text**

The team captain has no special status or privileges but has a degree of responsibility for the behaviour of the team.

**Explanation**

More logical to have this statement in Law 3 rather than Law 12.

**Law 04 – The Players' Equipment**

**04.1** Tape/material on/covering socks

**Old text**

The compulsory equipment of a player comprises the following(...)

- stockings – if tape or similar material is applied externally it must be the same colour as that part of the sock it is applied to

**New text**

- socks – tape or any material applied or worn externally must be the same colour as that part of the sock it is applied to or covers

**Explanation**

Clarifies that non-tape material must be the same colour as the sock it covers as some players wear ankle socks (or similar) which are a different colour to the sock.

#### 04.2 Loss of footwear and shinguard

##### Old text

If a player loses his footwear accidentally and immediately plays the ball and/or scores a goal, (...) (...) the goal is awarded.

##### New text

A player whose footwear or shinguard is accidentally lost must replace it as soon as possible and no later than when the ball next goes out of play; if, before doing so, the player plays the ball and/or scores a goal, the goal is awarded.

##### Explanation

It is clearer to specify that footwear must be replaced quickly and no later than when the ball next goes out of play. It is logical to apply the principle to shinguards.

#### 04.3 Colour of undergarments

##### Old text

The basic compulsory equipment of a player comprises the following separate items:

- a jersey or shirt with sleeves – if undergarments are worn, the colour of the sleeve must be the same main colour as the sleeve of the jersey or shirt
- shorts – if undershorts or tights are worn, they must be of the same main colour as the shorts

##### New text

The compulsory equipment of a player comprises the following separate items:

- a shirt with sleeves
- shorts

Undershirts must be the same colour as the main colour of the shirt sleeve; undershorts/tights must be the same colour as the main colour of the shorts or the lowest part of the shorts – players of the same team must wear the same colour.

##### Explanation

- **Undershirts** replaces **undergarments**.
- Manufacturers now make shorts with a different coloured lower part (hem). Law change gives the choice of the undershorts/tights being the same colour as the shorts or the 'hem' but the team must all wear the same colour.

**04.4 Caps****Old text**

Non-dangerous protective equipment(...) is permitted as are sports spectacles.

**New text**

Non-dangerous protective equipment(...) is permitted as are goalkeepers' caps and sports spectacles.

**Explanation**

Reference to goalkeepers' caps included so their use is permitted within the Laws.

**04.5 Electronic communication with players (including substitutes)****Old text**

The use of any form of electronic communication systems between players and/or technical staff is not permitted.

**New text**

The use of any form of electronic communication between players (including substitutes/substituted players) and/or technical staff is not permitted.

**Explanation**

Clarifies that electronic communication with substitutes is not permitted.

**04.6 Player returning after changing/correcting equipment****Old text**

In the event of any infringement of this Law(...):

- any player required to leave the field of play to correct his equipment must not re-enter without the referee's permission
- the referee checks that the player's equipment is correct before allowing him to re-enter the field of play
- the player is only allowed to re-enter the field of play when the ball is out of play

**New text**

A player who leaves the field of play to correct or change equipment must:

- have the equipment checked by a match official before being allowed to re-enter
- only re-enter with the referee's permission (which may be given during play)

---

## Explanation

---

Law was unclear about whether a player who chooses to leave the field of play (e.g. to change boots) can return during play. New wording allows the fourth official/assistant referee to check the equipment and, regardless of the reason for leaving the field, the player is treated the same as if returning after an injury. This is better for the game and reduces conflict/irritation.

## Law 05 – The Referee

### 05.1 Decisions of the referee – opinion and discretion

---

#### Additional text

---

Decisions will be made to the best of the referee's ability according to the Laws of the Game and the 'spirit of the game' and will be based on the opinion of the referee who has the discretion to take appropriate action within the framework of the Laws of the Game.

---

## Explanation

---

Throughout the Laws, there is reference to 'in the opinion of the referee' and 'at the discretion of the referee' so this statement removes the need to use 'in the opinion of/at the discretion of' regularly. The concept of the 'spirit of the game' now appears in the Laws.

### 05.2 Decisions of the referee – when decisions can not be changed

---

Old text	New text
The referee may only change a decision on realising that it is incorrect or, at his discretion, on the advice of an assistant referee or the fourth official, provided that he has not restarted play or terminated the match.	The referee may not change a decision on realising that it is incorrect or on the advice of another match official if play has restarted <u>or the referee has signalled the end of the first or second half (including extra time when played) and left the field</u> or terminated the match.

## Explanation

---

Clarifies that once the referee signals the end of a half and leaves the field a decision can not be changed even if information then comes to light e.g. during the half-time interval.

---

**05.3** Several offences committed at the same time

Old text	New text
<ul style="list-style-type: none"> <li>• punishes the more serious offence when a player (or players from the same team) commits more than one offence at the same time</li> <li>• Offences committed by players from different teams: the referee must stop play and restart it with a dropped ball.</li> </ul>	<ul style="list-style-type: none"> <li>• <u>punishes the more serious offence, in terms of sanction, restart, physical severity and tactical impact, when more than one offence occurs at the same time.</u></li> </ul>

**Explanation**

It should not matter if it is one or several players or from which team(s) as the most serious offence should be penalised. Same change included in Law 14.

**05.4** Authority to take disciplinary action from pre-match inspection of the field (see 12.8)

Old text	New text
<p>The referee has the authority to take disciplinary sanctions from the moment he enters the field of play until he leaves the field of play after the final whistle</p>	<ul style="list-style-type: none"> <li>• has the authority to take disciplinary action from entering the field of play <u>for the pre-match inspection</u> until leaving the field of play after the <u>match ends (including kicks from the penalty mark)</u>. <u>If, before entering the field of play at the start of the match, a player commits a sending-off offence, the referee has the authority to prevent the player taking part in the match (see Law 3.6); the referee will report any other misconduct.</u></li> </ul>

---

## Explanation

---

New wording identifies exactly when the referee's authority to take action starts. The current Law 12 wording relates to when there was no pre-match warming up, teams did not enter the field together etc. It is logical that if, for example, two players have a fight in the tunnel, or in the pre-match warm up, they can not be allowed to play as this would risk match control and not be good for the image of the game.

During the inspection of the field of play the referee can have the markings changed etc., so it is logical that this is when the authority to 'send off' a player starts. Non-sending-off offences will be reported so YCs cannot be issued prior to the match or carried into the match (See also 12.8).

---

### 05.5 Authority to show red and yellow cards

---

#### Old text

The referee has the power to show yellow or red cards during the half-time interval and after the match has finished as well as during extra time and kicks from the penalty mark, since the match remains under his jurisdiction at these times.

#### New text

- has the power to show yellow or red cards from entering the field of play at the start of the match until after the match has ended, including during the half-time interval, extra time and kicks from the penalty mark

---

## Explanation

---

Clarifies (in light of 5.4) that the referee may only use red and yellow cards from entering the field of play at the start of the match.

---

### 05.6 Player may have quick on-field assessment/treatment after YC/RC offence

---

#### Old text

The referee... ..stops the match if, in his opinion, a player is seriously injured and ensures that the player is removed from the field of play. An injured player may not be treated on the field and may only return after the match has restarted (...)

Exceptions to the requirement to leave the field are only when:

- a goalkeeper is injured

- a goalkeeper and an outfield player have collided and need immediate attention
- players from the same team have collided and need immediate attention
- a severe injury has occurred

---

**Additional text**

- a player is injured as the result of a physical offence for which the opponent is cautioned or sent off (e.g. reckless or serious foul challenge), if the assessment/treatment is completed quickly

---

**Explanation**

It is widely seen as unfair that a player who is injured by a serious foul and the trainer/doctor comes on, the player has to leave the field giving the offending team a numerical benefit (see Practical Guidelines).

---

**05.7 Impact of an outside agent touching a ball which is going into the goal**

**Old text**

An extra ball, other object or animal enters the field of play during the match, the referee must:

- stop play only if it interferes with play. Play must be restarted with a dropped ball

**New text**

an extra ball, other object or animal enters the field of play during the match, the referee must:

- stop play (and restart with a dropped ball) only if it interferes with play unless the ball is going into the goal and the interference does not prevent a defending player playing the ball, the goal is awarded if the ball enters the goal (even if contact was made with the ball) unless the ball enters the opponents' goal.

---

**Explanation**

This makes Law 5 consistent with the change in Law 3 (see 3.8).

## 05.8 Referee's equipment

### Additional text

#### Compulsory equipment

- Whistle(s)
- Watch(es)
- Red and yellow cards
- Notebook (or other means of keeping a record of the match)

#### Other equipment

Referees may be permitted to use:

- Equipment for communicating with other match officials – buzzer/beep flags, headsets etc(...)
- EPTS or other fitness monitoring equipment

Referees and other match officials are prohibited from wearing jewellery or any other electronic equipment.

### Explanation

Moved from Law 4; wording clarifies what equipment a match official is or may be permitted to use.

## Law 06 – The Other Match Officials

### 06.1 Title change

Old title	New title
The Assistant Referee	<u>The Other Match Officials</u>

### Explanation

The duties of all the other match officials (assistant referees, fourth official, additional assistant referees and reserve assistant referee) are now included in this Law.

### 06.2 Referee's authority over other match officials

#### Additional text

The match officials operate under the direction of the referee.



**Explanation**

Emphasises the referee's leadership role.

**06.3 Assistance given to the referee by other match officials**

**Additional text**

The match officials assist the referee with inspecting the field of play, the balls and players' equipment (including if problems have been resolved) and maintaining records of time, goals, misconduct etc(...).

**Explanation**

Statement early in the Law of the usual assistance given to the referee avoids repetition in sections on each match official

**06.4 Procedure if an official is unable to officiate**

**Old text**

Prior to the start of the competition, the organiser states clearly whether, if the referee is unable to continue, the fourth official takes over as the referee or whether the senior assistant referee or senior additional assistant referee takes over as referee with the fourth official becoming an assistant referee

**New text**

Competition rules must state clearly who replaces a match official who is unable to start or continue and any associated changes. In particular, it must be clear whether, if the referee is unable to start or continue, the fourth official or the senior assistant referee or senior additional assistant referee takes over

**Explanation**

Wording simplified so each scenario does not need to be listed.

**06.5 Duties of the fourth official**

**Additional text**

A fourth official (...) assists the referee at all times:

- checking a player's/ substitute's equipment (...)
- indicating the minimum amount of additional time the referee intends to play at the end of each half (including extra time).

---

## Explanation

Tasks usually performed by fourth officials have been added.

## Law 07 – The Duration of the Match

### 07.1 Additional time

#### Additional text

Allowance is made by the referee in each half for all time lost in that half through:

- assessment and/or removal from the field of play of injured players (...)
- stoppages for drinks or other medical reasons permitted by competition rules

---

## Explanation

These frequent causes of additional time have been added. In particular, approved 'drinks breaks' have been added so that they have validity within the Laws.

## Law 08 – The Start and Restart of Play

### 08.1 Inclusion of reference to all restarts

#### Additional text

Free kicks (direct or indirect), penalty kicks, throw-ins, goal kicks and corner kicks are other restarts (see Laws 13 to 17)

---

## Explanation

Illogical (especially to non-referees) that the Law about restarts only included the kick-off and dropped ball so reference to other restarts of play has been added.

### 08.2 Infringements when the ball is not in play

#### Additional text

If an infringement occurs when the ball is not in play this does not change how play is restarted.

---

## Explanation

Clarifies that the restart is not changed for an incident when the ball is not in play e.g. holding before a corner kick; violent conduct after a FK is awarded etc.

---

**08.3** Kick-off: ball must clearly move to be in play; can be kicked in any direction**Old text**

The ball is in play when it is kicked and moves forward

**New text**

The ball is in play when it is kicked and clearly moves

**Explanation**

Not requiring the ball to go forward at the kick-off means an attacker does not need to stand in the opponents' half (which is not permitted) to receive the ball. As with other Laws, the ball must clearly move to stop the practice of a player just touching the ball and then unsportingly pretending the kick has not been taken.

**08.4** Dropped ball position**Additional text**

The referee drops the ball at the position where it was when play was stopped, unless play was stopped inside the goal area in which case the ball is dropped on the goal area line which is parallel to the goal line at the point nearest to where the ball was when play was stopped.

**Explanation**

Clear statement here removes the many other times this appears in the current Laws.

**08.5** Referee can not determine the drop ball contest**Old text**

The referee cannot decide who may or may not contest a dropped ball.

**New text**

Any number of players may contest a dropped ball (including the goalkeepers); the referee cannot decide who may contest the dropped ball or its outcome.

**Explanation**

Clarifies that referees should not 'manufacture' dropped ball situations.

## 08.6 Dropped ball kicked directly into the goal

### Old text

If the ball enters the goal (...) (...)directly (...).

### New text

If a dropped ball enters the goal without touching at least two players (...).

### Explanation

Replacing 'directly' with 'without touching at least 2 players' is clearer and consistent with wording in other Laws.

## Law 09 – The Ball In and Out of Play

### 09.1 Ball rebounding off a match official

#### Old text

The ball is in play at all other times, including when:

- it rebounds off a goalpost, crossbar or corner flagpost and remains in the field of play
- it rebounds off the referee or an assistant referee when they are on the field of play

#### New text

The ball is in play at all other times, including when:

- it rebounds off a match official, goalpost, crossbar or corner flagpost and remains in the field of play

### Explanation

Change confirms that the ball is still in play if it rebounds off an official who is just off the field of play (AR, AAR) and the ball does not wholly pass over the line.

## Law 10 – Determining the Outcome of a Match

### 10.1 Title change

#### Old title

The Method of Scoring

#### New title

Determining the Outcome of a Match

### Explanation

Kicks from the Penalty Mark, Away goals, etc. now included in this Law.

**10.2.1** Choosing the goal for the kicks from the penalty mark (KFPM)**Old text**

The referee chooses the goal at which the kicks will be taken.  
The penalty area where the kicks from the penalty marks are taking place may be changed only if the goal or the playing surface becomes unusable.

**New text**

Unless there are other considerations (e.g. ground conditions, safety etc..) the referee tosses a coin to decide the goal at which the kicks will be taken which may only be changed for safety reasons or if the goal or playing surface becomes unusable.

**Explanation**

Referees find it difficult to decide which goal to use with home supporters at one end and away supporters at the other end. Subject to over-riding considerations (security, condition of the field etc...) the fairest method is to toss a coin.

**10.2.2** Eligible players (including those temporarily off the field)**Old text**

With the exception of the foregoing case, only players who are on the field of play at the end of the match, which includes extra time where appropriate, are eligible to take kicks from the penalty mark.

**New text**

With the exception of a substitute for an injured goalkeeper, only players who are on the field of play or are temporarily off the field (injury, adjusting equipment etc...) at the end of the match are eligible to take kicks from the penalty mark.

**Explanation**

Clarifies that a player temporarily off the field legitimately (injury, changing equipment etc...) can take part, as can a substitute who replaces a goalkeeper.

**10.2.3** Naming and order of penalty taker**Old text**

Each team is responsible for selecting the players from those on the field of play at the end of the match and the order in which they will take the kicks.

**New text**

Each team is responsible for selecting from the eligible players the order in which they will take the kicks. The referee is not informed of the order.

---

## Explanation

---

Clarifies that the names and/or the order of the kickers do not have to be given to the referee (some incorrectly ask for the names and stop the order being changed).

---

### 10.2.4 Same number of players

---

#### Old text

If at the end of the match and before the kicks start to be taken from the penalty mark one team has a greater number of players than its opponents, it must reduce its numbers to equate with that of its opponents and the captain must inform the referee of the name and number of each player excluded. If a player is injured or sent off during the taking of kicks from the penalty mark and the team has one player fewer, the referee should not reduce the number of players taking kicks for the other team. An equal number of players from each team is required only at the start of the taking of kicks from the penalty mark.

#### New text

If at the end of the match and before or during the kicks one team has a greater number of players than its opponents, it must reduce its numbers to the same number as its opponents and the referee must be informed of the name and number of each player excluded.

---

## Explanation

---

This applies the 'fair play' principle at the start of KFPM i.e. one team should not benefit from having fewer kickers than their opponents as this could mean their 'best' kicker taking a 2nd kick against the opponents' last/worst kicker.

---

**10.2.5** Goalkeeper unable to continue

**Old text**

A goalkeeper who is injured while kicks are being taken from the penalty mark and is unable to continue as goalkeeper may be replaced by a named substitute provided his team has not used the maximum number of substitutes permitted under the competition rules

**New text**

A goalkeeper who is unable to continue before or during the kicks and whose team has not used its maximum permitted number of substitutes, may be replaced by a named substitute, or a player excluded to equalise the number of players, but the goalkeeper takes no further part and may not take a kick.

**Explanation**

Clarifies that a goalkeeper can be replaced at any time by a substitute (or by a player excluded to make the numbers equal) but may not take a kick.

**10.2.6** When penalty is completed (see 14.3)

**Additional text**

The kick is completed when the ball stops moving, goes out of play or the referee stops play for any infringement of the Laws.

**Explanation**

Clarifies when a referee should decide a kick is over (see 14.3).

**10.2.7** Sequence of kickers

**Additional text**

- Each kick is taken by a different player and all eligible players must take a kick before any player can take a second kick
- The above principle continues for any subsequent sequence of kicks but a team may change the order of kickers

**Explanation**

Clarifies that all team members must take the same number of kicks before a player can take another kick; the order can be changed for the new 'round' of kicks.

## 10.2.8 Player leaving the field of play

### Additional text

Kicks from the penalty mark must not be delayed for a player who leaves the field of play. The player's kick will be 'forfeited' (not scored) if the player does not return in time to take a kick.

### Explanation

Clarifies that the referee must not delay KFPM if a player leaves the field of play; if the player is not back in time the kick is missed (forfeited). It is important to stop this potentially unfair conduct (instructions from the coach, deliberate delay, match fixing etc.).

## Law 11 – Offside

### 11.1 Status of halfway line

#### Old text

A player is not in an offside position if:

- he is in his own half of the field of play or (...).

#### New text

A player is in an offside position if:

- any part of the head, body or feet is in the opponents' half (excluding the halfway line)

### Explanation

Clarifies that the halfway line is 'neutral' for offside i.e. a player must have part of the body in the opponents' half to be in an offside position.

### 11.2 Status of players' arms

#### Additional text

A player is in an offside position if:

- any part of the head, body or feet is nearer to the opponents' goal line than both the ball and the second-last opponent. The hands and arms of all players, including the goalkeepers, are not included.

### Explanation

Clarifies that the hands and arms of the defenders, attackers and goalkeepers are not included when judging offside.



**11.3** Position not offence judged at the moment the ball is played**Old text**

A player in an offside position is only penalised if, at the moment the ball touches or is played by one of his team, he is, in the opinion of the referee, involved in active play by...

**New text**

A player in an offside position at the moment the ball is played or touched by a team-mate is only penalised on becoming involved in active play by...

**Explanation**

Clarifies that it is the player's (offside) position which is judged when the ball is played. The offence occurs after the ball is played e.g. an offside player who scores after a save by the goalkeeper commits the offence after the ball was played.

**11.4** Offence following a rebound or save**Old text**

gaining an advantage by being in that position by playing a ball:

- that rebounds or is deflected to him off the goalpost, crossbar or an opponent
- (...) from a deliberate save by any opponent

**New text**

gaining an advantage by being in that position by playing the ball or interfering with an opponent when it has:

- rebounded or been deflected off the goalpost, crossbar or an opponent
- been deliberately saved by any opponent

**Explanation**

Clarifies that 'interfering with an opponent' after a rebound, deflection or save is an offside offence.

**11.5** Position of free kick**Old text**

**p. 36** In the event of an offside offence, the referee awards an indirect free kick to the opposing team to be taken from the place where the infringement occurred;.

**New text**

If an offside offence occurs, the referee awards an indirect free kick where the offence occurred, including if it is in the player's own half of the field of play.

**p. 111** When an offside offence occurs, the referee awards an indirect free kick to be taken from the position of the offending player when the ball was last played to him by one of his team-mates

### Explanation

The Law and the interpretation were contradictory. Throughout the Laws, the general principle is that a FK is awarded where an offence occurs so this now applies to offside. A FK can be awarded in a player's own half if the player moves from an offside **position** in the opponents' half to commit an offside **offence** in the player's own half.

## 11.6 Defending player off the field

### Old text

Any defending player leaving the field of play for any reason without the referee's permission shall be considered to be on his own goal line or touch line for the purposes of offside until the next stoppage in play. If the player left the field of play deliberately, he must be cautioned when the ball is next out of play.

### New text

A defending player who leaves the field of play without the referee's permission shall be considered to be on the goal line or touchline for the purposes of offside until the next stoppage in play or until the defending team has played the ball towards the halfway line and it is outside their penalty area. If the player left the field of play deliberately, the player must be cautioned when the ball is next out of play.

### Explanation

It is unfair that an injured defending player off the field 'plays everyone inside' until play stops. The new wording defines the end of the phase of play when the defender is no longer considered to be on the field for the purposes of offside.

**11.7** Attacking player off the field**Old text**

It is not an offence in itself for a player who is in an offside position to step off the field of play to show the referee that he is not involved in active play. However, if the referee considers that he has left the field of play for tactical reasons and has gained an unfair advantage by re-entering the field of play, the player must be cautioned for unsporting behaviour. The player needs to ask for the referee's permission to re-enter the field of play.

**New text**

An attacking player may step or stay off the field of play not to be involved in active play. If the player re-enters from the goal line and becomes involved in play before the next stoppage in play or the defending team has played the ball towards the halfway line and it is outside their penalty area, the player shall be considered to be positioned on the goal line point for the purposes of offside. A player who deliberately leaves the field of play and re-enters without the referee's permission and is not penalised for offside and gains an advantage, must be cautioned.

**Explanation**

Clarifies how to deal with an attacking player who leaves or stays off the field of play and then returns.

**11.8** Attacking player in the goal**Old text**

If an attacking player remains stationary between the goalposts and inside the goal net as the ball enters the goal, a goal must be awarded. However, if(...) (...) the attacking player distracts an opponent, the goal must be disallowed, the player cautioned for unsporting behaviour and play restarted with a dropped ball(...).

**New text**

If an attacking player remains stationary between the goalposts and inside the goal as the ball enters the goal, a goal must be awarded unless the player commits an offside offence or Law 12 offence in which case play is restarted with an indirect or direct free kick.

---

## Explanation

Consistent with updated offside wording (i.e. removal of 'distracts') and the ability to penalise an offence off the field with a free kick when the ball is in play.

---

## Law 12 – Fouls and Misconduct

### 12.1 Infringements when the ball is not in play

#### Additional text

Direct and indirect free kicks and penalty kicks can only be awarded for fouls and misconduct committed whilst the ball is in play.

---

## Explanation

A definitive statement (from the interpretations section) that the ball must be in play for misconduct to be penalised with a free kick or penalty kick.

---

### 12.2 Direct free kick – add 'challenges'

#### Old text

A direct free kick is awarded to the opposing team if a player commits any of the following seven offences in a manner considered by the referee to be careless, reckless or using excessive force

- tackles an opponent

#### New text

A direct free kick is awarded if a player commits any of the following offences in a manner considered by the referee to be careless, reckless or using excessive force

- tackles or challenges an opponent.

---

## Explanation

'tackles' implies a challenge with the foot but some challenges can be with other parts of the body (e.g. knee) and technically were not covered.

---

### 12.3 Contact means direct free kick

#### Additional text

If an offence involves contact it is penalised by a direct free kick or penalty kick.

---

## Explanation

Clarifies that a direct free kick must be awarded if an offence involves contact.

---

**12.4** Reckless – removal of ‘complete’ from definition**Old text**

Reckless means that the player has acted with complete disregard to the danger to, or consequences for, his opponen(...) (...) must be cautioned.

**New text**

Reckless is when a player acts with disregard to the danger to, or consequences for, an opponent and must be cautioned.

**Explanation**

There were legal concerns about the meaning /relevance of ‘complete’.

**12.5** Serious foul play– removal of ‘far’ from definition**Old text**

Using excessive force means that the player has far exceeded the necessary use of force and is in danger of injuring his opponent(...) (...) must be sent off.

**New text**

Using excessive force is when a player exceeds the necessary use of force and endangers the safety of an opponent and must be sent off.

**Explanation**

There were legal concerns about the meaning/relevance of ‘far’.

**12.6** Direct free kick – add ‘impedes an opponent with contact’**Additional text**

A direct free kick is awarded if a player commits any of the following offences:

- impedes an opponent with contact

**Explanation**

Confirmation that impeding an opponent with contact is a direct free kick.

**12.7** Impeding without contact means indirect free kick**Old text**

An indirect free kick is also awarded to the opposing team if(...) (...) a player impedes the progress of an opponent.

**New text**

An indirect free kick is awarded if(...) a player impedes the progress of an opponent without any contact being made.

---

## Explanation

---

Confirmation that impeding an opponent without contact is an indirect free kick.

### 12.8 Authority to take disciplinary action from pre-match inspection of the field (see 5.4)

#### Old text

The referee has the authority to take disciplinary sanctions from the moment he enters the field of play until he leaves the field of play after the final whistle.

#### New text

The referee has the authority to take disciplinary action from entering the field of play for the pre-match inspection until leaving the field of play after the match ends (including kicks from the penalty mark).

If, before entering the field of play at the start of the match, a player commits a sending-off offence, the referee has the authority to prevent the player taking part in the match (see Law 3.6); the referee will report any other misconduct.

---

## Explanation

---

Same change as outlined and explained in Law 5 (see 5.4).

### 12.9 Advantage played for a red card offence and player then becomes involved

#### Additional text

Advantage should not be applied in situations involving serious foul play, violent conduct or a second cautionable offence unless there is a clear opportunity to score a goal. The referee must send off the player when the ball is next out of play but if the player plays the ball or challenges/interferes with an opponent, the referee will stop play, send off the player and restart with an indirect free kick.

---

**Explanation**

Clarifies that on the rare occasion that a referee plays advantage for a RC offence (only if a goal-scoring opportunity is imminent) if the RC player then becomes involved in play, the game must be stopped as it would be against 'fair play' if the player scored, contributed to a goal or stopped the opponents scoring.

**12.10 Cautions for handball**

**Old text**

There are different circumstances when a player must be cautioned for unsporting behaviour, e.g. if a player:

- commits a foul for the tactical purpose of interfering with or breaking up a promising attack
- holds an opponent for the tactical purpose of pulling the opponent away from the ball or preventing the opponent from getting to the ball
- handles the ball to prevent an opponent gaining possession or developing an attack
- handles the ball in an attempt to score a goal (irrespective of whether or not the attempt is successful)

**New text**

There are different circumstances when a player must be cautioned for unsporting behaviour, e.g. if a player:

- commits a foul or handles the ball to interfere with or stop a promising attack
- handles the ball in an attempt to score a goal (whether or not the attempt is successful) or in an unsuccessful attempt to prevent a goal

**Explanation**

- 'Preventing an opponent gaining possession' is removed as a YC offence as it causes some referees to YC every handball.
- Handling is included as a YC offence when it 'stops/interferes with a promising attack' (as with other offences which have the same effect).
- Clarifies that a player who tries unsuccessfully to handle the ball to stop a goal being scored should receive a YC.

## 12.11 Denial of an obvious goal-scoring opportunity in the penalty area

### Additional text

Where a player denies the opposing team a goal or an obvious goal-scoring opportunity by a deliberate handball offence the player is sent off wherever the offence occurs.

Where a player commits an offence against an opponent within their own penalty area which denies an opponent an obvious goal-scoring opportunity and the referee awards a penalty kick, the offending player is cautioned unless:

- The offence is holding, pulling or pushing or
- The offending player does not attempt to play the ball or there is no possibility for the player making the challenge to play the ball or
- The offence is one which is punishable by a red card wherever it occurs on the field of play (e.g. serious foul play, violent conduct etc.)

In all the above circumstances the player is sent off.

### Explanation

When a DOGSO offence is committed by a defender in the penalty area, the penalty kick effectively restores the goal-scoring opportunity so the punishment for the player should be less strong (a YC) than when the offence is committed outside the penalty area. However, where the offence is handball or clearly not a genuine attempt to play or challenge for the ball (as defined in the wording) the player will be sent off.

## 12.12 Serious foul play – inclusion of ‘challenge’

### Old text

A tackle that endangers the safety of an opponent must be sanctioned as serious foul play.

### New text

A tackle or challenge that endangers the safety of an opponent must be sanctioned as serious foul play.

### Explanation

Same change as in 12.2 – ‘challenge’ includes offences with the arms, elbows etc.



**12.13** Violent Conduct – no contact**Old text**

A player is guilty of violent conduct if he uses excessive force or brutality against an opponent when not challenging for the ball or excessive force or brutality against a team-mate, spectator, match official or any other person.

**New text**

Violent conduct is when a player uses or attempts to use excessive force or brutality against an opponent when not challenging for the ball, or against a team-mate, team official, match official, spectator or any other person, regardless of whether contact is made.

**Explanation**

Clarifies that attempted violence is punished by a RC even if unsuccessful.

**12.14** Violent Conduct – contact with the head/face**Additional text**

In addition, a player who, when not challenging for the ball, deliberately strikes an opponent or any other person on the head or face with the hand or arm, is guilty of violent conduct unless the force used was negligible.

**Explanation**

Clarifies that a player who deliberately hits/strikes an opponent on the head/face (when not challenging for the ball) should be sent off (unless negligible force).

## 12.15 Offences against substitutes, team officials, match officials etc...

### Old text

If the ball is in play and a player commits an offence inside the field of play:

- against an opponent, play is restarted with a direct free kick from the position where the offence occurred (see Law 13 – Position of free kick) or a penalty kick (if inside the offending player's own penalty area)
- against a team-mate, play is restarted with an indirect free kick from the position where the offence occurred (see Law 13 – Position of free kick)
- against a substitute or substituted player, play is restarted with an indirect free kick from the position of the ball when play was stopped (see Law 13 – Position of free kick)
- against the referee or an assistant referee, play is restarted with an indirect free kick from the position where the offence occurred (see Law 13 – Position of free kick)
- against another person, play is restarted with a dropped ball from the position of the ball when play was stopped, unless play was stopped inside the goal area, in which case the referee drops the ball on the goal area line parallel to the goal line at the point nearest to where the ball was located when play was stopped

### New text

If the ball is in play and a player commits an offence inside the field of play against:

- an opponent - indirect or direct free kick or penalty kick
- a team-mate, substitute, substituted player, team official or a match official – a direct free kick or penalty kick
- any other person – a dropped ball

**Explanation**

The punishment for an offence against another participant reflects the seriousness of such an action e.g. football sends out a weak/poor message if an offence against a match official is only an indirect free kick.

**12.16** Fouls off the field of play (see 13.3 + 14.1)

**Old text**

If the ball is in play and the offence occurred outside the field of play...

- if the player leaves the field of play to commit the offence, play is restarted with an indirect free kick from the position of the ball when play was stopped (see Law 13 – Position of free kick)

**New text**

If the ball is in play and the offence occurred outside the field of play(...) However, if a player leaves the field of play as part of play and commits an offence against another player, play is restarted with a free kick taken on the boundary line nearest to where the offence occurred; for direct free kick offences a penalty kick is awarded if this is within the offender’s penalty area.

**Explanation**

Law is changed as football would expect that if 2 players leave the field as part of normal action and one fouls the other off the field, a free kick should be awarded. No one would understand if the referee gave a RC/YC and then restarted with a dropped ball (or IDFK). The FK is awarded on the touchline/goal line nearest to where the foul occurred; if this is on the goal line in the offender’s penalty area a penalty is awarded.

**Law 13 – Free Kicks**

**13.1** Free kicks are awarded to the opposing team

**Old text**

Free kicks are direct or indirect.

**New text**

Direct and indirect free kicks are awarded to the opposing team of a player guilty of an offence or infringement.

---

**Explanation**

Stating that a free kick is awarded to the opposing team at the start of the Law allows the removal of the many uses of the phrase 'to the opposing team'.

---

**13.2** Position of free kicks**Addition text**

All free kicks are taken from the place where the infringement occurred except:

---

**Explanation**

Clear statement at the start of this Law allows the removal of specific reference to the position of the free kick in many of the Laws.

---

**13.3** Fouls off the field of play**Old text**

Free kicks awarded for offences involving a player entering, re-entering or leaving the field of play without permission are taken from the position of the ball when play was stopped.

**New text**

Free kicks for offences involving a player entering, re-entering or leaving the field of play without permission are taken from the position of the ball when play was stopped. However, if a player leaves the field of play as part of play and commits an offence against another player, play is restarted with a free kick taken on the boundary line nearest to where the offence occurred; for direct free kick offences, a penalty kick is awarded, if this is within the offender's penalty area.

---

**Explanation**

Consistent with change outlined in 12.16 and 14.1.

---

**13.4** Ball must clearly move to be in play**Old text**

The ball is in play when it is kicked and moves.

**New text**

The ball is in play when it is kicked and clearly moves...

**Explanation**

Change consistent with kick-off (8.3), penalty kick (14.2) and corner kick (17.2).

**13.5** Stopping/intercepting free kicks**Old text**

If a player decides to take a free kick quickly and an opponent who is near the ball deliberately prevents him taking the kick, the referee must caution the player for delaying the restart of play. If a player decides to take a free kick quickly and an opponent who is less than 9.15 m (10 yds) from the ball intercepts it, the referee must allow play to continue.

**New text**

If a player takes a free kick quickly and an opponent who is less than 9.15 m (10 yds) from the ball intercepts it, the referee allows play to continue. However, an opponent who deliberately prevents a free kick being taken must be cautioned for delaying the restart of play.

**Explanation**

Paragraphs reversed; clearer distinction between 'preventing' a free kick being taken and 'intercepting' a quick free kick after it has been taken.

**Law 14 – The Penalty Kick****14.1** Penalty for foul off the field of play (see 12.16 + 13.3)**Old text**

A penalty kick is awarded against a team that commits one of ten offences for which a direct free kick is awarded inside his own penalty area.

**New text**

A penalty kick is awarded if a player commits a direct free kick offence inside their penalty area or off the field as part of play as outlined in Laws 12 and 13.

---

## Explanation

---

Repeat of Law 12 and 13 changes that a penalty is awarded for an offence by a defender off the field of play with the ball in play if the nearest point to the offence is inside their own penalty area.

---

### 14.2 Stationary position and movement of the ball

---

#### Old text

The ball:

- must be placed on the penalty mark
- The ball is in play when it is kicked and moves

#### New text

The ball:

- must be stationary on the penalty mark
  - The ball is in play when it is kicked and clearly moves
- 

## Explanation

---

Consistent with other changes.

---

### 14.3 When penalty is completed (see 10.2.6)

---

#### Additional text

The penalty kick is completed when the ball stops moving, goes out of play or the referee stops play for any infringement of the Laws.

---

## Explanation

---

Clarifies when a penalty kick is over.

---

### 14.4 Some offences are always punished with an indirect free kick

---

#### Old text

If the referee gives the signal for a penalty kick to be taken and, before the ball is in play, one of the following occurs:  
the player taking the penalty kick infringes the Laws of the Game:

#### New text

Once the referee has signalled for a penalty kick to be taken, the kick must be taken. If, before the ball is in play, one of the following occurs:  
the player taking the penalty kick or a team-mate infringes the Laws of the Game:

---

- the referee allows the kick to be taken
- if the ball enters the goal, the kick is retaken
- if the ball does not enter the goal, the referee stops play and the match is restarted with an indirect free kick to the defending team from the place where the infringement occurred

the goalkeeper infringes the Laws of the Game:

- the referee allows the kick to be taken
- if the ball enters the goal, a goal is awarded
- if the ball does not enter the goal, the kick is retaken

a team-mate of the player taking the kick infringes the Laws of the Game:

- the referee allows the kick to be taken
- if the ball enters the goal, the kick is retaken
- if the ball does not enter the goal, the referee stops play and the match is restarted with an indirect free kick to the defending team from the place where the infringement occurred

a team-mate of the goalkeeper infringes the Laws of the Game:

- the referee allows the kick to be taken
- if the ball enters the goal, a goal is awarded
- if the ball does not enter the goal, the kick is retaken

- if the ball enters the goal, the kick is retaken
- if the ball does not enter the goal, the referee stops play and restarts with an indirect free kick

except for the following offences/ infringements when play will be stopped and restarted with an indirect free kick regardless of whether or not a goal is scored:

- a team-mate of the identified kicker takes the kick; the referee cautions the player who took the kick
- a penalty kick is kicked backwards;
- feinting to kick the ball once the kicker has completed the run-up (feinting in the run-up is permitted); the referee cautions the kicker

---

**Explanation**

Emphasises that the standard re-take/goal/indirect free kick decision does not apply to these situations, especially the wrong player taking the kick or 'illegal' feinting which are 'deliberate' acts of unsporting behaviour

---

**14.5 Offences by the goalkeeper****Additional text**

If the ball does not enter the goal the kick is retaken; the goalkeeper is cautioned if responsible for the infringement

---

**Explanation**

As the Law has been changed to deal more strongly with a penalty kicker who 'illegally feints', it is consistent that a goalkeeper who infringes the Law causing a retake is cautioned. This should encourage goalkeepers not to infringe this Law.

---

**14.6 Several offences committed at the same time****Old text**

a player of both the defending team and the attacking team infringes the Laws of the Game the kick is retaken

**New text**

a player of both teams infringes the Laws of the Game the kick is retaken unless a player commits a more serious offence (e.g. illegal feinting)

---

**Explanation**

Repeat of change in Law 5 where the more serious is penalised (See 5.3).

---



**Law 15 – The Throw-in****15.1** Ball is thrown with both hands**New text**

At the moment of delivering the ball, the thrower must:

- face the field of play
- have part of each foot either on the touch line or on the ground outside the touch line
- throws the ball with both hands from behind and over the head from the point where it left the field of play

**Explanation**

- **throws** is a more logical word to use than **delivers**
- combining bullet points 3 and 4 emphasises that the 'one handed' foul throw (ball thrown with one hand and guided with the other) is not permitted.

**15.2** Encroaching within 2m (2yds)**Old text**

If an opponent unfairly distracts or impedes the thrower

- he is cautioned for unsporting behaviour

**New text**

An opponent who unfairly distracts or impedes the thrower (including moving closer than 2m (2 yds) from the place where the throw-in is to be taken) is cautioned for unsporting behaviour and if the throw-in has been taken an indirect free kick is awarded.

**Explanation**

Clarifies that not respecting the 2m (2yds) distance is considered unfairly distracting or impeding and an IDFK is the restart if the throw-in has been taken.

## Law 16 – The Goal Kick

### 16.1 Corner kick if kicked directly into own goal

#### Additional text

- A goal may be scored directly from a goal kick but only against the opposing team; if the ball directly enters the kicker's goal a corner kick is awarded to the opponents if the ball left the penalty area.

#### Explanation

Clarifies the correct restart if a player scores an 'own goal' directly from a goal kick (e.g. in strong wind).

### 16.2 Ball must be stationary

#### New text

- The ball must be stationary and is kicked from any point within the goal area by a player of the defending team

#### Explanation

Clarifies that the ball must be stationary as this was not in the 'old' wording.

### 16.3 Attacker in the penalty area

#### Additional text

- If an opponent who is in the penalty area when the goal kick is taken touches or challenges for the ball before it has touched another player, the goal kick is retaken.

#### Explanation

Clarifies that any opponent(s) in the penalty area when the goal kick is taken can not touch/challenge for the ball until another player has touched it so that the player does not gain an advantage from having not left the penalty area as required by Law.

## Law 17 – The Corner Kick

### 17.1 Corner kick if kicked directly into own goal

#### Additional text

- A goal may be scored directly from a corner kick but only against the opposing team; if the ball directly enters the kicker's goal a corner kick is awarded to the opponents.

#### Explanation

Clarifies correct restart if a player scores an 'own goal' directly from a corner kick.

### 17.2 Ball must be stationary and then clearly move to be in play

#### New text

- The ball must be placed in the corner area
- The ball must be stationary and is kicked by a player of the attacking team
- The ball is in play when it is kicked and clearly moves (...)

#### Explanation

- Area replaces 'arc'
- Clarifies that the ball must be stationary
- Reflects change to other Laws, but which is especially important for corner kicks to stop a player just touching the ball then unsportingly pretending that the corner has not been taken

# Glossary

The Glossary contains words/phrases which need clarification or explanation beyond the detail in the Laws and/or which are not always easily translated into other languages.

# Football Bodies

## **The IFAB – The International Football Association Board**

Body composed of the four British FAs and FIFA which is responsible for the Laws of the Game worldwide. In principle, changes to the Laws may only be approved at the Annual General Meeting usually held in February or March

## **FIFA – Fédération Internationale de Football Association**

The governing body responsible for football throughout the world

## **Confederation**

Body responsible for football in a continent. The six confederations are AFC (Asia), CAF (Africa), CONCACAF (North, Central America and Caribbean), CONMEBOL (South America), OFC (Oceania) and UEFA (Europe)

## **National Football Association**

Body responsible for football in a country

# Football terms

## A

### **Abandon**

To end/terminate a match before the scheduled finish

### **Advantage**

The referee allows play to continue when an offence has occurred if this benefits the non-offending team

### **Additional time**

Time allowed at the end of each half for time 'lost' because of substitutions, injuries, disciplinary action, goal celebration etc.

### **Assessment of injured player**

Quick examination of an injury, usually by a medical person, to see if the player requires treatment

### **Away goals rule**

Method of deciding a match/tie when both teams have scored the same number of goals; goals scored away from home count double

## B

**Brutality**

An act which is savage, ruthless or deliberately violent

## C

**Caution**

Official sanction which results in a report to a disciplinary authority; indicated by showing a yellow card; two cautions in a match result in a player being dismissed (sent off)

**Charge (an opponent)**

Physical challenge against an opponent, usually using the shoulder and upper arm (which is kept close to the body)

## D

**Deceive**

Act to mislead/trick the referee into giving an incorrect decision/disciplinary sanction which benefits the deceiver and/or their team

**Direct free kick**

A free kick from which a goal can be scored by kicking the ball directly into the opponents' goal

**Discretion**

Judgment used by a referee or other match official when making a decision

**Dismissal**

Another word for 'sending-off' (red card)

**Dissent**

Public disagreement (verbal and/or physical) with a match official's decision; punishable by a caution (yellow card)

**Distract**

Disturb, confuse or draw attention (usually unfairly)

**Dropped ball**

A 'neutral' method of restarting play – the referee drops the ball between players of both teams; the ball is in play when it touches the ground

**E****Electronic player tracking system (EPTS)**

System which records and analyses data about the physical and physiological performance of a player

**Endanger the safety of an opponent**

Put an opponent at danger or risk (of injury)

**Excessive force**

Using more force/energy than is necessary

**Extra time**

A method of trying to decide the outcome of a match involving two additional periods of play



## F

**Feinting**

An action which attempts to confuse an opponent. The Laws define permitted and 'illegal' feinting

**Field of play (Pitch)**

The playing area confined by the touchlines and goal lines and goal nets where used

## G

**Goal line technology (GLT)**

Electronic system which immediately informs the referee when a goal has been scored i.e. the ball has wholly passed over the goal line in the goal  
*(See Law 1 for details)*

## H

**Hybrid system**

A combination of artificial and natural materials to create a playing surface which requires sunlight, water, air circulation and mowing

### **Indirect free kick**

A free kick from which a goal can only be scored if another player (of any team) touches the ball after it has been kicked

### **Infringement**

An action which is against/breaks/violates the Laws

### **Impede**

To delay, block or prevent an opponent's action or movement

### **Intentional**

A deliberate action (not an accident)

### **Intercept**

To prevent a ball reaching its intended destination

## K

### **Kicks from the penalty mark**

Method of deciding the result of a match by each team alternately taking kicks until one team has scored one more goal and both teams have taken the same number of kicks (unless during the first 5 kicks for each team, one team could not equal the other team's score even if they scored from all their remaining kicks)

## N

### **Negligible**

Insignificant, minimal

## O

**Offence**

An action which breaks/infringes/violates the Laws of the Game; sometimes relates particularly to illegal actions committed against a person, especially an opponent

**Offensive, insulting or abusive language**

Verbal or physical behaviour which is rude, hurtful, disrespectful; punishable by a sending-off (red card)

**Outside agent**

Any person who is not a match official or on the team list (players, substitutes and team officials)

## P

**Penalise**

To punish, usually by stopping play and awarding a free kick or penalty kick to the opposing team (*see also Advantage*)

**Played**

Action by a player which makes contact with the ball

**Playing distance**

Distance to the ball which allows a player to touch the ball by extending the foot/leg or jumping or, for goalkeepers, jumping with arms extended. Distance depends on the physical size of the player

## Q

### **Quick free kick**

A free kick taken (with the referee's permission) very quickly after play was stopped

## R

### **Reckless**

Any action (usually a tackle or challenge) by a player which disregards (ignores) the danger to, or consequences for, the opponent

### **Restart**

Any method of resuming play after it has been stopped

## S

### **Sanction**

Disciplinary action taken by the referee

### **Save**

An action by a player to stop the ball when it is going into or very close to the goal using any part of the body except the hands (unless a goalkeeper within their own penalty area)

### **Send off (Dismissal)**

Disciplinary action when a player is required to leave the field for the remainder of the match having committed a sending-off offence (indicated by a red card); if the match has started the player can not be replaced

**Serious foul play**

A tackle or challenge for the ball that endangers the safety of an opponent or uses excessive force or brutality; punishable by a sending-off (red card)

**Signal**

Physical indication from the referee or any match official; usually involves movement of the hand or arm or flag, or use of the whistle (referee only)

**Simulation**

An action which creates a wrong/false impression that something has occurred when it has not (*see also deceive*); committed by a player to gain an unfair advantage

**Spirit of the game**

The main/essential principles/ethos of football

**Suspend**

To stop a match for a period of time with the intention of eventually restarting play e.g. fog, heavy rain, thunderstorm, serious injury

**T****Tackle**

A challenge for the ball with the foot (on the ground or in the air)

**Team official**

Any non-player listed on the official team list e.g. coach, physiotherapist, doctor (*see technical staff*)

**Team list**

Official team document usually listing the players, substitutes and team officials

**Technical staff**

Official non-playing team members listed on the official team list e.g. coach, physiotherapist, doctor (*see team official*)

### **Technical area**

Defined area (in stadia) for the team officials which includes seating  
(See Law 1 for details)

## U

### **Undue interference**

Action/influence which is unnecessary

### **Unsporting behaviour**

Unfair action/behaviour; punishable by a caution

## V

### **Violent conduct**

An action, which is not a challenge for the ball, which uses or attempts to use excessive force or brutality against an opponent or when a player deliberately strikes someone on the head or face unless the force used is negligible

# Referee terms

## **Match official(s)**

General term for person or persons responsible for controlling a football match on behalf of a football association and/or competition under whose jurisdiction the match is played

## **Referee**

The main match official for a match who operates on the field of play. Other match officials operate under the referee's control and direction. The referee is the final/ultimate decision-maker

## **Other match officials**

Competitions may appoint other match officials to assist the referee:

- **Assistant referee**

A match official with a flag positioned on one half of each touchline to assist the referee particularly with offside situations and goal kick/corner kick/throw-in decisions

- **Fourth official**

A match official with responsibility for assisting the referee with both on-field and off-field matters, including overseeing the technical area, controlling substitutes etc.

- **Additional assistant referee (AAR)**

A match official positioned on the goal line to assist the referee particularly with situations in/around the penalty area and goal/no-goal decisions

- **Reserve assistant referee**

Assistant referee who will replace an assistant (and, if competition rules permit, a fourth official and/or AAR) who is unable to continue

# **Practical Guidelines** for Match Officials



# Introduction

These guidelines contain practical advice for match officials which supplements the information in the Laws of the Game section.

Reference is made in Law 5 to referees operating within the framework of the Laws of the Game and the 'spirit of the game'. Referees are expected to use common sense and to apply the 'spirit of the game' when applying the Laws of the Game, especially when making decisions relating to whether a match takes place and/or continues.

This is especially true for the lower levels of football where it may not always be possible for the Law to be strictly applied. For example, unless there are safety issues, the referee should allow a game to start/continue if:

- one or more corner flags is missing
- there is a minor inaccuracy with the markings on the field of play such as the corner area, centre circle etc.
- the goal posts/crossbar are not white

In such cases, the referee should, with the agreement of the teams, play/continue the match and must submit a report to the appropriate authorities.

Key:

- > AR = assistant referee
- > AAR = additional assistant referee

# Positioning, Movement and Teamwork

## 1. General positioning and movement

The best position is one from which the referee can make the correct decision. All recommendations about positioning must be adjusted using specific information about the teams, the players and events in the match.

The positions recommended in the graphics are basic guidelines. The reference to a “zone” emphasises that a recommended position is an area within which the referee is likely to be most effective. The zone may be larger, smaller or differently shaped depending on the exact match circumstances.

### Recommendations:

- The play should be between the referee and the lead AR
- The lead AR should be in the referee’s field of vision so the referee should usually use a wide diagonal system
- Staying towards the outside of the play makes it easier to keep play and the lead AR in the referee’s field of vision
- The referee should be close enough to see play without interfering with play
- “What needs to be seen” is not always in the vicinity of the ball. The referee should also pay attention to:
  - player confrontations off the ball
  - possible offences in the area towards which play is moving
  - offences occurring after the ball is played away

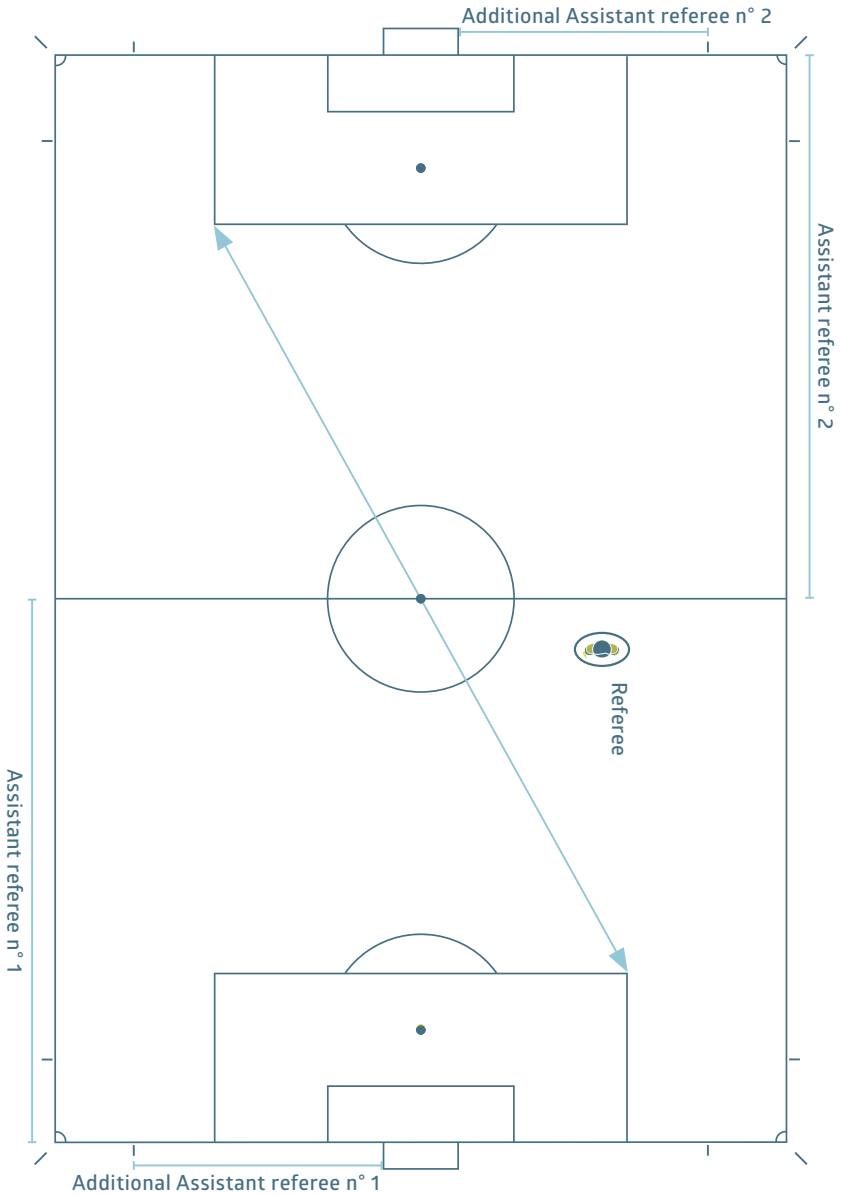

### Positioning of assistant referees and additional assistant referees

The AR must be in line with the second-last defender or the ball if it is nearer to the goal line than the second-last defender. The AR must always face the field of play, even when running. Side-to-side movement should be used for short distances. This is especially important when judging offside as it gives the AR a better line of vision.

The AAR position is behind the goal line except where it is necessary to move onto the goal line to judge a goal/no goal situation. The AAR is not allowed to enter the field of play unless there are exceptional circumstances.



## 2. Positioning and teamwork

### Consultation

When dealing with disciplinary issues, eye contact and a basic discreet hand signal from the AR to the referee may be sufficient. When direct consultation is required, the AR may advance 2-3 metres onto the field of play if necessary. When talking, the referee and AR should both face the field of play to avoid being heard by others and to observe the players and field of play.

### Corner kick

The AR's position for a corner kick is behind the corner flag in line with the goal line but the AR must not interfere with the player taking the corner kick and must check that the ball is properly placed in the corner area.

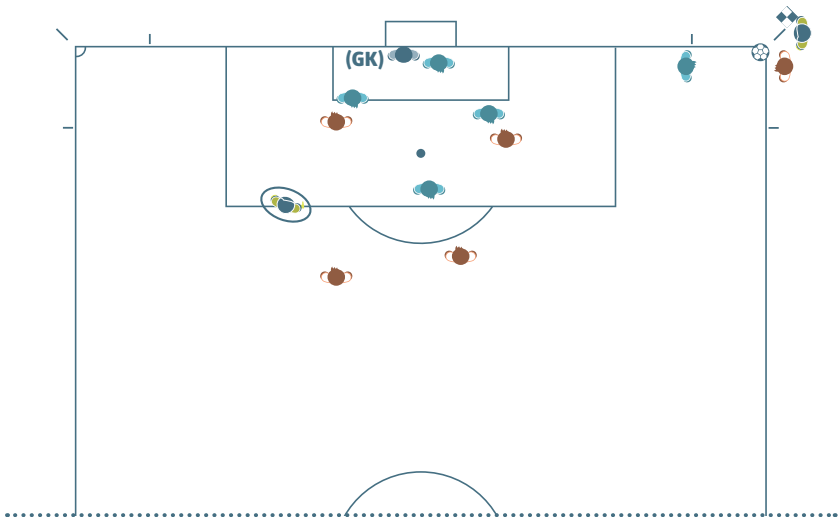

### Free kick

The AR's position for a free kick must be in line with the second-last defender to check the offside line. However, the AR must be ready to follow the ball by moving down the touchline towards the corner flag if there is a direct shot on goal.

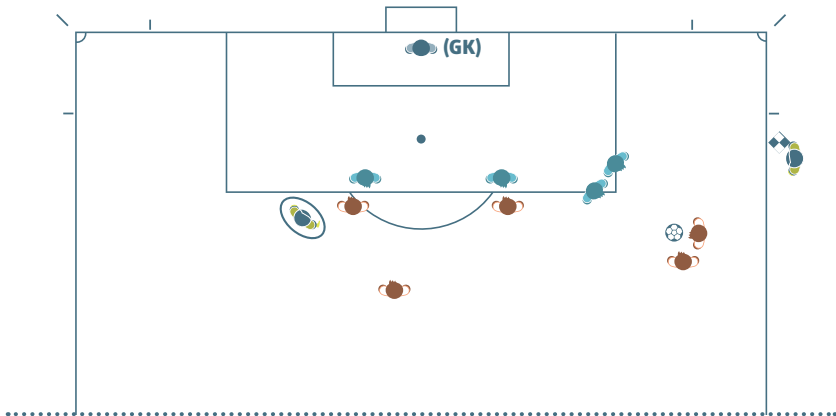
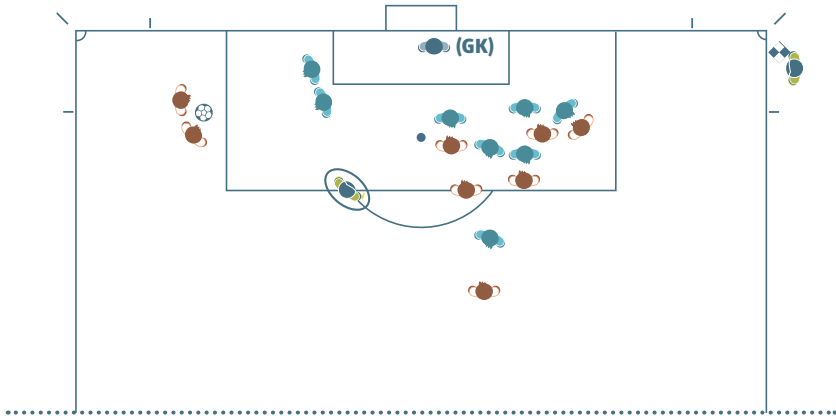

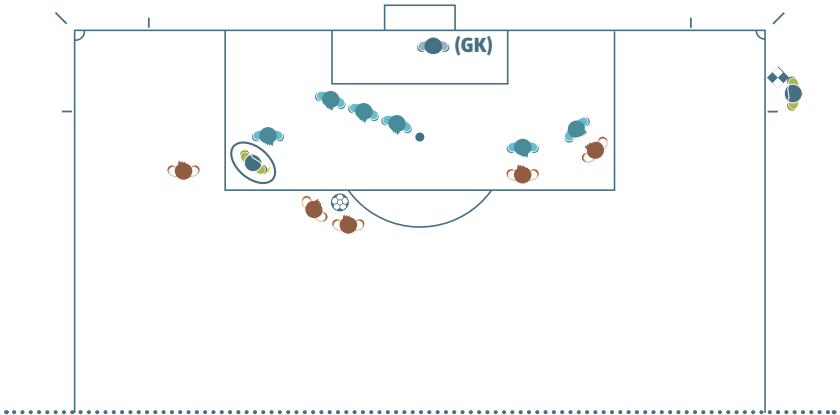
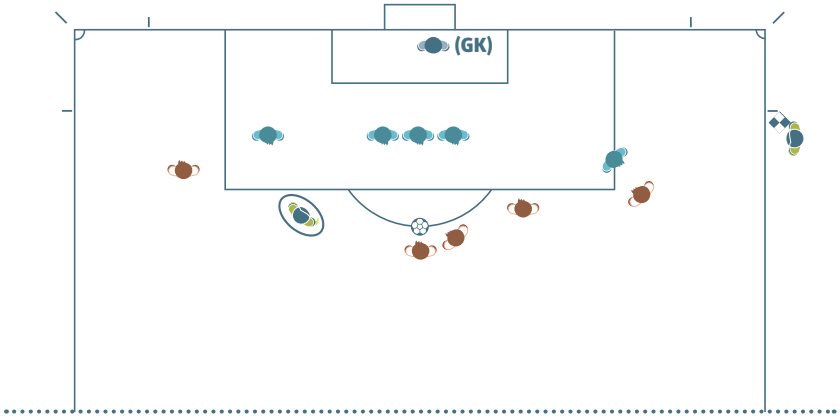

### Goal/no goal

When a goal has been scored and there is no doubt about the decision, the referee and assistant referee must make eye contact and the assistant referee must then move quickly 25–30 metres along the touchline towards the halfway line without raising the flag.

When a goal has been scored but the ball appears still to be in play, the assistant referee must first raise the flag to attract the referee's attention then continue with the normal goal procedure of running quickly 25–30 metres along the touchline towards the halfway line.

On occasions when the whole of the ball does not cross the goal line and play continues as normal because a goal has not been scored, the referee must make eye contact with the assistant referee and if necessary give a discreet hand signal.

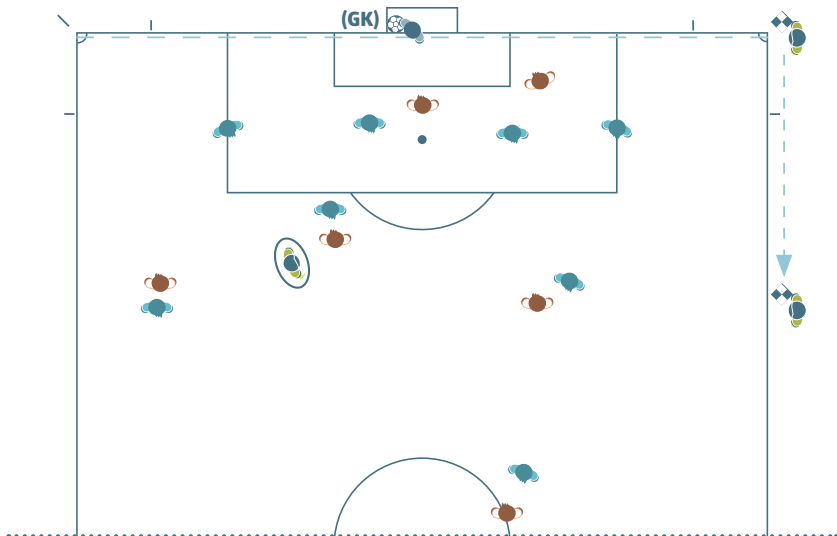



## Goal kick

The AR must first check if the ball is inside the goal area. If the ball is not placed correctly, the AR must not move from the position, make eye contact with the referee and raise the flag. Once the ball is placed correctly inside the goal area, the AR must move to the edge of the penalty area to check that the ball leaves the penalty area (ball in play) and that the attackers are outside. Finally, the AR must take a position to check the offside line.

However, if there is an AAR, the AR should take up a position in line with the edge of the penalty area and then the offside line and the AAR must be positioned at the intersection of the goal line and the goal area, and check if the ball is placed inside the goal area. If the ball is not placed correctly, the AAR must communicate this to the referee.

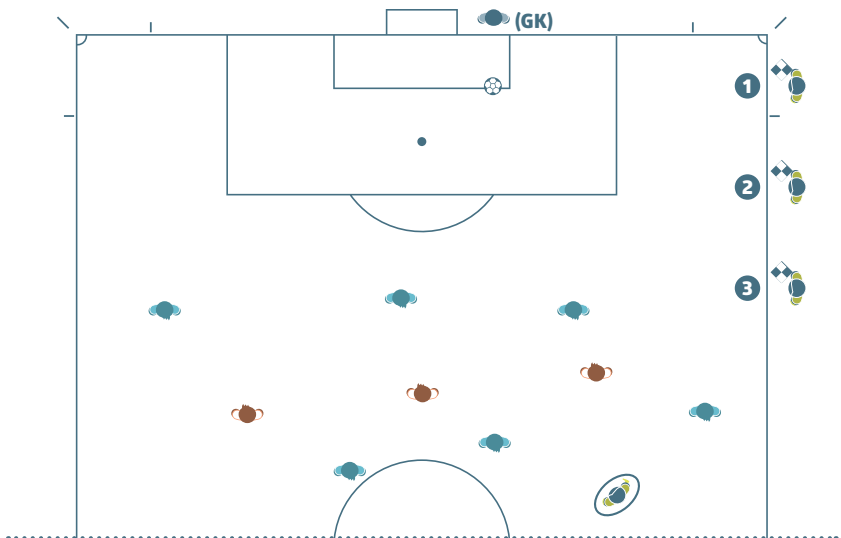

### Goalkeeper releasing the ball

The AR must take a position in line with the edge of the penalty area and check that the goalkeeper does not handle the ball outside the penalty area. Once the goalkeeper has released the ball, the AR must take a position to check the offside line.

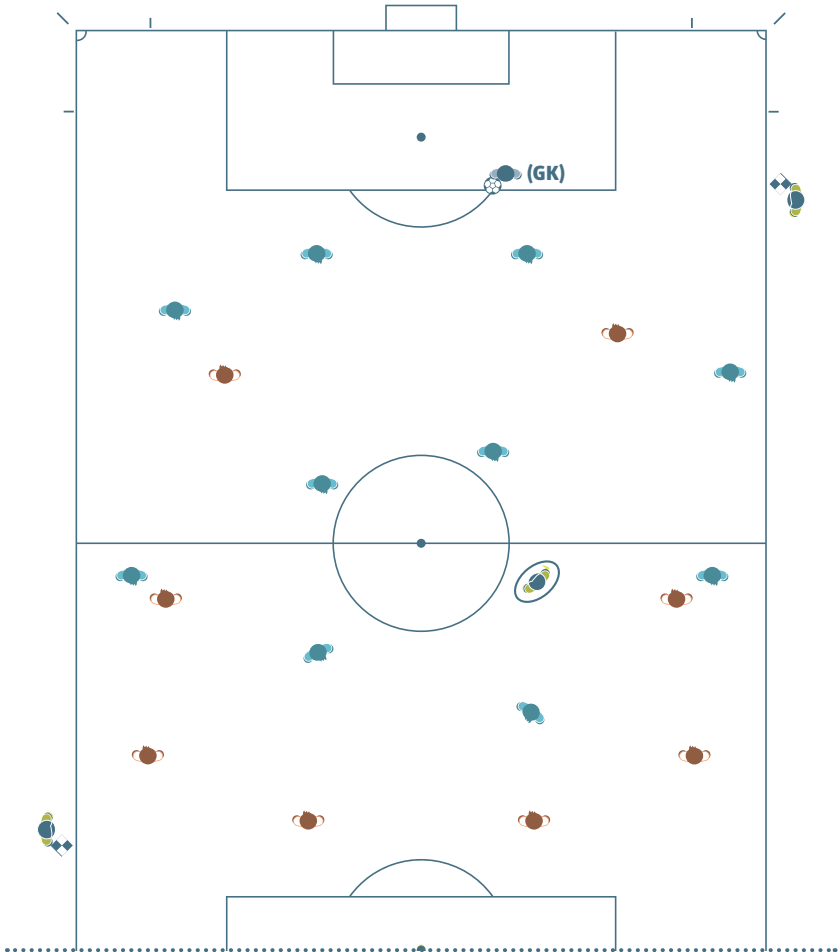

## Kick-off

The ARs must be in line with the second-last defender.

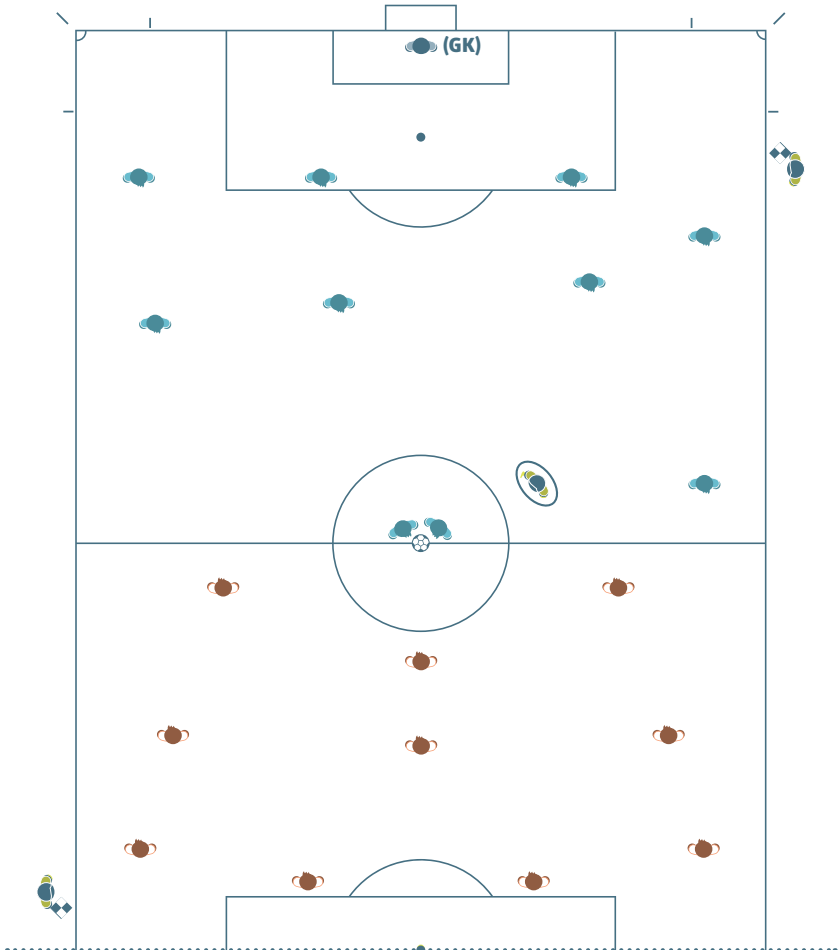

### Kicks from the penalty mark

One AR must be positioned at the intersection of the goal line and the goal area. The other AR must be situated in the centre circle to control the players. If there are AARs, they must be positioned at each intersection of the goal line and the goal area, to the right and left of the goal respectively; both ARs are situated in the centre circle.

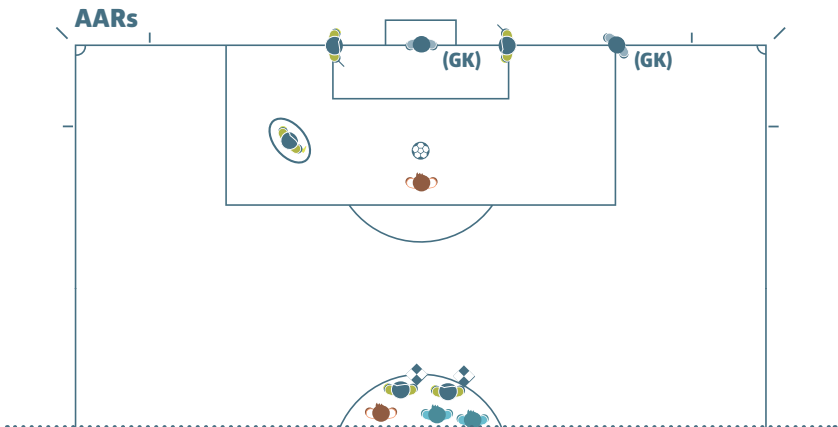
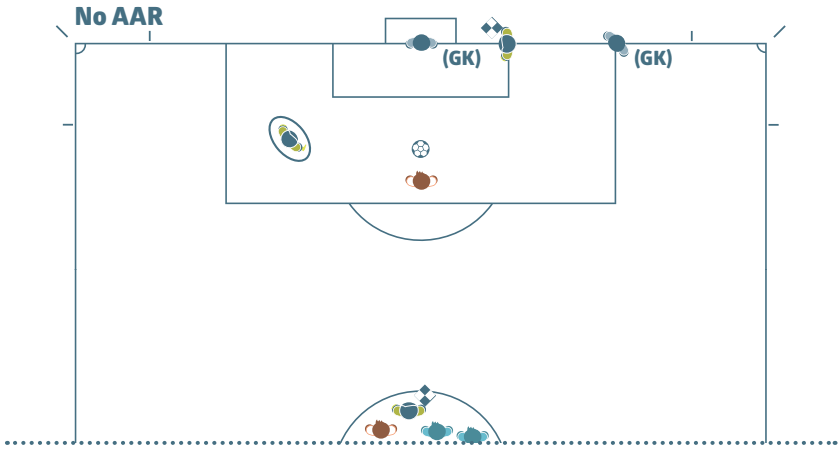

**Penalty kick**

The AR must be positioned at the intersection of the goal line and the penalty area.

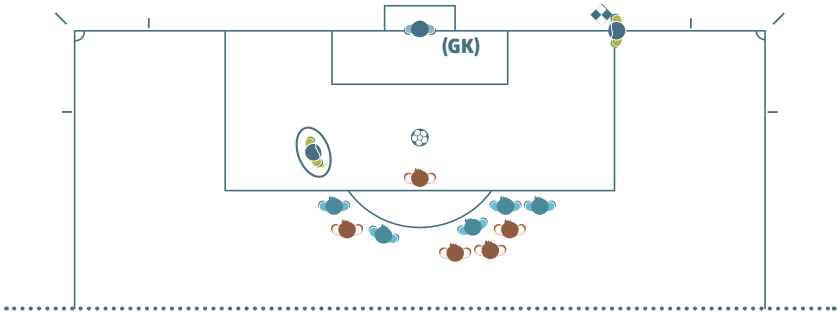

Where there are AARs the AAR must be positioned at the intersection of the goal line and the penalty area and the AR is positioned in line with the penalty mark (which is the offside line).

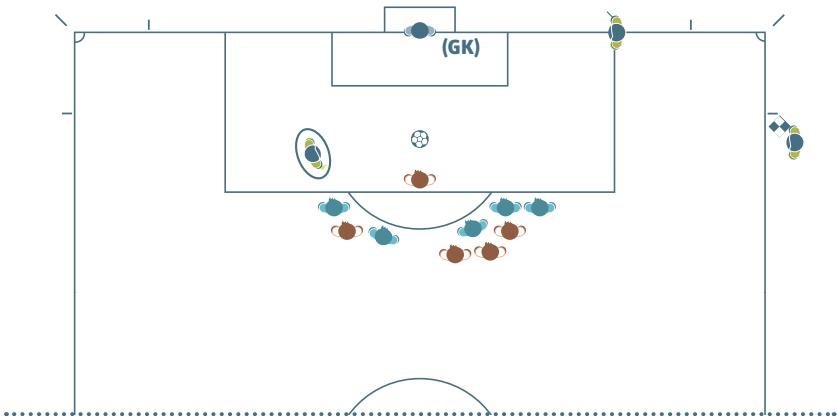

**Mass confrontation**

In situations of mass confrontation, the nearest AR may enter the field of play to assist the referee. The other AR must observe and record details of the incident. The fourth official should remain in the vicinity of the technical areas.

**Required distance**

When a free kick is awarded very close to the AR, the AR may enter the field of play (usually at the request of the referee) to help ensure that the players are positioned 9.15 m (10 yds) from the ball. In this case, the referee must wait until the AR is back in position before restarting play.

**Substitution**

If there is no fourth official, the AR moves to the halfway line to assist with the substitution procedure; the referee must wait until the AR is back in position before restarting play.

If there is a fourth official, the AR does not need to move to the halfway line as the fourth official carries out the substitution procedure unless there are several substitutions at the same time in which case the AR moves to the halfway line to assist the fourth official.

IFAB®



# Body Language, Communication and Whistle

## 1. Referees

### Body language

Body language is a tool that the referee uses to:

- help control the match
- show authority and self-control

Body language is not an explanation of a decision.

### Signals

See Law 5 for diagrams of signals

### Whistle

The whistle is needed to:

- start play (1st and 2nd half of normal play and extra time), after a goal
- stop play:
  - > for a free kick or penalty kick
  - > if the match is suspended or abandoned
  - > at the end of each half
- restart play for:
  - > free kicks when the appropriate distance is required
  - > penalty kicks
- restart play after it has been stopped for a:
  - > caution or sending-off
  - > injury
  - > substitution



The whistle is NOT needed to:

- stop play for a clear:
  - goal kick, corner kick, throw-in or goal
- restart play from:
  - most free kicks, and a goal kick, corner kick, throw-in or dropped ball

A whistle which is used too frequently/unnecessarily will have less impact when it is needed.

If the referee wants the player(s) to wait for the whistle before restarting play (e.g. when ensuring that defending players are 9.15m at a free kick) the referee must clearly inform the attacking player(s) to wait for the whistle.

If the referee blows the whistle in error and play stops, play is restarted with a dropped ball.

## 2. Assistant referees

### Beep signal

The beep signal system is an additional signal which is only used to gain the referee's attention. Situations when the signal beep may be useful include:

- offside
- offences (outside the view of the referee)
- throw in, corner kick, goal kick or goal (tight decisions)

### Electronic communication system

Where an electronic communication system is used, the referee will advise the ARs as to when it may be appropriate to use the communication system with, or instead of, a physical signal.

### Flag technique

The AR's flag must always be unfurled and visible to the referee. This usually means the flag is carried in the hand closest to the referee. When making a signal, the AR stops running, faces the field of play, makes eye contact with the referee and raises the flag with a deliberate (not hasty or exaggerated) motion. The flag should be like an extension of the arm. The ARs must raise the flag using the hand that will be used for the next signal. If circumstances change

and the other hand must be used, the AR should move the flag to the opposite hand below the waist. If the AR signals that the ball is out of play, the signal must be maintained until the referee acknowledges it.

If the AR signals for a sending-off offence and the signal is not seen immediately:

- if play has been stopped, the restart may be changed in accordance with the Laws (free kick, penalty kick, etc.)
- if play has restarted, the referee may still take disciplinary action but not penalise the offence with a free kick or penalty kick

### **Gestures**

As a general rule, the AR should not use obvious hand signals. However, in some instances, a discreet hand signal may assist the referee. The hand signal should have a clear meaning which should have been agreed in the pre-match discussion.

### **Signals**

See Law 6 for diagrams of signals

### **Corner kick / goal kick**

When the ball wholly passes over the goal line near to the AR, a signal should be made with the right hand (better line of vision) to indicate whether it is a goal kick or a corner kick.

When the ball wholly passes over the goal line the AR must raise the flag to inform the referee that the ball is out of play and then if it is:

- near to the AR - indicate whether it is a goal kick or a corner kick
- far from the AR - make eye contact and follow the referee's decision. The AR may also make a direct signal if the decision is an obvious one.

### **Fouls**

The AR must raise the flag when a foul or misconduct is committed in the immediate vicinity or out of the referee's vision. In all other situations, the AR must wait and offer an opinion if it is required and then inform the referee what was seen and heard, and which players were involved.

Before signalling for an offence, the AR must determine that:

- the offence was out of the referee's view or the referee's view was obstructed
- the referee would not have applied the advantage

When an offence/infringement occurs which requires a signal from the AR, the AR must:

- raise the flag with the same hand that will also be used for the remainder of the signal – this gives the referee a clear indication as to who will be awarded the free kick
- make eye contact with the referee
- give the flag a slight wave back and forth (avoiding any excessive or aggressive movement)

The AR must use the “wait and see technique” to allow play to continue and not raise the flag when the team against which an offence has been committed will benefit from the advantage; it is therefore very important for the AR to make eye contact with the referee.

### **Fouls inside the penalty area**

When a foul is committed by a defender inside the penalty area out of the vision of the referee, especially if near to the AR's position, the AR must first make eye contact with the referee to see where the referee is positioned and what action has been taken. If the referee has not taken any action, the AR must signal with the flag, use the electronic beep signal and then visibly move down the touchline towards the corner flag.

### **Fouls outside the penalty area**

When a foul is committed by a defender outside the penalty area (near the boundary of the penalty area), the AR should make eye contact with the referee, to see the referee's position and what action has been taken, and signal with the flag if necessary. In counter-attack situations, the AR should be able to give information such as whether or not a foul has been committed and whether a foul was committed inside or outside the penalty area, and what disciplinary action should be taken. The AR should make a clear movement along the touchline towards the halfway line to indicate when the offence took place outside the penalty area.

### **Goal – no goal**

When it is clear that the ball has wholly passed over the goal line in the goal, the AR must make eye contact with the referee without giving any additional signal.

When a goal has been scored but it is not clear whether the ball has passed over the line, the AR must first raise the flag to attract the referee's attention and then confirm the goal.

### **Offside**

The first action of the AR for an offside decision is to raise the flag (using the right hand, giving the AR a better line of vision) and then, if the referee stops play, use the flag to indicate the area of the field of play in which the offence occurred. If the flag is not immediately seen by the referee, the AR must maintain the signal until it has been acknowledged or the ball is clearly in the control of the defending team.

### **Penalty kick**

If the goalkeeper blatantly moves off the goal line before the ball is kicked and a goal is not scored, the AR must raise the flag.

### **Substitution**

Once the AR has been informed (by the fourth official or team official) that a substitution is requested, the AR must signal this to the referee at the next stoppage.

### **Throw-in**

When the ball wholly passes over the touchline:

- near to the AR – a direct signal should be made to indicate the direction of the throw-in
- far from the AR and the throw-in decision is an obvious one – the AR must make a direct signal to indicate the direction of the throw-in
- far from the AR and the AR is in doubt about the direction of the throw-in – the AR must raise the flag to inform the referee that the ball is out of play, make eye contact with the referee and follow the referee's signal

### 3. Additional assistant referees

The AARs use a radio communication system (not flags) to communicate with the referee. If the radio communication system fails to work, the AARs will use an electronic signal beep flagstick. AARs do not usually use obvious hand signals but, in some instances, a discreet hand signal may give valuable support to the referee. The hand signal should have a clear meaning and such signals should be agreed in the pre-match discussion.

The AAR, having assessed that the ball has wholly passed over the goal line within the goal, must:

- immediately inform the referee via the communication system that a goal should be awarded
- make a clear signal with the left arm perpendicular to the goal line pointing towards the centre of the field (flagstick in the left hand is also required). This signal is not required when the ball has very clearly passed over the goal line.

The referee will make the final decision.

# Other advice

## 1. Advantage

The referee may play advantage whenever an infringement or offence occurs but should consider the following in deciding whether to apply the advantage or stop play:

- the severity of the offence – if the infringement warrants a sending-off, the referee must stop play and send off the player unless there is a clear opportunity to score a goal
- the position where the offence was committed - the closer to the opponent's goal, the more effective the advantage can be
- the chances of an immediate, promising attack
- the atmosphere of the match

## 2. Allowance for time lost

Many stoppages in play are entirely natural (e.g. throw-ins, goal kicks). An allowance is made only when delays are excessive.

## 3. Holding an opponent

Referees are reminded to make an early intervention and to deal firmly with holding offences, especially inside the penalty area at corner kicks and free kicks. To deal with these situations:

- the referee must warn any player holding an opponent before the ball is in play
- caution the player if the holding continues before the ball is in play
- award a direct free kick or penalty kick and caution the player if it happens once the ball is in play

4. Offside

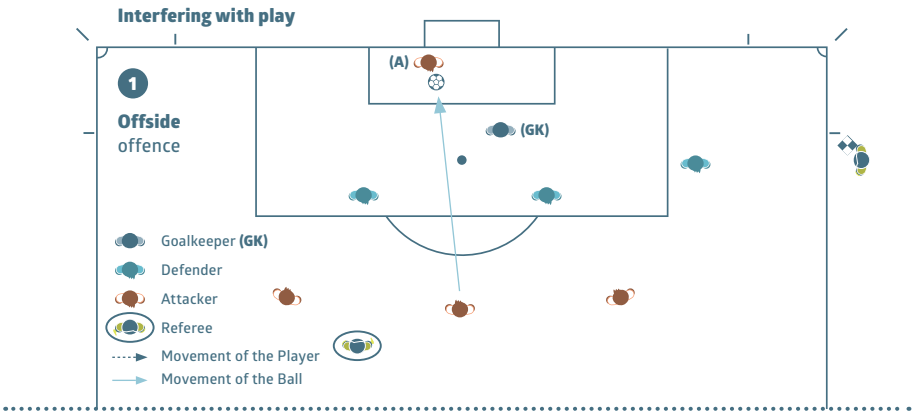

An attacker **in an offside position** (A), not interfering with an opponent, **touches the ball**. The assistant referee must raise the flag when the player **touches the ball**.

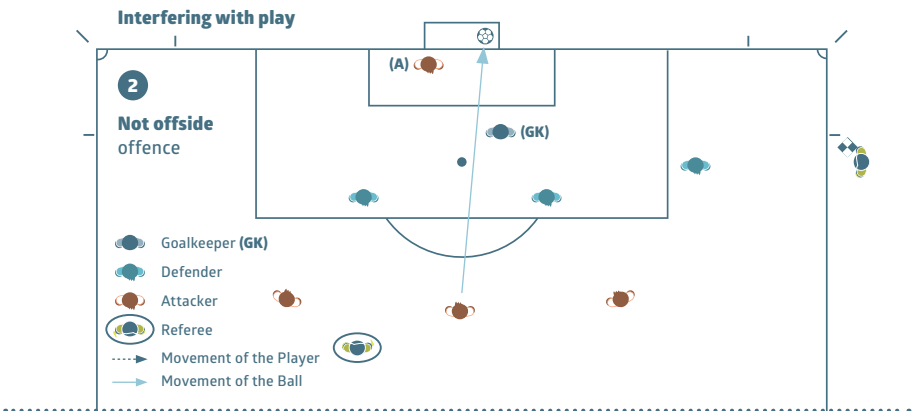

An attacker **in an offside position** (A), not interfering with an opponent, **does not touch the ball**. The player did not touch the ball, so cannot be penalised.

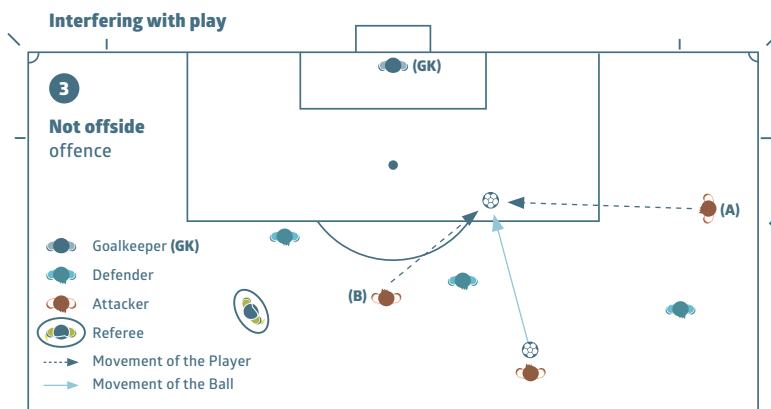

An attacker **in an offside position** (A) runs towards the ball and a team-mate **in an onside position** (B) also runs towards the ball and plays it. (A) did not touch the ball, so cannot be penalised.

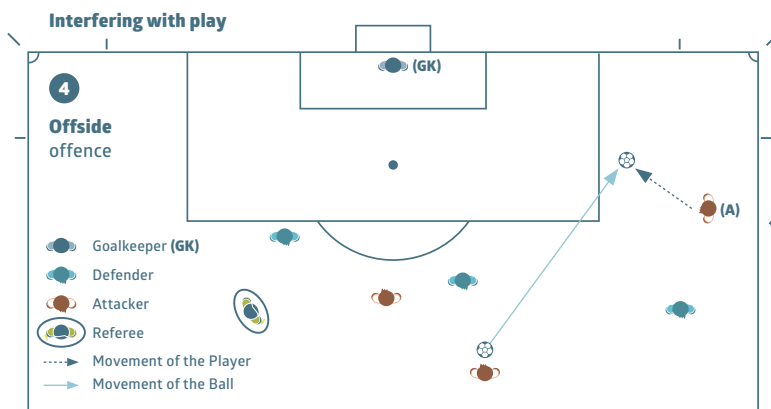

A player **in an offside position** (A) may be penalised before playing or touching the ball, if, in the opinion of the referee, no other team-mate in an onside position has the opportunity to play the ball.



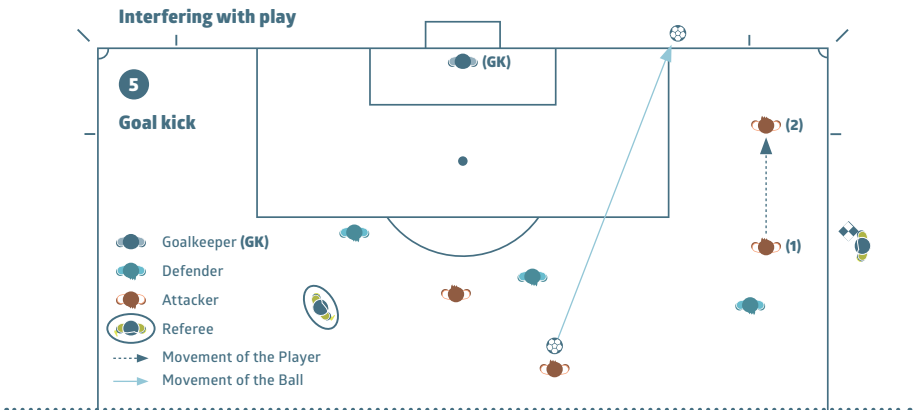

An attacker **in an offside position** (1) runs towards the ball and **does not touch** the ball. The assistant referee must signal **“goal kick”**.

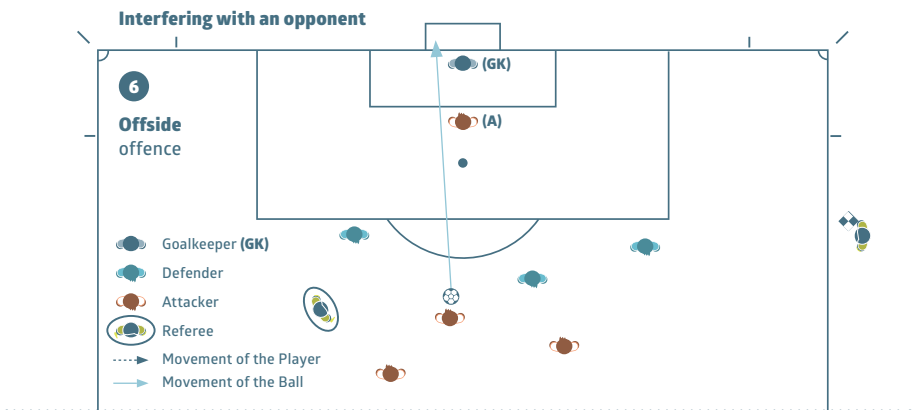

An attacker **in an offside position** (A) is clearly obstructing the goalkeeper’s line of vision. The player must be penalised for preventing an opponent from playing or being able to play the ball.

### Interfering with an opponent

7  
Not offside  
offence

- Goalkeeper (GK)
- Defender
- Attacker
- Referee
- Movement of the Player
- Movement of the Ball

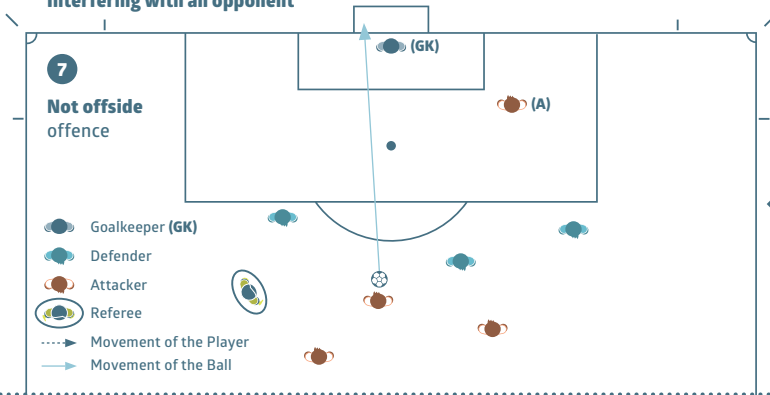

An attacker **in an offside position** (A) is **not** clearly obstructing the goalkeeper's line of vision or challenging an opponent for the ball.

### Interfering with an opponent

8  
Not offside  
offence  
Corner kick

- Goalkeeper (GK)
- Defender
- Attacker
- Referee
- Movement of the Player
- Movement of the Ball

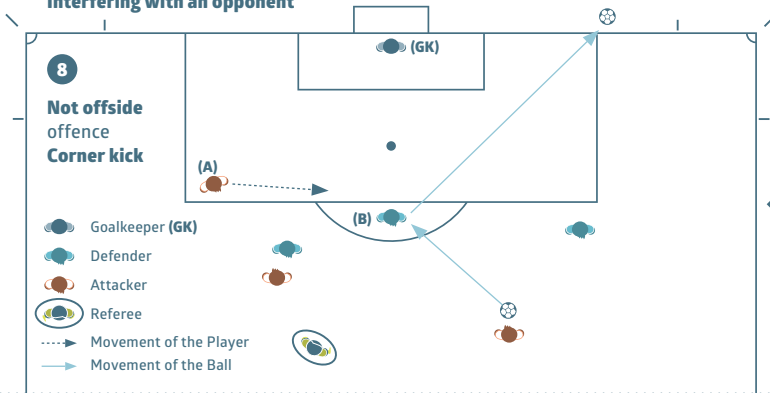

An attacker **in an offside position** (A) runs towards the ball but does not prevent the opponent from playing or being able to play the ball. (A) is **not** challenging an opponent (B) for the ball.

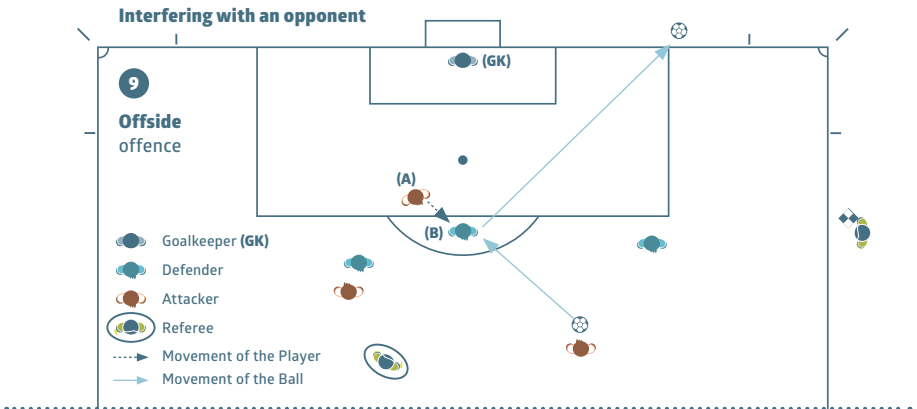

An attacker **in an offside position** (A) runs towards the ball preventing the opponent (B) from playing or being able to play the ball by challenging the opponent for the ball. (A) is challenging an opponent (B) for the ball.

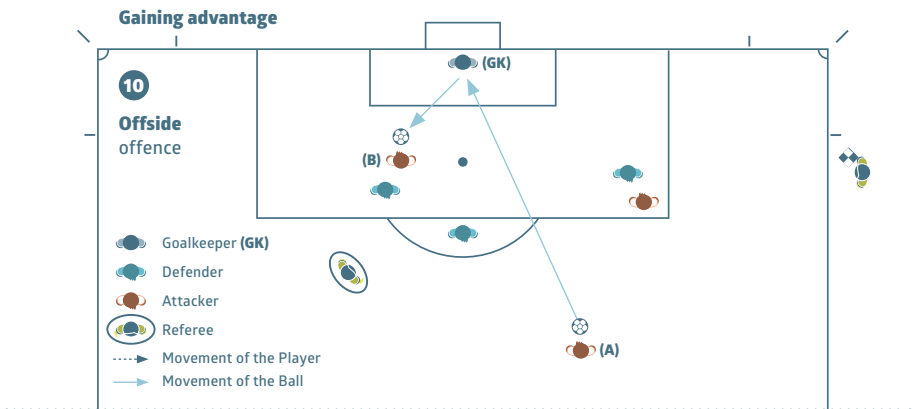

An attacker **in an offside position** (B) is penalised for **playing or touching the ball** that rebounds, is deflected or is played from a deliberate save by the goalkeeper having been **in an offside position** when the ball was last touched or is played by a team-mate.

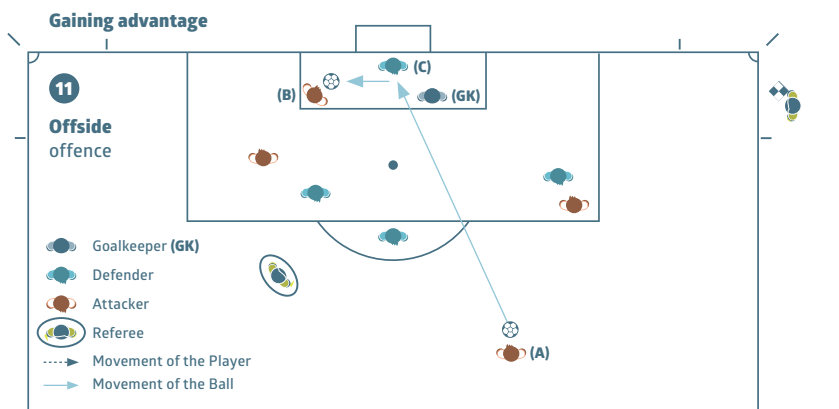

An attacker **in an offside position** (B) is penalised for **playing or touching the ball** that rebounds or is deflected from a deliberate save by a player from the defending team (C) having been **in an offside position** when the ball was last touched or is played by a team-mate.

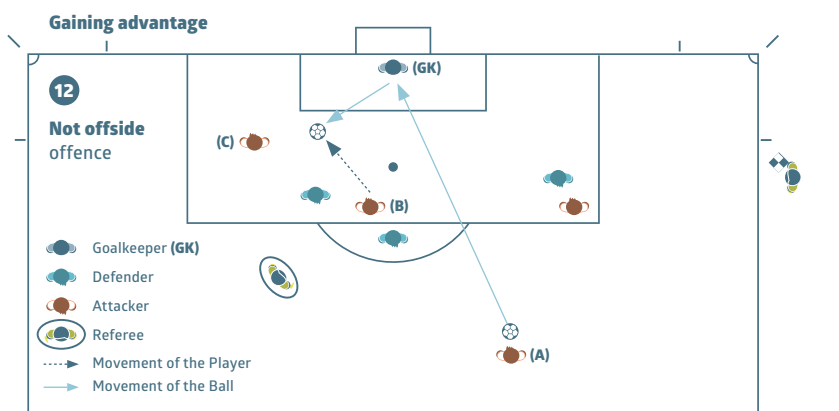

The shot by a team-mate (A) rebounds from the goalkeeper, (B) is in an onside position and plays the ball, (C) **in an offside position** is not penalised because the player did not gain an advantage from being in that position because the player did not touch the ball.

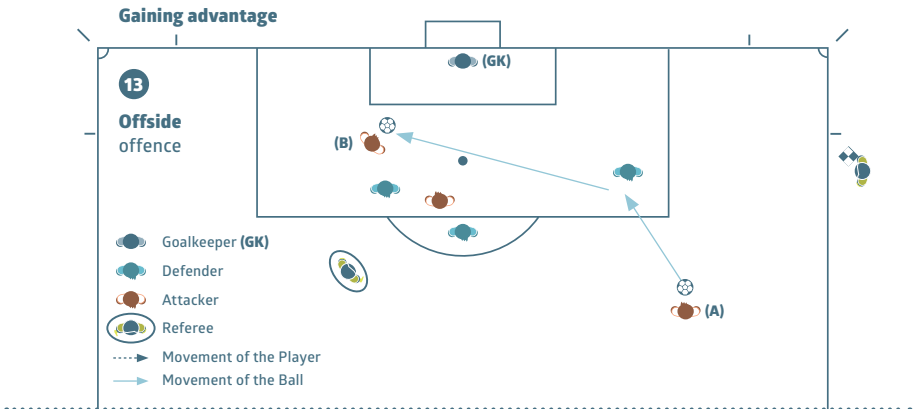

The shot by a team-mate (A) rebounds off or is deflected by an opponent to attacker (B) who is penalised for **playing or touching the ball** having previously been **in an offside position**.

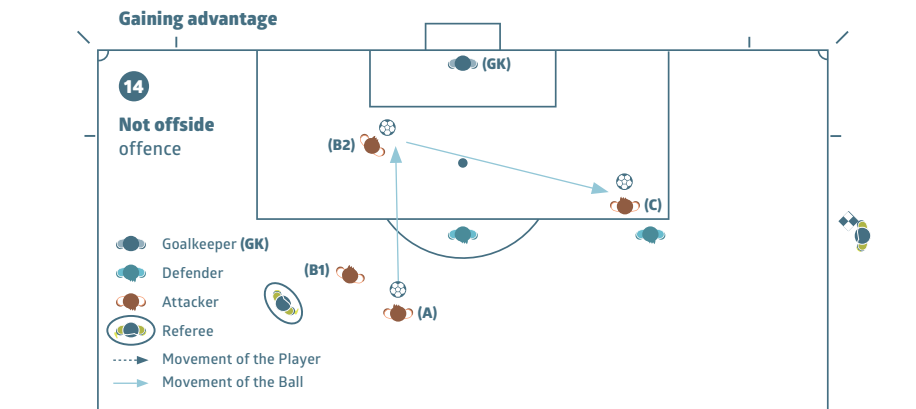

An attacker (C) is **in an offside position**, not interfering with an opponent, when a team-mate (A) passes the ball to player (B1) in an inside position who runs towards the opponents' goal and passes the ball (B2) to team-mate (C). Attacker (C) was **in an inside position** when the ball was passed, so cannot be penalised.

## 5. Treatment/assessment after a caution/sending-off

Previously, an injured player who received medical attention on the field of play must leave before the restart. This can be unfair if an opponent caused the injury as the offending team has a numerical advantage when play restarts.

However, this requirement was introduced because players often unsportingly used an injury to delay the restart for tactical reasons.

As a balance between these two unfair situations, The IFAB has decided that *only for a physical offence where the opponent is cautioned or sent off, an injured player can be quickly assessed/treated and then remain on the field of play.*

In principle, the delay should not be any longer than currently occurs when a medical person(s) comes on the field to assess an injury. The difference is that the point at which the referee used to require the medical person(s) and the player to leave is now the point at which the medical staff leave but the player can remain.

To ensure the injured player does not use/extend the delay unfairly, referees are advised to:

- be aware of the match situation and any potential tactical reason to delay the restart
- inform the injured player that if medical attention it required it must be quick
- signal for the medical person(s) (not the stretchers) and, if possible, remind them to be quick

When the referee decides play should restart either:

- the medical person(s) leaves and the player remains or
- the player leaves for further assessment/treatment (stretcher signal may be necessary)

As a general guide, the restart should not be delayed for more than about 20–25 seconds beyond the point when everyone was ready for play to restart.

The referee must make full allowance for the stoppage.

IFAB®





# Notes









# Notes







# Notes





