



your best alliance for compliance™

Fire & Safety Products

for Life & Property Protection

2022-2023

 Fire Safety

 Call Systems

 Access & Security

 DDA Compliance

TERMS AND CONDITIONS OF SUPPLY

- 1 Definitions**
In this Agreement, the following words shall have the following meanings:
"Completion Date" means any date agreed in writing by the Supplier and the Client by which time the Work is to be completed.
"Client" means the person, partnership or company identified on the Purchase Order Form
"Conditions" has the meaning given in Clause 12.4.
"Goods" means the goods identified in the Quotation or as further notified to the Client to be purchased by the Supplier, after agreement between the Parties.
"Quotation" means the document to which these Terms and Conditions of Sale are attached together with any correspondence sent by the Supplier prior to the Client accepting the Supplier's quote.
"Services" means the services identified in the Quotation or as further notified to the Client.
"Supplier" means Avansys LLP registered in England No OC384483, registered office address: Mayflower House, Bodmin Road, Coventry, CV2 5DB. CareAlert® and Fixir® are trade marks of Avansys LLP. Allan Fire is a trading style of Avansys LLP.
"Survey" has the meaning given in Clause 2.3.
"Work" means the Services and the Goods that the Supplier shall provide for and to the Client.
- 2 Work and materials**
- 2.1** The Supplier agrees to provide:
2.1.1 the Services; and
2.1.2 the Goods
to the Client subject to the provisions of these Terms and Conditions of Sale.
- 2.2** By accepting the Supplier's Quotation (with or without amendment) the Client agrees to be bound by these Terms and Conditions of Sale.
- 2.3** The Supplier may need to carry out a survey and inspection of the buildings, electrical supply, water supply, computer equipment and other facilities of the Client (the "Survey"). The Client acknowledges and agrees that the matters detailed in the Survey ("Client Action") which require action on the part of the Client shall be carried out before any Work is carried out.
- 2.4** This agreement may be varied, or added to, from time to time, in writing and signed by both Parties. The changes shall be clearly identified, together with the additional or different sums to be paid by the Client.
- 3 Performance of the Work**
- 3.1** Goods: On receiving confirmation from the Client that they want the Supplier to carry out the Works, the Supplier shall order the Goods.
- 3.2** Services: The Parties shall agree the time and place when the Services shall be performed, subject to the availability of the Supplier's staff and agents and the availability and delivery of the Goods.
- 3.3** The Supplier shall use reasonable endeavours to complete the Services by the Completion Date or meet such other dates as agreed by the Parties.
- 3.4** Time shall not be of the essence:
3.4.1 for the delivery of the Goods;
3.4.2 for the delivery of the Goods;
3.4.3 for any times for when the Services are to be performed, whether given or agreed to by the Supplier; or
3.4.4 for the length of time that any of the Services are to take, whether specified in the Specification Document or otherwise; or
3.4.5 for the Completion Date or such other date as agreed by the Parties.
- 4 Sums to be paid and payment**
- 4.1** Goods: When the Goods are ordered, the Supplier shall invoice the Client for the price specified by the supplier of the Goods plus the cost of any insurance, packaging, transportation and delivery charges. Except where otherwise agreed in writing the Client shall pay the invoice within 30 days of the date of the invoice.
- 4.2** Services: Except where otherwise agreed in writing payment for sums due for the Services shall be made within 30 days of the date of invoice.
- 4.3** All amounts stated are exclusive of VAT and/or any other applicable taxes or levy, which shall be charged in addition at the rate in force at the date any payment is required from the Client.
- 4.4** If payment of any sum due under this Agreement is not received by any due date specified for that sum, the Supplier shall be entitled to:
4.4.1 charge interest on the outstanding amount at the rate of 8% per annum above the Bank of England base rate, accruing daily; require that the Client make a payment in advance of any Services or part of the Services not yet supplied;
4.4.2 not provide any further Services or part of the Services; or
4.4.3 terminate this Agreement as provided for in Clause 15.
4.4.4 terminate this Agreement as provided for in Clause 15.
- 4.5** Without prejudice to any other right available to the Supplier, the Supplier shall be entitled to charge to the Client all legal and other costs reasonably incurred in the recovery of any debts and any bank charges made due to cheques defaulted in payment which are dishonoured.
- 4.6** All payments shall quote the Supplier's invoice number and other reference numbers.
- 5 Delivery of the Goods**
- 5.1** The Supplier shall deliver the Goods to the address specified by the Client on the date that the Supplier shall specify for the delivery (the "Delivery Date").
- 5.2** For the avoidance of doubt, the Delivery Date or other date given under this Agreement is no more than an estimate, and shall not be of the essence.
- 6 Risk**
- The risk in the Goods shall pass to the Client on the Delivery Date.
- 7 Property**
- The property in the Goods shall not pass to the Client until the Supplier has received the payment of the sums due in regard to the Goods (and any other sums that are due or owing to the Supplier) in full, whether or not delivery has made.
- 8 Time Limit for Claims**
- 8.1** The Client acknowledges and agrees that:
8.1.1 the Supplier has not given any warranty or condition as to the quality or fitness for any purpose of the Goods;
8.1.2 all conditions or warranties, express or implied (whether by statute or otherwise), are expressly excluded;
8.2 Any Claim by the Client which is based on any defect in the quality or condition of the Goods shall (whether or not delivery is refused by the Client) be notified to the Supplier within 7 days from the date of delivery or (where a defect or failure was not apparent on receipt of the Goods) within a reasonable time after discovery of the defect or failure. If delivery is not refused, and the Client does not notify the Supplier accordingly, the Client shall not be entitled to reject the Goods and the Supplier shall have no liability for such defect or failure, and the Client shall be bound to pay the price as if the Goods had been delivered in accordance with this Agreement.
- 8.3** Where Goods are despatched to the Client by carrier, non-delivery must be advised in writing within 14 days of the invoice date for the Goods failing which the Client shall be deemed to have received the Goods and shall be bound to pay the price as if the Goods had been delivered in accordance with this agreement.
- 8.4** Any shortage in Goods delivered to the Client must be advised to the Supplier within 3 days of the date of delivery, failing which the Client shall be deemed to have received the Goods and shall be bound to pay the price as if the Goods had been delivered in accordance with this agreement.
- 9 The Client's obligations**
- 9.1** The Client acknowledges and agrees that for the Supplier to be able to provide the Services the Client shall:
9.1.1 permit the Supplier, its employees and agents to carry out the Survey if required at such times as the Supplier may reasonably specify;
9.1.2 carry out the Client Action by the time and date agreed between the Supplier and the Client;
9.1.3 co-operate with the Supplier as the Supplier reasonably requires;
9.1.4 provide to the Supplier such information and documentation as the Supplier reasonably requires;
9.1.5 obtain all permissions, consents (including, but not limited to, planning permission), and health and safety approvals from such organisations and authorities which are required for the Goods to be installed and for the Services to be carried out;
9.1.6 make available to the Supplier the facilities, resources, working space and staff as the Supplier reasonably requires from time-to-time and
9.1.7 instruct the Client's staff and agents to co-operate and assist the Supplier.
- 9.2** The Supplier may charge the Client for any additional reasonable costs and expenses incurred by the Supplier caused by the Client's instructions, failure to provide instructions, or failure to comply with Clause 9.1.
- 10 Services**
- 10.1** The Parties shall agree the time and place when the Services shall be performed, subject to the availability of the Supplier's staff and agents.
- 10.2** The Supplier shall use reasonable endeavours to complete the Services by the Completion Date or meet such other dates as agreed by the Parties.
- 10.3** Time shall not be of the essence:
10.3.1 for any times for when the Services are to be performed; or
10.3.2 for the length of time that any of the Services are to take; or
10.3.3 for the Completion Date or such other date as agreed by the Parties.
- 11 Defects in the Goods**
- 11.1** The Supplier will, at its option, either make good by repair or by the supply of a replacement, where defects which, under proper use, appear in the Goods within a period of 12 months after the Goods have been delivered and installed, provided that:
11.1.1 the Client notifies the Supplier in writing of the claimed defects immediately on their appearance; and
11.1.2 the Supplier is satisfied that the defects arise solely from faulty design (other than a design made, furnished or specified by the Client for which the Supplier has disclaimed responsibility in writing), materials or workmanship; and
11.1.3 if required by the Supplier, any part of the Goods claimed to be defective are returned to the Supplier at the expense of the Client.
- 11.2** The repaired or replacement Goods will be delivered to the Client to the original place of delivery, but otherwise subject to the provisions of this Agreement.
- 11.3** As an alternative to Clause 11.1, the Supplier shall be, in its absolute discretion, entitled to return the sums paid by the Client for the Goods to the Client if the Client has already paid such sums when the claimed defect is notified by the Client to the Supplier.
- 11.4** The remedy provided in this Clause 11 is without prejudice to the other provisions of this Agreement, including, without limitation, Clause 12 below.
- 12 Liability for the Goods**
- 12.1** The Supplier shall not incur or accept any liability concerning any representation made by the Supplier (or made on the Supplier's behalf) to the Client (or any person acting on behalf of the Client) prior to the making of this Agreement where such representation was made or given in relation to the Conditions;
12.2 The Supplier shall not accept any liability to the Client concerning any express term or provision of this Agreement relating to the Goods where such a term relates to the Conditions;
12.3 All terms, conditions or warranties implied by statutory or common law relating to the Conditions concerning the Goods are excluded from the Agreement to the fullest extent permitted by law.
12.4 The Conditions' means:
12.4.1 the correspondence of the goods with any description; and/or
12.4.2 the quality of the goods; and/or
12.4.3 the fitness of the goods for any purpose(s) whatsoever (whether made known to the Supplier or not).
- 13 Warranties, liability and indemnities for the Services**
- 13.1** The Supplier warrants that it will use reasonable care in performing the Services.
- 13.2** If any part of the Services is performed negligently or in breach of the provisions of this Agreement then, at the request of the Client (if the request is given within six months of the Completion Date), the Supplier will re-perform the relevant part of the Services, always subject to Clause 14.1 and Clause 14.2 below.
- 13.3** The Supplier expressly does not warrant that any result or objective, whether stated in this Agreement or not, shall be achieved, be achievable or be attained at all or by a given Completion Date or any other date.
- 14 Liability generally**
- 14.1** Except in the case of death or personal injury caused by the Supplier's negligence, the Supplier's liability under or in connection with this Agreement whether arising in contract, tort, negligence, breach of statutory duty or otherwise howsoever, shall be limited in respect of any claim to the greater of:-
14.1.1 the sum for which the Supplier carries insurance cover regardless of whether such insurance is sufficient to cover the claim giving rise to the liability; or
14.1.2 the sum of £50,000.
- 14.2** The Supplier will not be responsible for the following:
14.2.1 Loss in relation to systems installed at the Client's premises prior to the date of this agreement arising:
14.2.1.1 before the completion of the Supplier's first routine inspection visit to the Client's premises; or
14.2.1.2 during the first 12 months from the start date of this agreement as a result of that part of a fire system which has not yet been inspected.
14.2.2 Loss due to the acts or neglect of any other person including the Client, the provider of any telephone line, redcare or other type of communication technology, police, fire or other authority or individual. None of these is the Supplier's agent for any purpose.
14.2.3 Delays, interruptions or suspensions in providing the Services, which are due to any other person (including the Client), thing or event which we could not reasonably be expected to prevent.
14.2.4 Loss due to the fact that equipment or cabling not supplied by the Supplier is connected to or installed near to any equipment or system installed by the Supplier.
14.2.5 Loss resulting from:
14.2.5.1 the fire, police or other authority failing to act in accordance with a proper emergency response;
14.2.5.2 a signal transmitted to the Supplier's alarm receiving centre not being received by the Supplier for reasons beyond the Supplier's control;
14.2.5.3 the failure of any cables or wiring installed within the fabric of the Client's Premises or buried underground prior to the start date;
14.2.5.4 the activation of a circuit breaker which affects the power supply to any part of the system installed by the Supplier; or
14.2.5.5 any other cause beyond the Supplier's reasonable control and not caused by our lack of reasonable care.
14.2.5.6 Losses due to the Client failing to follow the Supplier's recommendations given for additions, repairs or any work required to the system supplied by the Supplier.
14.2.5.7 Losses outside the purpose of the system installed by the Supplier.
14.2.5.8 Where equipment is damaged or lost in transit, unless the Client notifies the Supplier in writing within 10 days from the date of despatch of the equipment to the Client's premises.
14.2.5.9 Damage unavoidably caused to decorations, fittings and the like at the Client's premises as a result of any installation by the supplier or the provision by the Supplier of any services.
- 14.3** Neither Party shall be liable to the other Party in contract, tort, negligence, breach of statutory duty or otherwise for any loss, damage, costs or expenses of any nature whatsoever incurred or suffered by that other Party of an indirect or consequential nature including without limitation any economic loss or other loss of turnover, profits, business or goodwill.
- 14.4** The Client shall indemnify and hold harmless the Supplier from and against all Claims and Losses arising from loss, damage, liability, injury to the Supplier employees and third parties, infringement of third party intellectual property, or third party losses by reason of or arising out of any information supplied to the Supplier, its employees or suppliers, by the Client within or without the scope of this Agreement. "Claims" shall mean all demands, claims, proceedings, penalties, fines and liability (whether criminal or civil, in contract, tort or otherwise); and "Losses" shall mean all losses including without limitation financial losses, damages, legal costs and other expenses of any nature whatsoever.
- 14.5** Each of the Parties acknowledges that, in entering into this Agreement, it does not do so in reliance on any representation, warranty or other provision except as expressly provided in this Agreement, and any conditions, warranties or other terms implied by statute or common law are excluded from this Agreement to the fullest extent permitted by law.
- 14.6** Where the Goods or Services are sold under a consumer transaction (as defined by the Consumer Transactions (Restrictions on Statements) Order 1976 the statutory rights of the Client are not affected by these Terms.
- 15 Termination**
- 15.1** The Supplier may terminate this Agreement if:
15.1.1 the Client does not pay the amount(s) specified in the invoice(s) for the Goods or Services and upon the Supplier giving the Client 14 days' notice following the date specified for the payment of the invoice(s) in Clause 4.1;
15.1.2 the Client fails to carry out the Client Action and upon the Supplier giving the Client 14 days' notice following the end of the period specified by the Supplier under Clause 9.1.2.
- 15.2** Without prejudice to Clause 15.1 and any other remedies or rights, either Party may terminate this Agreement at any time by written notice to the other Party (Other Party) and the notice taking effect as specified in the notice.
15.2.1 If the Other Party is in material breach of its obligations under this Agreement, and where a breach is capable of remedy within 14 days, the breach is not remedied within 14 days by the Other Party receiving notice which specifies the breach and requiring the breach to be remedied; or
15.2.2 the Other Party becomes insolvent or if an order is made or a resolution is passed for the winding up of the Other Party (other than voluntarily) for the purpose of solvent amalgamation or re-constitution, or if an administrator, administrative receiver or receiver is appointed in respect of the whole or any part of the Other Party's assets or business, or if the Other Party makes any composition with its creditors or takes or suffers any similar or analogous action in consequence of debt.
- 15.3** If this Agreement is terminated because of the reason specified in Clause 15.1 above, then the Client shall pay for all Work carried out up to the date of termination and all sums due for payment after the date of termination which arise from commitments entered by the Supplier for the performance of the Work prior to the date of termination.
- 16 General**
- 16.1 Force majeure**
Neither Party shall have any liability under or be deemed to be in breach of this Agreement for any delays or failures in performance of this Agreement which result from circumstances beyond the reasonable control of that Party. The Party affected by such circumstances shall give written notice in writing when such circumstances cause a delay or failure in performance and when they cease to do so. If such circumstances continue for a continuous period of more than six months, either Party may terminate this Agreement by written notice to the other Party.
- 16.2** Entire agreement
This Agreement contains the whole agreement between the parties in respect of the sale and installation of the Goods and supplies and related matters prior written or oral agreements, representations or understandings between them relating to such subject matter. The parties confirm that they have not entered into this Agreement on the basis of any representation that is not expressly incorporated into this Agreement. Nothing in this Agreement excludes liability for fraud.
- 16.3** Waiver
No failure or delay by the Supplier in exercising any right, power or privilege under this Agreement shall impair the same or operate as a waiver of any such right, power or privilege. The exercise of any right, power or privilege shall not constitute an exercise of the same or the exercise of any other right, power or privilege. The rights and remedies provided in this Agreement are cumulative and not exclusive of any rights and remedies provided by law.
- 16.4** Severance
If any provision of this Agreement is prohibited by law or judged by a court to be unlawful, void or unenforceable, the provision shall nevertheless survive and the remainder of the Agreement shall remain in effect as far as possible without modifying the remaining provisions of this agreement, and shall not in any way affect any other circumstances or of the validity or enforcement of this Agreement.
- 16.5** Interpretation
In this Agreement unless the context otherwise requires:
16.5.1 words importing any gender include every gender;
16.5.2 words importing the singular number include the plural number and vice versa;
16.5.3 words importing persons include firms, companies and corporations and vice versa;
16.5.4 references to numbered clauses are references to the relevant clause in this Agreement;
16.5.5 any obligation on any Party not to do or omit to do anything is to include an obligation not to allow that thing to be done or omitted to be done;
- 16.6** the headings to the clauses of this Agreement shall not affect the interpretation;
16.6.7 any reference to an enactment includes reference to that enactment as amended or replaced from time to time and to any subordinate legislation or bylaw made under that enactment;
- 16.6.8** where the word 'including' is used in this Agreement, it shall be understood as meaning 'including without limitation'.
- 16.6** Notices
16.6.1 Any notice to be given under this Agreement shall be in writing and shall be sent by first class mail, or by facsimile or email (confirmed by first class mail), to the address or facsimile number of the relevant Party set out in the Quotation, or such other address or facsimile number as that Party may from time to time notify to the other Party in accordance with this clause 17.1.1.
16.6.2 Notices are deemed to have been received three working days after the day of posting (in the case of inland first class mail), or on the next working day after transmission (in the case of facsimile messages, but only if a transmission report is generated by the sender's facsimile machine recording a message from the recipient's facsimile machine, confirming that the facsimile was sent to the number indicated above and confirming that all pages were successfully transmitted).
16.6.3 In proving the giving of a notice it shall be sufficient to prove that the notice was left, or that the envelope containing the notice was properly addressed and posted, or that the applicable means of telecommunication was addressed and despatched and despatch of the transmission was confirmed and/or acknowledged as the case may be.
- 16.7** Law and jurisdiction
The validity, construction and performance of this Agreement shall be governed by English law and shall be subject to the exclusive jurisdiction of the English courts to which the Parties submit.
- 16.8** Third parties
For the purposes of the Contracts (Rights of Third Parties) Act 1999 and notwithstanding any other provision of this Agreement this Agreement is not intended to, and does not, give any person who is not a party to it any right to enforce any of its provisions.
- 17 Cancellation Rights-Consumer Contracts**
- 17.1** This clause shall apply where the client is dealing as a consumer and the Consumer Protection (Distance Selling) Regulations 2000 apply.
17.2 Your right of cancellation
17.2.1 The Client has the right to cancel the contract at any time up to the end of seven working days after it receives the goods or, in the case of services, the date the Supplier sends its order confirmation (see below). A working day is any day other than weekends and bank or other public holidays.
17.2.2 To exercise its right of cancellation, the Client must give written notice to the Supplier by hand or post, fax or email, at the address, fax number or email address shown below, giving details of the goods ordered and (where appropriate) their delivery.
17.2.3 If the Client exercises its right of cancellation after the goods have been delivered to it, the Client will be responsible for returning the goods to the Supplier at its own cost. The goods must be returned to the address shown below. The Client must take reasonable care to ensure the goods are not damaged in the meantime or in transit.
17.2.4 Once the Client has notified the Supplier that it is cancelling the contract, the Supplier will refund or recredit the Client within 30 days for any sum that has been paid by it or debited from its credit card for the goods or services.
17.2.5 If the Client does not return the goods as required, the Supplier may charge the Client a sum not exceeding the direct costs of recovering the goods.
17.2.6 You do not have the right to cancel the contract if the order is for audio or video recordings or computer software which have been unsealed by you, or for goods which by their nature cannot be returned or are liable to deteriorate or expire rapidly. The Supplier will notify you at the time your order is accepted if this applies.

All images and descriptions including dimensions are approximate and are only intended to provide a general idea of the goods to which they refer and will not form part of the contract. All colours shown are representations. Although we make every effort to show our products in their original colours, due to photography, printing methods and individual monitors, actual colours may vary. The Company's policy is one of continuous improvement and it reserves the right to make reasonable changes to products specifications at its discretion. When placing an order with the Company, the Buyer must be satisfied that the Company's then specification is appropriate for its (or its customer's) requirements.

Welcome

to the 2022-23 Edition Fixfire® Fire & Safety Products catalogue

Fixfire® provides a complete range of specialist products and services to facilitate Fire & Life Safety Compliance in buildings. This edition is packed with a diverse range of products from the popular Fixfire® IdentiRange™ of Fire Extinguisher Stands and Backplates, to solutions designed to protect Fire Safety Equipment from 'damage and abuse'. You will even find obscure items such as Fire Alarm and Emergency Lighting test keys in this informative and user friendly catalogue. Many products are available for next day delivery and our helpful Sales Team is always available to provide advice and technical support.

We look forward to serving you.

The Fixfire® Sales Team

Contents

SECTION ONE FIRE FIGHTING EQUIPMENT

- 4 Fire Extinguishers**
- 4 Commercial range
- 7 The Prestige Collection
- 8 Domestic range
- 8 Fire Blankets**
- 9 Welding Protection
- 11 Fire Hoses and Accessories**
- 11 Hoses & Reels
- 12 Accessories
- 13 Fire brigade equipment**
- 13 Lay Flat Hose
- 14 Accessories
- 15 Fire Buckets & Fire Beaters**
- 15 Fire Buckets & Accessories
- 16 Fire Extinguisher Mounting, Storage and Protection**
- 16 Brackets
- 17 Extinguisher Cabinets
- 18 Extinguisher Stands & Backplates
- 18 IdentiStand
- 19 IdentiPlate
- 20 Fire Extinguisher Mounting Storage and Protection - The Prestige Collection**
- 20 Prestige Extinguisher Stands
- 21 Fire Extinguisher Mounting Storage and Protection**
- 21 TuffStands
- 22 Site Stands

- 22 IdentiPoint
- 23 Extinguisher trolleys
- 24 Extinguisher and Hose Reel Covers
- 25 Anti-tamper products

SECTION TWO MEANS OF ESCAPE PRODUCTS

- 26 Fire alarm**
- 26 System accessories & Test equipment
- 28 Anti-tamper Products
- 28 Fire Detector and Warning Device Protection
- 30 Battery operated Fire Detectors
- 32 Fire Sentry Site Alarms
- 37 Self-Contained Alarms
- 38 Emergency lighting test keys**
- 39 Escape Door Furniture**
- 39 Door Closers, Hinges & Selector
- 37 Door hold-back devices
- 41 Panic hardware
- 43 Escape Door Anti-tamper devices**
- 43 Redlam Bolt and Spare Elements
- Escape door tamper seals
- 44 and Exit Stopper
- 45 Building evacuation products**
- 45 Fire warden kits
- 46 High Visibility Clothing
- 47 Torches and evacuation tools
- 48 Escape Ladders
- 49 Evacuation Chairs
- 50 Fire Resistant/Intumescent Products

- 50 Fire and Smoke Seals
- 51 Batwing Seals
- 52 Glazing Seals
- 54 Air transfer grilles
- 55 Mastic, Expanding Foam and Fire Retardant Spray
- 56 Pipe Seals
- 57 Intumescent Fire Pillows and Downlighter Covers
- 58 Fire & Safety Signs**
- 58 Standard Signs - Non-Photoluminescent
- 60 Post-Mounting Signs - Non-Photoluminescent
- 61 Fire Extinguisher Type Signs - Photoluminescent
- 61 Factory and Warehouse Signs
- 62 TuffSigns
- 64 The Prestige Collection - Prestige Signs
- 66 Sign Mounting Accessories

SECTION THREE FIRE LOG BOOK & FIRE DOCUMENT HOLDERS

- 67 Fire Log Book**
- 68 Fire Document Holders**

SECTION FOUR FIRST AID PRODUCTS

- 69 Standard & Workplace First Aid Kits

INDEX



Tried and trusted, the Ultimex™ range of fire extinguishers by Fixfire® is built to exacting and stringent standards for reliability, longevity and superior performance.



Guaranteed for ten year(s) (Subject to T&Cs)



Fitted with pressure gauge



Polyester coated



Kite Mark Certified & CE marked



Easy to understand instructions



Fitted with robust plastic skirts (freestanding versions)

Water

Part No.	Fire Rating	H (mm)	Overall W (inc. hose) (mm)	Weight (Kg)
X/W9	21A	522	320	13.29

X/W9

- Internal polythene lining
- Squeeze grip operation
- Approved to BS EN3
- Supplied complete with bracket.



Product Technical Tip

As with all of the larger portable Fire Extinguishers, you should consider whether the wall construction is adequate to withstand the weight of the appliance. Extinguisher stands should be considered for cavity wall applications.



X/W9

YOU MAY ALSO REQUIRE ...

FINDON P25



Anti-tamper Products



Foam

Part No.	Fire Rating	H (mm)	Overall W (inc. hose) (mm)	Weight (Kg)
X/F2	8A 55B	395	150	3.81
X/SF3	13A 89B	426	300	5.3
X/F6	21A 144B	560	300	9.65
X/F9	27A 183B	522	340	13.24

- Spray nozzle
- Internal polythene lining
- Squeeze grip operation
- Approved to BS EN3 including 35Kv dielectric test
- Supplied complete with bracket
- X/F2 supplied with transport bracket.



X/F2

X/SF3

X/F6

X/F9





Tried and trusted, the Ultimex™ range of fire extinguishers by Fixfire® is built to exacting and stringent standards for reliability, longevity and superior performance.



Guaranteed for ten years (Subject to T&Cs)



Fitted with pressure gauge



Polyester coated



Kite Mark Certified & CE marked



Easy to understand instructions



Fitted with robust plastic skirts (freestanding versions)

ABC Dry Powder

Part No.	Fire Rating	H (mm)	Overall W (inc. hose) (mm)	Weight (Kg)
X/P1	8A 55B	340	135	1.67
X/P2	13A 70B	370	150	3.62
X/P4	21A 113B	420	293	6.4
X/P6	34A 233B	503	260	8.94
X/P9	43A 233B	582	317	12.98

- Multi purpose application
- Squeeze grip operation
- Approved to BS EN3
- Supplied complete with bracket
- X/P1 & X/P2 supplied complete with transport bracket.



X/P1 X/P2 X/P4 X/P6 X/P9

Specialist Powder Extinguishers

Part No.	Description	Fire Rating	H (mm)	Overall W (inc. hose) (mm)	Weight (Kg)	Metal Fire Suitability
X/M28/9	9Kg M28 Fire Extinguisher	N/A	610	300	14.6	Magnesium, Sodium, Aluminium
X/L2/9	9Kg L2 Fire Extinguisher	N/A	610	300	14.6	Lithium

- Specialist metal fire applications
- Squeeze grip operation
- Low velocity long reach lance type applicator
- Approved to BS EN3
- Supplied complete with bracket.

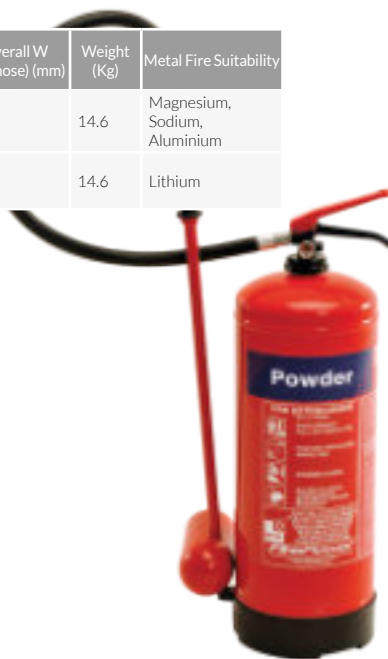

X/M28/9 & X/L2/9

PLEASE ENQUIRE ABOUT OUR RANGE OF...



Wheeled Extinguishers



Please enquire for more details.



Tried and trusted, the Ultimex™ range of fire extinguishers by Fixfire® is built to exacting and stringent standards for reliability, longevity and superior performance.



Guaranteed for ten year(s) (Subject to T&Cs)



Fitted with pressure gauge



Polyester coated



Kite Mark Certified & CE marked



Easy to understand instructions

CO₂

Part No.	Fire Rating	H (mm)	Overall W (inc. hose) (mm)	Weight (Kg)
X/C2	34B	490	180	4.91
X/C5	70B	750	310	11.43

- Aluminium alloy construction
- Harmless to machinery
- Squeeze grip operation
- Approved to BS EN3
- X/C2 supplied with frost free horn
- X/C5 supplied with hose and horn
- Supplied complete with bracket.



X/C2

X/C5

YOU MAY ALSO REQUIRE ...

FINDON P16

Transport Brackets



Wet Chemical

Part No.	Fire Rating	H (mm)	Overall W (inc. hose) (mm)	Weight (Kg)
X/WC6	13A 133B 75F	662	310	12.13

- Internal polythene lining
- High performance fire rating
- Squeeze grip operation
- Approved to BS EN3
- Supplied complete with bracket.



X/WC6

TYPICAL COMMERCIAL KITCHEN APPLICATION



Product Technical Tip



We recommend the installation of a 6 litre Wet Chemical extinguisher, 2Kg CO₂ extinguisher and a suitably sized Fire Blanket to provide protection for Commercial Kitchens.





A range of discreet, stylish fire extinguishers designed to compliment modern surroundings whilst providing the same high level of performance as the Ultimex[™] Range.



Guaranteed for ten years (Subject to T&S&Cs)



Fitted with pressure gauge



Easy to understand instructions

Water

Part No.	Fire Rating	H (mm)	Overall W (inc. hose) (mm)	Weight (Kg)
X/W9/S	21A	640	300	12.22

- Highly polished finish
- Greater corrosion resistance
- Suitable for use in hygiene critical environments
- Internal polythene lining
- Squeeze grip operation
- CE Marked
- Supplied complete with bracket.



X/W9/S



YOU MAY ALSO REQUIRE ...

FINDON P61

Complementing Fire signs



The **PRESTIGE**[™]
Collection

Foam

Part No.	Fire Rating	H (mm)	Overall W (inc. hose) (mm)	Weight (Kg)
X/F6/S	13A 144B	500	300	8.63
X/F9/S	21A 183B	640	300	12.22

- Spray nozzle
- Highly polished finish
- Greater corrosion resistance
- Suitable for use in hygiene critical environments
- Internal polythene lining
- Squeeze grip operation
- CE Marked
- Supplied complete with bracket.



X/F6/S

X/F9/S



CO₂

Part No.	Fire Rating	H (mm)	Overall W (inc. hose) (mm)	Weight (Kg)
X/C2/S	34B	490	180	4.91

- Aluminium alloy construction
- Highly polished finish
- Suitable for use in hygiene critical environments
- Harmless to machinery
- Squeeze grip operation
- CE Marked
- Supplied complete with bracket.



X/C2/S



YOU MAY ALSO REQUIRE ...

FINDON P20

Complementing Fire Extinguisher Stands



The **PRESTIGE**[™]
Collection



Fire Extinguishers

Domestic Range

The Fixfire® range of domestic extinguishers is designed and built to the same exacting quality as the commercial range. Ideal for domestic, vehicle and leisure use.



Fitted with pressure gauge



Polyester coated



Kite Mark Certified & CE marked



Easy to understand instructions

ABC Dry Powder

Part No.	Fire Rating	H (mm)	Overall W (inc. hose) (mm)	Weight (Kg)
X/P1/P	8A 34B	340	135	1.7
X/P2/P	13A 89B	370	150	3.65

- Multi purpose application
- Ideal for use in home, garage, vehicle, boat or caravan
- Squeeze grip operation
- Approved to BS EN3
- Supplied complete with transport bracket.



X/P1/P



X/P2/P



Fire Blankets

Portable

Fixfire® offers premium quality Fire Blankets which are Kite Marked and BAFE Certified.



5 year guarantee



Kite Marked



One piece construction



Made in UK

Portable

Part No.	Description
X/FB100	1M x 1M
X/FB120	1.2M x 1.2M
X/FB175	1.75M x 1.75M
X/FB180	1.2M x 1.8M

- Durable Single piece moulded plastic cover
- Ideal for use in kitchens and workshops
- High quality long life cloth
- Easy to use
- Kitemark certified to BSEN 1869:1997
- Wide range of sizes available.

Product Technical Tip



Fire Blankets should be mounted so as to position the hand hold device approximately 1.5 m from the floor.



X/FB100
X/FB120

X/FB175
X/FB180

YOU MAY ALSO REQUIRE ...

FIND ON P58

ID Signs





Fire Blankets

Welding Protection

Our range of high quality welding drapes and screens is suitable for all types of workshop environment. Designed to meet the most stringent standards for safety and long life.



One piece construction



Made in UK



EN Certified



Robust & Durable

Medium Duty Welding drape

Part No.	Description
X/HSC1	Medium Duty Welding Drape

- High performance coated glass fibre material protects from medium spatter and sparks
- Material offers very low level of gas permeability, excellent abrasion resistance, will not deteriorate as a result of weathering, flexing or oxidation
- Superior draping characteristics
- Complete with brass reinforced eyelets.



X/HSC1

Heavy Duty Welding drape

Part No.	Description
X/HS1306	Heavy Duty Welding Drape

- Ideal for use during cutting and welding operations
- Will protect from molten metal splashes
- Can withstand temperatures up to 1000°C
- Heavy duty robust material with superior tensile strength.



X/HS1306

Super Heavy Duty Welding drape

Part No.	Description
X/HS1500	Super Heavy Duty Welding Drape

- Excellent thermal properties
- Will protect from molten metal splashes
- For continuous use at 1000°C.



X/HS1500

Dust Sheet

Part No.	Description
X/FRD	Flame Retardant Dust Sheet

- Designed to meet H&S guidelines when working in public areas
- Manufactured from heavy duty cotton
- Fully washable
- Proban treated
- Large size - 3.65M x 2.75M.



X/FRD

YOU MAY ALSO REQUIRE ...

FIND ON P06

CO₂ Extinguishers suitable for workshop applications





Fire Blankets

Welding Protection

Our range of high quality welding drapes and screens is suitable for all types of workshop environment.



One piece construction



Made in UK



EN Certified



Robust & Durable

Light Duty Welding Screen

Part No.	Description
X/TPC	Light Duty Welding Screen

- Protects from welding glare, grinding, sparks etc.
- Conforms to BS EN 1598:1998
- Complete with brass reinforced eyelets
- Nylon reinforced.

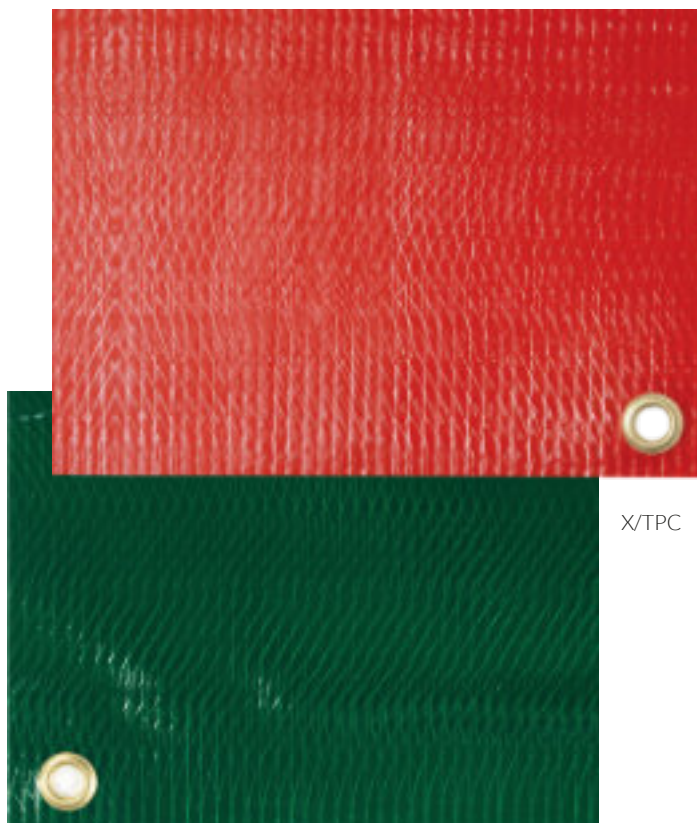

X/TPC

Welding Screen Stand

Part No.	Description
X/WSS1	Welding Screen Stand

- Manufactured from high quality durable steel tubing
- Complete with castors for ease of movement
- Supplied with flame retardant reinforced translucent red pvc screen
- Overall dimensions H1700 x W1870mm x D620mm
- Screen size H1400mm x W1720mm.



X/WSS1





Fire Hoses & Accessories

Hose & Reels

Our range of slimline manual and automatic reels is designed for reliability, performance and ease of installation and maintenance.



Robust & Durable



High Visibility



User-friendly



Kite Marked

Fixed / Swinging Reel

Part No.	Description
X/M1B	Fixed Manual Hose Reel
X/M1A	Fixed Automatic Hose Reel
X/M3B	Swinging Manual Hose Reel
X/M3A	Swinging Automatic Hose Reel

- Automatic or manual operation
- Beaded hose guide and jet spray nozzle included with all models
- Easy to install and maintain
- Simple to operate
- Easy to service
- Accommodates 30m of 25mm or 19mm bore hose
- Manufactured from zinc plated steel for corrosion protection
- Epoxy polyester powder coated for a high quality finish
- Technical data sheets with performance specification available
- Gate valves supplied separately.



X/M1B (Manual)
X/M1A (Automatic)



X/M3B (Manual)
X/M3A (Automatic)



X/M1930 (19mm bore)
X/M2530 (25mm bore)

YOU MAY ALSO REQUIRE ... FIND ON P24

Hose Reel Covers



Fire Reeling Hose

Part No.	Description
X/M1930	19mm x 30M Replacement Hose
X/M2530	25mm x 30M Replacement Hose

- Approved to EN694
- Available in 19mm or 25mm diameter bore
- Can be used within -20°C to 60°C temperature range
- Ideal for use where long intervals may occur between use.



Fire Hoses & Accessories

Accessories

The Fixfire® range of hose reel accessories and protection equipment provides everything you need to protect and maintain your hose reel installation.

Hose Accessories

Part No.	Description
X/HRN19	19mm Spray Nozzle
X/HRN25	25mm Spray Nozzle
X/HRG	Beaded Hose Reel Guide
X/FWP19	19mm Diameter Flexible Water Inlet Pipe
X/FWP25	25mm Diameter Flexible Water Inlet Pipe
X/GV19	19mm Diameter Gate Valve
X/GV25	25mm Diameter Gate Valve



YOU MAY ALSO REQUIRE ...

FIND ON P11

Replacement Fire Reeling Hose



Hose Nozzle Protector

Part No.	Description
X/HNP	Hose Nozzle Protector
X/HNP/S	Replacement Hose Nozzle Protector Tamper Seals (pack of 10)

- Protects from dirt and vandalism
- Reduces risk of legionella outbreaks
- Tamper evident seal incorporated
- Easy to install.



YOU MAY ALSO REQUIRE ...

FIND ON P17

Hose Reel Cabinet





Fire Brigade Equipment

Lay Flat Hose

Fixfire® offer a comprehensive range of fully compliant brigade equipment. Designed to deliver large quantities of water as required.



Lightweight



Robust & Durable



Made in UK



User-friendly



Marine Approved

Type 1 Uncoated Hose

Part No.	Description	Diameter	Length
X/T1FH/15/?	Type 1 Uncoated Layflat Hose	2 1/2"	15
X/T1FH/18/?	Type 1 Uncoated Layflat Hose	2 1/2"	18
X/T1FH/20/?	Type 1 Uncoated Layflat Hose	2 1/2"	20
X/T1FH/23/?	Type 1 Uncoated Layflat Hose	2 1/2"	23
X/T1FH/25/?	Type 1 Uncoated Layflat Hose	2 1/2"	25
X/T1FH/30/?	Type 1 Uncoated Layflat Hose	2 1/2"	30
X/T1FH/60/?	Type 1 Uncoated Layflat Hose	2 1/2"	60
Colours	Add: /R Red, /W White		

- High quality uncoated fire hose
- Widely used by Fire and Rescue Services, Marine and Industrial
- Ideally suited to general purpose fire fighting, water transfer and wash down use
- Lightweight fire hose
- Tough and hard wearing
- Flexible and easy to handle
- Manufactured to BS6391 and M.E.D. (Ships Wheel) approved for marine use
- All synthetic rot proof construction is immune to mildew and bacteria
- Easy to clean and maintain.



X/SFH

Type 3 Coated Hose

Part No.	Description	Diameter	Length
X/T3FH/15/?	Type 3 Coated Layflat Hose	2 1/2"	15
X/T3FH/18/?	Type 3 Coated Layflat Hose	2 1/2"	18
X/T3FH/20/?	Type 3 Coated Layflat Hose	2 1/2"	20
X/T3FH/23/?	Type 3 Coated Layflat Hose	2 1/2"	23
X/T3FH/25/?	Type 3 Coated Layflat Hose	2 1/2"	25
X/T3FH/30/?	Type 3 Coated Layflat Hose	2 1/2"	30
X/T3FH/60/?	Type 3 Coated Layflat Hose	2 1/2"	60
Colours	Add: /R Red, /B Blue or /Y Yellow		

- Premium high quality coated fire hose used by professional fire fighters around the world
- Hard wearing PVC/Nitrile lining and cover
- Excellent chemical, oil and ozone resistant qualities
- Will withstand accidental contact with hot embers
- Excellent abrasion resistance
- Requires no drying and cleaning
- Manufactured to BS6391 and M.E.D. (Ships Wheel) approved for marine use.



X/NFH



Product Technical Tip



In BS 6391 fire hoses are classified into three categories.

Type 1 and Type 2 hoses comprise a circular woven jacket or reinforcement made from a synthetic fibre with an impermeable internal elastomeric lining.

Type 1 hoses are those "to which no external treatment has been applied to the reinforcement and are therefore liable to absorb liquids and need to be thoroughly dried after use". These types of fire hoses are sometimes called "conventional hoses".

Type 2 hoses are those "to which an external elastomeric coating has been applied to the reinforcement to give some protection against the absorption of liquids and to improve resistance to abrasion of the reinforcement".

Type 3 hoses are those "to which an external elastomeric coating or covering has been applied to, or been incorporated in, the reinforcement to give the hoses very low absorption of liquids and high resistance to abrasion and heat."



Fire Brigade Equipment

Accessories

Fixfire® offer a comprehensive range of fully compliant brigade equipment. Designed to deliver large quantities of water as required.



Lightweight



Robust & Durable



Made in UK



User-friendly



Marine Approved

Standpipes

Part No.	Description
X/SP/SH	Single Alloy Standpipe
X/SP/DH	Double Alloy Standpipe

- Durable alloy construction
- Easily connects to the mains water supply
- Standpipes are available in single or double headed types
- Supplied with a 2½" British Round Thread female inlet
- Supplied with a 2½" instantaneous female single twist outlet
- Other outlets to BS336 can be supplied.



X/SP/SH



X/SP/DH



X/SP/HK

Hydrant Key & Bar

Part No.	Description
X/SP/HK	Hydrant Key and Bar

- Aluminium alloy construction
- Use to turn water supply on and off with at hydrant
- Bar is removable for easy storage.

Fire Nozzles

Part No.	Description
X/SFN	Spray Nozzle
X/RSFN	Rubber Bump Shield Spray Nozzle
X/LOFN	Lever Operated Spray Nozzle

- Manufactured from lightweight durable aluminium alloy
- On/off twist action jet or fan spray (X/SFN & X/RSFN)
- Lever operation for ease of operation and control (jet spray only)
- Instantaneous coupling
- 2 ½" coupling
- Multiple uses including fire fighting, cooling, wash-down and dust suppression.



X/SFN



X/RSFN

YOU MAY ALSO REQUIRE ...

FIND ON P17

Equipment Cabinets



X/LOFN





Fire Buckets & Fire Beaters

Fire Buckets & Accessories

Our range of fire buckets and beaters provide a traditional tried and tested method of fire fighting.

Metal Fire Bucket

Part No.	Description
X/MFB	Metal Fire Bucket
X/MFBL	Metal Fire Bucket Lid
X/FBB	Fire Bucket Bracket

- Suitable for wide range of applications, from garage forecourts to science labs
- Choice of bucket style to meet every requirement
- 10 Litre capacity
- Hanging bracket available separately
- Bucket lid supplied separately to bucket.



X/MFB

Plastic Fire Bucket

Part No.	Description
X/FB	Plastic Fire Bucket
X/FBL	Plastic fire bucket Lid
X/FBB	Fire Bucket Bracket

- Suitable for wide range of applications, from garage forecourts to science labs
- Choice of bucket style to meet every requirement
- 10 Litre capacity
- Hanging bracket available separately
- Bucket lid supplied separately to bucket.



X/FB

Fire Sand Bin

Part No.	Description
X/FSB	Fire Sand Bin

- Designed for bulk storage of fire sand and other fire fighting compounds
- Robust moulded plastic construction
- Corrosion proof
- Dimensions: H570 x W655 x D500.



X/FZS

Flamezorb

Part No.	Description
X/FZS	Flamezorb Fire Sand, 2Kg Bag

Flamezorb Fire Sand

- Superior absorbent properties to sand
- Lightweight – 2kg bag fills a 10L bucket
- Easy to clear up and dispose of
- Fully conforms to BS476 part 7 class 2t



X/FZS

Fire Beater

Part No.	Description
X/FBT	Fire Beater, 2kg Bag

Fire Beater

- Solid hardwood handle
- Industrial grade rubber beater for excellent knockdown
- 1200mm long handle.
- Beater size 310mm x 450mm



X/FBT



X/FBT

YOU MAY ALSO REQUIRE ...

FINDON P23

Site Trolleys

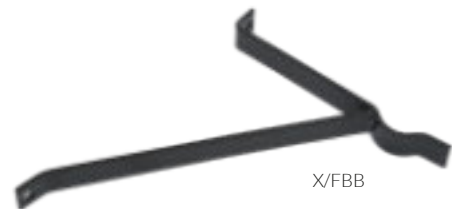

X/FBB



Fire Extinguisher Mounting, Storage & Protection Brackets

Our range of extinguisher brackets offers a simple, effective method of safely locating all types of fire extinguishers.

Standard Extinguisher Brackets

Part No.	Description
X/JB	J Bracket
X/LB2	2Kg CO ₂ Size Lug Bracket
X/LB5	5Kg CO ₂ Size Lug bracket

J Bracket

- Universal style
- Galvanised finish.

2Kg CO₂ Size lug Bracket

- Suits all makes of 2Kg CO₂ extinguisher
- Galvanised finish.

5Kg CO₂ size lug bracket

- Suits all makes of 5Kg CO₂ extinguisher
- Galvanised finish.



Transport Extinguisher Brackets

Part No.	Description
X/TB/JB	Transport J Bracket
X/TB/LB2	2Kg CO ₂ Size Transport Bracket
X/TB/LB5	5Kg CO ₂ Size Transport Bracket

Transport J bracket

- Universal style
- powder coated finish
- Supplied complete with webbing strap and quick release buckle

2Kg CO₂ size transport bracket

- Suits all makes of 2Kg CO₂ extinguisher
- Galvanised finish
- Supplied complete with webbing strap and quick release buckle

5Kg CO₂ size transport bracket

- Suits all makes of 5Kg CO₂ extinguisher
- Galvanised finish
- Supplied complete with webbing strap and quick release buckle

Product Technical Tip



In order to comply with BS 5306 part 8 extinguishers should be so mounted that the carrying handle is 1 metre above the floor. Smaller extinguishers of under 4kg total weight should be mounted with the handle at 1.5 metres above the floor.

X/TB/LB2 TRANSPORT BRACKET IN WALL MOUNTING APPLICATION





Fire Extinguisher Mounting, Storage & Protection

Extinguisher Cabinets

TuffCabinets™ is a complete range of fire equipment cabinets designed to be strong, lightweight, and weatherproof. Ideal for storage of all types of fire extinguishers and other associated equipment.



Robust & Durable



Weatherproof



High Visibility



User-friendly



Made in UK



...safe, secure & protected

Wall Mounting Cabinets

Part No.	Description	Dimensions
X/SEC/M	Single Extinguisher Cabinet Up to 6 Kg/litre Extinguisher Capacity	700H x 320W x 255D
X/SEC/L	Single Extinguisher Cabinet Up to 9 Kg/litre Extinguisher Capacity	830H x 330W x 265D
X/DEC	Double Extinguisher Cabinet	720H x 585W x 270D
X/TEC	Double/Triple Extinguisher Cabinet	850H x 565W x 375D
X/QEC	Quad Fire Equipemnt Cabinet	900H x 930W x 420D
/K	Keylock	

- Totally corrosion resistant design
- Can be wall, post or vehicle mounted
- Clear polypropylene vision panels in door
- Complete with internal equipment retaining straps
- Robust rotationally moulded construction for high impact resistance.



X/SEC/M



X/DEC



X/DEC/K



X/QEC

YOU MAY ALSO REQUIRE ...

FIND ON P25

Alarm your cabinet with a Mini Theft Stopper



Vehicle Mounting Cabinets

Part No.	Description	Dimensions
X/VEC/M	Medium Vehicle Extinguisher Cabinet Up to 6 Kg/litre Extinguisher Capacity	650H x 260W x 275D
X/VEC/L	Large Vehicle Extinguisher Cabinet 9 Kg/litre Extinguisher Capacity	750H x 300W x 300D
X/FKM	Fixing Kit for X/VEC/M, 30° or 60°	N/A
X/FKL	Fixing Kit for X/VEC/L, 30° or 60°	N/A

- Totally corrosion resistant design
- Kits available for easy vehicle mounting
- Complete with internal equipment retaining spring or strap.
- Robust rotationally moulded construction for high impact resistance.



X/VEC/L



X/VEC/L mounted on lorry



Call Systems



Access & Security



DDA Compliance



Fire Extinguisher Mounting, Storage & Protection

Extinguisher Stands & Backplates

Not sure how to mount your extinguishers? - unsuitable walls or no wall space? The IDENTiRange™ achieves a consistent installation whatever the situation.



Robust & Durable



High Visibility



Obvious if extinguisher is missing



Made in UK

IDENTiStand™

Extinguisher Stands

Part No.	Description
X/IS1	Single Stand
X/IS2	Double Stand

- All metal construction robust extinguisher stand
- Holes in feet for floor mounting
- Ideal for any situation where there is no suitable wall surface.

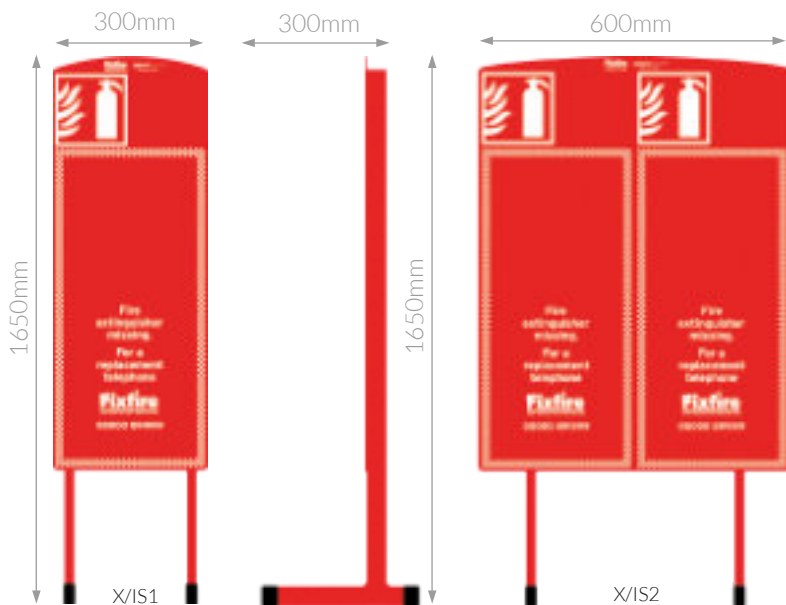

X/IS2

IDENTiRange™ - the success story...

When a major American Automotive Manufacturer approached Fixfire® in 1994 to mount Fire Extinguishers in awkward locations at their factory; Fixfire® rose to the challenge and set to work to develop the IdentiRange.

The outcome exceeded all expectations - not only were IdentiRange products installed throughout the factory - the IdentiRange quickly gained popularity and today, 1000's of IdentiRange products are installed in Industrial, Commercial and Healthcare premises throughout the UK.

IMPORTANT ORDERING INFORMATION



When Ordering Identi Range products, remember to order the appropriate Identilabel extinguishant ID sign and Brackets separately.





Fire Extinguisher Mounting, Storage & Protection

Extinguisher Stands & Backplates

Extinguishers missing / moving? The IDENTiRange™ is the solution for you...



Robust & Durable



High Visibility



Obvious if fire extinguisher is missing



Made in UK

IDENTiPlate™

Extinguisher Backplates

Part No.	Description
X/MSBP	Midi Single Backplate
X/MDBP	Midi Double Backplate
X/SBP	Single Backplate
X/DBP	Double Backplate

- Wall mounting backplate
- Double/Single versions
- Standard and midi size where height is restricted.

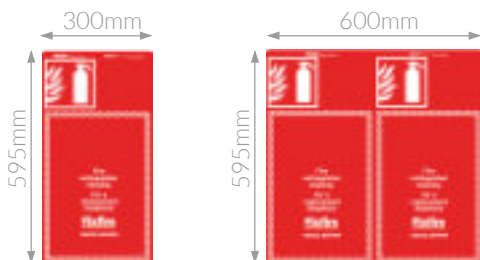

X/MSBP

X/MDBP

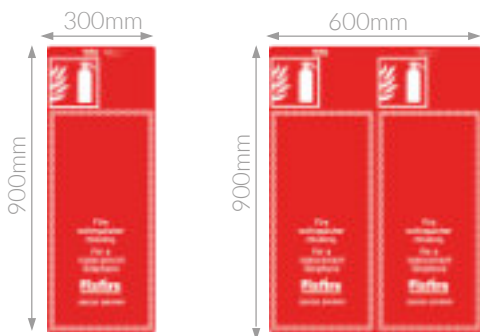

X/SBP

X/DBP

X/DBP DOUBLE IDENTIPLATE MOUNTED ON BRICK WALL



X/DBP

IDENTiLabel™

Part Number	Description
S/IL/W	IdentiLabel Water Extinguisher Label
S/IL/F	IdentiLabel AFFF Foam Spray Extinguisher Label
S/IL/P	IdentiLabel Dry Powder Extinguisher Label
S/IL/C	IdentiLabel CO ² Extinguisher Label
S/IL/WC	IdentiLabel Wet Chemical Extinguisher Label

- Extinguisher type label
- Fits in dedicated section.

All 135H x 135W (mm)



S/IL/W



S/IL/F



S/IL/C



S/IL/P



S/IL/WC



Mounting, Storage & Protection

Extinguisher Stands

A range of discreet, stylish fire extinguisher stands for any area where appearance matters.



Architecturally pleasing



Robust & Durable



Easy to Install



Lightweight

Prestige Stands

Part No.	Description
X/CS1	Single Extinguisher Stand
X/CS2	Double Extinguisher Stand

- Stylish chrome finish complements all shop, showroom and office environments
- Ideal for use where wall mounting of extinguishers is not suitable
- Strong single piece tubular frame construction
- Lightweight for ease of installation
- Supplied with multiple bracket kit.



X/CS2 (Double Stand)



X/CS1 (Single Stand)

Prestige Stand Clip Signs

Part No.	Description
X/6370ID/PF	ABC Powder ID Sign in Clip Frame
X/6373ID/PF	Foam Spray ID Sign in Clip Frame
X/6374ID/PF	Water ID Sign in Clip Frame
X/6372ID/PF	CO ₂ ID Sign in Clip Frame
X/6407ID/PF	Wet Chemical ID Sign in Clip Frame
X/6387ID/PF	Hydro-Spray ID Sign in Clip Frame

- Metal Effect coated plastic framed sign
- Clips to tubular frame
- Complements Prestige Stand perfectly!





Fire Extinguisher Mounting, Storage & Protection

TuffStands™

TuffStands™ are available in a choice of styles and finishes, TuffStands™ overcome the problems associated with wall-mounting appliances.



Architecturally pleasing



Moulded well in base to support extinguisher



Skirting board recess at rear of base



Dedicated extinguisher ID sign panel



Made in UK



Single / Double TuffStand

Part No.	Description	Dimensions
X/TS1/?	2 Part Single Extinguisher TuffStand	654H x 290W x 300D
X/TS2/?	2 Part Double Extinguisher TuffStand	654H x 290W x 300D
Colours	Add: /R/2 Red, /MG/2 Marble Grey, C/2 Cream	

- Suitable for all shop and office environments
- Ideal for use where wall mounting of extinguishers is not suitable
- Robust rotationally moulded construction
- Lightweight 2 part construction for ease of installation and storage
- Range of signs available to suit
- Can accommodate up to 9Kg size extinguishers
- Available in red, marble grey or cream finishes.



X/2P/TS1MG



X/2P/TS2R

Midi TuffStand

Part No.	Description	Dimensions
X/MTS1/?	Single Midi Tuffstand	620H x 310W x 265D
X/MTS2/?	Double Midi Tuffstand	620H x 310W x 265D
Colours	Add: /R/2 Red, /MG/2 Marble Grey, C/2 Cream	

- Compact design suitable for all shop and office environments
- Ideal for use where wall mounting of extinguishers is not suitable
- Skirting board recess built in
- Robust rotationally moulded construction
- Single stand designed to accommodate 1 x 6L/Kg size extinguisher
- Double stand designed to accommodate 1 x 6L/Kg size extinguisher and 1 x 2Kg CO₂ extinguisher
- Range of signs available to suit
- Available in red, marble grey or cream finishes.



X/MTS1/R



X/MTS2/C

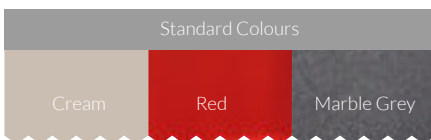

RECEPTION APPLICATION



YOU MAY ALSO REQUIRE ...

FIND ON P58

Photoluminescent Signs





Fire Extinguisher Mounting, Storage & Protection

Extinguisher Stands

Fixfire® offer a range of high quality versatile and durable site safety stands and fire points, designed to provide a focal safety point. Add fire safety signs and site alarms to create a full fire safety point for any building site.



Robust & Durable



High Visibility



Made in UK



Obvious if extinguisher is missing

Site Safety Stand

Part No.	Description
X/SS1	Site Safety Stand
X/SS2	Site Safety Stand
X/SS1/C	Castor Kit For Site Safety Stand)

- Can accommodate up to 3 extinguishers
- Heavy duty steel construction
- Powder coated finish for greater corrosion resistance
- 750x600mm rigid foamboard sign area
- Creates a central fire safety point for all building sites and factories
- Can be fitted with optional castors for ease of movement.



X/SS1



X/SS2

Product Technical Tip



Extinguishers should be sited in such a way that it is not necessary to travel from the site of any fire to reach an extinguisher further than 30 Metres in the case of a class A risk.

IdentiPoint

Part No.	Description
X/IP2	IdentiPoint Double Extinguisher Stand

- All metal construction robust extinguisher stand
- Holes in feet for floor mounting
- Incorporates 'Boxer Alarm' self contained fire alarm call point
- 600mm W x 1340mm H.



X/IP2

IMPORTANT ORDERING INFORMATION



When Ordering Identi Range products, remember to order the appropriate IdentiLabel extinguishant ID sign and Brackets separately





Fire Extinguisher Mounting, Storage & Protection

Extinguisher Trolleys

Our range of site trolleys complements the site safety stand range, offering a durable and versatile fire point solution where more mobility is called for. Site alarms can also be incorporated to create a full safety point.



Robust & Durable



High Visibility



Made in UK



Obvious if extinguisher is missing

Extinguisher Trolleys

Part No.	Description
X/DET	Double Extinguisher Trolley
X/TETB	Triple Extinguisher Trolley With Bucket Bracket
X/DCT	Double Extinguisher Tuffcabinet Trolley
X/FKMT	Rotationally Moulded Fire Point Trolley

Double & Triple Extinguisher Trolley

- Accommodates 2 extinguishers
- Robust Steel frame construction
- Heavy duty site wheels built in
- Corrosion resistant powder coated finish
- Mounting available for rotary hand bell (supplied separately)
- Integral bucket bracket available (optional extra)
- Versatile and mobile fire point for all building sites.

Extinguisher TuffCabinet Cabinet Trolley

- Robust site trolley and cabinet
- Can accommodate 2 extinguishers up to 9kg size each
- Lockable door with integral keybox for added security
- Excellent weatherproofing for extinguishers.

Double Extinguisher FireCart Trolley

- Robust rotationally moulded trolley.
- Can accommodate 2 extinguishers up to 9 Kg size each and a Fire Bucket.
- Top Panel section to fix site Fire Alarm Device and extinguisher ID signs.



X/DET



X/TETB



X/FKMT



X/FKMT Fire Cart shown with Fire Extinguishers, Fire Bucket and Site Fire Alarm fitted (order these items separately)



X/DCT



Fire Extinguisher Mounting, Storage & Protection

Extinguisher & Hose Reel Covers

Fixfire® equipment covers are a simple and cost effective method of protecting extinguishers and hose reels from tampering, damage and corrosion.



High Visibility



Made in UK



East to Fit

Extinguishers Covers

Part No.	Description
X/FEC/S	Small Cover
X/FEC/L	Large Cover

- Easily visible
- Full length vision panel
- 2 sizes to suit all types of extinguisher
- Velcro straps for ease of fitting.



X/FEC/S



X/FEC/L

Hose Reel Cover

Part No.	Description
X/HRC	Hose Reel Cover

- Designed to fit most 19mm and 25mm fire hose reels
- Easy and quick to install
- Printed with fire hose decal for high visibility.



X/HRC

YOU MAY ALSO REQUIRE ...

FINDON P12

Hose Reel Accessories





Fire Extinguisher Mounting, Storage & Protection Anti-tamper Products

Extinguisher stoppers from Fixfire® are innovative self contained security alarms designed to prevent the unauthorised use or theft of fire extinguishers.



High
Visibility



Loud



Battery
Powered



Easy to
Install

Extinguisher Stopper

Part No.	Description
X/STI6200	Extinguisher Stopper

Extinguisher Stopper

- Completely self contained
- Long life 9v battery
- Loud 120dB alarm
- Easy to install and maintain
- Effective security for all extinguishers.



X/STI6200

YOU MAY ALSO
REQUIRE ...

FIND ON
P28

Fire
Alarm
Call Point
Covers



Mini Theft Stopper

Part No.	Description
X/STI6255	Mini Theft Stopper

Mini Theft Stopper

- Self contained – battery operated
- Loud 95Db alarm
- Easy to install and maintain
- Can be fitted to TuffCabinet™ wall cabinets.



Supplied complete with clamp connector **and** magnetic contact (ideal for cabinet protection etc.)

X/STI6255

Pull-tite Seals

Part No.	Description
X/PTS/	Pull-Tite Seals

- Easy to use
- Manufactured from high quality polypropylene
- Available in red (R), White (W), Black (B), Green (G), Yellow (Y), orange (O) and Blue (BL)
- Supplied in packs of 500
- Easy to install
- Effective tamper evident security for extinguishers and can be used for other applications.

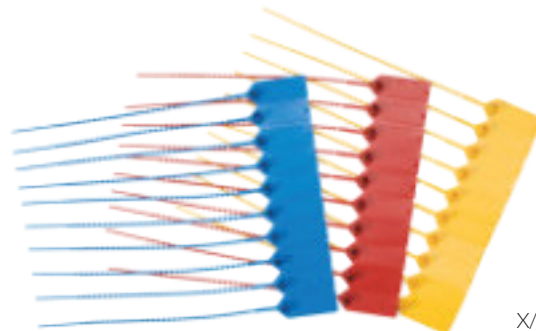

X/PTS/





Fire Alarm

System Accessories & Test Equipment

Fixfire® stocks a complete range of Fire Alarm Call Point spares and accessories to facilitate ongoing user tests and checks on your Fire Alarm System.

CALL POINT TYPE	TEST KEY	SPARE ELEMENT	COVER FLAP
APOLLO XP95/DISCOVERY	 XP95/BG/TK	Non-replaceable	 XP95/BG/PC
COOPER SAFETY	 G/MJ/TK	Plastic Coated Glass G/KG1 (Quantity 10)	 G/CXPC
GENT ADDRESSABLE	 G/71167-91NM	Plastic Coated Glass G/SEN-891 (Quantity 10)	N/A
GENT CONVENTIONAL	 G/71150-92	Plastic Coated Glass G/14112-09EN (Quantity 10)	N/A
KAC CURRENT STYLE	 G/SC070	Plastic Coated Glass G/KG1 (Quantity 10) Resettable G/PS240	 G/PS200
KAC OLD STYLE	 G/SC070	Plastic Coated Glass G/KG1 (Quantity 10) Resettable G/WF005-F	 G/PS078W
MENVIER OLD STYLE	 G/M/TK	Plastic Coated Glass G/KG1 (Quantity 10)	N/A
RAFIKI	 G/45-0022-S	Non-replaceable	N/A
STI	 G/RPK	Non-replaceable	N/A





Fire Alarm

System Accessories & Test Equipment

Fixfire® provides a range of Fire Detector test and maintenance equipment to facilitate the maintenance of your Fire Alarm System.



Robust & Durable



Lightweight



Made in UK



User Friendly

Detector Testers & Dusters

Part No.	Description
T/AERO-300-001	Hand Held Smoke Spray 150ml
T/SSAB-300-001	Smoke Sabre Hand Held Smoke Spray
T/SOLOA3-001	Aerosol Smoke Spray (for use with dispenser)
T/SOLOA7-001	Aerosol Detector Duster

- Handy aerosols for easy testing of detectors
- Hand held or dispenser types available
- Specialist aerosols also available
- Sabre Hand Held Smoke Spray features telescopic dispenser.



T/AERO-300-001



T/SSAB-300-001



T/SOLOA3-001



T/SOLOA7-001

Smoke Detector Testing Unit

Part No.	Description
T/SOLO330-001	Aerosol Smoke Dispenser

- Robust construction
- Dispenser conserves aerosol and ensures accurate test smoke dispersal
- Spring loaded mechanism for effective delivery
- Touch sensitive – ideal for suspended ceilings
- Clear test cup allows viewing of detector being tested.

T/SOLO330-001



AEROSOL SMOKE DISPENSER IN USE...



Detector Head Removal Tool

Part No.	Description
T/SOLO200-001	Detector Removing Tool

- Easy to use
- Fits standard poles
- Robust construction.

T/SOLO200-001



Extension poles

Part No.	Description
T/SOLO101-001	Fibreglass Extension Pole 1.13M
T/SOLO100-001	Fibreglass Telescopic Pole Extends to 4.5M

- Extremely lightweight
- All materials subjected to rigorous conductivity testing
- Poles can be combined quickly and easily
- Combine poles to reach maximum heights of 9M.

T/SOLO101-001



T/SOLO100-001



Fire Safety



Call Systems



Access & Security



DDA Compliance



Fire Alarm

Anti-tamper Products

Our range of Stopper call point covers is ideal to discourage unauthorised activation of fire alarm call points. Designed to accommodate both flush and surface mounted call points, and available with and without integral alarms to offer a simple solution for every situation.



High Visibility



Loud (where sounder is built in)



Robust & Durable



Easy to Install

Stopper Covers

Part No.	Description
PP/STI6530	Heavy Duty Call Point Cover (Flush Mounted)
PP/STI6531	Heavy Duty Call Point Cover (Surface Mounted)
PP/STI6532	Heavy Duty Call Point Cover (Flush Mounted) With Integral Alarm
PP/STI6533	Heavy Duty Call Point Cover (Surface Mounted) With Integral Alarm

- Tough construction
- Clear polycarbonate cover
- High visibility
- Loud 120Db sounder where incorporated
- Easy to install – can be retro fitted
- Self contained, battery operated.



PP/STI6530



PP/STI6830

Mini Stopper Covers

Part No.	Description
PP/STI6830	Mini Stopper Call Point Cover (Flush Mounted)
PP/STI6831	Mini Stopper Call Point Cover (Surface Mounted)

- Tough construction
- Clear polycarbonate cover
- Easy to install.

Fire Detector & Warning Device Protection



Robust & Durable



Easy to Install



Impact Resistant



Precision Engineered

Polycarbonate Fire Detector Cages

Part No.	Photo Key
PP/STI 8100	1
PP/STI8130	Not pictured
Colours	Add: Almond (A), Black (BLK) or White (WH)

- Available in a range of finishes
- Aesthetically pleasing for architecturally sensitive areas.
- Vandal resistant
- Flush or surface mounting types available.
- Tamper resistant mounting kits available
- Suitable for anti-ligature applications.
- Polycarbonate tested -400F (-400°) to 1200F (490°)

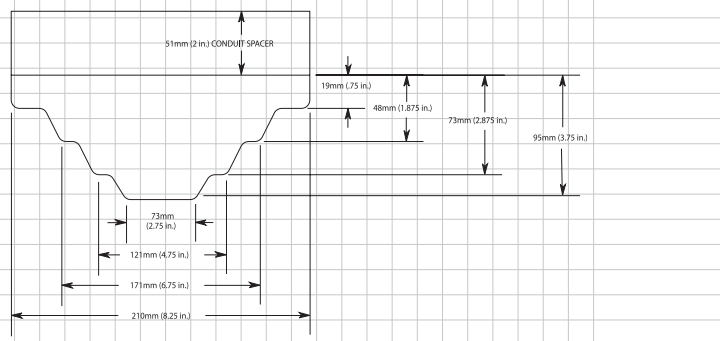



Fire Alarm

Fire Detector & Warning Device Protection

Range of rugged protective covers to prevent tampering and damage to important Fire Alarm devices.



Robust & Durable



East to Install



Impact Resistant



Precision Engineered

Fire Alarm Bell Cages

Part No.	Photo Key	Dimensions	
PP/STI 9631	1	270mm Dia	152mm deep
PP/STI 9632	2	420mm Dia	152mm Deep
PP/STI 9633	3	508mm Dia	152mm Deep

- Heavy duty protective cages to prevent vandalism or accidental damage
- Plastic coated galvanised steel construction
- Designed not to interfere with operation of protected equipment
- Supplied with full fixing kit.

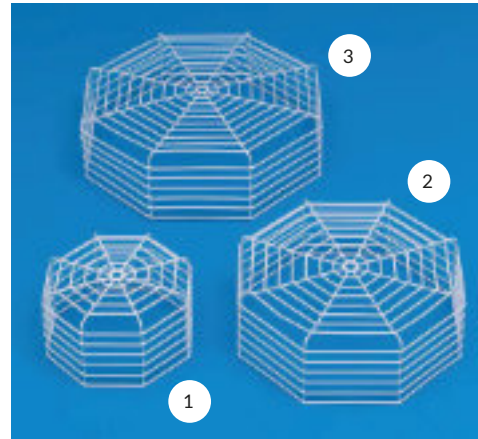

Fire Alarm Beacon/Sounder Cages

Part No.	Photo Key	Dimensions	
PP/STI9614	1	200mm Dia	150mm Deep
PP/STI 9615	2	95mm Dia	90mm Deep
PP/STI 9617	3	150mm Dia	125mm Deep
PP/STI 9664	4	98mm Dia	157mm Deep
PP/STI 9665	5	178mm Dia	214mm Deep

- Heavy duty protective cages to prevent vandalism or accidental damage
- Plastic coated galvanised steel construction
- Designed not to interfere with operation of protected equipment
- Supplied with full fixing kit.

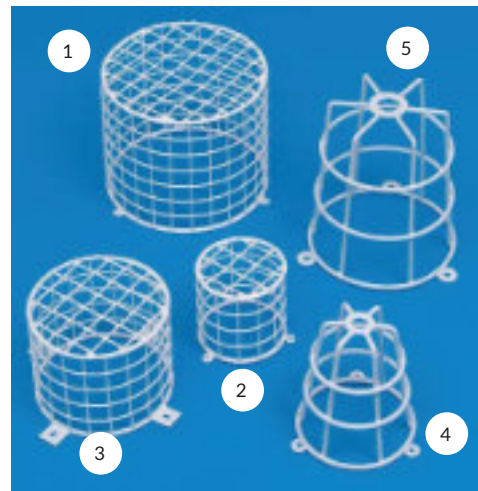

Fire Detector Cages

Part No.	Photo Key	Dimensions		
		MAX. INTERNAL DIAMETER	MIN. INTERNAL DIAMETER	INTERNAL DEPTH
PP/STI 9601	1	210mm	150mm	70mm
PP/STI 9604	2	175mm	125mm	75mm
PP/STI 9606	3	175mm	110mm	95mm
PP/STI 9609	4	215mm	78mm	124mm
PP/STI 9713	Not pictured	174mm	50mm	63mm
PP/STI 9602	5	215mm	155mm	108mm
PP/STI 9605	6	180mm	100mm	115mm
PP/STI 9610	8	214mm	85mm	145mm
PP/STI 9712	Not pictured	174mm	50mm	115mm
Finish	Add: Stainless Steel (SS)			

- Heavy duty protective cages to prevent vandalism or accidental damage
- Plastic coated galvanised steel construction or stainless steel option
- Designed not to interfere with operation of protected equipment
- Supplied with full fixing kit.

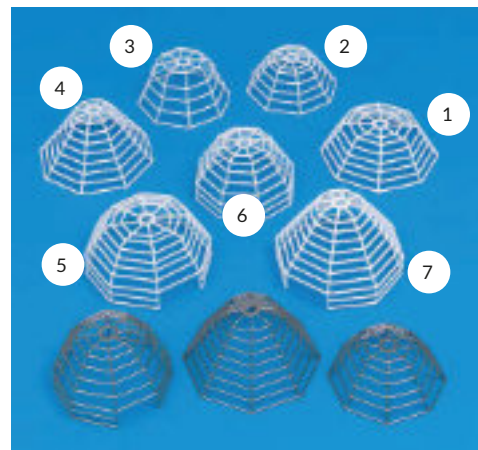



Fire Alarm

Battery Operated Fire Detectors

Fixfire® offer a full range of battery operated fire and CO2 detectors, providing early warning alarms in all domestic applications.



Loud



East to Install



Kitemarked



Domestic Grade

Battery Smoke Alarms

Part No.	Description
DI/Ei100C	9v Battery Ionisation Smoke Alarm

9v Battery Ionisation Smoke Alarm

- Dual Ionisation chamber sensor
- Built in Test button
- Interconnectable with other battery powered Aico alarms
- Low power cell warning
- Kite marked to BS EN 14604:2005
- 5 Year Guarantee.



DI/Ei100C

Part No.	Description
DI/Ei100L	9v Battery Ionisation Smoke Alarm With Built In Light

9v Battery Ionisation Smoke Alarm With Built In Light

- Dual Ionisation chamber sensor
- Built in Test button
- Built in emergency light - illuminates when in alarm state
- Low power cell warning
- Kitemarked to BS EN 14604:2005
- 5 Year Guarantee.



DI/Ei100L

Part No.	Description
DI/Ei103C	9v Battery Heat Alarm

9v Battery Heat Alarm

- Fixed temperature fast response thermistor type sensor, range 58°C ± 4°C
- Built-in Test button
- Interconnectable with other battery powered Aico alarms
- Kitemarked to 855446-2: 2003
- 5 Year Guarantee.



DI/Ei103C

Part No.	Description
DI/Ei105C	9v Battery Optical Smoke Alarm

9v Battery Optical Smoke Alarm

- Large volume Optical chamber sensor
- Built in Test button
- Interconnectable with other battery powered Aico alarms
- Low power cell warning
- Kitemarked to BS EN14604:2005
- 5 Year Guarantee.



DI/Ei105C





Fire Alarm

Battery Operated Fire Detectors

Fixfire® offer a full range of battery operated smoke and fire detectors, providing early warning alarms in all domestic applications.



Loud



Easy to Install



Kitemarked



Domestic Grade

CO Alarm

Part No.	Description
DI/Ei100C	CO Alarm

9V Battery CO Alarm

- Proven Electrochemical sensor (7 year life)
- Lithium battery (sealed in)
- Easy to use large Test/Hush button
- Pre alarm LED gives early warning of CO
- End of life indicator
- Loud distinctive alarm sound (85dB (A) at 3 metres)
- Power, alarm and fault indicator lights
- Memory feature records if Carbon Monoxide (CO) has been detected
- Kitemarked to BS EN50291-1
- 2010 BS EN50291-2:2010
- 5 Year Guarantee.



DI/EI208

Product Technical Tip



Where to locate your alarm:

- Kitchen/Garage Heat alarm
- Bedroom Ionisation alarm
- Hallway, landing, living room Optical alarm
- Boiler, open fire CO alarm





Fire Detection & Warning

Fire Sentry Site Alarms

Fixfire® offer a comprehensive range of battery operated fire alarms suitable for building sites where temporary installation is required.



Fire Sentry Self-contained/hardwire interlinkable

Hardwired, standalone or interlinkable site alarms

Part No.	Description
X/FS/MCP	Fire Sentry Manual Call Point

Fire Sentry Manual Call Point

- Easy Cable Free Installation
- Call Point Activated
- Resettable Call Point
- Call Point Key Supplied
- IP55 rated
- 110db Output
- 9v PP3 Battery Supplied
- Combined Sounder Strobe
- Link Upto 25 units using Bell Wire
- CE & LVD Approved
- Low maintenance costs

Part No.	Description
X/FS/PB	Fire Sentry Push Button

Fire Sentry Push Button

- Easy Cable Free Installation
- Push Button Activated
- IP55 rated
- 110db Output
- 9v PP3 Battery Supplied
- Combined Sounder Strobe
- Link Upto 25 units using Bell Wire
- CE & LVD Approved
- Low maintenance costs



X/FS/MCP

YOU MAY ALSO REQUIRE ...

FIND ON P32

Fire Exit Signs



X/FS/PB





Fire Detection & Warning

Fire Sentry Site Alarms

The versatile battery powered site Fire Alarm System.

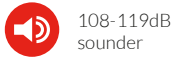

Fire Sentry Wireless Control Units

The Fire Sentry wireless system provides a single expandable solution which is suitable for the smallest to the largest construction site. Individual Fire Sentry wireless devices can be connected together with or without a central monitor panel.



X/FS/BS

Part No.	Description
X/FS/BS	FireSentry™ Base Station
X/FS/BS/FKMT	FireSentry™ Combined Manual Call Point and Alarm Sounder/Beacon mounted on FireKart Double Extinguisher trolley

Fire Sentry Wireless Monitor

- Category 1 radio module
- Independently tested to ETSI-300-220-1
- CE, RoHS, EMC & RED Compliant
- 25mm Bright LED display unit
- Scratch resistant UV Decals
- Status LED
- 85dB Buzzer
- 40 Addressable Devices
- Automatic battery low indication
- Completely wireless operation
- "Plug & Play" simple self installation
- Low maintenance costs
- Silent range test facility
- IP55 Enclosure



X/FS/BS/FKMT

FireKart Double Fire Extinguisher Trolley

- Robust rotationally moulded trolley.
- Can accommodate 2 extinguishers up to 9 Kg size each and a Fire Bucket.
- Top Panel section supports FireSentry device and extinguisher ID signs.



Part No.	Description
X/FS/MPLUS	Fire Sentry Wireless MonitorPlus

Fire Sentry Wireless MonitorPlus

This innovative and powerful Touch screen, full data-logging Base Station, is sure to offer the user unparalleled quality coupled with Fire Sentry's proven track record for reliability and uncomplicated operation. Informative data transfer, including full system history reporting, is available as standard at the touch of a button. Each device installed around your site can be configured to display its unique identity and location in Alpha Numeric format.

- Full Alpha Numeric device Identification
- First Aid monitoring function, as standard
- Innovative Touch Screen Operation
- Automatic Real Time system monitoring
- Fully printable system reporting
- On board real time Clock, with back up
- Five year on board SD card
- Standard USB export
- Mains with the option of Battery Back-up
- Compact unique desk top or wall mounting design
- Wipe down scratch resistant decals
- 85dB Buzzer

X/FS/MPLUS



Fire Detection & Warning

Fire Sentry Site Alarms

The versatile battery powered site Fire Alarm System.



Fire Sentry Wireless Field Devices

Part No.	Description
X/FS/CP/SB	FireSentry™ Combined Manual Call Point and Alarm Sounder/Beacon
X/FS/CP/SB/FKMT	FireSentry™ Combined Manual Call Point and Alarm Sounder/Beacon mounted on FireKart Double Extinguisher trolley
X/FSIP+/SK/SB	Site Alarm with Strike Knob actuator

Fire Sentry Wireless Call Point

- Manual Call Point with integral push button and lift up cover flap
- Easy to install
- Loud 118dB Siren
- Durable and robust construction
- Long lasting PP9 battery supplied with unit
- Suitable for use outside with IP65 rated switch
- 50mm Diameter switch makes for quick emergency operation
- 2 year manufacturers guarantee.

Fire Sentry IP+ Wireless Call Point

- Strike knob actuator
- Easy to install
- Loud 118dB Siren
- Durable and robust construction
- Long lasting PP9 battery supplied with unit
- Suitable for external use
- 50mm Diameter switch makes for quick emergency operation
- 2 year manufacturers guarantee.

FireKart Double Fire Extinguisher Trolley

- Robust rotationally moulded trolley.
- Can accommodate 2 extinguishers up to 9 Kg size each and a Fire Bucket.
- Top Panel section supports FireSentry device and extinguisher ID signs.



X/FS/CP/SB



X/FSIP+/SK/SB

Part No.	Description
X/FS/CP/SB/FA	FireSentry™ Combined Manual Call Point, Alarm Sounder/Beacon & First Aid Call button
X/FS/CP/SB/FA/FKMT	FireSentry™ Combined Manual Call Point, Alarm Sounder/Beacon & First Aid Call button mounted on FireKart Double Extinguisher trolley

Fire Sentry RF Call Point with First Aid Function

- Category 1 radio module
- Independently tested to ETSI-300-220-1
- CE, RoHs, EMC & RED Compliant
- 108dB Sounder and LED strobe
- Scratch resistant UV Decals
- Status LED
- 40 Addressable Devices
- Automatic battery low indication
- Completely wireless operation
- "Plug & Play" simple self installation
- Low maintenance costs
- Silent range test facility
- IP55 Enclosure
- "First Aid Call" feature

FireKart Double Fire Extinguisher Trolley

- Robust rotationally moulded trolley.
- Can accommodate 2 extinguishers up to 9 Kg size each and a Fire Bucket.
- Top Panel section supports FireSentry device and extinguisher ID signs.



X/FS/CP/SB/FA

X/FS/CP/SB/FA/FKMT





Fire Detection & Warning

Fire Sentry Site Alarms

The versatile battery powered site Fire Alarm System.



108-119dB
sounder



Wireless



Robust
Construction



Made
in UK



Available
for Hire

Fire Sentry Wireless Field Devices

Part No.	Description
X/FS/DS	Fire Sentry RF Automatic Smoke Detector

Fire Sentry RF Automatic Smoke Detector

- Automatic Smoke Detection
- Category 1 radio module
- Independently tested to ETSI-300-220-1
- CE, RoHs, EMC & RED Compliant
- New Easy-fix mounting
- IP68 Rated Antenna
- Link 40 Addressable Devices
- External lug for ceiling fixing
- Automatic battery low indication
- Completely wireless operation
- "Plug & Play" simple self installation
- Low maintenance costs
- Battery Supplied



X/FS/DS



NEW
DESIGN

Part No.	Description
X/FS/DH	Fire Sentry RF Automatic Heat Detector

Fire Sentry RF Automatic Heat Detector

- Automatic Heat Detection
- Category 1 radio module
- Independently tested to ETSI-300-220-1
- CE, RoHs, EMC & RED Compliant
- New Easy-fix mounting
- IP68 Rated Antenna
- Link 40 Addressable Devices
- Automatic battery low indication
- Completely wireless operation
- "Plug & Play" simple self installation
- Low maintenance costs
- Battery Supplied



X/FS/DH



NEW
DESIGN



Fire Safety



Call Systems



Access & Security



DDA Compliance



Fire Detection & Warning

Fire Sentry Site Alarms

The versatile battery powered site Fire Alarm System.



108-119dB sounder



Wireless



Robust Construction



Made in UK



Available for Hire

Fire Sentry Text Master

	Description
X/FSR/GSM	Fire Sentry GSM "Text Master"



X/FSR/GSM

Fire Sentry GSM "Text Master"

- 15 Character Site description
- Text Upto 5 Mobile Phone Numbers
- O2 or Orange sim card is required
- Full Size SIM Card required
- Wireless connection to other "Synergy" Units
- Requires 110-240v AC supply
- Ip67 Transformer Included
- IP65 Enclosure
- IP67 Antenna
- Indoor Use Only



Fire Sentry Accessories

Part No.	Description
X/FSR/RF	Fire Sentry Reset Fob

Fire Sentry Reset Fob

Suitable for:

- Fire Sentry TG Call Point
- Fire Sentry RF Call Point

Part No.	Description
X/FSR/BAT1	Fire Sentry Wireless Battery Pack

Fire Sentry Wireless Battery Pack

Suitable for:

- Fire Sentry Wireless Call Point Monitors
- Fire Sentry Wireless Base Station Monitors
- Fire Sentry Wireless Sounder Strobe Monitors

Part No.	Description
X/FSR/BAT2	?

Fire Sentry Detection Battery pack

Suitable for:

- Fire Sentry Smoke Detector
- Fire Sentry Heat Detector



X/FSR/RF



X/FSR/BAT1



X/FSR/BAT2

X/FS/CP/SB/FA





Fire Alarm

Self Contained Alarms

Our comprehensive range of site alarms is designed to be robust and easy to use. From hand held to fixed alarms, stand alone to portable systems, we provide an evacuation alarm for every application.



Loud



High
Visibility



User
Friendly



Robust

Air Horns

Part No.	Description
X/PHE	Pump Action Air Horn
X/GHE	Gas Air Horn
X/GHR	Gas Air Horn Refill

Easy to use, portable horns with a wide range of applications.

Pump Action Air Horn

- Easy to use hand pump action
- No need for refills
- Always ready to go in an emergency.

Gas Air Horn

- Ideal for providing temporary alarm cover for building sites
- 200ml can - allows for multiple uses
- 110dB loud horn
- Non flammable gas
- Refills available.

Gas Air Horn Refill

- 200ml can
- Fits X/GHE



X/GHE



X/PHE

Rotary Hand Bell

Part No.	Description
X/RHB	Rotary Hand Bell

Tried and tested means of raising the alarm.

Rotary Hand Bell

- Tried and tested robust design
- Bell sounds at 60dB at up to 35M
- Red coated diecast aluminium dome
- Diecast aluminium base plate
- Pre-drilled flange for simple installation.



X/RHB

Boxer Alarm

Part No.	Description
X/BA	Boxer Alarm

Simple and cost effective site alarm.

Boxer Alarm

- Combined call point and sounder
- Battery operated, no mains required
- Resets with a simple key
- Use individually or link up to 12 units
- No glass to replace or spares required
- Drop down flag, illuminated LED and 85 dB sounder
- Light, compact, industry standard format



X/BA





Emergency Lighting Test Keys

Fixfire® stocks a complete range of Emergency Lighting spares and accessories to facilitate ongoing user tests and checks of your Emergency Lighting Installation.

YOU MAY ALSO REQUIRE ...

FINDON P68

Fire Log Book...



Product Technical Tip



In order to comply with BS5266 Part 1 you should test your emergency lighting once a month and record the results in a site log book.

KEY SWITCH STYLE		FISH TAIL KEY
CRABTREE		 X/TK/CT
LEGRAND		 X/TK/LG
MEM		 X/TK/MEM
MK		 X/TK/MK

PLEASE ENQUIRE ABOUT OUR RANGE OF...



Emergency Lighting Spares including replacement battery packs and lamps





Escape Door Furniture

Door Closers, Hinges & Selector

Fixfire® escape door closers are robust, smart and easy to install. Conforming to all relevant standards to meet all safety requirements for fire doors and ensuring your safety.



Robust & Durable



Precision Engineered



Certify Approved



Long Life (tested for over 500,000 cycles)



Architecturally pleasing

Door Closers

Part No.	Description
H/8802	Standard Duty Door Closer
H/8803	Standard Duty Door Closer
H/1552	Heavy Duty Door Closer
H/1553	Heavy Duty Door Closer
H/1554	Heavy Duty Door Closer

- Die cast aluminium body
- Precision engineered mechanism
- Tested and certified to EN1154 and EN1634 part 1
- H/1553 tested for 1,000,000 cycles
- Attractive powder coated finish
- Adjustable speed
- Backcheck feature available
- Available with cover.

Part No.	Max Door Weight	Max Door Width Internal	Max Door Width External
H/1552	50kg	900mm	800mm
H/1553	65kg	1050mm	900mm
H/1554	80kg	1200mm	950mm
H/8802	45kg	900mm	
H/8803	65kg	965mm	



Hinges

Part No.	Description
H/522/1	304 Grade Stainless Steel Fire Door Hinge, Satin Finish
H/522/2	304 Grade Stainless Steel Fire Door Hinge, Polished Finish
H/523/1	316 Grade Stainless Steel Fire Door Hinge, Satin Finish
H/523/2	316 Grade Stainless Steel Fire Door Hinge, Polished Finish

- Grade 304 & 316 stainless steel
- 1 hour fire rated
- Supplied with fixings.



Door Selector

Part No.	Description
H/DS1	Door Selector For Double Door

- Ensures doors close in correct order, forming full fire seal automatically
- Easy to install
- Compatible with our range of Ryobi door closers
- High quality precision engineered construction.





Escape Door Furniture

Door Hold-Back Devices

Innovative yet simple, our range of wire free door holders and closers are ideal for office and care home environments. Easy to install, robust, intelligent and interference free, these are the ideal way to hold open fire doors legally.



User Friendly



EN Certified



Robust & Durable



Wire Free



Made in UK

Agrippa Wireless Door Holder

Part No.	Description
H/ADH	Agrippa Digital Wireless Door Holder

- Advanced, digital technology learns the sound of the fire alarm, releasing the door in the event of a fire
- Easy, wire free installation and programming
- Learning function to optimise settings to suit its installed position
- Can be programmed for timed daily releases
- 200 N holding force
- 2 x "C" cell batteries, easy access, 12 months life
- Battery life indication, low battery warning
- Approved to EN1155 and CE marked under the CPR
- No flooring damage.



Agrippa Wireless Door Closer

Part No.	Description
H/ADC	Agrippa Digital Wireless Door Closer

- The simple solution for legally holding open fire doors in buildings where access is essential
- Advanced, digital technology learns the sound of the fire alarm, closing the door in the event of a fire
- Can be programmed for timed daily releases
- Swing-free, making the door light and easy to handle
- Adjustable closing speed
- Holding angle of 65 - 105 degrees
- 2 x "C" cell batteries, easy access, 12 months life
- Approved to EN1155 and CE marked under the CPR.



H/ADH

H/ADC

PLEASE ENQUIRE ABOUT OUR RANGE OF...



We also offer wired in Fire Door Hold Back devices on a supply only or supply and installation basis.

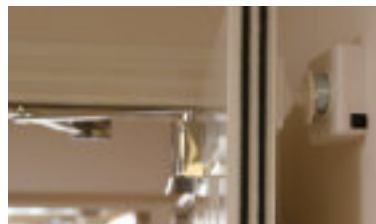



Escape Door Furniture

Panic Hardware

The Fixfire® range of fire door panic hardware is designed with ease of use and high security in mind. Conforming to all relevant standards, to ensure you meet health and safety requirements without compromising building security.



Robust & Durable



EN Certified



User Friendly



High Security



Architecturally Pleasing

Panic Hardware

Part No.	Description
H/297	Push Pad Door Rim Latch
H/296	Push Bar Door Panic Latch
H/294	Push Bar Single Door Panic Bolt
H/285	Push Bar Double Door Panic Bolt Set

Push Pad Door Rim Latch

- For single or double doors
- Non-handed
- Fire rated for use on timber and steel doors
- Surface mounted
- Adapter supplied for operating with a rim cylinder.

Push Bar Door Panic Latch

- For single or double doors
- Non-handed
- Fire rated for use on timber and steel doors
- Surface mounted
- Adapter supplied for operating with a rim cylinder
- Closed arm design.

Push Bar Single Door Panic Bolt

- For single or double doors
- Non-handed
- Fire rated for use on timber and steel doors
- Surface mounted
- Closed arm design.

Push Bar Double Door Panic Bolt Set

- For rebated doors
- 3 and 4 point locking available
- Non-handed
- Fire rated for use on timber and steel doors
- Surface mounted
- Closed arm design.



H/297



H/296



H/294



H/285

YOU MAY ALSO REQUIRE ...

FIND ON P45

Fire Warden Evacuation Equipment





Escape Door Furniture

Panic Hardware

The Fixfire® range of fire door panic hardware is designed with ease of use and high security in mind. Conforming to all relevant standards, to ensure you meet health and safety requirements without compromising building security.



Robust & Durable



EN Certified



User Friendly



High Security



Architecturally Pleasing

Panic Hardware

Part No.	Description
H/284	Push Bar Double Door Panic Bolt Set (Non Rebated Doors)
H/298	Outside Access Device

Push Bar Double Door Panic Bolt Set (non rebated doors)

- For non rebated doors
- 4 point locking
- Non-handed
- Fire rated for use on timber and steel doors
- Surface mounted
- Closed arm design.

Outside Access Device

- Supplied with 2 keys and a 5 pin cylinder
- Suitable for use with our complete range of bolts and latches
- Non-handed
- Fire rated for use on timber and steel doors
- Surface mounted on the outside of the door using concealed machine screws
- Supplied as standard for doors up to 60mm thick
- Longer spindles and screws are available on request for door thicknesses over 60mm.



H/284



H/298

Panic Bolt Alarm Unit

Part No.	Description
H/304	Panic Bolt Alarm Unit

Panic Bolt Alarm Unit

- For use with the panic bolt, the alarm is activated when the panic device is operated, or an attempt is made to remove the cover, and de-activated by a key. The unit is operated by a 9V battery.



H/304

Product Technical Tip



You should check that your Fire Exit mechanisms are in good working order as part of a routine maintenance regime.





Escape Door Anti-tamper Devices

Redlam Bolt & Spare Elements

The Redlam panic bolt is a simple, tried and tested fire door security device. We also offer a range of spare elements for other types of fire door security systems.



Robust & Durable



User Friendly



High Security

Redlam Panic Bolt

Part No.	Description
H/RPB1	Redlam Panic Bolt
H/PAD/LS	Long Shackle Padlock Complete With x2 Keys

Simple and effective security for all fire doors.

- Cast Aluminium construction
- Supplied complete with 1 x ceramic tube, Redlam hammer, chain and fixings
- Use padlock (Supplied separately) to prevent unauthorised removal of ceramic tube
- Overall size: H 75mm X W165mm X D55mm
- Surface mounted
- Closed arm design.

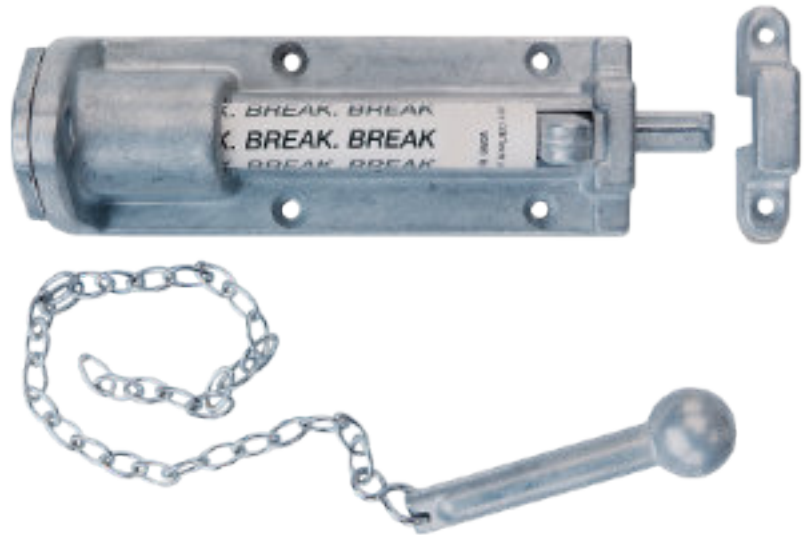

Spare Elements

Part No.	Description
H/0900/ST	Spare Glass Tubes To Suit Redlam Bolts (Box 20)
H/0900/CT	Spare Ceramic Tube To Suit Redlam Bolts (Box 20)
H/8070/1	Union Spare Plastic Dome
H/2QGP	Wellington Spare Glass, Orange Lettering On Frosted White (Size 79Mm X 54Mm)



H/0900/CT

H/0900/ST

YOU MAY ALSO REQUIRE ...

FIND ON P56

Fire Escape Signs



H/8070/1



H/2QGP





Escape Door Anti-tamper Devices

Escape Door Tamper Seals & Exit Stopper

To provide additional security and prevent unauthorised use of fire exits, we offer a range of anti-tamper alarms and seals.



High
Visibility



Loud



Robust &
Durable



Simple to
Install

Exit Stopper

Part No.	Description
X/ST16400	Exit Stopper

The exit stopper provides a simple and proven method of deterring unauthorised use of fire exits.

- Completely self contained alarm
- Loud 97dB alarm
- Highly visible unit, provides easily seen deterrent
- Key operated override facility
- Easy to install and maintain.



X/ST16400

YOU MAY ALSO
REQUIRE ...

FINDON
P28

Call Point Stopper



Escape Door Tamper Seals

Part No.	Description
X/EDTS	Fire Door Seal

Simple and effective escape door security

- Designed to deter unauthorised use of fire doors
- Average breaking strength of 10.5Kg
- Easy to install
- Supplied in strips of 10.

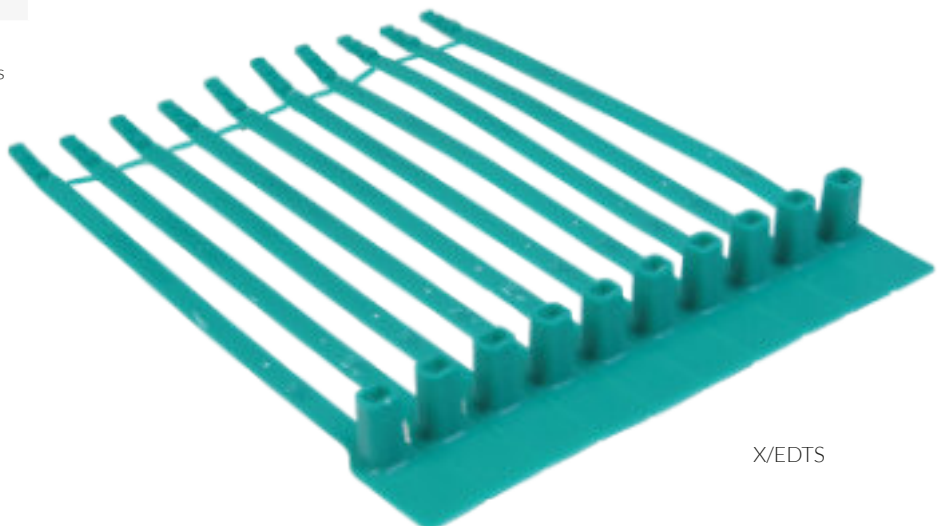

X/EDTS





Building Evacuation Products

Fire Warden Kits

Fixfire® fire warden kits are comprehensive and provide everything for the fire warden.



High
Visibility



Easily
Portable



User
Friendly

Basic Fire Warden Kit

Part No.	Description
E/WKB	Basic Fire Warden Kit

Kit includes

- 1 x Fire Warden Waistcoat
- 1 x E/MT torch
- 1 x Emergency gas horn
- 2 x lightsticks
- Entire kit is supplied in a screen printed hi-viz storage bag with shoulder straps.



YOU MAY ALSO
REQUIRE ...

FIND ON
P66



Premium Fire Warden Kit

Part No.	Description
E/WKP	Premium Fire Warden Kit

Kit includes

- 1 x Fire warden waistcoat
- 1 x Fire warden cap
- 1 x Fire warden telescopic sign
- 1 x Megaphone
- 1 x E/MLT torch
- 1 x Emergency gas horn
- 1 x Photoluminescent armband
- 10 x Lightsicks
- 10 x emergency whistles
- Entire kit is supplied in a durable red carrying bag.





Building Evacuation Products

High Visibility Clothing

A range of high quality clothing to make the fire warden stand out from the crowd.



High
Visibility



Durable

Fire Warden/ Marshal Cap

Part No.	Description
E/FWC	Fire Warden Cap
E/FMC	Fire Marshal Cap

- High visibility baseball cap enables marshals to be identified in crowded conditions
- Reflective badging for maximum visibility
- One size fits all.



E/FWC (Warden)

E/FMC (Marshal)

YOU MAY ALSO
REQUIRE ...

FINDON
P67

Fire Log
Book



Fire Warden/ Marshal Armband

Part No.	Description
E/FWA	Fire Warden Armband
E/FMA	Fire Marshal Armband

- Photoluminescent armbands complete with 'Fire Marshall' or Fire Warden' wording
- Extremely useful aid in fire evacuation coordination procedures
- Features Velcro fastening for simple application
- Strip size: L435mm x W65mm.



E/FWA (Warden)

E/FMA (Marshal)

Fire Warden/ Marshal Waistcoat

Part No.	Description
E/FWC	Fire Warden Waistcoat
E/FMC	Fire Marshal Waistcoat

- High visibility waistcoat incorporating reflective badging back and front
- M, L & XL sizing available
- Front badge size: 125 x 45mm, rear badge size 250 x 90mm.



Front



Back

E/FWC (Warden)



Building Evacuation Products

Torches & Evacuation Tools

Fixfire® offer a complete range of equipment to assist the fire warden in their job.

Torches

Part No.	Description
E/MT	Mini Torch
E/MLT	Large Torch

Mini Torch

- Mini Maglite torch
- Beam can be changed from flood to spot
- Made from machined aluminium
- Spare bulb inside tail cap
- Batteries not included.

Large Torch

- Specification as E/MT
- Takes 3 x D size batteries.



E/MT



E/MLT

Light Stick

Part No.	Description
E/LS	Light Stick

- Simply bend, snap and shake for instant light.
- No heat, no sparks, no flames
- No batteries required
- Light activated by safe, non toxic chemical reaction
- 150mm hexagonal shaped tube with hook and hole hanging facility.

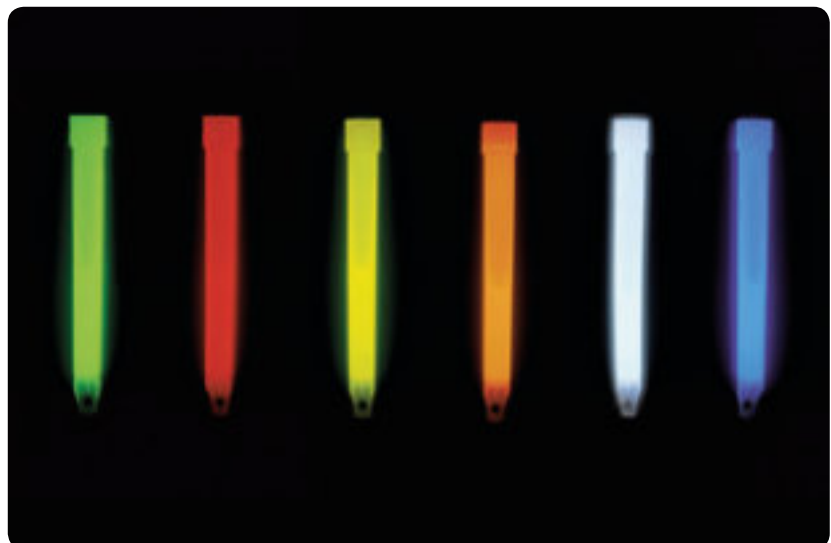

E/LS

Life Hammer

Part No.	Description
E/LH	Life Hammer

- Effective emergency escape tool
- Tough pointed double hammerhead combined with a sharp protected blade
- Supplied complete with bracket
- TUV approved
- Breaks auto glass and cuts seatbelts
- Overall tool size: L175mm x W68mm.



E/LH





Building Evacuation Products

Torches & Evacuation Tools

Everything to assist the fire warden in their role.

Firemans Axe

Part No.	Description
E/FA	Firemans Axe

- High quality axe for use in all emergency situations
- Constructed with tubular handle insulated to 20,000 Volts
- Long lasting drop forged head
- Overall tool size: L385mm x W205mm.



E/FA

Emergency Whistle

Part No.	Description
E/EW	Emergency Whistle

- Commercial grade, non corrosive, pea-less whistle
- Dimensions: L70mm x W22mm.



E/EW

Fire Escape Ladder

Part No.	Description
E/EL45	4.5M Ladder
E/EL75	7.5M Ladder

- Steel escape ladder, intended for domestic use only
- Suitable for 2 & 3 storey buildings
- Simply and quickly attaches to window for escape
- Will accommodate window openings up to 325mm deep
- Rung width: 295mm
- E/EL45: 4.5M long ladder length
- E/EL75: 7.5M long ladder length.

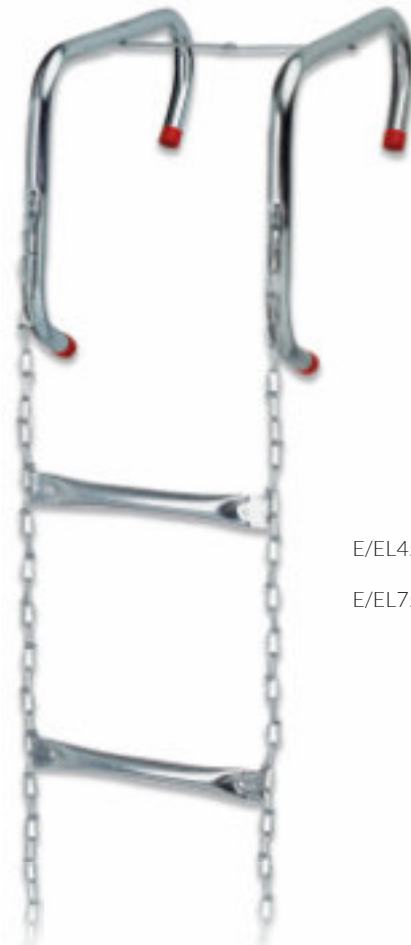

E/EL45 (4.5M)

E/EL75 (7.5M)

PLEASE ENQUIRE ABOUT...



Contact us for information on our Fire Training & Fire Risk Assessment service





Building Evacuation Products

Evacuation Chairs

Our range of premium evacuation chairs is designed for ease and speed of deployment. With a wide range of features available, there is a chair to suit every requirement.



Made in UK



Robust & Durable



Lightweight



12 Month Warranty



50% Less Staff Required

Ego Evacuation Chair

Part No.	Description
E/EGO	Ego Evacuation Chair

- Easy to open, load and evacuate
- Single operator technology
- Slim Storage
- Wheels auto brake when folded
- Up to 180Kg capacity
- Fitted with Stairblade self braking track belt for greater control on stairs
- Built in safety belt
- Supplied with wall mounting bracket, and cover.



E/EGO

PLEASE ENQUIRE ABOUT...



We also offer training on how to use evacuation chairs.

Versa Evacuation Chair

Part No.	Description
E/VER	Versa Evacuation Chair

- Easy to open, load and evacuate
- Single operator technology
- Slim Storage
- Four wheel chair for greater stability
- Up to 180Kg capacity
- Fitted with Stairblade self braking track belt for greater control on stairs
- Suitable for upstairs travel
- Integral stored passenger safety harness and headband
- Supplied with wall mounting bracket, operating handbook and cover.



E/VER

Product Technical Tip



You should carry out a periodic evacuation of your premises at least yearly for industrial and commercial premises and six monthly for shops and residential premises. The results should be recorded in a site fire log book.

Using an escape chair effectively...





Fire Resistant/Intumescent Products









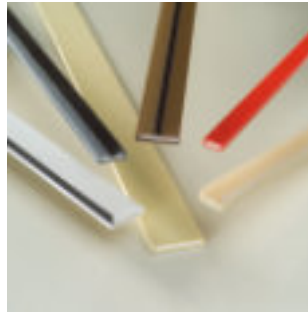



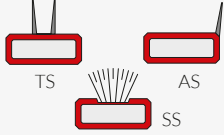

Fire & Smoke Seals

Fire & Smoke Seals are required around the edge of Fire Doors to achieve typically a 30 minute or 60 minute Fire Rating.

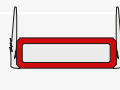
Fire & Smoke Seals

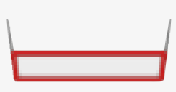
- Ultimate quality
- Installation friendly design
- Certifire Approved

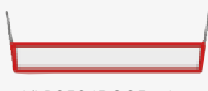

Combined Acoustic, Smoke and Fire Seals			 To order Fire and Smoke Seal add /TS, /AS or /SS to relevant Fire Seal Code. Eg. I/LP1004/SS	
	DS	Finesse™	Fire Seal	Fire & Smoke Seals
Seal Section Size  The complete solution for acoustic, smoke and fire containment		 The complete solution for acoustic, smoke and fire protection with superior aesthetics	 Intumescent fire seal for use where no smoke sealing is required	 Smoke and fire seals with a choice of elastomeric fins or brush pile smoke seal inserts
10 x 3mm & 10 x 4mm seals Can provide 30 minutes fire resistance. Two parallel seals can provide 60 minutes fire resistance in hardwood constructions, subject to manufacturers test evidence	 I/LP1004DS 10 x 4mm		 I/LP1004 10 x 4mm	Available in TS, AS and SS profiles AS to special order
15 x 4mm seals Suitable for softwood constructions or where the gap between the door and the frame is greater than usual.	 I/LP1504DS 15 x 4mm	 I/LP1504FS 15 x 4mm (Finesse™)	 I/LP1504 15 x 4mm	Available in TS, AS and SS profiles I/AS to special order
20 x 4mm seals Can provide 60 minutes fire resistance. Can be notched to fit around hinges.	 I/LP2004DS 20 x 4mm	 I/LP2004FS 20 x 4mm (Finesse™)	 I/LP2004 20 x 4mm May also be used between the door frame and masonry.	Available in TS, AS and SS profiles AS to special order
25 x 4mm seals These large seals help control door distortion.	 I/LP2504DS 25 x 4mm		 I/LP2504 25 x 4mm	Available in I/TS, AS and SS profiles AS to special order
Smoke seal material	Elastomeric fins 4mm or 6mm	Elastomeric fins 4mm	N/A	TS - Elastomeric fins 4mm or 6mm, AS - Elastomeric fin 4mm or 6mm, SS - Polypropylene brush pile 4mm
Min/max gap size	3mm / 4mm*	3mm / 4mm*	3mm / 4mm*	3mm / 4mm*
Nominal seal sizes	All seals are available in standard length of 2.1m. Other lengths are available to special order.			
Fitting	All Lorient intumescent fire seals have a self-adhesive backing. The adhesive used has been specially selected to provide excellent adhesion on a wide range of materials, including MDF on which it is usually difficult to obtain an effective bond.			
Finish	All Lorient acoustic, smoke and fire seals are available in a range of standard and special colours including woodgrain and metallic finishes.			

*Seals suitable for larger gaps available on request



Fire Resistant/Intumescent Products

Batwing® seals

The Lorient Batwing® Seal is a simple to install retrofit Cold Smoke Seal which is fitted into the rebate of the door frame.

Batwing® Seals

The Curved Fin Batwing® acoustic and smoke seal minimises the opening and closing resistance of the door leaf due to its unique, curved fins.

Flexible elastomeric fin material springs back to original shape to provide ongoing performance and durability in service.

Symmetrical design ensures fins are always in contact with two surfaces of the door leaf, creating an air chamber to provide excellent acoustic properties.

Acoustically tested in accordance with BS EN ISO 10140-1: 2010 +A1: 2012 and proven to meet the requirements of Approved Document E. Will achieve a rating of 31dB R_w when tested on a typical FD30 door assembly, in conjunction with a I/LAS8001 si threshold seal - no additional perimeter seal required.

Effective smoke seal up to 200°C.

Aggressive self-adhesive backing tested on many surfaces, including MDF. Variety of colours to blend with door designs. Fully tested for performance and durability under the third party certification schemes CERTIFIRE and British Board of Agrément. Tested to 1,000,000 opening and closing cycles on a full size door assembly, without failure.



LORIENT



Lorient Batwing® Seal fitted in door rebate in conjunction with plain Fire Seal

YOU MAY ALSO REQUIRE ...

FIND ON P36

Door Closers



PART NUMBER	I/LAS1206	I/LAS1007	I/LAS1212K	I/LAS1010	I/LAS1212	I/LAS1015
DESCRIPTION	Single Batwing®	Single Batwing®	Batwing®-on-a-Stick	Batwing®	Batwing®	Batwing®
LENGTH	2100mm	2100mm	2100mm	2100mm	2100mm	2100mm
SECTION DETAIL						

Colours available: Black (I/BLK), White (I/WH), Dark Brown (I/DB), Light Brown (I/LB), Grey (I/GR), Silver (I/SI), Cream (I/CR) & Clear(I/CLR).

*Single Batwing® is not Certifire accredited





Fire Resistant/Intumescent Products

Glazing seals

The Lorient range of glazing seals are designed to provide Fire Rated glazed panels in wall and doors. Each system is designed for simple installation and effective performance.

System-36 PLUS



Part No.	Product Reference	Lengths
I/LG1512	LG1512 System-36/6 PLUS Gasket For 6-7mm Glass	60m roll
I/LG1513	LG1513 System-36/7 PLUS Gasket For 7mm Glass	60m roll
I/LG1717	LG1717 System-36/10 PLUS Gasket For 9-11mm Glass	30m roll
I/LG2022	LG2022 System-36/15 PLUS Gasket For 14-16mm Glass	30m roll

System-36 consists of a flexible U-shaped intumescent gasket used with a range of standard fixing beads, for use in 30 minute fire resistant doors and screens.

- Available in sizes to suit different thicknesses of glass from 4mm to 23mm
- Supplied on a reel so it's easily dispensed and cut to length without wastage in off-cuts
- Flexible enough to be fitted to curved corners and circular vision panels.



System-63Ø



Part No.	Product Reference	Lengths
I/LG2715	System 63Ø Gasket For 6mm Georgian Wired or Pyran-S® Glass Only	50m coils, black
I/LX4002	Intumescent Liner 40Mm Wide	1m length
I/LX5002	Intumescent Liner 50Mm Wide	1m length

System-63Ø is a variant of System-36 which has been designed for use in circular apertures in 60 minute fire resistant doors.

- A cost-effective solution to the problem of incorporating circular glazed apertures
- Use with an intumescent liner
- Easy to fit.





Fire Resistant/Intumescent Products

Glazing seals

The Lorient range of glazing seals are designed to provide Fire Rated glazed panels in walls and doors. Each system is designed for simple installation and effective performance.

Flexible Figure 1 (FF1)



Part No.	Product Reference	Lengths
I/FF1	Flexible Figure 1 Intumescent Strip	50m Coils, 5 per box
Colours	Cream, white, black, light brown, dark brown, as standard colour matching to special order	

Flexible Figure 1 is designed for use with glazed apertures in 30 minute fire resistant doors.

- Comprises a pair of bead applied intumescent strips
- Flexible, quick and easy to install
- Available In a choice of colours
- Suitable for use with a variety of fire resistant glass types
- Unique design which enables tolerances between door, bead and glass thicknesses to be accommodated
- Glazing Beads for 44mm doors can be provided.



System-90 PLUS



Part No.	Product Reference	Lengths
LG2727	System-90 PLUS Channel	1m & 2.1m
I/ LG2727/ IL	54 x 2mm Intumescent Liner	1050mm
Colours	Cream, white, grey, black, light brown, red, dark brown, silver, maple as standard colour matching to special order	

System-90 PLUS is designed for 60 minute fire resistant doors and screens. Contact our Technical Services team for more information. When using a suitable door and screen construction (such as Georgia-Pacific system for high performance fire door assemblies which requires a specific beading system) it provides 90 minute fire resistance. 120 minute fire resistance can be attained when a suitable door only construction is used.

- Comprises a U-shaped PVC profile containing an intumescent core and an intumescent liner, and beads of wood or metal
- Tested with a range of glass types
- Glazing beads for 44mm and 54mm doors can be provided.





Fire Resistant/Intumescent Products

Air Transfer Grilles

Fire resistant air transfer grilles permit ventilation through fire rated compartments. Applications include vents to fire doors and within ducts which penetrate fire break walls or floors.

LV Fire Resistant Air Transfer Grilles

The LV Range of Air Transfer Grilles achieves a fire rating of up to 60 minutes subject to the installation type.



LVN Range

Grille Thickness	Width (mm)	Height (mm)
I/LVN20 (2 pieces x 20mm)	100mm - 600mm (in 25mm increments)	100mm - 600mm (in 25mm increments)
I/LVN25 (2 pieces x 25mm)	100mm - 600mm (in 25mm increments)	100mm - 600mm (in 25mm increments)

Part Code is formulated as follows; Prefix I/LVN20/ or I/LVN25/ followed by Width and Height eg I/LVN20/100100



LVV40 Range - Square Edge

Grille Thickness	Width (mm)	Height (mm)
I/LVV40 (40mm)	100mm - 600mm (in 25mm increments)	100mm - 600mm (in 25mm increments)

Part Code is formulated as follows; Prefix I/LVV40/ followed by Width and Height eg I/LVV40/100100

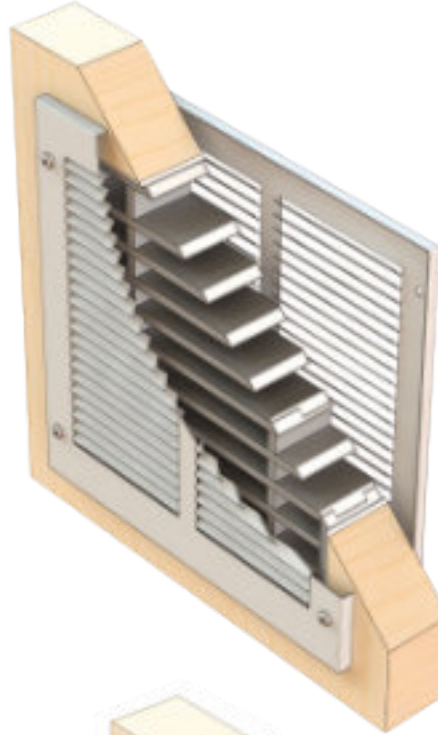

LVV40 Range Grille fitted with Cover Plates

Cover Plates

Grille Finish	Grille Width (mm)	Grille Height (mm)
I/CP/S (Silver)	100mm - 600mm (in 50mm increments)	100mm - 600mm (in 50mm increments)
I/CP/WH (White)	100mm - 600mm (in 50mm increments)	100mm - 600mm (in 50mm increments)

Part Code is formulated as follows; Prefix I/CP/SA followed by Width and Height eg I/CP/SA/100100

LVC40 Range - Circular

Part Code	Grille Finish	Actual Diameter (mm)	Suitable for nominal duct size
I/LVC40/100	40mm	98	100
I/LVC40/125	40mm	123	125
I/LVC40/150	40mm	148	150
I/LVC40/200	40mm	198	200

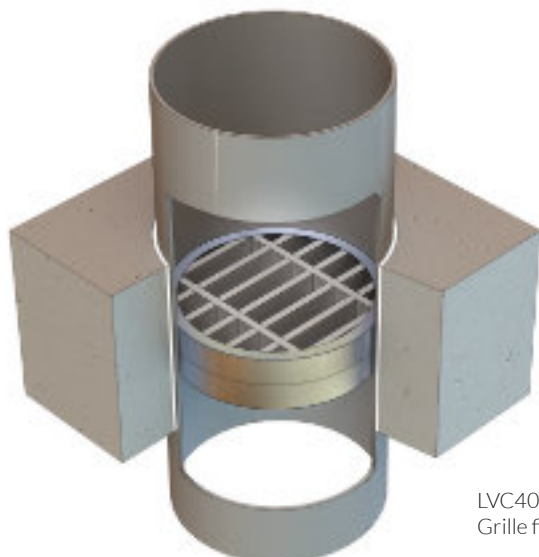

LVC40 Range Grille fitted in duct

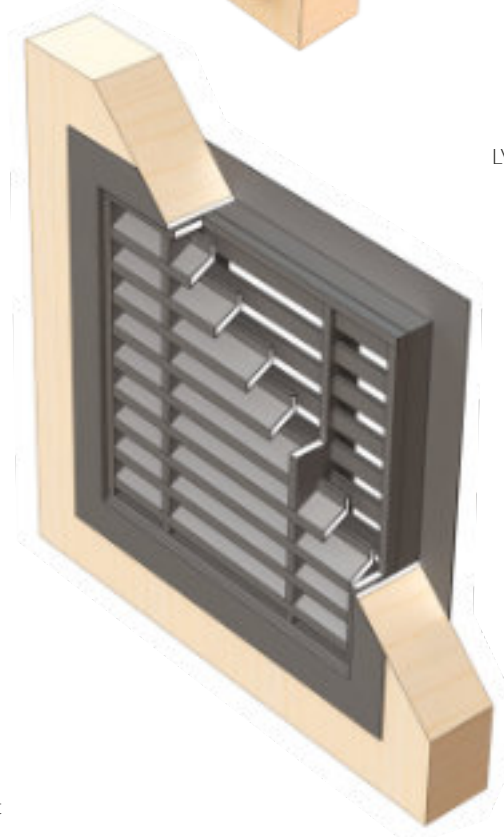

LVN Range Grille



Fire Resistant/Intumescent Products

Mastic, Expanding Foam & Fire Retardant Spray

Fixfire® provides a range of products to prevent the spread of fire in buildings.

Nullfire Fire Resistant Acrylic Sealant

Part No.	Description
I/M701/WH	White Fire Resistant Acrylic Sealant, 310ml Cartridge
I/M701/GR	Grey Fire Resistant Acrylic Sealant, 310ml Cartridge

Features

- Up to 5 hours fire resistance
- Suitable for gaps up to 50mm wide
- No insulative backing material required for fire performance, PE backing rod for depth gauge only
- Maintains substrate acoustic rating
- Reduces air leakage
- Excellent tool ability and low slump characteristics, can be smoothed
- Width to depth ratio of 2:1
- Accommodates movement of up to 10%
- Over paintable with most water based and oil based top seals
- Low shrinkage.

Fire performance

- Tested in accordance with EN 1366-4
- Up to 5 hours fire resistance
- Classification EN 13501.

Acoustic performance

- Tested in accordance with EN ISO 140-3:1995.

Air permeability performance

- Tested in accordance with EN 1026.



I/M701/WH /
I/M701/GR



I/FF177

Fire Rated PU Foam

Part No.	Description
I/FF177	Fire Rated PU Foam, 880ml Aerosol Can With Nozzle

Features

- Suitable for gap widths up to 30mm
- Up to 4 hours fire resistance
- Easy to use ergo-cap system
- Quick and easy to install
- Sets tack free in 10 minutes
- Sets in a semi ridged structure, yields to vibration.

Fire performance

- Tested in accordance with EN 1366-4
- Up to 4 hours fire resistance
- Classification EN 13501 and DIN 4102: Part 1, B1.

Acoustic performance

- Tested in accordance with EN ISO 140-3:1995.

Air permeability performance

- Tested in accordance with EN 1026.



X/FRS1



X/FRS5

Flame Retardant Spray

Part No.	Description
X/FRS1	750mL Flame Retardant Spray
X/FRS5	5L Flame Retardant Spray Refill

- Available in 750ml trigger spray and 5l refill sizes
- Water based fire proofing spray
- Will treat any water absorbent material, including natural and synthetic materials and fabrics
- Has passed BS5852:1990 and BS5867: part 2: 1980 standards
- Easy to apply
- 1L will treat 10-15m².





Fire Resistant/Intumescent Products

Pipe Seals

Fixfire® provides a range of products designed to maintain the integrity of fire compartments where services penetrate through walls, floors and ceilings.



Intumescent Pipe Collars

Part No.			Size
Fire Rating			
2 Hour	3 Hour	4 Hour	
-	-	I/AFPC32/4P	32mm
-	-	I/AFPC40/4P	40mm
I/AFPC55/2E	-	I/AFPC55/4P	55mm
-	-	I/AFPC63/4P	63mm
-	-	I/AFPC75/4P	75mm
-	-	I/AFPC82/4P	82mm
-	-	I/AFPC90/4P	90mm
I/AFPC110/2E	-	I/AFPC110/4P	110mm
I/AFPC125/2E	-	I/AFPC125/4P	125mm
-	-	I/AFPC160/4P	160mm
-	-	I/AFPC200/4P	200mm
-	-	I/AFPC225/4P	225mm
-	-	I/AFPC250/4P	250mm
-	I/AFPC275/3E	-	275mm
-	I/AFPC300/3E	-	300mm
-	I/AFPC315/3E	-	315mm
I/AFPC355/2E	-	-	355mm

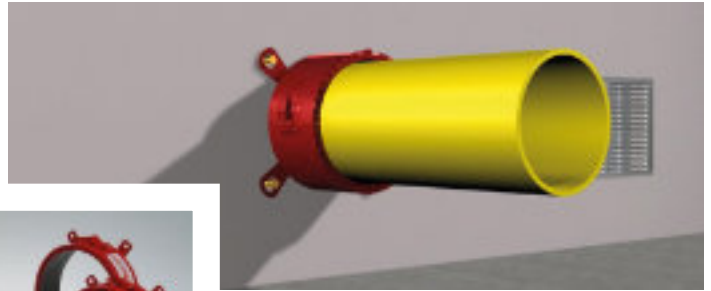

Wall Installation



Floor Installation

- Fire Resistance testing to BS476: Part 20: 1987, and EN1366-3
- Suitable for UPVC, ABS, MDPE, HDPE and PP pipes
- Up to 4 hours fire resistance
- Surface mounted, cast or semi-cast applications.

Intumescent Pipe Wraps

Part No.		Size
Fire Rating		
2 Hour	4 Hour	
-	I/AFIPW32/4	32mm
-	I/AFIPW40/4	40mm
-	I/AFIPW55/4	55mm
-	I/AFIPW63/4	63mm
-	I/AFIPW75/4	75mm
-	I/AFIPW82/4	82mm
-	I/AFIPW90/4	90mm
-	I/AFIPW110/4	110mm
-	I/AFIPW125/4	125mm
-	I/AFIPW160/4	160mm
I/AFIPW200/2	-	200mm

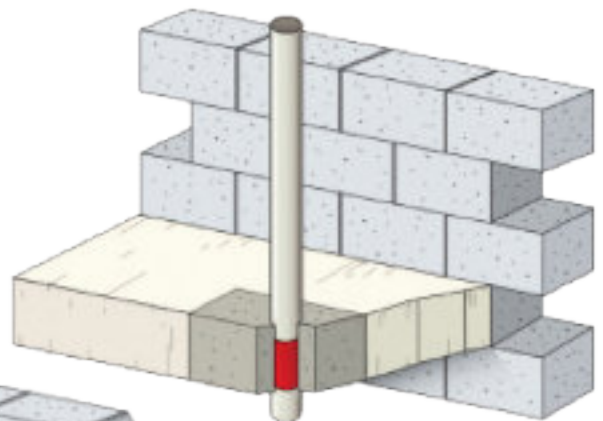

Floor Installation

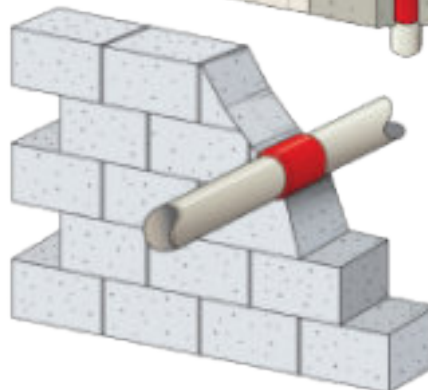

Wall Installation

- Fire resistance testing to EN 1366-3 EI120, and BS 476 240mins
- Suitable for PVC, Polypropylene, MDPE, HDPE, HPPE and ABS pipes up to 200mm
- Suitable for wall and floor installation
- Tested for following applications: block, concrete and masonry walls, concrete floors
- Large service openings up to 250 x 150mm
- Remains flexible between -40°C to +130°C
- Long life and easy to use
- Certifire 3rd Party Accredited.



Fire Resistant/Intumescent Products

Intumescent Fire Pillows & Downlighter Covers

Fixfire® provides a range of products designed to maintain the integrity of fire compartments where services penetrate through walls, floors and ceilings.

Intumescent Fire Pillows

Part No.	Size	Dimensions
I/AFFPL	Large	300mm x 200mm x 40mm
I/AFFPM	Medium	300mm x 150mm x 40mm
I/AFFPS	Small	300mm x 100mm x 40mm
I/AFFPSAS	Sausage	300mm x 50mm x 40mm

- Fire tested to BS476: Part 20:1987
- EN1366-3 EI120
- EN13501-2 Fire Resistance Classification
- EN1026 Air Permeability
- EN10140 Acoustic Reduction
- Up to 4 hours fire integrity
- Available in 4 standard sizes
- Easy to install & re-locate
- Removable for re-use
- For wall floor & ceiling penetrations
- Dustproof - safe for the work environment
- Protects cable trays & ducts
- Certifire Approval



Floor Installation

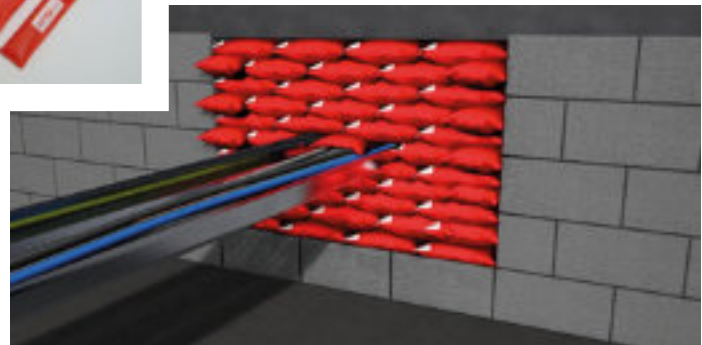

Wall Installation

Intumescent Downlighter Covers

Part No.	Size Reference	Maximum Fitting Size	Cutout Size Diameter mm
I/AFDLCOVS	Small	150x150	50-75
I/AFDLCOVM	Medium	200x200	75-100
I/AFDLCOVL	Large	250x250	100-140
I/AFDLCOVXL	X-Large	300x170	145x270
I/AFDLCOVXL	XX-Large	350x230	145x250

- Fire rated to BS EN 1365-2:2000/BS476 Part 23:1987
- 30 or 60 minute fire rating
- Covers a wide range of mains & low voltage downlighters
- Choice of 5 sizes
- Provides a highly insulating stable char when exposed to fire
- Prevents fire from penetrating the ceiling void and retains ceiling's fire protection integrity
- Acoustic Rated BS EN 150 140 : BS EN ISO 717
- Ventilated to reduce heat build up
- Installed in seconds
- No screws, drilling or additional supported required
- Maintenance free
- Can be used in suspended, plasterboard or concrete ceilings
- Lightweight & flexible cover can be fitted from below or above the ceiling
- Downlighter can be fitted as normal.



Standard Cone Version



Large Version





Fire & Safety Signs

Standard Signs - Non-Photoluminescent

The Fixfire® range of signs is available in several different materials, and in varying sizes to suit all applications. We can even produce bespoke signs to your exact requirements.



Robust & Durable



High Visibility



Easy to Install

Fire Door Notices



1 1606 **F N B**
2 1606 **F N B**
7 1606 **F**



1 1609 **B**
2 1609 **B**



1 1610 **B U**
2 1610 **B U**
7 1610 **B**



1 1616 **B**
2 1616 **B**



1 1618 **B U**
2 1618 **B U**



1 1621 **B**
2 1621 **B**



1 1635 **U**
2 1635 **U**



1 1636 **U**
2 1636 **U**

Emergency Escape Door Notices

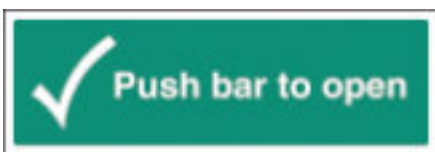

1 2047 **G L**
2 2047 **G L**



1 2034 **C F U**
2 2034 **C F U**



1 2037 **C F U**
2 2037 **C F U**

HOW TO ORDER	CHOOSE YOUR SIGN	CHOOSE MATERIAL CODES	CHOOSE SIZE CODES																							
	<p>1 1234 G L</p> <p>MATERIAL SIGN SIZE</p>	<ol style="list-style-type: none"> Rigid Plastic Self Adhesive Vinyl Photoluminescent Rigid Plastic Photoluminescent Self Adhesive Miscellaneous Products* Aluminium Polycarbonate Double Sided Hanging Version of Sign Single Sided Hanging Version of Sign Stainless Steel Brass 	<table border="0"> <tr> <td>A 75 x 100 mm</td> <td>J 400 x 200 mm</td> <td>S 75 x 200 mm</td> </tr> <tr> <td>B 80 x 80 mm</td> <td>K 300 x 400 mm</td> <td>T 210 x 210 mm</td> </tr> <tr> <td>C 150 x 150 mm</td> <td>L 450 x 150 mm</td> <td>U 100 x 100 mm</td> </tr> <tr> <td>D 150 x 100 mm</td> <td>M 600 x 200 mm</td> <td>V 300 x 150 mm</td> </tr> <tr> <td>E 150 x 200 mm</td> <td>N 400 x 400 mm</td> <td>W 600 x 000 mm</td> </tr> <tr> <td>F 200 x 200 mm</td> <td>P 600 x 400 mm</td> <td>X 200 x 100 mm</td> </tr> <tr> <td>G 300 x 100 mm</td> <td>Q 600 x 450 mm</td> <td>Y 70 x 70 mm</td> </tr> <tr> <td>H 250 x 300 mm</td> <td>R 178 x 203 mm</td> <td>Z 76mm diameter</td> </tr> </table>	A 75 x 100 mm	J 400 x 200 mm	S 75 x 200 mm	B 80 x 80 mm	K 300 x 400 mm	T 210 x 210 mm	C 150 x 150 mm	L 450 x 150 mm	U 100 x 100 mm	D 150 x 100 mm	M 600 x 200 mm	V 300 x 150 mm	E 150 x 200 mm	N 400 x 400 mm	W 600 x 000 mm	F 200 x 200 mm	P 600 x 400 mm	X 200 x 100 mm	G 300 x 100 mm	Q 600 x 450 mm	Y 70 x 70 mm	H 250 x 300 mm	R 178 x 203 mm
A 75 x 100 mm	J 400 x 200 mm	S 75 x 200 mm																								
B 80 x 80 mm	K 300 x 400 mm	T 210 x 210 mm																								
C 150 x 150 mm	L 450 x 150 mm	U 100 x 100 mm																								
D 150 x 100 mm	M 600 x 200 mm	V 300 x 150 mm																								
E 150 x 200 mm	N 400 x 400 mm	W 600 x 000 mm																								
F 200 x 200 mm	P 600 x 400 mm	X 200 x 100 mm																								
G 300 x 100 mm	Q 600 x 450 mm	Y 70 x 70 mm																								
H 250 x 300 mm	R 178 x 203 mm	Z 76mm diameter																								



Fire & Safety Signs

Standard Signs - Non-Photoluminescent

The Fixfire® range of signs is available in several different materials, and in varying sizes to suit all applications. We can even produce bespoke signs to your exact requirements



Robust & Durable



High Visibility



Easy to Install

Emergency Escape Signage



1 2003 G L M
2 2003 G L M
7 2003 G L
8 2003 G L M
9 2003 G L M



1 2004 G L M
2 2004 G L M
7 2004 G L
8 2003 G L M
9 2003 G L M



1 2001 G L M
2 2001 G L M
8 2003 G L M
9 2003 G L M



1 2002 G L M
2 2002 G L M
8 2003 G L M
9 2003 G L M



1 2007 G L M
2 2007 G L M
7 2007 G L
8 2003 G L M
9 2003 G L M



1 2008 G L M
2 2008 G L M
7 2008 G L
8 2003 G L M
9 2003 G L M



1 2005 G L M
2 2005 G L M
8 2003 G L M
9 2003 G L M



1 2006 G L M
2 2006 G L
8 2003 G L M
9 2003 G L M



1 2011 G L M
2 2011 G L M
8 2003 G L M
9 2003 G L M



1 2012 G L M
2 2012 G L M
8 2003 G L M
9 2003 G L M



1 2009 G L M
2 2009 G L
8 2003 G L M
9 2003 G L M



1 2010 G L M
2 2010 G L
8 2003 G L M
9 2003 G L M



1 2015 G L M
2 2015 G L M
8 2003 G L M
9 2003 G L M



1 2013 G L M
2 2013 G L
8 2003 G L M
9 2003 G L M



1 2014 G L M
2 2014 G L
8 2003 G L M
9 2003 G L M



1 2016 G L M
2 2016 G L M
8 2003 G L M
9 2003 G L M

8 2004 L FIRE EXIT SIGN SUSPENDED USING JET SET WIRES



PRODUCT TECHNICAL TIP



BS5499 PART 4

WHEN SIGNING AN ESCAPE ROUTE FOR A STRAIGHTON APPLICATION NOTE THAT AN UPWARD ARROW SHOULD BE USED. AN UPWARD ARROW IS DEFINED AS 'STRAIGHTON FROM HERE' OR 'STRAIGHT ON AND UP FROM HERE'. A DOWNWARD ARROW IS DEFINED AS 'STRAIGHTON AND DOWN FROM HERE'.





Fire & Safety Signs

Standard & Post Mounting Signs - Non-Photoluminescent

The Fixfire® range of signs is available in several different materials, and in varying sizes to suit all applications. We can even produce bespoke signs to your exact requirements



Robust & Durable



High Visibility



Easy to Install

Fire Action Notices

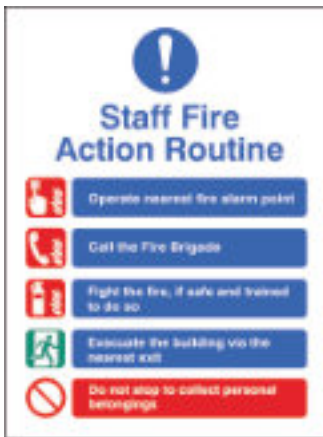

1 1439 **E H**
2 1439 **E H**

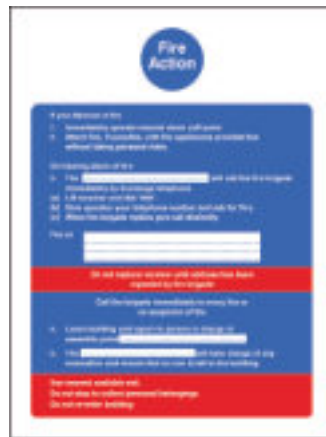

1 1401 **E H**
2 1401 **E H**



1 1432 **E H**
2 1432 **E H**

Assembly Point Signage

Wall and Fence Mounting



1 2509 **H Q** 6 2509 **H Q**
2 2509 **H Q** 7 2509 **H Q**



1 2055 **H Q**
2 2055 **H Q**
6 2055 **H Q**

Post Mounting

- Aluminium
- Includes channel for post mounting
- Order Channel Clips separately



5 2112 250x300mm
5 2113 450x600mm

Post Mounting Brackets



S/CH1339 50mm channel clip
S/CH1340 60mm channel clip
S/CH1341 76mm channel clip
S/CH1342 89mm channel clip
S/CH1343 102mm channel clip
S/CH1344 114mm channel clip
S/CH1345 140mm channel clip

HOW TO ORDER	CHOOSE YOUR SIGN	CHOOSE MATERIAL CODES	CHOOSE SIZE CODES
	 1 1234 GL MATERIAL SIGN SIZE	1 Rigid Plastic 2 Self Adhesive Vinyl 3 Photoluminescent Rigid Plastic 4 Photoluminescent Self Adhesive 5 Miscellaneous Products* 6 Aluminium 7 Polycarbonate 8 Double Sided Hanging Version of Sign 9 Single Sided Hanging Version of Sign 10 Stainless Steel 11 Brass	A 75 x 100 mm B 80 x 80 mm C 150 x 150 mm D 150 x 100 mm E 150 x 200 mm F 200 x 200 mm G 300 x 100 mm H 250 x 300 mm J 400 x 200 mm K 300 x 400 mm L 450 x 150 mm M 600 x 200 mm N 400 x 400 mm P 600 x 400 mm Q 600 x 450 mm R 178 x 203 mm S 75 x 200 mm T 210 x 210 mm U 100 x 100 mm V 300 x 150 mm W 600 x 000 mm X 200 x 100 mm Y 70 x 70 mm Z 76mm diameter



Fire & Safety Signs

Fire Extinguisher Type Signs - Photoluminescent

Our range of photoluminescent identification signs is designed to complete ant fire point installation. High visibility glow in the dark finish to aid location and identification of fire equipment in any emergency.



Robust & Durable



High Visibility



Easy to Install



Glow in the Dark

YOU MAY ALSO REQUIRE ... **FIND ON P21**

Extinguisher Stands

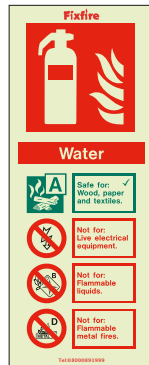

ID SIGNS FITTED TO X/MTS2/MG TUFFSTAND™

S/6362M/R



S/6387M/R



S/6361M/R



S/6360M/R

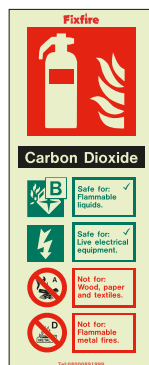

S/6265M/R



S/6267M/R



S/6266M/R



S/6366M/R



S/6374ID/R



S/6387ID/R



S/6373ID/R



S/6370ID/R

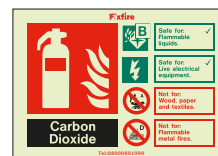

S/6372ID/R



S/6407ID/R



S/6408ID/R



S/6376ID/R





Fire & Safety Signs

TuffSigns™ Non-Photoluminescent

TuffSigns™ is a high performance and robust range of fire signs developed by Fixfire® for maximum visual impact in applications such as warehouses and factories where greater viewing distances are involved.



Robust & Durable



Weatherproof



High Visibility



User-friendly fixings



Made in UK



Bespoke signs to your design



Extra Large Fire Exit Signs

Part No.	Description	Dimensions (mm)
S/FE/D	Fire Exit - Downward Directional Arrow	300 x 900
S/FE/L	Fire Exit - Leftward Directional Arrow	300 x 900
S/FE/R	Fire Exit - Rightward Directional Arrow	300 x 900
S/FE/DS	Fire Exit - Horizontal Directional Arrow - Double Sided Hanging	300 x 900
S/FE/D/DS	Fire Exit - Downward Directional Arrow - Double Sided Hanging	300 x 900
S/FE/D/SS	Fire Exit - Downward Directional Arrow - Single Sided Hanging	300 x 900
S/FE/L/SS	Fire Exit - Leftward Directional Arrow - Single Sided Hanging	300 x 900
S/FE/R/SS	Fire Exit - Rightward Directional Arrow - Single Sided Hanging	300 x 900



S/FE/L



S/FE/R



S/FE/D

Fire Procedure Notices

Part No.	Description	Dimensions (mm)
S/FA/N1	N1 Fire Action Notice Inc. All Point Symbol	240 x 190
S/FA/NH	Nursing Home Fire Action Notice Inc. Call Point Symbol	240 x 190
Prestige Frame Options	Add: /SA (Satin Aluminium), /PB (Polished Brass), /PC (Polished Chrome)	

- Bespoke logos can be incorporated.



S/FA/N1



S/FA/NH



S/FA/N1/SPEC

Project that corporate image with your own customised signs



Fire & Safety Signs

TuffSigns™ Non-Photoluminescent

TuffSigns™ is a high performance and robust range of fire signs developed by Fixfire® for maximum visual impact in applications such as warehouses and factories where greater viewing distances are involved.



Robust & Durable



Weatherproof



High Visibility



User-friendly fixings



Made in UK



Bespoke signs to your design



Fire Point & Fire Extinguisher Signs

S/FP/S	Fire Point - Downward Arrow	360 x 180
S/FP/M	Fire Point - Downward Arrow	500 x 250
S/FP/L	Fire Point - Downward Arrow	400 x 600
S/FP/L/DS	Fire Point - Downward Arrow, Double Sided Hanging	400 x 600
S/FP/P	Fire Point Sign, Panoramic (Dimension Each Face)	300 x 200
S/EXT/S	Fire Extinguisher - Downward Arrow	360 x 180
S/EXT/M	Fire Extinguisher Sign - Downward Arrow	500 x 250
S/EXT/L	Fire Extinguisher Sign - Downward Arrow	400 x 600
S/EXT/L/DS	Fire Extinguisher Sign - Downward Arrow, Double Sided Hanging	400 x 600
S/EXT/P	Fire Extinguisher Sign, Panoramic (Dimension Each Face)	300 x 200



S/FP/P



S/FP/S



S/FP/M



S/FP/L



S/EXT/P



S/EXT/S



S/EXT/M



S/EXT/L

PLEASE ENQUIRE ABOUT...



Our latest Safety Signs Catalogue



SIGNS IN WAREHOUSE APPLICATION

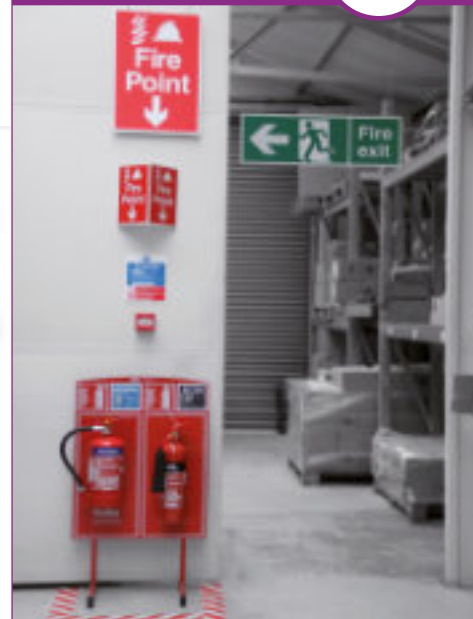



Fire & Safety Signs

Prestige Signs

Prestige signs by Fixfire® are a range of stylish signs to suit architecturally sensitive applications. Available in a range of metallic finishes to provide a durable and smart finishing touch to any office environment.



Architecturally pleasing



High Visibility



Robust & Durable



Made in UK

Prestige Signs

Fire Door Notices



10 9075 **Y**
11 9075 **Y**



10 9097 **Y**
11 9097 **Y**



10 9099 **Y**
11 9099 **Y**



6 9125 **Z**
10 9125 **Z**
11 9125 **Z**



6 9126 **Z**
10 9126 **Z**
11 9126 **Z**



6 9127 **Z**
10 9127 **Z**
11 9127 **Z**

Fire Exit Signs



10 5922 **G**
11 5922 **G**



10 5924 **G**
11 5924 **G**



10 5923 **G**
11 5923 **G**



10 5925 **G**
11 5925 **G**

Fire Procedure Notices



10 9528 **E**
11 9528 **E**



10 9538 **E**
11 9538 **E**

Fire Extinguisher Type Signs



10 9186 **S**
11 9186 **S**



10 9183 **S**
11 9183 **S**



10 9184 **S**
11 9184 **S**



10 9185 **S**
11 9185 **S**

HOW TO ORDER

CHOOSE YOUR SIGN ▶

CHOOSE MATERIAL CODES ▶

CHOOSE SIZE CODES ▶

Your Sign

<p>1 MATERIAL</p> <p>1234 SIGN</p> <p>G L SIZE</p>	<ol style="list-style-type: none"> 1 Rigid Plastic 2 Self Adhesive Vinyl 3 Photoluminescent Rigid Plastic 4 Photoluminescent Self Adhesive 5 Miscellaneous Products* 6 Aluminium 7 Polycarbonate 8 Double Sided Hanging Version of Sign 9 Single Sided Hanging Version of Sign 10 Stainless Steel 11 Brass 	<table style="width: 100%; border-collapse: collapse;"> <tr> <td style="width: 33%; vertical-align: top;"> <ol style="list-style-type: none"> A 75 x 100 mm B 80 x 80 mm C 150 x 150 mm D 150 x 100 mm E 150 x 200 mm F 200 x 200 mm G 300 x 100 mm H 250 x 300 mm </td> <td style="width: 33%; vertical-align: top;"> <ol style="list-style-type: none"> J 400 x 200 mm K 300 x 400 mm L 450 x 150 mm M 600 x 200 mm N 400 x 400 mm P 600 x 400 mm Q 600 x 450 mm R 178 x 203 mm </td> <td style="width: 33%; vertical-align: top;"> <ol style="list-style-type: none"> S 75 x 200 mm T 210 x 210 mm U 100 x 100 mm V 300 x 150 mm W 600 x 000 mm X 200 x 100 mm Y 70 x 70 mm Z 76mm diameter </td> </tr> </table>	<ol style="list-style-type: none"> A 75 x 100 mm B 80 x 80 mm C 150 x 150 mm D 150 x 100 mm E 150 x 200 mm F 200 x 200 mm G 300 x 100 mm H 250 x 300 mm 	<ol style="list-style-type: none"> J 400 x 200 mm K 300 x 400 mm L 450 x 150 mm M 600 x 200 mm N 400 x 400 mm P 600 x 400 mm Q 600 x 450 mm R 178 x 203 mm 	<ol style="list-style-type: none"> S 75 x 200 mm T 210 x 210 mm U 100 x 100 mm V 300 x 150 mm W 600 x 000 mm X 200 x 100 mm Y 70 x 70 mm Z 76mm diameter
<ol style="list-style-type: none"> A 75 x 100 mm B 80 x 80 mm C 150 x 150 mm D 150 x 100 mm E 150 x 200 mm F 200 x 200 mm G 300 x 100 mm H 250 x 300 mm 	<ol style="list-style-type: none"> J 400 x 200 mm K 300 x 400 mm L 450 x 150 mm M 600 x 200 mm N 400 x 400 mm P 600 x 400 mm Q 600 x 450 mm R 178 x 203 mm 	<ol style="list-style-type: none"> S 75 x 200 mm T 210 x 210 mm U 100 x 100 mm V 300 x 150 mm W 600 x 000 mm X 200 x 100 mm Y 70 x 70 mm Z 76mm diameter 			

Fire Safety

Call Systems

Access & Security

DDA Compliance

64

T: 024 7661 6699 E: compliance@fixfire.co.uk W: www.fixfire.co.uk

Fire & Safety Products for Life & Property



Fire & Safety Signs

Sign Mounting Accessories

Fixfire® provide a full range of accessories to allow easy and secure mounting of all types of signs in any situation.

Ceiling Tee Clip

Part No.	Description
S/522	Ceiling Tee Clip

- Clear polypropylene with loop
- Clips securely to suspended ceiling tee bars
- 19x19mm.

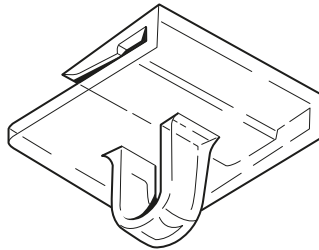

S/522

Rotating Ceiling Button

Part No.	Description
S/527	Rotating Ceiling Button

- White polypropylene ceiling button with eyelet that rotates 360° and self adhesive for fast application
- 25x25mm.

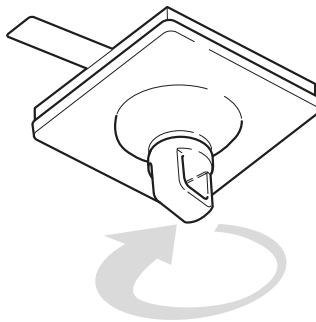

S/527

Magnetic Ceiling Hook

Part No.	Description
S/535	Magnetic Ceiling Hook

- White plastic cased magnet with hook
- Supports pull loads up to approx 2.5kg
- 35mm Ø.

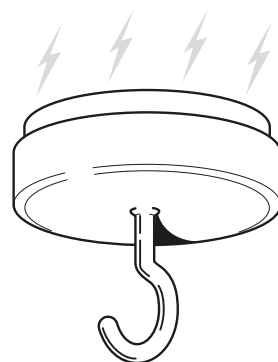

S/535

Oval Mobile Button

Part No.	Description
S/580	Oval Mobile Button

- White polypropylene ceiling button with loop and self adhesive finger tab for fast application
- 40x19mm

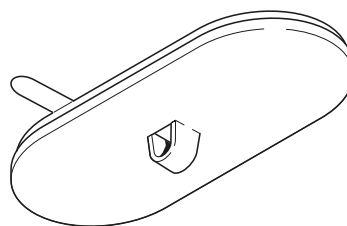

S/580

'S' Hook

Part No.	Description
S/7065-SM	Bright Metal Finish

- Bright metal finish
- 48mm long

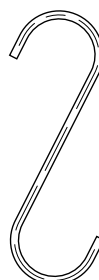

S/7065-SM





Fire & Safety Signs

Sign Mounting Accessories

Fixfire® provide a full range of accessories to allow easy and secure mounting of all types of signs in any situation.

Metal Clasp Ring

Part No.	Description
S/2309-25M	25mm Ø
S/2309-38M	38mm Ø
S/2309-50M	50mm Ø

- Bright metal hinged clasp ring for heavy duty signs or bright metal aesthetic
- Other sizes available to order.

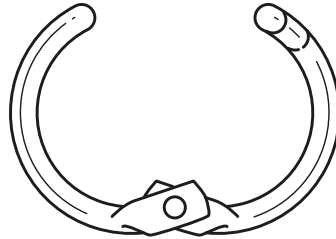

S/2309

Jet Set Wires

Part No.	Description
S/7020	17cm to 110cm Long. Load up to 0.35kg
S/7040	20cm to 140cm Long. Load up to 2.5kg
S/7060	31.5cm to 400cm Long. Load up to 2.5kg

- Pull to length hanging wires
- Simply pull to required length and it stays.

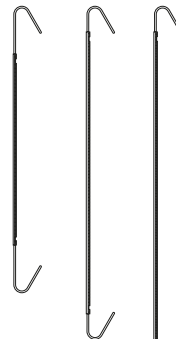

S/7020/40/60

Double Ended Hooks

Part No.	Description
S/7065/10	10Cm Long
S/7065/15	15Cm Long
S/7065/20	20Cm Long
S/7065/25	25Cm Long
S/7065/30	30Cm Long
S/7065/40	40Cm Long
S/7065/50	50Cm Long
S/7065/76	76Cm Long
S/7065/90	90Cm Long

- Bright galvanised 2mm thick wire double ended hooks for suspending and connecting signs

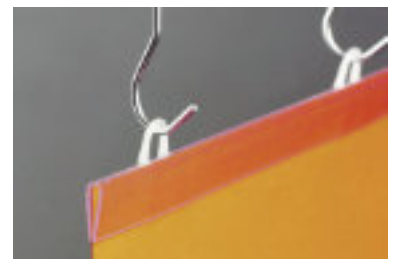
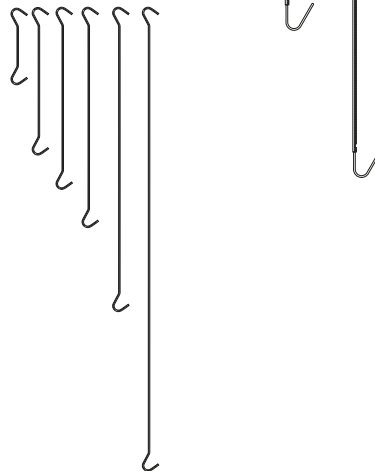

S/7065

Silicone

Part No.	Description
S/SIL/310	Silicone, 310ml Cartridge



S/SIL/310

Cartridge Gun

Part No.	Description
S/CG1	Cartridge Gun



S/CG1



Fire Log Book & Fire Document Holder

Every organisation needs one! The Fixfire® log book is a 'must have' tool to aid the compliance with the Regulatory Reform (Fire Safety) order 2005 (RRO).



Keep your evidence in one place



Demonstrates diligence to inspecting authorities



Robust, built to last



Clearly tabbed



Separate Events & Actions and Planned Maintenance Sections

Fire Log Book

Part No.	Description
CS/LB1	Fire Log Book
CS/LBC	Fire Log Book Cabinet

- Heavy duty ring binder
- Rigid tabbed dividers
- Simple and easy to follow layout
- Based on latest BS regulations with clear explanatory notes
- Capacity to store over 5 years worth of entries
- Fire records need to be kept on hand for easy accessibility. Our Fire Log Book cabinet ensures your Fire Safety Records are kept secure and accessible.

CS/LBC



CS/LB1





Fire Log Book & Fire Document Holders

Fire records need to be kept on hand for easy accessibility. Our cabinet and document holder provide a neat and visible way to keep your record easily available.



Robust & Durable



High Visibility



Easy to Install



Demonstrates Diligence to Inspecting Authorities



Keep your evidence in one place

Fire Log Book Cabinet

Part No.	Description
CS/LBC	Fire Log Book Cabinet

- Perfect home for your fire log book
- Ideal to fit next to fire alarm control panel
- Can accommodate A4 ring binders or lever arch files
- White powder coated finish
- Dimensions H370mm x W300mm X D140mm.



CS/LBC

Large Document Cabinet

Part No.	Description
X/LDC	Large Document Cabinet

- Low profile design
- Robust moulded plastic construction for zero corrosion
- Ideal for documents, hoses and accessories
- Can be used to store fire plans up to A3 size
- Water resistant seal
- Internal equipment restraining strap
- Dimensions: H610 x W505 x D190.



X/LDC

Fire Document Holder

Part No.	Description
E/FDH	Fire Document Holder

- With eyelet hanging point for secure fixing
- Screen printed front panel
- Roomy A4 capacity
- Size: H335mm x W270mm.



E/FDH



First Aid Products

Our range of quality first aid kits conform to all the latest standards, ensuring you remain safe and compliant with current regulations.

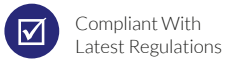

HSE Standard First Aid Kits

X/ACOP1
X/ACOP2
X/ACOP5



Part No.	Description
X/ACOP1	10 Person Hse First Aid Kit
X/ACOP2	20 Person Hse First Aid Kit
X/ACOP5	50 Person Hse First Aid Kit

- Robust and handy carry case
- Supplied with hanging bracket
- Generous contents level.

Workplace Standard First Aid Kits

X/AWSS
X/AWSM
X/AWSL



Part No.	Description
X/AWSS	Small Workplace Standard First Aid Kit
X/AWSM	Medium Workplace Standard First Aid Kit
X/AWSL	Large Workplace Standard First Aid Kit

- Robust and handy carry case
- Supplied with hanging bracket
- Workplace Standard kit compliant with BS8599 -1
- Generous contents level.

Part No.	HSE 10 Person	HSE 20 Person	HSE 50 Person	Workplace Small	Workplace Medium	Workplace Large
Guidance Leaflet	1	1	1	1	1	1
Plasters	20	40	60	40	60	100
Eye Pad	2	4	6	2	3	4
Triangular Bandage	4	6	8	2	3	4
Safety Pins	6	12	12	6	12	24
Med 12 x 12 Dressings	6	9	12	4	6	8
Large 18 x 18 Dressings	2	3	4	1	2	2
Antiseptic Wipes	6	10	20	20	30	40
Disposable Gloves	1	2	3	6	9	12
Adhesive Tape	-	-	-	1	1	1
Finger Dressing	-	-	-	2	3	4
Face Shield	1	1	1	1	1	2
Foil Blanket	-	-	-	1	2	3
Burn Dressing 10 x 10	-	-	-	1	2	2
Tuffcut Scissors	-	-	-	1	1	1
Conforming Bandage 7.5	-	-	-	1	2	2

Index

Product Description	Page	Product Description	Page	Product Description	Page
Agrippa Door Closer	37	Fire Door Alarm	41	Panic Bolt Alarm	39
Agrippa Door Holder	37	Fire Door Closers	36	Panic Latch	38-40
Air Horn	34	Fire Door Hardware	38-40	Photoluminescent Signs	58
Air transfer grilles	51	Fire Door Hinges	36	Pipe Collars	53
Alarm, Boxer	34	Fire Door Seals	41	Pipe Wraps	53
Alarm, Fire Door	41	Fire Door Selector	36	Post Mounting Signs	57
Alarm, Hand Bell	34	Fire Door Spares and Accessories	40-41	Prestige Signs	61
Alarm, Howler	32-33	Fire Escape Door Furniture	38-40	Prestige, Extinguishers	7
Alarm, Panic Bolt	39	Fire Escape Ladder	45	Prestige, Stands	20
Alarms, Site	32-34	Fire Evacuation Products	42-45	Prestige, The Collection	7
Armband, Fire Warden	43	Fire Extinguishers, Commercial	4,5,6	Protective Cages	28,29
Astroflame Products	53-54	Fire Extinguishers, Domestic	8	PU Foam, Fire Rated	52
Battery Smoke Alarms	30	Fire Extinguishers, Kitchen	6	Pull-tite Seals	25
Batwing Seal	48	Fire Extinguishers, Prestige	7	Radio-linked Site Alarm	32-33
Beater, Fire	15	Fire Extinguishers, Specialist	5	Redlam Panic Bolt	40
Bell, Rotary	34	Fire Hose Reel	11	Redlam Panic Bolt, Spares	40
Blankets, Fire	8	Fire Log Book	64	Rotary Hand Bell	34
Boxer Alarm	34	Fire Log Book Cabinet	65	Safety Signs	55-61
Bracket, Bucket	15	Fire Log Book Holder	65	Sand Bin, Fire	15
Bracket, Standard	16	Fire Pillows	54	Sand, Fire	15
Bracket, Transport	16	Fire Rated PU Foam	52	Screen, Welding	10
Bucket Bracket	15	Fire Reeling Hose	11	Seal, Batwing	48
Bucket, Fire	15	Fire Resistant Sealant	52	Seal, Fire and Smoke	47-48
Cabinet Alarm	17	Fire Retardant Dust Sheet	9	Sealant, Nullfire Fire Resistant	52
Cabinet Trolley	23	Fire Sand Bin	15	Seals, Extinguisher	25
Cabinets, Equipment	17	Fire Signs	55-61	Seals, Fire Door	41
Cabinets, Extinguisher	17	Fire Warden Armband	43	Sign Ceiling Mounts	62
Cabinets, Fire Log Book	65	Fire Warden Cap	43	Sign Clasps	62
Cabinets, Vehicle Mounting	17	Fire Warden Clothing	43	Sign Hooks	62-63
Cabinets, Wall Mounting	17	Fire Warden Kits	42	Sign Mounting Accessories	57,62-63
Cages, Alarm Equipment	28,29	Fire warden Waistcoat	43	Signs, Hanging	56,59-60
Call Point Accessories	26	Fireman's Axe	45	Signs, Non-photoluminescent	55-57
Call Point Covers	28	First Aid Kits	66	Signs, Photoluminescent	58
Call Point Test Keys	26	Flame Retardant Spray	52	Signs, Prestige	61
Cap, Fire Warden	43	FlameZorb	15	Signs, Warehouse	59-60
Carbon Monoxide Alarm	31	Flexible Figure 1 (FF1)	50	Silicone	63
Ceiling Clips	62	Freelink Alarm	32-33	Silicone Gun	63
Ceiling Mounts	62	Glazing Gasket	49-5	Single Part Stand	21
Chair, Evacuation	46	Hanging Signs	56,59-60	Site Alarms	32-34
Clothing, Fire Warden	43	Holder, Fire Log Book	65	Site Stands	22
Coated Hose	13	Hose Nozzle Protector	12	Site Trolley	23
Collars, Pipe	53	Hose Reel	11	Smoke Alarms - Domestic	30
Cover, Call Point	28	Hose Reel Accessories	12	Spare parts, Hose reel	12
Cover, Extinguisher	24	Hose Reel Covers	24	Spray, Flame Retardant	52
Cover, Hose reel	24	Hose, Coated	13	Stand, IdentiPoint	22
Detector Head Removal Tool	27	Hose, Lay Flat	13	Stand, IdentiStand	18
Detector Testing Equipment	27	Hose, Reeling	11	Stand, Welding Screen	10
Detector Testing Smoke Spray	27	Hose, Uncoated	13	Standpipe, Double	14
Domestic Smoke Alarms	30	Howler Alarm	32-33	Standpipe, Single	14
Door Closer, Wireless	37	Hydrant key	14	Stands, Site	22
Door Closers	36	IdentiPlate	19	System-36 PLUS	49
Door Holder, Wireless	37	IdentiPoint	22	System-63Ø	49
Downlighter Hoods	54	IdentiStand	18	System-90 PLUS	50
Drapes, Welding	9	Intumescent Air Transfer Grilles	51	Test Key, Emergency Light	35
Dust Sheet, Fire Retardant	9	Intumescent Expanding Foam	52	Test Key, Fire Alarm	26
Emergency Evacuation Chair	46	Intumescent Fire and Smoke Seal	47-48	Theft Stopper	25
Emergency Lighting Test Keys	35	Intumescent Fire Pillow	54	Torch	44
Emergency Whistle	45	Intumescent Mastic	52	Trolley, Cabinet	23
Equipment Cabinets	17	Intumescent Products	47-54	Trolley, Site	23
Evacuation Chair	46	Jet Set Wires	63	TuffCabinets	17
Expanding Foam, Intumescent	52	Key, Hydrant	14	TuffStand	21
Extinguisher Alarms	25	Ladder, Fire Escape	45	Two Part Stand	21
Extinguisher Backboard	19	Lay Flat Hose	13	Ultimex Products	4-6
Extinguisher bracket, Standard	16	Life Hammer	44	Uncoated Hose	13
Extinguisher bracket, Transport	16	Light Stick	44	Union Dome	40
Extinguisher Cover	24	Log Book	64	Waistcoat, Fire Warden	43
Extinguisher Stand, IdentiPoint	22	Lorient Products	47-51	Warehouse Signs	59-60
Extinguisher Stand, IdentiStand	18	LV Fire Resistant Air Transfer Grilles	51	Welding Drapes	9
Extinguisher Stand, Prestige	20	Mastic, Intumescent	52	Welding screen	10
Extinguisher Stand, TuffStand	21	No-Climb Detector Testing Equipment	27	Welding screen stand	10
Fire Alarm Accessories	26	Non-photoluminescent Signs	55-61	Wellington Glass	40
Fire Alarm Test Keys	26	Nozzle Protector	12	Whistle, Emergency	45
Fire and Smoke seal	47-48	Nozzles, Lay Flat Hose	14	Window Seals	49-50
Fire Beater	15	Nozzles, Reeling Hose	12	Wireless Door Closer	37
Fire Blankets	8	Nullfire Fire Resistant Sealant	52	Wireless Door Holder	37
Fire Buckets	15	Outside Access Device	39	Wireless Site Alarm	32-33
Fire Document Holder	65	Panic Bolt - Redlam	40	Wraps, Pipe	53

Visit our website
www.fixfire.co.uk



Head Office
Mayflower House
Bodmin Road
Wyken
Coventry CV2 5DB

**East Midlands & North East
(Regional Office)**
Systems House
Old Station Close
Shepshed LE12 9NJ



Visit our website

www.fixfire.co.uk



linkedin.com/company/fixfire



Main Switchboard: 024 7661 6699 • Freephone: 08000 891999 • Fax: 024 7662 1990

E-mail: compliance@fixfire.co.uk • Website: www.fixfire.co.uk

Fixfire® is a trade mark of Avansys LLP registered in UK No OC384483

© Avansys LLP 2019