



Providing Complete Energy Efficient Lighting Solutions

Edition 1



View the full range at
YESSS.CO.UK



FREE LIGHTING DESIGN SERVICE

Working with all leading manufacturers

Providing complete energy efficient lighting solutions with our FREE design service

Speak to your local branch for more information

CONTENTS

Commercial / Residential / Educational	
Downlights & Lamps	4-7
Bulkheads	8-9
LED Panels	10-11
Battens	12-13
Industrial & Warehouse	
Highbays	14
Lowbays	15
Non-Corrosive Battens	16
Sensors	17
Hazardous Lighting Solutions	
Hazardous Zones 1 & 2	18-19
Emergency Lighting	
Bulkheads	20
Emergency Exit Box	20-21
Emergency Hanging Signs	22-23
Emergency Downlights	24
Emergency Twin Spot	25
Emergency	26-27
Exterior Lighting	
Floodlights	28
Wall Lights & Wall Packs	29
Wall Lights & Lanterns	30-31
Street & Exterior Lighting	
Bollards & Floodlights	32
Sports / Pedestrian Light	33
Streetlights & Wall Lights	33-35
Site Lighting	
Site Lighting & Accessories	36-37
Visualite	38
YESSS Divisions	39

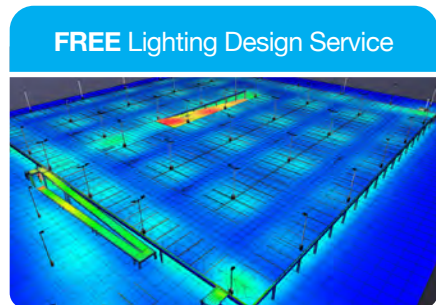

YOUR TRADE WEBSITE

STEP 1

Scan the QR CODE below to start your registration

or visit www.yesss.co.uk and click on 'Register' in the top area of the screen

STEP 2

Enter your personal details and YESSS account number

STEP 3

You will be sent an email to create your password

New easier way to register your trade account for online use in just 3 easy steps!

Log in with your trade account to access these online features:

- View your account including quotes, orders and statements
- Request a quote
- Create 'Favourite' lists for your different projects
- View your most frequently purchased products
- Ability to make a payment on your trade account
- View your local store stock
- Access to nationwide stock
- View your saved pricing
- Multi-quote ordering
- Click & Collect (within 1 hour)

Do you have multiple engineers working for you? Ask your local store about a more customised experience

Downlights

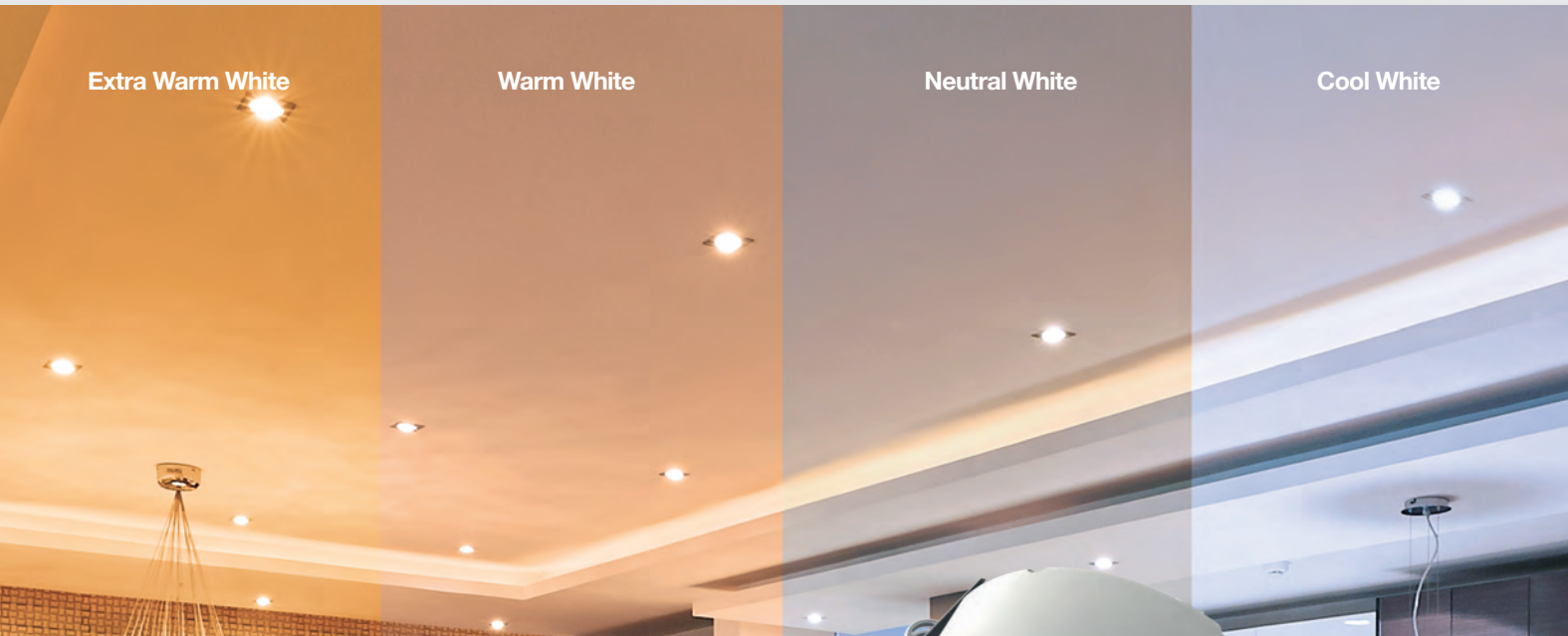

Fire Rated Downlight 5-7W LED CCT4

- Wattage / output selector switch: 5 Watt – 550 Lumen / 7 Watt – 750 Lumen
- Colour temperature selector switch: 2700K Extra Warm White, 3000K Warm White, 4000K Neutral White and 6000K Cool White
- Fire rated for 30, 60 and 90 minute ceilings
- Dimmable, remote flicker free driver
- Low profile design, aluminium heatsink and steel housing
- Removable push-fit terminal connector, loop in / loop out
- Twist and lock matt white bezel included
- Beam angle lens: 60°
- IP rating: IP65
- Colour rendering index: Ra80
- Rated life: 50,000 hours
- Cut out diameter: 72mm
- Operating temperature: -10°C to 40°C



Matt White Bezel included



Available to Order

Brushed Chrome, Polished Chrome, Polished Brass, Matt Black, Matt White & Satin Chrome

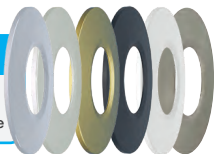

PART NO.	DESCRIPTION
Downlight with Matt White Bezel	
LXFRD/5-7/CCT4	LED Downlight 5-7W CCT4 with Matt White Bezel
LXFRD/5-7/CCT4/10	LED Downlight 5-7W CCT4 with Matt White Bezel, 10 Pack
Bezels	
LXFRD/5-7/BCB	Brushed Chrome Bezel
LXFRD/5-7/SCB	Satin Chrome Bezel
LXFRD/5-7/PCB	Polished Chrome Bezel
LXFRD/5-7/PBB	Polished Brass Bezel
LXFRD/5-7/MBB	Matt Black Bezel
LXFRD/5-7/MWB	Matt White Bezel



LXFRD/5-7/CCT4/10 (10 Pack)

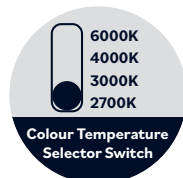
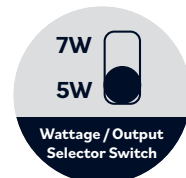

Downlights



Fire Rated Downlight 5-7W LED CCT4 Adjustable Tilt

- Wattage / output selector switch: 5 Watt – 550 Lumen / 7 Watt – 750 Lumen
- Colour temperature selector switch: 2700K Extra Warm White, 3000K Warm White, 4000K Neutral White and 6000K Cool White
- Adjustable tilt
- Fire rated for 30, 60 and 90 minute ceilings
- Dimmable, remote flicker free driver
- Low profile design, aluminium heatsink and steel housing
- Removable push-fit terminal connector, loop in / loop out
- Twist and lock matt white bezel included
- Beam angle lens: 60°
- IP rating: IP65
- Colour rendering index: Ra80
- Rated life: 50,000 hours
- Cut out diameter: 72mm
- Operating temperature: -10°C to 40°C



Matt White Bezel included

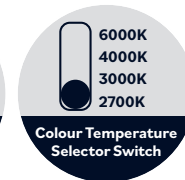
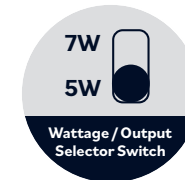

Available to Order

Brushed Chrome, Polished Chrome, & Matt Black



PART NO.	DESCRIPTION
Downlight with Matt White Bezel	
LXFRD/5-7/CCT4/T	LED Downlight 5-7W CCT4 with Matt White Bezel
Bezels	
LXFRD/5-7/BCB/T	Brushed Chrome Bezel
LXFRD/5-7/PCB/T	Polished Chrome Bezel
LXFRD/5-7/MBB/T	Matt Black Bezel

View our downlight range at YESSS.CO.UK



Don't Forget...



LED Downlight, 3Hr Emergency Remote Pack LiFePO4

- Maintained articulated emergency pack, compatible with Luxna LED downlights
- Emergency output power: 5W (70V-250V DC)
- Emergency discharge duration: 3 hours
- Conforms to EN60598-1 and EN60598-2-22

PART NO.	DESCRIPTION
LXERPA/230/EM3	LED Downlight 3 Hour Emergency Remote Pack



Downlights & Lamps



GU10 Fire Rated Downlights

- Suitable for mains powered LED GU10 base lamps
- 3 versions: Fixed, Tilt and IP65 rated
- 3 bezel finishes: White, Satin Chrome and Chrome
- 30, 60 and 90 minutes fire rating
- Push-fit terminations for fast wiring
- Loop-in, loop-out terminal block
- Die cast front bezels
- Operating temperature: -10°C to 40°C
- Lamp not included
- Warranty: 5 year



Fixed (White)



Tilt (Satin Chrome)



IP65 (Chrome)

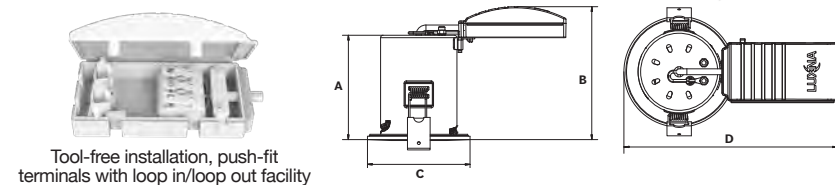

Tool-free installation, push-fit terminals with loop in/loop out facility

PART NO.	COLOUR FINISH	DIMENSIONS A x B x C x D	CUT OUT DIAMETER	IP RATING
Fixed				
LXFRDG/F/WH	White	88 x 112 x 86 x 167mm	73mm	IP20
LXFRDG/F/SCH	Satin Chrome	88 x 112 x 86 x 167mm	73mm	IP20
LXFRDG/F/CH	Chrome	88 x 112 x 86 x 167mm	73mm	IP20
Tilt				
LXFRDG/T/WH	White	88 x 112 x 96 x 177mm	86mm	IP20
LXFRDG/T/SCH	Satin Chrome	88 x 112 x 96 x 177mm	86mm	IP20
LXFRDG/T/CH	Chrome	88 x 112 x 96 x 177mm	86mm	IP20
IP65				
LXFRDG/IP65/WH	White	88 x 112 x 86 x 167mm	73mm	IP65
LXFRDG/IP65/SCH	Satin Chrome	88 x 112 x 86 x 167mm	73mm	IP65
LXFRDG/IP65/CH	Chrome	88 x 112 x 86 x 167mm	73mm	IP65



Glass SMD GU10 LED Lamps

- Available in non-dimmable and dimmable
- Halogen equivalent: 50W
- Life (Hours): 15,000
- 350 Lumens (useful Lumens, 90° cone)



- Beam angle: 38°
- IP20 rated
- Warranty: 2 year

PART NO.	WATTAGE	COLOUR TEMPERATURE	TOTAL LUMENS	USEFUL LUMENS	DIMMABLE
LXGU10LED/4.5WW	4.5W	2700K	420	350	No
LXGU10LED/4.5NW	4.5W	4000K	440	350	No
LXGU10LED/4.5CW	4.5W	6000K	440	350	No
LXGU10LED/5WWD	5W	2700K	430	350	Yes
LXGU10LED/5NWD	5W	4000K	450	350	Yes
LXGU10LED/5CWD	5W	6000K	450	350	Yes



Downlights



LED Recessed Round Panel Downlight

- Modern low-profile design with switchable colour temperature
- Ideal low cost and energy saving alternatives to compact fluorescent downlights
- Ultra slim design suitable for limited depth ceiling voids
- 3x CCT colour switchable: 3000/4000/6000K
- IP rating: IP44
- TP(a) rated opal PC diffuser
- Beam angle: 100°
- Life hours: 30,000
- Supplied with remote 'plug-and-play' driver, non-dimmable
- Separate TRIAC dimmable drivers available
- Emergency pack available

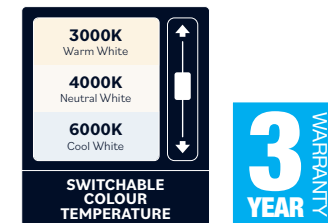

PART NO.	WATTAGE	DIMENSIONS (A x B x C) A=Outer B=Inner C=Depth	CUT-OUT	LUMENS
LXPLR6/CCT3	6W	120 x 95 x 22mm	100mm	600
LXPLR9/CCT3	9W	120 x 95 x 22mm	100mm	900
LXPLR12/CCT3	12W	170 x 145 x 22mm	150mm	1200
LXPLR18/CCT3	18W	225 x 195 x 22mm	200mm	1800
LXPLR24/CCT3	24W	225 x 195 x 22mm	200mm	2400

Recessed Round Panel Downlight LED Dimmable Driver

- Dimensions (L x W x D): 125 x 38 x 30mm

PART NO.	WATTAGE	DESCRIPTION
LXPLR6DD	6W	Use with LXPLR6/CCT3
LXPLR9DD	9W	Use with LXPLR9/CCT3
LXPLR12DD	12W	Use with LXPLR12/CCT3
LXPLR18DD	18W	Use with LXPLR18/CCT3
LXPLR24DD	24W	Use with LXPLR24/CCT3



Distributed by



7W LED Shaver Light

- Dual output shaver socket
- Lumen output: 450lm
- Colour temperature: 4000K
- Ingress protection: IP20
- Operating temp: -10°C - +40°C
- L x W x D: 500 x 60 x 35mm

PART NO.	DESCRIPTION
SL5010WH	7W Shaver Light



Bulkhead Decorative Round



LED Round Slim Bulkhead

- Slimline bulkhead with switchable power output and colour temperature
- 4x Power switchable: 10W, 12W, 14W, 16W
- 3x CCT colour switchable: 3000 / 4000 / 6500K
- IP65 rated polycarbonate housing and diffuser
- Push fit fast fix terminal block
- Life hours: 50,000
- Surface fixing kit included
- Diameter: 327mm, Depth: 77mm



PART NO.	MICROWAVE SENSOR	EMERGENCY EM3
LXBHRS/4PS/CCT3	No	No
LXBHRS/4PS/CCT3/EM3	No	Yes
LXBHRS/4PS/CCT3/MWS	Yes	No
LXBHRS/4PS/CCT3/MWS/EM3	Yes	Yes

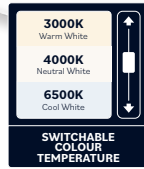
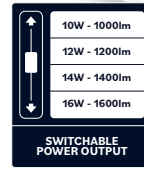

LED Round Ceiling / Wall Light

- Decorative bulkhead, ideal energy saving replacement for fluorescent 2D
- White polycarbonate base, bezel and opal diffuser
- 14W LED, 1100 Lumen
- IP Rating: IP65
- Colour temperature: 4000K
- Colour rendering index: Ra80
- Rated life: 30,000 hours
- Operating temperature: -10°C to 40°C (Standard) 0°C to 40°C (Emergency)
- Surface fixing kit included
- Width: 330mm, Height: 110mm



PART NO.	MICROWAVE SENSOR	EMERGENCY EM3
LXBHR14LEDNW	No	No
LXBHR14LEDNW/EM3	No	Yes
LXBHR14LEDNW/MWS	Yes	No
LXBHR14LEDNW/EM3/MWS	Yes	Yes



Bulkhead Utility



View our LED bulkhead range at YESSS.CO.UK



14W LED Bulkhead

- Low profile utility style bulkhead, ideal energy saving replacement for fluorescent 2D
- White or black polycarbonate base, opal diffuser
- 14W LED, 1200 Lumen
- IP Rating: IP65
- Colour temperature: 4000K
- Colour rendering index: Ra80
- Rated life: 30,000 hours
- Operating temperature: -10°C to 40°C (standard) 0°C to 40°C (emergency)
- Front diffuser locking screws
- Rear and side housing conduit/cable entry points



PART NO.	SHAPE	BASE COLOUR	MICROWAVE SENSOR	EMERGENCY
LXBHR14LEDNW/WO	Round	White	No	No
LXBHR14LEDNW/WO/MWS	Round	White	Yes	No
LXBHR14LEDNW/WO/EM3	Round	White	No	Yes
LXBHR14LEDNW/WO/EM3/MWS	Round	White	Yes	Yes
LXBHR14LEDNW/BO	Round	Black	No	No
LXBHR14LEDNW/BO/MWS	Round	Black	Yes	No
LXBHR14LEDNW/BO/EM3	Round	Black	No	Yes
LXBHR14LEDNW/BO/EM3/MWS	Round	Black	Yes	Yes
LXBHS14LEDNW/WO	Square	White	No	No
LXBHS14LEDNW/WO/MWS	Square	White	Yes	No
LXBHS14LEDNW/WO/EM3	Square	White	No	Yes
LXBHS14LEDNW/WO/EM3/MWS	Square	White	Yes	Yes
LXBHS14LEDNW/BO	Square	Black	No	No
LXBHS14LEDNW/BO/MWS	Square	Black	Yes	No
LXBHS14LEDNW/BO/EM3	Square	Black	No	Yes
LXBHS14LEDNW/BO/EM3/MWS	Square	Black	Yes	Yes



Panels



**LED Backlit Panel 600
26W - 120 Lm/W**

- High luminaire efficacy up to 120 Lumen/Watt
- TP(b) fire rating, low glare opal diffuser
- Backlit uniform light control
- 4000K and 6000K colour temperature
- Pre-wired remote flicker free driver
- 120° beam angle distribution
- IP rating: IP20

PART NO.	WATTAGE	DIMENSIONS (L x W x D)	LUMEN OUTPUT	COLOUR TEMPERATURE
LXPANB26LED66NW	26W	595 x 595 x 25mm	3120	4000K
LXPANB26LED66CW	26W	595 x 595 x 25mm	3120	6000K



**LED Backlit Panel 600
24W - 130 Lm/W**

- High luminaire efficacy up to 130 Lumen/Watt
- TP(a) fire rating, microprism diffuser optic
- UGR<19 rated for visual comfort
- 4000K and 6000K colour temperature
- Pre-wired remote flicker free driver
- 90° beam angle distribution
- IP rating: IP20

PART NO.	WATTAGE	DIMENSIONS (L x W x D)	LUMEN OUTPUT	COLOUR TEMPERATURE
LXPANB24LED66NW/A/19	24W	595 x 595 x 25mm	3120	4000K
LXPANB24LED66CW/A/19	24W	595 x 595 x 25mm	3120	6000K



LED Edgelit Panel Range

- Luminaire efficacy up to 100 Lumens / Watt
- Suitable for 24mm and 15mm T-bar grid ceiling installations
- Ultra slim design 10.5mm thickness
- Supplied with 'plug and play' driver, non-dimmable
- Easy installation, low maintenance

- Colour rendering index: Ra80
- Rated life (L70): 50,000 Hours
- Frame: aluminium white
- Beam spread: 120°
- IP rating: IP20

PART NO.	WATTAGE	DIMENSIONS (L x W x D)	LUMEN OUTPUT	COLOUR TEMPERATURE
LXPAN30LED66WW2	30W	595 x 595 x 10.5mm	3000	3000K
LXPAN30LED66NW2	30W	595 x 595 x 10.5mm	3000	4000K
LXPAN30LED66CW2	30W	595 x 595 x 10.5mm	3000	6000K
LXPAN60LED123NW2	60W	1195 x 295 x 10.5mm	5100	4000K
LXPAN60LED126NW2	60W	1195 x 595 x 10.5mm	5100	4000K
LXPAN60LED126CW2	60W	1195 x 595 x 10.5mm	5100	6000K



Panels



**20W PRO LED Backlit
Panel 600 - 150 Lm/W**

- Ultra high luminaire efficacy up to 150 Lumen/Watt
- TP(a) fire rating, microprism diffuser optic
- UGR<19 rated for visual comfort
- 4000K colour temperature
- Pre-wired remote flicker free driver
- 90° beam angle distribution
- IP rating: IP20

PART NO.	WATTAGE	DIMENSIONS (L x W x D)	LUMEN OUTPUT	COLOUR TEMPERATURE
LXPANB20LED66NW/A/19/P	20W	595 x 595 x 25mm	3000	4000K



Surface Mount Box Kit

- To suit Luxna LED panel sizes: 600 x 600 / 1200 x 600 / 1200 x 300mm
- Simple four point click assembly design
- Aluminium frame, RAL 9003

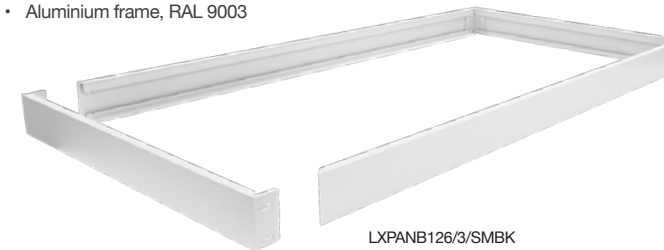

PART NO.	DESCRIPTION
LXPANB66SMBK	600 x 600 Kit
LXPANB126/3/SMBK	1200 600 / 300 Kit

LED Multi Dimmable Driver

- Suitable for 600 x 600 LED panels (30W driver)
- Suitable for 1200 x 600 & 1200 x 300 LED panels (60W driver)
- PUSH dim control using retractive (non-latching) switch
- Built in DALI protocol
- 1-10V control using rotary or slider potentiometer
- Flicker free, ENEC Approved



PART NO.	DESCRIPTION
LXLPF2-30-P1D58	30W Multi Dimmable Driver
LXLPF2-60-P1D58	60W Multi Dimmable Driver

Don't Forget

**Suspension
Cable Kits**



**LED Panel, 3 Hour
Emergency Pack LiFePO4**

- Remote emergency pack, maintained or non-maintained
- Polycarbonate housing: 188.5 x 60 x 33mm
- Compatible with LUXNA LED panel dimmable drivers
- Pre-wired with 'Plug and Play' connection leads
- Supplied with LED indicator cliphousing, white
- Battery type: LiFePO4 3.2V 4.0Ah



PART NO.	DESCRIPTION
LXERP/55/EM3	3 Hour Emergency Pack

**LED Panel, 3Hr Emergency
Remote Pack LiFePO4**

- Emergency discharge duration: 3 hours
- Maintained or non-maintained
- Polycarbonate housing: IP20 rated
- Charge LED indicator with 1x mounting clip included
- Pre-wired with 'Plug and Play' connection leads
- Emergency output power: 2W (10-80V DC)
- Available with self-test



PART NO.	DESCRIPTION
LXERP/80/EM3	Emergency Remote Pack
LXERP/80/ST/EM3	Self Test Emergency Remote Pack

Battens



LED Batten

- Highly efficient LED batten range, energy saving and maintenance free
- Designed to directly replace traditional twin and single body T8 and T5 fluorescent luminaires
- Luminaire efficacy up to 120 Lumen/Watt
- Impact resistant opal polycarbonate diffuser with steel housing
- Side release diffuser buttons for quick and simple installation
- Multiple rear and side cable or conduit entry points
- Fast push-fit, loop in-out terminal block
- Flicker Free LED driver, non-dimmable
- IP/IK rating: IP20/IK08
- Correlated colour temperature: 4000k
- Colour rendering index: Ra80
- Rated life (L70, Ta25°): 50,000 hours
- Operating temperature: -10°C to 40°C (standard), 0°C to 40°C (emergency)
- Voltage and frequency rating: 220-240V AC ~ 50/60 Hz
- Options available: side mount PIR or microwave sensors - see page 17



PART NO.	WATTAGE	DESCRIPTION	DIMENSIONS (L x W x H)	LUMEN OUTPUT
Standard				
LXBAT14LED	23W	4ft Single	1220 x 70 x 77mm	2760
LXBAT24LED	40W	4ft Twin	1220 x 70 x 77mm	4800
LXBAT15LED	37W	5ft Single	1525 x 70 x 77mm	4440
LXBAT25LED	60W	5ft Twin	1525 x 70 x 77mm	7200
LXBAT16LED	54W	6ft Single	1830 x 70 x 77mm	6480
LXBAT26LED	82W	6ft Twin	1830 x 70 x 77mm	9840
Emergency				
LXBAT14LED/EM3	23W	4ft Single EM3	1220 x 70 x 77mm	2760
LXBAT24LED/EM3	40W	4ft Twin EM3	1220 x 70 x 77mm	4800
LXBAT15LED/EM3	37W	5ft Single EM3	1525 x 70 x 77mm	4440
LXBAT25LED/EM3	60W	5ft Twin EM3	1525 x 70 x 77mm	7200
LXBAT16LED/EM3	54W	6ft Single EM3	1830 x 70 x 77mm	6480
LXBAT26LED/EM3	82W	6ft Twin EM3	1830 x 70 x 77mm	9840



View our LED batten range at YESSS.CO.UK

Options Available

PIR Motion Detector & Microwave Presence Detection Sensors

See Page 17

Battens



LED Surface Linear 5ft

- Ideal energy saving replacement for linear fluorescent
- Onboard wattage selector switch for single and twin output
- Highly efficient >130Lm/W
- Tough steel base with a hinged polycarbonate low glare diffuser
- Tridonic control gear
- Rear and side cable entry points
- Wattage: 27W (single) and 45W (twin)
- Lumen output: 3500 / 6200lm switchable
- Beam angle: 110°
- Ingress protection: IP20
- Operating temperature: standard version -20°C ~ +40°C, emergency version 0°C ~ +40°C
- Life hours: 50,000 (L70)
- Dimensions (L x W x H): 1500 x 207 x 71mm



Options Available

PIR Motion Detector & Microwave Presence Detection Sensors

See Page 17

PART NO.	WATTAGE	EMERGENCY	COLOUR TEMPERATURE	LUMEN OUTPUT
SLEA/5/WS/WH/840	27 - 45W	No	4000K	3500 - 6200
SLEA/5/WS/M3/WH/840	27 - 45W	Yes	4000K	3500 - 6200



Highbays



LED Highbay

- Ultra efficient up to 150 Lumen/Watt
- Dimmable 1-10V driver as standard
- Latest LED technology
- Black aluminium heatsink and driver housing, tempered glass lens
- Method of fixing: Suspension ring included
- Light distribution angle: 120°
- Impact protection rating: IK08
- IP rating: IP65
- Colour temperature: 5000K
- Colour rendering index: Ra80
- Rated life L80 B50 (Ta25°): 50,000 hours
- Operating temperature: standard -10°C to 40°C / emergency 0°C to 40°C
- Options available: reflectors and lenses



PART NO.	WATTAGE	EMG WATTS	LUMENS	EMG LUMEN OUTPUT	DIMENSIONS ØWxH
LXHBC100BCW	100W	-	15000	-	275 x 198mm
LXHBC150BCW	150W	-	22500	-	275 x 198mm
LXHBC200BCW	200W	-	30000	-	300 x 196mm
LXHBC100BCW/EM3	100W	4W	15000	550	275 x 198mm
LXHBC150BCW/EM3	150W	8W	22500	1000	275 x 198mm
LXHBC200BCW/EM3	200W	8W	30000	1000	300 x 196mm



Highbay Microwave Sensor

- Colour: black
- For use with LXHBC series
- 1-10V dimmable
- Max 15m mounting height
- Remote programmable
- IP rating: IP65



PART NO.	DESCRIPTION
LXHB-MSB-RC	Highbay LED Microwave Sensor

Remote Programmable Handset

For use with sensors

- LXHB-MSB-RC
- LXLB-MSW-RC

- Set
- Stand by period
 - Hold time
 - Daylight sensor
 - Detection area
 - Standby dimmable level



PART NO.	DESCRIPTION
LXHB-RC	Remote Control Handset

Lowbays



LED Lowbay

- Slim profile Lowbay, ideal energy saving replacement for traditional HID fittings
- Luminaire efficacy up to 145 Lumen/Watt
- Dimmable 1-10V flicker free LED driver
- Pure aluminium heatsink, Impact resistant clear polycarbonate cover lens
- Wire suspension fixing kit included
- Pre-wired input cable 1m
- Fast push-fit, loop in-out terminal block
- Light distribution angle: 120°
- IP/IK rating: IP20/IK10
- Correlated colour temperature: 5000k
- Colour rendering index: Ra80
- Rated life (L70, Ta25°): 50,000 hours
- Operating temperature: -40°C to 50°C
- Voltage and frequency rating: 220-240V AC ~ 50/60 Hz
- Options available:
 - Surface mounting bracket kit
 - Microwave motion and daylight sensor

Don't Forget...

Lowbay LED Bracket Mounting Kit

PART NO.	DESCRIPTION
LXLB-BMK	Lowbay LED Bracket Mounting Kit

PART NO.	WATTAGE	LUMENS	DIMENSIONS (L x W x H)
LXLBL100WCW	100W	14500	578 x 270 x 58mm
LXLBL150WCW	150W	21750	578 x 270 x 58mm
LXLBL200WCW	200W	29000	578 x 420 x 58mm



Don't Forget...

Lowbay Microwave Sensor



PART NO.	DESCRIPTION
LXLB-MSW-RC	Lowbay Microwave Sensor

View our LED lowbay range at YESSS.CO.UK



Non-Corrosive Batters



LED NCF IP65

- LED non-corrosive luminaire, highly efficient, energy saving and maintenance free
- Designed to directly replace traditional twin and single body T8 and T5 fluorescent luminaires
- Luminaire efficacy up to 120 Lumen/Watt
- Impact resistant polycarbonate body and frosted polycarbonate diffuser
- Anti-tamper grade 316 stainless steel clips and locking screws supplied as standard
- Emergency 3 hour-maintained versions with self-test button function fitted as standard
- Operating temperature: -20°C to 45°C (standard), 0°C to 45°C (emergency)
- Voltage and frequency rating: 220-240V AC ~ 50/60 Hz
- Surface and suspension mount brackets included
- Fast push-fit, loop in-out terminal block
- Flicker Free LED driver, non-dimmable
- IP/IK Rating: IP65/IK08
- Correlated colour temperature: 5000k
- Colour rendering index: Ra80
- Rated life (L70, Ta25°): 50,000 hours
- Options available: side mount PIR or microwave sensors



PART NO.	DESCRIPTION	WATTAGE	DIMENSIONS (L x W x H)	LUMEN OUTPUT
Standard				
LXNCF12LEDCW	LED 2ft Single	12W	632 x 85 x 81mm	1440
LXNCF22LEDCW	LED 2ft Twin	20W	632 x 103 x 81mm	2400
LXNCF14LEDCW	LED 4ft Single	20W	1232 x 85 x 81mm	2400
LXNCF24LEDCW	LED 4ft Twin	40W	1232 x 103 x 81mm	4800
LXNCF15LEDCW	LED 5ft Single	30W	1532 x 85 x 81mm	3600
LXNCF25LEDCW	LED 5ft Twin	60W	1532 x 103 x 81mm	7200
LXNCF16LEDCW	LED 6ft Single	40W	1800 x 85 x 81mm	4800
LXNCF26LEDCW	LED 6ft Twin	80W	1800 x 103 x 81mm	9600
Emergency				
LXNCF22LEDCW/EM3	LED 2ft Twin EM3	20W	632 x 103 x 81mm	2400
LXNCF14LEDCW/EM3	LED 4ft Single EM3	20W	1232 x 85 x 81mm	2400
LXNCF24LEDCW/EM3	LED 4ft Twin EM3	40W	1232 x 103 x 81mm	4800
LXNCF15LEDCW/EM3	LED 5ft Single EM3	30W	1532 x 85 x 81mm	3600
LXNCF25LEDCW/EM3	LED 5ft Twin EM3	60W	1532 x 103 x 81mm	7200
LXNCF16LEDCW/EM3	LED 6ft Single EM3	40W	1800 x 85 x 81mm	4800
LXNCF26LEDCW/EM3	LED 6ft Twin EM3	80W	1800 x 103 x 81mm	9600



Sensors



PIR Motion Detection Sensor

- Luminaire mount - batten, NCF, lowbay
- Suitable for 20mm cable entry knockout
- Ingress protection: IP65
- Installation height: 2-6m
- Detection range: 360°
- Detection distance: 10m max
- Ambient light (adjustable): <3-2000 Lux
- Time delay (adjustable): 10 sec to 30min
- Supplied with 700mm cable
- Operating temperature: -10°C ~ +40°C
- Voltage and frequency rating: 220-240V AC ~ 50/60 Hz



PART NO.	DESCRIPTION
SSEN/BP/ST/WH	PIR Motion Detection Sensor 500W Max LED

Microwave Presence Detection Sensor

- Luminaire mount - batten, NCF
- Suitable for 20mm cable entry knockout
- IP20, indoor use only
- Installation height: 2-6m
- Detection distance: 16 x 6m max (8m at 2.5m ceiling height)
- Hold time: 5s / 3m / 5m / 10m / 20 / 30min
- Daylight sensor: 5 / 10 / 30 / 50 lux / Disable
- 1m pre-wired flying leads
- Operating temperature: -10°C ~ +60°C
- Voltage and frequency rating: 220-240V AC ~ 50/60 Hz



PART NO.	DESCRIPTION
YL-MSW1	Microwave Presence Detector 400W Max LED

Outdoor Photocell Kit

- Smart switching delay Feature to Prevent Nuisance Activation
- Ingress protection: IP65
- Working temperature: -10°C ~ +30°C
- Voltage and frequency rating: 220-240V AC ~ 50 Hz



PART NO.	DESCRIPTION
CELLKIT	Outdoor Photocell Kit 1000W Max LED

Remote Head Photocell

- Ingress protection: IP65 (when installed)
- Head mount diameter: 20mm
- Working temperature: -40°C ~ +70°C
- Voltage and frequency rating: 220-240V AC ~ 50 Hz



PART NO.	DESCRIPTION
RCELL	Remote Head Photocell 400W Max LED

Fixed Head Photocell

- Ingress protection: IP65 (when installed)
- Head mount diameter: 16mm
- Lead length: 180mm
- Working temperature: -40°C ~ +70°C
- Voltage and frequency rating: 220-240V AC ~ 50 Hz



PART NO.	DESCRIPTION
MCELL	Fixed Head Photocell 1000W Max LED



Hazardous Zone 1 & Zone 2



Zone 2- Prima LED Ex Series

- Lifetime: 50,000 hours / L90B10
- Loop in Loop Out
- Through-wiring as standard
- Flexible mounting
- Certified T6 Gas & T85 Dust
- Max efficiency 141 L/W
- Lumen output to 8800lm
- 4000K standard
- 3000K, 5000K and 6500K Available
- Polycarbonate body with high impact resistant
- Polycarbonate diffuser UV stabilised
- 1 Entry / 2 entries
- Impact rating: IK10
- 22 IP66 rated



5 YEAR WARRANTY

PART NO.	DESCRIPTION	WATTAGE	LUMENS	LM/W
14823	4ft Single	30W	4400	113
14823EM3	4ft Single Emergency	30W	4400	113
14843	5ft Single	37W	5500	137
14843EM3	5ft, Single Emergency	37W	5500	137
14853	4ft Twin	42W	6400	139

PART NO.	DESCRIPTION	WATTAGE	LUMENS	LM/W
14853EM3	4ft Twin Emergency	42W	6400	139
14873	5ft Twin	53W	8000	137
14873EM3	5ft Twin Emergency	53W	8000	137
14883	5ft Twin	71W	11000	141
14883EM3	5ft Twin Emergency	71W	11000	141



Zone 1, 2, 21 & 22 Models (Standard)

- SafeSite® LED GRP linear
- Operating temperature:
Standard models: -40°C to +65°C
Emergency models: -20°C to +50°C
- IP66/67 DALI 1.0/2.0 as standard
- Up to 2,875 & 5,750 (nominal) lumen outputs
- Impact rating: IK08
- Add emergency on all part numbers with WGG at the end



10 YEAR WARRANTY

PART NO.	DESCRIPTION	WATTAGE	LUMENS	ZONE
P2ABMC23A54WGN	2ft Medium Beam	25W	2875	1
P2ABMCG3A54WGG	2ft Medium Beam	29W	2875	1
P2BBMC23A54WGN	2ft Medium Beam	25W	2875	2
P2BBMC23A54WGG	2ft Medium Beam	29W	2875	2

PART NO.	DESCRIPTION	WATTAGE	LUMENS	ZONE
P2ABMC23A54WGN	4ft Medium Beam	47W	5750	1
P4ABMCG6A54WGG	4ft Medium Beam	51W	5750	1
P4BBMC26A54WGN	4ft Medium Beam	47W	5750	2
P4BBMC26A54WGG	4ft Medium Beam	51W	5750	2

Hazardous Zone 1 & Zone 2



SafeSite LED High Bay

- Low power consumption
- Instant on/off
- Low maintenance
- Mercury free
- No UV or IR
- Resistant to shock and vibration

PART NO.	DESCRIPTION	WATTAGE	OUTPUT
HEA9MC4DN-KCG	Atex Flood / Highbay Zone 1/ 2	88W	9650
HEA9MC4GN-KCG	Atex Flood / Highbay Zone 1/ 2	112W	12500
HEA9MC4KN-KCG	Atex Flood / Highbay Zone 1/ 2	114W	1600
HEA9MC4PN-KCG	Atex Flood / Highbay Zone 1/ 2	212W	23500



SafeSite Bulkhead, Zone 1

The Dialight SafeSite® LED bulkhead luminaire backed by Hazardous Area Certification, Zone 1, 2, 21 and 22, is a premium durable, compact and versatile lighting solution, designed to keep hazardous areas illuminated and safe.

PART NO.	DESCRIPTION	OUTPUT
BHA4BC23NFNVGN	Clear Lens, 360°, 5000K	3300
BHA4BCG3NFNVGG	Clear Lens, 360°, 5000K, Emergency	3300



Zone 1 - Protecta III (IP66/67)

- Linear LED fittings, 2ft, 4ft and emergency
- Highly energy efficient
- Full length easy access diffuser clamp
- Screwless mains terminals
- 120,000 maintenance free hours at 25°C (L70)
- DTS-01 deluge tested
- Retro-fit geartray available



PART NO.	DESCRIPTION	WATTAGE	OUTPUT
PRGE/02L/LE	2ft LED Linear, 6000K	30W	2178
PRGE/02L/LE/EM	2ft LED Emergency, 6000K	32W	2178
PRGE/05L/LE	4ft LED Linear, 6000K	60W	4607



Zone 2 - Sterling III

- Linear LED fittings, 2ft, 4ft, 5ft and emergency
- 155,000 maintenance free hours at 45°C (L70)
- Lightweight and slimline construction
- Highly energy efficient
- IP65 rated



PART NO.	DESCRIPTION	WATTAGE	OUTPUT
ST3N/03L/LE/EM	2ft LED Emergency	26W	3592
ST3N/06L/LE	4ft LED Linear	44W	6241
ST3N/06L/LE/EM	4ft LED Emergency	48W	6241
ST3N/09L/LE	4ft LED Linear	64W	8798



Emergency Bulkhead



3W LED Emergency Bulkhead

- 3 hour emergency selectable self test, maintained or non-maintained operation
- Polycarbonate base and impact resistant diffuser
- Hinged gear tray for quick installation
- Push-fit terminal connector
- Top, side and rear 20mm conduit entry points
- Manufactured in accordance to: BS EN 60598-2-22
- 3W LED, 150 Lumen (AC)
- IP rating: IP65
- Colour temperature: 6000K
- Rated life: 30,000 hours
- Operating temperature: 0°C to 50°C
- Legend viewing distance: 18m
- Battery: LiFePO4 3.2V 1800mAh
- Dimensions: 350 x 110 x 60mm



5 YEAR WARRANTY

PART NO.	DESCRIPTION
LXEBH/S	3W LED Emergency Bulkhead

Accessories

Universal Legend Kit



PART NO.	DESCRIPTION
LXEBH/LK	Self adhesive ISO pictograms to configure Up, Down, Left or Right direction

Recessing Kit

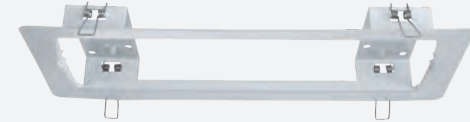

PART NO.	DESCRIPTION
LXEBH/RK	Semi-recessing kit including spring clip fixings

Emergency Exit Boxes



4W LED Emergency Exit Box Slim

- 3 hour emergency selectable self test, maintained or non-maintained operation
- Slim polycarbonate housing and interchangeable PVC legend panels
- Additional LED on base for downward illumination
- Rear 20mm conduit entry points
- IP rating: IP20
- Manufactured in accordance to: BS EN 60598-2-22
- Colour temperature: 6000K
- Rated life: 30,000 hours
- Operating temperature: 0°C to 50°C
- Legend maximum viewing distance: 30m
- Battery: LiFePO4 3.2V 1800mAh
- Dimensions: 390 x 190 x 30mm



INCLUDES ISO PICTOGRAM - UP ARROW

5 YEAR WARRANTY

PART NO.	DESCRIPTION
LXEEBS/S	4W LED Emergency Exit Box Slim

Legend Arrow - Slim



PART NO.	DESCRIPTION
LXEEBS/L/AU	PVC ISO Pictogram - Legend Arrow Up
LXEEBS/L/AD	PVC ISO Pictogram - Legend Arrow Down
LXEEBS/L/AR	PVC ISO Pictogram - Legend Arrow Right
LXEEBS/L/AL	PVC ISO Pictogram - Legend Arrow Left

4W LED Emergency Exit Box

- 3 hour emergency selectable self test, maintained or non-maintained operation
- Robust steel housing and interchangeable polycarbonate legend panels
- Diffuser panel on base for additional downward illumination
- Top and rear 20mm conduit entry points
- Manufactured in accordance to: BS EN 60598-2-22
- IP rating: IP20
- Colour temperature: 6000K
- Rated life: 30,000 hours
- Operating temperature: 0°C to 50°C
- Legend maximum viewing distance: 34m
- Battery: LiFePO4 3.2V 1800mAh
- Dimensions: 390 x 190 x 60mm



INCLUDES ISO PICTOGRAM - UP ARROW

5 YEAR WARRANTY

PART NO.	DESCRIPTION
LXEEB/S	4W LED Emergency Exit Box

Legend Arrow



PART NO.	DESCRIPTION
LXEEB/L/AU	Polycarbonate ISO Pictogram - Legend Arrow Up
LXEEB/L/AD	Polycarbonate ISO Pictogram - Legend Arrow Down
LXEEB/L/AR	Polycarbonate ISO Pictogram - Legend Arrow Right
LXEEB/L/AL	Polycarbonate ISO Pictogram - Legend Arrow Left

Emergency Exit Hanging Signs



3W LED Emergency Hanging Signs

Ideal for all commercial, leisure and hospitality emergency lighting applications. Open areas, escape routes and exits.

- 3 hour emergency selectable self test, maintained or non-maintained operation
- Polycarbonate and aluminium housing with interchangeable PVC legends
- Double sided acrylic hanging legend panel
- Push-fit terminal connector
- Test function button and LED indicator
- Manufactured in accordance to: BS EN 60598-2-22
- IP rating: IP20
- Colour temperature: 6000K
- Rated life: 30,000 hours
- Operating temperature: 0°C to 50°C
- Legend maximum viewing distance: 24m
- Battery: LiFePO4 3.2V 1800mAh



INCLUDES ISO PICTOGRAM - UP ARROW



5 YEAR WARRANTY

PART NO.	DESCRIPTION
LXEMME/S	Emergency Hanging Sign - Multi-Mount

Emergency Exit Hanging Signs



3W LED Emergency Hanging Sign Surface Mounted



PART NO.	DESCRIPTION
LXEHS/S	Emergency Hanging Sign - Surface Mounted

3W LED Emergency Hanging Sign Recessed Suspended



PART NO.	DESCRIPTION
LXEHS/RS/S	Emergency Hanging Sign - Recessed Suspended

3W LED Emergency Hanging Sign Recessed



PART NO.	DESCRIPTION
LXEHS/R/S	Emergency Hanging Sign - Recessed

Accessories



PART NO.	FOR USE WITH	DESCRIPTION
LXEMME/SMA	LXEMME	Wall Bracket and Side Mounting Arm
LXEMME/L/AU	LXEMME	PVC ISO Pictogram - Legend Arrow Up (2pcs)
LXEMME/L/AD	LXEMME	PVC ISO Pictogram - Legend Arrow Down (2pcs)
LXEMME/L/ALR	LXEMME	PVC ISO Pictogram - Legend Arrow Left / Right (2pcs)

SIDE MOUNTING ARM



Accessories



PART NO.	FOR USE WITH	DESCRIPTION
LXEHS/L/AU	LXEHS, LXEHS/RS & LXEHS/R	PVC ISO Pictogram - Legend Arrow Up (2pcs)
LXEHS/L/AD	LXEHS, LXEHS/RS & LXEHS/R	PVC ISO Pictogram - Legend Arrow Down (2pcs)
LXEHS/L/ALR	LXEHS, LXEHS/RS & LXEHS/R	PVC ISO Pictogram - Legend Arrow Left / Right (2pcs)

Emergency Downlights



3W LED Emergency Recessed Remote Downlight

- Open area anti-panic optic design provides uniform illumination with a wide symmetrical beam distribution
- 3 hour emergency selectable self test
- Non-maintained operation
- Compact aluminium housing construction
- Downlight head, driver and battery pre-wired for easy installation
- Dual LED glows green in standby mode and converts to high power white LED in the event of a mains failure
- 35mm diameter hole cut out size
- Manufactured in accordance to: BS EN 60598-2-22
- 3W LED, 150 Lumen
- IP rating: IP20
- Colour temperature: 6000K
- Rated Life: 30,000 hours
- Operating temperature: 0°C to 50°C
- Battery: LiFePO4 3.2V 1800mAh
- Dimensions: 42 x 22mm

Includes

White, Matt Silver and Black Bezels



PART NO.	DESCRIPTION
LXERS/S	Emergency Recessed Remote Downlight

3W LED Emergency Recessed Remote Downlight/CL

- 3 hour emergency selectable self test,
- Non-maintained operation
- Escape route and corridor optic design provides uniform illumination with an asymmetrical beam distribution
- 3W LED, 150 Lumen
- IP rating: IP20
- Colour temperature: 6000K
- Rated life: 30,000 hours
- Operating temperature: 0°C to 50°C
- Battery: LiFePO4 3.2V 1800mAh
- Supplied with white bezel only
- Dimensions: 42 x 22mm



PART NO.	DESCRIPTION
LXERS/CL/S	Emergency Recessed Remote Downlight c/w Corridor Lens

Emergency Twin Spot



Emergency Twin Spot 2x3W LED

- 3 hour emergency selectable self test
- Non-maintained operation
- Lightweight, impact resistant polycarbonate construction
- Push-fit terminal connector
- Side and rear 20mm conduit entry points
- Twin horizontal and vertically adjustable lamp heads
- Suitable for mounting in any orientation
- Individual LED indicators for Charge and Lamp status
- Manufactured in accordance to: BS EN 60598-2-22
- 6W LED (2x 3W), 500 Lumen
- IP rating: IP65
- Colour temperature: 6000K
- Rated life: 30,000 hours
- Operating temperature: 0°C to 50°C
- Battery: LiFePO4 3.2V 6000mAh
- Dimensions: 280 x 300 x 70mm



PART NO.	DESCRIPTION
LXETS/S	Emergency Twin Spot 2x3W LED

Emergency Bulkheads

Distributed by



10W High Output Emergency LED Bulkhead

- Standard and self test versions
- High lumen output
- Ideal remote emergency solution for highbay or lowbay luminaire installations
- Wall or ceiling mounted
- Easy installation design
- Robust polycarbonate construction
- Non-maintained, 3 hour emergency
- Adjustable lumen output: 1000/1500lm
- Colour temperature: 6500K
- Beam angle: 135°
- Ingress protection: IP65
- Impact rating: IK08
- Operating temperature: 5°C ~ +45°C
- Battery: LiFePO4 6.4V 6.6Ah

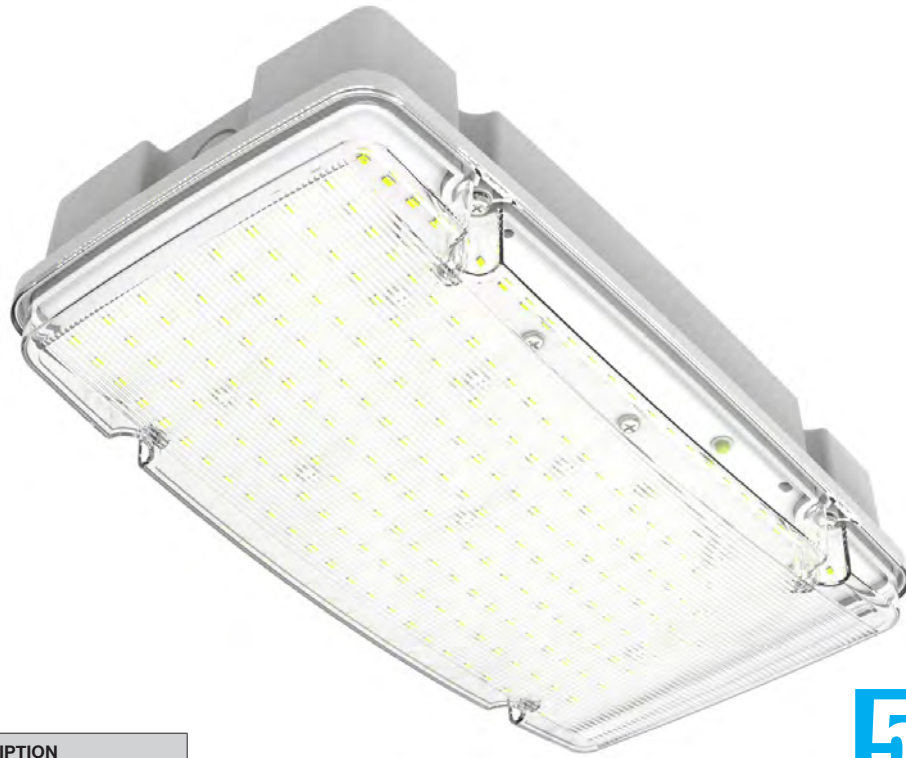

PART NO.	DESCRIPTION
SGUM/10/NM/WH/865	Non Maintained Emergency LED Bulkhead
SGUM/10/ST/WH/865	Self Test Emergency LED Bulkhead

3W Emergency LED Bulkhead

- Ideal for all industrial and commercial emergency lighting applications; open areas, escape routes and exits.
- Robust polycarbonate construction
- Adhesive legend-kit included
- Maintained and non-maintained, 3 hour emergency
- Wattage: 3W
- Lumen output: 150lm
- Colour temperature: 6500K
- Beam angle: 120°
- Ingress protection: IP65
- Impact rating: IK06
- Operating temperature: 0°C ~ +45°C
- Battery: LiFePO4 3.2V 1.5Ah



PART NO.	DESCRIPTION
SGUP/351/ST/WH/865	3W Emergency LED Bulkhead

Emergency Downlight / Twin Spot

Distributed by



2.2W Surface Emergency LED Downlights

- Non-maintained, 3 hour emergency
- Standard and self test versions
- Effective emergency lighting solution for commercial, retail, hospitality and leisure applications
- Supplied with open area and corridor lens
- Compact IP65 polycarbonate housing for surface mounting
- 20mm conduit entry points
- Wattage: 2.2W
- Lumen output: 280lm/230lm
- Colour temperature: 6500K
- Beam angle:
 - Open area lens: 150°
 - Corridor lens: 80°x30°
- Ingress protection: IP65
- Operating temperature: 5°C to +40°C
- Battery: LiFePO4 3.2V 3Ah



PART NO.	DESCRIPTION
SESS/2/NM/WH/865	Square, White LED Downlight
SESS/2/NM/BK/865	Square, Black LED Downlight
SESS/2/ST/WH/865	Square, White LED Downlight, Self Test
SESR/2/NM/WH/865	Round, White LED Downlight
SESR/2/NM/BK/865	Round, Black LED Downlight
SESR/2/ST/WH/865	Round, White LED Downlight, Self Test

8W High Output Emergency LED Twin Spotlight

- Non-maintained, 3 hour emergency
- Standard and self test versions
- Ideal solution for all commercial, industrial and warehouse emergency lighting applications
- Twin horizontal and vertically adjustable lamp heads
- Robust polycarbonate construction
- Wattage: 8W
- Lumen output: 2x500lm
- Colour temperature: 6500K
- Beam angle: 120°
- Ingress protection: IP65
- Impact rating: IK07
- Operating temperature: 5°C ~ +45°C
- Battery: LiFePO4 6.4V 6.6Ah



PART NO.	DESCRIPTION
SPBM/8/NM/WH/865	8W Emergency LED Twin Spotlight
SPBM/8/ST/WH/865	8W Emergency LED Twin Spotlight / Self Test



Floodlights



LED Floodlights

- Suitable for all residential, commercial and industrial external applications
- IP65 black die cast aluminium housing
- Toughened glass front cover
- Pre-fitted mains cable
- High efficiency: 120 Lm/W
- Beam spread: 110°
- Life hours: 50,000
- Colour temperature: 4000K

PIR Version

- IP65 housing and PIR sensor
- Detection distance: Up to 8m
- Detection range: 120°
- Time delay: 10 sec – 7 min
- PIR override function

PART NO.	PIR	WATTAGE	LUMENS
LXFL10BNW	No	10W	1200LM
LXFL10BNW-PIR	Yes	10W	1200LM
LXFL20BNW	No	20W	2400LM
LXFL20BNW-PIR	Yes	20W	2400LM
LXFL30BNW	No	30W	3600LM
LXFL30BNW-PIR	Yes	30W	3600LM
LXFL50BNW	No	50W	6000LM
LXFL50BNW-PIR	Yes	50W	6000LM
LXFL100BNW	No	100W	12000LM
LXFL150BNW	No	150W	18000LM
LXFL200BNW	No	200W	24000LM



Distributed by



LED Floodlights Asymmetric

- Highly efficient up to 120lm/w
- Asymmetric beam
- Slim black aluminium die-cast housing
- Tempered glass
- Colour temperature: 5000K

- Ingress protection: IP65
- Impact rating: IK08
- Operating temperature: -20°C ~ +45°C
- Life Hours: 50,000 (L70)

PART NO.	WATTAGE	LUMENS	DIMENSIONS W X H X D
SSTE/50/ST/BK/850	50W	5600LM	200 x 237 x 39mm
SSTE/100/ST/BK/850	100W	11860LM	282 x 321 x 41mm
SSTE/150/ST/BK/850	150W	17200LM	420 x 333 x 51mm
SSTE/200/ST/BK/850	200W	23900LM	470 x 385 x 51mm



Wall Pack / Wall Lights

Distributed by



LED Wall Light

- Highly efficient up to 140lm/w
- Modern die-cast aluminium housing
- Rear and side cable entry points
- Suitable for conduit and BESA Box installation
- Adjustable colour temperature
- Ingress protection: IP65
- Impact rating: IK10
- Operating temperature: Standard versions -20°C ~ +40°C, Emergency versions 0°C ~ +40°C*
- Life Hours: 50,000 (L70)

PART NO.	WATTAGE	LUMEN OUTPUT	COLOUR TEMP
MAXI			
SHA/OA/ST/CCT/ANT	13/18/28W	1700/2500/3500LM	3000/4000K
SHA/OA/M3/CCT/ANT*	13/18/28W	1700/2500/3500LM	3000/4000K
SHA/OA/ST/CCT/BLK	13/18/28W	1700/2500/3500LM	3000/4000K
SHA/OA/M3/CCT/BLK*	13/18/28W	1700/2500/3500LM	3000/4000K
MAXI - ASYMMETRIC BEAM			
SHA/AS/ST/CCT/ANT	13/18/28W	1700/2500/3500LM	3000/4000K
MIDI			
SSHM/OA/ST/CCT/ANT	7/8/10/12W	950/1150/1400/1550LM	3000/4000K
SSHM/OA/M3/CCT/ANT*	7/8/10/12W	950/1150/1400/1550LM	3000/4000K
SSHM/OA/ST/CCT/BLK	7/8/10/12W	950/1150/1400/1550LM	3000/4000K
SSHM/OA/M3/CCT/BLK*	7/8/10/12W	950/1150/1400/1550LM	3000/4000K
MINI			
SSHN/OA/ST/CCT/ANT	5W	585LM	4000K
SSHN/OA/ST/CCT/BLK	5W	585LM	4000K



LED Wall Pack 15W Mini, Angle Mounted

- Ideal energy saving replacement for fluorescent 2D
- Efficacy 100lm/w
- Rear and side M20 cable entry points
- Tough polycarbonate construction
- Beam angle: 120°
- Ingress protection : IP65
- Impact rating: IK08
- Operating temperature: Standard versions -10°C ~ +40°C, Emergency versions 0°C ~ +40°C*
- Life Hours: 50,000 (L70)
- 3 Hour Emergency
- Adjustable colour temperature

PART NO.	WATTAGE	LUMEN OUTPUT	COLOUR TEMP
SGEK/15/ST/BK/CCT	15W	1500LM	3000/4000K
SGEK/15/M3/BK/CCT*	15W	1500LM	3000/4000K

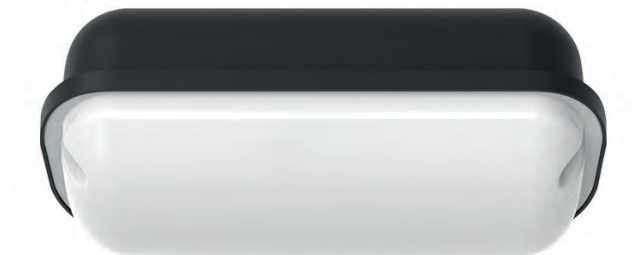

LED Wall Pack 22W Slim

- Black polycarbonate base and detachable front trim
- Opal polycarbonate impact resistant diffuser
- Lumen output: 1500Lm
- IP/IK rating: IP65/ IK08
- Colour temperature: 4000K
- Colour rendering index: Ra80
- Rated life: 30,000 hours
- Operating temperature: -10°C to 40°C (standard), 0°C to 40°C (emergency)
- Surface fixing and cable gland kit included
- Dimensions: 305 x 255 x 101mm (H x W x D)
- Photocell: 10-20 Lux On / 30-60 Lux Off

PART NO.	WATTAGE	DESCRIPTION
LXWPS	22W	Wall Pack
LXWPS/PC	22W	Wall Pack with Photocell
LXWPS/EM3	22W	Wall Pack with Emergency
LXWPS/EM3/PC	22W	Wall Pack with Photocell and Emergency



Wall Lights



LUTEC
CONNECTED BY LIGHTING

Rado IP44 GU10 Wall Light

- Available in Stainless Steel or Graphite
- Available with or without PIR
- LED GU10 required

PART NO.	FINISH	TYPE	PIR SENSOR
5510904001	Stainless Steel	Single, Down	No
5510909001	Stainless Steel	Single, Down	Yes
5510801001	Stainless Steel	Twin, Up / Down	No
5510809001	Stainless Steel	Twin, Up / Down	Yes
5510801424	Graphite	Twin, Up / Down	No
5510809424	Graphite	Twin, Up / Down	Yes

5510904001



5510801001



5510809424

Wall Lights

LUTEC
CONNECTED BY LIGHTING

Focus Wall Light

- 2 x GU10 (Lamp not included)
- IP44
- Dark Grey
- Depth: 109mm
- Height: 235mm
- Width: 110mm



PART NO.	DESCRIPTION
5604011118	Focus Wall Light - Dark Grey

Cotswold PIR Wall Light

- E27 (Lamp not included)
- IP Rating: IP44
- Black
- Depth: 205mm
- Height: 373mm
- Width: 110mm



PIR version

PART NO.	DESCRIPTION
5180602012	Cotswold PIR Wall Light
5180601012	Cotswold Wall Light

Corniche Up Wall Light

- Die-cast aluminium
- E27 (Lamp not included)
- IP Rating: IP44
- Depth: 225mm
- Height: 310mm
- Width: 190mm



PIR version

PART NO.	DESCRIPTION
5112102012	Corniche Up Wall Light
5112104012	Corniche Up Wall Light - PIR

Kelsey Wall Light

- E27 (Lamp not included)
- IP44
- Width: 120mm
- Length: 120mm
- Height: 200mm



PART NO.	DESCRIPTION
5273701012	Kelsey Wall Light - Matt Black

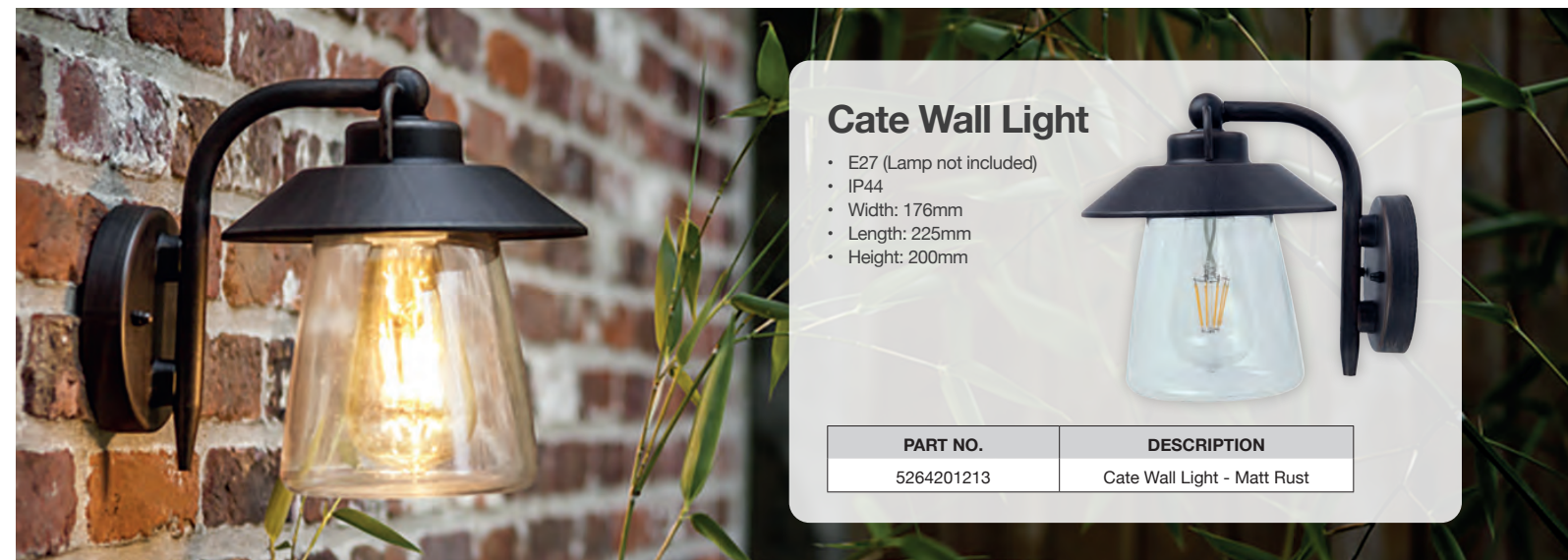

Cate Wall Light

- E27 (Lamp not included)
- IP44
- Width: 176mm
- Length: 225mm
- Height: 200mm



PART NO.	DESCRIPTION
5264201213	Cate Wall Light - Matt Rust

Bollards / Floodlights



LED Bollard

- Aluminium die-cast lamp head and extruded aluminium body
- High transparency polycarbonate diffuser
- High quality LED chips and driver
- UV protected pure polyester powder coated housing offering high corrosion resistance
- Integrated switch to select colour temperature between 3000K and 4000K



PART NO.	WATTAGE	RANGE	COLOUR TEMP	COLOUR	DIMENSIONS (H x W)	LUMENS
BRE-25-130-100	25W	BREMA	3000 / 4000K	Black	1000 x 168mm	2340 / 2370
GAL-H100-15-130	15W	GALLIA	3000K	Grey	1000 x 118mm	1050
LIP-25-130-100	25W	LIPSIA	3000 / 4000K	Grey	1000 x 168mm	2210 / 2380
LIP-25-130-80	25W	LIPSIA	3000 / 4000K	Grey	800 x 168mm	2210 / 2380
TOL-25-130-100	25W	TOLOSA	3000 / 4000K	Black	1000 x 168mm	950 / 1000

LED Floodlight

- Die-cast aluminium construction with tempered glass diffuser
- Optical lenses offer visual comfort and uniform light distribution
- High quality LED chips and driver
- UV protected pure polyester powder coated housing offering high corrosion resistance
- All external screws are in 304 stainless steel



PART NO.	RANGE	WATTAGE	LUMENS
GEN-S9-TP25	GENUA	9W	850
IPS-S75-TS25	IPSES	75W	7700
IPS-S100-TS25	IPSES	100W	11000
IPS-S120-TS25	IPSES	120W	13200
RAV-M30-TS25	RAVENNA	30W	3010
URB-FL-XS40-T3A-4K	URBA	40W	5500
URB-FL-XS60-T3A-4K	URBA	60W	8100
URB-FL-XS100-T3A-4K	URBA	100W	13890
URB-FL-S150-T3A-4K	URBA	150W	21540
URB-FL-S200-T3D-4K	URBA	200W	28120
URB-FL-M240-T3A-4K	URBA	240W	34220
URB-FL-M300-T3A-4K	URBA	300W	42450
URB-FL-L400-T3A-4K	URBA	400W	56080
URB-FL-L480-T3A-4K	URBA	480W	56080



Sports / Pedestrian / Streetlights



LED Sports Floodlight with TLCI

A high quality, stadium level sports floodlight with TLCI (Television Lighting Consistency Index) and available in a range of sizes to suit applications from a single tennis court to an international football stadium



PART NO.	WATTAGE	RANGE	LUMENS
FIN-S600-TM6-4K	600W	FINNIA	87000
FIN-M800-TM6-4K	800W	FINNIA	116000
FIN-L1200-TM6-4K	1200W	FINNIA	174000

LED Pedestrian Light

- Die-cast aluminium housing
- Optical lens offering visual comfort and uniform light distribution
- High quality LED chips and driver
- UV protected pure polyester powder coated housing offering high corrosion resistance
- Suitable for use with a range of controls and remote management systems
- All external screws are 304 stainless steel as standard



PART NO.	WATTAGE	RANGE	LUMENS
ELE-P-40-T1	40W	ELENIO	5300LM
SOR-T-40-T1-4K	40W	SORA	6270LM
URC-S60-T3A-4K	60W	URCI	9000LM



LED Streetlight

- Die-cast aluminium housing with super white tempered glass, available in three sizes
- Optical lenses with multiple distribution options, offering visual comfort and uniform light distribution
- High quality LED chips and DALI driver as standard, with in-built surge protection up to 20KV
- UV protected pure polyester powder coated housing offering high corrosion resistance
- Suitable for use with a range of controls and remote management systems
- All external screws are 304 stainless steel as standard



PART NO.	WATTAGE	RANGE	LUMENS
PAX-S40-T2W-4K	40W	PAX	5610LM
PAX-S80-T2D-4K	80W	PAX	11220LM
PAX-M100-T2A-4K	100W	PAX	14030LM
PAX-L200-T2A-4K	200W	PAX	28600LM





View the full LEDSCAPE range at YESSS.CO.UK



LEDSCAPE
THE POWER OF LIGHT

LED Street Lighting

- Die-cast aluminium housing available in two sizes, with super white tempered glass. Attractive, modern design
- Optical lenses with multiple distribution options, offering visual comfort and uniform light distribution
- High quality LED chips and DALI driver as standard, with in-built surge protection up to 20KV
- Tool-free, easy open housing for fast installation and maintenance. Power automatically disconnects when housing is opened for additional safety
- Adjustable mounting bracket allows both horizontal and vertical pole mounting. Bracket suitable for Ø60mm pole diameter, bracket accessories available for other pole sizes
- UV protected pure polyester powder coated housing offering high corrosion resistance
- Suitable for use with a range of controls and remote management systems
- All external screws are 304 stainless steel as standard
- RAL9007, other RAL colours available on request



PART NO.	WATTAGE	RANGE	LUMENS
URB-XS40-T3A-4K	40W	URBA	5290LM
URB-XS100-T3D-4K	100W	URBA	13080LM
URB-S150-T3A-4K	150W	URBA	19650LM



LEDSCAPE
THE POWER OF LIGHT

LED Traditional Light

- Die-cast aluminium housing
- Optical lenses offering visual comfort and uniform light distribution
- High quality LED chips and DALI driver as standard, with in-built surge protection up to 20KV
- UV protected pure polyester powder coated housing offering high corrosion resistance
- Suitable for use with a range of controls and remote management systems
- All external screws are 304 stainless steel as standard
- Other RAL colours available on request



PART NO.	WATTAGE	RANGE	LUMENS
MON-60-T32B	60W	MONA	8410LM
LON-60-T1-4K	60W	LONDINIUM	7800LM



LED Down Wall Light

High quality wall light with both down only and up and down lighting options for versatility, and available in three sizes to cover a variety of applications



PART NO.	WATTAGE	RANGE	LUMENS
GAZ-S12-80-D	12W	GAZA	960LM

LED Up Down Wall Light

High quality square wall light with both down only and up and down lighting options for versatility, and available in two sizes to cover a variety of applications



PART NO.	WATTAGE	RANGE	LUMENS
ASS-S20-TP25-UD	25W	ASSOS	2300LM

LED Wall Wash Light

A linear wall wash light available in three lengths and in fixed colour and RGBW options. Ideal for illuminating building facades and other structures such as bridges



PART NO.	WATTAGE	RANGE	LUMENS
DUB-S12-1040-RGBW	12W	DUBLINA	936LM



Connectable Festoon Kits Multi-Head Festoons, 110V

- Tough, IK08 light heads
- Unique fixing eyelets for screw or cable tie
- Supplied with handy, strong, storage & carry bag



PART NO.	DESCRIPTION
FKF1230YPW	30W, 12m, 6 Way, IP44
FKF50100W	100W, 50m, 20-Way, IP44
FKF2250W	50W, 22m, 10 Way, IP44
FKS30YPW	60cm Y-Splitter Cable

72W Uplight Workspace Lighting

- High light output, ideal for large spaces
- Aux socket for interlinking or power tools
- Convenient carry strap



View the full Red Arrow Site Light range at YESSS.CO.UK



PART NO.	DESCRIPTION
ULS72YPW	110V, 72W, LED Uplight - Standard

18W LED Hand Held & Tripod Work Light

- Hand-held or single and twin tripod worklights
- Height adjustable tripod
- Tripods have adjustable heads to direct the light
- 1.8m - 3m cable with a 16A 110V plug
- Colour temperature: 6500K
- Working temperature: -20°C to 50°C
- LED lifetime: 25,000 Hours



PART NO.	DESCRIPTION
GLH18	Garrison LED Hand Held Site Light, 1.8m Cable
GLW118	Tripod Work Light, 3m Cable
GLW218	2 x Garrison LED Worklight with Tripod, 3m Cable



Kyrpton Rechargeable Floodlight

- High light output, ideal for large spaces
- Emergency version, switchable to prevent discharge during storage
- Aux socket for interlinking or power tools
- Convenient carry strap



PART NO.	DESCRIPTION
KRY10	10W Rechargeable Floodlight
KRY20	20W Rechargeable Floodlight
KRY50	50W Rechargeable Floodlight

110V Slim Site Floodlight

- Ultra slim, lightweight design
- Bracket allows 360° adjustment
- High efficacy 95lm/W
- Built in surge protection
- Pre-wired with 1m cable



PART NO.	DESCRIPTION
FLAC100Y	100W, 110V, 6500K, IP65
FLAC150Y	150W, 110V, 6500K, IP65

20W LED Portable Task Light

- Tough, lightweight construction
- Built-in cable storage and carry handle
- Handy auxiliary socket on rear
- Pre-wired with 3m cable and plug



PART NO.	DESCRIPTION
ST20LED110V	20W LED Portable Task Light

8W Dual Voltage Site Bulkhead

- New sleek profile design
- Dual supply voltage - 110/240V for versatility
- Optional prismatic red or clear diffusers
- Smart optional trim to cover diffuser fixings



PART NO.	DESCRIPTION
TAO8Y	Opal, 5700K, 800lm
TAC8Y	Clear, 5700K, 900lm
TAR8Y	Red, 900lm

Comet Site Slim Floodlight

- Prewired 1m rubber cable
- U shaped mounting bracket
- IP65



PART NO.	DESCRIPTION
CMT50Y	50W Comet Site Slim Floodlight
CMT100Y	100W Comet Site Slim Floodlight
CMT150Y	150W Comet Site Slim Floodlight

16A Splitter Box

- Splitter box
- 4 Outlets
- 110V
- Yellow



PART NO.	DESCRIPTION
LFUK4S	110V Splitter Box



visualite

Sensory and Well-being Lighting Solutions



Explore our bespoke Visualite lighting panels or take a look at our pre-designed collection today
Find out more at YESSS.CO.UK

What is Visualite?

...Simply revolutionary

Powered by spectacular edge light technology and supplied with a vast array of stunning visuals, our new range of Visualite systems create an amazing lighting effect and ambience, incorporating the light source and bespoke image into one.

The Visualite system can provide a pleasant and powerful impact in any of these environments:

- Hospitals and other medical environments
- Retail and leisure
- Car showrooms
- Commercial offices
- Education
- Sport stadiums
- Basements
- Boardrooms
- Homes

Off-the-shelf versions also available, please visit www.yesss.co.uk/lighting/led-panels/led-sky-panels



As well as our YESSS Lighting division, we have a full range of other specialist divisions, each with their own team to provide technical assistance and design services that you may need for your next project.



Security Solutions

Providing a range of services from product recommendation to a full site design for any job from small domestic systems to large commercial sites, with our **FREE survey and design service**



CCTV • Intruder • Fire
Access Control • Nurse Call • Networking



Industrial Products and Services

Providing technical assistance with specialised industrial products, services and repairs



Industrial Electronic Repairs • Motors and Rewinds
Industrial Calibrations • Energy Saving Surveys & Solutions
Special Transformer Builds • Special Panel Builds



EV Charging, Solar Power and Battery Storage Solutions

We offer a full range of EV Charging, Solar and Battery storage solutions from high quality brands



Home EV Charging • Workplace EV Charging
Public EV Charging • Solar Power & Battery Storage
Wind Power • Carbon Detox Calculation



OVER 95 BRANCHES NATIONWIDE

Aberdeen 01224 701870 AB23 8JW	Castleford 01924 227972 WF6 1TN	Gateshead 0191 482 8718 NE11 0JY	Leeds 0113 385 5838 LS11 0EY	Nottingham North 0115 684 2181 NG7 7NW	Sutton 020 8641 9508 SM3 9PF
Ballymena 028 2563 6758 BT42 3HB	Chichester 01243 756978 PO19 8ET	Glasgow 0141 553 0148 G4 0ED	Leeds East 0113 236 5948 LS9 0SG	Peterborough 01733 902490 PE1 5UX	Swindon 01793 838928 SN3 4JG
Barnsley 01226 705928 S70 3PB	Christchurch 01425 282908 BH23 4JE	Grantham 01476 513518 NG31 7SA	Leicester 0116 268 9460 LE4 3EH	Poole 01202 307378 BH12 3PG	Trafford Park 0161 868 1400 M17 1PZ
Basingstoke 01256 300198 RG22 4AY	Colchester 01206 879494 CO4 9XP	Gravesend 01474 531098 DA11 8HB	Lewisham 020 8176 6255 SE12 0TX	Preston 01772 272758 PR1 1NU	Tunbridge Wells 01892 556958 TN2 3EH
Belfast East 028 9070 7928 BT5 6QR	Coleraine 028 7032 2618 BT52 2DF	Grimsby 01472 803718 DN31 2UJ	Lincoln 01522 508198 LN6 3RT	Redditch 01527 830600 B98 0GZ	Tyne Tunnel 0191 293 0588 NE29 7XJ
Belfast North 028 9078 2098 BT3 9BW	Coventry 024 7638 9600 CV7 9FW	Guernsey 01481 201718 GY1 2BG	Lisburn 028 9260 6758 BT27 5EW	Redhill 01737 859918 RH1 2LH	Wakefield 01924 666589 WF1 1DZ
Bellshill 01698 277518 ML4 3NP	Craigavon 028 3836 7668 BT63 5YX	Halifax 01422 397508 HX3 9HG	Livingston 01506 448858 EH54 5FD	Ripon 01765 643948 HG4 1AJ	Warrington 01925 578438 WA2 8NT
Berwick 01289 541990 TD15 2XF	Crayford 01322 625898 DA1 4AL	Hastings 01424 462448 TN35 4PP	London City 020 7537 6528 E3 2JE	Rotherham 01709 857128 S60 1EW	Watford 01923 606349 WD24 4PP
Birkenhead 0151 666 7358 CH41 5HU	Croydon 020 8253 0018 CR0 4YN	Hounslow 020 8814 3058 TW3 3LL	London North 020 8370 2018 N11 1JL	Rustington 01903 858928 BN16 3HQ	Weymouth 01305 752848 DT4 9TJ
Birmingham 0121 327 6161 B24 8HZ	Cumbernauld 01236 746278 G68 0LW	Hull 01482 971558 HU3 4XT	Luton 01582 542300 LU2 9NL	Selby 01757 244888 YO8 8LZ	Winchester 01962 826038 SO23 7RX
Blackpool 01253 832618 FY4 5FN	Dagenham 020 3823 4354 RM10 8PN	Inverness 01463 701128 IV1 1SY	Lymington 01425 282902 SO41 9BB	Sheffield East 0114 263 7528 S9 5FD	Yeovil 01935 403288 BA20 2SU
Bodmin 01208 262258 PL31 1FF	Darlington 01325 348668 DL1 4WF	Isle of Man 01624 675555 IM4 2AF	Manchester Central 0161 272 5628 M12 6AE	Sheffield North 0114 232 7068 S6 1PD	York 01904 236501 YO30 4UU
Bracknell 01344 865758 RG12 1RW	Derby 01332 253748 DE21 4BJ	Isle of Wight 01983 828918 PO30 5GY	Mansfield 01623 664928 NG18 5DN	Southport 01704 331695 PR9 7RL	
Bradford 01274 386808 BD4 7NE	Doncaster 01302 308708 DN2 4LT	Jersey 5 Oaks 01534 721414 JE2 7XQ	Morecambe 01524 590688 LA3 3BN	Stockport 0161 494 3708 SK6 2RF	
Brighton 01273 426508 BN3 5RY	Dundee 01382 883418 DD2 3NU	Jersey West 01534 872242 JE3 7AZ	Newbury 01635 277588 RG14 5PF	Stockton 01642 260858 TS18 2RJ	
Bristol 0117 332 8321 BS3 4JQ	Durham 0191 378 7888 DH7 8XQ	Kendal 01539 742858 LA9 6LZ	Northampton 01604 752100 NN5 7JT	Stornoway 01851 708938 HS1 2SE	
Burnley 01282 688078 BB12 7BF	Elgin 01343 562448 IV30 6AG	Kingston 020 3917 7080 KT2 5BQ	Nottingham 0115 957 8898 NG2 3JJ	Sunderland 0191 515 4568 SR4 6SN	



[YESSS.CO.UK/YESSS-LIGHTING](https://www.yesss.co.uk/yesss-lighting)

All product detail correct at time of going to press, but may be subject to change without notice. E & OE accepted and subject to T&Cs available on request.