

## HEATING SYSTEM PRODUCTS

Pex Tubing - Technical Specifications.....	4
Heat Exchangers - Water-to-Air .....	5-7
Heat Exchangers - Water-to-Water .....	8-9
Heat Exchangers - Convection .....	10
Piping - ThermoPEX And CentralPEX .....	11-12
Circulators .....	13
Circulators / Manifold .....	14
Manifolds .....	15
Fittings Kits .....	16
Fittings - PEX.....	17
Fittings - Threaded .....	18-19
Fittings - Copper / Sweat .....	20
Fittings - Push-Fit / Sharkbite .....	21
Valves .....	22
Valves - Caleffi.....	23
Valves - Mixing, Etc. ....	24
Thermostats / Aquastats.....	25

## OUTDOOR FURNACE PRODUCTS

Options & Accessories .....	26-28
Water Treatment / Firebox Protection .....	29
Tools.....	30-32
Door & Related .....	33
Gas Related .....	34
Chimney.....	35-36

# Alphabetical Index

24 Fan Conversion Kit - Classic Edge/Classic Edge HD	26	Chimney Support Brace Kit	36
24V Fan Conversion Kit - Classic Edge HDX	26	Chimney Tee Covers	36
Actuator, Thermal	15	Chimney Tee Kits, Stainless Steel	36
Adapter, Female 1" NPT - for Manifold Kits	15	Chimney Tee Restrictor Kit	36
Adapter, Female, 3/4" Hose	19	Cinch Tool	30
Adapter, Female - Copper Pipe	17	Clamp Crimp Ring, PEX Stainless Steel	12
Adapter, Male, 3/4" Hose	19	Clamp Crimp Ring Removal Tool	30
Elbow, PEX 90° - Threaded Pipe	17	Clamp, Hose, 1" or 1-1/4"	12
Elbow, PEX 90° Swoop	17	Clamp, Hose, 25mm	12
Adapter, PEX - Copper Pipe	17	Clamp, PEX, 1"	12
Adapter, PEX - Threaded Pipe	17	Clamp, Rubber	32
Adapters, Female - Copper	20	Cleaning Rod - Classic Edge / E-Classic	31
Adapters, Male - Copper	20	Cleaning Rod - Maxim	31
Elbow, PEX 90°	17	Cleaning Rod Scraper Attachment - Classic Edge / E-Classic	32
Adapters, PEX - Copper Pipe	17	Cleaning Tool, Afterburner	31
Adapters, PEX - Threaded Pipe	17	Cleaning Tool, Heat Exchanger	31
Air Filter	6	Clean Out Kit, Battery - Maxim	28
Air Handler Cabinet	7	Clip, Latch Spring	33
Antenna Mount Kit, External Wi-Fi	26	Conversion Kit, Natural Gas - E-Classic	34
Aquastat, Fixed	25	Cord, Power Supply	14
Aquastat, Immersible - Adjustable	25	Coupling, 25mm PEX	17
Aquastat, Pool	25	Coupling, Brass - 3/4"	19
Aquastat, Strap-on	25	Couplings, 1/2" and 1" PEX	17
Aquastat, Surface Mount - Adjustable	25	Couplings, Copper	20
Ash Rake - Classic	31	Cover, Outer Control	26
Ash Scoop - Maxim	32	Crimp Fittings Adapter Kit, 25mm to 1"	12
Ash Shovel - Classic	31	Crimp Tool, Universal	30
Ash Shovel - E-Classic	31	CS-25 Alkalinity Builder	29
Ash Shovel, Reaction Chamber	31	Decoiler	30
Ashtril	29	DISCAL® Air Separator	23
Auxiliary Auger Kits - Maxim	27	Door Seal Kits - Classic Edge/E-Classic	33
Auxiliary Auger Vibrator w/Timer Kit - Maxim	28	Door Seal Kits - Classic/Pallet Burner	33
Backflow Preventer	24	Door Seal, Silicone-Coated, 100-ft	33
Bag Holder Kit - Maxim	28	Draft Inducer	33
Ball Valve	22	Dual Fuel Burner Kits and Components	34
Ball Valve, PEX	22	Dual Fuel Kits	34
Ball Valve, Sweat	22	Elbow, 45° Street	18
Baseboard, Complete	10	Elbow, 90° - Copper	20
Baseboard Corners	10	Elbow, 90° - FPT	19
Baseboard End Cap	10	Elbow, 90° Reducing - Copper	20
Baseboard Joiner	10	Elbow, 90° Street	19
Blower & Motor	7	Elbow, 90° Street - 1" Copper	20
Brush, Cleaning	32	Elbow, Vent - Copper	20
Bushing, Hex - NPT	18	Fan Coil Unit, 50k Btu	7
Bushing, Reducing - Brass	18	Fan Coil Unit, 100k Btu	7
Bypass Alarm Kit - Classic Edge 750	27	Fan Coil Unit, 220k Btu	7
Caleffi 2-Way Zone Valve, 1" Sweat	23	Fan Convector (26k Btu)	6
Caleffi 2-Way Zone Valve, 3/4" FNPT	23	Fan Convector, Corner (7k Btu)	6
Caleffi 3-Way Thermostatic Mixing Valve, 3/4" NPT	23	Fan Convector, Kickspace	7
Caleffi 3-Way Zone Valve, NPT	23	Fan Convector, Wall Mount (7k Btu)	6
Caleffi 3-Way Zone Valve, Sweat	23	Fin Comb	30
Caleffi Zone Valve Repair Kits	23	FireStar II Wiring Kit	26
Caleffi Zone Valve Switches	23	FireStar XP Outdoor Wi-Fi Module Kit	26
Cap, Copper End	20	Fittings, Brass - for 1-1/4" PEX Pipe	17
Cap - for Manifold Kits	15	Fittings Kit, Domestic Hot Water Plate Exchanger	16
Caps, Round Pipe	18	Fittings Kit, Push-fit - for Water-to-Water Heat Exchanger	16
Cartridge, Water Softener	29	Fittings Kit, Single Pump Crimp	16
Central PEX 1/2" Pipe	11	Fittings Kit, Single Pump Sharkbite®	16
Central PEX 1" Pipe	11	Fittings Kit, Water Heater - for Plate Heat Exchanger	16
Central PEX 1" Pipe Sections	11	Fittings Kit, Water Heater - for Water-to-Water Heat Exchanger	16
Check Valve, Flow	24	Fittings, PEX Brass Clamp	17
Check Valve, Swing - Brass	22	Flange, 3/4" Isolation - with Drain Valve	14
Chimney Attachment Ring	35	Flange, Isolation	14
Chimney Band Clamp Kit, 6"	35	Flange Kits, Pump	14
Chimney Band Clamp Kit, 8"	35	Flue Brush & Handle	31
Chimney Base Brace Kit, 6"	36	Flue Brush & Handle Kit	31
Chimney Base Brace Kit, 8"	36	Gas Burner Kits - E-Classic	34
Chimney Cap/Spark Arrestor	35	Gasket, Ignitor Burner	34
Chimney Cleaning Kit - 6"	31	Gauges, Temperature	15
Chimney Cleaning Kit - 8"	31	Gauge, Temperature - for Manifold Kits	15
Chimney Components	36	Ground Rod Kit	26
Chimney Guy-Wire Band, 6"	35	Heat Exchanger Coil (50k Btu)	5
Chimney Guy-Wire Band Kit, 8"	35	Heat Exchanger Coil (80k Btu)	5
Chimney Rope Ring	36	Heat Exchanger Coil (95k Btu)	5
Chimney Sections, 6" - Edge 350/360 and 550/560, ECL 1450, Forge 1500/3500	35	Heat Exchanger Coil (100k Btu)	5
Chimney Sections, 6" - Maxim	35	Heat Exchanger Coil (125k Btu)	5
Chimney Sections, 8" - Classic	35	Heat Exchanger Coil (140k Btu)	5
Chimney Sections, 8" - Classic Edge 750/760/960, E-Classic	35	Heat Exchanger Coil (185k Btu)	5

# Alphabetical Index

Heat Exchanger Coil (220k Btu) . . . . .	5	Push-fit Fitting - Female Adapter . . . . .	21
Heat Exchanger, Domestic Water Heater, Double Wall, Water-to-Water . . . . .	8	Push-fit Fittings - Coupling, Straight . . . . .	21
Heat Exchanger, Domestic Water Heater, Water-to-Water . . . . .	8	Push-fit Fittings, Elbow . . . . .	21
Heat Exchanger, Plate . . . . .	8	Push-fit Fitting, Tee . . . . .	21
Heat Exchanger, Stainless 316L - for Swimming Pool . . . . .	9	Push-fit Fitting - Temperature Gauge . . . . .	21
Heat Exchanger, Titanium Grade 1 - for Swimming Pool . . . . .	9	Ratchet Cinch Tool . . . . .	30
Hoe, Firebox - Classic . . . . .	31	Reducer, Copper . . . . .	20
Hopper, 48-Bushel Kit - Maxim M175, M250, M255 P . . . . .	27	Regulator Kit, 2-Stage Gas . . . . .	34
Hopper, 48-Bushel Kit w/Auger - Maxim M255 PE . . . . .	27	Relay, 24-Volt . . . . .	25
Hopper Extension Kit - Maxim . . . . .	27	Relay, Fan Center . . . . .	25
Hopper Kit with Fuel Door - M250/M255 P . . . . .	28	Rope, Door Seal . . . . .	33
Hopper Vibrator Kit - Maxim . . . . .	28	Rope, Door Seal and Chimney Transition Box Cover - Maxim . . . . .	33
Hose Bibs, Brass . . . . .	22	Scraper, Heat Exchanger - E-Classic . . . . .	31
Hose Bibs, Brass - Straight . . . . .	22	Scraper Tool . . . . .	31
Hose, SP, Braided . . . . .	11	Sediment Trapper Filter, Hot Water, 3/4" . . . . .	29
Hose w/Regulator, Propane - Maxim . . . . .	34	Sharkbite Elbow . . . . .	21
Ignition Module, Gas . . . . .	34	Shut-off with Level Indicator, Propane - Maxim . . . . .	34
Inline Filter & Valve Assembly . . . . .	8	Sludge Conditioner . . . . .	29
Integrated Cleaning System - Classic Edge . . . . .	32	Solder & Soldering Flux . . . . .	32
LED Light Kit - Classic Edge . . . . .	27	Solenoid . . . . .	33
LED Light Kit, Secondary - Classic Edge . . . . .	27	Space Heater (100k Btu) . . . . .	6
Linkage . . . . .	33	Space Heater (140k Btu) . . . . .	7
Louvers . . . . .	6	Space Heater Cabinet (50k Btu) . . . . .	7
Manifold . . . . .	15	Space Heater, Suspended (100k Btu) . . . . .	6
Manifold Kit Connectors . . . . .	15	Stepper Conversion Kit - Classic Edge . . . . .	27
Manifold Kits . . . . .	15	Suspended Space Heater (220k Btu) . . . . .	6
Manifold w/o Valves . . . . .	15	Taco Switching Relay . . . . .	14, 25
Manifold w/Valves . . . . .	15	Tape, Blue Teflon, 1/2" x 1429" . . . . .	19
Mixing Valve, 4-way FNPT . . . . .	24	Tee, Brass, 3/4" . . . . .	18
MolyArmor 350 Corrosion Inhibitor . . . . .	29	Tee, Brass Diverter . . . . .	20
Moly/pH Single Strip Test Kit . . . . .	29	Tee, Brass Offset, 4" . . . . .	18
Mounting Bracket, Plate Heat Exchanger . . . . .	8	Tee, Brass - PEX . . . . .	17
Mounting Brackets - Swimming Pool Heat Exchangers . . . . .	9	Tee, Purging and Filling - 3/4" . . . . .	22
Mounting Kit, PEX Piping . . . . .	12	Tee, Reducing - Copper . . . . .	20
Mounting Kit, Plate Heat Exchanger . . . . .	8	Tees, Copper . . . . .	20
Mounting Kit, Plate Heat Exchanger, 5x12, Universal . . . . .	8	Tees, NPT . . . . .	18
Mount Kit, Wall - Pump . . . . .	14	ThermoPEX Coupling Kit - 1" and 1-1/4" . . . . .	11
Multimeter, Digital Pocket . . . . .	30	ThermoPEX Coupling Kit - 25mm . . . . .	11
Myson Replacement Items . . . . .	7	ThermoPEX Termination Cap . . . . .	11
Nipple, Black Close . . . . .	18	ThermoPEX with 1" or 1-1/4" PEX . . . . .	11
Nipple, Black - MPT . . . . .	18	ThermoPEX with 25mm PEX . . . . .	11
Nipple, Brass . . . . .	18	Thermostat Kit . . . . .	24
Nipple, Brass Close . . . . .	18	Thermostat, Line Voltage . . . . .	25
O-Ring Set . . . . .	14	Thermostat, Multi-stage - 24-Volt . . . . .	25
PEX 1-1/4" Pipe . . . . .	11	Thermostat, Plug-in . . . . .	25
PEX Crimp Rings / Crimp Tools . . . . .	12	Thermostat, Programmable - 24-Volt . . . . .	25
PEX Hanger . . . . .	12	Thermostat, Single-stage, Non-programmable - 24-Volt . . . . .	25
PEX Pipe Cutter . . . . .	30	Torch, Outdoor . . . . .	30
PEX Piping Clip Gun . . . . .	30	Transfer Auger with Fuel Door Assembly Kit - M175 . . . . .	28
PEX Piping Clips . . . . .	12	Transformer, 24-Volt . . . . .	25
Pin Extraction Tool . . . . .	30	Union, Brass Pipe - FIP . . . . .	18
Plug, 1/2" PEX . . . . .	17	Valve, 3-Way . . . . .	22
Plug, 1" PEX . . . . .	17	Valve Bodies, Thermostatic Radiator . . . . .	10
Plug, Pipe - MPT . . . . .	18	Valve, Gas Burner . . . . .	34
Plug, Pipe - Wrench Set . . . . .	30	Valve Head, TRV II . . . . .	10
Pump, Grundfos . . . . .	13	Valve, Radiant Mixing . . . . .	24
Pump Panel Extension Kit - Classic Edge 350/550 HD, Classic Edge 360/560 HDX . . . . .	26	Valve, Tempering . . . . .	24
Pump, Taco - 006 Series . . . . .	13	Valve, Water Heater Mixing, Caleffi . . . . .	23
Pump, Taco - 007 Series . . . . .	13	Valve, Water Heater Mixing, Taco . . . . .	24
Pump, Taco - 009 & 014 Series . . . . .	13	Vent Valve, Automatic . . . . .	24
Pump, Taco - 0015e3™ . . . . .	14	Water Sample Bottle Kit . . . . .	29
Pump, Taco - Viridian, VR1816 . . . . .	13	Water Temperature Indicator Kit, Indoor . . . . .	26
Pump, Taco - Viridian VT2218 . . . . .	13	Water Test Kit . . . . .	29
Push-fit - Depth Gauge/Deburring Tool . . . . .	21	Wood Moisture Meter, Mini 3-in-1 . . . . .	30
Push-fit - Disconnect Clip . . . . .	21	Y-Strainer . . . . .	8
Push-fit Fitting - Adapter, Male . . . . .	21	Zone Valve, 3-Way - 24-Volt . . . . .	22
Push-fit Fitting - Connector, Straight . . . . .	21	Zone Valve - Repair Kits . . . . .	22
Push-fit Fitting - Coupling, Reducing . . . . .	21	Zone Valves, Zone Sentry . . . . .	22

# Pex Tubing

## TECHNICAL SPECIFICATIONS

### PEX Tubing Technical Specifications

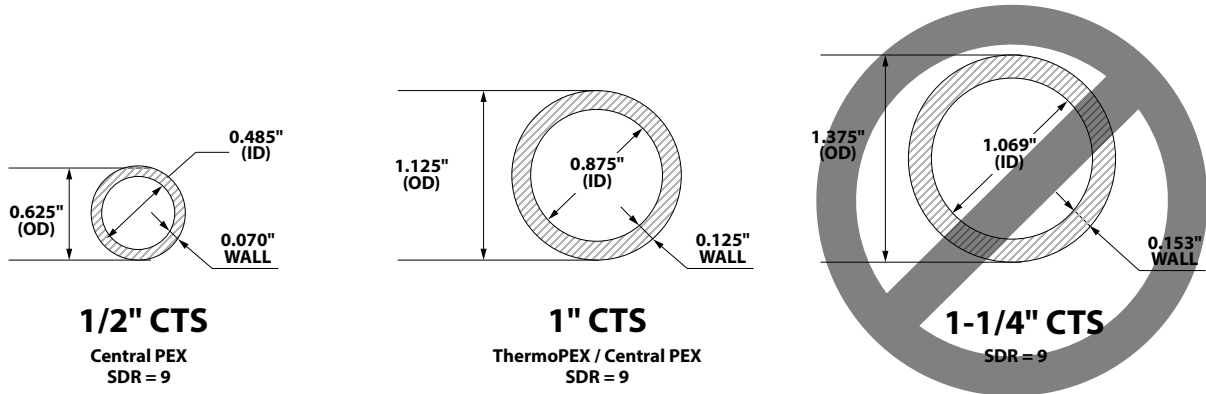

PEX Tubing Size (CTS/Nominal)	Outside Diamer (OD)	Minimum Wall Thickness	Inside Diameter (ID)
1/2"	0.625"	0.070"	0.485"
1"	1.125"	0.125"	0.875
1-1/4"	1.375"	0.153"	1.069"

**Notes:**

1. PEX tubing sizes are denoted by CTS (copper tubing size), not OD (Outside Diameter) or ID (Inside Diameter).
2. OD of PEX, copper and CPVC pipe with the same size (CTS) is the same. This is why push fittings can be used with all of these pipes.
3. PEX made to US standards must comply with a SDR-9 (Standard Dimension Ratio), which is the ratio of OD (Outside Diameter) to pipe wall thickness (9:1). Exceptions are nominal sizes 1/2" and below.

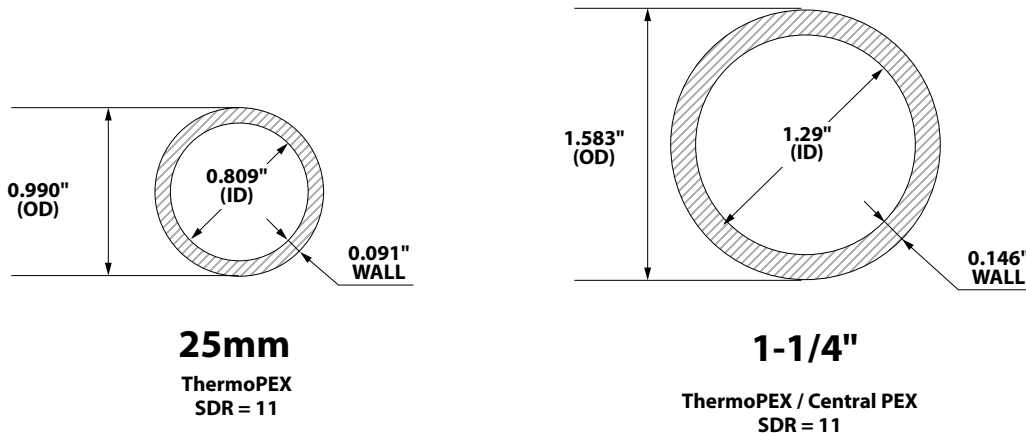

PEX Tubing Size (Nominal)	Outside Diamer (OD)	Minimum Wall Thickness	Inside Diameter (ID)
25mm	0.990"	0.091"	0.809"
1-1/4"	1.583"	0.146"	1.29"

**Notes:**

1. PEX with a SDR-11 (Standard Dimension Ratio) are NOT compatible with CTS (copper tubing size) fittings.
2. 25mm PEX and 1-1/4" PEX used in ThermoPEX are SDR-11 (Standard Dimension Ratio), which is the ratio of OD (Outside Diameter) to pipe wall thickness (11:1).

# Heating System

## HEAT EXCHANGERS - WATER-TO-AIR

Water-to-air heat exchanger coils are available in different sizes with different Btu outputs. Be sure to check the dimensions of the coil and the approximate plenum size, in addition to the outlet configuration.

p/n	Output (Btu)	Approx. Plenum Size (in.)	Dimensions			3/4" FPT Outlets
			Length (in.)	Width (in.)	Depth (in.)	
287	50,000	13 x 14	14	12-3/4	4-1/8	90°
109	80,000	13 x 18	18	12-3/4	4-1/8	Straight
102	95,000	15 x 18	20	15	4-1/8	Straight
106	100,000	17 x 18	19	16-1/2	4-1/8	Straight
107	125,000	18 x 18 to 18 x 20	20	17-3/4	4-1/8	Straight
704	125,000	18 x 18 to 18 x 20	20	17-3/4	4-1/8	90°
108	140,000	20 x 20	21	19	4-1/8	Straight
110	185,000	23 x 23	24	22-3/4	4-1/8	Straight
111	220,000	24 x 24	26	24	4-1/8	Straight

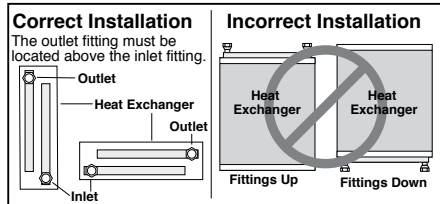

### Heat Exchanger Coil (50k Btu)

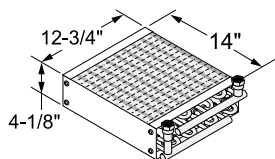

Water-to-air heat exchanger coil with 90° 3/4" female pipe thread (FPT) outlets. Dimensions: 12-3/4" x 14" x 4-1/8".

p/n 287 Description Heat Exchanger Coil, 50k Btu

### Heat Exchanger Coil (100k Btu)

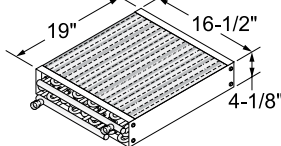

Water-to-air heat exchanger coil with straight 3/4" FPT outlets. Used in forced-air furnaces with plenum size of approximately 17" x 18". Dimensions: 16-1/2" x 19" x 4-1/8".

p/n 106 Description Heat Exchanger Coil, 100k Btu

### Heat Exchanger Coil (140k Btu)

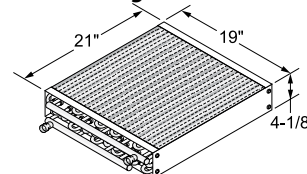

Water-to-air heat exchanger coil with straight 3/4" FPT outlets. Used in forced-air furnaces with plenum size of approximately 20" x 20". Dimensions: 19" x 21" x 4-1/8".

p/n 108 Description Heat Exchanger Coil, 140k Btu

### Heat Exchanger Coil (80k Btu)

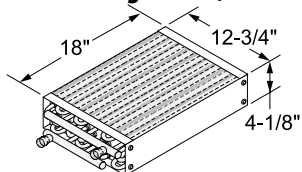

Water-to-air heat exchanger coil with straight 3/4" FPT outlets. Used in forced-air furnaces with plenum size of approximately 13" x 18". Dimensions: 12-3/4" x 18" x 4-1/8".

p/n 109 Description Heat Exchanger Coil, 80k Btu

### Heat Exchanger Coil (125k Btu)

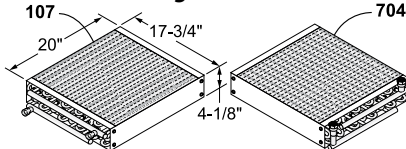

Water-to-air heat exchanger coil with straight (p/n 107) or 90-degree (p/n 704) 3/4" FPT outlets. Used in forced-air furnaces with plenum size from approximately 18" x 18" to 18" x 20". Dimensions: 17-3/4" x 20" x 4-1/8".

p/n 107 Description Heat Exchanger Coil, 125k Btu, straight outlets  
p/n 704 Description Heat Exchanger Coil, 125k Btu, 90° outlets

### Heat Exchanger Coil (185k Btu)

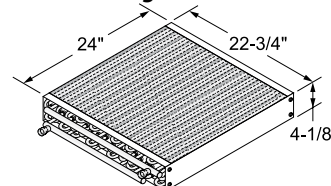

Water-to-air heat exchanger coil with straight 3/4" FPT outlets. Used in forced-air furnaces with plenum size of approximately 23" x 23". Dimensions: 22-3/4" x 24" x 4-1/8".

p/n 110 Description Heat Exchanger Coil, 185k Btu

### Heat Exchanger Coil (95k Btu)

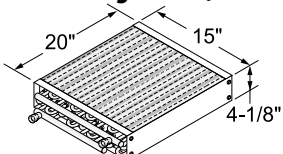

Water-to-air heat exchanger coils with straight 3/4" FPT outlets. Used in forced-air furnaces with plenum size of approximately 15" x 18". Dimensions: 15" x 20" x 4-1/8".

p/n 102 Description Heat Exchanger Coil, 95k Btu

### Heat Exchanger Coil (220k Btu)

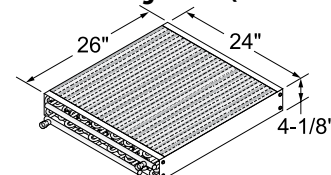

Water-to-air heat exchanger coil with straight 3/4" FPT outlets. Used in forced-air furnaces with plenum size of approximately 24" x 24". Dimensions: 24" x 26" x 4-1/8".

p/n 111 Description Heat Exchanger Coil, 220k Btu

**IMPORTANT INFORMATION ABOUT BTU RATINGS:**

Btu outputs and ranges are provided for comparison only. Actual Btu output will vary depending on a number of factors such as flow gpm, airflow cfm and water and air temperatures. Btu ratings assume high input factors and may not be achieved in actual installations and/or configurations with lower input factors.

# Heating System

## HEAT EXCHANGERS - WATER-TO-AIR

### Space Heater, Suspended (100k Btu)

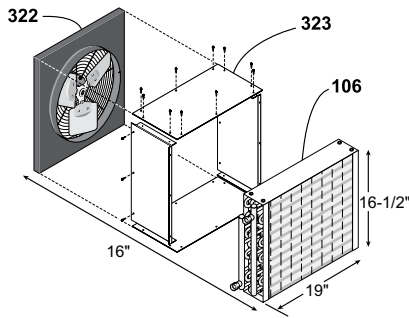

Order the following components for a complete Suspended Space Heater (100k Btu). Some assembly required. Assembled size approximately 19" x 16-1/2" x 16". Allow at least 6" on side for fittings.

p/n	Description
322	Fan
323	Transition
106	Heat Exchanger Coil, 100k Btu

### Suspended Space Heater (220k Btu)

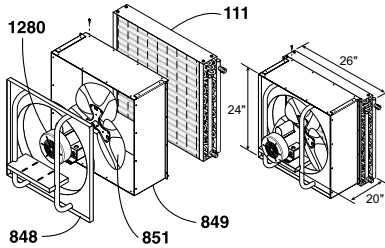

Order the following components for a complete Suspended Space Heater (220k Btu). Some assembly required. Assembled size approximately 26" x 24" x 20". Allow at least 6" on side for fittings.

p/n	Description
111	Heat Exchanger Coil, 220k Btu
849	Transition
848	Motor Frame
851	Fan Blades
1280	Fan Motor

### Louvers

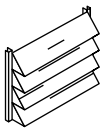

Bolt on to the face of the heat exchanger to direct heat downward.

p/n	Description
355	Louvers, fit Heat Exchanger Coil (p/n 106)
354	Louvers, fit Heat Exchanger Coil (p/n 108)
353	Louvers, fit Heat Exchanger Coil (p/n 111)

### Fan Convector (26k Btu)

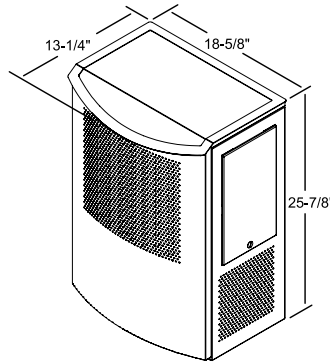

Central Boiler fan-forced convector. Quiet operation, integral filters and thermostat connections. 3/4" FPT fittings and on-off-thermostat switch. Output up to 26,000 Btu/hr. Color - taupe. 24-Volt Thermostat (p/n 588 or 8200008) is optional.

p/n	Description
1971	Fan Convector, 26k Btu
588	Programmable 24-Volt Thermostat
8200008	Non-programmable 24-Volt Thermostat
956	Elbow, 90-degree, 3/4" x 3/4" FPT (optional)

#### Replacement Components

343	Snap Disc
342	Switch, ON/OFF
2500703	Replacement Convector Fan Kit
340	Relay
2500010	Transformer
1949	Grab Catch

### Fan Convector, Wall Mount (7k Btu)

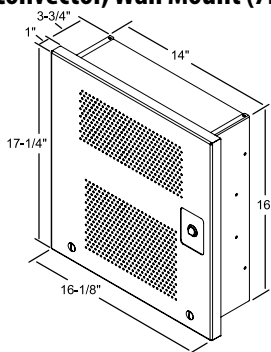

Central Boiler recessed wall, fan-forced convector. Quiet operation, integral filters and thermostat connections. Can use Female Adapter (p/n 6679) or Push-fit Fitting (p/n 606) for connection. 1/2" fittings and on-off-thermostat switch. Output up to 7,000 Btu/hr. 24-Volt Thermostat (p/n 588 or 8200008) is optional.

p/n	Description
1941	Fan Convector, Wall Mount, 7k Btu
588	Programmable 24-Volt Thermostat
8200008	Non-programmable 24-Volt Thermostat

#### Replacement Components

343	Snap Disc
342	Switch, ON/OFF
1940	Fan Motor
340	Relay
2500010	Transformer

### Fan Convector, Corner (7k Btu)

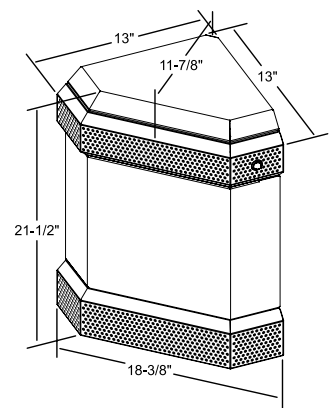

Central Boiler fan-forced convector. Quiet operation, integral filters and thermostat connections. Can use Female Adapter (p/n 6679) or Push-fit Fitting (p/n 606) for connection. 1/2" fittings and on-off-thermostat switch. Output up to 7,000 Btu/hr. 24-Volt Thermostat (p/n 588 or 8200008) is optional.

p/n	Description
1910	Fan Convector, Corner, 7k Btu
588	Programmable 24-Volt Thermostat
8200008	Non-programmable 24-Volt Thermostat

#### Replacement Components

343	Snap Disc
342	Switch, ON/OFF
1940	Fan Motor
340	Relay
2500010	Transformer

### Air Filter

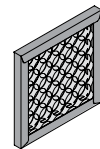

Replacement air filter (10" x 10" x 1") for fan-forced convectors. 1971 convector requires 2 filters; 1910 and 1941 convectors require 1.

p/n	Description
1938	Air Filter, 10" x 10" x 1"

### Space Heater (100k Btu)

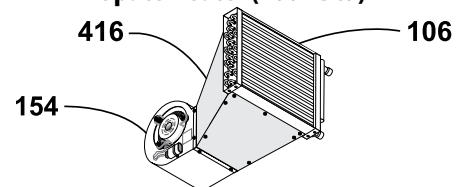

Order the following components for a Space Heater (100k Btu). Some assembly required. Assembled size approximately 19" x 21" x 33".

p/n	Description
416	Transition
154	Blower & Motor, 1/4-hp 3-speed fan
106	Heat Exchanger Coil, 100k Btu

# Heating System

## HEAT EXCHANGERS - WATER-TO-AIR

### Space Heater (140k Btu)

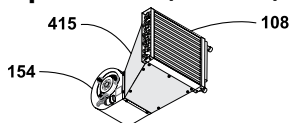

Order the following components for a Space Heater (140k Btu). Some assembly required. Assembled size approximately 19" x 21" x 33".

p/n	Description
415	Transition
154	Blower & Motor, 1/4-hp 3-speed fan
108	Heat Exchanger Coil, 140k Btu

### Space Heater Cabinet (50k Btu)

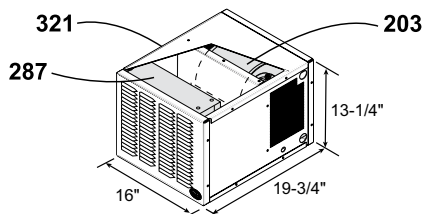

Cabinet for housing 1/15-hp Blower & Motor (p/n 203) and 50k Btu Heat Exchanger Coil (p/n 287). Each sold separately. Some assembly required. Dimensions: 16" x 19-3/4" x 13-1/4".

p/n	Description
321	Space Heater Cabinet

### Blower & Motor

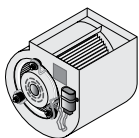

Blower & Motor assemblies.

p/n	Description
203	Blower & Motor, 1/15-hp
154	Blower & Motor, 1/4-hp, 3-speed fan
208	Blower & Motor, 1-hp, 3-speed fan

p/n 203 1/15 hp 115V	CFM (cubic feet per minute)							
	FREE AIR	1/8" SP	1/4" SP	3/8" SP	1/2" SP	3/4" SP	1" SP	1 1/2" SP
1530 rpm (1-speed)	465	430	397	357	308	N/A	N/A	N/A

p/n 154 1/4 hp 115V	CFM (cubic feet per minute)				
	FREE AIR	1/4" SP	1/2" SP	3/4" SP	1" SP
LOW speed	708	808	800	593	194
MED. speed	963	1063	1020	708	224
HIGH speed	1353	1349	1287	1014	250

p/n 208 1 hp 115V	CFM (cubic feet per minute)					
	1.2" SP	1.3" SP	1.4" SP	1.5" SP	1.6" SP	1.7" SP
LOW speed (1038 rpm)	2248	2143	2032	1890	1085	1498
MED. speed (1070 rpm)	2480	2373	2218	2084	1910	1696
HIGH speed (1097 rpm)	2701	2522	2373	2231	2057	1851

SP=static pressure, hp=horsepower

### Fan Coil Unit, 50k Btu

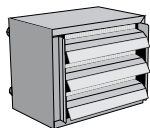

50k Btu fan coil unit (3/4" FIP) includes housing, fan, heat exchanger coil and louvers. Btu range: 20k-50k Btu. Approximate dimensions: 16-1/4" x 17" x 13-1/4". Motor: 70 watts. Approximately 588 cfm.

p/n	Description
2900544	Fan Coil Unit, 50k Btu
2900610	Replacement Fan, motor and shield, 50k Btu, for 29000544

### Fan Coil Unit, 100k Btu

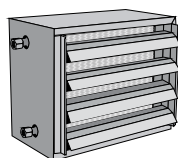

100k Btu fan coil unit (3/4" FIP) includes housing, fan, heat exchanger coil and louvers. Btu range: 40k-100k Btu. Approximate dimensions: 21" x 19" x 17". Motor: 180 watts. Approximately 1,352 cfm.

p/n	Description
2900545	Fan Coil Unit, 100k Btu
2900611	Replacement Fan, motor and shield, 100k Btu, for 29000545

### Fan Coil Unit, 220k Btu

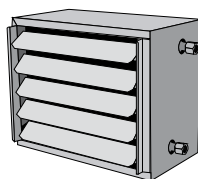

220k Btu fan coil unit (3/4" FIP) includes housing, fan, heat exchanger coil and louvers. Btu range: 80k-220k Btu. Approximate dimensions: 31" x 18" x 25". Motor: 330 watts. Approximately 2,823 cfm.

p/n	Description
2900546	Fan Coil Unit, 220k Btu
2900612	Replacement Fan, motor and shield, 220k Btu, for 29000546

### Air Handler Cabinet

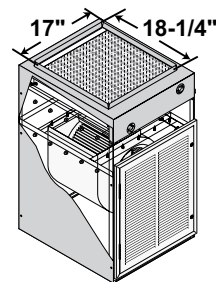

Two sizes allow multiple applications from 100k Btu to 220k Btu; cabinets are standard with front water access (refer to the chart below for specific applications).

**NOTE:** Blower & Motor and Heat Exchanger Coil are sold separately. Air Handler Cabinet door is capable of holding a filter (not included). Some assembly will be required. If utilizing an existing 24-volt thermostat to control blower, a Fan Center Relay (p/n 515) must be used.

p/n	Dimensions (in.)	Heat Exch. Coil Range	Blower & Motor	Water Access
301	36 x 20 x 23	100k-140k Btu	1/4-hp	Front
		Filter (not included): 16 x 20		
303	39 x 25 x 28	185k-220k Btu	1-hp	Front
		Filter (not included): 20 x 20		

p/n	Description
301	Air Handler Cabinet, 100k-140k Btu, front access
3822	Kit for 301 - back water access
303	Air Handler Cabinet, 185k-220k Btu, front access
3825	Kit for 303 - back water access

### Fan Convector, Kickspace

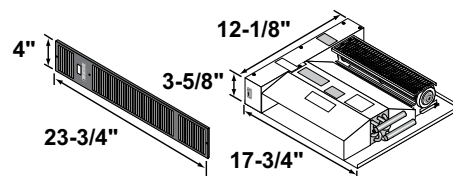

Myson Whispa™ III Kickspace 9000 fan-forced convector, output of 7,634-9,949 Btu/hr. Dimensions: 17-3/4" x 12-1/8" x 3-5/8". Weight: 15 lb. Fan speed (cfm): boost - 124, normal - 82. Cover grill is 4" x 23-3/4".

p/n	Description
5600000	Myson Whispa III Kickspace 9000 Fan Convector

### Myson Replacement Items

Replacement items for Myson fan convectors not listed here.

p/n	Description
211	Fan/Motor Assembly for 6771

# Heating System

## HEAT EXCHANGERS - WATER-TO-WATER

### Heat Exchanger, Plate

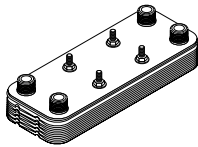

The Plate Heat Exchanger is a compact, high-performance, water-to-water, continuous flow heat exchanger with MPT ports. Units are 316L stainless, copper-brazed. For p/n 0020-051, no mounting studs are included but Mounting Bracket (p/n 1097) can be used.

p/n	Typical Application
5600003	Water heaters
0020-051	Water heaters
5744	Boilers up to 100k Btu
5600001	Boilers 100k-175k Btu
5600002	Boilers 175k-250k Btu
5600019	Applications up to 760k Btu

**p/n Description**

5600003 Plate Exchanger, 5 x 12-6, 3/4" Port  
 0020-051 Plate Exchanger, 4.57 x 11.26-20, 1" Port  
 5744 Plate Exchanger, 5 x 12-30, 1" Port  
 5600001 Plate Exchanger, 5 x 12-50, 1-1/4" Port  
 5600002 Plate Exchanger, 5 x 12-70, 1-1/4" Port  
 5600019 Plate Exchanger, 10 x 20-55, 1-1/4" Port

NOTE: Also see Swimming Pool Heat Exchangers (p/n 5600005 through 5600015).

### Y-Strainer

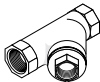

Y-Strainer with 0.20 mesh and FIP fittings. Recommended when installing plate-style heat exchangers. For 3/4" Y-Strainer, use 1/2" Brass Pipe Plug (p/n 6557) for cleanout port. For 1" Y-Strainer, use 3/4" Brass Pipe Plug (p/n 574) for cleanout port.

**p/n Description**

1695 Y-Strainer, 3/4" Brass  
 573 Y-Strainer, 1" Brass  
 1694 Y-Strainer, 1-1/4" Black

### Inline Filter & Valve Assembly

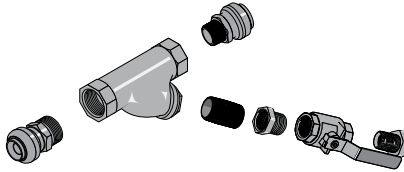

Fill valve and inline strainer with Sharkbite® 1" MPT fittings.

**p/n Description**  
 2500704 Inline Filter & Valve Assembly

### Mounting Bracket, Plate Heat Exchanger



Mounts most 5" x 12" Plate Heat Exchangers (30 or less) with mounting studs to a wall or similar surface.

**p/n Description**  
 5807-011 Plate Mounting Bracket

### Mounting Kit, Plate Heat Exchanger

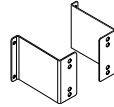

Mounts most 5x12 Plate Heat Exchangers (40 or more) with mounting studs to a wall or similar surface. Includes two mounting brackets.

**p/n Description**  
 2500299 Heat Exchanger Mounting Kit

### Mounting Kit, Plate Heat Exchanger, 5x12, Universal

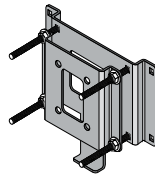

Universal mounting kit for 5x12 plate exchangers.

**p/n Description**  
 1097 Universal 5x12 Plate Heat Exchanger Mounting Kit

### Heat Exchanger, Domestic Water Heater, Water-to-Water

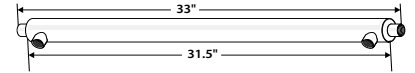

The Water-to-Water Heat Exchanger is a stainless steel water-to-water, domestic water heat exchanger with 3/4" FIP end and side ports. Install on existing water heater for thermal circulating heat transfer. Fittings Kit (p/n 2053) or Push-fit Fittings Kit (9263) are available separately for easy installation.

**NOTE: The 5600018 Heat Exchanger replaces the 591 Exchanger.**

**p/n Description**  
 5600018 Water-to-Water Heat Exchanger, 33"

### Heat Exchanger, Domestic Water Heater, Double Wall, Water-to-Water

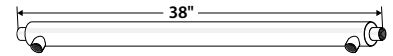

The water-to-water double wall heat exchanger is a stainless steel water-to-water, domestic water heat exchanger with 3/4" FIP end ports and side ports. Features a spiral turbulation design. Install on existing water heater for thermal circulating heat transfer.

**p/n Description**  
 5600017 Double Wall Water-to-Water Heat Exchanger



# Heating System

## HEAT EXCHANGERS - WATER-TO-WATER

### Heat Exchanger, Stainless 316L - for Swimming Pool

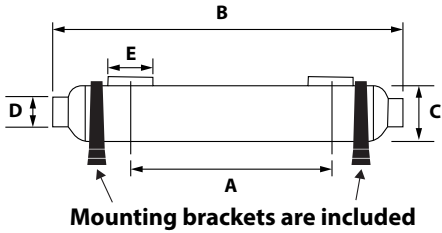

Stainless steel exchangers are used as hot tub or swimming pool heat exchangers. Other applications include snow melt or solar heating. **Not recommended for use with salt chlorinated pools or hot tubs.**

**Mounting brackets are included** for horizontal or vertical mounting. Should always be installed with the mounting bracket fixed to a wall, ceiling or floor to prevent damage from vibrations or water hammer.

p/n	Btu Rating	Pool Capacity (U.S. gallons)
5600005	55,000	3,960
5600006	155,000	11,900
5600007	300,000	23,800
5600008	360,000	29,000
5600009	600,000	47,500
5600010	1,200,000	95,100

#### Exchanger Dimensions

p/n	A (in.)	B (in.)	C (in.)	D (in.)	E (in.)
5600005	7.6	13.3	2.5	1	3/4
5600006	9.2	15.9	3.1	1	1-1/2
5600007	20.5	27.6	3.1	1-1/2	2
5600008	28	35	3.1	1-1/2	2
5600009	25.4	33.9	4.3	2	2-1/2
5600010	25.9	35.2	5	2	2-1/2

p/n	Description
5600005	Pool Heat Exchanger, 316L, 55k Btu
5600006	Pool Heat Exchanger, 316L, 155k Btu
5600007	Pool Heat Exchanger, 316L, 300k Btu
5600008	Pool Heat Exchanger, 316L, 360k Btu
5600009	Pool Heat Exchanger, 316L, 600k Btu
5600010	Pool Heat Exchanger, 316L, 1200k Btu

### Heat Exchanger, Titanium Grade 1 - for Swimming Pool

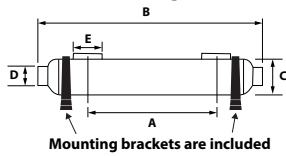

Titanium heat exchangers are ideal for swimming pools with salt water or where salt generator/chlorinators are used.

**Mounting brackets are included** for horizontal or vertical mounting. Should always be installed with the mounting bracket fixed to a wall, ceiling or floor to prevent damage from vibrations or water hammer.

p/n	Btu Rating	Pool Capacity (U.S. gallons)
5600011	55,000	3,960
5600012	155,000	11,900
5600013	300,000	23,800
5600014	360,000	29,000
5600015	600,000	47,500

#### Exchanger Dimensions

p/n	A (in.)	B (in.)	C (in.)	D (in.)	E (in.)
5600011	7.6	13.3	2.5	1	3/4
5600012	9.2	15.9	3.1	1	1-1/2
5600013	20.5	27.6	3.1	1-1/2	2
5600014	28	35	3.1	1-1/2	2
5600015	25.4	33.9	4.3	2	2-1/2

p/n	Description
5600011	Pool Heat Exchanger, Titanium Grade 1, 55k Btu
5600012	Pool Heat Exchanger, Titanium Grade 1, 155k Btu
5600013	Pool Heat Exchanger, Titanium Grade 1, 300k Btu
5600014	Pool Heat Exchanger, Titanium Grade 1, 360k Btu
5600015	Pool Heat Exchanger, Titanium Grade 1, 600k Btu

### Mounting Brackets - Swimming Pool Heat Exchangers



Replacement mounting brackets for Stainless 316L and Titanium Swimming Pool Heat Exchangers.

p/n	Description
3104665	Mounting Bracket, 55k Btu Pool Heat Exchangers
3104940	Mounting Bracket, 155k/300k/360k Btu Pool Heat Exchangers
3104941	Mounting Bracket, 600k Btu Pool Heat Exchangers
3104942	Mounting Bracket, 1200k Btu Pool Heat Exchangers

# Heating System

## HEAT EXCHANGERS - CONVECTION

### Valve Bodies, Thermostatic Radiator

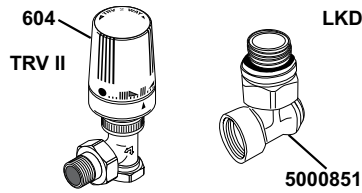

The valve body is threaded for nominal iron pipe threads and includes a compression nut and ferrule. Replacement head only is part number 5000378.

p/n	Description
604	TRV II Valve Body and Head, 1/2" Vertical
5000851	LKD Valve, 1/2" Preset Flow Rate

### Valve Head, TRV II



Replacement valve head for 604 TRV II Valve Body and Head, 1/2" vertical.

p/n	Description
5000378	Valve Head, 1/2" Vertical, TRV II

### Baseboard, Complete

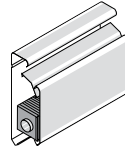

Each baseboard includes heating element and cover. Rated 610 Btu/ft at 180°F water temperature. Flow rate of 4 gal/min, 3/4" copper sweat fittings. End caps, joiners and corners sold separately.

p/n	Description
234	Baseboard, Complete, 2'
235	Baseboard, Complete, 3'
236	Baseboard, Complete, 4'
237	Baseboard, Complete, 5'
238	Baseboard, Complete, 6'

### Baseboard End Cap

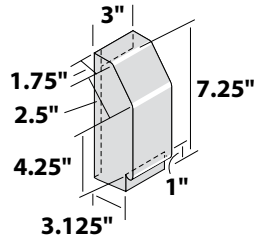

Left or right Baseboard End Caps for radiant baseboard water heater.

p/n	Description
232	Baseboard End Cap, Left
233	Baseboard End Cap, Right

### Baseboard Corners

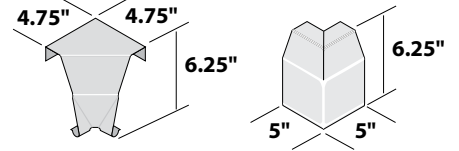

Inside and outside Baseboard Corner covers for radiant baseboard water heater.

p/n	Description
182	Baseboard Corner, Inside
183	Baseboard Corner, Outside

### Baseboard Joiner

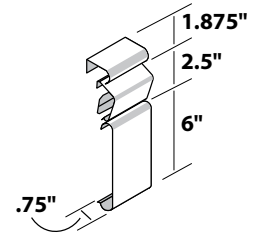

Used to cover joints in continuous lengths of baseboard.

p/n	Description
230	Baseboard Joiner

# Heating System

## PIPING - THERMOPEX AND CENTRALPEX

### ThermoPEX with 1" or 1-1/4" PEX



ThermoPEX is flexible pre-insulated piping consisting of two waterproof oxygen barrier PEX-A lines (supply and return) protected by polyurethane closed cell foam insulation and a thick, durable, waterproof polyethylene outer jacket. It is the ideal insulated piping for use with outdoor wood furnaces. The outside diameter of 1" ThermoPEX is 4-3/8"; 1-1/4" ThermoPEX has an outside diameter of 5".

Available with 1" Central PEX in 100-ft, 200-ft or 800-ft rolls, or with 1-1/4" PEX in 100-ft or 300-ft rolls.

p/n	Description
2441	ThermoPEX, 1", 100' Roll
5700034	ThermoPEX, 1", 200' Roll
2491	ThermoPEX, 1", 800' Roll
2799	ThermoPEX, 1-1/4", 100' Roll
2492	ThermoPEX, 1-1/4", 300' Roll

### ThermoPEX Coupling Kit - 1" and 1-1/4"

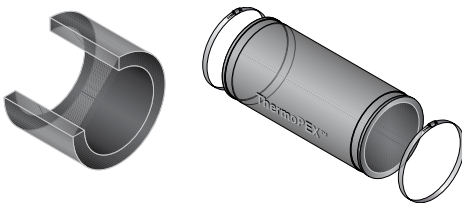

Twelve-inch rubber splice is used to join two ends of ThermoPEX together. Includes band clamps. Fittings and crimp rings for joining the PEX lines are sold separately.

p/n	Description
2447	ThermoPEX Coupling Kit, 1"
2495	ThermoPEX Coupling Kit, 1-1/4"
1333	PEX Coupling, 1"
381	Brass Coupling, 1-1/4" barb x 1-1/4" barb

### ThermoPEX with 25mm PEX



ThermoPEX with two 25mm waterproof oxygen barrier PEX-A lines (supply and return) is more flexible and easier to haul and ship. It's ideal for shorter runs and for the do-it-yourselfers. The outside diameter of 25mm ThermoPEX is 2-15/16".

The 55' roll (p/n 5700047) is UPS or Spee-Dee shippable.

The 95' roll (p/n 5700046) can be shipped via Spee-Dee.

p/n	Description
5700047	ThermoPEX, 25mm, 55' Roll
5700043	ThermoPEX, 25mm, 60' Roll
5700046	ThermoPEX, 25mm, 95' Roll
5700045	ThermoPEX, 25mm, 500' Roll

### ThermoPEX Coupling Kit - 25mm

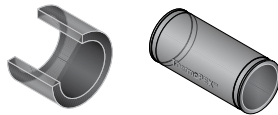

Twelve-inch rubber splice is used to join two ends of ThermoPEX together. Includes band clamps. Fittings and crimp rings for joining the PEX lines are sold separately.

p/n	Description
2500172	ThermoPEX Coupling Kit, 25mm

### ThermoPEX Termination Cap



Fits snugly over each end to protect and seal the insulation from water. Includes band clamps.

p/n	Description
5500014	ThermoPEX Cap, 25mm
2443	ThermoPEX Cap, 1"
2494	ThermoPEX Cap, 1-1/4"

### Hose, SP, Braided



For making flexible connections on the furnace.

p/n	Description
2900410	SP Hose, Braided, 3/4" x 18"
2900411	SP Hose, Braided, 3/4" x 24"

### Central PEX 1/2" Pipe



High-density, oxygen barrier PEX-B, cross-link pipe. Rated for temperatures to 180°F at 100 psi. Available in rolls up to 1000 ft long. Excellent for radiant floor heating applications.

p/n	Description
1320	Central PEX 1/2" Pipe, 300'
1321	Central PEX 1/2" Pipe, 500'
1322	Central PEX 1/2" Pipe, 1000'

### Central PEX 1" Pipe



High-density, non-oxygen barrier PEX-B, cross-link pipe, rated for temperatures to 180°F at 100 psi. Note that color has changed from green to red.

p/n	Description
1311	Central PEX 1" Pipe, 100'
1312	Central PEX 1" Pipe, 200'
1313	Central PEX 1" Pipe, 300'
1314	Central PEX 1" Pipe, 500'

### Central PEX 1" Pipe Sections

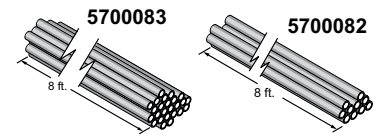

Central PEX 1" Pipe, non-oxygen barrier PEX-B, in straight 8-ft sections.

**Both can ship via UPS or truck.**

p/n	Description
5700082	Central PEX 1" Pipe, 8' straight section, 10 per bag
5700083	Central PEX 1" Pipe, 8' straight section, 25 per bag

### PEX 1-1/4" Pipe



High-density, oxygen barrier PEX-A, cross-link pipe, rated for 180°F.

p/n	Description
5670	PEX 1-1/4" Pipe, 150'
386	PEX 1-1/4" Pipe, 328'

# Heating System

## PIPING - THERMOPEX AND CENTRALPEX

### Clamp, Hose, 1" or 1-1/4"



1", or 1-1/4" stainless steel hose clamp.

p/n	Description
5978	Central Boiler Clamp, 1"
1745	Central Boiler Clamp, 1-1/4"

### Clamp, Hose, 25mm



25mm stainless steel hose clamp.

p/n	Description
5000638	PEX Stainless Steel Hose Clamp, 25mm

### Clamp, PEX, 1"



1" Stainless Steel PEX Clamps are excellent alternatives to the 5978 1" Stainless Steel Hose Clamps.

p/n	Description
5000380	1" Stainless Steel PEX Clamp

### Crimp Fittings Adapter Kit, 25mm to 1"

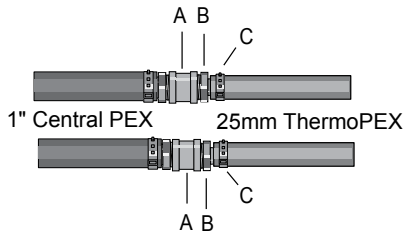

2	A	Female Coupler, Brass, 3/4" FPT
4	B	PEX Male Adapter, 25mm x 3/4" MIP
4	C	PEX Clamp Crimp Ring, 25mm

PEX adapter kit for coupling 25mm ThermoPEX tubing to 1" Central PEX with crimp fittings. Crimp fittings included shown in illustration.

p/n	Description
2500814	Crimp Fittings Adapter Kit, 25mm to 1" PEX

### PEX Crimp Rings / Crimp Tools



PEX Crimp Ring for PEX pipe. Crimp Tool (p/n 145) required for 1" crimp ring.

p/n	Description
1342	PEX Crimp Ring, 1/2"
1335	PEX Crimp Ring, 1"
145	Crimp Ring Tool, 1"

### Clamp Crimp Ring, PEX Stainless Steel



For use with Central PEX pipe. Install with Cinch Tool (p/n 5925) or Ratchet Cinch Tool (p/n 4472).

p/n	Description
5000465	PEX Stainless Steel Clamp Crimp Ring, 25mm

5927	PEX Stainless Steel Clamp Crimp Ring, 1/2"
5926	PEX Stainless Steel Clamp Crimp Ring, 1"

### Mounting Kit, PEX Piping

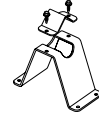

Used to secure 1" PEX and copper pipe. Includes base, top bracket and two screws.

p/n	Description
1360	PEX Piping Mounting Kit

### PEX Piping Clips

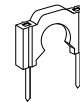

Clips used in PEX Piping Clip Gun (p/n 2900002). Qty. 100.

p/n	Description
2900003	PEX Piping Clips, 100 qty.

### PEX Hanger

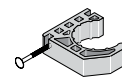

Half-moon, nail-in PEX Hanger for securing PEX piping. Available in two sizes.

p/n	Description
293	PEX Hanger, 1/2"
295	PEX Hanger, 1"

## Pump, Grundfos



Grundfos UPMS is a high-efficiency ECM variable-speed circulator that can be used as an integrated circulator pump in systems designed for a wide variety of heating applications. The pump features robust startup, self-venting ability and dry-running protection leading to fewer callbacks after installation.

- Speed-controlled, high-efficiency pump fitted with electronically commutated motor (ECM) with permanent magnet rotor and frequency converter.
- Next generation ECM pump designed to integrate with heat sources for better system efficiencies.
- Intuitive user interface.
- Three settings for constant curve.

	Max. Amp	Watt	Max. Shutoff Head (ft)	Max. Flow (gal/min)
UPMS 20-58 F	0.71 @ 38W	8.4-38	19	13.6
UPMS 20-78 F	1.25 @ 68W	2-68	25.6	16

p/n	Description
5800055	Grundfos UPMS 20-58 F Circulator
5800056	Grundfos UPMS 20-78 F Circulator

## Pump, Taco - 006 Series

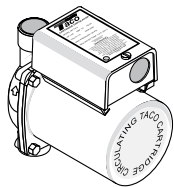

Taco 006 Bronze Circulation Pump for domestic water systems. No flange required, 3/4" sweat connection. Power Supply Cord (p/n 556) sold separately.

size	hp	Amp	Watt	Head (ft)	Volume (gal/min)
006	1/40	0.52	59.8	9	10

p/n	Description
175	Taco 006 Bronze Pump

## Pump, Taco - 007 Series

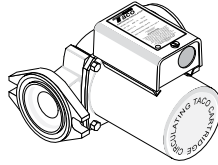

Taco 007 Circulation Pump requires flange kit (not included). Includes O-rings. Power Supply Cord (p/n 556) sold separately.

size	hp	Amp	Watt	Head (ft)	Volume (gal/min)
007	1/25	0.70	80.50	11	20
007 Priority	1/25	0.70	81.65	11	20

p/n	Description
5800004	Taco 007 Pump
5800011	Taco 007 Priority Pump

## Pump, Taco - 009 & 014 Series



Taco 009 and Taco 014 Circulation Pumps both require flange kit (not included). Includes O-rings. Power Supply Cord (p/n 556) sold separately.

size	hp	Amp	Watt	Head (ft)	Volume (gal/min)
009	1/8	1.40	161	34	8
014	1/8	1.55	178	22	32

p/n	Description
5800006	Taco 009 Pump
5800008	Taco 014 Pump

## Pump, Taco - Viridian<sup>™</sup> VT2218



The Taco Viridian VT2218 pump is a temperature sensing, variable speed wet rotor circulator with an ECM permanent magnet motor. Operating modes include Delta-T differential temperature, 4 fixed speeds, set point heat, set point cool and boiler protection.

- Delta-T operation maximizes system efficiency and comfort
- High-efficiency ECM motor uses up to 85% less electricity
- LCD displays operating mode, temperature or speed setting, watts, supply & return temperatures
- Easy to program and install
- 110-120V, 50/60 Hz single phase
- 1650-4200 RPM

Model	Max. Amp	Watt	Max. Shutoff Head (ft)	Max. Flow (gal/min)
VT2218F	0.67	9-58	22	18

p/n	Description
5800025	Taco Viridian Pump, VT2218
5800041	Replacement Temp. Sensor

# Heating System

## CIRCULATORS / MANIFOLD

### Taco Switching Relay



The SR501 single zone switching relay can easily replace any brand made by any manufacturer, and will even fit into the existing metal enclosure without rewiring incoming connections. The SR501 single zone switching relay is UL and CSA listed, uses a standard "ice cube" replaceable relay and is compatible with conventional and programmable thermostats. External indicator lights provide instant diagnostic feedback, making a snap of service calls or new installation start-ups.

p/n	Description
8200291	Switching Relay, Single Zone, Taco

### Cord, Power Supply



May be used to wire pumps when installed on furnaces. Power Supply Cord includes strain relief.

p/n	Description
555	Power Supply Cord, 48"

### Flange, Isolation

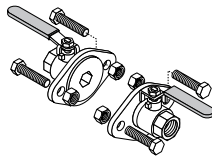

Kits include flanges, nuts and bolts. Isolation Flange 0020-366 is for one flange only. Full port, valved flange body.

p/n	Description
224	"Free Floating" Flange Kit, 3/4"
0020-366	Isolation Flange, 1"

**NOTE: Price is for one flange only.**

225	Isolation Flange Kit, 1-1/4"
-----	------------------------------

### Flange, 3/4" Isolation - with Drain Valve

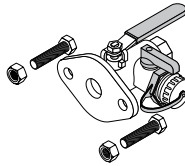

Includes flange, nuts and bolts.

p/n	Description
226	Isolation Flange with Drain Valve, 3/4"

### Flange Kits, Pump

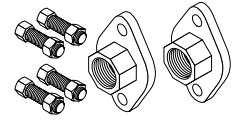

Each kit includes set of two female iron pipe (FIP) pump flanges. One set is used with each pump. Most installations use Pump Flange Kit, 3/4" (p/n 119).

p/n	Description
119	Pump Flange Kit, 3/4"
194	Pump Flange Kit, 1"
5800019	Pump Flange Kit, 1-1/4"

### O-Ring Set



Replacement O-rings for Taco pump flange.

p/n	Description
542	O-Ring Set

### Mount Kit, Wall - Pump

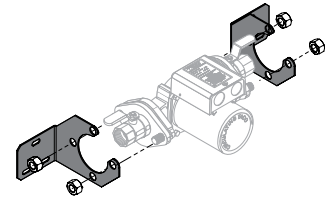

Brackets for supporting and securing pump and flanges to a wall. Figure shows one possible installation scenario. Pump, flanges and mounting hardware are not included.

p/n	Description
1366	Pump Wall Mount Kit

# Heating System MANIFOLDS

## Manifold Kits

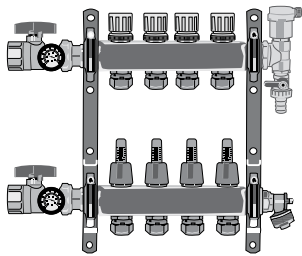

4-Loop shown for illustration purposes

Commonly used for radiant floor heat systems, stainless steel radiant manifold kits are available in various loop configurations for use with 1/2" PEX\*.

Each kit includes:

- See-through body flow meters with adjustable flow rates
- Isolation ball valves with 1" NPT fitting
- Temperature gauge for each isolation valve
- Automatic float vent
- 1/2" PEX compression connectors\*
- Mounting brackets

### p/n Description

2900552 Manifold Kit, 2-Loop  
2900553 Manifold Kit, 3-Loop  
2900554 Manifold Kit, 4-Loop  
2900556 Manifold Kit, 6-Loop  
2900558 Manifold Kit, 8-Loop  
2900560 Manifold Kit, 10-Loop  
2900562 Manifold Kit, 12-Loop  
5000673 O-Ring, Manifold

\*Kits include 1/2" PEX compression connectors and O-rings. Additional O-rings (p/n 5000673), 1/2" PEX compression connectors (p/n 2900563) or connectors for PEX-AL-PEX (p/n 2900564) can be ordered separately (see Manifold Kit Connectors).

## Manifold Kit Connectors



For use with Stainless Steel Radiant Manifold Kits.

### p/n Description

2900563 Connector, Compression, 1/2" PEX  
2900564 Connector, Compression, 1/2" PEX-AL-PEX -  
**ONLY FOR ALUMINUM CORE PEX**

## Adapter, Female 1" NPT - for Manifold Kits



For use with Stainless Steel Radiant Manifold Kits.

### p/n Description

2900614 Adapter, Manifold, Female 1" NPT

## Cap - for Manifold Kits



Can be used with Stainless Steel Radiant Manifold Kits.

### p/n Description

2900551 Loop Cap, Manifold

## Gauge, Temperature - for Manifold Kits



Manifold Temperature Gauge can be used with Stainless Steel Radiant Manifold Kits.

### p/n Description

2900596 Temperature Gauge, Manifold

## Actuator, Thermal

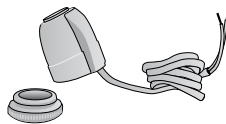

Optional Thermal Actuator (compatible with Stainless Steel Radiant Manifold Kits) is available with either 2-wire or 4-wire configuration. 2-wire provides individual loop flow control on multi-zoned manifold. 4-wire also features end switch for activation of a pump.

### p/n Description

2900549 Thermal Actuator, 2-wire  
2900550 Thermal Actuator, 4-wire

## Manifold w/Valves

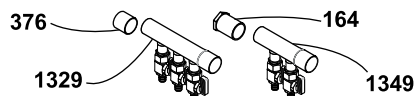

For use with 1/2" PEX pipe in radiant floor installations. Available in a 2- or 3-loop configuration. Manifold fittings are 1" copper sweat; valve fittings are 1/2" barbed.

### p/n Description

1349 Manifold w/Valves, 2-Loop  
1329 Manifold w/Valves, 3-Loop  
376 Copper Cap, 1"

## Manifold w/o Valves

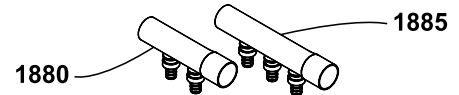

For use with 1/2" PEX pipe in radiant floor installations. Available in a 2- or 3-loop configuration. Manifold fittings are 1" copper sweat; valve fittings are 1/2" barbed. Does not include valves or caps.

### p/n Description

1880 Manifold w/o Valves, 2-Loop  
1885 Manifold w/o Valves, 3-Loop

## Manifold

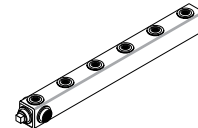

Manifold features two 1-1/4" fittings, six 3/4" FIP fittings and two 1-1/4" bungs (one at each end) for large building system. Manifold measures 3" x 3" x 33-1/2".

### p/n Description

395-011 Manifold

## Manifold

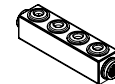

Manifold features 1-1/4" inlet and four 3/4" outlets. Manifold measures 3-1/4" x 3-1/4" x 12-1/4".

### p/n Description

1200033-011 Manifold, 1-1/4" Inlet x 3/4" Outlets

## Manifold

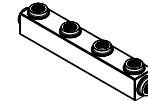

Manifold features 1-1/4" inlet and four 1-1/4" outlets. Manifold measures 3-1/4" x 3-1/4" x 19".

### p/n Description

1200034-011 Manifold, 1-1/4" Inlet x 1-1/4" Outlets

## Gauges, Temperature

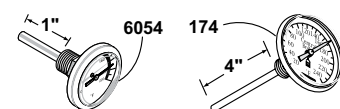

In-line, dial temperature gauge with 1/2" MPT (p/n 174) is optional for manifold, pool heater systems, etc. Gauge (p/n 6054) is 1/8" MPT, 1" diameter with 1" stem length, for use in tight areas.

### p/n Description

6054 Temp. Gauge, 1/8" MPT  
174 Temp. Gauge, 1/2" MPT

# Heating System

## FITTINGS KITS

### Fittings Kit, Water Heater - for Plate Heat Exchanger

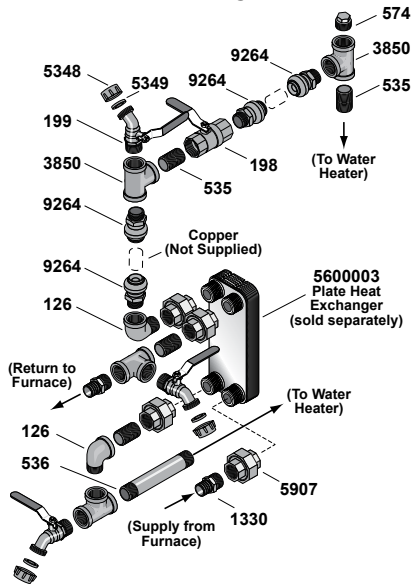

For domestic water heaters using Plate Heat Exchanger (p/n 5600003).

p/n	Description
2500013	Fittings Kit, threaded ports

### Fittings Kit, Water Heater - for Water-to-Water Heat Exchanger

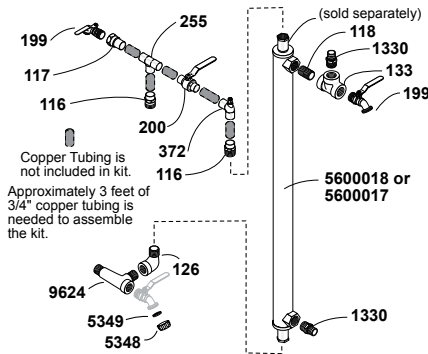

Used to install the Water-to-Water Heat Exchanger (p/n 5600018 or 5600017) on existing domestic water heater for thermal circulating heat transfer. Water-to-water heat exchanger is sold separately.

p/n	Description
2053	Fittings Kit

### Fittings Kit, Push-fit - for Water-to-Water Heat Exchanger

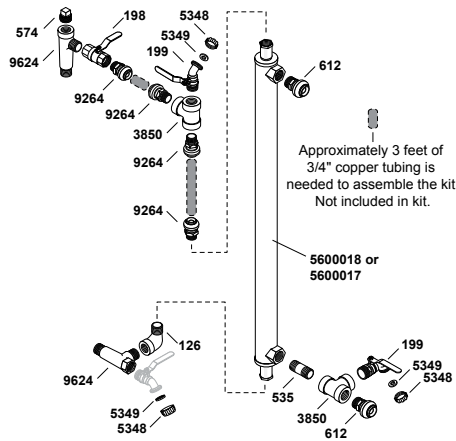

Used to install the Water-to-Water Heat Exchanger (p/n 5600018 or 5600017) on existing domestic water heater for thermal circulating heat transfer. Water-to-water heat exchanger is sold separately.

p/n	Description
9263	Push-fit Fittings Water Heater Kit

### Fittings Kit, Domestic Hot Water Plate Exchanger

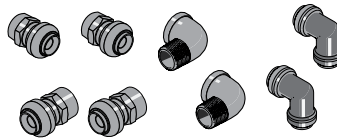

Used to install plate exchanger (with 1" ports) on existing domestic water heater. Water-to-water plate heat exchanger is sold separately.

Each kit includes:

- 2 - Street Elbow, 90° Brass, 1"
- 2 - Sharkbite Female Adapter, 1" FPT
- 2 - Sharkbite Elbow, 90°, 3/4"
- 2 - Sharkbite Reduce Adapter, 3/4" x 1" FNPT

p/n	Description
2500780	Domestic Hot Water Plate Exchanger Fittings Kit

### Fittings Kit, Single Pump Crimp

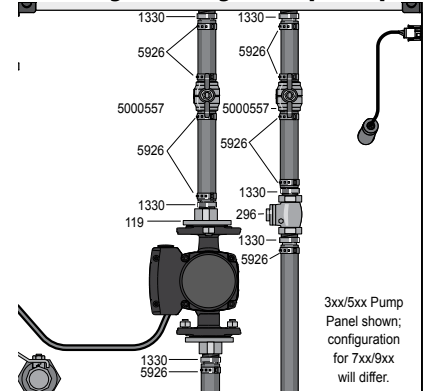

Kit for installing a single pump in the pump panel area of Classic Edge HDX models. Circulating pump sold separately.

p/n	Description
2500709	Single Pump Crimp Fittings Kit

### Fittings Kit, Single Pump Sharkbite®

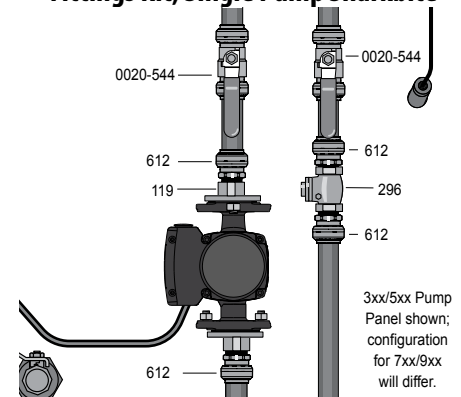

Kit for installing a single pump in the pump panel area of Classic Edge HDX models. Circulating pump sold separately.

p/n	Description
2500708	Single Pump Sharkbite Fittings Kit



### Fittings , PEX Brass Clamp

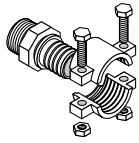

Brass adapter clamps for PEX pipe.

p/n	Description
5642	Brass Clamp Fittings, 1"
5643	Brass Clamp Fittings, 1-1/4"

### Coupling, 25mm PEX



For coupling two 25mm Central PEX pipe ends.

p/n	Description
5000462	PEX Coupling, 25mm

### Couplings, 1/2" and 1" PEX



For coupling two Central PEX pipe ends.

p/n	Description
1339	PEX Coupling, 1/2"
1333	PEX Coupling, 1"

### Fittings, Brass - for 1-1/4" PEX Pipe

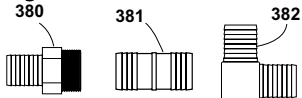

Brass fittings for 1-1/4" PEX pipe. To ease installation, it is recommended that a heat gun be used on the 1-1/4" PEX pipe.

p/n	Description
380	Male Adapter, 1-1/4" barb x 1-1/4" MIP
381	Brass Coupling, 1-1/4" barb x 1-1/4" barb
382	Brass Elbow, 1-1/4" barb x 1-1/4" barb

### Plug, 1/2" PEX



Brass crimp plug for 1/2" PEX.

p/n	Description
5000784	Plug, 1/2" PEX Crimp

### Plug, 1" PEX



Brass crimp plug for 1" PEX.

p/n	Description
5000785	Plug, 1" PEX Crimp

### Adapters, PEX - Threaded Pipe

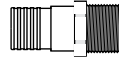

For adapting threaded pipe to Central PEX pipe.

p/n	Description
1341	PEX Adapter, 1/2" PEX x 1/2" MIP fittings
1336	PEX Adapter, 1/2" PEX x 3/4" MIP fittings
1330	PEX Adapter, 1" PEX x 3/4" MIP fittings
1324	PEX Adapter, 1" PEX x 1" MIP fittings

### Adapters, PEX - Copper Pipe



For adapting copper pipe to Central PEX pipe.

**NOTE: The 1331 PEX Adapter can also be used for 3/4" sweat applications by sweating the fitting inside.**

p/n	Description
1337	PEX Adapter, 1/2" PEX x 1/2" sweat fitting
1331	PEX Adapter, 1" PEX x 3/4" or 1" sweat fitting
1348	PEX Adapter, 1/2" PEX x 1/2" FIP fitting

### Adapter, PEX - Copper Pipe



For adapting copper pipe to Central PEX pipe.

p/n	Description
5000651	PEX Adapter, 1" PEX x 1" sweat fitting

### Adapter, PEX - Threaded Pipe



p/n	Description
5000464	PEX Adapter, 25mm x 3/4" MIP

### Adapter, Female - Copper Pipe

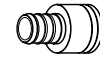

Adapts 1/2" copper pipe to 1/2" Central PEX pipe. Sweat end fits over copper pipe.

p/n	Description
6679	Female Adapter, 1/2" barb x 1/2" sweat fittings

### Elbow, PEX 90°



For coupling two Central PEX pipe ends together.

p/n	Description
1340	PEX 90° Elbow, Brass, 1/2"
1334	PEX 90° Elbow, Brass, 1"

### Elbow, PEX 90° - Threaded Pipe



For coupling 1" Central PEX pipe to 3/4" MPT threaded pipe.

p/n	Description
5000531	PEX Adapter, 1" PEX x 3/4" MPT fittings, 90° Elbow

### Elbow, PEX 90° Swoop

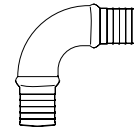

1" stainless steel PEX 90° swoop (sweep) elbow.

p/n	Description
5000768	PEX Swoop Elbow, 90°

### Tee, Brass - PEX



Brass tee for joining Central PEX pipe ends.

p/n	Description
1338	PEX Tee, 1/2"
1332	PEX Tee, 1"

# Heating System

## FITTINGS - THREADED

### Bushing, Hex - NPT



Hex bushing with national pipe threads (NPT).

p/n	Description
388	Hex Bushing, 1-1/4" x 3/4"
105	Hex Bushing, 1-1/2" x 3/4"
412	Hex Bushing, 1-1/4" x 1/2"
325	Hex Bushing, 3/4" x 1/2"
180	Hex Bushing, 3/4" x 1/8"
408	Hex Bushing, 1-1/2" x 1-1/4"

### Bushing, Reducing - Brass



Brass NPT reducing bushing.

p/n	Description
385	Brass Hex Bushing, 1-1/2" x 3/4"
3851	Brass Hex Bushing, 1-1/4" x 3/4"
3042	Brass Hex Bushing, 1/2" x 1/8"

### Union, Brass Pipe - FIP



Suggested for use with plate-style heat exchanger installations.

p/n	Description
5907	Brass Pipe Union, 3/4"
5908	Brass Pipe Union, 1"
5909	Brass Pipe Union, 1-1/4"

### Plug, Pipe - MPT



Pipe Plug, MPT, black, unless noted.

p/n	Description
331	Pipe Plug, 3/4"
574	Pipe Plug, Brass 3/4"
383	Pipe Plug, 1-1/4"
6557	Pipe Plug, Brass 1/2"

### Nipple, Black Close



Nipple (p/n 118) is used with pumps and ball valves. All nipples listed here are Schedule 80, extra heavy.

p/n	Description
118	Nipple, 3/4" x close, Schedule 80, extra heavy
409	Nipple, 1-1/4" x close, Schedule 80, extra heavy
314	Nipple, 1-1/2" x close, Schedule 80, extra heavy

### Nipple, Brass Close



Brass Nipple with 3/4" MPT x close fittings.

p/n	Description
270-0049	Nipple, Brass, 3/4" x close

### Nipple, Black - MPT

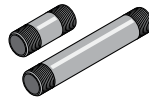

Extra-heavy male pipe thread (MPT) nipples.

p/n	Description
533	Nipple, 3/4" x 2"
534	Nipple, 3/4" x 7"
11157	Nipple, Schedule 80, Black, 1-1/4" x 3"
5000015	Nipple, Schedule 80, Black, 1-1/4" x 2-1/2"
5000018	Nipple, Schedule 80, Black, 3/4" x 3"

### Nipple, Brass

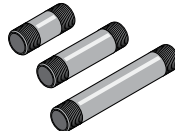

Brass nipples in varying lengths.

p/n	Description
535	Nipple, Brass, 3/4" x 2"
536	Nipple, Brass, 3/4" x 7"
5000394	Nipple, Brass, 3/4" x 4"
0020-186	Nipple, Brass, 1" x 2"

### Caps, Round Pipe



p/n	Description
332	3/4" Round Pipe Cap
333	1-1/4" Round Pipe Cap

### Tees, NPT

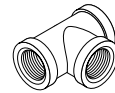

Black Tee (p/n 133) can be used for vent option near pump. Brass Tee (p/n 3850) can be used in domestic water situations. Black Tee (p/n 418) can be used to install 1-1/4" thermostatic valve.

p/n	Description
133	Tee, Black, 3/4" NPT
3850	Tee, Brass, 3/4" NPT
418	Tee, Black, 1-1/4" NPT

### Tee, Brass, 3/4"

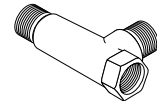

Brass Tee, 3/4" male x female x male. Mainly used for installing heat exchanger on water heater when push-fit fittings are used.

p/n	Description
9624	Tee, Brass, 3/4"

### Tee, Brass Offset, 4"

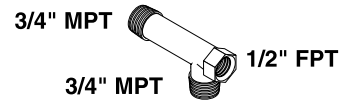

Can be used in conjunction with the Temperature Gauge (p/n 174 or p/n 6054) for monitoring furnace supply water temperature, or may be used instead of Nipple (p/n 533) and 90° Street Elbow (p/n 274) on supply and/or return bung.

p/n	Description
6764	Brass Offset Tee, 4"

### Elbow, 45° Street



NPT 45° Street Elbow (black).

p/n	Description
124	45° Street Elbow, 3/4"
5000017	45° Street Elbow, 1-1/4"

# Heating System FITTINGS - THREADED

---

## Elbow, 90° Street



90° Street Elbow in different sizes.

p/n	Description
411	90° Street Elbow, 1-1/4"
274	90° Street Elbow, 3/4"
126	90° Street Elbow, Brass, 3/4"

---

## Elbow, 90° - FPT



90° Elbow with female threads.

p/n	Description
956	90° Elbow, 3/4" x 3/4" FPT
5000016	90° Elbow, Black, 1-1/4"

---

## Coupling, Brass - 3/4"



Brass Coupling with 3/4" threaded fittings.

p/n	Description
5367	Brass Coupling, 3/4" thread

---

## Adapter, Female, 3/4" Hose



p/n	Description
4928	Brass Adapter, 3/4" female hose x 3/4" male pipe

---

## Adapter, Male, 3/4" Hose



p/n	Description
4929	Brass Adapter, 3/4" male hose x 3/4" male pipe

---

## Tape, Blue Teflon, 1/2" x 1429"



Compatible with a broad range of piping materials. Will not harden or crack on joint. Acts as a thread lubricant and anti-seize. No curing time, unlimited shelf life.

p/n	Description
10713	Tape, Blue Teflon, 1/2" x 1429"

# Heating System

## FITTINGS - COPPER / SWEAT

### Elbow, 90° Street - 1" Copper



90° street elbow with 1" female sweat fitting on one end and 1" male sweat fitting on the other.

p/n	Description
103	Street Elbow, 1"

### Couplings, Copper

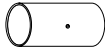

p/n	Description
146	Copper Coupling, 3/4" sweat x 3/4" sweat fittings
147	Copper Coupling, 1" sweat x 1" sweat fittings

### Adapters, Male - Copper



p/n	Description
116	Male Adapter, 3/4" sweat x 3/4" MIP fittings
120	Male Adapter, 1" sweat x 1" MPT fittings

### Adapters, Female - Copper



p/n	Description
164	Female Adapter, 1" sweat x 3/4" FIP fittings
117	Female Adapter, 3/4" sweat x 3/4" FIP fittings

### Tees, Copper

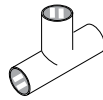

p/n	Description
138	Tee, Copper Pipe, 1" x 1" x 1" sweat fittings
255	Tee, Copper Pipe, 3/4" x 3/4" x 3/4" sweat fittings

### Tee, Reducing - Copper



p/n	Description
178	Reducing Tee, 1-1/2" x 1" x 1" sweat fittings

### Cap, Copper End



p/n	Description
376	Copper End Cap, 1" sweat fitting

### Elbow, Vent - Copper



p/n	Description
372	Vent Elbow, 3/4" x 3/4" sweat fittings

### Reducer, Copper



p/n	Description
231	Reducer, Copper Pipe, 1" x 3/4" sweat fittings

### Elbow, 90° Reducing - Copper



p/n	Description
123	90° Reducing Elbow, Copper Pipe, 1" x 3/4" sweat fittings

### Elbow, 90° - Copper



p/n	Description
276	90° Elbow, Copper Pipe, 3/4" x 3/4" sweat fittings
277	90° Elbow, Copper Pipe, 1" x 1" sweat fittings

### Tee, Brass Diverter

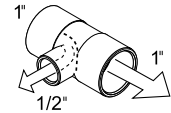

The diverter tee is an excellent sweat fitting used mainly with fan-forced heaters.

p/n	Description
6782	Brass Diverter Tee, 1" x 1" x 1/2"

# Heating System

## FITTINGS - PUSH-FIT / SHARKBITE

Push-fit and Sharkbite Fittings are designed to simplify pipe installation. The fittings allow the user to connect pipe in seconds with relative ease.

- Instant push-fit connection for increased ease-of-use.
- No soldering, clamps, unions or glue required.
- Lead-free
- Fits copper tubing and PEX piping and connects in any combination.

### Push-fit Fittings - Coupling, Straight

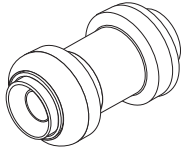

- |            |  |
|------------|--|
| <b>p/n</b> | <b>Description</b>                       |
| 606        | Push-fit Coupling, Straight, 1/2" x 1/2" |
| 607        | Push-fit Coupling, Straight, 3/4" x 3/4" |
| 608        | Push-fit Coupling, Straight, 1" x 1"     |

### Push-fit Fitting - Coupling, Reducing

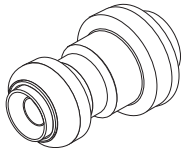

- |            |  |
|------------|--|
| <b>p/n</b> | <b>Description</b>                     |
| 609        | Push-fit Coupling, Reducing, 1" x 3/4" |

### Push-fit Fitting - Female Adapter

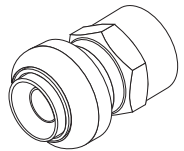

- |            |                                      |
|------------|--------------------------------------|
| <b>p/n</b> | <b>Description</b>                   |
| 611        | Push-fit Female Adapter, 1" x 1" FPT |

### Push-fit Fitting - Adapter, Male

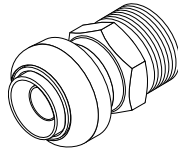

- |            |                                      |
|------------|--------------------------------------|
| <b>p/n</b> | <b>Description</b>                   |
| 612        | Push-fit Male Adapter, 1" x 3/4" MPT |

### Push-fit Fitting - Connector, Straight

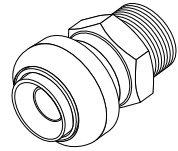

- |            |   |
|------------|---|
| <b>p/n</b> | <b>Description</b>                            |
| 9264       | Push-fit Connector, Straight, 3/4" x 3/4" MIP |

### Push-fit Fittings, Elbow

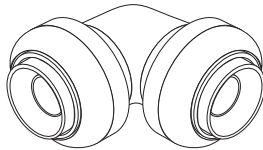

- |            |                             |
|------------|-----------------------------|
| <b>p/n</b> | <b>Description</b>          |
| 613        | Push-fit Elbow, 1" x 1"     |
| 9265       | Push-fit Elbow, 3/4" x 3/4" |

### Sharkbite Elbow

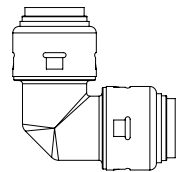

- |            |                                   |
|------------|-----------------------------------|
| <b>p/n</b> | <b>Description</b>                |
| 5000786    | Sharkbite Elbow, 90°, 3/4" x 3/4" |

### Push-fit Fitting, Tee

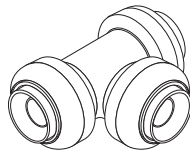

- |            |                            |
|------------|----------------------------|
| <b>p/n</b> | <b>Description</b>         |
| 614        | Push-fit Tee, 1" x 1" x 1" |

### Push-fit Fitting - Temperature Gauge



1/8" MPT Temperature Gauge (p/n 6054) installs on Temperature Gauge Fitting and fitting installs on push-fit fitting Tee (p/n 614).

- |            |   |
|------------|---|
| <b>p/n</b> | <b>Description</b>                                |
| 1350       | Push-fit Temperature Gauge Fitting, 1" x 1/8" NPT |

### Push-fit - Depth Gauge/Deburring Tool

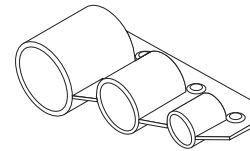

Deburs pipe and used to mark pipe to indicate when the pipe is inserted completely into the fitting. One tool for 1/2", 3/4" and 1" pipe.

- |            |                                     |
|------------|-------------------------------------|
| <b>p/n</b> | <b>Description</b>                  |
| 615        | Push-fit Depth Gauge/Deburring Tool |

### Push-fit - Disconnect Clip

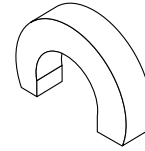

Used to disconnect push-fit fittings quickly and easily.

- |            |                                |
|------------|--------------------------------|
| <b>p/n</b> | <b>Description</b>             |
| 616        | Push-fit Disconnect Clip, 1/2" |
| 617        | Push-fit Disconnect Clip, 3/4" |
| 618        | Push-fit Disconnect Clip, 1"   |

# Heating System VALVES

## Zone Valves, Zone Sentry™

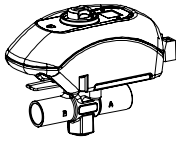

On-off, normally open or normally closed control in open and closed hydronic systems. Simple to install and operate, the valve can be installed in any direction, in any orientation. Snap-in quick connects make for a simple and secure wiring hook-up. LED shows full functionality of the valve's operation and thermostat status. Uses half the power of the 560 Series Zone Valves. 2-way or 3-way zone valves available.

p/n	Description
5800059	3-Way Zone Sentry Zone Valve, 1" NPT threads
5800021	3-Way Zone Sentry Zone Valve, 3/4" NPT threads
5800030	3-Way Zone Sentry Zone Valve, 3/4" sweat
5800028	3-Way Zone Sentry Zone Valve, 1" sweat
5800020	2-Way Zone Sentry Zone Valve, 3/4" NPT threads
5800027	2-Way Zone Sentry Zone Valve, 1" sweat
5800022	Replacement Actuator Head for Sentry Zone Valve

## Zone Valve, 3-Way - 24-Volt

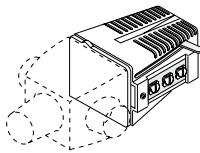

Replacement head for 114 and 127 3-Way Zone Valves (valves no longer available). Can also be used as a replacement head for 571 and 671 2-way zone valves.

p/n	Description
113	Replacement Head

## Hose Bibs, Brass



Brass hose bib, 3/4" MPT. Use brass cap (p/n 5348) with washer (p/n 5349) to cover end.

p/n	Description
199	Brass Hose Bib, 3/4" MPT
5349	Washer, 3/4"
5348	Cap, Brass, 3/4"

## Hose Bibs, Brass - Straight

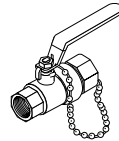

Straight brass hose bib with cap and chain, 3/4" FIP x 3/4" hose. For use as drain valve on some furnaces. For E-Classic 3250/3200 models. Will also require 1 each of nipple (p/n 118).

p/n	Description
5000700	Brass Hose Bib w/Cap and Chain, 3/4" FIP x 3/4" Hose

## Ball Valve

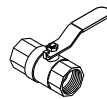

Brass FIP Ball Valves. The 3/4" Full Port Ball Valve (p/n 198) is used on both sides of the pump and on the furnace for each water line.

p/n	Description
186	Ball Valve, 1/2"
198	Ball Valve, 3/4" Full Port - Lead Free
5000661	Ball Valve, 1"
410	Ball Valve, 1-1/4"

## Tee, Purging and Filling - 3/4"

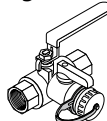

Used to fill system and purge system of air.

p/n	Description
5000083	Purge Tee, Drain, Brass, 3/4" female

## Valve, 3-Way

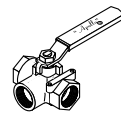

Manually operated, FIP, brass 3-Way Valve.

p/n	Description
330	3-Way Valve, Brass 3/4" FIP

## Ball Valve, Sweat



p/n	Description
200	Sweat Ball Valve, 3/4" x 3/4" sweat fitting - Lead Free

## Ball Valve, PEX



Full port ball valve for Central PEX.

p/n	Description
5000556	Ball Valve, 1/2" PEX, Full Port
5000557	Ball Valve, 1" PEX, Full Port

## Check Valve, Swing - Brass



Brass Swing Check Valve with FIP fittings prevents reverse circulation.

p/n	Description
296	Brass Swing Check Valve, 3/4"
5871	Brass Swing Check Valve, 1-1/4"

## Caleffi 2-Way Zone Valve, 3/4" FNPT

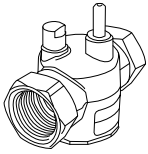

Two-way on/off two position valve, straight-through flow pattern, brass body, stainless steel stem, EPDM rubber seals and paddle. 3/4" FNPT connections. Requires Switch, sold separately.

**p/n Description**  
5800043 Zone Valve, 2-Way, 3/4" FNPT

## Caleffi 2-Way Zone Valve, 1" Sweat

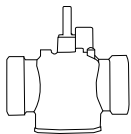

Two-way on/off two position valve, straight-through flow pattern, brass body, stainless steel stem, EPDM rubber seals and paddle. 1" sweat connections. Requires Switch, sold separately.

**p/n Description**  
5800044 Zone Valve, 2-Way, 1" Sweat

## Caleffi 3-Way Zone Valve, NPT

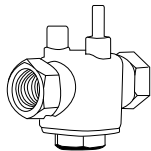

Three-way on/off two position valve, diverting flow pattern, brass body, stainless steel stem, EPDM rubber seals and paddle. 3/4" or 1" NPT connections. Requires Switch, sold separately.

**p/n Description**  
5800045 Zone Valve, 3-Way, 3/4" FNPT  
5800060 Zone Valve, 3-Way, 1" NPT

## Caleffi 3-Way Zone Valve, Sweat

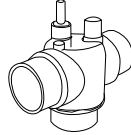

Three-way on/off two position valve, diverting flow pattern, brass body, stainless steel stem, EPDM rubber seals and paddle. 3/4" or 1" sweat connections. Requires Switch, sold separately.

**p/n Description**  
5800046 Zone Valve, 3-Way, 3/4" Sweat  
5800047 Zone Valve, 3-Way, 1" Sweat

## Caleffi Zone Valve Repair Kits

Repair kit for Caleffi Z2 & Z3 zone valves with 3/4" sweat fittings (p/n 2900765) and with 3/4" NPT & all 1" fittings (p/n 2900766).

**p/n Description**  
2900765 Zone Valve Repair Kit, 3/4" Sweat  
2900766 Zone Valve Repair Kit, 3/4" NPT, all 1" Fittings

## Caleffi Zone Valve Switches

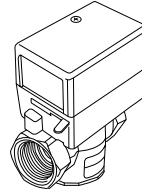
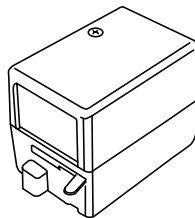

Shown Installed

Z1 actuator for motorized zone valves (closed). Easy push-button attachment, 7/8" knockout for 1/2" conduit connector. With auxiliary microswitch.

Rating of auxiliary switch contacts:  
5800058 – 0.0 A min, 0.4 A max (24 V to 120 V).  
5800049 – 0.25 A min, 5.0 A max (230 V).

**p/n Description**  
5800049 Switch, Zone Valve, 24V,5A,NC,18" Wires  
5800058 Switch, Zone Valve, 24V,0.4A,NC, Terminal Block

## Caleffi 3-Way Thermostatic Mixing Valve, 3/4" NPT

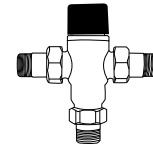

Adjustable thermostatic mixing valve for point of distribution in domestic water systems and radiant hydronic heating systems. Low-lead brass body. Locking set point knob.

**p/n Description**  
5800052 3-Way Thermostatic Mixing Valve, 3/4" NPT

## Valve, Water Heater Mixing, Caleffi

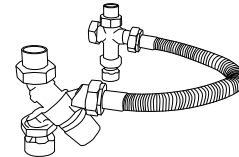

Thermostatic mixing valve kit for domestic water heaters. Adjustment temperature range: 95°F - 150°F. 3/4" MPT fittings.

**p/n Description**  
5800048 TankMixer, 3/4" NPT

## DISCAL® Air Separator

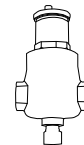

Brass body. Stainless steel float guide pin and linkage. Glass reinforced nylon internal element. 1" NPT female bottom thread. Air separation efficiency: up to 100% removal.

**p/n Description**  
5800051 DISCAL Air Separator, 1" FNPT

# Heating System

## VALVES - MIXING, ETC.

### Check Valve, Flow

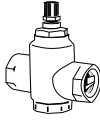

Used in hydronic heating to prevent ghost flow when the components are above the manifold. 1" threaded FNPT x FNPT connections.

**p/n**    **Description**  
5000670 Flow Check Valve, 1" Cast Iron

### Vent Valve, Automatic



Vents air automatically. For use in pressurized systems only. Fitting is 1/8" NPT.

**p/n**    **Description**  
286      Automatic Vent Valve

### Backflow Preventer

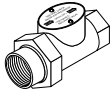

Backflow Preventer used to protect water supplies from contamination. Cast bronze body and brass union inlet connection. LEAD FREE.

**p/n**    **Description**  
5000472 Backflow Preventer, LF, 3/4"

### Valve, Tempering

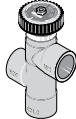

Mixing valve for tempering hot water, with an adjustable temperature range between 120-160°F.

**p/n**    **Description**  
140      Tempering Valve, 3/4" sweat fittings

### Valve, Radiant Mixing

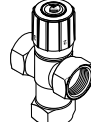

For controlling water temperature in various types of radiant heat systems. Temperature range 70°F - 145°F. Not an anti-scald valve and not intended to be used on water heaters.

**p/n**    **Description**  
306      Radiant Mixing Valve, 1/2" NPT fittings  
327      Radiant Mixing Valve, 3/4" NPT fittings  
329      Radiant Mixing Valve, 1" NPT fittings

### Valve, Water Heater Mixing, Taco



Designed specifically for water heaters, with a temperature range of 90°F - 130°F. Includes 18" braided hose and brass tee.

**p/n**    **Description**  
5000392 Water Heater Mixing Valve, 3/4" NPT fittings, lead free

### Mixing Valve, 4-way FNPT

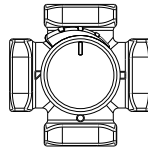

This unit mixes high-temperature boiler water with heated return water to create tempered water for radiant systems and other applications. It is manually operated.

**p/n**    **Description**  
64026    Mixing Valve, 1" x 4-way FNPT  
64031    Mixing Valve, 1-1/4" x 4-way FNPT

### Thermostat Kit

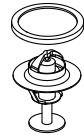

Replacement thermostat for thermostatic valve kits. Includes gasket and instructions.

**p/n**    **Description**  
1740      Thermostat Kit, 150°F



# Heating System

## THERMOSTATS / AQUASTATS

### Thermostat, Line Voltage

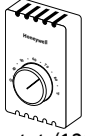

Line Voltage Thermostat (120-volt) used to start the fan on forced-air systems.

p/n	Description
1267	Line Voltage Thermostat

### Relay, 24-Volt

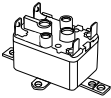

Used to connect a 24-volt thermostat to existing thermostat for a heat pump.

p/n	Description
8200293	Power Relay, 24V, SPNO-SPNC

### Relay, Fan Center



The Fan Center Relay is used to control a 110-volt fan with a 24-volt thermostat.

p/n	Description
515	Fan Center Relay

### Thermostat, Programmable - 24-Volt



Can be used in conjunction with zone valves, zone pumps and forced-air systems or used to operate 24-volt 3-way zone valves (requires 24-volt transformer).

p/n	Description
588	Programmable 24-Volt Thermostat

### Thermostat, Single-stage, Non-programmable - 24-Volt



Can be used in conjunction with zone valves, zone pumps and forced-air systems or used to operate 24-volt 3-way zone valves (requires 24-volt transformer).

p/n	Description
8200008	Non-programmable 24-Volt Thermostat

### Thermostat, Multi-stage - 24-Volt



Large, easy-to-read screen allows homeowners to use one thermostat to control up to three stages of heat and two stages of cooling. Fully programmable. Must be installed and wired by a qualified service technician.

p/n	Description
587	Multi-stage 24-Volt Thermostat

### Thermostat, Plug-in



Plug-in Thermostat, 13.5-amp rated, 110-Volt, is for operating fan.

p/n	Description
368	Plug-in Thermostat

### Transformer, 24-Volt



Used with 24-volt wall thermostat and 24-volt zone valves.

p/n	Description
188	24-Volt Transformer

### Aquastat, Pool

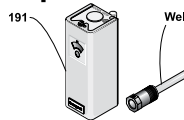

For controlling water temperature in pools, spas, etc., Immersible, temperature range of 40-180°F in one-degree differential. Well sold separately. With pool or hot tub applications, it is recommended to use a stainless steel well (p/n 1248), also sold separately.

p/n	Description
191	Pool Aquastat, 1/2" NPT fitting
1247	Well, 1/2" NPT fitting
1248	Well, Stainless Steel, 1/2" NPT fitting

### Aquastat, Fixed



Non-adjustable, immersible, 1/2" MPT fitting.

p/n	Description
290	Fixed Aquastat, 175°F
399	Fixed Aquastat, 190°F

### Aquastat, Immersible - Adjustable

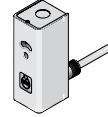

Adjustable between 110-240°F, immersible, with 1/2" MPT fittings on well (either close on rise or open on rise). Well is included with aquastat. Recommended operating setting is between 165-195°F. Can be installed on Classic model furnaces prior to serial number 25151 that were manufactured with a fixed aquastat.

p/n	Description
169	Adjustable Aquastat with Well, 1/2" MPT

### Aquastat, Strap-on

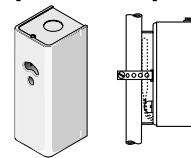

Strap-on Aquastat, adjustable from 65-200°F with 5- to 30-degree differential.

p/n	Description
0020-377	Aquastat, Strap-on

### Aquastat, Surface Mount - Adjustable



For 1992 and older Classic outdoor wood furnaces, adjustable from 100-240°F.

p/n	Description
204	Adjustable Aquastat

### Taco Switching Relay



The SR501 single zone switching relay can easily replace any brand made by any manufacturer, and will even fit into the existing metal enclosure without rewiring incoming connections. The SR501 single zone switching relay is UL and CSA listed, uses a standard "ice cube" replaceable relay and is compatible with conventional and programmable thermostats. External indicator lights provide instant diagnostic feedback, making a snap of service calls or new installation start-ups.

p/n	Description
8200291	Switching Relay, Single Zone, Taco

# Outdoor Furnace Products

## OPTIONS & ACCESSORIES

### FireStar XP Outdoor Wi-Fi Module Kit

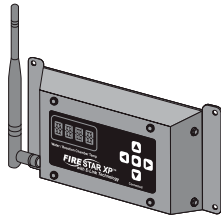

Outdoor Wi-Fi wireless display can be used to remotely view operational data on the FireStar II controller. Compatible only with a properly configured FireStar II equipped outdoor furnace (with software version 6.4x or higher on E-Classic or Classic Edge models, or 2.5x or higher on Maxim M255 PE models).

Kit includes FireStar XP Outdoor Wi-Fi Module, antenna, wiring, Quickstart Guide, Operator's Manual and installation instructions.

**NOTE: Wireless range varies widely with each installation. Prior to purchase, a site survey (using a smartphone or laptop) should be performed to determine if the furnace site is within range of customer's existing Wi-Fi network. Range is generally up to 100 feet when unobstructed and there is no interference. Uses 802.11 technology.**

#### E-CLASSIC/CLASSIC EDGE

p/n	Description
2500070	FireStar XP Outdoor Wi-Fi Module Kit
8200080	Wi-Fi Antenna only

#### MAXIM M255 PE

p/n	Description
2500185	FireStar XP Outdoor Wi-Fi Module Kit
8200080	Wi-Fi Antenna Only

### FireStar II Wiring Kit

Some earlier E-Classic models require this wiring kit in order to be able to monitor the bypass door and gas-fired wood ignition over the internet.

p/n	Description
2500023	FireStar II Wiring Kit

### Antenna Mount Kit, External Wi-Fi

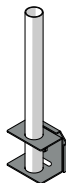

Used to mount a wi-fi antenna (not included) to the lift tab of the furnace.

p/n	Description
2500428	External Wi-Fi Antenna Mount Kit

### Cover, Outer Control

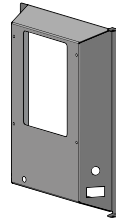

Optional outer control cover is pre-drilled for Outdoor Wi-Fi Module Kit (p/n 2500070).

p/n	Description
2000320	Outer Control Cover

### Water Temperature Indicator Kit, Indoor



Remote inline monitoring of water temperature (battery operated). Includes LCD, 75 feet of cord and probe. Dip switch can be set to either Fahrenheit or Celsius. NOTE: Black Tee (p/n 133) and Hex Bushing (p/n 180) are not included with the kit.

Replacement battery is AG13 alkaline button cell.

p/n	Description
5052	Indoor Water Temperature Indicator Kit
133	Tee, Black, 3/4" NPT
180	Hex Bushing, 3/4" x 1/8"

### Pump Panel Extension Kit - Classic Edge 350/550 HD Classic Edge 360/560 HDX

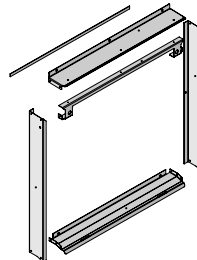

Kit provides additional room for mounting more than one pump on Classic Edge 350 or 550 HD models, or for 360 or 560 HDX models.

p/n	Description
2500164	Pump Panel Extension Kit, Classic Edge

### 24 Fan Conversion Kit - Classic Edge/Classic Edge HD

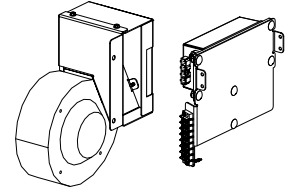

Kit is used to allow a Classic Edge or Classic Edge HD furnace to be operated with 24V DC (for systems off the grid, for example). Includes a 24V Combustion Fan and a low-voltage replacement power supply. Only for Classic Edge or Classic Edge HD 350, 550 or 750 models.

p/n	Description
2500398	24V Fan Conversion Kit

### 24V Fan Conversion Kit - Classic Edge HDX

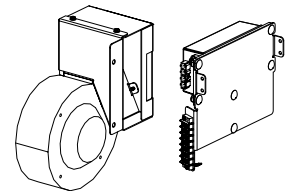

Kit is used to allow a Classic Edge HDX furnace to be operated with 24V DC (for systems off the grid, for example). Includes a 24V Combustion Fan and a low-voltage replacement power supply. Only for Classic Edge HDX 360, 560 or 760 (will not work for Classic Edge HDX 960).

p/n	Description
2500633	24V Fan Conversion Kit

### Ground Rod Kit

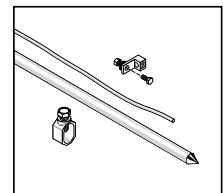

Used to electrically ground the furnace.

p/n	Description
6593	Ground Rod Kit

# Outdoor Furnace Products

## OPTIONS & ACCESSORIES

### LED Light Kit - Classic Edge

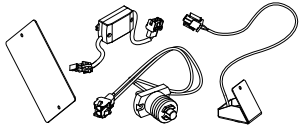

Adds an LED light under the eave on the controller side of the furnace.

p/n	Description
2500144	LED Light Kit

### Hopper Extension Kit - Maxim

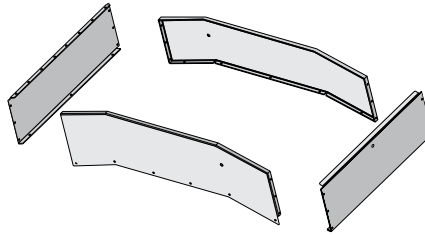

Increases hopper capacity by 3 bushels. For M175 models only.

p/n	Description
4536	Hopper Extension Kit - Green
4537	Hopper Extension Kit - Terra Brown

### Hopper, 48-Bushel Kit - Maxim M175, M250, M255 P

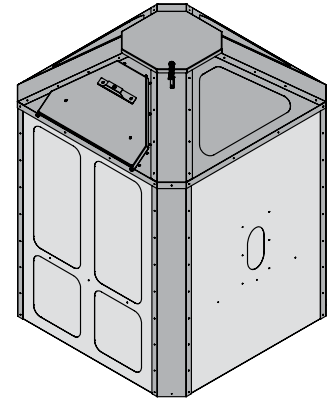

Increases fuel storage capacity, for Maxim M175, M250 and M255 P models. Does not include auxiliary auger. Use the 5-1/2' Auxiliary Auger Kit (p/n 2500007) to locate the 48-Bushel Hopper to the side of the outdoor furnace. Available in either green and olive gray or terra brown and taupe to match the Maxim. Dimensions: 48" x 48" x 66".

p/n	Description
9760	48-Bushel Hopper Kit - Green and Olive Gray
9660	48-Bushel Hopper Kit - Terra Brown and Taupe

### LED Light Kit, Secondary - Classic Edge

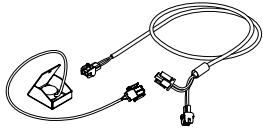

Secondary LED light is installed under the eave on the side of the furnace opposite the controller.

**NOTE: Requires LED Light Kit (p/n 2500144).**

p/n	Description
2500145	Secondary LED Light Kit

### Hopper, 48-Bushel Kit w/Auger - Maxim M255 PE

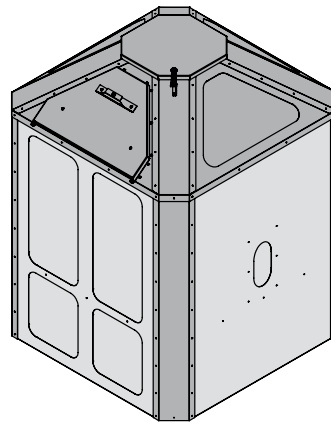

Increases fuel storage capacity, for Maxim M255 PE models. Includes 5-1/2' auxiliary auger, which is used to locate the 48-Bushel Hopper to the side of the outdoor furnace. Available in either green and olive gray or terra brown and taupe to match the Maxim. Dimensions: 48" x 48" x 66".

p/n	Description
2500724-021	48-Bushel Hopper Kit w/5-1/2' Auger - Terra Brown and Taupe
2500724-202	48-Bushel Hopper Kit w/5-1/2' Auger - Green and Olive Gray

### Auxiliary Auger Kits - Maxim

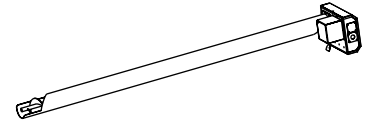

Transfer augers for external hoppers. Use 5-1/2' Auxiliary Auger Kit (p/n 2500007) with the 48-Bushel Hopper Kit (p/n 9660 or 9760) when the hopper is located to the side of the furnace. The 6' Auxiliary Auger Kit (p/n 2500008) and 8' Auxiliary Auger Kit (p/n 2500009) will not work with the 48-Bushel Hopper.

**NOTE: For furnaces with a serial number prior to M16073, the Power Cord (p/n 4177) must be purchased separately.**

p/n	Description
2500008	Auxiliary Auger Kit, 6'
2500007	Auxiliary Auger Kit, 5-1/2'
2500009	Auxiliary Auger Kit, 8'
2000041	Replacement Gear Motor, Auxiliary Auger
4177	Power Cord (see note above)

### Bypass Alarm Kit - Classic Edge 750

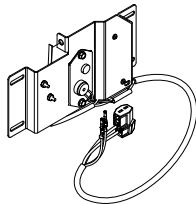

Adds a bypass alarm on Classic Edge 750 models. The bypass alarm sounds to let the operator know the bypass door is open.

p/n	Description
2500153	Bypass Alarm Kit, Classic Edge 750

### Stepper Conversion Kit - Classic Edge

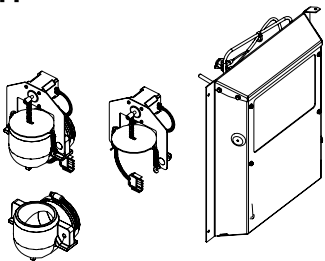

Kit for converting Classic Edge from solenoids to stepper motors. Includes control panel, stepper assembly, wiring, mounting hardware and instructions.

**NOTE: Kit can be used on the following Classic Edge models: Classic Edge 350 (s/n G300344 and above); Classic Edge 550 (s/n G500961 and above); Classic Edge 750 (s/n G700683 and above).**

p/n	Description
2500314	Stepper Conversion Kit, Classic Edge

# Outdoor Furnace Products

## OPTIONS & ACCESSORIES

### Bag Holder Kit - Maxim

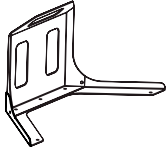

Bag Holder attaches to the inside of the door of the 48-Bushel Hopper to support bag of fuel.

p/n	Description
9804	Bag Holder Kit

### Hopper Vibrator Kit - Maxim

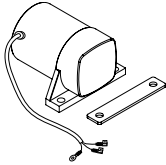

Vibrator attaches to the side of the Maxim's integrated hopper to keep fuel from bridging. Templates provided for both M175 or M250/M255 P models.

p/n	Description
9691	Hopper Vibrator Kit

### Auxiliary Auger Vibrator w/Timer Kit - Maxim

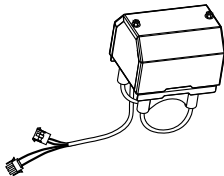

Vibrator is installed on the auxiliary auger connected to an external 43-bushel or 48-bushel hopper. For use with Auxiliary Auger Kits 2500007, 2500008 and 2500009 only. Vibration occurs based on timer setting.

p/n	Description
9458	Auxiliary Auger Vibrator w/Timer Kit

### Transfer Auger with Fuel Door Assembly Kit - M175

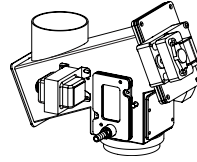

Kit includes transfer auger assembly with fuel door to reduce pellet consumption in low mode, allow the furnace to operate more efficiently and help prevent the condition in which the water suppression valve opens.

p/n	Description
2500073	Transfer Auger with Fuel Door Assembly Kit - M175

### Hopper Kit with Fuel Door - M250/M255 P

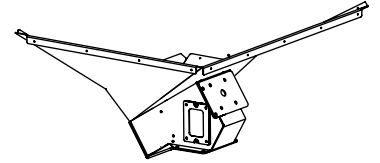

Kit includes hopper assembly with fuel door to reduce pellet consumption in low mode, allow the furnace to operate more efficiently and help prevent the condition in which the water suppression valve opens.

p/n	Description
2500050	Hopper Assembly with Fuel Door Kit - M250/M255 P

### Clean Out Kit, Battery - Maxim

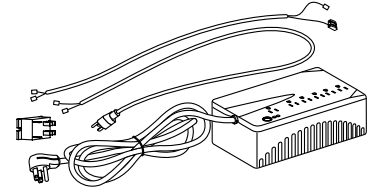

Provides power to clean out the burner auger in the event of a back burn condition during a power failure. Kit includes UPS, wiring, relay and brackets for M175 and M250/M255 P.

**NOTE: Not for use with Maxim M255 PE models.**

p/n	Description
2500005	Battery Clean Out Kit
2500143	Backup Battery Replacement

# Outdoor Furnace Products

## WATER TREATMENT / FIREBOX PROTECTION

### MolyArmor 350 Corrosion Inhibitor



MolyArmor 350 Corrosion Inhibitor provides excellent water jacket corrosion protection when properly maintained at a minimum of 350 ppm. It is easy to test for maintenance levels with a test kit (p/n 2500691). One gallon of MolyArmor 350 Corrosion Inhibitor treats 200 gallons of system water.

Models	Initial MolyArmor 350 Amount
Maxim M255 PE	1 gal.
Classic Edge 360, 560, CL 4030, 5036	1.5 gal.
Forge 1500	1.5 gal.
Classic Edge 760, CL 6048, ECL 3250, Forge 3500	2.5 gal.
Classic Edge 960, Pallet Burner	3.5 gal.
CL 7260	4.5 gal.

p/n	Description
2900630	MolyArmor 350 Corrosion Inhibitor

### Moly/pH Single Strip Test Kit



Test Kit for testing your furnace water when treated with MolyArmor 350 Corrosion Inhibitor. Test kit is a vial of 25 strips that only requires a single test strip for testing both pH and Moly. Instructions are provided on the label of the kit bottle.

Note that timing is important when checking the test pad to the color chart.

p/n	Description
2500691	Moly/pH Single Strip Test Kit

### Water Test Kit



Water Test Kits and replacement items for testing your furnace water ONLY if treated with 1650XL and MolyBoost. Complete kits include pH test strips.

p/n	Description
598	Water Test Kit, Complete
2900617	Ferrioin Indicator
2900618	CAN Solution
153	Litmus Paper

### Sludge Conditioner



Reduces mineral deposits in boiler side of water-to-water heat exchangers. Can be used as a preventative when filling the furnace or as a rescue treatment if corrosion occurs in the water jacket due to improperly maintained Corrosion Inhibitor levels.

Refer to following chart for the amount to use for each model furnace for preventative or rescue treatment applications. Note that 1 unit = 1 gallon.

**PREVENTATIVE IN HARD WATER:** While it is best to use softened water when filling the furnace, Sludge Conditioner should be used if the water quality is known to contain higher concentrations of minerals or solids.

**RESCUE TREATMENT FOR CORROSION:** If a furnace has been subjected to low Corrosion Inhibitor levels and corrosion is evident in the water jacket, Sludge Conditioner can be used by circulating through the furnace for one week to help clean some of the corrosion from inside the water jacket before flushing and refilling.

Models	Preventative Amount	Rescue Amount
Classic Edge 350/360 CL 4030, Forge 1500	1/2 unit	1 unit
Classic Edge 550/560, 750/760 E-Classic 1400, 1450, 2300, 2400 CL 5036, CL 6048, Forge 3500	1 unit	2 units
Classic Edge 960, E-Classic 3200, 3250 CL 7260, Pallet Burner	2 units	4 units

p/n	Description
166	Sludge Conditioner, 1 gal.

### Ashtrol

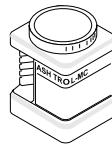

Used as a furnace firebox pH modifier.

p/n	Description
297	Ashtrol, 6.25 lbs

### Water Sample Bottle Kit



Used to submit required water samples for Titanium model furnaces. Each kit includes two bottles, two shipping boxes, and two generic mailing labels. Includes instructions.

p/n	Description
2500415	Kit, Water Sample Bottle

### Cartridge, Water Softener



For single use in filling water jacket, Water Softener Cartridge has 5,000 grains of removal capacity. For average water with 10 grains hardness, will treat 500 gallons water. May also be connected together to increase removal capacity.

p/n	Description
1310	Water Softener Cartridge

### Sediment Trapper Filter, Hot Water, 3/4"

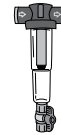

Centrifugal separation technology and 100 mesh filter element. Amber see-through cover easily removable for cleaning using no tools. Bottom valve used to empty sediment. Stainless steel screen filter is cleanable and reusable.

Rated to 200°F (93°C) @ 40 psi. Dimensions: 14-3/8" L x 5" W. Port size: 3/4" FPT.

p/n	Description
2900578	Hot Water Sediment Trapper Filter, 3/4" FPT
5000683	O-Ring, Replacement, for Hot Water Filter (p/n 2900578)

### CS-25 Alkalinity Builder



CS-25 Alkalinity Builder is an additive for increasing the alkalinity (pH) of systems that have been treated with propylene glycol antifreeze if MolyArmor 350 has achieved 350+ ppm moly but the pH of the treated system water is lower than 8.0.

To use, add 32 ounces of CS-25 Alkalinity Builder, circulate at operating temperature for 48 hours and test pH again. Repeat as needed, adding 32 ounces at a time and circulating for 48 hours before testing again.

If the system was NOT treated with propylene glycol antifreeze, MolyArmor 350 was added to achieve 350+ ppm moly, and the pH is lower than 8.0, drain the system. Then use makeup water from an alternate source that is within the recommended level of 6.5 - 8.0 pH before being treated with MolyArmor 350.

p/n	Description
2900667	CS-25 Alkalinity Builder, 1-gallon

# Outdoor Furnace Products

## TOOLS

### PEX Pipe Cutter

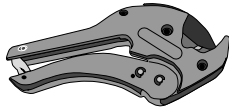

Designed for smooth, even cutting, the tool's jaw fits firmly over the pipe for a square, burr-free cut.

**p/n Description**  
2900619 PEX Pipe Cutter

### Cinch Tool

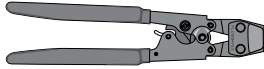

Tool for cinching 1" and 1/2" PEX Stainless Steel Clamp Crimp Rings to PEX pipe. Not for use with any other application.

**p/n Description**  
5925 Cinch Tool

### Ratchet Cinch Tool

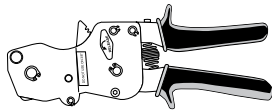

Compact, easy-to-use Ratchet Cinch Tool comes with calibrating device. For use with 5927, 5926 and 5000465 crimp rings.

**p/n Description**  
4472 Ratchet Cinch Tool

### Clamp Crimp Ring Removal Tool

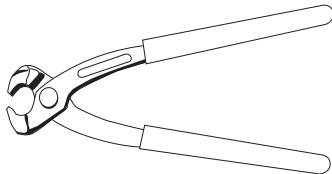

Used to remove PEX stainless steel clamp crimp rings (p/n 5927, 5926 and 5000465).

**p/n Description**  
2900737 Clamp Crimp Ring Install/Removal Tool

### PEX Piping Clip Gun

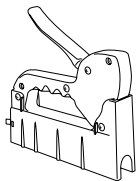

Used to secure 1/2" PEX pipe. Clips sold separately.

**p/n Description**  
2900002 PEX Piping Clip Gun

### Decoiler

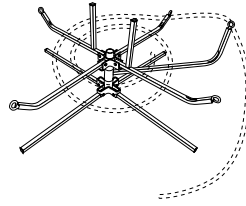

Useful when uncoiling and installing 1/2" tubing.

**p/n Description**  
1323 Decoiler

### Plug, Pipe - Wrench Set

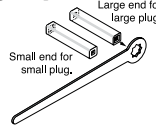

Large end is for 1-1/4"; small end fits 3/4" pipe plugs.

**p/n Description**  
5459 Pipe Plug Wrench Set

### Fin Comb

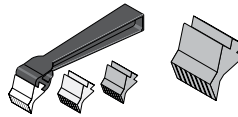

Tool with six interchangeable heads for straightening fins on water-to-air heat exchangers. For all units with 8, 9, 10, 11, 12 and 14 fins per inch.

**p/n Description**  
5918 Fin Comb

### Torch, Outdoor



Torch design allows easy starting of the fire in Classic Edge, E-Classic and Maxim models.

**p/n Description**  
2900325 Outdoor Torch

### Wood Moisture Meter, Mini 3-in-1



Measures accurately the moisture level of wood with a range of 6% - 42%, and the ambient temperature (°C/°F). Mini in size and portable for field works, very easy to operate and delivers accurate readings instantly.

**p/n Description**  
2900393 Wood Moisture Meter, Mini 3-in-1

### Multimeter, Digital Pocket



Digital multimeter performs several electrical measurement functions in one simple-to-use instrument.

**p/n Description**  
2657 Digital Pocket Multimeter

### Crimp Tool, Universal

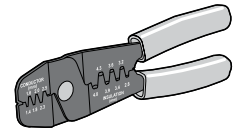

Used to crimp terminals. For 14-24 AWG wires.

**p/n Description**  
2900341 Universal Crimp Tool, 14-24 AWG

### Pin Extraction Tool

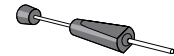

Tool for removing contact pins from behind connector blocks on E-Classic models.

**p/n Description**  
2656 Pin Extraction Tool

### Chimney Cleaning Kit - 6"

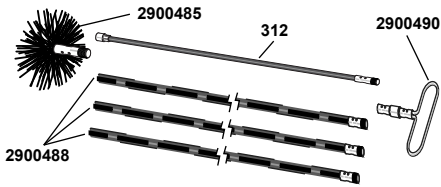

Kit for cleaning both the horizontal and vertical portions of all 6" chimneys. Includes components shown above. Replacement components may be purchased individually.

p/n	Description
2500738	Chimney Cleaning Kit, 6"
2900485	6" Chimney Brush
312	Extension Rod, 48" Fiber
2900488	Extension Rod, 48" Wire
2900490	Handle

### Chimney Cleaning Kit - 8"

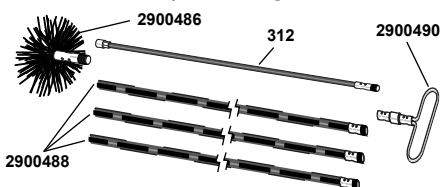

Kit for cleaning both the horizontal and vertical portions of all 8" chimneys. Includes components shown above. Replacement components may be purchased individually.

p/n	Description
2500739	Chimney Cleaning Kit, 8"
2900486	8" Chimney Brush
312	Extension Rod, 48" Fiber
2900488	Extension Rod, 48" Wire
2900490	Handle

### Cleaning Tool, Afterburner

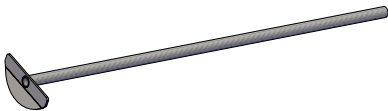

Tool for cleaning Afterburner and Reaction Chamber on Classic Edge HDX models.

p/n	Description
1200897-011	Afterburner Cleaning Tool

### Cleaning Tool, Heat Exchanger



Tool for cleaning multiple areas on Classic Edge models.

p/n	Description
3105186-011	Heat Exchanger Cleaning Tool

### Ash Shovel, Reaction Chamber

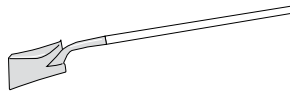

Flat shovel is used to remove ash. The shovel head angle allows for cleaning to the back of the Reaction Chamber on E-Classic and Classic Edge models.

p/n	Description
2900535	Ash Shovel

### Ash Shovel - E-Classic

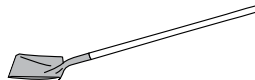

Used to remove ash from E-Classic models.

p/n	Description
1970	Ash Shovel

### Ash Shovel - Classic

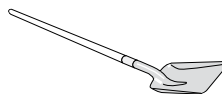

Used for removing ash from Classic models.

p/n	Description
299	Ash Shovel

### Ash Rake - Classic



Long, metal-handled ash rake is used to pull coals forward and to stir ashes in Classic models.

p/n	Description
300	Ash Rake

### Scraper Tool

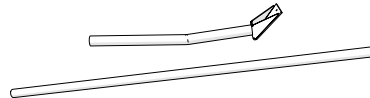

Used to maintain and clean the firebox.

p/n	Description
2900534	Scraper Tool

### Hoe, Firebox - Classic

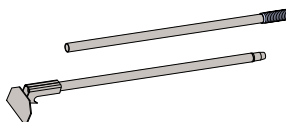

Used as a firebox maintenance tool for Classic models; hoe comes with metal handle.

p/n	Description
2900001	Hoe, Firebox, 72"

### Flue Brush & Handle

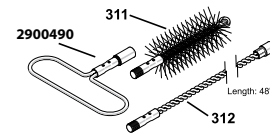

Used to clean the flue passageways of E-Classic 2300 and M175 models. Flue Brush Kit (p/n 310) includes 311, 312 and handle. Not to be used for cleaning 6" or 8" chimney.

p/n	Description
310	Flue Brush Kit
311	Flue Brush Only
312	Extension Rod, 48"
2900490	Replacement Handle

### Flue Brush & Handle Kit



Used to clean the flue passageways of E-Classic 2400 models and of Maxim M250/M255 P models. Flue Brush Kit (p/n 390) includes 398, 312 and handle. Not to be used for cleaning 6" or 8" chimney.

p/n	Description
390	Flue Brush Kit
312	Extension Rod, 48"
398	Flue Brush
2900490	Replacement Handle

### Scraper, Heat Exchanger - E-Classic



Used to clean the flue passageways of E-Classic models.

p/n	Description
2000128	Heat Exchanger Scraper, E-Classic 3200
2000127	Heat Exchanger Scraper, E-Classic 1450

### Cleaning Rod - Classic Edge / E-Classic



Used to clean the firebox.

p/n	Description
2001235	Cleaning Rod, Tempered, 5/8"

### Cleaning Rod - Maxim



Used to clean the firebox.

p/n	Description
317	Cleaning Rod

# Outdoor Furnace Products

## TOOLS

### Integrated Cleaning System - Classic Edge

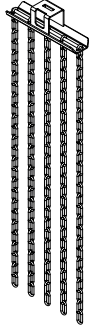

Installed in the heat exchanger and used with Cleaning Rod (p/n 9439) to clean heat exchanger in Classic Edge models without rear cleanout door.

p/n	Description
2500374	Integrated Cleaning System, Classic Edge 350/550
2500375	Integrated Cleaning System, Classic Edge 750

### Cleaning Rod Scraper Attachment - Classic Edge / E-Classic

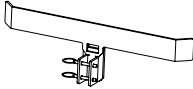

Attaches to the Cleaning Rod (p/n 9439) for cleaning the refractory slot.

p/n	Description
2500198	Cleaning Rod Scraper Attachment

### Ash Scoop - Maxim

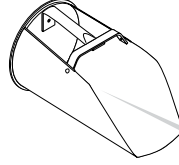

4-Quart galvanized Ash Scoop is ideal for cleaning ashes from furnace.

p/n	Description
315	Ash Scoop

### Solder & Soldering Flux



Low melting-point solder for easier soldering. Soldering flux includes brush. Use for easier soldering of copper sweat fittings.

p/n	Description
1325	Solder
100	Soldering Flux (6 oz)

### Brush, Cleaning

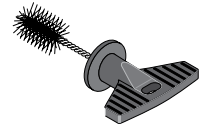

For cleaning the inside of copper fittings.

p/n	Description
378	Cleaning Brush, 3/4"
379	Cleaning Brush, 1"

### Clamp, Rubber

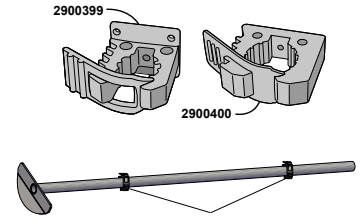

Rubber Clamps mount with a bolt and hold cleaning tools.

Accessory for holding cleaning tools. Available in two sizes. Price is for one clamp. Mounts with bolts or screws (not included).

p/n	Description
2900399	Rubber Clamp, Quick Fist, 0.63"-1.38"
2900400	Rubber Clamp, Quick Fist, 1.00"-2.25"



# Outdoor Furnace Products

## DOOR & RELATED

### Draft Inducer

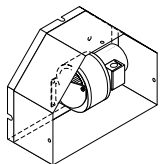

Bolts to existing draft hood (fan included). Must use 5-A fuse. Do not use CL 7260 High-Output fan (p/n 5549 or 2500640) if a burner has been installed on the outdoor furnace. The 203 Blower & Motor, 1/15-hp can be used if a fan only is needed for the high output draft inducer (p/n 5549 or 2500640). Draft Inducer (p/n 700) - 180 cfm; Draft Inducer (5549 and 2500640) - 450 cfm.

Draft inducer applications:

- Side Draft (p/n 400) - up to s/n 13427
- Ripple Front Door (p/n 500) - s/n 13428-19125
- Flat Front Cast Door (p/n 700) - s/n 19126 and later; non-Titanium models 4030 (s/n CL401000-CL401039), 5036 (s/n CL501000-CL501229), 6048 (s/n CL601000-CL601231); not for use with Titanium models
- Flat Front Steel Door (p/n 2500390)
- Draft Inducer for non-European Pallet Burner firebox door (p/n 5247) includes fan; does NOT include fuses. Side Draft Inducer for Pallet Burner (p/n 9623) includes fan

p/n	Description
400	Draft Inducer, Side Draft
500	Draft Inducer, Ripple Front Door

**NOTE: If there is no inner shield on the inside of the draft opening, it will be necessary to install Inner Shield Kit (p/n 553) before installing the Draft Inducer Kit (p/n 500).**

553	Inner Shield Kit
700	Draft Inducer, Flat Front Door

#### CL 4030 / 5036 / 6048

2500390 Draft Inducer, Flat Front Steel Door, CL 4030, 5036, 6048

#### CL 7260

6576	Draft Inducer, Cast Door, CL 7260 Dual Fuel (w/fuses)
5549	Draft Inducer, Cast Door, CL 7260 High Output
2001046	Draft Inducer, Steel Door, CL 7260
2500640	Draft Inducer, Steel Door, CL 7260 High Output

**NOTE: CL 7260 steel door draft inducers listed currently are only for doors with angled damper lids.**

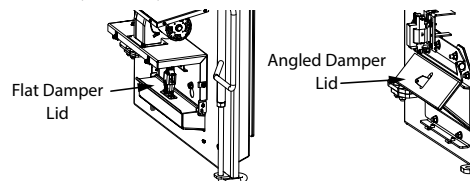

203 Replacement fan for High Output Draft Inducer (p/n 5549, 2500640) only

#### Pallet Burner

p/n	Description
2001050	Draft Inducer, Steel Door, Pallet Burner
5247	Draft Inducer, Pallet Burner firebox door
9623	Side Draft Inducer, Pallet Burner

Draft Inducer Replacement Fan applications:

- **Combustion Fan (p/n 5009)** - Replacement combustion fan without connectors for Draft Inducer kit# 500. For furnace models with recessed cast doors only.
- **Combustion Fan (p/n 11606)** - Replacement combustion fan with wiring for Classic/Pallet Burner cast door draft inducer kits 700, 6494, 6576, 5247 and Classic/Pallet Burner steel door draft inducer kits 2500390, 2001046, 2001050.
- **Combustion Fan (p/n 11618)** - Replacement combustion fan for Draft Inducer kit# 5549 or 2500640.
- **Combustion Fan (p/n 2000737)** - Replacement combustion fan for draft inducer kits 400 and 9623.

**NOTE: On E-Classic 2300 models with s/n E17807 and earlier, connector will need to be removed.**

p/n	Description
5009	Combustion Fan w/out Connectors
11606	Combustion Fan w/Wiring
11618	Combustion Fan
2000737	Combustion Fan Assembly

### Door Seal Kits - Classic Edge/E-Classic

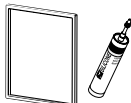

Door Seal Kits include silicone-coated fiberglass door seal, black silicone and instructions.

p/n	Description
2500697	Door Seal Kit - Classic Edge 350/360/ 550/560
2500698	Door Seal Kit - Classic Edge 750/760
2500698	Door Seal Kit - Classic Edge 960
2500698	Door Seal Kit - E-Classic 2300, 2400/3200/3250
2500697	Door Seal Kit - E-Classic 1400/1450
4050036	Foam Bumper Pad, Door Switch - Classic Edge and Forge models
806	Black Silicone

### Door Seal, Silicone-Coated, 100-ft



Silicone-coated 7/8" Door Seal is available in 100-foot lengths. Minimum lengths for Classic Edge models: 360=71", 560=79", 760=99", 960=106".

p/n	Description
6000064	Door Seal, Silicone-Coated, 7/8", 100-ft

### Door Seal Kits - Classic/Pallet Burner

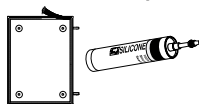

Kit includes Door Seal Rope cut to length and Black Silicone Adhesive.

p/n	Description
363	Door Seal Kit - Classic Models (except CL 7260), Forge models
364	Door Seal Kit - CL 7260
365	Door Seal Kit - Pallet Burner

### Rope, Door Seal

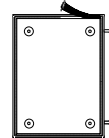

Sold either by the foot or in pre-cut lengths for specific model applications. Silicone is not included.

**NOTE: For CL 4030 and 5036 models, Door Seal Rope (p/n 360) should be cut to 8 feet before installing.**

p/n	Description
7674	Rope, 7/8", priced per ft
7594	Door Seal Rope, 1", priced per ft
360	Door Seal Rope, 7/8", 9' for CL 4030, 5036, 6048, Forge models
361	Door Seal Rope, 1", 12' for CL 7260
367	Door Seal Rope, 1", 23' for Pallet Burner

### Rope, Door Seal and Chimney Transition Box Cover - Maxim



Rope may be used for door seal or chimney transition box cover seal (each requires a 5-ft section). Sold by the foot. Silicone is not included.

p/n	Description
809	Door Seal Rope, 3/4", priced per ft

### Linkage



Linkage between the solenoid and damper control. Each linkage comes complete with cotter pins.

p/n	Description
2500053	Spring-Assisted Linkage, All Linkage Models
6145	Spring, Replacement for 2500053

### Clip, Latch Spring



Replacement latch spring clips for rear panels and Reaction Chamber panel.

p/n	Description
4357	Latch Spring Clip

### Solenoid

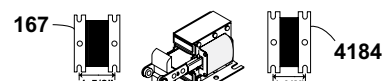

Because damper control solenoids are not interchangeable, check measurement and application dates carefully. Solenoid (p/n 167) is for pre-June 2000 Classic models. Solenoid (p/n 4184) is for models after June 2000 including all E-Classic models.

p/n	Description
167	Solenoid, 1-5/8" center-to-center bracket hole
4184	Solenoid, 1-3/8" center-to-center bracket hole

# Outdoor Furnace Products

## GAS RELATED

### Dual Fuel Burner Kits and Components

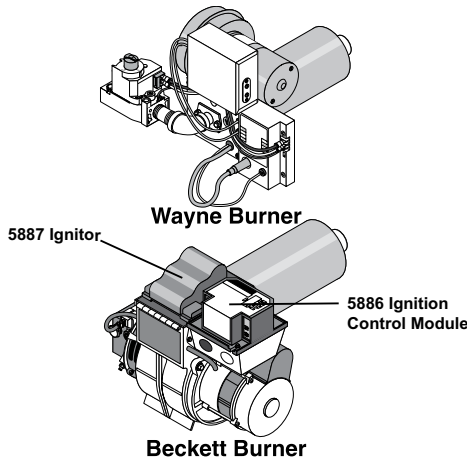

Gun-type burners are set up to Central Boiler's specifications. Kits include everything needed to mount the burner on the furnace.

### Dual Fuel Kits

These kits are for Classic outdoor wood furnace models with a serial number after 35515 and Hydofire models after HF101414. For models prior to these serial numbers, refer to the Retro Dual Fuel Kits below for the proper application.

p/n	Description
6834	Beckett Burner Kit, oil*
6833	Wayne Burner Kit, LP*
6843	Wayne Burner Kit, LP**

\*For all models except CL 7260 \*\*For CL 7260

### Gas Burner Kits - E-Classic

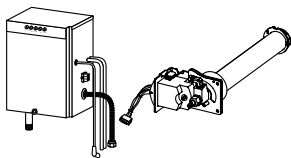

Optional LP gas burner for E-Classic 1400 IR, 1450 IR, 2400 IR and 3200 IR models.

p/n	Description
2500002	LP Gas Burner Kit, E-Classic 1400 IR Models
2500000	LP Gas Burner Kit, E-Classic 1450 IR Models
2500011	LP Upper Burner Kit, E-Classic 2300
2500003	LP Gas Burner Kit, E-Classic 2400 IR Models
2500004	LP Gas Burner Kit, E-Classic 3200 IR Models

### Conversion Kit, Natural Gas - E-Classic

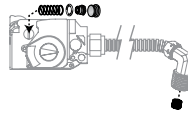

Converts E-Classic IR models with an optional LP gas burner (see E-Classic Gas Burner Kits) from propane to natural gas.

p/n	Description
2500001	Natural Gas Conversion Kit, E-Classic IR Models

### Conversion Kit, Natural Gas - E-Classic

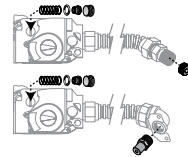

Converts original burners on E-Classic 2300 models from propane to natural gas (will not work with replacement burner kit 2500011).

p/n	Description
10598	Natural Gas Conversion Kit

### Conversion Kit, Natural Gas - E-Classic

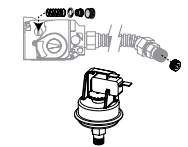

Converts E-Classic 1400 or 2400 models from propane to natural gas.

**NOTE: NG Conversion Kit only needed for gas burner kits sold before Dec. 1, 2010. After that date, complete gas burner kits are available.**

p/n	Description
10588	Natural Gas Conversion Kit, E-Classic 1400/2400

### Gasket, Ignitor Burner

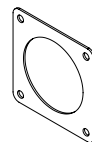

Replacement ignitor burner gasket for E-Classic 2300 models.

p/n	Description
8838	Ignitor Burner Gasket

### Regulator Kit, 2-Stage Gas

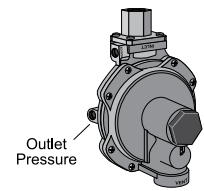

Regulates the gas pressure from an LP tank. For E-Classic and Maxim models.

p/n	Description
1930	2-Stage Gas Regulator Kit

### Hose w/Regulator, Propane - Maxim

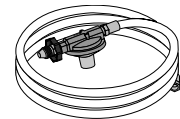

For use with M175 models only. Not recommended for use in cold weather.

p/n	Description
5567	Gas Hose w/Regulator

### Shut-off with Level Indicator, Propane - Maxim

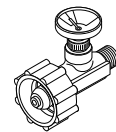

Used to monitor propane in a BBQ-style tank with Type 1 Acme threads connected to a Maxim furnace.

p/n	Description
4220	Propane Shut-off with Level Indicator

### Valve, Gas Burner

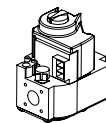

p/n	Description
10473	Gas Burner Valve

### Ignition Module, Gas

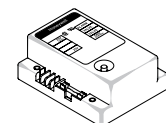

Replacement gas ignition module for Maxim and E-Classic models.

p/n	Description
2500088	Gas Ignition Module

# Outdoor Furnace Products

## CHIMNEY

### Chimney Sections, 8" - Classic

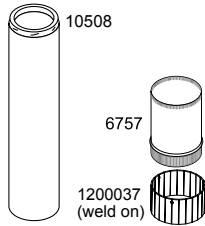

Type HT listed, factory-built, all stainless steel chimney section. If connecting to Chimney Extension (p/n 6500002), use 8" Chimney Band Clamp Kit (p/n 4518) at the joints, not Chimney Snaplock Clamp (p/n 10509). Sections are four feet long. The 8" Chimney Ring (p/n 1200037) is required for Classic furnaces with the square chimney box (requires welding to the furnace).

**NOTE: Classic furnaces with a square chimney box prior to s/n 28876 require a Chimney Conversion Adapter (p/n 6757).**

p/n	Description
10508	8" Chimney Extension, 4'
6757	Chimney Conversion Adapter, 8"
1200037	Chimney Weld Ring, 8"

### Chimney Sections, 8" - Classic Edge 750/760/960, E-Classic

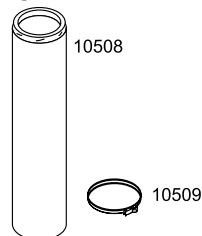

8" Stainless steel chimney currently shipped with Classic Edge 760 and 960 models and E-Classic models (except ECL 1450). Shipped with ECL 1400 since s/n E100299 and E-CL 2300 since s/n E17856. Compatible with Chimney Extension (p/n 6500002). If connecting to Chimney Extension (p/n 6500002), use 8" Chimney Band Clamp Kit (p/n 4518) at the joints, not Chimney Snaplock Clamp (p/n 10509). For outdoor applications only. Not to be used for venting of indoor heating appliances.

p/n	Description
10508	8" Chimney Extension, 4'
10509	Chimney Snaplock Clamp, 8"

### Chimney Sections, 6" - Classic Edge 350/360 and 550/560, E-Classic 1450, Forge 1500/3500

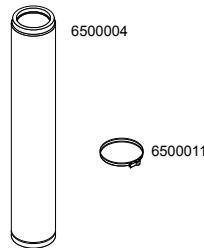

Type HT listed, factory-built, all stainless steel 6" chimney section. Sections are four feet long. Chimney Snaplock Clamp (6500011) should be used at each joint.

p/n	Description
6500004	6" Chimney Extension, 4'
6500011	Chimney Snaplock Clamp, 6"

### Chimney Sections, 6" - Maxim

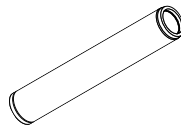

Type HT listed, factory-built, all stainless steel 6" chimney section. Sections are four feet long. Chimney Snaplock Clamp (6500011) should be used at each joint.

p/n	Description
6500004	6" Chimney Extension, 4'
6500011	Chimney Snaplock Clamp, 6"

### Chimney Cap/Spark Arrestor

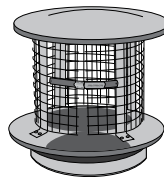

New version chimney cap/spark arrestor provides better fit, features a snaplock clamp and screen that is secured with a clamp-on fastener for easy removal. Available for 6" and 8" chimneys.

p/n	Description
2900597	6" Chimney Cap, Spark Arrestor
2900598	8" Chimney Cap, Spark Arrestor

### Chimney Band Clamp Kit, 6"



Reinforces strength between two sections of 6" chimney.

p/n	Description
9535	Chimney Band Clamp Kit, 6"

### Chimney Band Clamp Kit, 8"

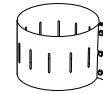

Reinforces strength between two sections of 8" chimney.

p/n	Description
4518	Chimney Band Clamp Kit, 8"

### Chimney Attachment Ring

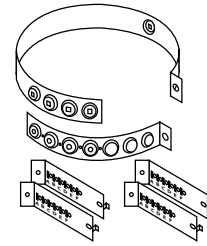

Used with electrical conduit (not included) to reinforce chimney when five or more sections are used. For 6" chimneys, must be located directly below 6" Chimney Locking Band (p/n 6500011) to reduce stress on the joint. For 8" chimneys, must be located directly below 8" Chimney Locking Band (p/n 10509) to reduce stress on the joint.

p/n	Description
774	Chimney Attachment Ring

### Chimney Guy-Wire Band, 6"

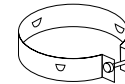

Attached to the outer casing of a 6" chimney to hold three guy-wires (not included). Recommended for chimneys exceeding the roof by 5' to 13' maximum.

p/n	Description
776	Guy-Wire Band

### Chimney Guy-Wire Band Kit, 8"



Used to provide additional stability to chimneys in installations where property damage could occur within the fall zone of the chimney. Guy wire is not included in kit.

p/n	Description
778	Chimney Guy-Wire Band Kit

# Outdoor Furnace Products

## CHIMNEY

### Chimney Base Brace Kit, 6"



Used to reinforce the chimney base when three or more chimney sections are used.

p/n	Description
2500044	Chimney Base Brace Kit, 6"

### Chimney Base Brace Kit, 8"

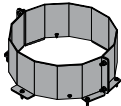

Used to reinforce the chimney base when three or more chimney sections are used.

p/n	Description
4519	Chimney Base Brace Kit, 8"

### Chimney Components

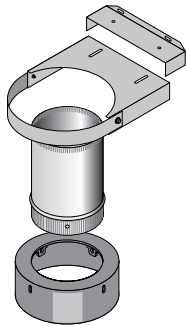

Chimney Adapter Kit (p/n 10895) converts CL 7260 and Pallet Burner models to the 8" Chimney Extension (p/n 10508). The conversion will require three Chimney Extensions (p/n 10508).

#### Chimney Extension Components

p/n	Description
10895	Chimney Adapter Kit, 10" to 8", For Pallet Burner and CL 7260 models
6172	Elbow, 8", 45-degree

### Chimney Tee Kits, Stainless Steel

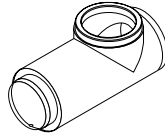

Type HT listed, factory-built, all stainless steel chimney tee. Kit includes chimney tee cover and chimney tee rope rings. NOTE: Silicone (p/n 806) is not included.

**10" Chimney Tee Kit (p/n 11605)** - Classic CL 7260 and Pallet Burner.

**8" Chimney Tee Kit (p/n 2500621)** - Classic Edge 750/760/960.

**8" Chimney Tee Kit (p/n 2500245)** - E-Classic 3200, 3250.

**8" Chimney Tee Kit (p/n 2500433)** - E-Classic 1400, 2300, 2400, Classic CL 4030, 5036, 6048.

**6" Chimney Tee Kit (p/n 2500620)** - Classic Edge 350/360, 550/560.

**6" Chimney Tee Kit (p/n 2500244)** - Forge 1500, 3500.

**6" Chimney Tee Kit (p/n 2500416)** - E-Classic 1450.

p/n	Description
11605	10" Chimney Tee Kit
2500621	8" Chimney Tee Kit
2500245	8" Chimney Tee Kit
2500433	8" Chimney Tee Kit
2500620	6" Chimney Tee Kit
2500244	6" Chimney Tee Kit
2500416	6" Chimney Tee Kit

### Chimney Support Brace Kit

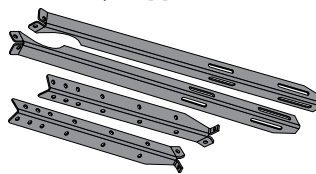

Reinforces strength of chimney support when several chimney sections are used. For use only with CL 4030, CL 5036 and CL 6048 models.

p/n	Description
4554	Chimney Support Brace Kit

### Chimney Support Brace Kit

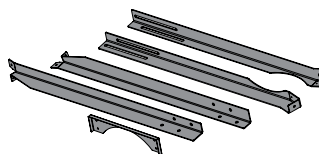

Reinforces strength of chimney support when several chimney sections are used. For use only with CL 7260 and Pallet Burner models.

p/n	Description
8402	Chimney Support Brace Kit

### Chimney Tee Restrictor Kit

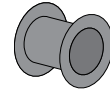

Installed in chimney tee to lower the burn rate. For use only with CL 4030, CL 5036 and CL 6048 models.

p/n	Description
10970	Chimney Tee Restrictor Kit

### Chimney Tee Covers

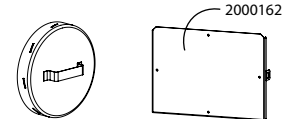

Replacement chimney tee covers. Chimney Tee Cover (p/n 2000162) is for E-Classic 1450 models with serial number E102543 and earlier; Chimney Tee Cover (p/n 2900319) is for E-Classic 1450 models with serial number E102544 and later.

p/n	Description
6165	10" Cover for Chimney Tee (p/n 11605)
10775	8" Cover for Chimney Tees (p/n 2500433, 2500245, 2500621)
2000162	Square Chimney Tee Cover, E-Classic 1450
2900319	6" Cover for Chimney Tee (p/n 2500244, 2500416, 2500620)

### Chimney Rope Ring

Replacement rope ring for chimneys. See table below for applications. When ordering p/n 809, 7674 or 7594, specify the length in feet.

Model	Rope Ring part number	
	Between chimney connector and furnace	Below first chimney section
ECL 1400	6000033	7632
ECL 1450	6000034	7674 (order 2 ft)
ECL 2300	6000033	7632
ECL 2400	6000033	7632
ECL 3200	6000033	7632
CL 4030	6000033	7632
CL 5036	6000033	7632
CL 6048	6000033	7632
CL 7260	7674 / 7594 (order 3 ft of each)	7632
Classic Edge 750/760/960	6000033	7632
Classic Edge 350/360 550/560	6000034	809 (order 2 ft)
Forge 1500/3500	6000034	809 (order 2 ft)

p/n	Description
6000033	Rope Ring (only), 2" Low Density Braid, 8" I.D.
6000034	Rope Ring (only), 1.75" Low Density Braid, 6" I.D.
7632	Rope Ring, 3/4", 8" ID
809	Door Seal Rope, 3/4", priced per ft
7674	Rope, 7/8", per foot
7594	Rope, 1", per foot

# Numerical Parts List

0020-051	Plate Exchanger, 4.57 x 11.26-20, 1" Port . . . . .	8	300	Ash Rake . . . . .	31
0020-186	Nipple, Brass, 1" x 2" . . . . .	18	301	Air Handler Cabinet, 100k-140k Btu, front access . . . . .	7
0020-366	Isolation Flange, 1" . . . . .	14	303	Air Handler Cabinet, 185k-220k Btu, front access . . . . .	7
0020-377	Aquastat, Strap-on . . . . .	25	306	Radiant Mixing Valve, 1/2" NPT fittings . . . . .	24
100	Soldering Flux (6 oz) . . . . .	32	310	Flue Brush Kit . . . . .	31
102	Heat Exchanger Coil, 95k Btu . . . . .	5	311	Flue Brush Only . . . . .	31
103	Street Elbow, 1" . . . . .	20	312	Extension Rod, 48" . . . . .	31
105	Hex Bushing, 1-1/2" x 3/4" . . . . .	18	314	Nipple, 1-1/2" x close, Schedule 80, extra heavy . . . . .	18
106	Heat Exchanger Coil, 100k Btu . . . . .	5, 6	315	Ash Scoop . . . . .	32
107	Heat Exchanger Coil, 125k Btu, straight outlets . . . . .	5	317	Cleaning Rod . . . . .	31
108	Heat Exchanger Coil, 140k Btu . . . . .	5, 7	321	Space Heater Cabinet . . . . .	7
109	Heat Exchanger Coil, 80k Btu . . . . .	5	322	Fan . . . . .	6
110	Heat Exchanger Coil, 185k Btu . . . . .	5	323	Transition . . . . .	6
111	Heat Exchanger Coil, 220k Btu . . . . .	5, 6	325	Hex Bushing, 3/4" x 1/2" . . . . .	18
113	Replacement Head . . . . .	22	327	Radiant Mixing Valve, 3/4" NPT fittings . . . . .	24
116	Male Adapter, 3/4" sweat x 3/4" MIP fittings . . . . .	20	329	Radiant Mixing Valve, 1" NPT fittings . . . . .	24
117	Female Adapter, 3/4" sweat x 3/4" FIP fittings . . . . .	20	330	3-Way Valve, Brass 3/4" FIP . . . . .	22
118	Nipple, 3/4" x close, Schedule 80, extra heavy . . . . .	18	331	Pipe Plug, 3/4" . . . . .	18
119	Pump Flange Kit, 3/4" . . . . .	14	332	3/4" Round Pipe Cap . . . . .	18
120	Male Adapter, 1" sweat x 1" MPT fittings . . . . .	20	333	1-1/4" Round Pipe Cap . . . . .	18
123	90° Reducing Elbow, Copper Pipe, 1" x 3/4" sweat fittings . . . . .	20	340	Relay . . . . .	6
124	45° Street Elbow, 3/4" . . . . .	18	342	Switch, ON/OFF . . . . .	6
126	90° Street Elbow, Brass, 3/4" . . . . .	19	343	Snap Disc . . . . .	6
133	Tee, Black, 3/4" NPT . . . . .	18, 26	353	Louvers, fit Heat Exchanger Coil (p/n 111) . . . . .	6
138	Tee, Copper Pipe, 1" x 1" x 1" sweat fittings . . . . .	20	354	Louvers, fit Heat Exchanger Coil (p/n 108) . . . . .	6
140	Tempering Valve, 3/4" sweat fittings . . . . .	24	355	Louvers, fit Heat Exchanger Coil (p/n 106) . . . . .	6
145	Crimp Ring Tool, 1" . . . . .	12	360	Door Seal Rope, 7/8", 9' for CL 4030, 5036, 6048, Forge models . . . . .	33
146	Copper Coupling, 3/4" sweat x 3/4" sweat fittings . . . . .	20	361	Door Seal Rope, 1", 12' for CL 7260 . . . . .	33
147	Copper Coupling, 1" sweat x 1" sweat fittings . . . . .	20	363	Door Seal Kit - Classic Models (except CL 7260), Forge models . . . . .	33
153	Litmus Paper . . . . .	29	364	Door Seal Kit - CL 7260 . . . . .	33
154	Blower & Motor, 1/4-hp 3-speed fan . . . . .	6, 7	365	Door Seal Kit - Pallet Burner . . . . .	33
164	Female Adapter, 1" sweat x 3/4" FIP fittings . . . . .	20	367	Door Seal Rope, 1", 23' for Pallet Burner . . . . .	33
166	Sludge Conditioner, 1 gal. . . . .	29	368	Plug-in Thermostat . . . . .	25
167	Solenoid, 1-5/8" center-to-center bracket hole . . . . .	33	372	Vent Elbow, 3/4" x 3/4" sweat fittings . . . . .	20
169	Adjustable Aquastat with Well, 1/2" MPT . . . . .	25	376	Copper Cap, 1" . . . . .	15, 20
174	Temp. Gauge, 1/2" MPT . . . . .	15	378	Cleaning Brush, 3/4" . . . . .	32
175	Taco 006 Bronze Pump . . . . .	13	379	Cleaning Brush, 1" . . . . .	32
178	Reducing Tee, 1-1/2" x 1" x 1" sweat fittings . . . . .	20	380	Male Adapter, 1-1/4" barb x 1-1/4" MIP . . . . .	17
180	Hex Bushing, 3/4" x 1/8" . . . . .	18, 26	381	Brass Coupling, 1-1/4" barb x 1-1/4" barb . . . . .	11, 17
180	Hex Bushing, 3/4" x 1/8" . . . . .	26	382	Brass Elbow, 1-1/4" barb x 1-1/4" barb . . . . .	17
182	Baseboard Corner, Inside . . . . .	10	383	Pipe Plug, 1-1/4" . . . . .	18
183	Baseboard Corner, Outside . . . . .	10	385	Brass Hex Bushing, 1-1/2" x 3/4" . . . . .	18
186	Ball Valve, 1/2" . . . . .	22	386	PEX 1-1/4" Pipe, 328' . . . . .	11
188	24-Volt Transformer . . . . .	25	388	Hex Bushing, 1-1/4" x 3/4" . . . . .	18
191	Pool Aquastat, 1/2" NPT fitting . . . . .	25	390	Flue Brush Kit . . . . .	31
194	Pump Flange Kit, 1" . . . . .	14	395-011	Manifold . . . . .	15
198	Ball Valve, 3/4" Full Port - Lead Free . . . . .	22	398	Flue Brush . . . . .	31
199	Brass Hose Bib, 3/4" MPT . . . . .	22	399	Fixed Aquastat, 190°F . . . . .	25
200	Sweat Ball Valve, 3/4" x 3/4" sweat fitting - Lead Free . . . . .	22	400	Draft Inducer, Side Draft . . . . .	33
203	Blower & Motor, 1/15-hp . . . . .	7, 33	408	Hex Bushing, 1-1/2" x 1-1/4" . . . . .	18
204	Adjustable Aquastat . . . . .	25	409	Nipple, 1-1/4" x close, Schedule 80, extra heavy . . . . .	18
208	Blower & Motor, 1-hp, 3-speed fan . . . . .	7	410	Ball Valve, 1-1/4" . . . . .	22
211	Fan/Motor Assembly for 6771 . . . . .	7	411	90° Street Elbow, 1-1/4" . . . . .	19
224	"Free Floating" Flange Kit, 3/4" . . . . .	14	412	Hex Bushing, 1-1/4" x 1/2" . . . . .	18
225	Isolation Flange Kit, 1-1/4" . . . . .	14	415	Transition . . . . .	7
226	Isolation Flange with Drain Valve, 3/4" . . . . .	14	416	Transition . . . . .	6
230	Baseboard Joiner . . . . .	10	418	Tee, Black, 1-1/4" NPT . . . . .	18
231	Reducer, Copper Pipe, 1" x 3/4" sweat fittings . . . . .	20	500	Draft Inducer, Ripple Front Door . . . . .	33
232	Baseboard End Cap, Left . . . . .	10	515	Fan Center Relay . . . . .	25
233	Baseboard End Cap, Right . . . . .	10	533	Nipple, 3/4" x 2" . . . . .	18
234	Baseboard, Complete, 2' . . . . .	10	534	Nipple, 3/4" x 7" . . . . .	18
235	Baseboard, Complete, 3' . . . . .	10	535	Nipple, Brass, 3/4" x 2" . . . . .	18
236	Baseboard, Complete, 4' . . . . .	10	536	Nipple, Brass, 3/4" x 7" . . . . .	18
237	Baseboard, Complete, 5' . . . . .	10	542	O-Ring Set . . . . .	14
238	Baseboard, Complete, 6' . . . . .	10	553	Inner Shield Kit . . . . .	33
255	Tee, Copper Pipe, 3/4" x 3/4" x 3/4" sweat fittings . . . . .	20	555	Power Supply Cord, 48" . . . . .	14
270-0049	Nipple, Brass, 3/4" x close . . . . .	18	573	Y-Strainer, 1" Brass . . . . .	8
274	90° Street Elbow, 3/4" . . . . .	19	574	Pipe Plug, Brass 3/4" . . . . .	18
276	90° Elbow, Copper Pipe, 3/4" x 3/4" sweat fittings . . . . .	20	587	Multi-stage 24-Volt Thermostat . . . . .	25
277	90° Elbow, Copper Pipe, 1" x 1" sweat fittings . . . . .	20	588	Programmable 24-Volt Thermostat . . . . .	6, 25
286	Automatic Vent Valve . . . . .	24	598	Water Test Kit, Complete . . . . .	29
287	Heat Exchanger Coil, 50k Btu . . . . .	5	604	TRV II Valve Body and Head, 1/2" Vertical . . . . .	10
290	Fixed Aquastat, 175°F . . . . .	25	606	Push-fit Coupling, Straight, 1/2" x 1/2" . . . . .	21
293	PEX Hanger, 1/2" . . . . .	12	607	Push-fit Coupling, Straight, 3/4" x 3/4" . . . . .	21
295	PEX Hanger, 1" . . . . .	12	608	Push-fit Coupling, Straight, 1" x 1" . . . . .	21
296	Brass Swing Check Valve, 3/4" . . . . .	22	609	Push-fit Coupling, Reducing, 1" x 3/4" . . . . .	21
297	Ashtril, 6.25 lbs . . . . .	29	611	Push-fit Female Adapter, 1" x 1" FPT . . . . .	21
299	Ash Shovel . . . . .	31	612	Push-fit Male Adapter, 1" x 3/4" MPT . . . . .	21

# Numerical Parts List

613	Push-fit Elbow, 1" x 1"	21	3822	Kit for 301 - back water access	7
614	Push-fit Tee, 1" x 1" x 1"	21	3825	Kit for 303 - back water access	7
615	Push-fit Depth Gauge/Deburring Tool	21	3850	Tee, Brass, 3/4" NPT	18
616	Push-fit Disconnect Clip, 1/2"	21	3851	Brass Hex Bushing, 1-1/4" x 3/4"	18
617	Push-fit Disconnect Clip, 3/4"	21	4177	Power Cord (see note above)	27
618	Push-fit Disconnect Clip, 1"	21	4184	Solenoid, 1-3/8" center-to-center bracket hole	33
700	Draft Inducer, Flat Front Door	33	4220	Propane Shut-off with Level Indicator	34
704	Heat Exchanger Coil, 125k Btu, 90° outlets	5	4357	Latch Spring Clip	33
774	Chimney Attachment Ring	35	4472	Ratchet Cinch Tool	30
776	Guy-Wire Band	35	4518	Chimney Band Clamp Kit, 8"	35
778	Chimney Guy-Wire Band Kit	35	4519	Chimney Base Brace Kit, 8"	36
806	Black Silicone	33	4536	Hopper Extension Kit - Green	27
809	Door Seal Rope, 3/4", priced per ft	33, 36	4537	Hopper Extension Kit - Terra Brown	27
848	Motor Frame	6	4554	Chimney Support Brace Kit	36
849	Transition	6	4928	Brass Adapter, 3/4" female hose x 3/4" male pipe	19
851	Fan Blades	6	4929	Brass Adapter, 3/4" male hose x 3/4" male pipe	19
956	90° Elbow, 3/4" x 3/4" FPT	6, 19	5009	Combustion Fan w/out Connectors	33
1097	Universal 5x12 Plate Heat Exchanger Mounting Kit	8	5052	Indoor Water Temperature Indicator Kit	26
1247	Well, 1/2" NPT fitting	25	5247	Draft Inducer, Pallet Burner firebox door	33
1248	Well, Stainless Steel, 1/2" NPT fitting	25	5348	Cap, Brass, 3/4"	22
1267	Line Voltage Thermostat	25	5349	Washer, 3/4"	22
1280	Fan Motor	6	5367	Brass Coupling, 3/4" thread	19
1310	Water Softener Cartridge	29	5459	Pipe Plug Wrench Set	30
1311	Central PEX 1" Pipe, 100'	11	5549	Draft Inducer, Cast Door, CL 7260 High Output	33
1312	Central PEX 1" Pipe, 200'	11	5567	Gas Hose w/Regulator	34
1313	Central PEX 1" Pipe, 300'	11	5642	Brass Clamp Fittings, 1"	17
1314	Central PEX 1" Pipe, 500'	11	5643	Brass Clamp Fittings, 1-1/4"	17
1320	Central PEX 1/2" Pipe, 300'	11	5670	PEX 1-1/4" Pipe, 150'	11
1321	Central PEX 1/2" Pipe, 500'	11	5744	Plate Exchanger, 5 x 12-30, 1" Port	8
1322	Central PEX 1/2" Pipe, 1000'	11	5807-011	Plate Mounting Bracket	8
1323	Decoiler	30	5871	Brass Swing Check Valve, 1-1/4"	22
1324	PEX Adapter, 1" PEX x 1" MIP fittings	17	5907	Brass Pipe Union, 3/4"	18
1325	Solder	32	5908	Brass Pipe Union, 1"	18
1329	Manifold w/Valves, 3-Loop	15	5909	Brass Pipe Union, 1-1/4"	18
1330	PEX Adapter, 1" PEX x 3/4" MIP fittings	17	5918	Fin Comb	30
1331	PEX Adapter, 1" PEX x 3/4" or 1" sweat fitting	17	5925	Cinch Tool	30
1332	PEX Tee, 1"	17	5926	PEX Stainless Steel Clamp Crimp Ring, 1"	12
1333	PEX Coupling, 1"	11, 17	5927	PEX Stainless Steel Clamp Crimp Ring, 1/2"	12
1334	PEX 90° Elbow, Brass, 1"	17	5978	Central Boiler Clamp, 1"	12
1335	PEX Crimp Ring, 1"	12	6054	Temp. Gauge, 1/8" MPT	15
1336	PEX Adapter, 1/2" PEX x 3/4" MIP fittings	17	6145	Spring, Replacement for 2500053	33
1337	PEX Adapter, 1/2" PEX x 1/2" sweat fitting	17	6165	10" Cover for Chimney Tee (p/n 11605)	36
1338	PEX Tee, 1/2"	17	6172	Elbow, 8", 45-degree	36
1339	PEX Coupling, 1/2"	17	6557	Pipe Plug, Brass 1/2"	18
1340	PEX 90° Elbow, Brass, 1/2"	17	6576	Draft Inducer, Cast Door, CL 7260 Dual Fuel (w/fuses)	33
1341	PEX Adapter, 1/2" PEX x 1/2" MIP fittings	17	6593	Ground Rod Kit	26
1342	PEX Crimp Ring, 1/2"	12	6679	Female Adapter, 1/2" barb x 1/2" sweat fittings	17
1348	PEX Adapter, 1/2" PEX x 1/2" FIP fitting	17	6757	Chimney Conversion Adapter, 8"	35
1349	Manifold w/Valves, 2-Loop	15	6764	Brass Offset Tee, 4"	18
1350	Push-fit Temperature Gauge Fitting, 1" x 1/8" NPT	21	6782	Brass Diverter Tee, 1" x 1" x 1/2"	20
1360	PEX Piping Mounting Kit	12	6833	Wayne Burner Kit, LP*	34
1366	Pump Wall Mount Kit	14	6834	Beckett Burner Kit, oil*	34
1694	Y-Strainer, 1-1/4" Black	8	6843	Wayne Burner Kit, LP**	34
1695	Y-Strainer, 3/4" Brass	8	7594	Door Seal Rope, 1", priced per ft	33
1740	Thermostat Kit, 150°F	24	7594	Rope, 1", per foot	36
1745	Central Boiler Clamp, 1-1/4"	12	7632	Rope Ring, 3/4", 8" ID	36
1880	Manifold w/o Valves, 2-Loop	15	7674	Rope, 7/8", per foot	36
1885	Manifold w/o Valves, 3-Loop	15	7674	Rope, 7/8", priced per ft	33
1910	Fan Convactor, Corner, 7k Btu	6	8402	Chimney Support Brace Kit	36
1930	2-Stage Gas Regulator Kit	34	8838	Ignitor Burner Gasket	34
1938	Air Filter, 10" x 10" x 1"	6	9263	Push-fit Fittings Water Heater Kit	16
1940	Fan Motor	6	9264	Push-fit Connector, Straight, 3/4" x 3/4" MIP	21
1941	Fan Convactor, Wall Mount, 7k Btu	6	9265	Push-fit Elbow, 3/4" x 3/4"	21
1949	Grab Catch	6	9458	Auxiliary Auger Vibrator w/Timer Kit	28
1970	Ash Shovel	31	9535	Chimney Band Clamp Kit, 6"	35
1971	Fan Convactor, 26k Btu	6	9623	Side Draft Inducer, Pallet Burner	33
2053	Fittings Kit	16	9624	Tee, Brass, 3/4"	18
2441	ThermoPEX, 1", 100' Roll	11	9660	48-Bushel Hopper Kit - Terra Brown and Taupe	27
2443	ThermoPEX Cap, 1"	11	9691	Hopper Vibrator Kit	28
2447	ThermoPEX Coupling Kit, 1"	11	9760	48-Bushel Hopper Kit - Green and Olive Gray	27
2491	ThermoPEX, 1", 800' Roll	11	9804	Bag Holder Kit	28
2492	ThermoPEX, 1-1/4", 300' Roll	11	10473	Gas Burner Valve	34
2494	ThermoPEX Cap, 1-1/4"	11	10508	8" Chimney Extension, 4'	35
2495	ThermoPEX Coupling Kit, 1-1/4"	11	10508	8" Chimney Extension, 4'	35
2656	Pin Extraction Tool	30	10509	Chimney Snaplock Clamp, 8"	35
2657	Digital Pocket Multimeter	30	10588	Natural Gas Conversion Kit, E-Classic 1400/2400	34
2799	ThermoPEX, 1-1/4", 100' Roll	11	10598	Natural Gas Conversion Kit	34
3042	Brass Hex Bushing, 1/2" x 1/8"	18	10713	Tape, Blue Teflon, 1/2" x 1429"	19

# Numerical Parts List

10775	8" Cover for Chimney Tees (p/n 2500433, 2500245, 2500621)	36	2500739	Chimney Cleaning Kit, 8"	31
10895	Chimney Adapter Kit, 10" to 8", For Pallet Burner and CL 7260 models	36	2500780	Domestic Hot Water Plate Exchanger Fittings Kit	16
10970	Chimney Tee Restrictor Kit	36	2500814	Crimp Fittings Adapter Kit, 25mm to 1" PEX	12
11157	Nipple, Schedule 80, Black, 1-1/4" x 3"	18	2900001	Hoe, Firebox, 72"	31
11605	10" Chimney Tee Kit	36	2900002	PEX Piping Clip Gun	30
11606	Combustion Fan w/Wiring	33	2900003	PEX Piping Clips, 100 qty.	12
11618	Combustion Fan	33	2900319	6" Cover for Chimney Tee (p/n 2500244, 2500416, 2500620)	36
64026	Mixing Valve, 1" x 4-way FNPT	24	2900325	Outdoor Torch	30
64031	Mixing Valve, 1-1/4" x 4-way FNPT	24	2900341	Universal Crimp Tool, 14-24 AWG	30
1200033-011	Manifold, 1-1/4" Inlet x 3/4" Outlets	15	2900393	Wood Moisture Meter, Mini 3-in-1	30
1200034-011	Manifold, 1-1/4" Inlet x 1-1/4" Outlets	15	2900399	Rubber Clamp, Quick Fist, 0.63"-1.38"	32
1200037	Chimney Weld Ring, 8"	35	2900400	Rubber Clamp, Quick Fist, 1.00"-2.25"	32
1200897-011	Afterburner Cleaning Tool	31	2900410-SP	Hose, Braided, 3/4" x 18"	11
2000041	Replacement Gear Motor, Auxiliary Auger	27	2900411-SP	Hose, Braided, 3/4" x 24"	11
2000127	Heat Exchanger Scraper, E-Classic 1450	31	2900485	6" Chimney Brush	31
2000128	Heat Exchanger Scraper, E-Classic 3200	31	2900486	8" Chimney Brush	31
2000162	Square Chimney Tee Cover, E-Classic 1450	36	2900488	Extension Rod, 48" Wire	31
2000320	Outer Control Cover	26	2900490	Handle	31
2000737	Combustion Fan Assembly	33	2900534	Scraper Tool	31
2001046	Draft Inducer, Steel Door, CL 7260	33	2900535	Ash Shovel	31
2001050	Draft Inducer, Steel Door, Pallet Burner	33	2900544	Fan Coil Unit, 50k Btu	7
2001235	Cleaning Rod, Tempered, 5/8"	31	2900545	Fan Coil Unit, 100k Btu	7
2500000	LP Gas Burner Kit, E-Classic 1450 IR Models	34	2900546	Fan Coil Unit, 220k Btu	7
2500001	Natural Gas Conversion Kit, E-Classic IR Models	34	2900549	Thermal Actuator, 2-wire	15
2500002	LP Gas Burner Kit, E-Classic 1400 IR Models	34	2900550	Thermal Actuator, 4-wire	15
2500003	LP Gas Burner Kit, E-Classic 2400 IR Models	34	2900551	Loop Cap, Manifold	15
2500004	LP Gas Burner Kit, E-Classic 3200 IR Models	34	2900552	Manifold Kit, 2-Loop	15
2500005	Battery Clean Out Kit	28	2900553	Manifold Kit, 3-Loop	15
2500007	Auxiliary Auger Kit, 5-1/2'	27	2900554	Manifold Kit, 4-Loop	15
2500008	Auxiliary Auger Kit, 6'	27	2900556	Manifold Kit, 6-Loop	15
2500009	Auxiliary Auger Kit, 8'	27	2900558	Manifold Kit, 8-Loop	15
2500010	Transformer	6	2900560	Manifold Kit, 10-Loop	15
2500011	LP Upper Burner Kit, E-Classic 2300	34	2900562	Manifold Kit, 12-Loop	15
2500013	Fittings Kit, threaded ports	16	2900563	Connector, Compression, 1/2" PEX	15
2500023	FireStar II Wiring Kit	26	2900564	Connector, Compression, 1/2" PEX-AL-PEX	15
2500044	Chimney Base Brace Kit, 6"	36	2900578	Hot Water Sediment Trapper Filter, 3/4" FPT	29
2500050	Hopper Assembly with Fuel Door Kit - M250/M255 P	28	2900596	Temperature Gauge, Manifold	15
2500053	Spring-Assisted Linkage, All Linkage Models	33	2900597	6" Chimney Cap, Spark Arrestor	35
2500070	FireStar XP Outdoor Wi-Fi Module Kit	26	2900598	8" Chimney Cap, Spark Arrestor	35
2500073	Transfer Auger with Fuel Door Assembly Kit - M175	28	2900610	Replacement Fan, motor and shield, 50k Btu, for 29000544	7
2500088	Gas Ignition Module	34	2900611	Replacement Fan, motor and shield, 100k Btu, for 29000545	7
2500143	Backup Battery Replacement	28	2900612	Replacement Fan, motor and shield, 220k Btu, for 29000546	7
2500144	LED Light Kit	27	2900614	Adapter, Manifold, Female 1" NPT	15
2500145	Secondary LED Light Kit	27	2900617	Ferrioin Indicator	29
2500153	Bypass Alarm Kit, Classic Edge 750	27	2900618	CAN Solution	29
2500164	Pump Panel Extension Kit, Classic Edge	26	2900619	PEX Pipe Cutter	30
2500172	ThermoPEX Coupling Kit, 25mm	11	2900630	MolyArmor 350 Corrosion Inhibitor	29
2500185	FireStar XP Outdoor Wi-Fi Module Kit	26	2900667	CS-25 Alkalinity Builder, 1-gallon	29
2500198	Cleaning Rod Scraper Attachment	32	2900737	Clamp Crimp Ring Install/Removal Tool	30
2500244	6" Chimney Tee Kit	36	2900765	Zone Valve Repair Kit, 3/4" Sweat	23
2500245	8" Chimney Tee Kit	36	2900766	Zone Valve Repair Kit, 3/4" NPT, all 1" Fittings	23
2500299	Heat Exchanger Mounting Kit	8	3104665	Mounting Bracket, 55k Btu Pool Heat Exchangers	9
2500314	Stepper Conversion Kit, Classic Edge	27	3104940	Mounting Bracket, 155k/300k/360k Btu Pool Heat Exchangers	9
2500374	Integrated Cleaning System, Classic Edge 350/550	32	3104941	Mounting Bracket, 600k Btu Pool Heat Exchangers	9
2500375	Integrated Cleaning System, Classic Edge 750	32	3104942	Mounting Bracket, 1200k Btu Pool Heat Exchangers	9
2500390	Draft Inducer, Flat Front Steel Door, CL 4030, 5036, 6048	33	3105186-011	Heat Exchanger Cleaning Tool	31
2500398	24V Fan Conversion Kit	26	4050036	Foam Bumper Pad, Door Switch - Classic Edge and Forge models	33
2500415	Kit, Water Sample Bottle	29	5000015	Nipple, Schedule 80, Black, 1-1/4" x 2-1/2"	18
2500416	6" Chimney Tee Kit	36	5000016	90° Elbow, Black, 1-1/4"	19
2500428	External Wi-Fi Antenna Mount Kit	26	5000017	45° Street Elbow, 1-1/4"	18
2500433	8" Chimney Tee Kit	36	5000018	Nipple, Schedule 80, Black, 3/4" x 3"	18
2500620	6" Chimney Tee Kit	36	5000083	Purge Tee, Drain, Brass, 3/4" female	22
2500621	8" Chimney Tee Kit	36	5000378	Valve Head, 1/2" Vertical, TRV II	10
2500633	24V Fan Conversion Kit	26	5000380	1" Stainless Steel PEX Clamp	12
2500640	Draft Inducer, Steel Door, CL 7260 High Output	33	5000392	Water Heater Mixing Valve, 3/4" NPT fittings, lead free	24
2500691	Moly/pH Single Strip Test Kit	29	5000394	Nipple, Brass, 3/4" x 4"	18
2500697	Door Seal Kit - Classic Edge 350/360/ 550/560	33	5000462	PEX Coupling, 25mm	17
2500697	Door Seal Kit - E-Classic 1400/1450	33	5000464	PEX Adapter, 25mm x 3/4" MIP	17
2500698	Door Seal Kit - Classic Edge 750/760	33	5000465	PEX Stainless Steel Clamp Crimp Ring, 25mm	12
2500698	Door Seal Kit - Classic Edge 960	33	5000472	Backflow Preventer, LF, 3/4"	17
2500698	Door Seal Kit - E-Classic 2300, 2400/3200/3250	33	5000531	PEX Adapter, 1" PEX x 3/4" MPT fittings, 90° Elbow	24
2500703	Replacement Convactor Fan Kit	6	5000556	Ball Valve, 1/2" PEX, Full Port	22
2500704	Inline Filter & Valve Assembly	8	5000557	Ball Valve, 1" PEX, Full Port	22
2500708	Single Pump Sharkbite Fittings Kit	16	5000638	PEX Stainless Steel Hose Clamp, 25mm	12
2500709	Single Pump Crimp Fittings Kit	16	5000651	PEX Adapter, 1" PEX x 1" sweat fitting	17
2500724-021	48-Bushel Hopper Kit w/5-1/2' Auger - Terra Brown and Taupe	27	5000661	Ball Valve, 1"	22
2500724-202	48-Bushel Hopper Kit w/5-1/2' Auger - Green and Olive Gray	27	5000670	Flow Check Valve, 1" Cast Iron	24
2500738	Chimney Cleaning Kit, 6"	31	5000673	O-Ring, Manifold	15

# Numerical Parts List

5000683	O-Ring, Replacement, for Hot Water Filter (p/n 2900578)	29
5000700	Brass Hose Bib w/Cap and Chain, 3/4" FIP x 3/4" Hose	22
5000768	PEX Swoop Elbow, 90°	17
5000784	Plug, 1/2" PEX Crimp	17
5000785	Plug, 1" PEX Crimp	17
5000786	Sharkbite Elbow, 90°, 3/4" x 3/4"	21
5000851	LKD Valve, 1/2" Preset Flow Rate	10
5500014	ThermoPEX Cap, 25mm	11
5600000	Myson Whispa III Kickspace 9000 Fan Convectur	7
5600001	Plate Exchanger, 5 x 12-50, 1-1/4" Port	8
5600002	Plate Exchanger, 5 x 12-70, 1-1/4" Port	8
5600003	Plate Exchanger, 5 x 12-6, 3/4" Port	8
5600005	Pool Heat Exchanger, 316L, 55k Btu	9
5600006	Pool Heat Exchanger, 316L, 155k Btu	9
5600007	Pool Heat Exchanger, 316L, 300k Btu	9
5600008	Pool Heat Exchanger, 316L, 360k Btu	9
5600009	Pool Heat Exchanger, 316L, 600k Btu	9
5600010	Pool Heat Exchanger, 316L, 1200k Btu	9
5600011	Pool Heat Exchanger, Titanium Grade 1, 55k Btu	9
5600012	Pool Heat Exchanger, Titanium Grade 1, 155k Btu	9
5600013	Pool Heat Exchanger, Titanium Grade 1, 300k Btu	9
5600014	Pool Heat Exchanger, Titanium Grade 1, 360k Btu	9
5600015	Pool Heat Exchanger, Titanium Grade 1, 600k Btu	9
5600017	Double Wall Water-to-Water Heat Exchanger	8
5600018	Water-to-Water Heat Exchanger, 33"	8
5600019	Plate Exchanger, 10 x 20-55, 1-1/4" Port	8
5700034	ThermoPEX, 1", 200' Roll	11
5700043	ThermoPEX, 25mm, 60' Roll	11
5700045	ThermoPEX, 25mm, 500' Roll	11
5700046	ThermoPEX, 25mm, 95' Roll	11
5700047	ThermoPEX, 25mm, 55' Roll	11
5700082	Central PEX 1" Pipe, 8' straight section, 10 per bag	11
5700083	Central PEX 1" Pipe, 8' straight section, 25 per bag	11
5800004	Taco 007 Pump	13
5800006	Taco 009 Pump	13
5800008	Taco 014 Pump	13
5800011	Taco 007 Priority Pump	13
5800019	Pump Flange Kit, 1-1/4"	14
5800020	2-Way Zone Sentry Zone Valve, 3/4" NPT threads	22
5800021	3-Way Zone Sentry Zone Valve, 3/4" NPT threads	22
5800022	Replacement Actuator Head for Sentry Zone Valve	22
5800025	Taco Viridian Pump, VT2218	13
5800027	2-Way Zone Sentry Zone Valve, 1" sweat	22
5800028	3-Way Zone Sentry Zone Valve, 1" sweat	22
5800030	3-Way Zone Sentry Zone Valve, 3/4" sweat	22
5800041	Replacement Temp. Sensor	13
5800043	Zone Valve, 2-Way, 3/4" FNPT	23
5800044	Zone Valve, 2-Way, 1" Sweat	23
5800045	Zone Valve, 3-Way, 3/4" FNPT	23
5800046	Zone Valve, 3-Way, 3/4" Sweat	23
5800047	Zone Valve, 3-Way, 1" Sweat	23
5800048	TankMixer, 3/4" NPT	23
5800049	Switch, Zone Valve, 24V,5A,NC,18" Wires	23
5800051	DISCAL Air Separator, 1" FNPT	23
5800052	3-Way Thermostatic Mixing Valve, 3/4" NPT	23
5800055	Grundfos UPMS 20-58 F Circulator	13
5800056	Grundfos UPMS 20-78 F Circulator	13
5800058	Switch, Zone Valve, 24V,0.4A,NC, Terminal Block	23
5800059	3-Way Zone Sentry Zone Valve, 1" NPT threads	22
5800060	Zone Valve, 3-Way, 1" NPT	23
6000033	Rope Ring (only), 2" Low Density Braid, 8" I.D.	36
6000034	Rope Ring (only), 1.75" Low Density Braid, 6" I.D.	36
6000064	Door Seal, Silicone-Coated, 7/8", 100-ft	33
6500004	6" Chimney Extension, 4'	35
6500011	Chimney Snaplock Clamp, 6"	35
8200008	Non-programmable 24-Volt Thermostat	6, 25
8200080	Wi-Fi Antenna only	26
8200291	Switching Relay, Single Zone, Taco	14, 25
8200293	Power Relay, 24V, SPNO-SPNC	25