

Neuro-Fuzzy Model of Development Forecasting and Effective Agrarian Sector Transformations of Ukraine

Diana Nemchenko¹, Vitaliy Kobets^{1[0000-0002-4386-4103]}, and Larisa Potravka²

¹ Kherson State University, 27, Universitetska st., Kherson, 73000 Ukraine
diana.alexandrovna03@gmail.com, vkobets@kse.org.ua

² Kherson State Agricultural University, 23 Stretenskaya st., Kherson, 73000 Ukraine
potravka@rambler.ru

Abstract. *Research goals and objective:* to predict the economic dynamics of the synergetic transformation model of Ukrainian agrarian sector using a neural network on fuzzy data.

The object of research: Neuro-Fuzzy Model of Economic Forecasting.

The subject of research: forecasting the economic dynamics of the synergetic transformation model of Ukrainian agrarian sector using a neural network on fuzzy data.

Research Methods are neuro model, fuzzy logic, assessment of the risk of Voronov and Maksimov

Results of the research: We can say that the risk of this forecast, predicted by the neural network, is "very low", we can definitely trust the forecast, and the risk is calculated by the equation of the neuroregression "low", which indicates that we can trust the forecast, but with caution and further monitoring.

Keywords: neuro model, fuzzy logic, economic forecasting.

1 Introduction

Application of optimization methods for fuzzy data is impossible, that's why neuro-fuzzy simulation is used as a mathematical methodology, which makes it possible to put forward and solve even those problems which have no complete statistics or in case there are only qualitative factors ensuring the possibility of adapting economic and mathematical models to changing economic conditions.

The purpose of the paper is to predict the economic dynamics of the synergetic transformation model of Ukrainian agrarian sector using a neural network on fuzzy data. Determining the size of synergistic effect of economic, ecological and social nature requires a mathematical interpretation with the use of up-to-date information technology, since the calculation of synergy in economic system is complicated by the random nature of economic phenomena in the conditions of transformation processes.

The development of scenarios for transforming the agrarian sector of the economy is possible only with the use of information technology.

The paper is organized as follows: part 2 describes related works concerning neuro-fuzzy models; part 3 describes Neuro-model "Nova Troya"; part 4 describes the results of the neuromodulation; the last part concludes.

2 Related Works

In market conditions any economic agent during their activities inevitably faces uncertainty. Even a professional is not able to predict changes that may occur in an uncertain external environment. Simplification of economic system model in the framework of traditional methods will inevitably lead to inadequacy of the resulting decisions due to incomplete consideration of an uncertainty of internal and external system environment. Consequently, the construction of accurate mathematical models of innovative development of economic industries, fit for implementation in software applications to solve analytical tasks of decision-making and its support, based on the use of traditional methods, can either be difficult or impossible at all [1].

An alternative way of simulating the behavior of complex economic systems is the assumption of their fuzziness when describing them. This statement is based on the principle of incompatibility of accuracy and meaningfulness [2]. Thus, the approach to solving economic problems of decision-making support has to be based on the fact that the key elements are certain fuzzy sets rather than numbers, but. Failure to take into account this factor in the creation of applied mathematical and software forecasting largely determines the shortcomings of modern technologies and systems for making economic decisions. Fuzzy logic as a set of theory basics, methods, algorithms, procedures and software is based on the use of fuzzy knowledge and expert assessments for solving a wide range of tasks [3].

This results in the fact that a number that has a specific meaning for an expert ceases to have one value (which requires traditional mathematics), but can be expressed by a set of values with its own probability. In this case, the probability reflects the impact and strength of possible active factors. The interpretation of fuzzy numbers is determined on a case-by-case basis and depends on the physical nature of these numbers, as well as on the factors that affect them. The fuzzy method allows to dramatically reduce the number of computations, which in turn leads to an increase in the speed of fuzzy systems [4]. Fuzzy logic is based on the concept of fuzzy set as an object with a function of belonging of an element to a set that can acquire any values in the interval $[0, 1]$, besides 0 or 1.

Artificial Neural Network is a mathematical toolkit that is a universal reproducer of complex nonlinear functional dependencies, which is based on the principles of the work of biological neural structures. This toolkit is used in data analysis, time series forecasting, signal processing, pattern recognition, etc. [5]. The structure of the artificial neuron is graphically presented in fig. 1.

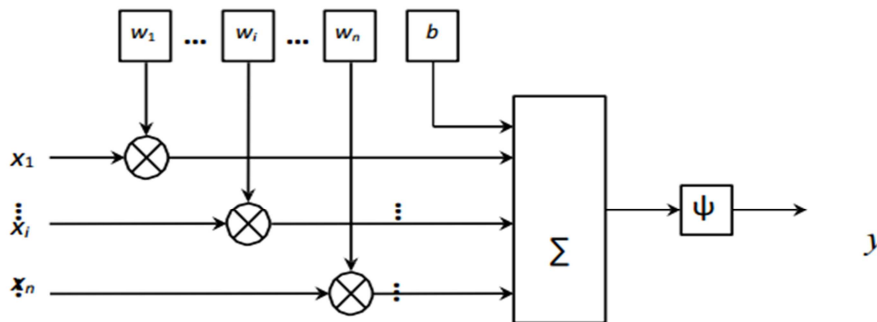

Fig. 1. Block structure of artificial neuron

An artificial neuron consists of an adder and a functional converter. The adder performs calculation of weighted signals that arrive via interneuronal connections from other neurons or external input signals. The functional converter transforms the output of the adder by the activation function of the given type. Both natural and artificial neurons can be trained depending on the activity of the processes that take place in them. Also, as a result of training, the weight of the interneuronal connections also changes, which also affects the behavior of the corresponding neuron.

Advantages and disadvantages of neural networks are demonstrated in table 1.

Table 1. Advantages and disadvantages of neural networks

Advantages of neural networks	Disadvantages and limitations of neural networks
- adaptability to environmental changes; - training on examples;	- effective forecasting requires a certain minimum number of observation (about 100 observations);
- parallel processing of information;	- significant time expenditures to achieve a satisfactory result;
- insensibility to errors;	- only specialists can prepare reliable interpretation of the results;
- ability to generalize gained knowledge	- learning algorithm can fall into the "trap" of the so-called local minimum error, and the best solution will not be obtained;
	- inability of traditional artificial neural networks to "explain" how they solve the problem.

One of the areas for application of neural networks is the agrarian industry. In the research works [6] agrarian industry of Ukraine was proved to be an important reserve for the growth of the national economy. Based on the experience of European Union and South-east Asian countries it was determined that their economic growth is a result of deep transformations, oriented towards ensuring the achievement of research and development in order to optimize the use of resources [7].

The experience of such models application indicates the possibility to predict the probable consequences of macroeconomic and industry decisions in the context of preserving existing relationships [8].

Modern relationships require new variables to describe them in the economic system, which involves the expansion of characterization methods such as neural modeling and fuzzy logic. The high degree of probability of changes in economic systems is formed under impact of external factors, which makes it impossible to clearly define the goals of the updated system. In this case, the experience of traditional simulation is not enough, so the transition to the neural model of the description of reality becomes relevant. In the transformation model of agrarian sector, the synergetic approach reflects the result of the joint interaction of economic, financial, social and institutional factors (fig.2).

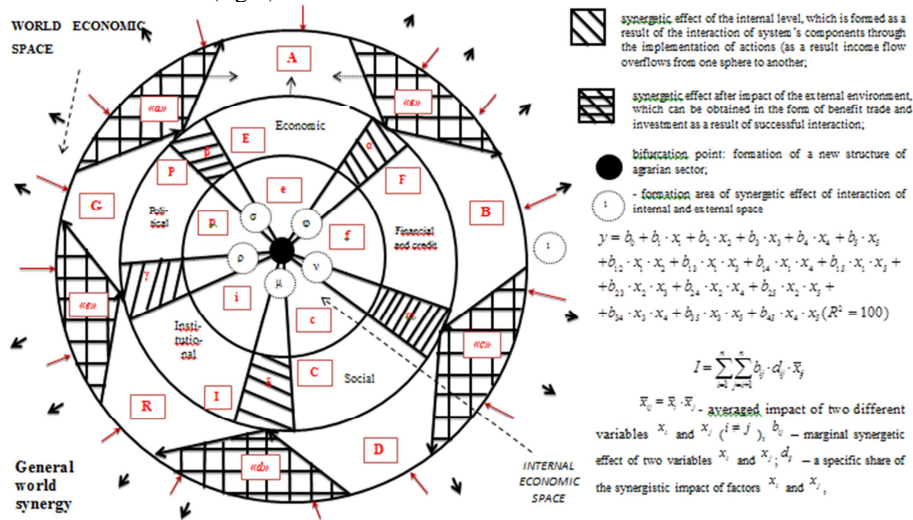

Fig. 2. Transformation model of agrarian sector

The synergetic effect determined by us is the result of the impact of external factors. For example, «E+F=α» under impact of the external factor creates the effect "B", which with the resulting index "s" (as a result of «F + C = ω») forms the effect "B". Result of the political and economic component creates the necessary conditions for the effective functioning of the agricultural sector of the economy [9].

Taking into account the results of the study, we believe that the synergetic effect of transformations (S) has to be the sum of the synergetic effect of the components, which function is close to the maximum under determined level of risk (r). The risks are natural, climatic, political, demographic, space threats, informational, ethnic, religious, cultural, social, military conflict risks, terrorism, etc. [10, 11].

3 Neuro-model "Nova Troya" in the problem "Inflation-production" inflation

The "Nova Troya" is a neural network model of "inflation-production", which uses a sample of 32 quarterly data for 2009-2016, formed on the basis of the financial statements of PLK TH "Nova Troya" (Ukraine, Kherson region Novotroitsk).

The task is to build a network based on the architecture of a multilayer perceptron using the Excel Neural Package architecture, which bases our data and forms the link between the indicators of economic growth of this enterprise (inputs of the model) and the level of inflation (output of the model), estimated through the quarterly consumer price index (CPI). The model will be used to predict the development of this enterprise for future periods of time (quarters).

Stage One. Introducing the source and placing them in Excel.

Table 2. Output data

	Year	Quarter	№	CPI	Receipts	Cost	Profit from sales	Balance profit	The cost of fixed assets	Total profitability	Own profitability
2											
3	2009	1	1	132,2	201840	200120	1720	1906	156120	1,2	4,7
4	2009	2	2	130,3	206151	204134	2017	2102	188200	1,1	4,3
5	2009	3	3	126,6	248842	245620	3222	2117	190264	1,1	4,3
6	2009	4	4	115,4	243189	240136	2940	1084	202404	0,5	1,8
7	2010	1	5	107,3	440531	400111	40420	30245	755344	4,19	5
8	2010	2	6	105,6	484255	422133	62122	36780	880112	4,2	20,4
9	2010	3	7	105,7	508470	445050	63420	45246	814466	5,6	27,1
10	2010	4	8	104,5	554502	484438	67918	52047	915842	5,7	28,5
11	2011	1	9	104	552753	522333	30420	41222	2015612	2	12,8
12	2011	2	10	103,5	564299	522177	42122	46780	2055388	2,3	14,2
13	2011	3	11	103,5	675642	632222	43420	43444	2091426	2,1	13
14	2011	4	12	107,6	700213	637123	48678	39395	2163830	1,8	11,3
15	2012	1	13	109,5	1272210	1229765	42445	78236	78236	5,4	21
16	2012	2	14	120,8	1493449	1432173	61276	76883	1582006	4,9	19,1
17	2012	3	15	113,2	1858141	1792262	65879	73245	1902642	3,8	15,1
18	2012	4	16	111,4	2029936	1941401	74123	60158	1928648	3,1	10,7
19	2013	1	17	111,7	2931555	2529111	402444	367200	7156120	5,1	22,6
20	2013	2	18	100,2	3333699	2932444	401255	375400	7388200	5,1	22,4
21	2013	3	19	105,1	4148223	3732344	415879	386250	7614264	5,1	22,4
22	2013	4	20	105,6	4229238	3821512	393314	429608	7842968	5,5	24,2
23	2014	1	21	106,1	4812096	4440203	582420	486620	10156144	4,8	20,6
24	2014	2	22	107,2	5513465	4532222	581111	532300	10188248	5,2	22,4
25	2014	3	23	106,1	5757577	4511107	625233	588100	10114246	5,8	25
26	2014	4	24	105	6562879	4633225	655719	652725	10233682	6,4	27,4
27	2015	1	25	103,4	10433333	4742424	690234	686111	10156144	6,8	22,1
28	2015	2	26	103,3	10462269	4755577	703846	702300	10188248	6,9	22,4
29	2015	3	27	103,9	10400553	4727524	710246	708100	1429432	5	26,2
30	2015	4	28	103,8	10609859	4822663	724964	712725	14294322	5	26,2
31	2016	1	29	103,8	10625287	4829676	721400	712344	10156144	7	22,6
32	2016	2	30	103,7	10631179	4832354	736800	732106	10188248	7,2	22,5
33	2016	3	31	101,2	10631157	4832344	740277	738212	10114246	7,3	25,1

Stage Two. Using Neural Analysis, we describe the placement of table 3.

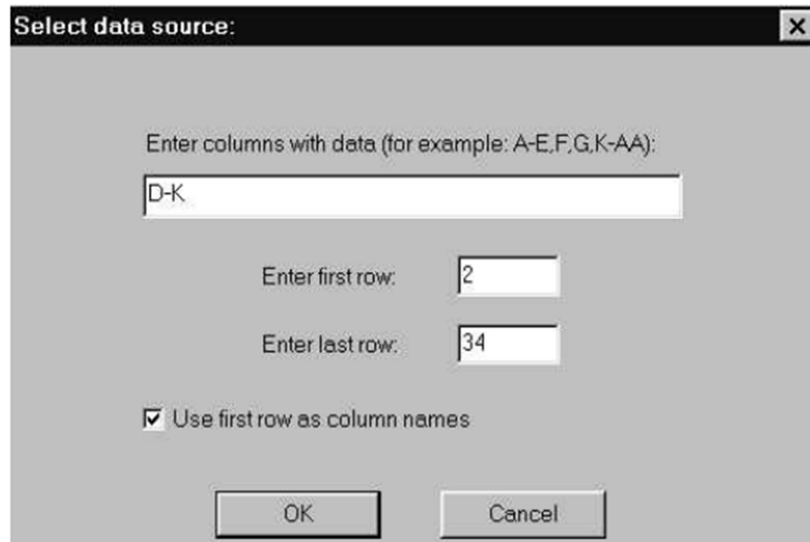

Fig. 3. Transformation model of agrarian sector

Stage Three. Identification of inputs (fig. 4)

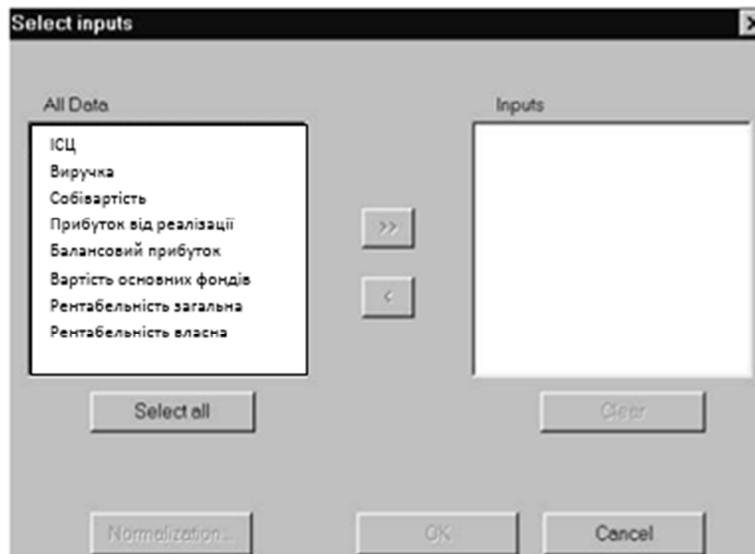

Fig. 4. Identification of inputs

The All Data window displays a complete list of 8 parameters of the model. As the input parameters we select the last 7. To do this, we perform the Select All command, which will carry all parameters to the Inputs window. Then we return the "extra" CPI

parameter back to the All Data window using the adjustment button <. The result obtained is shown below in fig.4.

Stage Four. We perform the preprocessing of input data using the Normalization function. This step allows you to get rid of unnecessary computational problems due to the alignment of the range of variables. We choose the Mean / Variance option, in which the data becomes dimensionless by subtraction of the average value and division by their dispersion. Now all inputs are comparable in order of magnitude.

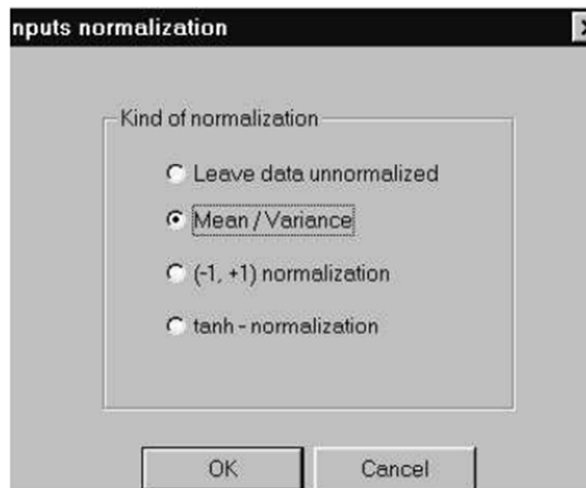

Fig. 5. Align the ranges of variables

Stage Five. Next, using the Select Outputs function, we select the output parameter - CPI and normalize it with **Mean/Variance** result:

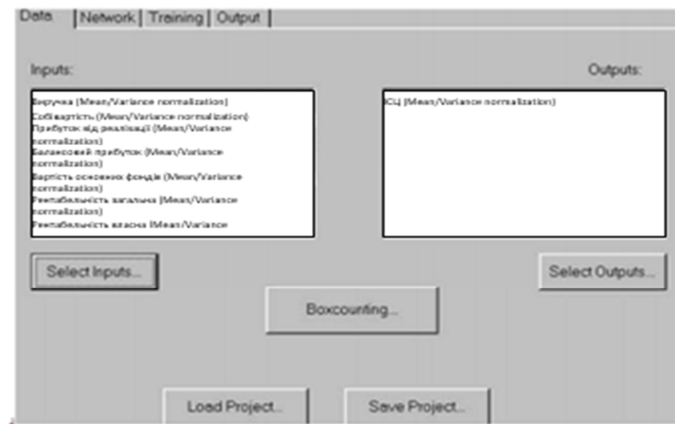

Fig. 6. Determine the outputs

Stage Six. We determine the significance of the input parameters. We use the Box-counting function, and the system by itself, using the Boxcounting algorithm, will

determine the statistical significance of the inputs for the specified outputs. In the Boxcounting results window in graphical form we will see that the most significant parameters are x_2 and x_6 (≈ 0.4 and 0.3 , respectively), and the significance of the parameters x_1 and x_5 is close to zero and they are insignificant in terms of the effect on the resulting variable. The rest of the variables occupy an intermediate position by significance. The values of the normalization parameters are shown below: mean predictability = 0.095 and variance (variance) = 0.109 . The more their ratio is different from 1, the better the predicted power of the model is. We calculate the ratio Average / Dispersion ≈ 0.87 . Apparently, it is close to one, that is, the predicted strength of this network is low. Reducing the number of inputs allows you to shorten the training time of the neural network or allows you to increase its nonlinear properties. So let's go back to the main window and remove the insignificant entries x_1 and x_5 from the list (fig.7).

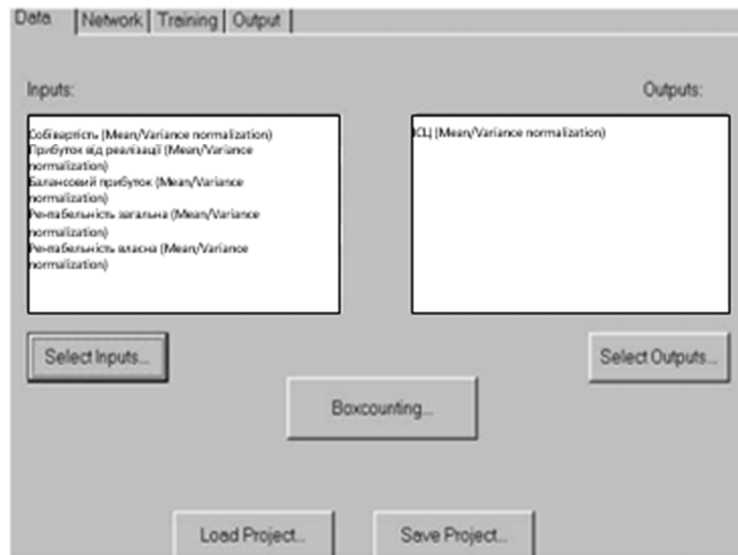

Fig. 7. Exclusion of insignificant inputs

Stage Seven. Find the equation of neuroregression for CPI in following form:

$$CPI(o) = 117.81 + 1.7 \cdot 10^{-6} \cdot x_2 - 3.003 \cdot 10^{-5} \cdot x_3 + 1.76 \cdot 10^{-5} \cdot x_4 - 1.99 \cdot x_5, \quad (1)$$

where: x_2 - cost, x_3 - sales profit, x_4 - balance profit, x_5 - total profitability. For comparison purposes, we estimated the equation of multiple regression:

$$CPI(p) = 117.59 + 1.96 \cdot 10^{-6} \cdot x_2 - 4.79 \cdot 10^{-6} \cdot x_3 - 1.022 \cdot 10^{-5} \cdot x_4 - 1.96 \cdot x_5. \quad (2)$$

The relevant statistics are shown in table 3.

Table 3. Relevant statistics of neuroregression

Neurostatistical indicator	Meaning
Number of training examples, n	32
The number of independent variables, k	4
A common neuromuscular disorder, $\Sigma(y_n - y_a)$	1983.74
Regression error, $\Sigma(y_c - y_a)^2$	648.12
Regression error, $\Sigma e(t)^2 = \Sigma \Sigma(y_n - y_a)^2 - \Sigma(y_c - y_a)^2$	1335.62
Determination coefficient, $R^2 = 1 - \Sigma e(t)^2 / \Sigma(y_n - y_a)^2$	0.33
Coefficient of multiple correlation, $R = \sqrt{R^2}$	0.57
Standard Error	7.03
Fisher test, $F = (R^2/k) / ((1 - R^2)/(n-k-1))$	3.28
The significance of the Fisher test	0.03

The critical value of Fisher test with a confidence probability of 0.95, $v_1 = k = 4$, $v_2 = n - k - 1 = 27$ is 2.73. Since $F_{\text{fact}} = 3.28 > F_{\text{tab}} = 2.73$, the regression is adequate. To estimate the independence of errors, we calculated the Durbin Watson criterion: $d = \Sigma(e(t) - e(t-1))^2 / \Sigma e(t)^2 = 1.41777E-05$. As critical table levels for $n = 32$ and $k = 4$ for a significance level of 5%, we got critical values $d_i = 1,18$ and $d_u = 1,73$. The calculated value did not fall into the interval, i.e. estimates can be considered independent. The following table shows the calculation of the coefficients of the neuroregression equation and the Student's statistics (t-criterion):

Table 4. Coefficients of the neuroregression equation and Student's statistics

Variable	Coefficient of regression	Standard Error	Student's test
CPI (Output)	117.81	3.42	34.42
Cost price	1.70129E-06	3.05E-06	0.5578
Profit from sales	-3.00265E-05	5.598E-05	-0.5363
Balance sheet profit	1.75885E-05	5.599E-05	0.3141
Profitability total	-1.99	0.94	-2.12

Stage Eight. We create a simple two-layer neural network (with one hidden layer) and architecture "4-3-1", using the Create Net command.

In the Network Constructor window, we define the network structure:

- number of layers without input (Number of layer) = 2;
- number of inputs (Number of inputs) = 4;

- the number of neurons in the 1st layer (Layer1, neuron) = 3;
- order of nonlinearity of the first layer (order) = 1;
- type of output function of the first layer (function) = tanh;
- the number of neurons in the second layer (neurons) = 1;
- the order of nonlinearity of the second layer (order) = 1;
- type of output function of the 2nd layer (function) = linear.

The screenshot shows a dialog box titled "Network Constructor" with a close button (X) in the top right corner. The "Number of layers" is set to 2. Below this, there are three columns: "neurons", "order", and "function". The first three rows are labeled "Not Exist" and have "0" neurons, "1" order, and "tanh" function. The fourth row is labeled "Layer 2" and has "1" neuron, "1" order, and "linear" function. The fifth row is labeled "Layer 1" and has "3" neurons, "1" order, and "tanh" function. At the bottom, the "Number of inputs" is set to 4.

	neurons	order	function
Not Exist	0	1	tanh
Not Exist	0	1	tanh
Not Exist	0	1	tanh
Layer 2	1	1	linear
Layer 1	3	1	tanh

Number of inputs: 4

Fig. 8. Preparing for the creation of a neural network

We get the following neuron network:

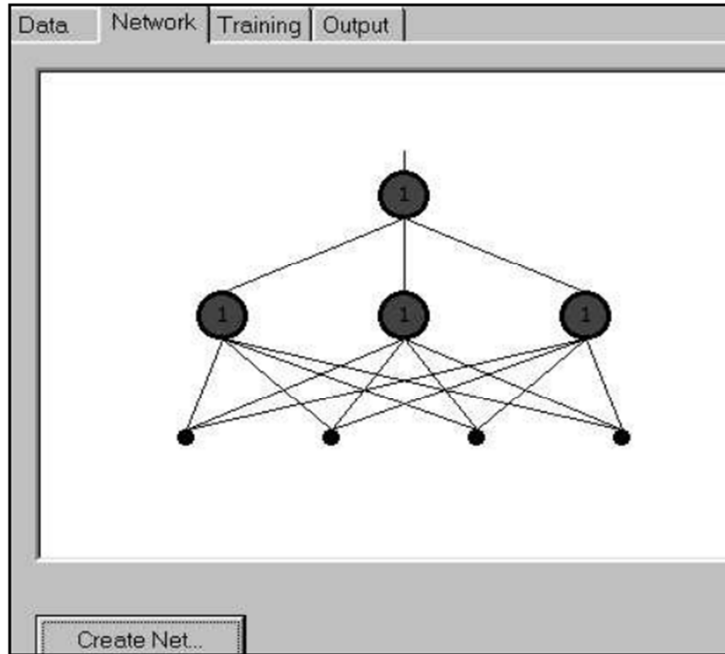

Fig. 9. Received neural network

Stage nine: Preparation for training the neural network. Before training we set the test set from the whole set of learning examples. Examples from this set will not participate in the training. They will serve as a base for building the estimates for the predicted properties of the trained network. With Edit test set in the window we set the size of the test sample (Number of test examples) = 0, and its character set in the random sample set (Random test set) (fig.10).

Fig. 10. Preparation for training the neural network

Stage ten: Training the neural network. In the course of the network learning you can see the change in the parameters in the field of training information (Training Info). We wait for the learning process to stop by itself or interrupt it artificially by pressing Stop Training button (fig.11).

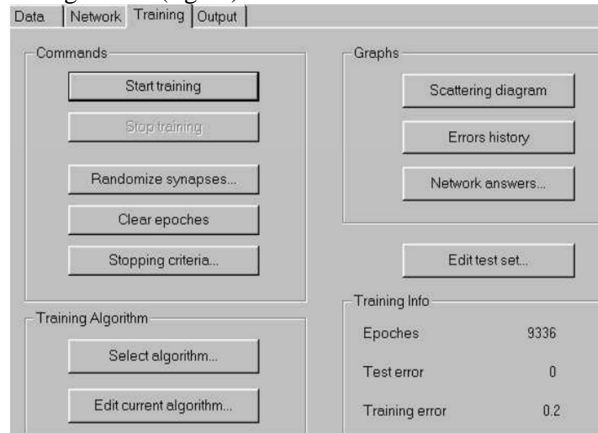

Fig. 11. Teaching the neural network

The learning process stopped by itself. As you can see, 9336 epoches have passed at the moment, and the current training error is 0.2.

Learning outcomes can be assessed visually on the Network responses graph. The corresponding window is shown below (green dotted line shows network feedback, and orange one marks real data).

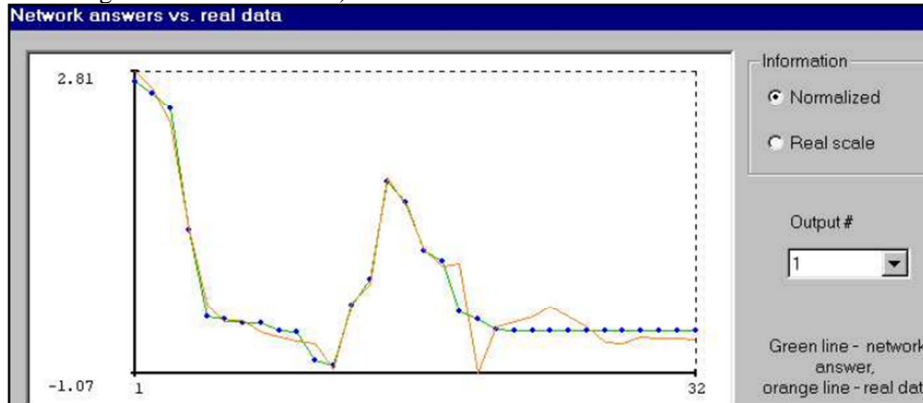

Fig. 12. Results of training of the neural network

Stage Eleven. Using Output all data, we output the results of the neural network (table 3).

Table 3. Output data

	Year	Quarter	№	CPI	CPI (predicted by the neural network)	Relative Error Neuro-Forecast	CPI (by equation of neuro-regression)	Relative Neuro-Regression Error
1								
2	2009	1	1	132,2	130,79	-0,01	115,42	-0,17
3	2009	2	2	130,3	129,64	-0,01	115,62	-0,15
4	2009	3	3	126,6	128,05	0,01	115,62	-0,11
5	2009	4	4	115,4	115,52	0	116,82	0,01
6	2010	1	5	107,3	105,81	-0,01	109,84	0,03
7	2010	2	6	105,6	105,8	0	109,44	0,04
8	2010	3	7	105,7	105,64	0	106,65	0,01
9	2010	4	8	104,5	105,65	0,01	106,45	0,02
10	2011	1	9	104	104,04	-0,01	113,83	0,1
11	2011	2	10	103,5	104,34	0,01	113,23	0,1
12	2011	3	11	103,5	101,9	0	113,63	0,1
13	2011	4	12	107,6	101,56	0,01	114,23	0,14
14	2012	1	13	109,5	107,25	0	107,05	-0,01
15	2012	2	14	120,8	110,04	0	108,04	-0,01
16	2012	3	15	113,2	120,6	0	110,24	-0,11
17	2012	4	16	111,4	118,12	0	111,63	-0,06
18	2013	1	17	111,7	113,09	-0,05	107,65	-0,06
19	2013	2	18	100,2	111,46	0,05	107,65	-0,04
20	2013	3	19	105,1	106,47	0	107,65	-0,04
21	2013	4	20	105,6	105,58	-0,01	106,85	0,07
22	2014	1	21	106,1	104,72	-0,01	108,24	0,03
23	2014	2	22	107,2	104,68	0	107,45	0,02
24	2014	3	23	106,1	104,7	0,01	106,25	0
25	2014	4	24	107,2	104,67	-0,03	105,05	-0,02
26	2015	1	25	106,1	104,75	-0,01	104,26	-0,02
27	2015	2	26	105	104,73	0	104,06	-0,01
28	2015	3	27	103,4	104,76	0,01	103,86	0
29	2015	4	28	103,3	104,61	0,01	107,85	0,05
30	2016	1	29	103,9	104,76	0,01	103,86	0,06
31	2016	2	30	103,8	104,78	0,01	103,46	0,12
32	2016	3	31	103,8	104,82	0,01	103,26	-0,01
33	2016	4	32	103,7	104,66	0,01	111,04	0,07

As it can be seen from the table, the results of neuromodeling are well approximated by actual data and the total square error is only 0.01%. The approximate regression equation obtained on the basis of neuromodeling, of course, contains a big mistake, but also only 0.15% (15 times worse). Graphic illustration of the table is given below.

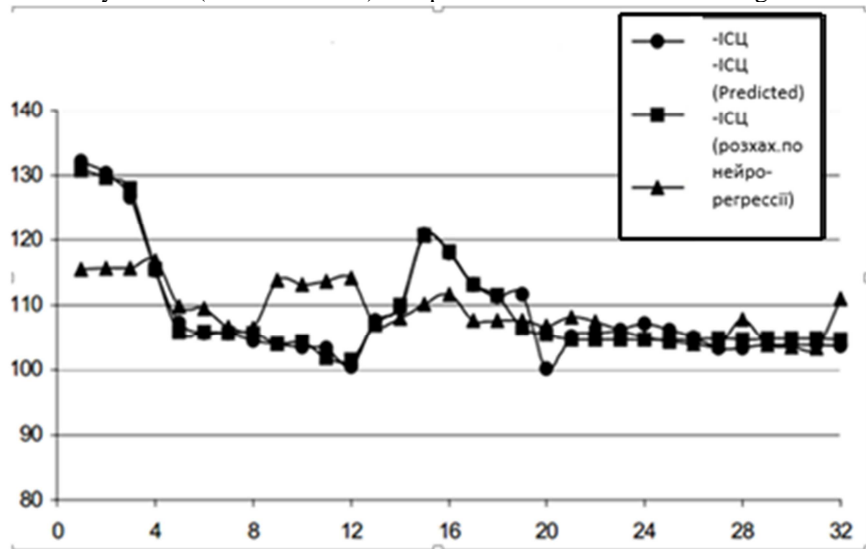

Fig. 13. Comparison of the actual inflation rate with neuroforecast

4 Summing up the results of the neuromodulation using the method of fuzzy logic

Let's consider integral assessment of the risk of V & M (Voronov and Maksimov):

Rating:

- accepts values from 0 to 1;
- every investor, based on his/hers investment preferences, can classify the value by allocating a segment of unacceptable risk values for themselves.

Advantages of the method:

- the full spectrum of possible scenarios for the investment process is formed on the basis of the fuzzy sets theory;
- the decision is made on the basis of the whole set of assessments rather than two assessments of the effectiveness of the project;
- the expected efficiency of the project is not a point indicator, but a field of interval values with its distribution of expectations, characterized by the function of belonging to the corresponding fuzzy number.

Using the following graduation (table 5):

Table 5. Integral assessment of the risk of V & M

Gradation	The degree of risk	Decision regarding the forecast
0 – 0,07	Very low	Trust the forecast
0,07 – 0,15	Low	Trust with caution and further monitoring
0,16 – 0,35	Average	Trust with limitations
0,36 – 0,4	High	Reject and view forecast
> 0,40	Very high	Do not trust the forecast
0 – 0,07	Very low	Trust the forecast

We can say that the risk of this forecast, predicted by the neural network, is "very low", we can definitely trust the forecast, and the risk is calculated by the equation of the neuroregression "low", which indicates that we can trust the forecast, but with caution and further monitoring.

5 Conclusion

Using the Excel Neural Package, a developed network is based on the architecture of the multilayer perceptron, which analyzes the data and forms the link between the indicators of economic growth of analyzed enterprise.

The analysis of existing diagnostic technique of CPI (consumer price index) and the assessment of the financial performance of the enterprise were carried out. It allowed conducting a comprehensive financial and economic analysis of the enterprise with using of fuzzy logic tools, which will enable the formation of an economic and mathematical model taking into account the specificity of the enterprise.

Одним з найбільш ефективних математичних інструментів, спрямованих на формалізацію і обробку невизначеної інформації, що інтегрує сучасні підходи і методи, є теорія нечіткої логіки. Даний математичний апарат дозволяє розглянути різні види невизначеності та отримати новий, якісно кращий прогноз розвитку економічних систем.

One of the most effective mathematical tools assigned at formalizing and processing of uncertain information which integrates modern approaches and methods is fuzzy logic theory. This mathematical instrument allows us to consider various types of uncertainty and get a new, qualitatively better forecast of the development of economic systems.

References

1. Altunin, A.E., Semukhin, M.V.: Models and algorithms of decision-making under fuzzy conditions. Tyumen State University, Tyumen (2000).
2. Aliev, R.A., Abdikeev, N.M., Shakhnazarov, M.M.: Production systems with artificial intelligence. Radio and communication, Moscow (1990).
3. Nguyen, H.T., Walker, A.: First Course in Fuzzy Logic. CRC Press, USA (1999).
4. Pospelov, D.A.: Fuzzy sets in models of control and artificial intelligence. Science, Moscow (1986).
5. Kobets V., Weissblut A.: (2018) Simulation Agent-Based Model of Heterogeneous Firms Through Software Module. In: Bassiliades N. et al. (eds) Information and Communication Technologies in Education, Research, and Industrial Applications. ICTERI 2017. Communications in Computer and Information Science, Vol 826. Springer, Cham, pp. 230-254 doi.org/10.1007/978-3-319-76168-8_11
6. Potravka, L.O.: Estimation of synergetic effect of structural transformations of the agro-food sector of Ukraine. Visnyk of Odessa National University named after Mechnikov 19 (20), 71--74 (2015).
7. Melnik, A., Vasina, A.: Structural transformation of the national economy of Ukraine as factors of modernization of the institutional basis of its development. Journal of the European Economy. TNEU 9 (1), 40—64 (2010).
8. Moiseev, N.N.: The mathematician puts experiment. Nauka, Moscow (1979).
9. Potravka, L.O.: Synergy of transformations of the agrarian sector of Ukraine. KSAU, Kherson (2016)
10. Kapitsa, S.P., Kurdyumov, S.P., Malinetsky, G.G.: Synergetics and forecasts of the future. Nauka, Moscow (2003).

11. Kobets, V., Poltoratskiy, M.: Using an Evolutionary Algorithm to Improve Investment Strategies for Industries in an Economic System (2016), CEUR Workshop Proceedings, vol. 1614, P. 485-501 (Indexed by: Sci Verse Scopus, DBLP, Google Scholar). Available: CEUR-WS.org/Vol-1614/ICTERI-2016-CEUR-WS-Volume.pdf