



# SIDE FLAIL ASSEMBLIES

JD6105D

Current as of GG /2011

---



## PARTS LISTING WITH MOUNTING AND OPERATING INSTRUCTIONS

---

**Tiger Corporation**  
3301 N. Louise Ave.  
Sioux Falls, SD 57107  
1-800-843-6849  
1-605-336-7900  
[www.tiger-mowers.com](http://www.tiger-mowers.com)

06011029

# TO THE OWNER / OPERATOR / DEALER

All implements with moving parts are potentially hazardous. There is no substitute for a cautious, safe-minded operator who recognizes the potential hazards and follows reasonable safety practices. The manufacturer has designed this implement to be used with all its safety equipment properly attached to minimize the chance of accidents.

**BEFORE YOU START!!** Read the safety messages on the implement and shown in this manual. Observe the rules of safety and use common sense!

**READ AND UNDERSTAND THIS MANUAL! Non-English speaking operators will need to GET THE MANUAL TRANSLATED as needed!**



# DANGER

**FAILING TO FOLLOW SAFETY MESSAGES AND OPERATING INSTRUCTIONS CAN CAUSE SERIOUS BODILY INJURY OR EVEN DEATH TO OPERATOR AND OTHERS IN THE AREA.**



1. Study and understand Operator's Manuals, Safety Decals, and Instructional Decals for tractor and implement to prevent misuse, abuse, and accidents. Practice before operating in a confined area or near passersby.

● Learn how to stop engine suddenly in an emergency. Be alert for passersby and especially children

2. Allow no children on or near folding mower or tractor. Allow no riders on tractor or implement. Falling off may cause serious injury or death from being run over by tractor or mower or contact with rotating blades.

3. Operate only with tractor having Roll-Over Protective Structure (ROPS) and with seat belt securely fastened to prevent injury and possible death from falling off or tractor overturn.

● Personal Protective Equipment such as Hard Hat, Safety Glasses, Safety Shoes, & Ear Plugs are recommended.

4. Block up or support raised machine and all lifted components securely before putting hands or feet under or working underneath any lifted component to prevent crushing injury or death from sudden dropping or inadvertent operation of controls. Make certain area is clear before lowering or folding

5. Before transporting, put Lift Lever in detent or full-lift position. Install Transport Safety Devices securely on folding mowers. Put Booms securely in Transport Rest.

● Folding and Boom Mowers have raised center of gravity. Slow down when turning and on hillsides.

6. Make certain that SMV sign, warning lights, and reflectors are clearly visible. Follow local traffic codes.

7. Never operate with Cutting Head or Folding Section raised if passersby, bystanders, or traffic are in the area to reduce possibility of injury or death from objects thrown by Blades under Guards or mower structure.

8. Before dismounting, secure implement in transport position or lower to ground.

● Put tractor in park or set brake, disengage PTO, stop engine, remove key, and wait until noise of rotation has ceased to prevent crushing by entanglement in rotating parts which could cause injury or death.

● Never mount or dismount a moving vehicle. Crushing from rollover may cause serious injury or death.

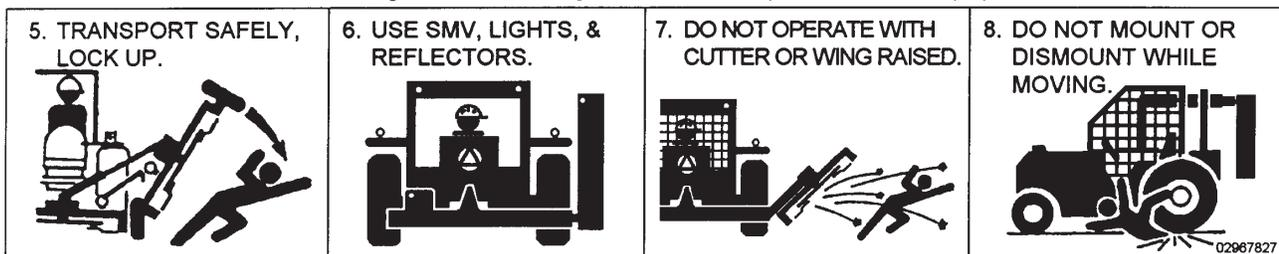

02967827

Warranty Information: Read and understand the complete Warranty Statement found in this manual. Fill out the Warranty Registration form in full and return it within 90 days. Make certain the Serial Number of the machine is recorded on the Warranty Card, and form that you retain.

# FORWARD

This manual contains information about many features of the Tiger mowing and roadside maintenance equipment. Some of these include: Safety precautions, Assembly instructions, Operations, Maintenance and Parts. This manual will also assist you in the proper break-in, daily care, and troubleshooting of your new mower.

We recommend that you read carefully the entire manual before operating the unit. Also, time spent in becoming fully acquainted with its performance features, adjustments, and maintenance schedules will be repaid in a long and satisfactory life of the equipment.

## **Troubleshooting - Please, before you call, help us to help you!**

Please look at the equipment to observe what is happening, then:

- Classify the problem
  - Hydraulic, electrical or mechanical - Read the trouble shooting section
  - Tractor or Truck chassis - Contact vehicle dealer
  
- If unable to correct the problem yourself, contact your local Tiger Dealer after gathering:
  - Machine model \_\_\_\_\_
  - Serial number \_\_\_\_\_
  - Dealer name \_\_\_\_\_
  - Detailed information about the problem including results of troubleshooting

**Attention Owner / Operator / Dealer:** It is your obligation to read, and understand, the warranty information section located at the back of this manual denoting that the purchaser understands the safety issues relating to this machine and has received and will read a copy of this manual.

If at any time, you have a service problem with your Tiger mower, Contact your local dealer for service and parts needed.

MANUFACTURED BY:

**Tiger Corporation**

3301 N. Louise Ave.

Sioux Falls, SD 57107

1-800-843-6849

1-605-336-7900

www.tiger-mowers.com

DISTRIBUTED BY:

\_\_\_\_\_

1- \_\_\_\_\_ - \_\_\_\_\_ - \_\_\_\_\_

1- \_\_\_\_\_ - \_\_\_\_\_ - \_\_\_\_\_



# TABLE OF CONTENTS

SAFETY SECTION_____	1
ASSEMBLY / MOUNTING SECTION_____	2
OPERATION SECTION_____	3
MAINTENANCE SECTION_____	4
PARTS SECTION_____	5
COMMON PARTS SECTION_____	6
WARRANTY INFORMATION_____	7



1012

**This symbol means:**

**CAUTION – YOUR SAFETY IS AT RISK!**

When you see this symbol, read and follow the associated instructions carefully or personal injury or damage may result.

Tiger is a registered trademark.





# **SAFETY SECTION**

Safety Section 1-1

# SAFETY

## GENERAL SAFETY INSTRUCTIONS AND PRACTICES

A careful operator is the best operator. Safety is of primary importance to the manufacturer and should be to the owner/operator. Most accidents can be avoided by being aware of your equipment, your surroundings, and observing certain precautions. The first section of this manual includes a list of Safety Messages that, if followed, will help protect the operator and bystanders from injury or death. Read and understand these Safety Messages before assembling, operating or servicing this Implement. This equipment should only be operated by those persons who have read the manual, who are responsible and trained, and who know how to do so responsibly.



The Safety Alert Symbol combined with a Signal Word, as seen below, is used throughout this manual and on decals which are attached to the equipment. The Safety Alert Symbol means: "ATTENTION! BECOME ALERT! YOUR SAFETY IS INVOLVED!" The Symbol and Signal Word are intended to warn the owner/operator of impending hazards and the degree of possible injury faced when operating this equipment.

**Practice all usual and customary safe working precautions and above all--- remember safety is up to YOU. Only YOU can prevent serious injury or death from unsafe practices.**



Indicates an imminently hazardous situation that, if not avoided, WILL result in DEATH OR VERY SERIOUS INJURY.



Indicates an imminently hazardous situation that, if not avoided, COULD result in DEATH OR SERIOUS INJURY.



Indicates an imminently hazardous situation that, if not avoided, MAY result in MINOR INJURY.

**Important**

Identifies special instructions or procedures that, if not strictly observed, could result in damage to, or destruction of the machine, attachments or the environment.

**NOTE:** *Identifies points of particular interest for more efficient and convenient operation or repair.*

READ, UNDERSTAND, and FOLLOW the following Safety Messages. Serious injury or death may occur unless care is taken to follow the warnings and instructions stated in this Manual and in the Safety Messages on the implement. Always follow the instruction in this manual and use good common sense to avoid hazards.



**NOTE:** *If you want a translation of this safety section in one of the following Languages, please contact: Translations at 1502 E. Walnut Street Seguin, TX 78155; Fax: (830) 372-9529; Safety Section Translations are available in Spanish, Portuguese, French, German, Russian. PN GS01*



# SAFETY

## OPERATOR SAFETY

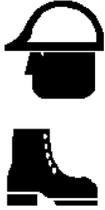
				
Read and understand Operator's Manual	Always wear Safety Glasses	Wear Hard Hat Safety Shoes	Never use Drugs or Alcohol when operating equipment	Wear Safety Vest when operating on or near roads

**⚠ WARNING** TO AVOID SERIOUS INJURY OR DEATH DO THE FOLLOWING:

- **READ, UNDERSTAND and FOLLOW** Operator's Manual instructions, Warnings and Safety Messages.
- **WEAR SAFETY GLASSES**, safety shoes, hard hat, hearing protection and gloves when operating or repairing equipment
- **WEAR** appropriate breathing respirator when operating in dusty conditions to avoid respiratory diseases.
- **DO NOT WEAR** loose clothing or jewelry to avoid rotating parts entanglement injury.
- **DO NOT USE DRUGS or ALCOHOL** before or while operating equipment.
- **DO NOT ALLOW** anyone to operate equipment under the influence of drug or alcohol.
- **CONSULT** medical professional for medication impairment side effects.
- **STAY ALERT**, prolonged operation can cause fatigue, **STOP and REST**.

### GENERAL OPERATING SAFETY

#### VISIBILITY CONDITIONS WHEN MOWING:

- **OPERATE IN DAYLIGHT** or with lights that gives at least 100 yards clear visibility.
- **BE ABLE TO SEE** and identify passersby, steep slopes, ditches, drop-offs, overhead obstructions, power lines, debris and foreign objects.

#### GROUND SPEED WHEN MOWING:

- **NORMAL SPEED** range is between 2 to 5mph.
- **ADJUST MOWING SPEED** for terrain conditions and grass type, density and cut height.
- **REDUCE MOWING SPEED** when near steep slopes, ditches, drop-offs, overhead obstructions, power lines and to avoid debris and foreign objects.

#### INSECT INFESTATION

- Do Not operate in areas where bees or insects may attack unless you **WEAR PROTECTIVE CLOTHING** or use enclosed tractor cab.

#### PTO SPEED:

- **DO NOT EXCEED IMPLEMENT RATED PTO SPEED**
- **AVOID** exceeding rated PTO speeds that may result in broken drivelines or blade failures.

#### SAFETY SIGNS:

- **REPLACE** missing, damaged or unreadable safety signs immediately. PN OS01

# SAFETY

## CONNECTION OR DISCONNECTING IMPLEMENT SAFETY

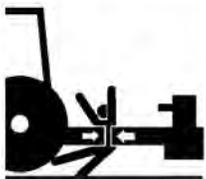
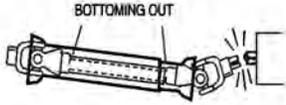
			
<p>Stop Tractor Remove Key Read Manual</p>	<p>Crushing injury between tractor and implement</p>	<p>Make sure PTO shaft is securely attached to tractor</p>	<p>Make sure PTO shaft are proper length</p>



**TO AVOID SERIOUS INJURY OR DEATH FROM BEING CRUSHED BY TRACTOR OR IMPLEMENT:**

**WHEN BACKING tractor to implement hitch:**

- **DO NOT ALLOW BYSTANDERS** between tractor and implement

**BEFORE connecting and disconnecting implement hitch:**

- **STOP TRACTOR ENGINE**, place transmission into park, engage parking brake and remove key.

**WHEN connecting and disconnecting implement hitch:**

- **DO NOT** crawl or walk under raised mower

**WHEN CONNECTING IMPLEMENT DRIVELINE:**

**TO AVOID implement driveline coming loose during operation:**

- **LUBRICATE** yoke spring locking collar to ensure it freely slides on PTO shaft
- **SECURELY** seat yoke locking balls in PTO shaft groove.
- **PUSH** and **PULL DRIVELINE** on both the tractor and implement **PTO SHAFTS** to ensure it is **SECURELY ATTACHED**

**TO AVOID broken driveline during operations:**

- **CHECK** driveline for proper length between PTO shaft and implement gearbox shaft.
- Drivelines too short can pull apart or disengage.
- Drivelines too long can bottom out.
- Bottoming driveline telescoping assembly will stop sliding and become solid.
- Driveline bottoming can push through support bearings and break off PTO shaft.

**CONTACT DEALER if implement driveline does not match Tractor PTO shaft:**

- **DO NOT USE PTO ADAPTER.**  
Using a PTO adapter can cause:
  - Excessive vibration, thrown objects, blade and implement failures by doubling operating speed.
  - Increased working length exposing unshielded driveline areas and entanglement hazards.

**DO NOT connect the Mower to a tractor with the PTO directly connected to the Tractor transmission. PN CDFM-01**

# SAFETY

## CRUSHING HAZARDS

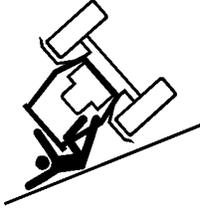
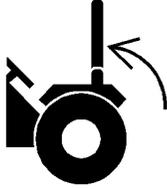
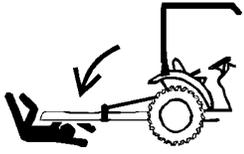
			
<p>Crushing injury from roll over</p>	<p>Lock ROPS in up position</p>	<p>Always wear seatbelt</p>	<p>Crushing injury implement falling</p>



**TO AVOID SERIOUS INJURY OR DEATH FROM FALLING OFF TRACTOR, EQUIPMENT RUN OVER, ROLLOVER AND CRUSHING BY FALLING WING OR IMPLEMENT:**

- **USE ROPS** and **SEAT BELT** equipped tractors for mowing operations.
- **KEEP ROPS** lock in up position.
- **ALWAYS BUCKLE UP** seat belt when operating tractor and equipment.
- **ONLY OPERATE** tractor and equipment while seated in tractor seat.

### **WHEN RAISING OR LOWERING IMPLEMENT:**

- Raise or lower **ONLY WHILE SEATED** in tractor seat with seat belt buckled.
- Raise or lower **ONLY** when implement tongue is securely attached to tractor drawbar **TO AVOID** implement tip over.
- **KEEP BYSTANDERS CLEAR** of area **TO AVOID** crushing.

**LIFTED Equipment can fall from mechanical or hydraulic failure or inadvertent Control Lever movement.**



**TO AVOID EQUIPMENT FALLING while working near or under lifted wings, components and implements raised by 3-Pointed tractor hitch:**

- **SECURELY SUPPORT** or **block up** raised equipment and components.
- **BLOCK UP** and **securely support** equipment before putting hands, feet or body under raised equipment or lifted components.

### **WHEN PARKING Implement and Tractor:**

- **LOWER** implement, **LOCK** or **BLOCK** lifted parts before leaving equipment.
- **NEVER** leave implement unattended in a raised position.



**TO AVOID CHILDREN FALLING OFF OR BEING CRUSHED BY EQUIPMENT:**

- **NEVER ALLOW** children to play on or around Tractor or Implement.

### **WHEN UNHITCHING IMPLEMENT:**

- **LOWER** implement, **LOCK** or **BLOCK** lifted parts before leaving equipment. *PN CHFM-01*

# SAFETY

## THROWN OBJECT HAZARDS

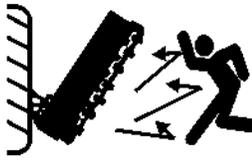
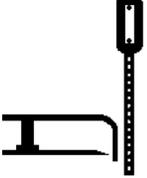
			
Mower Thrown Objects Hazard	Raised Mower Thrown Objects	Inspect Area remove foreign objects	Do not let blades contact solid objects



**ROTARY MOWERS CAN THROW OBJECTS 300 FEET OR MORE UNDER ADVERSE CONDITIONS.**

### TO AVOID SERIOUS INJURY OR DEATH TO OPERATOR OR BYSTANDERS FROM THROWN OBJECTS:

- KEEP bystanders 300 feet away

### STOP MOWING IF PASSERSBY ARE WITHIN 300 FEET UNLESS:

- **All THROWN OBJECT SHIELDING** including, Front and Rear Deflectors, Steel Guards, Bands, Side Skirts and Skid Shoes in place and in good condition when mowing.
- Mower sections or wing are adjusted to be close and parallel to ground without exposing blades.
- **MOWING AREA** has been inspected and foreign materials and debris have been removed.
- **PASSERSBY** are inside enclosed vehicle.

### INSPECT AREA FOR POTENTIAL THROWN OBJECTS BEFORE MOWING:

- **REMOVE** debris, rocks, wire, cable, metal objects and other foreign material from area. Wire, cable, rope, chains and metal objects can be thrown or swing outside deck with great velocity:
  1. **MARK** objects that cannot removed.
  2. **AVOID** these objects when mowing.

### HIGH GRASS and WEED AREA INSPECTION:

- **INSPECT** for and **REMOVE** any hidden large debris.
- **MOW** at Intermediate height
- **INSPECT** and remove remaining debris
- **MOW** at final height.

### MOWER THROWN OBJECT SHIELDING:

- **KEEP** all thrown object shielding including, Front and Rear Deflectors, Steel Guards, Bands, Side Skirts and Skid Shoes in place and in good condition when mowing.
- **DO NOT OPERATE** with any thrown object shielding missing, damaged or removed.

### RIGHT OF WAY (Highway) MOWING

- No shielding is 100% effective in preventing thrown objects. To Reduce Possibility of Injury:
  1. **MAINTAIN MOWER SHIELDING**, side skirts, skid shoes, and blades in good operational condition,
  2. **RAISE CUTTING HEIGHT** to **6 INCHES** minimum,
  3. **INSPECT AREA** thoroughly before mowing to **REMOVE** potential **THROWN OBJECT HAZARDS**,
  4. **NEVER ALLOW BLADES TO CONTACT SOLID OBJECTS** like wire, rocks, post, curbs, guardrails, or ground while mowing. *PN TOFM-01*

# SAFETY

## THROWN OBJECTS HAZARDS (CONTINUED)

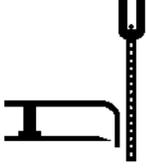
			
<p>Mower Thrown Objects Hazard</p>	<p>Raised Mower Thrown Objects</p>	<p>Inspect Area remove foreign objects</p>	<p>Do not let blades contact solid objects</p>

### MOWER OPERATION:

- **DO NOT** exceed mower's rated Cutting Capacity or cut non-vegetative material.
- **USE ENCLOSED TRACTOR CABS** when two or more mowers are operating in mowing area.
- **ADJUST** mower sections or wing close and parallel to ground without exposing blades
- **ADJUST** cutting **HEIGHT** to **AVOID BLADE CONTACT** with solid objects like wire, rocks, posts, curbs, guard rails and fixed obstructions.
- **DO NOT** operate mower when mower is raised or in transport position
- **STOP MOWING** immediately if blades strike heavy objects, fixed structures, metal guard rails and concrete structures:
  1. **BLADES CAN FAIL** from impact and objects can be thrown with great velocity.
  2. **INSPECT** and **REPLACE** any damaged blades.
  3. **CHECK** blade carrier balance and **REPLACE** if damaged.
- **DO NOT** mow in standing water **TO AVOID** possible **BLADE FAILURE**.
- **AVOID MOWING** in reverse:
  1. **STOP PTO** and back up mower.
  2. **LOWER** mower, engage **PTO** and mow forward.
- **STOP PTO** and **BLADES** when raising the mower to transport position.
- **DO NOT ENGAGE PTO** with mower in transport position.
- **STOP** mowing when **EXCESSIVE VIBRATION** occurs:
  1. **STOP PTO** and tractor **ENGINE**.
  2. **INSPECT** mower for vibration source
  3. **REPLACE** any damage parts and bent or damaged **BLADES**. *PN TOFM-02*

**SAFETY**

# SAFETY

## RUN OVER HAZARDS

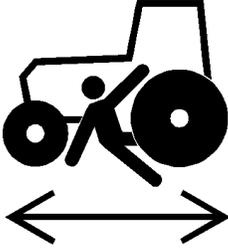
		
Operator run over hazard	Rider fall off run over hazard	Rider fall off run over hazard



**TO AVOID SERIOUS INJURY OR DEATH FROM FALLING OFF TRACTOR OR EQUIPMENT RUN OVER:**

- **USE ROPS** and **SEAT BELT** equipped tractors for mowing operations.
- **KEEP ROPS** locked in **UP** position.
- **ONLY** start tractor while seated in tractor seat.
- **ALWAYS BUCKLE UP** seat belt when operating tractor and equipment.
- **ONLY OPERATE** tractor and equipment while seated in tractor seat.
- **NEVER ALLOW RIDERS** on tractor or implement.

### **WHEN MOUNTING AND DISMOUNTING TRACTOR:**

- **ONLY** mount or dismount when tractor and moving parts are stopped.
- **STOP ENGINE AND PTO**, engage parking brake, lower implement, allow all moving parts to stop and remove key before dismounting from tractor. *PN R001*

# SAFETY

## PTO ENTANGLEMENT HAZARDS

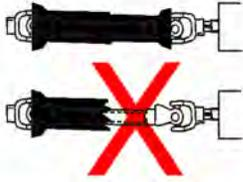
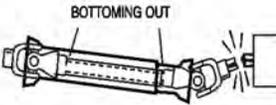
			
<p>Entanglement hazard Do Not approach or touch a rotating PTO driveshaft</p>	<p>Make sure PTO shaft is securely attached Do Not Use PTO Adapter</p>	<p>DO NOT Operate if PTO shields are damaged or missing</p>	<p>Make sure PTO shafts are proper length</p>



**KEEP AWAY FROM ROTATING DRIVELINES AND ELEMENTS TO AVOID SERIOUS INJURY OR DEATH:**

**STAY AWAY** and **KEEP** hands, feet and body **AWAY** from rotating blades, drivelines and parts until all moving elements have stopped.

- **STOP, LOOK** and **LISTEN** before approaching the mower to make sure all rotating motion has stopped.
- **ROTATING COMPONENTS CONTINUE to ROTATE** after the PTO is shut off.

### PTO SHIELDING:

#### TO AVOID SERIOUS INJURY OR DEATH FROM ENTANGLEMENT WHEN OPERATING IMPLEMENT:

- **KEEP PTO** shields, integral driveline shields and input shields installed
- **DO NOT OPERATE** mower without shields and guards in place or missing
- **REPAIR OR REPLACE** if damage, broken or missing
- **ALWAYS REPLACE GUARDS** that have been removed for service or maintenance.
- Do Not use PTO or PTO guard as a step.

#### TO AVOID broken driveline during operations:

- **CHECK** driveline for proper length between PTO shaft and implement gearbox shaft. *(Refer to Instructions in Operation Section)*
- Drivelines too short can pull apart or disengage.
- Drivelines too long can bottom out.  
Bottoming driveline telescoping assembly will stop sliding and become solid.
- Driveline bottoming can push through support bearings and break off PTO shaft
- **AVOID** sharp turns or lift mower to heights to cause driveline "knocking".
- Lubricate driveshaft-telescoping components weekly.

#### CONTACT DEALER if implement driveline does not match Tractor PTO shaft:

- **DO NOT USE PTO ADAPTER.**  
Using a PTO adapter can cause excessive vibration, thrown objects, blade and implement failures by doubling operating speed. Increased working length exposing unshielded driveline areas. *PN PE01*

# SAFETY

SAFETY

## MOWER BLADE CONTACT HAZARDS

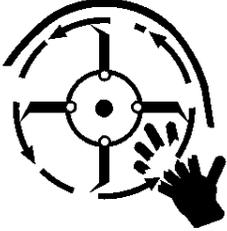
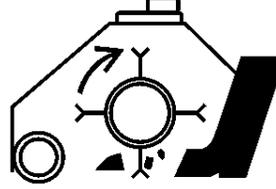
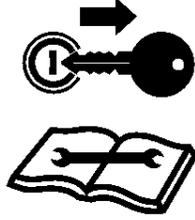
		
Do not put fingers underneath mower	Do not put foot underneath mower	Stop Tractor Remove Key Read Manual

**⚠ DANGER** KEEP AWAY FROM ROTATING BLADES TO AVOID SERIOUS INJURY OR DEATH FROM BLADE CONTACT:

- **STAY AWAY** and **KEEP HANDS, FEET** and **BODY AWAY** from rotating blades, drivelines and parts until all moving elements have stopped.
- **DO NOT** put hands or feet under mower decks
- **STOP** rotating **BLADES** disengage PTO and wait for blade to stop rotating before raising mower deck or wings
- **STOP LOOK** and **LISTEN** before approaching the mower to make sure all rotating motion has stopped. *PN MBFM-01*

## HIGH PRESSURE OILLEAK HAZARDS

		
High pressure oil penetrating skin	High pressure oil eroding skin	Using cardboard to check for oil leaks

**⚠ DANGER** TO AVOID SERIOUS INJURY OR DEATH FROM HIGH PRESSURE HYDRAULIC OIL LEAKS PENERATING SKIN:

- **DO NOT OPERATE** equipment with oil or fuel leaks.
- **KEEP** all hydraulic hoses, lines and connections in **GOOD CONDITION** and **TIGHT** before applying system pressure.
- **RELIEVE HYDRAULIC PRESSURE** before disconnecting lines or working on the system.
- **REMOVE** and replace hose if you suspect it leaks. Have dealer test it for leaks.

**HIGH PRESSURE FLUID LEAKS CAN BE INVISIBLE.**

**WHEN CHECKING FOR HYDRAULIC LEAKS AND WORKING AROUND HYDRAULIC SYSTEMS:**

- **ALWAYS WEAR** safety glasses and impenetrable gloves.
- **USE** paper or cardboard to search for leaks.
- **DO NOT USE** hands or body parts to search for leak.
- **KEEP** hands and body **AWAY** from pin holes and nozzles ejecting hydraulic fluid.
- Hydraulic fluid may cause gangrene if not surgically removed immediately by a doctor familiar with this form of injury.  
*PN HP01*



# SAFETY

## ELECTRICAL & FIRE HAZARDS

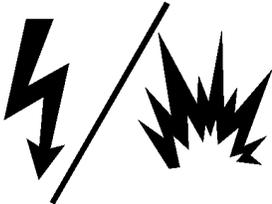
	
Strike and explosion Hazard Blades Contacting Utility or Gas Lines	Do not operate near fires. Keep mower deck clear of debris

### **⚠ DANGER**

**TO AVOID SERIOUS INJURY OR DEATH FROM ELECTRICAL CONTACT WHEN WORKING AROUND ELECTRICAL POWER LINES, GAS LINES AND UTILITY LINES:**

- **INSPECT** mowing area for overhead or underground electrical power lines, obstructions, gas lines, cables and Utility, Municipal, or other type structure.
- **DO NOT** allow mower to contact with any Utility, Municipal, or type of structures and obstructions.
- **CALL 811** and 1-800-258-0808 for identify buried utility lines.

**FIRE PREVENTION GUIDELINES while Operating, Servicing, and Repairing Mower and Tractor to reduce equipment and grass fire Risk:**

- **EQUIP** Tractor with a **FIRE EXTINGUISHER**
- **DO NOT OPERATE** mower on a tractor equipped with under frame exhaust
- **DO NOT SMOKE** or have open flame near Mower or Tractor
- **DO NOT DRIVE** into burning debris or freshly burnt area
- **AVOID FIRE IGNITION** by not allowing mower blade to contact solid objects like metal or rock.
- **ADJUST SLIP CLUTCHES** to avoid excessive slippage and clutch plate heating.
- **CLEAR** any grass clippings or debris buildup around mower drivelines, slip clutches, and gearboxes.
- **SHUT OFF ENGINE** while refueling. *PN EF02*

**SAFETY**

# SAFETY

## TRANSPORTING HAZARDS

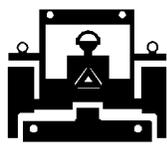
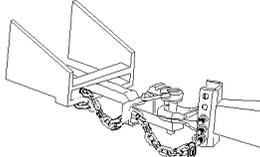
				
Use SMV signs and Flashing Lights	Loss of Control Stopping Hazard	Loss of Control Speeding Hazard	Use Safety Tow Chain - Tractor to Implement	Engage Transport Locks

### **WARNING**

TO AVOID SERIOUS INJURY AND DEATH WHEN TOWING OR TRANSPORTING EQUIPMENT:

- **KEEP** transport speed **BELOW 20 mph** to maintain control of equipment.
- **REDUCE SPEED** on inclines, on turns and in poor towing conditions.
- **DO NOT TOW** with trucks or other vehicles
- **USE** only properly sized and equipped tractor for towing equipment.
- **FOLLOW** all local traffic regulations.

#### TRACTOR REQUIREMENTS FOR TOWING OR TRANSPORTING IMPLEMENTS:

- **ONLY TRANSPORT** with tractor with **ROPS** in the raised position.
- **USE** properly sized and equipped tractor that exceeds implement weight by at least 20%
- **KEEP 20%** of tractor weight on front wheels to maintain safe steering.

#### BEFORE TRANSPORTING OR TOWING IMPLEMENT:

##### TRACTOR INSPECTION:

- **CHECK** steering and braking for proper operation and in good condition.
- **CHECK SMV** sign, reflectors and warning lights for proper operation and visibility behind unit.
- **CHECK** that your driving vision is not impaired by tractor, cab, or implement while seated in tractor seat.
- **ADJUST** your operating position, mirrors, and implement transport for clear vision for traveling and traffic conditions.

#### PREPARE IMPLEMENT FOR TRANSPORTING OR TOWING:

- **DISENGAGE PTO**
- **RAISE MOWER**
- **REMOVE** any cut material collected on mower deck.

#### TOWED MOWERS - ENGAGE TRANSPORT LOCKS AND SAFETY CHAINS:

- **INSTALL** center axle cylinder transport stops or pins
- **ATTACH** implement SAFETY CHAIN to tractor

#### DETERMINE STOPPING CHARACTERISTICS OF TRACTOR AND IMPLEMENT FOR TRANSPORTING OR TOWING:

##### BRAKING TESTS:

- **APPLY** brakes at increasing speeds
- Observe **STOPPING** distances increases with increased speeds.
- **DETERMINE** the maximum safe transport speed that does not exceed 20 mph

#### DETERMINE MAXIMUM TURNING SPEED BEFORE OPERATING ON ROADS OR UNEVEN GROUND:

- **TEST** equipment in slowly increasing speed in turns to determine it can be operated at higher speeds.
- **USE REDUCED** turning speeds in sharp turns to avoid equipment turning over.

#### WHEN TOWING OR TRANSPORTING EQUIPMENT:

- Always **WEAR SEAT BELT** when operating or transporting mower.
- **USE** low speeds to avoid overturn with raised wings.
- **USE** low speeds and gradual steering on curves, hills, rough or uneven surfaces and on wet roads
- **TURN ON** tractor **FLASHING WARNING LIGHTS**.
- **ALLOW** clearance for implement swing while turning. *PN TH02*

# SAFETY

## HAZARDS WITH MAINTENANCE OF IMPLEMENT

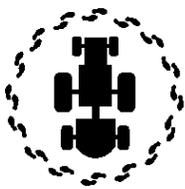
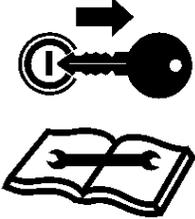
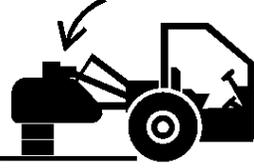
				
Periodically inspect all moving parts, lubricate drivelines, and tighten all fasteners	Stop engine remove key before conducting maintenance	Block up implement before servicing Use large blocks on soft or wet soil	Engage cylinder transport locks	Inspect Blades for damage or cracks

**WARNING** AVOID SERIOUS INJURY OR DEATH FROM COMPONENT FAILURE BY KEEPING IMPLEMENT IN GOOD OPERATING CONDITION IN PERFORMING PROPER SERVICE, REPAIRS AND MAINTENANCE.

**BEFORE PERFORMING SERVICE, REPAIRS AND MAINTENANCE ON THE IMPLEMENT:**

- **STOP ENGINE AND PTO**, engage parking brake, lower implement, allow all moving parts to stop and remove key before dismounting from tractor.
- **PLACE** implement on ground or securely block up raised equipment. Use large blocks on soft or wet soil.
- **PUSH** and **PULL** Remote Hydraulic Cylinder lever to relieve hydraulic pressure.
- **DISCONNECT IMPLEMENT** driveline from tractor **PTO SHAFT**.

**WEAR SAFETY GLASSES, PROTECTIVE GLOVES** and follow **SAFETY PROCEDURES** when performing service, repairs and maintenance on the implement:

- Always **WEAR** protective **GLOVES** when handling blades, knives, cutting edges or worn component with sharp edges.
- Always **WEAR GLOVES** and **SAFETY GLASSES** when servicing hot components
- **AVOID CONTACT** with hot hydraulic oil tanks, pumps, motors, valves and hose connection surfaces.
- **SECURELY** support or **BLOCK UP** raised implement, framework and lifted components before working underneath equipment.
- **STOP** any implement movements and **SHUT-OFF TRACTOR** engine before doing any work procedures.
- **USE** ladder or raised stands to reach high equipment areas inaccessible from ground.
- **ENSURE** good footing by standing on solid flat surfaces when getting on implement to perform work.
- **FOLLOW** manufacturer's instructions in handling oils, solvents, cleansers, and other chemical agents.
- **DO NOT** change any factory-set hydraulic calibrations to avoid component or equipment failures.
- **DO NOT** weld or alter implement, functions or components.
- **DO NOT WELD** or repair rotating mower components. These may cause vibrations and component failures being thrown from mower.

**PERFORM SERVICE, REPAIRS, LUBRICATION AND MAINTENANCE OUTLINED IN IMPLEMENT MAINTENANCE SECTION:**

- **INSPECT** for loose fasteners, worn or broken parts, leaky or loose fittings, missing or broken cotter keys and washers on pins, and all moving parts for wear.
- **REPLACE** any worn or broken parts with authorized service parts.
- **LUBRICATE** unit as specified by lubrication schedule
- **NEVER** lubricate, adjust or remove material while it is running or in motion.
- **TORQUE** all bolts and nuts as specified.

**BLADE INSPECTION:**

- **REPLACE** bent, damage, cracked or broken blades immediately with new blades.
- **AVOID** blade failures and thrown broken blades. **DO NOT** straighten, weld, or weld hard-facing blades.

**SAFETY SHIELDS, GUARDS AND SAFETY DEVICES INSPECTION:**

- **KEEP** all Deflectors, Steel Guards, Gearbox Shields, and PTO integral shields, Bands, Side Skirts and Skid Shoes in place and in good condition.
- **REPLACE** any missing, broken or worn safety shields, guards and safety devices.
- Engine Exhaust, some of its constituents, and certain vehicle components contain or emit chemicals known to the state of California to cause cancer, birth defects or other reproductive harm.
- Battery posts, terminals and related accessories contain lead and lead compounds, chemicals known to the state of California to cause cancer, birth defects or other reproductive harm. **PN HMFM-01**

**SAFETY**

# SAFETY

## PARTS INFORMATION

### PARTS INFORMATION

Tiger mowers use balanced and matched system components for blade carriers, blades, cuttershafts, knives, knife hangers, rollers, drivetrain components, and bearings. These parts are made and tested to Tiger specifications. Non-genuine "will fit" parts do not consistently meet these specifications. The use of "will fit" parts may reduce mower performance, void mower warranties, and present a safety hazard. Use genuine Tiger mower parts for economy and safety. (SPTM-1)

**SEE YOUR TIGER DEALER**

## Decal Location

**NOTE:** Tiger supplies safety decals on this product to promote safe operation. Damage to the decals may occur while in shipping, use, or reconditioning. Tiger cares about the safety of its customers, operators, and bystanders, and will replace the safety decals on this product in the field, free of charge (Some shipping and handling charges may apply). Contact your Tiger dealer to order replacement decals.

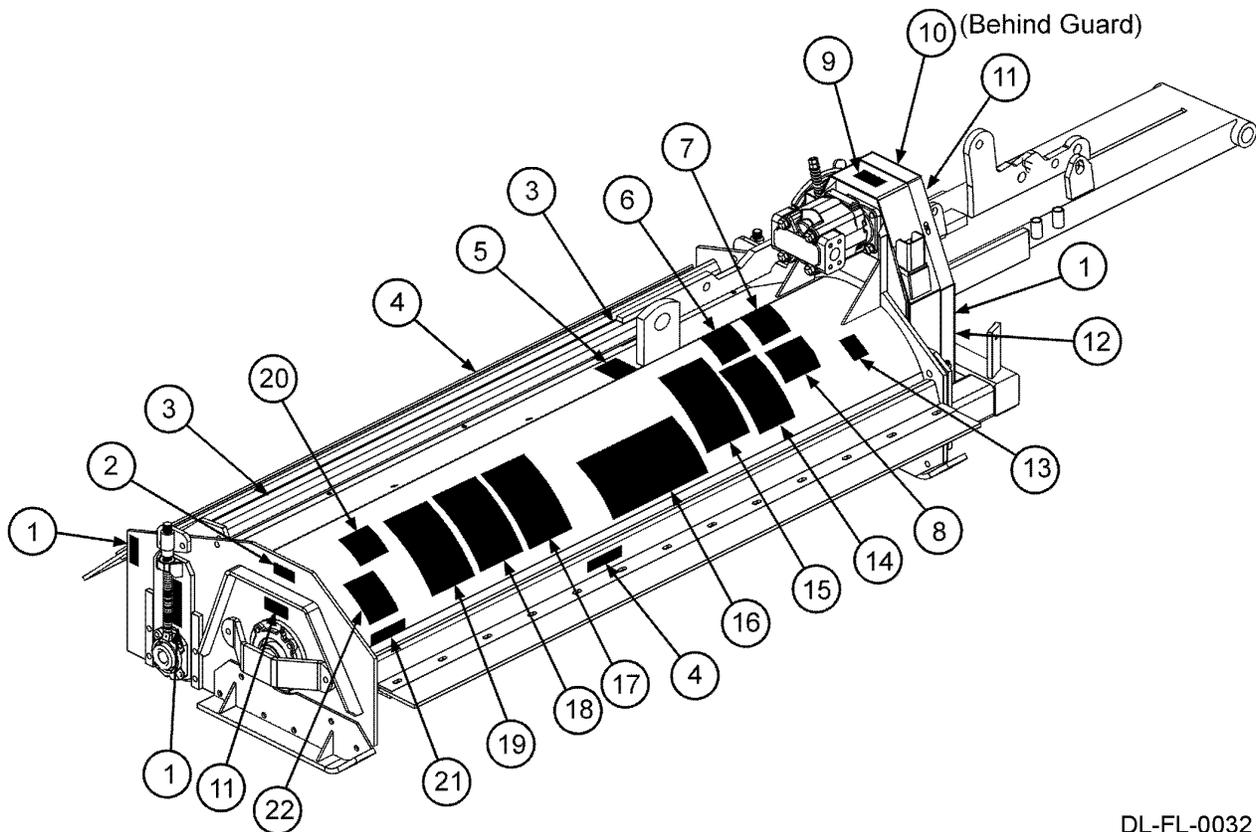

DL-FL-0032

SIDE FLAIL

Safety Section 1-14

SAFETY

# SAFETY

SAFETY

ITEM	PART NO.	QTY.	TYPE	DESCRIPTION
1.	6T3261	2	INSTRUCT	Greasing Instructions
2.	22839	1	INSTRUCT	Do Not Lubricate with Automatic Grease Gun
3.	42399	2	REFLECTOR	Red Reflector
4.	24028	2	DANGER	Thrown Object Hazard
5.	D703	1	DANGER	Crushing Hazard
6.	02962765	1	DANGER	Crushing Hazard & Pinch Points
7.	02965262	1	WARNING	Oil Leak Hazard
8.	D698	1	DANGER	Crushing Hazard - Injury or Death
9.	00758194	1	WARNING	Pinch Point Hazard
10.	D646	1	DANGER	Guard Missing, Do Not Operate
11.	6T3249A	2	INSTRUCT	Greasing Instructions-Cutter Shaft Bearing
12.	21405	2	INSTRUCT	Standard/Smooth Cut Measurements
13.	6T3221	1	IMPORTANT	Lubricate Spindle every 40 hours
14.	32709	1	WARNING	Use Genuine Tiger Parts
15.	D699	1	WARNING	Multi-Hazard
16.	31522	1	LOGO	Tiger Logo (10" x 5.5")
17.	D696	1	DANGER	Multi-Hazard
18.	D687	1	DANGER	Entanglement / Run Over Hazard
19.	D686	1	DANGER	Thrown Object / Crushing Hazard
20.	D706	1	INSTRUCT	Lubrication Chart - Rear Flail
21.	42400	1	REFLECTOR	Amber Reflector
22.	6T3236	1	LOGO	Made in the USA

# SAFETY

**SAFETY**

## Decal Description

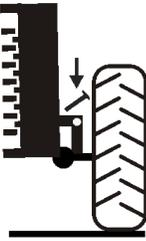
	<b>⚠ DANGER</b>	
	<b>Crushing Hazard</b> Transport Latch RAISE AND SECURELY LOCK Wing Transport Latch before transporting mower on roadways or working under wing.	
	<b>⚠ PELIGRO</b>	
	<b>Riesgo de Aplastamiento</b> <span style="float: right;">D703</span> Cierre de Transporte LEVANTE Y DE FORMA SEGURA ATRANQUE el cierre de ala de transporte antes de transportar el cortacésped en carretera o trabajando abajo de la ala.	

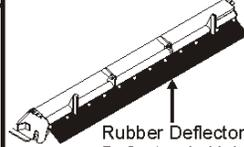
<b>⚠ DANGER</b>		<b>⚠ PELIGRO</b>	
<b>THROWN OBJECT HAZARD</b>	 Rubber Deflector Deflector de Hule	<b>RIESGO DE OBJETOS LANZADOS</b>	
TO AVOID SERIOUS INJURY OR DEATH: DO NOT OPERATE if Thrown Object Shielding is damaged or missing. <ul style="list-style-type: none"> <li>• Maintain Rubber Deflectors in good condition.</li> <li>• Inspect Rubber Deflectors frequently.</li> </ul>		PARA EVITAR LESION SERIA O MUERTE: NO OPERE si la Cubierta de Objetos Lanzados esta dañada o falta. <ul style="list-style-type: none"> <li>• Mantenga Los Deflectores de Hule en buenas condiciones.</li> <li>• Inspeccione Los Deflectores de Hule con frecuencia.</li> </ul> <span style="float: right;">24028</span>	

<b>⚠ WARNING</b>		<b>⚠ ADVERTENCIA</b>	
<b>PINCH POINT HAZARD</b>		<b>RIESGO DE PUNTOS DE PELLIZCO</b>	
TO AVOID SERIOUS INJURY: • DO NOT OPERATE with Belt Shield removed.		PARA EVITAR LESION SERIA: • NO OPERE con la cubierta de correa ausente. <span style="float: right;">00758194</span>	

# SAFETY

SAFETY

<b>⚠ WARNING</b>		<b>⚠ ADVERTENCIA</b>	
<p><b>TO AVOID SERIOUS INJURY OR DEATH FROM HIGH PRESSURE HYDRAULIC OIL LEAKS PENETRATING SKIN:</b></p> <ul style="list-style-type: none"> <li>• DO NOT OPERATE equipment with oil or fuel leaks.</li> <li>• KEEP all hydraulic hoses, lines and connections in good condition and tight before applying system pressure.</li> <li>• Relieve hydraulic pressure before disconnecting lines or working on the system.</li> <li>• REMOVE and replace hose if you suspect it leaks. Have dealer test it for leaks.</li> </ul> <p><b>HIGH PRESSURE FLUID LEAKS CAN BE INVISIBLE. WHEN CHECKING FOR HYDRAULIC LEAKS AND WORKING AROUND HYDRAULIC SYSTEMS:</b></p> <ul style="list-style-type: none"> <li>• DO NOT use hands to check for leaks.</li> <li>• ALWAYS WEAR safety glasses and impenetrable gloves.</li> <li>• USE paper or cardboard to search for leaks.</li> <li>• KEEP hands and body AWAY from pin holes and nozzles ejecting hydraulic fluid.</li> <li>• Hydraulic fluid may cause gangrene if not surgically removed immediately by a doctor familiar with this form of injury.</li> </ul>	    	<p><b>PARA EVITAR LESION SERIA O MUERTE POR LA PENETRACION A LA PIEL POR ALTA PRESION DE ACEITE HIDRÁULICO:</b></p> <ul style="list-style-type: none"> <li>• NO OPERE el equipo con fugas de aceite o combustible.</li> <li>• MANTENGA todas las mangueras hidráulicas, líneas y conexiones en buenas condiciones y apretadas antes de aplicar presión al sistema.</li> <li>• Releve la presión hidráulica antes de desconectar las líneas o trabajar en le sistema.</li> <li>• QUITE y reemplace la manguera si sospecha que hay fuga.</li> </ul> <p><b>FUGAS DE ALTA PRESIÓN PUEDEN SER INVISIBLE. AL VERIFICAR POR FUGAS HIDRAULICAS Y TRABAJANDO ALREDEDOR DE SISTEMAS HIDRAULICOS:</b></p> <ul style="list-style-type: none"> <li>• NO use las manos para verificar si hay agujeros.</li> <li>• SIEMPRE USE lentes de seguridad y guantes impenetrables.</li> <li>• USE papel o un cartón para buscar agujeros.</li> <li>• NO USE las manos o partes del cuerpo para buscar agujeros.</li> <li>• MANTEGA manos y cuerpo LEJOS de agujeros de afiler y boquillas que expulsan el liquido hidráulicos.</li> </ul>	<p>02965262</p>

<b>⚠ DANGER</b>		<b>⚠ PELIGRO</b>	
<b>Crushing Hazard - Injury or Death</b>		<b>Riesgo de Aplastamiento Lesion o Muerte</b>	
<p><b>TO AVOID SERIOUS INJURY OR DEATH:</b></p> <ul style="list-style-type: none"> <li>• STAND CLEAR when removing transport latch, lowering or raising wings.</li> <li>• CLEAR AREA of bystanders before lowering implement wings.</li> <li>• IMPLEMENT CAN FALL from hydraulic failure or accidental operation of controls.</li> <li>• BLOCK UP and securely support equipment before putting hands, feet or body under raised equipment or lifted components.</li> <li>• SECURELY ENGAGE transport latch before transportation or working under wing.</li> <li>• FILL CYLINDERS with oil before attempting to lower implement wings.</li> <li>• DO NOT OPERATE in transport position or with wings off ground.</li> </ul>	  	<p><b>PARA EVITAR LESION SERIA O MUERTE:</b></p> <ul style="list-style-type: none"> <li>• MANTENGASE LEJOS al quitar el cierre de transporte, bajando y devantando las alas.</li> <li>• DESOCUPE EL AREA de personas presentes antes de bajar las alas del implemento.</li> <li>• EL IMPLEMENTO PUEDE CAER del fracaso hidráulico o por operación accidental de controles.</li> <li>• BLOQUEE y soporte con seguridad antes de poner manos, pies o cuerpo debajo del equipo de componentes levantados.</li> <li>• CON SEGURIDAD ACTIVE el cierre de transporte antes de la transportacion o trabajar debajo de las alas.</li> <li>• LLENE LOS CILINDROS con aceite antes de intentar de bajar las alas del implemento.</li> <li>• NO OPERE en posicion de transporte o con las alas devantadas del la tierra.</li> </ul>	<p>D698</p>

# SAFETY

SAFETY





# SAFETY

SAFETY

<b>⚠ WARNING</b>		<b>⚠ ADVERTENCIA</b>	
<p><b>TO AVOID SERIOUS INJURY AND DEATH DURING TRANSPORTATION:</b></p> <ul style="list-style-type: none"> <li>• ALWAYS BUCKLE UP seat belt.</li> <li>• PLACE wing securely in Transport latch and turn off master switch.</li> <li>• CHECK SMV sign, reflectors and warning lights for visibility behind unit.</li> <li>• TURN ON tractor flashing warning lights.</li> </ul> <p><b>TO AVOID LOSS OF TRANSPORTATION CONTROL:</b></p> <ul style="list-style-type: none"> <li>• DO NOT travel at speeds over 20 mph.</li> <li>• REDUCE SPEED on inclines, in turns and in poor weather conditions.</li> </ul>		<p><b>PARA EVITAR LESION SERIA Y MUERTE DURANTE LA TRANSPORTACION:</b></p> <ul style="list-style-type: none"> <li>• SIEMPRE ABROCHE el cinturón de seguridad.</li> <li>• COLOQUE el brazo seguramente en transporte y apague el interruptor principal.</li> <li>• VERIFIQUE QUE EL SMV, reflectors, y luces intermitentes de advertencia pueden ser vistos claramente por detras de la unidad.</li> <li>• PRIENDA las luces intermitentes de advertencia.</li> </ul> <p><b>PARA EVITAR LA PÉRDIDA DEL CONTROL DE TRANSPORTACION:</b></p> <ul style="list-style-type: none"> <li>• NO remolque en velocidades arriba de 20 mph.</li> <li>• REDUZCA LA VELOCIDAD en inclinas, en vueltas y en pobres condiciones de remolque.</li> </ul>	
		D699_1	

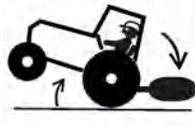
<b>⚠ WARNING</b>		<b>⚠ ADVERTENCIA</b>	
<p><b>TO AVOID SERIOUS INJURY AND DEATH DURING OPERATION:</b></p> <ul style="list-style-type: none"> <li>• DO NOT lift implement while on steep slopes.</li> <li>• KEEP AWAY from soft ditch banks and holes.</li> <li>• ALWAYS MAINTAIN 20% of tractor weight on front wheels.</li> <li>• DO NOT start or accelerate suddenly.</li> <li>• KEEP mower AT LEAST 10 FEET AWAY from electric lines and pipe lines.</li> </ul>		<p><b>PARA EVITAR LESION SERIA Y MUERTE DURANTE LA OPERACION:</b></p> <ul style="list-style-type: none"> <li>• NO levante el implemento al estar en pendientes pronunciados..</li> <li>• MANTENGASE ALEJADO DE agujeros y zanjas blandas..</li> <li>• MANTENGA SIEMPRE el 20% de peso del tractor en las ruedas delanteras.</li> <li>• NO comience ni acelere repentinamente.</li> <li>• MANTENGA la unidad, por lo menos 10 pies de distancia de las líneas electricas y líneas de tubo.</li> </ul>	
		D699_2	

<b>⚠ WARNING</b>		<b>⚠ ADVERTENCIA</b>	
<p><b>TO AVOID EQUIPMENT AND GRASS FIRES:</b></p> <ul style="list-style-type: none"> <li>• CLEAR AWAY grass or debris from hydraulic lines, circuits and decks.</li> </ul> <p><b>TO AVOID FIRE IGNITION:</b></p> <ul style="list-style-type: none"> <li>• DO NOT ALLOW BLADES TO CONTACT rocks, metal or solid objects.</li> <li>• DO NOT ALLOW OIL TO SPRAY on hot equipment or components.</li> </ul>		<p><b>PARA EVITAR INCIENDOS DE EQUIPO Y CÉSPED:</b></p> <ul style="list-style-type: none"> <li>• QUITE el césped y escombros de las líneas hidráulicas, circuito, y las cubiertas.</li> </ul> <p><b>PARA EVITAR INCIENDOS POR IGNICIÓN:</b></p> <ul style="list-style-type: none"> <li>• NO PERMITA QUE LAS CUCHILLAS CONTACTEN piedras, metal o objetos solidos.</li> <li>• NO PERMITA QUE EL ACEITE CAIGA en el equipo o componentes calientes.</li> </ul>	
D699_3		D699	

# SAFETY

**SAFETY**

<b>⚠ DANGER</b>	<b>⚠ PELIGRO</b>	
<b>KEEP AWAY THROWN OBJECTS HAZARD</b>	<b>CONSERVESE LEJOS OBJETOS LANZADOS</b>	
<p>Mower can throw objects up to 300 feet. <b>TO AVOID SERIOUS INJURY OR DEATH to operator or bystanders:</b></p> <ul style="list-style-type: none"> <li>• STOP mowing if bystanders or traffic come within 300 feet.</li> <li>• DO NOT OPERATE with thrown object shielding removed.</li> <li>• KEEP thrown object shielding in place and in good condition during operation.</li> <li>• INSPECT area for potential mower thrown object hazards before mowing.</li> <li>• Remove and AVOID objects such as wire, cable, metal objects and all other foreign material.</li> <li>• DO NOT ALLOW blades to contact solid objects like wire, rocks, posts, curbs or guard rails.</li> <li>• DO NOT OPERATE in transport position or with wings off ground.</li> </ul>	 <p style="text-align: center;"><b>TRASH BASURA</b></p>	<p>Cortacésped puede lanzar objetos hasta 300 pies. <b>PARA EVITAR LESION SERIA O MUERTE a operadores y personas presentes:</b></p> <ul style="list-style-type: none"> <li>• Pare de segar si personas o tráfico se acercan entre 300 pies del area de segar.</li> <li>• NO OPERE sin la cubierta para objetos lanzados.</li> <li>• MANTENGA la cubierta para objeto lanzado en su lugar y en buenas condiciones.</li> <li>• INSPECCIONE el área por si hay riesgos potenciales de objetos lanzados antes de segar.</li> <li>• REMUEVA y EVITE objetos como alambre, cable, objetos de metal y todo otro material extranjero.</li> <li>• NO DEJE que las cuchillas contacten los objetos sólidos como alambre, rocas, postes, borde de banqueta, o barandillas.</li> <li>• NO OPERE en posición de transporte o con las alas levantadas.</li> </ul> <p style="text-align: right; font-size: small;">D686_1</p>

<b>⚠ DANGER</b>	<b>⚠ PELIGRO</b>	
<b>Crushing Hazard Injury or Death</b>	<b>Riesgo de Aplastamiento Lesion o Muerte</b>	
<p><b>TO AVOID SERIOUS INJURY OR DEATH:</b></p> <ul style="list-style-type: none"> <li>• USE tractor equipped with Rollover Protective Structure ("ROPS") including roll bar and seat belt. Keep roll bar in raised position.</li> <li>• KEEP ALERT and AVOID hitting stumps, holes, ruts, and uneven terrain.</li> <li>• ALWAYS BUCKLE UP seat belt.</li> <li>• STAND CLEAR when removing transport latch, lowering or raising wings.</li> <li>• CLEAR AREA of bystanders before lowering implement wings.</li> <li>• IMPLEMENT CAN FALL from hydraulic failure or accidental operation of controls.</li> <li>• BLOCK UP and securely support equipment before putting hands, feet or body under raised equipment or lifted components.</li> </ul> <p style="text-align: right; font-size: small;">D686_3</p>		<p><b>PARA EVITAR LESION SERIA O MUERTE:</b></p> <ul style="list-style-type: none"> <li>• USE un tractor equipado con Estructura Protectora Contra Vuelcos ("ROPS") incluyendo barra antivuelco y cinturón de seguridad. Mantenga la barra antivuelco en la posición elevada.</li> <li>• MANTENGASE ALERTO y EVITE golpes en troncos, agujeros, pozos o terreno en desnivel.</li> <li>• SIEMPRE ABROCHE el cinturón de seguridad.</li> <li>• PERMANEZCA ALEJADO al quitar el seguro de transporte, y al bajar o subir las alas.</li> <li>• DESOCUPE el ÁREA de personas presentes antes de bajar las alas del implemento.</li> <li>• EL IMPLEMENTO SE PUEDE CAER por el mal funcionamiento hidraulico o operacion accidental de los controles.</li> <li>• BLOQUEE y soporte con seguridad el equipo antes de poner manos, pies o cuerpo debajo del equipo o componentes levantados.</li> </ul>

# SAFETY

**SAFETY**

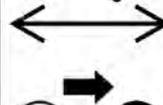
<b>⚠ DANGER</b>	<b>⚠ PELIGRO</b>
<b>KEEP AWAY</b> Entanglement Hazard	<b>MANTENGASE ALEJADO</b> Riesgo de Enredamiento
<p><b>TO AVOID SERIOUS INJURY OR DEATH:</b></p> <ul style="list-style-type: none"> <li>• DO NOT operate without guards in place and in good condition.</li> <li>• STAY AWAY and KEEP hands, feet and body AWAY from rotating blades, drivelines and parts that continue to move after power shut-off. WAIT until all moving elements have stopped.</li> <li>• STOP, LOOK and LISTEN for rotating motion before approaching implement.</li> <li>• STOP ENGINE and PTO, engage parking brake, lower implement, allow all moving parts to stop and remove key before dismounting from tractor.</li> </ul>	<div style="display: flex; flex-direction: column; align-items: center;">     </div> <p><b>PARA EVITAR LESION SERIA O MUERTE:</b></p> <ul style="list-style-type: none"> <li>• NO opere sin la cubierta protectora en su lugar y en buen estado.</li> <li>• MANTENGASE ALEJADO y MANTENGA manos, pies y cuerpo LEJOS de las cuchillas girando, líneas de conducción, y partes que siguen moviéndose después de que el poder es apagado. ESPERE hasta que todos los elementos móviles se han parado.</li> <li>• DETENGASE, OBSERVE y ESCUCHE por el movimiento de rotación antes de acercarse al implemento.</li> <li>• PARE EL MOTOR y el Toma De Fuerza (Barra Gitaloria) active el freno de mano, baje el implemento, y permita que todas las partes móviles se paren y quite la llave antes de desmontar del tractor.</li> </ul>
D687_1	

<b>⚠ DANGER</b>	<b>⚠ PELIGRO</b>
<b>Run Over Hazard</b> Injury or Death	<b>Riesgo de Atropello</b> Lesión o Muerte
<p><b>TO AVOID SERIOUS INJURY OR DEATH:</b></p> <ul style="list-style-type: none"> <li>• ALWAYS USE Roll Over Protective Structure ("ROPS") including ROLL BAR and SEAT BELT equipped tractors for mowing operations.</li> <li>• ONLY START Tractor while seated in the operator's seat.</li> <li>• DO NOT MOUNT or DISMOUNT Tractor in motion.</li> <li>• NEVER ALLOW riders on tractor or implement.</li> <li>• NEVER ALLOW children to operate or ride on tractor or implement.</li> <li>• KEEP BYSTANDERS CLEAR of area before moving tractor or implement.</li> <li>• STOP ENGINE AND PTO, engage parking brake, lower implement, allow all moving parts to stop and remove key before dismounting from tractor.</li> </ul>	<div style="display: flex; flex-direction: column; align-items: center;">    </div> <p><b>PARA EVITAR LESION SERIA O MUERTE:</b></p> <ul style="list-style-type: none"> <li>• SIEMPRE USE tractors equipados con una Estructura Protectora Contra Vuelcos ("ROPS") incluyendo BARRA ANTIVUELCOS y CINTURON DE SEGURIDAD al segar.</li> <li>• SOLO ENCIENDA el tractor mientras que esta sentado en el asiento del operador.</li> <li>• NO MONTE o DESMONTE el tractor en movimiento.</li> <li>• NUNCA PERMITA pasajeros en el tractor o implemento.</li> <li>• NUNCA PERMITA que niños operen o se monten en el tractor o implemento.</li> <li>• MANTENGA LAS PERSONAS PRESENTES LEJOS de la area antes de mover el tractor o implemento.</li> <li>• PARE EL MOTOR Y Toma De Fuerza (Barro Gitaloria), aplique el freno de mano, baje el implemento, y deje que todas las partes movíl paren completamente, y quite la llave antes de desmontar el tractor.</li> </ul>
D687_2	

# SAFETY

<b>⚠ DANGER</b>	<b>⚠ PELIGRO</b>
<p><b>TO AVOID SERIOUS INJURY OR DEATH FROM ENTANGLEMENT AND THROWN OBJECTS:</b></p> <ul style="list-style-type: none"> <li>• DO NOT OPERATE mower without shields and guards in place and in good condition.</li> <li>• DO NOT OPERATE with thrown object shielding or guards missing.</li> <li>• Thrown objects shielding, PTO and gearbox guarding are <b>SUBJECT TO WEAR</b>.</li> <li>• REPAIR OR REPLACE shielding if damaged, broken or missing. See Operator's Manual for all Shields and Guards.</li> <li>• ALWAYS REPLACE GUARDS that have been removed for service or maintenance.</li> <li>• DO NOT STEP ON drivelines or guards. <small>D696_1</small></li> </ul>	<div style="text-align: center;">  <p>Tractor PTO Guard (Cubierta del PTO) Implement PTO Guard (Cubierta del PTO) Shields (Cubiertas)</p> </div> <p><b>PARA EVITAR LESION SERIA O MUERTE POR ENREDAMIENTO Y OBJETOS LANZADOS:</b></p> <ul style="list-style-type: none"> <li>• NO OPERE la unidad sin cubiertas maya protectoras en su lugar y en buenas condiciones.</li> <li>• NO OPERE sin las cubiertas de objetos lanzados o si faltan las maya protectoras.</li> <li>• Cubierta de Objetos Lanzados, Toma De Fuerza (Barra Gítoria) y guardias de caja de engranaje son <b>SUJETO AL DESGASTE</b>.</li> <li>• REPARE O REEMPLACE cubiertas si son dañadas, quebradas, o si faltan.</li> <li>• SIEMPRE REEMPLACE CUBIERTAS que han sido quitadas para servicio o mantenimiento.</li> <li>• NO PISE EN las líneas de conducción o cubiertas.</li> </ul>

<b>⚠ DANGER</b>	<b>⚠ PELIGRO</b>
<p><b>TO AVOID SERIOUS INJURY OR DEATH:</b></p> <ul style="list-style-type: none"> <li>• READ AND UNDERSTAND the provided Operator's Manuals, safety signs and information decals for tractor and implement before operating equipment.</li> <li>• CONTACT DEALER immediately if you do not have manuals.</li> <li>• CONTACT DEALER to explain any instructions not fully understood.</li> <li>• KNOW HOW to stop tractor and equipment quickly for an emergency.</li> <li>• ALWAYS WEAR safety glasses.</li> <li>• WEAR hard hat, safety shoes and gloves for protection when operating equipment. <small>D696_2</small></li> </ul>	<div style="text-align: center;">  </div> <p><b>PARA EVITAR LESION SERIA O MUERTE:</b></p> <ul style="list-style-type: none"> <li>• LEA Y ENTIENDA el Manual de Operador proporcionado, signos de seguridad y calcomanias informativas para el tractor y implemento antes de operar el equipo.</li> <li>• CONTACTE AL DISTRIBUIDOR inmediatamente si no tiene los manuales.</li> <li>• CONTACTE AL DISTRIBUIDOR para que le explique cualquier instrucciones que no entiende completamente.</li> <li>• ENTIENDA COMO parar el tractor y equipo rapidamente en caso de una emergencia.</li> <li>• SIEMPRE USE lentes de seguridad.</li> <li>• USE un casco, zapatos de seguridad y guantes para su protection cuando esta operando el equipo. <small>D696</small></li> </ul>

# SAFETY

**SAFETY**

<p style="text-align: center;"><b>⚠ WARNING</b></p> <p><b>Non-genuine parts can fail catastrophically. TO AVOID SERIOUS INJURY OR DEATH:</b></p> <ul style="list-style-type: none"> <li>• ONLY use genuine TIGER replacement parts.</li> <li>• Non-genuine parts can fail creating hazardous conditions for operator and bystanders.</li> </ul> <p>Contact local dealer or TIGER about repair parts at:</p> <p>3301 N. LOUISE AVE., SIOUX FALLS, SD 57107          Customer Service: 800-843-6849.          Email: <a href="mailto:feedback@tiger-mowers.com">feedback@tiger-mowers.com</a></p> <p style="text-align: right; font-size: small;">32709_1</p>	<p style="text-align: center;"><b>⚠ ADVERTENCIA</b></p> <p><b>Partes que no son auténticas pueden fallar catastróficamente.</b></p> <p><b>PARA EVITAR LESION SERIA O MUERTE:</b></p> <ul style="list-style-type: none"> <li>• Use SOLAMENTE las partes de reemplazo auténticas de TIGER.</li> <li>• Partes que no son auténticas pueden fallar y causar condiciones peligrosas para el operador y personas presentes.</li> </ul> <p>Contacte a su distribuidor local o TIGER sobre partes de reparo a:</p> <p>3301 N. LOUISE AVE., SIOUX FALLS, SD 57107          Servicio al Cliente: 800-843-6849.          Correo Electronico: <a href="mailto:feedback@tiger-mowers.com">feedback@tiger-mowers.com</a></p>
<p style="text-align: center;"><b>IMPORTANT</b></p> <p style="text-align: center;"><b>BE AWARE      <u>BE TRAINED</u></b>  <b>BE ALERT      Before Operating</b>  <b>BE ALIVE      this Mower</b></p> <p>To prevent serious injury to yourself and/or bystanders, be trained in Safe Mowing Practices.</p> <p>Alamo Group Companies, Alamo Industrial, Bush Hog, M&amp;W, Rhino, Schulte, Tiger and Terrain King as well as AEM and FEMA provide training material that is critical for your Safety and the Safety of others when operating this equipment. Make these Safety Procedures an important part of every workday.</p> <p>Read and understand the Operator's Manual.</p> <p>Do not let untrained individuals operate this equipment.</p> <p>Contact your Dealer, AEM (<a href="http://www.aem.org">www.aem.org</a>), FEMA (314-878-2304, <a href="http://www.FarmEquipment.org">www.FarmEquipment.org</a>), or Alamo Group (<a href="http://www.Alamo-Group.com">www.Alamo-Group.com</a>) for information on training material or courses that provide training in Safer Operating Practices for Mowers.</p> <p style="text-align: right; font-size: small;">32709_2</p>	<p style="text-align: center;"><b>IMPORTANTE</b></p> <p style="text-align: center;"><b>ESTE CONSCIENTE      <u>SEA ENTRENADO</u></b>  <b>ESTE ALERTO      Antes de Funcionar</b>  <b>ESTE VIVO      Cortacésped</b></p> <p>Para prevenir lesiones graves a usted y/o personas presentes, sea entrenado en la Practica de Segar Seguro.</p> <p>Companias de Alamo Group, Alamo Industrial, Bush Hog, M&amp;W, Rhino, Schulte, Tiger y Terrain King asi como AEM y FEMA proporcionan material para entrenar que es esencial para su seguridad y la seguridad de otros al operar este equipo. Haga estos procedimientos de seguridad una parte importante de su día de trabajo.</p> <p>Lea y entienda el Manual de Operadores.</p> <p>No permita que personas sin entrenamiento funcionen este equipo.</p> <p>Contacte a su distribuidor, AEM (<a href="http://www.aem.org">www.aem.org</a>), FEMA (314-878-2304, <a href="http://www.FarmEquipment.org">www.FarmEquipment.org</a>), o Alamo Group (<a href="http://www.Alamo-Group.com">www.Alamo-Group.com</a>) para la informacion sobre el material de entrenamiento o cursos que ofrecen el entenamiento de Prácticas de Operación para Cortadoras.</p> <p style="text-align: right; font-size: small;">32709</p>

# SAFETY

## Federal Laws and Regulations

This section is intended to explain in broad terms the concept and effect of federal laws and regulations concerning employer and employee equipment operators. This section is not intended as a legal interpretation of the law and should not be considered as such.

### Employer-Employee Operator Regulations

U.S. Public Law 91-596 (The Williams-Steiger Occupational and Health Act of 1970) OSHA

#### This Act Seeks:

“...to assure so far as possible every working man and woman in the nation safe and healthful working conditions and to preserve our human resources...”

#### DUTIES

Sec. 5 (a) Each employer-

- (1) shall furnish to each of his employees employment and a place of employment which are free from recognized hazards that are causing or are likely to cause death or serious physical harm to his employees;
- (2) shall comply with occupational safety and health standards promulgated under this Act.
- (b) Each employee shall comply with occupational safety and health standards and all rules, regulations and orders issued pursuant to this Act which are applicable to his own actions and conduct.

### OSHA Training Requirements

**Title 29, Code of Federal Regulations Part 1928.57(a)(6). [www.osha.gov](http://www.osha.gov)**

Operator instructions. At the time of initial assignment and at least annually thereafter, the employer shall instruct every employee who operates an agricultural tractor and implements in the safe operating practices and servicing of equipment with which they are or will be involved, and of any other practices dictated by the work environment.

Keep all guards in place when the machine is in operation;

Permit no riders on equipment

Stop engine, disconnect the power source, and wait for all machine movement to stop before servicing, adjusting, cleaning or unclogging the equipment, except where the machine must be running to be properly serviced or maintained, in which case the employer shall instruct employees as to all steps and procedures which are necessary to safely service or maintain the equipment.

Make sure everyone is clear of machinery before starting the engine, engaging power, or operating the machine.

### Employer Responsibilities:

To ensure employee safety during Tractor and Implement operation, it is the employer's responsibility to:

1. Train the employee in the proper and safe operation of the Tractor and Implement.
2. Require that the employee read and fully understand the Tractor and Implement Operator's manual.
3. Permit only qualified and properly trained employees to operate the Tractor and Implement.
4. Maintain the Tractor and Implement in a safe operational condition and maintain all shields and guards on the equipment.
5. Ensure the Tractor is equipped with a functional ROPS and seat belt and require that the employee operator securely fasten the safety belt and operate with the ROPS in the raised position at all times.
6. Forbid the employee operator to carry additional riders on the Tractor or Implement.
7. Provide the required tools to maintain the Tractor and Implement in a good safe working condition and provide the necessary support devices to secure the equipment safely while performing repairs and service.
8. Require that the employee operator stop operation if bystanders or passersby come within 300 feet.

### Child Labor Under 16 Years of Age

Some regulations specify that no one under the age of 16 may operate power machinery. It is your responsibility to know what these regulations are in your own area or situation. (Refer to U.S. Dept. of Labor, Employment Standard Administration, Wage & Home Division, Child Labor Bulletin #102.)

# ASSEMBLY SECTION

# ASSEMBLY

Before attempting to mount your Tiger mower, it is important to read and understand all of the safety messages in the Safety Section of this manual.

• Read the safety messages in the Safety Section of this manual before attempting to mount the mower. Failure to do so could result in injury or death.



• Read the safety messages in the Safety Section of this manual before attempting to mount the mower. Failure to do so could result in injury or death.

• Read the safety messages in the Safety Section of this manual before attempting to mount the mower. Failure to do so could result in injury or death.

## TRACTOR PREPARATION

• Read the safety messages in the Safety Section of this manual before attempting to mount the mower. Failure to do so could result in injury or death.

• Read the safety messages in the Safety Section of this manual before attempting to mount the mower. Failure to do so could result in injury or death.

• Read the safety messages in the Safety Section of this manual before attempting to mount the mower. Failure to do so could result in injury or death.

• Read the safety messages in the Safety Section of this manual before attempting to mount the mower. Failure to do so could result in injury or death.

• Read the safety messages in the Safety Section of this manual before attempting to mount the mower. Failure to do so could result in injury or death.

• Read the safety messages in the Safety Section of this manual before attempting to mount the mower. Failure to do so could result in injury or death.

(ASM-JD-0001)

## MAINFRAME INSTALLATION

• Read the safety messages in the Safety Section of this manual before attempting to mount the mower. Failure to do so could result in injury or death.





# ASSEMBLY

## CRANKSHAFT ADAPTER

Q: 1. RO1 cccÖÄsçf! :Á ã@Ä [ ] Ä [ ] dÄ • çÄ@Ä Ä @ Ö^!^Ä ~ ||^ Ä ãÜDÄ  
SJ23950Ä äÄ || | , Ä@Ä • d~ &ç } • EÄÄ ASM-JD-0250)

## DRIVESHAFT AND FRONT PUMP MOUNTING

Q: çÄÄ | ä^ • ççÄ d Ä@Ä ç \ • ççÄ ç Ä | È  
U | ä^Ä | ä^ äÄ | ä^ • ççÄ [ ] | Ä [ ] d Ä@Ä [ ] Ä | ä^ • ççÄ Q • çÄ@Ä [ ] Ä [ ] d Ä@Ä  
{ [ ] } ç \* Ä | ä^ ^ çÄ UVÖÄÄ@Ä [ ] | Ä Ä - ^ Ä Ä | ^ Ä ä^ & ç } Ä äÄ@Ä [ ] Ä @ | äÄ^Ä  
ä • çÄ^ äÄ ä@Ä - ^ Ä ä^ Ä | Ä | È Q • çÄ@Ä ä, äÄ | Ä^ & | ä \* Ä [ ] Ä Ä@Ä [ ] Ä [ ] dÄ  
ÖUÄ UVÄ @ } È  
Q • çÄ [ ] Ä äÄ } Ä [ Ä@Ä | ä^ äÄ [ ] | ä \* Ä Ä | ç^ äÄ ÜÖÖÄÜSÖY DÄ äÄ Ä äÄ  
+ | çÄ Ä@Ä äÄ U | çÄÄ [ ] | Ä äÄ & Ä^Ä | äÄ Ä^Ä Ä Ä Ä | È Ä @ } Ä [ ] Ä [ ] ç \* Ä  
à | çÄ Ä^ & Ä • ä } È Ä @ & ä \* Ä | Ä | ä^ Ä [ ] | ä \* Ä^Ä | äÄ Ä^ { [ ç^ Ä@Ä [ ] Ä [ ] } ç \* Ä  
ä: äÄ ^ Ä [ | çÄ ] ^ Ä Ä Ä Ä äÄ | | Ä Ä@Ä äÄ | & ä \* Ä ^ } dÄ Ä @ } Ä@Ä^Ä [ | çÄ Ä  
• ~ & Ä • ä } È ä Ä & @ & ä \* Ä | Ä^Ä | äÄ Ä@Ä | ä^ • ççÄ Ä Ä | Ä | çÄ Ä^Ä | ~ ^ äÄ@Ä } äÄ  
] | äÄ } Ä@Ä | ä^ • ççÄ @ | äÄ^ Ä Ä + Ä Ä Ä + Ä äÄ [ ] | Ä Ä @ | äÄ [ ç^ Ä^Ä | Ä äÄ@Ä äÄ  
] | Ä • ~ | Ä Ä Ä } äÄ | äÄ Ä • Ä@Ä Ä Ä + Ä | ä äÄ@Ä } äÄ Ä@Ä çÄ Ä @ ç^ Ä@Ä | [ ] | Ä } äÄ  
] | äÄ Ä Ä @ | Ä Ä | | Ä Ä Ä Ä Ä } äÄ | äÄ Ä Ä | Ä@Ä çÄ äÄ ] ^ äÄ äÄ } • Ä | ÄÄ } \* ^ Ä  
• çÄ È

**CAUTION: DO NOT START THE TRACTOR UNTIL ALL HOSES ARE ATTACHED,**





# ASSEMBLY

## CABLE CONTROL LEVER STAND

Úlæ^Á@/æa|/æ| } d| |æ|ææ^o^ } Á@Á| | |Á| Á@æ@/æ|ææ^o^ Á+Á| { Á@Á| } o^ á|, ÉÁ  
 Ç| Á@Á| ~ ç|Á^æáæ| } ^|Á@^|d| Á@/æ|ææ^o^ Á+Á| { Á@Á^\*^Á-Á@/æ| | |ÉÁ@Á æá|æ| } ^|Á  
 [- Á@/æ|ææ^o^ @^ |á^Á^Á| { Á@Á^\*^Á-Á@/æ| | |ÉÁ^Áæ æ^Á^|, ÉÁ^Á^ |^Á@æ@/æ| &æ  
 ç| } Á-Á@Áæ áÁ æ|æ|, Á@Á| ^|ææ } Á-æ|æ| } d| |Áç^| Á@/æ|ææ| |æ| áÁ@æ@/æ| | |Á æ|Á| o^  
 •dä^Á@Áæ áÁ @ } Á @ ÉÁO^ ~ à|^æ@&Á } á|^Á@/æa|/æ|/æa|^•æ| áÁ á^•Á@ææ æ^Á^æ^ o^  
 , @ } Á|æ|æ \* ÉÁO^ áÁ^ |^Á|æ|æ \* Á| ~ à|^æ@&Á |ææ| } Á-Á@Áæ áÁ |Á| | |Á|ææ^ { } o^ Á  
 @ |^•ÉÁO^ |ÁÁ@ |^•Á^ Á æ&æ| } d| |æ|ææ^o^ } áÁ^&|^Á æ@ææ^•&^, •æ| áÁ^ | | &Á^ o^Á| ç^á^Á  
 Úæo^ Á^æ| } É

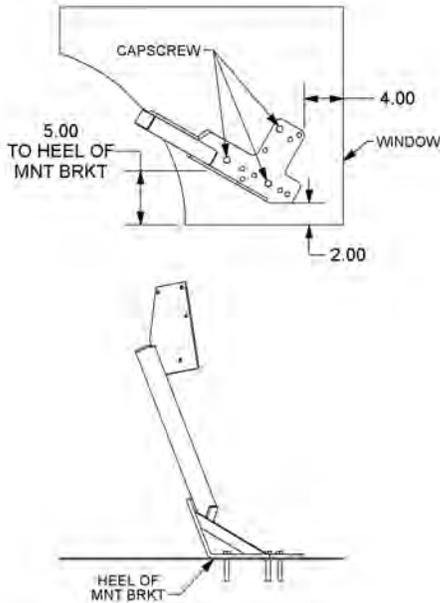

V@Á^ áá|^Á| | o^ } á|^Á@ÁæÁ æ|æ|, Áæ| Á^Á^æ| æ&æ| { •@æ|ææ| } æ| áÉÁ^Á^•æ^ ÉÁ  
 @/æ| ç| { &æ@ç| ~ ç|æ|æ|, Áæ| Á|æ| Áç|^Á@/æa|^•æ| áÁææ| æ| ç| |ææ| ÉÁV@^/æa|^•æ| æ|Á  
 à^Á| ~ ç^á^ Á@Áæç^Á | } ç^á^ } Á@Áæç^Á | } ç| \*Á|ææ|æ| áÁ @^ |á^Á| |ææ|æ| ^Á @æ| Á  
 à^ } á^Á|Áæ| |^Á@ { ÉÁ^&|^Áæa|^•æ| æ@æ|æ| Áæ|æ|æ| |^ÁVX^æ|^Áæ|æ|æ| } áÁ æ|ææÉ  
 ~ æ|æa|^•æ| æ|æ|æ| áÁ^ o^æ^Á-Á@/æa|^/æ|ææ|^Áæ| @Á^æÉÁO^ |Á| çæ|, Áç&••æa|^Á^ Á  
 @æ^Á^•&|^Áá^ } Á@Á^ o^æ^Á-Á@/æa|^É (ASM-JD-0239)É





# ASSEMBLY

## WEATHER-PACK / METRI-PACK ASSEMBLY

V@•^Á•d~ &ç}•Áç]]^Á Á[ c@Y ^æ@!ÉÚ& Áç áT ^d áÚ& Áç}}^&ç!•É

**NOTE: Use the specific tool for the type of connector you are assembling.**  
(ASM-C-0009)

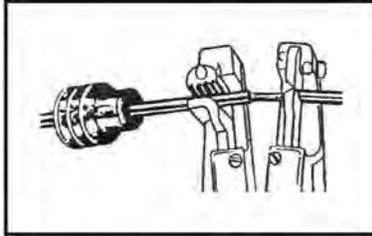

1. Apply seal to cable, before stripping insulation.



2. Align seal with cable insulation.

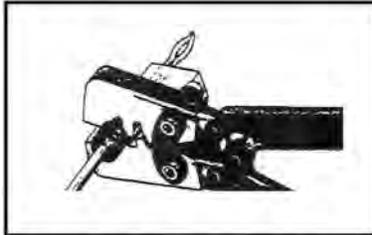

3. Put terminal in crimping tool, then position wire and seal in place.



4. Crimp and visually inspect for a good crimp before installing in connector body.



# ASSEMBLY

## NO VALVE OPTION

QÁ[ { ^Á•cè &•ÉÁ [ |o ÁeÁ@ÁæÁ Á@ÁæÁ |Áe Áe cæa ^Á |Ác& |Áe Á•^ÉÁáçç^Á  
{ æÁ [ oÁ^Á•cè |áÉP |•^ÁÉD +Dæ^Á Á^Áææ@áÁ [ { Á | |o Áé & |á á!•Áe Á@, } Á^ | |, ÉÁ  
~•á \*Á@ Áæá ç!•Áç æoÁHGÍ FDæ áÁ \*æ Áç | |Á |Áç æoÁHGÍÉD | |çæ^áÉP |•^Á•^áÁe Áe Á  
† || |, •ÁÁU çá æáÁO |á á!Áe í éé | Áç, [ Áç•^Áç ááÁO |á á!Áe í éé | ÁçÁ  
(ASM-JD6105 TSF NO VALVE)

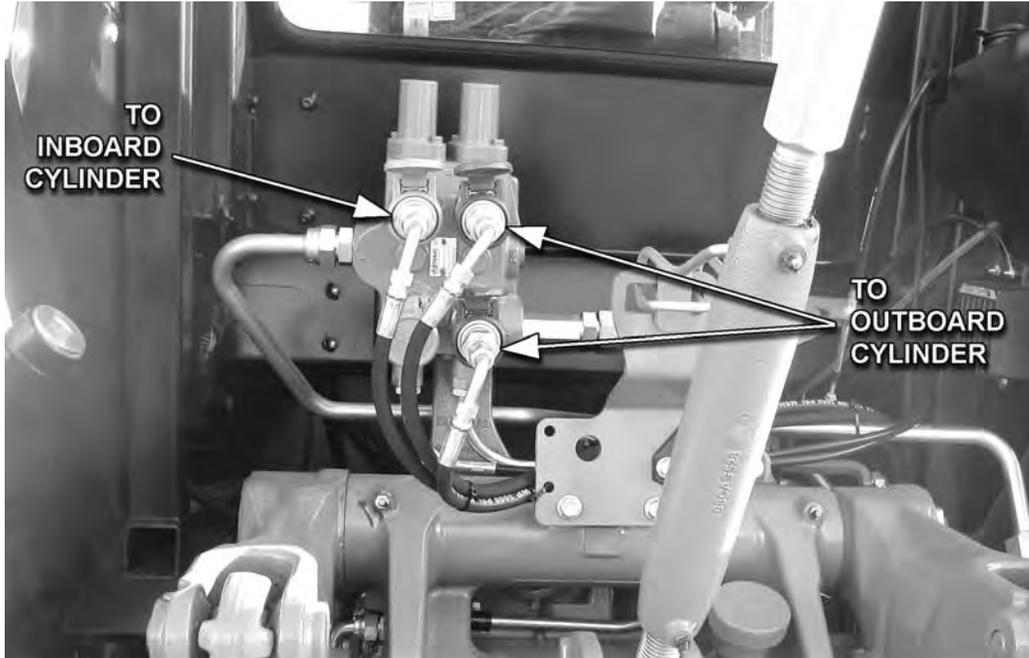

# ASSEMBLY

## VALVE MOUNTING

Remove the lift valve from the engine. The lift valve is located on the right side of the engine. To remove the lift valve, first disconnect the lift valve hose. Then, use a wrench to loosen the nut that secures the lift valve to the engine. Once the nut is loosened, pull the lift valve out of the engine.

When installing the lift valve, make sure it is properly seated in the engine. Tighten the nut to the proper torque. Reconnect the lift valve hose. The lift valve is extremely heavy and contains small parts. Please handle the lift valve with care. It is extremely heavy and contains small parts. (ASM-JD-0065)



# ASSEMBLY

## TRACTOR PLUMBING

Ü\{ [ç^Á@Áç & Á!^•~!^Áá^Á Á@Á^ [ç^Áç^ÉQÁ q|Á^Á^&••æ^Á Á^ } ]|:æq^Á  
!^ [ç^Áç@!ÁQ•^Áá^á^Á@Á^ [ & Á&••Á Á^ ] } ^&Á@ÁQ•^ÉQ•ç|Á@Á!^•~!^ÁQ•^Á  
ç Á@Á^æç|Á!^•~!^Á!|:çQ•ç|ÁQ•^ÁÉíÉí|HÁ|{ Á@Á| ^!Á^ [ ] áÁ|!ç^Á@Ááçç|Á  
ç Á@Á^æç|Á!ÁÖXÁçç^ÉQ•ç|Á!^•~!^ÁQ•^ÁÉíÉí|GÁ|{ Á@Á^æç|Á!^•~!^Á } Á@Á^Á  
[ Á@Á^æç|Á Á@Á ] ^!Á|!ç^Á@Ááçç^Á^!çQ•ç|Áç! } ÁQ•^ÁÉíÉí|GÁ|{ Á| ^!Á  
] |!ç^Ááççç^Á^!ç^Á@Áç! } Áç^Á } Á@Á^æç|ÉÜ^Á@Ááçç^Á^&ç } Á|Á^ç•Á^áÉ  
Á (ASM-JD-0242 6xxxD)

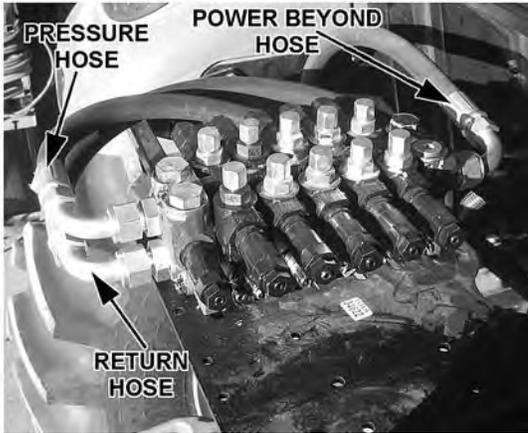
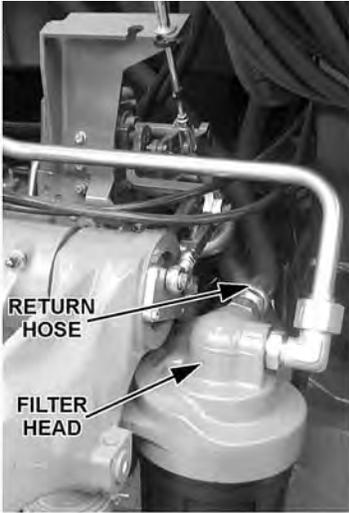
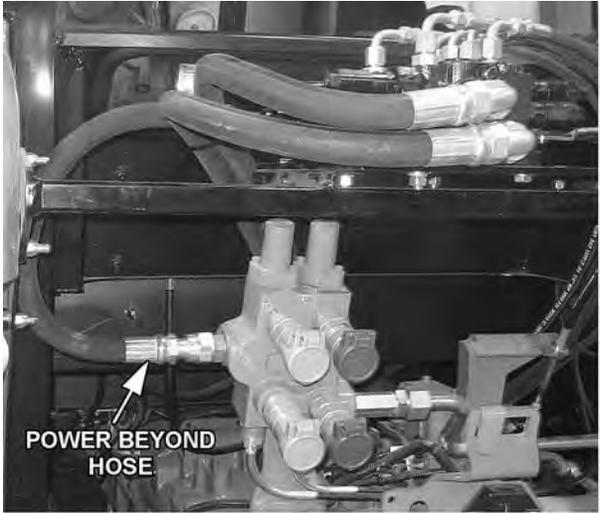



# ASSEMBLY

## MIRROR RELOCATION

Y @} Á • cãã \* Á Á cã Á [ , ^ Á } Á @ Á Ö Í F é Ö Á & ç Í È Á Á ^ & • • æ ^ Á Á | & æ ^ Á @ Á cã ^ Á ç , Á { á | È Á ^ { [ ç ^ Á @ Á á | | Á } á È • ä \* Á @ Á : æ ^ Á } á @ ç á , æ ^ Á | [ ç á ^ á È ^ | & æ ^ Á @ Á á | | Á | Á Á á [ ^ • } ç Á ç - Á - Á Á á @ Á [ , ^ Á Á ç | ^ á Á [ • á } È

(ASM-JD-0254)





# ASSEMBLY

## \*NOTE ON HUSCO CONTROL VALVES\*

T æ ~ æ Æ æ | ^ Å | } d [ | | ^ a Å P ~ • & Å | } d [ | Å ç ^ Å [ [ { Å [ , ^ i • Å ~ a ^ Å @ & Å ç ^ Å • Å æ @ Å c Æ  
 \* | æ Å • d æ ç \* Å | æ Å Å Æ í € Ç H D æ • ç | ^ a Å Å @ Å | } d [ | Å ç ^ Å [ | Å [ | o Å @ æ Å Å | } ^ & c a Å Å  
 @ Å | æ a Å } a Å - Å @ Å æ Å a Å ^ & | } a æ Å [ [ { & | æ a Å • Æ V @ Å @ & Å ç ^ Å | , • Å Å Å Å ^ Å  
 | , Å ç Å @ Å | æ a Å } a Å - Å @ Å æ Å a Å ^ & | } a æ Å [ [ { & | æ a Å • Æ a Å • d æ Å | , Å ~ Å - Å @ Å  
 & | æ a Å | Æ @ ^ a Å | | ç æ a \* Å | | ^ i Å [ [ { Å | } d [ | Æ V @ Å @ & Å ç ^ Å Æ í € Ç H Å ^ } a [ | Å F J i Ü Æ  
 Æ í H D Å Å æ Å Å | ^ æ æ & Å Å Å • ^ a æ ç c i Å H G F Å a Å Å ç c i Å H H U i Æ æ Ç Å | æ Å Æ Å  
 V @ • Å Å [ { | | } ^ ) c Å ç Å ^ Å ^ ) ç a a Å Å | | | , • Æ a Å Å Å Å ^ Å • ç | ^ a Å ^ i Å æ • Å ^ & ç } Å | Å @ Å  
 | æ Å ç ^ Å (ASM-HUSCO-0001)

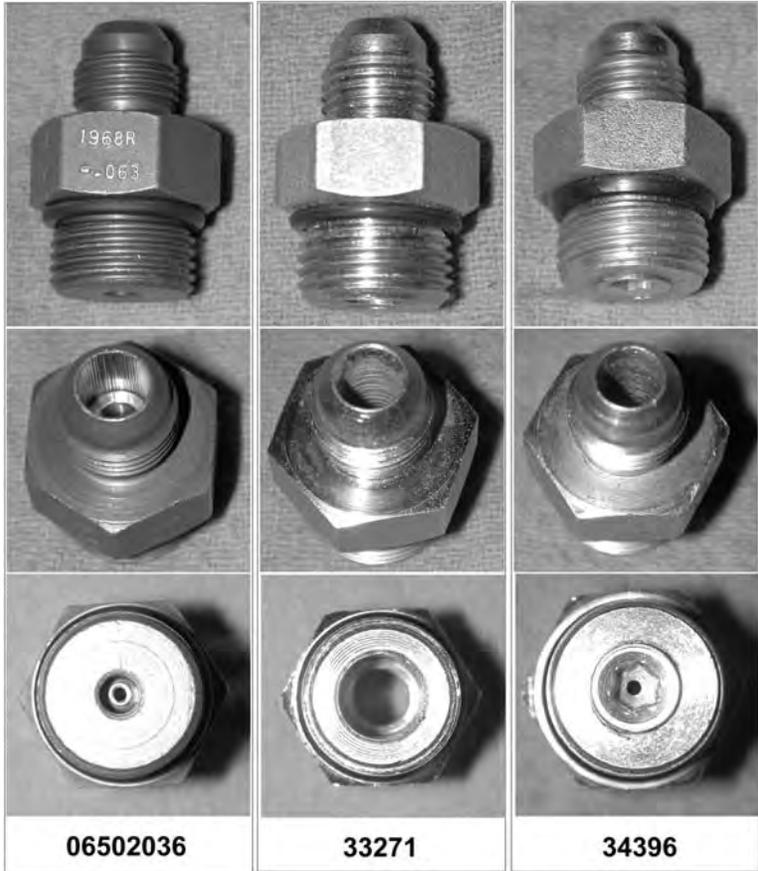

# ASSEMBLY

## HOSE AND WIRE ROUTING

1. Route the hose and wire from the origin to the hole. The distance from the origin to the hole is 10-1/2". The hole is 2.50" in diameter.

2. The distance from the origin to the hole is 22". The hole is 3.5" in diameter.

**NOTE: DO NOT CUT INTO TUBES / HOSES / WIRES WHEN DRILLING THROUGH METAL OR PLASTIC!** (ASM-JD-0068)

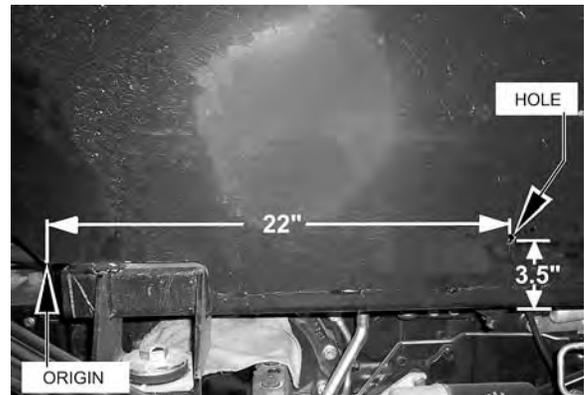
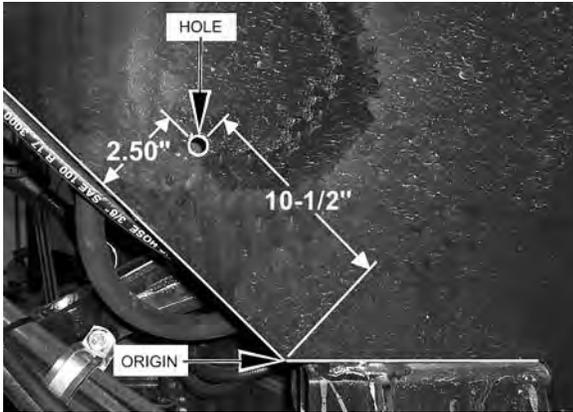

3. The distance from the origin to the hole is 22". The hole is 3.5" in diameter.

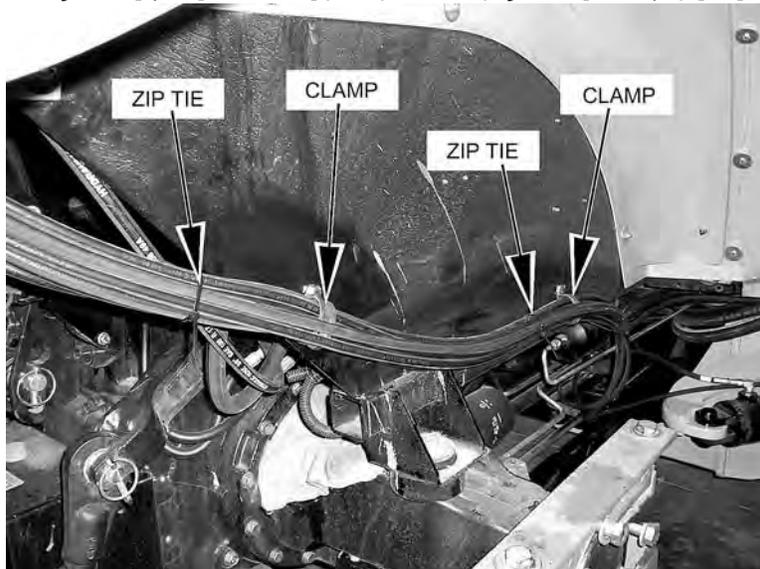





# ASSEMBLY

## SIDE MOWER HYDRAULIC DIAGRAM

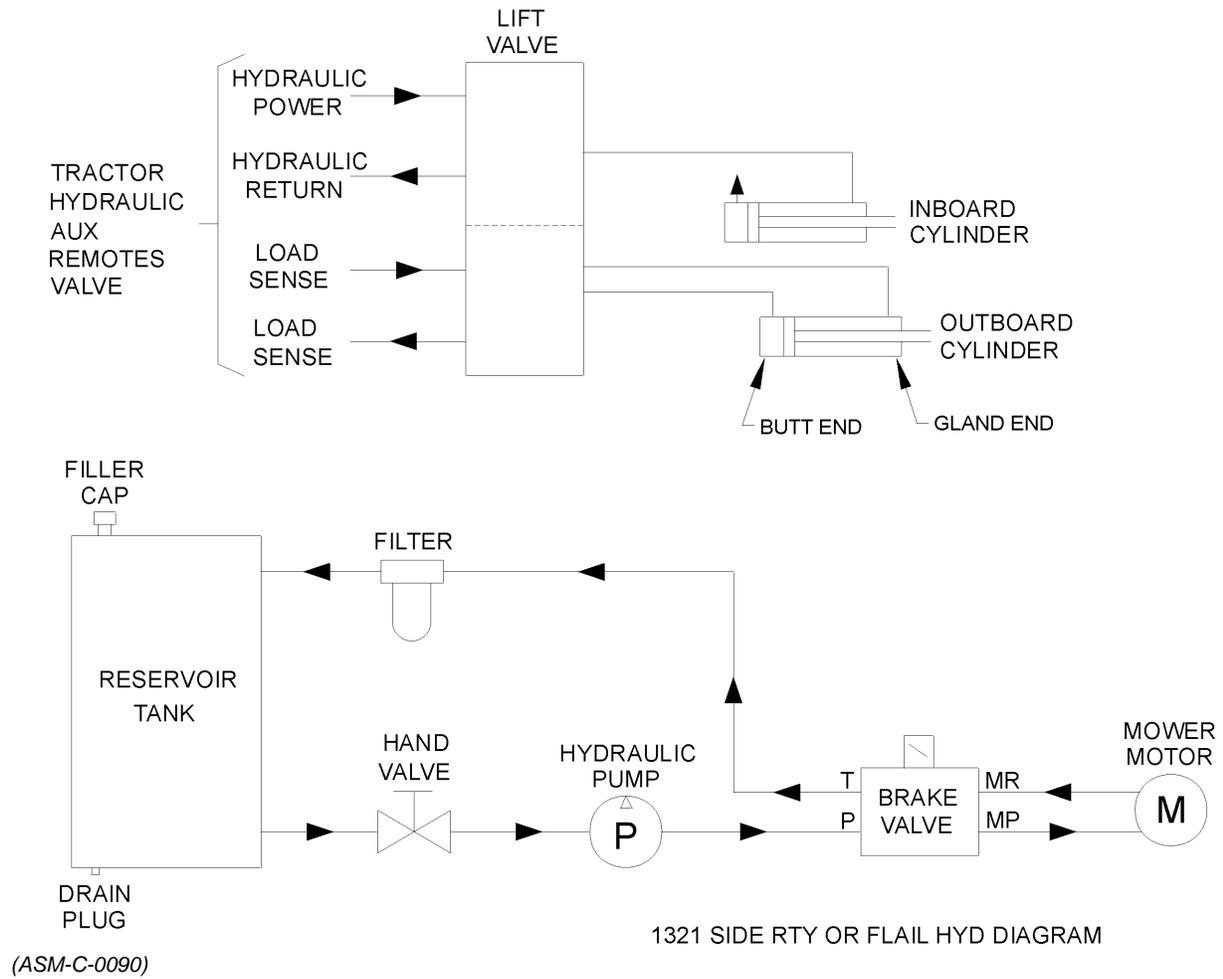





# ASSEMBLY

## CABLE LIFT DRAFT BEAM INSTALLATION

Q. 1. The cable lift draft beam is used to lift the draft beam from the deck to the masthead. It consists of a draft beam, a cable, a pulley, and a hook. The draft beam is attached to the deck and the pulley is attached to the masthead. The cable is attached to the hook and the draft beam. The hook is used to lift the draft beam from the deck to the masthead.

2. The draft beam is attached to the deck by a bracket. The bracket is attached to the deck by a bolt. The draft beam is attached to the pulley by a cable. The pulley is attached to the masthead by a bracket. The cable is attached to the hook by a cable.

3. The hook is attached to the cable by a cable. The hook is used to lift the draft beam from the deck to the masthead. The draft beam is attached to the pulley by a cable. The pulley is attached to the masthead by a bracket. The cable is attached to the hook by a cable.

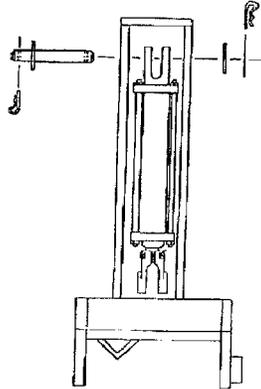

## DRAFT BEAM MOUNTING

1. The draft beam is mounted to the deck by a bracket. The bracket is attached to the deck by a bolt. The draft beam is attached to the pulley by a cable. The pulley is attached to the masthead by a bracket. The cable is attached to the hook by a cable.

2. The hook is attached to the cable by a cable. The hook is used to lift the draft beam from the deck to the masthead. The draft beam is attached to the pulley by a cable. The pulley is attached to the masthead by a bracket. The cable is attached to the hook by a cable.

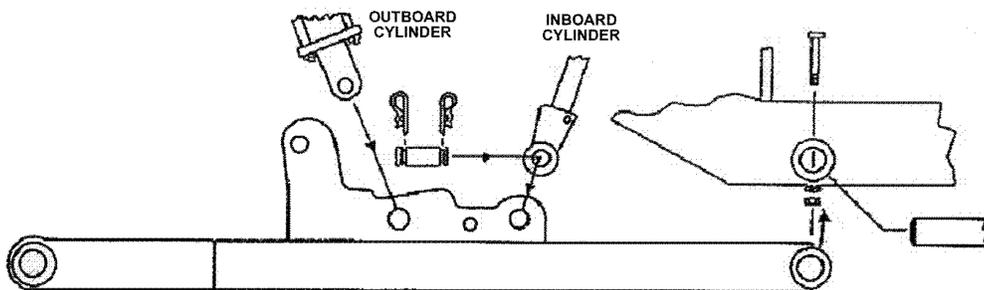

Q. 1. The draft beam is mounted to the deck by a bracket. The bracket is attached to the deck by a bolt. The draft beam is attached to the pulley by a cable. The pulley is attached to the masthead by a bracket. The cable is attached to the hook by a cable.

2. The hook is attached to the cable by a cable. The hook is used to lift the draft beam from the deck to the masthead. The draft beam is attached to the pulley by a cable. The pulley is attached to the masthead by a bracket. The cable is attached to the hook by a cable.



# ASSEMBLY

## LIMIT SWITCH MOUNTING

### ASSEMBLING LIMIT SWITCH

T [ ~ } 0 1 2 3 4 5 6 7 8 9 10 11 12 13 14 15 16 17 18 19 20 21 22 23 24 25 26 27 28 29 30 31 32 33 34 35 36 37 38 39 40 41 42 43 44 45 46 47 48 49 50 51 52 53 54 55 56 57 58 59 60 61 62 63 64 65 66 67 68 69 70 71 72 73 74 75 76 77 78 79 80 81 82 83 84 85 86 87 88 89 90 91 92 93 94 95 96 97 98 99 100

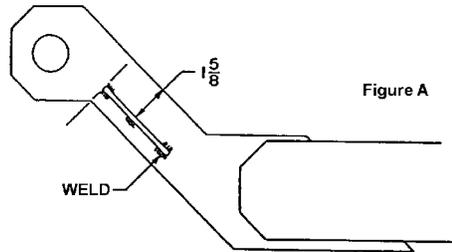

Figure A

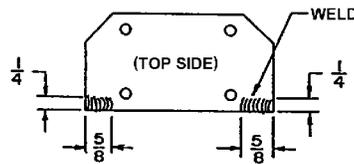

Figure B

### ADJUSTING LIMIT SWITCH

V [ 1 2 3 4 5 6 7 8 9 10 11 12 13 14 15 16 17 18 19 20 21 22 23 24 25 26 27 28 29 30 31 32 33 34 35 36 37 38 39 40 41 42 43 44 45 46 47 48 49 50 51 52 53 54 55 56 57 58 59 60 61 62 63 64 65 66 67 68 69 70 71 72 73 74 75 76 77 78 79 80 81 82 83 84 85 86 87 88 89 90 91 92 93 94 95 96 97 98 99 100

F 1 2 3 4 5 6 7 8 9 10 11 12 13 14 15 16 17 18 19 20 21 22 23 24 25 26 27 28 29 30 31 32 33 34 35 36 37 38 39 40 41 42 43 44 45 46 47 48 49 50 51 52 53 54 55 56 57 58 59 60 61 62 63 64 65 66 67 68 69 70 71 72 73 74 75 76 77 78 79 80 81 82 83 84 85 86 87 88 89 90 91 92 93 94 95 96 97 98 99 100

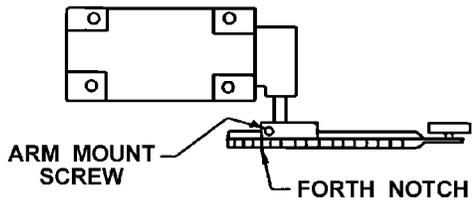

Figure C

### WIRING LIMIT SWITCH

U [ 1 2 3 4 5 6 7 8 9 10 11 12 13 14 15 16 17 18 19 20 21 22 23 24 25 26 27 28 29 30 31 32 33 34 35 36 37 38 39 40 41 42 43 44 45 46 47 48 49 50 51 52 53 54 55 56 57 58 59 60 61 62 63 64 65 66 67 68 69 70 71 72 73 74 75 76 77 78 79 80 81 82 83 84 85 86 87 88 89 90 91 92 93 94 95 96 97 98 99 100

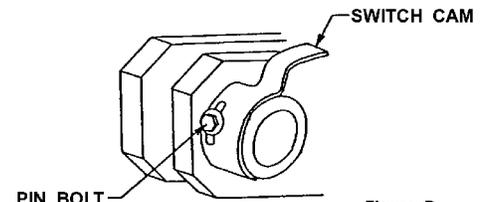

Figure D

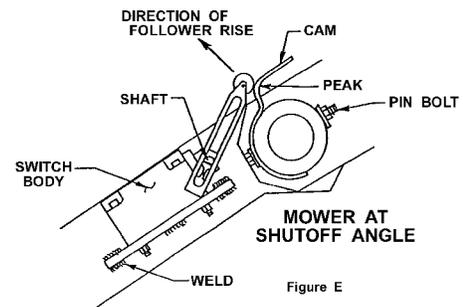

Figure E





# ASSEMBLY

## MOWER MOUNTING

1. Attach the mounting bracket to the tractor's PTO shaft using the provided bolts and nuts. The short end of the bracket fits inside the cylinder clevis.

2. Attach the outboard cylinder to the tractor's PTO shaft using the provided bolts and nuts. The outboard cylinder is attached to the tractor's PTO shaft using the provided bolts and nuts. The outboard cylinder is attached to the tractor's PTO shaft using the provided bolts and nuts.

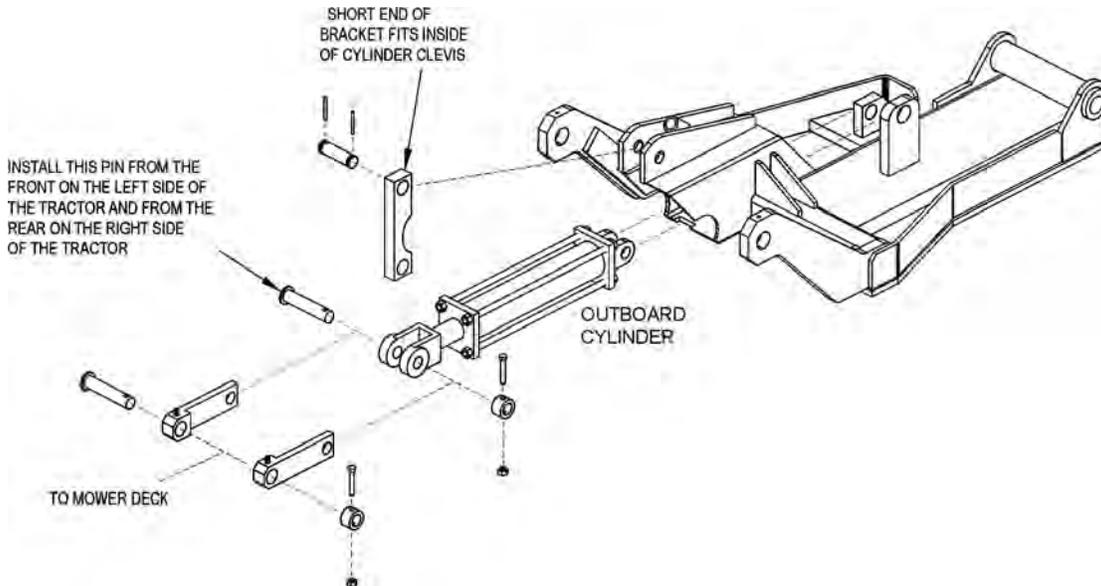

3. Attach the outboard cylinder to the tractor's PTO shaft using the provided bolts and nuts. The outboard cylinder is attached to the tractor's PTO shaft using the provided bolts and nuts. The outboard cylinder is attached to the tractor's PTO shaft using the provided bolts and nuts.

4. Attach the outboard cylinder to the tractor's PTO shaft using the provided bolts and nuts. The outboard cylinder is attached to the tractor's PTO shaft using the provided bolts and nuts. The outboard cylinder is attached to the tractor's PTO shaft using the provided bolts and nuts.

5. Attach the outboard cylinder to the tractor's PTO shaft using the provided bolts and nuts. The outboard cylinder is attached to the tractor's PTO shaft using the provided bolts and nuts. The outboard cylinder is attached to the tractor's PTO shaft using the provided bolts and nuts.

## LIFT CONTROL FEEDLINES

1. Attach the lift control feedlines to the tractor's lift control system using the provided bolts and nuts. The lift control feedlines are attached to the tractor's lift control system using the provided bolts and nuts.

2. Attach the lift control feedlines to the tractor's lift control system using the provided bolts and nuts. The lift control feedlines are attached to the tractor's lift control system using the provided bolts and nuts.

3. Attach the lift control feedlines to the tractor's lift control system using the provided bolts and nuts. The lift control feedlines are attached to the tractor's lift control system using the provided bolts and nuts.





# ASSEMBLY

## DECK / MOTOR FEEDLINE

Q • 0 1 2 3 4 5 6 7 8 9 10 11 12 13 14 15 16 17 18 19 20 21 22 23 24 25 26 27 28 29 30 31 32 33 34 35 36 37 38 39 40 41 42 43 44 45 46 47 48 49 50 51 52 53 54 55 56 57 58 59 60 61 62 63 64 65 66 67 68 69 70 71 72 73 74 75 76 77 78 79 80 81 82 83 84 85 86 87 88 89 90 91 92 93 94 95 96 97 98 99

Q • 0 1 2 3 4 5 6 7 8 9 10 11 12 13 14 15 16 17 18 19 20 21 22 23 24 25 26 27 28 29 30 31 32 33 34 35 36 37 38 39 40 41 42 43 44 45 46 47 48 49 50 51 52 53 54 55 56 57 58 59 60 61 62 63 64 65 66 67 68 69 70 71 72 73 74 75 76 77 78 79 80 81 82 83 84 85 86 87 88 89 90 91 92 93 94 95 96 97 98 99

Q • 0 1 2 3 4 5 6 7 8 9 10 11 12 13 14 15 16 17 18 19 20 21 22 23 24 25 26 27 28 29 30 31 32 33 34 35 36 37 38 39 40 41 42 43 44 45 46 47 48 49 50 51 52 53 54 55 56 57 58 59 60 61 62 63 64 65 66 67 68 69 70 71 72 73 74 75 76 77 78 79 80 81 82 83 84 85 86 87 88 89 90 91 92 93 94 95 96 97 98 99

Q • 0 1 2 3 4 5 6 7 8 9 10 11 12 13 14 15 16 17 18 19 20 21 22 23 24 25 26 27 28 29 30 31 32 33 34 35 36 37 38 39 40 41 42 43 44 45 46 47 48 49 50 51 52 53 54 55 56 57 58 59 60 61 62 63 64 65 66 67 68 69 70 71 72 73 74 75 76 77 78 79 80 81 82 83 84 85 86 87 88 89 90 91 92 93 94 95 96 97 98 99

Q • 0 1 2 3 4 5 6 7 8 9 10 11 12 13 14 15 16 17 18 19 20 21 22 23 24 25 26 27 28 29 30 31 32 33 34 35 36 37 38 39 40 41 42 43 44 45 46 47 48 49 50 51 52 53 54 55 56 57 58 59 60 61 62 63 64 65 66 67 68 69 70 71 72 73 74 75 76 77 78 79 80 81 82 83 84 85 86 87 88 89 90 91 92 93 94 95 96 97 98 99

Q • 0 1 2 3 4 5 6 7 8 9 10 11 12 13 14 15 16 17 18 19 20 21 22 23 24 25 26 27 28 29 30 31 32 33 34 35 36 37 38 39 40 41 42 43 44 45 46 47 48 49 50 51 52 53 54 55 56 57 58 59 60 61 62 63 64 65 66 67 68 69 70 71 72 73 74 75 76 77 78 79 80 81 82 83 84 85 86 87 88 89 90 91 92 93 94 95 96 97 98 99





# ASSEMBLY





# OPERATION SECTION

Operation Section 3-1

# OPERATION

## TIGER SIDE AND REAR FLAIL MOWER OPERATING INSTRUCTIONS

Tiger Side and Rear flail mowers are manufactured with quality material by skilled workers. These mowers are designed for cutting grass and small weeds. The mower is equipped with protective deflectors to prevent objects being thrown from the mower by the blades, however, no shielding is 100% effective. All shields, guards, and deflectors equipped on the mower must be maintained in good operational condition.

It is the operator's responsibility to be knowledgeable of all potential operating hazards and to take every reasonable precaution to ensure oneself, others, animals, and property are not injured or damaged by the mower, tractor, or a thrown object. Do not operate the mower if passersby, pets, livestock, or property are within 100 yards of the unit.

This section of the Operator's Manual is designed to familiarize, instruct, and educate safe and proper mower use to the operator. Pictures contained in this section are intended to be used as a visual aid to assist in explaining the operation of a Side and Rear flail mower and are not specific to any model. Some pictures may show shields removed for picture clarity. NEVER operate implement without all shields in place and in good operational condition. The operator must be familiar with the mower and tractor and all associated safety practices before operating the mower and tractor. Proper operation of the mower, as detailed in this manual, will help ensure years of safe and satisfactory use of the mower.

**IMPORTANT:** To avoid mower damage, retorque all bolts after the first 10 hours of operation. Refer to the Torque Chart at the end of the Maintenance Section to ensure bolts are properly tightened.

**READ AND UNDERSTAND THE ENTIRE OPERATING INSTRUCTIONS AND SAFETY SECTION OF THIS MANUAL AND THE TRACTOR MANUAL BEFORE ATTEMPTING TO USE THE TRACTOR AND IMPLEMENT.** If you do not understand any of the instructions, contact your nearest authorized dealer for a full explanation. Pay close attention to all safety signs and safety messages contained in this manual and those affixed to the implement and tractor. (OPS-U-0001)

READ, UNDERSTAND, and FOLLOW the following Safety Messages. Serious injury or death may occur unless care is taken to follow the warnings and instructions stated in the Safety Messages. Always use good common sense to avoid hazards. (SG-2)



Si no lee ingles, pida ayuda a alguien que si lo lea para que le traduzca las medidas de seguridad. (SG-3)



# OPERATION

## 1. OPERATOR REQUIREMENTS

Safe operation of the unit is the responsibility of a qualified operator. A qualified operator has read and understands the implement and tractor Operator's Manuals and is experienced in implement and tractor operation and all associated safety practices. In addition to the safety messages contained in this manual, safety signs are affixed to the implement and tractor. If any part of the operation and safe use of this equipment is not completely understood, consult an authorized dealer for a complete explanation.

If the operator cannot read the manuals for themselves or does not completely understand the operation of the equipment, it is the responsibility of the supervisor to read and explain the manuals, safety practices, and operating instructions to the operator.

Safe operation of equipment requires that the operator wear approved Personal Protective Equipment (PPE) for the job conditions when attaching, operating, servicing, and repairing the equipment. PPE is designed to provide operator protection and includes the following safety wear:

### PERSONAL PROTECTIVE EQUIPMENT (PPE)

- Always Wear Safety Glasses
- Hard Hat
- Steel Toe Safety Footwear
- Gloves
- Hearing Protection
- Close Fitting Clothing
- Respirator or Filter Mask (depends on operating conditions) (OPS-U-0002)

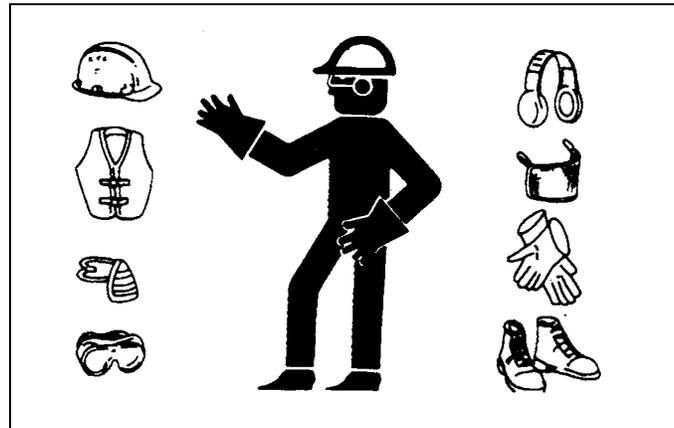

### **⚠ DANGER**

NEVER use drugs or alcohol immediately before or while operating the Tractor and Implement. Drugs and alcohol will affect an operator's alertness and coordination and therefore affect the operator's ability to operate the equipment safely. Before operating the Tractor or Implement, an operator on prescription or over-the-counter medication must consult a medical professional regarding any side effects of the medication that would hinder their ability to operate the E quipment safely. NEVER knowingly allow anyone to operate this equipment when their alertness or coordination is impaired. Serious injury or death to the operator or others could result if the operator is under the influence of drugs or alcohol. (SG-27)

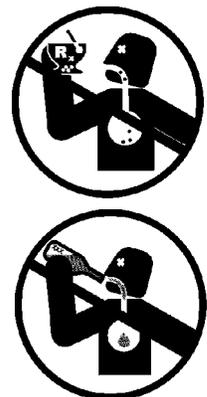

# OPERATION

## **2. TRACTOR REQUIREMENTS**

The tractor used to operate the mower must have the power, capacity and required equipment to safely operate the mower at a ground speed between 2 and 5 MPH. Operating the mower with a tractor that does not meet the following requirements may cause tractor or mower damage and could be a potential danger to the operator and passersby.

### **Tractor Requirements and Capabilities**

- ASAE approved Roll-Over Protective Structure (ROPS) or ROPS cab and seat belt.
- Tractor Safety Devices ..... Slow Moving Vehicle (SMV) emblem, lighting, PTO master shield
- Tractor Horsepower-Minimum ..... 65 HP Min Recommended
- Power Take Off ..... 540 RPM

### **2.1 ROPS and Seat Belt**

The tractor must be equipped with a Roll-Over-Protective-Structure (ROPS) (tractor cab or roll-bar) and seat belt to protect the operator from falling off the tractor, especially during a roll over where the driver could be crushed and killed. Only operate the tractor with the ROPS in the raised position and seat belt fastened. Tractor models not equipped with a ROPS and seat belt should have these life saving features installed by an authorized dealer. *OPS-U- 0003*



Operate this Equipment only with a Tractor equipped with an approved roll-over-protective system (ROPS). Always wear seat belts. Serious injury or even death could result from falling off the tractor--particularly during a turnover when the operator could be pinned under the ROPS. (SG-7)



### **2.2 Tractor Safety Devices**

If transporting or operating the tractor and implement near a public roadway, the tractor must be equipped with proper warning lighting and a Slow Moving Vehicle (SMV) emblem which are clearly visible from the rear of the unit. Lights and a SMV emblem must be equipped directly on implements if the visibility of the tractor warning signals are obscured.

Maintain all manufacturer equipped safety shields and guards. Always replace shields and guards that were removed for access to connect, service, or repair the tractor or implement. Never operate the tractor PTO with the PTO master shield missing or in the raised position. *OPS-U- 0004*

### **2.3 Tractor Horsepower**

The horsepower required to operate the mower depends on many factors including the vegetation to be cut, terrain condition, operator experience, and condition of the mower and tractor. For most mowing conditions, the Side and Rear mowers require a tractor with at least 65HP. Operating the mower with a tractor that does not have adequate power may damage the tractor engine.

# OPERATION

## 2.4 Front End Weight

Maintain a minimum of 20% total tractor weight on the tractor front end at all times. Front end weight is critical to maintain steering ability and to prevent the front end from rearing up. Consult your authorized tractor dealer for front weights and carriers.

## 2.5 Power Take Off (PTO)

Only operate the mower on a tractor equipped to operate at 540 rpm PTO speed. Tractors operating at 540 rpm will have a 1-3/8" diameter 6-spline PTO shaft stub. Refer to the tractor operator's manual for operating the PTO at the proper speed.

If operating an older model tractor where the tractor's transmission and PTO utilize one master clutch, an over-running clutch must be used between the PTO output shaft and the driveline of the mower. Consult an authorized tractor dealer to purchase and install an over-running clutch if needed.



**DO NOT** use a PTO adapter to attach a non-matching Implement driveline to a Tractor PTO. Use of an adapter can double the operating speed of the Implement resulting in excessive vibration, thrown objects, and blade and implement failure. Adapter use will also change the working length of the driveline exposing unshielded driveline areas. Serious bodily injury and/or equipment failure can result from using a PTO adapter. Consult an authorized dealer for assistance if the Implement driveline does not match the Tractor PTO.

(S3PT-14)



Never operate the Tractor and Mower if the Implement input driveline is directly connected to the Tractor transmission. Tractor braking distances can be substantially increased by the momentum of the rotating Mower blades driving the Tractor transmission even though the Tractor clutch has been disengaged. Install an over running clutch between the Tractor PTO and the Mower driveline to prevent this potentially dangerous situation. (S3PT-16)

## 3. GETTING ON AND OFF THE TRACTOR

Before getting onto the tractor, the operator must read and completely understand the implement and tractor operator manuals. If any part of either manual is not completely understood, consult an authorized dealer for a complete explanation. OPS-U-0007



Do not mount or dismount the Tractor while the tractor is moving. Mount the Tractor only when the Tractor and all moving parts are completely stopped. (SG-12)



# OPERATION

## 3.1 Boarding the Tractor

Use both hands and equipped handrails and steps for support when boarding the tractor. Never use control levers for support when mounting the tractor. Seat yourself in the operator's seat and secure the seat belt around you.

Never allow passengers to ride on the tractor or attached equipment. Riders can easily fall off and be seriously injured or killed from falling off and being ran over. It is the operator's responsibility to forbid all extra riders at all times. *OPS-U- 0008*



Never allow children to operate, ride on, or come close to the Tractor or Implement. Usually, 16-17 year-old children who are mature and responsible can operate the implement with adult supervision, if they have read and understand the Operator's Manuals, been trained in proper operation of the tractor and Implement, and are physically large enough to reach and operate the controls easily. (SG-11)



Never allow children or other persons to ride on the Tractor or Implement. Falling off can result in serious injury or death. (SG-10)



Do not mount or dismount the Tractor while the tractor is moving. Mount the Tractor only when the Tractor and all moving parts are completely stopped. (SG-12)



## 3.2 Dismounting the Tractor

Before dismounting, park the tractor and implement on a reasonably level surface, apply the parking brake, idle the engine down, disengage the PTO, and lower the implement to the ground. Shut down the tractor engine according to the operator's manual, remove the key, and wait for all motion to completely stop. Never leave the seat until the tractor, its engine and all moving parts have come to a complete stop.

Use hand rails and steps when exiting the tractor. Be careful of your step and use extra caution when mud, ice, snow or other matter has accumulated on the steps or hand rails. Use all handrails and steps for support and never rush or jump off the tractor. *OPS-U- 0009*



BEFORE leaving the tractor seat, always set the parking brake and/or set the tractor transmission in parking gear, disengage the PTO, stop the engine, remove the key, and wait for all moving parts to stop. Place the tractor shift lever into a low range or parking gear to prevent the tractor from rolling. Never dismount a Tractor that is moving or while the engine is running. Operate the Tractor controls from the tractor seat only. (SG-9)

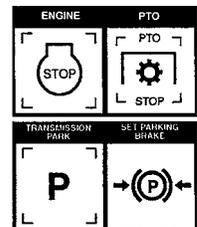

# OPERATION

## 4. STARTING THE TRACTOR

The operator must have a complete understanding of the placement, function, and operational use of all tractor controls before starting the tractor. Review the tractor operator's manual and consult an authorized dealer for tractor operation instructions if needed.

Essential Tractor Controls:

- Locate the light control switch.
- Locate the engine shut off control.
- Locate the brake pedals and the clutch.
- Locate the PTO control.
- Locate the 3-point hitch control lever.
- Locate the hydraulic remote control levers.

Before starting the tractor ensure the following:

- Conduct all pre-start operation inspection and service according to the tractor operator's manual.
- Make sure all guards, shields, and other safety devices are securely in place.
- The parking brake is on.
- The PTO control lever is disengaged.
- The 3-point hitch control lever is in the lowered position.
- The hydraulic remote control levers are in the neutral position.
- The tractor transmission levers are in park or neutral.

Refer to the tractor owner's manual for tractor starting procedures. Only start the tractor while seated and belted in the tractor operator's seat. Never bypass the ignition switch by short circuiting the starter solenoid.

After the tractor engine is running, avoid accidental contact with the tractor transmission to prevent sudden



Never run the Tractor engine in a closed building or without adequate ventilation. The exhaust fumes can be hazardous to your health. (SG-23)



Start tractor only when properly seated in the Tractor seat. Starting a tractor in gear can result in injury or death. Read the Tractor operators manual for proper starting instructions. (SG-13)



## 5. CONNECTING THE MOWER TO THE TRACTOR

Use extreme caution when connecting the mower to the tractor. The mower should be securely resting at ground level or setting on blocks. Keep hands and feet from under the mower deck and clear of pinch points between the tractor hitch arms and mower pins. OPS-R-0001

# OPERATION



Always shut the Tractor completely down, place the transmission in park, and set the parking brake before you or anyone else attempts to connect or disconnect the Implement and Tractor hitches. (S3PT-15)

## 5.1 Connecting the Rear Flail to the Tractor

1. Make sure the tractor is equipped with the correct PTO shaft. Change shafts if needed.
2. Shorten or remove the tractor drawbar to avoid interference when raising and lowering the mower.
3. Board the tractor and start the engine. Position the tractor to the mower with the 3-point lift arms positioned between the respective set of mower A-frame lift lugs. **Note:** Set the 3-point lift control to "Position Control" so that the lift arms maintain a constant height when attaching the mower. See the tractor Operator's Manual for correct settings when attaching 3-point equipment.
4. Turn off the tractor engine and dismount.
5. One lift arm at a time, align arm end hole between the set of A-frame lift lugs. Insert hitch pin through the lug and arm holes and insert retaining pin into hitch pin.
6. Walk around to opposite side and repeat procedure for remaining lift arm and hitch pin.
7. Extend or retract 3-point top link to align its end hole with the holes of the mower's top link. Insert the top link hitch pin and insert retaining pin into hitch pin.

Adjust any lower link check chains, guide blocks, or sway blocks to prevent the mower from swaying side to side and possible contact with tractor rear tires.



NOTE: Offset Adaptor Hitches are available to position the mower to the left or right. Mowers with Offset Adaptor hitches connect to the 3-Point hitch the same way as the mower A-frame.



# OPERATION

## 5.2 Connecting the Side Flails to the Tractor

1. Install the Draft Beam onto the Main Frame.
2. Raise the Draft Beam to line up with the the 'ears' on the Side Flail and install Pins and hardware.
3. Connect the Linkage and Cylinder to the Side Flail for a Combo Lift set-up or route and connect the cable to the Side Flail if it's a Cable Lift set-up.
4. Route and connect the hydraulic lines to the cylinders and from the Brake Valve to the Side Flail motor.



### **WARNING**

Do not operate this Equipment with hydraulic oil or fuel leaking. Oil and fuel are explosive and their presence could present a hazard. Do not check for leaks with your hand! High-pressure oil streams from breaks in the line could penetrate the skin and cause tissue damage including gangrene. To check for a hose leak, SHUT the unit ENGINE OFF and remove all hydraulic pressure. Wear oil impenetrable gloves, safety glasses and use Cardboard to check for evidence of oil leaks. If you suspect a leak, REMOVE the HOSE and have it tested at a Dealer. If oil does penetrate the skin, have the injury treated immediately by a physician knowledgeable and skilled in this procedure. (SG-15)



### **WARNING**

Avoid contact with hot surfaces including hydraulic oil tanks, pumps, motors, valves and hose connections. Relieve hydraulic pressure before performing maintenance or repairs. Use gloves and eye protection when servicing hot components. Contact with a hot surface or fluid can cause serious injury from burns or scalding. (SG-34)

### **DANGER**

**DO NOT** allow any person under a side mower unless mower is securely locked up or supported. **DO NOT** approach the Implement unless the Tractor is turned off and all motion has ceased. Never work under the frame work, or any lifted component unless the implement is securely supported or blocked up. A sudden or inadvertent fall by any of these components could cause serious injury or even death. (STI-03\_A)



# OPERATION

## 6. SETTING THE MOWER

Properly setting the cutting height is essential for efficient and safe operation. A properly set mower will make a more uniform cut, distribute clippings more evenly, require minimal tractor work, and follow the contour of uneven terrain. **NOTE:** Avoid very low cutting heights, striking the ground with the blades gives the most damaging shock loads and will cause damage to the mower and drive. Blades contacting the ground may cause objects to be thrown out from under the mower deck. Always avoid operating the mower at a height which causes the blades to contact the ground. OPS-U- 0010



Never work under the Implement, the framework, or any lifted component unless the Implement is securely supported or blocked up to prevent sudden or inadvertent falling which could cause serious injury or even death. (SG-14)



### 6.1 Roller Height Adjustment

1. The mower's cutting height is set by positioning the roller assembly for each mower section. Each section must be set at the same height to ensure an even cut across the entire width of the mower.
2. Place the tractor and mower on a level surface and completely lower the mower to the ground.
3. Shut down the tractor, place the transmission in park, and set the parking brake before dismounting.
4. One section at a time, place lifting device (scissors jack or hydraulic jack) under center of cutter housing.
5. Remove hex nuts, washers and carriage bolts from brackets at each end of roller. Make certain that roller bracket is free to move once the fasteners are removed. A stuck roller could drop unexpectedly and cause injury.
6. For Standard Duty flails, use lifting device to reposition cutter housing to desired cutting height. Align bracket holes with cutter housing, then reinstall hardware.
7. For Heavy Duty flails, loosen the Adjustment rod lock nut and adjust height by turning the Adjustment Rod. Retighten the Adjustment rod lock nut and then reinstall hardware.
8. Lower cutter housing to the ground and remove lifting device.

Standard Duty

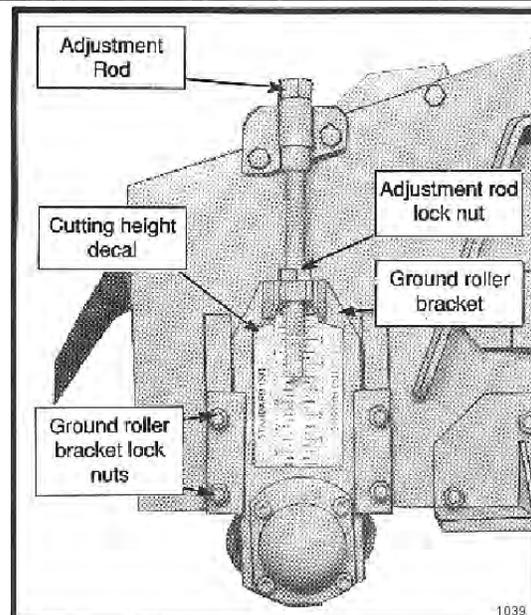
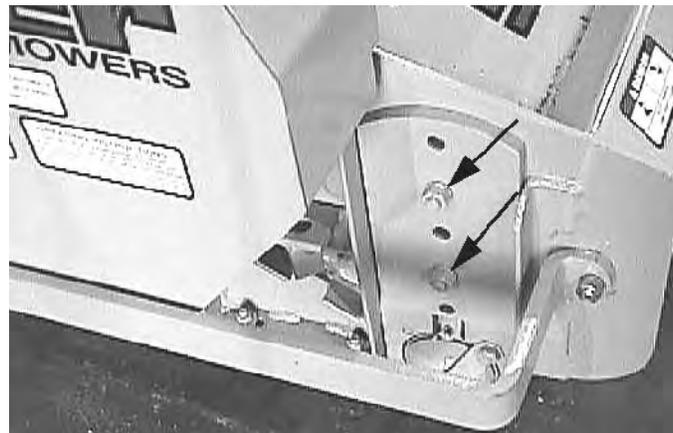

Side and Rear Flail

Operation Section 3-10

Heavy Duty

# OPERATION

Set cutting height according to procedures above for remaining two cutter sections. Make sure that all three rollers are set at the same height to ensure an even cut across the entire width of the mower.

## **6.2 Leveling Rear Flail Deck**

To facilitate a safe and efficient mowing operation, the mower should be operated parallel to the ground at all times. Never operate if front or rear of mower is tilted upward. Objects may be discharged at high speeds causing possible injury or even death.

Adjust Top Link to level mower roller adjustment. Side Skid Shoes should always be parallel to ground throughout the full adjustment range. Adjust cutting height of machine by raising or lowering rear roller as specified in Operation Section.



### **⚠️ WARNING**

Do not let the Blades turn when the Mower Deck is raised for any reason, including clearance or for turning. Raising the Mower deck exposes the Cutting Blades which creates a potentially serious hazard and could cause serious injury or even death from objects thrown from the Blades. (SRM-07)



## **7. DRIVELINE ATTACHMENT**

The driveline yoke and tractor PTO shaft must be dirt free and greased for attachment.

To connect the mower driveline to the tractor PTO output shaft, pull the driveline yoke collar back and align the grooves and splines of the yoke with those of the PTO shaft. Push the driveline yoke onto the PTO shaft, release the locking collar, and position the yoke until the locking collar balls are seated onto the PTO shaft. Push and pull the driveline back and forth several times to ensure a secure attachment.



After the driveline is securely attached, place the tractor PTO master shield back in the operating position. OPS-R-0003

# OPERATION

## **⚠ WARNING**

When attaching the Implement input driveline to the Tractor PTO, it is important that the connecting yoke spring activated locking collar slides freely and the locking balls are seated securely in the groove on the Tractor PTO shaft. Push and pull the driveline back and forth several times to ensure it is securely attached. A driveline not attached correctly to the Tractor PTO shaft could come loose and result in personal injury and damage to the Implement. (S3PT-17)

## **7.1 Driveline Length Check**

## **⚠ WARNING**

Before operating the Implement, check to make sure the Implement input driveline will not bottom out or become disengaged. Bottoming out occurs when the inner shaft penetrates the outer housing until the assembly becomes solid-it can shorten no more. Bottoming out can cause serious damage to the Tractor PTO by pushing the PTO into the Tractor and through the support bearings or downward onto the PTO shaft, breaking it off. A broken driveline can cause personal injury. (S3PT-18)

When fitting the mower to the tractor, the telescoping driveline must be inspected to ensure that at its most compressed position, the profiles do not “bottom out”, and when at its farthest extended position, there is sufficient engagement between the profiles to operate safely. At its shortest length, there must be at least a 1” clearance between each profile end and opposite profile universal joint. At its farthest operating extension, a minimum profile engagement of 12” must be maintained.

### **“Bottoming Out” Check Procedure**

- Disconnect driveline from the tractor and slide the profiles together until fully compressed.
- Place a mark on the inner shield 1/8” from the end of the outer shield and reattach the driveline to the PTO Shaft.
- With the **PTO NOT TURNING**, slowly drive the tractor with mower attached through the sharpest turn possible and watch shaft movement. With the **PTO NOT TURNING**, slowly drive the tractor with the mower attached through the most severe terrain conditions expected and watch shaft movement.
- If the distance between the mark and the outer shield becomes less than 2” at any point there is a potential problem bottoming out the driveline and the driveline should be shortened.  
*OPS-F-0001*

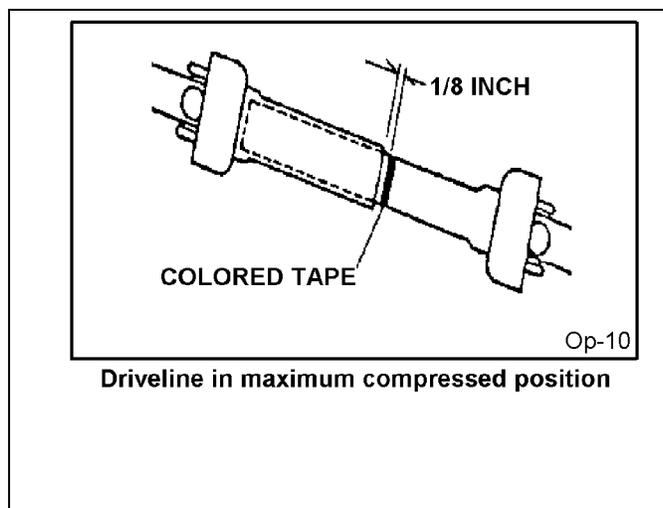

# OPERATION

## Shorten the driveline profiles as follows:

- Remove the driveline from the tractor.
- Position the mower to the point with the shortest distance between the tractor PTO shaft and cutter gearbox. Shut down the tractor and securely block the mower in this position.
- Pull driveline apart and reattach yoke to PTO shaft.
- Hold driveline sections parallel to one another and measure back 1" from yoke of each shaft and place mark on opposite section. Cut this length off with a saw.
- Round off all sharp edges and debur.
- Thoroughly grease then reinstall the driveline.
- Recheck for proper operation.

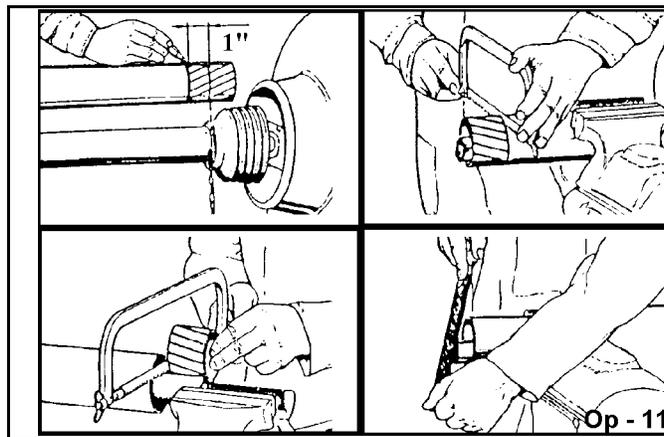

## Engagement Check Procedure

- With the driveline attached, position the mower to the point where the telescoping driveline is at its maximum extension. Completely shut down the tractor and secure in position.
- Mark the inner driveline shield 1/8" from the end of the outer shield.
- Disconnect the driveline from the tractor and separate the two driveline halves.
- Measure the distance from the mark to the end of the inner profile. This length is the amount the driveline profiles were engaged.
- If the engaged length is less than 12" the shaft is considered too short and should be replaced with a longer shaft. Consult an authorized dealer to purchase the required driveline length.

**NOTE:** If the driveline cannot be shortened and still maintain the required profile engagement, the operator must be made aware of terrain conditions and avoid situations which pose a potential problem to avoid damaging the driveline. OPS-F-0002

## 8. PRE-OPERATION INSPECTION AND SERVICE

Before each use, a pre-operation inspection and service of the implement and tractor must be performed. This includes routine maintenance and scheduled lubrication, inspecting that all safety devices are equipped and functional, and performing needed repairs. DO NOT operate the unit if the pre-operation inspection reveals any condition affecting safe operation. Perform repairs and replacement of damaged and missing parts as soon as noticed. By performing a thorough pre-operation inspection and service, valuable down time and repair cost can be avoided. OPS-U-0029



Always disconnect the main PTO Driveline from the Tractor before performing service on the Implement. Never work on the Implement with the tractor PTO driveline connected and running. Rotating Parts, Blades or Drivelines could turn without warning and cause immediate entanglement, injury or death. (S3PT-11)

# OPERATION

## **⚠ DANGER**

**DO NOT** allow any person under a folded wing unless wing is securely locked up or supported. **DO NOT** approach the Implement unless the Tractor is turned off and all motion has ceased. Never work under the frame work, or any lifted component unless the implement is securely supported or blocked up. A sudden or inadvertent fall by any of these components could cause serious injury or even death. (STI-03)



## **⚠ WARNING**

Periodically inspect all moving parts for wear and replace when necessary with authorized service parts. Look for loose fasteners, worn or broken parts, and leaky or loose fittings. Make sure all pins have attaching hardware. Serious injury may occur from not maintaining this machine in good working order. (SG-21\_A)

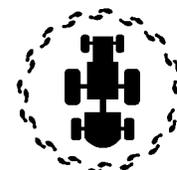

## **8.1 Tractor Pre-Operation Inspection/Service**

Refer to the tractor operator's manual to ensure a complete pre-operation inspection and scheduled service is performed according to the manufacturers recommendations. The following are some of the items that require daily service and inspection:

- Tire condition/air pressure
- Wheel lug bolts
- Steering linkage
- PTO shield
- SMV sign is clean and visible
- Tractor's lights are clean and functional
- Tractor Seat belt is in good condition
- Tractor ROPS is in good condition
- ROPS is in the raised position
- No tractor oil leaks
- Radiator free of debris
- Engine oil level and condition
- Engine coolant level and condition
- Power brake fluid level
- Power steering fluid level
- Fuel condition and level
- Sufficient lubrication at all lube points
- Air filter condition *OPS-U-0030*



# OPERATION

## 8.2 Mower Pre-Operation Inspection/Service

Before each mower use, a complete inspection and service is required to ensure the mower is in a good and safe working condition. Damaged and/or broken parts should be repaired and/or replaced immediately. To ensure the mower is ready for operation, conduct the following. OPS-R-0007



All Safety Shields, Guards and Safety devices including (but not limited to) - the Deflectors, Steel Guards, Gearbox Shields, PTO integral shields, and Retractable Door Shields should be used and maintained in good working condition. All safety devices should be inspected carefully at least daily for missing or broken components. Missing, broken, or worn items must be replaced at once to reduce the possibility of injury or death from thrown objects, entanglement, or

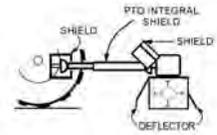

Replace bent or broken blades with new blades. NEVER ATTEMPT TO STRAIGHTEN, WELD, OR WELD HARDFACING ON BLADES SINCE THIS WILL LIKELY CRACK OR OTHERWISE DAMAGE THE BLADE WITH SUBSEQUENT FAILURE AND POSSIBLY CAUSE SERIOUS INJURY FROM THROWN BLADES. (SGM-10)

The operator's manual and safety signs affixed on the unit contain important instructions on the safe and proper use of the equipment. Maintain these important safety features on the implement in good condition to ensure the information is available to the operator at all times.

- Ensure all safety signs are in place and legible. Replace missing, damaged, and illegible decals. OPS-U-0011\_A



- Check that the main driveline is securely attached to the tractor and the locking collar is seated in the groove of the PTO Shaft.
- Inspect that the 3-point hitch pins are the proper size, correctly installed and secured to the tractor lift arms with retaining pins inserted.
- Ensure side mower hydraulics are secure at both ends. OPS-F-0015\_A



# OPERATION

## OPERATION

- Ensure rubber deflectors are in position and not damaged. Replace worn, broken, and missing sections immediately.
- Ensure the rollers are in good condition and rotate freely.
- Ensure the driveline integral shield is in good condition and rotate freely.
- Inspect that all bolts and screws are in position and are properly torqued. *OPS-F- 0004*



Op-255

- Inspect the condition of the side mowers and rear mower drive belts.
- Ensure the slip clutch (rear mower section only) is properly adjusted and the friction plates are not frozen together. Reference the Maintenance Section for proper slip clutch maintenance.
- Ensure the slip clutch shield and drive belts shields are in place and in good repair.
- Ensure the tractor PTO master shield is in place, lowered and in good condition. *OPS-F- 0005\_A*

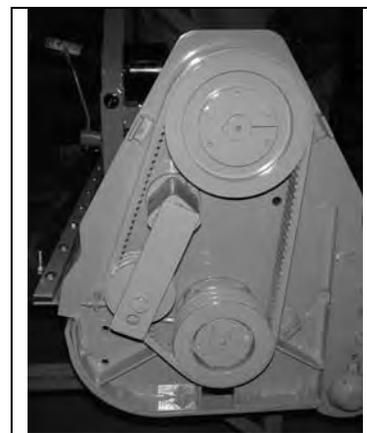

- Inspect oil level in gearbox and replenish if needed. A low oil level is a warning sign that the gearbox may be cracked or its seal is damaged and needs to be replaced.
- Check the oil level in tank and replenish if needed. **NOTE:** Do not fill the tank with oil above the level of the sight gauge. Over filling the tank with oil after initial filling may result in oil being discharged through the breather cap on the top of the hydraulic tank.
- Perform scheduled lubrication as specified in the Maintenance Section. *OPS-F- 0006\_A*

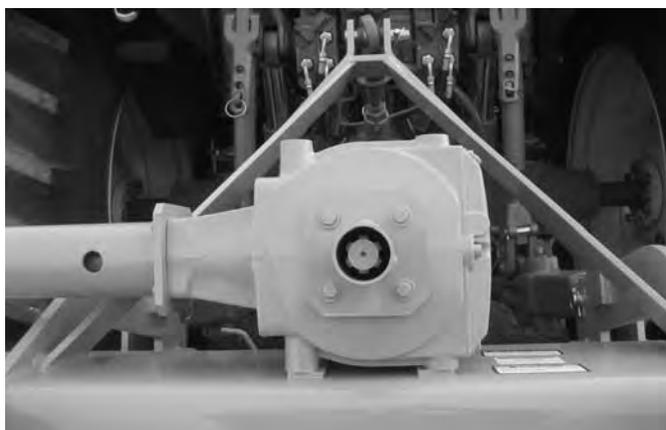



# OPERATION

- Inspect cutter knives and knife pins for looseness and excessive wear. Make sure the mower is securely blocked up before crawling beneath. Replace damaged, worn, and missing knives as complete sets to maintain cuttershaft balance.
- Remove any grass or other debris which may be wrapped around the cuttershafts.
- Inspect the condition of deck skid shoes and hardware. *OPS-F- 0007*



OPERATION

# OPERATION

## Flail Mower PRE-OPERATION Inspection



Mower ID# \_\_\_\_\_ Make \_\_\_\_\_

Date: \_\_\_\_\_ Shift \_\_\_\_\_



Before conducting the inspection, make sure the tractor engine is off, all rotation has stopped and the tractor is in park with the parking brake engaged. Make sure the mower is resting on the ground or securely blocked up and all hydraulic pressure has been relieved.

**Table 1:**

Item	Condition at Start of Shift	Specific Comments if not O.K.
The Operator's Manual is in the canister		
All safety decals are in place and legible		
The Mounting frame bolts are in place and tight		
The connection bolts & pins are tight		
There are no cracks in mower		
The Hydraulic Cylinders pins are tight		
The Hydraulic Pump hose connections are tight		
The Hydraulic Valve hose connections are tight		
The Hydraulic Valve controls function properly		
There are no leaking or damaged hoses		
The Hydraulic Oil level is full		
There is no evidence of Hydraulic leaks		
The Blades are not chipped, cracked or bent		
The Blade bolts are tight		
The Deflectors are in place and in good condition		
The shields are in place and in good condition		
The Skid shoes are in good condition & tight		
The Hyd. motor mounting bolts are tight		

Operator's Signature: \_\_\_\_\_

**DO NOT OPERATE an UNSAFE TRACTOR or BOOM**

# OPERATION

## Tractor PRE-OPERATION Inspection



Mower ID# \_\_\_\_\_ Make \_\_\_\_\_

Date: \_\_\_\_\_ Shift \_\_\_\_\_



Before conducting the inspection, make sure the tractor engine is off, all rotation has stopped and the tractor is in park with the parking brake engaged. Make sure the mower is resting on the ground or securely blocked up and all hydraulic pressure has been relieved.

**OPERATION**

Item	Condition at Start of Shift	Specific Comments if not O.K.
The flashing lights function properly		
The SMV Sign is clean and visible		
The tires are in good condition with proper pressure		
The wheel lug bolts are tight		
The tractor brakes are in good condition		
The steering linkage is in good condition		
There are no visible oil leaks		
The hydraulic controls function properly		
The ROPS or ROBS Cab is in good condition		
The seatbelt is in place and in good condition		
The 3-point hitch is in good condition		
The drawbar pins are securely in place		
The PTO master shield is in place		
The engine oil level is full		
The brake fluid level is full		
The power steering fluid level is full		
The fuel level is adequate		
The engine coolant fluid level is full		
The radiator is free of debris		
The air filter is in good condition		

Operator's Signature: \_\_\_\_\_

**DO NOT OPERATE an UNSAFE TRACTOR or MOWER**

This Inspection Form may be freely duplicated for extra copies.

# OPERATION

## 9. DRIVING THE TRACTOR AND IMPLEMENT

Safe tractor transport requires the operator possess a thorough knowledge of the model being operated and precautions to take while driving with an attached implement. Ensure the tractor has the capacity to handle the weight of the implement and the tractor operating controls are set for safe transport. To ensure safety while driving the tractor with an attached implement, review the following. *OPS-U- 0012*



This Implement may be wider than the Tractor. Be careful when operating or transporting this equipment to prevent the Implement from running into or striking sign posts, guard rails, concrete abutments or other solid objects. Such an impact could cause the Implement and Tractor to pivot violently resulting in loss of steering control, serious injury, or even death. Never allow the Implement to contact obstacles. (S3PT-12)



Transport only at speeds where you can maintain control of the equipment. Serious accidents and injuries can result from operating this equipment at high speeds. Understand the Tractor and Implement and how it handles before transporting on streets and highways. Make sure the Tractor steering and brakes are in good condition and operate properly.



Before transporting the Tractor and Implement, determine the proper transport speeds for you and the equipment. Make sure you abide by the following rules:

Test the tractor at a slow speed and increase the speed slowly. Apply the Brakes smoothly to determine the stopping characteristics of the Tractor and Implement. As you increase the speed of the Tractor the stopping distance increases. Determine the maximum transport speed not to exceed 20 mph (30 kph) for transporting this equipment.

Test the equipment at a slow speed in turns. Increase the speed through the turn only after you determine that the equipment can be operated at a higher speed. Use extreme care and reduce your speed when turning sharply to prevent the tractor and implement from turning over. Determine the maximum turning speed for you and this equipment before operating on roads or uneven ground.



Only transport the Tractor and Implement at the speeds which allow you to properly control the equipment.

Be aware of the operating conditions. Do not operate the Tractor with weak or faulty brakes or worn tires. When operating down a hill or on wet or rain slick roads, the braking distance increases: use extreme care and reduce your speed. When operating in traffic always use the Tractor's flashing warning lights and reduce your speed. Be aware of traffic around you and watch out for the other guy. (SG-19)

# OPERATION

## **9.1 Starting the Tractor**

The procedure to start the tractor is model specific. Refer to the tractor operator's manual for starting procedures for your particular tractor. Consult an authorized dealer if the starting procedure is unclear. Ensure the 3-point control lever is in the lowered position and the PTO is disengaged before starting the tractor. OPS-U-0033



## **9.2 Brake and Differential Lock Setting**

Make sure the tractor brakes are in good operating condition. Tractor brakes can be set to operate independently allowing single rear wheel braking action or locked together to provide simultaneous rear wheel braking. FOR MOST DRIVING AND OPERATING CONDITIONS, THE BRAKE PEDALS SHOULD BE LOCKED TOGETHER TO PROVIDE THE MOST EFFECTIVE BRAKING ACTION.

Always disengage the tractor differential lock when turning. When engaged the differential lock will prevent or limit the tractor from turning. During normal cutting conditions, locking the differential provides no benefit and should not be used.

OPS-U-0013



Raising the Mower

# OPERATION

Using the tractor 3-point hitch control lever, raise the mower off the ground about 6", or just high enough to clear any ground obstacles. When raising the mower, make sure all connection points are securely attached and at least 1" clearance is maintained between the driveline and the deck. If necessary, place an upper lift strip on the 3-point hitch control lever to limit the height the mower can be raised to avoid driveline damage.



## **9.3 Driving the Tractor and Implements**

Start off driving at a slow speed and gradually increase your speed while maintaining complete control of the tractor and units. Moving slowly at first will also prevent the tractor from rearing up and loss of steering control. The tractor should never be operated at speeds that cannot be safely handled or which will prevent the operator from stopping quickly during an emergency. If the power steering or engine ceases operating, stop the tractor immediately as the tractor will be difficult to control.



Drive the tractor with the 3-point lift arms in the raised position and lock the control lever in the transport detent position to prevent damage to the mower driveline when turning.

Perform turns with the tractor and units at slow speeds to determine how the tractor with an attached mower handles a turn. Determine the safe speed to maintain proper control of the tractor when making turns.



To avoid overturns, drive the tractor with care and at safe speeds, especially when operating over rough ground, crossing ditches or slopes, and turning corners. Tractor wheel tread spacing should be increased when working on inclines or rough ground to reduce the possibility of tipping.

Use extreme caution when operating on steep inclines.

# OPERATION

## **9.4 Crossing Ditches and Steep Inclines**

When crossing ditches with steep banks or going up sharp inclines, it is possible that the main driveline inner profile will penetrate into the outer housing to its maximum depth until the assembly becomes solid (driveline is at its extreme shortest length). This type of abusive operation can cause serious damage to the tractor and mower drive by pushing the PTO into the tractor and through the support bearings or downward onto the PTO shaft, breaking it off.

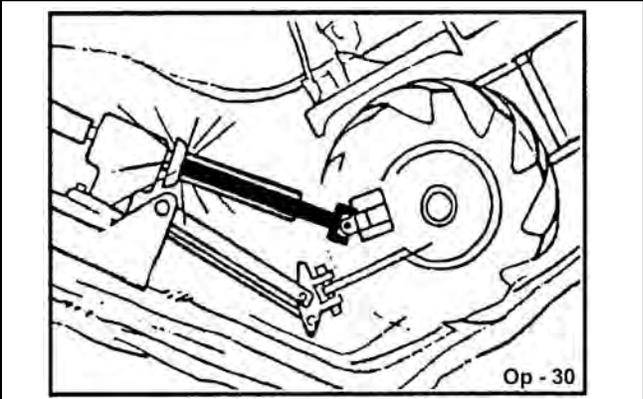

### **WARNING**

Damage resulting from over-collapse of the driveline's inner profile and its outer housing may allow the driveline to come loose from the Tractor which could cause bodily injury to the operator or bystanders and/or extensive damage to the Tractor or Implement. OPS-R-0020

When confronted with an incline or ditch, do not approach from an angle which is perpendicular or straight on as damage to over collapse of the driveline may occur.

When crossing such terrain, the implement should be fully lowered for a lower center of gravity and added stability. OPS-R-0021

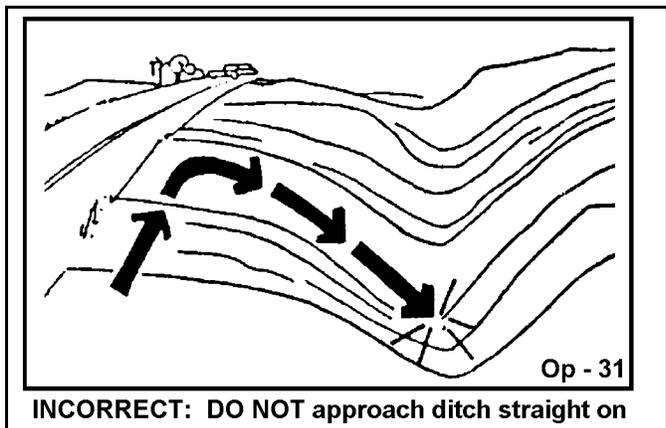

# OPERATION

Inclines and ditches should be approached along a line which is at an angle as shown. This type of path will reduce the possibility of over-collapse of the driveline and resulting damage. If the gradient is so steep that such an approach increases the possibility of a tractor roll-over, select an alternate crossing path.

When operating the tractor and mower across slopes and inclines, through ditches, and other uneven terrain conditions, it is important to maintain sufficient deck to ground clearance. Blade contact with the ground may cause soil, rocks and other debris to be thrown out from under the mower resulting in possible injury and/or property damage. Ground contact also produces a severe shock load on the mower drive and to the mower blades resulting in possible damage and premature wear.

OPS-R-0022

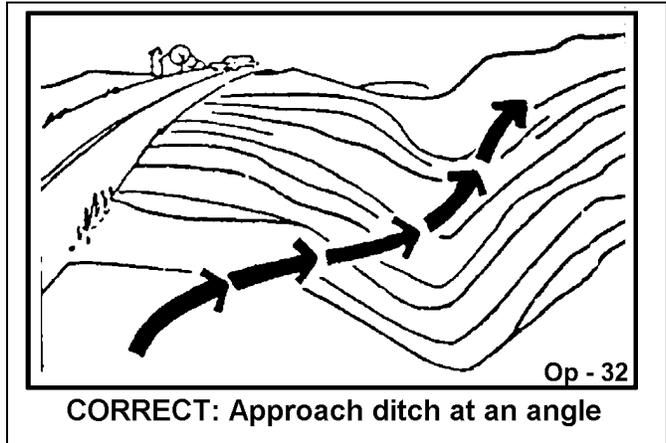

## 10. OPERATING THE TRACTOR AND IMPLEMENT

**THE OPERATOR MUST COMPLETELY UNDERSTAND HOW TO OPERATE THE TRACTOR AND IMPLEMENT AND ALL CONTROLS BEFORE ATTEMPTING TO OPERATE.** The operator must read and understand the Safety and Operation Sections of the implement and tractor operator's manuals. These manuals must be read and explained to any operator who cannot read. Never allow someone to operate the implement and tractor without complete operating instructions.

Before starting any operation, the operator must become familiar with the area to be worked in and any obstacles and hazards contained within to ensure safety to the operator, bystanders, and equipment. Special attention should be paid to foreign debris, rough terrain, steep slopes, and passersby and animals in the area.

OPS-U-0015

### **WARNING**

Extreme care should be taken when operating near loose objects such as gravel, rocks, wire, and other debris. Inspect the area before mowing. Foreign objects should be removed from the site to prevent machine damage and/or bodily injury or even death. Any objects that cannot be removed must be clearly marked and carefully avoided by the operator. Stop mowing immediately if blades strike a foreign object. Repair all damage and make certain rotor or blade carrier is balanced before resuming mowing. (SGM-05)





# OPERATION

## **WARNING**

Many varied objects, such as wire, cable, rope, or chains, can become entangled in the operating parts of the mower head. These items could then swing outside the housing at greater velocities than the blades. Such a situation is extremely hazardous and could result in serious injury or even death. Inspect the cutting area for such objects before mowing. Remove any like object from the site. Never allow the cutting blades to contact such items.

(SGM-06)

### **10.1 Foreign Debris Hazards**

Before mowing, inspect the area to make sure there are no foreign objects that the mower blades could hit or become entangled with. Remove all foreign objects and debris. If objects are too big to remove, mark them clearly and be sure to prevent the mower blades from contacting them.

If you hit a solid object or foreign debris, stop the mower and tractor at once. Immediately idle the engine speed and disengage the PTO. Wait for all mower rotating motion to stop, then raise the mower and move the tractor and implement off the object. Inspect the area and remove, or mark the location of the debris. Inspect the condition of the mower and make any needed repairs immediately. Make sure the blades are not damaged and the carrier is balanced before resuming operation.

Always wear your seat belt securely fastened and only operate the tractor and mower with the ROPS in the raised position. If the tractor or mower hits a tree stump, rock, or bump, a sudden movement could throw you off of the seat and under the tractor and/or mower. The seat belt is your best protection from falling off the tractor and the ROPS provides protection from being crushed during a tractor roll-over. *OPS-F-0010*



Op - 33



Op-266

### **10.2 Bystanders/Passersby Precautions**

If a bystander comes within 300 feet of the tractor while the mower is being operated, stop the tractor at once, idle the engine and disengage the PTO. Do not engage the PTO again until all bystanders are well past the 300 foot distance. *OPS-R-0024*

# OPERATION



Flail Mowers are capable under adverse conditions of throwing objects for great distances (300 feet or more) and causing serious injury or death. Follow safety messages carefully.



STOP MOWING IF PASSERSBY ARE WITHIN 300 FEET UNLESS:

-Front and Rear Deflectors, Chain Guards, or Bands are installed and in good, workable condition;

-Mower sections are running close to and parallel to the ground without exposed Blades;

-All areas have been thoroughly inspected and all foreign material such as rocks, cans, glass, and general debris has been removed.

**NOTE:** Where there are grass and weeds high enough to hide debris that could be struck by the blades, the area should be: inspected and large debris removed, mowed at an intermediate height, inspected closely with any remaining debris being removed, and mowed again at desired final height. (This will also reduce power required to mow, reduce wear and tear on the Mower drivetrain, spread cut material better, eliminate

## 10.3 Engaging the Power Take Off (PTO)

Before engaging the PTO, make certain that the area is clear of bystanders and passersby. The implement must be completely lowered and the deck positioned at a safe operating height. NEVER engage the PTO with the implement in the raised position.

Set the tractor engine speed at approximately 1,000 RPM before engaging the PTO. Shift the PTO control to the on position, and slowly increase the engine speed until the PTO is operating at the rated speed. If you hear unusual noises or see or feel abnormal vibrations, disengage the PTO immediately. Inspect the implement to determine the cause of the noise or vibration and repair the abnormality. OPS-U- 0027



Do not let the Blades turn when the Mower Deck is raised for any reason, including clearance or for turning. Raising the Mower deck exposes the Cutting Blades which creates a potentially serious hazard and could cause serious injury or even death from objects thrown from the Blades. (SRM-07)



Do not put hands or feet under mower decks. Blade Contact can result in serious injury or even death. Stay away until all motion has stopped and the decks are securely blocked up. (SGM-09)

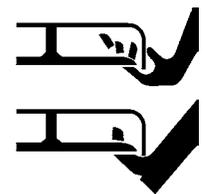

# OPERATION

## **10.4 PTO RPM and Ground Speed**

Ground speed for mowing will depend upon the height, type, and density of vegetation to be cut. Recommended speed for efficient mower performance is between 2 and 5 mph(3-8 kph). Operate the mower at its full rated PTO speed to maintain blade speed for a clean cut. Refer to the tractor operator's manual or the tractor instrument panel for the engine speed and gear to provide the required PTO and desired ground speed. Make sure that the mower is operating at its full rated speed before entering the vegetation to be cut. If it becomes necessary to temporarily regulate engine speed, increase or decrease the throttle gradually.

Ground speed is achieved by transmission gear selection and not by the engine operating speed. The operator may be required to experiment with several gear range combinations to determine the best gear and range which provides the most ideal performance from the mower and most efficient tractor operation. As the severity of cutting conditions increase, the ground speed should be decreased by selecting a lower gear to maintain the proper operating PTO speed. OPS-R-0025



Do not exceed the rated PTO speed for the Implement. Excessive PTO speeds can cause Implement driveline or blade failures resulting in serious injury or death. (SG-26)



Mow at the speed that you can safely operate and control the tractor and mower. The correct mowing speed depends on terrain condition and grass type, density, and height of cut. Normal ground speed range is from 2 to 5 mph(3-8 kph). Use slow mowing speeds when operating on or near steep slopes, ditches, drop-offs, overhead obstructions, power lines, or when debris and foreign objects are to be avoided. (SGM-07)

## **10.5 Operating the Mower**

Only operate the mower from the tractor operator's seat with the seatbelt securely fastened. The tractor must be equipped with a ROPS in the raised position or a ROPS cab.

The mower is designed to cut vegetation up to 2" in diameter. Sharp blades will produce a cleaner cut and require less power. Travel at a speed that allows the mower sufficient time to cut through the vegetation and maintain the PTO operating speed to prevent overloading the mower and tractor. Choose a driving pattern that provides the maximum pass length and minimizes turning.

Under certain conditions, tractor tires may roll some grasses down preventing them from being cut at the same height as the surrounding area. When this occurs, reduce the tractor ground speed while maintaining the operating speed of the mower. A slower ground speed will permit grasses to at least partially rebound and be cut. Taking a partial cut and/or reversing the direction of travel may also help produce a cleaner cut.

Avoid mowing in the reverse direction when possible. In situations where the mower must be backed to access areas to be cut, make sure there are no persons or other foreign debris behind the mower before mowing in reverse. When mowing in reverse, operate the tractor and mower at a reduced ground speed to ensure tractor and mower control is maintained. OPS-R-0026

# OPERATION

**WARNING**

Do not mow with two machines in the same area except with Cab tractors with the windows closed. (SGM-11)

**WARNING**

Mow only in conditions where you have clear visibility in daylight or with adequate artificial lighting. Never mow in darkness or foggy conditions where you cannot clearly see at least 300 feet (90 m) in front and to the sides of the tractor and mower. Make sure that you can clearly see and identify passersby, steep slopes, ditches, drop-offs, overhead obstructions, power lines, debris and foreign objects. If you are unable to clearly see these type of items discontinue mowing. (SGM-01)

**WARNING**

Avoid mowing in reverse direction when possible. Check to make sure there are no persons behind the mower and use extreme care when mowing in reverse. Mow only at a slow ground speed where you can safely operate and control the tractor and mower. Never mow an area that you have not inspected and removed debris or foreign material. (SGM-08)

**WARNING**

Follow these guidelines to reduce the risk of equipment and grass fires while operating, servicing, and repairing the Mower and Tractor:



- Equip the Tractor with a fire extinguisher in an accesible location.
- Do Not operate the Mower on a Tractor with an underframe exhaust.
- Do Not smoke or have an open flame near the Mower and Tractor.
- Do Not drive into burning debris or freshly burnt areas.
- Ensure slip clutches are properly adjusted to prevent excessive slippage and plate heating.
- Never allow clippings or debris to collect near drivelines, slip clutches, and gearboxes. Periodically shut down the Tractor and Mower and clean clippings and collected debris from the mower deck. (SGM-12)

# OPERATION

## **10.6 Shutting Down the Implement**

To shut down the implement, first bring the tractor to a complete stop. Then slow down the implement by reducing the engine speed before disengaging the PTO. Wait for all motion to stop before proceeding to drive or shut down the tractor.



Park the tractor on a level surface, place the transmission in park or neutral and apply the parking brake, lower the attached implement to the ground, shut down the engine, remove the key, and wait for all motion to come to a complete stop before exiting the tractor. OPS-F-0011



## **11. DISCONNECTING THE MOWER FROM THE TRACTOR**

Before disconnecting the mower, the PTO must be disengaged and all motion at a complete stop. Move the mower to a level storage location and lower both side mowers to the ground. If the mower will be stored with the sections in the raised position, be sure that the travel locks are engaged. If the mower is not resting securely on the ground, block the mower up securely before attempting to disconnect it from the tractor. Use extreme care to keep feet and hands from under the mower and clear of any pinch points. OPS-F-0012\_A



# OPERATION

**DANGER**

Always shut the Tractor completely down, place the transmission in park, and set the parking brake before you or anyone else attempts to connect or disconnect the Implement and Tractor hitches. (S3PT-15)

**DANGER**

Never stand or allow another person to stand between a running Tractor and the Mower when disconnecting the Implement from the Tractor 3-point hitch. Always shut the Tractor off completely and set the parking brake before attempting to disconnect the Mower pins from the Tractor hitch.

After disconnecting the 3 lift points, remove the mower driveline from the tractor PTO shaft. Lay the driveline down carefully to avoid damaging the driveline or its shield. Do not let the driveline fall into mud or dirt, which can contaminate the bearing and shorten the life of the driveline.

OPS-F-0013



**DANGER**

Never work under the Implement, the framework, or any lifted component unless the Implement is securely supported or blocked up to prevent sudden or inadvertent falling which could cause serious injury or even death. (SG-14)



# OPERATION

## 12. MOWER STORAGE

It is recommended that the mower be stored with the center section and both side mowers fully lowered to ground level. If the mower is stored with the side mowers in the raised position, select a level area and engage travel locks and travel lock pins to prevent the side mowers from falling BEFORE disconnecting the rear mower.

Properly preparing and storing the mower at the end of the season is critical to maintaining its appearance and to help ensure years of dependable service. The following are suggested storage procedures:

- Thoroughly clean all debris off the mower to prevent damage from rotting grass and standing water.
- Lubricate all mower grease points and fill gearbox oil levels as detailed in the Maintenance Section.
- Tighten all bolts and pins to the recommended torque.
- Check the mower for worn and damaged parts. Perform repairs and make replacements immediately so that the mower will be ready for use at the start of the next season.
- Store the mower in a clean, dry place with the mower housing resting securely on blocks or at ground level.
- Keep the driveline yoke from sitting in water, dirt and other contaminants.
- Use spray touch-up enamel where necessary to prevent rust and maintain the appearance of the mower.



It is critical that driveline clutches slip when an obstacle or heavy load is encountered to avoid mower and/or tractor damage. If the mower sits outside for an extended period of time or is exposed to rain and/or humid air, the clutch lining plates must be inspected to ensure they are not frozen together from rust or corrosion. If the mower has been exposed to such conditions, at the start of each mowing season, and any time it is



Never allow children to play on or around Tractor or Implement. Children can slip or fall off the Equipment and be injured or killed. Children can cause the Implement to shift or fall crushing themselves or others. (SG-25)

# OPERATION

## 13. TRANSPORTING THE TRACTOR AND IMPLEMENT

Inherent hazards of operating the tractor and implement and the possibility of accidents are not left behind when you finish working in an area. Therefore, the operator must employ good judgement and safe operation practices when transporting the tractor and implement between locations. By using good judgement and following safe transport procedures, the possibility of accidents while moving between locations can be substantially minimized. *OPS-U-0017*



Never allow children or other persons to ride on the Tractor or Implement. Falling off can result in serious injury or death. (SG-10)



OPERATION

Before transporting the tractor and mower, idle the tractor engine, disengage the PTO and wait for all mower moving parts to come to a complete stop. Raise the mower sections and ensure transport locks engage and install the travel lock pins. *OPS-F-0021*





# OPERATION

Before transporting the tractor on a public roadway or boarding a trailer for transport, the tractor brake pedals should be locked together. Locking the pedals ensures that both wheels brake simultaneously while stopping, especially when making an emergency stop.



Use extreme caution and avoid hard applications of the tractor brakes when carrying equipment at road speeds. Never haul the implement at speeds greater than 20 MPH (32 kph). OPS-U- 0018\_A

If the tractor's hydraulic pump is not independent of the tractor PTO, or if the tractor PTO has to be run to have hydraulic power, disconnect the mower driveline from the tractor PTO output shaft. Secure the driveline to the mower deck to prevent driveline damage or loss during transport.

## **13.1 Transporting on Public Roadways**

Extreme caution should be used when transporting the tractor and implement on public roadways. The tractor must be equipped with all required safety warning features including a SMV emblem and flashing warning lights to alert drivers of the tractor's presence. Remember that roadways are primarily designed for automotive drivers and most drivers will not be looking out for you, therefore, you must look out for them. Check your side view mirrors frequently and remember that vehicles will approach quickly because of the tractor's slower speed. Be extremely cautious when the piece of equipment that you are carrying is wider than the tractor tire width and/or extends beyond your lane of the road. OPS-U- 0019\_A

**NOTE:** Ensure that the mower sections are fully raised and that the transport locks are engaged for each section.



Only carry the Implement behind a properly sized and equipped Tractor which exceeds the weight of the Implement by at least 20%. DO NOT carry the Implement behind a truck or other type of vehicle. Never carry the Implement and another Implement connected in tandem. Never carry the Implement at speeds over 20 MPH. (STI-06\_A)



Never allow children or other persons to ride on the Tractor or Implement. Falling off can result in serious injury or death. (SG-10)



# OPERATION

## **WARNING**

Make certain that the “Slow Moving Vehicle” (SMV) sign is installed in such a way as to be clearly visible and legible. When transporting the Equipment use the Tractor flashing warning lights and follow all local traffic regulations. (SG-6)

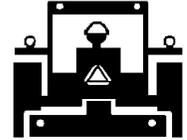

## OPERATION

The SMV (Slow-Moving Vehicle) emblem is universal symbol used to alert drivers of the presence of equipment traveling on roadways at a slow speed. SMV signs are a triangular bright orange with reflective red trim for both easy day and night visibility. Make sure the SMV sign is clean and visible from the rear of the unit before transporting the tractor and implement on a public roadway. Replace the SMV emblem if faded, damaged, or no longer reflective. OPS-U-0020



Make sure that all tractor flashing warning lights, headlights, and brake/tail lights are functioning properly before proceeding onto public roads. While newer model tractors have plenty of lighting to provide warning signals and operating lighting, most older models are only equipped with operating lights. Consult an authorized tractor dealer for lighting kits and modifications available to upgrade the lighting on older tractor models. OPS-U-0021



When operating on public roads, have consideration for other road users. Pull to the side of the road occasionally to allow all following traffic to pass. Do not exceed the legal speed limit set in your country for agricultural tractors. Always stay alert when transporting the tractor and implement on public roads. Use caution and reduce speed if other vehicles or pedestrians are in the area. OPS-U-0022



# OPERATION

Reduce speed before turning or applying the brakes. Ensure that both brake pedals are locked together when operating on public roads. *OPS-U- 0023*



## **13.2 Hauling the Tractor and Implement**

Before transporting a loaded tractor and implement, measure the height and width dimensions and gross weight of the complete loaded unit. Ensure that the load will be in compliance with the legal limits set for the areas that will be traveled through. *OPS-U- 0024*



Use adequately sized and rated trailers and equipment to transport the tractor and implement. Consult an authorized dealer to determine the proper equipment required. Using adequately sized chains, heavy duty straps, cables and/or binders, securely tie down both the front and rear of the tractor utilizing the proper tie down locations as specified by the tractor manufacturer. *OPS-U- 0025*



# OPERATION

# OPERATION

Side and Rear Flail

Operation Section 3-36

# **MAINTENANCE SECTION**

Maintenance Section 4-1

# MAINTENANCE

## General Instructions

Tiger Mowers are designed for high performance and rugged durability, yet with simplified maintenance. The purpose of this section of the manual is to help the operator in the regular servicing of the mower. Regular maintenance at the intervals mentioned will result in the maximum efficiency and long life of the Tiger Mower.

When you purchase a Tiger Mower you also acquire another valuable asset, Tiger's parts organization. Our rapid and efficient service has guaranteed the customer satisfaction for many years. Tiger parts keep up with the demands for efficiency, safety and endurance expected of the Tiger Mower.

## Maintenance Precautions

- Be sure end of grease gun and fittings are clean before using. Debris injected into bearings, etc. with grease will cause immediate damage.
- DO NOT use a power grease gun to lubricate bearings. These require very small and exact amounts of lubrication. Refer to the detailed maintenance section for specific lubrication instructions. DO NOT over-grease bearings.
- Lexan windows should be washed with mild soap or detergent and luke warm water, using a soft clean sponge or soft cloth. DO NOT use abrasive or alkaline cleaners or metal scrapers on lexan windows!
- Be alert to maintenance indicators such as the in-tank filter pressure gauge, hydraulic reservoir sight gauge, etc. Take the required action to correct any problems immediately.
- Release of energy from pressurized systems may cause inadvertent actuation of cylinders, or sudden release of compressed springs. Before disconnecting any hoses relieve pressure by shutting tractor off, setting cutter on ground and actuating lift valve handles.

### **WARNING**

DO NOT use hands to check for suspected leaks in hydraulic hoses! Hydraulic fluid escaping under pressure can have sufficient force to penetrate skin and cause serious injury. If fluid is injected into skin, it must be surgically removed within a few hours or gangrene may result. Use a small piece of wood or cardboard, not hands, to search for pin hose leaks. Be sure all connections are tight and hoses and lines are not damaged before applying pressure.

## Break in Period

In addition to following the break in instructions for your particular tractor, the in-tank hydraulic fluid filter should be replaced after the first 50 hours of service. Thereafter the filter should be replaced every 500 hours, or yearly, whichever comes first.

Re-torque wheel lugs after first five hours of operation and periodically thereafter. See torque specifications listed in the tractor's service manual for your particular model. **Wheel lugs must always be re-torqued whenever a wheel is removed and reinstalled.**

### **DANGER**

Never work under the Implement, the framework, or any lifted component unless the Implement is securely supported or blocked up to prevent sudden or inadvertent falling which could cause serious injury or even death. (SG-14)



### **WARNING**

Do not modify or alter this Implement. Do not permit anyone to modify or alter this Implement, any of its components or any Implement function. (SG-8)

# MAINTENANCE



Always disconnect the wire leads from the mower pump solenoid before performing service on the Tractor or Mower. Use caution when working on the Tractor or Mower. Tractor engine must be stopped before working on Mower or Tractor. The Mower Blades could inadvertently be turned on without warning and cause immediate dismemberment, injury or death. (SBM-12a)

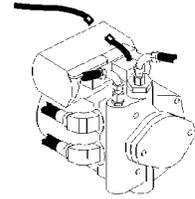

**MAINTENANCE**

## Regular Maintenance

The intervals at which regular servicing should be done are based on hours of operation. Use the tractor's hour meter to determine when regular servicing is required.

### Daily or Every 8 Hours

ITEM	SERVICE	COMMENTS
Drive Shaft Yoke, U-Joint & Stub Shaft	Grease	Grease as instructed in detailed maintenance section
Pump Drive Shaft Coupler	Check and Lube	Insure driveshaft end play
Crankshaft Adapter	Check rubber grommets	Replace grommets if damaged or missing
Pivot Points	Lubricate	Inject grease until it appears at ends
Hydraulic Fittings	Check for leaks	Tighten when needed. Do not use hands to check for leaks, see maintenance precautions
Knives	Check	Inspect for missing or damaged knives, change as needed.
Belts	Check/Adjust	Check if broken, tighten as required.
Main Frame and Deck	Check	Retorque bolts to torque specifications in this section

Side and Rear Flail

Maintenance Section 4-3

# MAINTENANCE

**MAINTENANCE**

ITEM	SERVICE	COMMENTS
Hydraulic Fluid Level	Check	Add if required per fluid recommendations
Rear Flail Drive (if applicable) Bearing Flange and Shaft Coupler	Lubricate	Grease as instructed in detailed maintenance section
Cutter Shaft	Lubricate	Grease as instructed in detailed maintenance section
Ground Roller Bearings	Lubricate	Grease as instructed in detailed maintenance section

## WEEKLY OR EVERY 50 HOURS

ITEM	SERVICE	COMMENTS
In Tank Hyd. Fluid Filter (10 micron filter)	Change	Change after first 50 hours only, then every 500 hours or yearly
In-Line High Pressure Filter (10 micron filter)	Change	Change after first 50 hours only, then every 500 hours or yearly

## MONTHLY OR EVERY 150 HOURS

Hydraulic Fluid Level	Check	Add as needed
Hyd. Tank Breather	Clean/Check/Replace	Clean or replace Element as required
Rear Tire Type		Max P.S.I.
480/80R38		29
18.4-34		26
18.4-38		26



# MAINTENANCE

## YEARLY OR EVERY 500 HOURS

ITEM	SERVICE	COMMENTS
Hydraulic Tank Fluid	Change	
In Tank Hydraulic Fluid Filter <b>(10 micron filter)</b>	Change	
In-Line HP Filter <b>(10 micron filter)</b>	Change	or Change when indicated by restriction indicator.
Hydraulic Tank Breather	Change	

**MAINTENANCE**

# MAINTENANCE

## TROUBLESHOOTING

SYMPTOMS	CAUSE	REMEDY
<b>Vibration</b>	<ol style="list-style-type: none"> <li>1. Loose Bolts</li> <li>2. Cutter assembly Unbalanced</li> </ol>	<ol style="list-style-type: none"> <li>1. Check all bolts and tighten to recommended torque specs.</li> <li>2a. Check for damaged blades, disc or cuttershaft. Replace if needed.</li> <li>2b. Check for wire, rope, etc. entangled in the cutter assembly</li> </ol>
<b>Mower will not lift</b>	<ol style="list-style-type: none"> <li>1. Hyd. Fluid Low</li> <li>2. Leaks in line</li> <li>3. Faulty relief valve</li> <li>4. Kinked or blocked</li> <li>5. Faulty cylinder</li> </ol>	<ol style="list-style-type: none"> <li>1. Check and refill hydraulic fluid</li> <li>2. Tighten or replace fittings and hoses</li> <li>3. Check pressure in line. Line pressure should be at least 2500 PSI</li> <li>4. Clean or replace lines</li> <li>5. Inspect, repair or replace cylinder</li> </ol>
<b>Mower will not start or run</b>	<ol style="list-style-type: none"> <li>1. Blown fuse</li> <li>2. Ball valves closed</li> <li>3. Low oil level</li> <li>4. Line leak</li> <li>5. Electronic solenoid faulty</li> </ol>	<ol style="list-style-type: none"> <li>1. Check fuse between mower switch and ignition/replace</li> <li>2. Make sure valves are open</li> <li>3. Check hydraulic tank and fill</li> <li>4. Check all fittings and lines, re-tighten or replace</li> <li>5a. <b>Without</b> the tractor running, turn the mower switch to on. A low audible click is not heard if the solenoid is engaging the solenoid spool. If click is not heard, leave switch in on position and with a screwdriver or other steel object, touch the small nut on the end of the solenoid. If the metallic object is not attracted to the nut, check the fuse and wiring for an open circuit. If the object is attracted but no click is heard, replace the solenoid.</li> <li>5b. Remove the four bolts holding the small block to the main block. Lift and remove small block being careful not to damage O-rings/filter. Clean filter and re-install.</li> </ol>

# MAINTENANCE

5c. Remove large nut on side of large valve block. Remove spring, and use needle nose vise grip to pull spool from block. Check block and spool for contaminants and scratches. Clean parts or replace if scratched.

**Oil Temperature rises above 200 deg. F**

1. Belts
1. Low oil level
2. Kinked or blocked hose
3. Worn pump/motor

1. Bring oil to proper level.
2. Inspect, repair, or replace hoses.
3. Disable and repair.

**Motor runs but will not cut.**

1. Belts
2. Tensioner

1. Inspect belts and pulleys. Replace belts and repair as needed.
2. Adjust tensioner nut until flatwasher is flush with top of guide.

**Mower turns slowly or not at all.**

1. Contaminants restricting spool movement in valve body.
2. Suction lines obstructed
3. Low oil level

1. Remove large nut on side of large valve block. Remove spring, and use needle nose vise grip to pull spool from block. Check block and spool for contaminants and scratches. Clean parts or replace if scratched.
2. Check for kinks or obstruction in suction hose.
3. Check Hyd. tank level and fill.

**Pump will not work**

1. Excessive wear on internal parts

1. Disassemble and repair.

**Motor will not work**

1. Excessive wear on internal parts

1. Disassemble and repair.

**NOTE:** If flow meter is available, check pressure and flow volume for all suspected hydraulic problems.

**If the solution to your problem cannot be found in this section, call the Technical Service representative at the number shown on the front cover of this manual.**

# MAINTENANCE

These are intended to be general specifications. See tractor operator's or service manual for exact specifications for your unit.

## LUBRICATION RECOMMENDATIONS

Description	Application	General Specification	Recommended Mobil Lubricant
Tractor Hydraulics	Reservoir	JD-20C	Mobilfluid®
Mower Hydraulics	Reservoir		
Cold Temperatures 0° F Start-Up		ISO 46 Anti-Wear/ Low Temp	Mobil DTE® 15M
Normal Temperatures 15° F Start-Up		ISO 46 Anti-Wear	Nuto® H46, Mobil DTE®25
Flail Rear Gearbox	Reservoir	PAO Synthetic Extreme Pressure Gear Lube	Mobil® 1 Synthetic Gear Lubricant LS 75W-90 Mobil® Delvac Synthetic 75W-90
Cutter Shaft & Ground Roller Shaft(Flail)	Grease Gun	Lithium-Complex NLGI 2 ISO 320	Mobil Delvac® Xtreme Grease, Mobilgrease CM-S
Drive Shaft Coupler (Flail and Rotary)	Grease Gun	Lithium-Complex NLGI2-ISO 320	Mobil Delvac® Xtreme Grease, Mobilgrease CM-S
Drive Shaft Yoke, U-joint & Stub Shaft	Grease Gun	Lithium-Complex Extreme Pressure NLGI2-ISO 320	Mobilgrease CM-S

**MAINTENANCE**

# MAINTENANCE

MAINTENANCE

## TORQUE SPECIFICATIONS

Torque for Standard Fasteners																	
Nominal Dia. (in.)	threads per inch	Grade 2			Grade 5			Grade 8			Grade 9						
		Tightening Torque			Tightening Torque			Tightening Torque			Tightening Torque						
		Lubed	Dry Plated	Dry plain	Lubed	Dry Plated	Dry plain	Lubed	Dry Plated	Dry plain	Lubed	Dry Plated	Dry plain				
K = 0.15			K = 0.17			K = 0.20			K = 0.15			K = 0.17			K = 0.20		
Unified Coarse Thread Series																	
1/4	20	49 in-lbs	59 in-lbs	66 in-lbs	76 in-lbs	86 in-lbs	101 in-lbs	107 in-lbs	122 in-lbs	143 in-lbs	126 in-lbs	143 in-lbs	168 in-lbs				
5/16	18	101	122	135	157	178	209	221	251	295	259	294	346				
3/8	16	15 ft-lbs	18 ft-lbs	20 ft-lbs	23 ft-lbs	26 ft-lbs	31 ft-lbs	33 ft-lbs	37 ft-lbs	44 ft-lbs	38 ft-lbs	43 ft-lbs	51 ft-lbs				
7/16	14	24	29	32	37	42	49	52	59	70	61	70	82				
1/2	13	37	44	49	57	64	75	80	90	106	94	106	125				
9/16	12	53	63	70	82	92	109	115	130	154	135	153	180				
5/8	11	73	87	97	113	128	150	159	180	212	186	211	248				
3/4	10	129	155	172	200	227	267	282	320	376	331	375	441				
7/8	9	125	150	167	322	365	429	455	515	605	533	604	710				
1	8	187	225	250	483	547	644	681	772	909	799	905	1065				
1 1/8	7	266	319	354	596	675	794	836	955	1128	983	1128	1341				
1 1/4	7	375	450	500	840	952	1121	1173	1345	1581	1375	1581	1863				
1 1/2	6	652	783	869	1462	1657	1950	2031	2311	2712	2349	2712	3206				
Fine Thread Series																	
1/4	28	56 in-lbs	68 in-lbs	75 in-lbs	87 in-lbs	99 in-lbs	116 in-lbs	123 in-lbs	139 in-lbs	164 in-lbs	144 in-lbs	163 in-lbs	192 in-lbs				
5/16	24	112	135	150	174	197	231	245	278	327	287	325	383				
3/8	24	17 ft-lbs	20 ft-lbs	23 ft-lbs	26 ft-lbs	30 ft-lbs	35 ft-lbs	37 ft-lbs	42 ft-lbs	49 ft-lbs	43 ft-lbs	49 ft-lbs	58 ft-lbs				
7/16	20	27	32	36	41	47	55	58	66	78	68	78	91				
1/2	20	41	49	55	64	72	85	90	102	120	105	120	141				
9/16	18	59	71	78	91	103	121	128	146	171	151	171	201				
5/8	18	82	99	110	127	144	170	180	204	240	211	239	281				
3/4	16	144	173	192	223	253	297	315	357	420	369	418	492				
7/8	14	138	165	184	355	403	474	502	568	669	588	666	784				
1	14	210	252	280	542	614	722	765	867	1020	896	1016	1195				
1 1/8	12	298	357	397	668	757	890	933	1063	1227	1069	1239	1439				
1 1/4	12	415	498	553	930	1055	1241	1294	1470	1710	1476	1664	1958				
1 1/2	12	734	880	978	1645	1865	2194	2288	2624	3057	2627	3044	3619				

Torque values for 1/4 and 5/16-in series are in inch-pounds. All other torque values are in foot-pounds. K = 0.15 for "lubricated" conditions  
 Torque values calculated from formula T=KDF, where K = 0.17 for zinc plated and dry conditions  
 K = 0.20 for plain and dry conditions D = Nominal Diameter  
 F = Clamp Load

Torque-Tension Relationship for Metric Fasteners													
Nominal Dia. (mm)	Pitch	Class 4.6			Class 8.8			Class 10.9			Class 12.9		
		Tightening Torque			Tightening Torque			Tightening Torque			Tightening Torque		
		Lubed	Dry Plated	Dry plain	Lubed	Dry Plated	Dry plain	Lubed	Dry Plated	Dry plain	Lubed	Dry plain	
K = 0.15			K = 0.17			K = 0.20			K = 0.15			K = 0.20	
3	0.5	0.28	0.32	0.38	0.73	0.82	0.97	1.0	1.2	1.4	1.2	1.6	
3.5	0.6	0.44	0.50	0.59	1.1	1.3	1.5	1.6	1.9	2.2	1.9	2.5	
4	0.7	0.66	0.74	0.87	1.7	1.9	2.3	2.4	2.7	3.2	2.8	3.8	
5	0.8	1.3	1.5	1.8	3.4	3.9	4.5	4.9	5.5	6.5	5.7	7.6	
6	1	2.3	2.6	3.0	5.8	6.6	7.7	8.3	9.4	11	9.7	13	
6	1.25	2.1	2.3	2.7	5.3	6.0	7.0	7.6	8.6	10	8.8	12	
7	1	3.8	4.3	5.0	9.7	11	13	14	16	19	16	22	
8	1	5.9	6.8	7.8	15	17	20	22	24	29	25	34	
8	1.25	5.5	6.2	7.3	14	16	19	20	23	27	24	31	
10	1.25	11	13	15	29	33	39	42	48	56	49	66	
10	1.5	11	12	14	28	32	37	40	45	53	47	62	
12	1.25	21	23	28	53	60	71	76	86	101	89	119	
12	1.5	20	22	26	51	58	68	73	82	97	85	113	
12	1.75	19	21	25	49	55	65	70	79	93	81	108	
14	1.25	26	29	34	66	75	89	95	108	127	111	148	
14	1.5	28	32	37	72	82	96	103	117	138	121	161	
14	2	30	34	40	78	88	104	111	126	148	130	173	
18	1.5	50	57	67	129	146	171	184	208	245	215	287	
18	2	47	53	62	121	137	161	173	196	230	202	269	
18	2.5	73	82	97	187	212	249	268	303	357	313	417	
18	3	65	73	86	167	189	222	239	270	318	279	372	
20	1.5	101	115	135	270	306	360	374	424	498	437	583	
20	2.5	91	104	122	236	267	314	337	382	449	394	525	

Clamp load calculated as 75% of the proof load for specified bolts. K = 0.15 for "lubricated" conditions  
 All torque values are listed in foot-pounds K = 0.17 for zinc plated, dry conditions  
 Torque values calculated from formula T=KDF, where K = 0.20 for plain and dry conditions D = Nominal Diameter  
 F = Clamp Load

# MAINTENANCE

## MAINTENANCE

### RECOMMENDED FILLING INSTRUCTIONS FOR HYDRAULIC RESERVOIRS

When filling or checking the oil level, the unit should be parked on a level surface., shut OFF, and allow sufficient time to cool to ambient temperature. Use caution when removing the pressurized breather. Do not place face over opening when removing breather.

If your reservoir has two sight glasses: The reservoir should be filled to the top of the lower sight glass on the side of the tank. Do not over-fill. The reservoir has been over-filled when oil is visible in the upper sight glass. If tank has too much oil, the excess may be expelled through the pressurized breather.

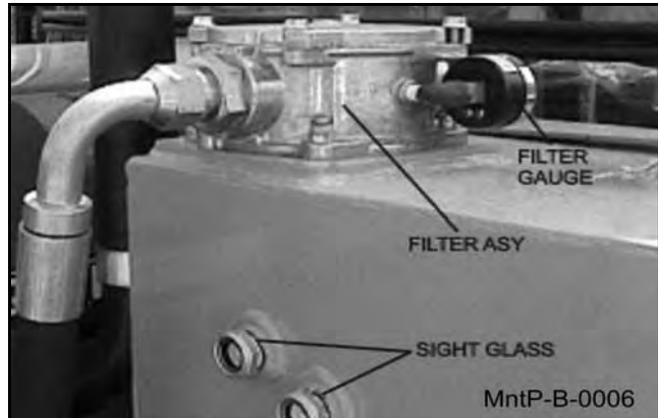

If your reservoir has one sight glass/temperature gage: The reservoir should be filled to the center of the sight glass on the side of the tank. Do not over-fill. If the tank has too much oil, the excess may be expelled through the pressurized breather.

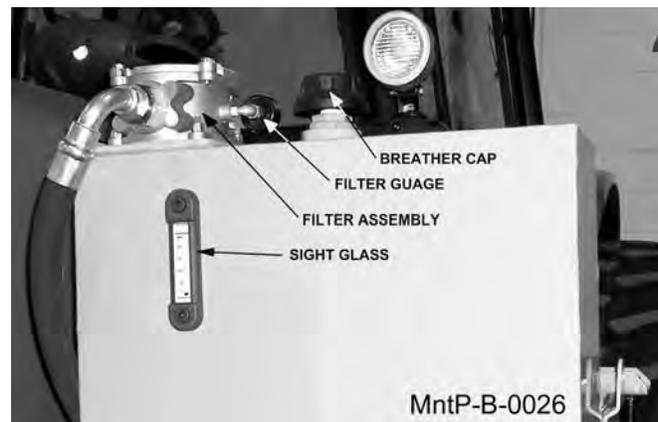

### REPLACING IN-TANK HYDRAULIC FILTER:

Loosen the four bolts on the top cover of the filter housing. Turn cover counter-clockwise until cover is free. Remove and replace filter. Replace top cover and cover bolts in opposite order as removed.



# MAINTENANCE

MAINTENANCE

## REPLACING HIGH PRESSURE HYDRAULIC FILTER ELEMENT:

Ensure that the system has been shut down and depressurized. Locate High Pressure Filter housing. Confirm that the element to be installed matches the element p/n on the filter model tag. (Example: V3.0510-06 (world line 100, HD049 model)). Locate the bottom of the High Pressure Bowl. Using the appropriate spanner wrench or ratchet, turn in a counterclockwise rotation, (looking at the bottom of the bowl) to remove the bowl from the head. The first couple rotations will seem tight as the o-ring passes the sealing flats. Once the o-ring has cleared the sealing flats the bowl should spin freely. Taking care not to drop the bowl, finish removing the bowl from the head.

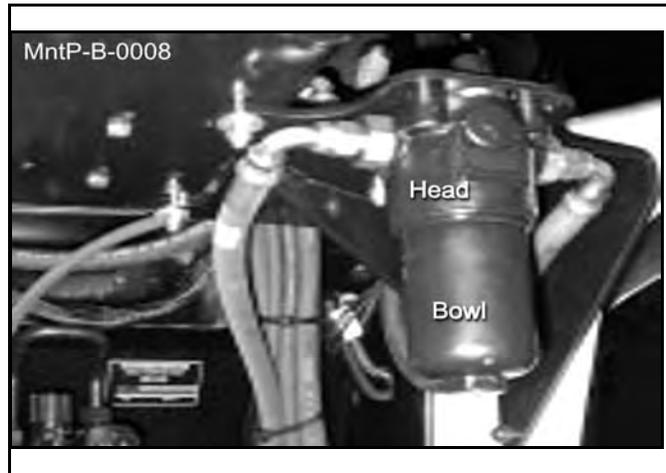

**WARNING: bowl will be full of oil!** Pour the oil from the bowl into a container. This oil should be considered contaminated due to the outside-in direction of flow through the element. Clean the inside of the bowl if dirt is present. Remove the old element from the filter head by pulling with a rotation motion. Dispose of the used element properly. Remove the new element from the packaging. Using your finger, dab and lubricate the o-ring in the top of the new element with oil. Install the new element into and on the mounting boss within the head. Ensure that the element is fully seated on the boss. Clean and inspect the o-ring that is affixed in the bowl and lubricate with oil. Using a clockwise rotation, screw the bowl back into the head, ensuring that the bowl has not been cross-threaded into the head. Continue to tighten the bowl into the head, using the spanner wrench or ratchet. The rotation of the bowl will become tighter once the o-ring engages the sealing flats. Once the bowl has bottomed out, back-off the bowl by 1/6 turn. This ensures that the o-ring is seated properly within the sealing flats. Element change out and re-assembly is now complete. Start the machine and inspect the filter area, checking that there is no oil leaking from the filter assembly. Replace the filter first at 50 hours of operation, then yearly (500 hours) or when indicated by restriction indicator.

## GREASING INNER AND OUTER DRAFT BEAM PIVOT POINTS

Locate the grease zerks on the inner and outer draft beam pivot bosses. Inject Lithium-Complex Extreme Pressure grease conforming to NLG12-ISO 320 specifications into each zerk until grease protrudes from joints. Grease all pivots daily or every 8 hours of service.

# MAINTENANCE

MAINTENANCE

## GREASING THE UPPER AND LOWER SHEAVES

Locate the grease zerks on the ends of the upper and lower sheave pins. **Mnt-R-0018** Inject Lithium-Complex Extreme Pressure grease conforming to NLGI2-ISO 320 specifications into each pin until it protrudes from the ends. These should also be greased daily or for every 8 hours of service.

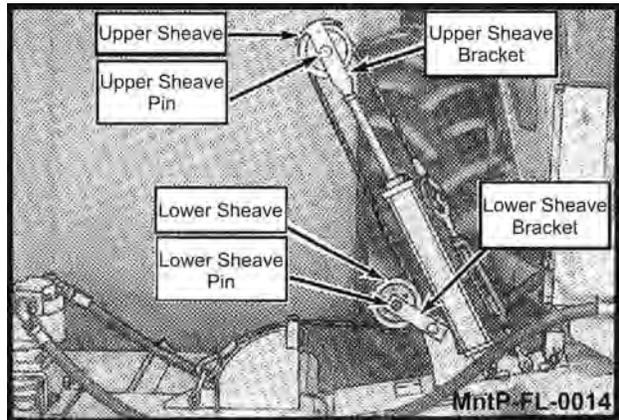

## GREASING PTO SHAFTS

After bringing the tractor to a complete stop, shut off the engine and remove the PTO shaft from the tractor. Slide the shaft apart to expose the grease zerk. Grease the shaft with 5 pumps of grease and the U-joints until grease protrudes from caps per the scheduled interval in the maintenance section.

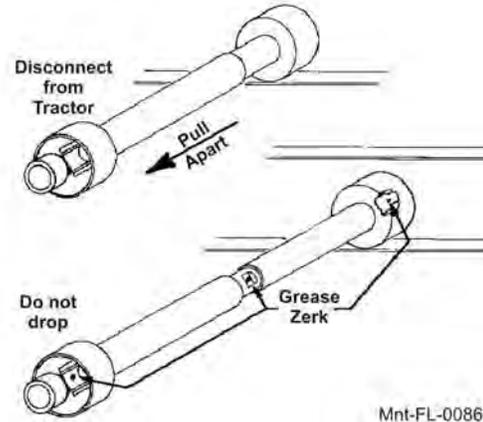

## GREASING INNER AND OUTER DRAFT BEAM PIVOT POINTS

Locate the grease zerks on the inner and outer draft beam pivot bosses. Inject Lithium-Complex Extreme Pressure grease conforming to NLGI2-ISO 320 specifications into each zerk until grease protrudes from joints. Grease all pivot points daily or every 8 hours of service.

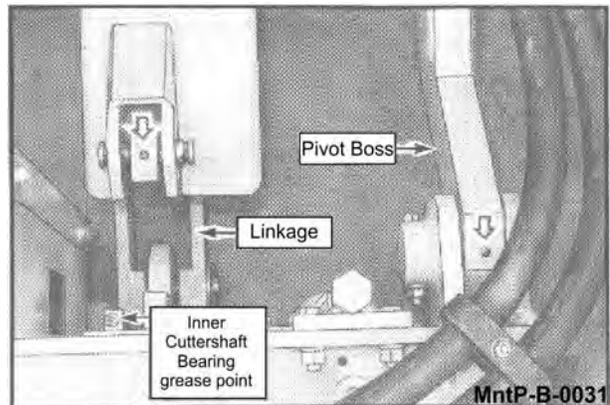
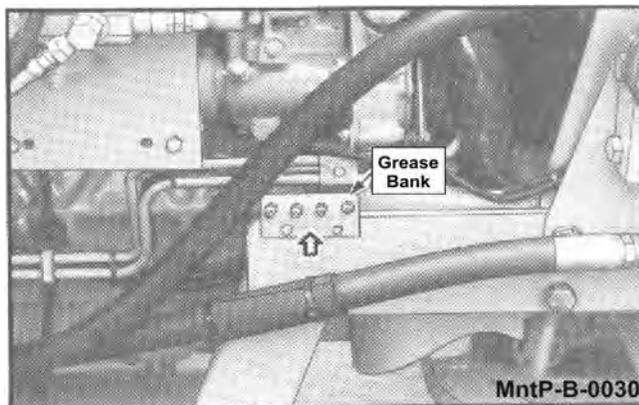



# MAINTENANCE

MAINTENANCE

With the cutter head lowered, locate the grease zerks on the linkage and pivot bo sses. Inject Lithium-Complex Extreme Pressure grease conforming to NLG12-ISO 320 specifications until it pr otrudes from the ends. With the cutter head in this position it is also possible to grease the draft beam cylinder anchors and pins. Now raise the cutter head to expose the remaining zerks on the deck tilt linkages and on the other end of the cylinder.

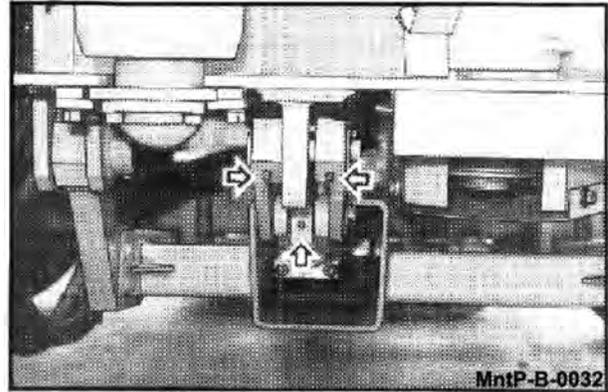

## GREASING THE REAR DRIVE BEARING AND EXTENSION COUPLER SHAFT

Locate the grease zerks for the rear flail drive extension shaft. Make sure the zerks are clean before injecting grease. One pump of grease into flange zerk and shaft coupler once every day or for every 8 hours of service.

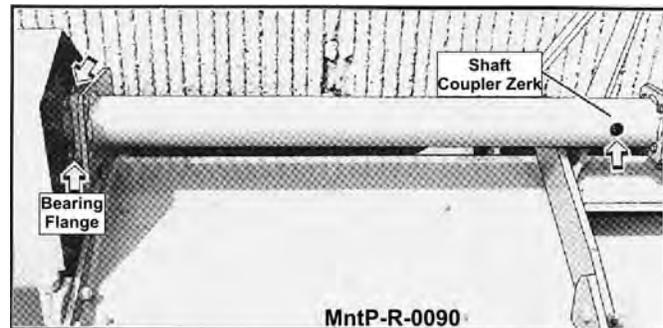

## GREASING PUMP DRIVESHAFT COUPLER

With engine stopped, ensure driveshaft alignment by grasping coupler and sliding back and forth. Coupler should slide freely with approximately 1/8" of end play. If coupler does not slide freely, inspect for loose pump mount bolts, or damaged or loose crank shaft adapter. Inject-Lithium Complex Extreme Pressure grease conforming to NLG12-ISO 320 specifications into coupler until grease begins to protrude from ends. Grease daily or every 8 hours. Do not over grease.

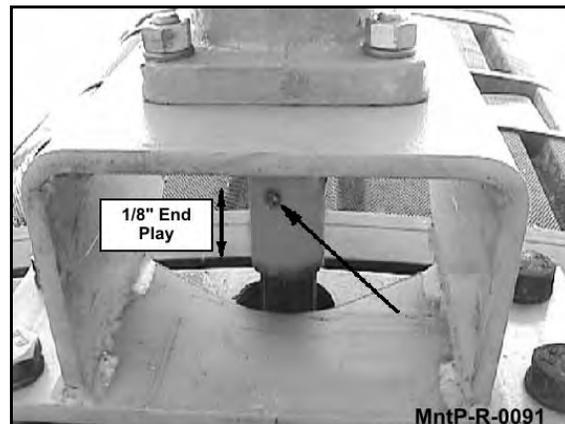

# MAINTENANCE

MAINTENANCE

## DRIVE SHAFT YOKE, U-JOINT STUB SHAFT

With engine stopped, inject Lithium-Complex extreme pressure grease conforming to NLGI2-ISO 320 specifications into universal joints and slip yoke until grease appears at the seal. Grease them daily or every 8 hours.

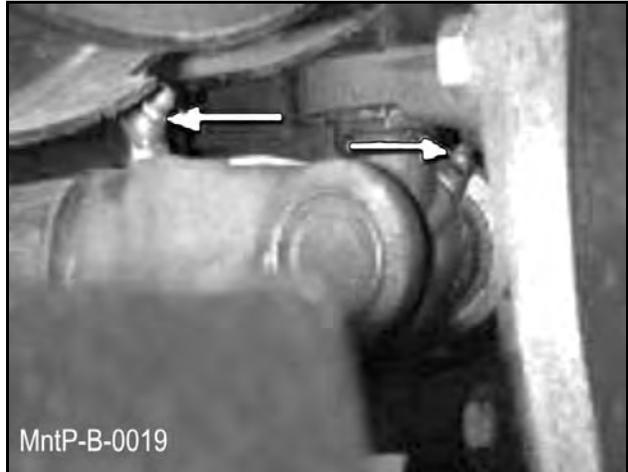
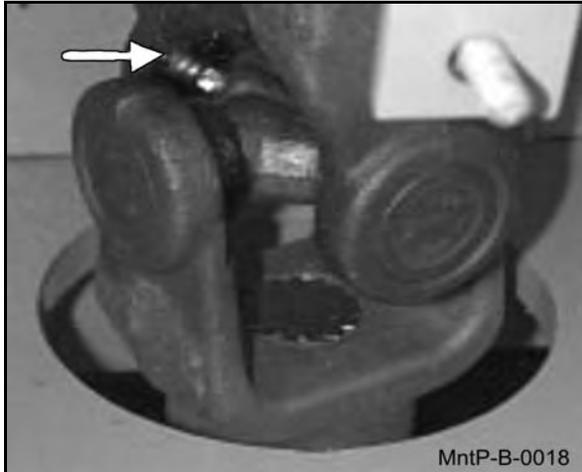

## ADJUSTING THE CABLE LIFT

Extend the outboard cylinder until the mower deck touches its stop on the draft beam as shown.

**NOTE:** Make sure the cable turnbuckle is loose enough to allow the cylinder to reach full extension before the head reaches the stop. Now hold the head against the stop and tighten the turnbuckle until the cable is tight. Lower and raise the head to check the adjustment. The head should touch its stop at the same time the cylinder reaches full extension. Tighten turnbuckle lock nuts securely after adjustment is complete.

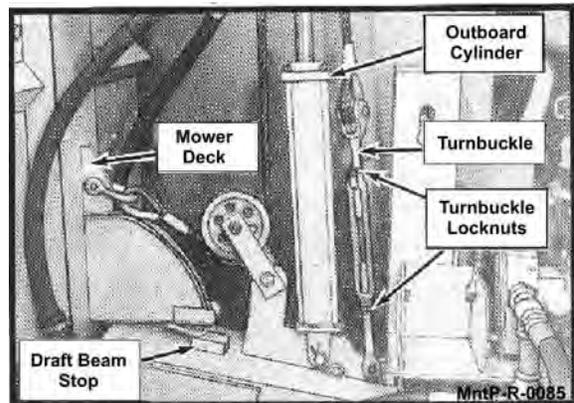

# MAINTENANCE

## ADJUSTING THE CUTTING HEIGHT

Loosen the four ground roller bracket locknuts. Loosen the adjustment rod locknut and turn the adjustment rod to adjust the cutting height. The cutting height is indicated by the end of the adjustment rod on the cutting height decal. When cutting height has been achieved, tighten the ground roller bracket locknuts and the adjustment rod locknut securely. Be sure both sides of the flail are adjusted the same.

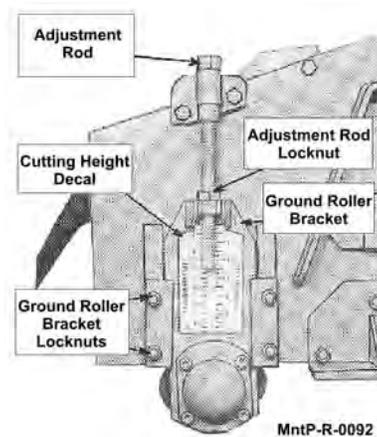

## ADJUSTING STANDARD DUTY CUT HEIGHT

To adjust the cutting height of the standard duty flail head the two nuts on the roller shaft brackets must be taken off and moved to the desired location/height. Be sure that both sides of the shaft are adjusted to corresponding holes so the shaft remains level.

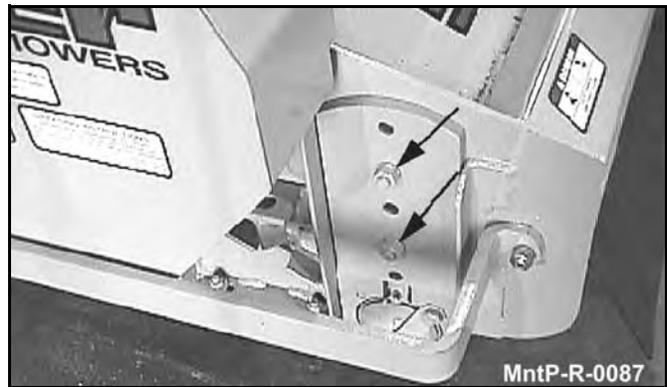

## BALL VALVES

The ball valve at the hydraulic reservoir may need to be closed during certain maintenance or repair procedures. **THE BALL VALVE MUST BE OPEN (handle parallel with valve) WHEN TRACTOR IS RESTARTED OR PUMP IS COUPLED TO MOTOR OR PTO!** Failure to do so will result in component failure!

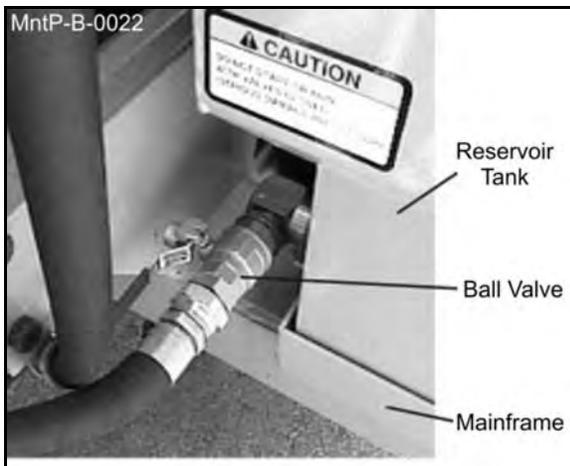

# MAINTENANCE

MAINTENANCE

## GREASING CUTTER SHAFT-FLAIL MOWERS

Locate grease zerks on each end of cutter shaft(s). These are located on the bearing cover. Normal conditions require one or two pumps in each bearing, using Lithium-Complex Extreme Pressure grease conforming to NLGI2-ISO 320 specifications. This is to be done with a standard grease gun daily or at **8 hour intervals**. **CAUTION: Over greasing may cause premature seal failure.**

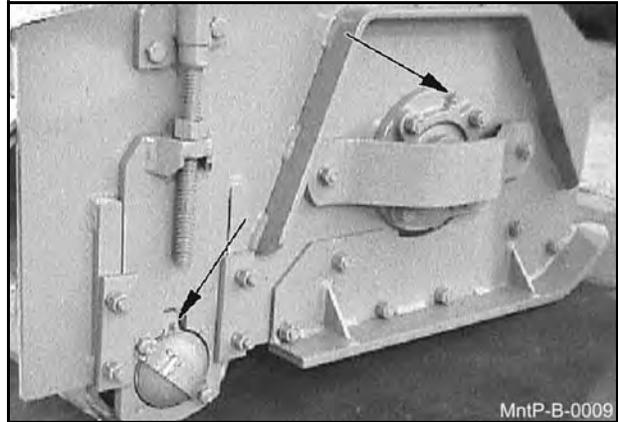

## GREASING GROUND ROLLER SHAFT-FLAIL

Locate grease zerks on each end of roller tube at lower rear of head. Normal conditions require one or two pumps in each bearing, using Lithium-Complex Extreme Pressure grease conforming to NLGI2-ISO 320 specifications. This is to be done with a standard grease gun daily or at **8 hours intervals**. **CAUTION: Over greasing may cause premature seal failure.**

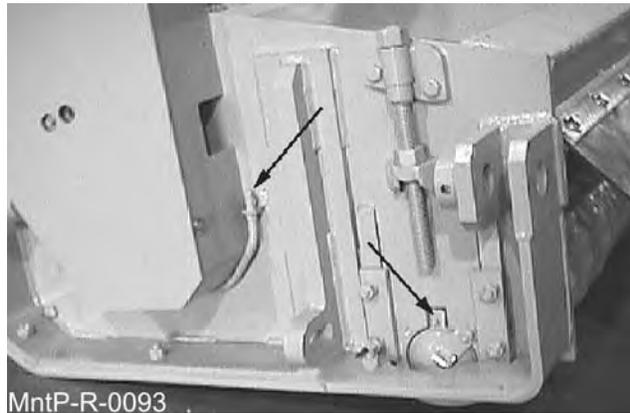

## GREASING THE IDLER TENSION ARMS

Locate the access holes and grease zerks in the belt shields of the side and rear flails. Normal conditions require one pump daily or every 8 hours of service with multi-purpose grease.

# MAINTENANCE

## IDLER TENSION

Locate the idler tensioning rod for each flail. Loosen the locking nut. Turn the adjusting nut until the washer between the spring and nuts are flush with the spring housing or guide. Tighten locking nut securely. For standard cut on side flail adjust until the spring washer is flush with the top of the spring housing. **MntP-R-0094** Use the same method to adjust hydraulically driven rear flails.

For standard cut on the mechanically driven rear flail mower, adjust so that the spring washer is flush with the spring guide. **MntP-R-0095**

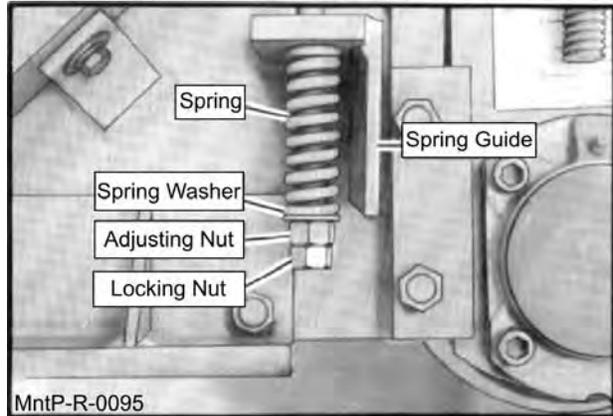
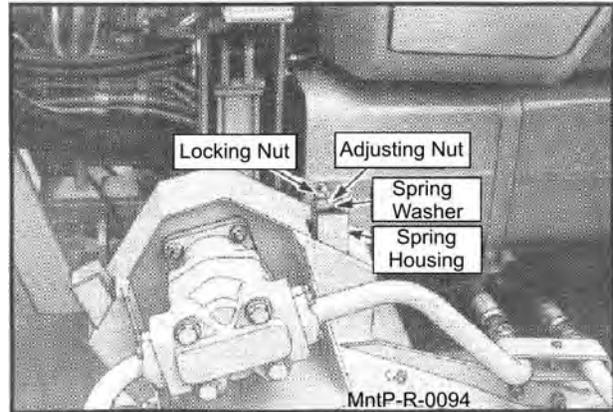

# MAINTENANCE

## ROSTA TENSIONER

### STANDARD DUTY REAR FLAILS

Remove the shield guard over the belt shield. Next, remove the belt shield that covers the tensioner, belt and sheaves.



BELT SHIELD

SHIELD  
GUARD

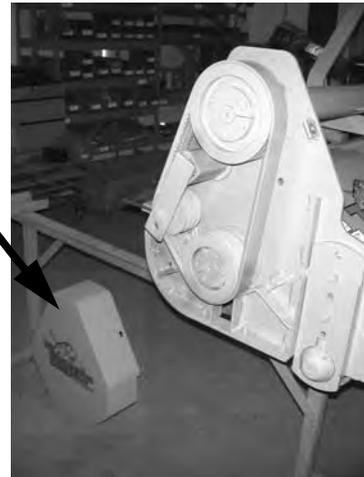

Place a straight edge over both sheaves and measure the belt tension (See TENSIONER MEASUREMENT PROCEDURE). To adjust the Rosta Tensioner, first, loosen the Rosta Stop and Rosta Bolt that secures the Rosta to the flail. Next use the Wrench (P/N 06401023 available) to adjust the tension of the belt. After the tension has been set, secure the Rosta Stop and re-torque the Rosta Bolt to specs.



STRAIGHT EDGE

ROSTA WRENCH



ROSTA STOP



ROSTA  
TENSIONER

Side and Rear Flail

Maintenance Section 4-18

MAINTENANCE

# MAINTENANCE

## TENSIONER MEASUREMENT PROCEDURE

1. Measure the Belt Span (SEE SKETCH).
2. Position the bottom of the Large "O" Ring on the Span Scale at the measured Belt Span.
3. Set the Small "O" Ring on the Deflection Force Scale to Zero.
4. Place the tension gauge squarely on the belt at the center of the belt span. Apply a force on the plunger perpendicular to the belt span until the bottom of the Large "O" Ring is even with the bottom of a straight edge laid across the sheaves.
5. Remove the tension gauge and read the force applied from the bottom of the Small "O" Ring on the Deflection Force Scale.
6. Compare the force denoted by the Small "O" Ring with the values shown. The force should be between the values given for either a New Belt or Used Belt.
7. Make sure to use the force values in pounds if the span is measured in inches. Use kilograms of force if the span is measured in centimeters.
8. NOTE: The ratio of the deflection to belt span is  $1/64$  in either units of measurements.

### Deflection Force Values - Standard Duty

**New Belt: 20 to 25 pounds**

**Used Belt: 12 to 20 pounds**

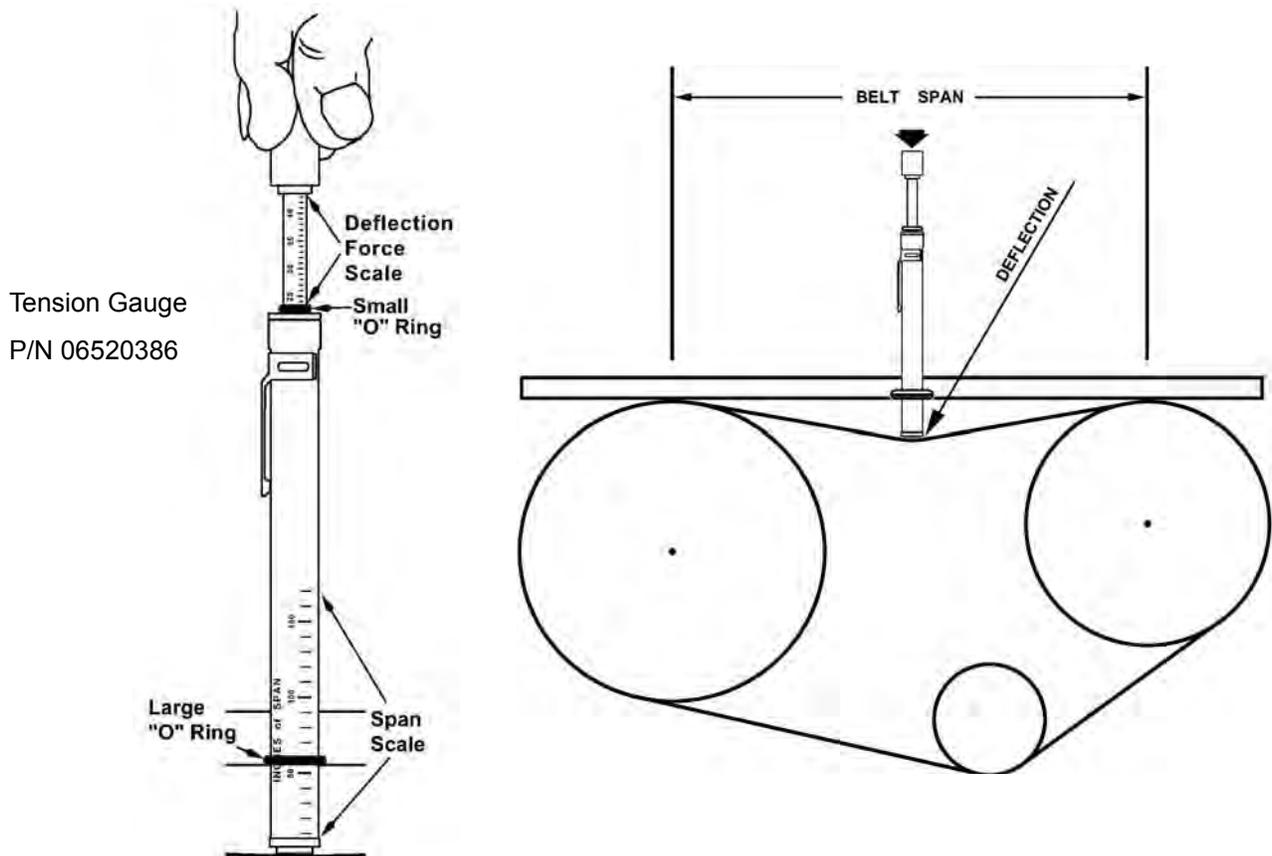

# MAINTENANCE

## REVERSING MOWER ROTATION OF SIDE FLAIL MOWERS

To reverse the rotation of the side and hydraulically driven Heavy Duty rear flail, a different idler arm is needed only for side flail. Part No. TF4346 is used in standard rotation. Part No. TF4345 is used in reverse rotation.

Before attempting this procedure be sure all dirt is cleaned away from the motor and around all hose connections. This will prevent the oil from becoming contaminated. 1-Start by removing the belt shield from the flail mower. 2-Remove the locking and adjusting nut, spring washer and spring from the idler tensioning rod. 3-Disconnect the tensioning rod from the idler arm. 4-Remove the idler arm with the pulley attached.

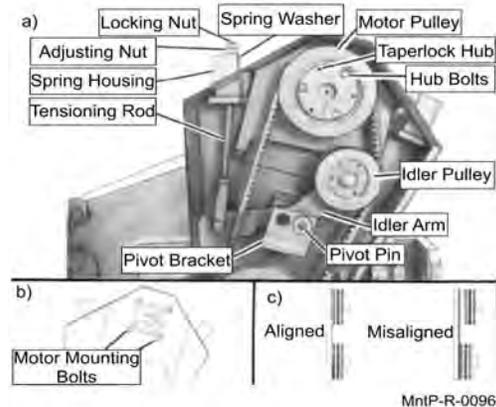

5-Remove the idler pulley from the idler arm and reinstall in the short end of the new idler arm.

Reinstall the idler arm and pivot pin. The pivot pin is installed into the hole in the pivot bracket closest to the idler pulley. When assembling for **standard** cut rotation, the idler arm is installed with the idler pulley toward the front of the mower with the pivot pin in the front hole. When assembling for **reverse** rotation, with smooth cut knives, the idler arm is installed with the pulley toward the rear of the mower with the pivot pin in the rear hole.

Now disconnect the hoses and fittings from the motor and remove the taper-lock hub and pulley from the motor by removing the three hub bolts from the existing positions and inserting simultaneously into the threaded holes. Remove the four bolts holding the motor. Rotate the motor 180° so the hump is opposite the prior position. Reinstall the motor bolts and torque to 75 ft. lbs. Reconnect the hoses and fittings to the motor in the same configuration as before, i.e. the hose that was connected to the front port on the motor should now be connected to the port that is now facing the front.

Reinstall the taper-lock hub and pulley on the motor by installing the hub bolts in the original holes and tightening until the hub just contacts the pulley. Then, position the pulley on the motor shaft approximately 3/16" beyond the idler pulley and tighten and torque the hub bolts to 18 ft. lbs. Be sure the pulleys are vertically aligned when tight (see diagram on previous page), loosen and readjust if needed.

Reinstall the belts and idler tensioning rod. Tighten and lock the tensioning rod as shown previously in the Maintenance Section. Reinstall the belt shield.

With the motor rotation changed, now all of the knives on the cutter shaft must be changed as required. The cutter shaft rotates in the same direction as the tractor tires when going forward for standard cut knives. The shaft rotates opposite to standard rotation for smooth cut knives. Smooth cut knives should be installed so the cutting edge is forward.

When operating in standard rotation, the front shield must be removed and the baffle installed. When operating in reverse rotation, remove the baffle and install the front shield. Finally, reposition the wear pads on the hoses and replace the zip ties as needed to prevent the hydraulic hoses from rubbing or chafing.



# MAINTENANCE

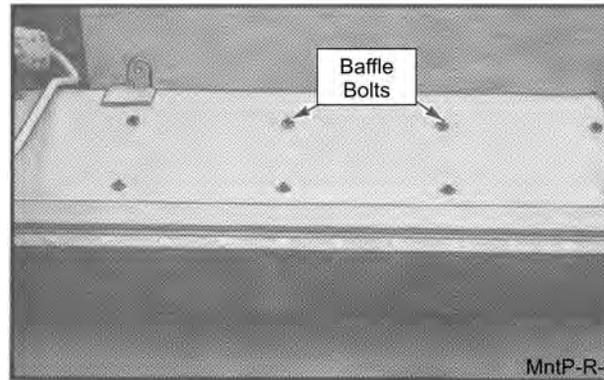
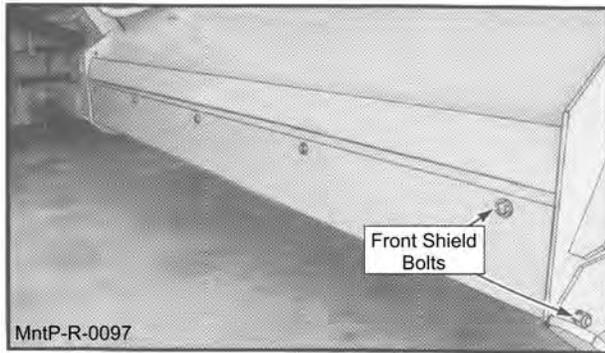

MAINTENANCE

## REVERSING MOWER ROTATION OF SD REAR FLAIL MOWERS

Remove the shield guard and belt shield. Next, remove the Rosta stop and loosen the Rosta Tensioner (**CAUTION:** the Rosta Tensioner is under belt pressure. Sudden release of this pressure may cause serious injury). Remove the Rosta Tensioner and relocate to the Reverse Rotation Tensioner location. Using the Rosta wrench, tension the belt, then tighten the Rosta bolt. Check the tension and adjust as needed. When the correct tension is achieved install the Rosta stop and torque the bolts appropriately.

Rosta Tensioner

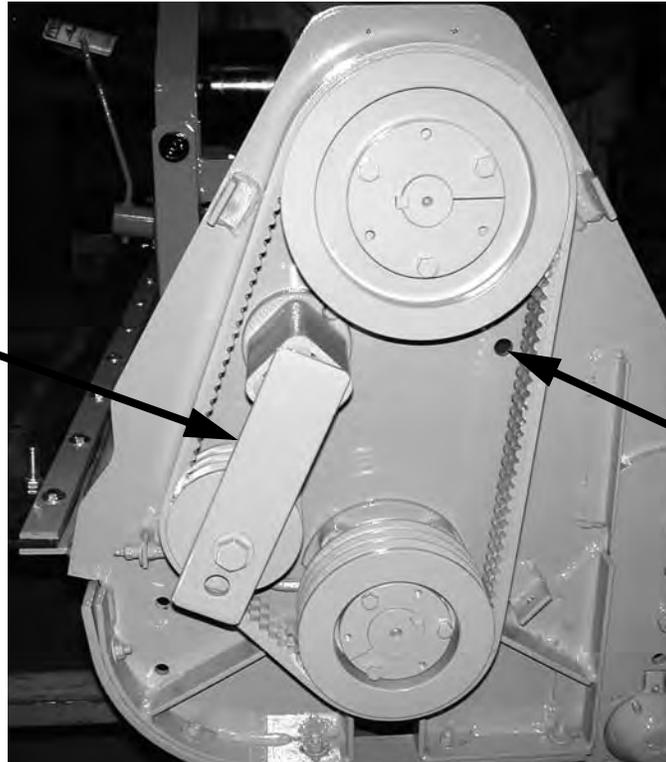

# MAINTENANCE

## MAINTENANCE

### REVERSING MOWER ROTATION REAR MECHANICAL DRIVEN FLAIL MOWERS

Remove the rear shaft guard and disconnect the chain coupling to the shaft. Disconnect the P.T.O. drive shaft from the right angle gear box. Remove the gear box from the flail frame and lay down flat so that gear oil does not leak out.

Switch the top breather vent plug with the drain plug on the bottom. Remove the input shaft guard. The input shaft must be pressed through or turned around so the rear extension is equal to what the original front dimension was. Turn the gear box 180° and install on the flail frame so the frame so the chain coupling sprockets are side by side and the breather vent plug is on the top of the case.

The sprocket must be aligned and spaced approximately 3/8" apart. When changing from standard cut to smooth cut rotation, a spacer plate may have to be installed between the gear box and the frame. When changing from smooth cut to standard cut rotation the spacer plate is to be omitted. Install the chain for the chain coupling. If there is any binding, or not free movement in the chain, the bearing next to the coupler may be shimmed as required to eliminate the chain binding.

Change all the knives on the cutter shaft as required. The cutter shaft rotates in the same direction as the tractor tires when going forward for standard knives. The cutter shaft rotates opposite the tractor tires for smooth cut knives.

Remove the belt shield. Then remove the adjusting nuts, washer and spring from the idler tensioning rod. Remove the clevis rod and small bushing from the idler arm. Remove the idler arm with the pulley attached. Remove the idler pulley from the idler arm and install the pulley on the other end of the idler arm. Reinstall the idler arm in the pivot bracket. For standard cut rotation the pulley is toward the front, for reverse rotation with smooth knives, the idler pulley is toward the rear. Install the small bushing in the idler arm and connect the idler tensioning rod.

Tightening the adjusting nuts for the idler arm tensioner as shown previously in the Maintenance Section. Install the belt shield, the shaft guard and PTO shaft guards.

When operating the mower in reverse rotation with smooth cut knives, remove the baffle and install the front shield. When operating the mower in standard rotation with standard cut knives, remove the front shield and install the baffle.

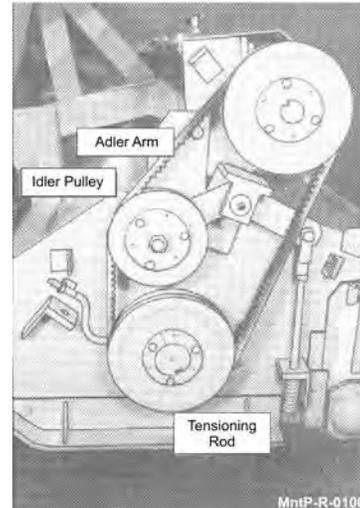
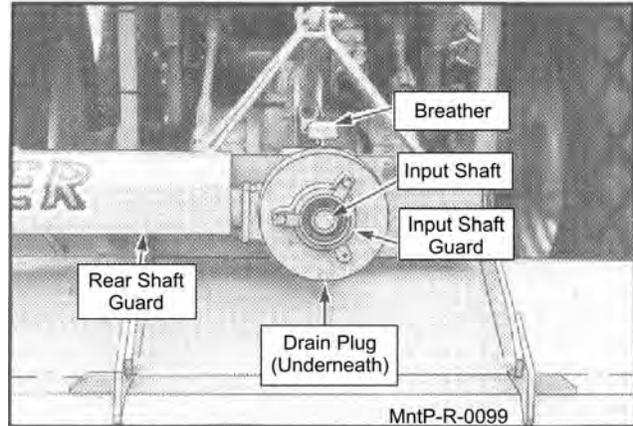

# MAINTENANCE

## Flail Blades Inspection



Inspect the Blades daily for abnormal wear. REPLACE ALL BLADES on the carrier IMMEDIATELY if any blades have:

- Become bent or deformed from its original shape, or
- Wear inside the blade bolt hole, or
- Any cracks are visible, or
- Deep gouges in the blade's surface are present, or
- Gouges or chipped areas in the cutting edge are larger than 1/4"(8mm), or
- The material on the leading edge has been worn away by more than 1/4"(8mm)

**DO NOT** straighten, sharpen, weld or hard-face blades

Failure to replace worn or damaged blades may lead to catastrophic failure of the blades and ejection of the broken part with tremendous force which may cause serious bodily injury or death.

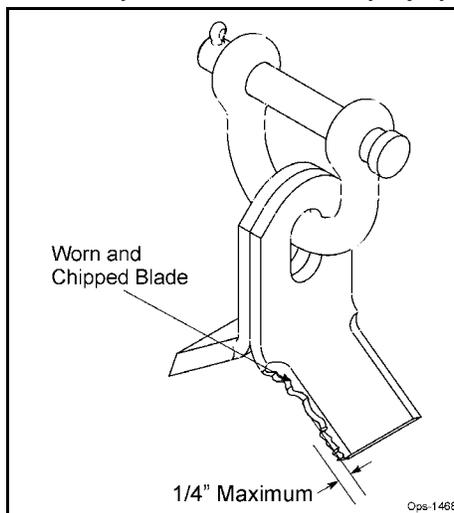

Always replace blades in sets

- Blades that are damaged may indicate severe service or abuse. If one blade is worn or damaged other blades on the same shaft will have been subjected to the same severe service or abuse.
- The Flail rotor turns at speeds exceeding 2000 RPM and is dynamically balanced at the factory. Differences in blade weight between used blades with loss of material from gouges or wear as compared to new blades can cause severe vibration and damage to the Flail rotor. Always replace blades as complete sets.

### Important

Use only genuine Alamo Industrial replacement blades and fasteners. Other blades and fasteners may not meet the Alamo Industrial requirements and could fail during operation resulting in part being thrown out from under the mower.



Never attempt to sharpen blades. OPS-U-0044

# MAINTENANCE

## Blade Pins and D-Ring Inspection

Inspect Blade Pins and D-Rings daily for wear or damage as follows:



Inspect the Blade pins and D-Rings daily for abnormal wear. Make sure the cotter pins are in place and properly spread. REPLACE BLADE Pins and D-Rings IMMEDIATELY if they have:

- Visible cracks or
- If a Pin or D-Ring has visible worn areas, or
- If a Pin or D-Ring has gouges or chipped areas

Failure to replace abnormally worn pins or D-Rings may lead to catastrophic failure and ejection of the broken part, which may cause serious bodily injury or death.

Always replace the pins and D-Rings whenever excessive wear is noticed.

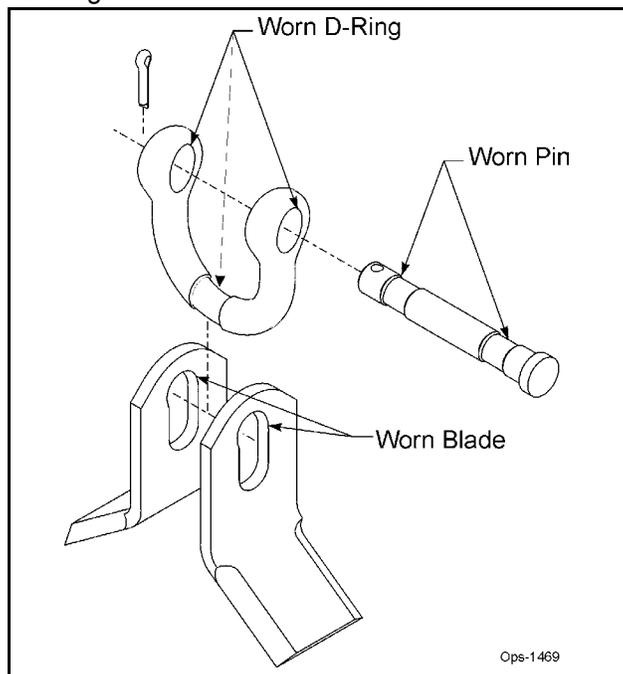

### Important

If the cotter pins are broken by contact with other flail blades, remove the pin and reverse the direction the pin is inserted through the D-Ring so that the cotter pin is on the opposite side of the D-Ring. This will prevent the next set of blades from swinging back and hitting the cotter pin. OPS-U-0045

# MAINTENANCE

## Flail Axe Blades Inspection



Inspect the Blades daily for abnormal wear. REPLACE ALL BLADES on the carrier IMMEDIATELY if any blades have:

- Become bent or deformed from its original shape, or
- Oval shape wear inside the blade bolt hole, or
- Any cracks are visible, or
- Deep gouges in the blade's surface are present, or
- Gouges or chipped areas in the cutting edge are larger than 1/4"(8mm), or
- The material on the leading edge has been worn away by more than 1/4"(8mm)

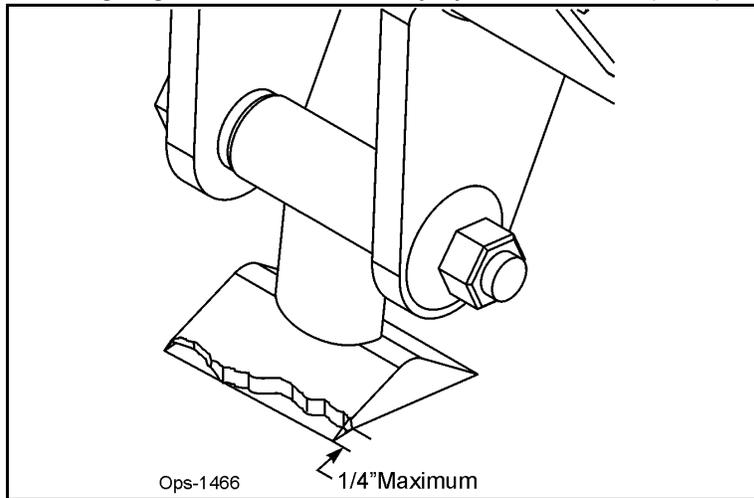

Failure to replace worn or damaged blades may lead to catastrophic failure of the blades and ejection of the broken part with tremendous force which may cause serious bodily injury or death.

Always replace blades in sets

- Blades that are damaged may indicate severe service or abuse. If one blade is worn or damaged other blades on the same shaft will have been subjected to the same severe service or abuse.
- The Flail Axe rotor turns at speeds exceeding 2000 RPM and is dynamically balanced at the factory. Differences in blade weight between used blades with loss of material from gouges or wear, as compared to new blades, can cause severe vibration and damage to the Flail Axe rotor. Always replace blades as complete sets.



Use only genuine Alamo Industrial replacement blades, blade bolts and fasteners. Other blades and bolts may not meet the requirements of Alamo Industrial and may fail during operation, resulting in the part failing and being thrown out from under the mower.



Never attempt to sharpen blades. OPS-U-0042

# MAINTENANCE

## Flail Axe Blade Bolt Inspection

Inspect Blade Bolts daily for wear or damage as follows:



Inspect the Blade Bolt daily for abnormal wear. REPLACE ALL BLADE BOLTS on the carrier IMMEDIATELY if any bolts have:

- Visible cracks or
- If the blade bolt is worn or any recessed area is visible on the bolt, or
- If Blade Bolt has gouges or chipped areas. or
- If Bushing fits loose in the Rotor Shaft.

Failure to replace abnormally worn bolts or bushings may lead to catastrophic failure of the blades and ejection of the broken part, which may cause serious bodily injury or death.

Always replace Blade Bolts with new bolts and new bushings whenever replacing the Blades. To tighten bolts and nuts, first apply thread lock to nut. Make sure to tighten bolts and nuts just enough to allow the blades to swing freely and not bend the cuttershaft lugs. If cuttershaft lugs are bent together because of over tightening the blades will not swing freely. OPS-U-0043

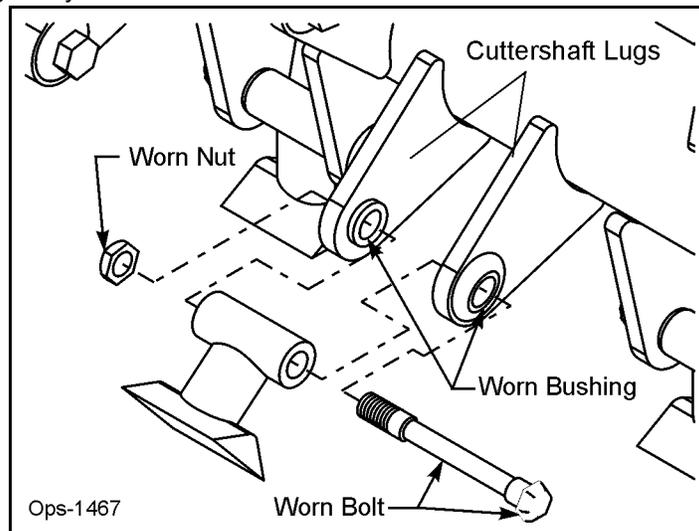

## 50" FLAIL KNIFE BLADE REPLACEMENT

1. If knives are damaged or badly worn, they will need to be replaced as a set. Replacing a single knife can cause severe vibration and possible damage to the mower. The knife should not be welded on for any reason.
2. Always replace the knife bolts when replacing the knives. **DO NOT REUSE THE KNIFE BOLTS OR NUTS.**
3. Assemble knives, bushings, bolts and nuts as shown in Parts Section of the manual.
4. Install the locking hex nut so that the flat face of the nut is towards the knife.
5. Apply Loctite 271 or equivalent to threads.
6. Torque nut to 50 ft. lbs. Knife must swing freely.

# MAINTENANCE



**DO NOT re-use the locking hex nuts for mounting the knives. If hex nut becomes loose, or required removal for knife replacement or any other reason, it must be discarded and replaced with a new nut.**

## 63" BOOM FLAIL KNIFE REPLACEMENT

1. If knives are damaged or badly worn, they will need to be replaced as a set. Replacing a single knife can cause severe vibration and possible damage to the mower.
2. Assemble knives, clevis, bolts and nuts as shown in Parts Section of manual.
3. Install locking hex nut so that the flat face of nut is towards the knife.
4. Apply Loctite 271 or equivalent to threads.
5. Torque nut to 35 FT. LBS. Knife must swing freely.



**DO NOT re-use the locking hex nuts for mounting the knives. If hex nut become loose, or require removal for knife replacement or any other reason, they must be discarded and replaced with new nuts.**



**Knives should not be welded on for any reason.**

## STANDARD OR HEAVY DUTY SIDE OR REAR FLAIL KNIFE REPLACEMENT

1. If knives are damaged or badly worn, they will need to be replaced as a set. Replacing a single knife can cause severe vibration and possible damage to the mower.
2. Assemble knives, clevis, bolts and nuts as shown in Parts Section of manual.
3. Install locking hex nut so that the flat face of nut is towards the knife.
4. Apply Loctite 271 or equivalent to threads.
5. Torque nut to 35 FT. LBS. Knife must swing freely.



**DO NOT re-use the locking hex nuts for mounting the knives. If hex nut become loose, or require removal for knife replacement or any other reason, they must be discarded and replaced with new nuts.**



**Knives should not be welded on for any reason.**





# MAINTENANCE

**PAGE INTENTIONALLY LEFT BLANK**

**MAINTENANCE**

# MAINTENANCE

## CUTTERSHAFT BEARING REPLACEMENT

1. Remove existing cuttershaft, bearings and string guards.
2. Make sure that the end knives on each end of the cuttershaft are oriented as shown.
3. Apply anti-seize on cuttershaft as shown on next page.
4. Install non-drive side bearing first.
5. Install the top of the string guard on the non-drive side first. Use Loctite-271 or equivalent and torque (95 ft-lb or 104ft-lb if you use an extension).
6. Install the bearing and top string guard on the drive side.
7. Center the cuttershaft between the string guards. Use Loctite-271 or equivalent and torque (95ft-lb or 104ft-lb if you use an extension) the top string guard on the drive side.
8. Install, use Loctite-271 or equivalent, and torque (95ft-lb or 104ft-lb if you use an extension) the bottom string guard on both sides.
9. Make sure the cuttershaft is centered. On the non-drive side, tighten one set-screw in the bearing onto the cuttershaft.
10. Remove the other set screw and drill a 5/16" hole into the cuttershaft 3/16" deep through the hole in the bearing. BE CAREFUL NOT TO DAMAGE THE THREADS IN THE BEARING HOLE.
11. Replace the set screw in the bearing, use Loctite-271 or equivalent, and tighten onto the cuttershaft through the new hole.
12. Remove the other set screw and repeat the drilling procedure (Step 10). Replace the set screw as stated in Step 11.
13. Repeat steps 9 through 12 on the drive side.
14. Grease both bearings properly.

**See illustration on next page**

# MAINTENANCE

MAINTENANCE

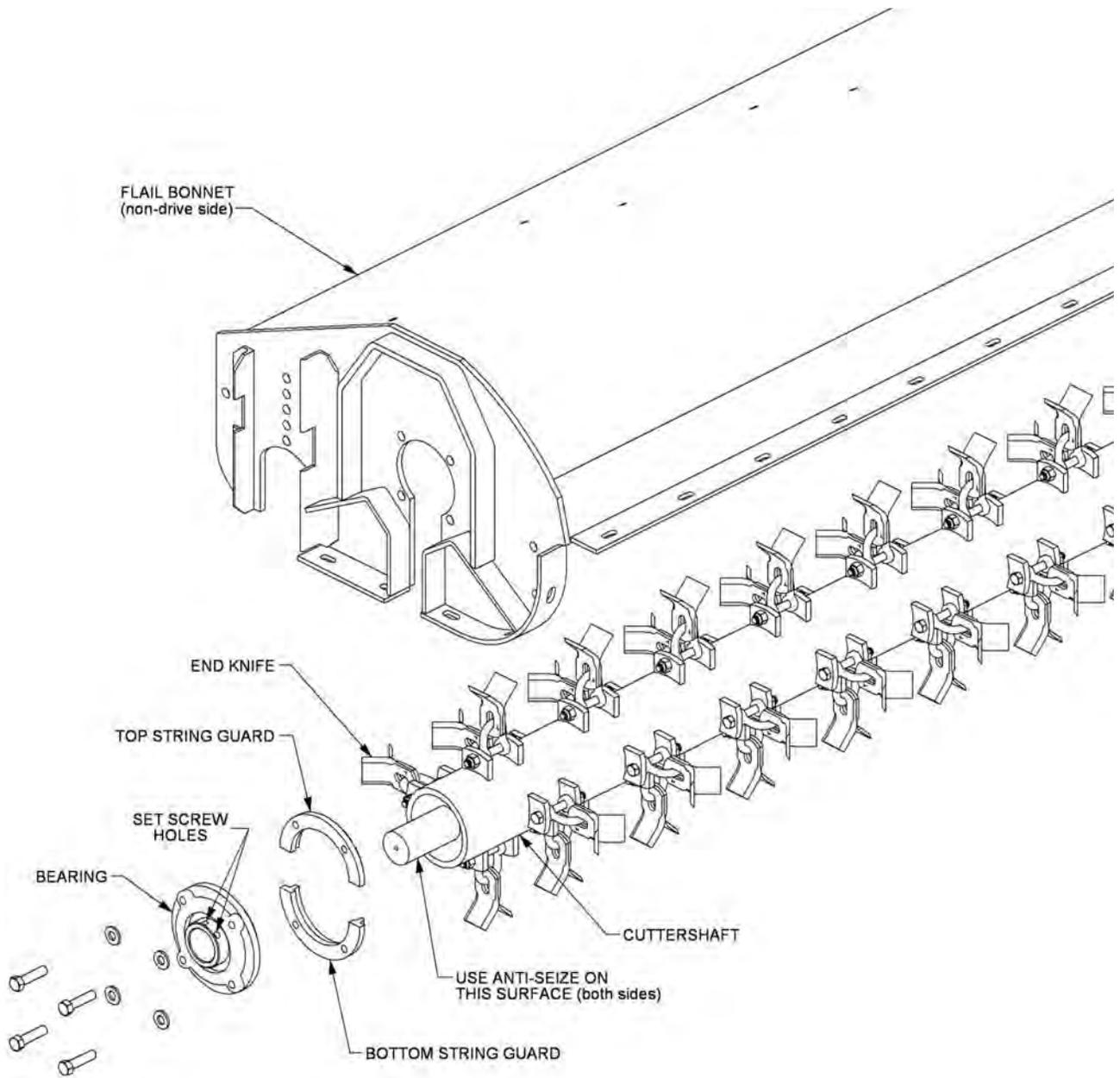

Side and Rear Flail

Maintenance Section 4-31

# MAINTENANCE

MAINTENANCE

## DAILY MAINTENANCE SCHEDULE

The following services should be performed daily or every 8 hours of service, following the detailed maintenance instructions in the operator's manual.

- \_\_\_\_\_ Pump Drive Shaft: Check for end play in driveshaft / coupler and lubricate at zerks.
- \_\_\_\_\_ Crankshaft adapter: If equipped with rubber grommets check condition, replace if missing or damaged.
- \_\_\_\_\_ Pivot points: Inject grease until it appears at ends.
- \_\_\_\_\_ Hydraulic fittings: Check for leaks with paper or cardboard. Tighten fittings or replace hoses immediately.
- \_\_\_\_\_ Knives: Inspect for missing or damaged knives, change (only complete sets) as needed.
- \_\_\_\_\_ Belts: Check/Tighten/Replace belts as needed.
- \_\_\_\_\_ Main Frame/Deck: Unless otherwise specified retorque bolts according to torque specifications in this section.
- \_\_\_\_\_ Hydraulic Fluid Level: Add, if required, per fluid recommendations.
- \_\_\_\_\_ Rear Flail Drive, Bearing Flange and Shaft Couplers (if applicable): Grease as instructed in the detailed maintenance section.
- \_\_\_\_\_ Cutter Shaft and Ground Roller: Grease as instructed in the detailed Maintenance Section.

Service performed by: \_\_\_\_\_ Date: \_\_\_/\_\_\_/\_\_\_ Hour

Meter: \_\_\_\_\_

Maintenance Section

\*\*This page may be copied and used as part of the daily maintenance routine.

# PARTS SECTION

# PART NAME INDEX

RCTVUQTFGT&I 'I W&G	5
VTCEVQT'O QWP V'MK	6
VTCEVQT'O QWP V'MK/'J [ FTCWN&U	8
VTCEVQT'O QWP V'MK/'\ GTQ'URQQN	:
VTCEVQT'O QWP V'MK/'\ GTQ'URQQN/'J [ FTCWN&U	32
ECDNG*O CP WCN+N&H'XCNXG'4'URQQN	34
4'URQQN'ECDNG'EQP VTQN'UVC P F	36
ECDNG*O CP WCN+N&H'XCNXG'DTGCMF QY P '28724273	38
DCVVGIT[ 'TGNQECVIQP	3:
RWO R'F T&G UJ CHV'DTGCMF QY P	42
Y J GGN'URCEGT	43
P QVGLU	44

## PARTS ORDERING GUIDE

The following instructions are offered to help eliminate needless delay and error in processing purchase orders for the equipment in this manual.

1. The Parts Section is prepared in logical sequence and grouping of parts that belong to the basic machine featured in this manual. Part Numbers and Descriptions are given to help locate the parts and quantities required.
2. The Purchase Order must indicate the **Name and Address** of the person or organization ordering the parts, **who should be charged**, and if possible, the **serial number of the machine** for which the parts are being ordered.
3. The purchase order must clearly list the **quantity of each part**, the complete and correct **part number**, and the basic **name of the part**.
4. The manufacturer reserves the right to substitute parts where applicable.
5. Some parts may be unlisted items which are special production items not normally stocked and are subject to special handling. Request a quotation for such parts before sending a purchase order.
6. The manufacturer reserves the right to change prices without prior notice.

NOTE: When ordering replacement decals, refer to the part numbers and descriptions listed in the safety section in the front of this manual.

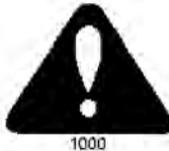

For maximum safety and to guarantee optimum product reliability, always use genuine **Tiger** replacement parts. The use of inferior replacement parts may cause premature or catastrophic failure which could result in serious injury or death.

Direct any questions regarding parts to:

**Tiger Corporation**  
3301 N. Louise Ave.  
Sioux Falls, SD 57107  
1-800-843-6849  
1-605-336-7900

# TRACTOR MOUNT KIT

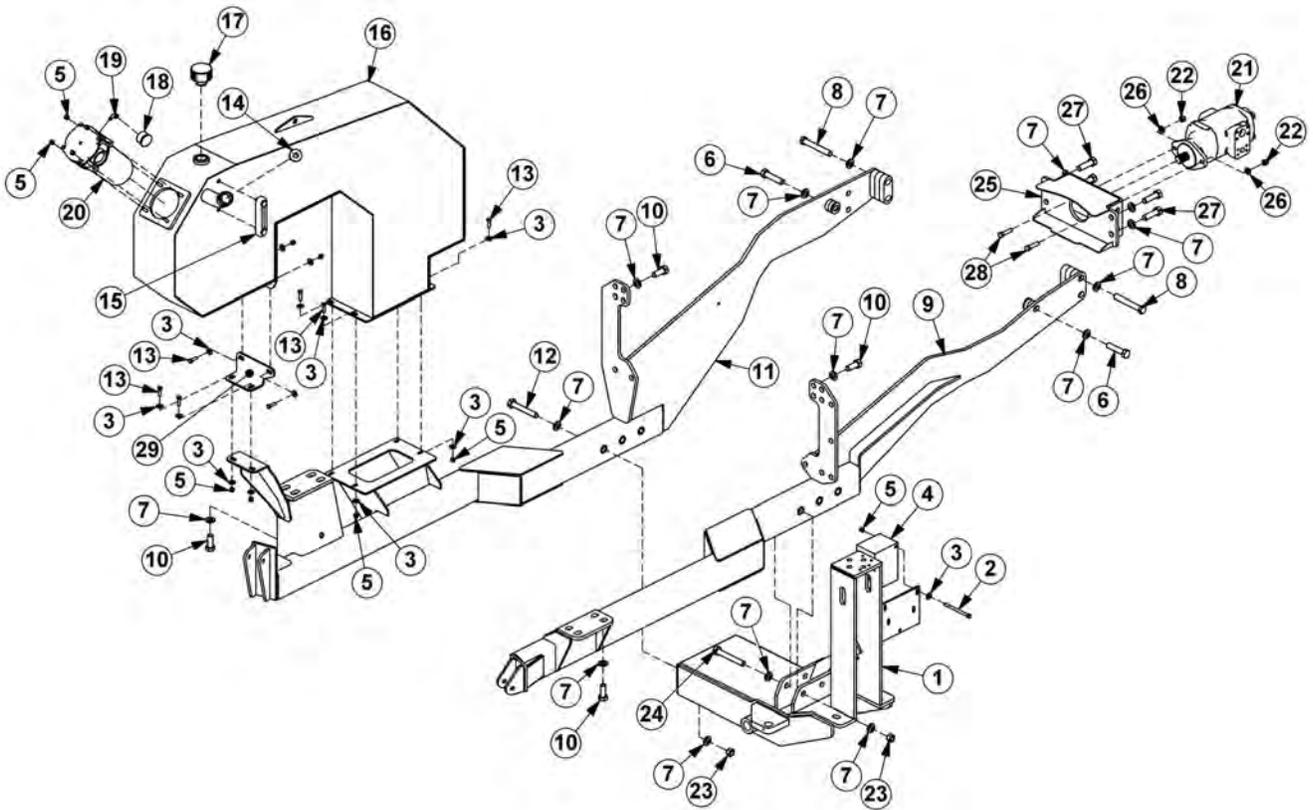



## TRACTOR MOUNT KIT

Continued...

ITEM	PART NO.	QTY.	DESCRIPTION
1	06300236	1	MAIN FRAME,JD6XXXD
2	21644	2	CAPSCREW,3/8" X 5",NC
3	22016	6	FLATWASHER,3/8"
4	06510083	1	VALVE,BRAKE
5	21627	18	NYLOCK NUT,3/8",NC
6	30708	2	CAPSCREW,20MM X 90MM,2.5P
7	33880	38	FLATWASHER,3/4"
8	06530542	4	CAPSCREW,20MM X 130MM,2.5P
9	06300234	1	AXLE BRACE,RIGHT
10	31731	20	CAPSCREW,20MM X 50MM,2.5P
11	06300278	1	AXLE BRACE,LEFT
12	21842	3	CAPSCREW,3/4" X 5",NC
13	21631	8	CAPSCREW,3/8" X 1-1/4",NC
14	06505127	1	PLUG,#20 SAE
15	06505067	1	SIGHT GLASS
---	06503175	1	KIT,SEAL,SIGHT GLASS
16	06700091	1	TANK,WHEEL WELL
17	06505077	1	CAP,BREATHER
18	6T0649	1	FILTER GAUGE
19	TF4888	1	STREET ELBOW,1/8"
20	06505044	1	ASSY,FILTER,IN-TANK
21	23438	1	PUMP
22	21727	2	NYLOCK NUT,1/2",NC
23	21825	6	HEX NUT,3/4",NC
24	6T2309	3	CAPSCREW,3/4" X 5-1/2",NC
25	06380061	1	MOUNT,PUMP
26	06533004	2	FLATWASHER,1/2",SAE
27	25341	4	CAPSCREW,16MM X 70MM
28	21733	2	CAPSCREW,1/2" X 2",NC
29	06412310	1	BRACKET, WHEEL WELL TANK

## TRACTOR MOUNT KIT - HYDRAULICS

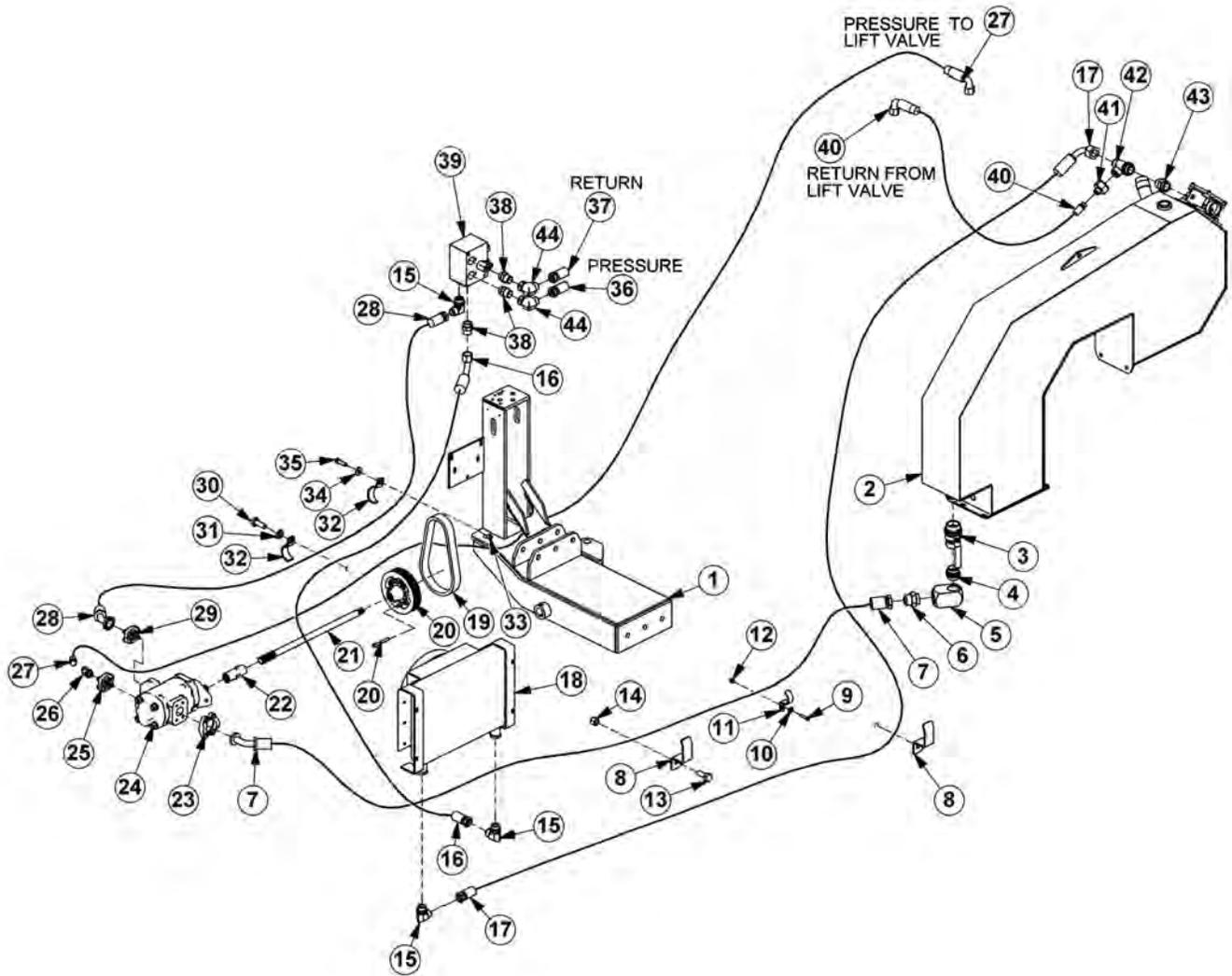

ITEM	PART NO.	QTY.	DESCRIPTION
1	06300236	1	MAINFRAME
2	06700213	1	TANK, HYDRAULIC, WHEEL WELL
3	34309	1	BALL VALVE, 1 - 1/2" FOR
4	06503083	1	ADAPTER, 1-1/2" ORB X 1-1/2" ORB
5	06503084	1	ELBOW, 1-1/2" FB X 1-1/2" FB
6	34710	1	ADAPTER, 1-1/2" ORB X 1-1/2" MJ
7	06500746	1	HOSE, 2" X 107

JD6XXXD SIDE FLAIL

## TRACTOR MOUNT KIT - HYDRAULICS

Continued...

ITEM	PART NO.	QTY.	DESCRIPTION
8	32382	2	BRACKET,HOSE
9	21632	1	CAPSCREW,3/8" X 1-1/2", NC
10	22016	1	FLATWASHER,3/8"
11	06411136	1	BRACKET,HOSE
12	21627	1	NYLOCK NUT,3/8", NC
13	21832	1	CAPSCREW,3/4" X 2", NC
14	21827	1	NYLOCK NUT,3/4", NC
15	34117	3	ELBOW,1"MB X 1"MJ,FORGED
16	06500243	1	HOSE,1" X 97"
17	06400812	1	HOSE,1" X 197"
18	-----	1	COOLER,FRONT MNT ASSEMBLY
19	T208891	1	JOHN DEERE BELT
20	LVB24989	1	JOHN DEERE PULLEY KIT
21	06420116	1	DRIVE SHAFT
22	6T0375B	1	COUPLING
23	TF4854	1	KIT,FLANGE #24
24	23438	1	PUMP
25	06503174	1	KIT,FLANGE,#12
26	06503198	1	ELBOW,3/4" MJ X 12FL45°
27	06500811	1	HOSE,1" X 182"
28	06500744	1	HOSE,1" X 71"
29	TF4852	1	KIT,FLANGE,#20
30	30708	1	CAPSCREW,20MM X 90MM, 2.5P
31	33880	1	FLATWASHER,3/4"
32	TB3012	2	CLAMP,CROSSOVER TUBE
33	21727	1	NYLOCK NUT,1/2", NC
34	22018	1	FLATWASHER,1/2",WIDE
35	21732	1	CAPSCREW,1/2" X 1- 3/4" NC
36	06500684	1	HOSE,1" X 96"
37	06500683	1	HOSE,1" X 93"
38	33555	3	ADAPTER,1"MB X 1"MJ
39	06510083	1	BRAKE VALVE
40	06500496	1	HOSE,3/4" X 50"
41	35280	1	ADAPTER, 1-1/4"FJ X 3/4" MJ
42	34656	1	TEE,RUN,1-1/4" ORB X 1-1/4" MJ X 1-1/4"
43	34067	1	ADAPTER,1-1/4" MOR X 1-1/4" MJ
44	33259	2	ELBOW,1" MJ X 1" FJX 90°

JD6XXXD SIDE FLAIL

# TRACTOR MOUNT KIT - ZERO SPOOL

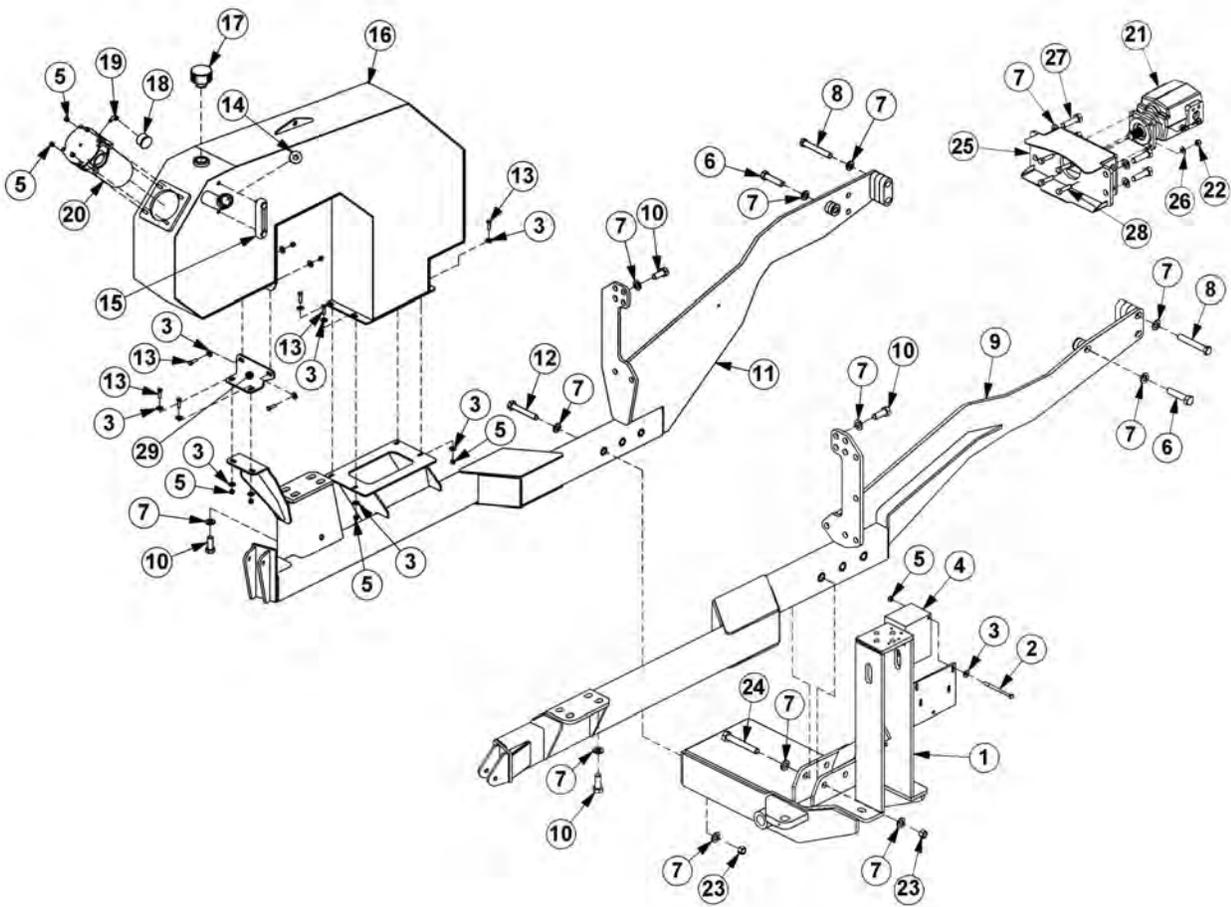

## TRACTOR MOUNT KIT - ZERO SPOOL

Continued...

ITEM	PART NO.	QTY.	DESCRIPTION
1	06300236	1	MAIN FRAME,JD6XXXD
2	21644	2	CAPSCREW,3/8" X 5",NC
3	22016	6	FLATWASHER,3/8"
4	06510083	1	VALVE,BRAKE
5	21627	8	NYLOCK NUT,3/8",NC
6	30708	2	CAPSCREW,20MM X 90MM,2.5P
7	33880	38	FLATWASHER,3/4"
8	06530542	4	CAPSCREW,20MM X 130MM,2.5P
9	06300234	1	AXLE BRACE,RIGHT
10	31731	20	CAPSCREW,20MM X 50MM,2.5P
11	06300278	1	AXLE BRACE,LEFT
12	21842	3	CAPSCREW,3/4" X 5",NC
13	21639	2	CAPSCREW,3/8" X 3-1/4",NC
14	06505127	1	PLUG,#20 SAE
15	06505067	1	SIGHT GLASS
---	06503175	1	KIT,SEAL,SIGHT GLASS
16	06700213	1	TANK,WHEEL WELL
17	06505077	1	CAP,BREATHER
18	6T0649	1	FILTER GAGE
19	TF4888	1	STREET ELBOW,1/8"
20	06505044	1	ASSY,FILTER,IN-TANK
21	23152	1	PUMP
22	21727	4	NYLOCK NUT,1/2",NC
23	21825	6	HEX NUT,3/4",NC
24	6T2309	3	CAPSCREW,3/4" X 5-1/2",NC
25	06380061	1	MOUNT,PUMP
26	06533004	4	FLATWASHER,1/2",SAE
27	25341	4	CAPSCREW,16MM X 70MM
28	21733	4	CAPSCREW,1/2" X 2",NC
29	06412310	1	BRACKET, WHEEL WELL TANK



## TRACTOR MOUNT KIT ZERO SPOOL - HYDRAULICS

Continued...

ITEM	PART NO.	QTY.	DESCRIPTION
1	---	1	MAIN FRAME * REFER TO TRACTOR MOUNT KIT
2	06700213	1	TANK, HYDRAULIC, WHEEL WELL
3	06503084	1	ELBOW, 1-1/2" FOR X 1-1/2" FOR
4	06503083	1	ADAPTER, 1-1/2" MOR X 1-1/2" MOR
5	34309	1	BALL VALVE, 1-1/2" FOR
6	34710	1	ADAPTER, 1-1/2" MOR X 1-1/2" MJ
7	----	1	AXLE BRACE, LH * REFER TO TRACTOR MOUNT KIT
8	32382	2	BRACKET, HOSE
9	21632	1	CAPSCREW, 3/8" X 1-1/2", NC
10	22016	1	FLATWASHER, 3/8"
11	06411136	1	BRACKET, HOSE
12	21627	1	NYLOCK NUT, 3/8", NC
13	21832	1	CAPSCREW, 3/4" X 2", NC
14	21827	1	NYLOCK NUT, 3/4", NC
15	06500680	1	HOSE, 1-1/2" X 107"
16	TF4852	2	KIT, FLANGE, #20
17	23152	1	PUMP
18	6T0375B	1	COUPLING
19	06420166	1	DRIVE SHAFT
20	BLV10679	1	JOHN DEERE PULLEY KIT
21	----	-	JOHN DEERE BELT (EXISTING)
22	06500274	1	HOSE, 1" X 74"
23	30708	1	CAPSCREW, 20MM X 90MM, 2.5P
24	33880	1	FLATWASHER, 3/4"
25	TB3012	2	CLAMP, HOSE
26	21727	1	NYLOCK NUT, 1/2", NC
27	22018	1	FLATWASHER, 1/2"
28	21732	1	CAPSCREW, 1/2" X 1-3/4"
29	34117	1	ELBOW, 1" MOR X 1" MJ
30	33554	1	ELBOW, 1" MOR X 1" MJ, 45°
31	06510083	1	BRAKE VALVE
32	33555	2	ADAPTER, 1" MOR X 1" MJ
33	33259	2	ELBOW, 1" MOR X 1" FJX90
34	06500683	1	HOSE, 1" X 96" (RETURN)
35	06500684	1	HOSE, 1" X 93 (PRESSURE)
36	---	1	AXLE BRACE, RH * REFER TO TRACTOR MOUNT KIT
37	06500747	1	HOSE, 1" X 115"
38	34064	1	ADAPTER, 1-1/4" MOR X 1" MJ

JD6XXXD SIDE FLAIL





## CABLE (MANUAL) LIFT VALVE 2 SPOOL

Continued...

ITEM	PART NO.	QTY.	DESCRIPTION
1	06502185	1	VALVE,2SP
2	06340033	1	VALVE MNT
3	34622	1	PLATE,VALVE,REAR MNT
4	21632	6	CAPSCREW,3/8" X 1-1/2",NC
5	6T2615	4	WASHER,FENDER,3/8"
6	21627	10	NYLOCK NUT,3/8",NC
7	21630	4	CAPSCREW,3/8" X 1",NC
8	22016	4	FLATWASHER,3/8"
9	06505100	2	CBL,CNTRL,108"
10	6T4411	2	CLEVIS,CBL CTRL,3/16"
11	6T3017	2	ROLLPIN,3/16" X 1"
12	21500	4	HEX NUT,1/4",NF
14	33271	3	ADAPTER,1/2"MOR X 3/8"MJ
15	33562	1	HOSE,1/4" X 130"
16	33364	2	HOSE,1/4" X 120"
20	06500811	1	HOSE,3/4" X 182"
21	06503023	2	ADAPTER
22	06500496	1	HOSE, 3/4" X 50"

## 2 SPOOL CABLE CONTROL STAND

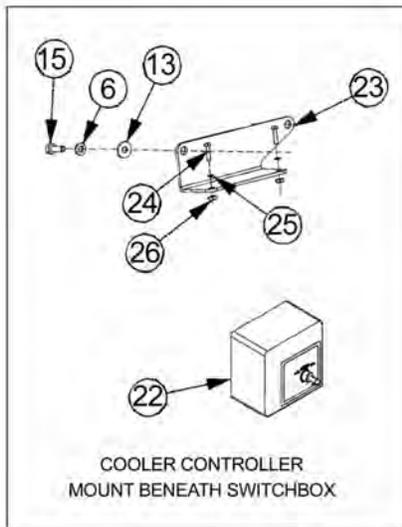
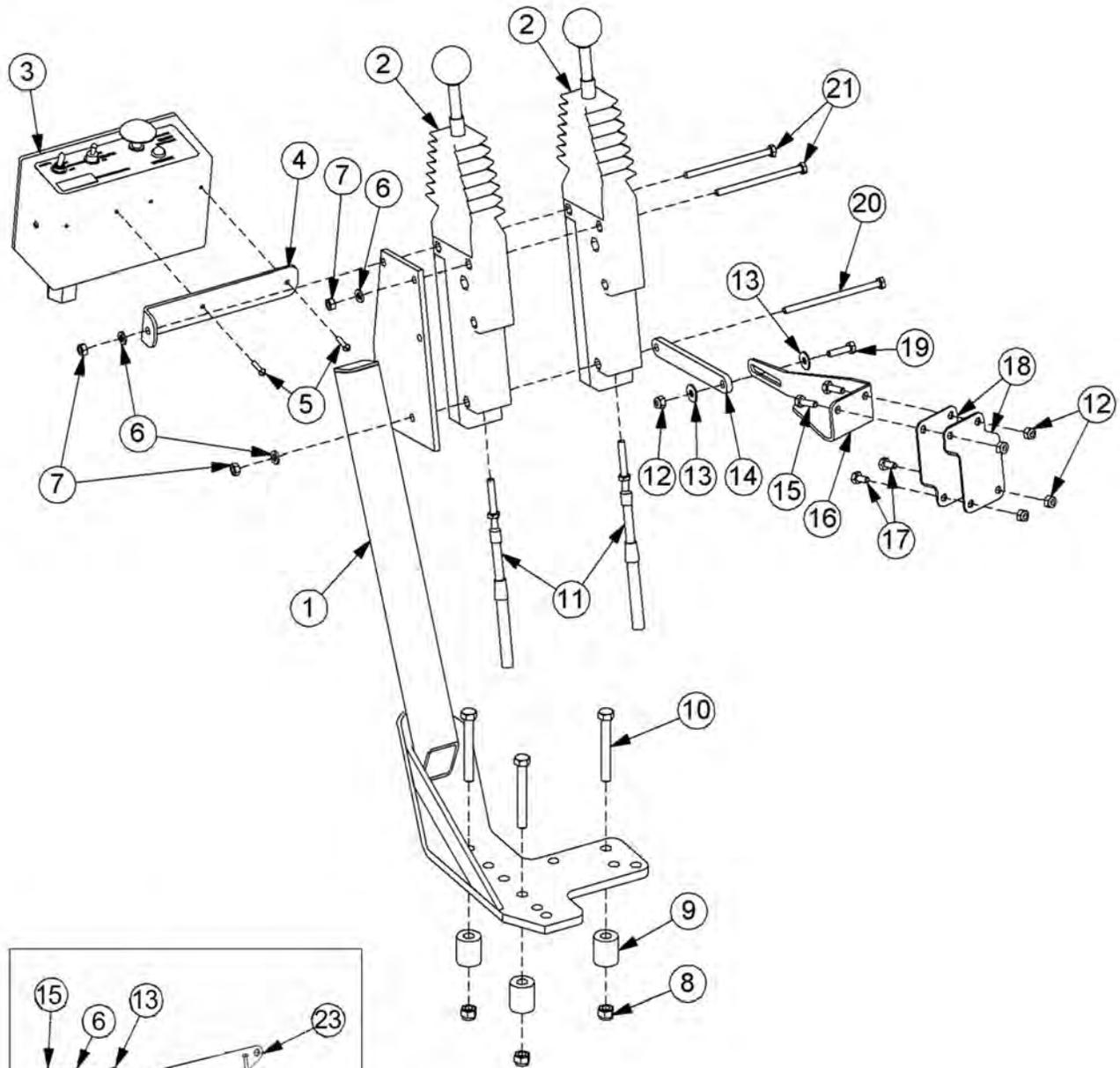

## 2 SPOOL CABLE CONTROL STAND

Continued...

ITEM	PART NO.	QTY.	DESCRIPTION
1	23865B	1	BRKT,CTRL,CBL
2	6T1251	2	CBL CTRL BOX,180 DEG
3	06510102	1	SWITCH BOX,SIDE
4	34496	1	BRKT,SWITCH BOX
5	6T3951	2	SCREW,MACHINE,8-32 X 1/2"
6	21986	3	LOCKWASHER,1/4"
7	21525	3	HEX NUT,1/4",NC
8	21627	3	NYLOCK NUT,3/8",NC
9	27082B	3	SPACER
10	21636	3	CAPSCREW,3/8" X 2-1/2",NC
11	06505100	2	CBL,CNTRL,108"
12	21527	5	NYLOCK NUT,1/4",NC
13	22014	2	FLATWASHER,1/4"
14	06402045	1	SUPPORT,STAND
15	21529	2	CAPSCREW,1/4" X 3/4",NC
16	06411087	1	BRKT,STABILIZER
17	21528	2	CAPSCREW,1/4" X 1/2",NC
18	06411086	2	BRKT,MNT
19	21530	1	CAPSCREW,1/4" X 1",NC
20	21544	1	CAPSCREW,1/4" X 4-1/2",NC
21	21542	2	CAPSCREW,1/4" X 4",NC
22	06510045	1	CONTROLLER, COOLER FAN
23	06411407	1	BRACKET, CONTROLLER
24	32359	2	SCREW, MACHINE, 8-32 X 3/4"
25	32360	2	LOCKWASHER, #8
26	32361	2	HET NUT #8

CABLE (MANUAL) LIFT VALVE BREAKDOWN 06502051

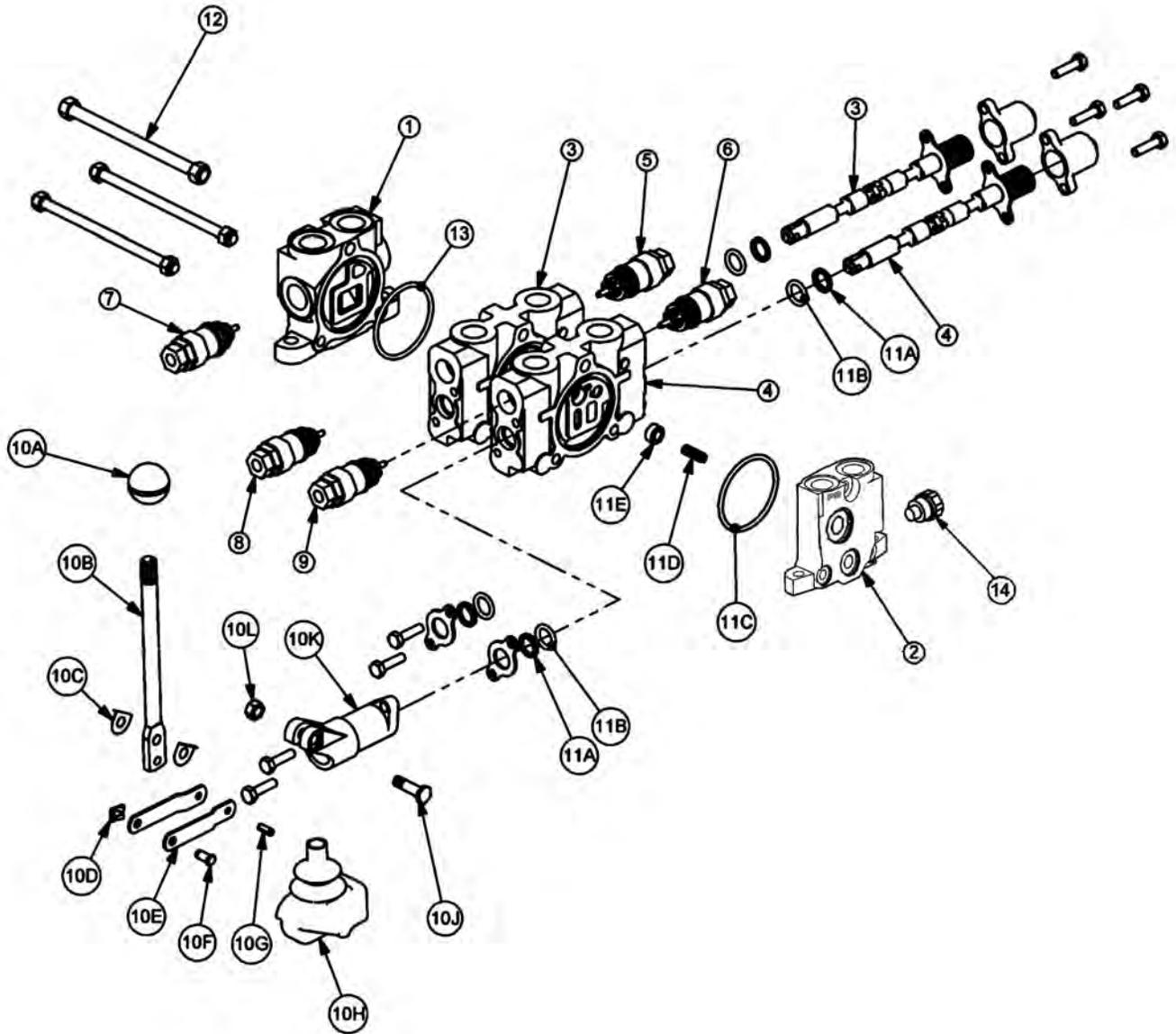

## CABLE (MANUAL) LIFT VALVE BREAKDOWN 06502051

Continued...

ITEM	PART NO.	QTY.	DESCRIPTION
1	06502149	1	INLET END COVER
2	06502150	1	END COVER,OPEN CENTER
3	TB1017P	1	VALVE SECTION (SINGLE ACTING,SPRING DETENT)
4	06502091	1	VALVE SECTION (DOUBLE ACTING,CENTER SPRING)
5	N/A	-	N/A
6	31861	1	RELIEF VALVE, 360 PSI
7	TB1017E	1	RELIEF VALVE, 2250 PSI
8	TB1017M	1	SHUT-OFF PLUG
9	TB1017M	1	SHUT-OFF PLUG
10	TB1017L	2	LEVER KIT (FOR ONE SECTION)
10A	-----	1	LEVER KNOB
10B	-----	1	LEVER
10C	-----	2	LEVER WASHER
10D	-----	1	LEVER CLIP
10E	-----	2	LINKAGE
10F	-----	1	LEVER PIN
10G	-----	1	ROLL PIN
10H	-----	1	LEVER BOOT
10J	-----	1	LEVER BOLT
10K	-----	1	LEVER DUST COVER
10L	-----	1	LEVER NUT
11	TB1017A	2	VALVE SEAL KIT (FOR ONE SECTION)
11A	-----	2	WIPER
11B	-----	2	O-RING SMALL
11C	-----	2	O-RING LARGE
11D	-----	1	SPRING
11E	-----	1	PUCKET
12	TB1017X	1	TIE ROD KIT
13	24214	1	O-RING, LARGE
14	TB1017M	1	PLUG, RELIEF PORT

# BATTERY RELOCATION

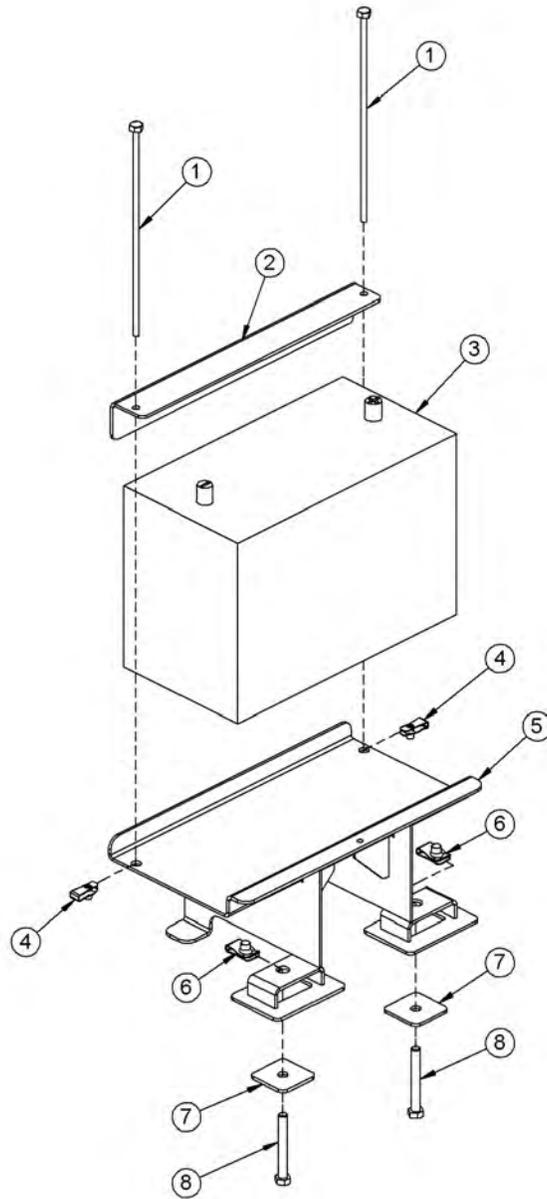

## BATTERY RELOCATION

Continued...

ITEM	PART NO.	QTY.	DESCRIPTION
1	06530234	2	CAPSCREW,1/4" X 10",NC
2	06411429	1	ANGLE
3	-----	-	BATTERY *EXISTING PART
4	35176	2	NUT CLIP,1/4",NC
5	06370231	1	RELOCATION BRACKET
6	06537029	2	NUT CLIP,3/8",NC
7	06401784	2	SQUARE PLATE
8	21638	2	CAPSCREW,3/8" X 3",NC





# WHEEL SPACER

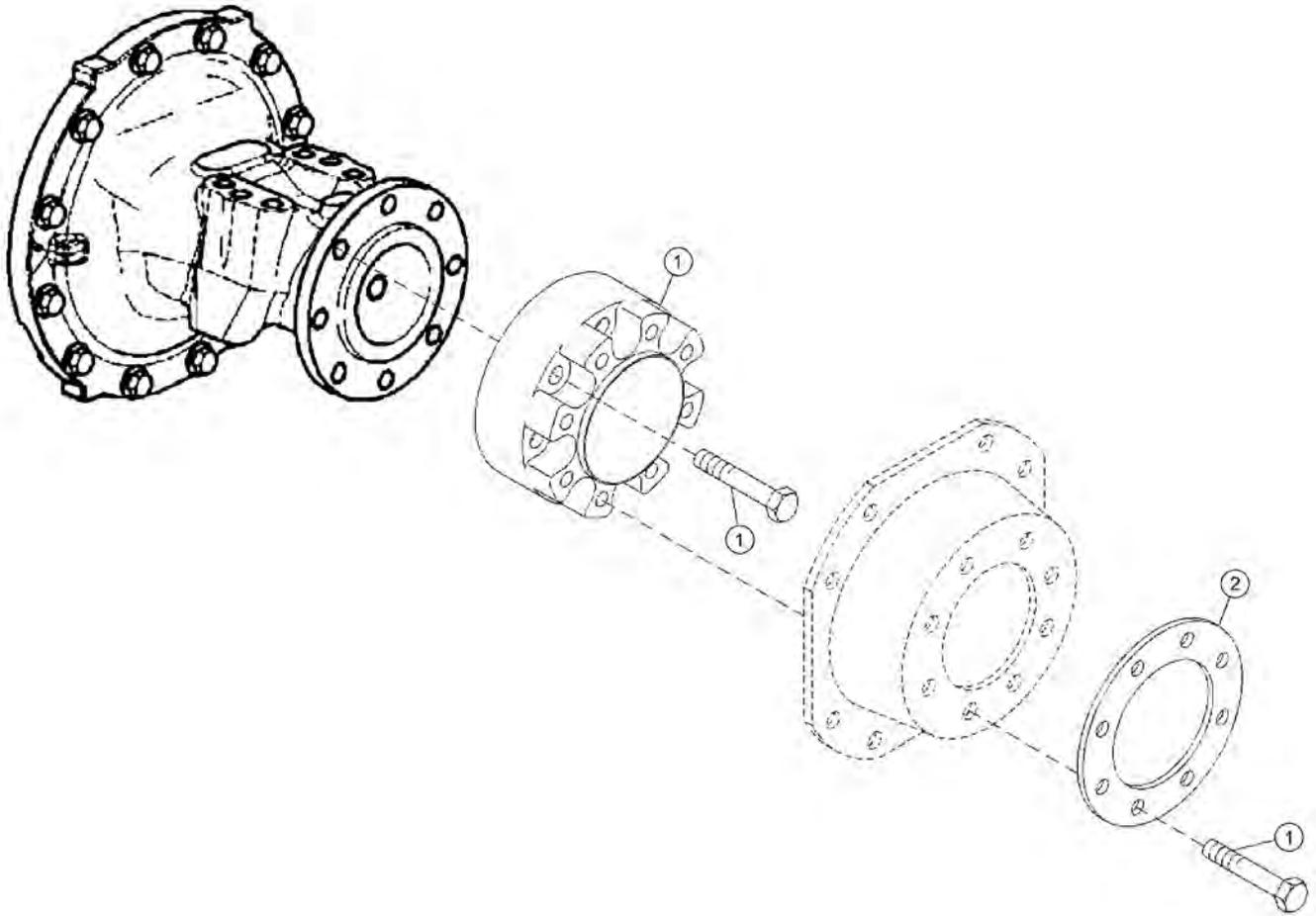

ITEM	PART NO.	QTY.	DESCRIPTION
1	06770025	1	KIT,SPCR,WHL,JD
2	06400919	1	RING,SPACER,WHEEL,JD

JD6XXXD SIDE FLAIL

**NOTES**

**NOTES**

# COMMON SIDE FLAIL - EXTREME DUTY

## PARTS SECTION

## NOTES

# PART NAME INDEX

PARTS ORDERING GUIDE.....	5
CABLE DRAFT BEAM ASSEMBLY.....	6
COMBO DRAFT BEAM ASSEMBLY.....	8
60IN CABLE SIDE FLAIL - STANDARD ROTATION.....	10
60IN CABLE SIDE FLAIL - REVERSE ROTATION.....	12
60IN COMBO SIDE FLAIL - STANDARD ROTATION.....	14
60IN COMBO SIDE FLAIL - REVERSE ROTATION.....	16
75IN CABLE SIDE FLAIL - STANDARD ROTATION.....	18
75IN CABLE SIDE FLAIL - REVERSE ROTATION.....	20
75IN COMBO SIDE FLAIL - STANDARD ROTATION.....	22
75IN COMBO SIDE FLAIL - REVERSE ROTATION.....	24
90IN CABLE SIDE FLAIL - STANDARD ROTATION.....	26
90IN CABLE SIDE FLAIL - REVERSE ROTATION.....	28
90IN COMBO SIDE FLAIL - STANDARD ROTATION.....	30
90IN COMBO SIDE FLAIL - REVERSE ROTATION.....	32
FRONT FLAP - STANDARD ROTATION MOWERS.....	34
CABLE SIDE FLAIL DRIVE ASSEMBLY.....	36
COMBO SIDE FLAIL DRIVE ASSEMBLY.....	38
CABLE LIFT ARM ASSEMBLY.....	40
3IN X 10IN HYDRAULIC CYLINDER BREAKDOWN.....	42
3IN X 12IN HYDRAULIC CYLINDER BREAKDOWN.....	43
3IN X 18IN HYDRAULIC CYLINDER BREAKDOWN.....	44
PUMP AND GRILL GUARD OPTIONS.....	45
RESERVOIR TANK FILTER ASSEMBLY.....	46
CABLE (MANUAL) LIFT VALVE BREAKDOWN - 30198.....	48
CABLE (MANUAL) LIFT VALVE BREAKDOWN - 31320.....	50
CABLE (MANUAL) LIFT VALVE BREAKDOWN - 31322.....	52
CABLE (MANUAL) LIFT VALVE BREAKDOWN - 31752.....	54
CABLE (MANUAL) LIFT VALVE BREAKDOWN - 06502040.....	56
CABLE (MANUAL) LIFT VALVE BREAKDOWN - 06502042.....	58
FRONT HYDRAULIC PUMP BREAKDOWN.....	60
FLAIL MOTOR BREAKDOWN.....	62
COOLER ASSEMBLY.....	64
BRAKE VALVE ASSEMBLY.....	66
BRAKE VALVE HYDRAULIC SCHEMATIC.....	67
SIDE FLAIL TRAVEL LOCK.....	68
CABLE LIFT BEAM TRAVEL LOCK.....	69
COMBO LIFT BEAM TRAVEL LOCK.....	70
SWITCH BOX.....	71
SWITCH BOX SCHEMATIC.....	72

COMMON SIDE FLAIL - XD

## PART NAME INDEX

FIRE SUPPRESSION SYSTEM.....	73
FIRE SUPPRESSION 3-POINT MOUNT.....	74
FIRE SUPPRESSION FRONT MOUNT.....	76
FIRE SUPPRESSION SYSTEM ELECTRICAL SCHEMATIC.....	78
WETCUT.....	79
WETCUT 50 GALLON TANK - 3PNT MOUNT.....	80
WETCUT 100 OR 150 GALLON TANK - 3PNT MOUNT.....	81
WETCUT 3PNT PLUMBING - 50IN MOWERS.....	82
WETCUT 3PNT PLUMBING - LARGE MOWERS.....	84
WETCUT FRONT PLUMBING - 50IN MOWERS.....	86
WETCUT FRONT PLUMBING - LARGE MOWERS.....	88
WETCUT 50IN SPRAYER HEAD ASSEMBLY.....	90
WETCUT 60IN SPRAYER HEAD ASSEMBLY.....	92
WETCUT CABLES.....	94

## PARTS ORDERING GUIDE

The following instructions are offered to help eliminate needless delay and error in processing purchase orders for the equipment in this manual.

1. The Parts Section is prepared in logical sequence and grouping of parts that belong to the basic machine featured in this manual. Part Numbers and Descriptions are given to help locate the parts and quantities required.
2. The Purchase Order must indicate the **Name and Address** of the person or organization ordering the parts, **who should be charged**, and if possible, the **serial number of the machine** for which the parts are being ordered.
3. The purchase order must clearly list the **quantity of each part**, the complete and correct **part number**, and the basic **name of the part**.
4. The manufacturer reserves the right to substitute parts where applicable.
5. Some parts may be unlisted items which are special production items not normally stocked and are subject to special handling. Request a quotation for such parts before sending a purchase order.
6. The manufacturer reserves the right to change prices without prior notice.

NOTE: When ordering replacement decals, refer to the part numbers and descriptions listed in the safety section in the front of this manual.

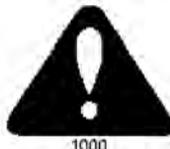

For maximum safety and to guarantee optimum product reliability, always use genuine **Tiger** replacement parts. The use of inferior replacement parts may cause premature or catastrophic failure which could result in serious injury or death.

Direct any questions regarding parts to:

**Tiger Corporation**  
3301 N. Louise Ave.  
Sioux Falls, SD 57107  
1-800-843-6849  
1-605-336-7900

# CABLE DRAFT BEAM ASSEMBLY

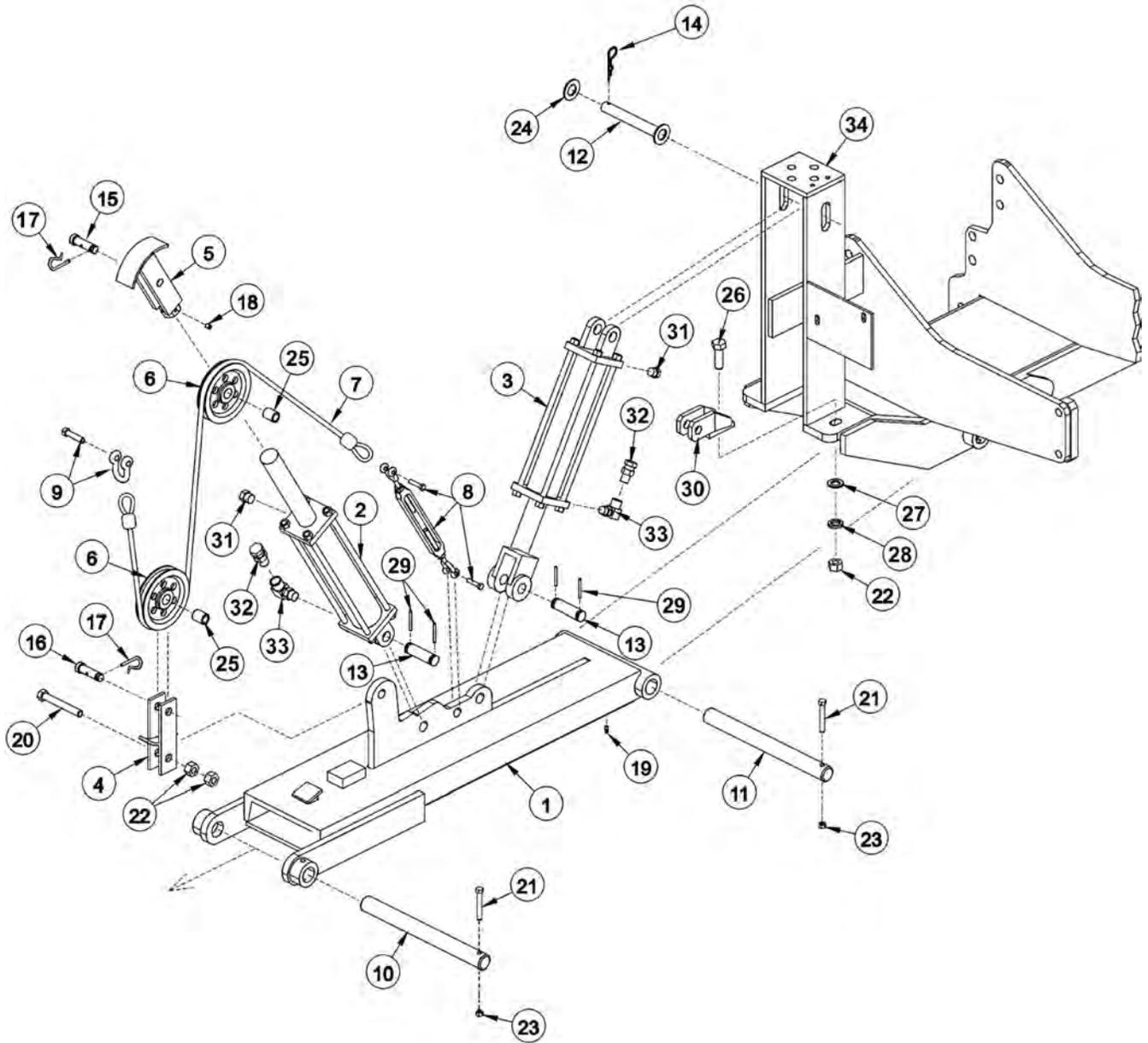

COMMON SIDE FLAIL - XD



## CABLE DRAFT BEAM ASSEMBLY

Continued...

ITEM	PART NO.	QTY.	DESCRIPTION
1	6T0103E	-	DRAFT BEAM (EXTENDED 6" 4WD)
-----	6T0105	-	DRAFT BEAM (STD WITH TRAVEL LOCK)
-----	6T0108	-	DRAFT BEAM (30 LB CHANNEL, 45 3/8")
2	6T0150	1	CYLINDER 3" X 18"
3	6T0151R	1	HYD. CYLINDER 3" X 10"
4	6T0100	1	LOWER SHEAVE BRACKET
5	6T0101	1	UPPER SHEAVE BRACKET
6	33768	2	SHEAVE
7	6T0110	1	LIFT CABLE (STD 1/2" X 87 1/2")
-----	6T0110E	-	LIFT CABLE (EXTENDED 6" 4WD)
-----	6T0110L	-	LIFT CABLE (EXTENDED 15")
8	6T0115	1	TURN BUCKLE
9	6T0112	1	SHACKLE WITH PIN
10	6T2999	1	OUTER DRAFT BEAM PIN 1 1/2" X 14 1/2"
11	6T3001	1	INNER DRAFT BEAM PIN 1 1/2" X 15 3/4"
12	6T3005	1	CYLINDER PIN 1" X 6 5/8"
13	TB1033	2	CLEVIS PIN 1" X 4"
14	6T3004	1	R - CLIP 3/16"
15	6T3010	1	UPPER SHEAVE PIN WITH ZERK 3/4" X 3"
16	6T3009	1	LOWER SHEAVE PIN WITH ZERK 3/4" X 2 1/2"
17	6T3020	2	R - CLIP 5/32"
18	6T2272	1	SET SCREW 3/8" X 1/2"
19	6T3211	1	GREASE ZERK 1/8" STRAIGHT
20	21837	1	CAPSCREW 3/4" X 3 1/4"
21	21688	2	CAPSCREW 7/16" X 3 1/4"
22	21825	2	HEX NUT 3/4"
23	21677	2	NYLOCK NUT 7/16"
24	22023	1	FLAT WASHER 1"
25	6T0104N	2	SHEAVE PIN BUSHING 1" OD X 3/4" ID
26	21833	1	CAPSCREW 3/4" X 2 1/4"
27	22021	1	FLAT WASHER 3/4"
28	21993	1	LOCK WASHER 3/4"
29	06537021	4	ROLL PIN
30	6T0106	1	TRAVEL LOCK BRACKET
31	6T4258	2	BREATHER 1/2"
32	34396	2	RESTRICTOR
33	34244	2	ELBOW FITTING 1/2"
34	-----	-	MAIN FRAME *REFER TO TRACTOR PARTS SECTION

COMMON SIDE FLAIL - XD

# COMBO DRAFT BEAM ASSEMBLY

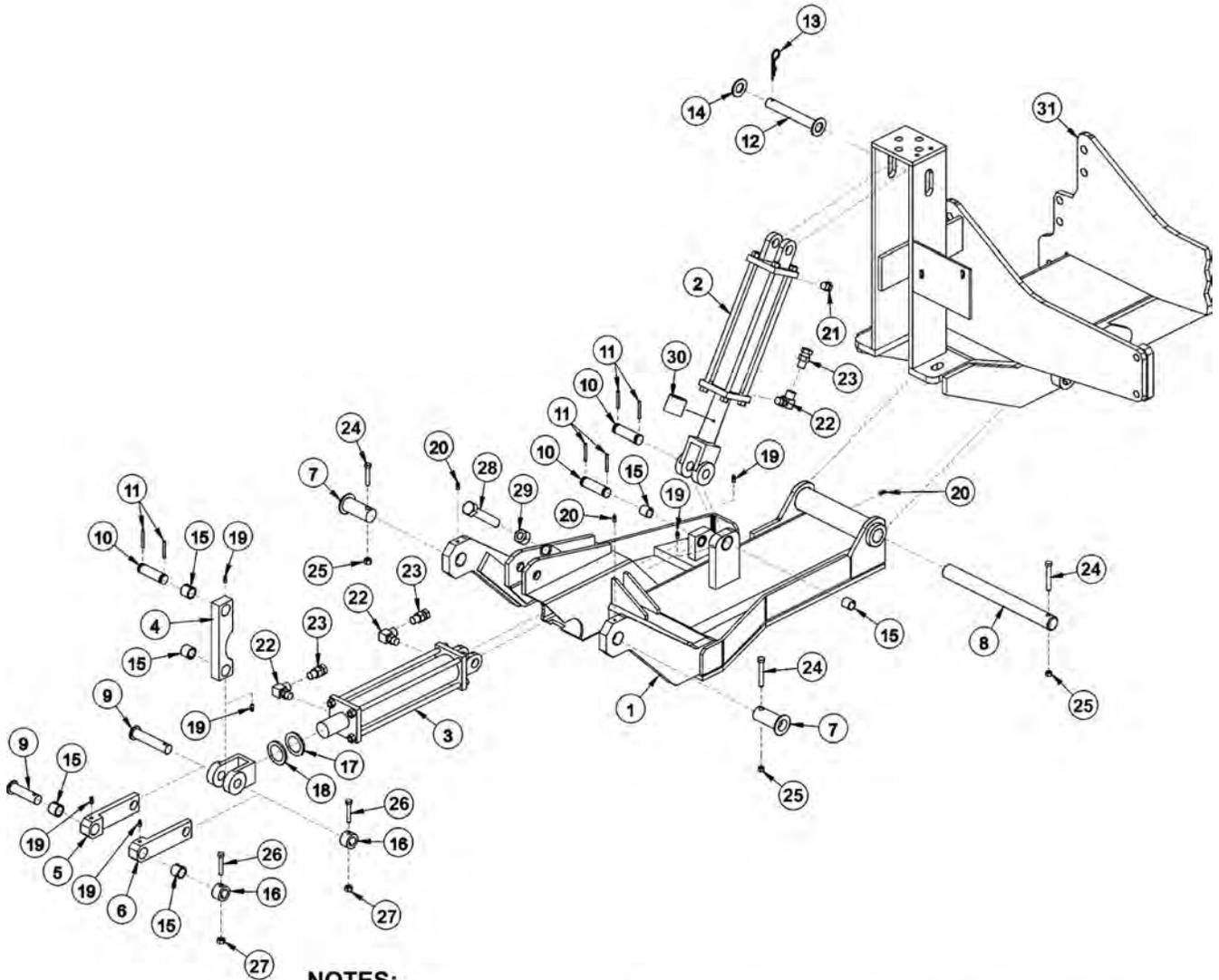

## NOTES:

1. ITEM 30 IS USED ON THE GLAND END OF ITEM 2 (AS NEEDED)
2. ORIENTATION OF ITEMS 4,5 & 6 ARE CRITICAL

## COMBO DRAFT BEAM ASSEMBLY

Continued...

ITEM	PART NO.	QTY.	DESCRIPTION
1	28955D	1	COMBO DRAFT BEAM -HVY DTY FLAIL
2	6T0151R	1	HYD. CYLINDER 3" X 10"
3	25343	1	HYD. CYLINDER 3" X 12" - HVY DTY
4	TF4500A	1	PIVOT ARM
5	TF4507B	1	RIGHT LINKAGE ARM
6	TF4506B	1	LEFT LINKAGE ARM
7	TF4514A	2	PIN, HEAD PIVOT
8	6T3001	1	PIN, BEAM PIVOT
9	TF4519	2	PIN, LINKAGE
10	TB1033	3	PIN, CLEVIS
11	06537021	6	ROLLPIN
12	6T3005	1	PIN, 1" W/ CAP
13	6T3004	1	R-CLIP HAIRPIN
14	6T2614	1	FLATWASHER 1"
15	TB3010	8	BUSHING 1"
16	22847	2	BOSS, LINKAGE PIN
17	22076	1	SPACER, HYD. CYLINDER 1/4" (AS NEEDED)
18	22077	1	SPACER, HYD. CYLINDER 5/16" (AS NEEDED)
19	6T3207	6	GREASE ZERK 1/4"
20	6T3211	3	GREASE ZERK 1/8"
21	6T4258	1	BREATHER 1/2"
22	34244	3	ELBOW FITTING 1/2"
23	34396	3	SWIVEL RESTRICTOR
24	21688	3	CAPSCREW 7/16" X 3 1/4"
25	21677	3	NYLOCK NUT 7/16"
26	21635	2	CAPSCREW 3/8" X 2 1/4"
27	21625	2	HEX NUT 3/8"
28	21831	1	CAPSCREW 3/4" X 1 3/4"
29	21825	1	HEX NUT 3/4"
30	06700095	1	CYLINDER SPACER W/SET SCREW
31	-----	-	MAIN FRAME *REFER TO TRACTOR PARTS SECTION

COMMON SIDE FLAIL - XD

## 60IN CABLE SIDE FLAIL - STANDARD ROTATION

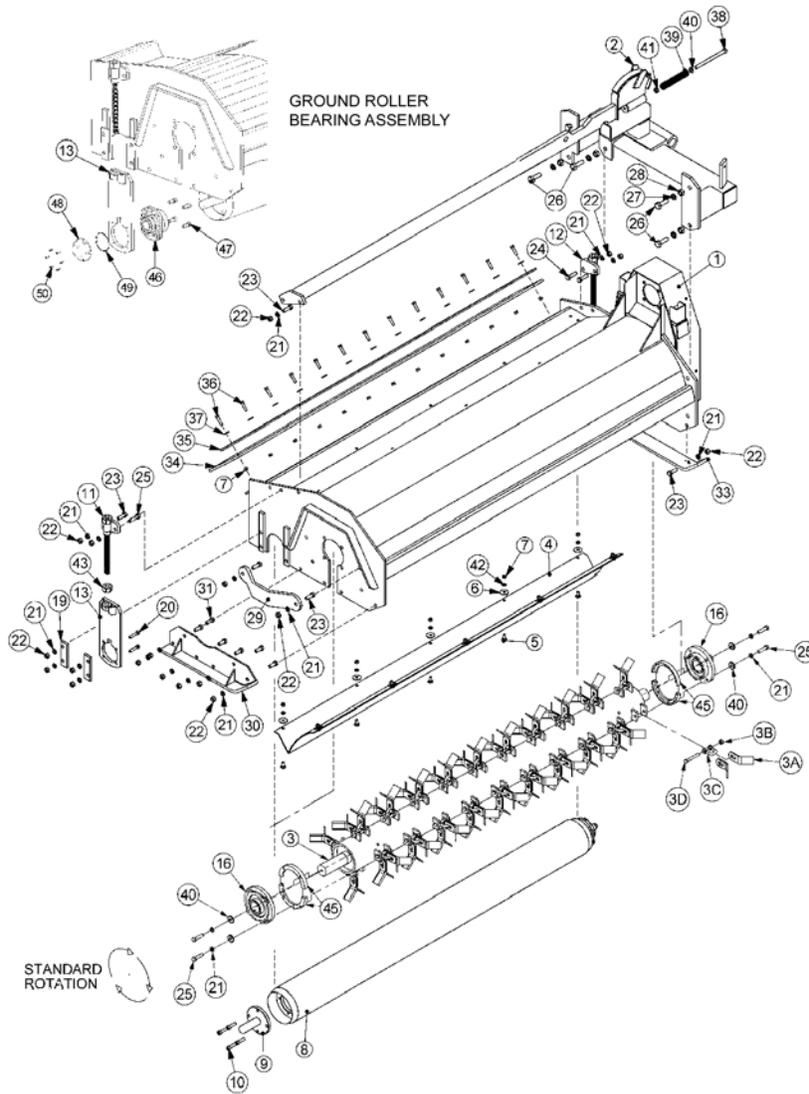

ITEM	PART NO.	QTY.	DESCRIPTION
1	22031	1	BONNET,60",HD,TSF
2	21297C	1	MOUNTING FRAME
---	TF1807A	-	CUTTERSHAFT,ASSY,60" HD
3	TF1807	1	CUTTERSHAFT,60"
3A	33714	64	KNIFE,FLAIL,STANDARD
3B	21677	32	NYLOCK NUT,7/16" NC
3C	TF1020	32	KNIFE MTG CLEVIS,FLAIL
3D	34011	32	KNIFE MTG BOLT,FLAIL
4	TF1802A	1	BAFFLE,FLAIL,60" HD,STC
5	6T2283	10	CARRIAGE BOLT,3/8" X 1",NC
6	6T2615	10	WASHER,FENDER,3/8"
7	21625	20	HEX NUT,3/8",NC

COMMON SIDE FLAIL - XD

## 60IN CABLE SIDE FLAIL - STANDARD ROTATION

Continued...

ITEM	PART NO.	QTY.	DESCRIPTION
8	30277	1	GROUND ROLLER
9	TF1045B	2	GRND ROLLER STUB SHAFT
11	TF4334	1	ROD,GROUND ROLLER ADJ,RT
12	TF4335	1	ROD,GROUND ROLLER ADJ,LF
13	TF4333A	2	GROUND ROLLER ADJ BRK
16	TF1018	2	BEARING,FLANGE,2-3/16"
19	TF4336	4	CLAMPING BLOCK,LH
20	6T2291	8	PLOW BOLT,1/2" X 2",NC
21	21990	31	LOCKWASHER,1/2"
22	21725	23	HEX NUT,1/2",NC
23	21731	6	CAPSCREW,1/2" X 1-1/2",NC
24	21732	2	CAPSCREW,1/2" X 1-3/4",NC
25	21733	9	CAPSCREW,1/2" X 2",NC
26	21783	5	CAPSCREW,5/8" X 2",NC
27	21992	5	LOCKWASHER,5/8"
28	21775	5	HEX NUT,5/8"
29	TF1040	1	GUARD,CUTTER SHAFT
30	TF4371	1	SKID SHOE,L/PROFILE - OUTER
31	21730	6	CAPSCREW,1/2" X 1-1/4",NC
33	TF4365	1	SKID SHOE,L/PROFILE - INNER
34	TF1804	1	FLAP,DEFLECTOR,TSF/TRF,60"
35	TF1803	1	FLAP RETAINING BAR
36	21632	10	CAPSCREW,3/8" X 1-1/2",NC
37	22016	10	FLATWASHER,3/8"
38	21745	1	CAPSCREW,1/2" X 7",NC
39	27005	1	SPRING, PUSHOFF,SIDE RTRY
40	27938	3	BUSHING,MACH,1OD X 1/2ID X 14GA.
41	21727	1	NYLOCK NUT,1/2"
42	21988	10	LOCKWASHER,3/8"
43	21399	2	HEX NUT,3/4" (ACME THRD)
45	31204	2	STRING GUARD,HD
46	06520028	2	BEARING,FLANGE,1-3/8"
47	6T2331	8	CAPSCREW,7/16" X 1",SOCKET HEAD
48	06520027	2	CAP,BEARING,GRND ROLLER
49	06520029	2	O-RING,2-3/4" X 3/32"
50	06530001	12	CAPSCREW,SKT HD

COMMON SIDE FLAIL - XD

## 60IN CABLE SIDE FLAIL - REVERSE ROTATION

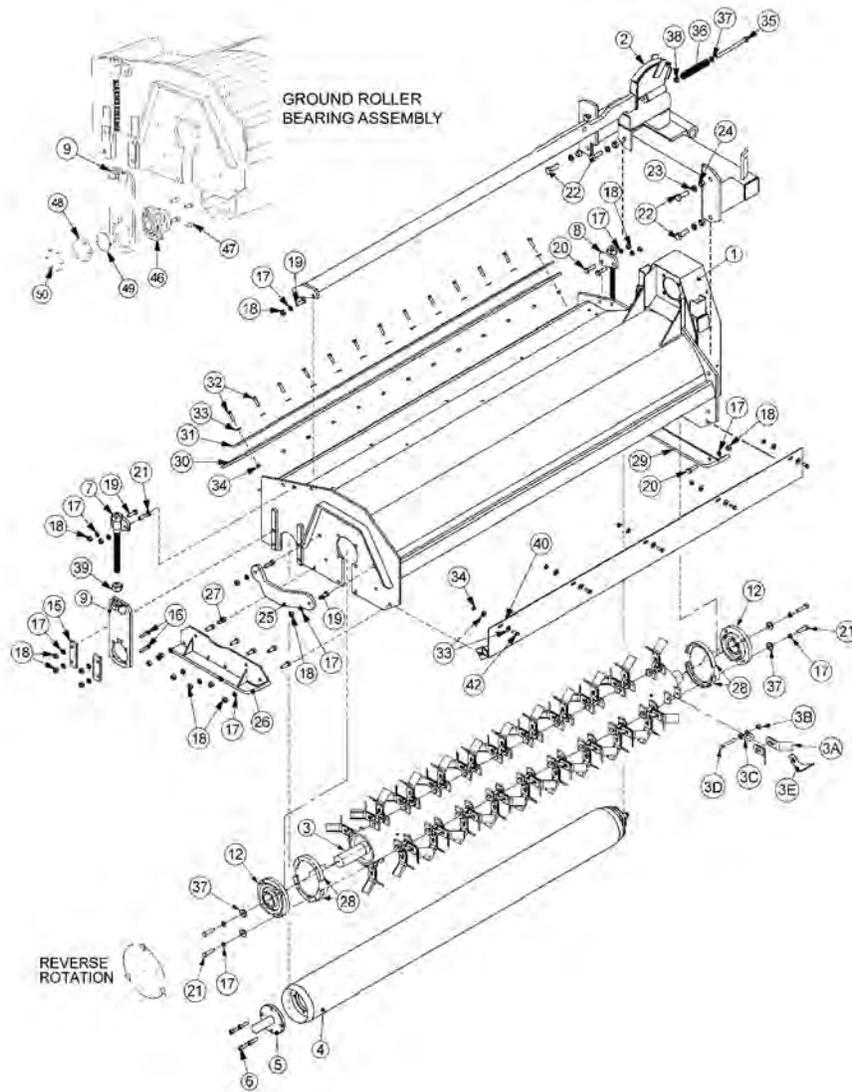

ITEM	PART NO.	QTY.	DESCRIPTION
1	22031	1	BONNET,60",HD,TSF
2	21297C	1	MOUNTING FRAME
---	TF1807A	-	CUTTERSHAFT,ASSY,60" HD
3	TF1807	1	CUTTERSHAFT,60"
3A	33714	64	KNIFE,FLAIL,STANDARD
3B	21677	32	NYLOCK NUT,7/16" NC
3C	TF1020	32	KNIFE MTG CLEVIS,FLAIL
3D	34011	32	KNIFE MTG BOLT,FLAIL
3E	TF1019F	32	KNIFE,FLAIL (SMOOTH CUT)
4	30277	1	GROUND ROLLER
5	TF1045B	2	GRND ROLLER STUB SHAFT
7	TF4334	1	ROD,GROUND ROLLER ADJ,RT

COMMON SIDE FLAIL - XD

## 60IN CABLE SIDE FLAIL - REVERSE ROTATION

Continued...

ITEM	PART NO.	QTY.	DESCRIPTION
8	TF4335	1	ROD,GROUND ROLLER ADJ,LF
9	TF4333A	2	GROUND ROLLER ADJ BRK
12	TF1018	2	BEARING,FLANGE,2-3/16"
15	TF4336	4	CLAMPING BLOCK,LH
16	6T2291	8	PLOW BOLT,1/2" X 2",NC
17	21990	31	LOCKWASHER,1/2"
18	21725	23	HEX NUT,1/2",NC
19	21731	6	CAPSCREW,1/2" X 1-1/2",NC
20	21732	3	CAPSCREW,1/2" X 1-3/4",NC
21	21733	5	CAPSCREW,1/2" X 2",NC
22	21783	5	CAPSCREW,5/8" X 2",NC
23	21992	5	LOCKWASHER,5/8"
24	21775	5	HEX NUT,5/8"
25	TF1040	1	GUARD,CUTTER SHAFT
26	TF4371	1	SKID SHOE,L/PROFILE - OUTER
27	21730	5	CAPSCREW,1/2" X 1-1/4",NC
28	31204	2	STRING GUARD,HD
29	TF4365	1	SKID SHOE,L/PROFILE - INNER
30	TF1804	1	FLAP,DEFLECTOR,TSF/TRF,60"
31	TF1803	1	FLAP RETAINING BAR
32	21632	10	CAPSCREW,3/8" X 1-1/2",NC
33	22016	20	FLATWASHER,3/8"
34	21625	15	HEX NUT,3/8",NC
35	21745	1	CAPSCREW,1/2" X 7",NC
36	27005	1	SPRING,PUSHOFF
37	27938	9	BUSHING,MACH,1OD X 1/2ID X 14GA.
38	21727	1	NYLOCK NUT,1/2"
39	21399	2	HEX NUT,3/4" (ACME THRD)
40	TF1801	1	FRONT TRASH GUARD
42	21630	5	CAPSCREW,3/8" X 1",NC
46	06520028	2	BEARING,FLANGE,1-3/8"
47	6T2331	8	CAPSCREW,7/16" X 1",SOCKET HEAD
48	06520027	2	CAP,BEARING,GRND ROLLER
49	06520029	2	O-RING,2-3/4" X 3/32"
50	06530001	12	CAPSCREW,SKT HD

COMMON SIDE FLAIL - XD

## 60IN COMBO SIDE FLAIL - STANDARD ROTATION

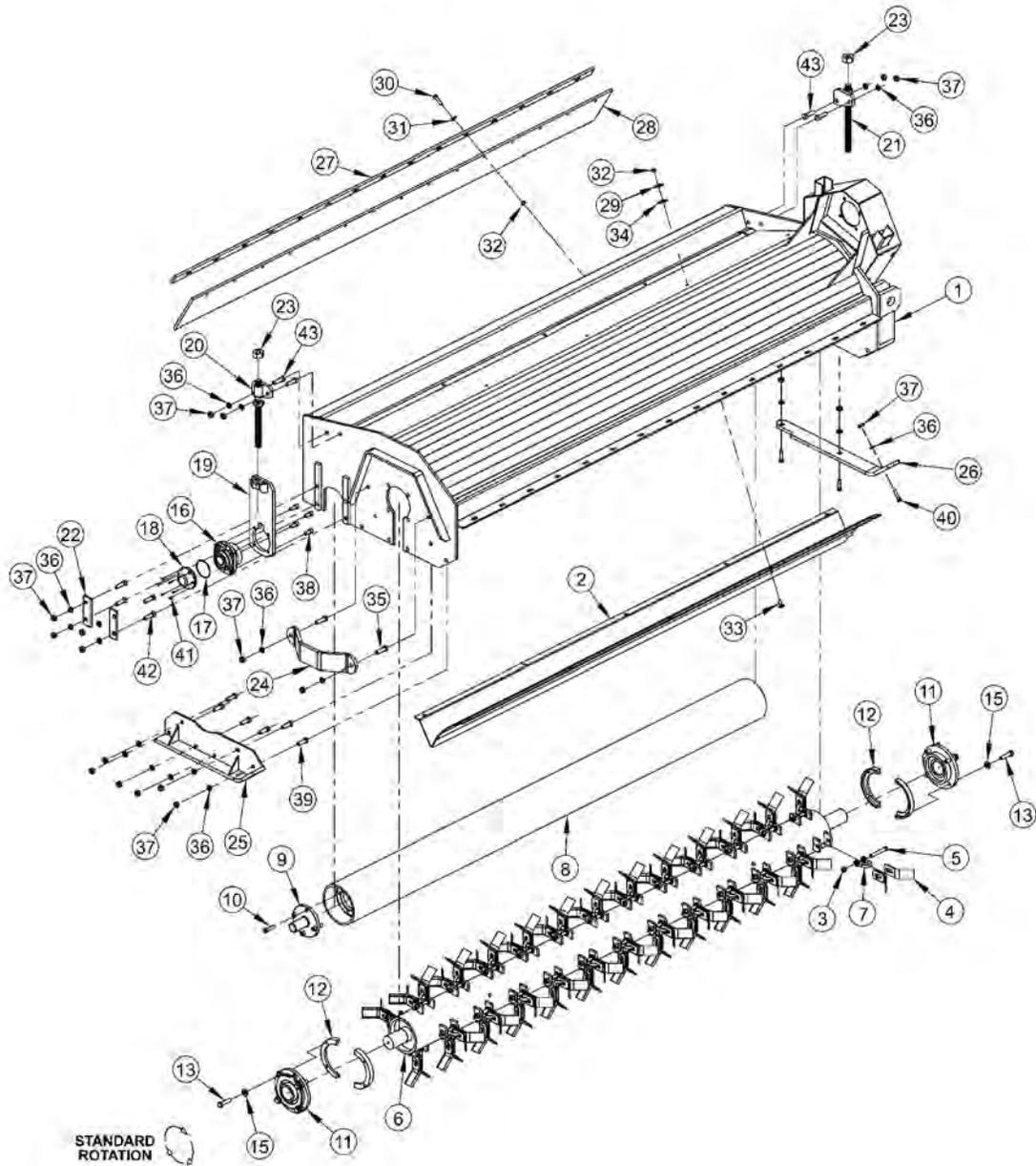

ITEM	PART NO.	QTY.	DESCRIPTION
1	33913	1	BONNET 60" COMBO
2	TF1802A	1	BAFFLE,FLAIL,60" HD,STC
---	TF1807A	1	CUTTERSHAFT,ASSY,60" HD,STC
3	21677	32	NYLOCK NUT,7/16 NC

COMMON SIDE FLAIL - XD



## 60IN COMBO SIDE FLAIL - STANDARD ROTATION

Continued...

ITEM	PART NO.	QTY.	DESCRIPTION
4	33714	64	KNIFE,FLAIL,STANDARD
5	34011	32	CAPSCREW,7/16X3 7/16,NC GR8
6	TF1807	1	CUTTERSHAFT,60" HD
7	TF1020	32	KNIFE MTG CLEVIS,FLAIL
8	30277	1	GROUND ROLLER 60"
9	TF1045B	2	STUB SHAFT,GROUND ROLLER
10	6T2330	8	CAPSCREW,SKT HD,7/16X1-1/2NC
11	TF1018	2	BEARING,FLANGE,2-3/16
---	06200347	-	STRING GUARD,KIT,HD(ITEMS 12,13,15)
12	31204	2	STRING GUARD, HD
13	06530217	8	CAPSCREW,1/2 X 2,NC,L9
15	06533006	12	FLATWASHER,1/2,SAE,L9
16	06520028	2	BEARING,FLANGE,1 3/8,GRNDRLR
17	06520029	2	O-RING,2 3/4X3/32,AS568A-148
18	06520027	2	CAP,BEARING,GRNDRLR
19	TF4333A	2	GROUND ROLLER ADJ,BRKT
20	TF4334	1	ROD,GROUND ROLLER ADJ,RT
21	TF4335	1	ROD,GROUND ROLLER ADJ,LF
22	TF4336	4	PLATE,GROUND ROLLER LOCK
23	21399	2	HEX NUT,3/4 (ACME) BULK
24	TF1040	1	GUARD,CUTTER SHAFT
25	TF4371	1	SKID SHOE,L/PROFILE-OUTER
26	23272A	1	SKID SHOE,T3F,INNER
27	TF1803	1	BAR,FLAP,TSF/TRF 60
28	TF1804	1	FLAP,DEFLECTOR,TSF 60
29	21988	8	LOCKWASHER,3/8
30	21632	10	CAPSCREW,3/8 X 1-1/2 NC
31	22016	10	FLATWASHER,3/8
32	21625	18	HEX NUT,3/8 NC
33	6T2283	8	CARRIAGE BOLT,3/8 X 1 NC
34	6T2615	8	WASHER,FENDER 3/8
35	21732	2	CAPSCREW,1/2 X 1-3/4 NC
36	21990	23	LOCKWASHER,1/2
37	21725	23	HEX NUT,1/2 NC
38	6T2331	8	CAPSCREW,SKT HD,7/16 X 1 NC
39	21730	6	CAPSCREW,1/2 X 1-1/4 NC
40	23293	3	PLOW,BOLT,1/2 X 1-3/4 NC
41	06530001	12	CAPSCREW,SKT HD,8-32X1/2,SS
42	6T2291	8	PLOW BOLT,1/2 X 2 NC GR5
43	21731	4	CAPSCREW,1/2 X 1-1/2 NC

COMMON SIDE FLAIL - XD

## 60IN COMBO SIDE FLAIL - REVERSE ROTATION

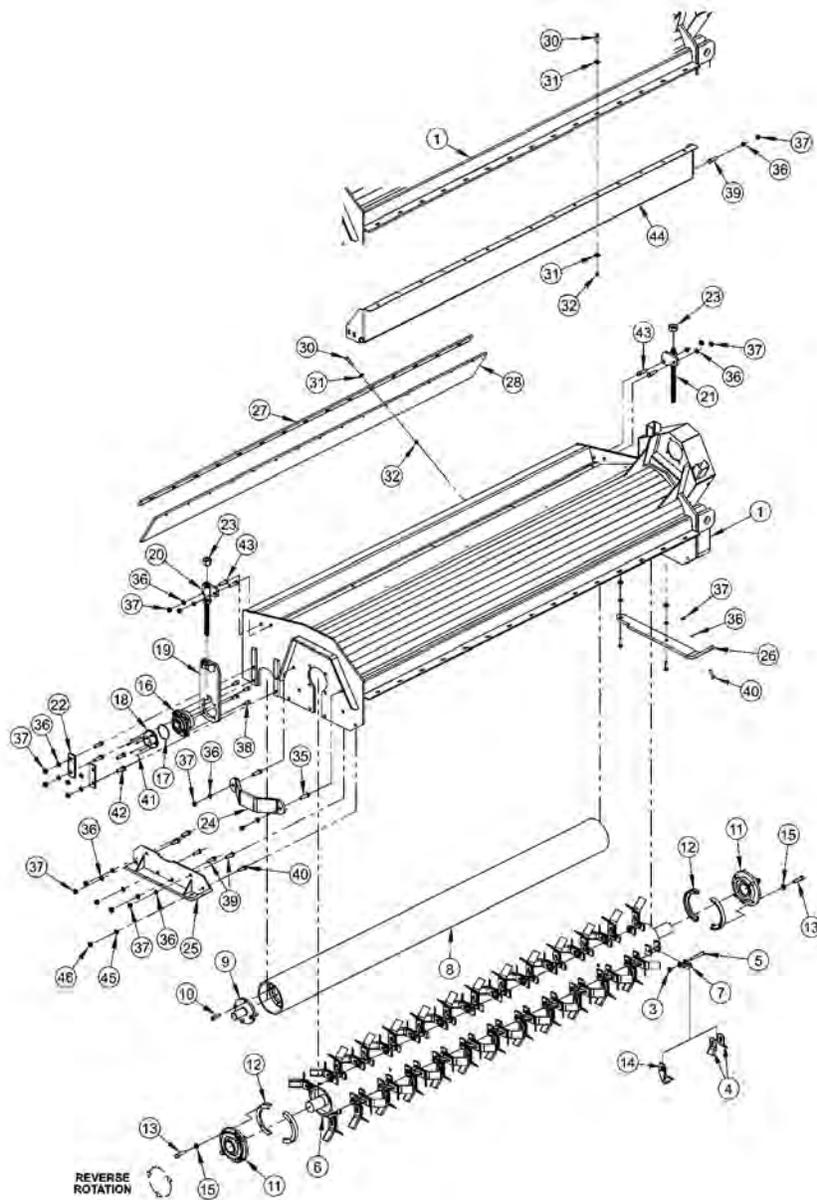

ITEM	PART NO.	QTY.	DESCRIPTION
1	33913	1	BONNET 60" COMBO
---	TF1807A	-	CUTTERSHAFT,ASSY,60" HD,STC
3	21677	32	NYLOCK NUT,7/16 NC
4	33714	64	KNIFE,FLAIL,STANDARD
5	34011	32	CAPSCREW,7/16X3 7/16,NC GR8
6	TF1807	1	CUTTERSHAFT,60" HD
7	TF1020	32	KNIFE MTG CLEVIS,FLAIL
8	30277	1	GROUND ROLLER 60"
9	TF1045B	2	STUB SHAFT,GROUND ROLLER
10	6T2330	8	CAPSCREW,SKT HD,7/16X1-1/2NC

COMMON SIDE FLAIL - XD

## 60IN COMBO SIDE FLAIL - REVERSE ROTATION

Continued...

ITEM	PART NO.	QTY.	DESCRIPTION
11	TF1018	2	BEARING,FLANGE,2-3/16
---	06200347	-	STRING GUARD,KIT,HD(ITEMS 12,13,15)
12	31204	2	STRING GUARD, HD
13	06530217	8	CAPSCREW,1/2 X 2,NC,L9
14	TF1019F	32	KNIFE,FLAIL (SMOOTH CUT)
15	06533006	12	FLATWASHER,1/2,SAE,L9
16	06520028	2	BEARING,FLANGE,1 3/8,GRNDRLR
17	06520029	2	O-RING,2 3/4X3/32,AS568A-148
18	06520027	2	CAP,BEARING,GRNDRLR
19	TF4333A	2	GROUND ROLLER ADJ,BRKT
20	TF4334	1	ROD,GROUND ROLLER ADJ,RT
21	TF4335	1	ROD,GROUND ROLLER ADJ,LF
22	TF4336	4	PLATE,GROUND ROLLER LOCK
23	21399	2	HEX NUT,3/4 (ACME) BULK
24	TF1040	1	GUARD,CUTTER SHAFT
25	TF4371	1	SKID SHOE,L/PROFILE-OUTER
26	23272A	1	SKID SHOE,T3F,INNER
27	TF1803	1	BAR,FLAP,TSF/TRF 60
28	TF1804	1	FLAP,DEFLECTOR,TSF 60
30	21632	20	CAPSCREW,3/8 X 1-1/2 NC
31	22016	30	FLATWASHER,3/8
32	21625	20	HEX NUT,3/8 NC
35	21732	2	CAPSCREW,1/2 X 1-3/4 NC
36	21990	23	LOCKWASHER,1/2
37	21725	23	HEX NUT,1/2 NC
38	6T2331	8	CAPSCREW,SKT HD,7/16 X 1 NC
39	21730	6	CAPSCREW,1/2 X 1-1/4 NC
40	23293	3	PLOW,BOLT,1/2 X 1-3/4 NC
41	06530001	12	CAPSCREW,SKT HD,8-32X1/2,SS
42	6T2291	8	PLOW BOLT,1/2 X 2 NC GR5
43	21731	4	CAPSCREW,1/2 X 1-1/2 NC
44	TF1801	1	TRASH GUARD,60REV ROT-HD
45	22018	1	FLATWASHER,1/2,WIDE
46	21727	1	NYLOCK NUT,1/2 NC

COMMON SIDE FLAIL - XD

## 75IN CABLE SIDE FLAIL - STANDARD ROTATION

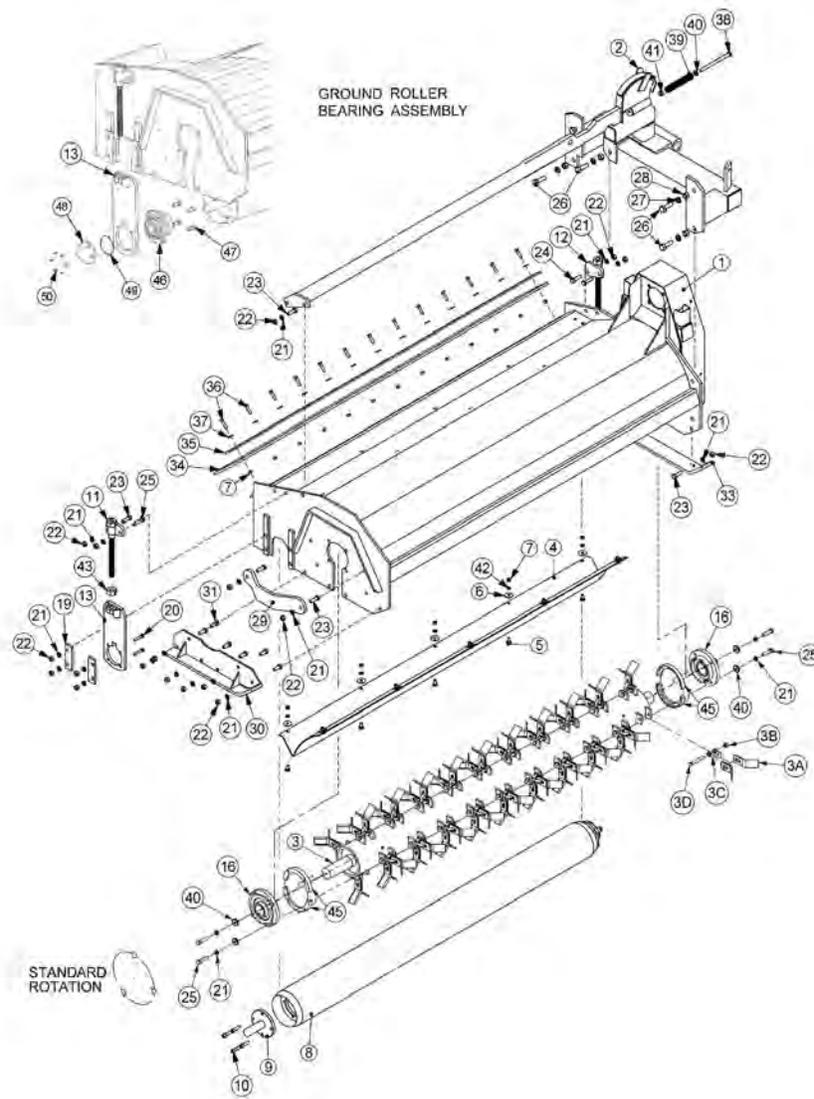

ITEM	PART NO.	QTY.	DESCRIPTION
1	22032	1	BONNET,75,HD,TSF
2	21298C	1	MOUNTING FRAME
-----	TF1002A	-	CUTTERSHAFT,ASSY,75" HD
3	TF1002	1	CUTTERSHAFT,75"
3A	33714	80	KNIFE,FLAIL,STANDARD
3B	21677	40	NYLOCK NUT,7/16" NC
3C	TF1020	40	KNIFE MTG CLEVIS,FLAIL
3D	34011	40	KNIFE MTG BOLT,FLAIL
4	TF1402A	1	BAFFLE,FLAIL,75" HD,STC
5	6T2283	10	CARRIAGE BOLT,3/8" X 1"NC
6	6T2615	10	WASHER,FENDER 3/8"
7	21625	23	HEX NUT,3/8",NC

COMMON SIDE FLAIL - XD

## 75IN CABLE SIDE FLAIL - STANDARD ROTATION

Continued...

ITEM	PART NO.	QTY.	DESCRIPTION
8	28738	1	GROUND ROLLER
9	TF1045B	2	GRND ROLLER STUB SHAFT
10	6T2330	8	CAPSCREW,7/16" X 1-1/2",SOCKET HEAD
11	TF4334	1	ROD,GROUND ROLLER ADJ,RT
12	TF4335	1	ROD,GROUND ROLLER ADJ,LF
13	TF4333A	2	GROUND ROLLER ADJ BRK
16	TF1018	2	BEARING,FLANGE,2-3/16"
19	TF4336	4	CLAMPING BLOCK, LH
20	6T2291	8	PLOW BOLT,1/2" X 2" NC
21	21990	31	LOCKWASHER, 1/2"
22	21725	23	HEX NUT, 1/2" NC
23	21731	6	CAPSCREW, 1/2 X 1 1/2,NC
24	21732	2	CAPSCREW, 1/2 X 1 3/4,NC
25	21733	9	CAPSCREW, 1/2 X 2,NC
26	21783	5	CAPSCREW, 5/8 X 2,NC
27	21992	5	LOCKWASHER, 5/8
28	21775	5	HEX NUT, 5/8
29	TF1040	1	GUARD, CUTTER SHAFT
30	TF4371	1	SKID SHOE,L/PROFILE - OUTER
31	21730	6	CAPSCREW, 1/2 X 1 1/4,NC
33	TF4365	1	SKID SHOE,L/PROFILE - INNER
34	TF1016	1	FLAP,DEFLECTOR,TSF/TRF 75
35	TF1029	1	FLAP RETAINING BAR
36	21632	13	CAPSCREW,3/8" X 1-1/2" NC
37	22016	13	FLATWASHER,3/8"
38	21745	1	CAPSCREW, 1/2 X 7,NC
39	27005	1	SPRING, PUSHOFF, SIDE RTRY
40	27938	3	BUSHING,MACH,1ODX1/2IDX14GA.
41	21727	1	NYLOCK NUT, 1/2"
42	21988	10	LOCKWASHER, 3/8"
43	21399	2	HEX NUT, 3/4" (ACME THRD)
45	31204	2	STRING GUARD, HD
46	06520028	2	BEARING,FLANGE, 1 3/8"
47	6T2331	8	CAPSCREW, 7/16" X 1", SOCKET HEAD
48	06520027	2	CAP,BEARING, GRND ROLLER
49	06520029	2	O-RING,2 3/4" X 3/32"
50	06530001	12	CAPSCREW, SKT HD

COMMON SIDE FLAIL - XD

## 75IN CABLE SIDE FLAIL - REVERSE ROTATION

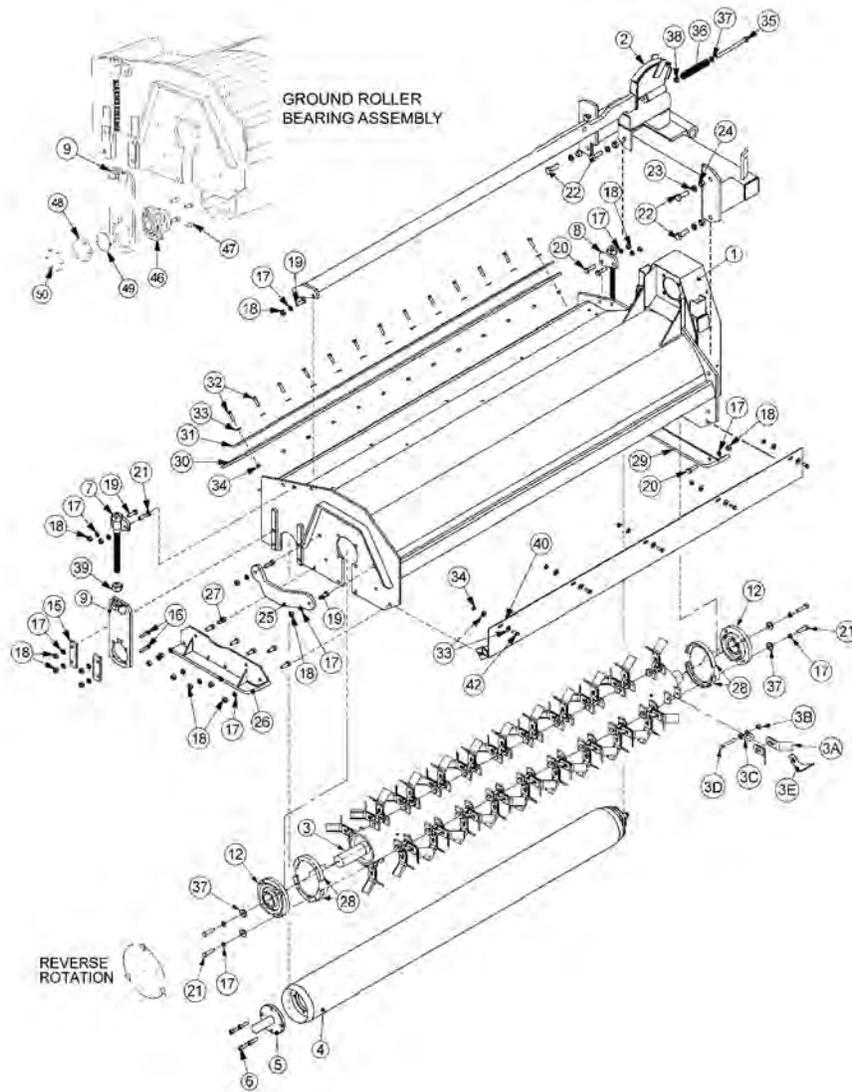

ITEM	PART NO.	QTY.	DESCRIPTION
1	22032	1	BONNET,75,HD,TSF
2	21298C	1	MOUNTING FRAME
---	TF1002A	-	CUTTERSHAFT,ASSY,75" HD
3	TF1002	1	CUTTERSHAFT,75"
3A	33714	80	KNIFE,FLAIL,STANDARD
3B	21677	40	NYLOCK NUT,7/16" NC
3C	TF1020	40	KNIFE MTG CLEVIS,FLAIL
3D	34011	40	KNIFE MTG BOLT,FLAIL
3E	TF1019F	40	KNIFE,FLAIL (SMOOTH CUT)
4	28738	1	GROUND ROLLER
5	TF1045B	2	GRND ROLLER STUB SHAFT
6	6T2330	8	CAPSCREW,7/16" X 1-1/2",SOCKET HEAD

COMMON SIDE FLAIL - XD

## 75IN CABLE SIDE FLAIL - REVERSE ROTATION

Continued...

ITEM	PART NO.	QTY.	DESCRIPTION
7	TF4334	1	ROD,GROUND ROLLER ADJ,RT
8	TF4335	1	ROD,GROUND ROLLER ADJ,LF
9	TF4333A	2	GROUND ROLLER ADJ BRK
12	TF1018	2	BEARING,FLANGE,2-3/16"
15	TF4336	4	CLAMPING BLOCK, LH
16	6T2291	8	PLOW BOLT,1/2" X 2" NC
17	21990	31	LOCKWASHER, 1/2"
18	21725	23	HEX NUT, 1/2" NC
19	21731	6	CAPSCREW, 1/2 X 1 1/2,NC
20	21732	3	CAPSCREW, 1/2 X 1 3/4,NC
21	21733	5	CAPSCREW, 1/2 X 2,NC
22	21783	5	CAPSCREW, 5/8 X 2,NC
23	21992	5	LOCKWASHER, 5/8
24	21775	5	HEX NUT, 5/8
25	TF1040	1	GUARD, CUTTER SHAFT
26	TF4371	1	SKID SHOE,L/PROFILE - OUTER
27	21730	5	CAPSCREW, 1/2 X 1 1/4,NC
28	31204	2	STRING GUARD, HD
29	TF4365	1	SKID SHOE,L/PROFILE - INNER
30	TF1016	1	FLAP,DEFLECTOR,TSF/TRF 75
31	TF1029	1	FLAP RETAINING BAR
32	21632	13	CAPSCREW,3/8" X 1-1/2" NC
33	22016	23	FLATWASHER,3/8"
34	21625	18	HEX NUT,3/8",NC
35	21745	1	CAPSCREW, 1/2 X 7,NC
36	27005	1	SPRING, PUSHOFF, SIDE RTRY
37	27938	9	BUSHING,MACH,1ODX1/2IDX14GA.
38	21727	1	NYLOCK NUT, 1/2
39	21399	2	HEX NUT, 3/4" (ACME THRD)
40	TF1403	1	FRONT TRASH GUARD
42	21630	5	CAPSCREW, 3/8 X 1,NC
46	06520028	2	BEARING,FLANGE, 1 3/8"
47	6T2331	8	CAPSCREW, 7/16" X 1", SOCKET HEAD
48	06520027	2	CAP,BEARING, GRND ROLLER
49	06520029	2	O-RING,2 3/4" X 3/32"
50	06530001	12	CAPSCREW, SKT HD

COMMON SIDE FLAIL - XD

## 75IN COMBO SIDE FLAIL - STANDARD ROTATION

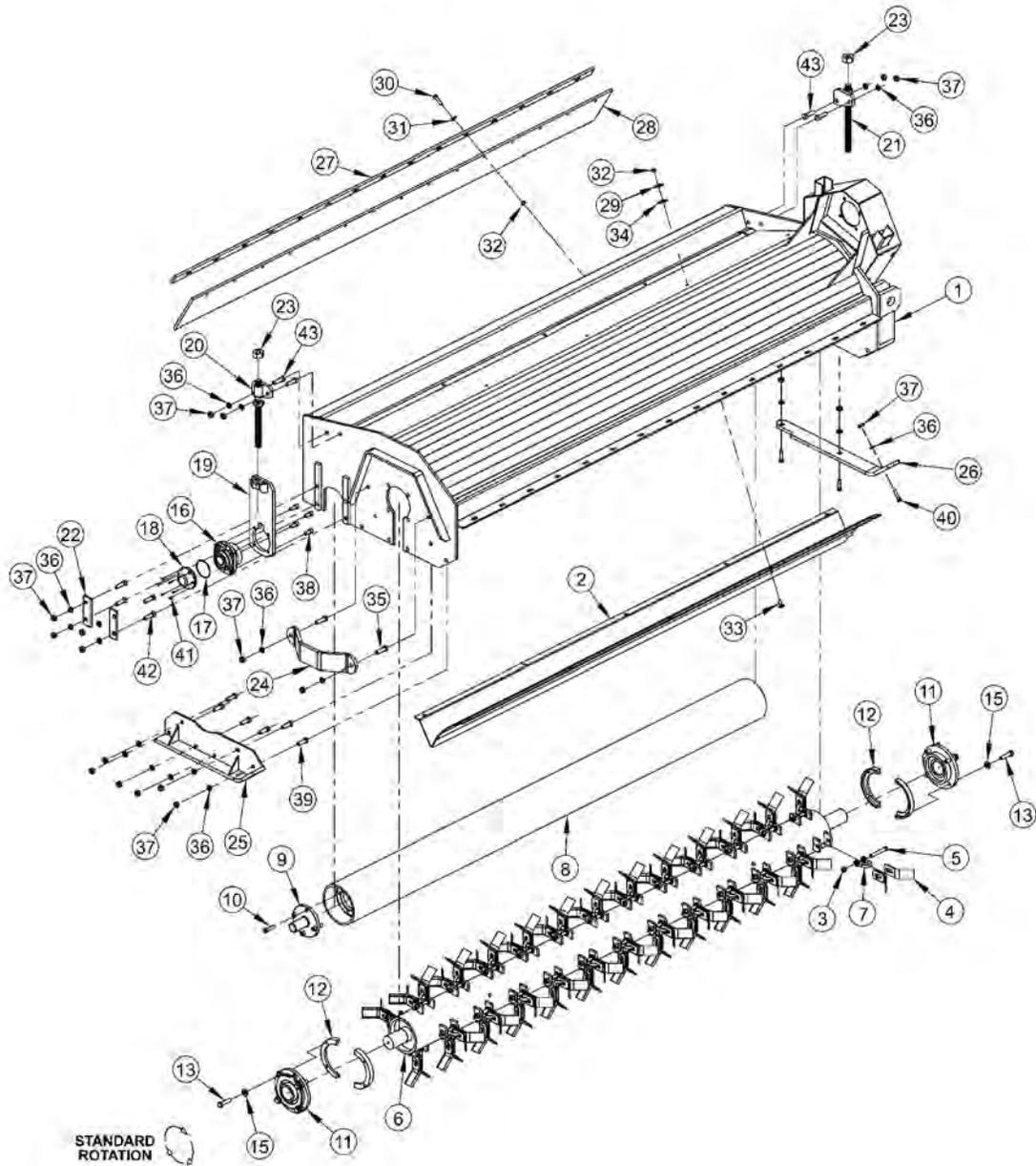

ITEM	PART NO.	QTY.	DESCRIPTION
1	21499A	1	BONNET,75,HD
2	TF1402A	1	BAFFLE,FLAIL,75HD,STD ROT
---	TF1002A	-	CUTSFT ASSY,75HD,STD KNIVES
3	21677	40	NYLOCK NUT,7/16 NC

COMMON SIDE FLAIL - XD



## 75IN COMBO SIDE FLAIL - STANDARD ROTATION

Continued...

ITEM	PART NO.	QTY.	DESCRIPTION
4	33714	80	KNIFE,FLAIL,STANDARD
5	34011	40	CAPSCREW,7/16X3 7/16,NC GR8
6	TF1002	1	CUTTERSHAFT,75,HD
7	TF1020	40	KNIFE MTG CLEVIS,FLAIL
8	28738	1	GROUND ROLLER,75
9	TF1045B	2	STUB SHAFT,GROUND ROLLER
10	6T2330	8	CAPSCREW,SKT HD,7/16X1-1/2NC
11	TF1018	2	BEARING,FLANGE,2-3/16
---	06200347	-	STRING GUARD,KIT,HD(ITEMS 12,13,15)
12	31204	2	STRING GUARD, HD
13	06530217	8	CAPSCREW,1/2 X 2,NC,L9
15	06533006	12	FLATWASHER,1/2,SAE,L9
16	06520028	2	BEARING,FLANGE,1 3/8,GRNDRLR
17	06520029	2	O-RING,2 3/4X3/32,AS568A-148
18	06520027	2	CAP,BEARING,GRNDRLR
19	TF4333A	2	GROUND ROLLER ADJ,BRKT
20	TF4334	1	ROD,GROUND ROLLER ADJ,RT
21	TF4335	1	ROD,GROUND ROLLER ADJ,LF
22	TF4336	4	PLATE,GROUND ROLLER LOCK
23	21399	2	HEX NUT,3/4 (ACME) BULK
24	TF1040	1	GUARD,CUTTER SHAFT
25	TF4371	1	SKID SHOE,L/PROFILE-OUTER
26	23272A	1	SKID SHOE,T3F,INNER
27	TF1029	1	BAR,FLAP,TSF/TRF 75
28	TF1016	1	FLAP,DEFLECTOR,TSF/TRF 75
29	21988	10	LOCKWASHER,3/8
30	21632	13	CAPSCREW,3/8 X 1-1/2 NC
31	22016	13	FLATWASHER,3/8
32	21625	23	HEX NUT,3/8 NC
33	6T2283	10	CARRIAGE BOLT,3/8 X 1 NC
34	6T2615	10	WASHER,FENDER 3/8
35	21732	2	CAPSCREW,1/2 X 1-3/4 NC
36	21990	23	LOCKWASHER,1/2
37	21725	23	HEX NUT,1/2 NC
38	6T2331	8	CAPSCREW,SKT HD,7/16 X 1 NC
39	21730	6	CAPSCREW,1/2 X 1-1/4 NC
40	23293	3	PLOW,BOLT,1/2 X 1-3/4 NC
41	06530001	12	CAPSCREW,SKT HD,8-32X1/2,SS
42	6T2291	8	PLOW BOLT,1/2 X 2 NC GR5
43	21731	4	CAPSCREW,1/2 X 1-1/2 NC

COMMON SIDE FLAIL - XD

## 75IN COMBO SIDE FLAIL - REVERSE ROTATION

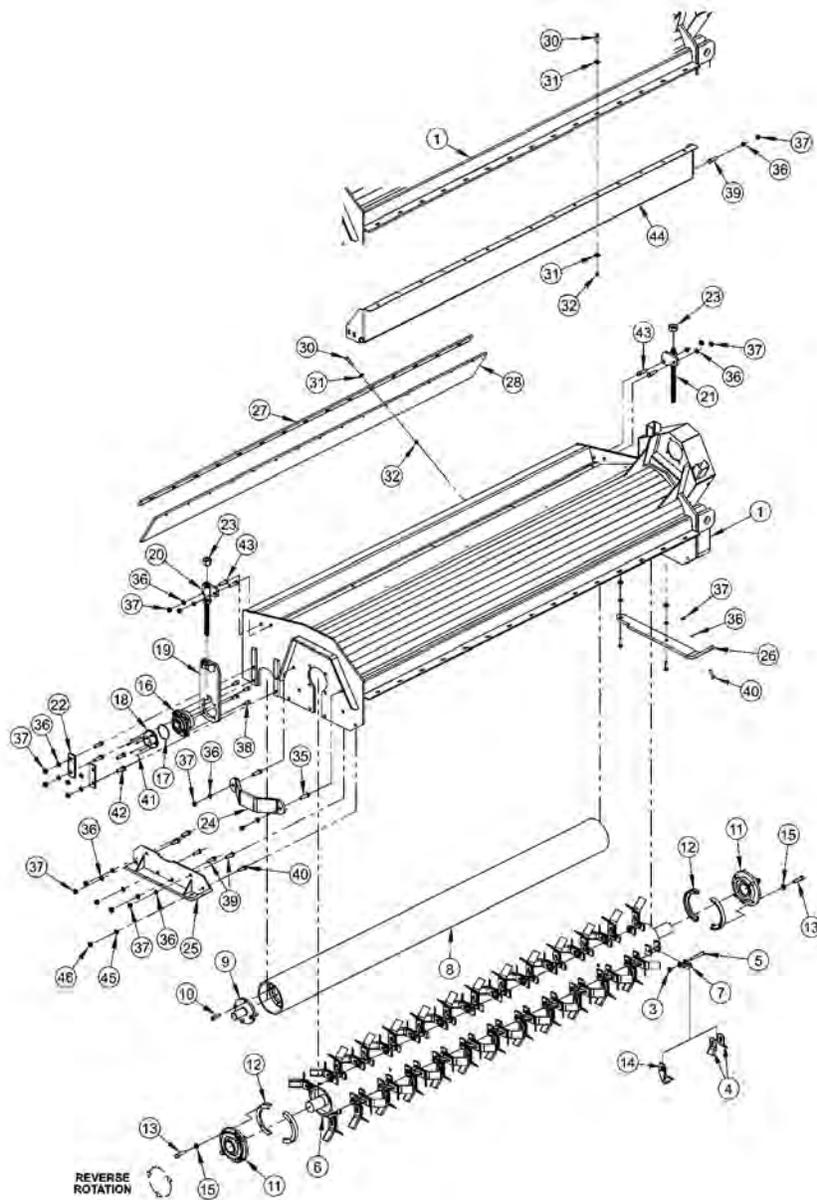

ITEM	PART NO.	QTY.	DESCRIPTION
1	21499A	1	BONNET,75,HD
---	TF1002A	-	CUTSHFT ASSY,75HD
3	21677	40	NYLOCK NUT,7/16 NC
4	33714	80	KNIFE,FLAIL,STANDARD
5	34011	40	CAPSCREW,7/16X3 7/16,NC GR8
6	TF1002	1	CUTTERSHAFT,75,HD
7	TF1020	40	KNIFE MTG CLEVIS,FLAIL
8	28738	1	GROUND ROLLER,75
9	TF1045B	2	STUB SHAFT,GROUND ROLLER
10	6T2330	8	CAPSCREW,SKT HD,7/16X1-1/2NC

COMMON SIDE FLAIL - XD

## 75IN COMBO SIDE FLAIL - REVERSE ROTATION

Continued...

ITEM	PART NO.	QTY.	DESCRIPTION
11	TF1018	2	BEARING,FLANGE,2-3/16
---	06200347	-	STRING GUARD,KIT,HD(ITEMS 12,13,15)
12	31204	2	STRING GUARD, HD
13	06530217	8	CAPSCREW,1/2 X 2,NC,L9
14	TF1019F	40	KNIFE,FLAIL (SMOOTH CUT)
15	06533006	12	FLATWASHER,1/2,SAE,L9
16	06520028	2	BEARING,FLANGE,1 3/8,GRNDRLR
17	06520029	2	O-RING,2 3/4X3/32,AS568A-148
18	06520027	2	CAP,BEARING,GRNDRLR
19	TF4333A	2	GROUND ROLLER ADJ,BRKT
20	TF4334	1	ROD,GROUND ROLLER ADJ,RT
21	TF4335	1	ROD,GROUND ROLLER ADJ,LF
22	TF4336	4	PLATE,GROUND ROLLER LOCK
23	21399	2	HEX NUT,3/4 (ACME) BULK
24	TF1040	1	GUARD,CUTTER SHAFT
25	TF4371	1	SKID SHOE,L/PROFILE-OUTER
26	23272A	1	SKID SHOE,T3F,INNER
27	TF1029	1	BAR,FLAP,TSF/TRF 75
28	TF1016	1	FLAP,DEFLECTOR,TSF/TRF 75
30	21632	26	CAPSCREW,3/8 X 1-1/2 NC
31	22016	39	FLATWASHER,3/8
32	21625	26	HEX NUT,3/8 NC
35	21732	2	CAPSCREW,1/2 X 1-3/4 NC
36	21990	23	LOCKWASHER,1/2
37	21725	23	HEX NUT,1/2 NC
38	6T2331	8	CAPSCREW,SKT HD,7/16 X 1 NC
39	21730	6	CAPSCREW,1/2 X 1-1/4 NC
40	23293	3	PLOW,BOLT,1/2 X 1-3/4 NC
41	06530001	12	CAPSCREW,SKT HD,8-32X1/2,SS
42	6T2291	8	PLOW BOLT,1/2 X 2 NC GR5
43	21731	4	CAPSCREW,1/2 X 1-1/2 NC
44	TF1403	1	TRASH GUARD,75REV ROT-HD
45	22018	1	FLATWASHER,1/2,WIDE
46	21727	1	NYLOCK NUT,1/2 NC

COMMON SIDE FLAIL - XD

## 90IN CABLE SIDE FLAIL - STANDARD ROTATION

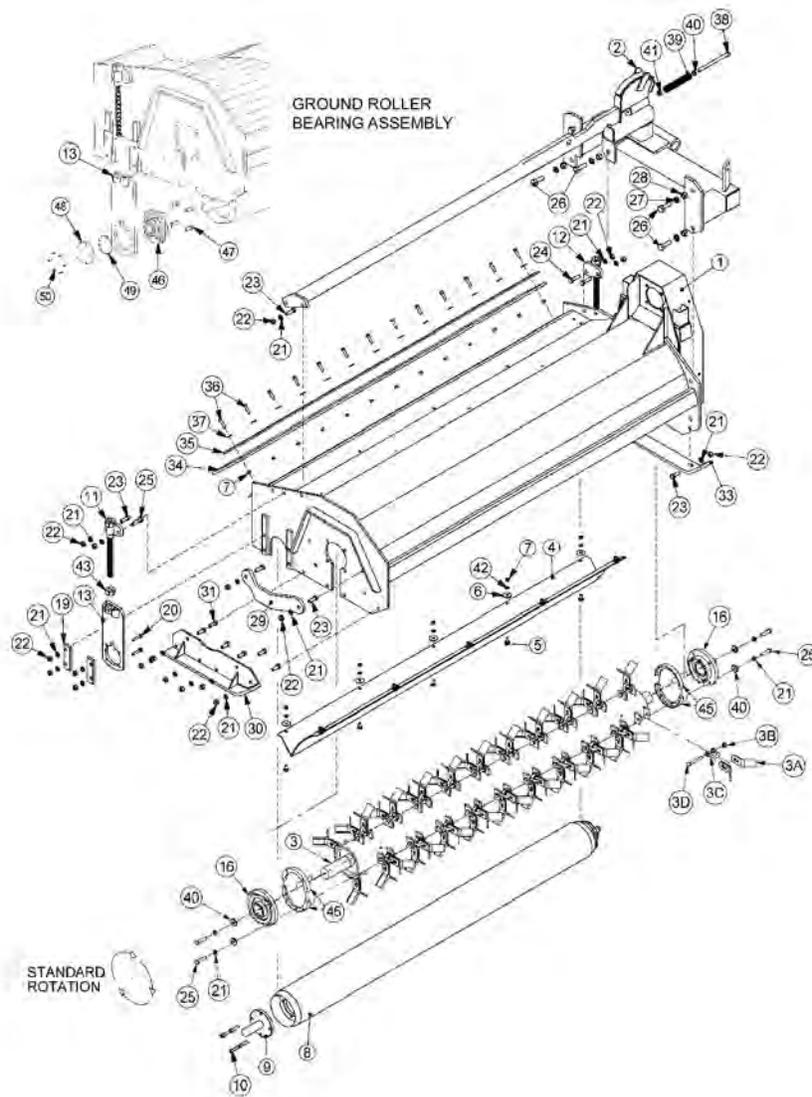

ITEM	PART NO.	QTY.	DESCRIPTION
1	27047	1	BONNET,90,HD,TSF
2	27048A	1	MOUNTING FRAME
-----	TF1102A	-	CUTTERSHAFT,ASSY,90" HD,STC
3	TF1102	1	CUTTERSHAFT,90"
3A	33714	96	KNIFE,FLAIL,STANDARD
3B	21677	48	NYLOCK NUT,7/16" NC
3C	TF1020	48	KNIFE MTG CLEVIS,FLAIL
3D	34011	48	KNIFE MTG BOLT,FLAIL
4	TF1502A	1	BAFFLE,FLAIL,90" HD,STC
5	6T2283	10	CARRIAGE BOLT,3/8" X 1"NC
6	6T2615	10	WASHER,FENDER 3/8"
7	21625	23	HEX NUT,3/8",NC

COMMON SIDE FLAIL - XD

**90IN CABLE SIDE FLAIL - STANDARD ROTATION**

Continued...

<b>ITEM</b>	<b>PART NO.</b>	<b>QTY.</b>	<b>DESCRIPTION</b>
8	27972A	1	GROUND ROLLER
9	TF1045B	2	GRND ROLLER STUB SHAFT
10	6T2330	8	CAPSCREW, 7/16 X 1 1/2, SOCKET HEAD
11	TF4334	1	ROD,GROUND ROLLER ADJ,RT
12	TF4335	1	ROD,GROUND ROLLER ADJ,LF
13	TF4333A	2	GROUND ROLLER ADJ BRK
16	TF1018	2	BEARING,FLANGE,2-3/16"
19	TF4336	4	CLAMPING BLOCK, LH
20	6T2291	8	PLOW BOLT,1/2" X 2" NC
21	21990	31	LOCKWASHER, 1/2"
22	21725	23	HEX NUT, 1/2" NC
23	21731	6	CAPSCREW, 1/2 X 1 1/2,NC
24	21732	2	CAPSCREW, 1/2 X 1 3/4,NC
25	21733	9	CAPSCREW, 1/2 X 2,NC
26	21783	5	CAPSCREW, 5/8 X 2,NC
27	21992	5	LOCKWASHER, 5/8
28	21775	5	HEX NUT, 5/8
29	TF1040	1	GUARD, CUTTER SHAFT
30	TF4371	1	SKID SHOE,L/PROFILE - OUTER
31	21730	6	CAPSCREW, 1/2 X 1 1/4,NC
33	TF4365	1	SKID SHOE,L/PROFILE - INNER
34	TF1116	1	FLAP,DEFLECTOR,TSF/TRF 90
35	TF1135	1	FLAP RETAINING BAR
36	21632	13	CAPSCREW,3/8" X 1-1/2" NC
37	22016	13	FLATWASHER,3/8"
38	21745	1	CAPSCREW, 1/2 X 7,NC
39	27005	1	SPRING, PUSHOFF, SIDE RTRY
40	27938	9	BUSHING,MACH,1ODX1/2IDX14GA.
41	21727	1	NYLOCK NUT, 1/2
42	21988	10	LOCKWASHER, 3/8"
43	21399	2	HEX NUT, 3/4" (ACME THRD)
45	31204	2	STRING GUARD, HD
46	06520028	2	BEARING,FLANGE, 1 3/8"
47	6T2331	8	CAPSCREW, 7/16" X 1", SOCKET HEAD
48	06520027	2	CAP,BEARING, GRND ROLLER
49	06520029	2	O-RING,2 3/4" X 3/32"
50	06530001	12	CAPSCREW, SKT HD

COMMON SIDE FLAIL - XD

## 90IN CABLE SIDE FLAIL - REVERSE ROTATION

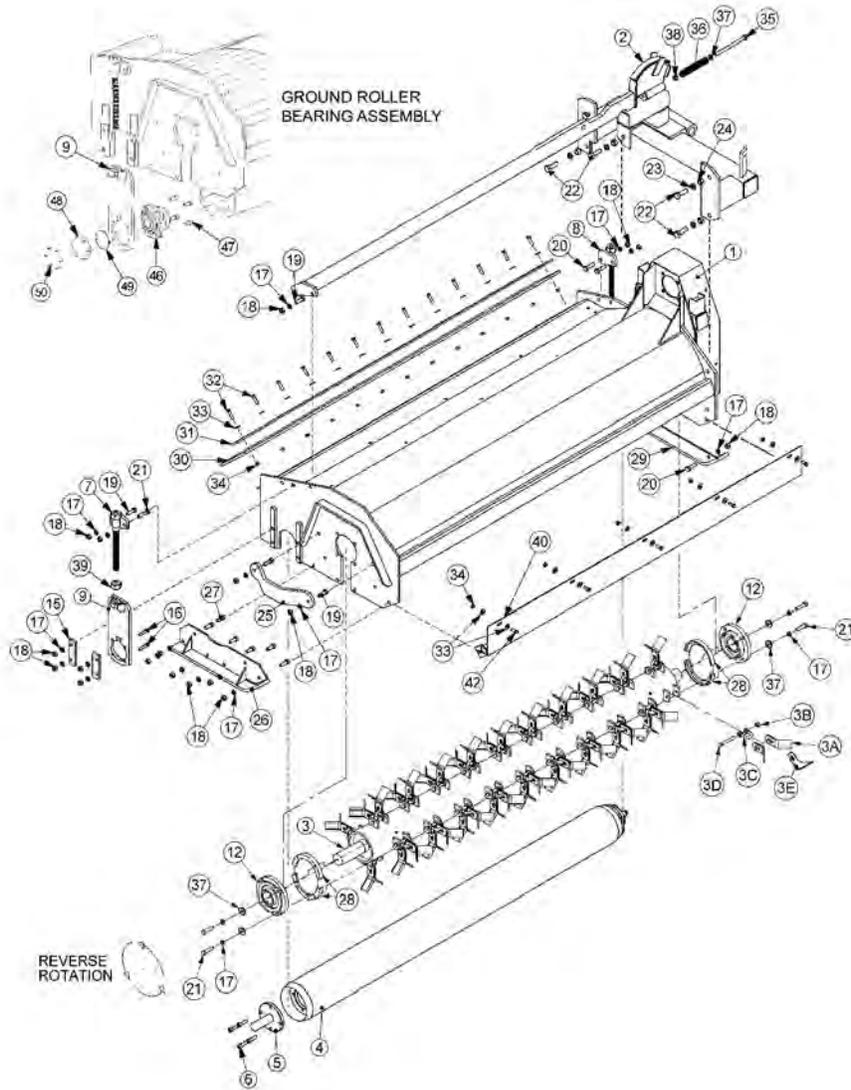

ITEM	PART NO.	QTY.	DESCRIPTION
1	27047	1	BONNET,90,HD,TSF
2	27048A	1	MOUNTING FRAME
---	TF1102A	-	CUTTERSHAFT,ASSY,90" HD,STC
3	TF1102	1	CUTTERSHAFT,90"
3A	33714	96	KNIFE,FLAIL,STANDARD
3B	21677	48	NYLOCK NUT,7/16" NC
3C	TF1020	48	KNIFE MTG CLEVIS,FLAIL
3D	34011	48	KNIFE MTG BOLT,FLAIL
3E	TF1019F	48	KNIFE,FLAIL (SMOOTH CUT)
4	27972A	1	GROUND ROLLER
5	TF1045B	2	GRND ROLLER STUB SHAFT
6	6T2330	8	CAPSCREW, 7/16 X 1-1/2, SOCKET HEAD

COMMON SIDE FLAIL - XD

## 90IN CABLE SIDE FLAIL - REVERSE ROTATION

Continued...

ITEM	PART NO.	QTY.	DESCRIPTION
7	TF4334	1	ROD,GROUND ROLLER ADJ,RT
8	TF4335	1	ROD,GROUND ROLLER ADJ,LF
9	TF4333A	2	GROUND ROLLER ADJ BRK
12	TF1018	2	BEARING,FLANGE,2-3/16"
15	TF4336	4	CLAMPING BLOCK, LH
16	6T2291	8	PLOW BOLT,1/2" X 2" NC
17	21990	31	LOCKWASHER, 1/2"
18	21725	23	HEX NUT, 1/2" NC
19	21731	6	CAPSCREW, 1/2 X 1-1/2,NC
20	21732	3	CAPSCREW, 1/2 X 1-3/4,NC
21	21733	9	CAPSCREW, 1/2 X 2,NC
22	21783	5	CAPSCREW, 5/8 X 2,NC
23	21992	5	LOCKWASHER, 5/8
24	21775	5	HEX NUT, 5/8
25	TF1040	1	GUARD, CUTTER SHAFT
26	TF4371	1	SKID SHOE,L/PROFILE - OUTER
27	21730	5	CAPSCREW, 1/2 X 1-1/4,NC
28	31204	2	STRING GUARD, HD
29	TF4365	1	SKID SHOE,L/PROFILE - INNER
30	TF1116	1	FLAP,DEFLECTOR,TSF/TRF 90
31	TF1135	1	FLAP RETAINING BAR
32	21632	13	CAPSCREW,3/8" X 1-1/2" NC
33	22016	23	FLATWASHER,3/8"
34	21625	18	HEX NUT,3/8",NC
35	21745	1	CAPSCREW, 1/2 X 7,NC
36	27005	1	SPRING, PUSHOFF, SIDE RTRY
37	27938	9	BUSHING,MACH,1ODX1/2IDX14GA.
38	21727	1	NYLOCK NUT, 1/2
39	21399	2	HEX NUT, 3/4" (ACME THRD)
40	TF1503	1	FRONT TRASH GUARD
42	21630	5	CAPSCREW, 3/8 X 1,NC
46	06520028	2	BEARING,FLANGE, 1-3/8"
47	6T2331	8	CAPSCREW, 7/16" X 1", SOCKET HEAD
48	06520027	2	CAP,BEARING, GRND ROLLER
49	06520029	2	O-RING,2-3/4" X 3/32"
50	06530001	12	CAPSCREW, SKT HD

COMMON SIDE FLAIL - XD

## 90IN COMBO SIDE FLAIL - STANDARD ROTATION

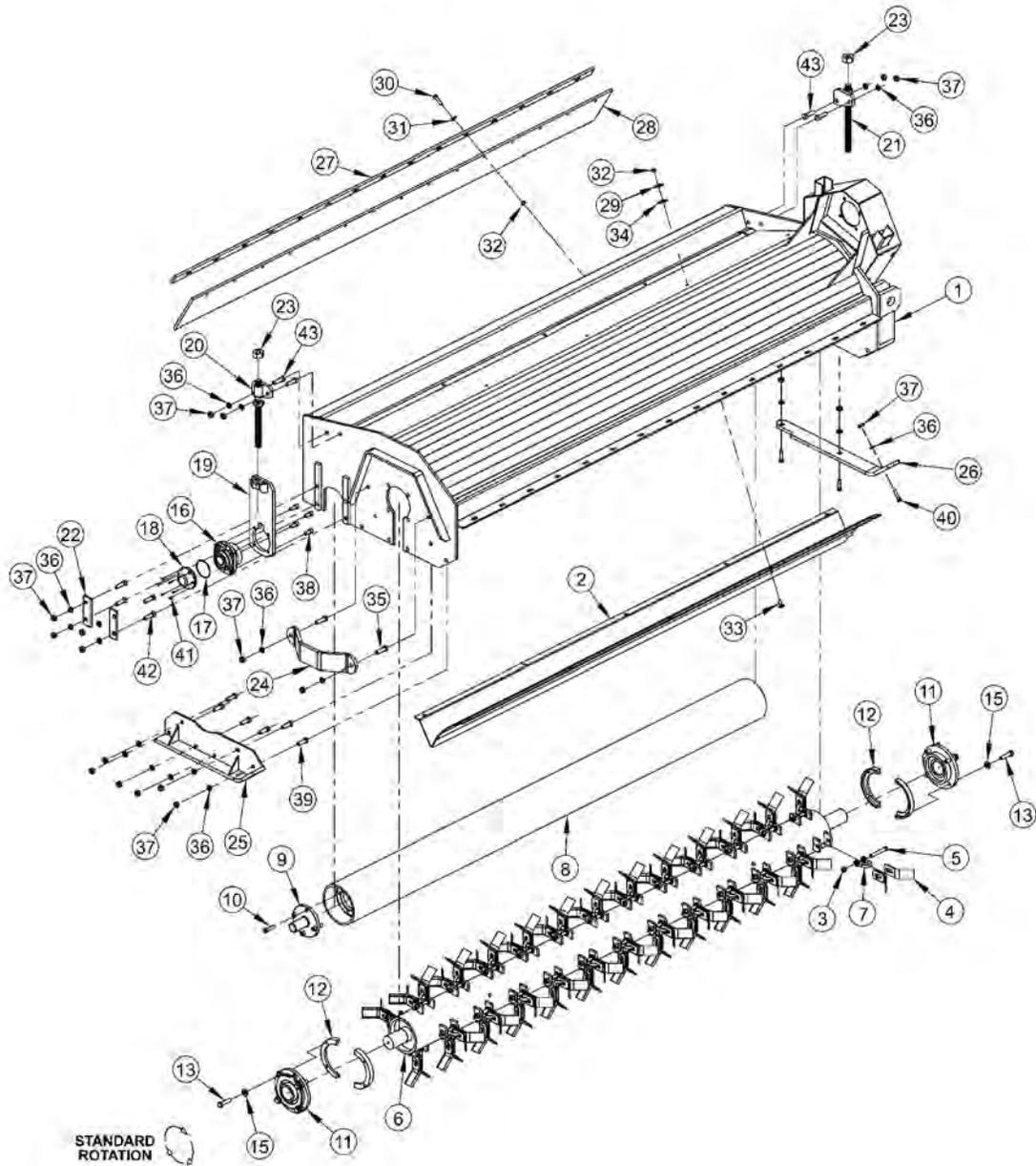

ITEM	PART NO.	QTY.	DESCRIPTION
1	22083A	1	BONNET,90,HD,ASSY
2	TF1502A	1	BAFFLE,FLAIL,90HD,STD ROT
---	TF1102A	-	CUTSHT ASSY,90HD
3	21677	48	NYLOCK NUT,7/16 NC

COMMON SIDE FLAIL - XD



## 90IN COMBO SIDE FLAIL - STANDARD ROTATION

Continued...

ITEM	PART NO.	QTY.	DESCRIPTION
4	33714	96	KNIFE,FLAIL,STANDARD
5	34011	48	CAPSCREW,7/16X3 7/16,NC GR8
6	TF1102	1	CUTTERSHAFT,90,HD
7	TF1020	48	KNIFE MTG CLEVIS,FLAIL
8	27972A	1	GROUND ROLLER,90
9	TF1045B	2	STUB SHAFT,GROUND ROLLER
10	6T2330	8	CAPSCREW,SKT HD,7/16X1-1/2NC
11	TF1018	2	BEARING,FLANGE,2-3/16
---	06200347	-	STRING GUARD,KIT,HD(ITEMS 12,13,15)
12	31204	2	STRING GUARD, HD
13	06530217	8	CAPSCREW,1/2 X 2,NC,L9
15	06533006	12	FLATWASHER,1/2,SAE,L9
16	06520028	2	BEARING,FLANGE,1 3/8,GRNDRLR
17	06520029	2	O-RING,2 3/4X3/32,AS568A-148
18	06520027	2	CAP,BEARING,GRNDRLR
19	TF4333A	2	GROUND ROLLER ADJ,BRKT
20	TF4334	1	ROD,GROUND ROLLER ADJ,RT
21	TF4335	1	ROD,GROUND ROLLER ADJ,LF
22	TF4336	4	PLATE,GROUND ROLLER LOCK
23	21399	2	HEX NUT,3/4 (ACME) BULK
24	TF1040	1	GUARD,CUTTER SHAFT
25	TF4371	1	SKID SHOE,L/PROFILE-OUTER
26	23272A	1	SKID SHOE,T3F,INNER
27	TF1135	1	BAR,FLAP,TSF/TRF 90
28	TF1116	1	FLAP,DEFLECTOR,TSF/TRF 90
29	21988	10	LOCKWASHER,3/8
30	21632	15	CAPSCREW,3/8 X 1-1/2 NC
31	22016	15	FLATWASHER,3/8
32	21625	25	HEX NUT,3/8 NC
33	6T2283	10	CARRIAGE BOLT,3/8 X 1 NC
34	6T2615	10	WASHER,FENDER 3/8
35	21732	2	CAPSCREW,1/2 X 1-3/4 NC
36	21990	23	LOCKWASHER,1/2
37	21725	23	HEX NUT,1/2 NC
38	6T2331	8	CAPSCREW,SKT HD,7/16 X 1 NC
39	21730	6	CAPSCREW,1/2 X 1-1/4 NC
40	23293	3	PLOW,BOLT,1/2 X 1-3/4 NC
41	06530001	12	CAPSCREW,SKT HD,8-32X1/2,SS
42	6T2291	8	PLOW BOLT,1/2 X 2 NC GR5
43	21731	4	CAPSCREW,1/2 X 1-1/2 NC

COMMON SIDE FLAIL - XD

## 90IN COMBO SIDE FLAIL - REVERSE ROTATION

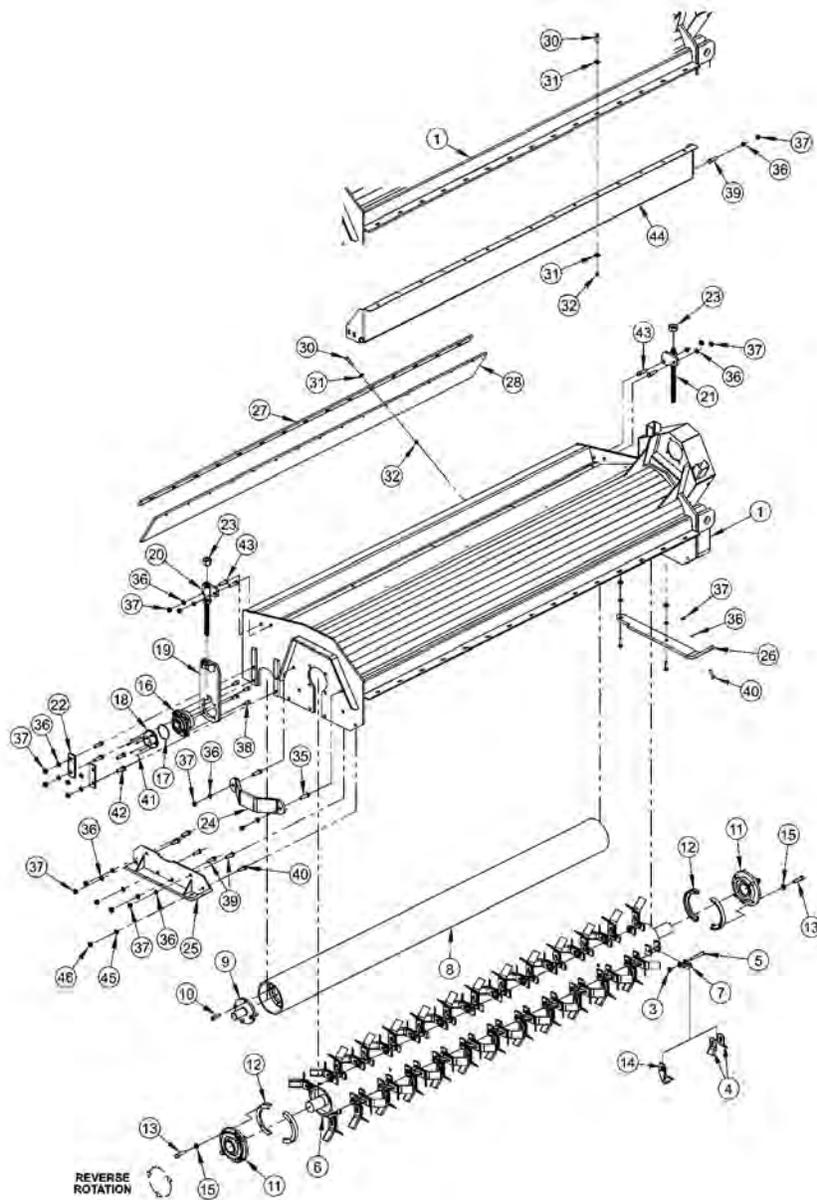

ITEM	PART NO.	QTY.	DESCRIPTION
---	22083A	-	BONNET,90,HD,ASSY
1	22084A	1	BONNET 90"
---	TF1102A	-	CUTSHFT ASSY,90HD,STD KNIVES
3	21677	48	NYLOCK NUT,7/16 NC
4	33714	96	KNIFE,FLAIL,STANDARD
5	34011	48	CAPSCREW,7/16X3 7/16,NC GR8
6	TF1102	1	CUTTERSHAFT,90,HD
7	TF1020	48	KNIFE MTG CLEVIS,FLAIL
8	27972A	1	GROUND ROLLER,90
9	TF1045B	2	STUB SHAFT,GROUND ROLLER

COMMON SIDE FLAIL - XD

## 90IN COMBO SIDE FLAIL - REVERSE ROTATION

Continued...

ITEM	PART NO.	QTY.	DESCRIPTION
10	6T2330	8	CAPSCREW,SKT HD,7/16X1-1/2NC
11	TF1018	2	BEARING,FLANGE,2-3/16
---	06200347	-	STRING GUARD,KIT,HD(ITEMS 12,13,15)
12	31204	2	STRING GUARD, HD
13	06530217	8	CAPSCREW,1/2 X 2,NC,L9
14	TF1019F	48	KNIFE,FLAIL (SMOOTH CUT)
15	06533006	12	FLATWASHER,1/2,SAE,L9
16	06520028	2	BEARING,FLANGE,1 3/8,GRNDRLR
17	06520029	2	O-RING,2 3/4X3/32,AS568A-148
18	06520027	2	CAP,BEARING,GRNDRLR
19	TF4333A	2	GROUND ROLLER ADJ,BRKT
20	TF4334	1	ROD,GROUND ROLLER ADJ,RT
21	TF4335	1	ROD,GROUND ROLLER ADJ,LF
22	TF4336	4	PLATE,GROUND ROLLER LOCK
23	21399	2	HEX NUT,3/4 (ACME) BULK
24	TF1040	1	GUARD,CUTTER SHAFT
25	TF4371	1	SKID SHOE,L/PROFILE-OUTER
26	23272A	1	SKID SHOE,T3F,INNER
27	TF1135	1	BAR,FLAP,TSF/TRF 90
28	TF1116	1	FLAP,DEFLECTOR,TSF/TRF 90
30	21632	30	CAPSCREW,3/8 X 1-1/2 NC
31	22016	45	FLATWASHER,3/8
32	21625	30	HEX NUT,3/8 NC
35	21732	2	CAPSCREW,1/2 X 1-3/4 NC
36	21990	23	LOCKWASHER,1/2
37	21725	23	HEX NUT,1/2 NC
38	6T2331	8	CAPSCREW,SKT HD,7/16 X 1 NC
39	21730	6	CAPSCREW,1/2 X 1-1/4 NC
40	23293	3	PLOW,BOLT,1/2 X 1-3/4 NC
41	06530001	12	CAPSCREW,SKT HD,8-32X1/2,SS
42	6T2291	8	PLOW BOLT,1/2 X 2 NC GR5
43	21731	4	CAPSCREW,1/2 X 1-1/2 NC
44	TF1503	1	TRASH GUARD,90REV ROT-HD
45	22018	1	FLATWASHER,1/2,WIDE
46	21727	1	NYLOCK NUT,1/2 NC

COMMON SIDE FLAIL - XD

FRONT FLAP - STANDARD ROTATION MOWERS

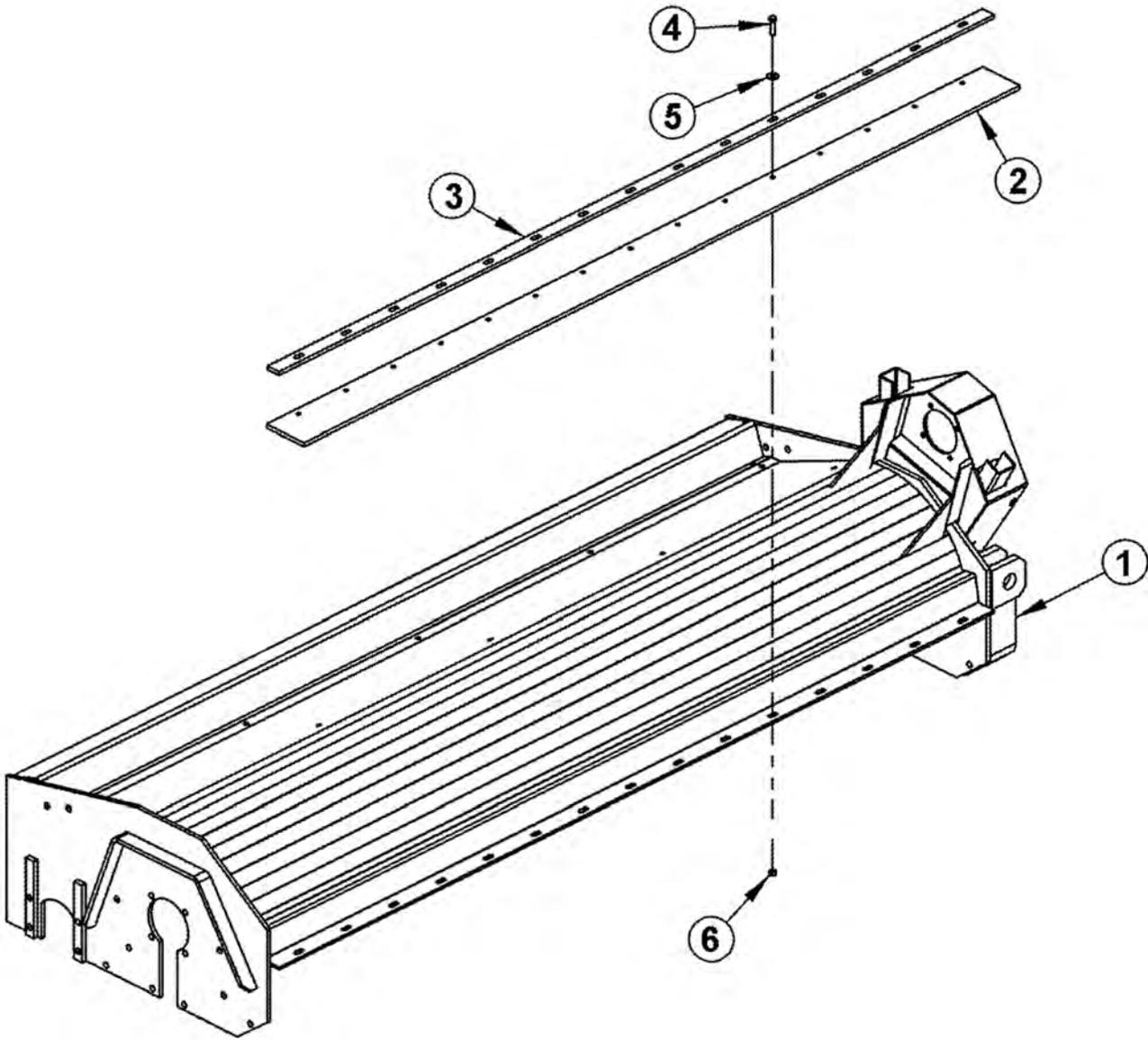

COMMON SIDE FLAIL - XD

## FRONT FLAP - STANDARD ROTATION MOWERS

Continued...

ITEM	PART NO.	QTY.	DESCRIPTION
1	-----	-	BONNET *REFER TO HEAD ASSEMBLY
2	06520240	1	FLAP,FRONT,60IN
---	06520242	1	FLAP,FRONT,75IN
----	06520243	1	FLAP,FRONT,90IN
3	TF1803	1	BAR,FLAP,60IN
---	TF1029	1	BAR,FLAP,75IN
----	TF1135	1	BAR,FLAP,90IN
4	21632	10	CAPSCREW,3/8" X 1-1/2",NC (60IN FLAIL)
---	-----	13	CAPSCREW,3/8" X 1-1/2",NC (75IN FLAIL)
----	-----	15	CAPSCREW,3/8" X 1-1/2",NC (90IN FLAIL)
5	22016	10	FLATWASHER,3/8" (60IN FLAIL)
---	-----	13	FLATWASHER,3/8" (75IN FLAIL)
----	-----	15	FLATWASHER,3/8" (90IN FLAIL)
6	21625	10	HEX NUT,3/8",NC (60IN FLAIL)
---	-----	13	HEX NUT,3/8",NC (75IN FLAIL)
----	-----	15	HEX NUT,3/8",NC (90IN FLAIL)

COMMON SIDE FLAIL - XD

# CABLE SIDE FLAIL DRIVE ASSEMBLY

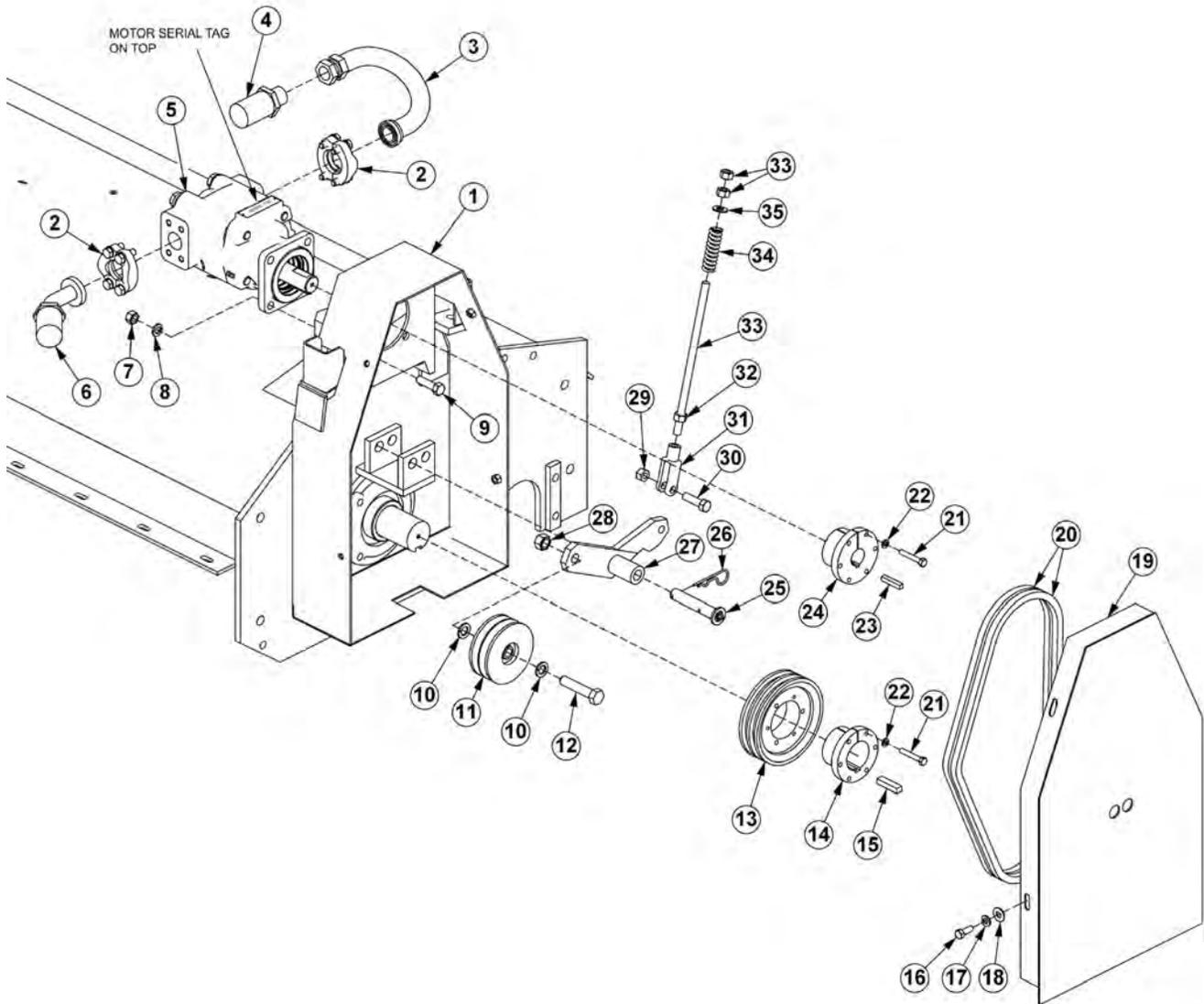

COMMON SIDE FLAIL - XD

## CABLE SIDE FLAIL DRIVE ASSEMBLY

Continued...

ITEM	PART NO.	QTY.	DESCRIPTION
1	-----	-	BONNET *REFER TO FLAIL PARTS
2	TF4852	2	KIT,FLANGE,#20
3	34227	1	PREFORMED TUBE
4	-----	-	HOSE (RETURN FOR STANDARD ROTATION)
5	06504013	1	MOTOR
6	-----	-	HOSE (PRESSURE FOR STANDARD ROTATION)
7	21725	4	HEX NUT,1/2,NC
8	21990	4	LOCKWASHER,1/2
9	21732	4	CAPSCREW,1/2 X 1-3/4,NC
10	21992	2	LOCKWASHER,5/8
11	31293	1	SHEAVE,IDLER,ASSY,4.4 O.D.
12	21787	1	CAPSCREW,5/8 X 3,NC
13	TF3040	1	SHEAVE,6.3 O.D.
14	TF3011	1	BUSHING,2-3/16
15	TF1025	1	KEY,3/8 X 1/2
16	21630	4	CAPSCREW,3/8 X 1,NC
17	21988	4	LOCKWASHER,3/8
18	22016	4	FLATWASHER,3/8
19	TF1404	1	SHIELD
20	TF3020	2	V-BELT (530)
21	21584	6	CAPSCREW,5/16 X 2,NC
22	21987	6	LOCKWASHER,5/16
23	TF1125	1	KEY,5/16 SQUARE
24	TF3013	1	BUSHING,1-1/4
25	TF3605	1	IDLER ARM PIN
26	6T3004	1	R-CLIP
27	TF4346	1	IDLER ARM (STANDARD ROTATION)
-----	TF4345	-	IDLER ARM (REVERSE ROTATION - NOT SHOWN)
28	21775	1	HEX NUT,5/8,NC
29	6T2418	1	HEX NUT,1/2,NC,STOVER
30	21732	1	CAPSCREW,1/2 X 1-3/4,NC
31	PT3611A	1	CLEVIS
32	21700	3	HEX NUT,1/2,NF
33	32494	1	ROD,THREADED
34	TF3620A	1	TENSIONER SPRING
35	27938	1	MACHINED BUSHING

COMMON SIDE FLAIL - XD

# COMBO SIDE FLAIL DRIVE ASSEMBLY

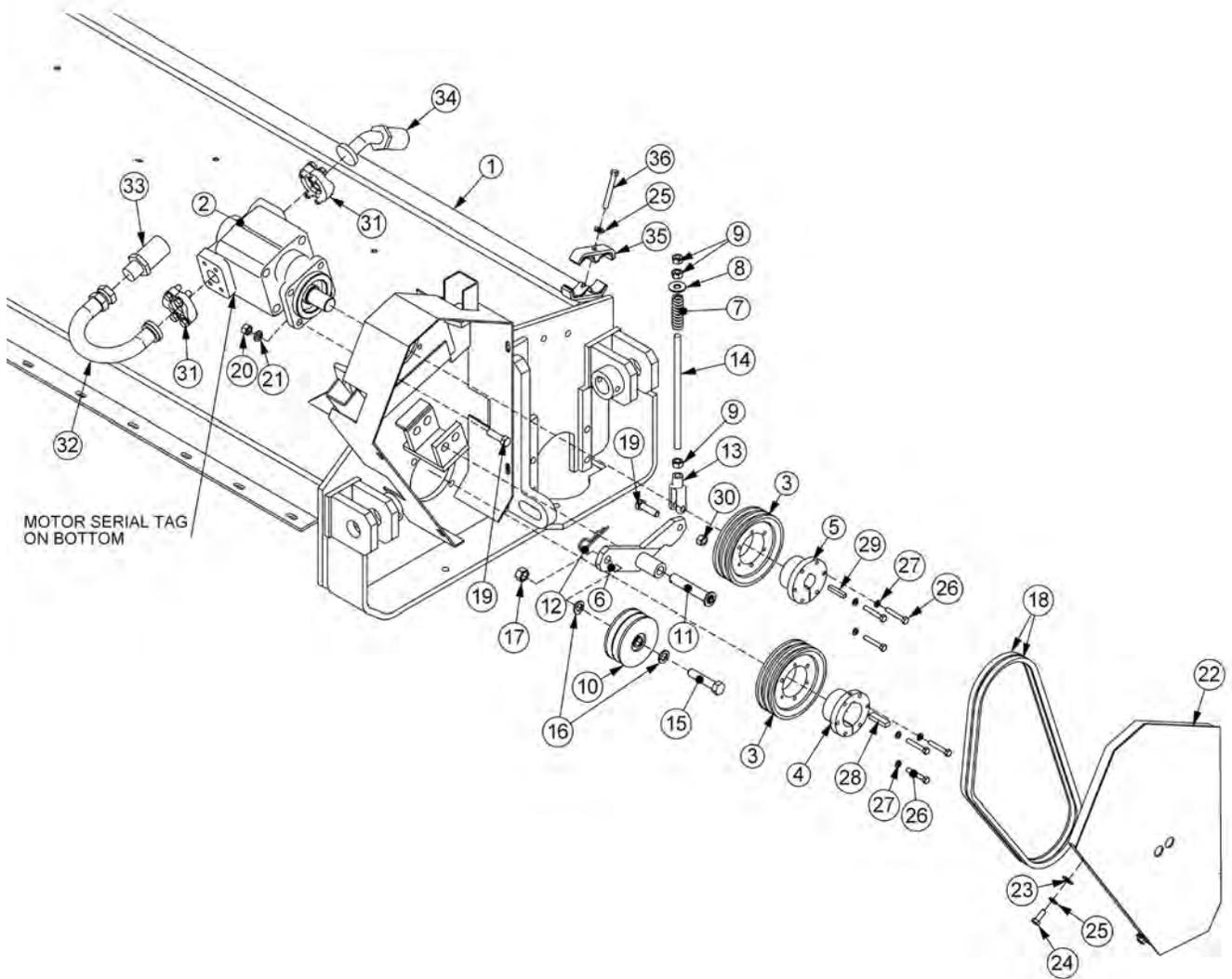

MOTOR SERIAL TAG  
ON BOTTOM



## COMBO SIDE FLAIL DRIVE ASSEMBLY

Continued...

ITEM	PART NO.	QTY.	DESCRIPTION
1	-----	-	BONNET *REFER TO FLAIL PARTS
2	06504013	1	MOTOR,TSF
3	TF3040	2	SHEAVE,6.3
4	TF3011	1	BUSHING,QD,SK,2-3/16"
5	TF3013	1	BUSHING,QD,SK 1-1/4"
6	TF4346	1	IDLER ARM (STANDARD ROTATION)
-----	TF4345	-	IDLER ARM (REVERSE ROTATION - NOT SHOWN)
7	TF3620A	1	SPRING,TENSIONER
8	22018	1	FLATWASHER,1/2",WIDE
9	21700	3	HEX NUT, 1/2", NF
10	31293	1	SHEAVE,IDLER ASSY, 4.4 O.D.
11	TF3605	1	PIN,IDLER ARM 3/4"X4-1/4"
12	6T3004	1	R-CLIP (HAIRPIN COTTER, 3/16")
13	PT3611A	1	CLEVIS,6"
14	32494	1	ROD, THREADED, 1/2-20NF
15	21787	1	CAPSCREW,5/8" X 3", NC
16	21992	2	LOCKWASHER, 5/8
17	21775	1	HEX NUT, 5/8
18	TF3020	2	V-BELT, (530)
19	21732	5	CAPSCREW, 1/2 X 1 3/4,NC
20	21725	4	HEX NUT, 1/2" NC
21	21990	4	LOCKWASHER, 1/2"
22	TF4564	1	BELT SHEILD (RIGHT)
23	22016	4	FLATWASHER,3/8"
24	21630	4	CAPSCREW, 3/8 X 1,NC
25	21988	5	LOCKWASHER, 3/8"
26	21584	6	CAPSCREW, 5/16 X 2,NC
27	21987	6	LOCKWASHER, 5/16"
28	TF1025	1	KEY,1/4" X 1/2" X 1-7/8" SQ
29	TF1125	1	KEY,3/8" X 1/2" X 1-7/8" SQ
30	21727	1	NYLOCK NUT, 1/2
31	TF4852	2	KIT,FLANGE,#20
32	34227	1	PREFORMED TUBE
33	-----	-	HOSE (RETURN FOR STANDARD ROTATION)
34	-----	-	HOSE (PRESSURE FOR STANDARD ROTATION)
35	TB3031	1	CLAMP,HOSE
36	21638	1	CAPSCREW,3/8 X 3,NC

COMMON SIDE FLAIL - XD

# CABLE LIFT ARM ASSEMBLY

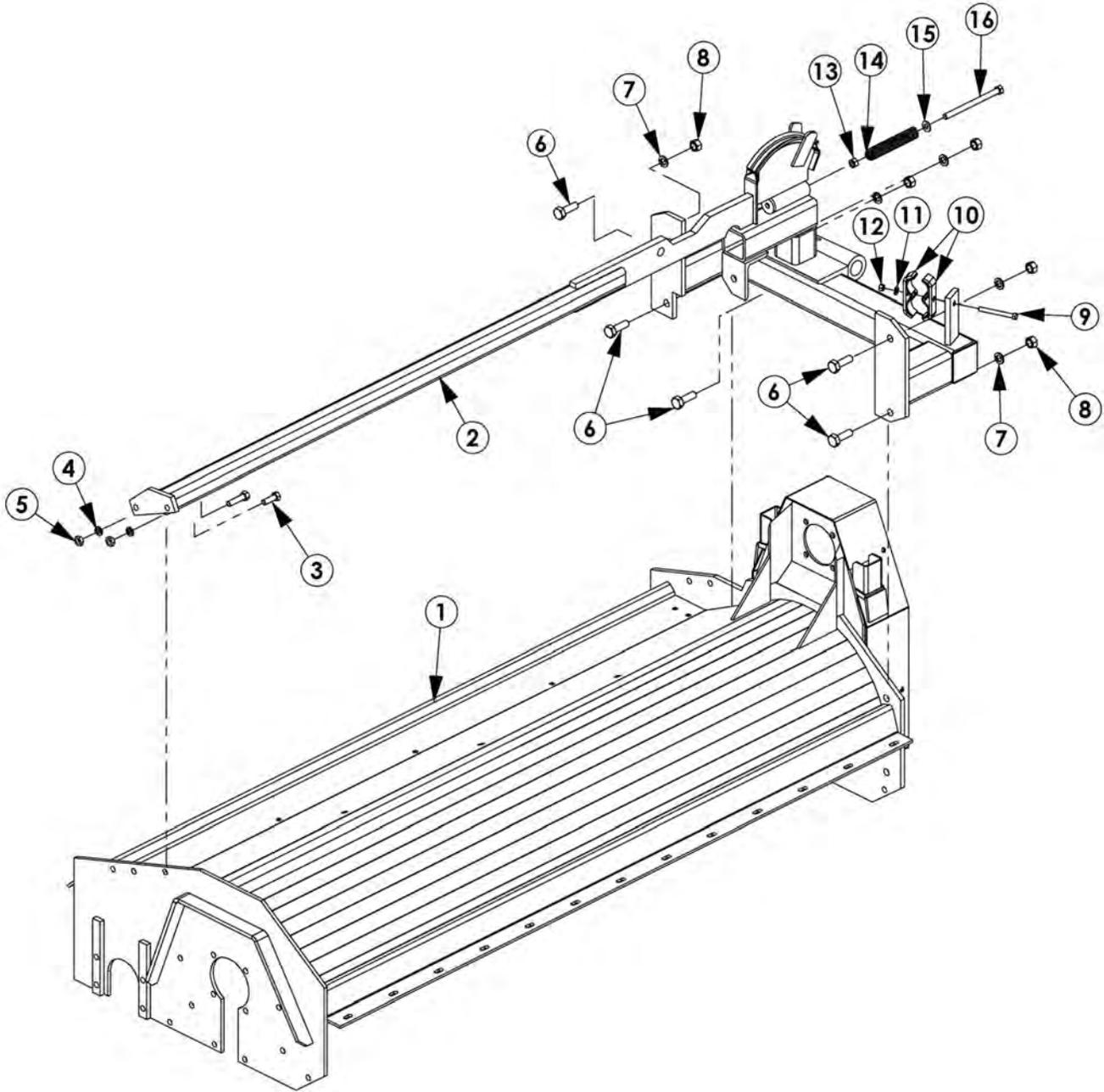

COMMON SIDE FLAIL - XD

## CABLE LIFT ARM ASSEMBLY

Continued...

ITEM	PART NO.	QTY.	DESCRIPTION
1	-----	-	BONNET *REFER TO FLAIL PARTS
2	21297C	1	LIFT ARM,TSF,60,CPLT
-----	21298C	-	LIFT ARM,TSF,75,CPLT
	27048A	-	LIFT ARM,TSF,90,CPLT
3	21733	2	CAPSCREW,1/2 X 2,NC
4	21990	2	LOCKWASHER,1/2
5	21725	2	HEX NUT,1/2,NC
6	21783	5	CAPSCREW,5/8 X 2,NC
7	21992	5	LOCKWASHER,5/8
8	21775	5	HEX NUT,5/8,NC
9	21640	1	CAPSCREW,3/8 X 3-1/2,NC
10	TB3031	2	CLAMP,HOSE
11	21988	1	LOCKWASHER,3/8
12	21625	1	HEX NUT,3/8,NC
13	21727	1	NYLOCK NUT,1/2,NC
14	27005	1	SPRING,PUSH-OFF
15	27938	1	MACHINED BUSHING
16	21745	1	CAPSCREW,1/2 X 7,NC

## 3IN X 10IN HYDRAULIC CYLINDER BREAKDOWN

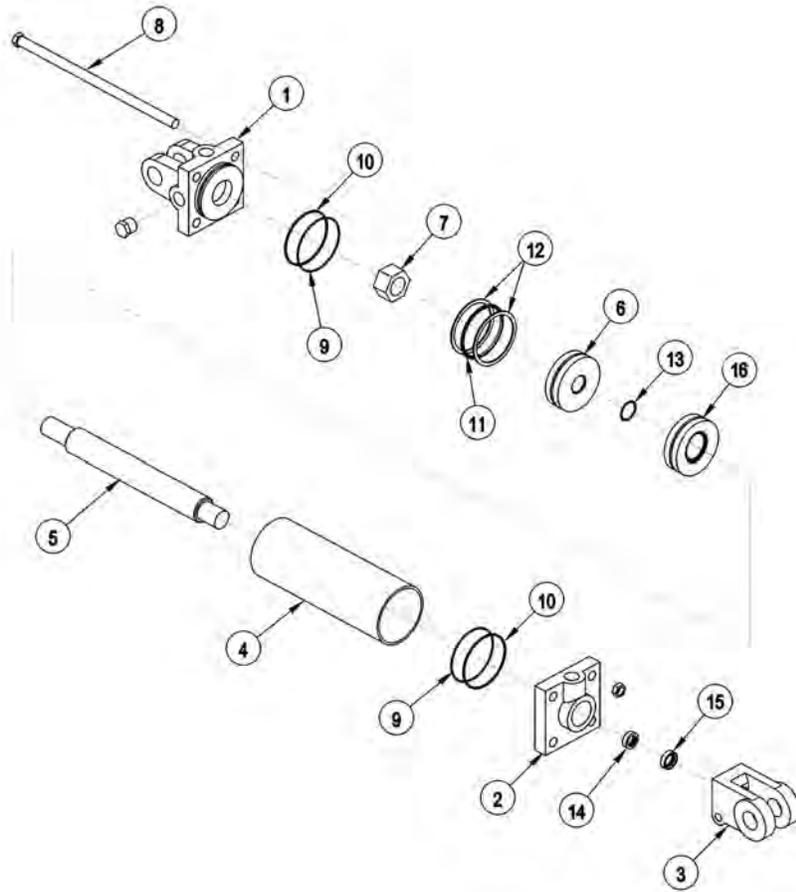

ITEM	PART NO.	QTY.	DESCRIPTION
-----	6T0151R	-	CYLINDER 3" X 10"
1	6T0167	1	CYLINDER BUTT
2	6T0170	1	CYLINDER GLAND
3	6T0178	1	CLEVIS END
4	6T0164	1	CYLINDER TUBE
5	6T0161	1	PISTON ROD
6	6T0173	1	PISTON
7	6T0179	1	LOCKNUT
8	6T0176	4	TIE ROD ASY
-----	6T0187	-	SEAL KIT
9	-----	2	O - RING
10	-----	2	BACK - UP WASHER
11	-----	1	O - RING
12	-----	2	BACK - UP WASHER
13	-----	1	O - RING
14	-----	1	U - CUP
15	-----	1	WIPER
16	NA	-	NA

COMMON SIDE FLAIL - XD

## 3IN X 12IN HYDRAULIC CYLINDER BREAKDOWN

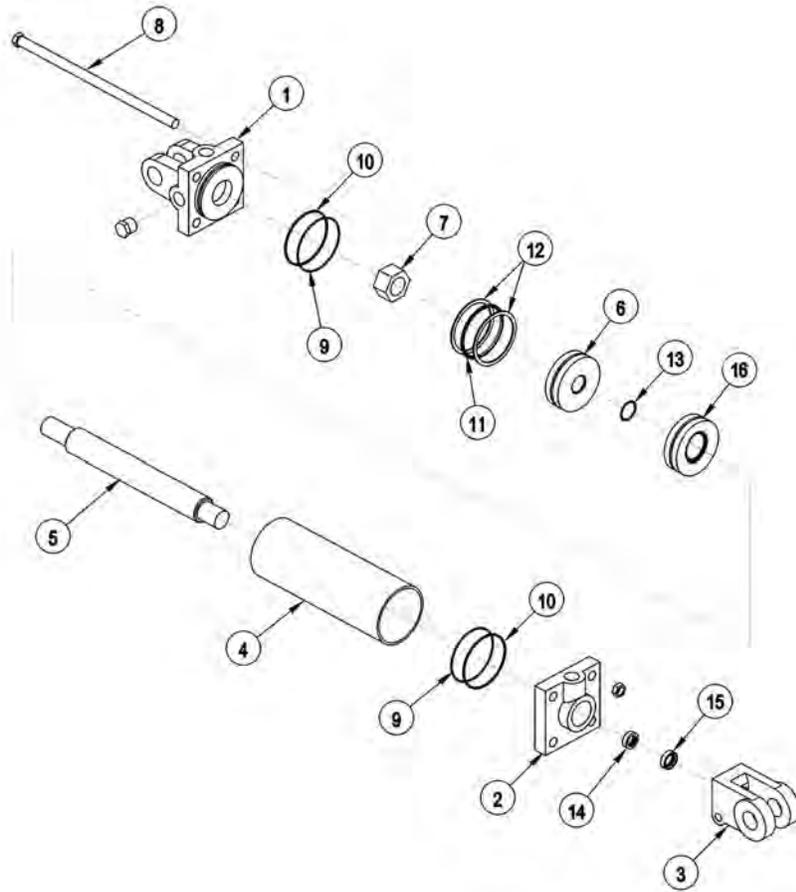

ITEM	PART NO.	QTY.	DESCRIPTION
-----	25343	-	CYLINDER 3" X 12"
1	6T0167	1	CYLINDER BUTT
2	6T0170	1	CYLINDER GLAND
3	6T0178	1	CLEVIS END
4	6T0204	1	CYLINDER TUBE
5	6T0203	1	PISTON ROD
6	6T0173	1	PISTON
7	6T0179	1	LOCKNUT
8	6T0205	4	TIE ROD ASY
-----	6T0187	-	SEAL KIT
9	-----	2	O - RING
10	-----	2	BACK - UP WASHER
11	-----	1	O - RING
12	-----	2	BACK - UP WASHER
13	-----	1	O - RING
14	-----	1	U - CUP
15	-----	1	WIPER
16	6T0206	1	SPACER

COMMON SIDE FLAIL - XD

## 3IN X 18IN HYDRAULIC CYLINDER BREAKDOWN

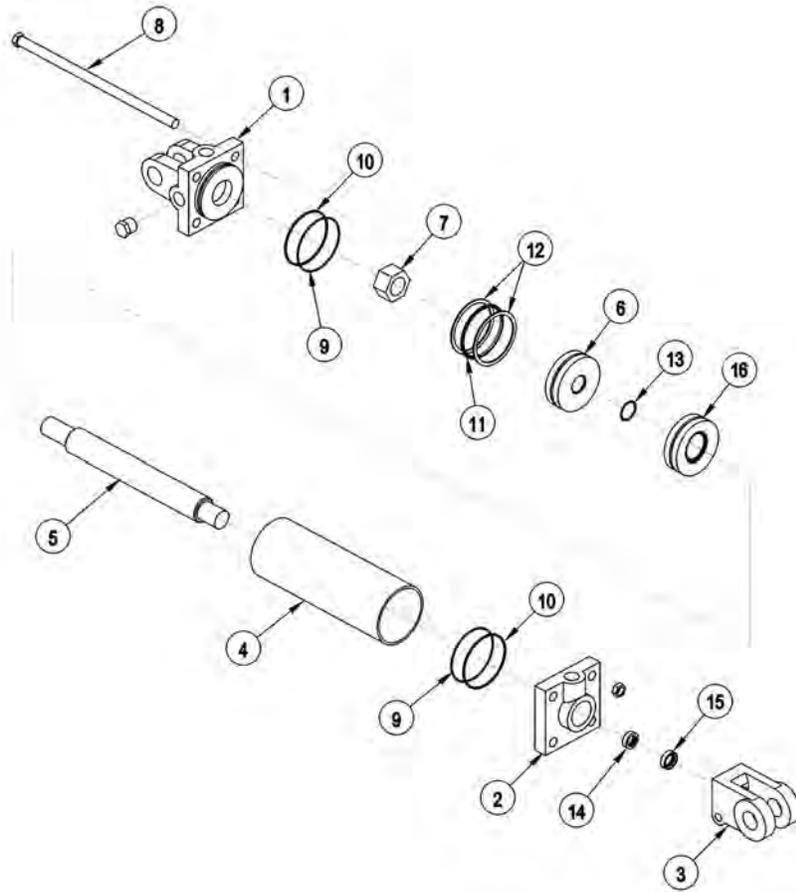

ITEM	PART NO.	QTY.	DESCRIPTION
-----	6T0150	-	CYLINDER 3" X 18"
1	6T0167	1	CYLINDER BUTT
2	6T0170	1	CYLINDER GLAND
3	6T0178	1	CLEVIS END
4	6T0165	1	CYLINDER TUBE
5	6T0162	1	PISTON ROD
6	6T0173	1	PISTON
7	6T0179	1	LOCKNUT
8	6T0177	4	TIE ROD ASY
-----	6T0187	-	SEAL KIT
9	-----	2	O - RING
10	-----	2	BACK - UP WASHER
11	-----	1	O - RING
12	-----	2	BACK - UP WASHER
13	-----	1	O - RING
14	-----	1	U - CUP
15	-----	1	WIPER
16	N/A	-	N/A

COMMON SIDE FLAIL - XD

## PUMP AND GRILL GUARD OPTIONS

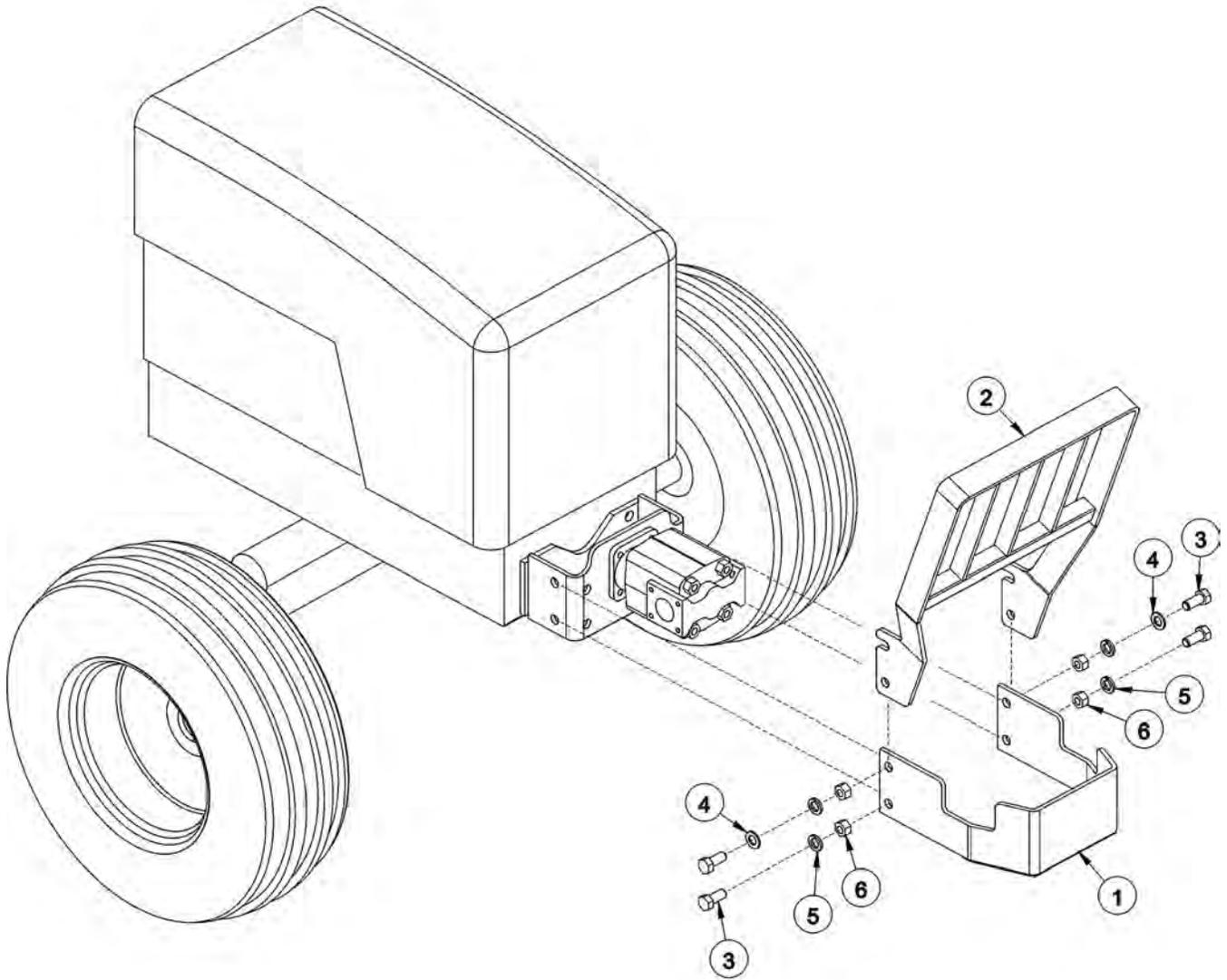

ITEM	PART NO.	QTY.	DESCRIPTION
1	32430	1	UNIVERSAL PUMP GUARD
2	32737	1	UNIVERSAL GRILL GUARD
3	21833	4	CAPSCREW,3/4" X 2-1/4",NC
4	22021	2	FLATWASHER,3/4"
5	21993	4	LOCKWASHER,3/4"
6	21825	4	HEX NUT,3/4",NC

COMMON SIDE FLAIL - XD

# RESERVOIR TANK FILTER ASSEMBLY

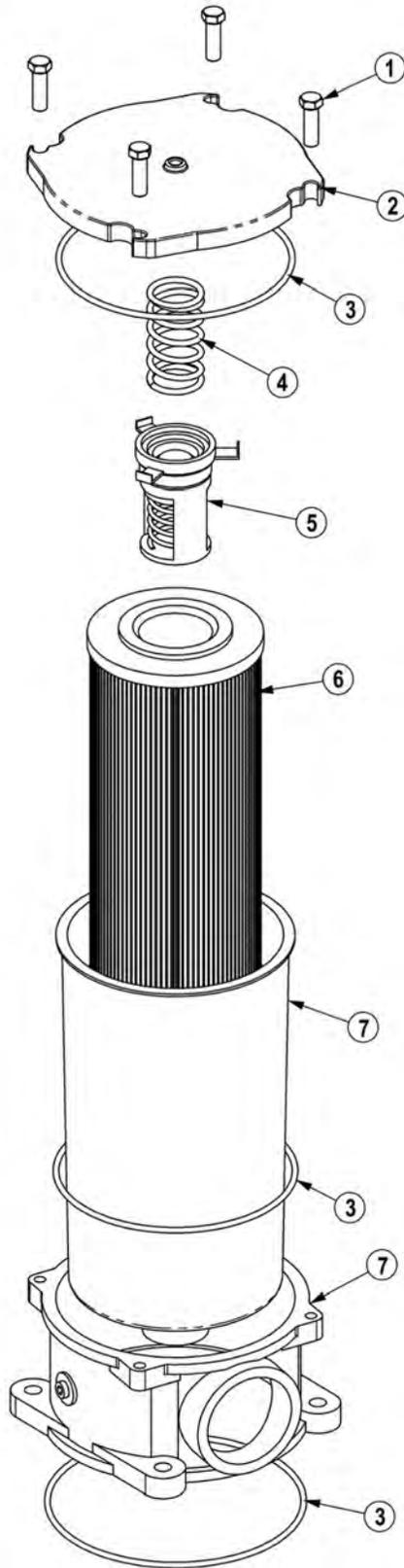



## RESERVOIR TANK FILTER ASSEMBLY

Continued...

ITEM	PART NO.	QTY.	DESCRIPTION
-----	06505044	-	FILTER ASSY SAE 10 MICRON
1	28583	4	CAPSCREW,8MM X 25MM(1.25 PITCH)
2	06505045	1	COVER
3	06505046	1	SEAL KIT
4	06505047	1	SPRING
5	06505048	1	BYPASS
6	35259	1	FILTER,10 MIC,RETURN LINE
7	06505049	1	CAN/BODY

CABLE (MANUAL) LIFT VALVE BREAKDOWN - 30198

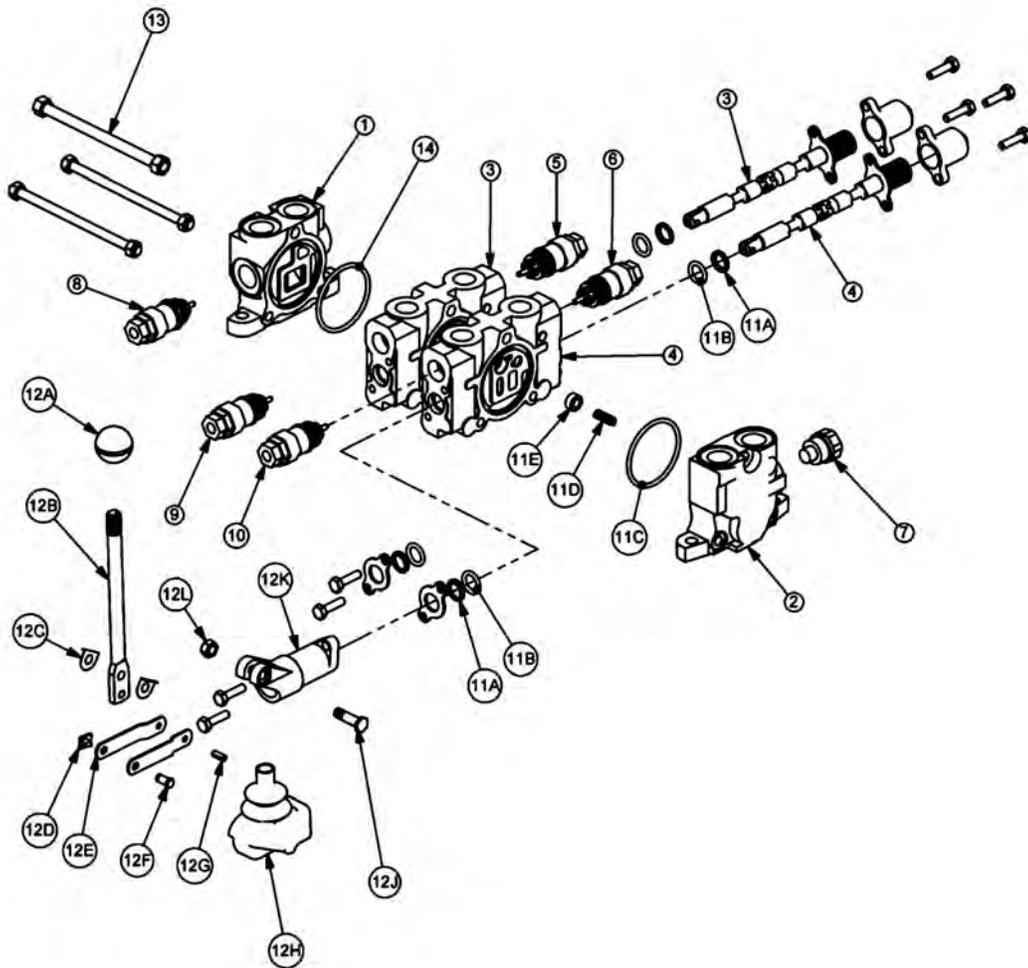

COMMON SIDE FLAIL - XD

## CABLE (MANUAL) LIFT VALVE BREAKDOWN - 30198

Continued...

ITEM	PART NO.	QTY.	DESCRIPTION
1	TB1017S	1	INLET END COVER
2	TB1702	1	END COVER, POWER BEYOND
3	TF3009	1	VALVE SECTION (DOUBLE ACTING, DETENT - FLOAT)
4	TF3009	1	VALVE SECTION (DOUBLE ACTING, DETENT - FLOAT)
5	06503067	1	RELIEF PLUG
6	TF4212	1	RELIEF VALVE, 200 PSI
7	TB1017M	1	SHUT-OFF PLUG
8	TB1017E	1	RELIEF VALVE, 2250 PSI
9	TB1017M	1	SHUT-OFF PLUG
10	TB1017M	1	SHUT-OFF PLUG
11	TB1017A	2	VALVE SEAL KIT (FOR ONE SECTION)
11A	-----	2	WIPER
11B	-----	2	O-RING SMALL
11C	-----	1	O-RING LARGE
11D	-----	1	SPRING
11E	-----	1	PUCKET
12	TB1017L	2	LEVER KIT (FOR ONE SECTION)
12A	-----	1	LEVER KNOB
12B	-----	1	LEVER
12C	-----	2	LEVER WASHER
12D	-----	1	LEVER CLIP
12E	-----	2	LINKAGE
12F	-----	1	LEVER PIN
12G	-----	1	ROLL PIN
12H	-----	1	LEVER BOOT
12J	-----	1	LEVER BOLT
12K	-----	1	LEVER DUST COVER
12L	-----	1	LEVER NUT
13	TB1017X	1	TIE ROD KIT
14	24214	1	O-RING, LARGE

# CABLE (MANUAL) LIFT VALVE BREAKDOWN - 31320

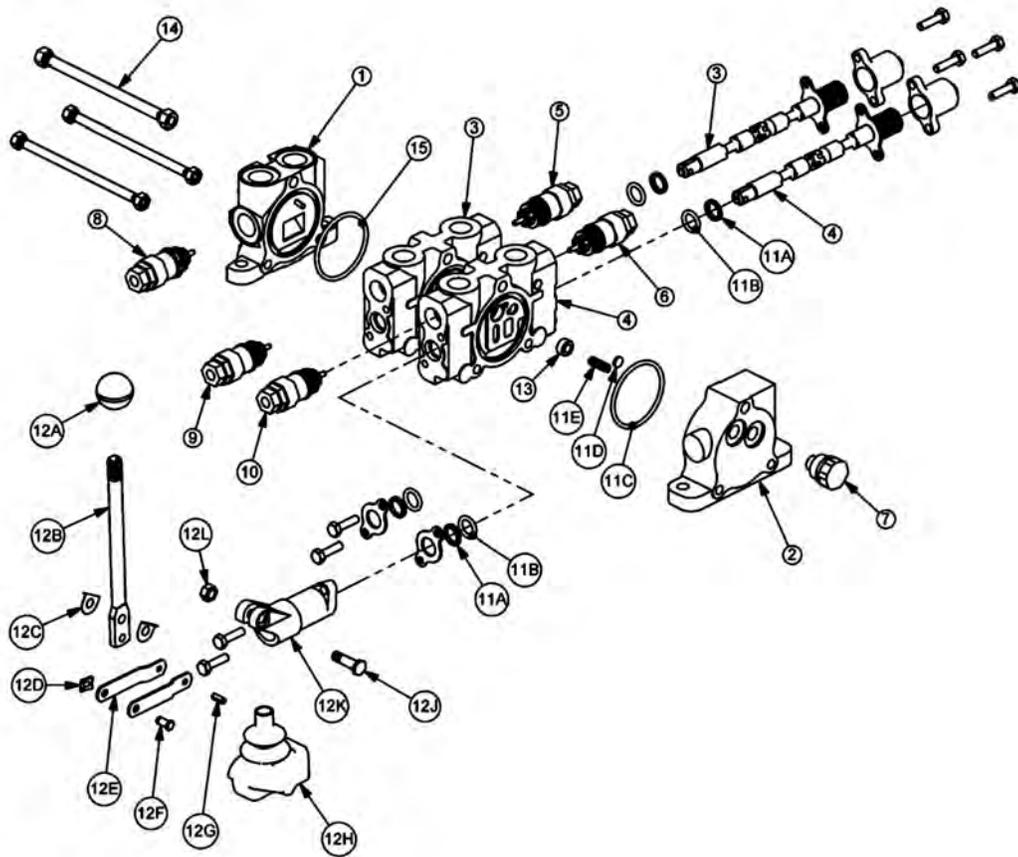

COMMON SIDE FLAIL - XD

## CABLE (MANUAL) LIFT VALVE BREAKDOWN - 31320

Continued...

ITEM	PART NO.	QTY.	DESCRIPTION
1	31595	1	INLET END COVER
2	31594	1	END COVER, LOAD SENSE
3	31597	1	VALVE SECTION (DOUBLE ACTING, CENTER SPRING)
4	31597	1	VALVE SECTION (DOUBLE ACTING, CENTER SPRING)
5	06503067	1	RELIEF PLUG
6	06503067	1	RELIEF PLUG
7	N/A	-	N/A
8	6T4209	1	RELIEF PLUG
9	31862	1	RELIEF VALVE, 2175 PSI
10	31862	1	RELIEF VALVE, 2175 PSI
11	31593	2	VALVE SEAL KIT (FOR ONE SECTION)
11A	-----	2	WIPER
11B	-----	2	O-RING SMALL
11C	-----	1	O-RING LARGE
11D	-----	1	SHUTTLE DISC
11E	-----	1	SPRING
12	TB1017L	2	LEVER KIT (FOR ONE SECTION)
12A	-----	1	LEVER KNOB
12B	-----	1	LEVER
12C	-----	2	LEVER WASHER
12D	-----	1	LEVER CLIP
12E	-----	2	LINKAGE
12F	-----	1	LEVER PIN
12G	-----	1	ROLL PIN
12H	-----	1	LEVER BOOT
12J	-----	1	LEVER BOLT
12K	-----	1	LEVER DUST COVER
12L	-----	1	LEVER NUT
13	31603	2	COMPENSATOR
14	TB1017X	1	TIE ROD KIT
15	24214	1	O-RING, LARGE

# CABLE (MANUAL) LIFT VALVE BREAKDOWN - 31322

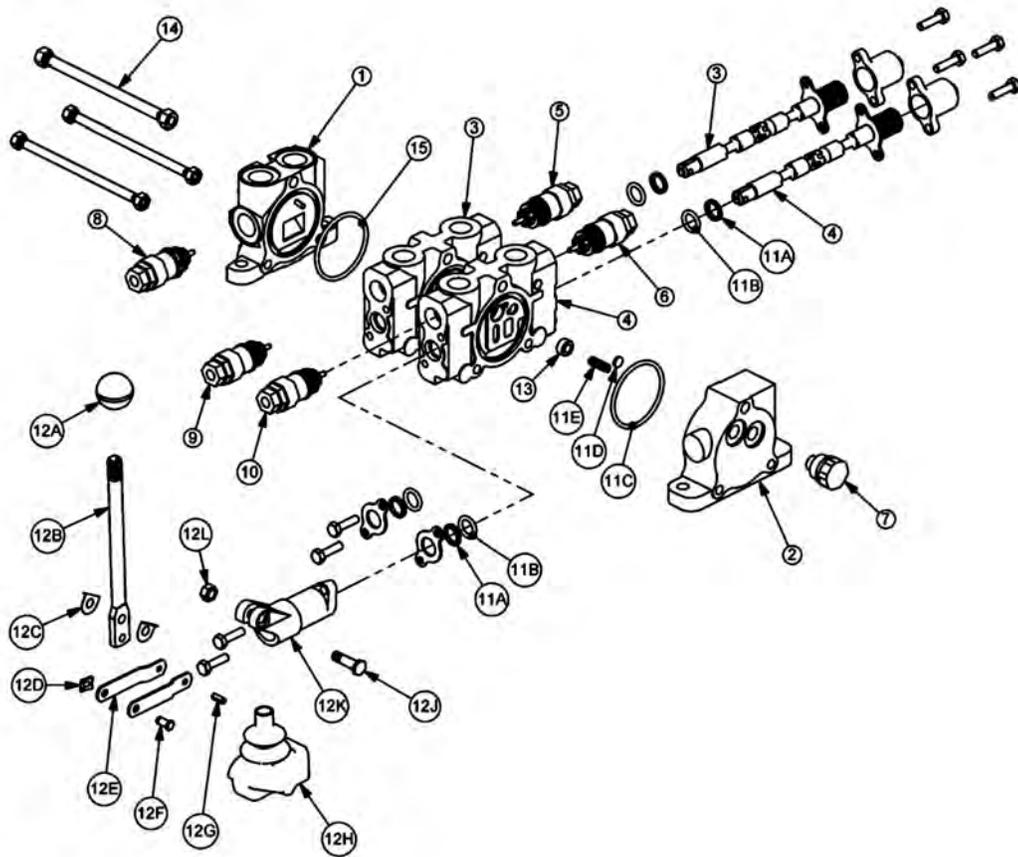

COMMON SIDE FLAIL - XD

## CABLE (MANUAL) LIFT VALVE BREAKDOWN - 31322

Continued...

ITEM	PART NO.	QTY.	DESCRIPTION
1	31595	1	INLET END COVER
2	31594	1	END COVER, LOAD SENSE
3	31600	1	VALVE SECTION (DOUBLE ACTING, DETENT-FLOAT)
4	31600	1	VALVE SECTION (DOUBLE ACTING, DETENT-FLOAT)
5	06503067	1	RELIEF PLUG
6	31861	1	RELIEF VALVE, 360 PSI
7	N/A	-	N/A
8	6T4209	1	RELIEF PLUG
9	31862	1	RELIEF VALVE, 2175 PSI
10	31862	1	RELIEF VALVE, 2175 PSI
11	31593	2	VALVE SEAL KIT (FOR ONE SECTION)
11A	-----	2	WIPER
11B	-----	2	O-RING SMALL
11C	-----	1	O-RING LARGE
11D	-----	1	SHUTTLE DISC
11E	-----	1	SPRING
12	TB1017L	2	LEVER KIT (FOR ONE SECTION)
12A	-----	1	LEVER KNOB
12B	-----	1	LEVER
12C	-----	2	LEVER WASHER
12D	-----	1	LEVER CLIP
12E	-----	2	LINKAGE
12F	-----	1	LEVER PIN
12G	-----	1	ROLL PIN
12H	-----	1	LEVER BOOT
12J	-----	1	LEVER BOLT
12K	-----	1	LEVER DUST COVER
12L	-----	1	LEVER NUT
13	31603	2	COMPENSATOR
14	TB1017X	1	TIE ROD KIT
15	24214	1	O-RING, LARGE

CABLE (MANUAL) LIFT VALVE BREAKDOWN - 31752

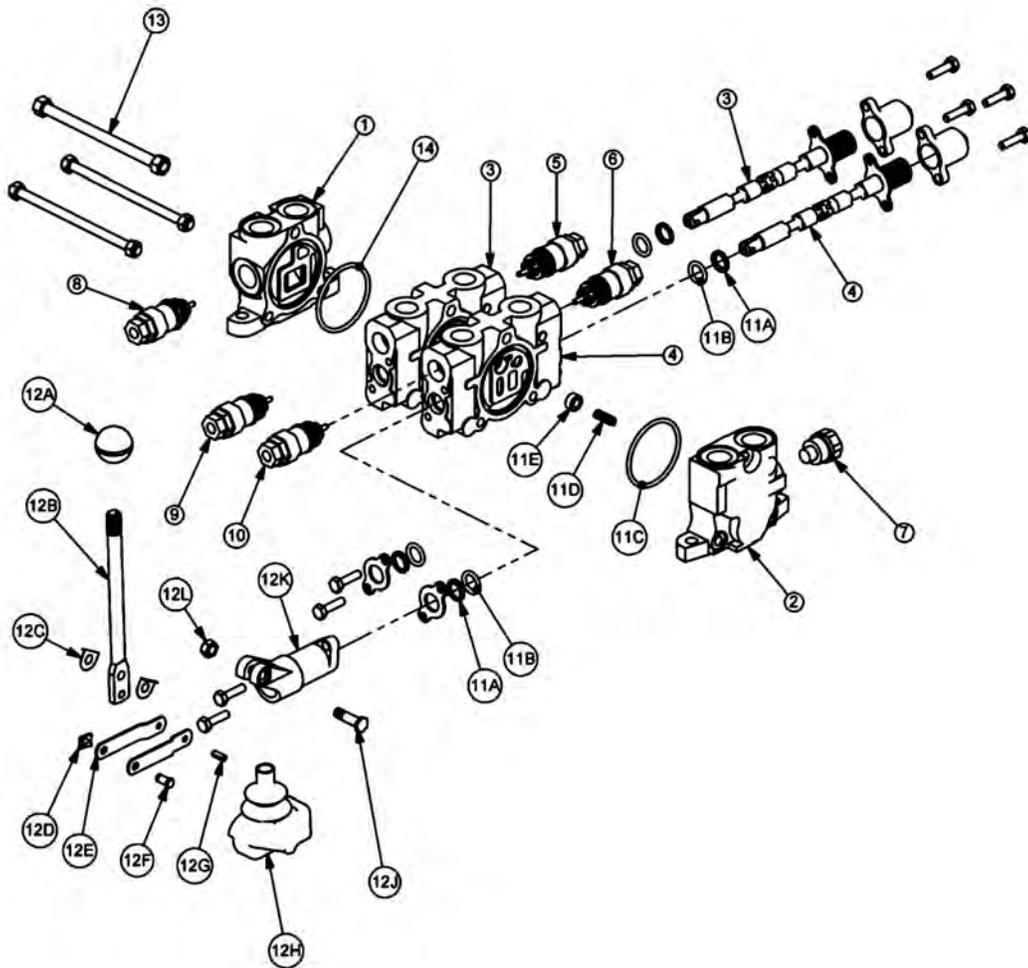

COMMON SIDE FLAIL - XD



## CABLE (MANUAL) LIFT VALVE BREAKDOWN - 31752

Continued...

ITEM	PART NO.	QTY.	DESCRIPTION
1	TB1017S	1	INLET END COVER
2	TB1702	1	END COVER, POWER BEYOND
3	TB1017P	1	VALVE SECTION (SINGLE ACTING, SPRING DETENT)
4	TB1017P	1	VALVE SECTION (SINGLE ACTING, SPRING DETENT)
5	N/A	-	N/A
6	N/A	-	N/A
7	TB1017M	1	SHUT-OFF PLUG
8	TB1017E	1	RELIEF VALVE, 2250 PSI
9	TB1017M	1	SHUT-OFF PLUG
10	TB1017M	1	SHUT-OFF PLUG
11	TB1017A	2	VALVE SEAL KIT (FOR ONE SECTION)
11A	-----	2	WIPER
11B	-----	2	O-RING SMALL
11C	-----	1	O-RING LARGE
11D	-----	1	SPRING
11E	-----	1	PUCKET
12	TB1017L	2	LEVER KIT (FOR ONE SECTION)
12A	-----	1	LEVER KNOB
12B	-----	1	LEVER
12C	-----	2	LEVER WASHER
12D	-----	1	LEVER CLIP
12E	-----	2	LINKAGE
12F	-----	1	LEVER PIN
12G	-----	1	ROLL PIN
12H	-----	1	LEVER BOOT
12J	-----	1	LEVER BOLT
12K	-----	1	LEVER DUST COVER
12L	-----	1	LEVER NUT
13	TB1017X	1	TIE ROD KIT
14	24214	1	O-RING, LARGE

CABLE (MANUAL) LIFT VALVE BREAKDOWN - 06502040

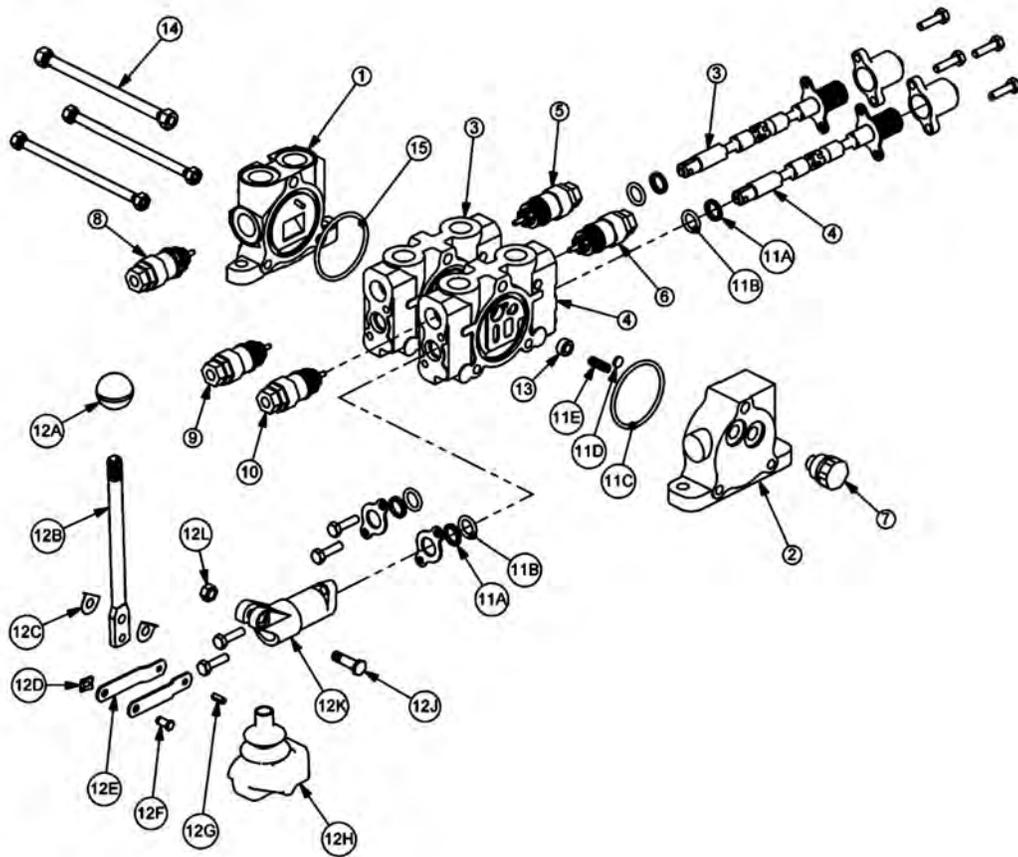

COMMON SIDE FLAIL - XD

## CABLE (MANUAL) LIFT VALVE BREAKDOWN - 06502040

Continued...

ITEM	PART NO.	QTY.	DESCRIPTION
1	31595	1	INLET END COVER
2	31594	1	END COVER, LOAD SENSE
3	31597	1	VALVE SECTION (DOUBLE ACTING, CENTER SPRING)
4	31597	1	VALVE SECTION (DOUBLE ACTING, CENTER SPRING) (REMOVE SHUTTLE DISC)
5	06503067	1	RELIEF PLUG
6	06503067	1	RELIEF PLUG
7	06503068	1	RELIEF PLUG
8	N/A	-	N/A
9	31862	1	RELIEF VALVE, 2175 PSI
10	31862	1	RELIEF VALVE, 2175 PSI
11	31593	2	VALVE SEAL KIT (FOR ONE SECTION)
11A	-----	2	WIPER
11B	-----	2	O-RING SMALL
11C	-----	1	O-RING LARGE
11D	-----	1	SHUTTLE DISC
11E	-----	1	SPRING
12	TB1017L	2	LEVER KIT (FOR ONE SECTION)
12A	-----	1	LEVER KNOB
12B	-----	1	LEVER
12C	-----	2	LEVER WASHER
12D	-----	1	LEVER CLIP
12E	-----	2	LINKAGE
12F	-----	1	LEVER PIN
12G	-----	1	ROLL PIN
12H	-----	1	LEVER BOOT
12J	-----	1	LEVER BOLT
12K	-----	1	LEVER DUST COVER
12L	-----	1	LEVER NUT
13	31603	2	COMPENSATOR
14	TB1017X	1	TIE ROD KIT
15	24214	1	O-RING, LARGE

# CABLE (MANUAL) LIFT VALVE BREAKDOWN - 06502042

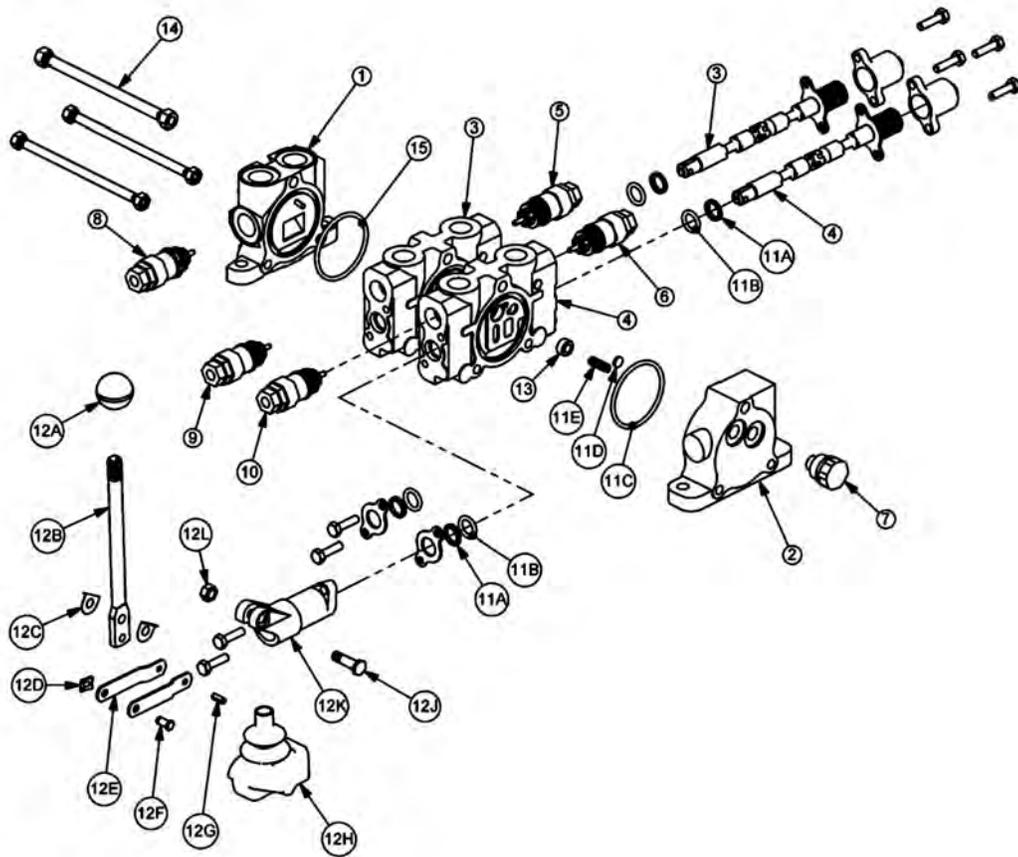

## CABLE (MANUAL) LIFT VALVE BREAKDOWN - 06502042

Continued...

ITEM	PART NO.	QTY.	DESCRIPTION
1	31595	1	INLET END COVER
2	31594	1	END COVER, LOAD SENSE
3	31600	1	VALVE SECTION (DOUBLE ACTING, DETENT FLOAT)
4	31600	1	VALVE SECTION (DOUBLE ACTING, DETENT FLOAT) (REMOVE SHUTTLE DISC)
5	06503067	1	RELIEF PLUG
6	31861	1	RELIEF VALVE, 360 PSI
7	06503068	1	RELIEF PLUG
8	6T4209	1	RELIEF PLUG
9	31862	1	RELIEF VALVE, 2175 PSI
10	31862	1	RELIEF VALVE, 2175 PSI
11	31593	2	VALVE SEAL KIT (FOR ONE SECTION)
11A	-----	2	WIPER
11B	-----	2	O-RING SMALL
11C	-----	1	O-RING LARGE
11D	-----	1	SHUTTLE DISC
11E	-----	1	SPRING
12	TB1017L	2	LEVER KIT (FOR ONE SECTION)
12A	-----	1	LEVER KNOB
12B	-----	1	LEVER
12C	-----	2	LEVER WASHER
12D	-----	1	LEVER CLIP
12E	-----	2	LINKAGE
12F	-----	1	LEVER PIN
12G	-----	1	ROLL PIN
12H	-----	1	LEVER BOOT
12J	-----	1	LEVER BOLT
12K	-----	1	LEVER DUST COVER
12L	-----	1	LEVER NUT
13	31603	2	COMPENSATOR
14	TB1017X	1	TIE ROD KIT
15	24214	1	O-RING, LARGE

COMMON SIDE FLAIL - XD

# FRONT HYDRAULIC PUMP BREAKDOWN

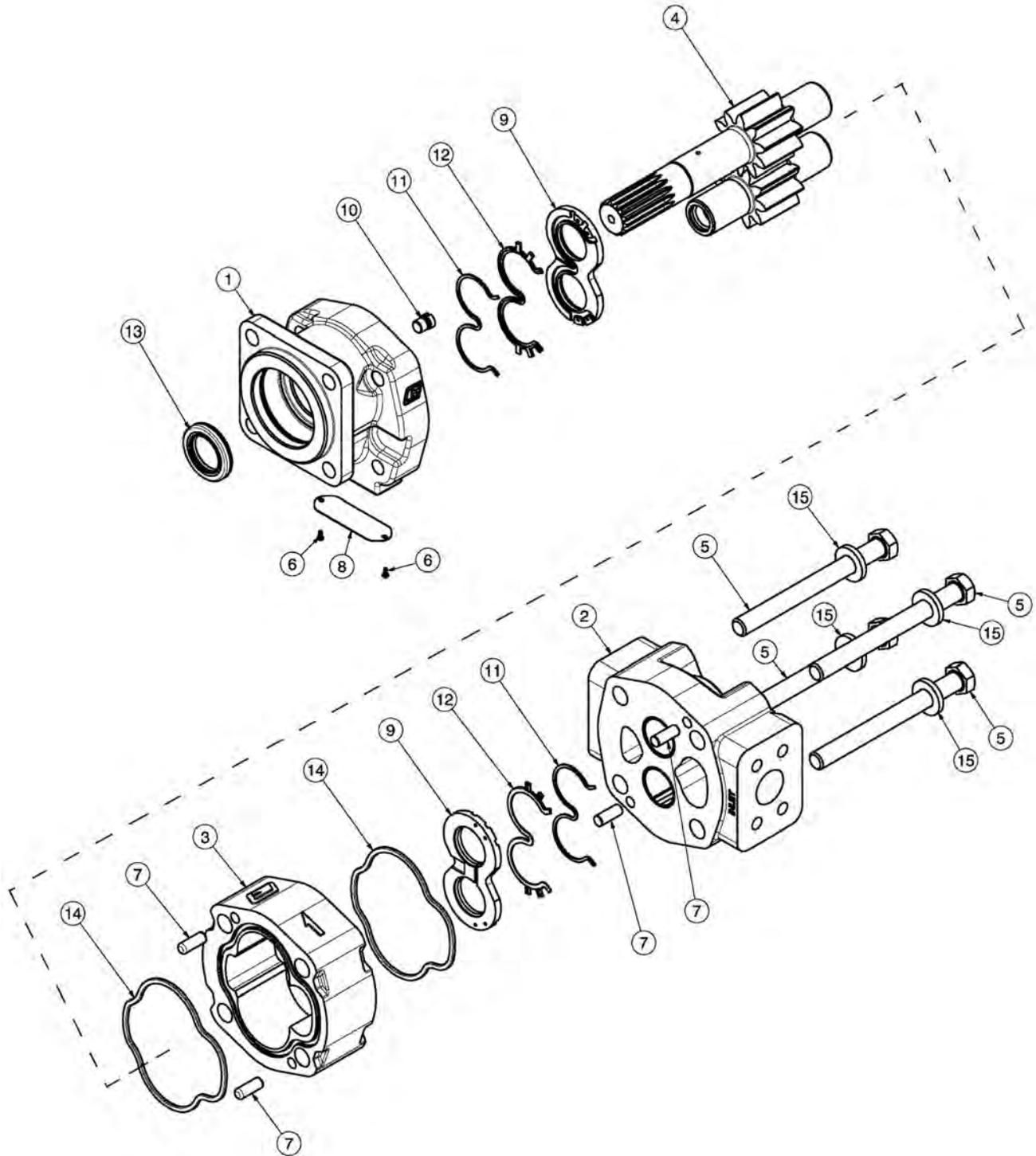

COMMON SIDE FLAIL - XD

## FRONT HYDRAULIC PUMP BREAKDOWN

Continued...

ITEM	PART NO.	QTY.	DESCRIPTION
---	23152	1	PUMP ASSEMBLY,1-3/4",COMPLETE
1	22766	1	SHAFT END COVER
2	22779	1	PORT END COVER
3	22774	1	GEAR HOUSING,1-3/4"
4	22771	1	GEAR SET
5	23824	4	CAPSCREW
6	06504078	2	SCREW,DRIVE
7	22773	4	DOWEL PINS
8	06504077	1	NAMEPLATE
9	22770	2	THRUST PLATE
10	22767	1	PLUG
11	06504075	2	SEAL,BK-UP
12	06504074	2	SEAL,CHAN
13	22765	1	SEAL,LIP
14	06504076	2	SEAL,SQ-R
15	02961917	4	WASHER
---	24150	1	SEAL KIT (INCLUDES 11, 12, 13 AND 14)

# FLAIL MOTOR BREAKDOWN

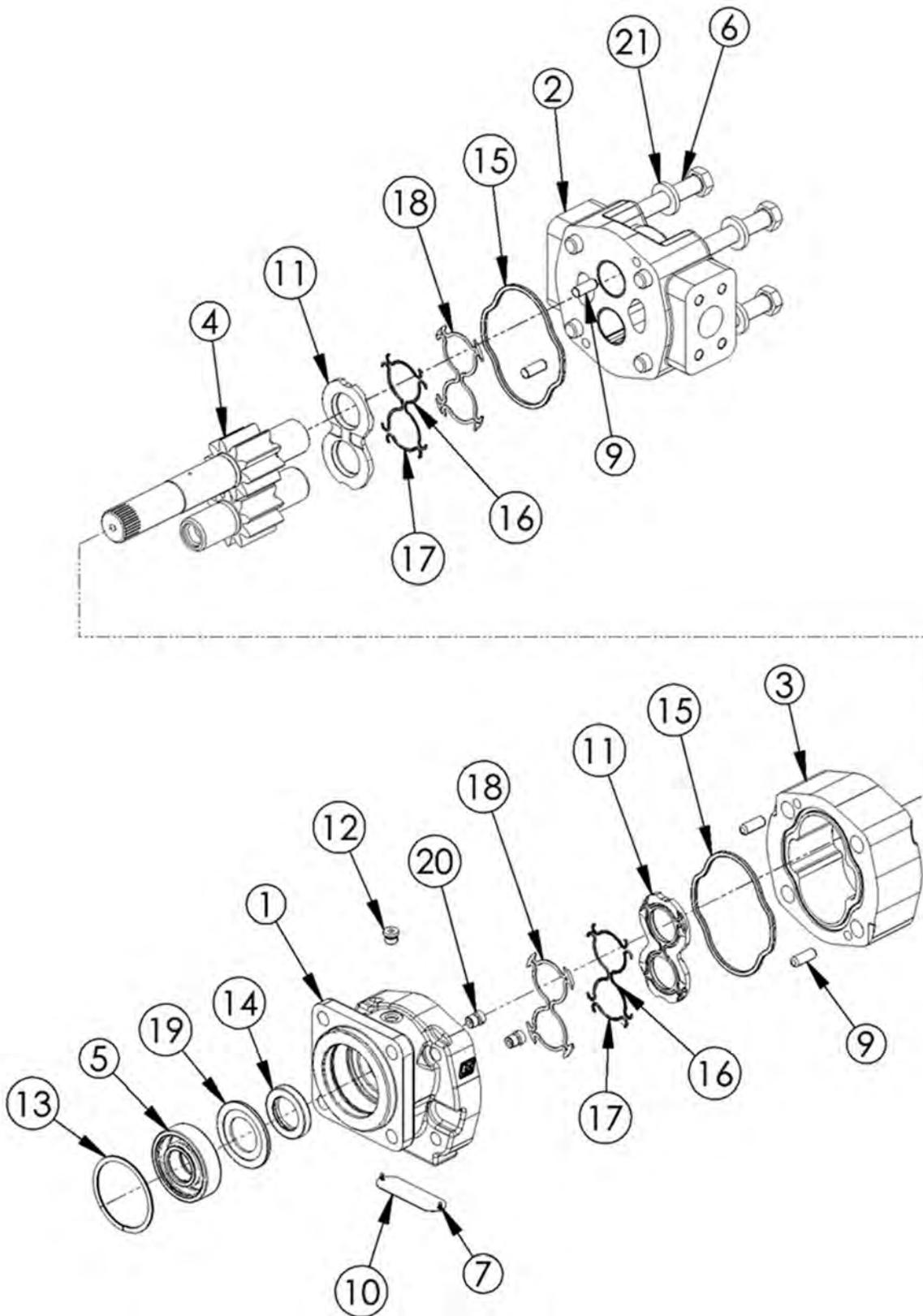

COMMON SIDE FLAIL - XD



## FLAIL MOTOR BREAKDOWN

Continued...

ITEM	PART NO.	QTY.	DESCRIPTION
-----	06504132	-	MOTOR ASSEMBLY 350 - TSF
1	06504039	1	SHAFT END COVER
2	06504040	1	PORT END COVER
3	06504041	1	GEAR HOUSING
4	06504042	1	MATCHED GEAR SET
5	TF4402	1	BALL BEARING
6	06504043	4	CAP SCREW
7	06504044	2	SET SCREW
8	06504028	1	KEY
9	06504045	4	DOWEL PIN
10	-----	1	NAMEPLATE
11	22763759	2	THRUSTPLATE
12	02961940	1	HEX PLUG
13	TF4401	1	SNAP RING
14	06504049	1	LIP SEAL (INCLUDED IN SEAL KIT)
15	TF4410	2	GASKET SEAL (INCLUDED IN SEAL KIT)
16	06504046	4	SIDE SEAL (INCLUDED IN SEAL KIT)
17	06504047	4	END SEAL (INCLUDED IN SEAL KIT)
18	TF4407	2	BACK-UP SEAL (INCLUDED IN SEAL KIT)
19	06504048	1	SEAL RETAINER
20	6T5809	2	CHECK ASSEMBLY
21	02961917	4	WASHER
-----	06504023	-	SEAL KIT (INCLUDES 14, 15, 16, 17, AND 18)

# COOLER ASSEMBLY

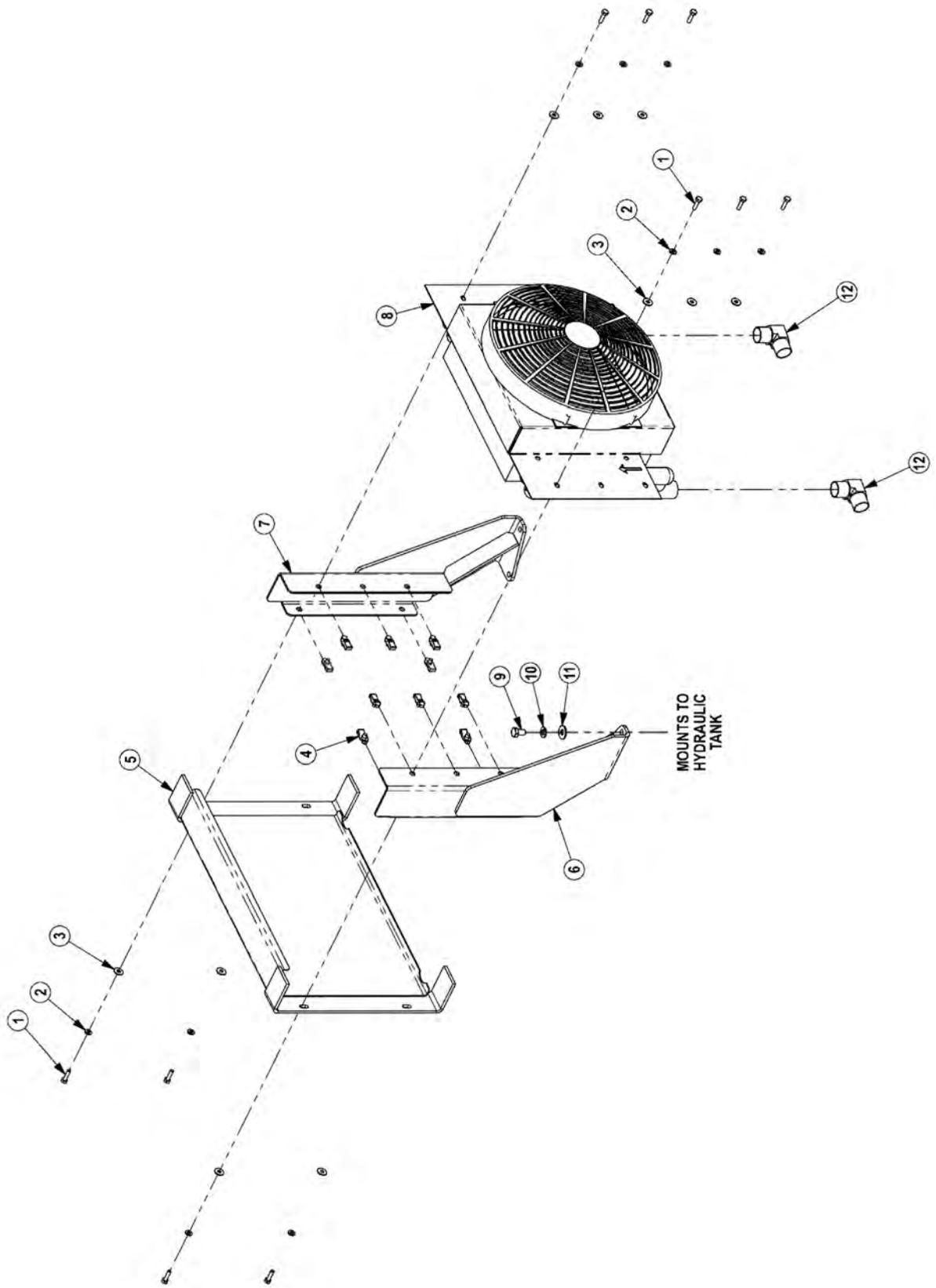

## COOLER ASSEMBLY

Continued...

ITEM	PART NO.	QTY.	DESCRIPTION
1	21530	10	CAPSCREW,1/4 X1 NC
2	21986	10	LOCKWASHER,1/4
3	22014	10	FLATWASHER,1/4
4	35176	10	1/4 U-NUT
5	06370015	1	SCREEN,COOLER,FRNT
6	06380006	1	MNT,COOLER,BUMPER TANK,RH
7	06380007	1	MNT,COOLER,BUMPER TANK,LH
8	06510026	1	COOLER,FRONT MNT
---	06510029	1	FAN ASSY, ONLY
9	21629	4	CAPSCREW,3/8 X 3/4 NC
10	21988	4	LOCKWASHER,3/8
11	22016	4	FLATWASHER,3/8
12	34117	2	ELBOW,1MOR X 1MJ90,FORGED

COMMON SIDE FLAIL - XD

## BRAKE VALVE ASSEMBLY

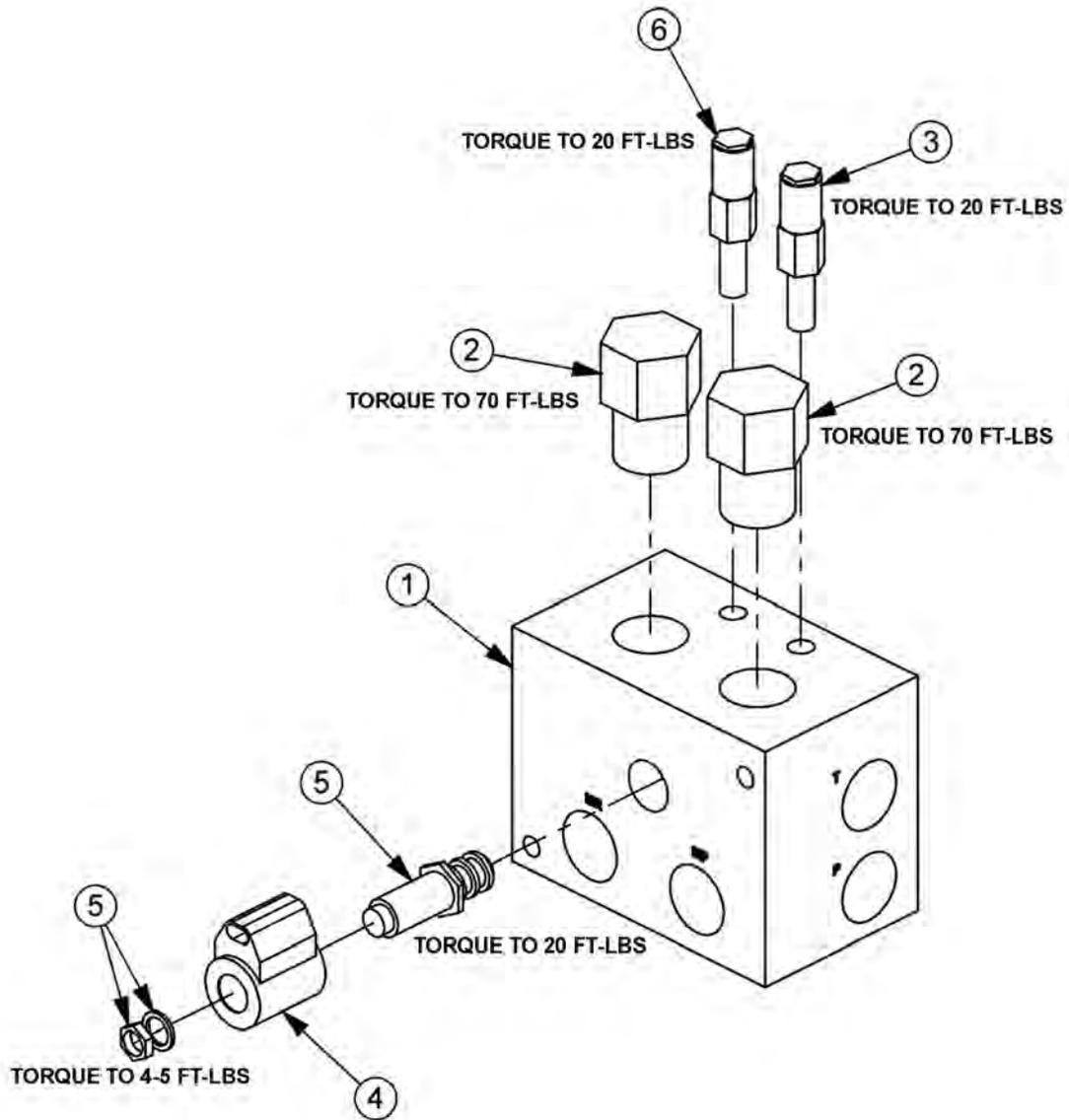

ITEM	PART NO.	QTY.	DESCRIPTION
---	06510083	1	BRAKE VALVE, ASSY
1	34092	1	BRAKE VALVE, BLANK
2	34094	2	LOGIC ELEMENT
3	34095	1	RELIEF VALVE, 3000 PSI
4	06510095	1	METRI PAK COIL
5	34093	1	CARTRIDGE, 2 POSITION, 3 WAY (WITH NUT & WASHER)
6	34091	1	RELIEF VALVE, 2600 PSI
---	34096	2	RELIEF SEAL KIT
----	34097	1	SOLENOID SEAL KIT
---	34098	2	ELEMENT SEAL KIT

COMMON SIDE FLAIL - XD

## BRAKE VALVE HYDRAULIC SCHEMATIC

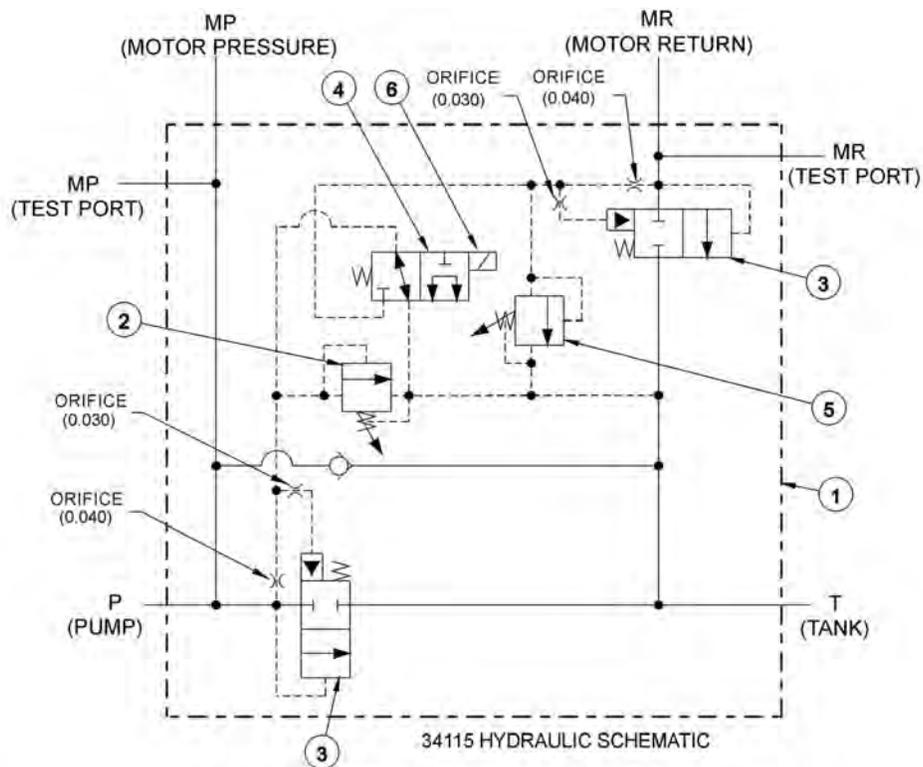

### BRAKE VALVE TROUBLESHOOTING

#### FAILURE MODE:

- MOWER WILL NOT START - system pressure is low (engine not lugging).
- MOWER WILL NOT START - system pressure is high (engine lugging). "MR" port will be high pressure.
- MOWER WILL NOT ROTATE AT FULL SPEED - limited power.
- MOWER BLADE WILL NOT STOP - blade will not stop in proper time.

#### CHECK STEPS

- 1 thru 6
- 7
- 3 thru 5
- 7 thru 9

#### CORRECTIVE STEPS:

1. Check for voltage at solenoid (item 6), voltage must be between 10.2 volts and 13.8 volts.
2. Remove, inspect solenoid and cartridge (items 4, 6) for wear or contamination.
3. Remove, inspect logic elements near "P" port (item 3) for wear or contamination.
4. Remove, inspect 3000 psi relief valve (item 2) for wear or contamination.
5. Remove and inspect orifices near "P" port for contamination.
6. Remove "P" port hose and fitting, visually inspect for contamination, check ball for movement.
7. Remove and inspect orifices near "MR" port for contamination.
8. Remove, inspect 2600 psi relief valve (item 5) for wear of contamination.
9. Remove, inspect logic element near "MR" port (item 3) for wear or contamination.

## SIDE FLAIL TRAVEL LOCK

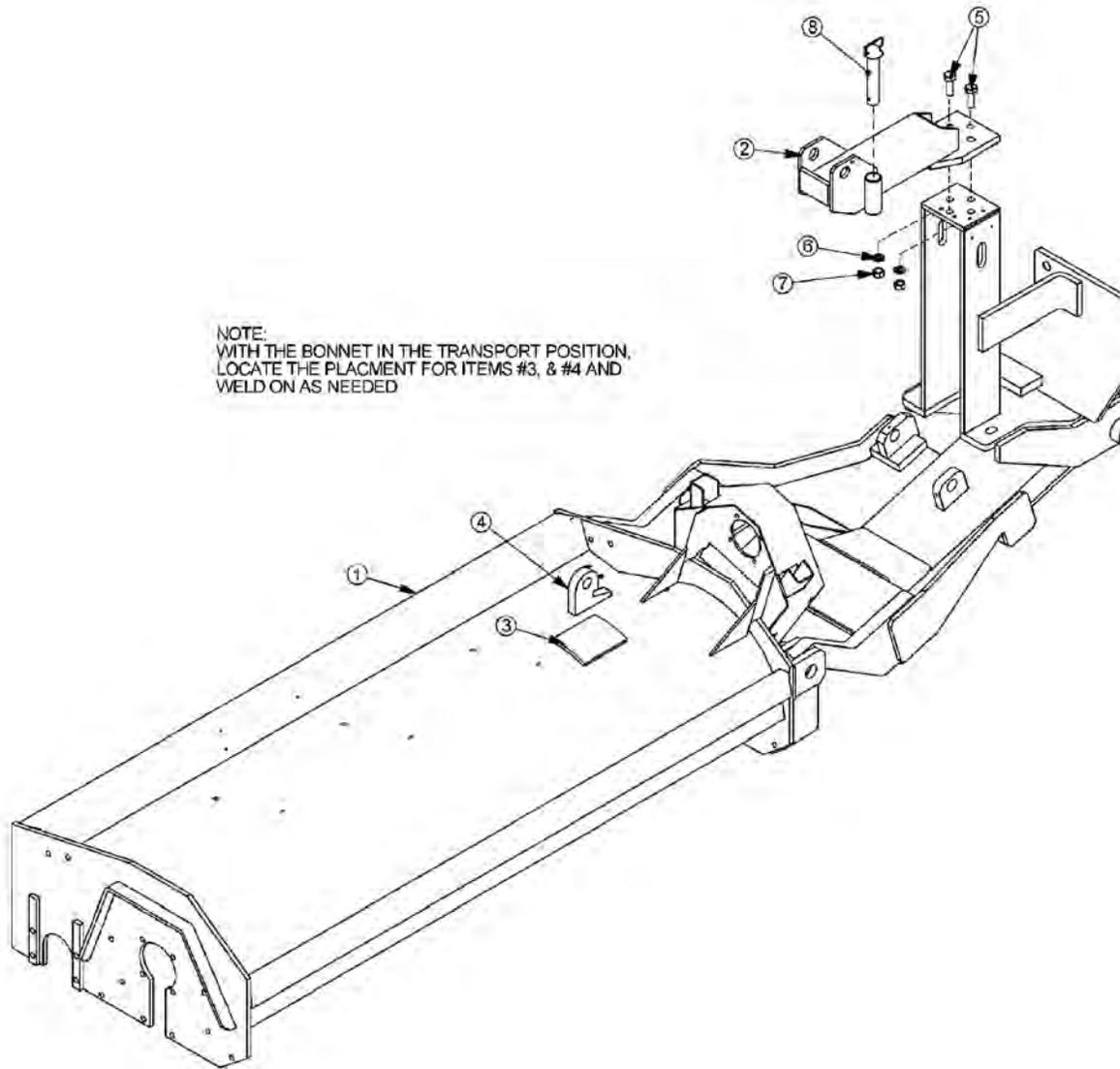

ITEM	PART NO.	QTY.	DESCRIPTION
1	-----	-	BONNET *REFER TO FLAIL ASSEMBLY
2	30531A	1	BRACKET, TRAVEL LOCK
3	TF4248	1	PLATE, TRAVEL LOCK
4	23745	1	TRAVEL LOCK HOOK
5	21783	2	CAPSCREW, 5/8" X 2" NC
6	21992	2	LOCKWASHER, 5/8"
7	21775	2	HEX NUT, 5/8" NC
8	TF4250	1	PIN, TRAVEL LOCK

## CABLE LIFT BEAM TRAVEL LOCK

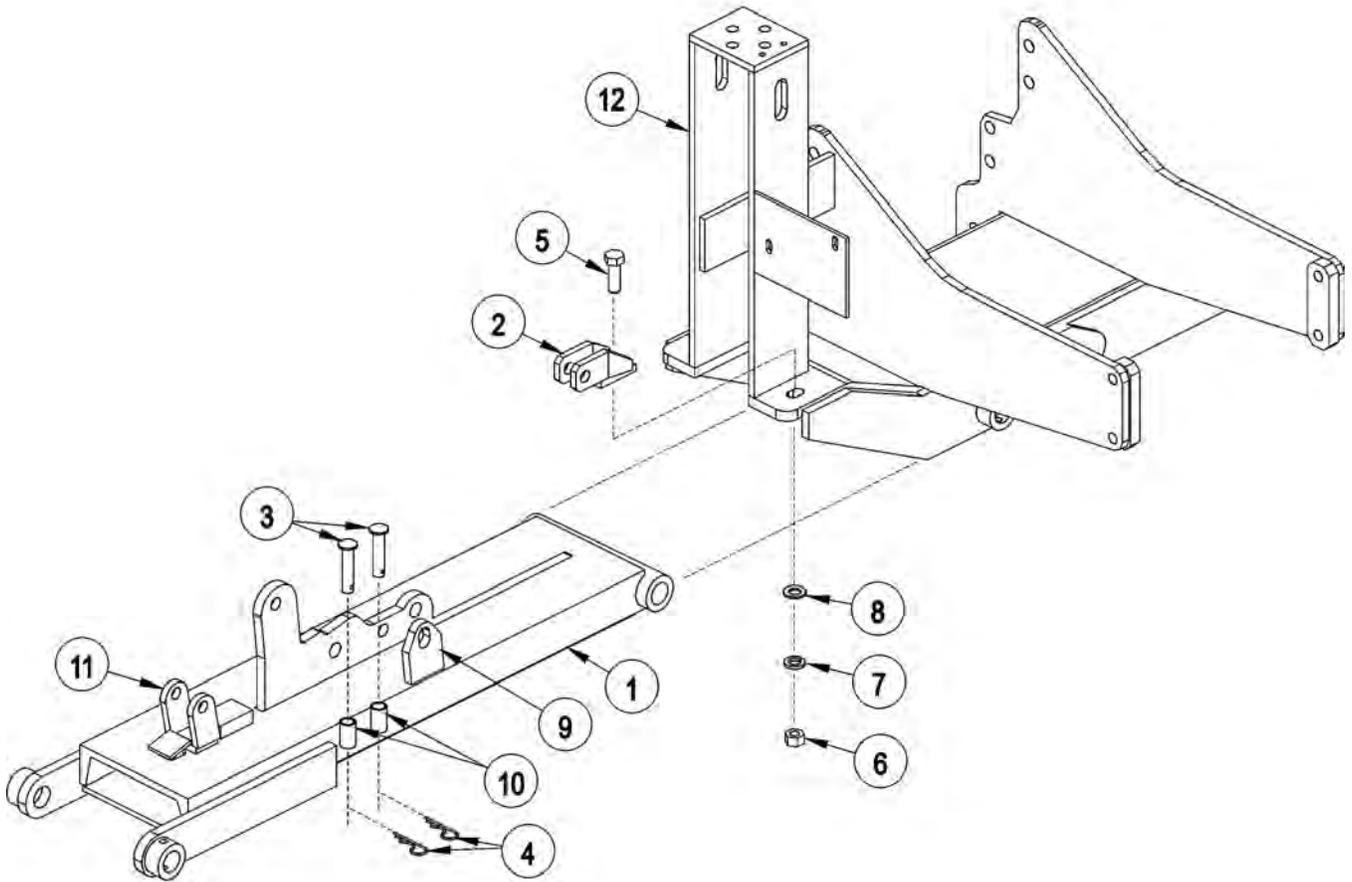

ITEM	PART NO.	QTY.	DESCRIPTION
1	6T0105	1	DRAFT BEAM (STD WITH TRAVEL LOCKS)
-----	27241	-	DRAFT BEAM EXT 6 (STD WITH TRAVEL LOCKS)
2	6T0106	1	TRAVEL LOCK BRACKET
3	6T0107	2	TRAVEL LOCK PINS 3/4" X 3 1/4"
4	6T3020	2	R - CLIP 5/32"
5	21833	1	CAPSCREW 3/4" X 2 1/4"
6	21825	1	HEX NUT 3/4"
7	21993	1	LOCK WASHER 3/4"
8	22021	1	FLAT WASHER 3/4"
9	22600	1	TRAVEL LOCK EAR
10	22604	2	PIN HOLDER
11	22601C	1	TRAVEL LOCK ASY
12	-----	-	MAIN FRAME *REFER TO PARTS SECTION

## COMBO LIFT BEAM TRAVEL LOCK

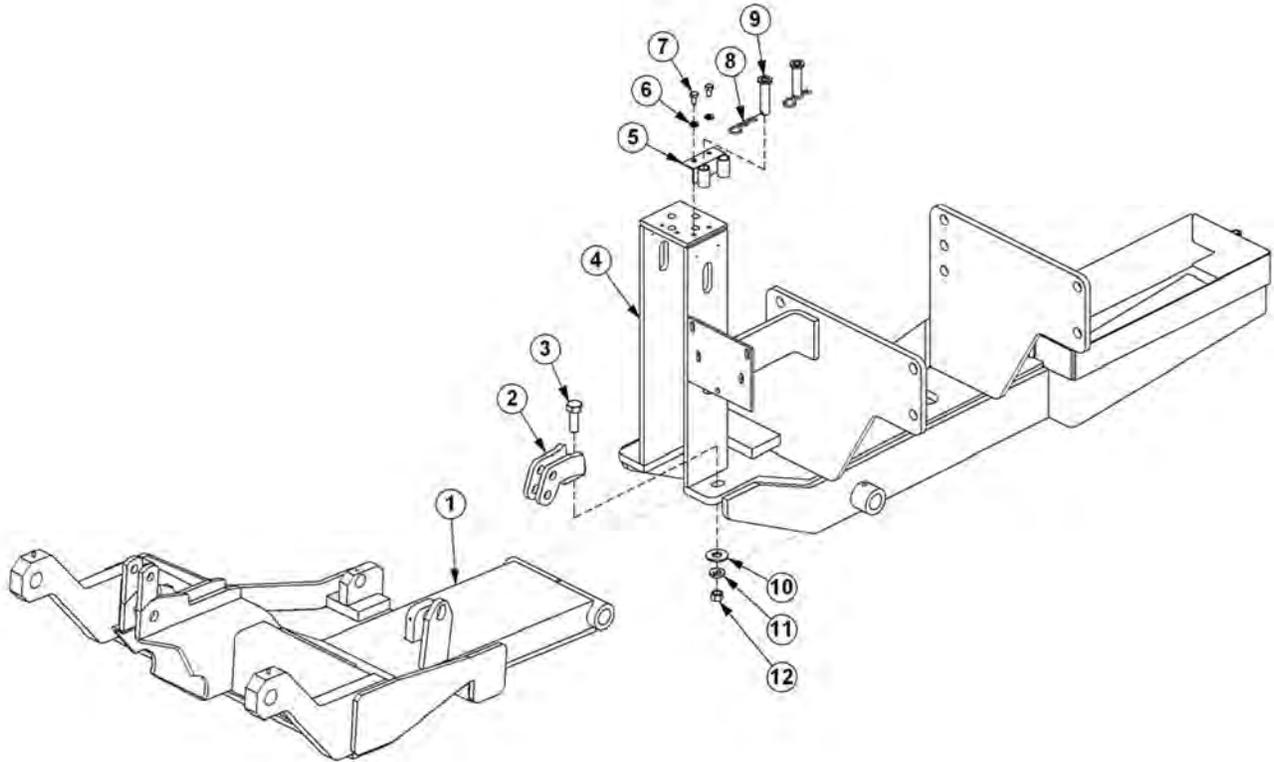

ITEM	PART NO.	QTY.	DESCRIPTION
1	31063	1	DRAFT BEAM
2	6T0106	1	TRAVEL LOCK BRACKET
3	21833	1	CAPSCREW 3/4" X 2 1/4"
4	-----	-	MAIN FRAME *REFER TO PARTS SECTION
5	33856	1	BRKT,PIN HOLDER
6	21988	2	LOCK WASHER 3/8"
7	21629	2	CAPSCREW 3/8" X 3/4"
8	6T3020	2	R - CLIP 5/32"
9	6T0107	2	TRAVEL LOCK PINS 3/4" X 3 1/4"
10	22021	1	FLAT WASHER 3/4"
11	21993	1	LOCK WASHER 3/4"
12	21825	1	HEX NUT 3/4"

COMMON SIDE FLAIL - XD



## SWITCH BOX

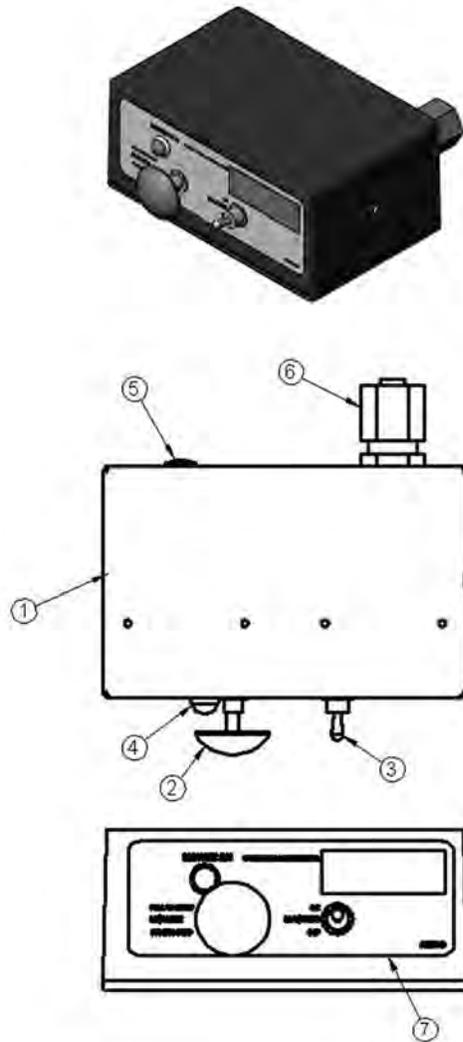

ITEM	PART NO.	QTY.	DESCRIPTION
1	06514013	1	SWBX,ALUM,BLK,06510102
2	35226	1	SWITCH,MOWER,COLEHERSEE
3	33811	1	SWITCH,MASTER/DECK FLOAT
4	6T3923	1	INDICTATOR LIGHT,ON,RED
5	06514014	1	BREAKER,10A,SWBX
6	34540	1	STRAIN RELIEF,3/4,BLACK,NYLON
7	06550018	1	DECAL,SWTCHBX,TM/TSF,CG
8	35227	1	RELAY,DP,DT,12V,LY2F,35226

# SWITCH BOX SCHEMATIC

## 06510102 SCHEMATIC COMMON GROUND SWITCH BOX SIDE MOWER

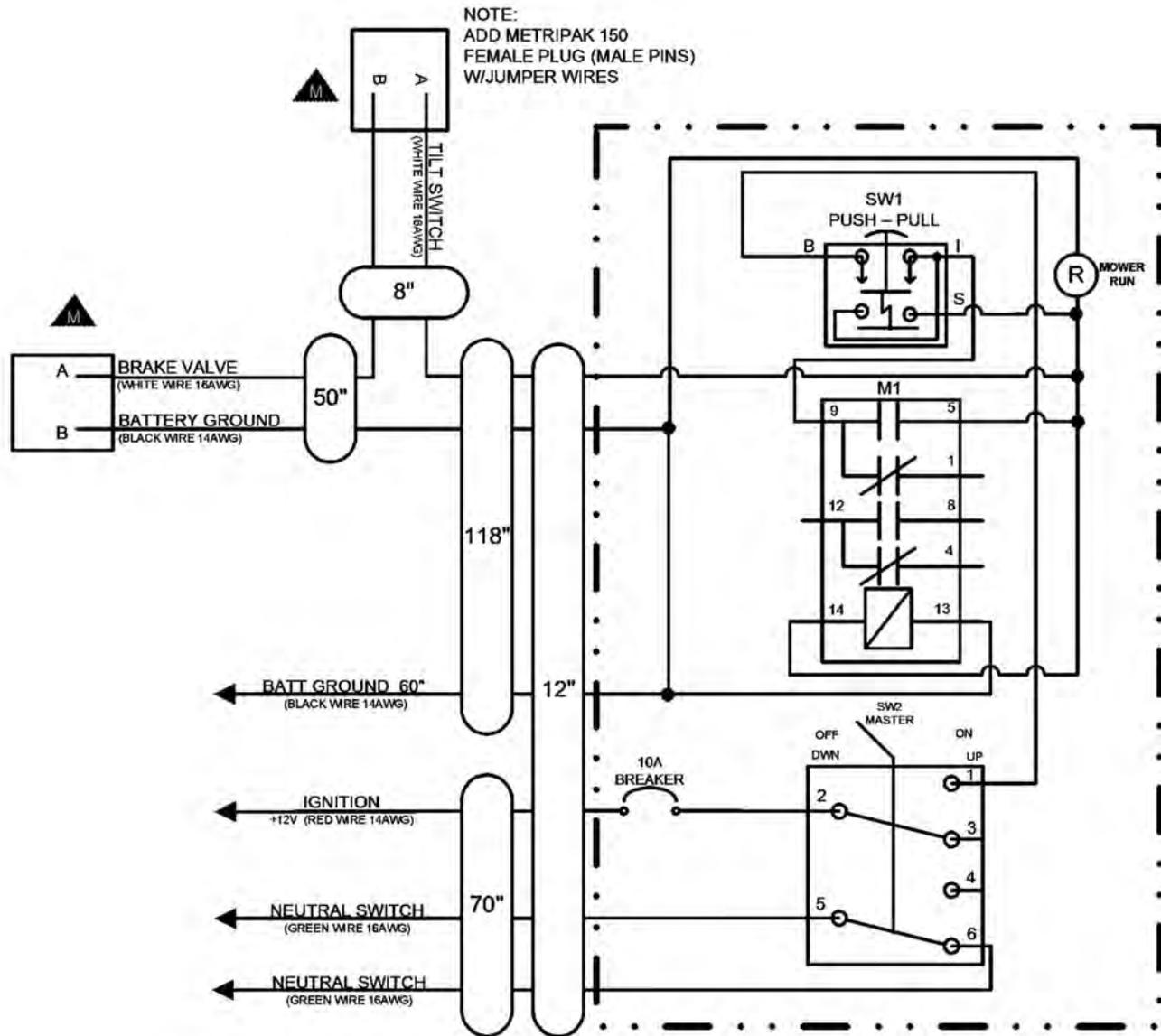

SEE DRAWING # 06515000 FOR A FULL DESCRIPTION OF ALL CONNECTORS

**FIRE SUPPRESSION SYSTEM  
SECTION**

# FIRE SUPPRESSION 3-POINT MOUNT

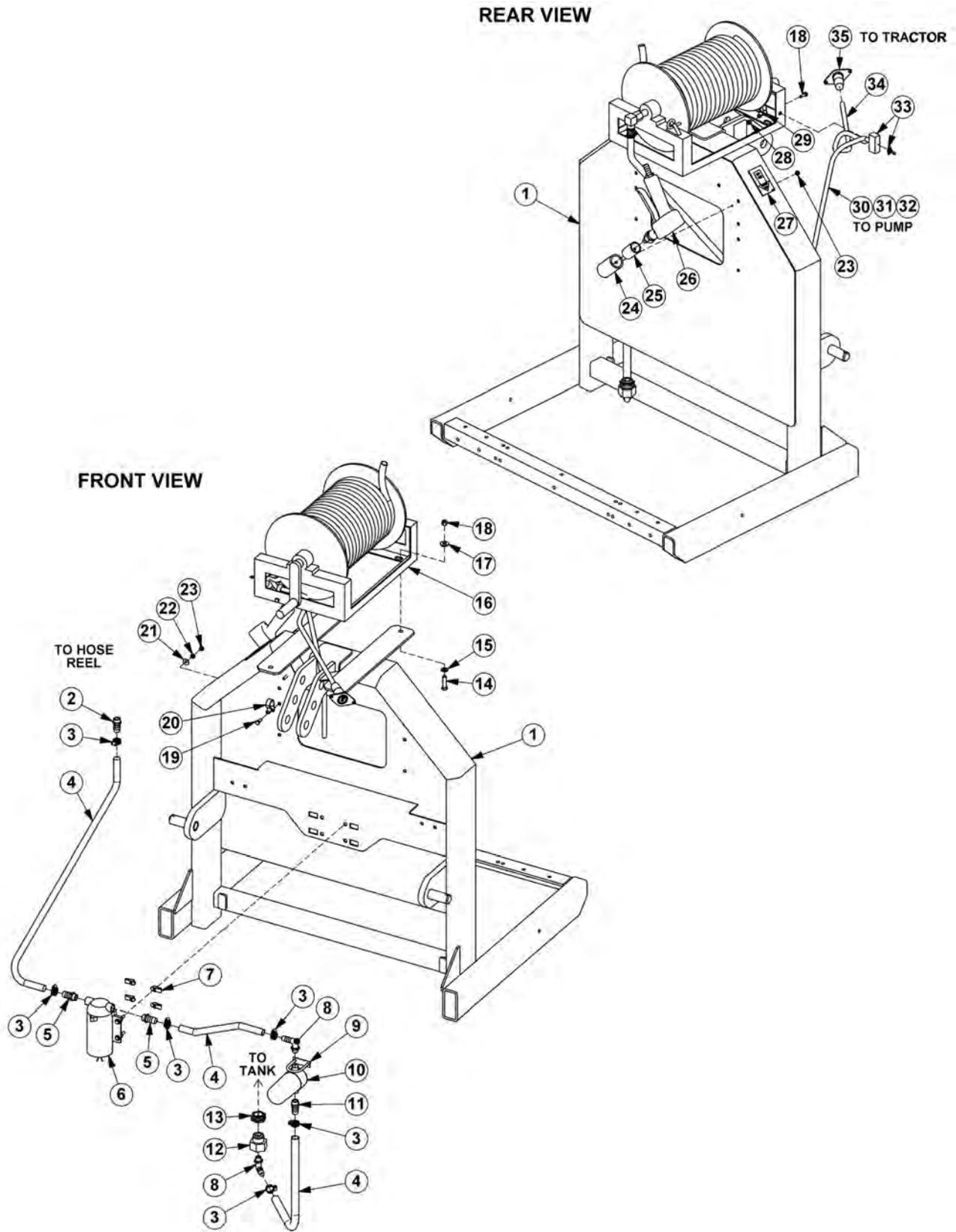

COMMON SIDE FLAIL - XD

## FIRE SUPPRESSION 3-POINT MOUNT

Continued...

ITEM	PART NO.	QTY.	DESCRIPTION
1	06370137	1	MOUNT,3PNT,FIRE SYS
2	06503108	1	FITTING,1/2"BARB X 1/2"MP
3	35091	6	CLAMP,HOSE,#6
4	06520469	5	HOSE,1/2",BULK (FEET)
5	06503168	2	SWIVEL,1/2"STR,POLY
6	06520359	1	PUMP,LARGE
7	35176	4	U-NUT,1/4"
8	06520367	2	ELBOW,1/2"BARB X 1/2"MP,POLY
9	27329	1	U-BOLT,1/4"
10	06520361	1	FILTER
---	06520351	1	ELEMENT,FILTER
11	06520349	1	FITTING,BARB,HOSE
12	06503169	1	REDUCER,BUSHING (100 & 150 GALLON TANKS ONLY)
13	06520346	1	FITTING,BULKHEAD (50 GALLON TANKS ONLY)
14	21632	4	CAPSCREW,3/8" X 1-1/2",NC
15	21988	4	LOCKWASHER,3/8"
16	06520360	1	HOSE REEL
17	22016	4	FLATWASHER,3/8"
18	21627	4	NYLOCK NUT,3/8",NC
19	21529	2	CAPSCREW,1/4" X 3/4",NC
20	06510258	1	CLAMP,3/4"
21	22014	1	FLATWASHER,1/4"
22	21986	1	LOCKWASHER,1/4"
23	21525	2	HEX NUT,1/4",NC
24	06370121	1	HOLSTER
25	06430090	1	SLEEVE
26	06520366	1	GUN,FIRE SYS
27	6T3222	1	DECAL
28	21527	1	NYLOCK NUT,1/4",NC
29	06510257	1	CLAMP,3/8"
30	28055	5	WIRE,BLACK,14GA (FEET)
31	24200	5	WIRE,RED,14GA (FEET)
32	22802	5	WIRE WRAP (FEET)
33	PT3905A	1	SWITCH
34	06510256	4	CABLE,14GA,4WIRE (FEET)
35	06510255	1	PLUG,7PIN,TRCTR

COMMON SIDE FLAIL - XD



## FIRE SUPPRESSION FRONT MOUNT

Continued...

ITEM	PART NO.	QTY.	DESCRIPTION
1	06520342	1	TANK,50 GALLON
2	06370204	1	MNT,TANK,FRNT,50 GALLON
3	35176	4	U-NUT,1/4,3/4 TO CENTER
4	35091	6	CLAMP,HOSE,#6
5	06503168	2	SWIVEL,1/2 STR,POLY
6	06520469	8	HOSE,1/2,SPRAYER
7	06520359	1	PUMP,FIRE KIT
8	06503108	1	FITTING,1/2" BARB X 1/2"MP
9	06520367	2	ELBOW,1/2MPX1/2BARB,POLY
10	27329	1	U-BOLT,1/4X2X1
11	06520361	1	FILTER,FIRE KIT,RAILKUT
---	06520351	1	STRAINER,40 MESH
12	06520349	1	FITTING,BARB,HOSE,WETCUT
13	06520346	1	FITTING,BULKHEAD
14	21627	8	NYLOCK NUT,3/8 NC
15	22016	16	FLATWASHER,3/8,GR8
16	06510255	1	PLUG,7PIN,TRCTR
17	06510256	22	WIRE,14GA,4WIRE (FEET)
18	21631	8	CAPSCREW,3/8X1 1/4, NC,GR8
19	06370207	1	MNT,FIRE SUPPRESSION
20	21527	3	NYLOCK NUT,1/4 NC
21	06510257	2	CLAMP,3/8X1/4,INS
22	21529	2	CAPSCREW,1/4 X 3/4 NC
23	6T3222	1	DECAL,CONTROL,ON-OFF SWITCH
24	PT3905A	1	SWITCH,MOWER
25	06520360	1	HOSE REEL,FIRE KIT,RAILKUT
26	06520366	1	GUN,FIRE KIT,RAILKUT
27	06430090	1	SLEEVE,GUN,FIRE SYS
28	06370121	1	HOLSTER,FIRESYS,RAILKUT

COMMON SIDE FLAIL - XD

# FIRE SUPPRESSION SYSTEM ELECTRICAL SCHEMATIC

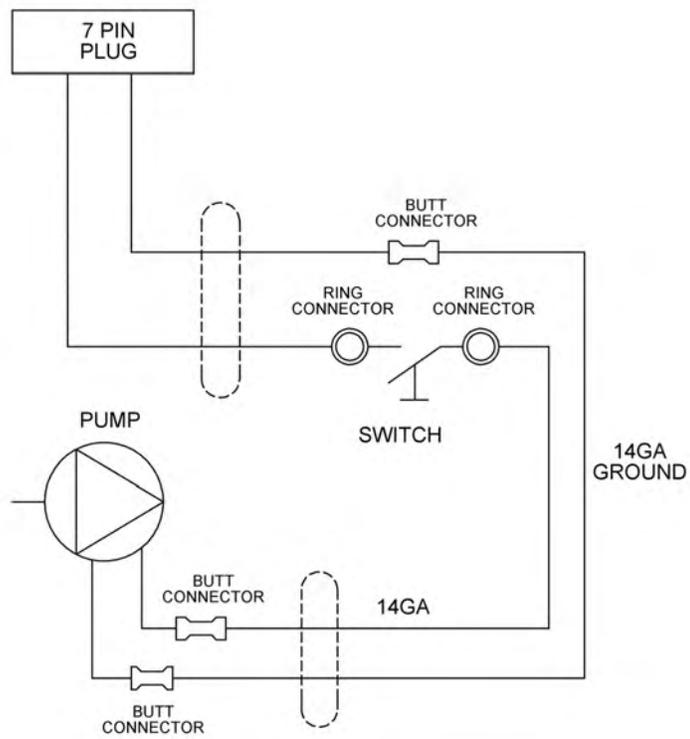



**WETCUT**

**WETCUT  
SECTION**

## WETCUT 50 GALLON TANK - 3PNT MOUNT

**INSTALL ITEM 2 INTO ITEM 1 FIRST**

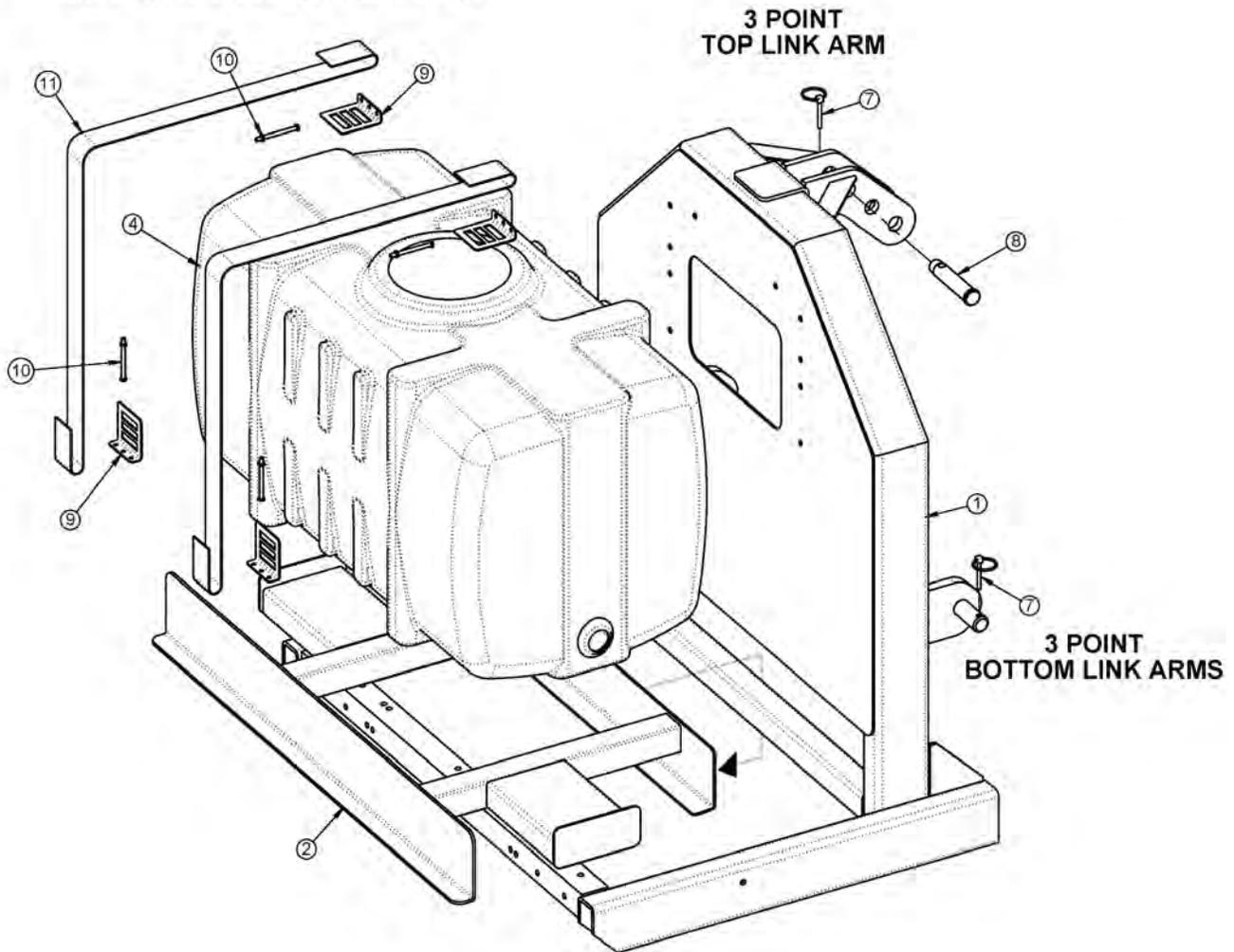

ITEM	PART NO.	QTY.	DESCRIPTION
1	06370128	1	MNT,3PNT,UNI
2	06370136	1	MNT,TANK,50GAL,WETCUT
4	06520342	1	TANK,50GA.,WETCUT
7	RD1032	3	PIN,LYNCH 1/4" X 2"
8	TB1036	1	PIN,SEC BOOM SWIV 1X4-11/16"
9	06520343	4	ANCHOR,STRAP,WETCUT
10	06520344	4	BOLT,STRAP,TANK,WETCUT
11	06520345	2	STRAP,TANK,WETCUT

COMMON SIDE FLAIL - XD

## WETCUT 100 OR 150 GALLON TANK - 3PNT MOUNT

INSTALL ITEM 2 INTO ITEM 1 FIRST

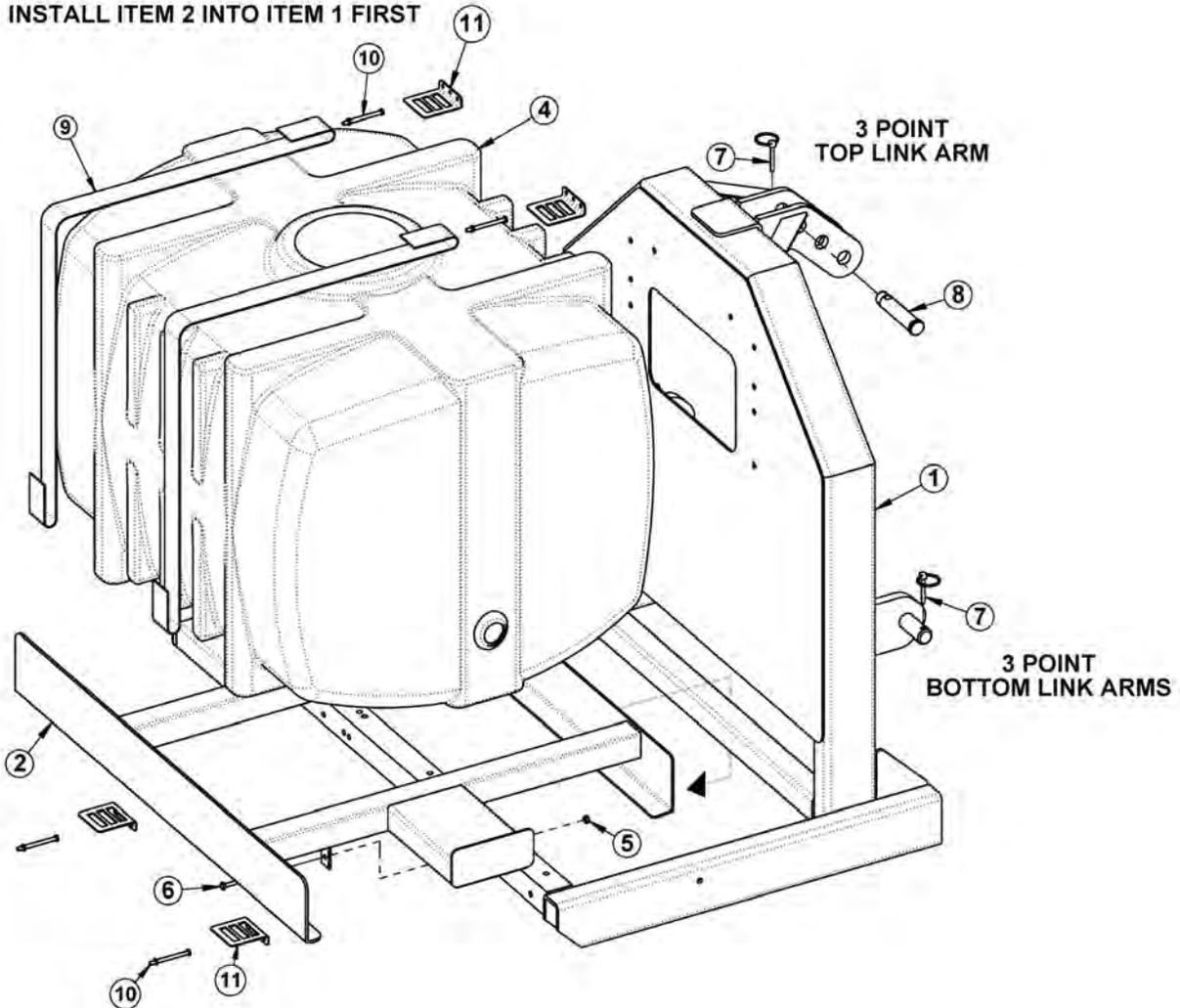

ITEM	PART NO.	QTY.	DESCRIPTION
1	06370128	1	MNT,3PNT,UNI
2	06370138	1	MNT,TANK,100GAL,WETCUT
-----	06370139	-	MNT,TANK,150GAL,WETCUT
4	06520372	1	TANK,100GA.,WETCUT
-----	06520373	-	TANK,150GA.,WETCUT
5	21527	2	HEX NUT,NYLOCK,1/4" NC
6	21530	2	CAPSCREW,1/4" X 1" NC
7	RD1032	3	PIN,LYNCH 1/4" X 2"
8	TB1036	1	PIN,SEC BOOM SWIV 1X4-11/16"
9	06520345	2	STRAP,TANK,WETCUT
10	06520344	4	BOLT,STRAP,TANK,WETCUT
11	06520343	4	ANCHOR,STRAP,WETCUT

COMMON SIDE FLAIL - XD

# WETCUT 3PNT PLUMBING - 50IN MOWERS

1. NOTE ORIENTATION ON ITEM ⑨
2. ITEMS ⑰ ⑱ ⑲ ⑳ CUT FROM SUPPLIED 1/2" HOSE
3. ITEMS ㉑ ㉒ ㉓ CUT FROM SUPPLIED 3/8" HOSE

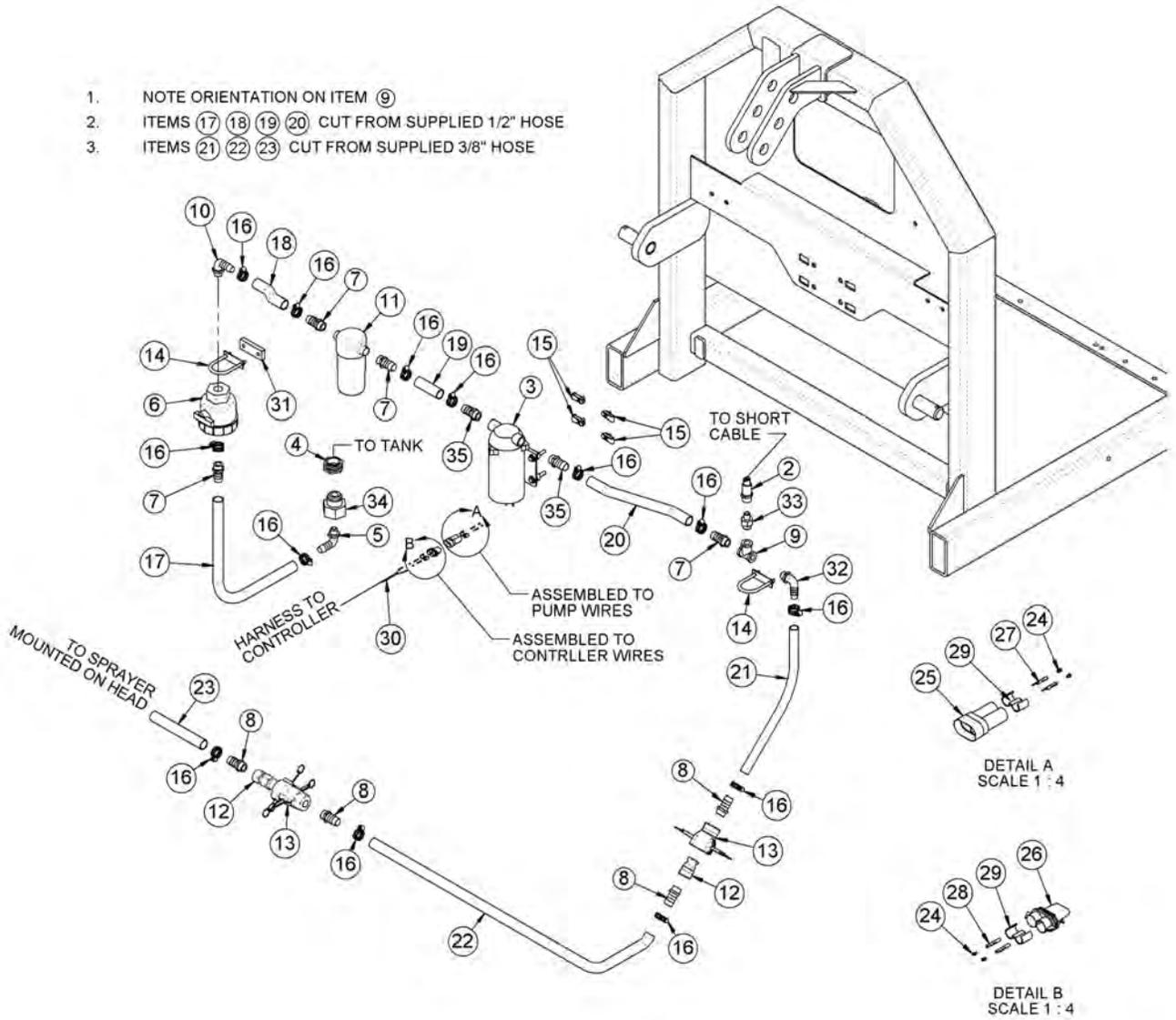

## WETCUT 3PNT PLUMBING - 50IN MOWERS

Continued...

ITEM	PART NO.	QTY.	DESCRIPTION
1	06370128	1	MNT,3PNT,UNI
2	06520336	1	CNTRLR,SENSOR,06520333
3	06520341	1	PUMP,WETCUT
4	06520346	1	FITTING,BULKHEAD,WETCUT (50 GALLON TANKS ONLY)
5	06520347	1	FITTING,ELBOW,WETCUT
6	06520348	1	VLV,BALL,WETCUT
7	06520349	4	FITTING,BARB,HOSE,WETCUT
8	06503173	4	FITTING,1/2MP X 3/8" BARB
9	06520353	1	FITTING,TEE,WETCUT
10	06520367	1	ELBOW,1/2" X 1/2" BARB,POLY
11	06520361	1	FILTER,FIRE KIT,RAILKUT
12	06520400	2	QUIK CPLR,MALE,1/2",WETCUT
13	06520401	2	QUIK CPLR,FEM,1/2",WETCUT
14	27329	2	U-BOLT,1/4" X 1" X 2"
15	35176	4	U-NUT,1/4",3/4" TO CENTER
16	35091	13	CLAMP, HOSE #6
17 - 20	06520469	5	1/2" HOSE (FEET)
21 - 23	06520316	-	3/8" HOSE (INCLUDED WITH SPRAYER)
24	06510051	4	SEAL,16-18GA,METPAK
25	06510052	1	CONN.,BODY,MALE,METRIPACK 150
26	06510053	1	CONN.,BODY,FEM,METRIPACK 150
27	06510054	2	TERMINAL,MALE,16/18GA.METPAK
28	06510055	2	TERMINAL,FEM,16/18GA.METPAK
29	06510056	2	TPA
30	06520337	1	INCLUDED WITH CONTROLLER
31	06401133	1	SPACER,Ø.31" X 1.75" X .38"
32	06503165	1	ELBOW,1/2"MP X 3/8" BARB
33	06520354	1	BUSHING,REDUCER,WETCUT
34	06503169	1	BUSHING,1"MP X 1/2"FP (100 & 150 GALLON TANKS ONLY)
35	06503176	2	FITTING,BARB,3/8"MP X 1/2" BARB

COMMON SIDE FLAIL - XD

# WETCUT 3PNT PLUMBING - LARGE MOWERS

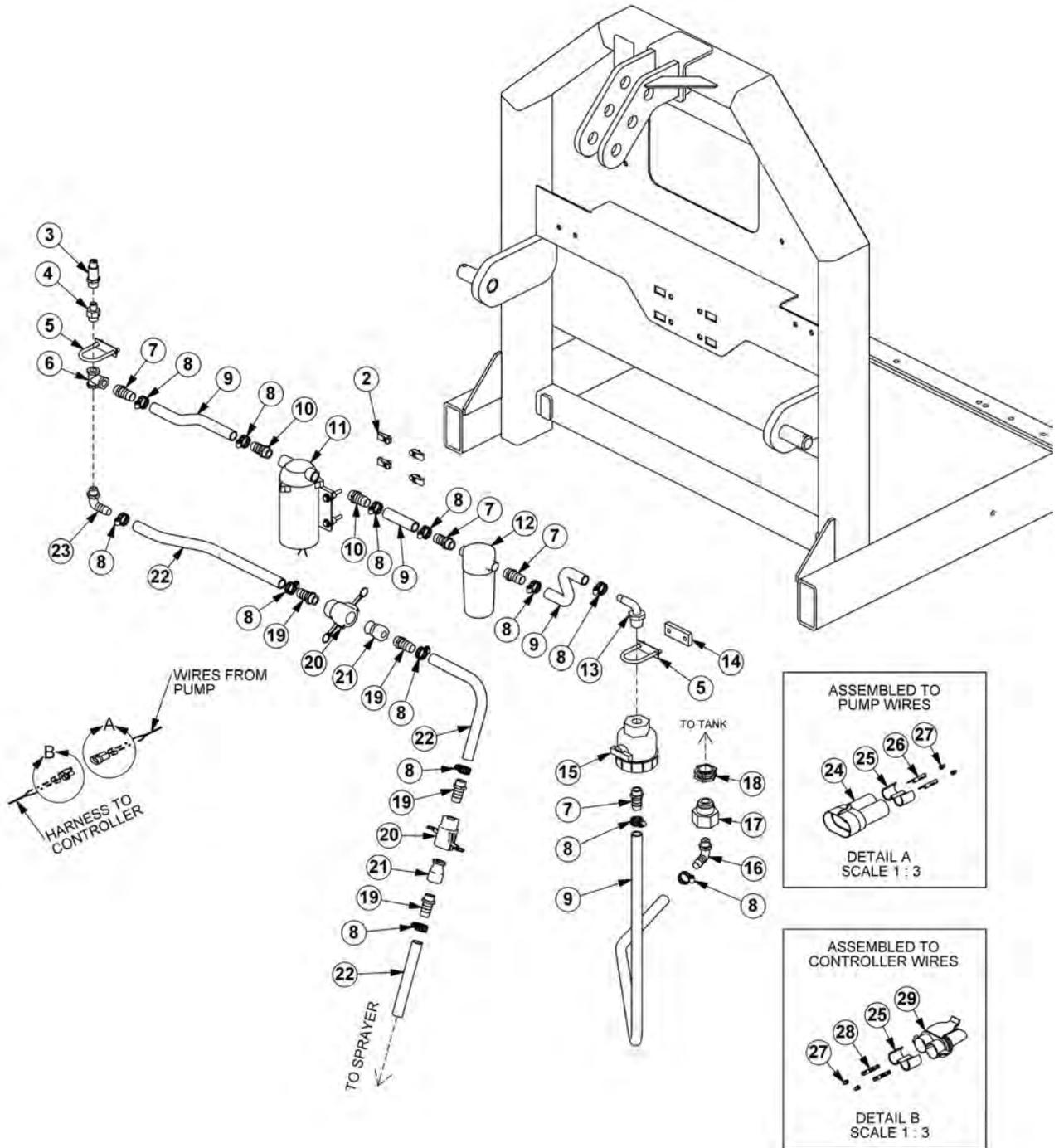

## WETCUT 3PNT PLUMBING - LARGE MOWERS

Continued...

ITEM	PART NO.	QTY.	DESCRIPTION
1	06370128	1	MNT,3PNT,UNI
2	35176	4	U-NUT,1/4,3/4 TO CENTER
3	06520336	1	CNTRLR,SENSOR,06520333
4	06520354	1	BUSHING,REDUCER,WETCUT
5	27329	2	U-BOLT,1/4" X 1" X 2"
6	06520353	1	FITTING,TEE,WETCUT
7	06520349	4	FITTING,BARB,HOSE,WETCUT
8	35091	13	CLAMP, HOSE #6
9	06520469	5	1/2" HOSE (FEET)
10	06503168	2	SWIVEL,1/2" STR
11	06520359	1	PUMP,LARGE
12	06520361	1	FILTER,FIRE KIT,RAILKUT
---	06520351	1	STRAINER,40MESH
13	06520367	1	ELBOW,1/2X1/2BARB,POLY
14	06401133	1	SPACER,Ø.31X1.75X.38
15	06520348	1	VLV,BALL,WETCUT
16	06520347	1	FITTING,ELBOW,WETCUT
17	06503169	1	BUSHING,1MPX1/2FP (100 & 150 GALLON TANKS ONLY)
18	06520346	1	FITTING,BULKHEAD,WETCUT (50 GALLON TANKS ONLY)
19	06503173	4	FITTING,BARB,1/2X3/8,WETCUT
20	06520401	2	QUIK CPLR,FEM,1/2,WETCUT
21	06520400	2	QUIK CPLR,MALE,1/2,WETCUT
22	06520316	-	3/8" HOSE (INCLUDED WITH SPRAYER)
23	06503165	1	ELBOW,1/2X3/8BARB,POLY
24	06510052	1	CONN.,BODY,MALE,METRIPACK 150
25	06510056	2	TPA
26	06510054	2	TERMINAL,MALE,16/18GA.METPAK
27	06510051	4	SEAL,16-18GA,METPAK
28	06510055	2	TERMINAL,FEM,16/18GA.METPAK
29	06510053	1	CONN.,BODY,FEM,METRIPACK 150

COMMON SIDE FLAIL - XD

# WETCUT FRONT PLUMBING - 50IN MOWERS

1. NOTE ORIENTATION ON ITEM ⑨
2. ITEMS ⑰ ⑱ ⑲ ⑳ CUT FROM SUPPLIED 1/2" HOSE
3. ITEMS ㉑ ㉒ ㉓ CUT FROM SUPPLIED 3/8" HOSE

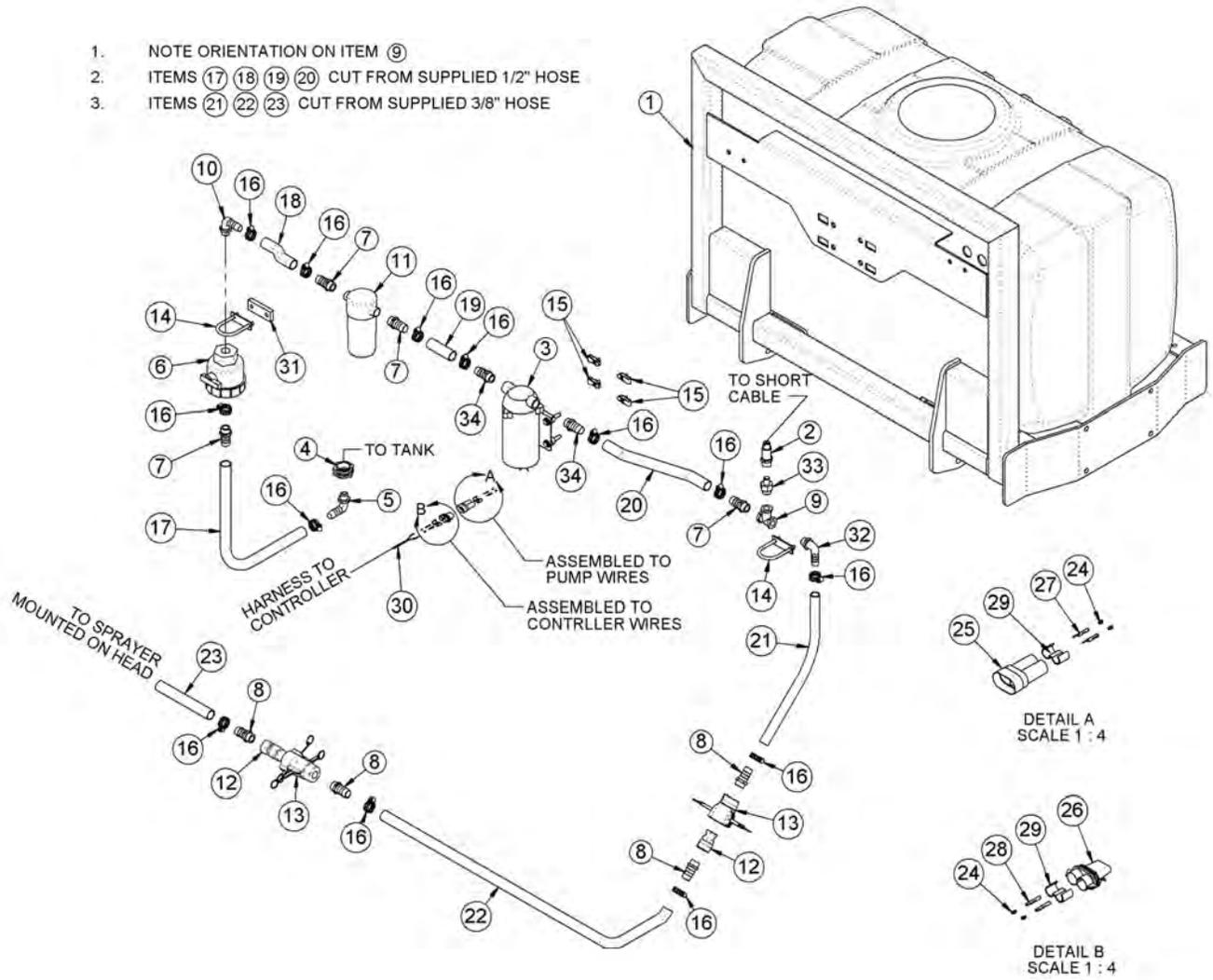



## WETCUT FRONT PLUMBING - 50IN MOWERS

Continued...

ITEM	PART NO.	QTY.	DESCRIPTION
1	06370204	1	MNT,FRONT,UNI
2	06520336	1	CNTRLR,SENSOR,06520333
3	06520341	1	PUMP,WETCUT
4	06520346	1	FITTING,BULKHEAD,WETCUT
5	06520347	1	FITTING,ELBOW,WETCUT
6	06520348	1	VLV,BALL,WETCUT
7	06520349	4	FITTING,BARB,HOSE,WETCUT
8	06503173	4	FITTING,1/2"MP X 3/8"BARB
9	06520353	1	FITTING,TEE,WETCUT
10	06520367	1	ELBOW,1/2"MP X 1/2"BARB,POLY
11	06520361	1	FILTER,FIRE KIT,RAILKUT
---	06520351	1	STRAINER,40MESH
12	06520400	2	QUIK CPLR,MALE,1/2",WETCUT
13	06520401	2	QUIK CPLR,FEM,1/2",WETCUT
14	27329	2	U-BOLT,1/4" X 1" X 2"
15	35176	4	U-NUT,1/4",3/4" TO CENTER
16	35091	13	CLAMP,HOSE #6
17 - 20	06520469	5	1/2" HOSE (FEET)
21 - 23	06520316	-	3/8" HOSE (INCLUDED WITH SPRAYER)
24	06510051	4	SEAL,16-18GA,METPAK
25	06510052	1	CONN.,BODY,MALE,METRIPACK 150
26	06510053	1	CONN.,BODY,FEM,METRIPACK 150
27	06510054	2	TERMINAL,MALE,16/18GA.METPAK
28	06510055	2	TERMINAL,FEM,16/18GA.METPAK
29	06510056	2	TPA
30	06520337	1	INCLUDED WITH CONTROLLER
31	06401133	1	SPACER,Ø.31" X 1.75" X .38"
32	06503165	1	ELBOW,1/2"MP X 3/8"BARB,POLY
33	06520354	1	BUSHING,REDUCER,WETCUT
34	06503176	2	FITTING,3/8"MP X 1/2"BARB

COMMON SIDE FLAIL - XD

# WETCUT FRONT PLUMBING - LARGE MOWERS

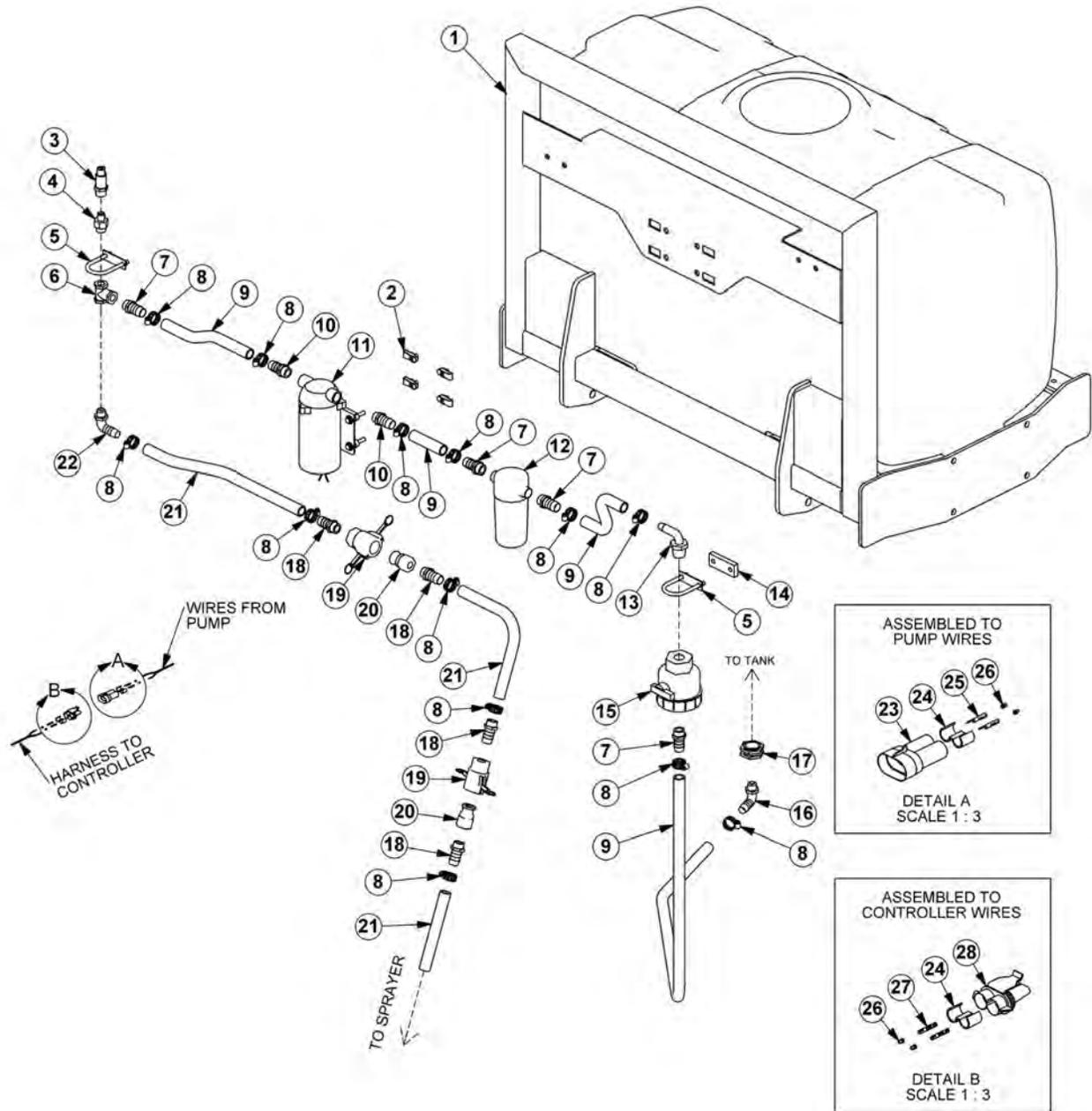

## WETCUT FRONT PLUMBING - LARGE MOWERS

Continued...

ITEM	PART NO.	QTY.	DESCRIPTION
1	06370204	1	MNT,FRONT,UNIV
2	35176	4	U-NUT,1/4,3/4 TO CENTER
3	06520336	1	CNTRLR,SENSOR,06520333
4	06520354	1	BUSHING,REDUCER,WETCUT
5	27329	2	U-BOLT,1/4" X 1" X 2"
6	06520353	1	FITTING,TEE,WETCUT
7	06520349	4	FITTING,BARB,HOSE,WETCUT
8	35091	13	CLAMP, HOSE #6
9	06520469	5	1/2" HOSE (FEET)
10	06503168	2	SWIVEL,1/2" STR
11	06520359	1	PUMP,LARGE
12	06520361	1	FILTER,FIRE KIT,RAILKUT
---	06520351	1	STRAINER,40MESH
13	06520367	1	ELBOW,1/2X1/2BARB,POLY
14	06401133	1	SPACER,Ø.31X1.75X.38
15	06520348	1	VLV,BALL,WETCUT
16	06520347	1	FITTING,ELBOW,WETCUT
17	06520346	1	FITTING,BULKHEAD,WETCUT
18	06503173	4	FITTING,BARB,1/2X3/8,WETCUT
19	06520401	2	QUIK CPLR,FEM,1/2,WETCUT
20	06520400	2	QUIK CPLR,MALE,1/2,WETCUT
21	06520316	-	3/8" HOSE (INCLUDED WITH SPRAYER)
22	06503165	1	ELBOW,1/2X3/8BARB,POLY
23	06510052	1	CONN.,BODY,MALE,METRIPACK 150
24	06510056	2	TPA
25	06510054	2	TERMINAL,MALE,16/18GA.METPAK
26	06510051	4	SEAL,16-18GA,METPAK
27	06510055	2	TERMINAL,FEM,16/18GA.METPAK
28	06510053	1	CONN.,BODY,FEM,METRIPACK 150

COMMON SIDE FLAIL - XD

# WETCUT 50IN SPRAYER HEAD ASSEMBLY

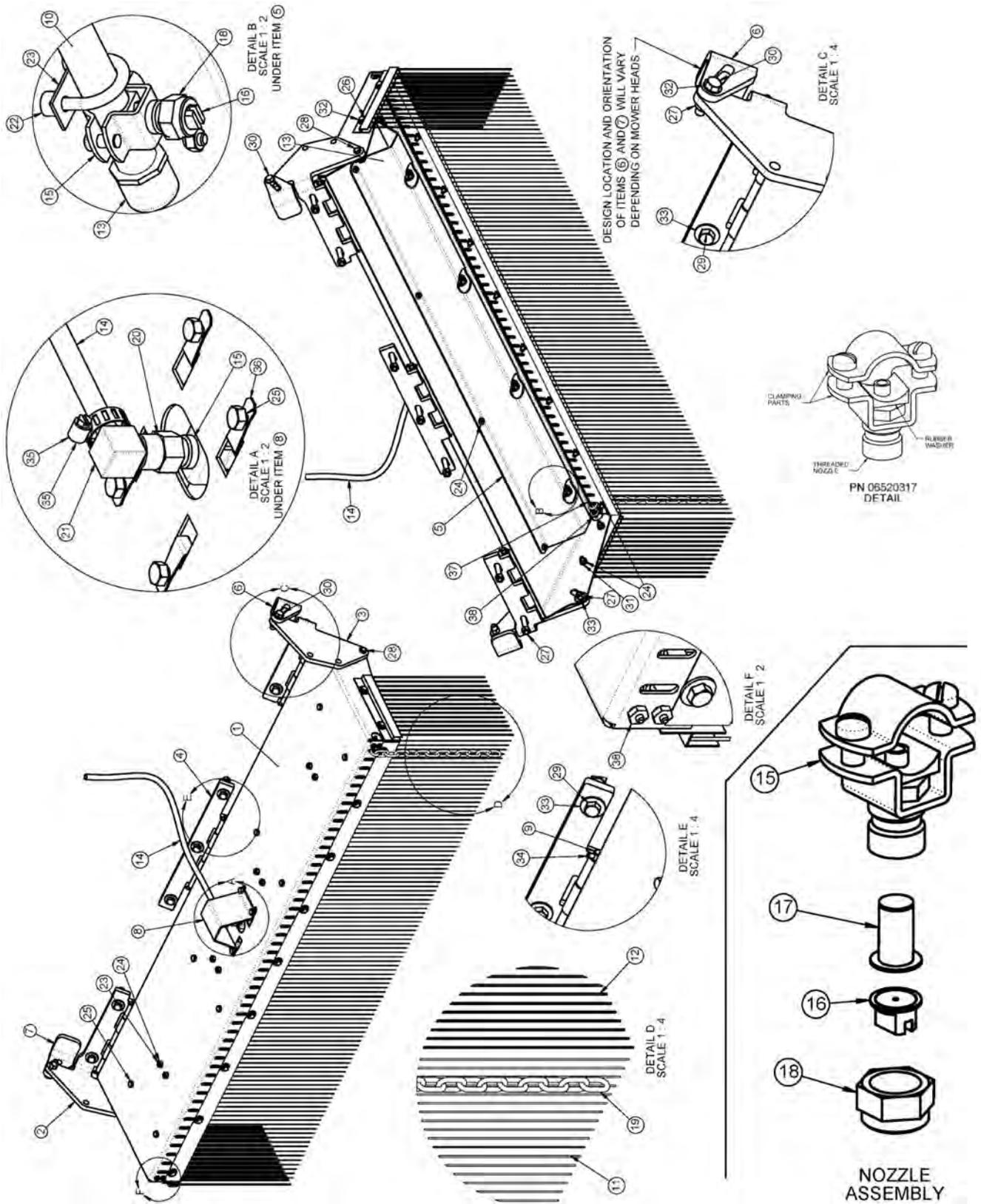

COMMON SIDE FLAIL - XD

## WETCUT 50IN SPRAYER HEAD ASSEMBLY

Continued...

ITEM	PART NO.	QTY.	DESCRIPTION
1	06370105	1	HOOD,SPRAYER
2	06370106	1	HINGE,LH,SPRAYER
3	06370107	1	HINGE,RH,SPRAYER
4	06370108	1	HINGE,CNTR,SPRAYER
5	06410668	1	GUARD,SPRAYER,WETCUT
6	06410753	1	MNT,RH,WET CUT (FLAIL)
---	06410942	1	MNT,RH,WET CUT (ROTARY)
7	06410754	1	MNT,LH,WET CUT (FLAIL)
---	06410943	1	MNT,LH,WET CUT (ROTARY)
8	06410796	1	GUARD,HOSE,WETCUT
9	06420069	3	PIN,HINGE,WET CUT
10	06497003	1	TUBE,LG,SPRAYER
11	06499012	1	SKIRT,ANTI SPRAY,50
12	06499013	2	SKIRT,ANTI SPRAY,7
13	06520314	2	TUBE,CAP,SPRAYER
14	06520316	15	HOSE,SPRAYER (FEET)
15	06520317	5	NOZZLE,SPRAYER
16	06520319	4	TIP,NOZZLE,SPRAYER
17	06520320	4	FILTER,NOZZLE,SPRAYER
18	06520321	4	NUT,NOZZLE,SPRAYER
19	06520322	49	CHAIN,.18" X 1.31" X 13LINKS
20	06520381	1	ADAPTER,1/4"NPT,WETCUT
21	06520382	1	ELBOW,BARB,3/8" X 1/4"NPT
22	06520383	8	SPACER,.50"O.D. X .252" I.D. X .38",NYLON
23	32550	4	U-BOLT,1/4" X 1" X 1" X 1-3/4"
24	21527	29	HEX NUT,NYLOCK,1/4",NC
25	21528	12	CAPSCREW,1/4" X 1/2",NC
26	21529	13	CAPSCREW,1/4" X 3/4",NC
27	21625	11	HEX NUT,3/8",NC
28	21630	2	CAPSCREW,3/8" X 1",NC
29	21634	7	CAPSCREW,3/8" X 2",NC
30	21632	2	CAPSCREW,3/8" X 1-1/2",NC
31	21986	4	LOCKWASHER,1/4"
32	22014	15	FLATWASHER,1/4"
33	22016	9	FLATWASHER,3/8",GR8
34	34698	6	ROLL PIN, PLAIN, 3/16" X 7/8"
35	35091	1	CLAMP,HOSE #6
36	35176	4	U-NUT,1/4",3/4" TO CENTER
37	06520376	5	CABLE,3/16"
38	06537022	2	U-BOLT,CABLE,3/16"

COMMON SIDE FLAIL - XD

# WETCUT 60IN SPRAYER HEAD ASSEMBLY

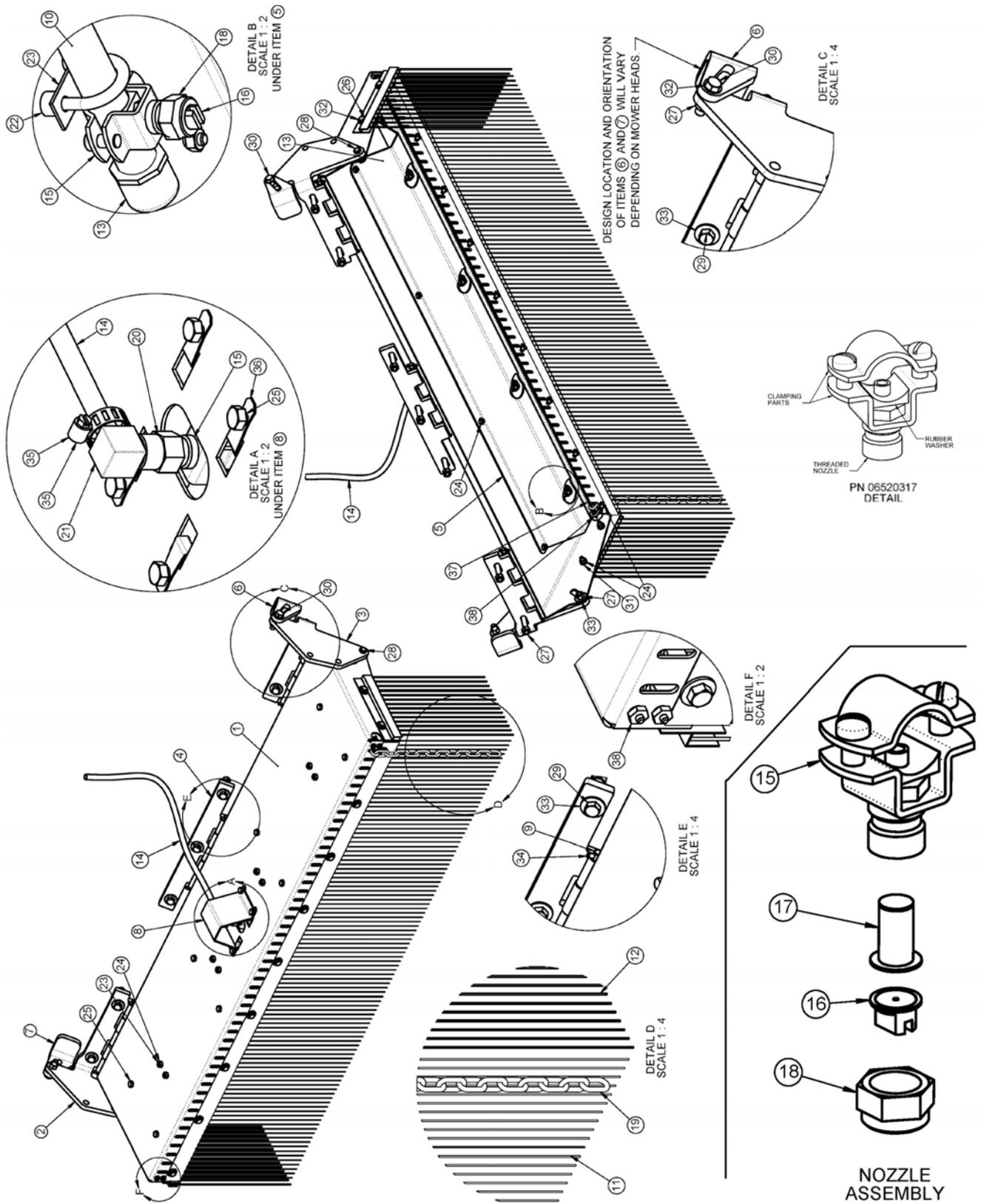

COMMON SIDE FLAIL - XD

## WETCUT 60IN SPRAYER HEAD ASSEMBLY

Continued...

ITEM	PART NO.	QTY.	DESCRIPTION
1	06370210	1	HOOD,SPRAYER
2	06370106	1	HINGE,LH,SPRAYER
3	06370107	1	HINGE,RH,SPRAYER
4	06370108	1	HINGE,CNTR,SPRAYER
5	06411234	1	GUARD,SPRAYER,WETCUT
6	06410753	1	MNT,RH,WET CUT (FLAIL)
---	06410942	1	MNT,RH,WET CUT (ROTARY)
7	06410754	1	MNT,LH,WET CUT (FLAIL)
---	06410943	1	MNT,LH,WET CUT (ROTARY)
8	06410796	1	GUARD,HOSE,WETCUT
9	06420069	3	PIN,HINGE,WET CUT
10	06497009	1	TUBE,LG,SPRAYER
11	06499018	1	SKIRT,ANTI SPRAY,60
12	06499013	2	SKIRT,ANTI SPRAY,7
13	06520314	2	TUBE,CAP,SPRAYER
14	06520316	15	HOSE,SPRAYER (FEET)
15	06520317	6	NOZZLE,SPRAYER
16	06520319	5	TIP,NOZZLE,SPRAYER
17	06520320	5	FILTER,NOZZLE,SPRAYER
18	06520321	5	NUT,NOZZLE,SPRAYER
19	06520322	61	CHAIN,.18" X 1.31" X 13LINKS
20	06520381	1	ADAPTER,1/4"NPT,WETCUT
21	06520382	1	ELBOW,BARB,3/8" X 1/4"NPT
22	06520383	10	SPACER,.50"O.D. X .252" I.D. X .38",NYLON
23	32550	5	U-BOLT,1/4" X 1" X 1" X 1-3/4"
24	21527	33	HEX NUT,NYLOCK,1/4",NC
25	21528	15	CAPSCREW,1/4" X 1/2",NC
26	21529	13	CAPSCREW,1/4" X 3/4",NC
27	21625	13	HEX NUT,3/8",NC
28	21630	2	CAPSCREW,3/8" X 1",NC
29	21634	7	CAPSCREW,3/8" X 2",NC
30	21632	4	CAPSCREW,3/8" X 1-1/2",NC
31	21986	4	LOCKWASHER,1/4"
32	22014	33	FLATWASHER,1/4"
33	22016	11	FLATWASHER,3/8",GR8
34	34698	6	ROLL PIN, PLAIN, 3/16" X 7/8"
35	35091	1	CLAMP,HOSE #6
36	35176	4	U-NUT,1/4",3/4" TO CENTER
37	06520376	6	CABLE,3/16" (FEET)
38	06537022	2	U-BOLT,CABLE,3/16"

COMMON SIDE FLAIL - XD

# WETCUT CABLES

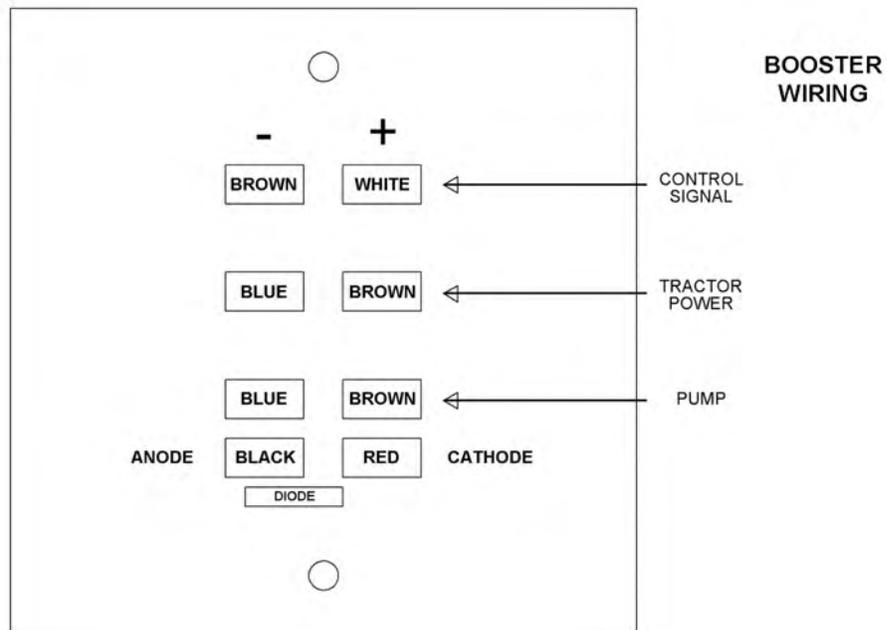
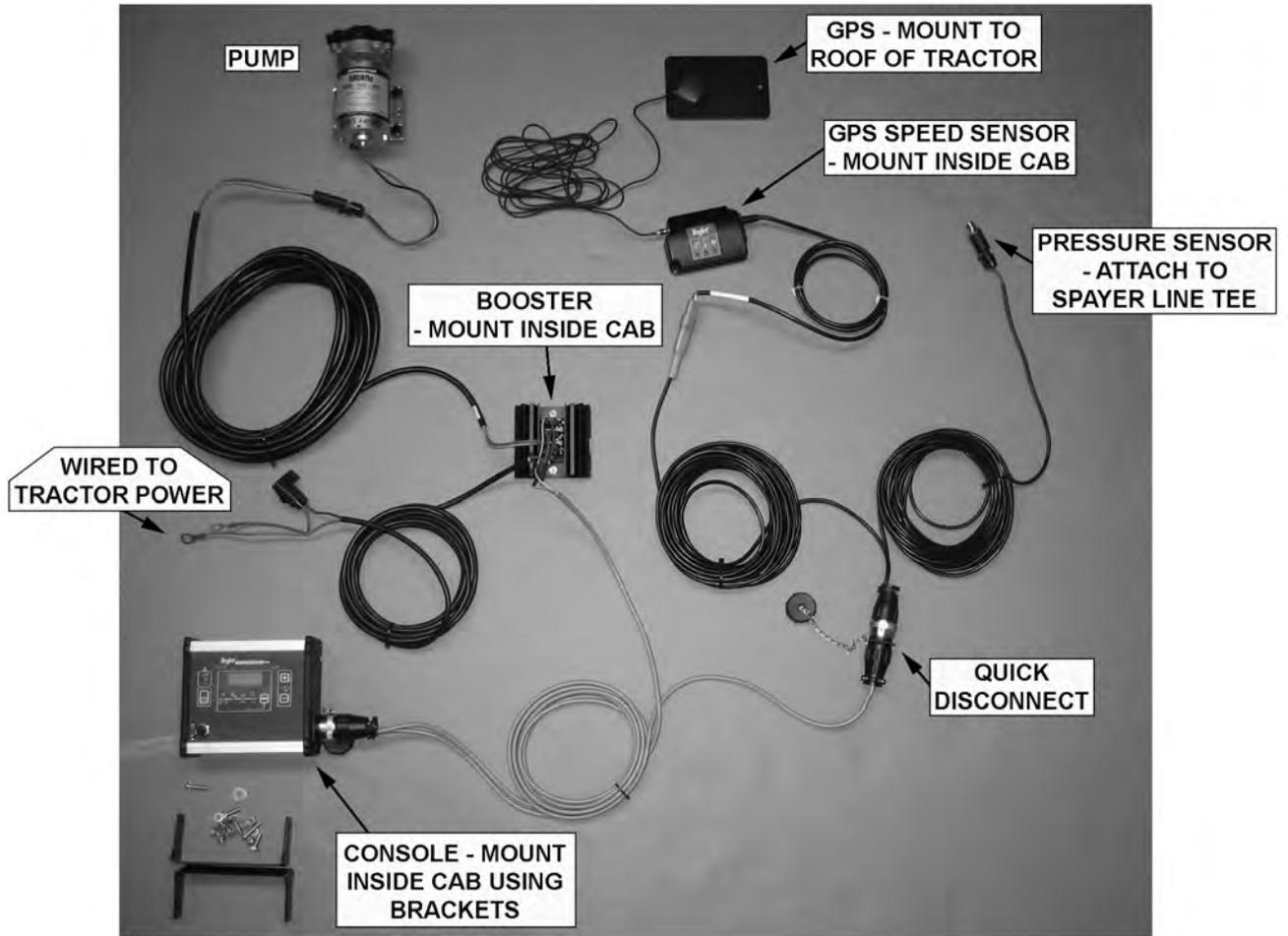



**WARRANTY  
SECTION**



## WARRANTY INFORMATION

Tiger Corporation, 3301 N. Louise, Sioux Falls, South Dakota, warrants to the original Retail Customer, the new Tiger equipment is free of defects in material and workmanship. Any part of equipment that in Tiger's judgement, show evidence of such defects will be repaired or replaced without charge, provided that the failure of part(s) shall have occurred within twelve (12) months from the date of delivery of said equipment to the Retail Customer. Expendable components such as knives, oil, chain sprockets, skid shoes, knife mounting disks and the like are excluded but not limited to this warranty.

The Retail Customer must pay the transportation cost to and from the Tiger Dealer's service shop for warranty service. Warranty service will be performed by the Tiger Dealer from whom the equipment was purchased, during service shop regularly scheduled days and hours of operation.

All Tiger obligation under this warranty shall be terminated if the equipment is modified or altered in ways not approved in writing by Tiger, if repair parts other than genuine Tiger repair parts have been used, or if the equipment has been subject to misuse, neglect, accident, improper maintenance or improper operation.

Tiger Corporation reserves the right to make improvements in design or changes in specification at any time without incurring any obligation to owners of equipment previously sold.

No agent or person has authority to alter, add to or waive the above warranties which are agreed to be in the only warranties, representations or promises, expressed or implied, as to the quality or performance of the products covered and which do not include any implied warranty of merchantability or fitness. In no event will Tiger be liable for incidental or consequential damages or injuries, including, but not limited to, loss of profits, rental or substitute equipment or other commercial loss.

**THERE ARE NO WARRANTIES WHICH EXTEND  
BEYOND THOSE EXPRESSED HEREIN.**

It is the Purchasers obligation to sign the warranty registration form **AFTER** he / she has Read and Understands the Operation and Safety Instructions stated within this manual.

## **ONE LAST WORD**

This manual cannot possibly cover all of the potentially hazardous situations you will encounter. By being familiar with the safety rules, operating and maintenance instructions in this manual you can help prevent accidents. The objective of this manual is to help make you a better operator. Remember, **SAFETY IS YOU!**



1012

Your safety and the safety of those around you depends on **YOU**. Common sense should play a large role in the operation of this machine.

Since we at Tiger Corporation are constantly striving to improve our products, we reserve the right to change specifications or design at any time.

## TO THE OWNER / OPERATOR / DEALER



To keep your implement running efficiently and safely, read your manual thoroughly and follow these directions and the Safety Messages in this manual and on the machine. The table of contents clearly identifies each section where you can easily find the information you need.

The Occupational Safety and Health Act (OSHA 1928.51 subpart C) makes the following minimum requirements for tractor operators.

### **OWNER REQUIREMENTS:**

1. Provide a Roll-Over-Protective Structure that meets the requirements of this Standard; and
2. Provide Seatbelts that meet the requirements of this Standard and SAE J3C; and
3. Ensure that each employee uses such Seatbelt while the tractor is moving; and
4. Ensure that each employee tightens the Seatbelt sufficiently to confine the employee to the protected area provided by the ROPS.

### **OPERATOR REQUIREMENTS:**

1. Securely fasten seatbelt if the tractor has a ROPS.
2. Where possible, avoid operating the tractor near steep ditches, embankments, and holes.
3. Reduce speed when turning, crossing slopes, and on rough, slick, or muddy surfaces.
4. Stay off slopes too steep for safe operation.
5. Watch where you are going – especially at row ends, on roads, and around trees.
6. Do Not permit others to ride.
7. Operate the tractor smoothly – no jerky turns, starts, or stops.
8. Hitch only to the draw-bar and hitch points recommended by the tractor manufacturer.
9. When the tractor is stopped, set brakes securely and use park lock, if available



Printed in USA  
© Tiger Corporation