



JD6M MY20 SIDE ROTARY w/ INDEPENDENT HYDRAULICS

Current as of 3/10/2021



PARTS LISTING WITH
MOUNTING AND OPERATING
INSTRUCTIONS

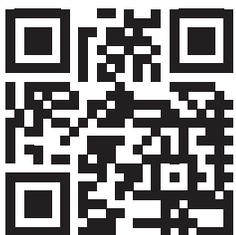

Tiger Corporation
3301 N. Louise Ave.
Sioux Falls, SD 57107
1-800-843-6849
1-605-336-7900
www.tigermowers.com

06011060

TO THE OWNER / OPERATOR / DEALER

All implements with moving parts are potentially hazardous. There is no substitute for a cautious, safe-minded operator who recognizes the potential hazards and follows reasonable safety practices. The manufacturer has designed this implement to be used with all its safety equipment properly attached to minimize the chance of accidents.

BEFORE YOU START!! Read the safety messages on the implement and shown in this manual. Observe the rules of safety and use common sense!

READ AND UNDERSTAND THIS MANUAL! Non-English speaking operators will need to GET THE MANUAL TRANSLATED as needed!



DANGER

FAILING TO FOLLOW SAFETY MESSAGES AND OPERATING INSTRUCTIONS CAN CAUSE SERIOUS BODILY INJURY OR EVEN DEATH TO OPERATOR AND OTHERS IN THE AREA.



1. Study and understand Operator's Manuals, Safety Decals, and Instructional Decals for tractor and implement to prevent misuse, abuse, and accidents. Practice before operating in a confined area or near passersby.
● Learn how to stop engine suddenly in an emergency. Be alert for passersby and especially children

2. Allow no children on or near folding mower or tractor. Allow no riders on tractor or implement. Falling off may cause serious injury or death from being run over by tractor or mower or contact with rotating blades.

3. Operate only with tractor having Roll-Over Protective Structure (ROPS) and with seat belt securely fastened to prevent injury and possible death from falling off or tractor overturn.
● Personal Protective Equipment such as Hard Hat, Safety Glasses, Safety Shoes, & Ear Plugs are recommended.

4. Block up or support raised machine and all lifted components securely before putting hands or feet under or working underneath any lifted component to prevent crushing injury or death from sudden dropping or inadvertent operation of controls. Make certain area is clear before lowering or folding

5. Before transporting, put Lift Lever in detent or full-lift position. Install Transport Safety Devices securely on folding mowers. Put Booms securely in Transport Rest.
● Folding and Boom Mowers have raised center of gravity. Slow down when turning and on hillsides.

6. Make certain that SMV sign, warning lights, and reflectors are clearly visible. Follow local traffic codes.

7. Never operate with Cutting Head or Folding Section raised if passersby, bystanders, or traffic are in the area to reduce possibility of injury or death from objects thrown by Blades under Guards or mower structure.

8. Before dismounting, secure implement in transport position or lower to ground.
● Put tractor in park or set brake, disengage PTO, stop engine, remove key, and wait until noise of rotation has ceased to prevent crushing by entanglement in rotating parts which could cause injury or death.
● Never mount or dismount a moving vehicle. Crushing from runover may cause serious injury or death.

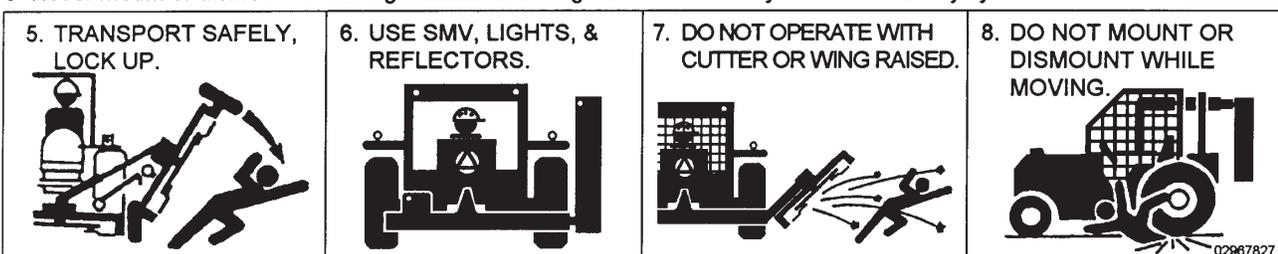

Warranty Information: Read and understand the complete Warranty Statement found in this manual. Fill out the Warranty Registration form in full and return it within 90 days. Make certain the Serial Number of the machine is recorded on the Warranty Card, and form that you retain.

FORWARD

This manual contains information about many features of the Tiger mowing and roadside maintenance equipment. Some of these include: Safety precautions, Assembly instructions, Operations, Maintenance and Parts. This manual will also assist you in the proper break-in, daily care, and troubleshooting of your new mower.

We recommend that you read carefully the entire manual before operating the unit. Also, time spent in becoming fully acquainted with its performance features, adjustments, and maintenance schedules will be repaid in a long and satisfactory life of the equipment.

Troubleshooting - Please, before you call, help us to help you!

Please look at the equipment to observe what is happening, then:

- Classify the problem
 - Hydraulic, electrical or mechanical - Read the trouble shooting section
 - Tractor or Truck chassis - Contact vehicle dealer

- If unable to correct the problem yourself, contact your local Tiger Dealer after gathering:
 - Machine model _____
 - Serial number _____
 - Dealer name _____
 - Detailed information about the problem including results of troubleshooting

Attention Owner / Operator / Dealer: It is your obligation to read, and understand, the warranty information section located at the back of this manual denoting that the purchaser understands the safety issues relating to this machine and has received and will read a copy of this manual.

If at any time, you have a service problem with your Tiger mower, Contact your local dealer for service and parts needed.

MANUFACTURED BY:

Tiger Corporation

3301 N. Louise Ave.

Sioux Falls, SD 57107

1-800-843-6849

1-605-336-7900

www.tigermowers.com

DISTRIBUTED BY:

1- _____ - _____ - _____

1- _____ - _____ - _____

TABLE OF CONTENTS

SAFETY SECTION_____	1
ASSEMBLY / MOUNTING SECTION_____	2
OPERATION SECTION_____	3
MAINTENANCE SECTION_____	4
PARTS SECTION_____	5
COMMON PARTS SECTION_____	6
WARRANTY INFORMATION_____	7



1012

This symbol means:

CAUTION – YOUR SAFETY IS AT RISK!

When you see this symbol, read and follow the associated instructions carefully or personal injury or damage may result.

Tiger is a registered trademark.



SAFETY SECTION

SAFETY

General Safety Instructions and Practices

A safe and careful operator is the best operator. Safety is of primary importance to the manufacturer and should be to the owner / operator. Most accidents can be avoided by being aware of your equipment, your surroundings, and observing certain precautions. The first section of this manual includes a list of Safety Messages that, if followed, will help protect the operator and bystanders from injury or death. Read and understand these Safety Messages before assembling, operating or servicing this mower. This equipment should only be operated by those persons who have read the Manual, who are responsible and trained, and who know how to do so safely and responsibly.

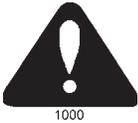

The Safety Alert Symbol combined with a Signal Word, as seen below, is used throughout this manual and on decals which are attached to the equipment. The Safety Alert Symbol means: “**ATTENTION! BECOME ALERT! YOUR SAFETY IS INVOLVED!**” The symbol and signal word are intended to warn the owner / operator of impending hazards and the degree of possible injury when operating this equipment.

Practice all usual and customary safe working precautions and above all -- remember safety is up to YOU! Only YOU can prevent serious injury or death from unsafe practices.

DANGER!



Indicates an imminently hazardous situation that, if not avoided, WILL result in DEATH OR VERY SERIOUS INJURY.

WARNING!



Indicates an imminently hazardous situation that, if not avoided, COULD result in DEATH OR SERIOUS INJURY.

CAUTION!



Indicates an imminently hazardous situation that, if not avoided, MAY result in MINOR INJURY.

IMPORTANT!

Identifies special instructions or procedures that, if not strictly observed, could result in damage to, or destruction of the machine, attachments or the environment.

NOTE: *Identifies points of particular interest for more efficient or convenient operation or repair.* (SG-1)

READ, UNDERSTAND, and FOLLOW the following Safety Messages. Serious injury or death may occur unless care is taken to follow the warnings and instructions stated in the Safety Messages. Always use good common sense to avoid hazards. (SG-2)

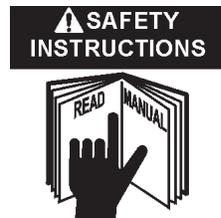

SAFETY

SAFETY

PELIGRO!



Si no lee Ingles, pida ayuda a alguien qui si lo lea para que le traduzca las medida de seguridad. (SG-3)



¡ LEA EL INSTRUCTIVO!

DANGER!



Never operate the Tractor or Implement until you have read and completely understand this Manual, the Tractor Operator's Manual, and each of the Safety Messages found in the Manual or on the Tractor and Implement. Learn how to stop the tractor engine suddenly in an emergency. Never allow inexperienced or untrained personnel too operate the Tractor and Implement without supervision. Make sure the operator has fully read and understood the manuals prior to operation. (SG-4)



WARNING!



Always maintain the safety decals in good readable condition. If the decals are missing, damaged, or unreadable, obtain and install replacement decals immediately. (SG-5)

WARNING!



Make certain that the "Slow Moving Vehicle" (SMV) sign is installed in such a way as to be clearly visible and legible. When transporting the Equipment use the Tractor flashing warning lights and follow all local traffic regulations. (SG-6)

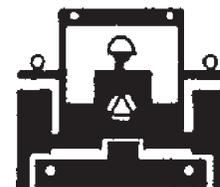

WARNING!



Operate this Equipment only with a Tractor equipped with an approved roll-over-protective system (ROPS). Always wear seat belts. Serious injury or even death could result from falling off the tractor--particularly during a turnover when the operator could be pinned under the ROPS. (SG-7)



WARNING!



Do not modify or alter this Implement. Do not permit anyone to modify or alter this Implement, any of its components or any Implement function. (SG-8)

DANGER!



BEFORE leaving the tractor seat, always engage the brake and/or set the tractor transmission in parking gear, disengage the PTO, stop the engine, remove the key, and wait for all moving parts to stop. Place the tractor shift lever into a low range or parking gear to prevent the tractor from rolling. Never dismount a Tractor that is moving or while the engine is running. Operate the Tractor controls from the tractor seat only. (SG-9)

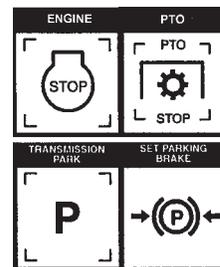

SAFETY

SAFETY

DANGER!



Never allow children or other persons to ride on the Tractor or Implement. Falling off can result in serious injury or death.

(SG-10)



DANGER!



Never allow children to operate or ride on the Tractor or Implement.

(SG-11)



WARNING!



Do not mount the Tractor while the tractor is moving. Mount the Tractor only when the Tractor and all moving parts are completely stopped.

(SG-12)



DANGER!



Start tractor only when properly seated in the Tractor seat. Starting a tractor in gear can result in injury or death. Read the Tractor operators manual for proper starting instructions. (SG-13)



DANGER!



Never work under the Implement, the framework, or any lifted component unless the Implement is securely supported or blocked up to prevent sudden or inadvertent falling which could cause serious injury or even death. (SG-14)



DANGER!



Do not operate this Equipment with hydraulic oil leaking. Oil is expensive and its presence could present a hazard. Do not check for leaks with your hand! Use a piece of heavy paper or cardboard. High-pressure oil streams from breaks in the line could penetrate the skin and cause tissue damage including gangrene. If oil does penetrate the skin, have the injury treated immediately by a physician knowledgeable and skilled in this procedure. (SG-15)



SAFETY

WARNING!



The operator and all support personnel should wear hard hats, safety shoes, safety glasses, and proper hearing protection at all times for protection from injury including injury from items thrown by the equipment. (SG-16)

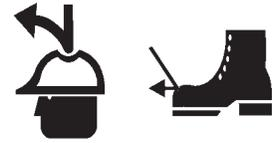

CAUTION!



PROLONGED EXPOSURE TO LOUD NOISE MAY CAUSE PERMANENT HEARING LOSS! Tractors with or without an Implement attached can often be noisy enough to cause permanent hearing loss. We recommend that you always wear hearing protection if the noise in the Operator's position exceeds 80db. Noise over 85db over an extended period of time will cause severe hearing loss. Noise over 90db adjacent to the Operator over an extended period of time will cause permanent or total hearing loss. *Note:* Hearing loss from loud noise [from tractors, chain saws, radios, and other such sources close to the ear] is cumulative over a lifetime without hope of natural recovery. (SG-17)



WARNING!



Transport only at safe speeds. Serious accidents and injuries can result from operating this equipment at unsafe speeds. Understand the Tractor and Implement and how it handles before transporting on streets and highways. Make sure the Tractor steering and brakes are in good condition and operate properly.



Before transporting the Tractor and Implement, determine the safe transport speeds for you and the equipment. Make sure you abide by the following rules:

1. **Test the tractor at a slow speed and increase the speed slowly. Apply the Brakes smoothly to determine the stopping characteristics of the Tractor and Implement. As you increase the speed of the Tractor the stopping distance increases. Determine the maximum safe transport speed for you and this Equipment.**
2. **Test the equipment at a slow speed in turns. Increase the speed through the turn only after you determine that it is safe to operate at a higher speed. Use extreme care and reduce your speed when turning sharply to prevent the tractor and implement from turning over. Determine the maximum safe turning speed for you and this equipment before operating on roads or uneven ground. Only transport the Tractor and Implement at the speeds that you have determined are safe and which allow you to properly control the equipment.**
3. **Be aware of the operating conditions. Do not operate the Tractor with weak or faulty brakes. When operating down a hill or on wet or rain slick roads, the braking distance increases: use extreme care and reduce your speed. When operating in traffic always use the Tractor's flashing warning lights and reduce your speed. Be aware of traffic around you and watch out for the other guy.** (SG-19)



SAFETY

SAFETY

WARNING!



Never attempt to lubricate, adjust, or remove material from the Implement while it is in motion or while tractor engine is running. Make sure the tractor engine is off before working on the Implement.

(SG-20)

WARNING!



Periodically inspect all moving parts for wear and replace when necessary with authorized service parts. Look for loose fasteners, worn or broken parts, and leaky or loose fittings. Make sure all pins have cotter pins and washers. Serious injury may occur from not maintaining this machine in good working order. (SG-21)



WARNING!



Always read carefully and comply fully with the manufacturers instructions when handling oil, solvents, cleansers, and any other chemical agent. (SG-22)



DANGER!



Never run the tractor engine in a closed building or without adequate ventilation. The exhaust fumes can be hazardous to your health.

(SG-23)

DANGER!



KEEP AWAY FROM ROTATING ELEMENTS to prevent entanglement and possible serious injury or death. (SG-24)



DANGER!



Never allow children to play on or around Tractor or Implement. Children can slip or fall off the Equipment and be injured or killed. Children can cause the Implement to shift or fall crushing themselves or others. (SG-25)

DANGER!



DO NOT allow any person under a folded wing unless wing is securely locked up or supported. **DO NOT** approach the Implement unless the Tractor is turned off and all motion has ceased. Never work under the frame work, or any lifted component unless the implement is securely supported or blocked up. A sudden or inadvertent fall by any of these components could cause serious injury or even death. (STI-3)



SAFETY

CAUTION!



On a fully-assembled unit, do not remove the Wing Retaining Strap until hoses are attached to the tractor and the Wing Cylinders are filled with oil. Lower the Wings slowly and carefully. Keep bystanders away during operations. (STI-5)

DANGER!



NEVER use drugs or alcohol immediately before or while operating the Tractor and Implement. Drugs and alcohol will affect an operator's alertness and coordination and therefore affect the operator's ability to operate the equipment safely. Before operating the Tractor or Implement, an operator on prescription or over-the-counter medication must consult a medical professional regarding any side effects of the medication that would hinder their ability to operate the Equipment safely. **NEVER** knowingly allow anyone to operate this equipment when their alertness or coordination is impaired. Serious injury or death to the operator or others could result if the operator is under the influence of drugs or alcohol. (SG-27)



DANGER!



Operate the Tractor and/or Implement controls only while properly seated in the Tractor seat with the seat belt securely fastened around you. Inadvertent movement of the Tractor or Implement may cause serious injury or death. (SG-29)

WARNING!



Mow only in conditions where you have clear visibility in daylight or with adequate artificial lighting. Never mow in darkness or foggy conditions where you cannot clearly see at least 100 yards in front and to the sides of the tractor and mower. Make sure that you can clearly see and identify passersby, steep slopes, ditches, drop-offs, overhead obstructions, power lines, debris and foreign objects. If you are unable to clearly see this type of items discontinue mowing. (SGM-1)

DANGER!



There are obvious and hidden potential hazards in the operation of this Mower. **REMEMBER!** This machine is often operated in heavy brush and in heavy weeds. The Blades of this Mower can throw objects if shields are not properly installed and maintained. Serious injury or even death may occur unless care is taken to insure the safety of the operator, bystanders, or passersby in the area. Do not operate this machine with anyone in the immediate area. Stop mowing if anyone is within 100 yards of mower. (SGM-2)



DANGER!



All Safety Shields, Guards and Safety devices including (but not limited to) - the Deflectors, Chain Guards, Steel Guards, Gearbox Shields, PTO integral shields, and Retractable Door Shields should be used and maintained in good working condition. All safety devices should be inspected carefully at least daily for missing or broken components. Missing, broken, or worn items must be replaced at once to reduce the possibility of injury or death from thrown objects, entanglement, or blade contact. (SGM-3)

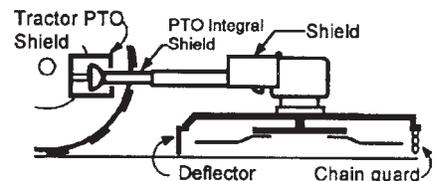

SAFETY

SAFETY

DANGER!



The rotating parts of this machine have been designed and tested for rugged use. However, the blades could fail upon impact with heavy, solid objects such as metal guard rails and concrete structures. Such impact could cause the broken objects to be thrown outward at very high velocities. To reduce the possibility of property damage, serious injury, or even death, never allow the cutting blades to contact such obstacles. (SGM-4)

WARNING!



Extreme care should be taken when operating near loose objects such as gravel, rocks, wire, and other debris. Inspect the area before mowing. Foreign objects should be removed from the site to prevent machine damage and/or bodily injury or even death. Any objects that cannot be removed must be clearly marked and carefully avoided by the operator. Stop mowing immediately if blades strike a foreign object. Repair all damage and make certain rotor or blade carrier is balanced before resuming mowing. (SGM-5)



WARNING!



Many varied objects, such as wire, cable, rope, or chains, can become entangled in the operating parts of the mower head. These items could then swing outside the housing at greater velocities than the blades. Such a situation is extremely hazardous and could result in serious injury or even death. Inspect the cutting area for such objects before mowing. Remove any like object from the site. Never allow the cutting blades to contact such items. (SGM-6)

WARNING!



Mow at the speed that you can safely operate and control the tractor and mower. Safe mowing speed depends on terrain condition and grass type, density, and height of cut. Normal ground speed range is from 0 to 5 mph. Use slow mowing speeds when operating on or near steep slopes, ditches, drop-offs, overhead obstructions, power lines, or when debris and foreign objects are to be avoided. (SGM-7)

WARNING!



Avoid mowing in reverse direction when possible. Check to make sure there are no persons behind the mower and use extreme care when mowing in reverse. Mow only at a slow ground speed where you can safely operate and control the tractor and mower. Never mow an area that you have not inspected and removed debris or foreign material. (SGM-8)

WARNING!



Do not put hands or feet under mower decks. Blade Contact can result serious injury or even death. Stay away until all motion has stopped and the decks are securely blocked up. (SGM-9)



DANGER!



Replace bent or broken blade with new blades. NEVER ATTEMPT TO STRAIGHTEN OR WELD ON BLADES SINCE THIS WILL LIKELY CRACK OR OTHERWISE DAMAGE THE BLADE WITH SUBSEQUENT FAILURE AND POSSIBLE SERIOUS INJURY FROM THROWN BLADES. (SGM-10)

WARNING!



Do not mow with two machines in the same area except with Cab tractors with the windows closed. (SGM-11)

SAFETY

DANGER!



Rotary Mowers are capable under adverse conditions of throwing objects for great distances (100 yards or more) and causing serious injury or death. Follow safety messages carefully.

STOP MOWING IF PASSERSBY ARE WITHIN 100 YARDS UNLESS:

- Front and Rear Deflectors are installed and in good, working condition;
- Mower Head is running close to and parallel to the ground without exposed Blades;
- Passersby are outside the existing thrown-object zone;
- All areas have been thoroughly inspected and all foreign material such as rocks, cans, glass, and general debris has been removed.

NOTE: Where there are grass and weeds high enough to hide debris that could be struck by the blades, the area should be: inspected and large debris removed, mowed at an intermediate height, inspected closely with any remaining debris removed, and mowed again at desired final height. (SBM-1)

WARNING!



Each Rear Wheel must have a minimum of 1,000 pounds contact with the surface to prevent lateral instability and possible tip-over which could result in serious bodily injury or even death. Widen the wheel tread and add weights if needed. Refer to the mounting instructions or call Customer Service if you need assistance with Counterweight Procedure. (SFL-3)

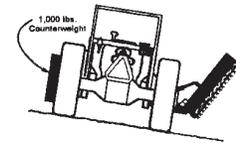

WARNING!



Do not operate Mower if excessive vibration exists. Shut down PTO and the Tractor engine. Inspect the Mower to determine the source of the vibration. If Mower blades are missing or damaged replace them immediately. Do not operate the mower until the blades have been replaced and the Mower operates smoothly. Operating the Mower with excessive vibration can result in component failure and broken objects to be thrown outward at very high velocities. To reduce the possibility of property damage, serious injury, or even death, never allow the Mower to be operated with blades missing. (SFL-4)

WARNING!



Do not let the Blades turn when the Mower Deck is raised for any reason, including clearance or for turning. Raising the Mower deck exposes the Cutting Blades which creates a potentially serious hazard and could cause serious injury or even death from objects thrown from the Blades. (SRM-7)



DANGER!



Use extreme caution when raising the Mower head. Stop the Blades from turning when the Mower Head is raised and passersby are within 100 yards. Raising the Mower head exposes the Cutting Blades which creates a potentially serious hazard and can cause serious injury by objects thrown from the Blades or by contact with the Blades.

(SBM-2)

SAFETY

SAFETY

WARNING!



Never leave the Tractor and Implement unattended while the Implement is in the lifted position. Accidental operation of lifting lever or a hydraulic failure may cause sudden drop of unit with injury or death by crushing. To properly park the implement when disconnecting it from the tractor, lower the stand and put the retaining pin securely in place, or put a secure support under the A-Frame. Lower the implement carefully to the ground. Do not put hands or feet under lifted components. (S3PT-1)

WARNING!



Relieve hydraulic pressure prior to doing any maintenance or repair work on the Implement. Place the Mower Head on the ground or securely supported on blocks or stands, disengage the PTO, and turn off the engine. Push and pull the control Levers or Joystick several times to relieve pressure prior to starting any maintenance or repair work. (SBM-6)

DANGER!



Always disconnect the wire leads from the mower valve solenoid before performing service on the Tractor or Mower. Use caution when working on the Tractor or Mower. Tractor engine must be stopped before working on Mower or Tractor. The Mower Blades could inadvertently be turned on without warning and cause immediate dismemberment, injury or death. (SBM-12)

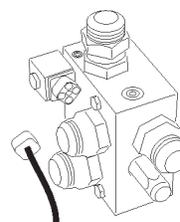

WARNING!



Use extreme care when lowering or unfolding the implement's wings. Make sure no bystanders are close by or underneath the wings. Allow ample clearance around the implement when folding or unfolding the wings. Use extreme caution around buildings or overhead power lines.

(S3PT-

5)

WARNING!



Relieve hydraulic pressure prior to doing any maintenance or repair work on the Implement. Place the Implement on the ground or securely blocked up, disengage the PTO, and turn off the tractor engine. Push and pull the Remote Cylinder lever in and out several times prior to starting any maintenance or repair work. (S3PT-9)



DANGER!



This Implement is wider than the Tractor. Be careful when operating or transporting this equipment to prevent the Implement from running into or striking sign posts, guard rails, concrete abutments or other solid objects. Such an impact could cause the Implement and Tractor to pivot violently resulting in loss of steering control, serious injury, or even death. Never allow the Implement to contact obstacles. (S3PT-12)

DANGER!



The flail cutter shaft is designed for standard rotation (same rotation as the tractor wheel during forward travel). **Never operate the cutter shaft in the reverse rotation.** Operating this mower in reverse rotation may cause objects to be thrown out the front of the mower head.



SAFETY

SAFETY

WARNING!



The rotating parts of this machine continue to rotate even after the Tractor has been turned off. The operator should remain in his seat for 60 seconds after the brake has been set, the PTO disengaged, the tractor turned off, and all evidence of rotation has ceased. (SBM-5)

“Wait a minute...Save a life!”

WARNING!



Engine Exhaust, some of its constituents, and certain components contain or emit chemicals known to the state of California to cause cancer and birth or other reproductive harm.

WARNING!



Battery post, terminals and related accessories contain lead and lead compounds, chemicals known to the state of California to cause cancer and birth or other reproductive harm. **Wash hands after handling!**

Tiger mowers use balanced and matched system components for blade carriers, blades, cutter-shafts, knives, knife hangers, rollers, drive-train components and bearings. These parts are made and tested to Tiger specifications. Non-genuine “will fit” parts do not consistently meet these specifications. The use of “will fit” parts may reduce mower performance, void mower warranties and present a safety hazard. Use genuine Tiger mower parts for economy and safety.

SEE YOUR



DEALER

In addition to the design and configuration of this Implement, including Safety Signs and Safety Equipment, hazard control and accident prevention are dependent upon the awareness, concern, prudence, and proper training of personnel involved in the operation, transport, maintenance, and storage of the machine. Refer also to Safety Messages and operation instruction in each of the appropriate sections of the Tractor and Equipment Manuals. Pay close attention to the Safety Signs affixed to the Tractor and Equipment. (SG-18)

SAFETY

SAFETY

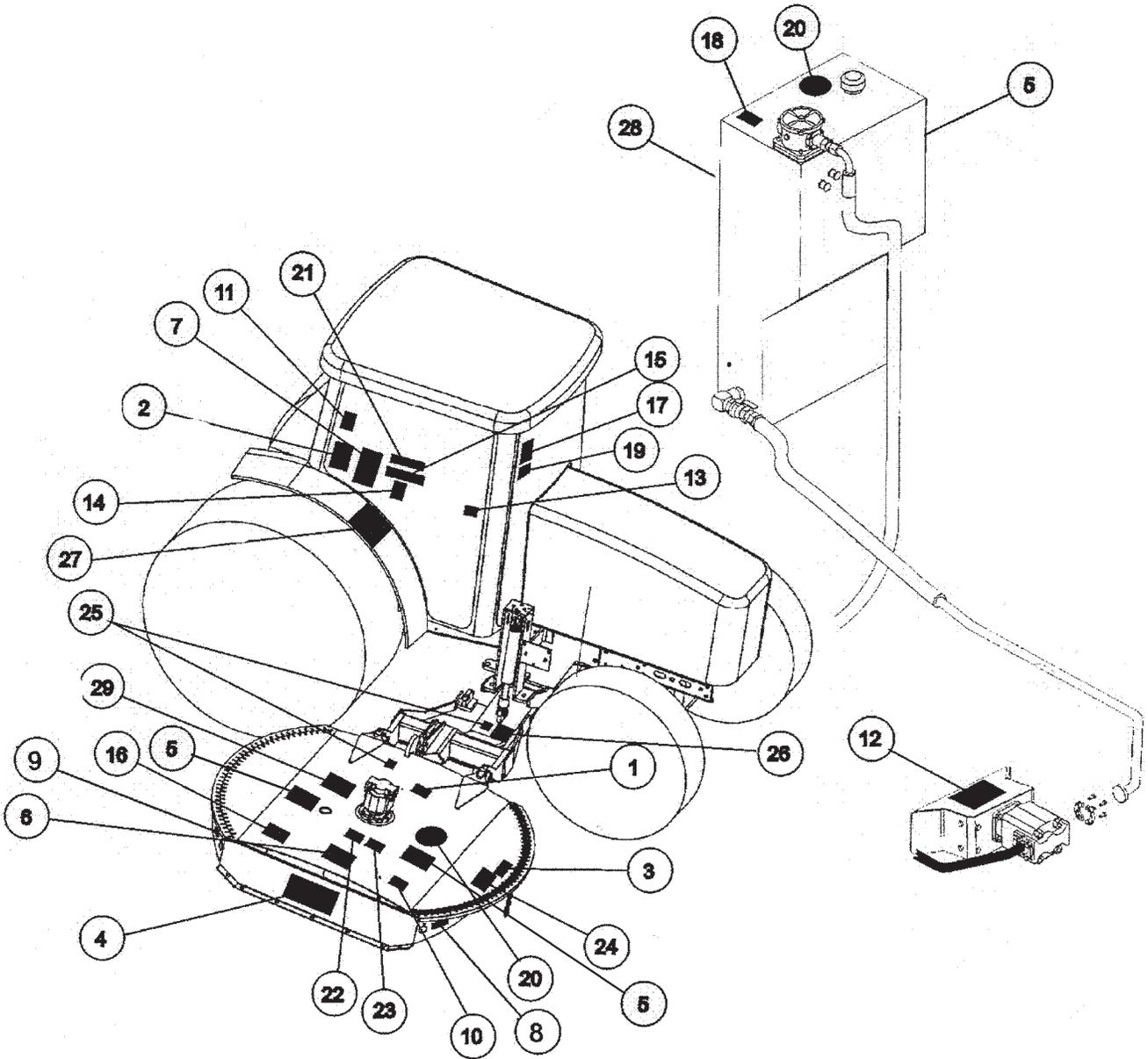

SAFETY

SAFETY

ITEM	PART NO.	QTY.		DESCRIPTION
1	22839	1	INSTRUCT	Don Not Lubricate With Automatic Grease Gun
2	22840	1	WARNING	Foreign Objects Contacted
3	24028	1	WARNING	Inspect Rear Flap
4	31522	1	LOGO	TIGER MOWERS
5	31523	3	LOGO	TIGER MOWERS
6	42350	1	DANGER	Cuttershaft Direction
7	33743	1	INSTRUCT	Mowing Safet Tips
8	42399	1	REFLECT	Red Reflector
9	42400	1	REFLECT	Amber Reflector
10	6T3217	1	DANGER	Keep Hands and Feet Clear
11	6T3219	1	WARNING	Read Operators and Maintenance Manuals
12	6T3220	1	INTRUCT	Lubricate Pump, Driveshaft Daily
13	6T3221	1	CAUTION	Lubricate Spindle When Mower and Tractor Off
14	6T3222	1	INSTRUCT	Engine will not start when mower is engaged
15	1059	1	INSTRUCT	Mower Positions
16	6T3224	1	DANGER	Stay Clear, Discharge Opening
17	6T3230	1	WARNING	Don't Operate with Bystanders in Area
18	6T3233	1	CAUTION	DONOT Start or Run with Valves closed
19	6T3234	1	CAUTION	Check Crankshaft Adapter Daily
20	6T3236	1	LOGO	Made In USA
21	6T3243	1	WARNING	Replace Bolts and Locknut if damaged
22	6T3249A	1	INSTRUCT	Grease Inst. Cuttershaft Bearing
23	6T3261	1	INSTRUCT	Grease Inst. Ground Roller Bearing
24	TB1011	1	WARNING	Do Not Work Mower with Safety Shiel Removed
25	02962764	1	WARNING	Pinch Point
26	02965262	1	WARNING	Hydraulic Hose Repair
27	02967827	1	DANGER	Multi Warn Messages
28	34852	1	INSTRUCT	Hydraulic Specifications
29	00756059	1	WARNING	Check Hydraulic Hose with Cardboard

SAFETY

SAFETY

DO NOT LUBRICATE WITH AUTOMATIC GREASE GUN. GREASE WITH HAND GREASE GUN ONLY.

P/N22839

PART NO.
LOCATION

22839
MOWER DECK



22840
INSIDE OF CAB

WARNING

INSPECT REAR FLAP FREQUENTLY TO BE SURE IT IS IN SAFE WORKING CONDITION. DO NOT OPERATE MOWER WITH FLAP REMOVED OR WORN.

24028

24028
MOWER DECK



10"X5.5" 31522
MOWER DECK

18.25"X10" 31523
HYDRAULIC TANK

SAFETY

⚠ DANGER

TO AVERT THROWN OBJECTS,
CUTTER SHAFT MUST TURN IN THIS



DIRECTION

PART NO.
LOCATION

42350
MOWER DECK

MOWING SAFETY TIPS ⚠

- ▶ Read & understand the Operator's Manual.
- ▶ Wear Your Seat Belt.
- ▶ Keep all shields and guards in place.
- ▶ Make sure equipment is in proper working order.
- ▶ Never attempt to get off or on a moving truck.
- ▶ Never allow riders on truck or equipment.
- ▶ Only start the truck from the seat with the key.
- ▶ Always inspect the area before mowing.
Remove all foreign debris.
- ▶ Always keep bystanders and coworkers a minimum of 300 feet away.
- ▶ Never allow the mower blades to contact solid objects or foreign material.
- ▶ Never approach rotating elements.
- ▶ Disengage mower head. Shut down Aux. Engine place transmission in park, set parking brake, shut off truck engine, and remove key. Wait till all rotating motion has stopped before leaving seat.



33743
INSIDE OF CAB

5



42399
MOWER DECK



42400
MOWER DECK

SAFETY

SAFETY

SAFETY



PART NO.
LOCATION

6T3217
MOWER DECK



6T3219
INSIDE OF CAB

6T3220
FRONT PUMP MOUNT



6T3221
INSIDE OF CAB

29-6T3221

SAFETY

NOTICE:
Engine will not
start when mower
is engaged.



6T3222

PART NO.
LOCATION

6T3233
INSIDE OF CAB

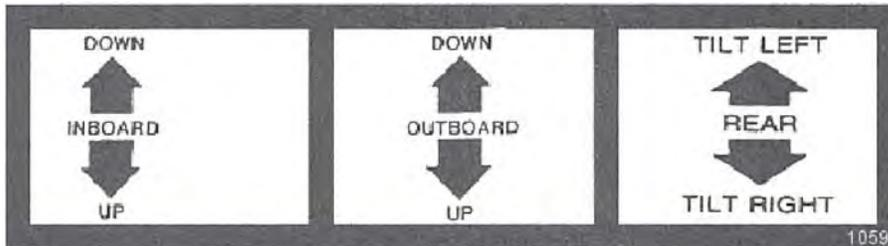

1059

1059

6T3234
INSIDE OF CAB



6T3236
MOWER DECK

⚠ WARNING

**DO NOT OPERATE THIS EQUIPMENT
WITH BYSTANDERS IN THE AREA!**

ROTARY MOWERS HAVE THE INHERENT ABILITY TO
THROW DEBRIS CONSIDERABLE DISTANCES WHEN
KNIVES ARE ALLOWED TO STRIKE FOREIGN OBJECTS.
OPERATOR CAUTION MUST BE TAKEN OR SERIOUS
INJURY CAN RESULT.

6T-3230

6T3243
INSIDE OF CAB

SAFETY

SAFETY

SAFETY

PART NO.
LOCATION



6T3233
HYDRAULIC TANK



6T3234
INSIDE OF CAB



6T3236
MOWER DECK
HYDRAULIC TANK

6T3243
INSIDE OF CAB

SAFETY

PART NO.
LOCATION

GREASING INSTRUCTIONS

GROUND SHAFT BEARING
GREASE EVERY 8 HRS. OR DAILY

NOTE: If unusual environmental conditions exist; extreme temperatures, moisture, or contaminants more frequent lubrication is required.

6T3249A

6T3249A
MOWER DECK

GREASING INSTRUCTIONS

GROUND ROLLER BEARING
GREASE EVERY 8 HRS. OR DAILY

NOTE: If unusual environmental conditions exist; extreme temperatures, moisture, or contaminants more frequent lubrication is required.

6T3261

6T3261
MOWER DECK

WARNING

DO NOT OPERATE MOWER
WITH SAFETY SHIELD REMOVED.

TB1011

TB1011
MOWER DECK



WARNING

PINCH POINTS

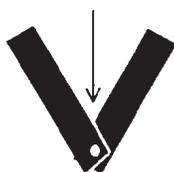

02962764

02962764
MOWER DECK
DRAFT BEAM

SAFETY

SAFETY

SAFETY

PART NO.
LOCATION

02965262
DRAFT BEAM

DANGER

FAILING TO FOLLOW SAFETY MESSAGES AND OPERATING INSTRUCTIONS CAN CAUSE SERIOUS BODILY INJURY OR EVEN DEATH TO OPERATOR AND OTHERS IN THE AREA.



1. Study and understand Operator's Manuals, Safety Decals, and Instructional Decals for tractor and implement to prevent misuse, abuse, and accidents. Practice before operating in a confined area or near passersby.
 - Learn how to stop engine suddenly in an emergency. Be alert for passersby and especially children.
2. Allow no children on or near folding mower or tractor. Allow no riders on tractor or implement. Falling off may cause serious injury or death from being run over by tractor or mower or contact with rotating blades.
3. Operate only with tractor having Roll-Over Protective Structure (ROPS) and with seat belt securely fastened to prevent injury and possible death from falling off or tractor overturn.
 - Personal Protective Equipment such as Hard Hat, Safety Glasses, Safety Shoes, & Ear Plugs are recommended.
4. Block up or support raised machine and all lifted components securely before putting hands or feet under or working underneath any lifted component to prevent crushing injury or death from sudden dropping or inadvertent operation of controls. Make certain area is clear before lowering or folding.
5. Before transporting, put Lift Lever in detent or full-lift position. Install Transport Safety Devices securely on folding mowers. Put Booms securely in Transport Rest.
 - Folding and Boom Mowers have raised center of gravity. Slow down when turning and on hillsides.
6. Make certain that SMV sign, warning lights, and reflectors are clearly visible. Follow local traffic codes.
7. Never operate with Cutting Head or Folding Section raised if passersby, bystanders, or traffic are in the area to reduce possibility of injury or death from objects thrown by Blades under Guards or mower structure.
8. Before dismounting, secure implement in transport position or lower to ground.
 - Put tractor in park or set brake, disengage PTO, stop engine, remove key, and wait until noise of rotation has ceased to prevent crushing by entanglement in rotating parts which could cause injury or death.
 - Never mount or dismount a moving vehicle. Crushing from rollover may cause serious injury or death.



02967827
CAB FENDER

SAFETY



Tiger Corporation

800-843-6849

www.tiger-mowers.com

SAFETY

Description	Application	General Specification	Recommended Lubricant
Tractor Hydraulics	Reservoir	JD-20C	Mobilfluid® 424
Mower Hydraulics	Reservoir	ISO 46 Anti-Wear/ Low Temp	Mobil DTE® 15M
Cold Temperatures 0°F Start-up		JD-20C	Mobilfluid® 424
Normal Temperatures 10°F Start-up		ISO 46 Anti-Wear	Mobil DTE® 25
Normal Temperatures 15°F Start-up		ISO 100 Anti-Wear	Mobil DTE® 18M
High Operating Temperatures Above 90°F Ambient			
Flail Rear Gearbox	Reservoir	PAO Synthetic Extreme Pressure Gear Lube	Mobilube SHC® 75W-90, Mobil 1 Synthetic Gear Lubricant
Cutter Shaft and Ground Roller Shaft (Flail)	Grease Gun	Lithium Complex, NLGI 2 ISO 320	Mobilgrease® CM-S
Drive Shaft Coupler (Rotary and Flail) Drive Shaft Yoke, U - Joint and Stub Shaft	Grease Gun	Lithium Complex, NLGI 2 ISO 320	Mobilgrease® CM-S
Boom Swivel, Boom Cylinder Pivots (Rotary and Flail Boom Type)	Grease Gun	Lithium Complex, NLGI 2 ISO 320	Mobilgrease® CM-S
Deck Boom Pivot & Deck Stop Adjustment (Rotary and Flail)	Grease Gun	Lithium Complex, NLGI 2 ISO 320	Mobilgrease® CM-S
Deck Spindle (Rotary)	Grease Gun	Tiger Spindle Lubricant	Tiger Part #25351

For Mobil product information, availability, or technical information, call 1-800-662-4525.

Tiger PN 34852

34852
HYDRAULIC TANK

WARNING

USE PAPER OR CARDBOARD TO CHECK FOR LEAKS. **NEVER USE YOUR HAND.** IF OIL PENETRATES SKIN, GANGRENE OR OTHER SERIOUS INJURY COULD OCCUR. **GET IMMEDIATE MEDICAL ATTENTION.**
See Operator's Manual.

00756059

00756059
MOWER DECK

SAFETY

SAFETY

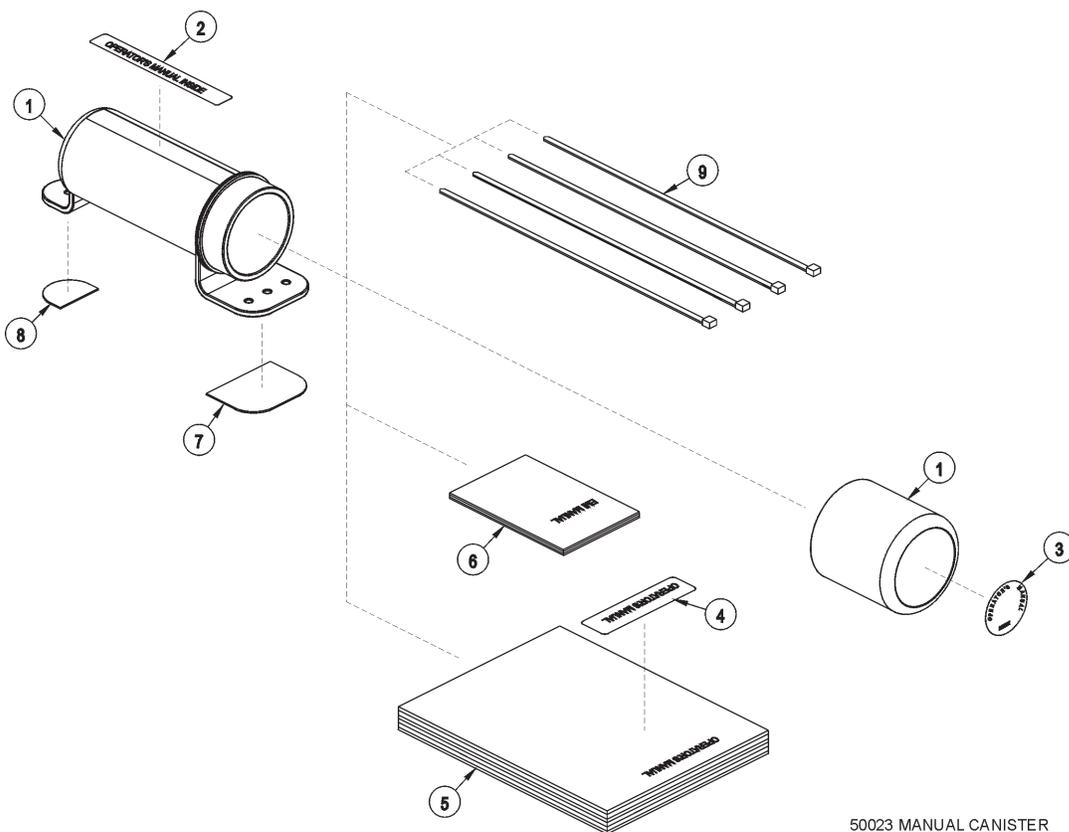

50023 MANUAL CANISTER

ITEM	PART NO.	QTY.	DESCRIPTION
	50023	AVAIL	MANUAL CANISTER COMPLETE
1	00776031	1	Round Manual Canister
	33997	1	Decal, Sheet, Manual Canister
2		*	Decal
3		*	Decal
4		*	Decal
5	*	AVAIL	Specification Product Manual
6	33753	1	EMI Safety Manual
7	34296	1	Front Adhesive Pad
8	34297	1	Rear Adhesive Pad
9	6T1823	4	Zip Tie 14" Long

NOTE:

The manual canister can be bolted, zip tied or adhered to a variety of surfaces. Locate a protected area within the view of the operator. Then select an installation method and attach the canister. **CAUTION-AVOID DRILLING HOLES INTO UNKNOWN AREAS**, wires and other parts may be located behind these areas. When adhering the canister to a surface, thoroughly clean that surface before installing the canister.

SAFETY

FEDERAL LAWS AND REGULATIONS

This section is intended to explain in broad terms the concept and effect of federal laws and regulations concerning employer and employee equipment operators. This section is not intended as a legal interpretation of the law and should not be considered as such.

Employer-Employee Operator Regulations

U.S. Public Law 91-596 (The Williams-Steiger Occupational and Health Act of 1970) OSHA

This Act Seeks:

“...to assure so far as possible every working man and woman in the nation safe and healthful working conditions and to preserve our human resources...”

DUTIES

Sec. 5 (a) Each employer-

(1) shall furnish to each of his employees employment and a place of employment which are free from recognized hazards that are causing or are likely to cause death or serious physical harm to his employees;

(2) shall comply with occupational safety and health standards promulgated under this Act.

(b) Each employee shall comply with occupational safety and health standards and all rules, regulations and orders issued pursuant to this Act which are applicable to his own actions and conduct.

OSHA Regulations

OSHA regulations state in part: “At the time of initial assignment and at least annually thereafter, the employer shall instruct every employee in the safe operation and servicing of all equipment with which the employee is, or will be involved.”

Employer Responsibilities:

To ensure employee safety during Truck and Implement operation, it is the employer’s responsibility to:

1. Train the employee in the proper and safe operation of the Truck and Implement.
2. Require that the employee read and fully understand the Truck and Implement Operator’s manual.
3. Permit only qualified and properly trained employees to operate the Truck and Implement.
4. Maintain the Truck and Implement in a safe operational condition and maintain all shields and guards on the equipment.
5. Ensure the Truck is equipped with functional seat belts and require that the employee operator securely fasten the safety belts at all times.
6. Forbid the employee operator to carry additional riders on the Truck.
7. Provide the required tools to maintain the Truck and Implement in a good safe working condition and provide the necessary support devices to secure the equipment safely while performing repairs and service.

Child Labor Under 16 Years of Age

Some regulations specify that no one under the age of 16 may operate power machinery. It is your responsibility to know what these regulations are in your own area or situation. (Refer to U.S. Dept. of Labor, Employment Standard Administration, Wage & Home Division, Child Labor Bulletin #102.)

SAFETY

SAFETY

ASSEMBLY SECTION

ASSEMBLY

Before attempting to mount your Tiger mower, it is important to read and understand all of the safety messages in the Safety Section of this manual.

Check complete shipment list against the packing list to make sure there are no shortages. Make certain the tractor model is the appropriate one for the mower received!



Always use a floor jack, hoist or fork lift to lift and raise heavy parts.

Read and understand the entire Assembly Section instructions before attempting to mount your Tiger mower. Refer to the Parts Section of this manual for detailed illustrations to locate all parts. (ASM-C-0001)

TRACTOR PREPARATION

- A. Remove engine side panels, or raise hood to access front pulley.
- B. Remove plugs from tractor casting where mainframe and pump mount will be attached.
- C. Remove any front weights and weight supports.
- D. Raise the tractor onto jack-stands and remove the right and left rear wheels.
- E. Remove paint where the common frame will contact the tractor's frame rail.
- F. Remove toolbox mounting bracket. (Retain hardware to use installing cooler mount.)
- G. Remove fuel tank support bracket. (Retain to reinstall after frame is mounted.)

(ASM-JD-0001 JD6M MY20)



ASSEMBLY

FRONT CRANKSHAFT PULLEY

Tiger has found that the front crankshaft pulley used by John Deere will not allow for the installation of a front drive system. You will need to order a different pulley, washer and bolt from John Deere to allow for a front drive to be installed on your tractor.

Inspect the front pulley on your tractor to verify you have the correct pulley needed to mount the spacer plate. If your pulley has the (4) four holes needed to mount the spacer, your pulley is the correct one needed. If your pulley does not have the (4) four holes in the pulley, you will need to order the correct pulley, washer and bolt from John Deere.

PARTS REQUIRED TO PURCHASE FROM JOHN DEERE:

Pulley from JD - DV107758

Washer from JD - R517237

Bolt from JD - R516648

Torque on the pulley bolt with Loctite is 369 lb-ft.

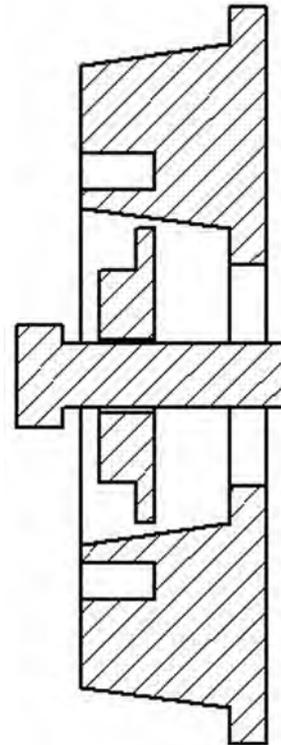
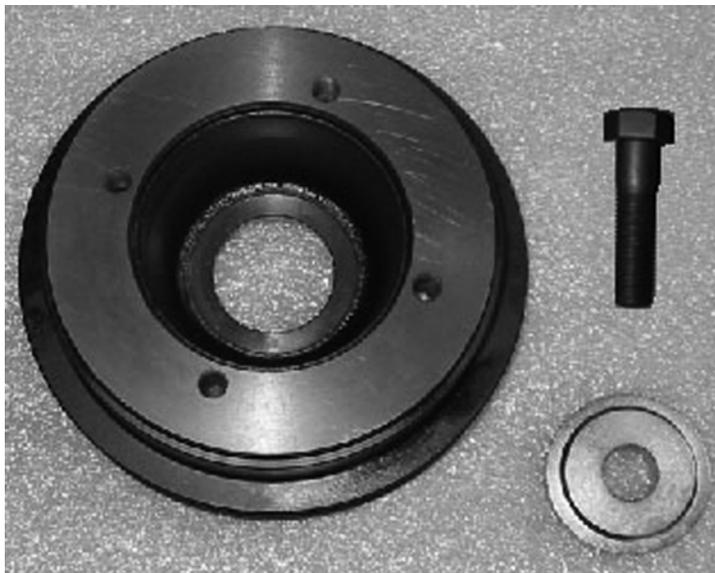

Solution:

1. Clean nose of crankshaft using TY16285 clean and cure primer.
2. Apply a light 2-3mm bead of TY15969 retaining compound around the leading edge of the crankshaft nose.
3. Dip damper mounting capscrew in clean SAE30 engine oil (Always use a new capscrew).
4. Position damper/pulley on the crankshaft and thread capscrew up tight (do not rely on the capscrew to pull the pulley straight onto the taper).
5. Tighten capscrew to specification 500Nm (369lb-ft) (the engine will most likely have to be pinned).
6. Measure run-out on the pulley, spec is 0.003" or less.

(ASM-JD-0080)



ASSEMBLY

DRIVESHAFT AND FRONT PUMP MOUNTING

Install spacer plate on tractor engine using bolts and lockwashers as shown in Parts Section. Grease sleeve section of the driveshaft and install from the side of the engine compartment. Once you have the sleeve section in place, bolt to spacer plate using bolts and lockwashers as shown in Parts Section. Install shaft end of driveshaft through opening and into driveshaft sleeve. Shaft and sleeve yokes should be aligned, if shaft does not insert easily in sleeve, turn shaft 180°, and then install. Align the notches on the shaft and yoke tube as shown in picture below. **Shaft end must be installed in correct orientation, failure to do so may result in damage to tractor and/or driveshaft.** After installation of shaft end, install pump mount. Next, install pump. After pump is secured, install driveshaft in to pump shaft. The end of driveshaft should be no more than 1/2" away from contact with pump housing. Tighten crimping bolt on driveshaft. Lube driveshaft and check all hoses, flanges, the pump, pump mount, driveshaft and mounting plate to ensure all fasteners are tightened before operation.

CAUTION: DO NOT START THE TRACTOR UNTIL ALL HOSES ARE ATTACHED, TANK IS FILLED WITH PROPER OIL AND BALL VALVES ARE OPEN! STARTING AT THIS TIME WILL CAUSE SERIOUS DAMAGE TO THE PUMP. (ASM-JD-0007)

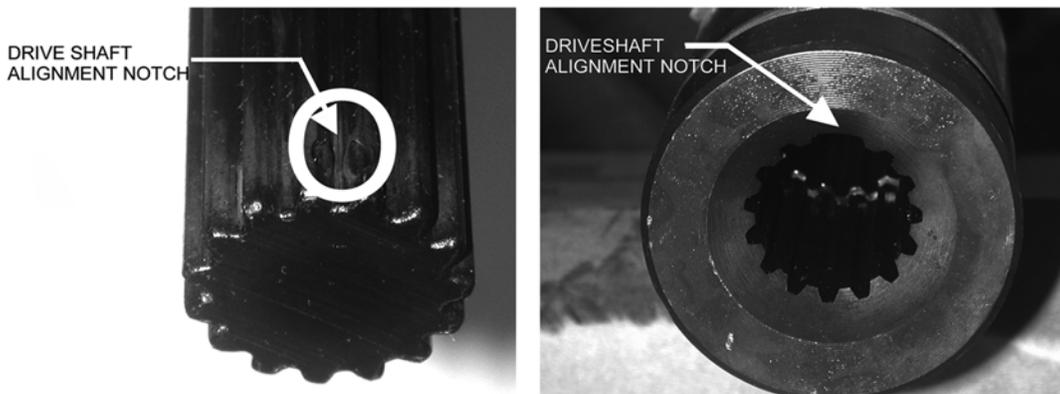

ADJUSTING REAR WHEELS

Raise rear of tractor onto jack-stands. **Follow the instructions in the tractor owner's manual for adjusting tires and rims.** The back wheels **MUST** be adjusted to the widest setting. **NOTE:** This may require switching the wheels to opposite sides of tractor. Also take note of any width restrictions when transporting by trailer. (For ease of installation, it is best to leave the rear wheels removed during installation of the mower.) (ASM-B-0001)



ASSEMBLY

APPLICATION OF LOCTITE 2047 MOWER MAINFRAME MOUNTING BOLTS

All mower mainframe mounting bolts shall be secured utilizing Loctite 2047 and torqued per the Torque Chart in the maintenance section. Shake bottle for 60 seconds before use. To prevent clogging of nozzle, do not allow tip to touch metal surfaces during application. If tip of nozzle becomes clogged, cut off tip as required. If female threads are contaminated or rusty, clean threads by using a thread chaser prior to installation of bolts. Apply thread locker to threads of bolts as shown below. The allowable fixture time is (1) hour maximum. Therefore bolts must be torqued within this time limit. The cure time is 72 hours at room temperature, therefore machine is not to be used in actual application, except for function testing, until the Loctite is allowed to cure.

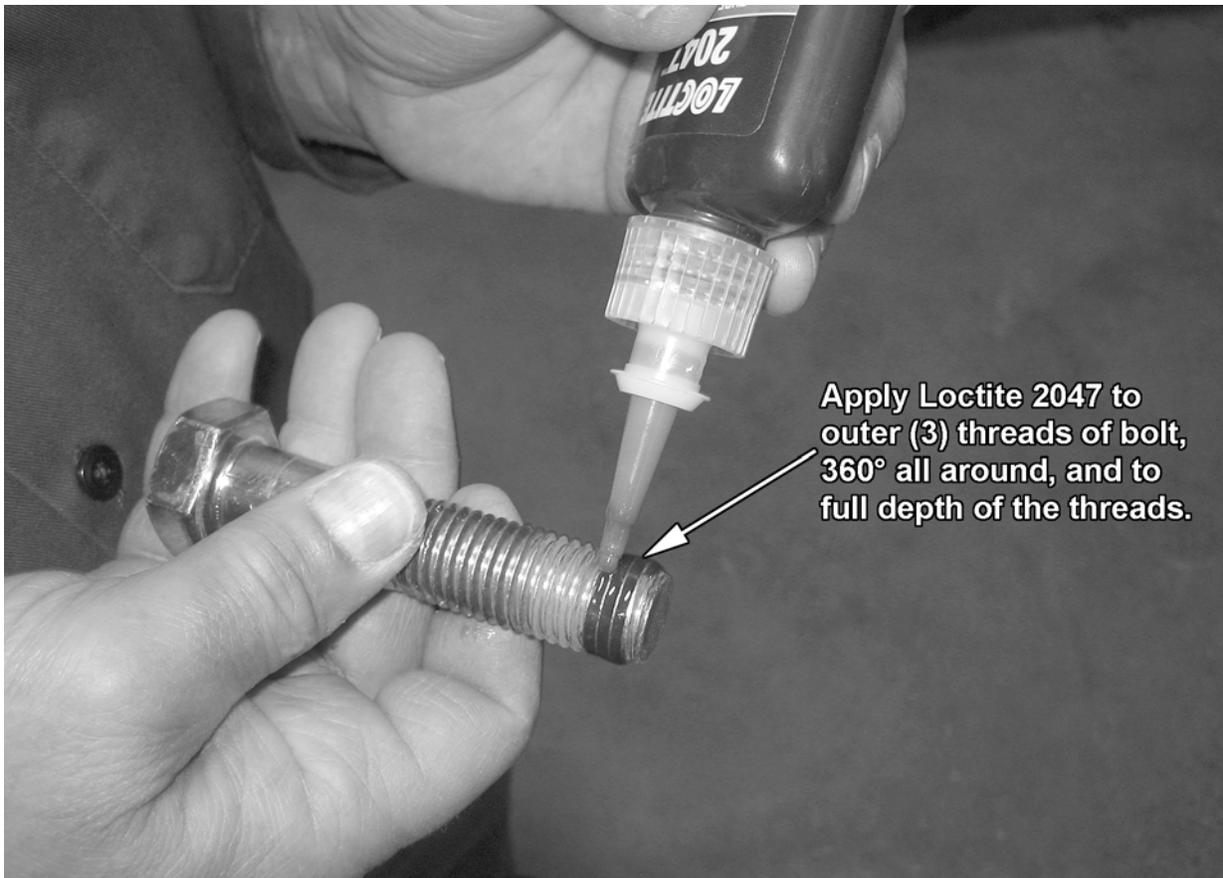

Apply Loctite 2047 to outer (3) threads of bolt, 360° all around, and to full depth of the threads.

(ASM-C-LOCTITE MNT BOLTS)



ASSEMBLY

SWITCHBOX WIRING

Power for the switchbox is accessed through the port located on the right rear of the cab. A John Deere plug is used, part number RE67651. DO NOT connect the plug to the cab port until the wiring is completed. The wires in the plug are colored RED, BLACK and ORANGE. **IMPORTANT: The hot wire will be the RED wire or the ORANGE wire.** ALWAYS test these wires to determine which is which. The hot wire needs to be capped. Attach connector 34538 to end of hot wire and tape wire back on itself. Connect the BLACK wire of the plug to the BLACK wire from the switchbox. Connect the keyed hot wire of the plug to the red wire of the switchbox.

After connecting the power to the switchbox, route the white wire along the cables or wires to the solenoid valve. (ASM-JD-0245)



ASSEMBLY

CONTINUOUS DUTY SOLENOID SWITCH

The solenoid switch is mounted near the battery behind the steps on the right side of the tractor.(see photos below). Secure with hardware provided. (ASM-JD-0083 JD6M MY20) .

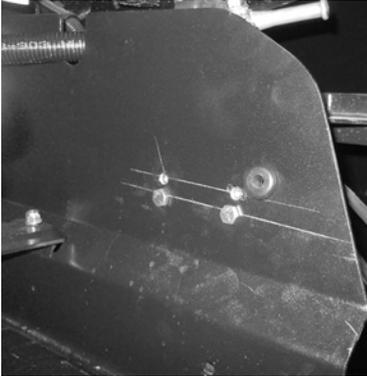

Route wires to and from the Continuous Duty Solenoid Switch as shown below.

- A.) ORANGE 10 GA. wire from terminal (A) to +12V battery fusible link.
- B.) RED 14 GA. wire from terminal (B) to tractor plug in cab.
- C.) BLACK 14 GA. wire from terminal (C) to -12V battery post.
- D.) RED 10 GA. wire from terminal (D) to fan temperature gauge. (ASM-JD-0083d)

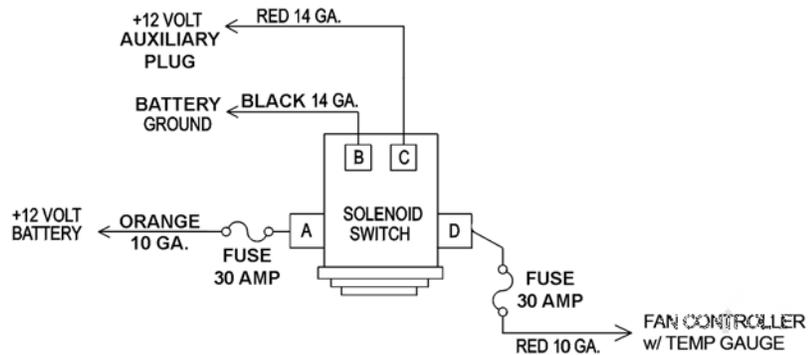

ASSEMBLY

CABLE CONTROL MOUNTING

Remove the cup holder from the right corner post of the cab. The cup holder can be relocated to the left side of the cab on the floor. The hole created in the corner post will be used to attach the cable control support bracket.

The rear corner of the cable control stand is placed approximately 6-1/4" from the edge of the mat. The front edge of the stand is up against the corner cab post and the door sill lip of the mat. Before you mark or drill any holes, check for support plates or wires under the mat and the cab floor. NOTE: Cutting into plates or wires makes more work for everyone and could be dangerous. When you know where the wires/plates lie, mark one of the mounting holes. Drill a 3/8" hole through the mat and through the floor of the cab. Next, lift the mat up and mark the other two holes on the cab floor. Drill the holes through the floor. Mark the mat and drill the other two 3/8" holes. Use a 1" hole saw and cut a 1" hole through the mat over each 3/8" hole. Secure the stand to the floor with the spacers, capscrews and nylock nuts provided.

(ASM-JD6M MY20 CABLE CONTROL)

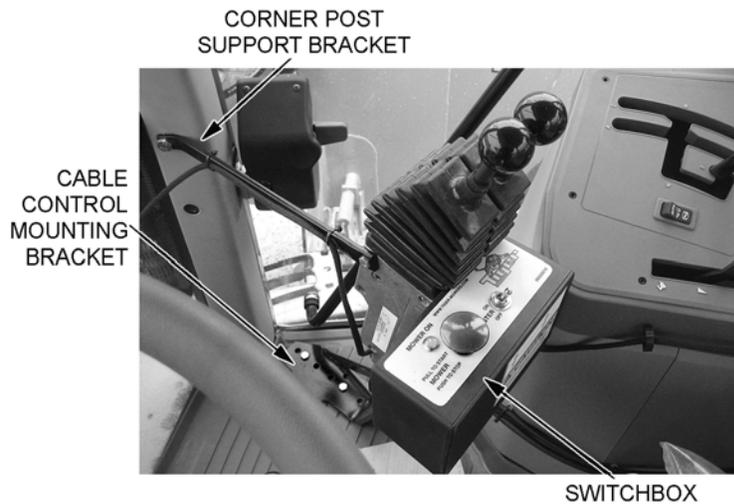

ASSEMBLY

VALVE MOUNTING

Remove the plug from the second port in the rear of the Husco valve and place it in the port in the front of the valve. Secure the valve bracket to the tractor with hardware shown in the Parts Section of the manual. Align the holes for the cables on the Husco control valves and center the Husco valve on the valve plate as shown below. Route the hydraulic lines from the lift valve to the hydraulic cylinders as noted on the lift valve page of the Parts Section. Install the control cables to the valve and the mounting plate on the Husco valves. *(ASM-JD7X30-0001 JD6M IH 2spl hsc)*



ASSEMBLY

6110-30M/R VALVE MOUNTING

The mounting bracket for JD 6110-30M/R series tractors features two long legs which need to be attached as shown in the photo below. Secure the bracket to the tractor with hardware shown in the Parts Section of the manual. Center the Danfoss valve on the valve plate. Align the holes on the valve with the plate holes and secure the lift valve on top of the mounting plate. Route the hydraulic lines from the lift valve to the hydraulic cylinders as noted on the lift valve page of the Parts Section. Attach the electrical control cables. (ASM-JD7X30-0001 JD6110 TANDEM)

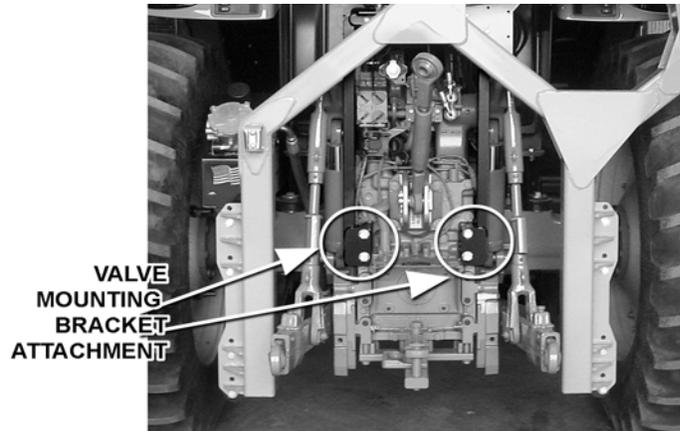

ASSEMBLY

COOLER LOCATION

The cooler mount and cooler are located on the left side of the tractor, where the toolbox was on the tractor's fuel tank. Remove the fuel tank support tube to install the mainframe, axle braces and left riser. Re-attach the fuel tank support tube to the left riser. Use the hardware from the toolbox mounting bracket to use while installing cooler. See the Parts Section for details of cooler installation. *(ASM-JD6M MY20 NEW SIDE COOLER)*



ASSEMBLY

SIDE MOWER HYDRAULIC DIAGRAM

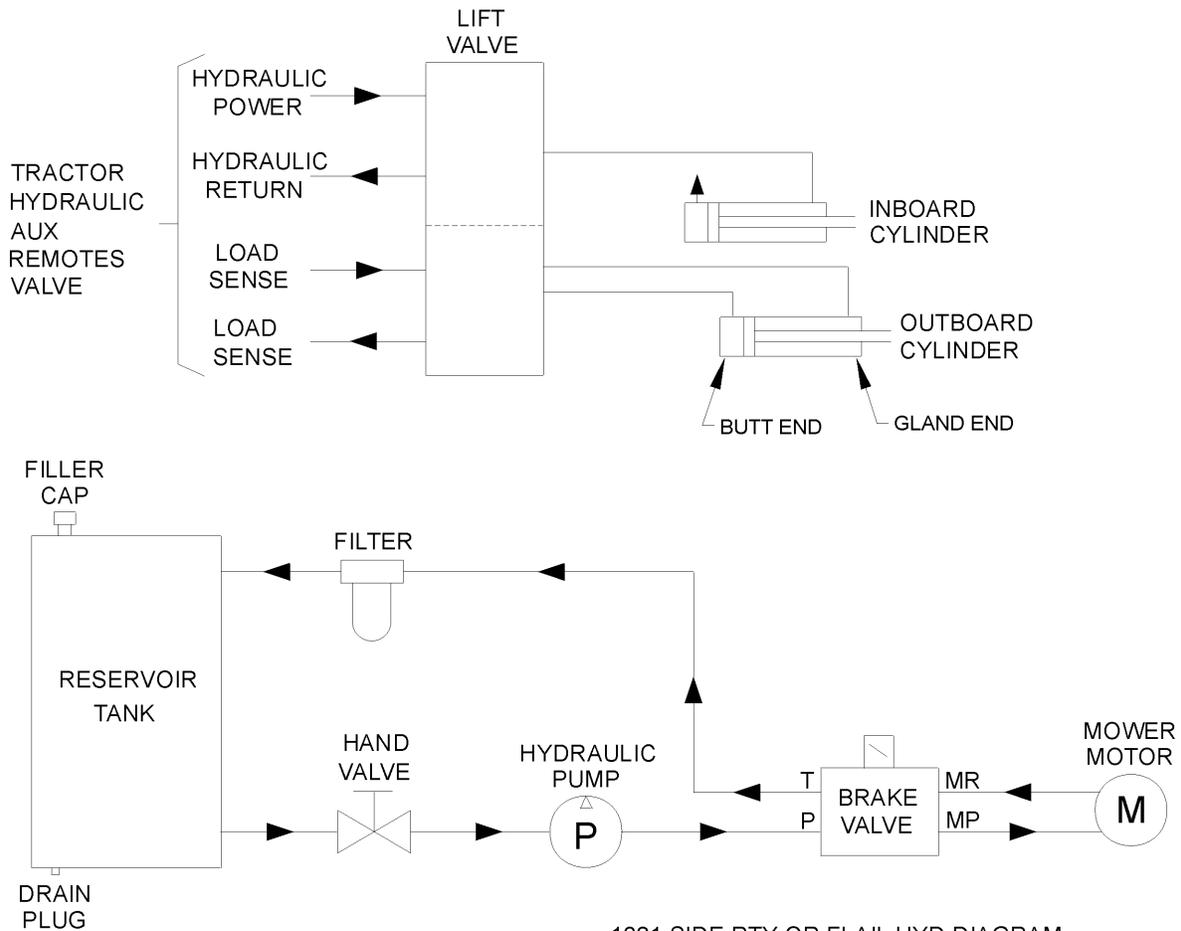

1321 SIDE RTY OR FLAIL HYD DIAGRAM

(ASM-C-0090)

WHEEL WELL HYDRAULIC TANK INSTALLATION

Install all fittings and tubes into tank and tank filter as shown in the Parts Section illustration. Insert tank sight glass onto the tractor side of the tank.

Place the tank in the mounting bracket on the axle brace as shown in the Parts Section. Secure the tank with the hardware provided.

Install the filter gauge into the filter housing so that it points to the rear of the tractor and is clearly visible to the operator. The tank breather cap is ready for use as the tank is filled. Some of these items may already be installed. (ASM-C-0103)

FILLING HYDRAULIC RESERVOIR

Refer to the Maintenance Section for filling specifications and hydraulic oil requirements.

NOTE: Starting or running your Tiger mower before filling reservoir will cause serious damage to the hydraulic pump.

(ASM-C-0004hydro resrv)



ASSEMBLY

WHEEL WELL HOSE ROUTING

Hoses travel along the right hand wheel well from the lift valve to the mainframe and boom. Hose clamps #06520536 are used to route the hoses as shown below. Clamps 1 and 2 (near the lift valve) use 1/4" x 1" bolts #21530, flatwashers #22014 and nylock nuts #21527. Hose clamp 3 uses 3/8" x 1-1/2" bolt #21632, flatwashers #22016 and nylock nut #21627. Place as many hoses in the clamp as fit without compromising pressure. Any hoses that don't fit into the clamp are to be secured to the others with zip ties. For protection of hoses in contact with metal edges, wrap hoses with split hose sections. Use zip ties between the clamps as needed.

(ASM-JD 6145 wheel well hose routing)

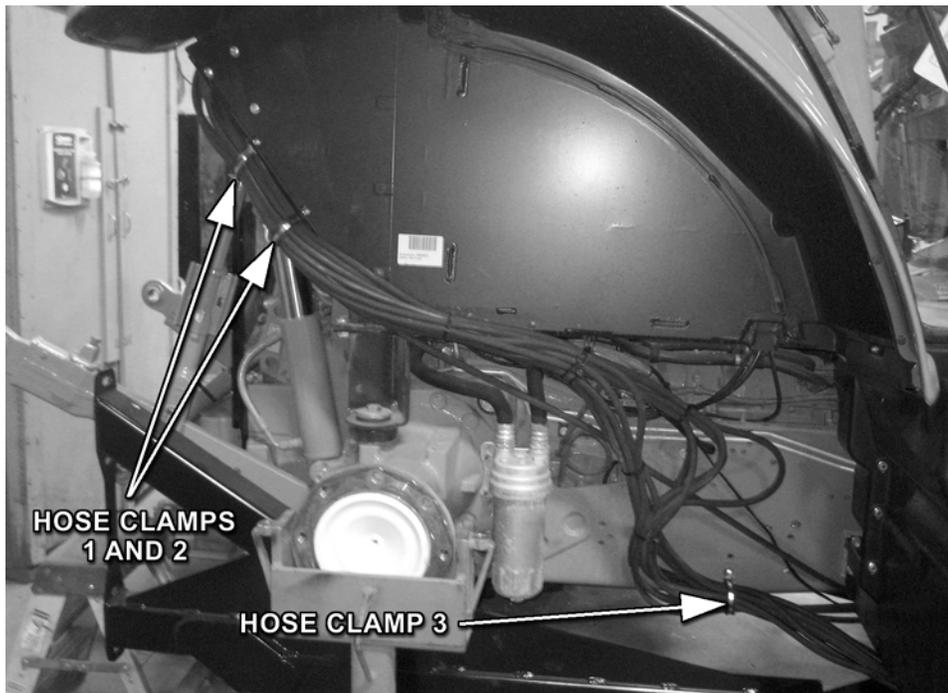

ASSEMBLY

HOSE COVERING

Secure hoses together with zip ties wherever loose. Wrap the hoses between the swivel and main boom with the hose cover provided. Wrap the hoses between the main boom and secondary boom with the hose cover provided. Where hoses may contact the frame or other edges, wrap with split hose and secure with hose clamps or zip ties.

On non-cab units, the pressure and return hoses from the control valve will also need to be routed inside the protective hose wrap. Cover the valve and valve fittings with the hose cover and secure with the string provided. *(ASM-C-0058)*

TEMPERATURE GAUGE MOUNTING (OPTIONAL)

Mount the temperature gauge where it is clearly visible to the operator. Attach the green (-) wire from the negative post on the gauge to a grounded bolt on the tractor frame. Remove paint if needed to make a good ground. Remove the pipe plug from the side of the hydraulic reservoir and install the temperature sensor using thread sealing tape. Run the white wire from the (s) sensor post of the gauge to the temperature sensor on the hydraulic reservoir tank. *(ASM-C-0051)*



ASSEMBLY

DRAFT BEAM INSTALLATION

Install ½" O-ring breather into butt port of inboard cylinder. Install fittings in the rod end of the cylinder according to the diagram in the Common Parts section. These fittings should be positioned to face the butt end of the cylinder.

Next turn the clevis onto the rod of the cylinder until it is tight against the shoulder and lock into place with locking bolt on clevis.

The inboard cylinder can now be installed into the main frame mast with the pin, flatwasher and R-clip as shown below.

Install all fittings in the outboard cylinder and adjust to point towards the butt end of the cylinder. Attach the hoses as specified in the Parts Section. Slide the cylinder into the draft beam from the outside of the draft beam and attach cylinder to the draft beam with clevis pin and rollpins. (ASM-C-0076 Berm Draft Beam rotary)

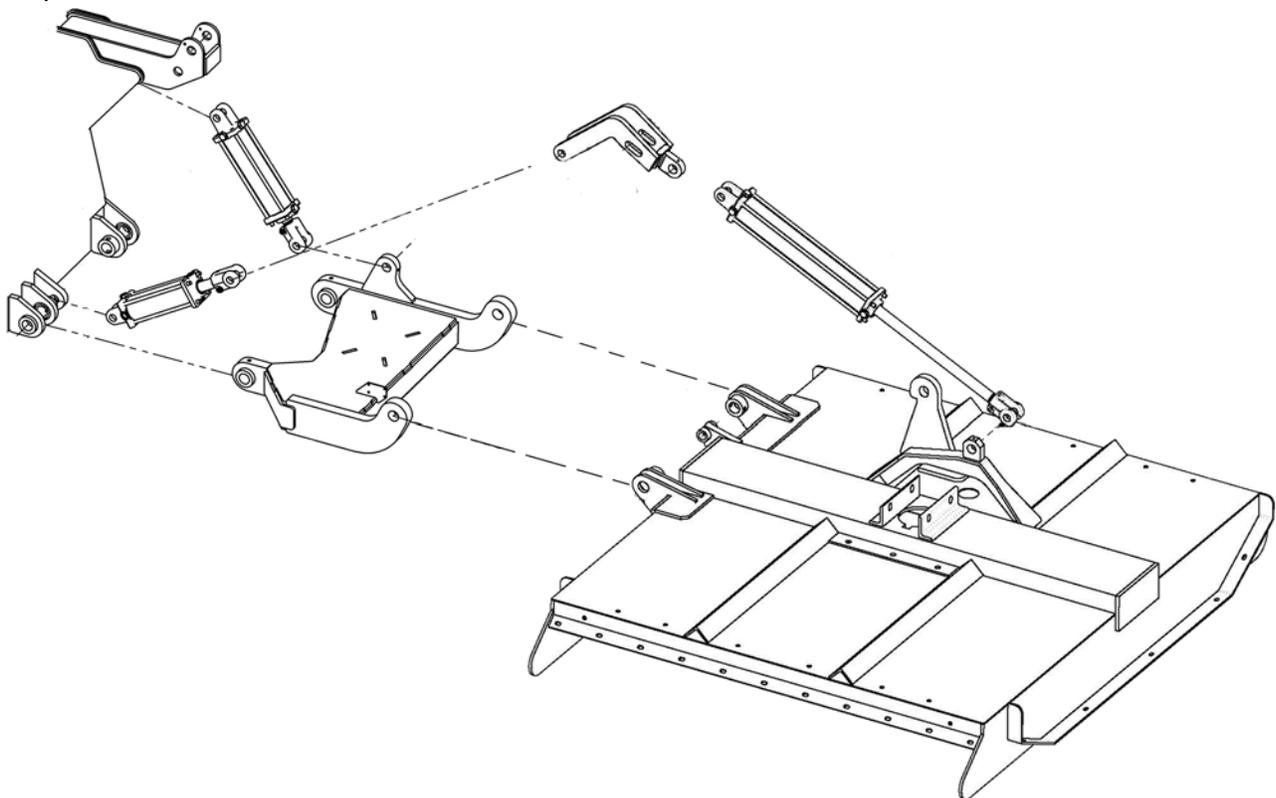

DECK ATTACHMENT

The pivot assembly is used to attach the head to the secondary boom. Install the deck pivot cylinder using the pins and hardware, which is illustrated in the Common Section.

Connect the fittings and hoses from the pivot cylinder to the small preformed tubes on the boom arm. Connect the fittings and hoses from the motor to the large preformed tubes on the boom arm. Connect all remaining hoses from the control valve to the cylinders and / or preformed tubes on the boom arm. Refer to Common Section for diagrams. (ASM-C-0018)



ASSEMBLY

FINAL PREPARATION FOR OPERATION

Place operator's safety and operation decals on the steering column and side console where they are clearly visible to the operator. These decals should be understood by each operator of the machine in conjunction with the Safety and Operation Sections of this book. The decals are to be maintained in good condition as a reminder to the operator, and should be replaced if damaged.

All bosses, pins and pivot points will need to be greased as instructed in the Maintenance Section of this manual. The hydraulic reservoir can also be filled with the recommended fluid (see Maintenance Section) and the filter installed in the top of the tank. Double check all fittings and fasteners **BEFORE** starting tractor. Also secure any loose hoses together with zip ties and wrap with split hoses where friction may occur on the hoses.



BEFORE starting or operating the tractor you must read and understand the Safety and Operation Sections of this manual completely.

BE SURE THE BALL VALVES ARE OPEN! Start tractor and allow instruments to stabilize. Using a piece of paper or cardboard as noted in the Safety and Maintenance Sections, check all fittings and connections for hydraulic leaks.

If a leak is found, you must shut down the tractor and set the cutter on the ground. Before attempting to fix the leak, you must actuate the lift valve handles several times to relieve any pressure in the lines.

Before operating the mower, the cutter head and boom should be slowly moved throughout the full range of motion. Watch for any condition that would cause pinching or excess stress on the hoses. The steering and front axle travel should also be carefully moved through their full range of motion. If any condition occurs in which the hoses contact the tires, the steering and / or front axle travel may need to be limited as described in the tractor operator's manual. This should also be done if the tires rub, or are extremely close to any other part of the mower, such as the hydraulic tank or draft beam. This may include adding shims or adjusting stop bolts in the tractor front to solve the problem. While checking motion, you should also check that the control circuits are connected according to the operator's decal for the valve handles.

MOWER TESTING

Take the tractor to a place free of loose objects on the ground. Operate the cylinders through their full range of motion again, to clear the lines of air. Follow the instructions in the Operation Section to operate the mower. Vibration of the mower should be minimal at all times. After a 5 minute test run, the knife bolts should be retorqued, and retorqued once again after the first few hours of operation.

If any parts of this Assembly Section, or any other section of this manual are not clearly understood you must contact your dealer or the address on the front of this manual for assistance!*(ASM-C-0010)*



OPERATION SECTION

Operation Section 3-1

OPERATION

TIGER SIDE ROTARY MOWER OPERATING INSTRUCTIONS

Tiger Side Rotary Mowers are manufactured with quality material by skilled workers. The side mower positions may optionally be controlled with the tractors remote hydraulic connections or a combination of lift valve and remote hydraulics. If so, determine which position of the mower is to be controlled by each remote lever. The mower is equipped with safety warning decals, protective deflectors, shields, and other safety features to provide operator and passerby protection, however, no shielding is 100% accurate. ALL safety equipment and safety warning decals must be maintained on the unit in good operational condition at all times.

It is the operator's responsibility to be knowledgeable of all potential operating hazards and to take every reasonable precaution to ensure oneself, others, animals, and property are not injured or damaged by the mower, tractor or a thrown object. Do not operate the mower if bystanders, passersby, pets or livestock are within 300 feet of the unit.

This section of the Operator's Manual is designed to familiarize, instruct, and educate operators to the safe and proper use of the mower. Pictures contained in this section are intended to be used as a visual aid to assist in explaining the operation of a mower and are not specific. Some pictures may show shields removed to enhance visual clarity. NEVER operate the unit without all safety equipment in place and in good operational condition. The operator must be familiar with the unit and tractor operation and all safety practices before beginning operation. Proper operation, as detailed in this manual, will help ensure years of safe and satisfactory use of the mower.

READ AND UNDERSTAND THE ENTIRE OPERATING INSTRUCTIONS AND SAFETY SECTION OF THIS MANUAL AND THE TRACTOR MANUAL BEFORE ATTEMPTING TO USE THE TRACTOR AND IMPLEMENT. If you do not understand any of the instructions, contact your nearest authorized dealer for a full explanation. Pay close attention to all safety signs and safety messages contained in this manual and those affixed to the implement and tractor. (OPS-U-0001)

READ, UNDERSTAND, and FOLLOW the following Safety Messages. Serious injury or death may occur unless care is taken to follow the warnings and instructions stated in the Safety Messages. Always use good common sense to avoid hazards. (SG-2)



Si no lee ingles, pida ayuda a alguien que si lo lea para que le traduzca las medidas de seguridad. (SG-3)



OPERATION

1. STANDARD EQUIPMENT AND SPECIFICATIONS

SIDE ROTARY

Cutting Width	60" and 72" Actual Cut
Spindle Drive	Direct Spline and Direct Flexible Coupler
Cutter Assembly	One-piece formed dish type with one-piece forged spindle assembly
Cutter Head Arc	180° on Cable Lift and 159° on Combo Draft Beam
Knives	Two full swinging high suction heat treated knives standard Optional three, four or six knives available
Main Frame	*Solid mount design may include front, mid and rear braces (May vary depending on tractor model)
Lift Control	Tractor Hydraulic or Optional Cable control and valves

* May vary depending on tractor model.



The Mower is designed for certain mowing applications and is rated to cut up to a specific size vegetation (see Mower Standard Equipment and Specifications). DO NOT use this mower to cut vegetation above the Mower's rated capacity or to cut any type of non-vegetative material. Only operate this Mower on a properly sized and equipped Tractor. Operating this Mower in an application for which it is not designed and/or operating the Mower with the wrong size Tractor can cause Mower component damage and equipment failure resulting in possible serious injury or death. (SGM-14)

OPERATION

OPERATION

2. OPERATOR REQUIREMENTS

Safe operation of the unit is the responsibility of a qualified operator. A qualified operator has read and understands the implement and tractor Operator's Manuals and is experienced in implement and tractor operation and all associated safety practices. In addition to the safety messages contained in this manual, safety signs are affixed to the implement and tractor. If any part of the operation and safe use of this equipment is not completely understood, consult an authorized dealer for a complete explanation.

If the operator cannot read the manuals for themselves or does not completely understand the operation of the equipment, it is the responsibility of the supervisor to read and explain the manuals, safety practices, and operating instructions to the operator.

Safe operation of equipment requires that the operator wear approved Personal Protective Equipment (PPE) for the job conditions when attaching, operating, servicing, and repairing the equipment. PPE is designed to provide operator protection and includes the following safety wear:

PERSONAL PROTECTIVE EQUIPMENT (PPE)

- Always Wear Safety Glasses
- Hard Hat
- Steel Toe Safety Footwear
- Gloves
- Hearing Protection
- Close Fitting Clothing
- Respirator or Filter Mask (depends on operating conditions) (OPS-U-0002)

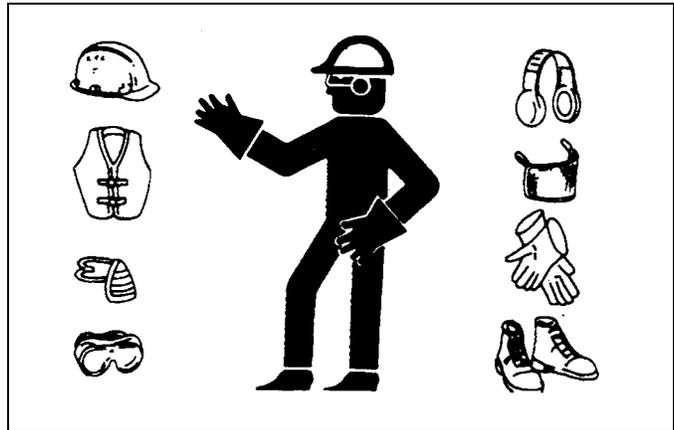

NEVER use drugs or alcohol immediately before or while operating the Tractor and Implement. Drugs and alcohol will affect an operator's alertness and coordination and therefore affect the operator's ability to operate the equipment safely. Before operating the Tractor or Implement, an operator on prescription or over-the-counter medication must consult a medical professional regarding any side effects of the medication that would hinder their ability to operate the Equipment safely. NEVER knowingly allow anyone to operate this equipment when their alertness or coordination is impaired. Serious injury or death to the operator or others could result if the operator is under the influence of drugs or alcohol. (SG-27)



OPERATION

3. TRACTOR REQUIREMENTS

In addition to tractor horsepower and size required to operate the boom unit, the tractor must also be properly equipped to provide operator protection, to alert approaching vehicle drivers of the tractor's presence, and to ensure tractor stability when mowing with the boom fully extended.

Tractor Requirements and Capabilities

- ASABE approved Roll-Over Protective Structure (ROPS) or ROPS cab and seat belt.
- Tractor Safety Devices Slow Moving Vehicle (SMV) emblem, lighting
- Tractor Ballast 20% Minimum of total tractor weight on front end of tractor.
- Power Take Off 540 RPM

3.1 ROPS and Seat Belt

The tractor must be equipped with a Roll-Over-Protective-Structure (ROPS) (tractor cab or roll-bar) and seat belt to protect the operator from falling off the tractor, especially during a rollover, where the driver could be crushed and killed. Only operate the tractor with the ROPS in the raised position and seat belt fastened. Tractor models not equipped with a ROPS and seat belt should have these life saving features installed by an authorized dealer. *OPS-U- 0003*



Operate this Equipment only with a Tractor equipped with an approved roll-over-protective system (ROPS). Always wear seat belts. Serious injury or even death could result from falling off the tractor--particularly during a turnover when the operator could be pinned under the ROPS. (SG-7)



3.2 Tractor Safety Devices

If transporting or operating the tractor and implement near a public roadway, the tractor must be equipped with proper warning lighting and a Slow Moving Vehicle (SMV) emblem which are clearly visible from the rear of the unit. Lights and a SMV emblem must be equipped directly on implements if the visibility of the tractor warning signals are obscured.

Maintain all manufacturer equipped safety shields and guards. Always replace shields and guards that were removed for access to connect, service, or repair the tractor or implement. *OPS-U- 0004_A*

3.3 Tractor Horsepower

The horsepower required to operate the mower depends on many factors including vegetation to be cut, terrain condition, operator experience and condition of the mower and tractor. For most mowing conditions, the side rotary works best on a tractor with at least 90 HP. Operating the mower with a tractor that does not have adequate power may damage the tractor engine.

OPERATION

3.4 Front End Weight

A minimum of 20% total tractor weight must be maintained on the tractor front end at all times. Front end weight is critical to maintain steering control and to prevent the tractor from rearing up while driving. If the front end is too light, add weight until a minimum of 20% total weight is reached on the front tires. Front weights and weight carriers can be purchased through an authorized tractor dealership. *OPS-U- 0005*

4. GETTING ON AND OFF THE TRACTOR

Before getting onto the tractor, the operator must read and completely understand the implement and tractor operator manuals. If any part of either manual is not completely understood, consult an authorized dealer for a complete explanation. *OPS-U- 0007*

⚠ WARNING Do not mount or dismount the Tractor while the tractor is moving. Mount the Tractor only when the Tractor and all moving parts are completely stopped. (SG-12)



4.1 Boarding the Tractor

Use both hands and equipped handrails and steps for support when boarding the tractor. Never use control levers for support when mounting the tractor. Seat yourself in the operator's seat and secure the seat belt around you.

Never allow passengers to ride on the tractor or attached equipment. Riders can easily fall off and be seriously injured or killed from falling off and being run over. It is the operator's responsibility to forbid all extra riders at all times. *OPS-U- 0008*

⚠ DANGER Never allow children to operate, ride on, or come close to the Tractor or Implement. Usually, 16-17 year-old children who are mature and responsible can operate the implement with adult supervision, if they have read and understand the Operator's Manuals, been trained in proper operation of the tractor and Implement, and are physically large enough to reach and operate the controls easily. (SG-11)



⚠ DANGER Never allow children or other persons to ride on the Tractor or Implement. Falling off can result in serious injury or death. (SG-10)



⚠ WARNING Do not mount or dismount the Tractor while the tractor is moving. Mount the Tractor only when the Tractor and all moving parts are completely stopped. (SG-12)



OPERATION

4.2 Dismounting the Tractor

Before dismounting, park the tractor and implement on a reasonably level surface, apply the parking brake, idle the engine down and lower the implement to the ground. Shut down the tractor engine according to the operator's manual, remove the key, and wait for all motion to completely stop. Never leave the seat until the tractor, its engine and all moving parts have come to a complete stop.

Use hand rails and steps when exiting the tractor. Be careful of your step and use extra caution when mud, ice, snow or other matter has accumulated on the steps or hand rails. Use all handrails and steps for support and never rush or jump off the tractor. *OPS-U- 0009_A*



BEFORE leaving the tractor seat, always set the parking brake and/or set the tractor transmission in parking gear, disengage the PTO, stop the engine, remove the key, and wait for all moving parts to stop. Place the tractor shift lever into a low range or parking gear to prevent the tractor from rolling. Never dismount a Tractor that is moving or while the engine is running. Operate the Tractor controls from the tractor seat only. (SG-9)

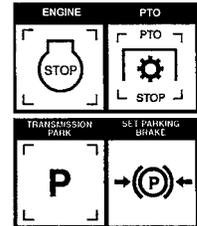

5. STARTING THE TRACTOR

The operator must have a complete understanding of the placement, function, and operational use of all tractor controls before starting the tractor. Review the tractor operator's manual and consult an authorized dealer for tractor operation instructions if needed.

Essential Tractor Controls:

- Locate the light control switch.
- Locate the engine shut off control.
- Locate the brake pedals and the clutch.
- Locate the PTO control.
- Locate the 3-point hitch control lever.
- Locate the hydraulic remote control levers.

Before starting the tractor ensure the following:

- Conduct all pre-start operation inspection and service according to the tractor operator's manual.
- Make sure all guards, shields, and other safety devices are securely in place.
- The parking brake is on.
- The PTO control lever is disengaged.
- The 3-point hitch control lever is in the lowered position.
- The hydraulic remote control levers are in the neutral position.
- The tractor transmission levers are in park or neutral.

Refer to the tractor owner's manual for tractor starting procedures. Only start the tractor while seated and belted in the tractor operator's seat. Never bypass the ignition switch by short circuiting the starter solenoid.

After the tractor engine is running, avoid accidental contact with the tractor transmission to prevent sudden and unexpected tractor movement. *OPS-U-0028*

OPERATION



Never run the Tractor engine in a closed building or without adequate ventilation. The exhaust fumes can be hazardous to your health. (SG-23)



Start tractor only when properly seated in the Tractor seat. Starting a tractor in gear can result in injury or death. Read the Tractor operator's manual for proper starting instructions. (SG-13)



OPERATION

6. CONNECTING THE MOWER TO THE TRACTOR

Use extreme caution when connecting the mower to the tractor. The mower should be securely resting at ground level or setting on blocks. Keep hands and feet from under the mower deck and clear of pinch points between the tractor hitch arms and mower pins. *OPS-R-0001*

6.1 Connecting Mower Hydraulics

Attach the 1" Hoses from the Brake Valve to the hydraulic motor on the Rotary Head. (Refer to **Figure Ops-1252**). Secure the hose sleeves on each hose with zip ties on both ends. *OPS-R-0104*



Avoid contact with hot surfaces including hydraulic oil tanks, pumps, motors, valves and hose connections. Relieve hydraulic pressure before performing maintenance or repairs. Use gloves and eye protection when servicing hot components. Contact with a hot surface or fluid can cause serious injury from burns or scalding. (SG-34)

OPERATION

WARNING

Do not operate this Equipment with hydraulic oil or fuel leaking. Oil and fuel are explosive and their presence could present a hazard. Do not check for leaks with your hand! High-pressure oil streams from breaks in the line could penetrate the skin and cause tissue damage including gangrene. To check for a hose leak, SHUT the unit ENGINE OFF and remove all hydraulic pressure. Wear oil impenetrable gloves, safety glasses and use Cardboard to check for evidence of oil leaks. If you suspect a leak, REMOVE the HOSE and have it tested at a Dealer. If oil does penetrate the skin, have the injury treated immediately by a physician knowledgeable and skilled in this procedure. (SG-15)



7. PRE-OPERATION INSPECTION AND SERVICE

Before each use, a pre-operation inspection and service of the implement and tractor must be performed. This includes routine maintenance and scheduled lubrication, inspecting that all safety devices are equipped and functional, and performing needed repairs. DO NOT operate the unit if the pre-operation inspection reveals any condition affecting safe operation. Perform repairs and replacement of damaged and missing parts as soon as noticed. By performing a thorough pre-operation inspection and service, valuable down time and repair cost can be avoided. OPS-U-0029

WARNING

Periodically inspect all moving parts for wear and replace when necessary with authorized service parts. Look for loose fasteners, worn or broken parts, and leaky or loose fittings. Make sure all pins have attaching hardware. Serious injury may occur from not maintaining this machine in good working order. (SG-21_A)



DANGER

All Safety Shields, Guards and Safety devices including (but not limited to) - the Deflectors, Chain Guards, Steel Guards, Gearbox Shields, PTO integral shields, and Retractable Door Shields should be used and maintained in good working condition. All safety devices should be inspected carefully at least daily for missing or broken components. Missing, broken, or worn items must be replaced at once to reduce the possibility of injury or death from thrown objects, entanglement, or blade contact. (SGM-3)

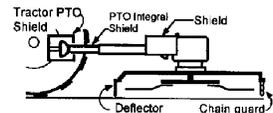

OPERATION

7.1 Tractor Pre-Operation Inspection/Service

Refer to the tractor operator's manual to ensure a complete pre-operation inspection and scheduled service is performed according to the manufacturer's recommendations. The following are some of the items that require daily service and inspection:

- Tire condition/air pressure
- Wheel lug bolts
- Steering linkage
- PTO shield
- SMV sign is clean and visible
- Tractor's lights are clean and functional
- Tractor seat belt is in good condition
- Tractor ROPS is in good condition
- ROPS is in the raised position
- No tractor oil leaks
- Radiator free of debris
- Engine oil level and condition
- Engine coolant level and condition
- Power brake fluid level
- Power steering fluid level
- Fuel condition and level
- Sufficient lubrication at all lube points
- Air filter condition *OPS-U-0030*



- Inspect mower blades and hardware for looseness and excessive wear. Make sure the mower is securely blocked up before crawling beneath or that the mechanical travel lock is engaged. Replace damaged, worn, and missing knives as complete sets to maintain mower balance.
- Remove any grass or other debris which may be wrapped around the spindle.
- Inspect the condition of deck skid shoes chains, flaps and hardware. *OPS-R-205*



OPERATION

WARNING

Periodically inspect all moving parts for wear and replace when necessary with authorized service parts. Look for loose fasteners, worn or broken parts, and leaky or loose fittings. Make sure all pins have attaching hardware. Serious injury may occur from not maintaining this machine in good working order. (SG-21_A)



OPERATION

The operator's manual and safety signs affixed on the unit contain important instructions on the safe and proper use of the equipment. Maintain these important safety features on the implement in good condition to ensure the information is available to the operator at all times.

- Ensure all safety signs are in place and legible. Replace missing, damaged, and illegible decals. OPS-U-0011_A



NOTE: The mower Operator's Manual and affixed Decals contain important instructions on the safe and proper use of the mower. Maintain these important safety features on the mower in good condition to ensure the information is available to the operator at all times.

FRAME ASSEMBLY

- Inspect condition of mounting frame weldment.
- Inspect condition of frame Assembly.
- Ensure all bolts and screws are in position and are properly torqued.
- Ensure all pins are in place and fastened with screws.
- Ensure frame is properly mounted to tractor and hardware is properly installed and tightened. OPS-R-0099



OPERATION

HYDRAULIC LINE INSPECTION

- Check for hydraulic leaks along hoses, cylinders and fittings. **IMPORTANT:** DO NOT use your hands to check for oil leaks. Use a piece of heavy paper or cardboard to check for hydraulic oil leaks.
- Inspect the condition of the valve weldment.
- Ensure fitting is properly connected
- Inspect condition of bushings. OPS-R-0100_A



WARNING

Do not operate this Equipment with hydraulic oil or fuel leaking. Oil and fuel are explosive and their presence could present a hazard. Do not check for leaks with your hand! High-pressure oil streams from breaks in the line could penetrate the skin and cause tissue damage including gangrene. To check for a hose leak, SHUT the unit ENGINE OFF and remove all hydraulic pressure. Wear oil impenetrable gloves, safety glasses and use Cardboard to check for evidence of oil leaks. If you suspect a leak, REMOVE the HOSE and have it tested at a Dealer. If oil does penetrate the skin, have the injury treated immediately by a physician knowledgeable and skilled in this procedure. (SG-15)



OPERATION

HYDRAULIC PUMP/OIL RESERVOIR

- Check oil reservoir level and oil condition. (Add specific type oil if low)
- Change hydraulic oil filter and hydraulic oil according to maintenance schedule.
- Ensure there are no oil leaks and fitting are properly connected
- Inspect overall condition of hydraulic pump.
- Inspect pump drive shaft.



OPERATION

Check the fluid level in the Hydraulic Tank on the Tractor, and add oil if required. As the air has been forced out of the Cylinders and Hoses, it goes into the Hydraulic Tank and reduces the volume of oil. Maintain the oil level within the sight gauge located on the side of the reservoir. Never fill the tank above the sight gauge to allow for the expansion of the oil. The tank maintains pressure after the mower has been run. Stand off to one side when removing the breather cap element to prevent possible injury.

OPS-R-215

WARNING

Attention: Oil Filler Cap is also the Pressure Relief Cap.

Remove cap slowly to relieve pressure before removing cap completely. Stay clear to prevent being scalded with hot oil that may spray out of the tank that is still pressurized and may cause serious injury to eyes, face, and exposed skin. (Ops-0001-MISC)

WARNING

Avoid contact with hot surfaces including hydraulic oil tanks, pumps, motors, valves and hose connections. Relieve hydraulic pressure before performing maintenance or repairs. Use gloves and eye protection when servicing hot components. Contact with a hot surface or fluid can cause serious injury from burns or scalding. (SG-34)

OPERATION

OPERATION

ROTARY HEAD INSPECTION

- Inspect blades and blade bolts for looseness and excessive wear. Rotate to 90° to make for checking easier. Replace damaged, worn, and missing blades as complete sets to maintain rotary balance.
- Ensure blade carrier nuts are torqued to proper specifications.
- Ensure rubber deflectors are in position and not damaged. Replace worn, broken, and missing sections immediately.
- Ensure hydraulic lines are properly connected to the hydraulic motor. Check for hydraulic leaks along hoses and fittings. **DO NOT** use your hands to check for oil leaks. Use a piece of heavy paper or cardboard to check for hydraulic oil leaks.
- Inspect the condition of deck skid shoes and hardware. *OPS-R-216*



Do not put hands or feet under mower decks. Blade Contact can result in serious injury or even death. Stay away until all motion has stopped and the decks are securely blocked up. (SGM-09)



Do not put hands or feet under mower decks. Blade Contact can result in serious injury or even death. Stay away until all motion has stopped and the decks are securely blocked up. (SFL-2)



OPERATION

7.2 Cutting Component Inspection

Inspect blade pan and blade assembly for the following: OPS-U-0031

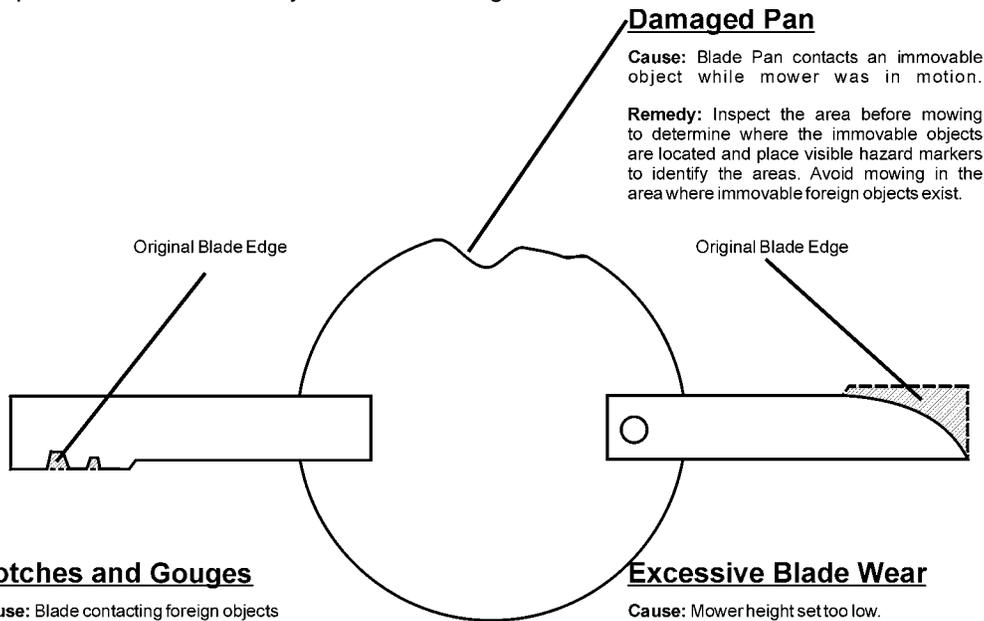

Damaged Pan

Cause: Blade Pan contacts an immovable object while mower was in motion.

Remedy: Inspect the area before mowing to determine where the immovable objects are located and place visible hazard markers to identify the areas. Avoid mowing in the area where immovable foreign objects exist.

Notches and Gouges

Cause: Blade contacting foreign objects

Remedy: Inspect the area to be mowed and remove foreign objects that could cause damage to the blades

Excessive Blade Wear

Cause: Mower height set too low.
Blade used past intended life.

Remedy: Replace blades more often.
Adjust mower height for mowing
Conditions to eliminate blade-to-ground contact

Op-22



Inspect the Blades daily for abnormal wear. REPLACE BOTH BLADES on that carrier IMMEDIATELY if either blade has:

- Become bent or deformed from it's original shape or
- Any cracks are visible, or
- Deep gouges in the blade's surface are present, or
- Gouges or chipped areas in the cutting edge are larger than 1/2"(12.7mm), or
- The material on the leading edge has been worn away by more than 1/2(12.7mm)"

Failure to replace abnormally worn blades may lead to catastrophic failure of the blades and ejection of the broken part with tremendous force which may cause serious bodily injury or death. OPS-U-0032

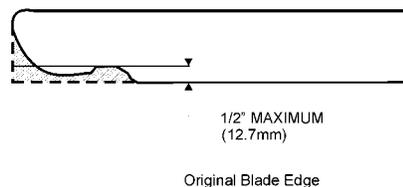

1/2" MAXIMUM
(12.7mm)

Original Blade Edge

NOTE:
Replace Blades in pairs after no more than 1/2" (12.7mm) wear
Op-23

OPERATION

OPERATION

7.3 Blade Bolt Inspection

Inspect Blade Bolt Head daily for wear as followed:

Excessive Blade Bolt Wear

Cause: Blade Bolt contacts a foreign or solid object while Blade is in motion.

Remedy: Inspect the area before mowing to determine where the foreign objects are located and place visible hazard markers to identify the areas where immovable foreign objects exist, and avoid hitting the objects.

Notches and Gouges

Cause: Blade Bolt contacting foreign objects.

Remedy: Inspect area to be mowed and remove foreign objects that could cause damage to the blade bolt.

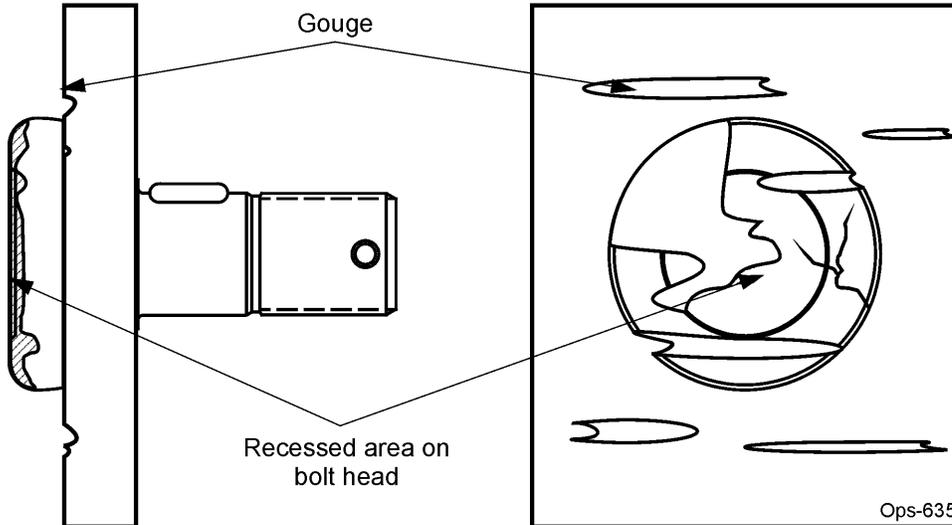

⚠ DANGER

Inspect the Blade Bolt Heads daily for abnormal wear. REPLACE BOTH BLADE BOLTS on the Blades IMMEDIATELY if either blade bolts has:

- Visible cracks or
- If the recessed area on blade bolt is worn off or
- If Blade Bolt has gouges or chipped areas.

Failure to replace abnormally worn blade bolts may lead to catastrophic failure of the blades and ejection of the broken part which may cause serious bodily injury or death.

Always replace Blade Bolts with new bolts whenever replacing the Blades. OPS-U-0037

OPERATION

Tractor PRE-OPERATION Inspection



Mower ID# _____ Make _____

Date: _____ Shift _____



Before conducting the inspection, make sure the tractor engine is off, all rotation has stopped and the tractor is in park with the parking brake engaged. Make sure the mower is resting on the ground or securely blocked up and all hydraulic pressure has been relieved.

OPERATION

Item	Condition at Start of Shift	Specific Comments if not O.K.
The flashing lights function properly		
The SMV Sign is clean and visible		
The tires are in good condition with proper pressure		
The wheel lug bolts are tight		
The tractor brakes are in good condition		
The steering linkage is in good condition		
There are no visible oil leaks		
The hydraulic controls function properly		
The ROPS or ROBS Cab is in good condition		
The seatbelt is in place and in good condition		
The 3-point hitch is in good condition		
The drawbar pins are securely in place		
The PTO master shield is in place		
The engine oil level is full		
The brake fluid level is full		
The power steering fluid level is full		
The fuel level is adequate		
The engine coolant fluid level is full		
The radiator is free of debris		
The air filter is in good condition		

Operator's Signature: _____

DO NOT OPERATE an UNSAFE TRACTOR or MOWER

This Inspection Form may be freely duplicated for extra copies.

OPERATION

Side Rotary Mower PRE-OPERATION Inspection



Mower ID# _____ Make _____

Date: _____ Shift _____



Before conducting the inspection, make sure the tractor engine is off, all rotation has stopped and the tractor is in park with the parking brake engaged. Make sure the mower is resting on the ground or securely blocked up and all hydraulic pressure has been relieved.

Table 1:

Item	Condition at Start of Shift	Specific Comments if not O.K.
The Operator's Manual is in the tractor		
All safety decals are in place and legible		
The hydraulic cylinders pins are tight		
There are no leaking or damaged hoses		
The mower deck is clear of cut grass and debris		
Chain guards/deflectors are in place & in good		
Blade carrier retaining nut is tight		
Blades are not chipped, cracked or bent		
Blade bolts are tight		
Wheel lug nuts are tight		
Transport locks are in good condition		

Operator's Signature: _____

DO NOT OPERATE an UNSAFE TRACTOR or MOWER

OPERATION

DRIVING THE TRACTOR AND IMPLEMENT

Safe tractor transport requires the operator possess a thorough knowledge of the model being operated and precautions to take while driving with an attached implement. Ensure the tractor has the capacity to handle the weight of the implement and the tractor operating controls are set for safe transport. To ensure safety while driving the tractor with an attached implement, review the following. *OPS-U- 0012*



Never run the Tractor engine in a closed building or without adequate ventilation. The exhaust fumes can be hazardous to your health. (SG-23)



Transport only at speeds where you can maintain control of the equipment. Serious accidents and injuries can result from operating this equipment at high speeds. Understand the Tractor and Implement and how it handles before transporting on streets and highways. Make sure the Tractor steering and brakes are in good condition and operate properly.



Before transporting the Tractor and Implement, determine the proper transport speeds for you and the equipment. Make sure you abide by the following rules:

Test the tractor at a slow speed and increase the speed slowly. Apply the Brakes smoothly to determine the stopping characteristics of the Tractor and Implement. As you increase the speed of the Tractor the stopping distance increases. Determine the maximum transport speed not to exceed 20 mph (30 kph) for transporting this equipment.

Test the equipment at a slow speed in turns. Increase the speed through the turn only after you determine that the equipment can be operated at a higher speed. Use extreme care and reduce your speed when turning sharply to prevent the tractor and implement from turning over. Determine the maximum turning speed for you and this equipment before operating on roads or uneven ground.

Only transport the Tractor and Implement at the speeds which allow you to properly control the equipment.

Be aware of the operating conditions. Do not operate the Tractor with weak or faulty brakes or worn tires. When operating down a hill or on wet or rain slick roads, the braking distance increases: use extreme care and reduce your speed. When operating in traffic always use the Tractor's flashing warning lights and reduce your speed. Be aware of traffic around you and watch out for the other guy. (SG-19)



OPERATION

7.4 Starting the Tractor

The procedure to start the tractor is model specific. Refer to the tractor operator's manual for starting procedures for your particular tractor. Consult an authorized dealer if the starting procedure is unclear. Ensure the 3-point control lever is in the lowered position and the PTO is disengaged before starting the tractor. OPS-U-0033



7.5 Brake and Differential Lock Setting

Make sure the tractor brakes are in good operating condition. Tractor brakes can be set to operate independently allowing single rear wheel braking action or locked together to provide simultaneous rear wheel braking. FOR MOST DRIVING AND OPERATING CONDITIONS, THE BRAKE PEDALS SHOULD BE LOCKED TOGETHER TO PROVIDE THE MOST EFFECTIVE BRAKING ACTION.

Always disengage the tractor differential lock when turning. When engaged the differential lock will prevent or limit the tractor from turning. During normal cutting conditions, locking the differential provides no benefit and should not be used.

OPS-U-0013



OPERATION

7.6 Driving the Tractor and Implement

Start off driving at a slow speed and gradually increase your speed while maintaining complete control of the tractor and unit. Moving slowly at first will also prevent the tractor from rearing up and loss of steering control. The tractor should never be operated at speeds that cannot be safely handled or which will prevent the operator from stopping quickly during an emergency. If the power steering or engine ceases operating, stop the tractor immediately as the tractor will be difficult to control.

Perform turns with the tractor and units at slow speeds to determine how the tractor with an attached blade or rake handles a turn. Determine the safe speed to maintain proper control of the tractor when making turns. When turning with a towed implement, the overall working length of the unit is increased. Allow additional clearance for the units when turning.

To avoid overturns, drive the tractor with care and at safe speeds, especially when operating over rough ground, crossing ditches or slopes, and turning corners. Tractor wheel tread spacing should be increased when working on inclines or rough ground to reduce the possibility of tipping.

Use extreme caution when operating on steep slopes. Keep the tractor in a low gear when going downhill. DO NOT coast or free-wheel downhill. *OPS-U-0014*

7.7

When confronted with an incline or ditch, do not approach from an angle which is perpendicular or straight on as damage may occur.

When crossing such terrain, the implement should be fully lowered for a lower center of gravity and added stability. *OPS-R-206*

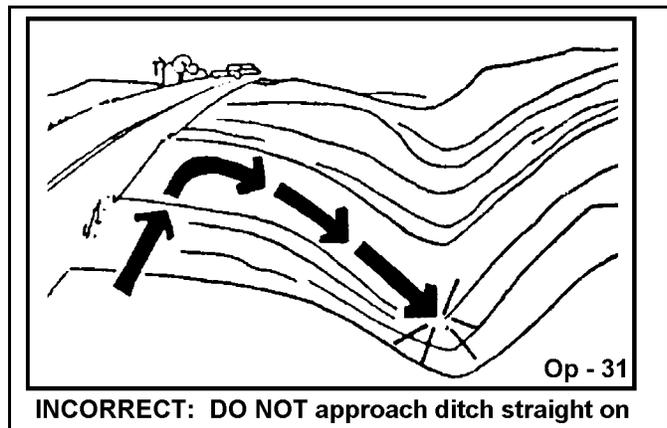

OPERATION

Inclines and ditches should be approached along a line which is at an angle as shown. This type of path will reduce the possibility of resulting damage. If the gradient is so steep that such an approach increases the possibility of a tractor roll-over, select an alternate crossing path.

When operating the tractor and mower across slopes and inclines, through ditches, and other uneven terrain conditions, it is important to maintain sufficient deck to ground clearance. Blade contact with the ground may cause soil, rocks and other debris to be thrown out from under the mower resulting in possible injury and/or property damage. Ground contact also produces a severe shock load on the mower drive and to the mower blades resulting in possible damage and premature wear.
OPS-R-207

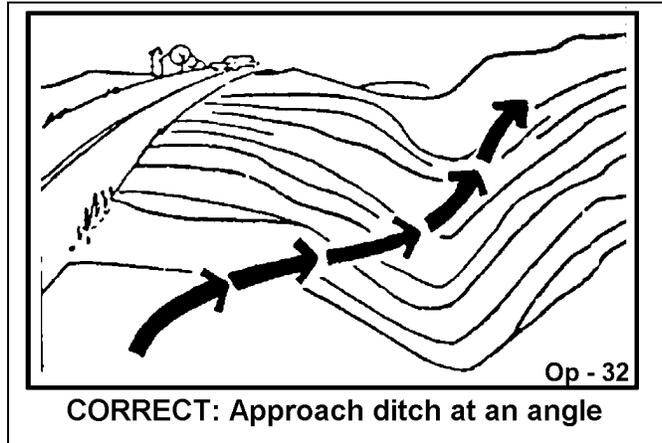

8. OPERATING THE TRACTOR AND IMPLEMENT

THE OPERATOR MUST COMPLETELY UNDERSTAND HOW TO OPERATE THE TRACTOR AND IMPLEMENT AND ALL CONTROLS BEFORE ATTEMPTING TO OPERATE. The operator must read and understand the Safety and Operation Sections of the implement and tractor operator's manuals. These manuals must be read and explained to any operator who cannot read. Never allow someone to operate the implement and tractor without complete operating instructions.

Before starting any operation, the operator must become familiar with the area to be worked in and any obstacles and hazards contained within to ensure safety to the operator, bystanders, and equipment. Special attention should be paid to foreign debris, rough terrain, steep slopes, and passersby and animals in the area.
OPS-U- 0015

WARNING

Extreme care should be taken when operating near loose objects such as gravel, rocks, wire, and other debris. Inspect the area before mowing. Foreign objects should be removed from the site to prevent machine damage and/or bodily injury or even death. Any objects that cannot be removed must be clearly marked and carefully avoided by the operator. Stop mowing immediately if blades strike a foreign object. Repair all damage and make certain rotor or blade carrier is balanced before resuming mowing. (SGM-05)



OPERATION

⚠️ WARNING

Many varied objects, such as wire, cable, rope, or chains, can become entangled in the operating parts of the mower head. These items could then swing outside the housing at greater velocities than the blades. Such a situation is extremely hazardous and could result in serious injury or even death. Inspect the cutting area for such objects before mowing. Remove any like object from the site. Never allow the cutting blades to contact such items.

(SGM-06)

8.1 Foreign Debris Hazards

Before mowing, inspect the area to make sure there are no foreign objects that the mower blades could hit or become entangled with. Remove all foreign objects and debris. If objects are too big to remove, mark them clearly and be sure to prevent the mower blades from contacting them.

If you hit a solid object or foreign debris, stop the mower and tractor at once. Immediately idle the engine speed. Wait for all mower rotating motion to stop, then raise the mower and move the tractor and implement off the object. Inspect the area and remove, or mark the location of the debris. Inspect the condition of the mower and make any needed repairs immediately. Make sure the blades are not damaged and the carrier is balanced before resuming operation.

Always wear your seat belt securely fastened and only operate the tractor and mower with the ROPS in the raised position. If the tractor or mower hits a tree stump, rock, or bump, a sudden movement could throw you off of the seat and under the tractor and/or mower. The seat belt is your best protection from falling off the tractor and the ROPS provides protection from being crushed during a tractor roll-over. *OPS-R-208*



Remove Foreign Material



Raise Mower over solid objects

8.2 Bystanders/Passersby Precautions

If a bystander comes within 300 feet of the tractor while the mower is being operated, stop the tractor at once, stop the mower and idle the tractor engine. Do not engage the mower again until all bystanders are well past the 300 foot distance. *OPS-R-209*

OPERATION



Rotary Mowers are capable under adverse conditions of throwing objects for great distances (300 feet or more) and causing serious injury or death. Follow safety messages carefully.



STOP MOWING IF PASSERSBY ARE WITHIN 300 Feet UNLESS:

- Front and Rear Deflectors, Chain Guards, or Bands are installed and in good, workable condition;
- Mower sections or Wings are running close to and parallel to the ground without exposed Blades;
- Passersby are outside the existing thrown-object zone;
- All areas have been thoroughly inspected and all foreign material such as rocks, cans, glass, and general debris has been removed.

NOTE: *Where there are grass and weeds high enough to hide debris that could be struck by the blades, the area should be: inspected and large debris removed, mowed at an intermediate height, inspected, closely with any remaining debris being removed, and mowed again at desired final height. (This will also reduce power required to mow, reduce wear and tear on the Mower drivetrain, spread cut material better, reduce streaking, and make the final cut more uniform).* (SRM-01)



Do not let the Blades turn when the Mower Deck is raised for any reason, including clearance or for turning. Raising the Mower deck exposes the Cutting Blades which creates a potentially serious hazard and could cause serious injury or even death from objects thrown from the Blades. (SRM-07)



BEFORE leaving the tractor seat, always set the parking brake and/or set the tractor transmission in parking gear, disengage the PTO, stop the engine, remove the key, and wait for all moving parts to stop. Place the tractor shift lever into a low range or parking gear to prevent the tractor from rolling. Never dismount a Tractor that is moving or while the engine is running. Operate the Tractor controls from the tractor seat only. (SG-9)

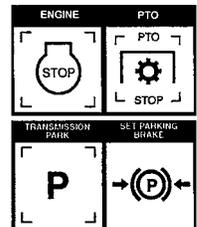

OPERATION

8.3 Ground Speed

Ground speed for mowing will depend upon the height, type, and density of vegetation to be cut. Recommended speed for efficient mower performance is between 2 and 5 mph(3-8 kph). Operate the mower at the proper speed to maintain blade speed for a clean cut. Refer to the tractor operator's manual or the tractor instrument panel for the engine speed and gear to provide the desired ground speed. Make sure that the mower is operating at its full rated speed before entering the vegetation to be cut. If it becomes necessary to temporarily regulate engine speed, increase or decrease the throttle gradually.

Ground speed is achieved by transmission gear selection and not by the engine operating speed. The operator may be required to experiment with several gear range combinations to determine the best gear and range which provides the most ideal performance from the mower and most efficient tractor operation. As the severity of cutting conditions increase, the ground speed should be decreased by selecting a lower gear to maintain the proper speed. OPS-R-210

WARNING

Mow at the speed that you can safely operate and control the tractor and mower. The correct mowing speed depends on terrain condition and grass type, density, and height of cut. Normal ground speed range is from 2 to 5 mph(3-8 kph). Use slow mowing speeds when operating on or near steep slopes, ditches, drop-offs, overhead obstructions, power lines, or when debris and foreign objects are to be avoided. (SGM-07)

DANGER

Operate the Tractor and/or Implement controls only while properly seated in the Tractor seat with the seat belt securely fastened around you. Inadvertent movement of the Tractor or Implement may cause serious injury or death. (SG-29)

9. Operating the Control Valves - Side Mount

POSITION CONTROL VALVE - The Valve is located to the right of the operator at a convenient height on a non-cab unit. The Valve is located behind the rear window in a cab tractor. The Valve operation plate is located on the fender for non-cab units and on the switchbox for cab units.



Ops-1246

MOWER VALVE OPERATION

OPERATION

MOWER LIFT

The handle nearest the center of the tractor, actuates the Lift Cylinder (Inboard).

Pulling the valve handle back, towards the operator, causes the Lift Cylinder to raise the Extension Arm.

If the handle is released, the valve will automatically return to center and the Extension Arm will be locked in place.

Pushing the valve handle forward, away from the operator, causes the Lift Cylinder to lower the Extension Arm.

Pulling the handle all the way back until it locks places the mower lift function in float, allowing the unit to rise and fall with the terrain.

MOWER TILT

The handle furthest to the center of the tractor, actuates the Tilt Cylinder (Outboard).

Pulling the valve handle back, toward the operator, causes the Tilt Cylinder to raise the Mower Head.

If the handle is released, the valve will automatically return to center and the head will be locked in place.

Pushing the valve handle forward, away from the operator, causes the Tilt Cylinder to lower the Mower Head.

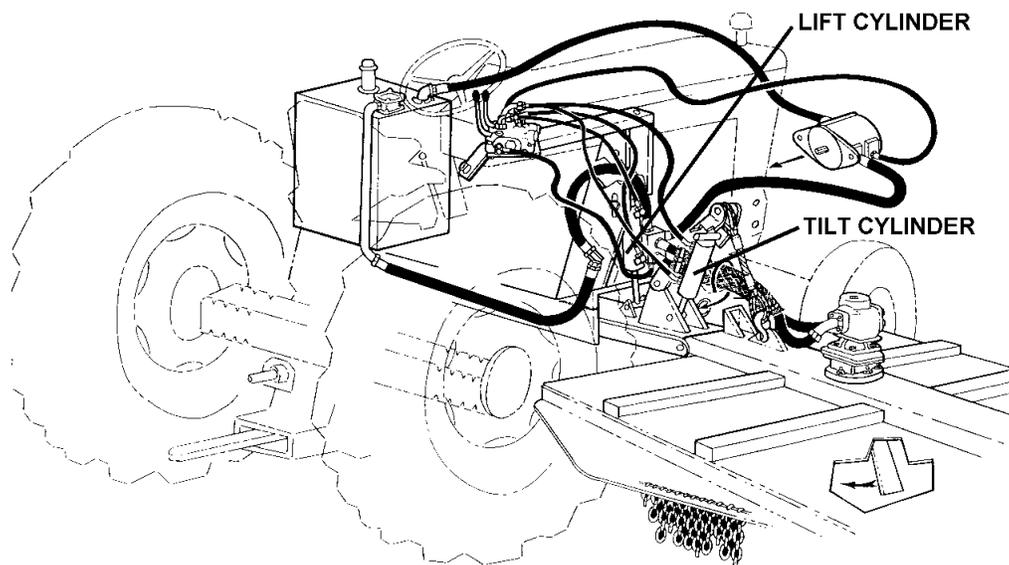

Op-206

HEAD PITCH

Incorrect head pitch and/or alignment can cause poor cutting performance in side rotary mowers.

Head Pitch is defined as the relationship of the front of the mower to the rear of the mower, as viewed from the side. The desired head pitch for the Side Rotary mowers is for the blade at the front of the mower to be between 3/4" and 1" lower than the blade at the rear.

OPERATION

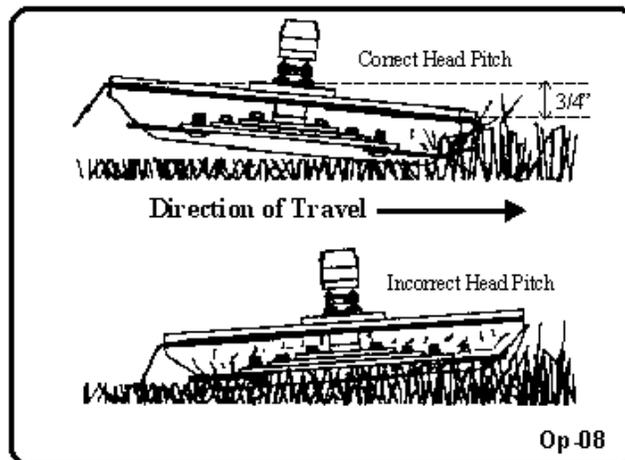

MEASUREMENT OF HEAD PITCH

1. CUT MOWER OFF AND ALLOW BLADES TO STOP ROTATING
2. Move machine to a flat, level area such as a concrete slab
3. Lower mower head to within several inches of the ground but do not rest head on ground.
4. Stop engine.
5. Position blades toward front and rear. Measure the distance from the bottom of the blade tips to the ground, with the blades hanging (at rest). Use two people to measure. Normal drift of the cylinders will cause inaccurate measurements if the front and rear not measured at the same time. **DO NOT ALLOW ANOTHER PERSON TO OPERATE THE CONTROLS WHILE MEASUREMENTS ARE BEING TAKEN.**
6. Bent blades, bars, pans, or loose bolts will make measurements useless.

ALIGNMENT

Head alignment is defined as the relationship of the centerline of the mower to the centerline of the tractor. The desired alignment is that the centerlines of the tractor and mower are parallel to each other.

Misalignment contributes to “streaking” due to the skid shoe laying a wide strip of grass flat. This flattened grass is sometimes not picked up by the mower on subsequent passes. Misalignment also contributes to excessive power consumption because the side skirts tend to “doze” material against the side of the mower, adding drag to the tractor.

Alignment problems can easily be seen by standing in the front or rear of the machine. Align the front and rear of the machine. Align the front and rear edges of the rear tire and compare to the side skirt of the mower (mower head resting on the ground).

OPERATION

OPERATION

9.1 Basic Troubleshooting Guide for First Start-up.

- a. Electrical solenoid valve does not work - check wiring, possible faulty switch, possible faulty solenoid.
- b. Pump is making noise - check for obstruction in suction hose and tank suction assembly, check alignment of pump driveshaft.
- c. Cylinders will not raise - hoses from cylinder incorrectly connected to valve bank, pump not supplying oil.
- d. Cylinder raises slowly - hoses from cylinder incorrectly connected to valve bank, work port reliefs on valve bank set too low - replace as required.
- e. Filter reads in red - viscosity of oil too high - wait until oil heats up before checking filter gauge. If gauge reads in red even after unit is hot, then filter must be replaced.



Never operate the Tractor or Implement until you have read and completely understand this Manual, the Tractor Operator's Manual, and each of the Safety Messages found in the Manual or on the Tractor and Implement. Learn how to stop the tractor engine suddenly in an emergency. Never allow inexperienced or untrained personnel to operate the Tractor or Implement without supervision. Make sure the operator has fully read and understood the manuals prior to operation. (SG-4)

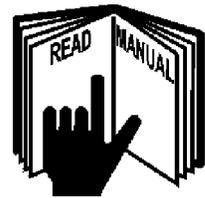

Always maintain the safety signs in good readable condition. If the safety signs are missing, damaged, or unreadable, obtain and install replacement safety signs immediately. (SG-5)



BEFORE leaving the tractor seat, always set the parking brake and/or set the tractor transmission in parking gear, disengage the PTO, stop the engine, remove the key, and wait for all moving parts to stop. Place the tractor shift lever into a low range or parking gear to prevent the tractor from rolling. Never dismount a Tractor that is moving or while the engine is running. Operate the Tractor controls from the tractor seat only. (SG-9)

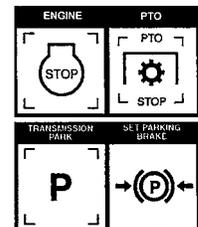

OPERATION

9.2 Control Location and Functions

The side mower height is controlled with a two or three spool valve and is coordinated as shown below. The optional three spool valve allows for the operation of a rear rotary mower or side ditcher. If the unit is equipped with a three spool valve, do not operate the third spool handle unless a rear rotary or ditcher is mounted.

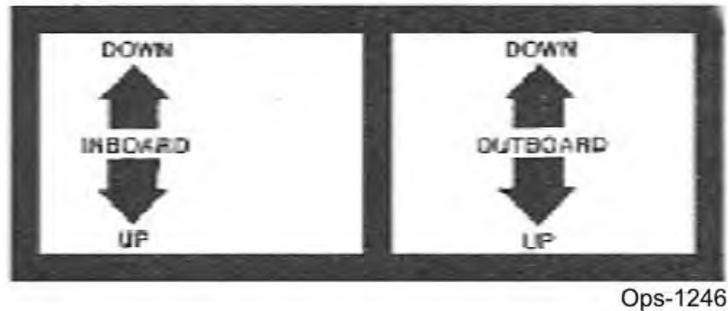

The rear mower height is controlled with the 3-point hitch control lever. Follow the instructions for this control in the tractor operator's manual. The tilt of the rear mower is controlled with the third spool of the lift valve, and is coordinated as shown in **Figure Ops-1246**.

The side and rear mower positions may optionally be controlled with the tractor's remote hydraulic connections or a combination of lift valve and remote hydraulics. If so, determine which position of the side or rear mower is to be controlled by each remote lever.

The side mower ON/OFF switch is located in a switch box mounted to the valve stand or cable controls for non-cab and cab units respectively. If operating a rear mower, the ON/OFF switch is located in the switch box with a side mower switch.

This machine may be equipped with an auxiliary oil temperature gauge, an amp gauge or oil pressure gauge. If oil temperature reaches 200° F, stop mowers and see **Troubleshooting Section** for possible causes. Keep and eye on all gauges for indication of problems.

OPERATION

9.3 Operating the Mower

Only operate the mower from the tractor operator's seat with the seatbelt securely fastened. The tractor must be equipped with a ROPS in the raised position or a ROPS cab.

The mower is designed to cut vegetation up to 2" in diameter. Sharp blades will produce a cleaner cut and require less power. Travel at a speed that allows the mower sufficient time to cut through the vegetation to prevent overloading the mower and tractor. Choose a driving pattern that provides the maximum pass length and minimizes turning.

Under certain conditions, tractor tires may roll some grasses down preventing them from being cut at the same height as the surrounding area. When this occurs, reduce the tractor ground speed while maintaining the operating speed of the mower. A slower ground speed will permit grasses to at least partially rebound and be cut. Taking a partial cut and/or reversing the direction of travel may also help produce a cleaner cut.

Avoid mowing in the reverse direction when possible. In situations where the mower must be backed to access areas to be cut, make sure there are no persons or other foreign debris behind the mower before mowing in reverse. When mowing in reverse, operate the tractor and mower at a reduced ground speed to ensure tractor and mower control is maintained. *OPS-R-211*



Do not mow with two machines in the same area except with Cab tractors with the windows closed. (SGM-11)



Mow only in conditions where you have clear visibility in daylight or with adequate artificial lighting. Never mow in darkness or foggy conditions where you cannot clearly see at least 300 feet (90 m) in front and to the sides of the tractor and mower. Make sure that you can clearly see and identify passersby, steep slopes, ditches, drop-offs, overhead obstructions, power lines, debris and foreign objects. If you are unable to clearly see these type of items discontinue mowing. (SGM-01)



Follow these guidelines to reduce the risk of equipment and grass fires while operating, servicing, and repairing the Mower and Tractor:



- Equip the Tractor with a fire extinguisher in an accessible location.
- Do Not operate the Mower on a Tractor with an underframe exhaust.
- Do Not smoke or have an open flame near the Mower and Tractor.
- Do Not drive into burning debris or freshly burnt areas.
- Ensure slip clutches are properly adjusted to prevent excessive slippage and plate heating.
- Never allow clippings or debris to collect near drivelines, slip clutches, and gearboxes. Periodically shut down the Tractor and Mower and clean clippings and collected debris from the mower deck. (SGM-12)

OPERATION

WARNING

When rotating parts are in motion, serious injury may occur if caution is not used or danger is not recognized. Never allow bystanders within **300 feet** of the machine when in operation. Extreme care should be taken when operating near loose objects - such as gravel, rocks and debris. These conditions should be avoided.

The rotating parts in this machine have been designed and tested for rugged use. However, they could fail upon impact with heavy solid objects-such as steel guard rails, concrete abutments, etc., causing them to be thrown at a very high velocity. Never allow cutter head to contact such objects. Inspecting the cutting area for such objects prior to mowing can help eliminate these potential hazards.

Once on location, lower the mower deck slightly above the material to be cut, so the mower does not have to start under a load. Bring the RPM of the tractor up to 1200 and engage the side mower. If a rear mower is being used, allow the RPM to return to 1200 before engaging the rear mower.

The rotary mower deck should always be carried rather than dragged on the skid shoes when mowing on the ground. Dragging the rotary mower heads causes an extreme side load on the tractor resulting in premature tire wear. It also causes excessive horsepower consumption and drastically decreases blade life. Dragging the rear mower can also cause damage to the road. Once the necessity skill is attained at controlling the height and position of the side rotary mower, it will be easy to carry the mower head(s) and do a proficient job of cutting.

When cutting tall shrubs or small trees (maximum recommended size of material to be cut is 2" diameter), begin each pass at the top of the material and work down with each consecutive pass. Use a low speed to allow the cutting blades time to mulch as well as cut the foliage. When the initial pass has been made, disengage the mower and return the mower to the travel position. Return to the starting point and make next pass.

CAUTION

When using the rotary cutting head for trimming trees and shrubs, let the mower saw into them. Do not lower the mower head down directly onto a tree or stump. The mower blades are designed to cut with the end, and misuse can cause damage to the blade and a hazardous situation for the operator.

To ensure a clean cut, engine speed should be maintained at approximately 1800-2200 RPM. If the tractor slows less than 1800 RPM, shift to the next lower gear. **DO NOT** ride the clutch, this will cause premature clutch failure. **The engine should not be operated at any time at more than 2400 RPM on the tractor tachometer.**

DO NOT use excessive force when positioning cutting head into heavy branches or small stumps (2" diameter). Damage to the unit may result. It is best to let the cutter head "eat away" slowly at heavy cutting jobs.

The mower will operate more efficiently in tougher conditions and with less power if the knives are kept sharp. If the mower begins to vibrate, stop the tractor, check for wire wrapped in the spindle or damaged knives. When replacing knives, replace all knives with new knives to ensure proper balance so the mower will not vibrate. Severe vibration will result, if knives with unequal wear are used. Follow the instructions in the **Maintenance Section** closely when replacing knife blades.

WARNING

If bystanders approach within 300 feet while mower is in operation, turn mower switch "OFF" immediately! After shutdown, never leave the tractor or allow bystanders to approach within **300 feet** of the unit until all motion stops completely.

OPERATION

When encountering a very severe condition which causes the tractor to stall, disengage mower, start tractor, raise the mower from the cut. Shut tractor off and inspect the mower, blades and disk for damage before engaging mower again.

If the blades jam or stop, disengage the clutch and raise the head slightly or back the tractor up. Normally, this will clear the cutter head. If not, shut off the mower(s), raise the cutter heads, turn off the tractor and set the parking brake. After all motion stops completely, leave the tractor and clear the cutting heads manually.

After the first day of operation, all bolts should be checked and tightened securely. This should be done periodically to ensure the bolts do not become loose and cause damage to the tractor or mower, or injury to the operator.

When you get to the end of a pass, slightly raise the mower (2-4") before turning. Never raise the mower entirely while the blades are turning. If the mower must be raised higher than 12" from ground level, disengage the mower and wait for all mower rotation to come to a complete stop before proceeding to raise the mower. NEVER raise the mower while the blades are turning.

OPS-R-212



WARNING

Do not let the Blades turn when the Mower Deck is raised for any reason, including clearance or for turning. Raising the Mower deck exposes the Cutting Blades which creates a potentially serious hazard and could cause serious injury or even death from objects thrown from the Blades. (SRM-07)



Do not mow or drive the tractor into material that is burning or areas that recently burned and may contain hot spots. Burning material, sparks and coals could be thrown from the mower to areas of vegetation that might ignite. Tire damage can occur when driving over hot material. Oil and grease on the tractor and mower could ignite resulting in equipment destruction. Carry a fire extinguisher on the tractor at all times to extinguish possible fires encountered.

OPERATION

DANGER

All Safety Shields, Guards and Safety devices including (but not limited to) - the Deflectors, Chain Guards, Steel Guards, Gearbox Shields, PTO integral shields, and Retractable Door Shields should be used and maintained in good working condition. All safety devices should be inspected carefully at least daily for missing or broken components. Missing, broken, or worn items must be replaced at once to reduce the possibility of injury or death from thrown objects, entanglement, or blade contact. (SGM-3)

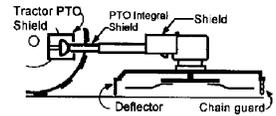

WARNING

Many varied objects, such as wire, cable, rope, or chains, can become entangled in the operating parts of the mower head. These items could then swing outside the housing at greater velocities than the blades. Such a situation is extremely hazardous and could result in serious injury or even death. Inspect the cutting area for such objects before mowing. Remove any like object from the site. Never allow the cutting blades to contact such items. (SGM-06)

DANGER

The rotating parts of this machine have been designed and tested for rugged use. However, the blades could fail upon impact with heavy, solid objects such as metal guard rails and concrete structures. Such impact could cause the broken objects to be thrown outward at very high velocities. To reduce the possibility of property damage, serious injury, or even death, never allow the cutting blades to contact such obstacles. (SGM-4)

OPERATION

OPERATION

9.4 Shutting Down the Implement

To shut down attached mower head, first bring the tractor to a complete stop. Decrease engine RPM to idle then disengage cutterhead. The mower head will come to a complete stop within a suitable amount of time. Do not engage or disengage the cutterheads at a high RPM unless there is an emergency situation.



Park the tractor on a level surface, place the transmission in park or neutral and apply the parking brake, lower the attached implement to the ground, shut down the engine, remove the key, and wait for all motion to come to a complete stop before exiting the tractor. OPS-U-0016



BEFORE leaving the tractor seat, always set the parking brake and/or set the tractor transmission in parking gear, disengage the PTO, stop the engine, remove the key, and wait for all moving parts to stop. Place the tractor shift lever into a low range or parking gear to prevent the tractor from rolling. Never dismount a Tractor that is moving or while the engine is running. Operate the Tractor controls from the tractor seat only. (SG-9)

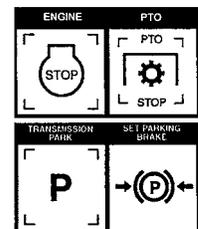

10. DISCONNECTING THE MOWER FROM THE TRACTOR

Before disconnecting the mower, the mower must be disengaged and blade rotation at a complete stop. Move the mower to a level storage location and place the mower head on the ground. If the mower is not resting securely on the ground, block the mower up securely before attempting to disconnect it from the tractor.

Use extreme care to keep feet and hands from under the mower and clear of any pinch points. OPS-R-213



Never stand or allow another person to stand between a running tractor and the mower when disconnecting the implement from the tractor.

OPERATION



Always shut the Tractor completely down, place the transmission in park, and set the parking brake before you or anyone else attempts to connect or disconnect the Implement. (SRM-20)

11. MOWER STORAGE

It is recommended that the mower be stored with the mower fully lowered to ground level. If the mower is stored in the raised position, select a level area and place blocks under the mower to prevent the mower from falling BEFORE disconnecting the mower from the tractor.

Properly preparing and storing the mower at the end of the season is critical to maintaining its appearance and to help ensure years of dependable service. The following are suggested storage procedures:

- Thoroughly clean all debris off the mower to prevent damage from rotting grass and standing water.
- Lubricate all mower grease points and fill oil levels as detailed in the maintenance section.
- Tighten all bolts and pins to the recommended torque.
- Check the mower for worn and damaged parts. Perform repairs and make repairs immediately so that the mower will be ready for use at the start of the next season.
- Store the mower in a clean, dry place with the mower housing resting securely on blocks or at ground level.
- Use spray touch-up enamel where necessary to prevent rust and maintain the appearance of the mower.



OPS-R-214



Never allow children or other persons to ride on the Tractor or Implement. Falling off can result in serious injury or death. (SG-10)



12. TRANSPORTING THE TRACTOR AND IMPLEMENT

Inherent hazards of operating the tractor and implement and the possibility of accidents are not left behind when you finish working in an area. Therefore, the operator must employ good judgement and safe operation practices when transporting the tractor and implement between locations. By using good judgement and following safe transport procedures, the possibility of accidents while moving between locations can be substantially minimized. OPS-U- 0017

OPERATION



Make certain that the “Slow Moving Vehicle” (SMV) sign is installed in such a way as to be clearly visible and legible. When transporting the Equipment use the Tractor flashing warning lights and follow all local traffic regulations. (SG-6)

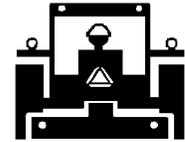

12.1 Transporting Mower

TRANSPORTING UNDER THE UNIT'S OWN POWER

When transporting between job sites or between cutting passes, the following procedure should be followed:

1. Shut off the power to the cutting head(s) and allow all motion to come to a complete stop.
2. Raise the draft beam to its highest position.
3. Raise the side mower until the deck stops against the draft beam.
4. Raise the rear mower with the 3-point hitch control lever. The unit is now in position for self-transportation.

TRANSPORTING UNIT BY FLATBED TRAILER

Most tractors with a side mounted mower head attached will be over legal transporting width (102" wide). For this reason, one of the following procedures must be followed:

1. Transporting with side mower attached: Use a loading dock or ramp to load tractor onto trailer. Center the tractor with mowers attached between the sides of the trailer. Make sure the draft beam and head are fully raised and secured. Lower the rear mower onto the trailer. Secure the tractor and rear mower to the trailer with chains. Obtain proper over-width permits and mark the vehicle and mower as over-width as required by law. Check the tractor operator's manual for any tractor requirements to transport by flatbed trailer.
2. Transporting with side mower removed: Park the tractor and turn the engine off. Remove the key to avoid accidental starting. Close ball valves on the hydraulic reservoir. To avoid contaminating the hydraulic system, make sure all fittings on the side mower motor and solenoid control valve are clean. Disconnect the motor pressure hose at the solenoid control valve and return hoses at the solenoid valve. See **Figure Ops-1226**.

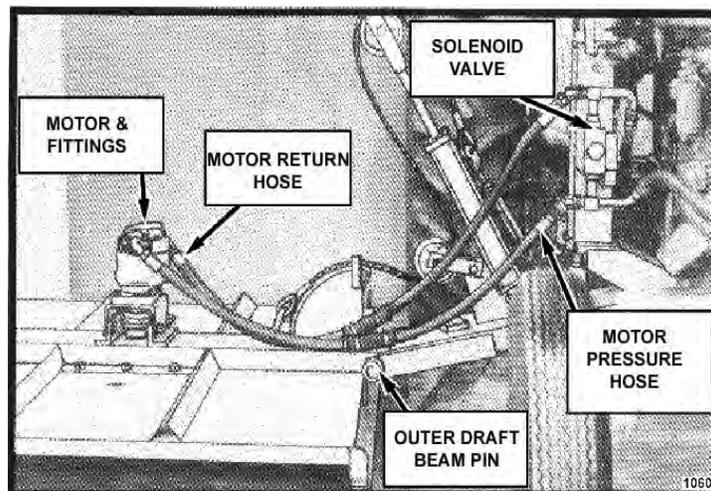

Ops-1226

OPERATION

Next, cap or plug the hose ends and the ports on the solenoid valve and motor. For a cable lift mower disconnect the lift cable from the head and secure the loose end back onto the cable with the cable clevis. For a combo lift mower, disconnect the linkage from the mower and replace the pin and hardware with the draft beam to prevent loss. For all mowers, remove the hardware and draft beam outer pivot pin. Separate the mower head from the tractor. Now, reinstall the pivot pin and hardware into the draft beam to prevent loss. **OPEN THE BALL VALVES ON THE HYDRAULIC RESERVOIR BEFORE STARTING TRACTOR AGAIN!** Serious damage will be caused if tractor is started with the ball valves closed.

Use a loading dock or ramps to load the tractor onto the trailer, centering the tractor between the sides of the trailer. Make sure the tractor (and rear mower) and trailer are within legal transporting width. Lower the rear mower onto the trailer and set the loose hide mower on the trailer. Secure the tractor and mowers to the trailer with chains. Check the tractor operator's manual for any requirements to transport by flatbed trailer. Reverse this procedure to unload and remount the mowers after transporting. Be sure all pins are secure, all connections are tight and any lost fluid is replaced before using mowers. Use teflon tape when connecting all pipe style fittings.

12.2 Transporting on Public Roadways

Extreme caution should be used when transporting the tractor and implement on public roadways. The tractor must be equipped with all required safety warning features including a SMV emblem and flashing warning lights to alert drivers of the tractor's presence. Remember that roadways are primarily designed for automotive drivers and most drivers will not be looking out for you, therefore, you must look out for them. Check your side view mirrors frequently and remember that vehicles will approach quickly because of the tractor's slower speed. Be extremely cautious when the piece of equipment that you are towing is wider than the tractor tire width and/or extends beyond your lane of the road. *OPS-R-217*



Make certain that the "Slow Moving Vehicle" (SMV) sign is installed in such a way as to be clearly visible and legible. When transporting the Equipment use the Tractor flashing warning lights and follow all local traffic regulations. (SG-6)

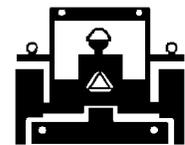

OPERATION

OPERATION

The SMV (Slow-Moving Vehicle) emblem is universal symbol used to alert drivers of the presence of equipment traveling on roadways at a slow speed. SMV signs are a triangular bright orange with reflective red trim for both easy day and night visibility. Make sure the SMV sign is clean and visible from the rear of the unit before transporting the tractor and implement on a public roadway. Replace the SMV emblem if faded, damaged, or no longer reflective. *OPS-U-0020*



Make sure that all tractor flashing warning lights, headlights, and brake/tail lights are functioning properly before proceeding onto public roads. While newer model tractors have plenty of lighting to provide warning signals and operating lighting, most older models are only equipped with operating lights. Consult an authorized tractor dealer for lighting kits and modifications available to upgrade the lighting on older tractor models. *OPS-U-0021*



When operating on public roads, have consideration for other road users. Pull to the side of the road occasionally to allow all following traffic to pass. Do not exceed the legal speed limit set in your country for agricultural tractors. Always stay alert when transporting the tractor and implement on public roads. Use caution and reduce speed if other vehicles or pedestrians are in the area. *OPS-U-0022*



Never allow children or other persons to ride on the Tractor or Implement. Falling off can result in serious injury or death. (SG-10)



OPERATION

WARNING

Make certain that the "Slow Moving Vehicle" (SMV) sign is installed in such a way as to be clearly visible and legible. When transporting the Equipment use the Tractor flashing warning lights and follow all local traffic regulations. (SG-6)

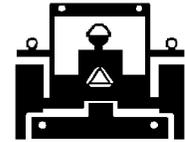

Reduce speed before turning or applying the brakes. Ensure that both brake pedals are locked together when operating on public roads. OPS-U- 0023



12.3 Hauling the Tractor and Implement

Before transporting a loaded tractor and implement, measure the height and width dimensions and gross weight of the complete loaded unit. Ensure that the load will be in compliance with the legal limits set for the areas that will be traveled through. OPS-U- 0024



OPERATION

OPERATION

OPERATION

Use adequately sized and rated trailers and equipment to transport the tractor and implement. Consult an authorized dealer to determine the proper equipment required. Using adequately sized chains, heavy duty straps, cables and/or binders, securely tie down both the front and rear of the tractor utilizing the proper tie down locations as specified by the tractor manufacturer. *OPS-U- 0025*



Arrange the chains so that when tightened, the chains are pulling downward and against themselves. Carefully tighten the securing chains or other fasteners using boomers or binders to apply maximum tension. Use extreme care when attaching and removing the securing devices as the extreme tension involved when released has the potential to inflict serious injury.

While hauling the tractor and implement, make occasional stops to check that the tractor and implement have not moved or shifted and that the securing chains have maintained tension. If during transport a hard braking, sharp turning, or swerving action was performed, stop at the next safe location to inspect the security of the load. *OPS-U- 0026*



OPERATION

13. TROUBLESHOOTING GUIDE

HYDRAULIC CYLINDER NOT WORKING - Check level of hydraulic fluid (see sight gauge on tank). Check to see if pump is functioning properly by attempting to use another cylinder or pressure gauge. If pump is working properly, check the pressure on the line. The relief valve may be by-passing fluid at too low pressures. If cylinder is still not functioning properly, check the line for stoppage. The pistons in hydraulic cylinders are virtually trouble-free, but occasionally one will have a scored wall and allow oil to flow around the piston. In this case, replace the cylinder.

NOTE: Refer to repair parts section on valve bank settings on individual relief cartridges.

HYDRAULIC MOTOR NOT WORKING - Check lines for kinks or if they are pinched. If the motor is “bogging down” under load, recheck the relief valve setting on the cutter valve.

HYDRAULIC VALVE - Failures in the hydraulic system are almost always caused by other elements in the system other than the valve; so the entire system should be checked before the valve is changed. A malfunction in any hydraulic valve section will require replacement of that section (but not the replacement of the valve bank) since the insides are honed to fit individually. Attachments such as the relief valves and detent may be serviced individually.

STRUCTURAL MEMBERS

Failure in structural members generally results from rough treatment. While they are constructed to withstand abuse, they cannot be made strong enough to withstand abnormal abuse. The factory does not warrant these parts to any extent other than in normal use in grass, weeds, brush, small bushes, and small trees which the unit is designed to cut. This mounted implement removes weight from front wheels and can cause loss of steering with possible overturn. Add front end weight until 20% of tractor original weight is on front wheels when boom is in transport position for steering safety and prevention of bodily injury. Transport slowly on rough surface to prevent bouncing front wheels off surface with loss of steering and possible injury

OPERATION

OPERATION

SIDE ROTARY

Operation Section 3-42

MAINTENANCE SECTION

Maintenance Section 4-1

MAINTENANCE

GENERAL INSTRUCTIONS

Tiger Mowers are designed for high performance and rugged durability, yet with simplified maintenance. The purpose of this section of the manual is to help the operator in the regular servicing of the mower. Regular maintenance at the intervals mentioned will result in the maximum efficiency and long life of the Tiger Mower.

When you purchase a Tiger Mower you also acquire another valuable asset, Tiger's parts organization. Our rapid and efficient service has guaranteed the customer satisfaction for many years. Tiger parts keep up with the demands for efficiency, safety and endurance expected of the Tiger Mower.

MAINTENANCE PRECAUTIONS

- Be sure end of grease gun and zerks are clean before using. Debris injected into bearings, etc. with grease will cause immediate damage.
- DO NOT use a power grease gun to lubricate bearings. These require very small and exact amounts of lubrication. Refer to the detailed maintenance section for specific lubrication instructions. DO NOT over-grease bearings.
- Lexan windows should be washed with mild soap or detergent and luke warm water, using a soft clean sponge or soft cloth. DO NOT use abrasive or alkaline cleaners or metal scrapers on lexan windows!
- Be alert to maintenance indicators such as the in-tank filter pressure gauge, hydraulic reservoir sight gauge, etc. Take the required action to correct any problems immediately.
- Release of energy from pressurized systems may cause inadvertent actuation of cylinders, or sudden release of compressed springs. Before disconnecting any hoses relieve pressure by shutting tractor off, setting cutter on ground and actuating lift valve handles.

WARNING

DO NOT use hands to check for suspected leaks in hydraulic hoses! Hydraulic fluid escaping under pressure can have sufficient force to penetrate skin and cause serious injury. If fluid is injected into skin, it must be surgically removed within a few hours or gangrene may result. Use a small piece of wood or cardboard, not hands, to search for pin hose leaks. Be sure all connections are tight and hoses and lines are not damaged before applying pressure.

BREAK IN PERIOD

In addition to following the break in instructions for your particular tractor, the in-tank hydraulic fluid filter should be replaced after the first 50 hours of service. Thereafter the filter should be replaced every 500 hours, or yearly, whichever comes first.

Re-torque wheel lugs after first five hours of operation and periodically thereafter. See torque specifications listed in the tractor's service manual for your particular model. **Wheel lugs must always be re-torqued whenever a wheel is removed and reinstalled.**

DANGER

Never work under the Implement, the framework, or any lifted component unless the Implement is securely supported or blocked up to prevent sudden or inadvertent falling which could cause serious injury or even death. (SG-14)



MAINTENANCE



Do not modify or alter this Implement. Do not permit anyone to modify or alter this Implement, any of its components or any Implement function. (SG-8)



Relieve hydraulic pressure prior to doing any maintenance or repair work on the Implement. Place the Mower Head on the ground or securely supported on blocks or stands, disengage the PTO, and turn off the engine. Push and pull the control Levers or Joystick several times to relieve pressure prior to starting any maintenance or repair work. (SBM-6)



Always disconnect the wire leads from the mower pump solenoid before performing service on the Tractor or Mower. Use caution when working on the Tractor or Mower. Tractor engine must be stopped before working on Mower or Tractor. The Mower Blades could inadvertently be turned on without warning and cause immediate dismemberment, injury or death. (SBM-12a)

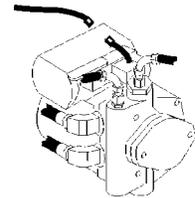

MAINTENANCE

MAINTENANCE OF CRANKSHAFT ADAPTER ASSEMBLY (RIGID ENGINE MOUNT TRACTORS ONLY)

If replacement of components of the crankshaft adapter assembly is required, follow the assembly procedures shown below. Seat rubber grommet completely into counterbore, then seat steel grommet completely into rubber grommet while rubber grommet is supported.

(ASM-JD-0051 CRANKSHAFT ADAPTER MAINTENANCE)

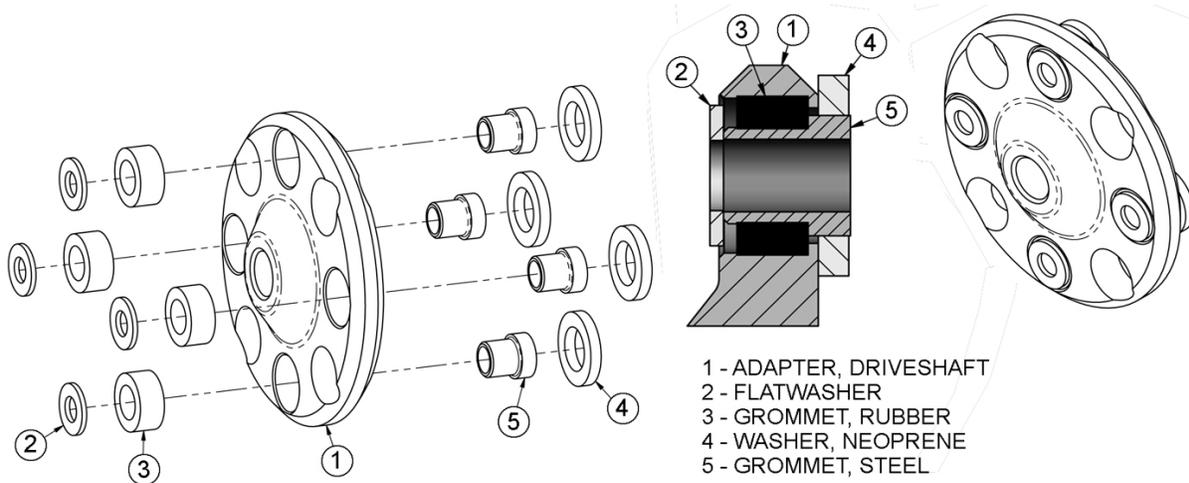

MAINTENANCE

REGULAR MAINTENANCE

The intervals at which regular servicing should be done are based on hours of operation. Use the tractors hour meter to determine when regular servicing is required.

Daily or Every 8 Hours

ITEM	SERVICE	COMMENTS
Drive Shaft Yoke, U-Joint & Stub Shaft	Grease	Grease as instructed in detailed Maintenance Section
Pump Drive Shaft	Check and Lube	Insure drive shaft end play
Crankshaft Adapter	Check rubber grommets	Replace grommets if damaged or missing
Pivot Points	Lubricate	Inject grease until it appears at end
Hydraulic Fittings	Check for leaks	Tighten when needed. Do Not use hands to check for leaks. See Maintenance Precautions
Knives	Check	Inspect for missing or damaged knives, change or sharpen as needed
Spindle mounting bolts (spindle to deck)	Check	3/4" x 2" torque to 331ft./lbs.
Knife mounting bolts (knife to disk)	Check	Pre-lubricate threads, then torque to 800 ft. lbs.
Disk mounting bolts (disk to spindle)	Check	5/8" X 1-3/4" bolt torque to 204 dry or 184 oiled ft. lbs.
Belts	Check/Adjust	Check if broken, tighten as required
Main Frame and Deck	Check	Retorque bolts to torque specifications in this section
Hydraulic Fluid Level	Check	Add if required per fluid recommendations
SIDE ROTARY	Maintenance Section 4-4	

MAINTENANCE

MAINTENANCE

WEEKLY OR EVERY 40 HOURS

ITEM	SERVICE	COMMENTS
Rotary Spindle	Lubricate	Every 40 hours or weekly

WEEKLY OR EVERY 50 HOURS

ITEM	SERVICE	COMMENTS
In Tank Hydraulic Fluid Filter (10 micron filter)	Change	Change after first 50 hours only then every 500 hours or yearly
In-Line High Pressure Filter (10 micron filter)	Change	Change after first 50 hours only then every 500 hours or yearly

MONTHLY OR EVERY 150 HOURS

ITEM	SERVICE	COMMENTS
Hydraulic Fluid Level	Check	Add as needed
Hydraulic Tank Breather	Clean/Check/Replace	Clean or replace Element as required
Rear Tire Type	Max P.S.I.	
480/80R38	29	
18.4-34	26	
18.4-38	26	

MAINTENANCE

MAINTENANCE

YEARLY OR EVERY 500 HOURS

MAINTENANCE

ITEM	SERVICE	COMMENTS
Spindle Grease	Change	
Motor to Spindle Spline	Change	
Hydraulic Tank Fluid	Change	
In Tank Hydraulic Fluid Filter (10 micron filter)	Change	
In-Line HP Filter (10 micron filter)	Change	or Change when indicated by restriction indicator.
Hydraulic Tank Breather	Change	
Motor to Spindle Spline Connection		Grease as instructed in the detailed maintenance section

MAINTENANCE

MAINTENANCE

TROUBLESHOOTING

SYMPTOMS	CAUSE	REMEDY
Vibration	Loose Bolts	Check all bolts and tighten to recommended torque specifications in this section
	Cutter assembly	a. Check for damaged blades, disc, unbalanced or cutter shaft. b. Replace if needed. c. Check for wire, rope, etc. entangled in the cutter assembly
Mower will not lift	Hydraulic Fluid Low Leaks in line Faulty relief valve	Check and refill Hyd Fluid Tighten or replace fittings and hoses Check pressure in line. Line pressure in Control Valve should be at least 2500 P.S.I.
	Kinked or blocked	Clean or replace lines
	Faulty cylinder	Inspect, repair or replace cylinder
Oil Temperature rises	Low oil level above 200°F Kinked/blocked hoses Worn pump/motor	Bring oil to proper level. Inspect / Repair / Replace Disable and Repair
Mower will not start or run	Blown fuse	Check fuse between mower switch and ignition / replace
	Ball valves closed Low oil level Line leak	Make sure valves are open Check Hyd. tank and fill Check all fittings and lines, re-tighten or replace
	Electronic solenoid faulty	a. Without the tractor running, turn the mower switch to on. A low audible click is not heard if the solenoid is engaging the solenoid spool. If click is not heard, leave switch in on position and with a screwdriver or other steel object, touch the small nut on the end of the solenoid. If the metallic object is not attracted to the nut, check the fuse and wiring for an open circuit. If the object is attracted but no "click" is heard, replace the solenoid.

MAINTENANCE

TROUBLESHOOTING (CONTINUED)

- b. Remove the four bolts holding the small block to the main block. Lift and remove small block being careful not to damage O-rings/filter.
- c. Clean filter and re-install.
- d. Remove large nut on side of large valve block. Remove spring, and use needle nose vise grip to pull spool from block, check block and spool for contaminants and scratches. Clean parts or replace if scratched.

Motor runs but will not cut

Belts
Tensioner

Inspect belts and pulleys. Replace belts and repair as needed.
Adjust tensioner nut flat washer washer is flush with top of guide.

Mower turns slowly or not at all

Contaminants restricting spool movement in valve body

Remove large nut on side of large valve block. Remove spring, and use needle nose vise grip to pull spool from block. Check block and spool for contaminants and scratches.

Clean parts or replace if scratched.

Suction lines obstructed

Check for kinks or obstruction in suction hose.

Low oil level

Check Hyd. tank level and fill.

Pump will not work

Excessive wear on internal parts

Disassemble and repair.

Motor will not work

Excessive wear on internal parts

Disassemble and repair

NOTE: If flow meter is available, check pressure and flow volume for all suspected hydraulic problems.

If the solution to your problem cannot be found in this section, call the Technical Service representative at the number shown on the front cover of this manual.

MAINTENANCE

MAINTENANCE

TORQUE SPECIFICATIONS

Torque for Standard Fasteners

Nominal Dia. (in.)	threads per inch												
		Grade 2			Grade 5			Grade 8			Grade 9		
		Tightening Torque			Tightening Torque			Tightening Torque			Tightening Torque		
		Lubed	Dry Plated	Dry plain	Lubed	Dry Plated	Dry plain	Lubed	Dry Plated	Dry plain	Lubed	Dry Plated	Dry plain
		K = 0.15	K = 0.17	K = 0.20	K = 0.15	K = 0.17	K = 0.20	K = 0.15	K = 0.17	K = 0.20	K = 0.15	K = 0.17	K = 0.20
Unified Coarse Thread Series													
1/4	20	49 in-lbs	59 in-lbs	66 in-lbs	76 in-lbs	86 in-lbs	101 in-lbs	107 in-lbs	122 in-lbs	143 in-lbs	126 in-lbs	143 in-lbs	168 in-lbs
5/16	18	101	122	135	157	178	209	221	251	295	259	294	346
3/8	16	15 ft-lbs	18 ft-lbs	20 ft-lbs	23 ft-lbs	26 ft-lbs	31 ft-lbs	33 ft-lbs	37 ft-lbs	44 ft-lbs	38 ft-lbs	43 ft-lbs	51 ft-lbs
7/16	14	24	29	32	37	42	49	52	59	70	61	70	82
1/2	13	37	44	49	57	64	75	80	90	106	94	106	125
9/16	12	53	63	70	82	92	109	115	130	154	135	153	180
5/8	11	73	87	97	113	128	150	159	180	212	186	211	248
3/4	10	129	155	172	200	227	267	282	320	376	331	375	441
7/8	9	125	150	167	322	365	429	455	515	606	533	604	710
1	8	187	225	250	483	547	644	681	772	909	799	905	1065
1 1/8	7	266	319	354	596	675	794	966	1095	1288	1132	1283	1510
1 1/4	7	375	450	500	840	952	1121	1363	1545	1817	1597	1810	2130
1 1/2	6	652	783	869	1462	1657	1950	2371	2688	3162	2779	3150	3706
Fine Thread Series													
1/4	28	56 in-lbs	68 in-lbs	75 in-lbs	87 in-lbs	99 in-lbs	116 in-lbs	123 in-lbs	139 in-lbs	164 in-lbs	144 in-lbs	163 in-lbs	192 in-lbs
5/16	24	112	135	150	174	197	231	245	278	327	287	325	383
3/8	24	17 ft-lbs	20 ft-lbs	23 ft-lbs	26 ft-lbs	30 ft-lbs	35 ft-lbs	37 ft-lbs	42 ft-lbs	49 ft-lbs	43 ft-lbs	49 ft-lbs	58 ft-lbs
7/16	20	27	32	36	41	47	55	58	66	78	68	78	91
1/2	20	41	49	55	64	72	85	90	102	120	105	120	141
9/16	18	59	71	78	91	103	121	128	146	171	151	171	201
5/8	18	82	99	110	127	144	170	180	204	240	211	239	281
3/4	16	144	173	192	223	253	297	315	357	420	369	418	492
7/8	14	138	165	184	355	403	474	502	568	669	588	666	784
1	14	210	252	280	542	614	722	765	867	1020	896	1016	1195
1 1/8	12	298	357	397	668	757	890	1083	1227	1444	1269	1439	1693
1 1/4	12	415	498	553	930	1055	1241	1509	1710	2012	1768	2004	2358
1 1/2	12	734	880	978	1645	1865	2194	2668	3024	3557	3127	3544	4169

Torque values for 1/4 and 5/16 in series are in inch-pounds. All other torque values are in foot-pounds. K = 0.15 for "lubricated" conditions D = Nominal Diameter
 Torque values calculated from formula T=KDF, where K = 0.17 for zinc plated and dry conditions F = Clamp Load
 K = 0.20 for plain and dry conditions

Torque-Tension Relationship for Metric Fasteners

Nominal Dia. (mm)	Pitch											
		Class 4.6			Class 8.8			Class 10.9			Class 12.9	
		Tightening Torque			Tightening Torque			Tightening Torque			Tightening Torque	
		Lubed	Dry Plated	Dry plain	Lubed	Dry Plated	Dry plain	Lubed	Dry Plated	Dry plain	Lubed	Dry plain
		K = 0.15	K = 0.17	K = 0.20	K = 0.15	K = 0.17	K = 0.20	K = 0.15	K = 0.17	K = 0.20	K = 0.15	K = 0.20
		(ft-lbs)	(ft-lbs)	(ft-lbs)	(ft-lbs)	(ft-lbs)	(ft-lbs)	(ft-lbs)	(ft-lbs)	(ft-lbs)	(ft-lbs)	(ft-lbs)
3	0.5	0.28	0.32	0.38	0.73	0.82	0.97	1.0	1.2	1.4	1.2	1.6
3.5	0.6	0.44	0.50	0.59	1.1	1.3	1.5	1.6	1.9	2.2	1.9	2.5
4	0.7	0.66	0.74	0.87	1.7	1.9	2.3	2.4	2.7	3.2	2.8	3.8
5	0.8	1.3	1.5	1.8	3.4	3.9	4.5	4.9	5.5	6.5	5.7	7.6
6	1	2.3	2.6	3.0	5.8	6.6	7.7	8.3	9.4	11	9.7	13
6	1.25	2.1	2.3	2.7	5.3	6.0	7.0	7.6	8.6	10	8.8	12
7	1	3.8	4.3	5.0	9.7	11	13	14	16	19	16	22
8	1	5.9	6.6	7.8	15	17	20	22	24	29	25	34
8	1.25	5.5	6.2	7.3	14	16	19	20	23	27	24	31
10	1.25	11	13	15	29	33	39	42	48	56	49	66
10	1.5	11	12	14	28	32	37	40	45	53	47	62
12	1.25	21	23	28	53	60	71	76	86	101	89	119
12	1.5	20	22	26	51	58	68	73	82	97	85	113
12	1.75	19	21	25	49	55	65	70	79	93	81	108
14	1.25	26	29	34	66	75	89	95	108	127	111	148
14	1.5	28	32	37	72	82	96	103	117	138	121	161
14	2	30	34	40	78	88	104	111	126	148	130	173
16	1.5	50	57	67	129	146	171	184	208	245	215	287
16	2	47	53	62	121	137	161	173	196	230	202	269
18	1.5	73	82	97	187	212	249	268	303	357	313	417
18	2.5	65	73	86	167	189	222	239	270	318	279	372
20	1.5	101	115	135	270	306	360	374	424	498	437	583
20	2.5	91	104	122	236	267	314	337	382	449	394	525

Clamp load calculated as 75% of the proof load for specified bolts. K = 0.15 for "lubricated" conditions D = Nominal Diameter
 All torque values are listed in foot-pounds K = 0.17 for zinc plated, dry conditions F = Clamp Load
 Torque values calculated from formula T=KDF, where K = 0.20 for plain and dry conditions

MAINTENANCE

LUBRICATION RECOMMENDATIONS

DESCRIPTION	APPLICATION	GENERAL SPECIFICATION	RECOMMENDED MOBIL LUBRICANT
Tractor Hydraulics	Reservoir	JD-20C MF M1135, M1141 FNHM2C134D (FNH201)	Mobilfluid® 424
Mower Hydraulics	Reservoir		
	Cold Temperatures 0°F Start-Up Normal Temperatures 10°F Start-Up	ISO 46 Anti-Wear-Low Temp JD-20C MF M1135, M1141 FNH M2C134D (FNH201)	Mobil DTE 15M Mobilfluid 424
	Normal Temperatures 15°F Start-Up High Operating Temp. Above 90°F	ISO 46 Anti-Wear ISO 100 Anti-Wear	Mobil DTE 25 Mobil DTE 18M
Flail Rear Gearbox	Grease	PAO Synthetic Extreme Pressure Gear Lube	Mobil SHC 75W-90 Mobil 1 Synthetic Gear
Cutter Shaft & Ground Roller Shaft (Flail)	Grease Gun	Lithium-Complete Extreme Pressure NLGI - ISO 320	Mobilgrease CM-S
Drive Shaft Coupler (Flail and Rotary)	Grease Gun	Lithium-Complex Extreme Pressure NLGI 2 - ISO 320	Mobilgrease CM-S
Drive Shaft Yoke, U-joint & Stub Shaft	Grease Gun	Lithium-Complex Extreme Pressure NLGI 2 - ISO 320	Mobilgrease CM-S
Deck Spindle (Rotary)	Grease Gun	Tiger Part Spindle Lubricant Part Number 06540000	Mobilith SHC 220
Motor to spindle spline connection	Fill bore in spindle		Accrolube with PTFE

MAINTENANCE

SIDE ROTARY

Maintenance Section 4-10

MAINTENANCE

POLYCARBONATE CARE AND MAINTENANCE

The proprietary UV and Abrasion Resistant surface coating on SHIELDS SUPERCOATED polycarbonate significantly improves performance. Periodic cleaning using proper procedures and compatible cleaners are recommended to prolong service life. Tiger Corp. polycarbonate is SUPERCOATED on both sides.

CLEANING THE SUPERCOAT HARD-COAT

1. Wash with a mild solution of soap or detergent and lukewarm water.
2. Using a soft cloth or sponge, gently wash the sheet to loosen dirt and grime and rinse well with clean water.
3. To prevent water spotting, thoroughly dry with chamois or cellulose sponge.
4. Avoid the use of abrasive cleaners, squeegees and/or other cleaning implements that may mar or gouge the coating.

CLEANING AGENTS WHICH HAVE BEEN FOUND TO BE COMPATIBLE UNDER LABORATORY CONDITIONS:

- Aqueous Solutions of Soaps and Detergents

Windex	Top Job	Joy	Mr. Clean
Fantastik	Formula 409	Sumalight D12	Brucodecid

- Organic Solvents

Butyl Cellosolve	Kerosene	Hexel, F.O. 554	Naphtha (VM&P Grade)
Neleco-Placer	Turco 5042		

- Alcohols

Methanol	Isopropyl
----------	-----------

All residual organic solvents should be removed with a secondary rinse.

GRAFFITI REMOVAL

Butyl cellosolve (for removal of paints, marking pen inks, lipstick, etc.) The use of masking tape, adhesive tape or link removal tools work well for lifting off old weathered paints.

To remove labels, stickers, etc., the use of kerosene or VM&P naphtha are generally effective. When the solvent will not penetrate sticker material, apply heat (hair dryer) to soften the adhesive and promote removal.

If a material is found to be incompatible in a short-term test, it will usually be found to be incompatible in the field. The converse, however, is not always true. Favorable performance is no guarantee that actual end-use conditions have been duplicated. Therefore, these results should be used as a guide only and it is recommended that the user test the products under actual end-use conditions.

MAINTENANCE

MAINTENANCE

RECOMMENDED FILLING INSTRUCTIONS FOR HYDRAULIC RESERVOIRS

When filling or checking the oil level, the unit should be parked on a level surface., shut “OFF”, and allow sufficient time to cool to ambient temperature. Use caution when removing the pressurized breather. Do not place face over opening when removing breather.

If your reservoir has two sight glasses: The reservoir should be filled to the top of the lower sight glass on the side of the tank. Do not overfill. The reservoir has been overfilled when oil is visible in the upper sight glass. If tank has too much oil, the excess may be expelled through the pressurized breather.

If your reservoir has one sight glass/temperature gage: The reservoir should be filled to the center of the sight glass on the side of the tank. Do not over-fill. If the tank has too much oil, the excess may be expelled through the pressurized breather

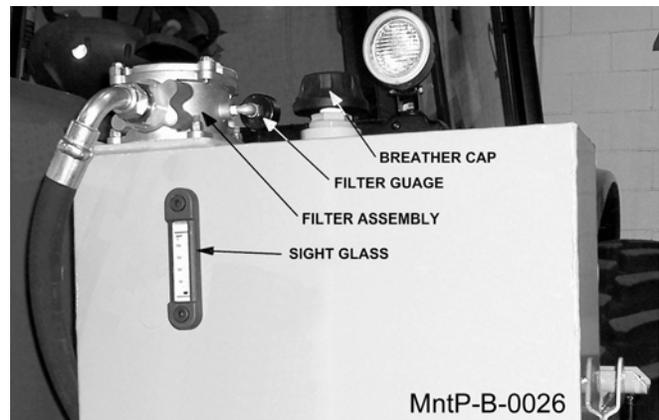
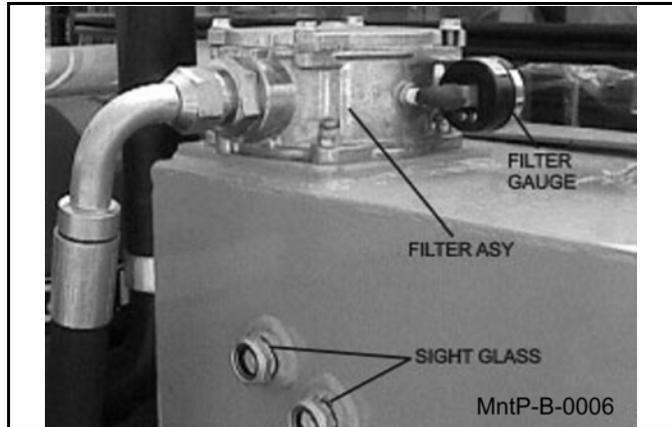

REPLACING IN-TANK HYDRAULIC FILTER

Loosen the four bolts on the top cover of the filter housing. Turn cover counter-clockwise until cover is free. Remove and replace filter. Replace top cover and cover bolts in opposite order as removed.



MAINTENANCE

REPLACING HIGH PRESSURE HYDRAULIC FILTER ELEMENT

Be certain that the system has been shut down and depressurized. Locate High Pressure Filter housing. Confirm that the new element to be installed matches the element p/n on the filter model tag. *Example: V3.0510-06 (world line 100, HD049 model)*. Locate the bottom of the High Pressure Bowl. Using the appropriate spanner wrench or ratchet, and turning in a counterclockwise rotation, (looking at the bottom of the bowl) remove the bowl from the head. The first couple rotations will seem tight as the o-ring passes the sealing flats. Once the o-ring has cleared the sealing flats, the bowl should spin freely. Taking care not to drop the bowl, finish removing the bowl from the head.

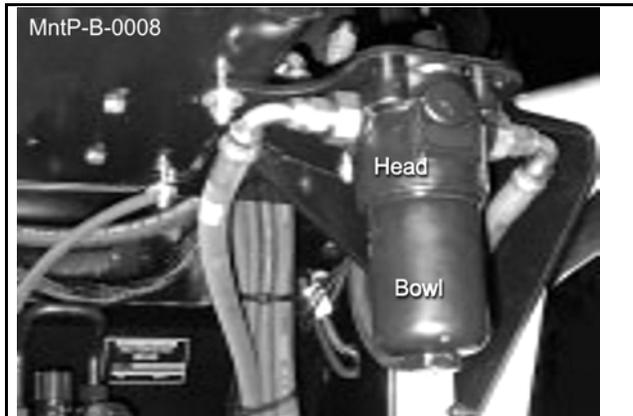

WARNING: Bowl will be full of oil! Pour the oil from the bowl into a container. This oil should be considered contaminated due to the outside-in flow direction through the element. Clean the inside of the bowl if "dirt" is present. Remove the old element from the filter head by pulling with a rotating motion. Dispose of the used element properly. Remove the new element from the packaging. Using your finger, dab and lubricate the o-ring in the top of the new element with oil. Install the new element into and on the mounting boss within the head. Ensure that the element is fully seated on the boss. Clean and inspect the o-ring that is affixed in the bowl and lubricate with oil. Using a clockwise rotation, screw the bowl back into the head, ensuring that the bowl has not been crossthreaded into the head. Continue to tighten the bowl, using the spanner wrench or ratchet. The rotation of the bowl will become tighter once the o-ring engages the sealing flats. Once the bowl has bottomed out, back-off the bowl by 1/6 turn. This ensures that the o-ring is seated properly within the sealing flats. Element change out and re-assembly is now complete. Start the machine and inspect the filter area checking that there is no oil leaking from the filter assembly. Replace the element for the first time at 50 hours of operation, then yearly (500 hours) or when indicated by restriction indicator.

MAINTENANCE

MAINTENANCE

MAINTENANCE

GREASING THE SHEAVE

Locate the grease zerk on the ends of the sheave pin. Inject Lithium-Complex Extreme Pressure grease conforming to NLGI2-ISO 320 specifications into the pin until it protrudes from the ends. This should be greased daily or for every 8 hours of service.

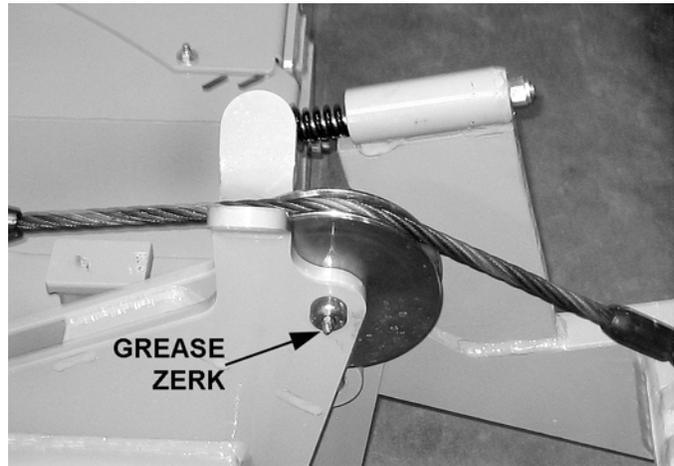

TIGHTENING BLADE BOLTS AND DISK BOLTS

After every 8 hours of operation or daily, the knife bolts and disk bolts should be tightened as follows:

Knife Mounting Bolts (2 or 3 ea.) torque to 800 oiled ft. lbs.

Disk Mounting Bolts (6 ea.) torque to 204 dry or 180 oiled ft./lbs.

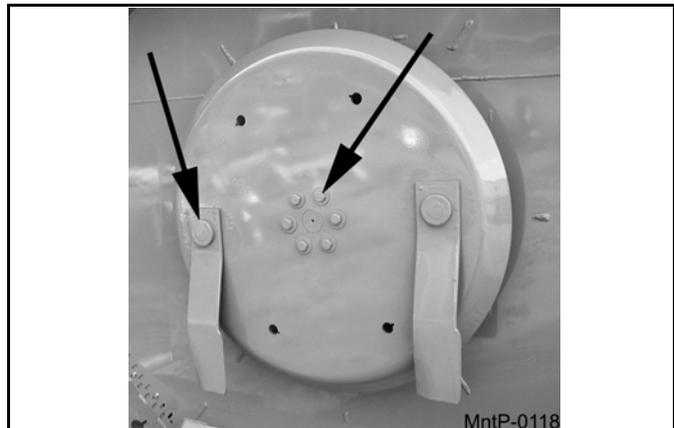

MAINTENANCE

GREASING DRAFT BEAM PIVOT POINTS

Locate the grease zerks on the inner and outer draft beam pivot bosses. Inject Lithium-Complex extreme pressure grease, conforming to NLGI2-ISO 320 specifications, into each zerk until grease protrudes from joints. Grease all pivots daily or every 8 hours of service.

With the cutter head lowered, locate the grease zerks on the linkage and pivot bosses. Inject Lithium-Complex extreme pressure grease, conforming to NLGI2-ISO 320 specifications, until it protrudes from the ends. With the cutter head in this position it is also possible to grease the draft beam cylinder anchors and pins. Now raise the cutter head to expose the remaining zerks on the deck tilt linkages and on the other end of the cylinder.

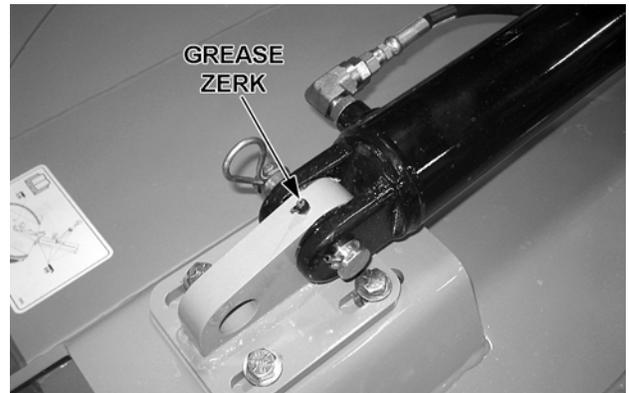
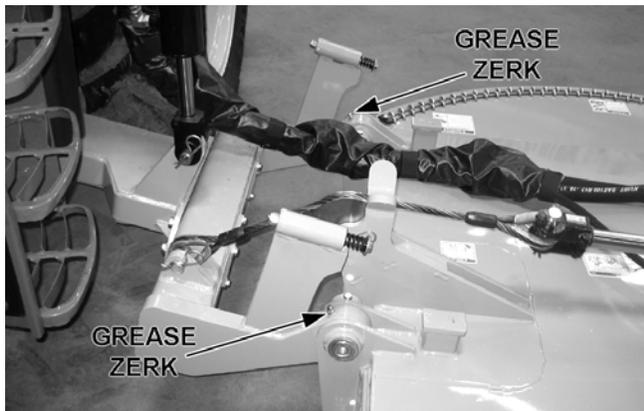

GREASING PUMP DRIVE SHAFT COUPLER

With engine stopped, ensure driveshaft alignment by grasping coupler and sliding back and forth. Coupler should slide freely with approximately 1/8" of end play. If coupler does not slide freely, inspect for loose pump mount bolts, or damaged or loose crankshaft adapter. Inject-Lithium Complex extreme pressure grease, conforming to NLGI2-ISO 320 specifications, into coupler until grease begins to protrude from ends. Grease daily or every 8 hours. Do not over grease.

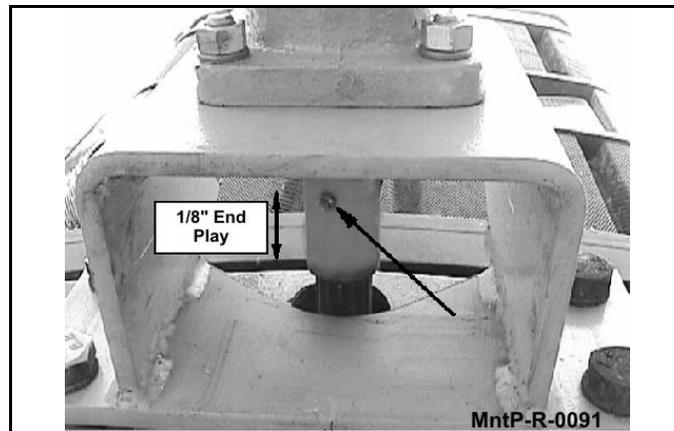

MAINTENANCE

DRIVE SHAFT YOKE, U-JOINT & STUB SHAFT

With engine stopped, inject Lithium-Complex extreme pressure grease, conforming to NLGI2-ISO 320 specifications, into universal joints and slip yoke until grease appears at the seal. Grease them daily or every 8 hours.

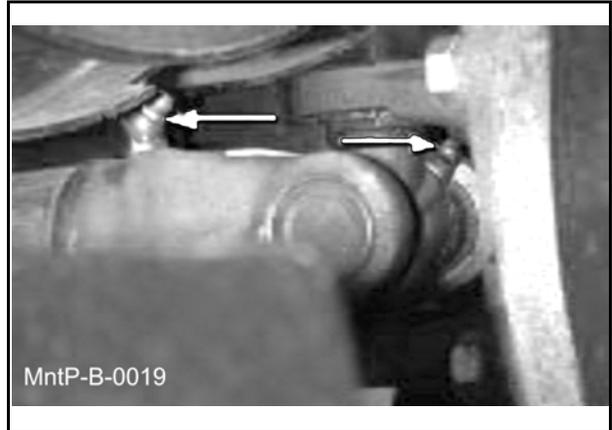
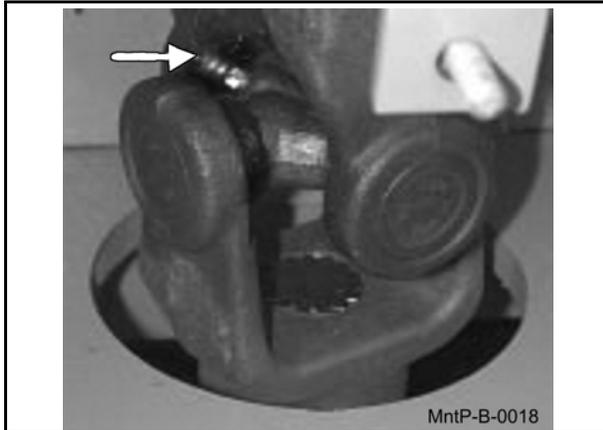

MAINTENANCE

MAINTENANCE

BALL VALVES

The ball valves at the hydraulic reservoir may need to be closed during certain maintenance or repair procedures. **THE BALL VALVES MUST BE OPEN (handle parallel with valve) WHEN TRACTOR IS RE-STARTED OR WHEN THE PUMP IS COUPLED TO MOTOR OR P.T.O.!** Failure to do so will result in component failure!

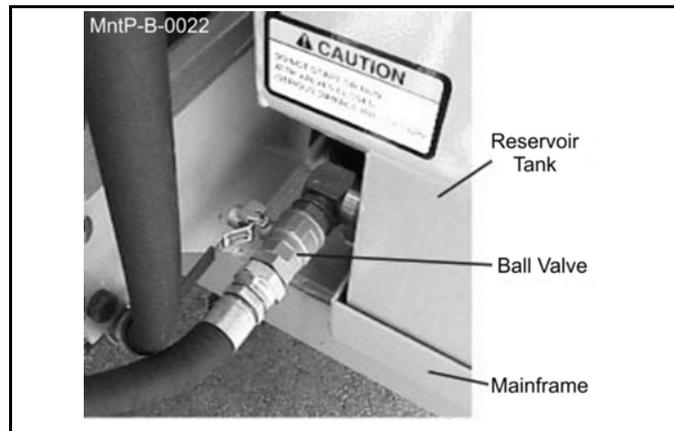

GREASING SPINDLE

Locate grease fitting on inside of deck housing. Inject Tiger Spindle Lubricant, part number 06540000, into spindle housing. Fill with lubricant until lubricant weeps out of top spindle seal. Lubricate spindle weekly or every 40 hours of use.

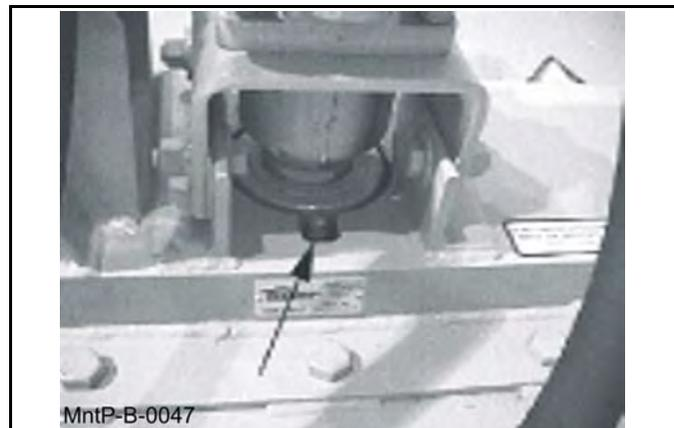

TIGHTENING SPINDLE BOLTS

The spindle mounting bolts should be checked and retorqued daily or every 10 hours of service. Torque the (6) bolts shown below to 357 dry or 315 oiled ft. lbs.



MAINTENANCE

GREASING MOTOR SPLINE TO SPINDLE SPLINE

For direct drive mowers, locate motor spline and spindle spline on the mower deck. Clean old grease from splines on motor shaft and in spindle. Fill bore in spindle with Accrolube with PTFE (Tiger #06520310). Use about 4 ounces of grease. Change grease yearly or every 500 hours.

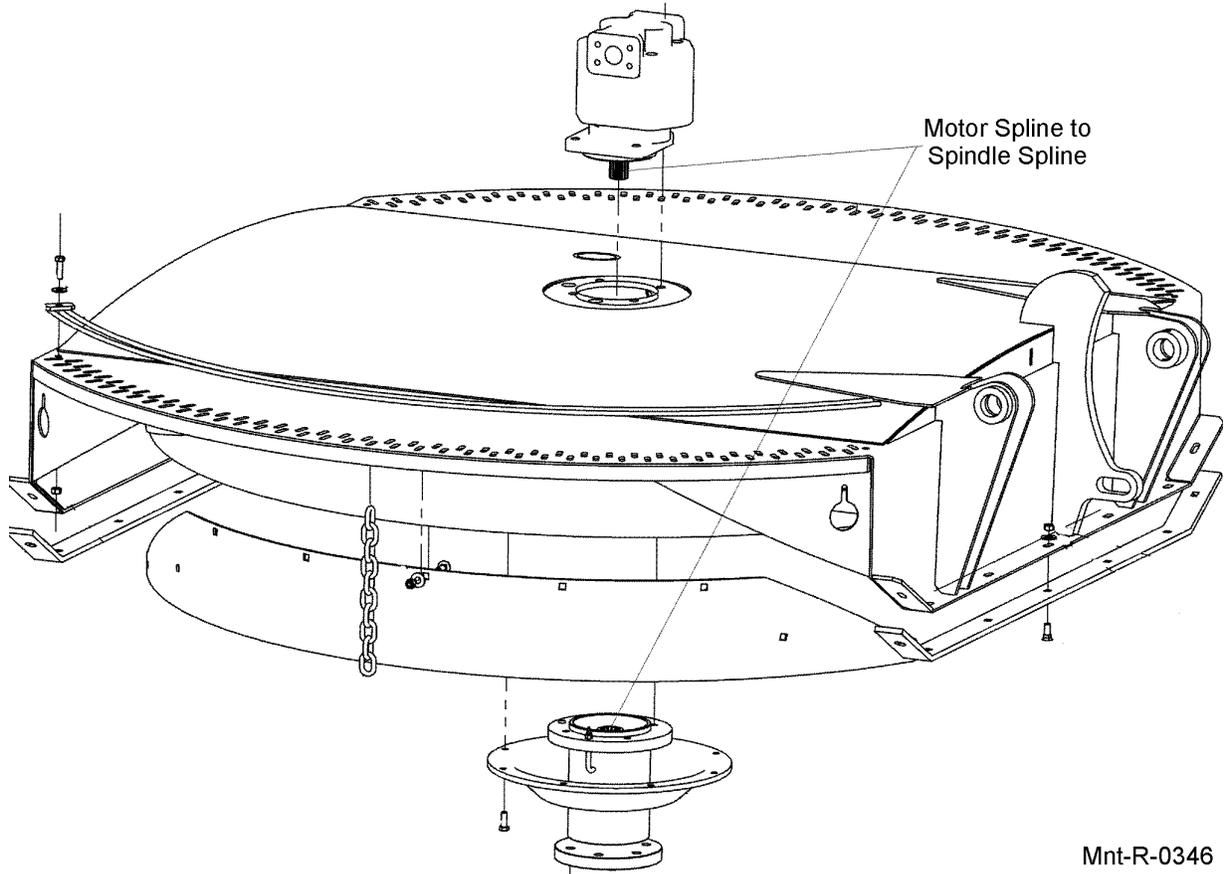

Mnt-R-0346

MAINTENANCE

MAINTENANCE

Blades

Check the Blades for cracks and wear and Blade Bolts for tightness, daily. Blades should be replaced when they are worn excessively, bent, deformed, or out of balance.

CAUTION

Blades should always be replaced in pairs. Blades of different weights can cause serious imbalance and damage to the machine and personnel. When replacing blades, take care to replace the blade bolts, nuts, and washers.

Important

Make sure the mower blades are turning clockwise when looking down from the top of the mower. Follow the color coding on the hydraulic hoses and fittings to make sure the motor and hydraulics hoses are assembled properly. Connect the red hose connection only to red fitting. Connect the blue hose connection only to the blue fitting. The blade rotation on the leading edge of the mower should discharge the cut material away from the tractor and operator.

WARNING

If the leading edge of the mower blades are rotating backwards they can discharge material toward the operator. If this occurs discontinue mowing immediately and reverse the direction of the motor rotation by correctly installing the motor pressure and return hoses. Contact your dealer or Alamo Industrial for specific information on the hose routing.

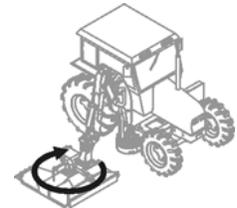

MAINTENANCE

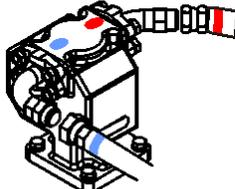
WARNING	ADVERTENCIA
TO AVOID SERIOUS INJURY AND DEATH FROM THROWN OBJECTS: <ul style="list-style-type: none">● MAKE CERTAIN blades rotate the correct direction.	PARA EVITAR LESION SERIA O MUERTE POR OBJETOS LANZADOS: <ul style="list-style-type: none">● ASEGURE que las cuchillas giran en la dirección correcta.
BLADE ROTATION  ROTACIÓN DE CUCHILLAS	
Return Retorno BLUE	 Pressure Presión RED

D619

MAINTENANCE

ROTARY KNIFE REPLACEMENT

1. Be sure you have a complete matching set of new knives for replacement.
2. Remove knives and inspect holes for damage. Also watch for cracks in the disk around the holes.
3. Lube threads with anti-seize, motor oil or grease. Install bolts through knife and disk from bottom side of disk. Install new self-locking nuts and torque them to 800 ft. lbs.
4. The knives should swing freely to absorb shocks from impact when striking objects.



WARNING

WHEN CUTTING HEAVY BRUSH, KNIFE BOLTS SHOULD BE INSPECTED HOURLY AND RETORQUED TO 1070 DRY OR 800 OILED FT./LBS.

REPLACEMENT OF ROTARY DISK



CAUTION

Failure to follow the following warnings and instructions may result in serious injury or damage to the equipment or property!

The bolts that attach the knife mounting disk to the spindle must be grade 8. These 5/8 inch bolts are to be torqued according to the chart in this section.

A thread locking agent may be applied to threads of all mounting bolts before they are installed.

Disks must be inspected daily for hairline cracks between spindle mounting bolts or around the knife mounting bolts. These cracks indicate metal fatigue caused by severe abuse. If cracks are present, the disk must be replaced.

Inspect the disk mounting bolts daily when checking tightness of blade mounting bolts. If a disk mounting bolt is loose, it must be removed, threads cleaned, fresh thread locking agent applied, and tightened to proper torque value.

If a knife mounting bolt is loose, the self locking nut must be replaced as a safety precaution. Lubricate threads with anti-seize, grease or motor oil. Place bolts through knife and disk from bottom side of disk. Install self locking nuts and torque them to 800 ft. lbs.

1. **WARNING: The disk alone weighs over 100 lbs.** Be sure its weight can be supported before attempting to replace. The use of a lift mechanism will ease replacement.
2. Remove the six disk mounting bolts and the disk from the spindle.
3. Install new disk and align with mounting bolt holes.
4. Apply a thread locking agent to all of the mounting bolts and install the bolts through the disk.

NOTE: *Disk bolts must be Grade 8.*

5. Tighten bolts down and torque to values noted.
6. See knife replacement instructions for replacing the knives onto the new disk.

HEAVY DUTY SPINDLE ASSEMBLY INSTALLATION AND BEARING ADJUSTMENT



A press **MUST** be used to install bearing cups, bearing cones, and seals. **DO NOT** use a hammer to install races, bearings, or seals. The parts of assembly may be damaged.

NOTE: The grease zerk and gussets are located on the top side of the spindle housing. Be sure the spindle is assembled correctly.

Be sure to wear eye protection and other protective equipment as needed when working on spindle assembly.

THE SPINDLE ASSEMBLY

See the diagram below for identification of spindle parts, while servicing.

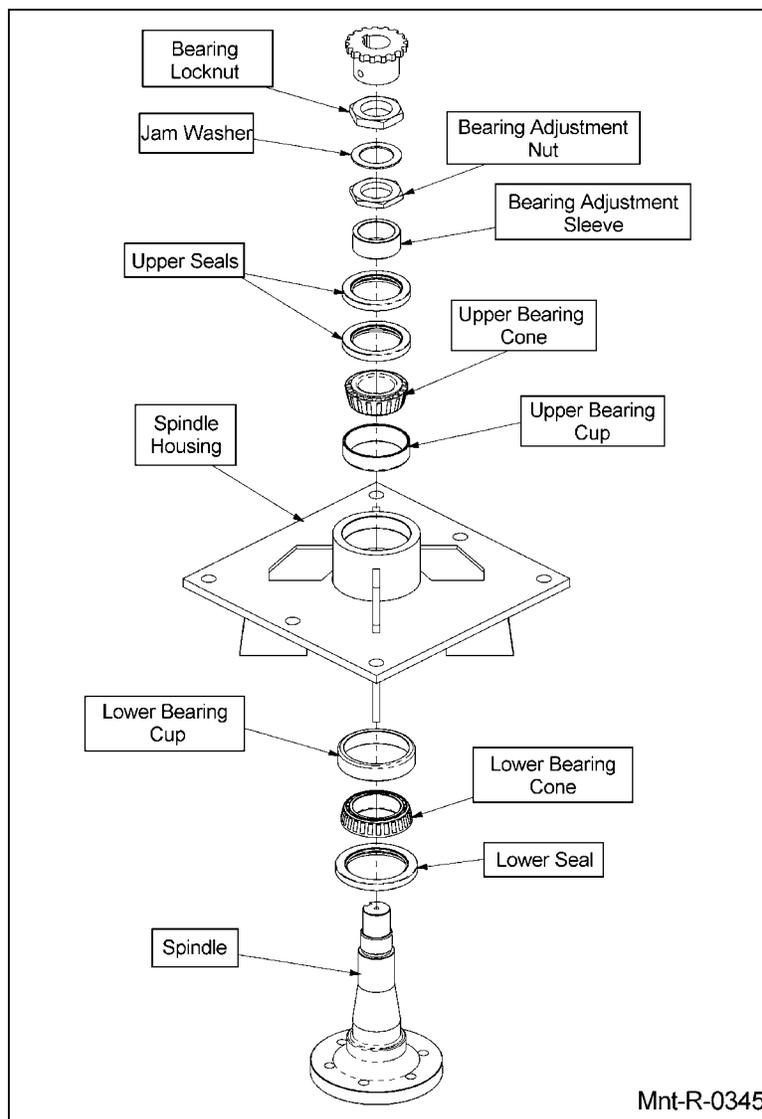

MAINTENANCE

BEARING INSTALLATION

1. Press upper bearing cup into the spindle housing
2. Turn the spindle housing over and press in the lower bearing cup.
3. Place the lower bearing cone in the bearing cup. Next press the seal into the spindle housing. The inner lip of the seal must be DOWN, towards the bearing, so lubricant is sealed inside the housing.
4. Install the spindle in the housing. Lightly press the end of the spindle to seat the spindle against the bearing inner race.
5. Turn the spindle housing over (up position) and fill with Tiger Spindle Lubricant (part number 06540000) to the top edge of the upper bearing cup.
6. Support the bottom of the spindle and press the upper bearing cone and bearing adjustment sleeve onto the spindle.

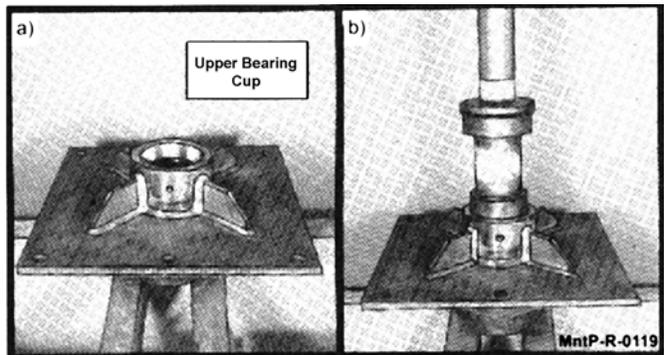

NOTE: The spindle housing must turn freely when seating the bearing cone and sleeve.

7. Press the two upper seals into the spindle housing. The inner lip of the seals must be UP, away from the bearing, so excess lubricant can escape.
8. Install the bearing adjustment nut (thin nut) so there is 1-1/6" clearance between the nut and the sleeve. Install the jam washer, placing the tab into the key-way. Install the bearing lock nut (thin nut) and hand tighten against jam washer and adjustment nut. See the following section for bearing adjustment.

BEARING ADJUSTMENT

1. Clamp the bottom end of the spindle securely in a vise so the spindle housing turns freely.
2. Position a magnetic base dial indicator on the outer diameter of the spindle housing. Locate the end of the dial indicator against the flat end of the spindle shaft. The dial indicator will now measure accurately bearing end play.
3. Tighten the bearing adjustment nut until there is 0.012 inch movement when the spindle housing is pried upward away from the vise jaws.
4. When there is 0.012 inch free play between the spindle and housing, install the bearing lock nut (thick nut). Hold the adjusting nut securely and tighten the lock nut to 300 ft. lbs. of torque.
5. After the lock nut is tightened, there must be 0.001 inch to 0.003 inch of free play when lightly prying up on the spindle housing.

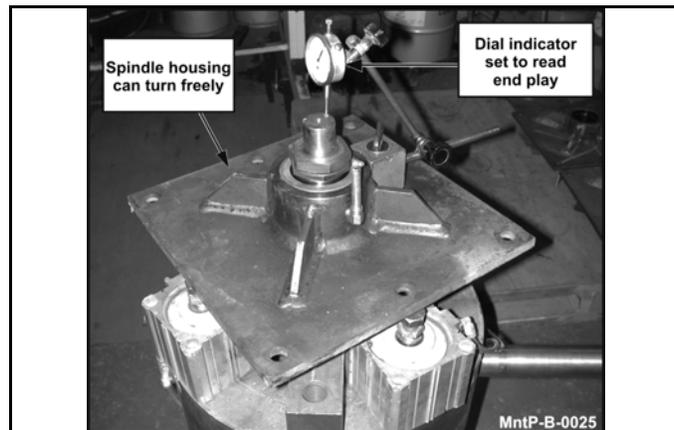

If the end play is correct, 0.001 inch to 0.003 inch, bend tabs up on jam washer to prevent the lock nut from loosening.

If the end play is NOT correct, loosen the lock nut and turn the adjustment nut as required and re-tighten the lock nut. Repeat first part of step 5.

MAINTENANCE

MAINTENANCE

DAILY MAINTENANCE SCHEDULE

The following services should be performed daily or every 8 hours of service, following the detailed maintenance instructions in the operator's manual.

- _____ Pump Driveshaft: Check for end play in driveshaft / coupler and lubricate at zerks.
- _____ Crankshaft adapter: If equipped with rubber grommets check condition, replace if missing or damaged.
- _____ Pivot points: Inject grease until it appears at ends.
- _____ Hydraulic fittings: Check for leaks with paper or cardboard. Tighten fittings or replace hoses immediately
- _____ Knives: Inspect for missing or damaged knives, change (only complete sets) as needed.
- _____ Belts: Check/Tighten/Replace belts as needed.
- _____ Mainframe/Deck: Unless otherwise specified retorque bolts according to torque specifications in this section.
- _____ Hydraulic Fluid Level: Add, if required, per fluid recommendations.
- _____ Rear Flail Drive, Bearing Flange and Shaft Couplers (if applicable): Grease as instructed in the detailed Maintenance Section.
- _____ Cutter Shaft and Ground Roller: Grease as instructed in the detailed Maintenance Section.

Service performed by: _____ Date: ___/___/___ Hour

Meter: _____

Maintenance Section

**This page may be copied and used as part of the daily maintenance routine.

MAINTENANCE

MAINTENANCE

SIDE ROTARY

Maintenance Section 4-24

PARTS SECTION

PART NAME INDEX

PARTS ORDERING GUIDE.....	3
TRACTOR MOUNT KIT.....	4
TRACTOR MOUNT KIT - HYDRAULICS.....	6
CABLE (MANUAL) LIFT VALVE 2 SPOOL.....	8
2 SPOOL CABLE CONTROL MOUNT.....	10
BERM DRAFT BEAM TM.....	12
BERM DRAFT BEAM TSR.....	14
BERM DRAFT BEAM - HYDRAULICS.....	16
NOTES.....	17
COOLER MOUNT.....	18
NOTES 1.....	20

PARTS ORDERING GUIDE

The following instructions are offered to help eliminate needless delay and error in processing purchase orders for the equipment in this manual.

1. The Parts Section is prepared in logical sequence and grouping of parts that belong to the basic machine featured in this manual. Part Numbers and Descriptions are given to help locate the parts and quantities required.
2. The Purchase Order must indicate the **Name and Address** of the person or organization ordering the parts, **who should be charged**, and if possible, the **serial number of the machine** for which the parts are being ordered.
3. The purchase order must clearly list the **quantity of each part**, the complete and correct **part number**, and the basic **name of the part**.
4. The manufacturer reserves the right to substitute parts where applicable.
5. Some parts may be unlisted items which are special production items not normally stocked and are subject to special handling. Request a quotation for such parts before sending a purchase order.
6. The manufacturer reserves the right to change prices without prior notice.

NOTE: When ordering replacement decals, refer to the part numbers and descriptions listed in the safety section in the front of this manual.

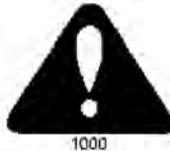

For maximum safety and to guarantee optimum product reliability, always use genuine **Tiger** replacement parts. The use of inferior replacement parts may cause premature or catastrophic failure which could result in serious injury or death.

Direct any questions regarding parts to:

Tiger Corporation
3301 N. Louise Ave.
Sioux Falls, SD 57107
1-800-843-6849
1-605-336-7900

TRACTOR MOUNT KIT

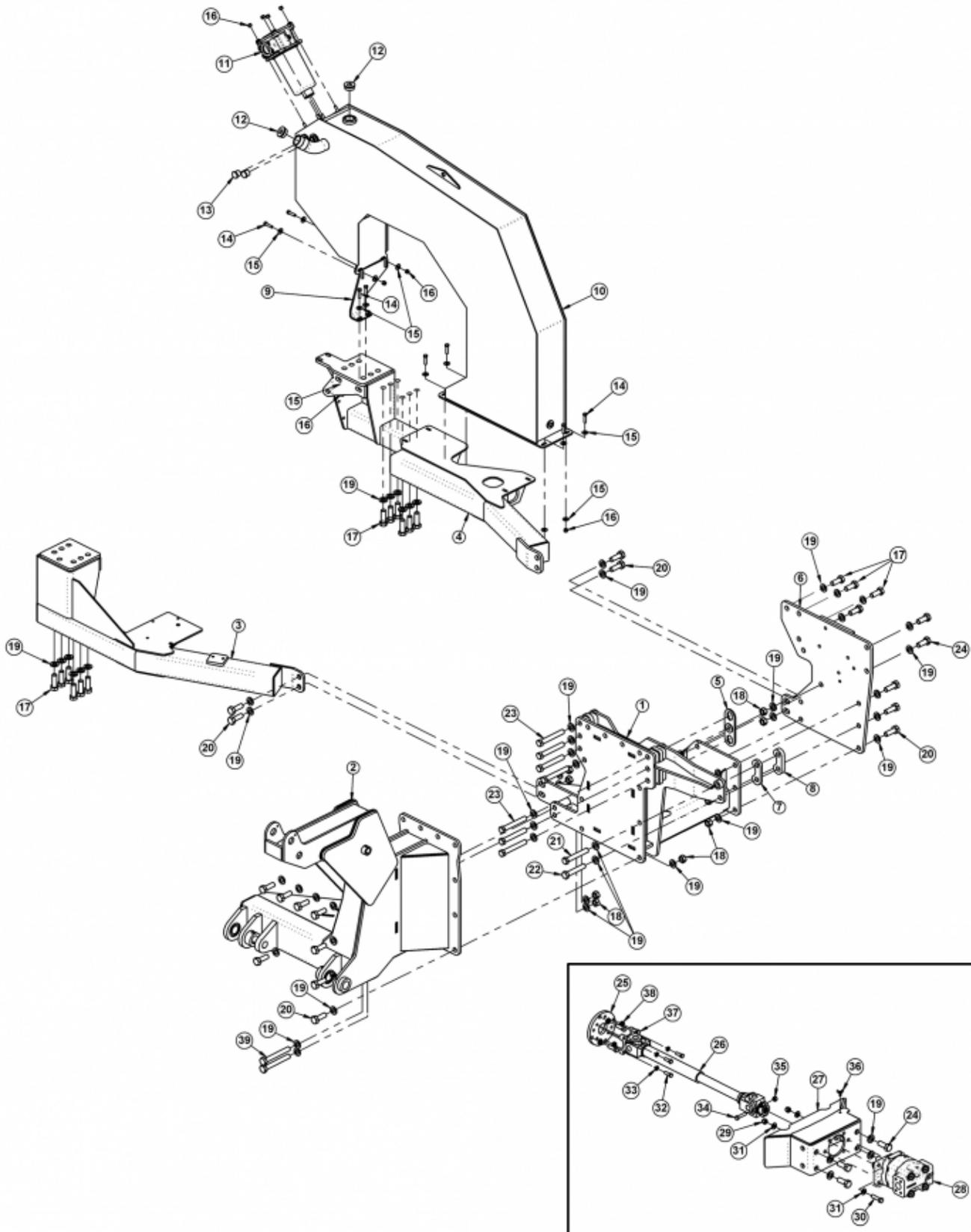

TRACTOR MOUNT KIT

Continued...

ITEM	PART NO.	QTY.	DESCRIPTION
1	06300383	1	MNFRM,MNT,JD6110M,T4F
2	06300398	1	MNFRM,TSF, JD6110M, BERM
3	06300483	1	AXLBRC,RH,JD6110M,MY20, TM
4	06300484	1	AXLBRC,LH,JD6110M,MY20,TM
5	06370355	1	HOLDER,NUT,MID
6	06380112	1	RISER,LH,IH,JD6M,20
7	06403829	1	SPACER,FRONT
8	06403836	1	SPACER,FRONT,2
9	06412418	1	SUPPORT,TANK,06380084
10	06380115	1	TANK,RES,JD6MY20
11	06505044	1	FLTR ASSY,IN-TANK CPLT,SAE10MP
12	06505127	2	PLUG,SAE #20
13	6T1209	2	SIGHT GLASS,TANK
14	21632	8	CAPSCREW,3/8" X 1-1/2" NC
15	22016	16	FLATWASHER,3/8",GR8
16	21627	12	NYLOCK NUT,3/8",NC
17	27281	15	CAPSCREW,20MMX60MM(2.5 PITCH)
18	06531008	19	HEX NUT,3/4 NC,GR 8
19	33880	66	FLATWASHER,3/4",GR 8,SAE
20	06530237	19	CAPSCREW, 3/4 X 2 1/4,NC,GR8
21	06530542	1	CAPSCREW,20MM X 130MM
22	31240	1	CAPSCREW,20MMX110MM(2.5 PITCH)
23	06530545	7	CAPSCREW,20MM X 140MM,2.5P.GR10.9
24	31731	7	CAPSCREW,20MMX50MM(2.5 PITCH)
25	34998	1	SPACER,DRIVESHAFT,JD72-7510/20
26	34999	1	DRIVESHAFT,U-JOINT,JD62-7510/2
27	34993	1	MNT,PUMP,JD,U DRIVE
28	23152	1	PUMP,P350-1-3/4,GEAR
29	21727	4	NYLOCK NUT,1/2,NC
30	21733	4	CAPSCREW, 1/2 X 2,NC
31	06533004	8	FLAT WASHER,1/2,SAE,GR 8
32	21680	4	CAPSCREW, 7/16 X 1 1/4,NC
33	21989	4	LOCKWASHER, 7/16"
34	21658	1	CAPSCREW, 7/16 X 2 ,NF
35	34848	1	HEX NUT, 7/16
36	06537071	1	SCREW,WING,1/4X5/8,NC,TYPE D,Z
37	6T2514	4	CAPSCREW,14MMX40MM(2.0 PITCH)
38	6T2624	4	LOCKWASHER,16MM
39	06530238	2	CAPSCREW, 3/4 X 6,NC,GR8

JD6M MY20 SIDE ROTARY w IH

TRACTOR MOUNT KIT - HYDRAULICS

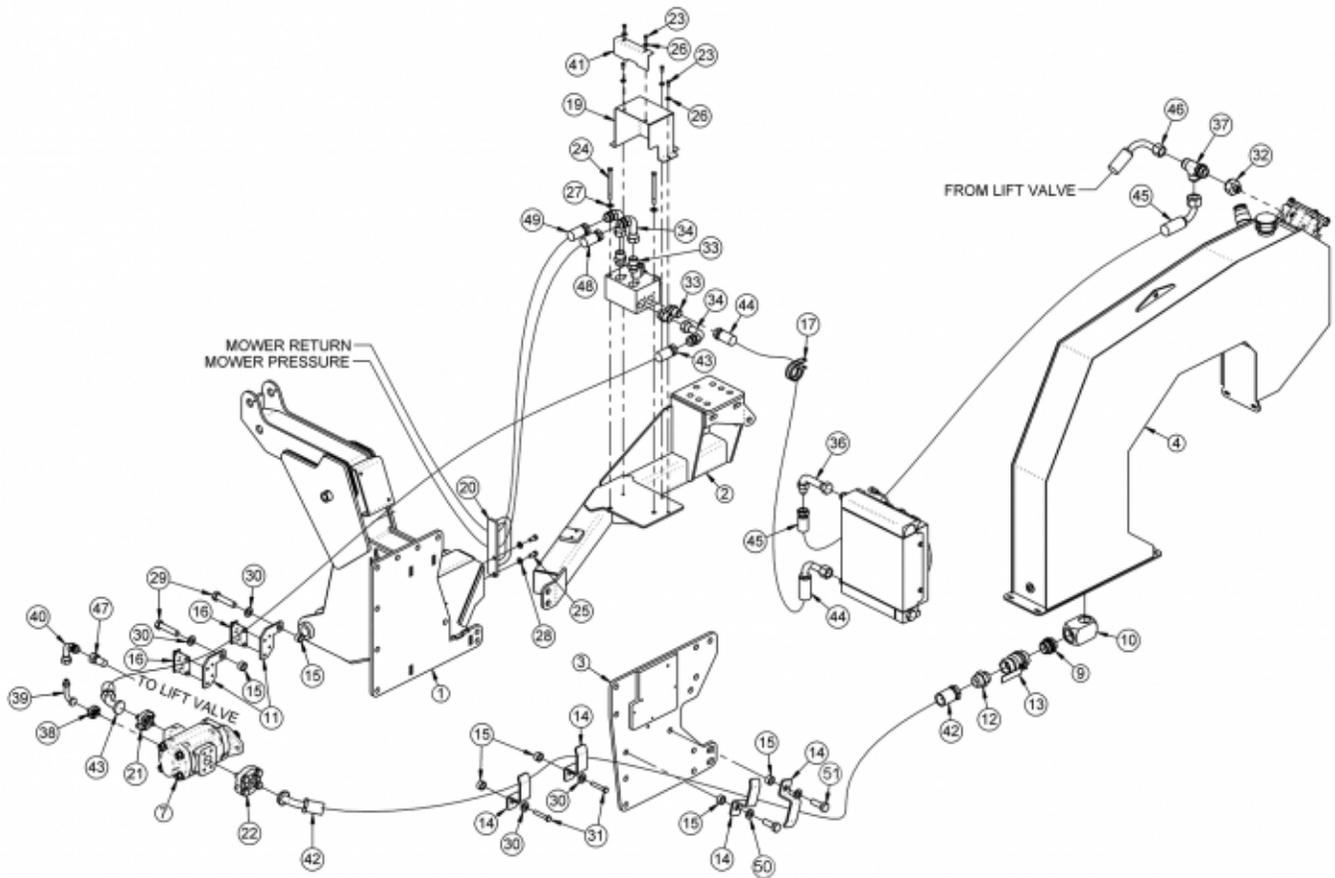

ITEM	PART NO.	QTY.	DESCRIPTION
1	06300398	1	MNFRM,TSF,JD6110M,BERM
2	06300483	1	AXLBRC,RH,JD6110M,MY20,TM
3	06380112	1	RISER,LH,IH,JD6M,20
4	06380115	1	TANK,RES,JD6MY20
5	06505044	1	FLTR ASSY,IN-TANK CPLT,SAE10MP
6	06505127	1	PLUG,SAE #20
7	23438	1	PUMP,TANDEM,P350-1 3/4 - 1/2,BOLT
8	06505077	1	CAP,BREATHER,1 5/8MB
9	06503083	1	ADAPTER,1 1/2ORB X 1 1/2ORB
10	06503084	1	ELBOW,1-1/2FOR X 1-1/2FOR,MACH
11	34626	2	CLAMP BRKT,62-6420
12	34710	1	ADAPTER,1 1/2ORB X 1 1/2MJ
13	34309	1	BALL VALVE,1 1/2 FOR
14	32382	4	BRACKET,HOSE
15	24849	6	SPACER
16	06505017	2	CLAMP KIT,HOSE,1X1.4,2PST
17	06520536	1	CLAMP,HOSE,2 1/2",INS
18	06510083	1	VALVE,BRAKE,SOL,3000PSI,METRI

JD6M MY20 SIDE ROTARY w IH

TRACTOR MOUNT KIT - HYDRAULICS

Continued...

ITEM	PART NO.	QTY.	DESCRIPTION
19	06412593	1	COVER,BV,06300482
20	06370364	1	GUIDE,HOSE,BERM,XD
21	TF4852	1	KIT,FLANGE,#20
22	TF4854	2	KIT,FLANGE,#24
23	21529	3	CAPSCREW,1/4" X 3/4" NC
24	21644	2	CAPSCREW,3/8" X 5" NC
25	21679	2	CAPSCREW, 7/16 X 1,NC
26	22014	3	FLATWASHER,1/4,GR8
27	22016	2	FLATWASHER,3/8",GR8
28	22017	2	FLATWASHER,7/16"
29	30708	2	CAPSCREW,20MMX90MM(2.5 PITCH)
30	33880	4	FLATWASHER,3/4",GR 8,SAE
31	06530519	2	CAPSCREW,12MMX70MM(1.75)
32	35280	1	ADAPTER,1-1/4FJX3/4MJ
33	33555	4	NIPPLE,MALE LONG,1MOR X 1MJ
34	06503200	3	ELBOW,16MJX16FJX,BT90
35	06510351	1	COOLER,ADAMS,OPTIMUM
36	06503222	1	ELBOW,16MJX16FJX,BT90,L
37	34656	1	TEE,RUN,1-1/4ORBX1 1/4MJX1 1/4
38	06503174	1	KIT,FLANGE,#12
39	06503238	1	ELBOW,3/4MJX12FL,BT90
40	06503199	1	ELBOW,12MJX12FJX,BT90
41	06412711	1	COVER,BV,06340079
42	06500746	1	HOSE,#24X107(24FJXX24FL45)
43	06501308	1	HOSE,#16X114(16FJXX20FL45)
44	06501309	1	HOSE,#16X93(16FJXX16FJX90L)
45	06501313	1	HOSE,#16X161(20FJXX16FJX90L)
46	06500953	1	HOSE,#12X35(12FJX90X12FJX)
47	06501259	1	HOSE,#12X205(12FJXX12FJX90)
48	06500753	1	HOSE,#16X103(16FJXX16MJ)
49	06501272	1	HOSE,#16X95(16FJXX20FL45)
50	33880	2	FLATWASHER
51	06530237	2	CAPSCREW, 3/4" X 2-1/4" NC

CABLE (MANUAL) LIFT VALVE 2 SPOOL

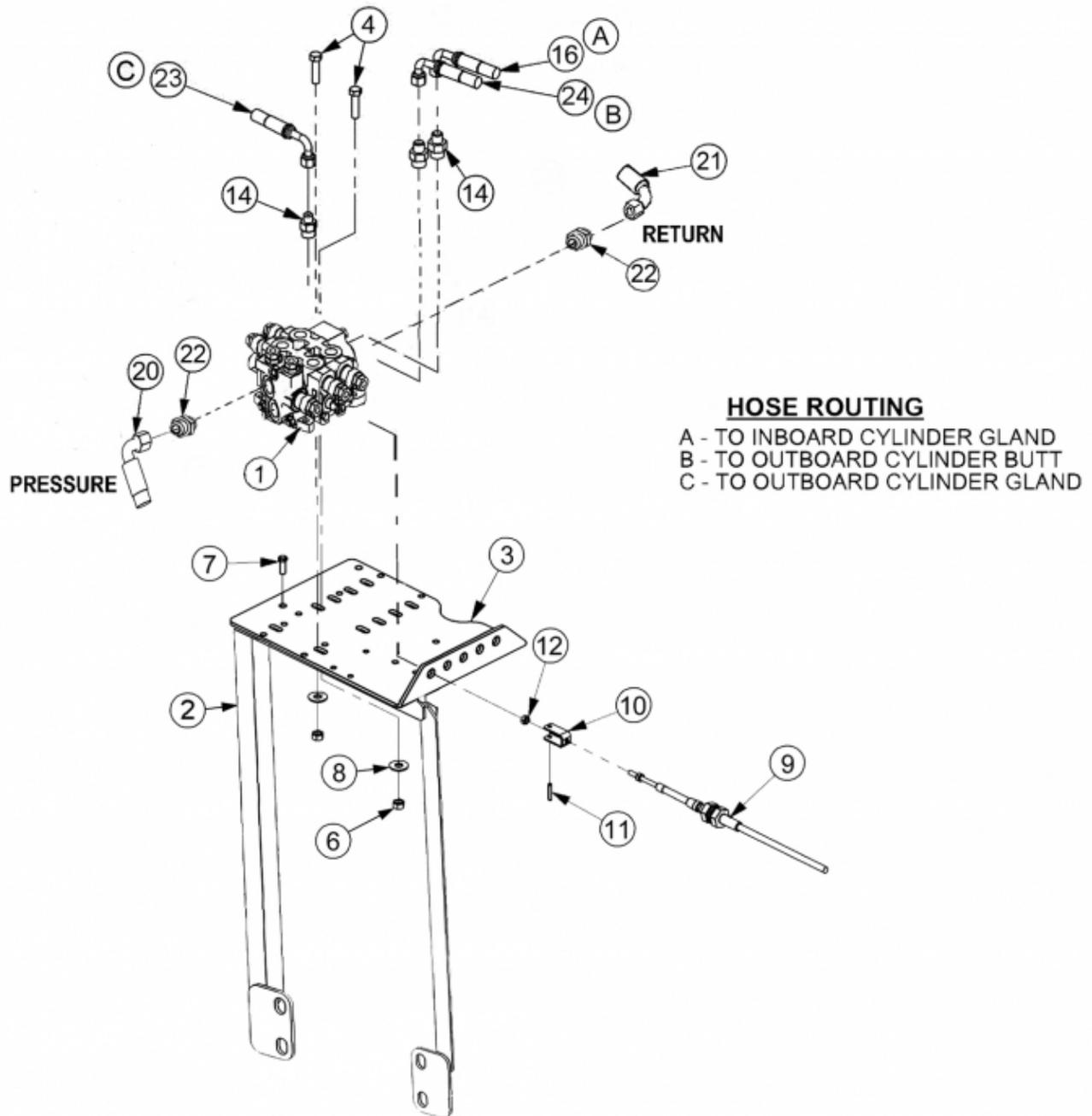

CABLE (MANUAL) LIFT VALVE 2 SPOOL

Continued...

ITEM	PART NO.	QTY.	DESCRIPTION
1	06502180	1	VALVE,2SP,HSC
2	06340033	1	VALVE MNT
3	34622	1	PLATE,VALVE,REAR MNT
4	21632	9	CAPSCREW,3/8" X 1-1/2",NC
5	6T2615	4	WASHER,FENDER,3/8"
6	21627	13	NYLOCK NUT,3/8",NC
7	21630	4	CAPSCREW,3/8" X 1",NC
8	22016	4	FLATWASHER,3/8"
9	06505100	2	CBL,CNTRL,108"
10	6T4411	2	CLEVIS,CBL CTRL,3/16"
11	6T3017	2	ROLLPIN,3/16" X 1"
12	21500	4	HEX NUT,1/4",NF
14	33271	3	ADAPTER,1/2"MOR X 3/8"MJ
16	35111	1	HOSE,1/4" X 140"
20	06501259	1	HOSE,3/4" X 205"
21	06500953	1	HOSE,3/4" X 35"
22	06503218	2	ADAPTER, 3/4"MB X 3/4"MJ
23	06500311	1	HOSE, 1/4" X 156"
24	34025	1	HOSE, 1/4" X 152"

2 SPOOL CABLE CONTROL MOUNT

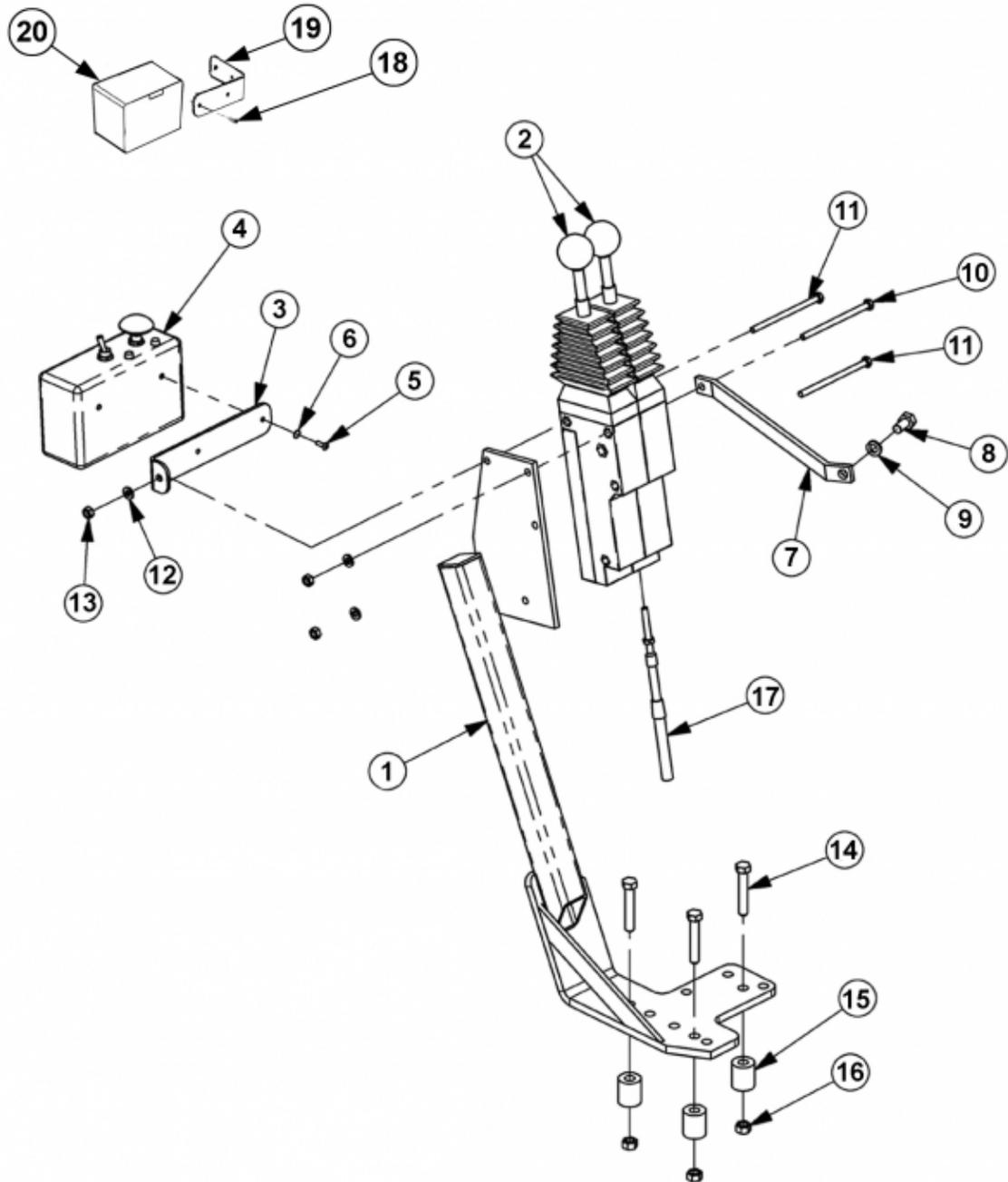

2 SPOOL CABLE CONTROL MOUNT

Continued...

ITEM	PART NO.	QTY.	DESCRIPTION
1	23865B	1	CABLE CONTROL MOUNT STAND
2	6T1251	2	CABLE CONTROL BOX
3	34496	1	BRACKET, SWITCHBOX
4	06510102	1	SWITCHBOX
5	6T3951	2	SCREW, MACHINE, 8/32 X 1/2
6	32360	2	LOCKWASHER #8
7	30750A	1	BRACKET, CABLE CONTROL
8	33534	1	CAPSCREW, 10MM X 20MM 1.5P
9	32691	1	LOCKWASHER 10MM
10	21544	1	CAPSCREW, 1/4" X 5" NC
11	21542	2	CAPSCREW, 1/4" X 4" NC
12	21986	3	LOCKWASHER, 1/4"
13	21525	3	HEX NUT, 1/4" NC
14	21635	3	CAPSCREW, 3/8" X 2-1/4" NC
15	27082B	3	SPACER
16	21627	3	NYLOCK NUT, 3/8" NC
17	06505100	2	108" CABLE CONTROL
18	6T3951	2	SCREW, MACHINE 8/32 X 1/2
19	06412358	1	BRACKET
20	06510045	1	COOLER FAN CONTROLLER

BERM DRAFT BEAM TM

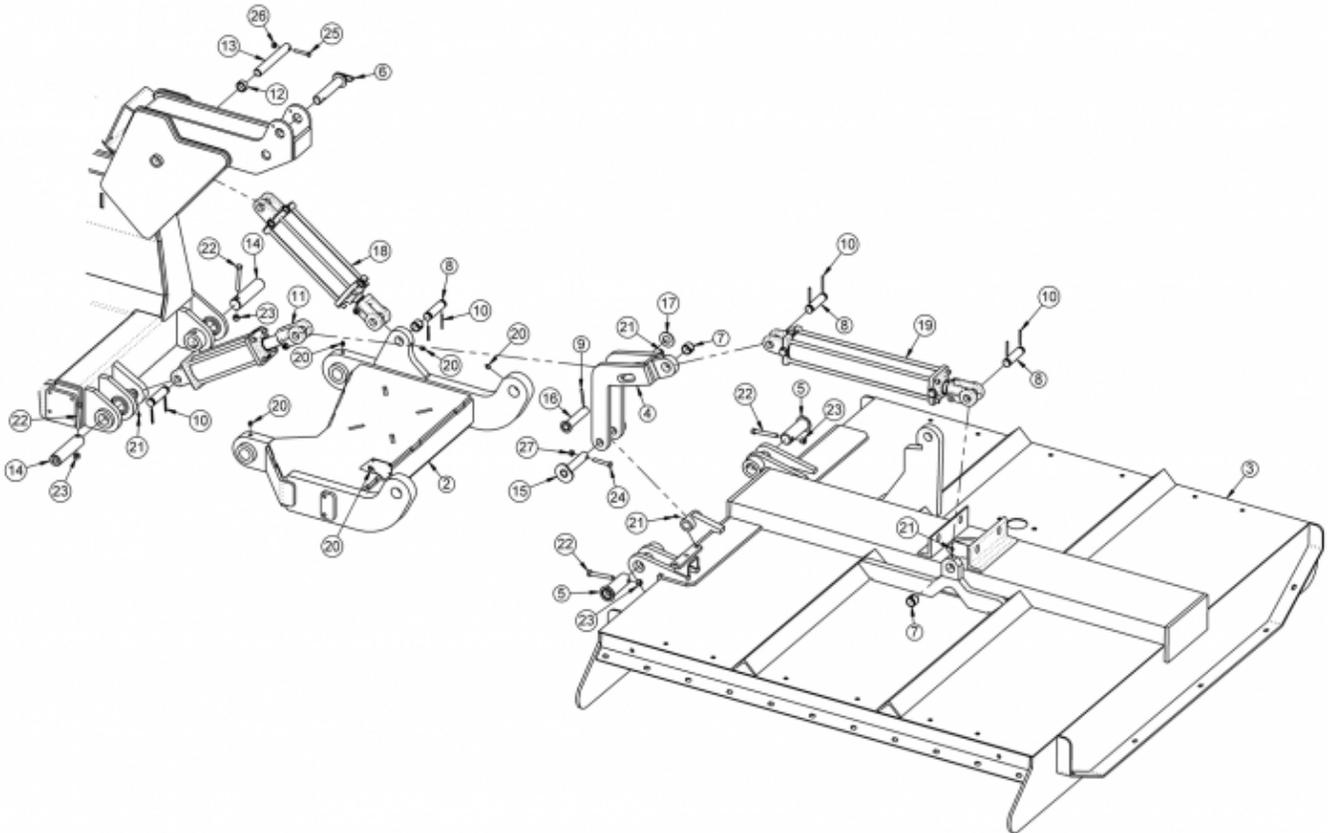

BERM DRAFT BEAM TM

Continued...

ITEM	PART NO.	QTY.	DESCRIPTION
1	06300398	1	MNFRM,TSF,JD6110M,BERM
2	06350019	1	DRAFT BEAM,BERM
3	06320288	1	DECK,TM60,XD,BERM
4	23833A	1	TILT LINK, 9030, T3F,RT
5	TF4514A	2	PIN,1.50X4.50,W/Ø.47,CAP,PULL
6	TF4250	1	PIN,TRAVEL LOCK
7	TB3010	3	BUSHING,1
8	TB1033	4	PIN,CLEVIS,1X4
9	TB1023	1	ROLLPIN,7/32" X 2"
10	06537021	8	ROLL PIN, 5MM X 50MM
11	06501037	1	CYLINDER,3X8,180
12	06430219	1	SPCR,1.32X1.05X.58
13	06420204	1	PIN,1.00X7.75,W/.38 HOLE
14	06420203	2	PIN,1.50X6.19,W/.47,PULL
15	23829	1	PIN,1.00X5.19,W/Ø.44,CAP
16	23827C	1	PIN,1.00X4.94,W/Ø.22,CAP
17	6T2614	1	FLATWASHER,1",SAE
18	6T0151R	1	CYLINDER,3X10,RTRY TOP PORT
19	6T0150	1	CYLINDER,3X18
20	6T3211	5	GREASE ZERK,1/8" X STR
21	6T3207	4	GREASE ZERK,1/4"
22	21688	4	CAPSCREW, 7/16 X 3 1/4,NC
23	21677	4	NYLOCK NUT,7/16 NC
24	21635	1	CAPSCREW,3/8X2 1/4,NC
25	21584	1	CAPSCREW, 5/16 X 2,NC
26	21577	1	HEX NUT,NYLOCK,5/16" NC
27	21627	1	NYLOCK NUT,3/8",NC
28	21986	1	LOCKWASHER, 1/4"
29	21530	1	CAPSCREW,1/4X1,NC,GR8
30	22014	1	FLATWASHER,1/4,GR8
31	21525	1	HEX NUT, 1/4" NC

BERM DRAFT BEAM TSR

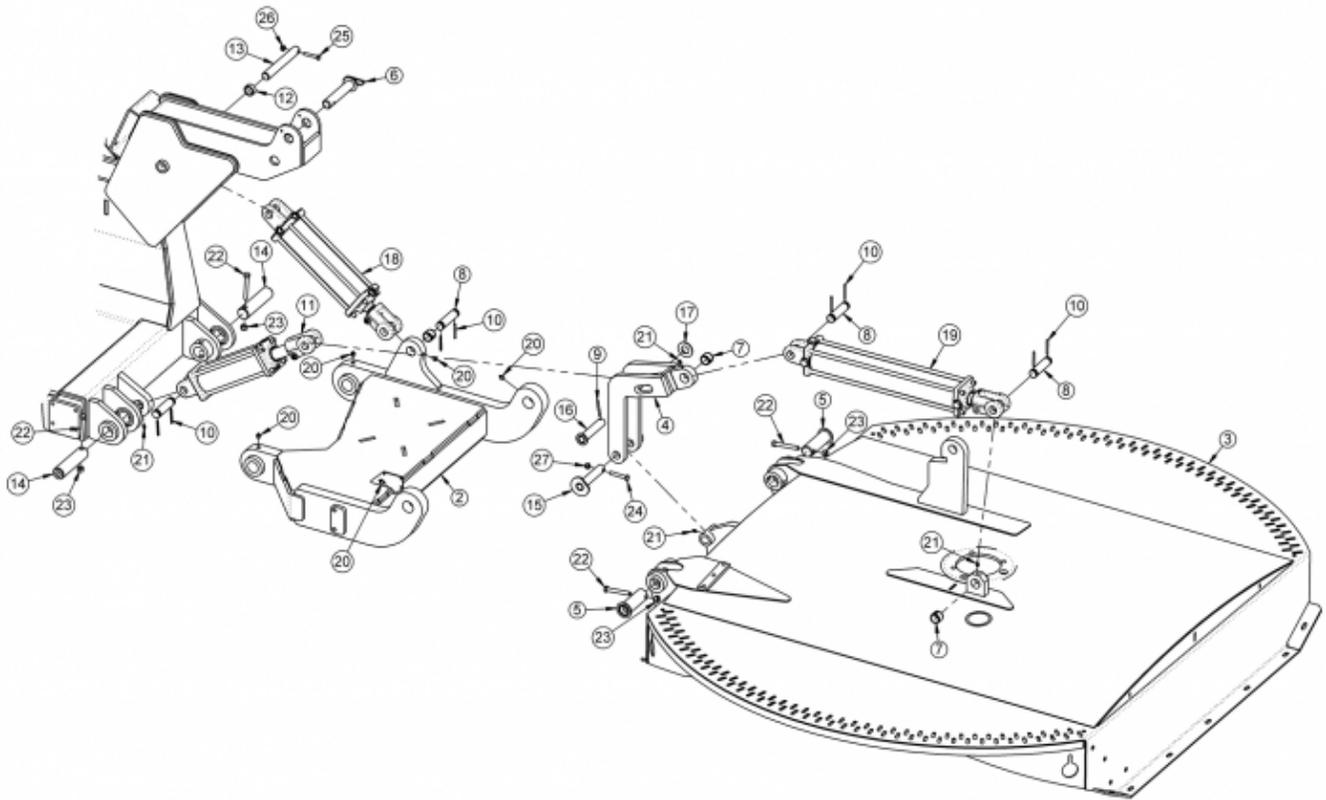

BERM DRAFT BEAM TSR

Continued...

ITEM	PART NO.	QTY.	DESCRIPTION
1	06300398	1	MNFRM,TSF,JD6110M,BERM
2	06350019	1	DRAFT BEAM,BERM
3	06320287	1	DECK,TSR60,XD,BERM
4	23833A	1	TILT LINK, 9030, T3F,RT
5	TF4514A	2	PIN,1.50X4.50,W/Ø.47,CAP,PULL
6	TF4250	1	PIN,TRAVEL LOCK
7	TB3010	3	BUSHING,1
8	TB1033	4	PIN,CLEVIS,1X4
9	TB1023	1	ROLLPIN,7/32" X 2"
10	06537021	8	ROLL PIN, 5MM X 50MM
11	06501037	1	CYLINDER,3X8,180
12	DEFAULT	1	SPCR,1.32X1.05X.58
13	06420204	1	PIN,1.00X7.75,W/.38 HOLE
14	06420203	2	PIN,1.50X6.19,W/.47,PULL
15	23829	1	PIN,1.00X5.19,W/Ø.44,CAP
16	23827C	1	PIN,1.00X4.94,W/Ø.22,CAP
17	6T2614	1	FLATWASHER,1",SAE
18	6T0151R	1	CYLINDER,3X10,RTRY TOP PORT
19	6T0150	1	CYLINDER,3X18
20	6T3211	5	GREASE ZERK,1/8" X STR
21	6T3207	4	GREASE ZERK,1/4"
22	21688	4	CAPSCREW, 7/16 X 3 1/4,NC
23	21677	4	NYLOCK NUT,7/16 NC
24	21635	1	CAPSCREW,3/8X2 1/4,NC
25	21584	1	CAPSCREW, 5/16 X 2,NC
26	21577	1	HEX NUT,NYLOCK,5/16" NC
27	21627	1	NYLOCK NUT,3/8",NC
28	21986	1	LOCKWASHER, 1/4"
29	21530	1	CAPSCREW,1/4X1,NC,GR8
30	22014	1	FLATWASHER,1/4,GR8
31	21525	1	HEX NUT, 1/4" NC

BERM DRAFT BEAM - HYDRAULICS

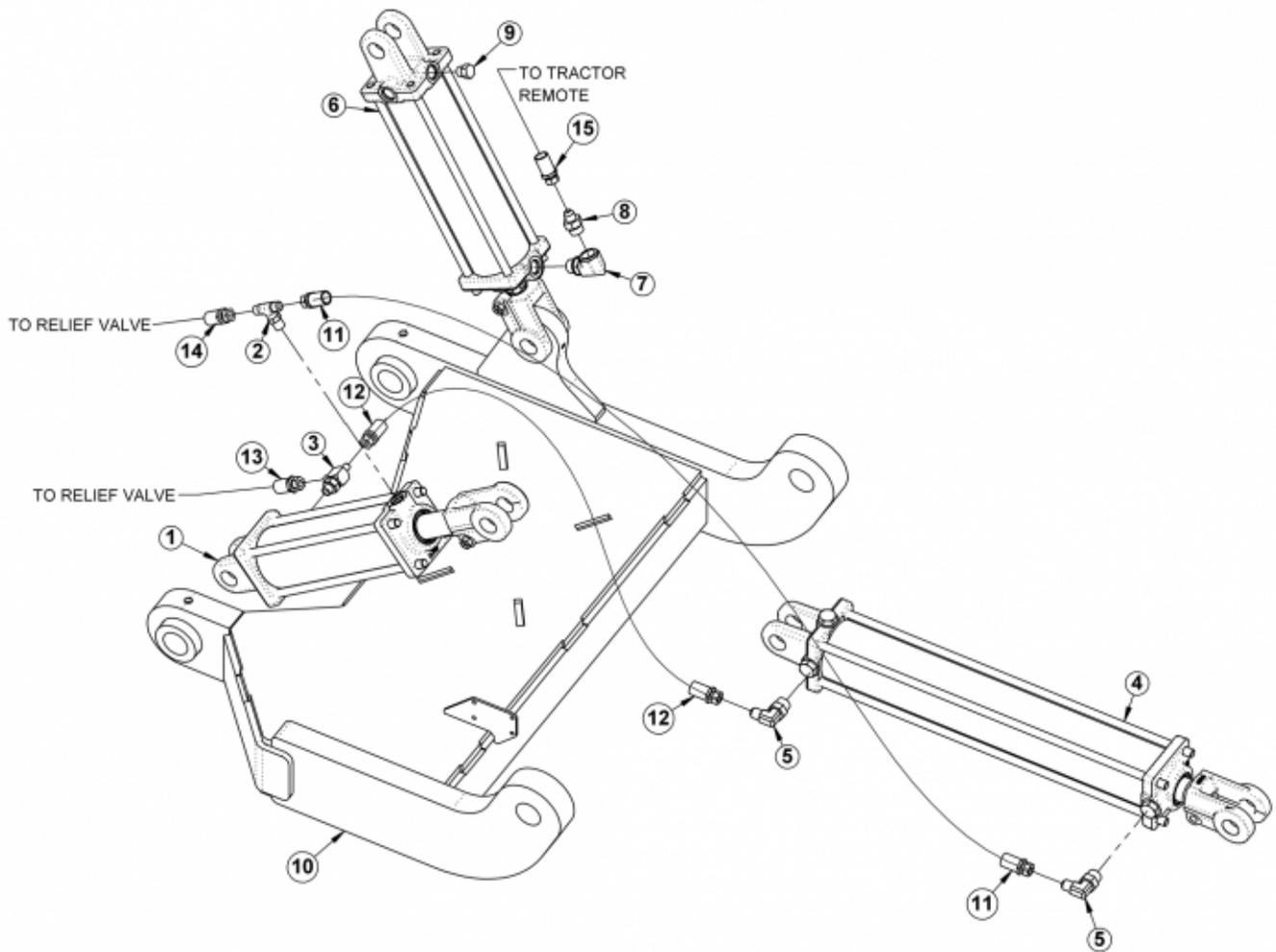

ITEM	PART NO.	QTY.	DESCRIPTION
1	06501037	1	CYLINDER,3X8,180
2	34020	1	TEE,BRANCH,3/8MJX1/2ORBX3/8MJ
3	06503029	1	TEE,RUN,1/2ORBX3/8MJX3/8MJ
4	6T0150	1	CYLINDER,3X18
5	32810	2	ELBOW, 1/2 X 3/8"
6	6T0151R	1	CYLINDER,3X10,RTRY TOP PORT
7	34244	1	ELBOW, 1/2ORB X 1/2FOR
8	34396	1	ADAPTER,.06" REST,1/2" X 3/8"
9	6T4258	1	BREATHER,1/2 O-RING
10	06350019	1	DRAFT BEAM,BERM
11	06500848	1	HOSE,#4X46(6FJXX6FJX)
12	32909	1	HOSE,#4X36(6FJXX6FJX)
13	06500848	1	HOSE,#4X46(6FJXX6FJX)
14	33496	1	HOSE,#4X58(6FJXX6FJX)
15	06500311	1	HOSE,#4X156(6FJX90X6FJX)

NOTES

NOTES

COOLER MOUNT

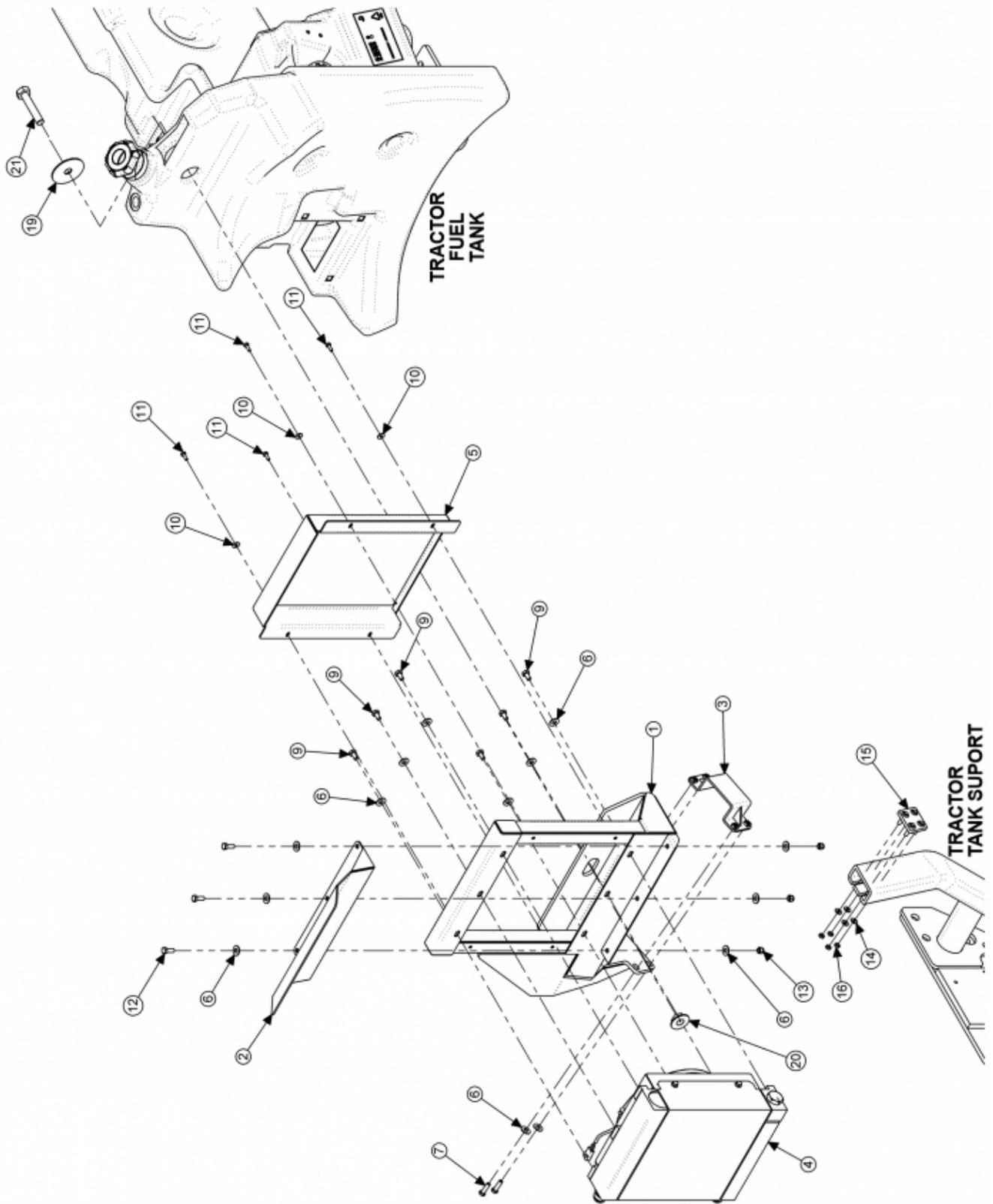

COOLER MOUNT

Continued...

ITEM	PART NO.	QTY.	DESCRIPTION
1	06380124	1	MOUNT, COOLER, LH, JD6M, 20
2	06380113	1	GUARD
3	06380125	1	CLAMP, COOLER, JD6M, 20
4	06510351	1	COOLER, ADAMS, OPTIMUM
5	06380118	1	GUARD, FAN, COOLER, JD6M
6	22016	16	FLATWASHER, 3/8" GR8
7	21631	4	CAPSCREW, 3/8" X 1-1/4", NC, GR8
8	06380112	1	RISER, LH, IH, JD6M, 20
9	21629	6	CAPSCREW, 3/8" X 3/4", NC
10	22014	4	FLATWASHER, 1/4" GR8
11	21529	4	CAPSCREW, 1/4" X 3/4" NC
12	21630	3	CAPSCREW, 3/8" X 1" NC
13	21627	3	NYLOCK NUT, 3/8" NC
14	----	4	8MM FLATWASHER (RE-USED FROM TRACTOR)
15	---	1	BOLT PLATE (RE-USED FROM TRACTOR)
16	----	4	8MM HEX NUT (RE-USED FROM TRACTOR)
17	---	1	TANK SUPPORT (RE-USED FROM TRACTOR)
18	----	1	TRACTOR FUEL TANK (RE-USED FROM TRACTOR)
19	---	1	WASHER (RE-USED FROM TRACTOR)
20	----	1	3/4" FLANGE NUT (RE-USED FROM TRACTOR)
21	---	1	3/4" CAPSCREW (RE-USED FROM TRACTOR)

NOTES

COMMON SIDE ROTARY

PARTS SECTION

PART NAME INDEX

PARTS ORDERING GUIDE.....	3
60IN SIDE CABLE TM ROTARY MOWER.....	4
72IN SIDE CABLE TM ROTARY MOWER.....	6
60IN SIDE COMBO TM ROTARY MOWER.....	8
72IN SIDE COMBO TM ROTARY MOWER.....	10
60IN SIDE TM CHAIN GUARDS.....	12
72IN SIDE TM CHAIN GUARDS.....	14
60IN SIDE TSR ROTARY MOWER.....	16
60IN SIDE TSR REAR GUARDS.....	18
SIDE ROTARY CASTER WHEEL ASSEMBLY.....	20
CASTER WHEEL ASSEMBLY.....	22
ROTARY DISK AND KNIVES.....	23
TM MOWER SPINDLE ASSEMBLY.....	24
TSR MOWER SPINDLE ASSEMBLY.....	26
ROTARY MOTOR BREAKDOWN.....	28
60IN TSR ROTARY MOTOR BREAKDOWN.....	30
FRONT HYDRAULIC PUMP BREAKDOWN.....	32
PUMP AND GRILL GUARD OPTIONS.....	34
RESERVOIR TANK FILTER ASSEMBLY.....	35
3IN X 10IN HYDRAULIC CYLINDER BREAKDOWN.....	36
3IN X 12IN HYDRAULIC CYLINDER BREAKDOWN.....	37
3IN X 18IN HYDRAULIC CYLINDER BREAKDOWN.....	38
CABLE (MANUAL) LIFT VALVE BREAKDOWN - 30801.....	39
CABLE (MANUAL) LIFT VALVE BREAKDOWN - 31320.....	41
CABLE (MANUAL) LIFT VALVE BREAKDOWN - 31321.....	43
CABLE (MANUAL) LIFT VALVE BREAKDOWN - 31752.....	45
CABLE (MANUAL) LIFT VALVE BREAKDOWN - 06502040.....	47
CABLE (MANUAL) LIFT VALVE BREAKDOWN - 06502041.....	49
BRAKE VALVE ASSEMBLY.....	51
BRAKE VALVE HYDRAULIC SCHEMATIC.....	52
SWITCH BOX.....	53
SWITCH BOX SCHEMATIC.....	54

COMMON SIDE ROTARY

PARTS ORDERING GUIDE

The following instructions are offered to help eliminate needless delay and error in processing purchase orders for the equipment in this manual.

1. The Parts Section is prepared in logical sequence and grouping of parts that belong to the basic machine featured in this manual. Part Numbers and Descriptions are given to help locate the parts and quantities required.
2. The Purchase Order must indicate the **Name and Address** of the person or organization ordering the parts, **who should be charged**, and if possible, the **serial number of the machine** for which the parts are being ordered.
3. The purchase order must clearly list the **quantity of each part**, the complete and correct **part number**, and the basic **name of the part**.
4. The manufacturer reserves the right to substitute parts where applicable.
5. Some parts may be unlisted items which are special production items not normally stocked and are subject to special handling. Request a quotation for such parts before sending a purchase order.
6. The manufacturer reserves the right to change prices without prior notice.

NOTE: When ordering replacement decals, refer to the part numbers and descriptions listed in the safety section in the front of this manual.

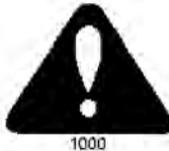

For maximum safety and to guarantee optimum product reliability, always use genuine **Tiger** replacement parts. The use of inferior replacement parts may cause premature or catastrophic failure which could result in serious injury or death.

Direct any questions regarding parts to:

Tiger Corporation
3301 N. Louise Ave.
Sioux Falls, SD 57107
1-800-843-6849
1-605-336-7900

60IN SIDE CABLE TM ROTARY MOWER

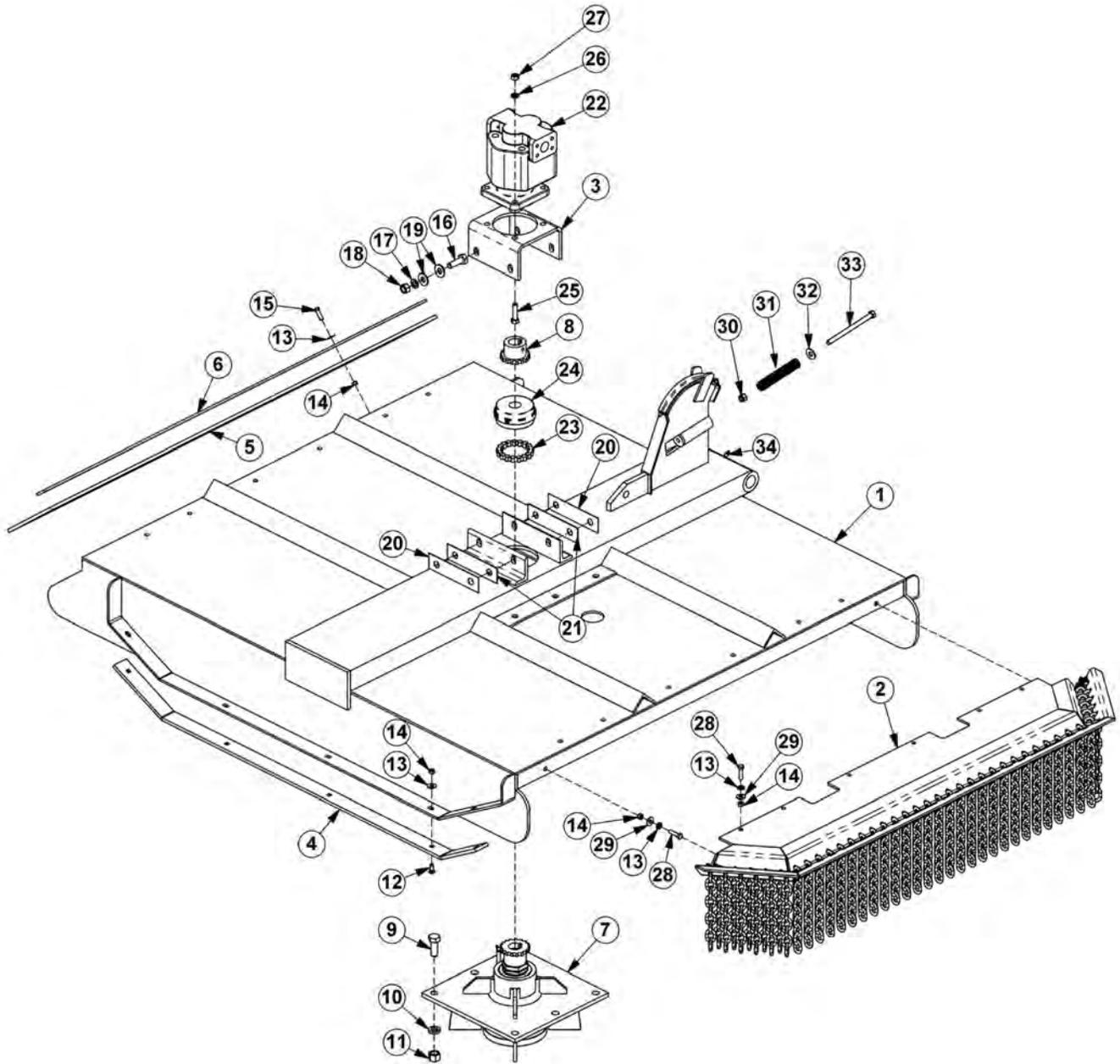

COMMON SIDE ROTARY

60IN SIDE CABLE TM ROTARY MOWER

Continued...

ITEM	PART NO.	QTY.	DESCRIPTION
1	32099	1	RTRY, 60" DECK, CABLE
2	31773	1	GAURD,CHAIN,FRONT,SR60
3	6T1001	1	BRKT, MOTOR MTG, 60"SIDE RTRY
4	6T0820H	2	SKID SHOE, TM60
5	22592	1	FLAP, DEFLECTOR, TM60
6	6T0823	1	BAR, FLAP, TM60
7	6T1024H5	1	SPINDLE ASSY,CPLT,HD,5/8" HOLES
8	21223	1	SPROCKET, 1-1/4" BORE
9	6T2277	6	CAPSCREW,3/4" X 2",NF
10	21993	6	LOCKWASHER,3/4",GR 8
11	6T2413	6	HEX NUT,3/4",NF,GR 8
12	6T2270	10	PLOW BOLT,3/8" X 1",NC
13	22016	29	FLATWASHER,3/8"
14	21625	29	HEX NUT,3/8",NC
15	21631	11	CAPSCREW, 3/8" X 1-1/4",NC
16	21783	4	CAPSCREW, 5/8" X 2",NC
17	21992	4	LOCKWASHER, 5/8"
18	21775	4	HEX NUT, 5/8"
19	25270	8	FLATWASHER,5/8",GR 8
20	6T0822	2	SHIM, MOTOR MOUNT, 14GA. (AS NEEDED)
21	6T0822A	2	SHIM, MOTOR MOUNT, 18 GA. (AS NEEDED)
22	06504011	1	MOTOR,(M365-2 1/4" GEAR)
23	6T1029	1	CHAIN, COUPLING
24	6T1033	1	COVER, COUPLING
25	21733	4	CAPSCREW, 1/2" X 2",NC
26	21990	4	LOCKWASHER,1/2"
27	21725	4	HEX NUT, 1/2",NC
28	21632	8	CAPSCREW,3/8" X 1-1/2",NC
29	21988	8	LOCKWASHER,3/8"
30	21727	1	NYLOCK NUT,1/2",NC
31	27005	1	SPRING,PUSHOFF,SIDE RTRY
32	22018	1	FLATWASHER,1/2",WIDE
33	21745	1	CAPSCREW,1/2" X 7",NC
34	6T3211	1	GREASE ZERK

COMMON SIDE ROTARY

72IN SIDE CABLE TM ROTARY MOWER

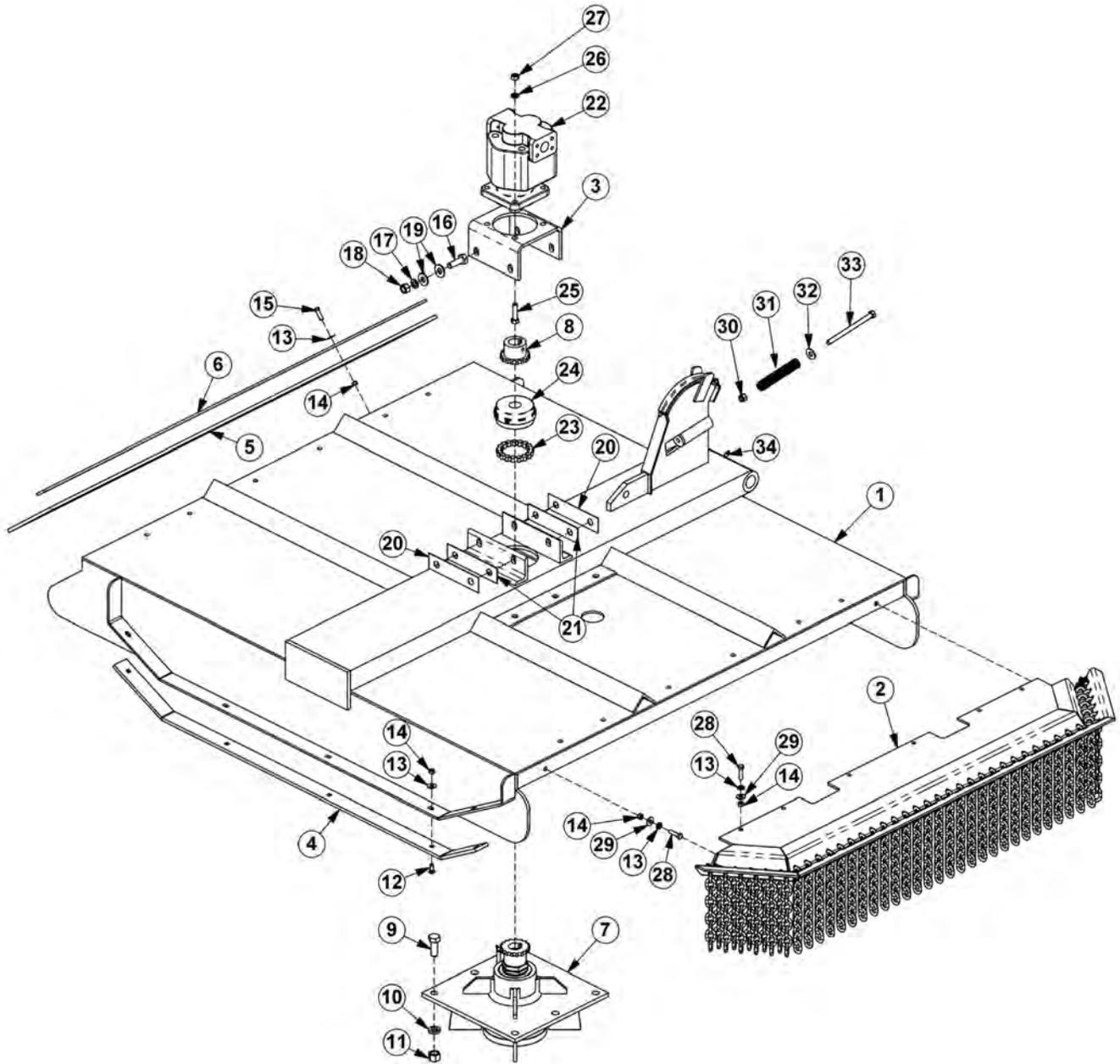

COMMON SIDE ROTARY

72IN SIDE CABLE TM ROTARY MOWER

Continued...

ITEM	PART NO.	QTY.	DESCRIPTION
1	21225B	1	RTRY,72" DECK, CABLE
2	31931	1	GUARD,CHAIN,FRONT,SR72
3	6T1001	1	BRKT, MOTOR MTG, 60"SIDE RTRY
4	21248	2	SKID SHOE, TM72
5	21295B	1	FLAP, DEFLECTOR, TM72
6	21242A	1	BAR, FLAP, TM72
7	6T1024H5	1	SPINDLE ASSY,CPLT,HD,5/8" HOLES
8	21223	1	SPROCKET, 1-1/4" BORE
9	6T2277	6	CAPSCREW,3/4" X 2",NF
10	21993	6	LOCKWASHER,3/4",GR 8
11	6T2413	6	HEX NUT,3/4",NF,GR 8
12	6T2270	10	PLOW BOLT,3/8" X 1",NC
13	22016	29	FLATWASHER,3/8"
14	21625	29	HEX NUT,3/8",NC
15	21631	11	CAPSCREW, 3/8" X 1-1/4",NC
16	21783	4	CAPSCREW, 5/8" X 2",NC
17	21992	4	LOCKWASHER, 5/8"
18	21775	4	HEX NUT, 5/8"
19	25270	8	FLATWASHER,5/8",GR 8
20	6T0822	2	SHIM, MOTOR MOUNT, 14GA. (AS NEEDED)
21	6T0822A	2	SHIM, MOTOR MOUNT, 18 GA. (AS NEEDED)
22	06504011	1	MOTOR,(M365-2 1/4" GEAR)
23	6T1029	1	CHAIN, COUPLING
24	6T1033	1	COVER, COUPLING
25	21733	4	CAPSCREW, 1/2" X 2",NC
26	21990	4	LOCKWASHER,1/2"
27	21725	4	HEX NUT, 1/2",NC
28	21632	8	CAPSCREW,3/8" X 1-1/2",NC
29	21988	8	LOCKWASHER,3/8"
30	21727	1	NYLOCK NUT,1/2",NC
31	27005	1	SPRING,PUSHOFF,SIDE RTRY
32	22018	1	FLATWASHER,1/2",WIDE
33	21745	1	CAPSCREW,1/2" X 7",NC
34	6T3211	1	GREASE ZERK

COMMON SIDE ROTARY

60IN SIDE COMBO TM ROTARY MOWER

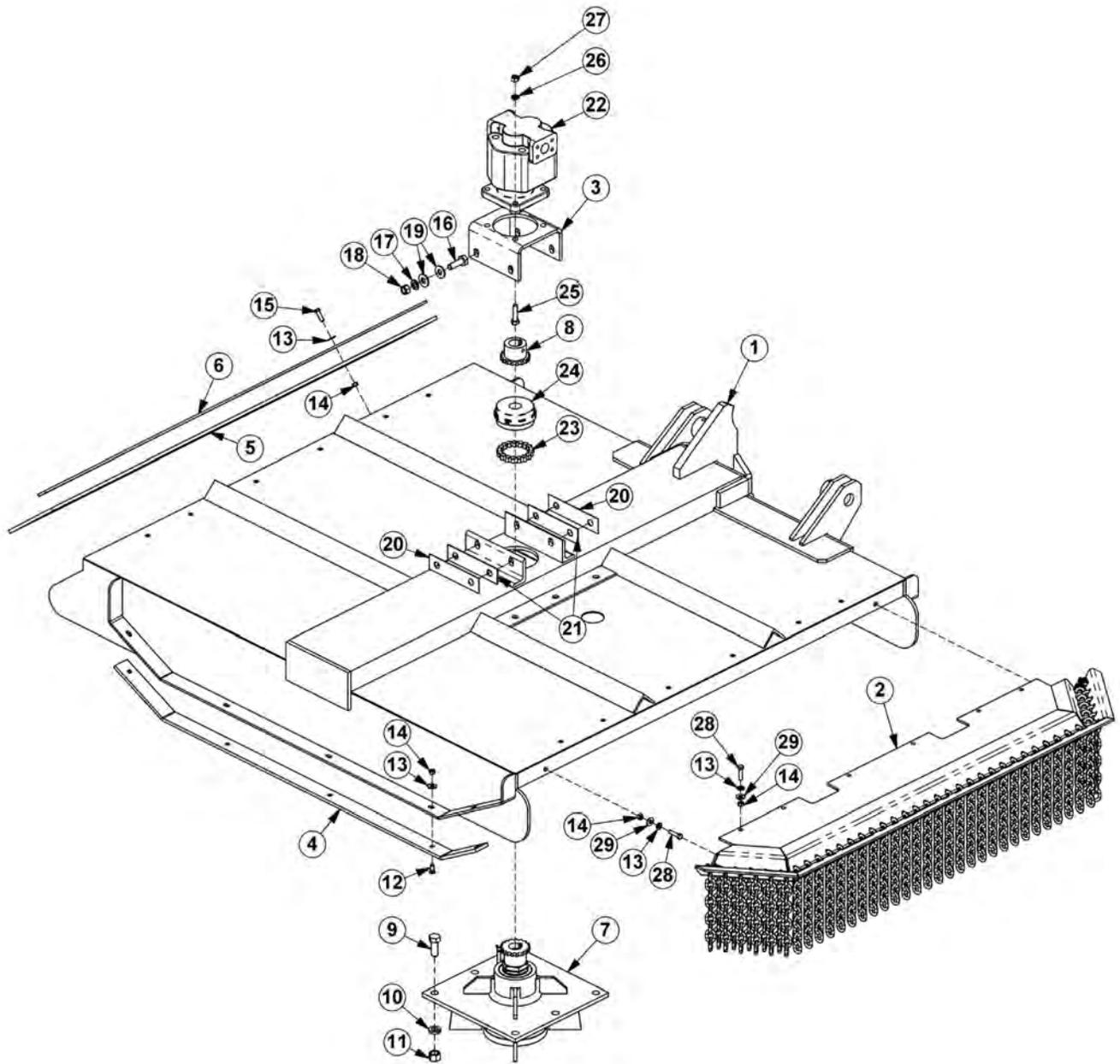

COMMON SIDE ROTARY

60IN SIDE COMBO TM ROTARY MOWER

Continued...

ITEM	PART NO.	QTY.	DESCRIPTION
1	30087D	1	RTRY, 60" DECK, COMBO - STD DUTY
---	32617	1	RTRY, 60" DECK, COMBO - HEAVY DUTY
2	31773	1	GUARD,CHAIN,FRONT,SR60
3	6T1001	1	BRKT, MOTOR MTG, 60"SIDE RTRY
4	6T0820H	2	SKID SHOE, TM60
5	22592	1	FLAP, DEFLECTOR, TM60
6	6T0823	1	BAR, FLAP, TM60
7	6T1024H5	1	SPINDLE ASSY,CPLT,HD,5/8" HOLES
8	21223	1	SPROCKET, 1-1/4" BORE
9	6T2277	6	CAPSCREW,3/4" X 2",NF
10	21993	6	LOCKWASHER,3/4",GR 8
11	6T2413	6	HEX NUT,3/4",NF,GR 8
12	6T2270	10	PLOW BOLT,3/8" X 1",NC
13	22016	29	FLATWASHER,3/8"
14	21625	29	HEX NUT,3/8",NC
15	21631	11	CAPSCREW, 3/8" X 1-1/4",NC
16	21783	4	CAPSCREW, 5/8" X 2",NC
17	21992	4	LOCKWASHER, 5/8"
18	21775	4	HEX NUT, 5/8"
19	25270	8	FLATWASHER,5/8",GR 8
20	6T0822	2	SHIM, MOTOR MOUNT, 14GA. (AS NEEDED)
21	6T0822A	2	SHIM, MOTOR MOUNT, 18 GA. (AS NEEDED)
22	06504011	1	MOTOR,(M365-2 1/4" GEAR)
23	6T1029	1	CHAIN, COUPLING
24	6T1033	1	COVER, COUPLING
25	21733	4	CAPSCREW, 1/2" X 2",NC
26	21990	4	LOCKWASHER,1/2"
27	21725	4	HEX NUT, 1/2",NC
28	21632	8	CAPSCREW,3/8" X 1-1/2",NC
29	21988	8	LOCKWASHER,3/8"

COMMON SIDE ROTARY

72IN SIDE COMBO TM ROTARY MOWER

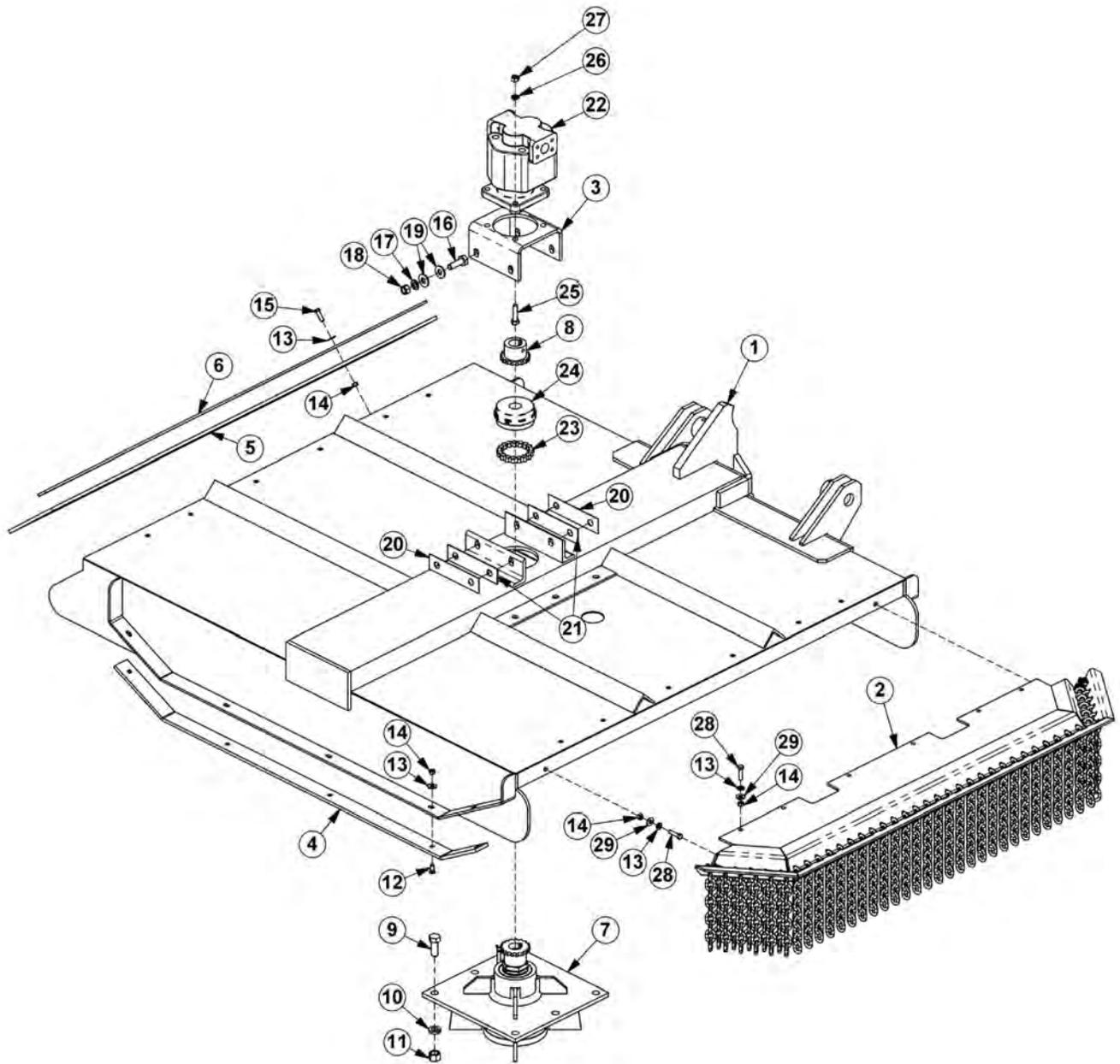

COMMON SIDE ROTARY

72IN SIDE COMBO TM ROTARY MOWER

Continued...

ITEM	PART NO.	QTY.	DESCRIPTION
1	34260	1	RTRY, 72" DECK, COMBO - STD DUTY
---	31408A	1	RTRY, 72" DECK, COMBO - HEAVY DUTY
2	31931	1	GUARD,CHAIN,FRONT,SR72
3	6T1001	1	BRKT, MOTOR MTG, 60"SIDE RTRY
4	21248	2	SKID SHOE, TM72
5	21295B	1	FLAP, DEFLECTOR, TM72
6	21242A	1	BAR, FLAP, TM72
7	6T1024H5	1	SPINDLE ASSY,CPLT,HD,5/8" HOLES
8	21223	1	SPROCKET, 1-1/4" BORE
9	6T2277	6	CAPSCREW,3/4" X 2",NF
10	21993	6	LOCKWASHER,3/4",GR 8
11	6T2413	6	HEX NUT,3/4",NF,GR 8
12	6T2270	10	PLOW BOLT,3/8" X 1",NC
13	22016	29	FLATWASHER,3/8"
14	21625	29	HEX NUT,3/8",NC
15	21631	11	CAPSCREW, 3/8" X 1-1/4",NC
16	21783	4	CAPSCREW, 5/8" X 2",NC
17	21992	4	LOCKWASHER, 5/8"
18	21775	4	HEX NUT, 5/8"
19	25270	8	FLATWASHER,5/8",GR 8
20	6T0822	2	SHIM, MOTOR MOUNT, 14GA. (AS NEEDED)
21	6T0822A	2	SHIM, MOTOR MOUNT, 18 GA. (AS NEEDED)
22	06504011	1	MOTOR,(M365-2 1/4" GEAR)
23	6T1029	1	CHAIN, COUPLING
24	6T1033	1	COVER, COUPLING
25	21733	4	CAPSCREW, 1/2" X 2",NC
26	21990	4	LOCKWASHER,1/2"
27	21725	4	HEX NUT, 1/2",NC
28	21632	8	CAPSCREW,3/8" X 1-1/2",NC
29	21988	8	LOCKWASHER,3/8"

COMMON SIDE ROTARY

60IN SIDE TM CHAIN GUARDS

STANDARD FRONT CHAIN GUARD

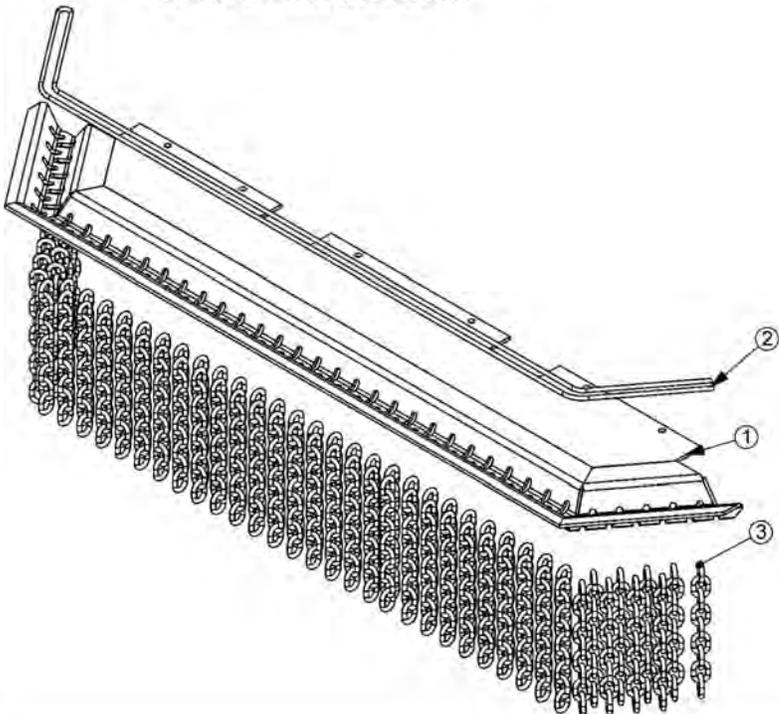

OPTIONAL REAR CHAIN GUARD

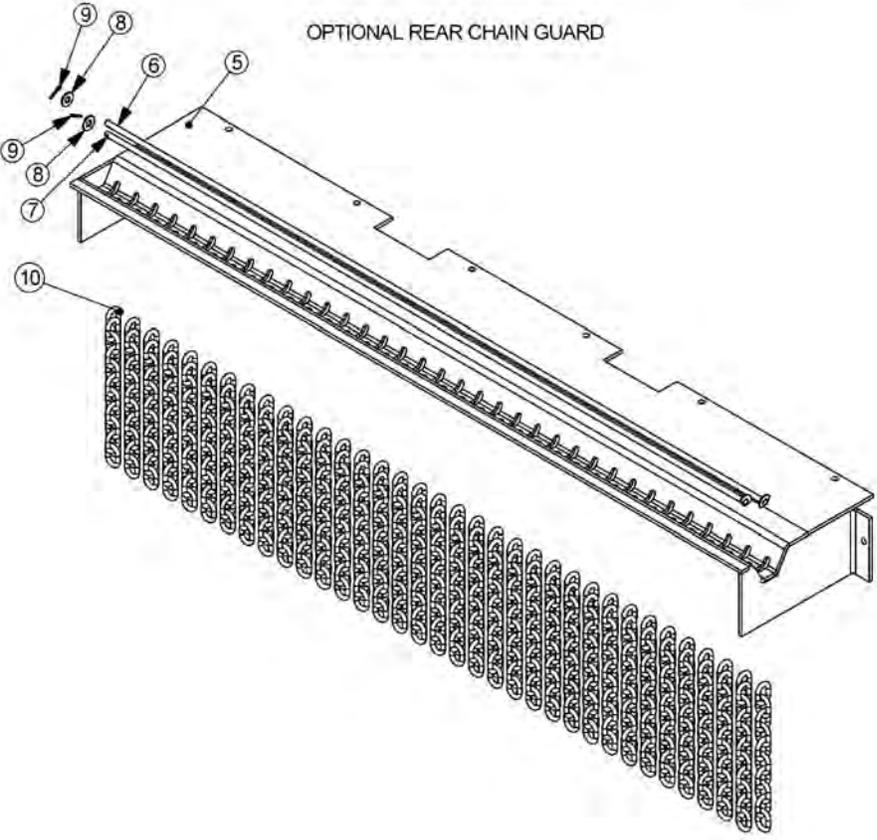

60IN SIDE TM CHAIN GUARDS

Continued...

ITEM	PART NO.	QTY.	DESCRIPTION
---	31773	-	GUARD,CHAIN,TM60,FRONT,ASSY
1	31762	1	GUARD,CHAIN,TM60,FRONT
2	28407	12	CABLE,5/16",BULK (QTY IN FEET)
3	22993	77	CHAIN,5/16",GR30,9 LINK
4	28408	4	U-BOLT,CABLE,5/16" (NOT SHOWN)
---	31774	-	GUARD,CHAIN,TM60,REAR,ASSY
5	31763	1	GUARD,CHAIN,TM60,REAR
6	31879	1	ROD,SHORT,TM60
7	31878	1	ROD,LONG,TM60
8	22016	2	FLATWASHER,3/8",GR8
9	6T3028	2	COTTER PIN,1/8" X 1"
10	22992	69	CHAIN,5/16",GR30,10 LINK

COMMON SIDE ROTARY

72IN SIDE TM CHAIN GUARDS

STANDARD FRONT CHAIN GUARD

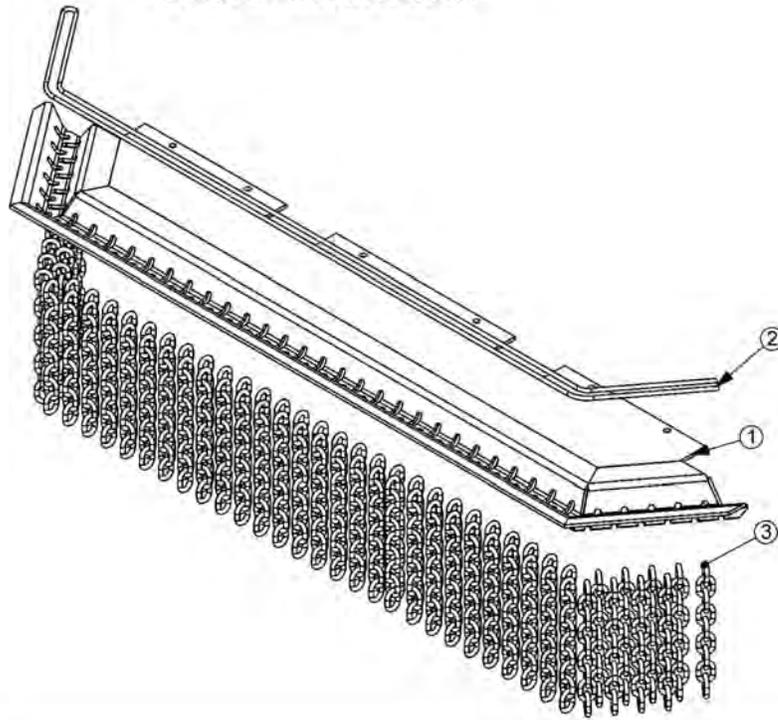

OPTIONAL REAR CHAIN GUARD

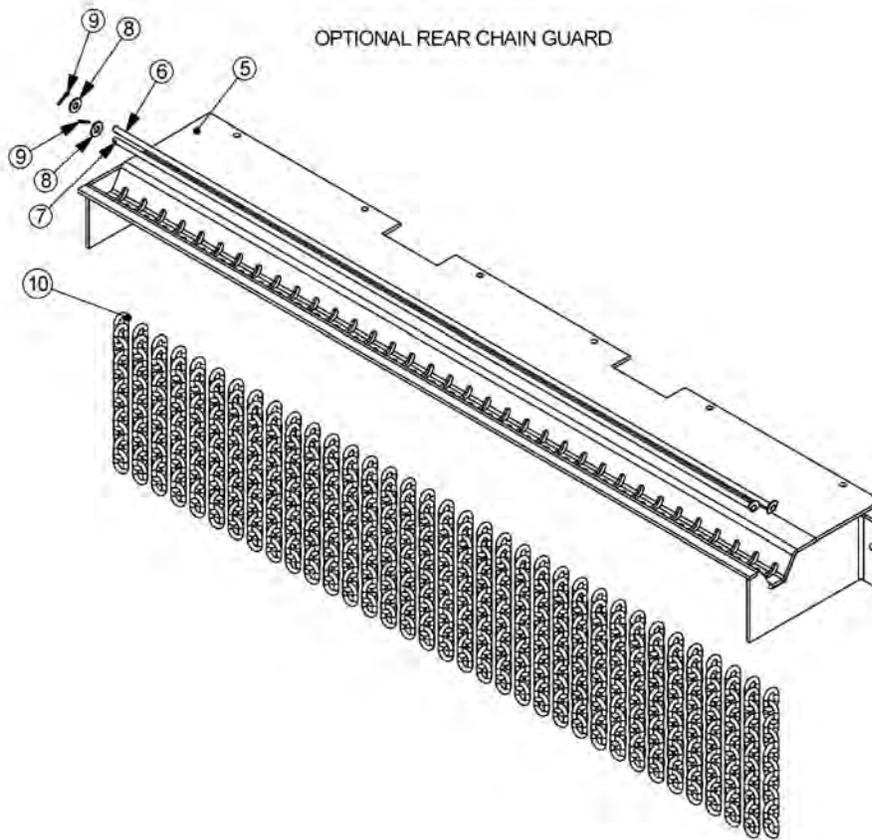

72IN SIDE TM CHAIN GUARDS

Continued...

ITEM	PART NO.	QTY.	DESCRIPTION
---	31931	-	GUARD,CHAIN,TM72,FRONT,ASSY
1	31863	1	GUARD,CHAIN,TM72,FRONT
2	28407	14	CABLE,5/16",BULK (QTY IN FEET)
3	22993	91	CHAIN,5/16",GR30,9 LINK
4	28408	4	U-BOLT,CABLE,5/16" (NOT SHOWN)
---	31932	-	GUARD,CHAIN,TM60,REAR,ASSY
5	31864	1	GUARD,CHAIN,TM60,REAR
6	31934	1	ROD,LONG,TM72
7	31933	1	ROD,SHORT,TM72
8	22016	2	FLATWASHER,3/8",GR8
9	6T3028	2	COTTER PIN,1/8" X 1"
10	22992	83	CHAIN,5/16",GR30,10 LINK

COMMON SIDE ROTARY

60IN SIDE TSR ROTARY MOWER

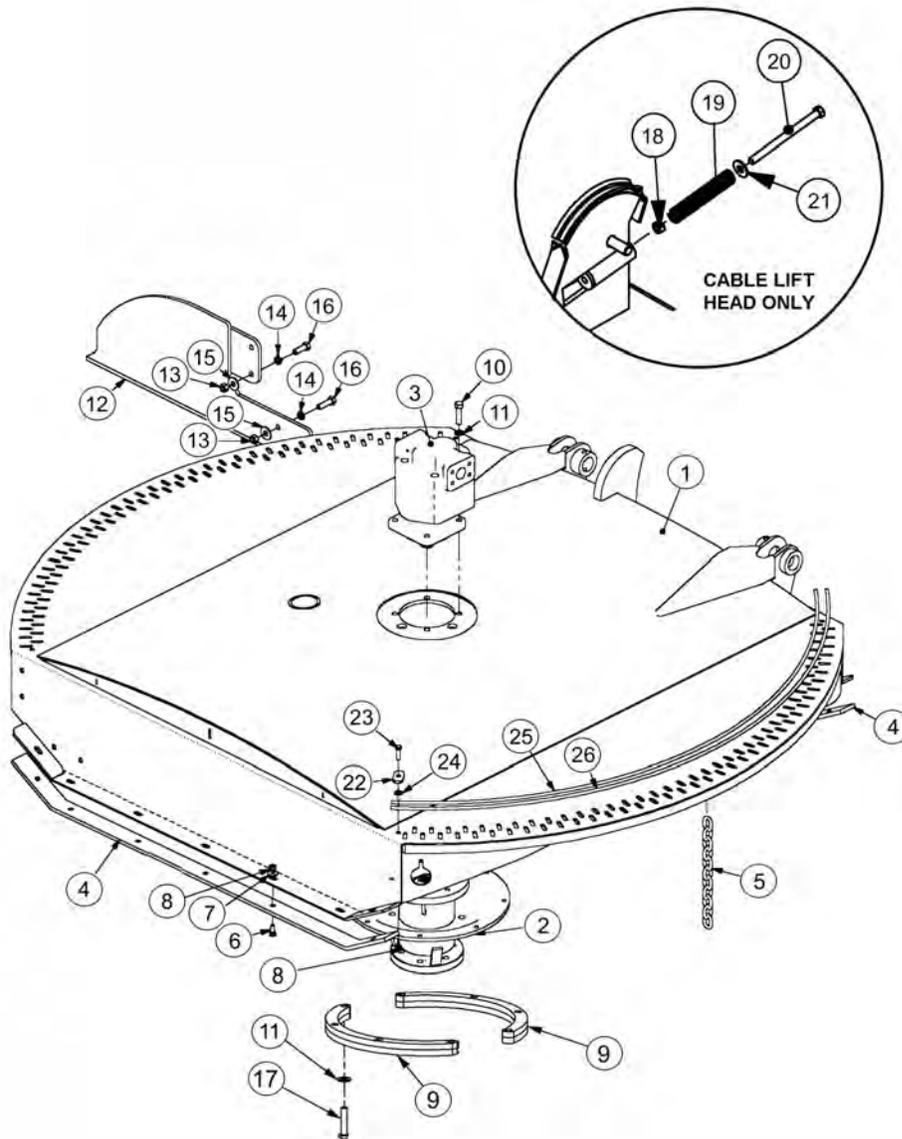

COMMON SIDE ROTARY

60IN SIDE TSR ROTARY MOWER

Continued...

ITEM	PART NO.	QTY.	DESCRIPTION
1	34975	1	HEAVY DUTY GRASSKAT COMBO
-----	06320005	1	STD DUTY GRASSKAT COMBO
-----	06320008	1	HEAVY DUTY GRASSKAT CABLE
2	34980	1	SPINDLE ASSY,TM 60"
3	06504016	1	CURRENT MOTOR,(M365-1 1/4" 14-SPLINE)
4	06410254	2	SKID,OUTBOARD,TM60
5	22992	156	CHAIN,10 LINK
6	6T2270	14	PLOW BOLT,3/8" X 1" NC
7	22016	26	FLATWASHER,3/8"
8	21625	30	HEX NUT,3/8",NC
9	06320011	2	SPACER,TSF,SPINDLE
10	6T1025	4	CAPSCREW, 1/2 X 2,GR 8,NC
11	06533004	12	FLATWASHER,1/2,SAE,GR 8
12	06370029	1	TIRE GUARD, LEFT
13	21725	8	HEX NUT, 1/2",NC
14	21990	8	LOCKWASHER, 1/2"
15	22018	8	FLATWASHER, 1/2",WIDE
16	21731	4	CAPSCREW, 1/2" X 1-1/2" NC
17	06530221	8	CAPSCREW,1/2 X 2-1/4,NF,GR8
18	21745	1	NYLOCK NUT, 1/2
19	21727	1	SPRING, PUSHOFF, SIDE RTRY
20	27005	1	CAPSCREW, 1/2 X 7,NC
21	22018	1	FLATWASHER,1/2",WIDE
22	34972	4	PLATE,CAP,CHAIN
23	21631	16	CAPSCREW, 3/8 X 1-1/4,NC
24	21988	16	LOCKWASHER, 3/8"
25	34974	2	ROD,CHAIN,INNER,TM60
26	34973	2	ROD,CHAIN,OUTER,TM60

COMMON SIDE ROTARY

60IN SIDE TSR REAR GUARDS

OPTIONAL REAR CHAIN GUARD

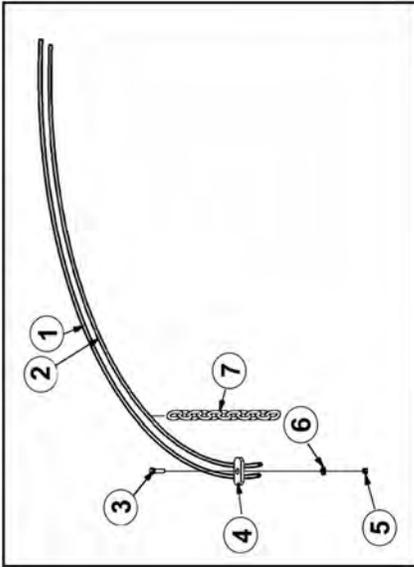

STANDARD SQUARE REAR FLAP GUARD

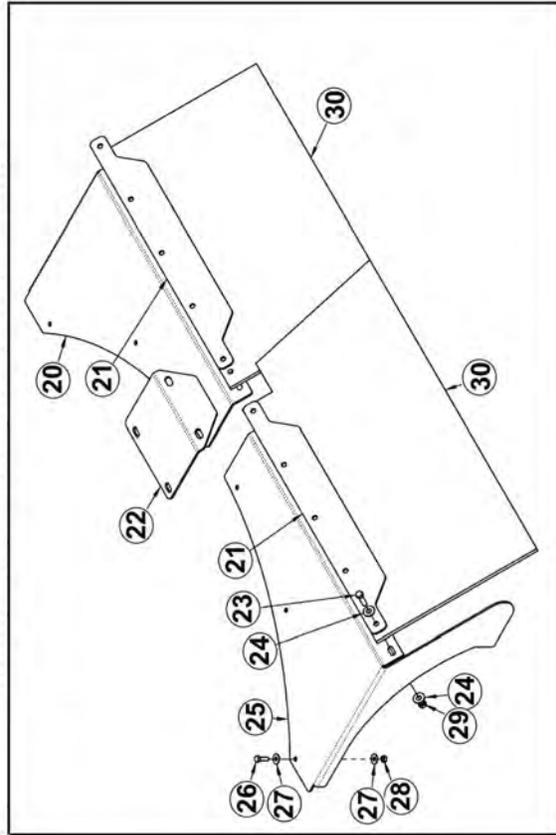

60IN SIDE TSR REAR GUARDS

Continued...

ITEM	PART NO.	QTY.	DESCRIPTION
1	34973	2	ROD,CHAIN,OUTER,TM60
2	34974	2	ROD,CHAIN,INNER,TM60
3	21631	16	CAPSCREW, 3/8 X 1-1/4,NC
4	34972	4	PLATE,CAP,CHAIN
5	21625	30	HEX NUT,3/8",NC
6	21988	16	LOCKWASHER, 3/8"
7	22992	156	CHAIN,10 LINK
20	06410947	1	MNT,FLAP,RH,EXT,TSR
21	06401184	2	STRAP,FLAP,EXT,TSR
22	06410948	1	COVER,FLAP,EXT,TSR
23	21632	10	CAPSCREW,3/8" X 1-1/2" NC
24	22016	20	FLATWASHER,3/8",GR8
25	06410946	1	MNT,FLAP,LH,EXT,TSR
26	21580	6	CAPSCREW,5/16 X 1 NC
27	22015	12	FLATWASHER,5/16
28	21577	6	NYLOCK NUT, 5/16,NC
29	21625	10	HEX NUT,3/8",NC
30	06520331	2	FLAP,EXT,TSR

COMMON SIDE ROTARY

SIDE ROTARY CASTER WHEEL ASSEMBLY

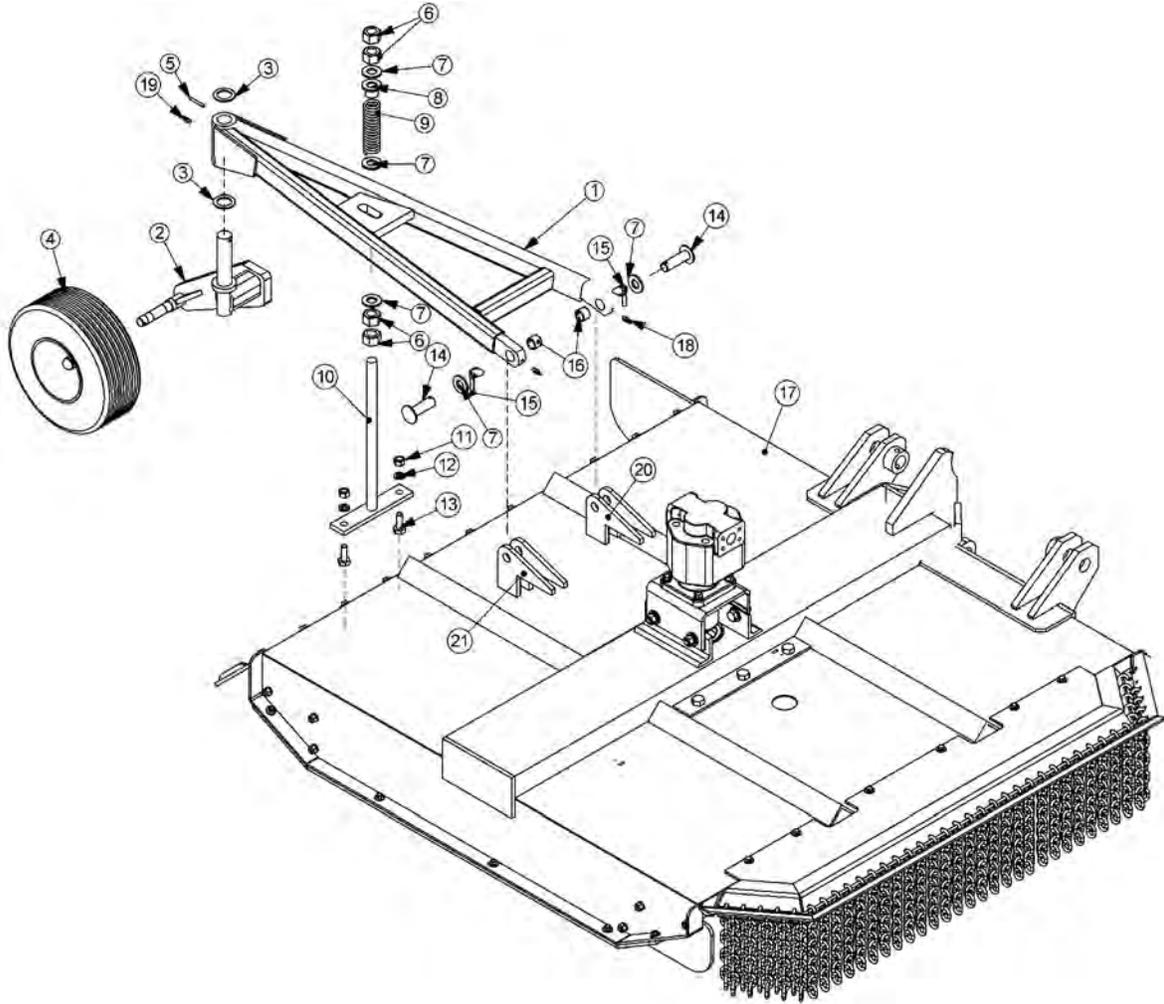

COMMON SIDE ROTARY

SIDE ROTARY CASTER WHEEL ASSEMBLY

Continued...

ITEM	PART NO.	QTY.	DESCRIPTION
1	25214C	1	FRAME,CASTER,WHL (TM60)
---	28297A	-	FRAME,CASTER WHL (TM72)
2	22057	1	SPINDLE,CASTER AXLE,ASSY
3	6T2617	2	BUSHING,MACH,1-1/2IDX 2-1/4OD
4	28548	1	CASTER WHEEL,SOLID TIRE
---	22065	1	HUB,ASSY,CASTER
----	22066	1	HUB,CASTER
---	22070	1	DUST CAP
----	22071	5	HUB STUD
---	22073	1	HEX NUT,1",NF (SLOTTED)
----	22533	1	COTTER PIN,3/16" X 2"
---	6T0830	2	BEARING,CONE,CASTER WHEEL
----	6T0838	1	SEAL
---	23329	1	WHEEL,CPLT,SOLID TIRE
----	21416	1	TIRE,SOLID
---	22697	1	RIM,OUTER
----	22696	1	RIM,CASTER
5	6T3014	1	ROLL PIN,1/4" X 2"
6	21925	4	HEX NUT,1",NC
7	22023	5	FLATWASHER,1"
8	22753	1	TUBE,PROTECTOR
9	22058	1	SPRING,REAR RTRY
10	22059B	1	ADJ ROD,TRR
11	21775	2	HEX NUT,5/8"
12	21992	2	LOCKWASHER,5/8"
13	21782	2	CAPSCREW,5/8" X 1-3/4",NC
14	22060	2	CASTER FRAME PIN
15	TF1143	2	PIN,LYNCH,7/16" X 2"
16	TB3010	2	BUSHING,1"
17	-----	1	RTRY,CPLT,TM
18	6T3207	2	GREASE ZERK,1/4" X STR
19	6T3211	1	GREASE ZERK,1/8" X STR
20	21441	2	CASTER FRAME ANCHOR (TM60)
---	42527	2	CASTER FRAME ANCHOR (TM72)
21	21442	2	CASTER FRAME ANCHOR (TM60)
---	42527	2	CASTER FRAME ANCHOR (TM72)

COMMON SIDE ROTARY

CASTER WHEEL ASSEMBLY

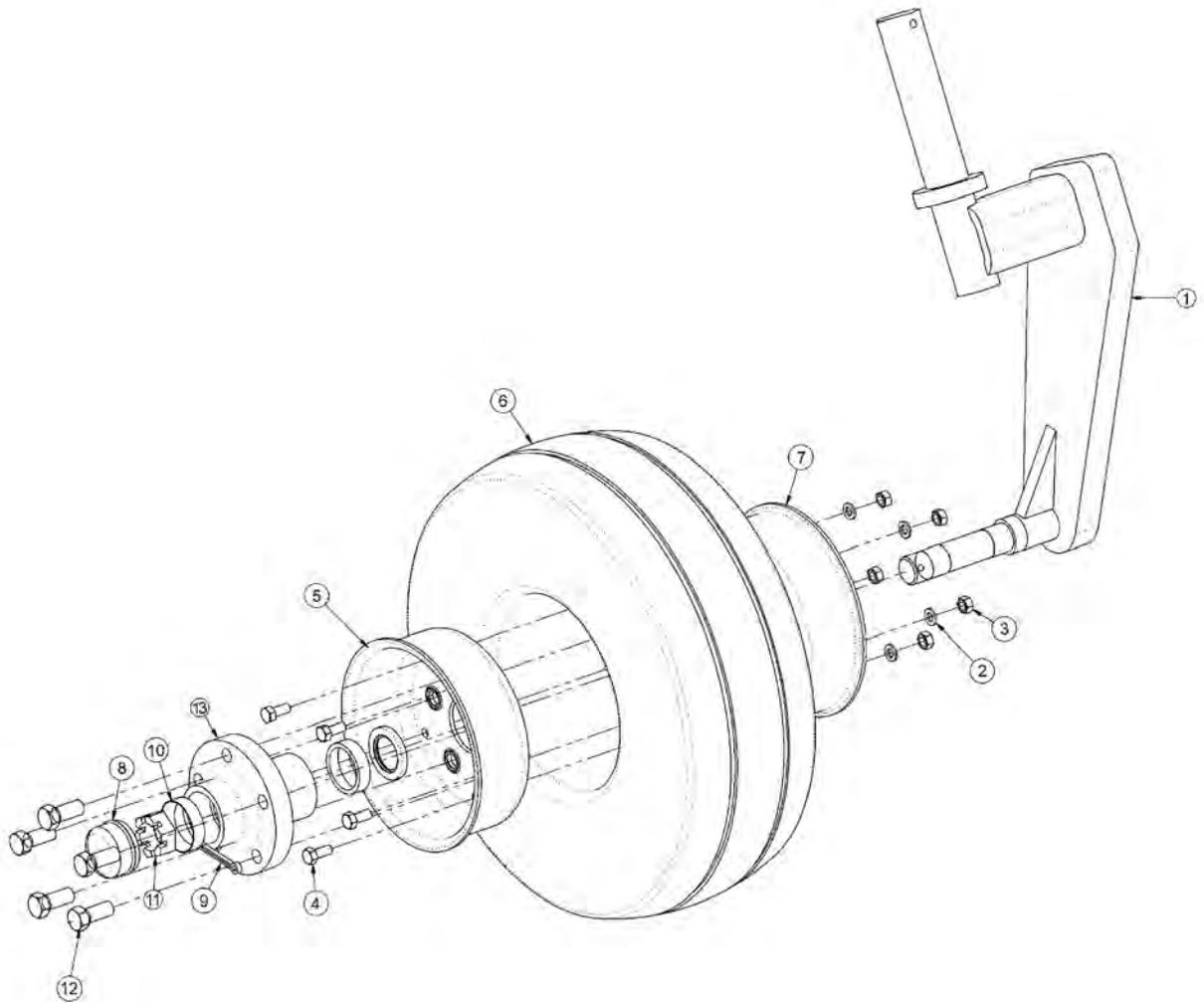

ITEM	PART NO.	QTY.	DESCRIPTION
1	22057	1	SPINDLE,CASTER AXLE,ASSY
2	21987	5	LOCKWASHER,5/16"
3	21575	5	HEX NUT,5/16"
4	28548	5	CAPSCREW,5/16" X 3/4",NC
5	22697	1	RIM,OUTER,CASTER ASSY
6	21416	1	TIRE,SOLID
7	22696	1	RIM,CASTER WHEEL
8	22070	1	DUST CAP
9	22533	1	COTTER PIN,3/16" X 2"
10	6T0836	2	CUP,CASTER WHEEL
11	22073	1	HEX NUT,1",NF (SLOTTED JAM NUT)
12	22071	5	HUB STUD
13	22066	1	HUB,CASTER WHEEL

COMMON SIDE ROTARY

ROTARY DISK AND KNIVES

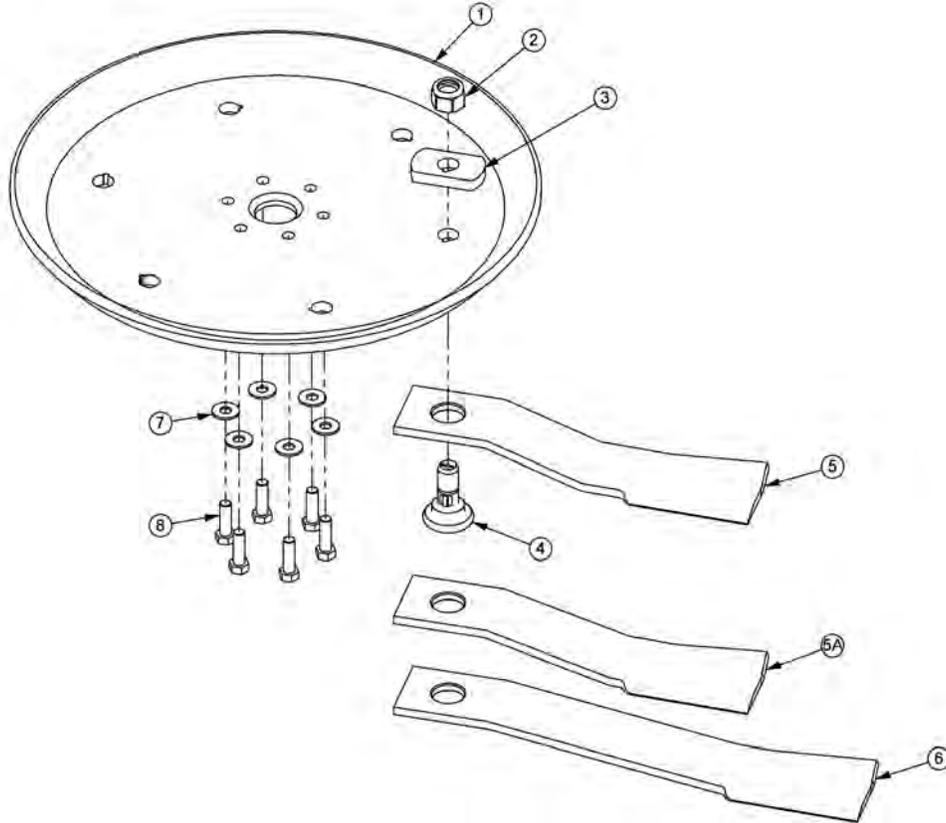

ITEM	PART NO.	QTY.	DESCRIPTION
1	34876	1	BLADE MOUNTING DISK
2	6T1023R	2	NYLOCK NUT,1-1/8"
3	34878	2	SPACER
4	34497	2	KNIFE MOUNTING BOLT
5	34685	2	KNIFE,60" HIGH SUCTION - STANDARD
5A	34684	2	KNIFE,60" - OPTIONAL
6	34682	2	KNIFE 72" (MOUNT ON 72" MOWER ONLY)
7	25270	6	FLATWASHER,5/8",USS,GR8
8	6T2259	6	CAPSCREW,5/8" X 1-3/4",NF
----	6T1825	-	LOCTITE - USED ON ALL DISK MOUNTING BOLTS
---	27167	-	BOLT KIT (INCLUDE ITEMS 7 & 8)
----	06700002	-	KIT,60/72,DISK,KNF MTG (INCLUDE ITEM 1, 3,7 & 8)

COMMON SIDE ROTARY

TM MOWER SPINDLE ASSEMBLY

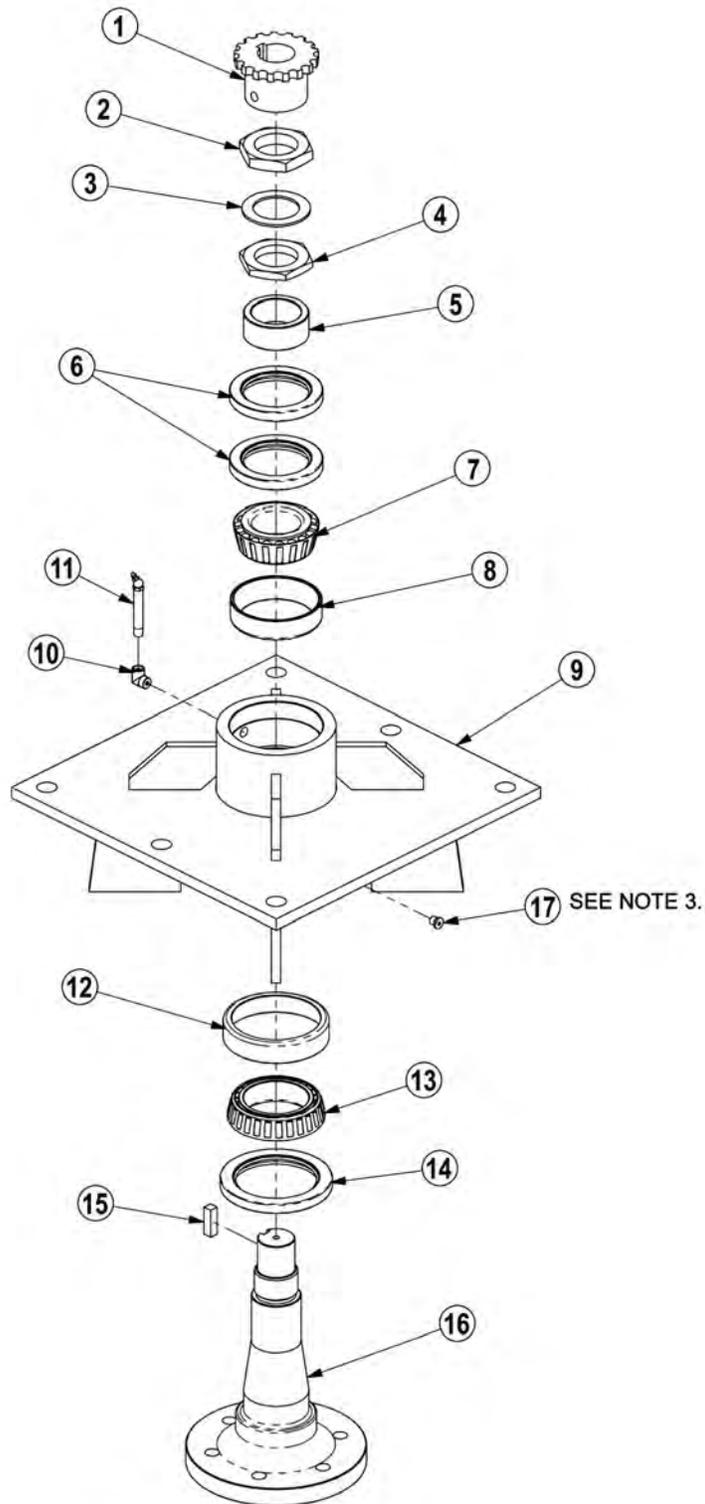

NOTES:

1. FREEPLAY: .001" - .003"
2. GREASE: FILL WITH MOBILITH SHC 220.
3. APPLY LOCTITE "271" TO O-RING PLUG THRDS.

TM MOWER SPINDLE ASSEMBLY

Continued...

ITEM	PART NO.	QTY.	DESCRIPTION
-----	6T1024H5	-	SPINDLE ASSEMBLY COMPLETE
1	6T1031	1	SPROCKET
2	6T1016	1	BEARING LOCK NUT - THICK
3	22596	1	JAM WASHER
4	6T1015	1	BEARING ADJUSTMENT NUT - THIN
5	6T1014	1	BEARING ADJUSTMENT SLEEVE
6	6T1011	1	UPPER SEAL - SET OF 2
7	6T1012	1	BEARING CONE
8	6T1013	1	BEARING CUP
9	6T1010H	1	SPINDLE HOUSING
10	30570	1	FITTING STREET ELBOW
11	33990	1	GREASE ZERK
12	6T1013H	1	BEARING CUP
13	6T1012H	1	BEARING CONE
14	6T1011H	1	LOWER SEAL
15	6T1019	1	SPINDLE KEY
16	PT1018H-5	1	SPINDLE
17	06503064	1	O-RING PLUG, 1/8"
-----	31771	-	SPINDLE REBUILD KIT (INCLUDES ITEMS 2 - 8 AND 12 - 15)

COMMON SIDE ROTARY

TSR MOWER SPINDLE ASSEMBLY

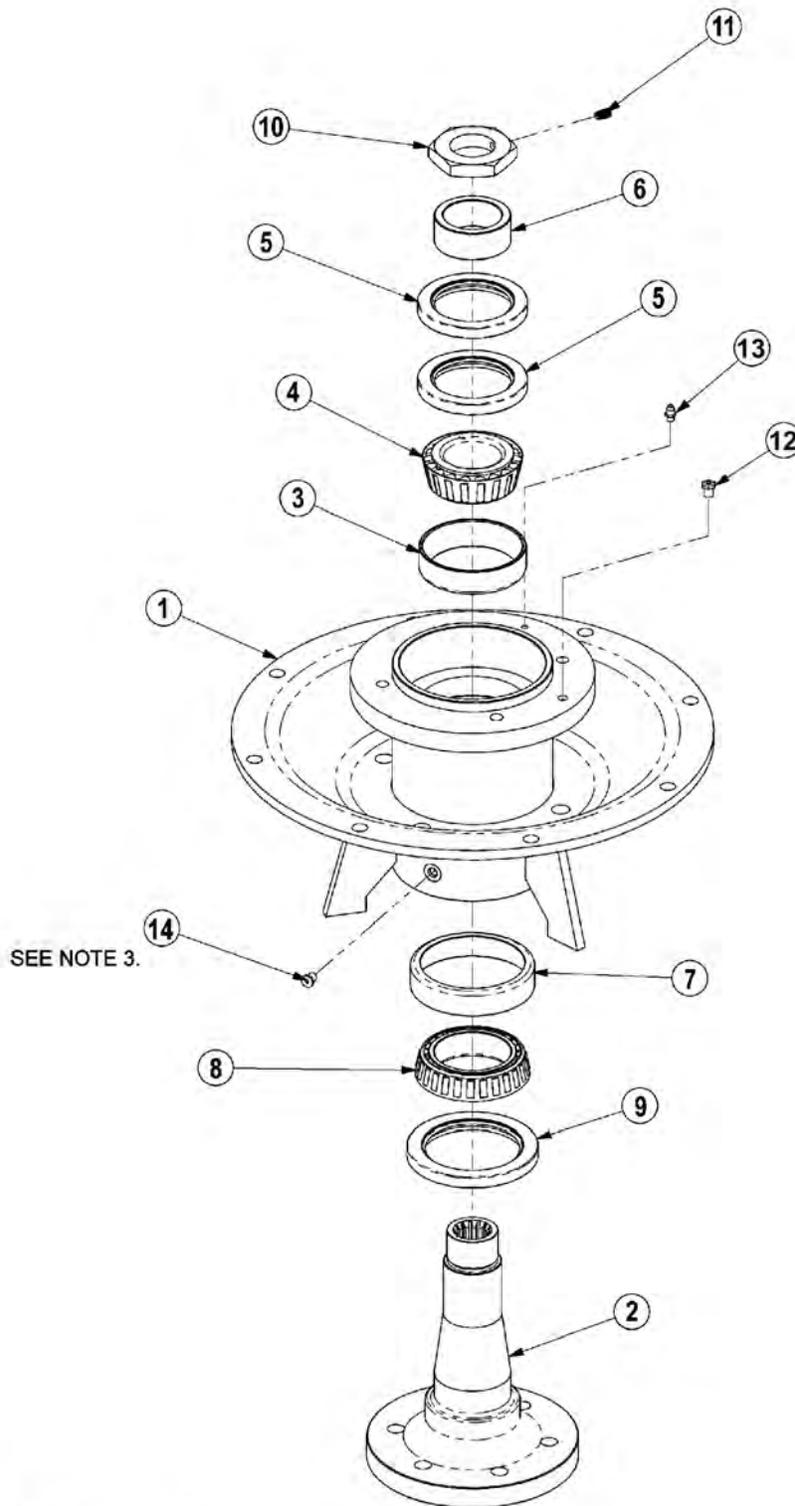

NOTES:

- 1. FREEPLAY: .001" - .003"
- 2. GREASE: FILL WITH MOBILITH SHC 220.
- 3. APPLY LOCTITE "271" TO O-RING PLUG THRDS.

TSR MOWER SPINDLE ASSEMBLY

Continued...

ITEM	PART NO.	QTY.	DESCRIPTION
-----	34980	-	SPINDLE ASSEMBLY COMPLETE
1	34978	1	SPINDLE MOUNT
2	34979	1	SPINDLE,TM60
3	6T1013	1	BEARING CUP
4	6T1012	1	BEARING CONE
5	6T1011	1	UPPER SEAL - SET OF 2
6	6T1014	1	BEARING ADJUSTMENT SLEEVE
7	6T1013H	1	BEARING,CUP,HD
8	6T1012H	1	BEARING CONE,HD
9	6T1011H	1	SEAL,LOWER,HD
10	34985	1	NUT W/SETSCREW
11	6T2275	1	SETSCREW,5/16" X 1/2",NC
12	34988	1	RELIEF,1PSI,1/8" NPT
13	6T3207	1	ZERK,1/4" X STR
14	06503064	1	O-RING PLUG, 1/8"

COMMON SIDE ROTARY

ROTARY MOTOR BREAKDOWN

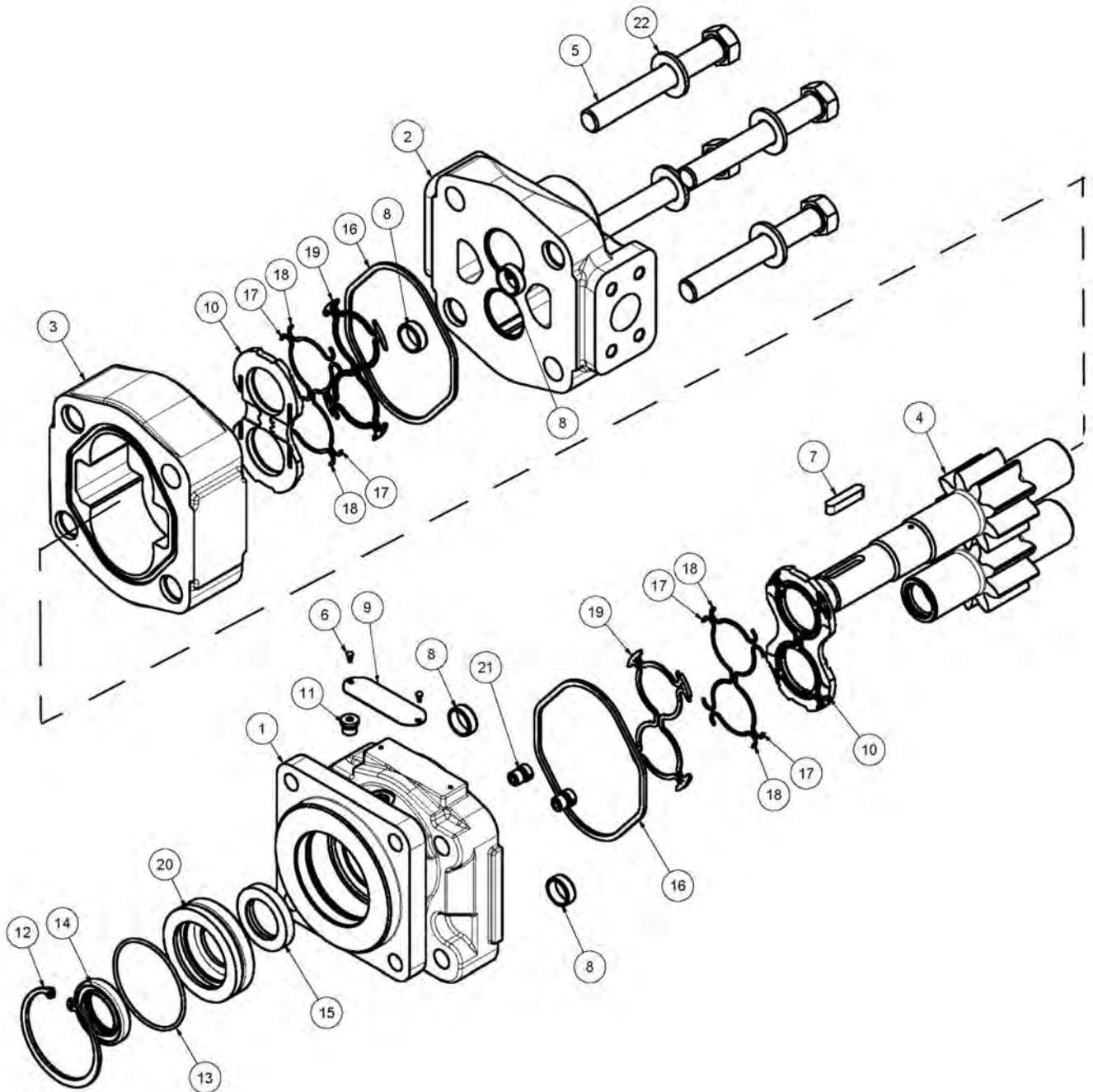

COMMON SIDE ROTARY

ROTARY MOTOR BREAKDOWN

Continued...

ITEM	PART NO.	QTY.	DESCRIPTION
	06504011	-	MOTOR ASSEMBLY
1	22790	1	END,COVER
2	06504088	1	HOUSING, PEC
3	06504111	1	HOUSING, GEAR
4	06504026	1	SET, GEAR SHAFT
5	06504104	4	CAPSCREW
6	06504078	2	SCREW, DRIVE
7	06504092	1	KEY
8	06504093	4	PIN, DOWEL
9	06504094	1	NAME PLATE
10	06504095	2	THRPL
11	2961940	1	PLUG, ODT
12	2962200	1	RING, SNAP
13	06504096	1	O RING
14	6T5101	1	SEAL, LIP
15	06504097	1	SEAL, LIP
16	22797	2	SEAL, SQ-R
17	06504098	4	SEAL, SIDE CHAN
18	06504099	4	SEAL, END CHAN
19	06504100	2	SEAL, BK-UP
20	06504101	1	RTNR, SEAL
21	6T5809	2	CHECK ASS'Y
22	06504102	4	WASHER
---	06504103	-	SEAL KIT

COMMON SIDE ROTARY

60IN TSR ROTARY MOTOR BREAKDOWN

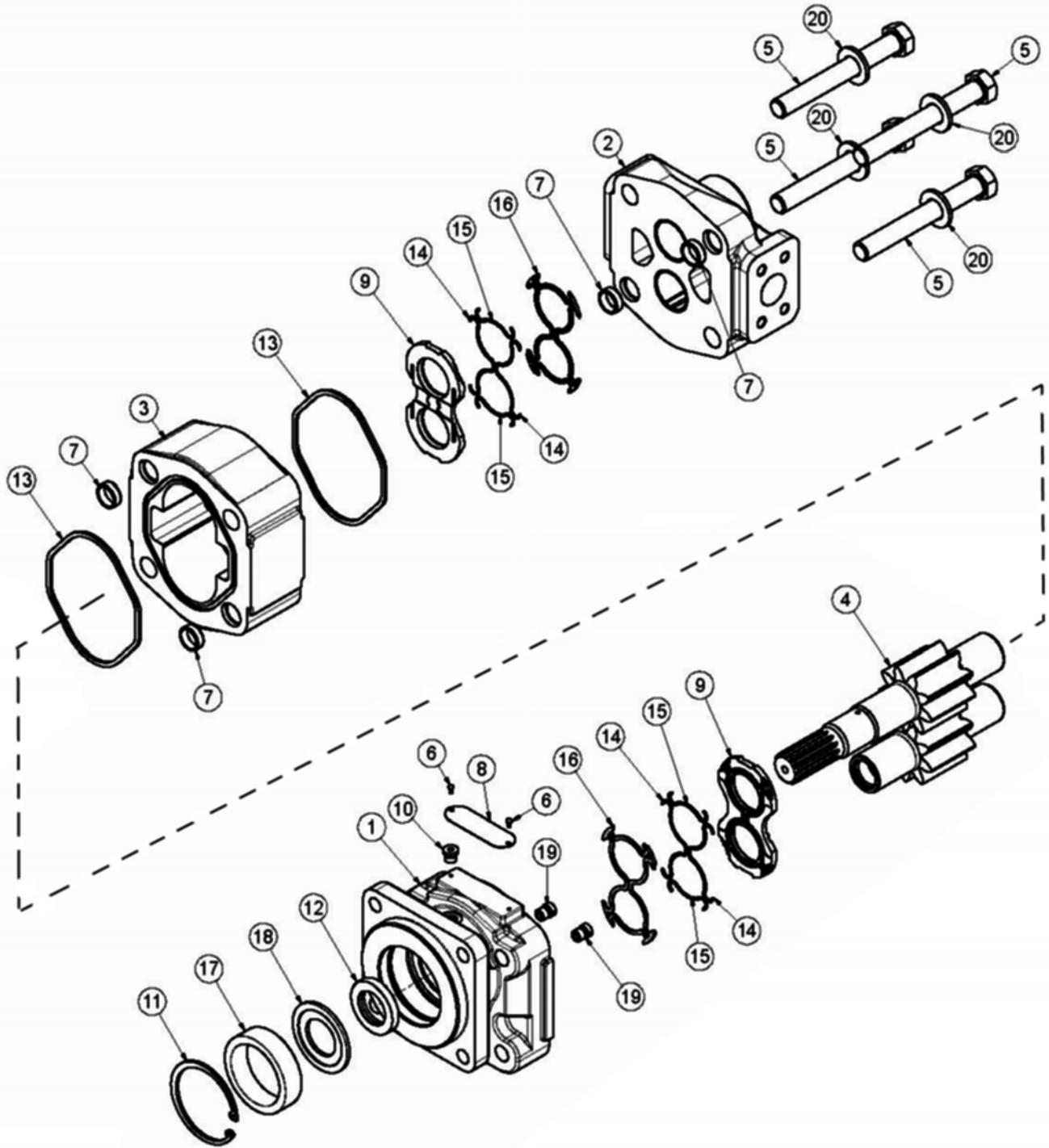

COMMON SIDE ROTARY

60IN TSR ROTARY MOTOR BREAKDOWN

Continued...

ITEM	PART NO.	QTY.	DESCRIPTION
	06504016	-	MOTOR(M365-1 1/4SPLINE),SEALED
1	22790	1	COVER,END
2	06504088	1	HOUSING,PEC
3	06504111	1	HOUSING,GEAR
4	06504110	1	SET,GEAR SHAFT
5	06504104	4	CAP SCREW
6	06504078	2	SCREW,DRIVE
7	06504093	4	PIN,DOWEL
8	06504094	1	NAME PLATE
9	06504095	2	THRPL
10	02961940	1	PLUG,ODT (0.25)
11	6T5200	1	RING,SNAP
12	06504097	1	SEAL,LIP
13	22797	2	SEAL,SQ-R
14	06504098	4	SEAL,SIDE CHAN
15	06504099	4	SEAL,END CHAN
16	06504100	2	SEAL,BK-UP
17	06504112	1	SPACER
18	06504113	1	RTNR,SEAL
19	6T5809	2	CHECK ASS'Y
20	06504102	4	WASHER
---	06504022	1	SEAL KIT

COMMON SIDE ROTARY

FRONT HYDRAULIC PUMP BREAKDOWN

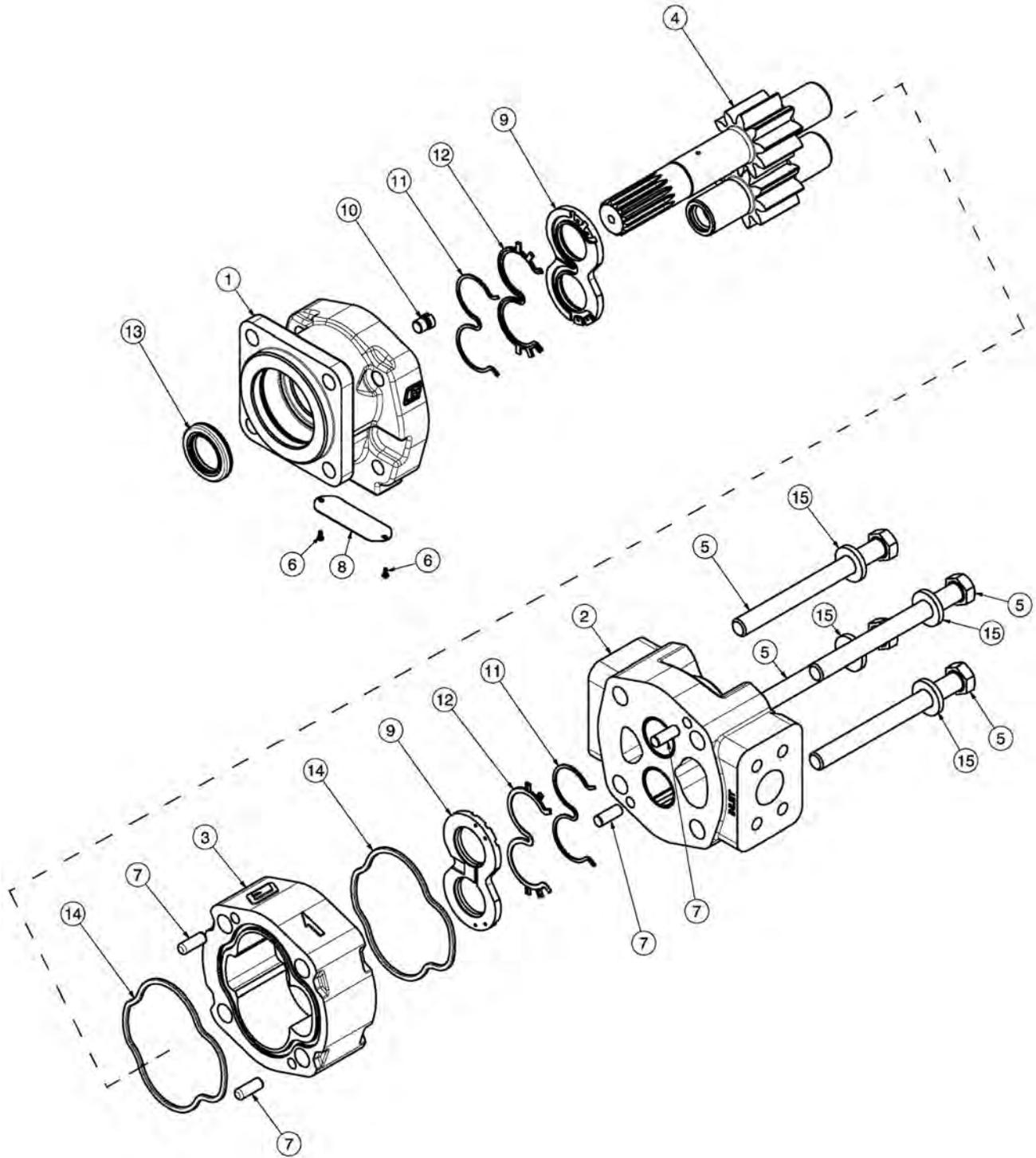

COMMON SIDE ROTARY

FRONT HYDRAULIC PUMP BREAKDOWN

Continued...

ITEM	PART NO.	QTY.	DESCRIPTION
---	23152	1	PUMP ASSEMBLY,1-3/4",COMPLETE
1	22766	1	SHAFT END COVER
2	22779	1	PORT END COVER
3	22774	1	GEAR HOUSING,1-3/4"
4	22771	1	GEAR SET
5	23824	4	CAPSCREW
6	06504078	2	SCREW,DRIVE
7	22773	4	DOWEL PINS
8	06504077	1	NAMEPLATE
9	22770	2	THRUST PLATE
10	22767	1	PLUG
11	06504075	2	SEAL,BK-UP
12	06504074	2	SEAL,CHAN
13	22765	1	SEAL,LIP
14	06504076	2	SEAL,SQ-R
15	02961917	4	WASHER
---	24150	1	SEAL KIT (INCLUDES 11, 12, 13 AND 14)

COMMON SIDE ROTARY

PUMP AND GRILL GUARD OPTIONS

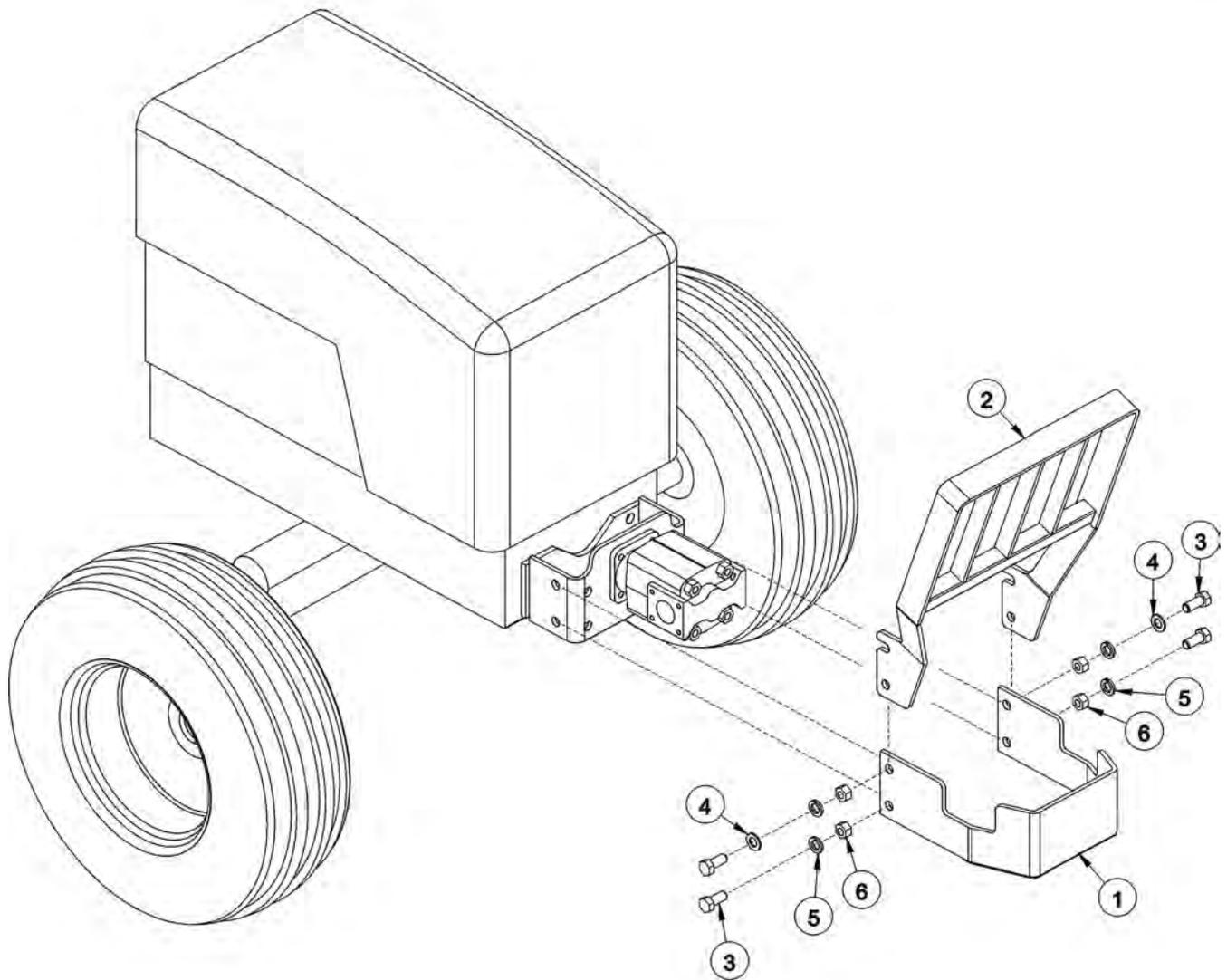

ITEM	PART NO.	QTY.	DESCRIPTION
1	32430	1	UNIVERSAL PUMP GUARD
2	32737	1	UNIVERSAL GRILL GUARD
3	21833	4	CAPSCREW,3/4" X 2-1/4",NC
4	22021	2	FLATWASHER,3/4"
5	21993	4	LOCKWASHER,3/4"
6	21825	4	HEX NUT,3/4",NC

COMMON SIDE ROTARY

RESERVOIR TANK FILTER ASSEMBLY

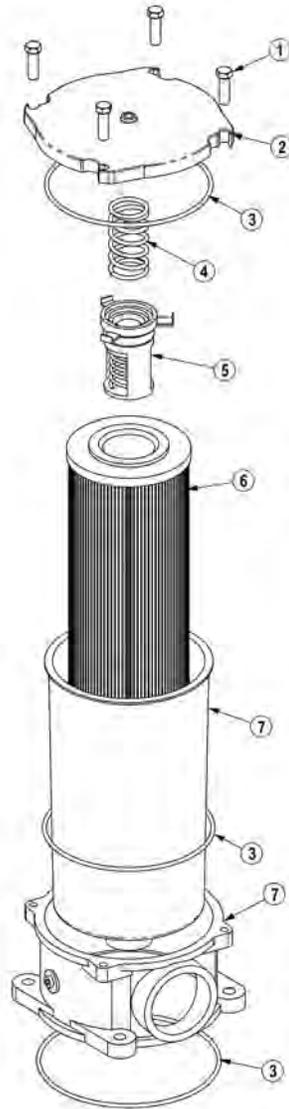

ITEM	PART NO.	QTY.	DESCRIPTION
---	06505044	-	FILTER ASSY SAE 10 MICRON
1	28583	4	CAPSCREW, 8MM X 25MM(1.25 PITCH)
2	06505045	1	COVER
3	06505046	1	SEAL KIT
4	06505047	1	SPRING
5	06505048	1	BYPASS
6	35259	1	FILTER, 10 MIC, RETURN LINE
7	06505049	1	CAN/BODY

COMMON SIDE ROTARY

3IN X 10IN HYDRAULIC CYLINDER BREAKDOWN

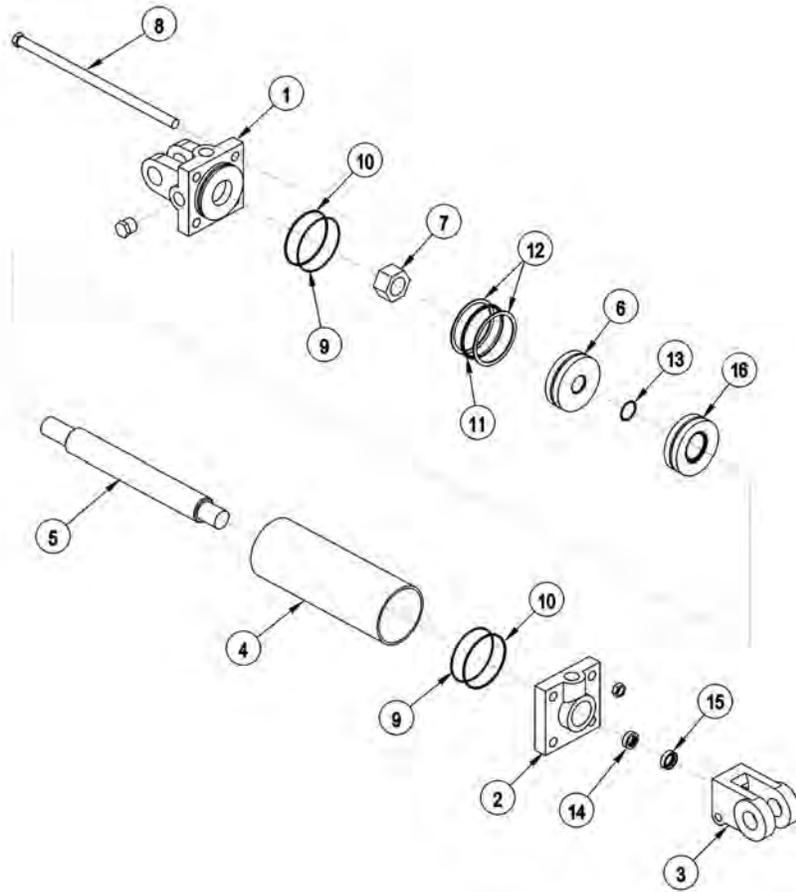

ITEM	PART NO.	QTY.	DESCRIPTION
-----	6T0151R	-	HYD. CYLINDER 3" X 10"
1	6T0167	1	CYLINDER BUTT
2	6T0170	1	CYLINDER GLAND
3	6T0178	1	CLEVIS END
4	6T0164	1	CYLINDER TUBE
5	6T0161	1	PISTON ROD
6	6T0173	1	PISTON
7	6T0179	1	LOCKNUT
8	6T0176	4	TIE ROD ASY
-----	6T0187	-	SEAL KIT
9	-----	2	O - RING
10	-----	2	BACK - UP WASHER
11	-----	1	O - RING
12	-----	2	BACK - UP WASHER
13	-----	1	O - RING
14	-----	1	U - CUP
15	-----	1	WIPER

COMMON SIDE ROTARY

3IN X 12IN HYDRAULIC CYLINDER BREAKDOWN

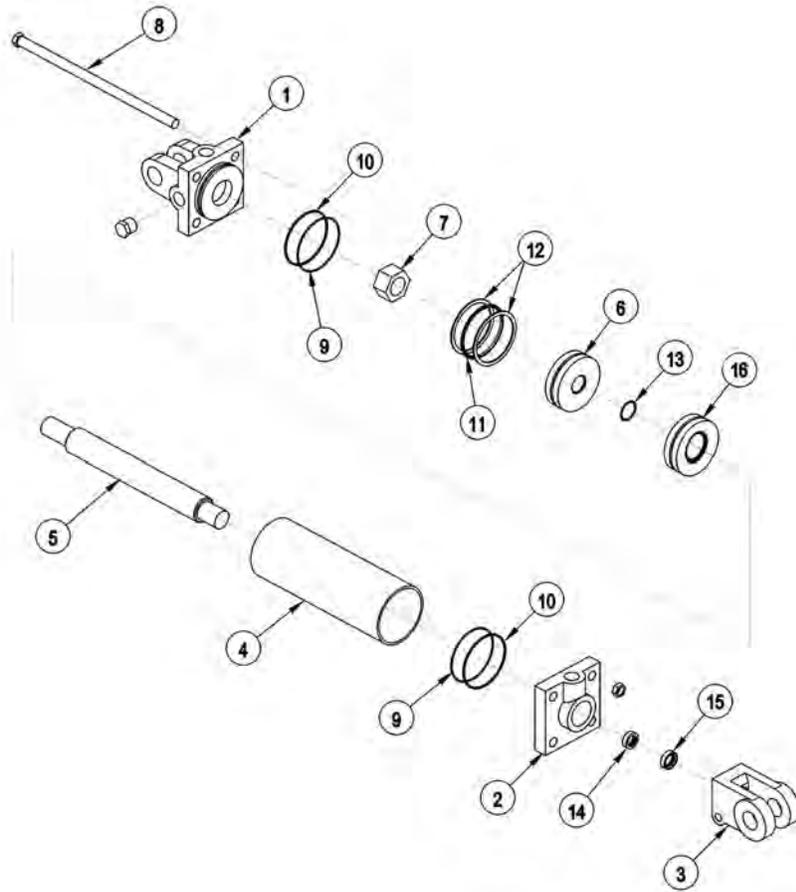

ITEM	PART NO.	QTY.	DESCRIPTION
-----	32215	-	HYD. CYLINDER 3" X 12" (STD DUTY)
-----	25343	-	HYD. CYLINDER 3" X 12" (HVY DUTY)
1	6T0167	1	CYLINDER BUTT
2	6T0170	1	CYLINDER GLAND
3	6T0178	1	CLEVIS END
4	6T0204	1	CYLINDER TUBE
5	6T0203	1	PISTON ROD
6	6T0173	1	PISTON
7	6T0179	1	LOCKNUT
8	6T0205	4	TIE ROD ASY
-----	6T0187	-	SEAL KIT
9	-----	2	O - RING
10	-----	2	BACK - UP WASHER
11	-----	1	O - RING
12	-----	2	BACK - UP WASHER
13	-----	1	O - RING
14	-----	1	U - CUP
15	-----	1	WIPER

COMMON SIDE ROTARY

3IN X 18IN HYDRAULIC CYLINDER BREAKDOWN

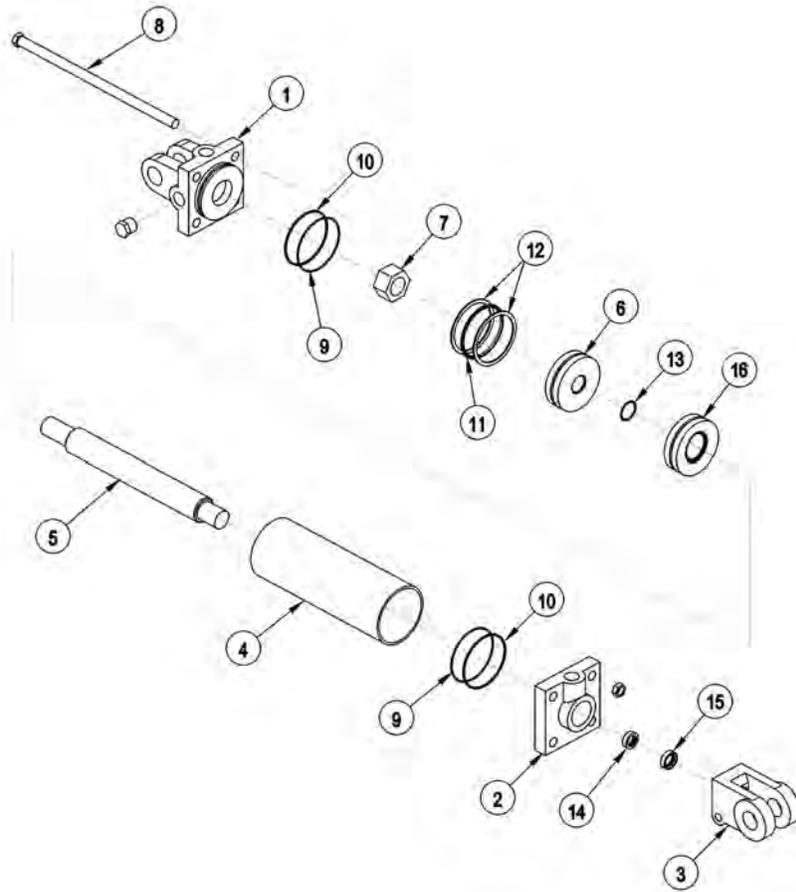

ITEM	PART NO.	QTY.	DESCRIPTION
-----	6T0150	-	CYLINDER 3" X 18"
1	6T0167	1	CYLINDER BUTT
2	6T0170	1	CYLINDER GLAND
3	6T0178	1	CLEVIS END
4	6T0165	1	CYLINDER TUBE
5	6T0162	1	PISTON ROD
6	6T0173	1	PISTON
7	6T0179	1	LOCKNUT
8	6T0177	4	TIE ROD ASY
-----	6T0187	-	SEAL KIT
9	-----	2	O - RING
10	-----	2	BACK - UP WASHER
11	-----	1	O - RING
12	-----	2	BACK - UP WASHER
13	-----	1	O - RING
14	-----	1	U - CUP
15	-----	1	WIPER
16	6T0206	1	SPACER

COMMON SIDE ROTARY

CABLE (MANUAL) LIFT VALVE BREAKDOWN - 30801

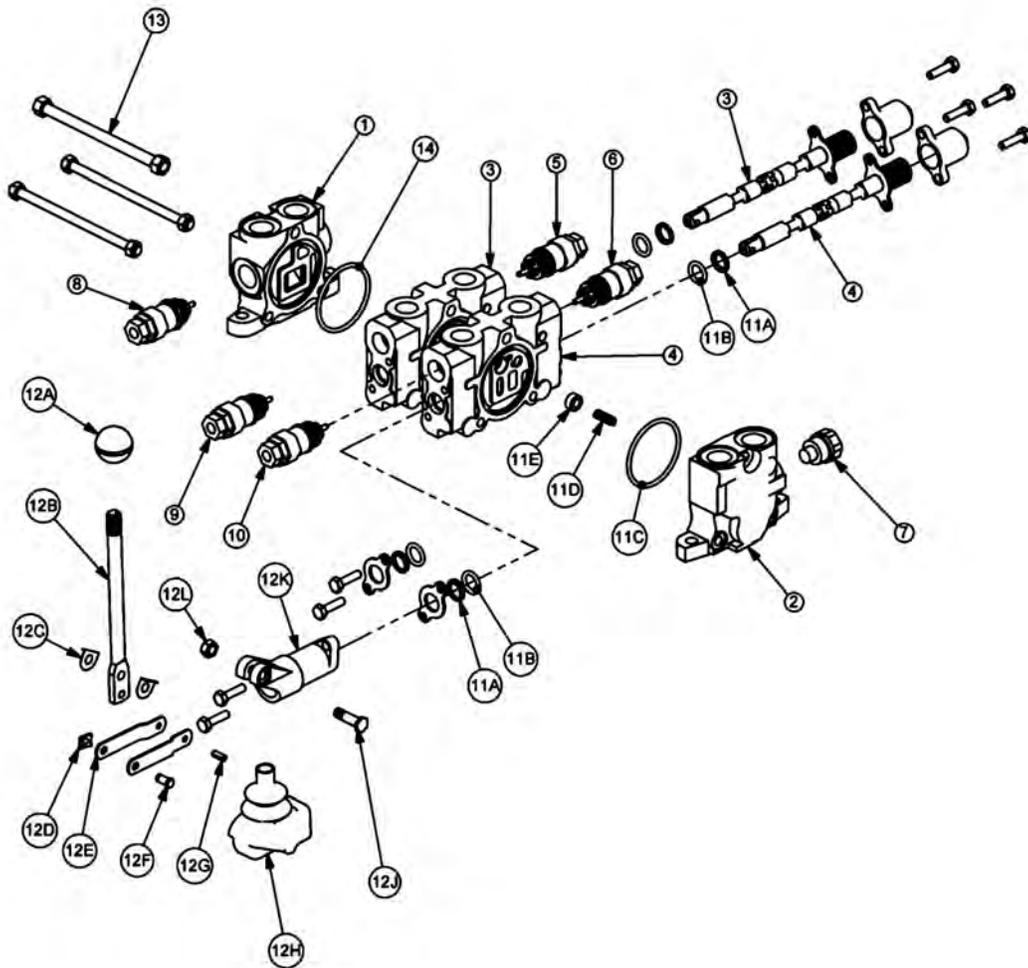

COMMON SIDE ROTARY

CABLE (MANUAL) LIFT VALVE BREAKDOWN - 30801

Continued...

ITEM	PART NO.	QTY.	DESCRIPTION
1	TB1017S	1	INLET END COVER
2	TB1702	1	END COVER, POWER BEYOND
3	TB1017P	1	VALVE SECTION (SINGLE ACTING, SPRING DETENT)
4	06502091	1	VALVE SECTION (DOUBLE ACTING, CENTER SPRING) (NO AUX VALVE PORTS)
5	N/A	-	N/A
6	N/A	-	N/A
7	TB1017M	1	SHUT-OFF PLUG
8	TB1017E	1	RELIEF VALVE, 2250 PSI
9	TB1017M	1	SHUT-OFF PLUG
10	N/A	-	N/A
11	TB1017A	2	VALVE SEAL KIT (FOR ONE SECTION)
11A	-----	2	WIPER
11B	-----	2	O-RING SMALL
11C	-----	1	O-RING LARGE
11D	-----	1	SPRING
11E	-----	1	PUCKET
12	TB1017L	2	LEVER KIT (FOR ONE SECTION)
12A	-----	1	LEVER KNOB
12B	-----	1	LEVER
12C	-----	2	LEVER WASHER
12D	-----	1	LEVER CLIP
12E	-----	2	LINKAGE
12F	-----	1	LEVER PIN
12G	-----	1	ROLL PIN
12H	-----	1	LEVER BOOT
12J	-----	1	LEVER BOLT
12K	-----	1	LEVER DUST COVER
12L	-----	1	LEVER NUT
13	TB1017X	1	TIE ROD KIT
14	24214	1	O-RING, LARGE

COMMON SIDE ROTARY

CABLE (MANUAL) LIFT VALVE BREAKDOWN - 31320

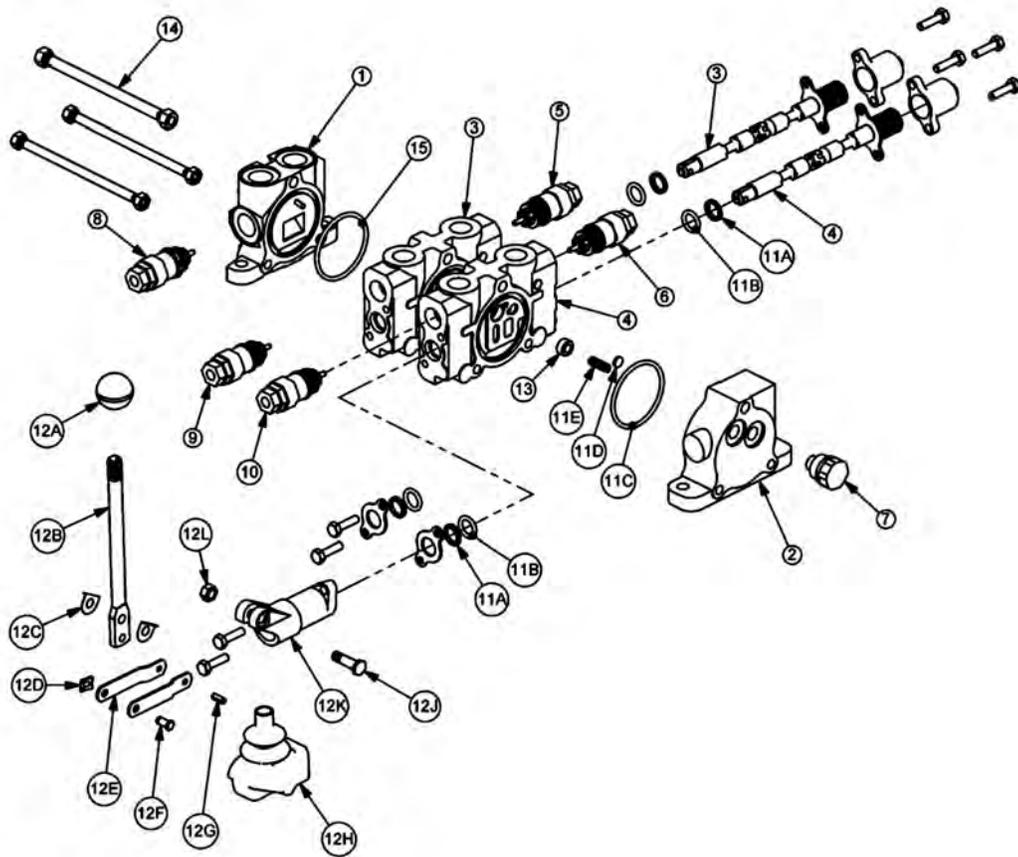

COMMON SIDE ROTARY

CABLE (MANUAL) LIFT VALVE BREAKDOWN - 31320

Continued...

ITEM	PART NO.	QTY.	DESCRIPTION
1	31595	1	INLET END COVER
2	31594	1	END COVER, LOAD SENSE
3	31597	1	VALVE SECTION (DOUBLE ACTING, CENTER SPRING)
4	31597	1	VALVE SECTION (DOUBLE ACTING, CENTER SPRING)
5	06503067	1	RELIEF PLUG
6	06503067	1	RELIEF PLUG
7	N/A	-	N/A
8	6T4209	1	RELIEF PLUG
9	31862	1	RELIEF VALVE, 2175 PSI
10	31862	1	RELIEF VALVE, 2175 PSI
11	31593	2	VALVE SEAL KIT (FOR ONE SECTION)
11A	-----	2	WIPER
11B	-----	2	O-RING SMALL
11C	-----	1	O-RING LARGE
11D	-----	1	SHUTTLE DISC
11E	-----	1	SPRING
12	TB1017L	2	LEVER KIT (FOR ONE SECTION)
12A	-----	1	LEVER KNOB
12B	-----	1	LEVER
12C	-----	2	LEVER WASHER
12D	-----	1	LEVER CLIP
12E	-----	2	LINKAGE
12F	-----	1	LEVER PIN
12G	-----	1	ROLL PIN
12H	-----	1	LEVER BOOT
12J	-----	1	LEVER BOLT
12K	-----	1	LEVER DUST COVER
12L	-----	1	LEVER NUT
13	31603	2	COMPENSATOR
14	TB1017X	1	TIE ROD KIT
15	24214	1	O-RING, LARGE

COMMON SIDE ROTARY

CABLE (MANUAL) LIFT VALVE BREAKDOWN - 31321

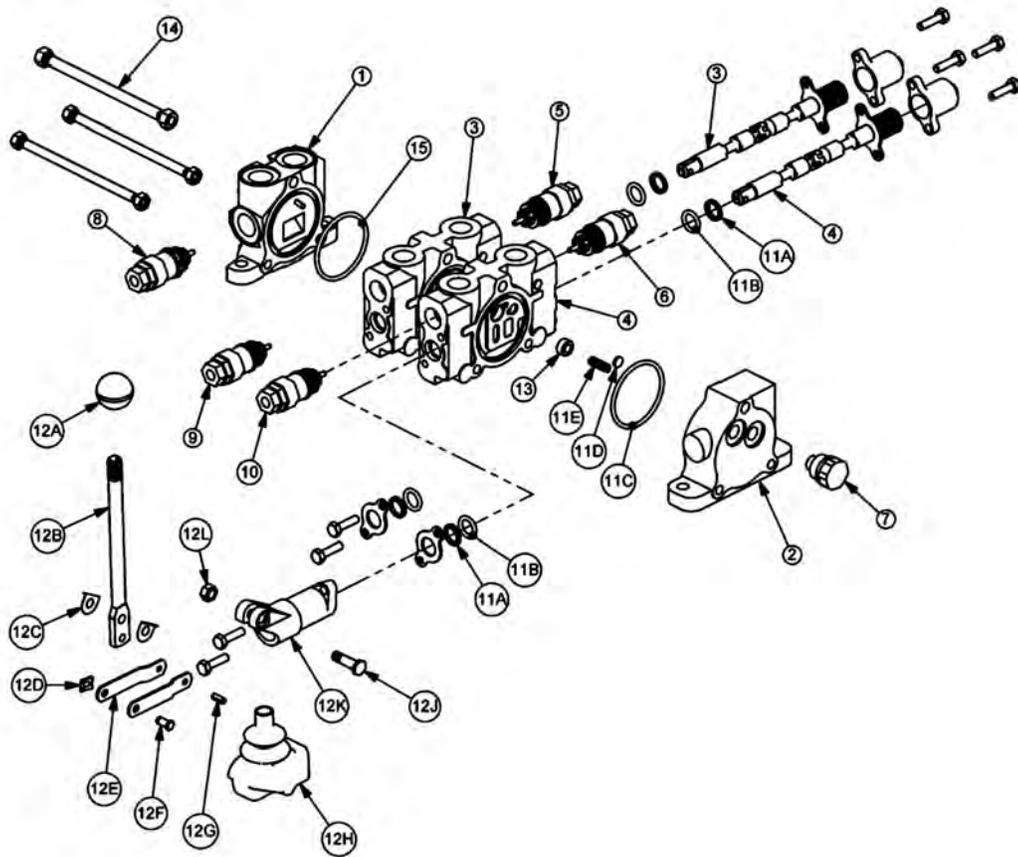

COMMON SIDE ROTARY

CABLE (MANUAL) LIFT VALVE BREAKDOWN - 31321

Continued...

ITEM	PART NO.	QTY.	DESCRIPTION
1	31595	1	INLET END COVER
2	31594	1	END COVER, LOAD SENSE
3	31597	1	VALVE SECTION (DOUBLE ACTING, CENTER SPRING)
4	31597	1	VALVE SECTION (DOUBLE ACTING, CENTER SPRING)
5	06503067	1	RELIEF PLUG
6	31861	1	RELIEF VALVE, 360 PSI
7	N/A	-	N/A
8	6T4209	1	RELIEF PLUG
9	31862	1	RELIEF VALVE, 2175 PSI
10	31862	1	RELIEF VALVE, 2175 PSI
11	31593	2	VALVE SEAL KIT (FOR ONE SECTION)
11A	-----	2	WIPER
11B	-----	2	O-RING SMALL
11C	-----	1	O-RING LARGE
11D	-----	1	SHUTTLE DISC
11E	-----	1	SPRING
12	TB1017L	2	LEVER KIT (FOR ONE SECTION)
12A	-----	1	LEVER KNOB
12B	-----	1	LEVER
12C	-----	2	LEVER WASHER
12D	-----	1	LEVER CLIP
12E	-----	2	LINKAGE
12F	-----	1	LEVER PIN
12G	-----	1	ROLL PIN
12H	-----	1	LEVER BOOT
12J	-----	1	LEVER BOLT
12K	-----	1	LEVER DUST COVER
12L	-----	1	LEVER NUT
13	31603	2	COMPENSATOR
14	TB1017X	1	TIE ROD KIT
15	24214	1	O-RING, LARGE

COMMON SIDE ROTARY

CABLE (MANUAL) LIFT VALVE BREAKDOWN - 31752

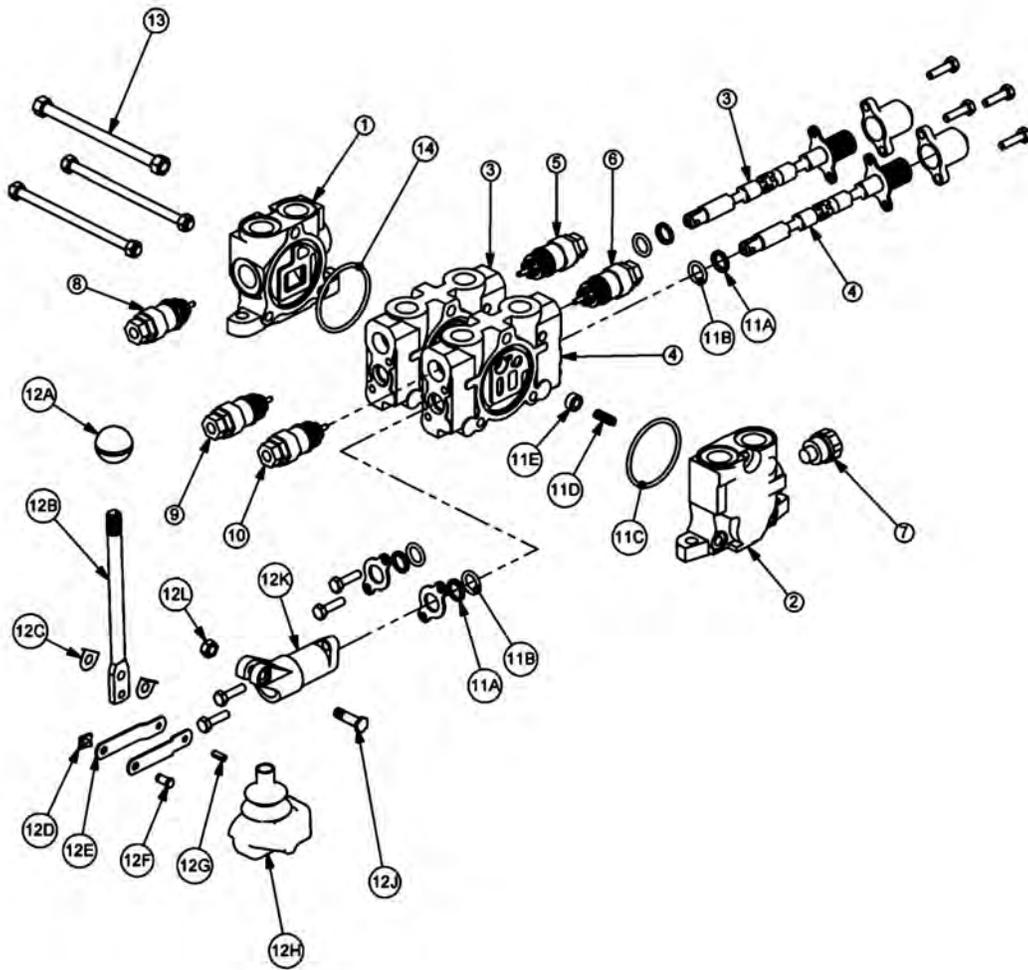

COMMON SIDE ROTARY

CABLE (MANUAL) LIFT VALVE BREAKDOWN - 31752

Continued...

ITEM	PART NO.	QTY.	DESCRIPTION
1	TB1017S	1	INLET END COVER
2	TB1702	1	END COVER, POWER BEYOND
3	TB1017P	1	VALVE SECTION (SINGLE ACTING, SPRING DETENT)
4	TB1017P	1	VALVE SECTION (SINGLE ACTING, SPRING DETENT)
5	N/A	-	N/A
6	N/A	-	N/A
7	TB1017M	1	SHUT-OFF PLUG
8	TB1017E	1	RELIEF VALVE, 2250 PSI
9	TB1017M	1	SHUT-OFF PLUG
10	TB1017M	1	SHUT-OFF PLUG
11	TB1017A	2	VALVE SEAL KIT (FOR ONE SECTION)
11A	-----	2	WIPER
11B	-----	2	O-RING SMALL
11C	-----	1	O-RING LARGE
11D	-----	1	SPRING
11E	-----	1	PUCKET
12	TB1017L	2	LEVER KIT (FOR ONE SECTION)
12A	-----	1	LEVER KNOB
12B	-----	1	LEVER
12C	-----	2	LEVER WASHER
12D	-----	1	LEVER CLIP
12E	-----	2	LINKAGE
12F	-----	1	LEVER PIN
12G	-----	1	ROLL PIN
12H	-----	1	LEVER BOOT
12J	-----	1	LEVER BOLT
12K	-----	1	LEVER DUST COVER
12L	-----	1	LEVER NUT
13	TB1017X	1	TIE ROD KIT
14	24214	1	O-RING, LARGE

COMMON SIDE ROTARY

CABLE (MANUAL) LIFT VALVE BREAKDOWN - 06502040

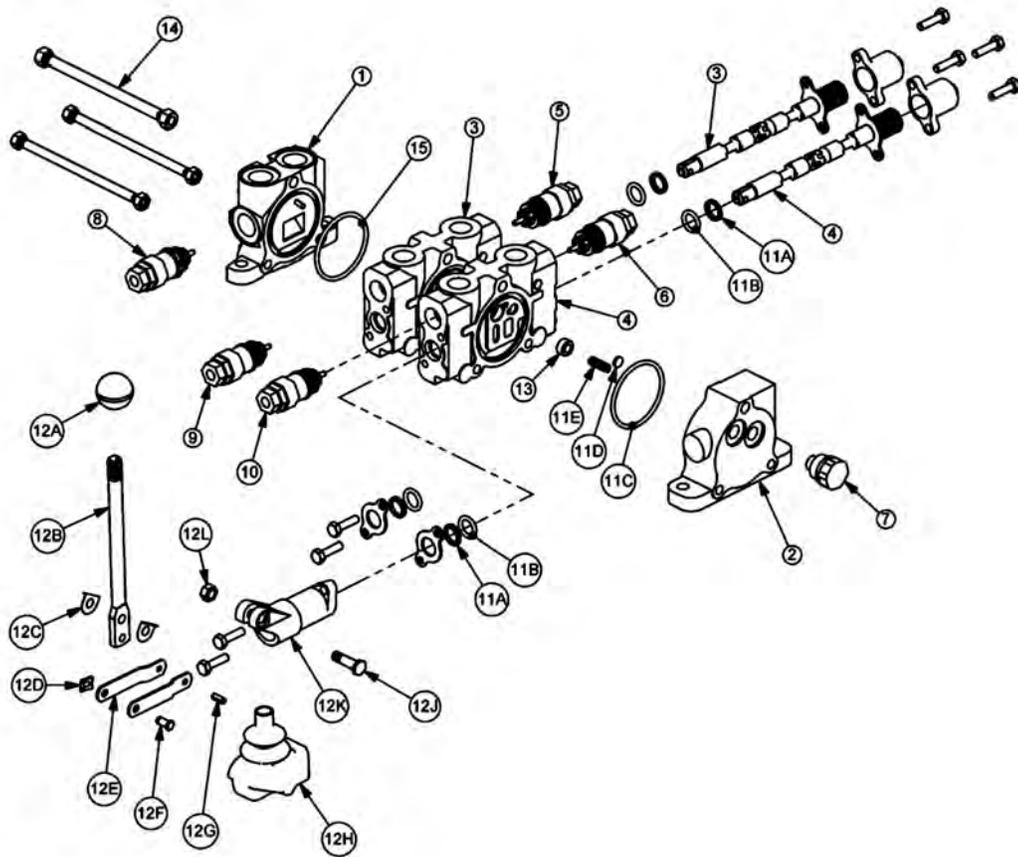

COMMON SIDE ROTARY

CABLE (MANUAL) LIFT VALVE BREAKDOWN - 06502040

Continued...

ITEM	PART NO.	QTY.	DESCRIPTION
1	31595	1	INLET END COVER
2	31594	1	END COVER, LOAD SENSE
3	31597	1	VALVE SECTION (DOUBLE ACTING, CENTER SPRING)
4	31597	1	VALVE SECTION (DOUBLE ACTING, CENTER SPRING) (REMOVE SHUTTLE DISC)
5	06503067	1	RELIEF PLUG
6	06503067	1	RELIEF PLUG
7	06503068	1	RELIEF PLUG
8	N/A	-	N/A
9	31862	1	RELIEF VALVE, 2175 PSI
10	31862	1	RELIEF VALVE, 2175 PSI
11	31593	2	VALVE SEAL KIT (FOR ONE SECTION)
11A	-----	2	WIPER
11B	-----	2	O-RING SMALL
11C	-----	1	O-RING LARGE
11D	-----	1	SHUTTLE DISC
11E	-----	1	SPRING
12	TB1017L	2	LEVER KIT (FOR ONE SECTION)
12A	-----	1	LEVER KNOB
12B	-----	1	LEVER
12C	-----	2	LEVER WASHER
12D	-----	1	LEVER CLIP
12E	-----	2	LINKAGE
12F	-----	1	LEVER PIN
12G	-----	1	ROLL PIN
12H	-----	1	LEVER BOOT
12J	-----	1	LEVER BOLT
12K	-----	1	LEVER DUST COVER
12L	-----	1	LEVER NUT
13	31603	2	COMPENSATOR
14	TB1017X	1	TIE ROD KIT
15	24214	1	O-RING, LARGE

COMMON SIDE ROTARY

CABLE (MANUAL) LIFT VALVE BREAKDOWN - 06502041

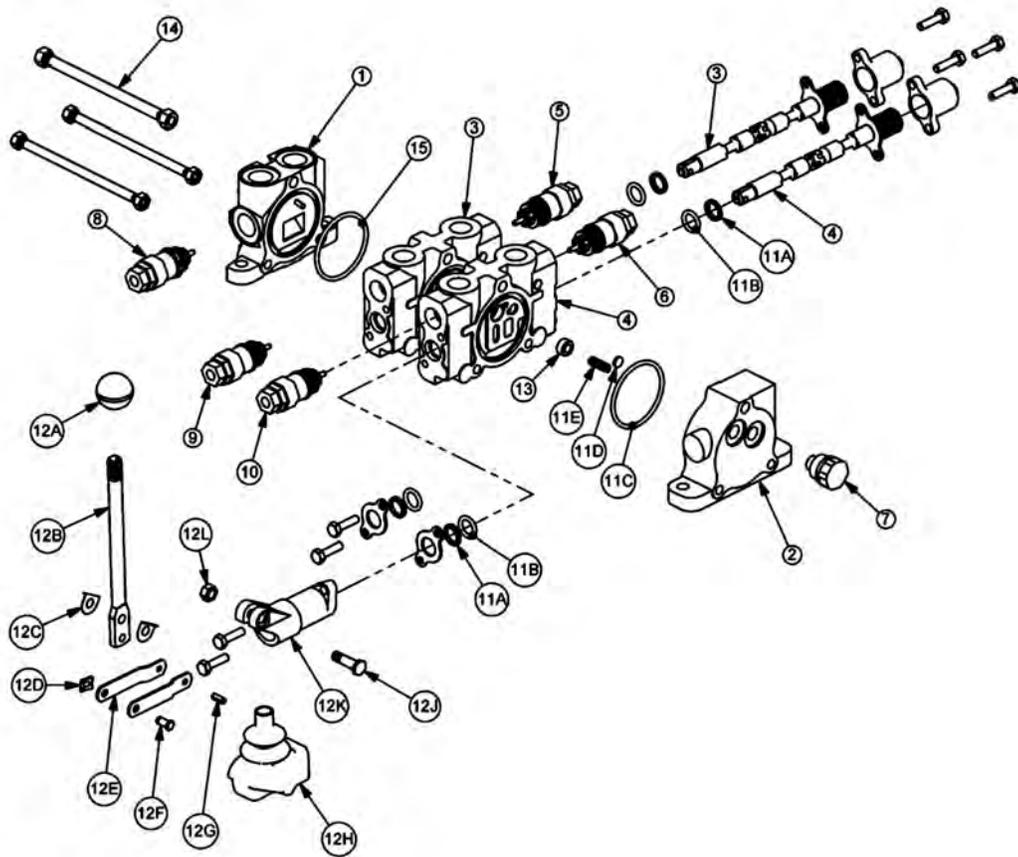

COMMON SIDE ROTARY

CABLE (MANUAL) LIFT VALVE BREAKDOWN - 06502041

Continued...

ITEM	PART NO.	QTY.	DESCRIPTION
1	31595	1	INLET END COVER
2	31594	1	END COVER, LOAD SENSE
3	31597	1	VALVE SECTION (DOUBLE ACTING, CENTER SPRING)
4	31597	1	VALVE SECTION (DOUBLE ACTING, CENTER SPRING)
5	06503067	1	RELIEF PLUG
6	31861	1	RELIEF VALVE, 360 PSI
7	06503068	1	RELIEF PLUG
8	6T4209	1	RELIEF PLUG
9	31862	1	RELIEF VALVE, 2175 PSI
10	31862	1	RELIEF VALVE, 2175 PSI
11	31593	2	VALVE SEAL KIT (FOR ONE SECTION)
11A	-----	2	WIPER
11B	-----	2	O-RING SMALL
11C	-----	1	O-RING LARGE
11D	-----	1	SHUTTLE DISC
11E	-----	1	SPRING
12	TB1017L	2	LEVER KIT (FOR ONE SECTION)
12A	-----	1	LEVER KNOB
12B	-----	1	LEVER
12C	-----	2	LEVER WASHER
12D	-----	1	LEVER CLIP
12E	-----	2	LINKAGE
12F	-----	1	LEVER PIN
12G	-----	1	ROLL PIN
12H	-----	1	LEVER BOOT
12J	-----	1	LEVER BOLT
12K	-----	1	LEVER DUST COVER
12L	-----	1	LEVER NUT
13	31603	2	COMPENSATOR
14	TB1017X	1	TIE ROD KIT
15	24214	1	O-RING, LARGE

COMMON SIDE ROTARY

BRAKE VALVE ASSEMBLY

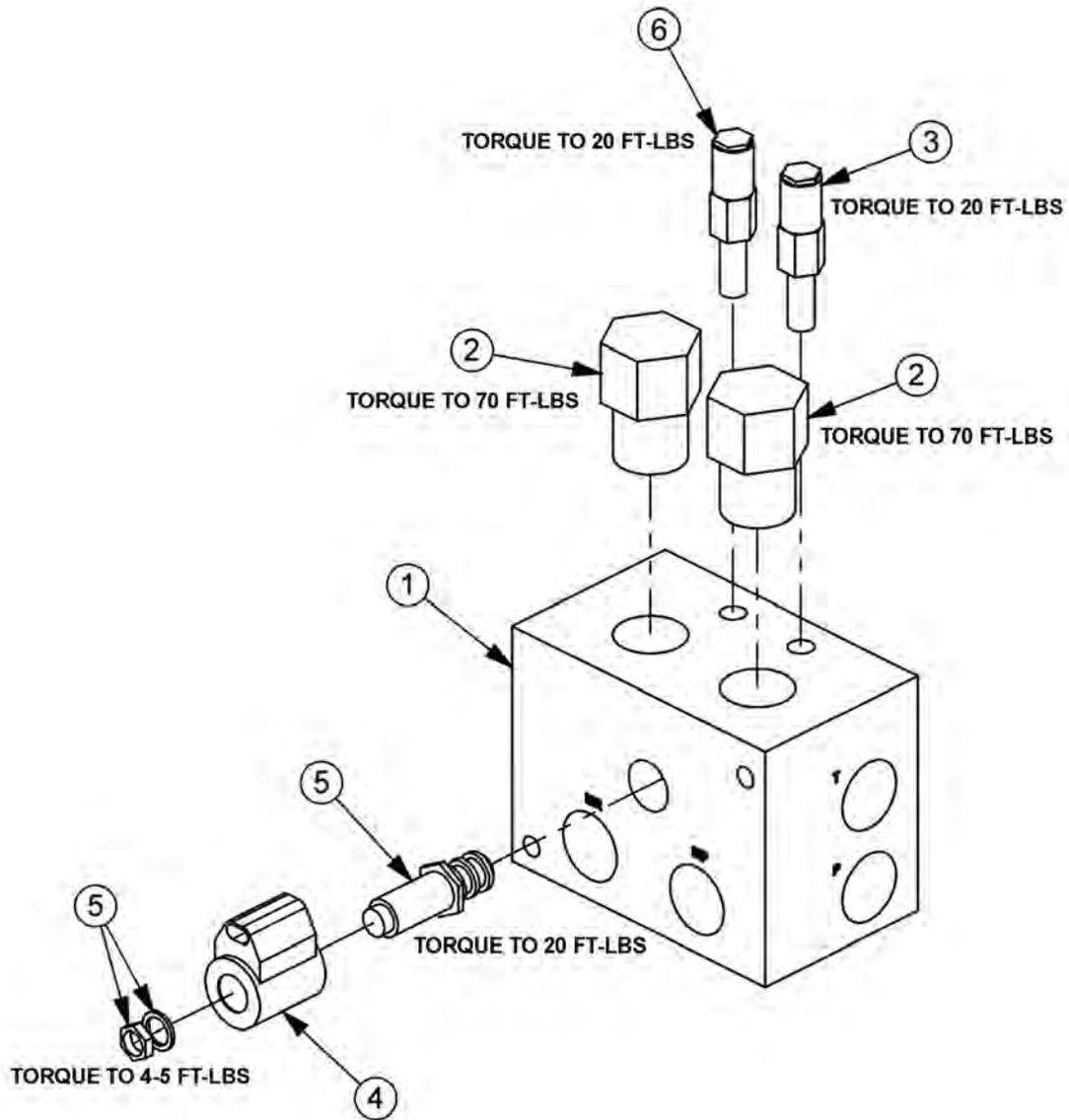

ITEM	PART NO.	QTY.	DESCRIPTION
---	06510083	1	BRAKE VALVE, ASSY
1	34092	1	BRAKE VALVE, BLANK
2	34094	2	LOGIC ELEMENT
3	34095	1	RELIEF VALVE, 3000 PSI
4	06510095	1	METRI PAK COIL
5	34093	1	CARTRIDGE, 2 POSITION, 3 WAY (WITH NUT & WASHER)
6	34091	1	RELIEF VALVE, 2600 PSI
---	34096	2	RELIEF SEAL KIT
----	34097	1	SOLENOID SEAL KIT
---	34098	2	ELEMENT SEAL KIT

COMMON SIDE ROTARY

BRAKE VALVE HYDRAULIC SCHEMATIC

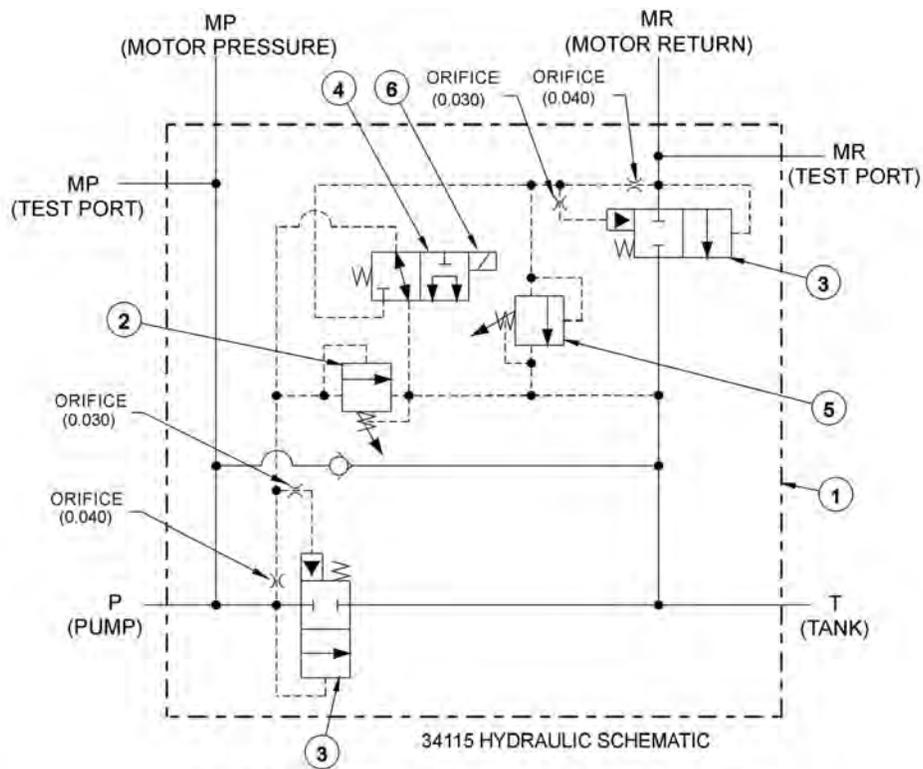

BRAKE VALVE TROUBLESHOOTING

FAILURE MODE:

- MOWER WILL NOT START - system pressure is low (engine not lugging).
- MOWER WILL NOT START - system pressure is high (engine lugging). "MR" port will be high pressure.
- MOWER WILL NOT ROTATE AT FULL SPEED - limited power.
- MOWER BLADE WILL NOT STOP - blade will not stop in proper time.

CHECK STEPS

- 1 thru 6
- 7
- 3 thru 5
- 7 thru 9

CORRECTIVE STEPS:

1. Check for voltage at solenoid (item 6), voltage must be between 10.2 volts and 13.8 volts.
2. Remove, inspect solenoid and cartridge (items 4, 6) for wear or contamination.
3. Remove, inspect logic elements near "P" port (item 3) for wear or contamination.
4. Remove, inspect 3000 psi relief valve (item 2) for wear or contamination.
5. Remove and inspect orifices near "P" port for contamination.
6. Remove "P" port hose and fitting, visually inspect for contamination, check ball for movement.
7. Remove and inspect orifices near "MR" port for contamination.
8. Remove, inspect 2600 psi relief valve (item 5) for wear of contamination.
9. Remove, inspect logic element near "MR" port (item 3) for wear or contamination.

SWITCH BOX

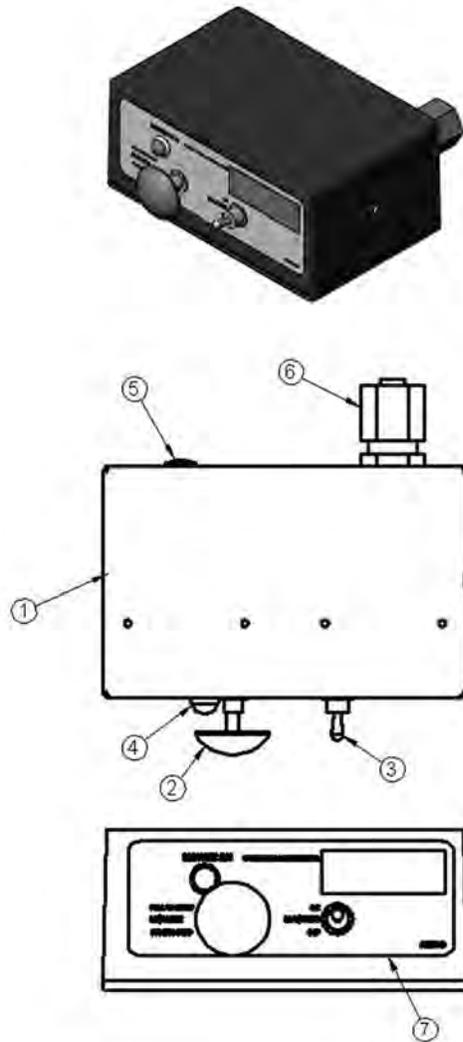

ITEM	PART NO.	QTY.	DESCRIPTION
1	06514013	1	SWBX,ALUM,BLK,06510102
2	35226	1	SWITCH,MOWER,COLEHERSEE
3	33811	1	SWITCH,MASTER/DECK FLOAT
4	6T3923	1	INDICTATOR LIGHT,ON,RED
5	06514014	1	BREAKER,10A,SWBX
6	34540	1	STRAIN RELIEF,3/4,BLACK,NYLON
7	06550018	1	DECAL,SWTCHBX,TM/TSF,CG
8	35227	1	RELAY,DP,DT,12V,LY2F,35226

COMMON SIDE ROTARY

SWITCH BOX SCHEMATIC

06510102 SCHEMATIC COMMON GROUND SWITCH BOX SIDE MOWER

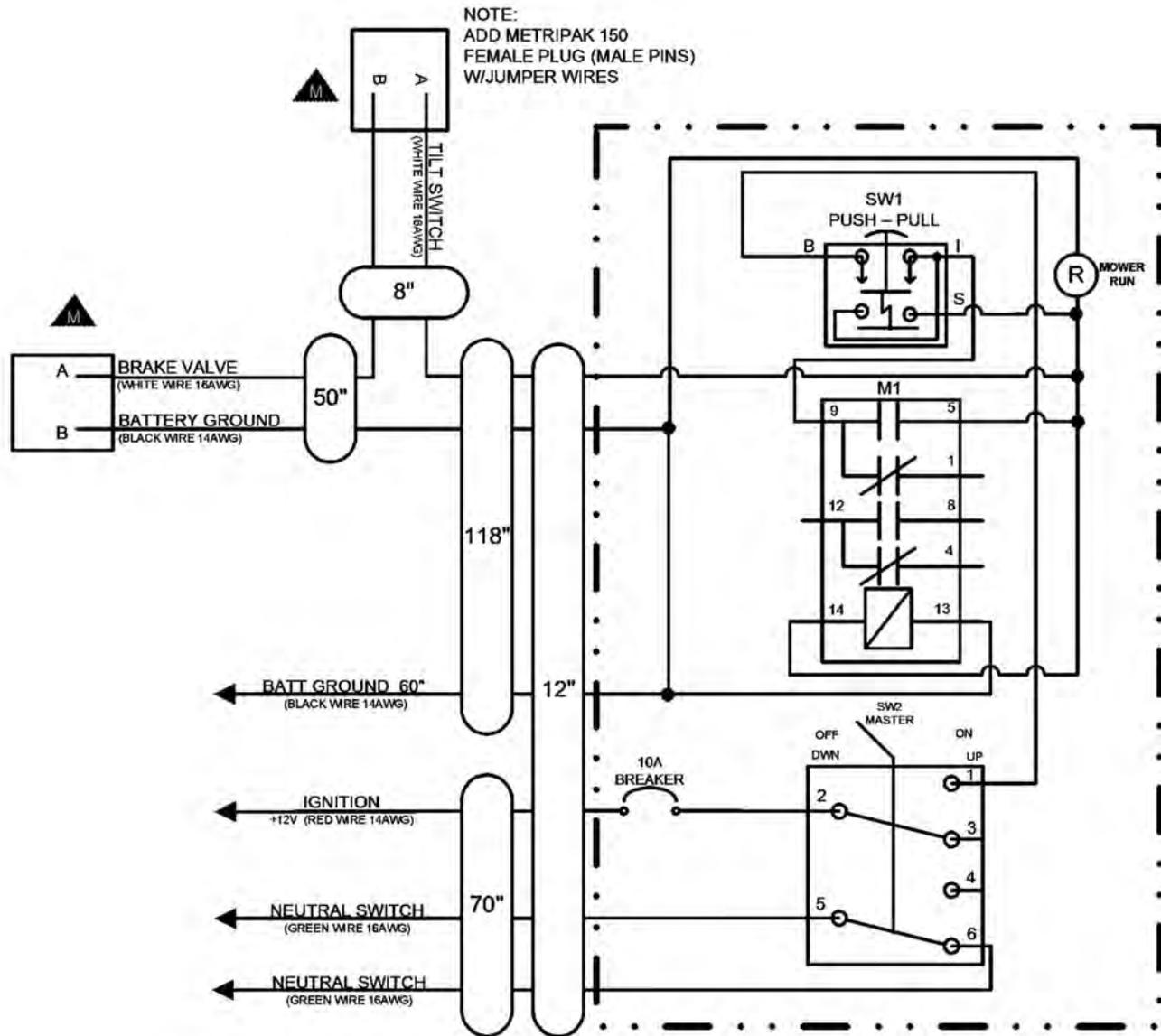

SEE DRAWING # 06515000 FOR A FULL DESCRIPTION OF ALL CONNECTORS

WARRANTY SECTION

WARRANTY INFORMATION

Tiger Corporation, 3301 N. Louise, Sioux Falls, South Dakota, warrants to the original Retail Customer, the new Tiger equipment is free of defects in material and workmanship. Any part of equipment that in Tiger's judgement, show evidence of such defects will be repaired or replaced without charge, provided that the failure of part(s) shall have occurred within twelve (12) months from the date of delivery of said equipment to the Retail Customer. Expendable components such as knives, oil, chain sprockets, skid shoes, knife mounting disks and the like are excluded but not limited to this warranty.

The Retail Customer must pay the transportation cost to and from the Tiger Dealer's service shop for warranty service. Warranty service will be performed by the Tiger Dealer from whom the equipment was purchased, during service shop regularly scheduled days and hours of operation.

All Tiger obligation under this warranty shall be terminated if the equipment is modified or altered in ways not approved in writing by Tiger, if repair parts other than genuine Tiger repair parts have been used, or if the equipment has been subject to misuse, neglect, accident, improper maintenance or improper operation.

Tiger Corporation reserves the right to make improvements in design or changes in specification at any time without incurring any obligation to owners of equipment previously sold.

No agent or person has authority to alter, add to or waive the above warranties which are agreed to be in the only warranties, representations or promises, expressed or implied, as to the quality or performance of the products covered and which do not include any implied warranty of merchantability or fitness. In no event will Tiger be liable for incidental or consequential damages or injuries, including, but not limited to, loss of profits, rental or substitute equipment or other commercial loss.

**THERE ARE NO WARRANTIES WHICH EXTEND
BEYOND THOSE EXPRESSED HEREIN.**

It is the Purchasers obligation to sign the warranty registration form **AFTER** he / she has Read and Understands the Operation and Safety Instructions stated within this manual.

ONE LAST WORD

This manual cannot possibly cover all of the potentially hazardous situations you will encounter. By being familiar with the safety rules, operating and maintenance instructions in this manual you can help prevent accidents. The objective of this manual is to help make you a better operator. Remember, **SAFETY IS YOU!**



1012

Your safety and the safety of those around you depends on **YOU**. Common sense should play a large role in the operation of this machine.

Since we at Tiger Corporation are constantly striving to improve our products, we reserve the right to change specifications or design at any time.

TO THE OWNER / OPERATOR / DEALER



To keep your implement running efficiently and safely, read your manual thoroughly and follow these directions and the Safety Messages in this manual and on the machine. The table of contents clearly identifies each section where you can easily find the information you need.

The Occupational Safety and Health Act (OSHA 1928.51 subpart C) makes the following minimum requirements for tractor operators.

OWNER REQUIREMENTS:

1. Provide a Roll-Over-Protective Structure that meets the requirements of this Standard; and
2. Provide Seatbelts that meet the requirements of this Standard and SAE J3C; and
3. Ensure that each employee uses such Seatbelt while the tractor is moving; and
4. Ensure that each employee tightens the Seatbelt sufficiently to confine the employee to the protected area provided by the ROPS.

OPERATOR REQUIREMENTS:

1. Securely fasten seatbelt if the tractor has a ROPS.
2. Where possible, avoid operating the tractor near steep ditches, embankments, and holes.
3. Reduce speed when turning, crossing slopes, and on rough, slick, or muddy surfaces.
4. Stay off slopes too steep for safe operation.
5. Watch where you are going – especially at row ends, on roads, and around trees.
6. Do Not permit others to ride.
7. Operate the tractor smoothly – no jerky turns, starts, or stops.
8. Hitch only to the draw-bar and hitch points recommended by the tractor manufacturer.
9. When the tractor is stopped, set brakes securely and use park lock, if available



Printed in USA
© Tiger Corporation