



BENGAL BOOM ASSEMBLIES

JD6140-50M/R

Current as of 4/5/2018



PARTS LISTING WITH MOUNTING AND OPERATING INSTRUCTIONS

Tiger Corporation
3301 N. Louise Ave.
Sioux Falls, SD 57107
1-800-843-6849
1-605-336-7900
www.tiger-mowers.com

© Tiger Corporation

06020025

TO THE OWNER / OPERATOR / DEALER

All implements with moving parts are potentially hazardous. There is no substitute for a cautious, safe-minded operator who recognizes the potential hazards and follows reasonable safety practices. The manufacturer has designed this implement to be used with all its safety equipment properly attached to minimize the chance of accidents.

BEFORE YOU START!! Read the safety messages on the implement and shown in this manual. Observe the rules of safety and use common sense!

READ AND UNDERSTAND THIS MANUAL! Non-English speaking operators will need to GET THE MANUAL TRANSLATED as needed!



DANGER

FAILING TO FOLLOW SAFETY MESSAGES AND OPERATING INSTRUCTIONS CAN CAUSE SERIOUS BODILY INJURY OR EVEN DEATH TO OPERATOR AND OTHERS IN THE AREA.



1. Study and understand Operator's Manuals, Safety Decals, and Instructional Decals for tractor and implement to prevent misuse, abuse, and accidents. Practice before operating in a confined area or near passersby.

● Learn how to stop engine suddenly in an emergency. Be alert for passersby and especially children

2. Allow no children on or near folding mower or tractor. Allow no riders on tractor or implement. Falling off may cause serious injury or death from being run over by tractor or mower or contact with rotating blades.

3. Operate only with tractor having Roll-Over Protective Structure (ROPS) and with seat belt securely fastened to prevent injury and possible death from falling off or tractor overturn.

● Personal Protective Equipment such as Hard Hat, Safety Glasses, Safety Shoes, & Ear Plugs are recommended.

4. Block up or support raised machine and all lifted components securely before putting hands or feet under or working underneath any lifted component to prevent crushing injury or death from sudden dropping or inadvertent operation of controls. Make certain area is clear before lowering or folding

5. Before transporting, put Lift Lever in detent or full-lift position. Install Transport Safety Devices securely on folding mowers. Put Booms securely in Transport Rest.

● Folding and Boom Mowers have raised center of gravity. Slow down when turning and on hillsides.

6. Make certain that SMV sign, warning lights, and reflectors are clearly visible. Follow local traffic codes.

7. Never operate with Cutting Head or Folding Section raised if passersby, bystanders, or traffic are in the area to reduce possibility of injury or death from objects thrown by Blades under Guards or mower structure.

8. Before dismounting, secure implement in transport position or lower to ground.

● Put tractor in park or set brake, disengage PTO, stop engine, remove key, and wait until noise of rotation has ceased to prevent crushing by entanglement in rotating parts which could cause injury or death.

● Never mount or dismount a moving vehicle. Crushing from rollover may cause serious injury or death.

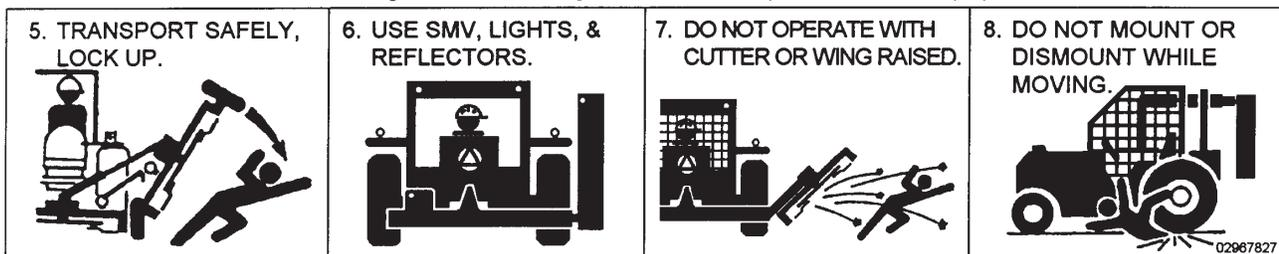

02967827

Warranty Information: Read and understand the complete Warranty Statement found in this manual. Fill out the Warranty Registration form in full and return it within 90 days. Make certain the Serial Number of the machine is recorded on the Warranty Card, and form that you retain.

FORWARD

This manual contains information about many features of the Tiger mowing and roadside maintenance equipment. Some of these include: Safety precautions, Assembly instructions, Operations, Maintenance and Parts. This manual will also assist you in the proper break-in, daily care, and troubleshooting of your new mower.

We recommend that you read carefully the entire manual before operating the unit. Also, time spent in becoming fully acquainted with its performance features, adjustments, and maintenance schedules will be repaid in a long and satisfactory life of the equipment.

Troubleshooting - Please, before you call, help us to help you!

Please look at the equipment to observe what is happening, then:

- Classify the problem
 - Hydraulic, electrical or mechanical - Read the trouble shooting section
 - Tractor or Truck chassis - Contact vehicle dealer

- If unable to correct the problem yourself, contact your local Tiger Dealer after gathering:
 - Machine model _____
 - Serial number _____
 - Dealer name _____
 - Detailed information about the problem including results of troubleshooting

Attention Owner / Operator / Dealer: It is your obligation to read, and understand, the warranty information section located at the back of this manual denoting that the purchaser understands the safety issues relating to this machine and has received and will read a copy of this manual.

If at any time, you have a service problem with your Tiger mower, Contact your local dealer for service and parts needed.

MANUFACTURED BY:

Tiger Corporation

3301 N. Louise Ave.

Sioux Falls, SD 57107

1-800-843-6849

1-605-336-7900

www.tiger-mowers.com

DISTRIBUTED BY:

1- _____ - _____ - _____

1- _____ - _____ - _____

TABLE OF CONTENTS

SAFETY SECTION_____	1
ASSEMBLY / MOUNTING SECTION_____	2
OPERATION SECTION_____	3
MAINTENANCE SECTION_____	4
PARTS SECTION_____	5
COMMON PARTS SECTION_____	6
WARRANTY INFORMATION_____	7



1012

This symbol means:

CAUTION – YOUR SAFETY IS AT RISK!

When you see this symbol, read and follow the associated instructions carefully or personal injury or damage may result.

Tiger is a registered trademark.



SAFETY SECTION

SAFETY

A safe and careful operator is the best operator. Safety is of primary importance to the manufacturer and should be to the owner / operator. Most accidents can be avoided by being aware of your equipment, your surroundings, and observing certain precautions. The first section of this manual includes a list of Safety Messages that, if followed, will help protect the operator and bystanders from injury or death. Read and understand these Safety Messages before assembling, operating or servicing this mower. This equipment should only be operated by those persons who have read the Manual, who are responsible and trained, and who know how to do so safely and responsibly.

The Safety Alert Symbol combined with a Signal Word, as seen below, is used throughout this manual and on decals which are attached to the equipment. The Safety Alert Symbol means: **“ATTENTION! BECOME ALERT! YOUR SAFETY IS INVOLVED!”** The symbol and signal word are intended to warn the owner / operator of impending hazards and the degree of possible injury when operating this equipment.

Practice all usual and customary safe working precautions and above all -- remember safety is up to YOU! Only YOU can prevent serious injury or death from unsafe practices.

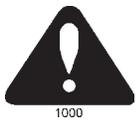

This is the Safety Alert Symbol. When you see this symbol on your machine or in these instructions, be alert to the potential for personal injury.

CAUTION!



The lowest level of Safety Message; warns of possible injury. Decals located on the equipment with this signal word are Black and Yellow.

WARNING!



Serious injury or possible death! Decals are Black and Orange.

DANGER!



Imminent death / critical injury. Decals are Red and White.

READ, UNDERSTAND, and FOLLOW the following Safety Messages. Serious injury or death may occur unless care is taken to follow the warnings and instructions stated in the Safety Messages. Always use good common sense to avoid hazards. (SG-2)

SAFETY INSTRUCTIONS



SAFETY

PELIGRO!



Si no lee Ingles, pida ayuda a alguien que si lo lea para que le traduzca las medidas de seguridad. *UI /5+



¡ LEA EL INSTRUCTIVO!

DANGER!



Never operate the Tractor or Implement until you have read and completely understand this Manual, the Tractor Operator's Manual, and each of the Safety Messages found in the Manual or on the Tractor and Implement. Learn how to stop the tractor engine suddenly in an emergency! Never allow inexperienced or untrained personnel to operate the Tractor and Implement without supervision. Make sure the operator has fully read and understood the manuals prior to operation. *UI /6+



WARNING!



Always maintain the safety decals in good readable condition. If the decals are missing, damaged, or unreadable, obtain and install replacement decals immediately. *UI /7+

WARNING!



Make certain that the "Slow Moving Vehicle" (SMV) sign is installed in such a way as to be clearly visible and legible. When transporting the Equipment use the Tractor flashing warning lights and follow all local traffic regulations. *UI /8+

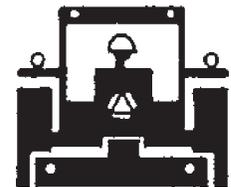

WARNING!



Operate this Equipment only with a Tractor equipped with an approved roll-over-protective system (ROPS). Always wear seat belts. Serious injury or even death could result from falling off the tractor--particularly during a turnover when the operator could be pinned under the ROPS. *UI /9+



WARNING!



Do not modify or alter this Implement. Do not permit anyone to modify or alter this Implement, any of its components or any Implement function. *UI /:+

DANGER!



BEFORE leaving the tractor seat, always engage the brake and/or set the tractor transmission in parking gear, disengage the PTO, stop the engine, remove the key, and wait for all moving parts to stop. Place the tractor shift lever into a low range or parking gear to prevent the tractor from rolling. Never dismount a Tractor that is moving or while the engine is running. Operate the Tractor controls from the tractor seat only.

*****UI /:+

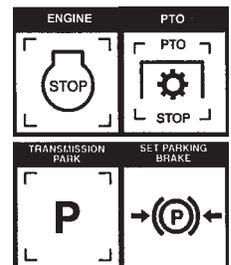

SAFETY

DANGER!



Never allow children or other persons to ride on the Tractor or Implement. Falling off can result in serious injury or death.

*****UI /32+



DANGER!



Never allow children to operate or ride on the Tractor or Implement.

*****UI /33+



WARNING!



Do not mount the Tractor while the tractor is moving. Mount the Tractor only when the Tractor and all moving parts are completely stopped.

34+

*****UI /



DANGER!



Start tractor only when properly seated in the Tractor seat. Starting a tractor in gear can result in injury or death. Read the Tractor operators manual for proper starting instructions.

*UI /35+



DANGER!



Never work under the Implement, the framework, or any lifted component unless the Implement is securely supported or blocked up to prevent sudden or inadvertent falling which could cause serious injury or even death.

***UI /36+



DANGER!



Do not operate this Equipment with hydraulic oil leaking. Oil is expensive and its presence could present a hazard. Do not check for leaks with your hand! Use a piece of heavy paper or cardboard. High-pressure oil streams from breaks in the line could penetrate the skin and cause tissue damage including gangrene. If oil does penetrate the skin, have the injury treated immediately by a physician knowledgeable and skilled in this procedure.

***UI /37+



SAFETY

WARNING!



The operator and all support personnel should wear hard hats, safety shoes, safety glasses, and proper hearing protection at all times for protection from injury including injury from items thrown by the equipment. *UI /38+

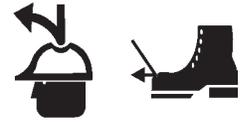

CAUTION!



PROLONGED EXPOSURE TO LOUD NOISE MAY CAUSE PERMANENT HEARING LOSS! Tractors with or without an Implement attached can often be noisy enough to cause permanent hearing loss. We recommend that you always wear hearing protection if the noise in the Operator's position exceeds 80db. Noise over 85db over an extended period of time will cause severe hearing loss. Noise over 90db adjacent to the Operator over an extended period of time will cause permanent or total hearing loss. *Note:* Hearing loss from loud noise [from tractors, chain saws, radios, and other such sources close to the ear] is cumulative over a lifetime without hope of natural recovery. *UI /19+



WARNING!



Transport only at safe speeds. Serious accidents and injuries can result from operating this equipment at unsafe speeds. Understand the Tractor and Implement and how it handles before transporting on streets and highways. Make sure the Tractor steering and brakes are in good condition and operate properly.



Before transporting the Tractor and Implement, determine the safe transport speeds for you and the equipment. Make sure you abide by the following rules:

1. Test the tractor at a slow speed and increase the speed slowly. Apply the Brakes smoothly to determine the stopping characteristics of the Tractor and Implement. As you increase the speed of the Tractor the stopping distance increases. Determine the maximum safe transport speed for you and this Equipment.
2. Test the equipment at a slow speed in turns. Increase the speed through the turn only after you determine that it is safe to operate at a higher speed. Use extreme care and reduce your speed when turning sharply to prevent the tractor and implement from turning over. Determine the maximum safe turning speed for you and this equipment before operating on roads or uneven ground.
3. Only transport the Tractor and Implement at the speeds that you have determined are safe and which allow you to properly control the equipment.



Be aware of the operating conditions. Do not operate the Tractor with weak or faulty brakes. When operating down a hill or on wet or rain slick roads, the braking distance increases: use extreme care and reduce your speed. When operating in traffic always use the Tractor's flashing warning lights and reduce your speed. Be aware of traffic around you and watch out for the other guy. (SG-19)

SAFETY

WARNING!



Never attempt to lubricate, adjust, or remove material from the Implement while it is in motion or while tractor engine is running. Make sure the tractor engine is off before working on the Implement.

*****UI /42+

WARNING!



Periodically inspect all moving parts for wear and replace when necessary with authorized service parts. Look for loose fasteners, worn or broken parts, and leaky or loose fittings. Make sure all pins are properly secured. Serious injury may occur from not maintaining this machine in good working order. *UI /43+



WARNING!



Always read carefully and comply fully with the manufacturers instructions when handling oil, solvents, cleansers, and any other chemical agent. *UI /44+



DANGER!



Never run the tractor engine in a closed building or without adequate ventilation. The exhaust fumes can be hazardous to your health.

*UI /45+

DANGER!



KEEP AWAY FROM ROTATING ELEMENTS to prevent entanglement and possible serious injury or death.

*****UI /46+



DANGER!



Never allow children to play on or around Tractor or Implement. Children can slip or fall off the Equipment and be injured or killed. Children can cause the Implement to shift or fall crushing themselves or others. *UI /47+

SAFETY

DANGER!



NEVER use drugs or alcohol immediately before or while operating the Tractor and Implement. Drugs and alcohol will affect an operator's alertness and coordination and therefore affect the operator's ability to operate the equipment safely. Before operating the Tractor or Implement, an operator on prescription or over-the-counter medication must consult a medical professional regarding any side effects of the medication that would hinder their ability to operate the Equipment safely. **NEVER** knowingly allow anyone to operate this equipment when their alertness or coordination is impaired. Serious injury or death to the operator or others could result if the operator is under the influence of drugs or alcohol. *UI /49+



DANGER!



Operate the Tractor and/or Implement controls only while properly seated in the Tractor seat with the seat belt securely fastened around you. Inadvertent movement of the Tractor or Implement may cause serious injury or death. *UI /4; +

WARNING!



Mow only in conditions where you have clear visibility in daylight or with adequate artificial lighting. Never mow in darkness or foggy conditions where you cannot clearly see at least 100 yards in front and to the sides of the tractor and mower. Make sure that you can clearly see and identify passersby, steep slopes, ditches, drop-offs, overhead obstructions, power lines, debris and foreign objects. If you are unable to clearly see this type of items discontinue mowing. *UI 0/3+

DANGER!



There are obvious and hidden potential hazards in the operation of this Mower. REMEMBER! This machine is often operated in heavy brush and in heavy weeds. The Blades of this Mower can throw objects if shields are not properly installed and maintained. Serious injury or even death may occur unless care is taken to insure the safety of the operator, bystanders, or passersby in the area. Do not operate this machine with anyone in the immediate area. Stop mowing if anyone is within 100 yards of mower. *UI 0/4+



DANGER!



All Safety Shields, Guards and Safety devices including (but not limited to) - the Deflectors, Chain Guards, Steel Guards, Gearbox Shields, PTO integral shields, and Retractable Door Shields should be used and maintained in good working condition. All safety devices should be inspected carefully at least daily for missing or broken components. Missing, broken, or worn items must be replaced at once to reduce the possibility of injury or death from thrown objects, entanglement, or blade contact. *UI 0/5+

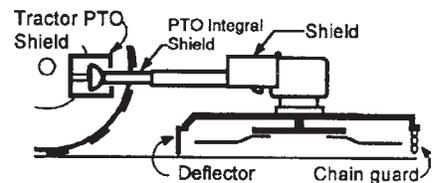

SAFETY

DANGER!



The rotating parts of this machine have been designed and tested for rugged use. However, the blades could fail upon impact with heavy, solid objects such as metal guard rails and concrete structures. Such impact could cause the broken objects to be thrown outward at very high velocities. To reduce the possibility of property damage, serious injury, or even death, never allow the cutting blades to contact such obstacles. *UI O/6+

WARNING!



Extreme care should be taken when operating near loose objects such as gravel, rocks, wire, and other debris. Inspect the area before mowing. Foreign objects should be removed from the site to prevent machine damage and/or bodily injury or even death. Any objects that cannot be removed must be clearly marked and carefully avoided by the operator. Stop mowing immediately if blades strike a foreign object. Repair all damage and make certain rotor or blade carrier is balanced before resuming mowing. *UI O/7+



WARNING!



Many varied objects, such as wire, cable, rope, or chains, can become entangled in the operating parts of the mower head. These items could then swing outside the housing at greater velocities than the blades. Such a situation is extremely hazardous and could result in serious injury or even death. Inspect the cutting area for such objects before mowing. Remove any like object from the site. Never allow the cutting blades to contact such items. **UI O/8+

WARNING!



Mow at the speed that you can safely operate and control the tractor and mower. Safe mowing speed depends on terrain condition and grass type, density, and height of cut. Normal ground speed range is from 0 to 5 mph. Use slow mowing speeds when operating on or near steep slopes, ditches, drop-offs, overhead obstructions, power lines, or when debris and foreign objects are to be avoided. *UI O/9+

WARNING!



Avoid mowing in reverse direction when possible. Check to make sure there are no persons behind the mower and use extreme care when mowing in reverse. Mow only at a slow ground speed where you can safely operate and control the tractor and mower. Never mow an area that you have not inspected and removed debris or foreign material. ***UI O/; +

WARNING!



Do not put hands or feet under mower decks. Blade Contact can result serious injury or even death. Stay away until all motion has stopped and the decks are securely blocked up. *UI O/; +



DANGER!



Replace bent or broken blade with new blades. NEVER ATTEMPT TO STRAIGHTEN OR WELD ON BLADES SINCE THIS WILL LIKELY CRACK OR OTHERWISE DAMAGE THE BLADE WITH SUBSEQUENT FAILURE AND POSSIBLE SERIOUS INJURY FROM THROWN BLADES. ****UI O/32+

SAFETY

WARNING!



Do not mow with two machines in the same area except with Cab tractors with the windows closed. *U O/33+

DANGER!



Rotary and Flail Mowers are capable under adverse conditions of throwing objects for great distances (100 yards or more) and causing serious injury or death. Follow safety messages carefully. **STOP MOWING IF PASSERSBY ARE WITHIN 100 YARDS UNLESS:**

- Front and Rear Deflectors are installed and in good, working condition;
- Mower Head is running close to and parallel to the ground without exposed Blades;
- Passersby are outside the existing thrown-object zone;
- All areas have been thoroughly inspected and all foreign material such as rocks, cans, glass, and general debris has been removed.



NOTE: Where there are grass and weeds high enough to hide debris that could be struck by the blades, the area should be: inspected and large debris removed, mowed at an intermediate height, inspected closely with any remaining debris being removed, and mowed again at desired final height. *UDO/3+

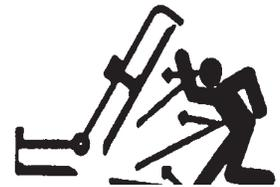

DANGER!



Use extreme caution when raising the Mower head. Stop the Blades from turning when the Mower Head is raised and passersby are within 100 yards. Raising the Mower head exposes the Cutting Blades which creates a potentially serious hazard and can cause serious injury by objects thrown from the Blades or by contact with the Blades. *****UDO/4+

DANGER!



Be particularly careful in transport. The Mower has raised the center of gravity for the tractor and has increased the possibility of overturn. Turn curves or go up slopes only at low speed and using a gradual turning angle. Slow down on rough or uneven surfaces. *UDO/5+



WARNING!



Never Leave the mower unattended while the head is in the raised position. The mower could fall causing serious injury to anyone who might inadvertently be under the mower. *****UDO/6+



WARNING!



The rotating parts of this machine continue to rotate even after the Tractor has been turned off. The operator should remain in his seat for 60 seconds after the brake has been set, the PTO disengaged, the tractor turned off, and all evidence of rotation has ceased. *UDO/7+

“Wait a minute...Save a life!”

SAFETY



Relieve hydraulic pressure prior to doing any maintenance or repair work on the Implement. Place the Mower Head on the ground or securely supported on blocks or stands, disengage the PTO, and turn off the engine. Push and pull the control Levers or Joystick several times to relieve pressure prior to starting any maintenance or repair work. *UDO /8+

DANGER!



Always keep a careful lookout and use extreme care when working around overhead obstructions. Never allow the Mower head or boom within 10 feet of any power line. When working close to overhead power lines consult your electric company for a safe code of operation. *UDO /9+

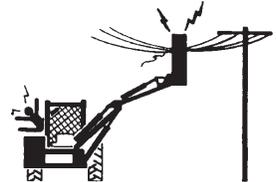

DANGER!



When transporting Boom Mower on a truck or trailer, the height or width may exceed legal limits when the boom is in the transport position. Contact with side or overhead structures or power lines can cause property damage or serious injury or death. If necessary lower boom to reduce height and/or remove mowing head to reduce width to the legal limits. *UDO /; +

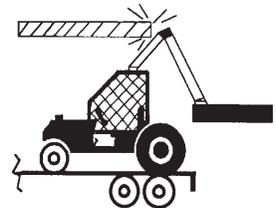

DANGER!



Never operate the Tractor and Mower Unit without an OPS (Operators Protective Structure) or Cab to prevent injury from objects thrown from ground or from overhead trimming. Stop mowing if workers or passersby are within 100 yards. *UDO /; +



DANGER!



Each Rear Wheel must have a minimum of 1500 pound contact with the surface to prevent lateral instability and possible tip-over which could result in serious bodily injury or even death. Widen the wheel tread and add weights if needed. Refer to the mounting instructions or call Customer Service if you need assistance with Counterweight Procedure. *UDO /33+



DANGER!



Always disconnect the wire leads from the mower pump solenoid before performing service on the Tractor or Mower. Use caution when working on the Tractor or Mower. Tractor engine must be stopped before working on Mower or Tractor. The Mower Blades could inadvertently be turned on without warning and cause immediate dismemberment, injury or death. ***UDO /34c+

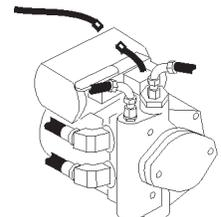

DANGER!



The flail cutter shaft is designed for standard rotation (same rotation as the tractor wheels during forward travel). **Never operate the cutter shaft in the reverse rotation.** Operating this mower in reverse rotation may cause objects to be thrown out the front of the mower head.



SAFETY

WARNING!



Engine Exhaust, some of its constituents, and certain components contain or emit chemicals known to the state of California to cause cancer and birth or other reproductive harm.

WARNING!



Battery posts, terminals and related accessories contain lead and lead compounds, chemicals known to the state of California to cause cancer and birth or other reproductive harm. **Wash hands after handling!**

Tiger mowers use balanced and matched system components for blade carriers, blades, cutter-shafts, knives, knife hangers, rollers, drive-train components and bearings. These parts are made and tested to Tiger specifications. Non-genuine “will fit” parts do not consistently meet these specifications. The use of “will fit” parts may reduce mower performance, void mower warranties and present a safety hazard. Use genuine Tiger mower parts for economy and safety.

SEE YOUR  DEALER

In addition to the design and configuration of this Implement, including Safety Signs and Safety Equipment, hazard control and accident prevention are dependent upon the awareness, concern, prudence, and proper training of personnel involved in the operation, transport, maintenance, and storage of the machine. Refer also to Safety Messages and operation instruction in each of the appropriate sections of the Tractor and Equipment Manuals. Pay close attention to the Safety Signs affixed to the Tractor and Equipment. (SG-18)

SAFETY

DANGER

FAILING TO FOLLOW SAFETY MESSAGES AND OPERATING INSTRUCTIONS CAN CAUSE SERIOUS BODILY INJURY OR EVEN DEATH TO OPERATOR AND OTHERS IN THE AREA.

1. 	2. NO RIDERS, NO CHILDREN OPERATORS 	3. USE SAFETY SHOES, HARD HAT, SAFETY GLASSES, SEAT BELTS, & ROPS 	4. BLOCK UP SECURELY BEFORE WORKING UNDER
---------------	--	--	--

1 Study and understand Operator's Manuals, Safety Signs, and Instructional Decals for tractor & flail mower to prevent misuse, abuse, & accidents. Practice before operating mower in a confined area or near passersby.

- Learn how to stop engine suddenly in an emergency. Be alert for passersby and especially children.

2 Allow no children on or near implement or tractor. Allow no riders on tractor or implement. Falling off can cause serious injury or death from being runover by tractor or mower or contact with Flail Mower Blades.

3 Operate only with tractor having Roll-Over Protective Structure (ROPS) and with seatbelt fastened securely and snugly to prevent injury and possible death from falling off or tractor overturn. Personal Protective Equipment such as Hard Hat, Safety Glasses, Safety Shoes, and Ear Plugs are recommended.

4 Block up or support raised machine and all lifted components securely before putting hands or feet under or working underneath any lifted component to prevent crushing injury or death from sudden dropping or inadvertent operation of controls. Make certain that area is clear before lowering or folding.

5 Before transporting, put Lift Lever in detent or full-lift position. Install Transport Safety Devices securely on folding implements. Slow down when turning and on hillsides.

- Install **Restrictor in folding circuit to slow down lowering and unfolding if action is faster than is desirable.

6 Make certain that SMV sign, Warning Lights, and Reflectors are clearly visible. Follow local traffic codes.

7 Never operate with Flail Mower or Folding Section raised if passersby, bystanders or traffic are in the area to reduce possibility of injury or death from objects thrown by Blades under Shields or implement structure.

8 Before dismounting, secure flail mower in transport position or lower to ground.

- Put tractor in park or set brake, disengage PTO, stop engine, remove key, and wait until noise of rotation has ceased to prevent entanglement in rotating parts which may cause injury or death.
- Never mount or dismount a moving vehicle. Crushing from runover may cause injury or death.

5. TRANSPORT SAFELY, LOCK UP 	6. USE SMV, LIGHTS, & REFLECTORS. 	7. DONOT OPERATE WITH MOWER OR WING RAISED 	8. DO NOT MOUNT OR DISMOUNT WHILE MOVING
---	--	---	---

PART NO.
LOCATION

002369
HYDRAULIC TANK

PELIGRO

Si No Lee Ingles. Pida Ayuda a Alguien Que Si Lo Lea. Para Que le Traduzca las Medidas de Seguridad.

LEA EL INSTRUCTIVO

00725746

00725746
INSIDE OF CAB

DANGER

THROWN OBJECTS

CUTTING BLADES

KEEP AWAY - ROTATING BLADES

BEING HIT BY THROWN OBJECTS OR CONTACTING ROTATING BLADES CAN CAUSE INJURY OR DEATH.

- Stop mowing if passersby enter the area of thrown objects (See Operator's Manual).
- Use special care if Mower Head or Wing is raised off the ground. (See Manual).
- Operate only if all Guards-Deflectors are in place and in good condition.

00769737

00769737
MOWER DECK

SAFETY



PART NO.
LOCATION

00758194
MOWER DECK



02962764
MAIN BOOM, SECONDARY BOOM, MAIN FRAME



02962765
MAIN FRAME

02965262
HYDRAULIC TANK

SAFETY

DANGER

CUTTING BLADES



THROWN OBJECTS



PART NO.
LOCATION

02967668
MOWER DECK

KEEP AWAY - ROTATING BLADES

BEING HIT BY THROWN OBJECTS OR CONTACTING ROTATING BLADES CAN CAUSE INJURY OR DEATH

- Stop mowing if passersby enter the area of thrown objects. (See Operator's Manual)
- Use special care when Flail or Wing is raised off the ground. (See Oper. Manual)
- Operate only if all Guards-Deflectors are in place and in good condition.

02971123
HYDRAULIC TANK



03200285
OUTSIDE OF CAB

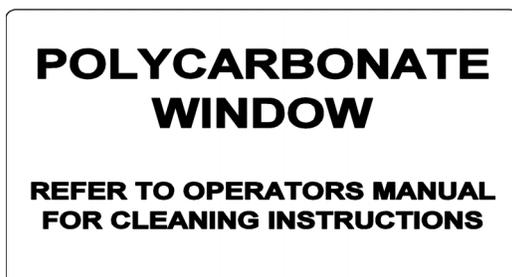

22645
INSIDE OF CAB

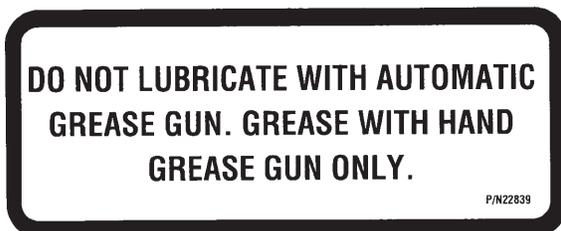

22839
MOWER DECK

SAFETY



PART NO.
LOCATION

22840
INSIDE OF CAB



24028
MOWER DECK

25387
INSIDE OF CAB



10" x 5.5" 31522
MOWER DECK, MAIN BOOM
18.25" x 10" 31523
HYDRAULIC TANK
13.5" x 7" 31513

SAFETY

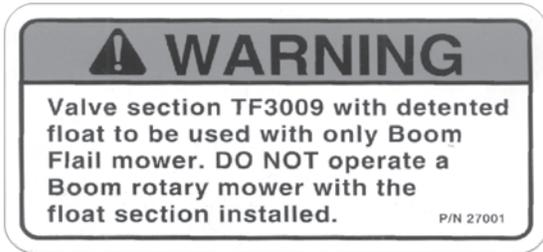

PART NO.
LOCATION

27001
INSIDE OF CAB



31935
INSIDE OF CAB

DANGER

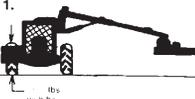
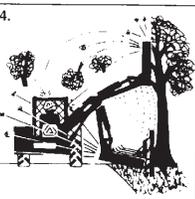
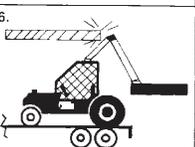
1. EACH REAR WHEEL MUST HAVE A MINIMUM OF 1500 POUNDS CONTACT WITH THE SURFACE TO PREVENT LATERAL INSTABILITY AND POSSIBLE TIP-OVER WITH BODILY INJURY. WIDEN WHEEL TREAD AND ADD WEIGHTS IF NEEDED. SEE MANUAL OR CALL TIGER CUSTOMER SERVICE FOR COUNTERWEIGHT PROCEDURE.
 
2. TRANSPORT CAREFULLY! SLOW DOWN EVEN MORE ON SLOPES AND WHEN TURNING; NEVER TURN UP A SLOPE SHARPLY OR AT HIGH SPEED; AND USE EXTRA CARE IN ROUGH OR BUMPY AREAS TO PREVENT OVERTURN AND POSSIBLE CRUSHING INJURY OR DEATH. IF YOUR VIEW TO THE REAR IS BLOCKED, IT IS YOUR RESPONSIBILITY TO INSTALL MIRRORS THAT PROVIDE A REAR VIEW TO PREVENT ACCIDENTS FROM BLIND SPOTS.
 
3. REAR-MOUNTED BOOM MOWERS MOVE CENTER OF GRAVITY TO THE REAR AND REMOVE WEIGHT FROM FRONT WHEELS. ADD FRONT BALLAST UNTIL AT LEAST 20% OF TRACTOR'S WEIGHT IS ON FRONT WHEELS TO PREVENT REARING UP, LOSS OF STEERING CONTROL, AND POSSIBLE INJURY.
 
4. NEVER OPERATE UNIT WITHOUT AN OPS (OPERATOR PROTECTIVE STRUCTURE) OR CAB TO PREVENT INJURY FROM OBJECTS THROWN FROM GROUND AND OVERHEAD TRIMMING. STOP CUTTING IF ANYONE IS WITHIN 100 YARDS.
 
5. KEEP THE BOOM AND CUTTERHEAD AT LEAST 10 FEET FROM ELECTRIC LINES AND PIPE LINES TO PREVENT ACCIDENTAL CONTACT AND POSSIBLE SERIOUS INJURY OR EVEN DEATH.
 
5. WHEN TRANSPORTING BOOM MOWERS ON A TRUCK OR TRAILER, THE HEIGHT OR WIDTH MAY EXCEED LEGAL LIMITS. CONTACT WITH SIDE OR OVERHEAD STRUCTURES OR POWER LINES CAN CAUSE SERIOUS INJURY OR DEATH. LOWER BOOM TO REDUCE HEIGHT AND/OR REMOVE MOWING HEAD TO REDUCE WIDTH TO THE LEGAL LIMITS, IF NEEDED. 32707
 

32707
HYDRAULIC TANK



42350
MOWER DECK

SAFETY

ATTENTION

**SERVICE HYDRAULIC SYSTEM
WITH UNIVERSAL TRACTOR
HYDRAULIC OIL.**

32708

PART NO.
LOCATION

32708
HYDRAULIC TANK

CAUTION

For your safety and to guarantee optimum product reliability, always use genuine TIGER replacement parts. The use of inferior "will-fit" parts will void warranty of your TIGER implement and may cause premature or catastrophic failure which can result in serious injury or death. If you have any questions concerning the repair parts you are using, contact TIGER, 3301 N. LOUISE AVE., SIOUX FALLS, SD 57107

32709

32709
INSIDE OF CAB

33224
MOWER DECK

Tiger™

33438
MAIN BOOM

SAFETY

PART NO.
LOCATION

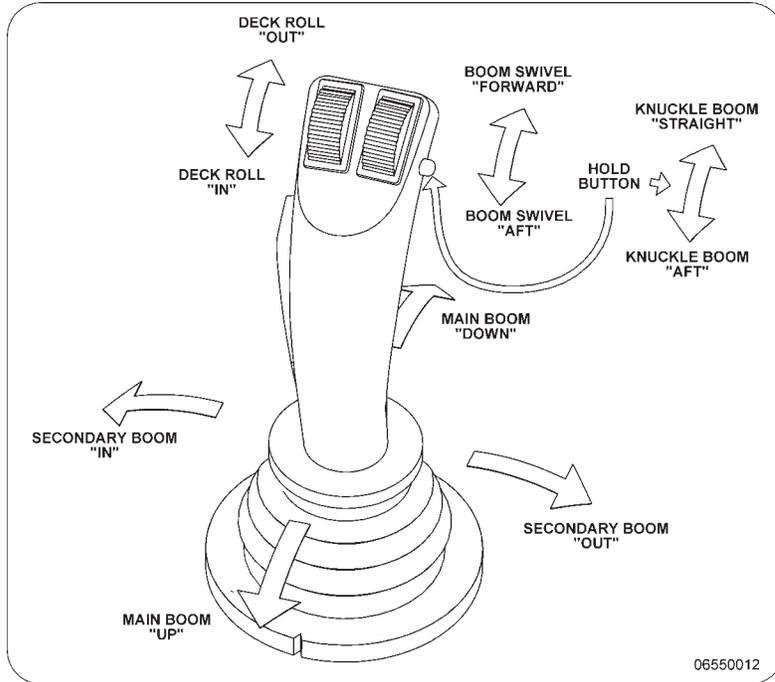

06550012
INSIDE OF CAB

MOWING SAFETY TIPS

- 1 Read & understand the Operators Manual.
- 2 Wear Your Seat Belt.
- 3 Keep all shields and guards in place.
- 4 Make sure equipment is in proper working condition.
- 5 Never attempt to get off or on a moving tractor.
- 6 Never allow riders on tractor or equipment.
- 7 Only start the tractor from the seat with the key.
- 8 Always inspect the area before mowing. Remove all foreign debris.
- 9 Always keep bystanders and coworkers a minimum of 300 feet away.
- 10 Never allow the mower blades to contact solid objects or foreign material.
- 11 Never approach rotating elements.
- 12 Disengage the PTO, place transmission in "Park", set parking brake, shut off engine, and remove key and wait until all rotating motion has stopped before leaving seat.

Tiger

33743

33743
INSIDE OF CAB

SAFETY

PART NO.
LOCATION



RED 42399
REFLECTIVE TAPE
MOWER DECK



AMBER 424006
REFLECTIVE TAPE
MOWER DECK



6T3217
MOWER DECK



6T3219
INSIDE OF CAB

6T3220
FRONT PUMP MOUNT

SAFETY



PART NO.
LOCATION

6T3221
INSIDE OF CAB

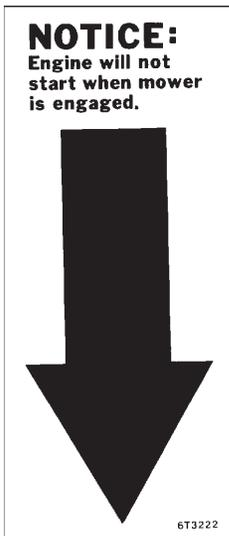

6T3222
INSIDE OF CAB



6T3224
MOWER DECK

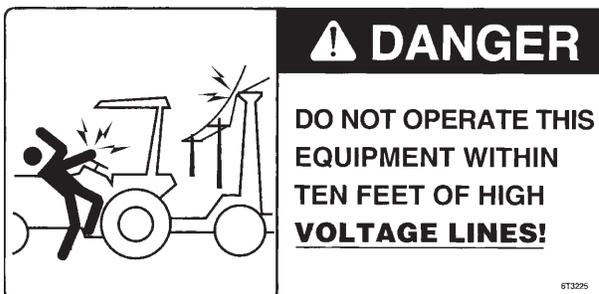

6T3225
INSIDE OF CAB

SAFETY

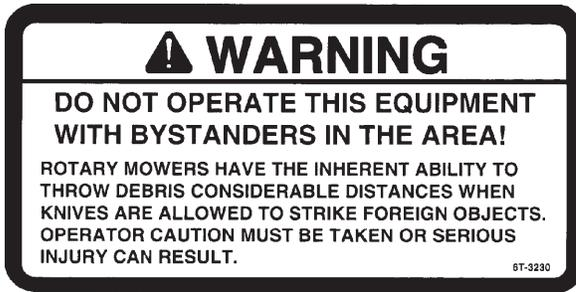

PART NO.
LOCATION

6T3230
INSIDE OF CAB



6T3231
INSIDE OF CAB



6T3233
HYDRAULIC TANK



6T3234
INSIDE OF CAB



6T3236
MOWER DECK

SAFETY

⚠ WARNING

WHEN CUTTING HEAVY BRUSH,
BLADE BOLTS SHOULD BE
INSPECTED HOURLY AND
RETORQUED TO 600 FT. LBS.

6T-3237

6T3237

PART NO.
LOCATION
6T3237
INSIDE OF CAB

<p>DOWN ↑ MAIN BOOM ↓ UP</p> <p><small>06650008</small></p>	<p>OUT ↑ SECONDARY BOOM ↓ IN</p>	<p>OUT ↑ DECK ROLL ↓ IN</p>	<p>CLOSE ↑ SHIELD ↓ OPEN</p>	<p>FORWARD ↑ SWIVEL ↓ AFT</p>	<p>IN ↑ SWITCH / KNUCKLE ↓ OUT</p>
---	--	---	--	---	--

06550008
INSIDE OF CAB

<p>⚠ WARNING</p> <p>IT IS RECOMMENDED THAT THE BOLT AND LOCK NUT BE REPLACED WHENEVER BLADES ARE REPLACED. REPLACE THESE ANY TIME THEY ARE DAMAGED OR WORN AS FAILURE TO DO SO CAN LEAD TO BLADES COMING OFF CAUSING SERIOUS INJURY OR DEATH.</p>	<p>IMPORTANT</p> <ul style="list-style-type: none"> • WHEN REPLACING BLADES, IT IS RECOMMENDED THAT ALL BLADES BE REPLACED FOR PROPER BALANCE TO AVOID EXCESSIVE VIBRATIONS WHICH CAN DAMAGE SPINDLE ASSEMBLY. • SEE YOUR OPERATOR'S MANUAL FOR PROPER INSTALLATION INSTRUCTIONS. <p><small>6T-3243</small></p>
--	--

6T3243
INSIDE OF CAB

GREASING INSTRUCTIONS
CUTTER SHAFT BEARING

GREASE EVERY 8 HRS. OR DAILY

NOTE: If unusual environmental conditions exist-extreme temperatures, moisture, or contaminants-more frequent lubrication is required.

6T3249A

6T3249A
MOWER DECK

GREASING INSTRUCTIONS
GROUND ROLLER BEARING

GREASE EVERY 8 HRS. OR DAILY

NOTE: If unusual environmental conditions exist-extreme temperatures, moisture, or contaminants-more frequent lubrication is required.

6T3261

6T3261
MOWER DECK

SAFETY



WARNING

**DO NOT OPERATE MOWER
WITH SAFETY SHIELD REMOVED.**

TB1011

TB1011
MOWER DECK



Tiger Corporation

800-843-6849
www.tiger-mowers.com

Description	Application	General Specification	Recommended Lubricant
Tractor Hydraulics	Reservoir	JD-20C	Mobilfluid® 424
Mower Hydraulics Cold Temperatures 0°F Start-up Normal Temperatures 10°F Start-up Normal Temperatures 15°F Start-up High Operating Temperatures Above 90°F Ambient	Reservoir	ISO 46 Anti-Wear/ Low Temp JD-20C ISO 46 Anti-Wear ISO 100 Anti-Wear	Mobil DTE® 15M Mobilfluid® 424 Mobil DTE® 25 Mobil DTE® 18M
Flail Rear Gearbox	Reservoir	PAO Synthetic Extreme Pressure Gear Lube	Mobilube SHC® 75W-90, Mobil 1 Synthetic Gear Lubricant
Cutter Shaft and Ground Roller Shaft (Flail)	Grease Gun	Lithium Complex, NLGI 2 ISO 320	Mobilgrease® CM-S
Drive Shaft Coupler (Rotary and Flail) Drive Shaft Yoke, U - Joint and Stub Shaft	Grease Gun	Lithium Complex, NLGI 2 ISO 320	Mobilgrease® CM-S
Boom Swivel, Boom Cylinder Pivots (Rotary and Flail Boom Type)	Grease Gun	Lithium Complex, NLGI 2 ISO 320	Mobilgrease® CM-S
Deck Boom Pivot & Deck Stop Adjustment (Rotary and Flail)	Grease Gun	Lithium Complex, NLGI 2 ISO 320	Mobilgrease® CM-S
Deck Spindle (Rotary)	Grease Gun	Tiger Spindle Lubricant	Tiger Part #25351

For Mobil product information, availability, or technical information, call 1-800-662-4525.

Tiger PN 34852

34852
HYDRAULIC TANK

SAFETY

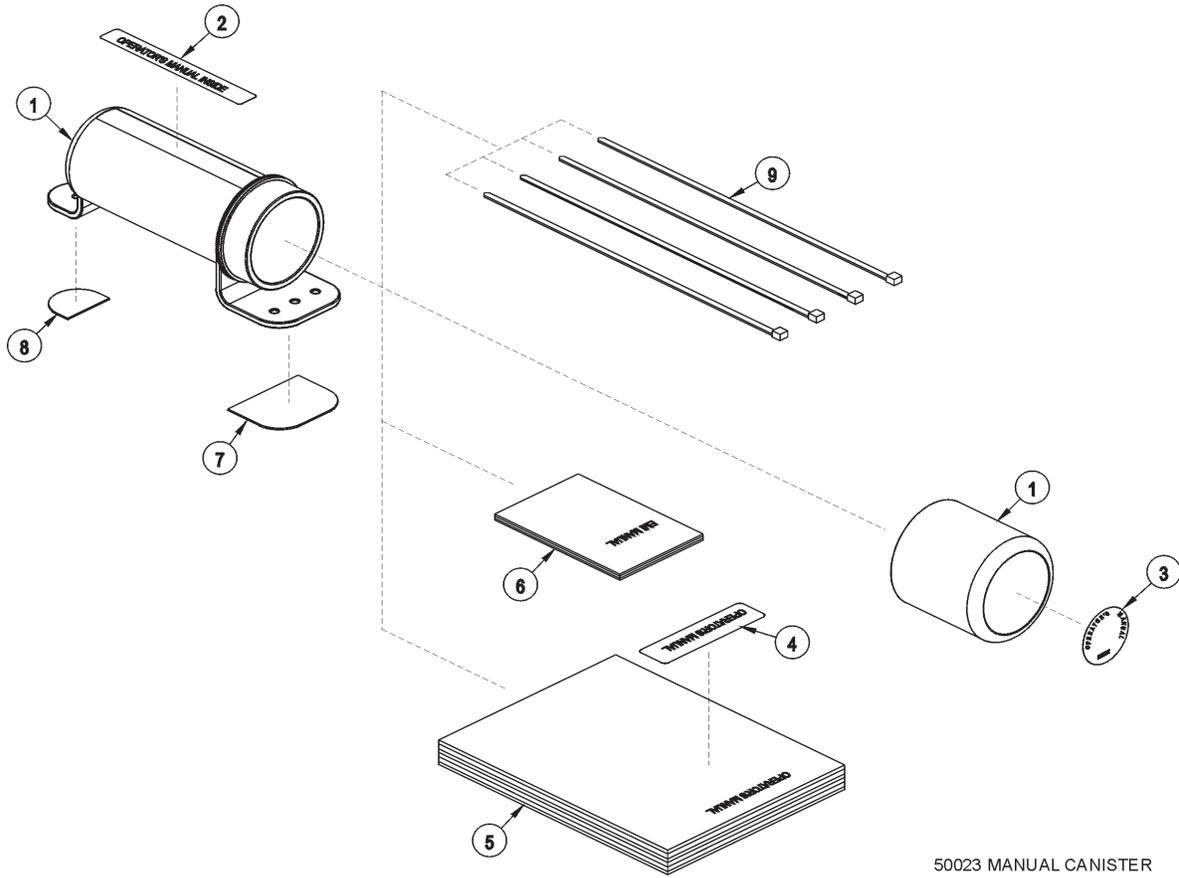

50023 MANUAL CANISTER

ITEM	PART NO.	QTY.	DESCRIPTION
	50023	AVAIL	MANUAL CANISTER COMPLETE
1	00776031	1	ROUND MANUAL CANISTER
	33997	1	DECAL, SHEET, MANUAL CANISTER
2		*	DECAL
3		*	DECAL
4		*	DECAL
5	*	AVAIL	SPECIFIC PRODUCT MANUAL
6	33753	1	E M I SAFETY MANUAL
7	34296	1	FRONT ADHESIVE PAD
8	34297	1	REAR ADHESIVE PAD
9	6T1823	4	ZIP TIE 14" LONG

NOTE:

The manual canister can be bolted, zip tied or adhered to a variety of surfaces. Locate a protected area within the view of the operator. Then select an installation method and attach the canister. **CAUTION - AVOID DRILLING HOLES INTO UNKNOWN AREAS**, wires and other parts may be located behind these areas. When adhering the canister to a surface, thoroughly clean that surface before installing the canister.

SAFETY

FEDERAL LAWS AND REGULATIONS

This section is intended to explain in broad terms the concept and effect of federal laws and regulations concerning employer and employee equipment operators. This section is not intended as a legal interpretation of the law and should not be considered as such.

Employer-Employee Operator Regulations

U.S. Public Law 91-596 (The Williams-Steiger Occupational and Health Act of 1970) OSHA

This Act Seeks:

“...to assure so far as possible every working man and woman in the nation safe and healthful working conditions and to preserve our human resources...”

DUTIES

Sec. 5 (a) Each employer-

(1) shall furnish to each of his employees employment and a place of employment which are free from recognized hazards that are causing or are likely to cause death or serious physical harm to his employees;

(2) shall comply with occupational safety and health standards promulgated under this Act.

(b) Each employee shall comply with occupational safety and health standards and all rules, regulations and orders issued pursuant to this Act which are applicable to his own actions and conduct.

OSHA Regulations

OSHA regulations state in part: “At the time of initial assignment and at least annually thereafter, the employer shall instruct every employee in the safe operation and servicing of all equipment with which the employee is, or will be involved.”

Employer Responsibilities:

To ensure employee safety during Tractor and Implement operation, it is the employer’s responsibility to:

1. Train the employee in the proper and safe operation of the Tractor and Implement.
2. Require that the employee read and fully understand the Tractor and Implement Operator’s manual.
3. Permit only qualified and properly trained employees to operate the Tractor and Implement.
4. Maintain the Tractor and Implement in a safe operational condition and maintain all shields and guards on the equipment.
5. Ensure the Tractor is equipped with a functional ROPS and seat belt and require that the employee operator securely fasten the safety belt and operate with the ROPS in the raised position at all times.
6. Forbid the employee operator to carry additional riders on the Tractor or Implement.
7. Provide the required tools to maintain the Tractor and Implement in a good safe working condition and provide the necessary support devices to secure the equipment safely while performing repairs and service.

Child Labor Under 16 Years of Age

Some regulations specify that no one under the age of 16 may operate power machinery. It is your responsibility to know what these regulations are in your own area or situation. (Refer to U.S. Dept. of Labor, Employment Standard Administration, Wage & Home Division, Child Labor Bulletin #102.)

SAFETY

ASSEMBLY SECTION

ASSEMBLY

Before attempting to mount your Tiger mower, it is important to read and understand all of the safety messages in the Safety Section of this manual.

Check complete shipment list against the packing list to make sure there are no shortages. Make certain the tractor model is the appropriate one for the mower received!



Always use a floor jack, hoist or fork lift to lift and raise heavy parts.

Read and understand the entire Assembly Section instructions before attempting to mount your Tiger mower. Refer to the Parts Section of this manual for detailed illustrations to locate all parts. (ASM-C-0001)

TRACTOR PREPARATION

- A. Remove right and left hand steps.
- B. Disconnect battery cables from both batteries.
- C. Remove engine side panels, or raise hood to access front pulley.
- D. Remove plugs from tractor casting where mainframe and pump mount will be attached.
- E. Remove any front weights and weight supports.
- F. Raise the tractor onto jack-stands and remove the right and left rear wheels.

(ASM-JD-0001)

CRANKSHAFT ADAPTER

If necessary, remove the four capscrews from the crankshaft pulley. Then install the crankshaft adapter to the pulley with capscrews and lockwashers as shown in the Parts Section.

(ASM-JD-0051)

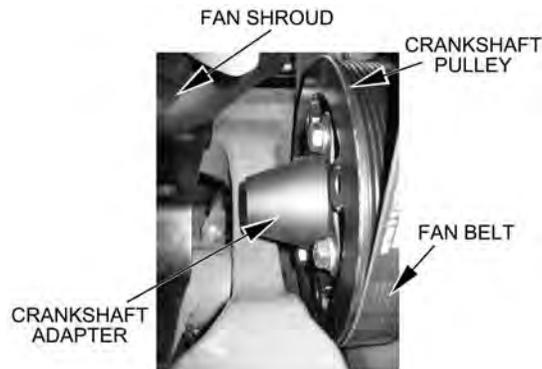

ASSEMBLY

FRONT CRANKSHAFT PULLEY

Tiger has found that the front crankshaft pulley used by John Deere will not allow for the installation of a front drive system. You will need to order a different pulley, washer and bolt from John Deere to allow for a front drive to be installed on your tractor.

Inspect the front pulley on your tractor to verify you have the correct pulley needed to mount the spacer plate. If your pulley has the (4) four holes needed to mount the spacer, your pulley is the correct one needed. If your pulley does not have the (4) four holes in the pulley, you will need to order the correct pulley, washer and bolt from John Deere.

PARTS REQUIRED TO PURCHASE FROM JOHN DEERE:

Pulley from JD - R516320

Washer from JD - R517237

Bolt from JD - R516648

Torque on the pulley bolt with locktite is 369 lb-ft.

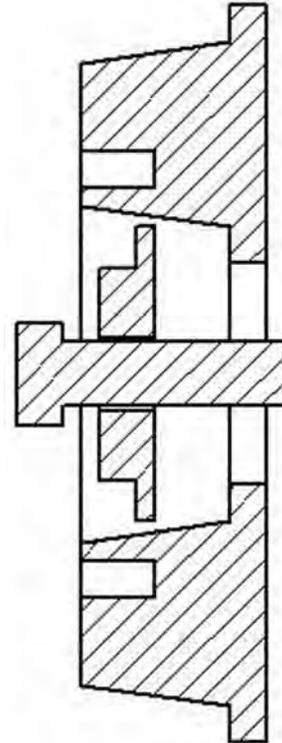
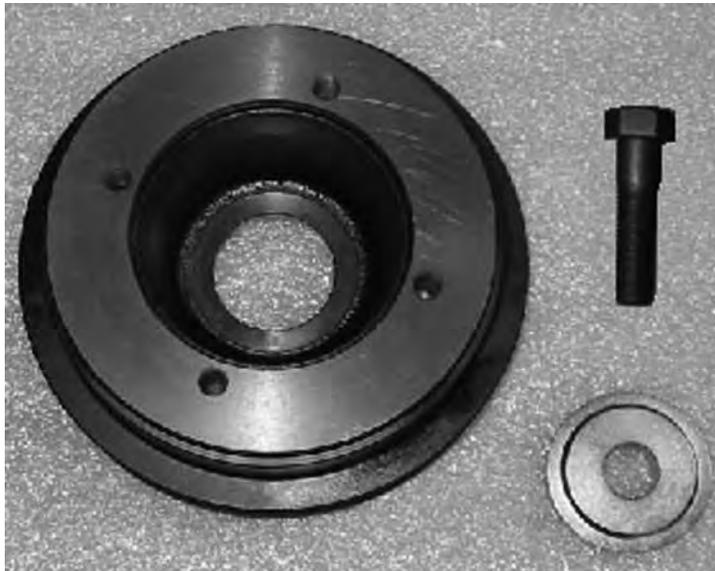

Solution:

1. Clean nose of crankshaft using TY16285 clean and cure primer.
2. Apply a light 2-3mm bead of TY15969 retaining compound around the leading edge of the crankshaft nose.
3. Dip damper mounting capscrew in clean SAE30 engine oil (Always use a new capscrew).
4. Position damper/pulley on the crankshaft and thread capscrew up tight (do not rely on the capscrew to pull the pulley straight onto the taper).
5. Tighten capscrew to specification 500Nm (369lb-ft) (the engine will most likely have to be pinned).
6. Measure run-out on the pulley, spec is 0.003" or less.

(ASM-JD-0080)



ASSEMBLY

DRIVESHAFT AND FRONT PUMP MOUNTING

Install spacer plate on tractor engine using bolts and lockwashers as shown in Parts Section. Grease sleeve section of the driveshaft and install from the side of the engine compartment. Once you have the sleeve section in place, bolt to spacer plate using bolts and lockwashers as shown in Parts Section. Install shaft end of driveshaft through opening and into driveshaft sleeve. Shaft and sleeve yokes should be aligned, if shaft does not insert easily in sleeve, turn shaft 180°, and then install. Align the notches on the shaft and yoke tube as shown in picture below. **Shaft end must be installed in correct orientation, failure to do so may result in damage to tractor and/or driveshaft.** After installation of shaft end, install pump mount. Next, install pump. After pump is secured, install driveshaft in to pump shaft. The end of driveshaft should be no more than 1/2" away from contact with pump housing. Tighten crimping bolt on driveshaft. Lube driveshaft and check all hoses, flanges, the pump, pump mount, driveshaft and mounting plate to ensure all fasteners are tightened before operation.

CAUTION: DO NOT START THE TRACTOR UNTIL ALL HOSES ARE ATTACHED, TANK IS FILLED WITH PROPER OIL AND BALL VALVES ARE OPEN! STARTING AT THIS TIME WILL CAUSE SERIOUS DAMAGE TO THE PUMP. (ASM-JD-0007)

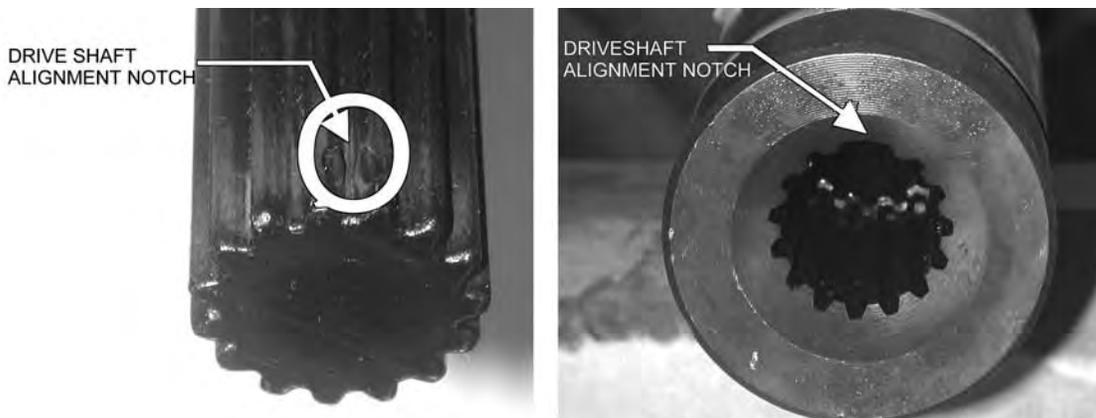

ADJUSTING REAR WHEELS

Raise rear of tractor onto jack-stands. **Follow the instructions in the tractor owner's manual for adjusting tires and rims.** The back wheels **MUST** be adjusted to the widest setting. NOTE: This may require switching the wheels to opposite sides of tractor. Also take note of any width restrictions when transporting by trailer. (For ease of installation, it is best to leave the rear wheels removed during installation of the mower.) (ASM-B-0001)



ASSEMBLY

POLYCARBONATE SAFETY WINDOW

NOTE: Installing a boom mower requires that all of the right side windows be replaced or protected with a polycarbonate window. This should be done before mounting the mainframe.

1. Disconnect gas shock at door. Remove the right side cab door/window glass from tractor cab by removing hinge pins. Also, remove rear right side window.
2. Remove the existing hardware and discard factory glass door and window.
3. Place small bead of adhesive seal in the bottom of the trim lock bubble seal.
4. Install trim lock bubble seal on polycarbonate starting at the center bottom horizontal portion.
5. Install existing hardware removed from glass door and window on the polycarbonate.
6. Install the polycarbonate assembly in the cab with existing and supplied hardware.
7. Place the retaining brackets on the upper front and lower front (if applicable) of the cab door/window with the 8mm capscrews.
8. Place the last bracket at the bottom of the door by the fender as shown in the illustration below. Hold the bracket in place and mark the door jam.
9. Drill a $21/64$ " hole in the door jam for the $5/16$ " capscrew and mount the bracket.
10. Install the right rear poly window into place where the factory window was removed (if applicable). (ASM-JD-0052)

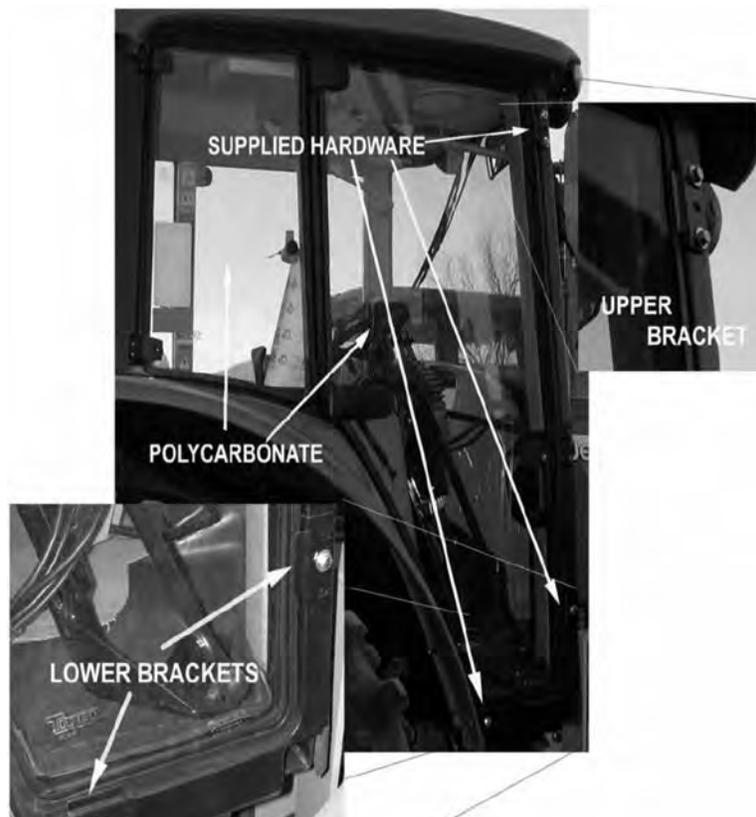

ASSEMBLY

PANORAMIC POLYCARBONATE SAFETY WINDOW

NOTE: Installing a boom mower requires that all of the right side windows be replaced or protected with a polycarbonate window. This should be done before mounting the mainframe. John Deere R series tractors require a panoramic safety window.

1. Disconnect gas shock at door. Remove the right side cab door/window glass from tractor cab by removing hinge pins.
2. Remove the existing hardware and discard factory glass door.
3. Place small bead of adhesive seal in the bottom of the trim lock bubble seal.
4. Install trim lock bubble seal on polycarbonate starting at the center bottom horizontal portion.
5. Install existing hardware removed from glass door and window on the polycarbonate.
6. Install the polycarbonate assembly in the cab with existing and supplied hardware.
7. Place the existing and supplied retaining brackets on the upper and lower front and rear of the panoramic cab window.
8. Locate the third fender screw from the bottom and place the retaining clip between the fender and the cab.
9. Apply RTV silicone liberally along the entire length of the top edge of the polycarbonate safety window. (JD-0052_pan)

APPLY RTV SILICONE ALONG ENTIRE TOP EDGE OF WINDOW



ASSEMBLY

SIDE MIRROR MOUNTING

Disassemble the right side mirror bracket. Cut the square rod and pipe (shown in picture below) 6-1/4". Assemble them together. Mount the right mirror bracket and hardware on the upper right corner of the tractor cab as shown in picture below. Refer the Parts Section-- safety screen, cab for hardware details. (ASM-JD7220-0001)

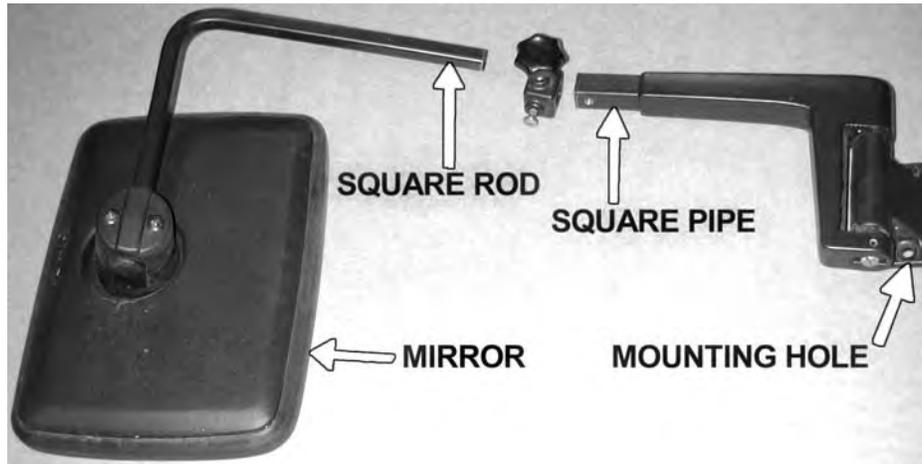

MAINFRAME INSTALLATION

With an overhead hoist and / or jack-stands, raise one side of the frame up to the correctly matching mounting holes. Install capscrews and all other hardware as shown in mainframe Parts Section to secure the sides of the mainframe to the tractor casting. DO NOT tighten at this time. Remove the capscrews one at a time and apply a thread locking agent. Reinsert the capscrews and tighten / torque to values noted in the torque chart located in the Maintenance Section of this manual. (ASM-C-0003)



ASSEMBLY

SWITCHBOX WIRING

Power for the switchbox is accessed through the port located on the right rear of the cab. A John Deere plug is used, part number RE67651. DO NOT connect the plug to the cab port until the wiring is completed. The wires in the plug are colored RED, BLACK and ORANGE. The RED wire will always be hot, so it needs to be capped. Attach connector 34538 to end of RED wire and tape wire back on itself. The BLACK and ORANGE wires are hot when tractor key is turned to "on". Connect the BLACK wire of the plug to the BLACK wire from the switchbox. Then connect the ORANGE wire of the plug to the RED wire from the switchbox. **IMPORTANT: In some cases the red and orange wires may be switched.** ALWAYS test the wires to be certain which wire is which.

The two GREEN wires must be connected to the neutral safety wire by cutting the neutral safety wire and connecting one GREEN wire to one end and the second GREEN wire to the other. Refer to the switchbox schematic and wiring diagram for additional information.

The Neutral Safety wire is a brown wire located under steering column. Cut a slot in the right side of column to access, WATCH OUT for existing wires.

After connecting the power to the switchbox, route the white wire along the cables or wires to the solenoid valve. (ASM-JD-0245)

WEATHER-PACK / METRI-PACK ASSEMBLY

These instructions apply to both Weather-Pack and Metri-Pack connectors.

NOTE: Use the specific tool for the type of connector you are assembling.

(ASM-C-0009)

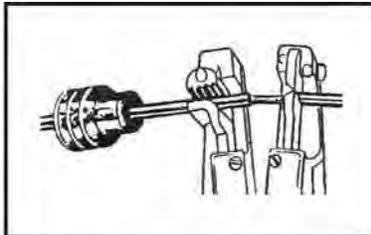

1. Apply seal to cable, before stripping insulation.



2. Align seal with cable insulation.

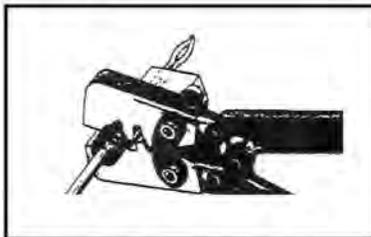

3. Put terminal in crimping tool, then position wire and seal in place.

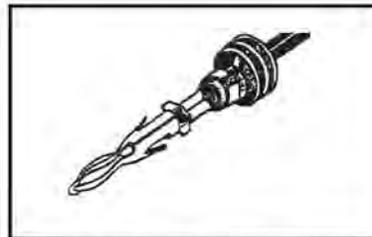

4. Crimp and visually inspect for a good crimp before installing in connector body.



ASSEMBLY

HYDRAULIC PORTS

These ports are located at the rear of the tractor, under the lift valve, where the valve mounting bracket attaches to the tractor. The load sense port is on top, then the pressure and finally the return port, as shown in the image below. Refer to the Parts Section for additional information. (ASM-JD60-7030-0004)

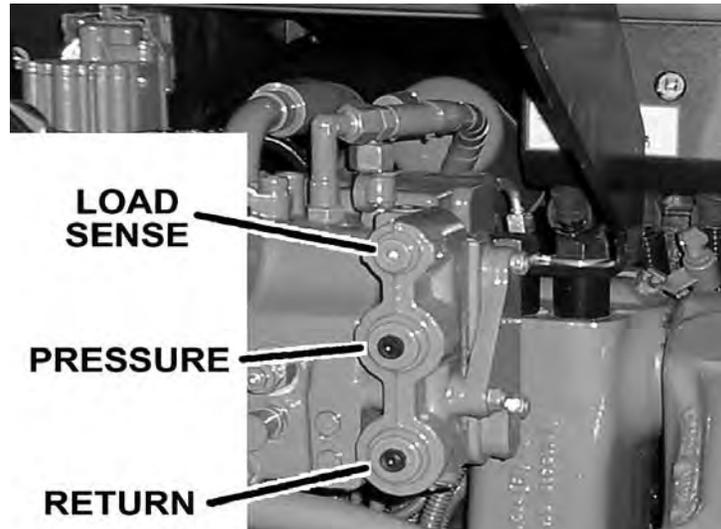

PRESSURE LINE INSTALLATION

The hydraulic pressure line will be plumbed into the rear of the tractor remote valve. Locate the pressure port on the rear remotes and remove the plug (refer to the Hydraulic Ports illustration and the Parts Section pages for position of the pressure port). After the plug is removed install 27mm adapter. Next, connect a 1/2" hose from the tractor remote valve to the Tiger valve. (ASM-27mmPRESSURE-0001)

RETURN LINE INSTALLATION

The return line will be plumbed next to the pressure line on the tractor remote valve. Locate the return port and remove the plug (refer to the Hydraulic Ports illustration and the Parts Section for the position of the return port). After the plug is removed install 27mm adapter or elbow. Next, connect a 1/2" hose from the tractor remote valve to the Tiger valve. (ASM-27mmRETURN-0001)

LOAD SENSE LINE INSTALLATION

The load sense line will be plumbed into the bottom of the tractor remote valve (refer to the Hydraulic Ports illustration and the Parts Section pages for the position of the load sense port). Locate the plug on the tractor rear remotes for the load sense, and remove the plug. Install a 14mm adapter or elbow and run a 1/4" hose from the remotes to the Tiger valve. Refer to the Parts Section pages for an exploded diagram of the tractor remote valve hookup. (ASM-14mmLOAD SENSE-0001)



ASSEMBLY

MANUAL LIFT VALVE PORTS

(ASM-C-0057)

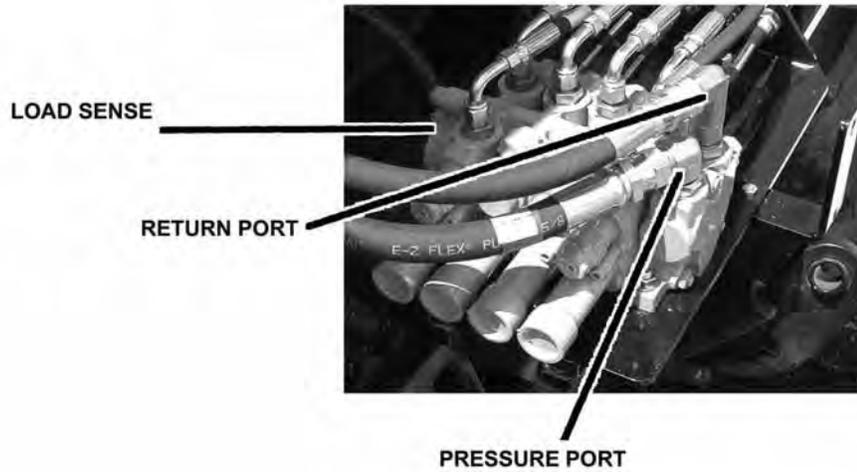

MANUAL SWITCHBOX MOUNTING

The switchbox is to be secured to the operator's side of the control handles, or valve stand. Refer to the Parts Section for assembly and components needed.

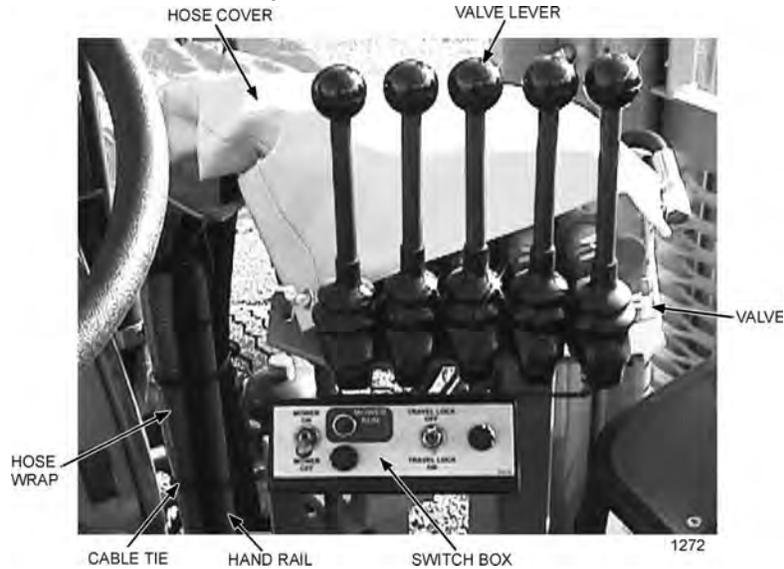

(ASM-C-0053)



ASSEMBLY

VALVE MOUNTING

The mounting bracket for JD 6xxxR series tractors features two long legs which need to be attached as shown in the photo below. Secure the bracket to the tractor with hardware shown in the Parts Section of the manual. Align the holes for the cables on the Husco control valves and center the Danfoss valve on the valve plate. Then align the holes on the valve with the plate holes and secure the lift valve on top of the mounting plate. Route the hydraulic lines from the lift valve to the hydraulic cylinders as noted on the lift valve page of the Parts Section. Install the control cables to the valve and the mounting plate on the Husco valves. On the Danfoss valves, attach the electrical control cables. (ASM-JD7X30-0001 JD6140R)

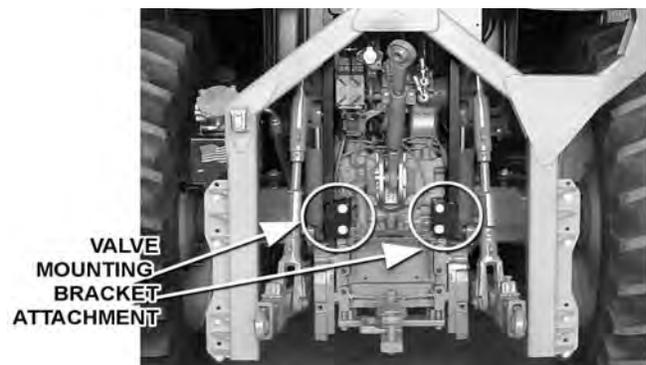
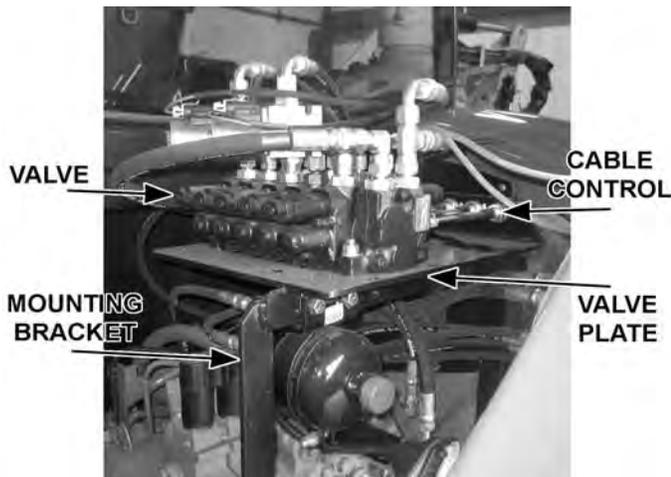

ASSEMBLY

CABLE CONTROL LEVER STAND

On the corner cab post, mark a point at 1-3/8" from the windshield and 22-1/2" from the floor; then cut a 3/4" diameter hole through the outer plastic shell. This will expose a threaded steel boss to attach the control box support bracket.

The rear corner of the cable control stand is placed approximately 6-1/4" from the edge of the mat. The front edge of the stand is up against the corner cab post and the door sill lip of the mat. Before you mark or drill any holes, check for support plates or wires under the mat and the cab floor.

NOTE: Cutting into plates or wires makes more work for everyone and could be dangerous. When you know where the wires/plates lie, mark one of the mounting holes. Drill a 3/8" hole through the mat and through the floor of the cab. Next, lift the mat up and mark the other two holes on the cab floor. Drill the holes through the floor. Mark the mat and drill the other two 3/8" holes.

Drill the holes through the floor. Mark the mat and drill the other two 3/8" holes.

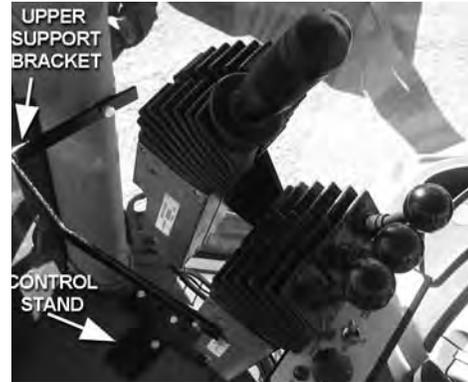

Use a 1" hole saw and cut a 1" hole through the mat over each 3/8" hole. Secure the stand to the floor with the spacers, capscrews and nylock nuts provided.

Secure cables and wires from the control stand with zip ties and route past the right side of the driver's seat. Drill a 2 1/4" diameter hole in the triangular area behind the driver's seat. Drill a hole to the outside rear of the tractor.

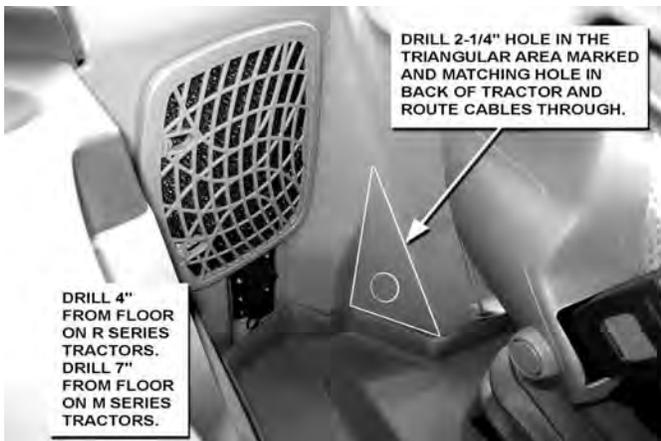

Wrap the cables with the 6" split hose at the point they pass through the hole, and secure the zip-ties. Apply RTV sealer in and around individual cables and split hose, inside and outside of the cab for a water tight seal. Install upper support bracket from cab post to the control lever stand. (ASM-JD CBL MNT-0002c)

STAND PLACEMENT

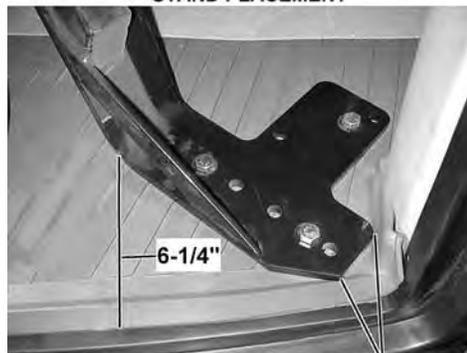

ASSEMBLY

NOTE ON HUSCO CONTROL VALVES

Manual, cable controlled (Husco control valve) boom mowers require check valves with integral restricting orifice (#06502036) installed in the control valve work ports that are connected to the gland ends of the main and secondary boom cylinders. This check valve allows oil to free flow into the gland end of the main and secondary boom cylinders, but restricts flow out of the cylinder, thereby providing proper boom control. This check valve, #06502036 (Vendor #1968R-.063) is similar in appearance to hose adapter #33271 and Adapter #34396, with .06 orifice. These components can be identified as follows, and are to be installed per Parts Section for the lift valve. (ASM-HUSCO-0001)

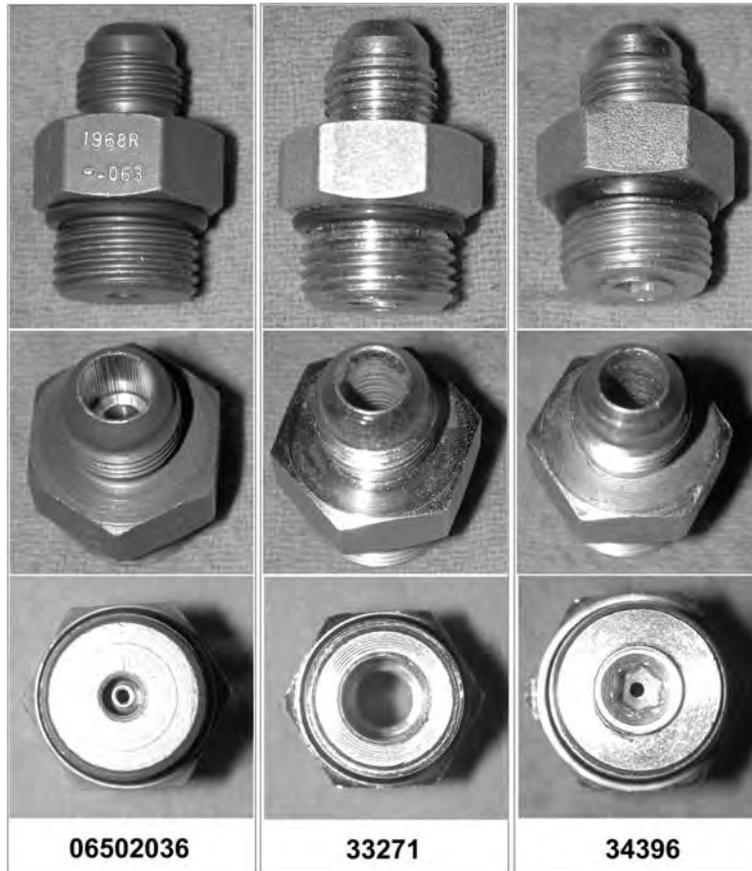

ASSEMBLY

ELECTRONIC LIFT VALVE PORTS

(ASM-C-0089)

DANFOSS VALVE

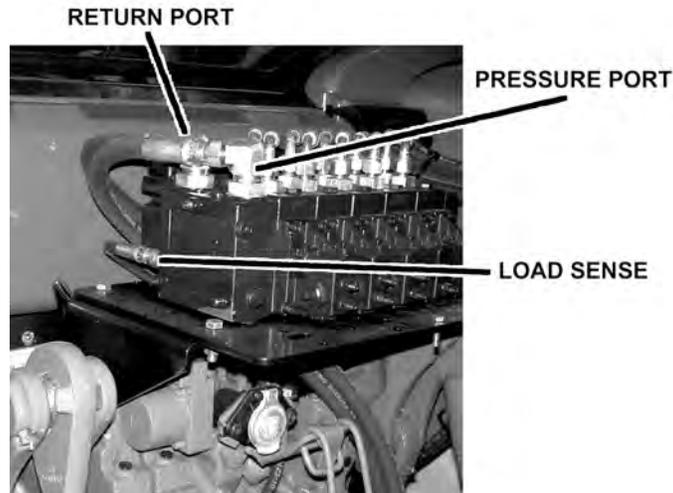

JOYSTICK SWITCHBOX MOUNTING

Locate the two holes in the right front corner of the cab frame. These will be the mounting holes for the two mounting bolts of the switchbox bracket. See picture below. Mount the bracket using the hardware supplied, as noted in the Parts Section. (ASM-JD-0081)

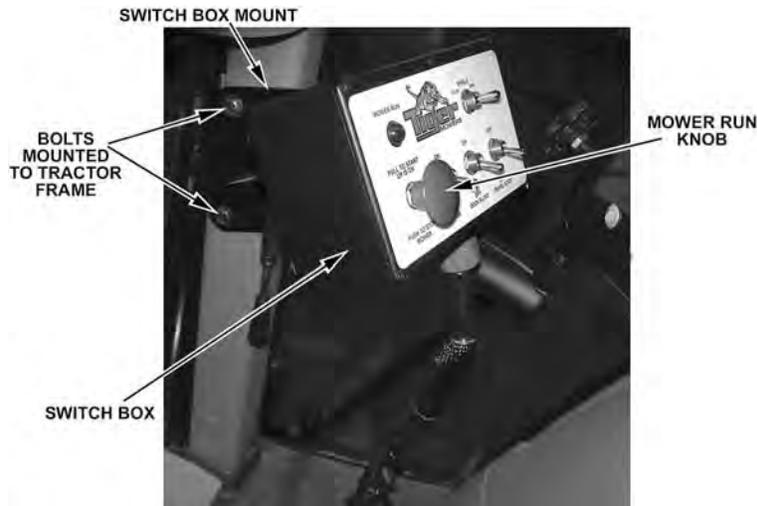

ASSEMBLY

JOYSTICK CONTROL MOUNTING

Mounting the joystick control requires that the right armrest be modified and an additional bracket attached to accommodate the joystick. The armrest must be removed by sliding off the plastic cover and removing the capscrew from the lower right side of the seat. This will leave the armrest loose so it can be removed. Once the armrest is removed, place the joystick holder under the armrest, so the indentation on the outside of the armrest is lined up with the hole in the armrest bracket which the capscrew will need to pass through. Once they are lined up, mark the armrest where the hole passes through the armrest bracket. A 1/2" hole must be drilled through the armrest so that the bracket can be secured. After the initial 1/2" hole is drilled, on the inside of the armrest the hole must be cut to a larger diameter up to the metal plate in the armrest, so that a spacer and hex nut can be fastened to the capscrew which will secure the bracket. Install the armrest bracket on the armrest with the hardware shown in the Parts Section. Once the bracket is installed, re-attach the armrest to the seat using the existing hardware previously removed. Then install the joystick in the bracket with the machine screws shown in the Parts Section. Route the lift valve wires from the switchbox through the cab and out the back window. Cover with conduit and secure with ties or clamps as necessary. (ASM-JD-0082)

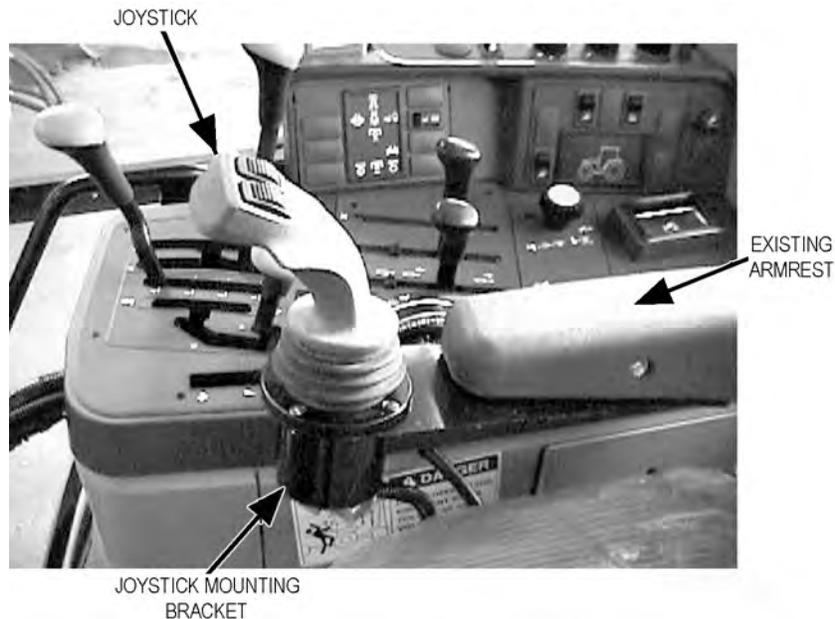

ASSEMBLY

BOOM JOYSTICK CONTROL CALIBRATION

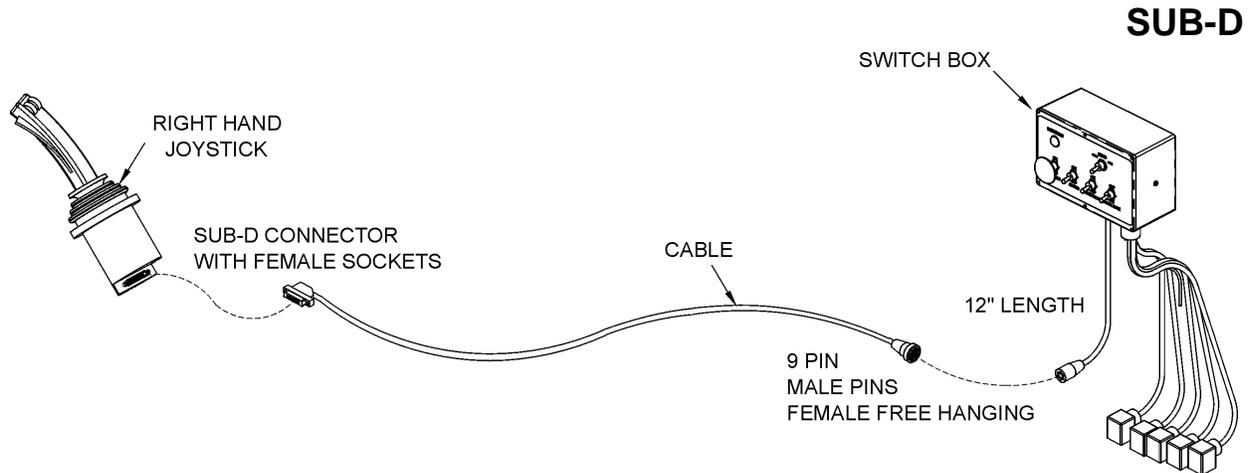

This Electronic control valve is now equipped with higher-resolution actuators on Main Boom, Secondary Boom, Deck Roll, and Swivel functions. These actuators have “active fault monitoring”. The Deck Shield section does not have “active fault monitoring”. The joystick is unchanged and provides a ratio-metric voltage signal. The neutral signal voltage is half or 50% of tractor supply voltage. A 25% signal voltage will shift the valve spool to full “A-Port”, and 75% signal voltage will shift the spool to full “B-Port” in the Main, Secondary, and Swivel valve sections. On the Deck Roll function a 34% signal voltage will shift the valve spool to full “A-Port” and a 68% signal voltage will shift the spool to full “B-port”. If an actuator with active fault monitoring receives a signal from the joystick that is less than 15% or greater than 85% of supply voltage the actuator will “fault out” and shut down. Also, if there is an internal failure in the actuator or if the spool position is greater than that specified by the signal voltage from the joystick, the actuator will “fault out” and shut down. An “active fault” condition causes the actuator to drive the spool to neutral, shut down, and activate a “red” LED on the top of the actuator. The active fault can be canceled by simply cycling the Master Switch “OFF” and then “ON”, which resets the fault monitoring, and causes the LED on top of the actuator be “green” again.



The joystick control is equipped with signal adaption potentiometers.

These provide the capability to individually adjust the oil flow to each boom function. It is important that the boom functions do not travel too fast. Excessive boom speed can reduce the stability of the unit and decrease operator control.

Note: Use a Phillips screw driver and be sure to adjust the screws carefully! DO NOT turn the potentiometers beyond their stopping point, potentiometers are very delicate! Turning the “A” or “B” port potentiometers clockwise increases the oil flow to increase the boom function speed, and turning them counterclockwise decreases the oil flow to decrease the boom function speed. See the graphic on the next few pages for help in adjusting.



ASSEMBLY

BOOM JOYSTICK CONTROL CALIBRATION (CONTINUED)

Run tractor at normal operating RPM to adjust the settings as follows.

Set the dead band compensation potentiometer first.

Set the dead band compensation potentiometer at 50%, or halfway between full clockwise and full counter-clockwise.

Setting Signal Adaptation Potentiometers:

Disconnect the Deutsch connectors from the actuators of the valve. Use a Volt/Ohm meter to measure signal voltage and adjust the signal adaptation potentiometers as needed. Pin #4 is tractor supply voltage. Pin #1 is signal voltage from the joystick, and pin #3 is ground. First, measure supply voltage between pins 4 and 3. Then measure signal voltage between pins 1 and 3 while indexing the joystick function fully in both the "A" and "B" port direction. Divide the signal voltage by the supply voltage to get signal voltage as a % of supply voltage. This percentage should not be less than 25% or greater than 75% for the Main Boom, Secondary Boom, or Swivel function. This percentage should not be less than 30% or greater than 62% for the Deck Roll function. Note these initial settings for the Deck Roll function should prevent the spool from shifting into float. *After making this first adjustment to deck roll if the spool still goes into float, adjust the "B" port screw additionally counterclockwise.*

Reconnect Deutsch connectors on control cables to actuators on Electronic valve. Run tractor until hydraulic system is at operating temperature. Now refine the adjustments of the signal adaptation potentiometers for both "A" and "B" ports for all proportional functions to achieve the following function times. Note: turning potentiometer clockwise increases the flow or the function speed, and turning them counter-clockwise decreases the flow or the function speed. Note, if during this procedure the trim potentiometer is set to full "counterclockwise" but the function is still too fast, use the mechanical stops at the manual actuator end of the valve section to further limit flow. Turn limit screw in or clockwise to limit flow. The upper limit screw limits flow to "B-port", and the lower limit screw limits flow to "A-port". However DO NOT adjust the limit screw on "B-port" of deck roll function. Limiting "B-port" will prevent "float" function.



ASSEMBLY

BOOM JOYSTICK CONTROL CALIBRATION (CONTINUED)

MAIN BOOM: “A” Port, Boom Up: 8-10 Seconds

(Note: Extend secondary boom completely; roll deck to be level with ground, and lower main boom until deck is on ground. Now index main boom “up” function and determine the time required for main boom to rise completely.)

“B” Port, Boom Down: 6-8 Seconds

(Note: Extend secondary boom completely, roll deck to be level with ground, and raise the main boom to “full up”. Then index the main boom “down” function to determine the amount of time required for the deck to contact the ground. CAUTION: Stop the boom just as the deck contacts the ground.)

SECONDARY

BOOM: “A” Port, Boom Out: 8-10 Seconds

(Position main boom full up, roll deck out until deck cylinder is fully retracted, and bring secondary boom in completely. Then index the secondary boom “out” function and determine the time required for boom to extend out completely.)

“B” Port, Boom In: 8-10 Seconds

(Position the main boom full up, roll deck out until deck cylinder is fully retracted, and extend secondary boom completely. Then index the secondary boom “in” function and determine the time required for boom to come in.)

DECK ROLL: “A” Port, Deck Out: 7-9 Seconds

(Raise main boom to vertical, extend secondary boom out slightly so that deck can be articulated without contacting the main boom, and roll deck in until deck cylinder is completely extended. Then index the deck roll “out” function and determine the time required for the deck to roll out.)

“B” Port, Deck In: Target 7-9 Seconds (but DO NOT use Limit Screw)

(Raise main boom to vertical, extend secondary boom out slightly so that deck can be articulated without contacting the main boom, and roll deck out until deck cylinder is completely retracted. Then index the deck roll “in” function and determine the time required for the deck to roll in.)

BOOM

SWIVEL: “A” Port, Boom Aft: 14-16 Seconds for 3PS, 3OS, SS

(Extend booms completely; rotate head to be level with ground, lower main boom until deck is just above ground, and swivel boom full forward. Then index the boom swivel “aft” function and determine the time required for the boom to swivel full aft. Use caution when doing this, stop boom before main boom contacts tire.)

“B” Port, Boom Forward: 14-16 Seconds for 3PS, 3OS, SS

(Extend booms completely, rotate head to be level with ground, lower main boom until deck is just above ground, and swivel boom aft until near tire. Then index the boom swivel “forward” function and determine the time required for the boom to swivel full forward.)

(ASM-C-0082)



ASSEMBLY

BOOM JOYSTICK DIAGRAM (ASM-C-0082A)

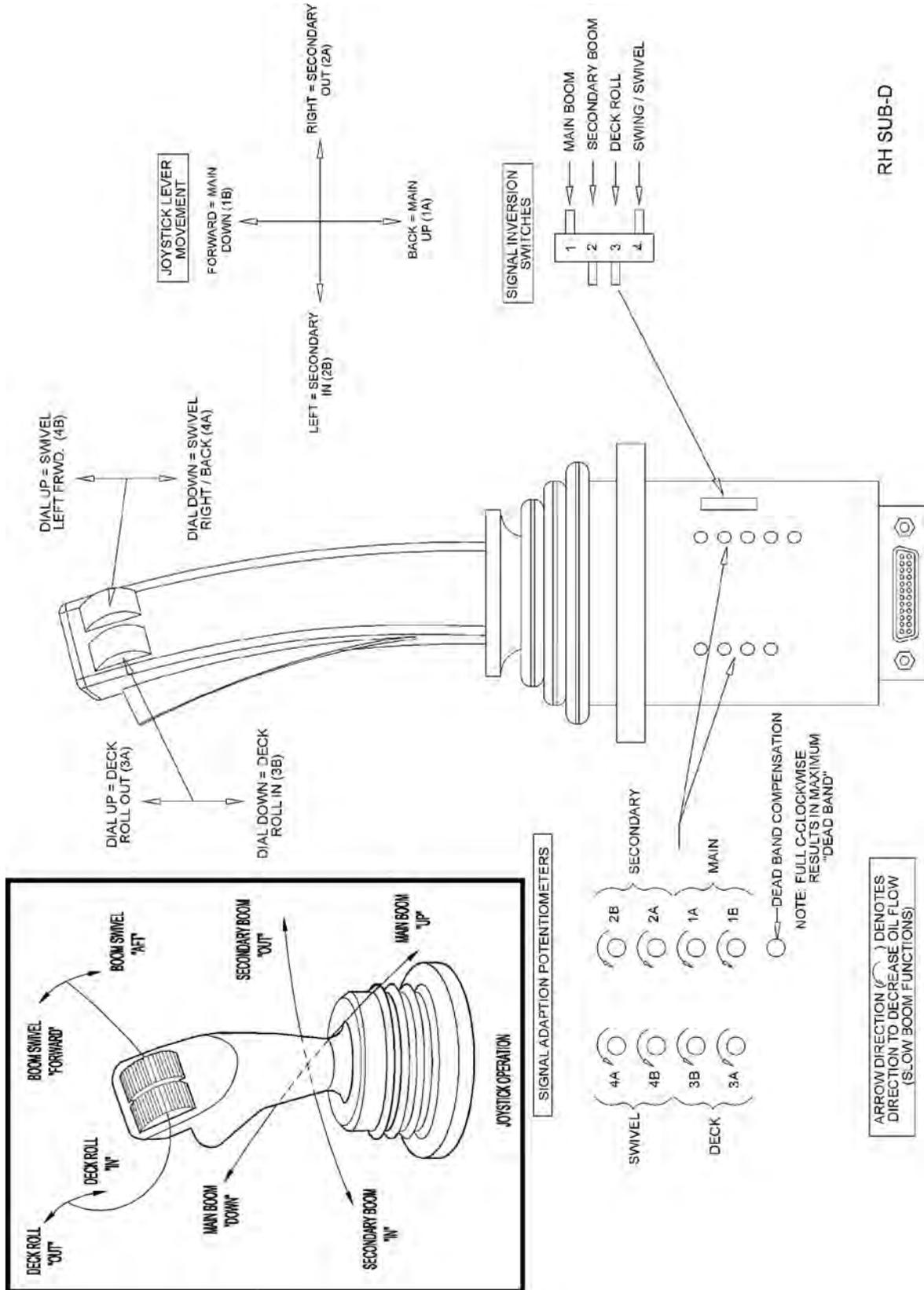

ASSEMBLY

REAR STOW BENGAL HOSE ROUTING

WARNING NOTE: The sudden release of hydraulic pressure could cause the sudden movement of very heavy parts. Anyone in the way of these parts could be severely hurt or killed. DO NOT ALLOW these hydraulic hoses to BREAK or BURST. To prevent hydraulic failure make sure the hoses do not pinch or stretch as boom moves. Measure TWICE, check TWICE then proceed with caution.



Route the hoses through the space between the swivel and the mainframe. Connect the hoses to the brake valve. Assemble the swivel clamp and place the return hose for the motor in the middle and the pressure line on the bottom. Place the 1/4" hoses in the top clamp and wrap the hoses with a split hose before tightening the clamp. If not all of the 1/4" hoses fit, route two of the hoses above the clamp and secure them to the other hoses with a zip tie. Make sure there is enough slack for all hoses to pivot at the joint where the main boom arm bends in the swivel, and tighten the hoses in the clamp. Wrap the hoses on either side of the clamp with the hose wrap. This will protect the hoses from abrasion and heat. (ASM-T4 HOSE ROUTING-0001)



ASSEMBLY

REAR STOW BENGAL HOSE ROUTING (CONT.)

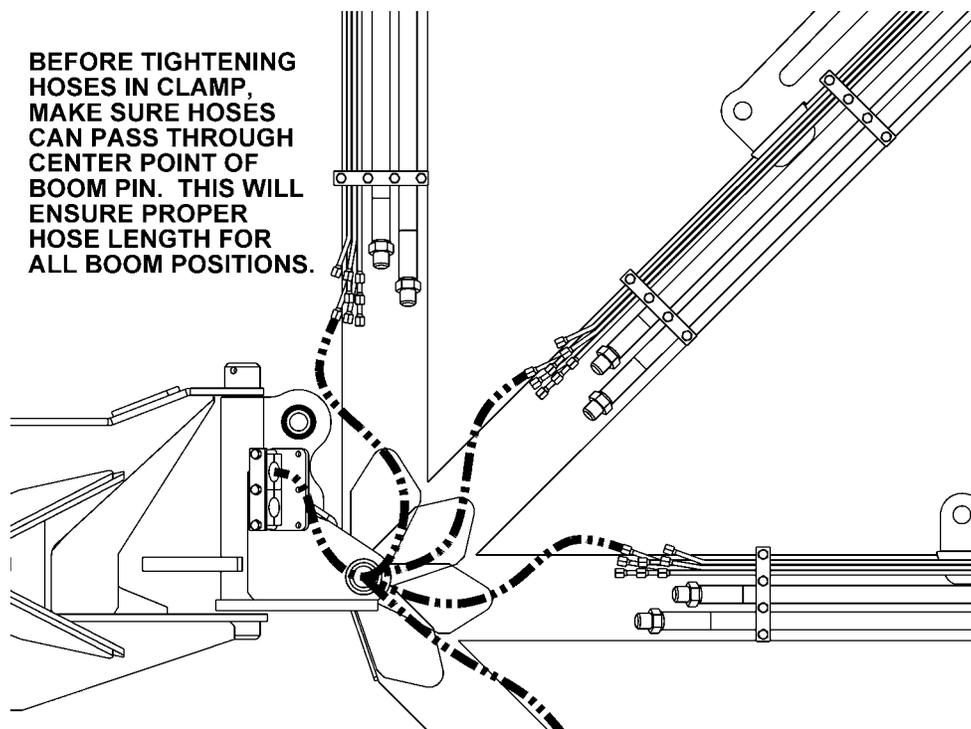

Arrange the hoses in the clamp that attaches to the boom mounting bracket as shown above, with the 1" motor hoses closest to the bracket and the return hose closest to the boom arm. Pull the hoses snug from the swivel to the mounting bracket clamps, when main boom is still forward, and tighten the hoses in the clamp.

Make sure the 1" motor hoses do not kink as the boom arm is moved into the stowing position. If this happens the motor hoses will have to be shortened, because there is too much hose between clamps. (ASM-30S, 3PS HOSE ROUTING-0001B)



ASSEMBLY

(ASM-C-0023)

BOOM HYDRAULIC DIAGRAM

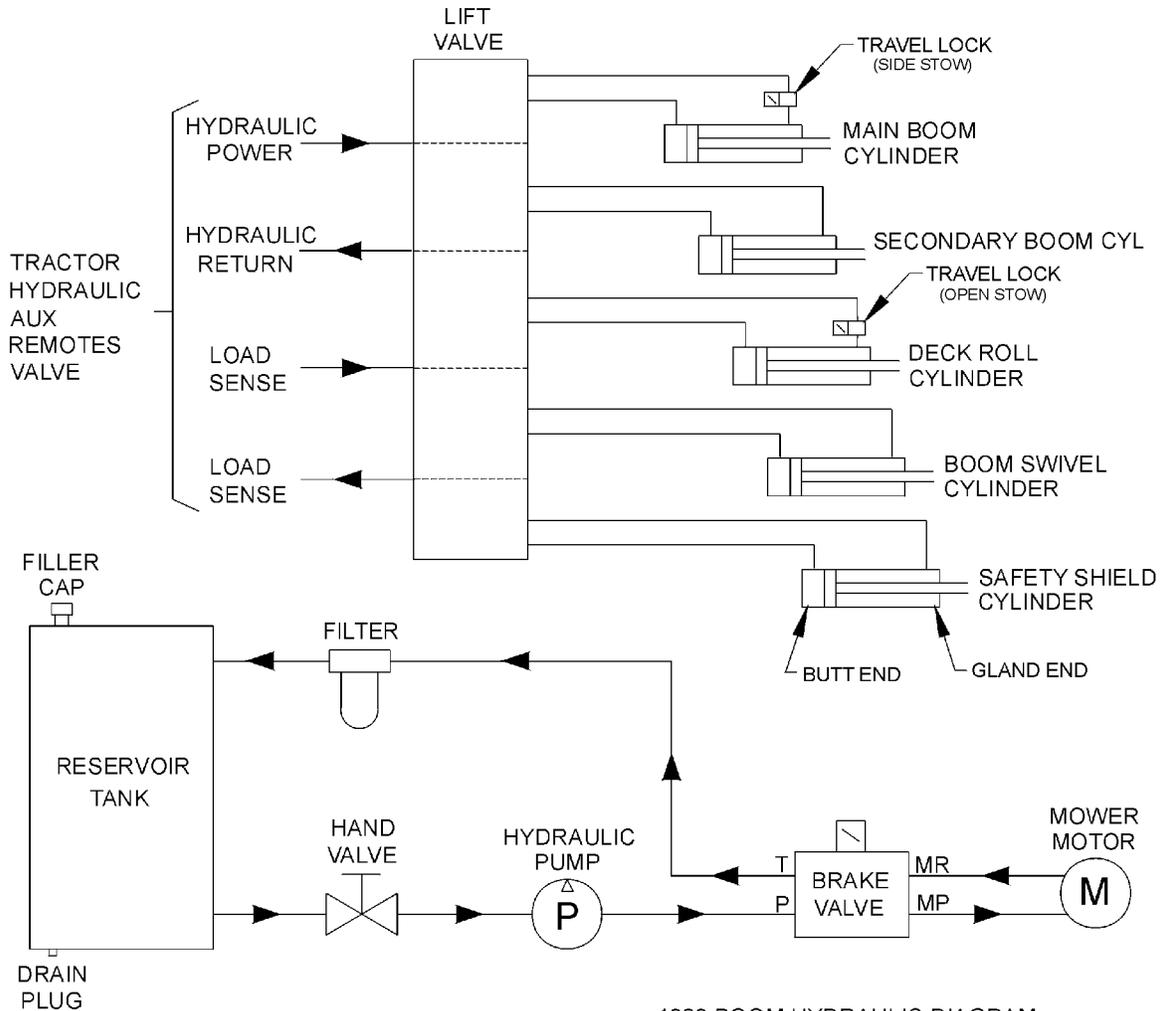

WHEEL WELL HYDRAULIC TANK INSTALLATION

Install all fittings and tubes into tank and tank filter as shown in the Parts Section illustration. Insert tank sight glass onto the tractor side of the tank.

Place the tank in the mounting bracket on the axle brace as shown in the Parts Section. Secure the tank with the hardware provided.

Install the filter gauge into the filter housing so that it points to the rear of the tractor and is clearly visible to the operator. The tank breather cap is ready for use as the tank is filled. Some of the forementioned items may be already installed. (ASM-C-0103)

WHEEL SPACERS

When mounting a boom mower, a spacer kit is needed for both rear wheels (part # 06200637). After removing the wheels attach the spacer to the wheel portion of the axle with the hardware provided. When you are ready to re-attach the wheel, the wheel goes on first then the reinforcement ring and finally the hardware provided. (ASM-JD-0099)



ASSEMBLY

FILLING HYDRAULIC RESERVOIR

Refer to the Maintenance Section for filling specifications and hydraulic oil requirements.

NOTE: Starting or running your Tiger mower before filling reservoir will cause serious damage to the hydraulic pump.

(ASM-C-0004hydro resrv)

INSTALLING O-RING FITTINGS

Installing straight, 45° and 90° O-rings requires that the O-ring and washer be up against the swivel body. Insert the swivel and turn in until the swivel is pointed in the desired direction and O-ring contact is made. Hold swivel in set direction with a wrench and turn the O-ring nut away from the swivel body and carefully tighten. *(ASM-C-0056)*

INSTALLING NATIONAL PIPE FITTINGS

Whenever installing a pipe fitting, wrap the threads clockwise (looking at the end) with teflon tape. In this way, the tape will be tightened when installed. NOTE: It is not necessary to tape O-ring fittings, or those installed in swivels. *(ASM-C-0088)*

PREFORMED TUBE INSTALLATION

Lay booms on floor so that the side with the clamp plates is up. Locate all tube clamps and install them loosely onto the clamp plates.

Arrange the tubes and hoses as outlined in the Common Parts Section. Install the tubes closest to the boom arm first, being careful not to pinch the tubes. Place the other tubes outside of the first tubes. Snug all clamp bolts, but do not tighten. Check all tubes for correct alignment and that none are pinched or bent. The clamp bolts can now be tightened. *(ASM-C-0085)*

GENERAL HOSE INSTALLATION

Refer to the Parts Section for detailed information about hoses and fittings for this application. *(ASM-C-0011)*

HOSE COVERING

Secure hoses together with zip ties wherever loose. Wrap the hoses between the swivel and main boom with the hose cover provided. Wrap the hoses between the main boom and secondary boom with the hose cover provided. Where hoses may contact the frame or other edges, wrap with split hose and secure with hose clamps or zip ties.

On non-cab units, the pressure and return hoses from the control valve will also need to be routed inside the protective hose wrap. Cover the valve and valve fittings with the hose cover and secure with the string provided. *(ASM-C-0058)*

ACCUMULATOR INSTALLATION

Install the accumulator bracket on the right mainframe mast or lift valve mount, if applicable, with the capscrews, lockwashers and spacers, if applicable, as shown in the Parts Section. Install the accumulator in the bracket and secure with the hardware shown. Install fittings and hoses to the cylinder and control valve as shown in the Parts Section. **Use teflon tape on all pipe fittings (except O-rings).** *(ASM-C-0012)*



ASSEMBLY

SOLENOID BRAKE VALVE

Install a solenoid valve on the mounting bracket with the supplied hardware as shown in the Parts Section in this manual. While installing the fittings to the brake valve, the electrical coil on the spool may have to be removed to make room. When reinstalling the coil, it is important to use no more than 5 ft. lbs. (or 60in. lbs.) torque. **WARNING: OVER TORQUE TO THE COIL WILL RESULT IN HYDRAULIC FAILURE OF SPOOL.** (ASM-C-0025)

TEMPERATURE GAUGE MOUNTING (OPTIONAL)

Mount the temperature gauge where it is clearly visible to the operator. Attach the green (-) wire from the negative post on the gauge to a grounded bolt on the tractor frame. Remove paint if needed to make a good ground. Remove the pipe plug from the side of the hydraulic reservoir and install the temperature sensor using thread sealing tape. Run the white wire from the (s) sensor post of the gauge to the temperature sensor on the hydraulic reservoir tank. (ASM-C-0051)

WHEEL WEIGHT MOUNTING

For all tractors using a boom mower, a wheel weight will be required for the rear left side wheel. It will be necessary to mount the weight in the wheel using the long capscrews, lockwashers, flatwashers, spacers (if applicable), and hex nuts per the diagram in the Parts Section.

Installation is most easily done with a fork lift, inserting a fork in the center slot of the wheel weight. The head of the capscrews is to be toward the OUTSIDE of the weight, with flatwashers on both the inside and outside of the assembly.

The left rear tire may also be filled with a mixture of water and calcium chloride at about five pounds per gallon. Tire air pressure should be maintained according to the Maintenance Section. (ASM-C-0055)



ASSEMBLY

OS AXLE BRACE MOUNTING

The open stow axle braces are to be mounted under the rear axle of the tractor. The other end of the axle brace mounts on the outside of the lower rear corners of the main frame. After attaching the boomrest, it should fit tightly and level under the tractor. Attach the axle brace(s) to the main frame with hardware shown in the Parts Section and tighten. Attach the axle braces to the rear axle using the mounting hardware shown in the Parts Section, but DO NOT tighten.

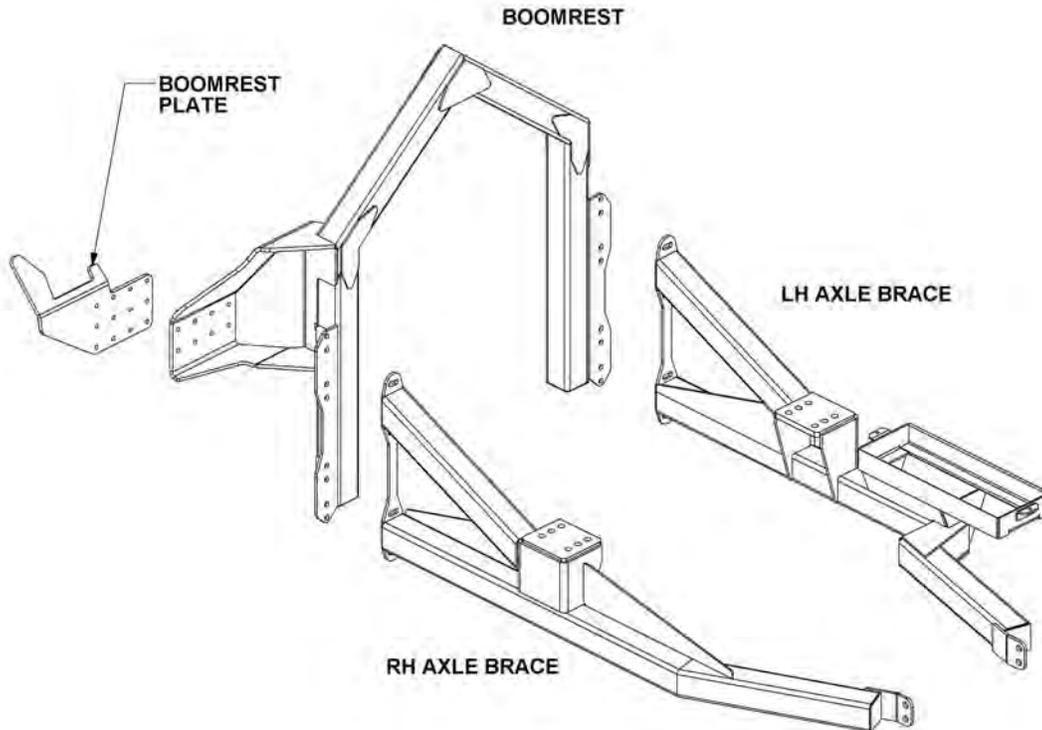

OS BOOMREST MOUNTING

Carefully raise the open stow boomrest and align the holes with those of the axle brace. Now install all attaching hardware, as shown in the Parts Section, loosely, to allow for the alignment with the left and right axle brace. Tighten / torque all hardware on the brace and the boomrest. Finally, add the boomrest plate to the boomrest as shown in the Parts Section. (ASM-JD-0246)

DECK ATTACHMENT

The pivot assembly is used to attach the head to the secondary boom. Install the deck pivot cylinder using the pins and hardware, which is illustrated in the Common Section.

Connect the fittings and hoses from the pivot cylinder to the small preformed tubes on the boom arm. Connect the fittings and hoses from the motor to the large preformed tubes on the boom arm. Connect all remaining hoses from the control valve to the cylinders and / or preformed tubes on the boom arm. Refer to Common Section for diagrams. (ASM-C-0018)

"



ASSEMBLY

3-POINT SPACER BLOCKS

To help stabilize the 3-point arms on your tractor for Open Stow, Legal Rear Stow or Triple flail applications, 3-Point Spacers (P/N 06402260) need to be installed. To attach the spacer blocks on JD6140-50R tractors, 5/8" capscrews (P/N 21784) and 5/8" flatwashers (P/N 33764) will be used. (ASM-C-0036 jd6140r)

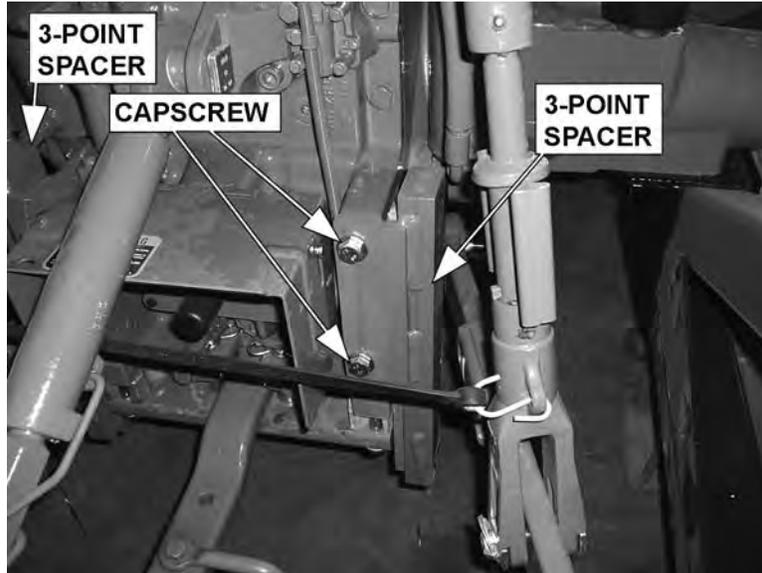

3-POINT BOOM REST MOUNTING

Install the boomrest onto the 3-point hitch using the pins as shown in the Parts Section. Adjust the bottom arms so the boom clears the tractor fender (X); adjust the top link so that the boom saddle is approximately level with the ground. Re-adjust once the boom is completely installed and operable. Adjust the top link until the boom is properly seated in the boomrest (Z) and no part of the boom (including hoses) comes into contact with the tractor cab. Using the side turnbuckles, adjust the boom and boomrest all the way to the right for proper width restrictions. Check your local width regulations before transporting your mower. You may need to adjust the boomrest for overall height as well (Y). (ASM-C-0054)

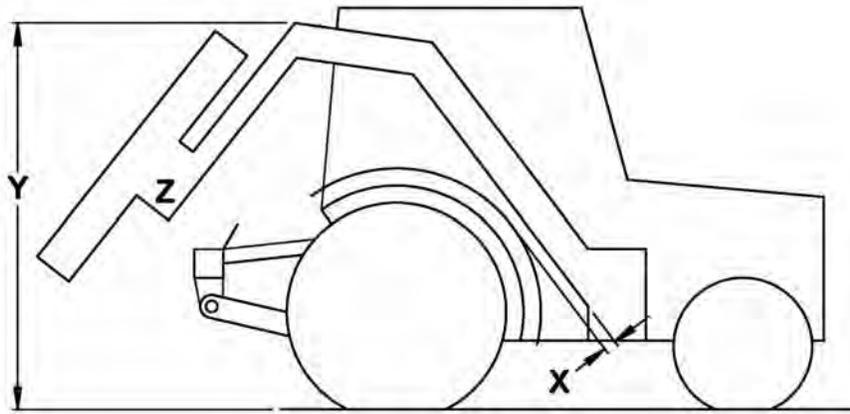

ASSEMBLY

SINGLE COLUMN BOOMREST MOUNTING

Carefully lower the boomrest and align the holes with those of the axle brace. Now install all attaching hardware, as shown in the Parts Section, loosely, to allow for the alignment with the axle brace. Tighten / torque all hardware on the axle brace and the boomrest. Finally, add the Boomrest Plate with the hardware provided so it lines up with the boom in the rear stowing position. (ASM-JD-0053)

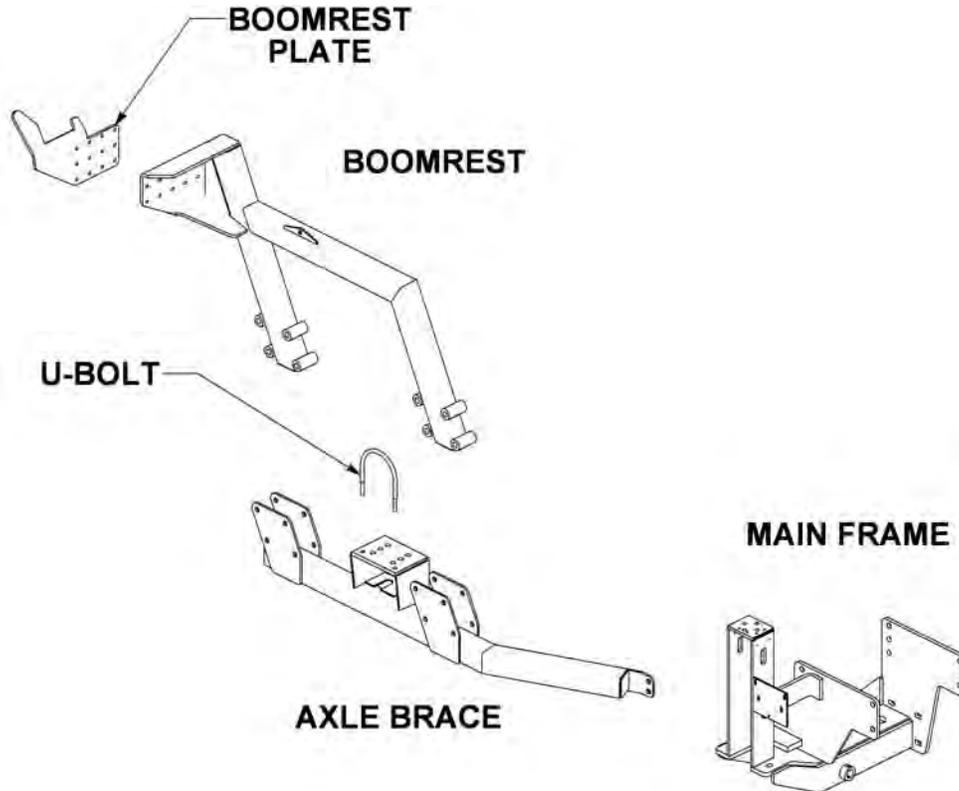

MAIN BOOM INSTALLATION

Install the boom swivel into the mainframe as shown in the Parts Section using a hoist. Line up holes in swivel and mainframe for large swivel pin and insert pin. Secure with hardware as shown.

Attach the inner end of the main boom to the swivel bracket with the cylinder anchors positioned upward, and at a right angle to the tractor. Secure it with the horizontal hinge pin. Secure the hinge pin in the boss with capscrews, etc. (see Parts Section).

Attach the butt end of the main boom cylinder to the swivel with the cylinder pin and roll pins shown in the Parts Section.

Install the travel lock on the rod end of the main boom cylinder. This should be facing the butt end of the cylinder after installation.

Install the fittings and hoses to the main boom cylinder per Parts Section.

GREASE HINGE PIN ZERKS ON BOOM AFTER ASSEMBLY, ONCE UNDER LOAD WITH BOOM ELEVATED, AND AGAIN AT REST WITH BOOM SUPPORTED. (ASM-C-0013)



ASSEMBLY

FINAL PREPARATION FOR OPERATION

Place operator's safety and operation decals on the steering column and side console where they are clearly visible to the operator. These decals should be understood by each operator of the machine in conjunction with the Safety and Operation Sections of this book. The decals are to be maintained in good condition as a reminder to the operator, and should be replaced if damaged.

All bosses, pins and pivot points will need to be greased as instructed in the Maintenance Section of this manual. The hydraulic reservoir can also be filled with the recommended fluid (see Maintenance Section) and the filter installed in the top of the tank. Double check all fittings and fasteners BEFORE starting tractor. Also secure any loose hoses together with zip ties and wrap with split hoses where friction may occur on the hoses.



BEFORE starting or operating the tractor you must read and understand the Safety and Operation Sections of this manual completely.

BE SURE THE BALL VALVES ARE OPEN! Start tractor and allow instruments to stabilize. Using a piece of paper or cardboard as noted in the Safety and Maintenance Sections, check all fittings and connections for hydraulic leaks.

If a leak is found, you must shut down the tractor and set the cutter on the ground. Before attempting to fix the leak, you must actuate the lift valve handles several times to relieve any pressure in the lines.

Before operating the mower, the cutter head and boom should be slowly moved throughout the full range of motion. Watch for any condition that would cause pinching or excess stress on the hoses. The steering and front axle travel should also be carefully moved through their full range of motion. If any condition occurs in which the hoses contact the tires, the steering and / or front axle travel may need to be limited as described in the tractor operator's manual. This should also be done if the tires rub, or are extremely close to any other part of the mower, such as the hydraulic tank or draft beam. This may include adding shims or adjusting stop bolts in the tractor front to solve the problem. While checking motion, you should also check that the control circuits are connected according to the operator's decal for the valve handles.

MOWER TESTING

Take the tractor to a place free of loose objects on the ground. Operate the cylinders through their full range of motion again, to clear the lines of air. Follow the instructions in the Operation Section to operate the mower. Vibration of the mower should be minimal at all times. After a 5 minute test run, the knife bolts should be retorqued, and retorqued once again after the first few hours of operation.

If any parts of this Assembly Section, or any other section of this manual are not clearly understood you must contact your dealer or the address on the front of this manual for assistance! (ASM-C-0010)



CD9 F5 HCB'G97 HCB

Operation Section 3-1

CD9F5HCB

CD9F5HCB; BGF17HCBG

Tiger Booms are manufactured with quality material by skilled workers. The Boom is designed to attach to a tractor and operate various heads for a wide range of vegetative maintenance applications. The boom and heads are equipped with safety warning decals, protective deflectors, shields, and other safety features to provide operator and passerby protection, however, no shielding is 100% accurate. ALL safety equipment and safety warning decals must be maintained on the unit in good operational condition at all times.

It is the operator's responsibility to be knowledgeable of all potential operating hazards and to take every reasonable precaution to ensure oneself, others, animals, and property are not injured or damaged by the boom unit, tractor or a thrown object. Do not operate the boom and attached head if bystanders, passersby, pets or livestock are within 300 feet of the unit.

This section of the Operator's Manual is designed to familiarize, instruct, and educate operators to the safe and proper use of the boom and attached head. Pictures contained in this section are intended to be used as a visual aid to assist in explaining the operation of a Boom and are not specific to a Boom. Some pictures may show shields removed to enhance visual clarity. NEVER operate the boom unit without all safety equipment in place and in good operational condition. The operator must be familiar with the boom unit and tractor operation and all safety practices before beginning operation. Proper operation, as detailed in this manual, will help ensure years of safe and satisfactory use of the Boom

F958 5B8 1 B89FGH5B8 H<9 9BHF9 CD9F5HCB; BGF17HCBG 5B8 G5: 9HMG97HCB C: H<G A5BI 5 @ 5B8 H<9 HF57HCF A5BI 5 @ 69: CF9 5HH9ADHCB; HC I G9 H<9 HF57HCF 5B8 AD@A9BH If you do not understand any of the instructions, contact your nearest authorized dealer for a full explanation. Pay close attention to all safety signs and safety messages contained in this manual and those affixed to the implement and tractor. (OPS-U-0001)

READ, UNDERSTAND, and FOLLOW the following Safety Messages. Serious injury or death may occur unless care is taken to follow the warnings and instructions stated in the Safety Messages. Always use good common sense to avoid hazards. (SG-2)

SAFETY INSTRUCTIONS



PELIGRO

Si no lee ingles, pida ayuda a alguien que si lo lea para que le traduzca las medidas de seguridad. (SG-3)

¡ LEA EL INSTRUCTIVO!



CD9F5HCB

Safe Operation of the Unit

Safe operation of the unit is the responsibility of a qualified operator. A qualified operator has read and understands the implement and tractor Operator's Manuals and is experienced in implement and tractor operation and all associated safety practices. In addition to the safety messages contained in this manual, safety signs are affixed to the implement and tractor. If any part of the operation and safe use of this equipment is not completely understood, consult an authorized dealer for a complete explanation.

If the operator cannot read the manuals for themselves or does not completely understand the operation of the equipment, it is the responsibility of the supervisor to read and explain the manuals, safety practices, and operating instructions to the operator.

Safe operation of equipment requires that the operator wear approved Personal Protective Equipment (PPE) for the job conditions when attaching, operating, servicing, and repairing the equipment. PPE is designed to provide operator protection and includes the following safety wear:

Required Personal Protective Equipment (PPE)

- Always Wear Safety Glasses
- Hard Hat
- Steel Toe Safety Footwear
- Gloves
- Hearing Protection
- Close Fitting Clothing
- Respirator or Filter Mask (depends on operating conditions) (OPS-U-0002)

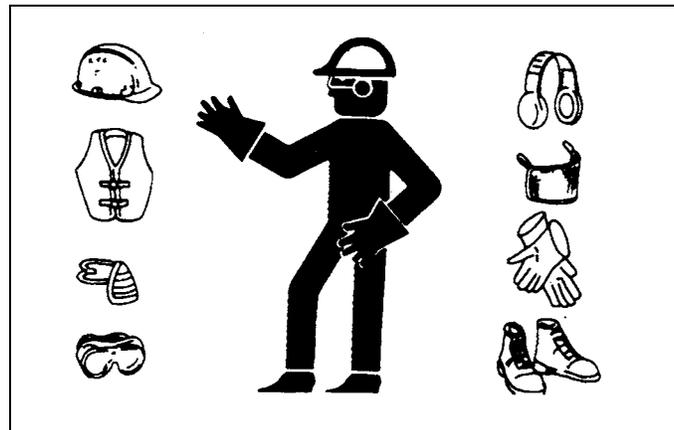

DANGER

NEVER use drugs or alcohol immediately before or while operating the Tractor and Implement. Drugs and alcohol will affect an operator's alertness and coordination and therefore affect the operator's ability to operate the equipment safely. Before operating the Tractor or Implement, an operator on prescription or over-the-counter medication must consult a medical professional regarding any side effects of the medication that would hinder their ability to operate the equipment safely. NEVER knowingly allow anyone to operate this equipment when their alertness or coordination is impaired. Serious injury or death to the operator or others could result if the operator is under the influence of drugs or alcohol. (SG-27)

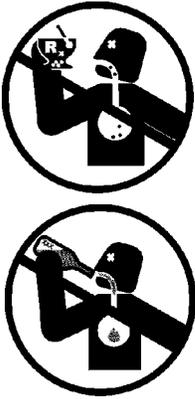

CD9F5HCB

CD9F5HCB

Minimum Tractor Requirements

In addition to tractor horsepower and size required to operate the boom unit, the tractor must also be properly equipped to provide operator protection, to alert approaching vehicle drivers of the tractor's presence, and to ensure tractor stability when mowing with the boom fully extended.

Tractor Safety Features

- ASAE approved Roll-Over Protective Structure (ROPS) or ROPS cab and seat belt.
- Operator Protection Tractor must be equipped with protective structure such as operator cage or lexan window to protect operator from thrown object and falling objects
- Tractor Safety Devices Slow Moving Vehicle (SMV) emblem, lighting,
- Tractor Ballast As required to maintain at least 1500 lbs. on left rear tire

Roll-Over Protective Structure (ROPS)

The tractor must be equipped with a Roll-Over-Protective-Structure (ROPS) (tractor cab or roll-bar) and seat belt to protect the operator from falling off the tractor, especially during a roll over where the driver could be crushed and killed. Only operate the tractor with the ROPS in the raised position and seat belt fastened. Tractor models not equipped with a ROPS and seat belt should have these life saving features installed by an authorized dealer. OPS-U- 0003



Operate this Equipment only with a Tractor equipped with an approved roll-over-protective system (ROPS). Always wear seat belts. Serious injury or even death could result from falling off the tractor--particularly during a turnover when the operator could be pinned under the ROPS. (SG-7)



Operator Protection

The tractor must be equipped with protective equipment to shield the operator from falling and thrown objects. For cab tractors, the tractor must be equipped with an operator safety screen on its right side or the right side windows must be fitted with a shatter resistant safety window. For non-cab tractors, the tractor must be equipped with a ROPS and operator protective safety cage that provides protection to the right and above the operator seat. DO NOT remove the ROPS from non-cab tractors to equip a safety cage.

OPS-B- 0001



CD9F5HCB



Never operate the Tractor and Mower Unit without an OPS (Operators Protective Structure) or Cab to prevent injury from objects thrown from ground or from overhead trimming. Stop mowing if workers or passersby are within 300 feet. (SBM-9)



Operating on a Public Roadway

If the tractor will be operated near or traveled on a public roadway it must be equipped with proper warning lighting and a Slow Moving Vehicle (SMV) emblem which are clearly visible from the rear of the unit. Most tractor's have different settings for operating and transporting lighting. Refer to the tractor operator's manual for using the tractor's light switch and operating the turn signals.

OPS-B-0017



CD9F5HCB

CD9F5HCB

CD9F5HCB

Minimum Down Force

To ensure tractor stability when operating on flat surfaces the left rear tractor tire MUST exert a minimum down force (weight) of 1500 lbs. on the ground when the tractor is on level ground, its boom is fully extended and the mower head is horizontal and two feet above the ground. For units which have the ability to operate on either side of the tractor, these requirements must also be met for the right side tire when the boom is extended to the left side as described above. A tractor that does not meet this criteria is DANGEROUS and should not be operated as upset of the unit can occur resulting in possible serious injury and property damage. NOTE: All factory mounted units are tested and meet the ballast requirement before shipment; further testing is not required unless the unit is operated in a manner other than what is considered standard operating conditions.

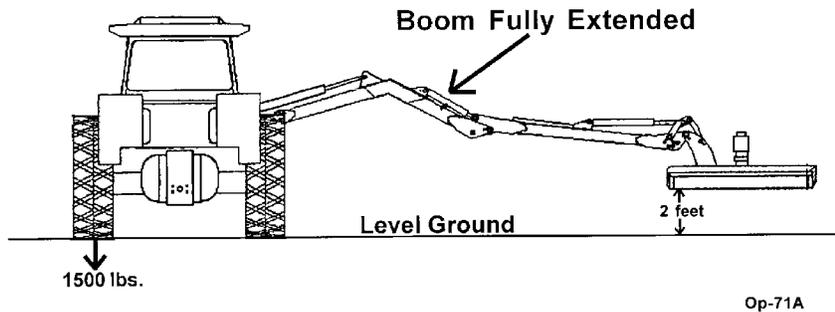

If the unit is operated on slopes greater than 5°, additional counterweight will be required. Operation of the unit on slopes greater than 11 percent (6.4 degrees) is not recommended under any circumstances. On a tractor with a 96" outside to outside tire spread, an 11 percent (6.4 degrees) slope occurs when one rear tractor tire is about 8" lower than the other rear tire. OPS-B-0018

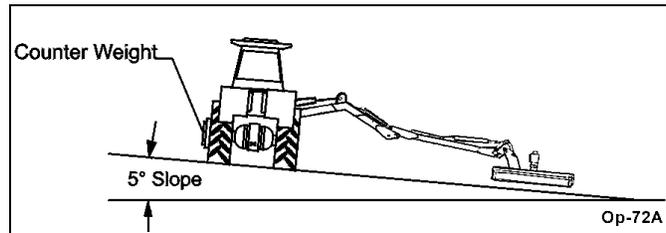

Operator Manual

Before getting onto the tractor, the operator must read and completely understand the implement and tractor operator manuals. If any part of either manual is not completely understood, consult an authorized dealer for a complete explanation. OPS-U-0007



Do not mount or dismount the Tractor while the tractor is moving. Mount the Tractor only when the Tractor and all moving parts are completely stopped. (SG-12)



CD9F5HCB

CD9F5HCB

Use Both Hands and Equipped Handrails and Steps for Support when Boarding the Tractor.

Use both hands and equipped handrails and steps for support when boarding the tractor. Never use control levers for support when mounting the tractor. Seat yourself in the operator's seat and secure the seat belt around you.

Never allow passengers to ride on the tractor or attached equipment. Riders can easily fall off and be seriously injured or killed from falling off and being ran over. It is the operator's responsibility to forbid all extra riders at all times. OPS-U- 0008



Never allow children to operate, ride on, or come close to the Tractor or Implement. Usually, 16-17 year-old children who are mature and responsible can operate the implement with adult supervision, if they have read and understand the Operator's Manuals, been trained in proper operation of the tractor and Implement, and are physically large enough to reach and operate the controls easily. (SG-11)



Never allow children or other persons to ride on the Tractor or Implement. Falling off can result in serious injury or death. (SG-10)



Do not mount or dismount the Tractor while the tractor is moving. Mount the Tractor only when the Tractor and all moving parts are completely stopped. (SG-12)



Before Dismounting the Tractor, Idle the Tractor Engine Down, Disengage the Head and Retract the Boom Arm to the Transport Position.

Before dismounting the tractor, idle the tractor engine down, disengage the head and retract the boom arm to the transport position. Park the tractor on a level surface, place the transmission in neutral and set the parking brake. Shut down the tractor engine, remove the key, and wait for all motion to come to a complete stop before exiting the operator's seat. NEVER leave the seat until the tractor, its engine, and mower head movement have come to a complete stop.

Use hand rails and extra steps when exiting the tractor. Be careful of your step and use extra caution when mud, ice, snow, and other matter has accumulated on the steps and handrails. Never rush or jump off the tractor. OPS-B- 0002



BEFORE leaving the tractor seat, always set the parking brake and/or set the tractor transmission in parking gear, disengage the PTO, stop the engine, remove the key, and wait for all moving parts to stop. Place the tractor shift lever into a low range or parking gear to prevent the tractor from rolling. Never dismount a Tractor that is moving or while the engine is running. Operate the Tractor controls from the tractor seat only. (SG-9)

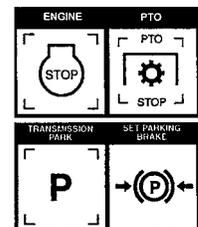

CD9F5HCB

CD9F5HCB

('GH5 FHCB; 'H<9 'HF57 HCF

The operator must have a complete understanding of the placement, function, and operational use of all tractor controls before starting the tractor. Review the tractor operator's manual and consult an authorized dealer for tractor operation instructions if needed.

Essential Tractor Controls:

- Locate the ignition key/switch
- Locate the engine shut off control
- Locate the hydraulic control levers
- Locate the light control lever
- Locate the brake pedals and clutch
- Locate the PTO control
- Locate the 3 point hitch control lever
- Locate the boom operating controls (joystick or valve bank)

Before starting the tractor ensure the following:

- Conduct all pre-start operation inspection and service according to the tractor operator's manual.
- Make sure all guards, shields, and other safety devices are securely in place.
- The parking brake is on.
- The tractor transmission levers are in park or neutral.
- The boom operating controls are in the neutral and off position.
- The PTO control lever is disengaged.
- The hydraulic remote control levers are in the neutral position.

Refer to the tractor owner's manual for tractor starting procedures. Only start the tractor while seated and belted in the tractor operator's seat. Never bypass the ignition switch by short circuiting the starter solenoid. After the tractor engine is running, avoid accidental contact with the tractor transmission to prevent sudden and unexpected tractor movement. OPS-B- 0003



Never run the Tractor engine in a closed building or without adequate ventilation. The exhaust fumes can be hazardous to your health. (SG-23)



Start tractor only when properly seated in the Tractor seat. Starting a tractor in gear can result in injury or death. Read the Tractor operators manual for proper starting instructions. (SG-13)



CD9F5HCB

CD9F5HCB

7 CBB97HB; 5H57<B; <958GHC'H<9'6CCA'

1. Start by attaching the pivot bracket(3) to the boom(1) using pin(5) and hardware. Next attach the cylinder to the pivot bracket(3) using pin(8) and roll pins.
2. Then attach the dogleg(4) to the mower(2) using pin(7) and hardware.
3. Use a hoist to lower the boom(1) down to the mower(2). Insert the upper pin(6) through the end of the boom and the mower. Attach with hardware.
4. Then align the dogleg(4) and the pivot bracket(3). Attach with pin(9) and hardware.
5. Finally make sure all bolts, nuts, and pins are tightened to recommended torque. OPS-B- 0004_D

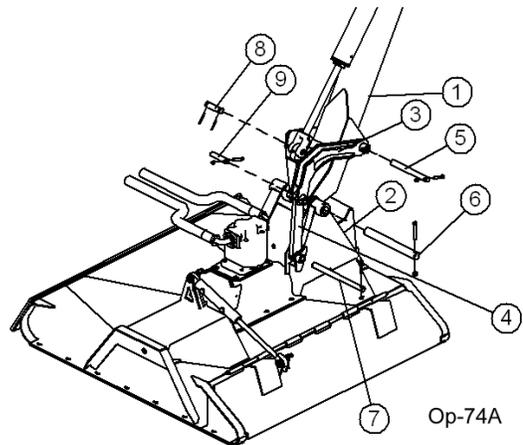

WARNING

Avoid contact with hot surfaces including hydraulic oil tanks, pumps, motors, valves and hose connections. Relieve hydraulic pressure before performing maintenance or repairs. Use gloves and eye protection when servicing hot components. Contact with a hot surface or fluid can cause serious injury from burns or scalding. (SG-34)

WARNING

Do not operate this Equipment with hydraulic oil or fuel leaking. Oil and fuel are explosive and their presence could present a hazard. Do not check for leaks with your hand! High-pressure oil streams from breaks in the line could penetrate the skin and cause tissue damage including gangrene. To check for a hose leak, SHUT the unit ENGINE OFF and remove all hydraulic pressure. Wear oil impenetrable gloves, safety glasses and use Cardboard to check for evidence of oil leaks. If you suspect a leak, REMOVE the HOSE and have it tested at a Dealer. If oil does penetrate the skin, have the injury treated immediately by a physician knowledgeable and skilled in this procedure. (SG-15)



* 'DF9!CD9F5HCB'BGD97HCB'5B8'G9FJ=79

Before each use, a pre-operation inspection and service of the implement and tractor must be performed. This includes routine maintenance and scheduled lubrication, inspecting that all safety devices are equipped and functional, and performing needed repairs. DO NOT operate the unit if the pre-operation inspection reveals any condition affecting safe operation. Perform repairs and replacement of damaged and missing parts as soon as noticed. By performing a thorough pre-operation inspection and service, valuable down time and repair cost can be avoided. OPS-U-0029

CD9F5HCB

WARNING

Periodically inspect all moving parts for wear and replace when necessary with authorized service parts. Look for loose fasteners, worn or broken parts, and leaky or loose fittings. Make sure all pins have attaching hardware. Serious injury may occur from not maintaining this machine in good working order. (SG-21_A)

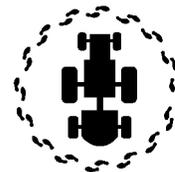

DANGER

All Safety Shields, Guards and Safety devices including (but not limited to) - the Deflectors, Chain Guards, Steel Guards, Gearbox Shields, PTO integral shields, and Retractable Door Shields should be used and maintained in good working condition. All safety devices should be inspected carefully at least daily for missing or broken components. Missing, broken, or worn items must be replaced at once to reduce the possibility of injury or death from thrown objects, entanglement, or blade contact. (SGM-3)

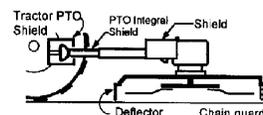

CD9F5HCB

*** Refer to the tractor operator's manual to ensure a complete pre-operation inspection and scheduled service is performed according to the manufacturers recommendations. The following are some of the items that require daily service and inspection:**

Refer to the tractor operator's manual to ensure a complete pre-operation inspection and scheduled service is performed according to the manufacturers recommendations. The following are some of the items that require daily service and inspection:

- Tire condition/air pressure
- Wheel lug bolts
- Steering linkage
- PTO shield
- SMV sign is clean and visible
- Tractor's lights are clean and functional
- Tractor Seat belt is in good condition
- Tractor ROPS is in good condition
- ROPS is in the raised position
- No tractor oil leaks
- Radiator free of debris
- Engine oil level and condition
- Engine coolant level and condition
- Power brake fluid level
- Power steering fluid level
- Fuel condition and level
- Sufficient lubrication at all lube points
- Air filter condition OPS-U-0030



CD9F5HCB

* Inspect and service the boom arm and head prior to operation. Damaged and/or broken parts should be repaired and/or replaced immediately. To ensure the unit is ready for operation, conduct the following:

OPS-B- 0020



Periodically inspect all moving parts for wear and replace when necessary with authorized service parts. Look for loose fasteners, worn or broken parts, and leaky or loose fittings. Make sure all pins have attaching hardware. Serious injury may occur from not maintaining this machine in good working order. (SG-21_A)



CD9F5HCB

The operator's manual and safety signs affixed on the unit contain important instructions on the safe and proper use of the equipment. Maintain these important safety features on the implement in good condition to ensure the information is available to the operator at all times.

- Ensure all safety signs are in place and legible. Replace missing, damaged, and illegible decals. OPS-U- 0011_A



FRAME ASSEMBLY

- Inspect condition of mounting frame weldment.
- Inspect condition of Swivel Assy.
- Ensure all bolts and screws are in position and are properly torqued.
- Ensure all pins are in place and fastened with screws.
- Ensure frame is properly mounted to tractor and hardware is properly installed and tightened. OPS-B- 0021_D



Boom

Operation Section 3-11

CD9F5 HCB

WARNING

Relieve hydraulic pressure prior to doing any maintenance or repair work on the Implement. Place the Mower Head on the ground or securely supported on blocks or stands, disengage the PTO, and turn off the engine. Push and pull the control Levers or Joystick several times to relieve pressure prior to starting any maintenance or repair work. (SBM-6)

WARNING

Never Leave the mower unattended while the head is in the raised position. The mower could fall causing serious injury to anyone who might inadvertently be under the mower. (SBM-4)



CD9F5 HCB

BOOM ARM ASSEMBLY

- Inspect condition of each arm section weldment
- Ensure all pins are in place.
- Ensure all bolts, nuts and rollpins are properly installed.
- Check condition of bushings at boom pivot points and hydraulic cylinder tangs.
- Ensure each hydraulic cylinder is installed and retained correctly. Ensure the proper size pins are used to retain the cylinders in place and are secured properly. OPS-B- 0022_D



WARNING

Never attempt to lubricate, adjust, or remove material from the Implement while it is in motion or while tractor engine is running. (SG-20)

HYDRAULIC LINE INSPECTION

- Check for hydraulic leaks along hoses, cylinders and fittings. **DO NOT** use your hands to check for oil leaks. Use a piece of heavy paper or cardboard to check for hydraulic oil leaks.
- Inspect the condition of the valve mounting.
- Ensure fittings are properly connected. OPS-B- 0023_D

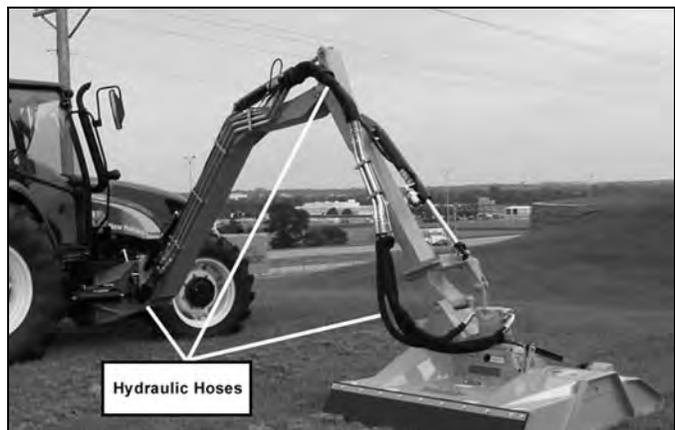

CD9F5HCB

WARNING

Do not operate this Equipment with hydraulic oil or fuel leaking. Oil and fuel are explosive and their presence could present a hazard. Do not check for leaks with your hand! High-pressure oil streams from breaks in the line could penetrate the skin and cause tissue damage including gangrene. To check for a hose leak, SHUT the unit ENGINE OFF and remove all hydraulic pressure. Wear oil impenetrable gloves, safety glasses and use Cardboard to check for evidence of oil leaks. If you suspect a leak, REMOVE the HOSE and have it tested at a Dealer. If oil does penetrate the skin, have the injury treated immediately by a physician knowledgeable and skilled in this procedure. (SG-15)



HYDRAULIC PUMP/OIL RESERVOIR

- Check oil reservoir level and oil condition. (Add specific type oil if low)
- Change hydraulic oil filter and hydraulic oil according to maintenance schedule.
- Ensure there are no oil leaks and fitting are properly connected
- Inspect overall condition of hydraulic pump.
- Inspect pump drive shaft.



Check the fluid level in the Hydraulic Tank on the Tractor, and add oil if required. As the air has been forced out of the Cylinders and Hoses, it goes into the Hydraulic Tank and reduces the volume of oil. Maintain the oil level within the sight gauge located on the side of the reservoir. Never fill the tank above the sight gauge to allow for the expansion of the oil. The tank maintains pressure after the mower has been run. Stand off to one side when removing the breather cap element to prevent possible injury. OPS-B 0024_E

WARNING

Attention: Oil Filler Cap is also the Pressure Relief Cap.

Remove cap slowly to relieve pressure before removing cap completely. Stay clear to prevent being scalded with hot oil that may spray out of the tank that is still pressurized and may cause serious injury to eyes, face, and exposed skin. *Qu/2223/O.R.E.+

WARNING

Avoid contact with hot surfaces including hydraulic oil tanks, pumps, motors, valves and hose connections. Relieve hydraulic pressure before performing maintenance or repairs. Use gloves and eye protection when servicing hot components. Contact with a hot surface or fluid can cause serious injury from burns or scalding. (SG-34)

CD9F5HCB

CD9F5HCB

ROTARY HEAD INSPECTION

- Inspect blades and blade bolts for looseness and excessive wear. Rotate to 90° to make for checking easier. Replace damaged, worn, and missing blades as complete sets to maintain rotary balance.
- Ensure motor bolts and nuts are tightened to the appropriate torque.
- Ensure rubber deflectors are in position and not damaged. Replace worn, broken, and missing sections immediately.
- Ensure hydraulic lines are properly connected to the hydraulic motor. Check for hydraulic leaks along hoses and fittings. DO NOT use your hands to check for oil leaks. Use a piece of heavy paper or cardboard to check for hydraulic oil leaks.
- Inspect the condition of deck skid shoes and hardware. OPS-B- 0025



WARNING

Do not put hands or feet under mower decks. Blade Contact can result in serious injury or even death. Stay away until all motion has stopped and the decks are securely blocked up. (SGM-09)



DANGER

All Safety Shields, Guards and other safety devices including (but not limited to) - Deflectors, Steel Guards and Gearbox Shields must be used and maintained in good working condition. All safety devices should be inspected carefully at least daily for missing or broken components. Missing, broken, or worn items must be replaced at once to reduce the possibility of injury or death from thrown objects, entanglement, or blade contact. (SSM-07)

CD9F5HCB

CD9F5HCB

FLAIL HEAD INSPECTION

- Inspect blades and blade bolts for looseness and excessive wear. Rotate to 90° to make for checking easier. Replace damaged, worn, and missing blades as complete sets to maintain cuttershaft balance.
- Ensure rubber deflectors are in position and not damaged. Replace worn, broken, and missing sections immediately.
- Ensure the rollers are in good condition and rotate freely.
- Inspect that all bolts and screws are in position and are properly torqued.
- Ensure hydraulic lines are properly connected to the hydraulic motor. Check for hydraulic leaks along hoses and fittings. DO NOT use your hands to check for oil leaks. Use a piece of heavy paper or cardboard to check for hydraulic oil leaks.
- Inspect the condition of the drive belts.
- Ensure the drive belt shields are in place and in good repair.
- Remove any grass or other debris which may be wrapped around the cuttershafts ends.
- Inspect the condition of deck skid shoes and hardware. OPS-B- 0026_B



Do not put hands or feet under mower decks. Blade Contact can result in serious injury or even death. Stay away until all motion has stopped and the decks are securely blocked up. (SFL-2)



All Safety Shields, Guards and other safety devices including (but not limited to) - Deflectors, Steel Guards and Gearbox Shields must be used and maintained in good working condition. All safety devices should be inspected carefully at least daily for missing or broken components. Missing, broken, or worn items must be replaced at once to reduce the possibility of injury or death from thrown objects, entanglement, or blade contact. (SSM-07)

CD9F5HCB

CD9F5HCB

* " 7 i Hjb] '7 ca dcbYbh-bgdYWfcb

Inspect blade pan and blade assembly for the following: OPS-U-0031

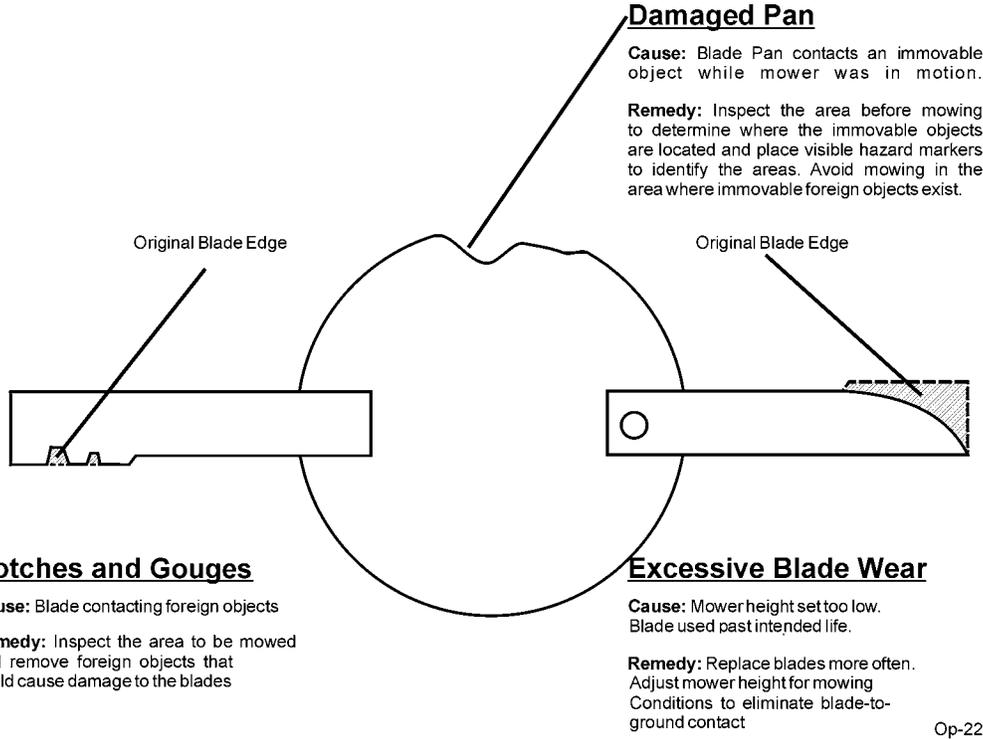

Inspect the Blades daily for abnormal wear. REPLACE BOTH BLADES on that carrier IMMEDIATELY if either blade has:

- Become bent or deformed from it's original shape or
- Any cracks are visible, or
- Deep gouges in the blade's surface are present, or
- Gouges or chipped areas in the cutting edge are larger than 1/2"(12.7mm), or
- The material on the leading edge has been worn away by more than 1/2(12.7mm)"

Failure to replace abnormally worn blades may lead to catastrophic failure of the blades and ejection of the broken part with tremendous force which may cause serious bodily injury or death. OPS-U-0032

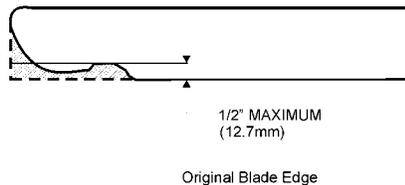

NOTE:
 Replace Blades in pairs after no more than 1/2" (12.7mm) wear
 Op-23

CD9F5HCB

Boom PRE-OPERATION Inspection



O qy gt "K %aaaaaaaaaaaaaaaa

O cmg aaaaaaaaaaaaaaaaaaaaa

F cvg<"*****"aaaaaaaaaaaaaaaa

Uj klv aaaaaaaaaaaaaaaaaaaaa



6 YZ:fY Wc bXi W]b['H Y]bgdYW]cbž a U_Y gi fY'H Y fUWcf 'Yb[]bY]g'cZZU''fcHU]cb\ Uq
 glcddYX' UbX' H Y fUWcf ']g']b' dUf_ ' k]H ' H Y dUf_]b[' VfU_Y Yb[U] YX" AU_Y gi fY' H Y
 a ck Yf ']g'fYg]b[' cb' H Y [fci bX'cf' gYW fY miV'cW_YX' i d'UbX'U' \ mXfU']WdfYggi fY\ Uq
 VYYb'fY]Y] YX"

Table 1:

Kgo	Eqpf kklq'cv'Uctv' qh'Uj klv	Ur gekle'Ego o gpw" kh'pqv'QCMO
Vj g'Qr gtcvt ai'O cpwcrku'lp'yj g'tcevqt		
Cmluchgv 'f gecni'ctg'lp'r meg'cpf 'rgi kdr		
Vj g'o qwpvpi 'htco g'dqnu'ctg'lp'r meg'cpf 'kij v		
Vj g'dqgo 'eqppgevkp'dqnu' 'r kpu'ctg'kij v		
Vj gtg'ctg'pq'etcemi'lp'dqgo		
Vj g'j {f tcwle'e { rpf gtu'r kpu'ctg'kij v		
Vj g'j {f tcwle'r wo r 'j que'eqppgevkpu'ctg'kij v		
Vj g'j {f tcwle'xcxkg'eqpvqnu'hpvevkp'r tqr gtn		
Vj gtg'ctg'pq'rgcnkpi 'qt'f co ci gf 'j qugu		
Vj g'j {f tcwle'qlrlrpxgriku'hw		
Vj gtg'ku'pq'gxkf gpeg'qh'j {f tcwle'rgcni		
Vj g'drcf gu'ctg'pqvej kr gf . 'etcemf 'qt'dgpv		
Vj g'drcf g'dqnu'ctg'kij v		
Vj g'f ghgevqtu'ctg'lp'r meg'cpf 'lp'i qaf 'eqpf kklq		
Vj g'dqgo 'uj lgrfu'ctg'lp'r meg'cpf 'lp'i qaf 'eqpf kklq		
Vj g'unkf 'uj qgu'ctg'lp'i qaf 'eqpf kklq'cpf 'kij v		
Vj gtg'ctg'pq'etcemi'qt'j qgu'lp'dqgo 'f gem		
Vj g'j {f tcwle'o qvt'o qwpvpi 'dqnu'ctg'kij v		
Vj g'dqgo 'j gcf 'ur lpf rg'j qwukpi 'ku'kij v'cpf 'hwdtlecyf		

Qr gtcvt ai'Uki pcwtg<

DO NOT OPERATE an UNSAFE TRACTOR or MOWER

CD9F5HCB

CD9F5HCB

Control Lever Decal

A control lever decal similar to the one shown below should be near the control valve to remind the operator of the lever functions.

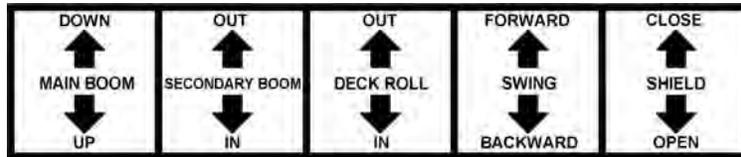

The main control valve on the Tiger Boom Mower has four sections with tapered spools, located near the right side of the steering wheel. The malfunction of a section of the valve does not necessitate the replacement of the entire “bank”, only the faulty section. Each section of the valve controls a certain position of the boom or deck. Seated in the operators seat, the controls from left to right are #1-primary (main) boom, #2-secondary boom, #3 -deck roll, #4-boom (swivel) swing, and #5- boom (safety) shield.

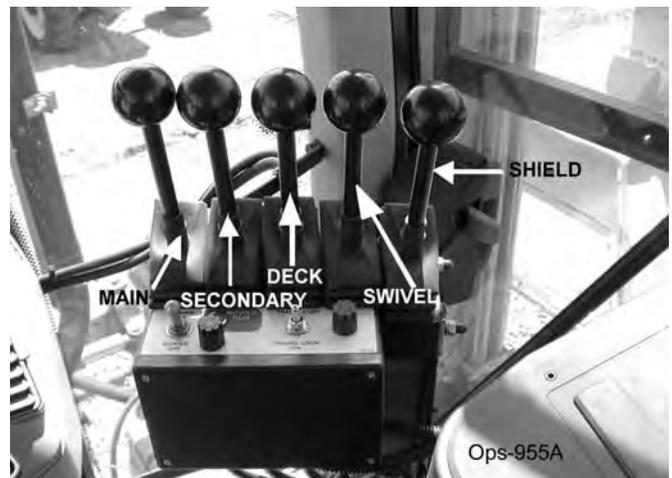
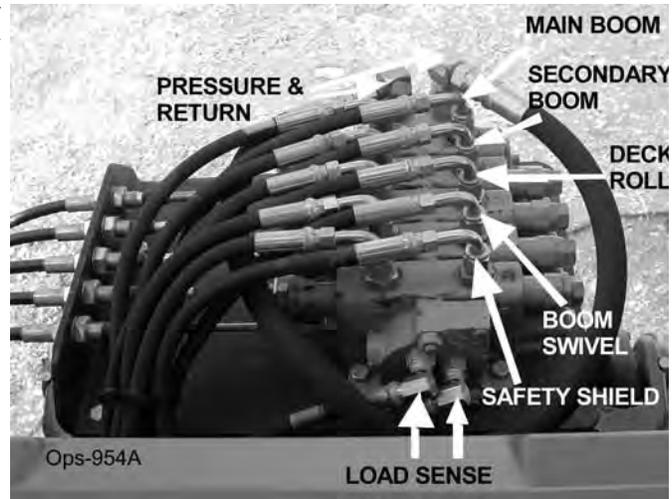

CD9F5HCB

CD9F5HCB

* Safety Shield

The Safety Shield lever opens and closes the shield located on the front of the cutter head. When moving at or near the ground, always have the shield in the closed position. When mowing in the brush or in trees above ground level the shield may be opened for easier cutting. Read and follow the warnings on the decal shown below. Do not run the cutter head into material larger than 6" diameter.

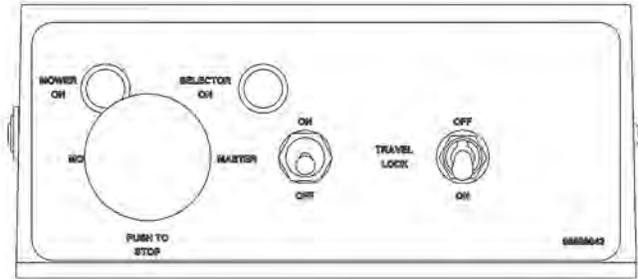

⚠ DANGER

SAFETY SHIELD & DEFLECTOR OPERATION

SAFETY SHIELD

DEFLECTOR

- Failure to close Safety Shield and Deflector may allow objects to be thrown outward with great force which can cause property damage, bodily injury, or death.

1. Keep Safety Shield and Deflector fully closed when cutting grass and weeds to reduce possibility of objects being thrown outward by the Blades if persons are in the area.
2. Before Cutting brush, trimming limbs, or other such operations, raise the Deflector and Safety Shield fully to allow the blades to contact the material if area is clear of passerby. Operator must stop cutting and close shield if passerby enters the thrown objects area or blade contact area.
3. Repair or replace Safety Shield and Deflectors as needed.
4. Always transport with Safety Shield and Deflector closed.

02967867

CD9F5HCB

CD9F5HCB

LEVER #1 MAIN BOOM

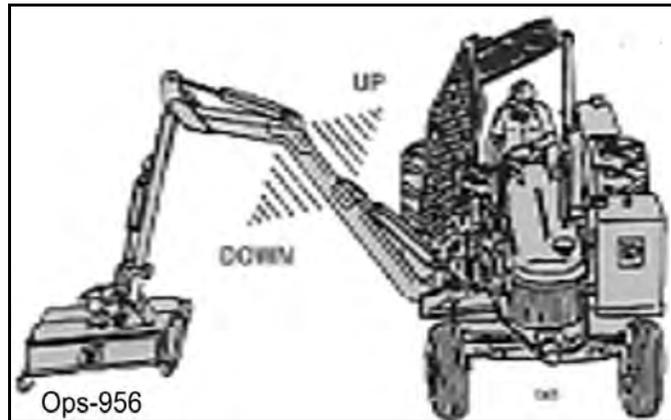

LEVER #2 SECONDARY BOOM

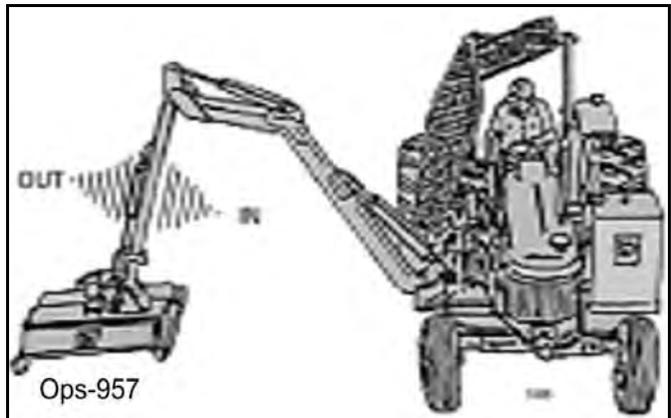

LEVER #3 DECK ROLL

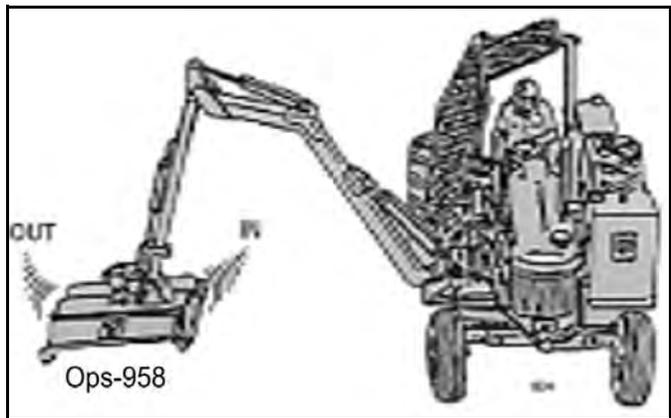

Boom

Operation Section 3-21

CD9F5 HCB

CD9F5 HCB

LEVER #4 BOOM SWIVEL

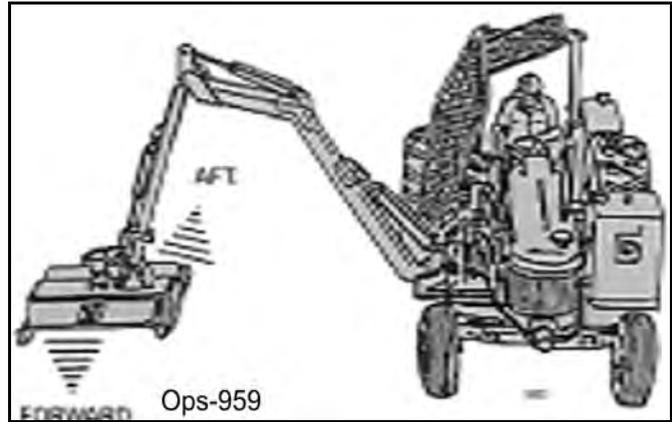

LEVER #5 BOOM SHIELD

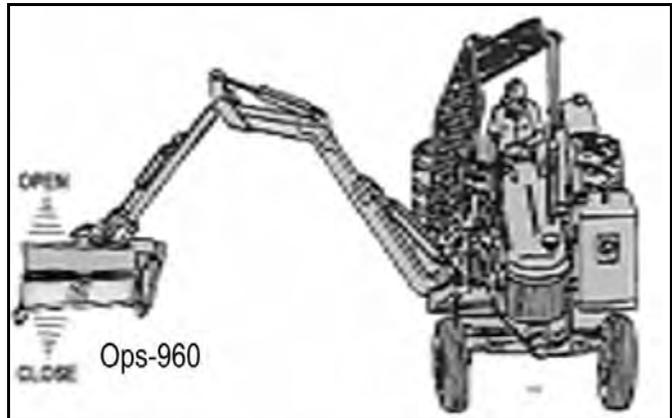

Boom

Operation Section 3-22

CD9F5HCB

WARNING



NOTE: **8C'BCH** operate mower head while boom mower is in the boom rest, or in the stored position! Red "Mower Run" light indicates mower is "ON".

The boom functions are controlled by an electronic joystick. The Joystick Master Switch enables the joystick control for controlling the boom motion functions. This switch is to be in the "OFF" position when starting the tractor and when boom is stowed for transporting the machine.



If the joystick control is not operating properly, turn the master switch to the "OFF" position. Install the manual valve handle onto valve and operate the functions individually to stow boom. After boom is stowed in rest, transport the unit to the maintenance facility and contact your Tiger dealer for assistance.



8C'BCH attempt to operate the valve manually for mowing operations!

Note: Pushing manual valve handles "out" or "away" from the tractor cab will bring the main boom "up", secondary boom "out", roll deck "out", and swivel boom "aft". Pulling manual handles toward cab will let main boom "down", bring secondary boom "in", roll deck "in", and swivel boom "forward".

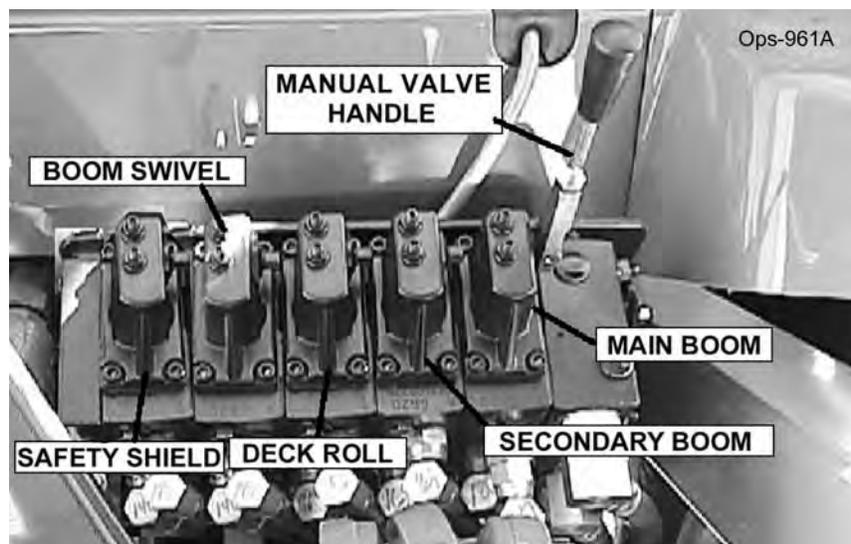

CD9F5HCB

CD9F5HCB

Joystick Controller Functions

The diagrams below and on the next page show the functions that are performed through the use of the joystick controller.

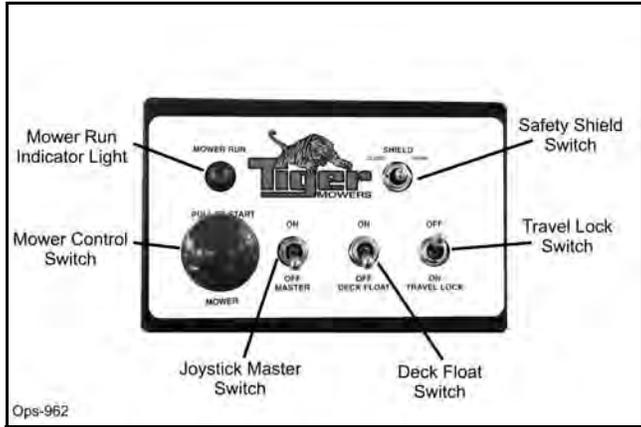

The Safety Shield switch opens and closes the shield located on the front of the cutter head. When moving at or near the ground, always have the shield in the closed position. When moving in brush or in trees above ground level the shield may be opened for easier cutting. Read and follow the warnings on the decal shown below.

⚠ DANGER

SAFETY SHIELD OPERATION

- Failure to close Safety Shield may allow objects to be thrown outward with great force which can cause property damage, bodily injury, or death.

1. Keep Safety Shield fully closed when cutting grass and weeds to reduce possibility of objects being thrown outward by the Blades and to prevent contact with the Blades if persons are in the area.
2. Before cutting brush, trimming limbs, or other such operations, raise Safety Shield fully to allow the blades to contact the material if area is clear of passersby. Operator must stop cutting and close shield if passerby enters the thrown objects area or blade contact area.
3. Repair or replace Safety Shield as needed.
4. Always transport with Safety Shield closed. Ops-963

CD9F5HCB

CD9F5HCB

>cmgW 7 cbfc`

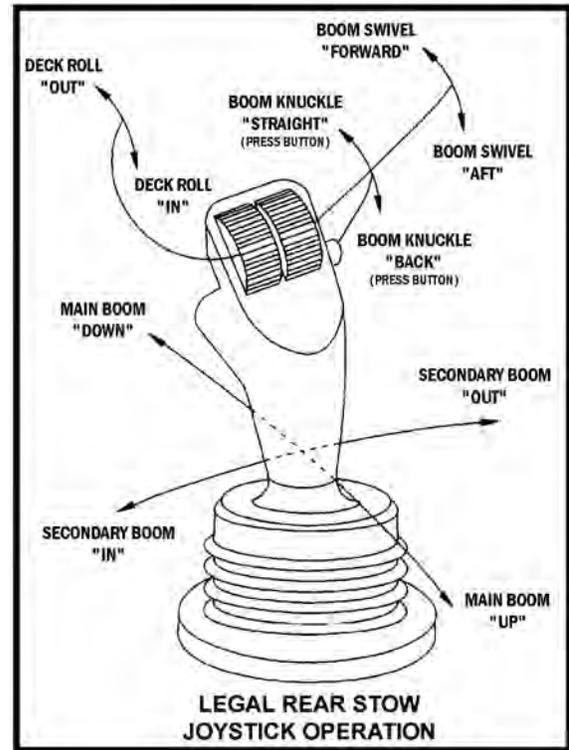
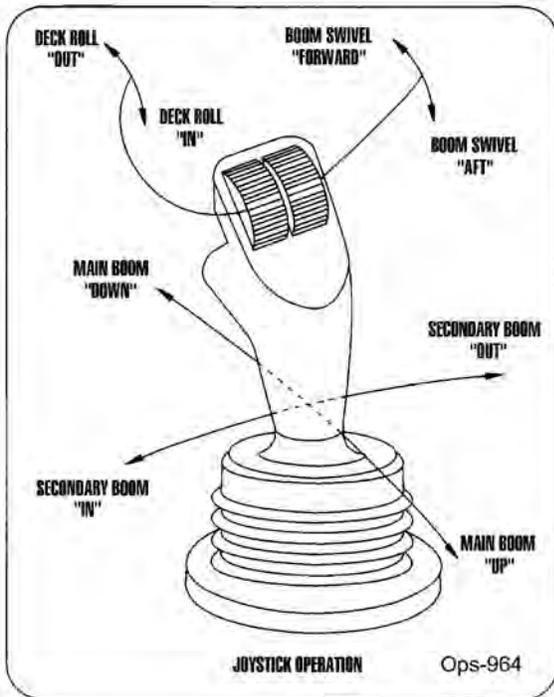

JOYSTICK FWD/BACK MOVES MAIN BOOM

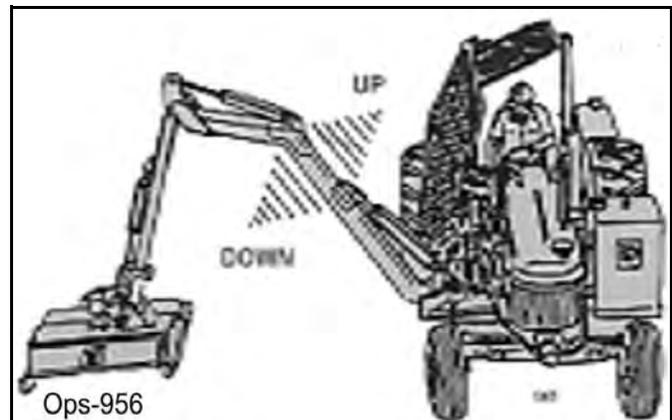

CD9F5 HCB

CD9F5 HCB

JOYSTICK LEFT/RIGHT MOVES SECONDARY BOOM

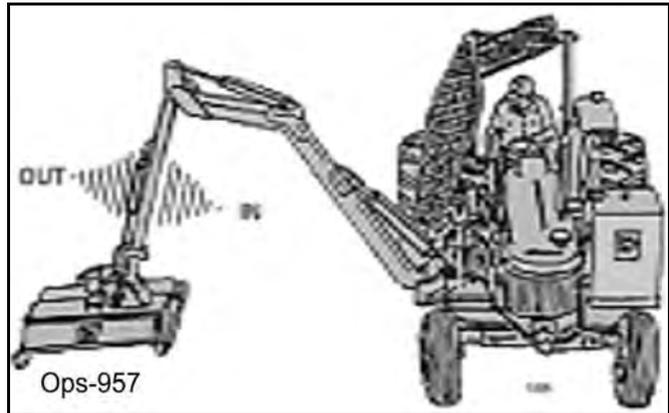

LEFT JOYSTICK ROLLER MOVES DECK ROLL

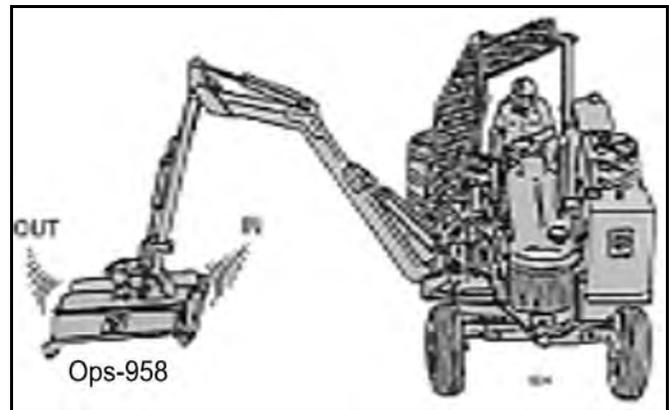

RIGHT JOYSTICK ROLLER MOVES BOOM SWIVEL

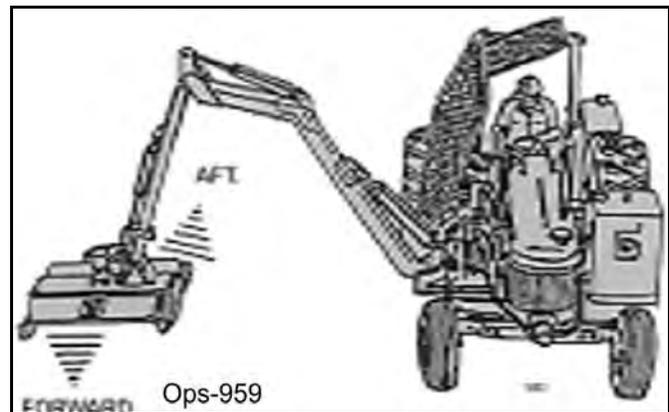

CD9F5HCB

CD9F5HCB

RIGHT JOYSTICK ROLLER WHILE PRESSING
BUTTON MOVES BOOM KNUCKLE ON A LEGAL
REAR STOW BOOM

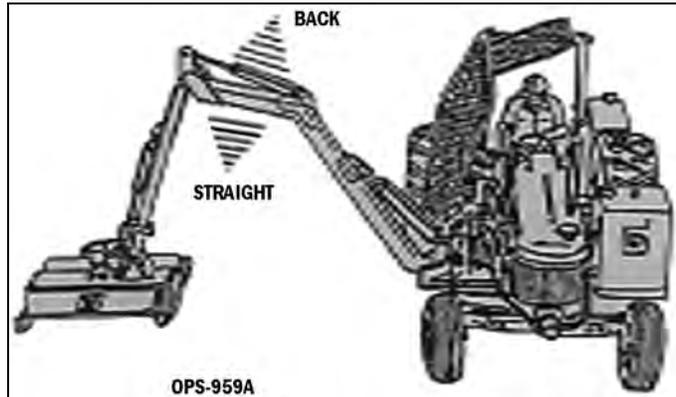

SHIELD SWITCH (on switch box) OPERATES
SAFETY SHIELD

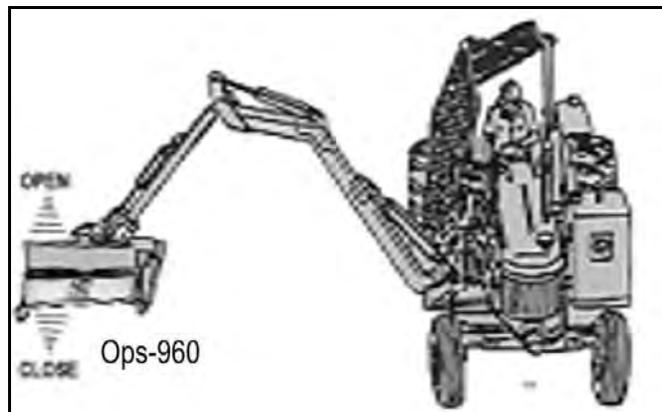

SAFE TRACTOR TRANSPORT WITH A BOOM

Safe tractor transport requires the operator to possess a thorough knowledge of the model being operated and precautions to take while driving with an attached implement. Ensure the tractor has the capacity to handle the weight of the boom and the tractor operating controls are set for safe transport. To ensure safety while driving the tractor with a boom, review the following.

Read all safety instructions. Decals on the Boom warn you of particular and multiple hazards. Some decals are attached close to part of the Boom where there is a possible hazard. Read and make sure you understand the safety messages before you operate the implement. Keep all decals clean and readable. Replace lost or damaged decals, refer to safety section for more information.

Keep all person's well clear of mower since blades can throw objects with great velocity for a considerable distance! KEEP CLEAR! OPS-B- 0005

CD9F5HCB

⚠ DANGER

Never operate the Tractor or Implement until you have read and completely understand this Manual, the Tractor Operator's Manual, and each of the Safety Messages found in the Manual or on the Tractor and Implement. Learn how to stop the tractor engine suddenly in an emergency. Never allow inexperienced or untrained personnel to operate the Tractor or Implement without supervision. Make sure the operator has fully read and understood the manuals prior to operation. (SG-4)



⚠ WARNING

Always maintain the safety signs in good readable condition. If the safety signs are missing, damaged, or unreadable, obtain and install replacement safety signs immediately. (SG-5)

⚠ DANGER

BEFORE leaving the tractor seat, always set the parking brake and/or set the tractor transmission in parking gear, disengage the PTO, stop the engine, remove the key, and wait for all moving parts to stop. Place the tractor shift lever into a low range or parking gear to prevent the tractor from rolling. Never dismount a Tractor that is moving or while the engine is running. Operate the Tractor controls from the tractor seat only. (SG-9)

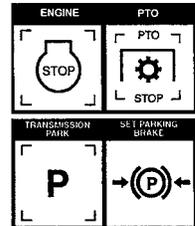

CD9F5HCB

CD9F5HCB

WARNING

Transport only at speeds where you can maintain control of the equipment. Serious accidents and injuries can result from operating this equipment at high speeds. Understand the Tractor and Implement and how it handles before transporting on streets and highways. Make sure the Tractor steering and brakes are in good condition and operate properly.



Before transporting the Tractor and Implement, determine the proper transport speeds for you and the equipment. Make sure you abide by the following rules:

Test the tractor at a slow speed and increase the speed slowly. Apply the Brakes smoothly to determine the stopping characteristics of the Tractor and Implement. As you increase the speed of the Tractor the stopping distance increases. Determine the maximum transport speed not to exceed 20 mph (30 kph) for transporting this equipment.

Test the equipment at a slow speed in turns. Increase the speed through the turn only after you determine that the equipment can be operated at a higher speed. Use extreme care and reduce your speed when turning sharply to prevent the tractor and implement from turning over. Determine the maximum turning speed for you and this equipment before operating on roads or uneven ground.

Only transport the Tractor and Implement at the speeds which allow you to properly control the equipment.

Be aware of the operating conditions. Do not operate the Tractor with weak or faulty brakes or worn tires. When operating down a hill or on wet or rain slick roads, the braking distance increases: use extreme care and reduce your speed. When operating in traffic always use the Tractor's flashing warning lights and reduce your speed. Be aware of traffic around you and watch out for the other guy. (SG-19)



CD9F5HCB

Starting the Tractor

The procedure to start the tractor is model specific. Refer to the tractor operator's manual for starting procedures for your particular tractor. Consult an authorized dealer if the starting procedure is unclear. Ensure the 3-point control lever is in the lowered position and the PTO is disengaged before starting the tractor. OPS-U-0033



CD9F5HCB

CD9F5HCB

Brake Pedals

Make sure the tractor brakes are in good operating condition. Tractor brakes can be set to operate independently allowing single rear wheel braking action or locked together to provide simultaneous rear wheel braking. FOR MOST DRIVING AND OPERATING CONDITIONS, THE BRAKE PEDALS SHOULD BE LOCKED TOGETHER TO PROVIDE THE MOST EFFECTIVE BRAKING ACTION.



Always disengage the tractor differential lock when turning. When engaged the differential lock will prevent or limit the tractor from turning. During normal cutting conditions, locking the differential provides no benefit and should not be used.

OPS-U- 0013

WARNING

Be aware of the operating conditions. Do not operate the Tractor with weak or faulty brakes. When operating down a hill or on wet or rain slick roads, the braking distance increases; use extreme care and reduce your speed in these conditions. When operating in traffic, always use the Tractor's flashing warning lights and reduce your speed. Be aware of traffic around you and watch out for the other guy. *Qru/2226/OKE+

DANGER

BEFORE leaving the tractor seat, always set the parking brake and/or set the tractor transmission in parking gear, disengage the PTO, stop the engine, remove the key, and wait for all moving parts to stop. Place the tractor shift lever into a low range or parking gear to prevent the tractor from rolling. Never dismount a Tractor that is moving or while the engine is running. Operate the Tractor controls from the tractor seat only. (SG-9)

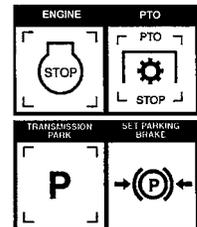

CD9F5HCB

Start off driving at a slow speed and gradually increase your speed while maintaining complete control of the tractor.

Start off driving at a slow speed and gradually increase your speed while maintaining complete control of the tractor. Never operate the tractor at speeds that cannot be safely handled or which will prevent the operator from stopping quickly during an emergency. If the power steering or engine ceases operating, stop the tractor immediately as the tractor will be difficult to control.

Perform turns with the tractor and mower at slow speeds to determine how the tractor with and attached implement handles a turn. Determine the safe speed to maintain proper control of the tractor when making turns. When turning with the implement the overall working length and width of the unit is increased. Allow additional clearance for the unit when turning or when passing large obstructions.



To avoid overturns, drive the tractor with care and at safe speeds, especially when operating over rough ground, crossing ditches or slopes, and turning corners. Use extreme caution when operating on steep slopes. Keep the tractor in a low gear when going downhill. DO NOT coast or free-wheel downhill.

OPS-B- 0006



CD9F5HCB

CD9F5HCB

CD9F5HCB



Never Leave the mower unattended while the head is in the raised position. The mower could fall causing serious injury to anyone who might inadvertently be under the mower (SBM-4)



Always keep a careful lookout and use extreme care when working around overhead obstructions. Never allow the Mower head or boom within 10 feet of any power line. When working close to overhead power lines consult your electric company for a safe code of operation. (SBM-7)



- "CD9F5HB; H<9'6CCA' I B#5B8'5H57<98'<958

H<9' CD9F5HCF' AI GH' 7CAD@H9@M' I B89FGH5B8' <CK' HC' CD9F5H9' H<9'HF5' 7HCF' 5B8 ACK9F'5B8'5@@7CBHFC@G'69: CF9'5HH9ADHB; 'HC'ACK" The operator must read and understand the Safety and Operation Sections of this manual and the tractor operator's manuals. These manuals must be read and explained to any operator who cannot read. Never allow someone to operate the unit without complete operating instructions.

To ensure safety to the operator, bystanders, and equipment and before starting any mowing operation. The operator must become familiar with the area to be mowed, and any obstacles and hazards contained within. Special attention should be paid to foreign debris, overhead obstructions, rough terrain, steep slopes, passersby and animals in the area.

Only operate the mower head from the tractor operator's seat with the seatbelt securely fastened. Only operate a boom and equipped head on cabbed tractor that is equipped with a polycarbonate safety-protected right side window or a non cabbed tractor equipped with a ROPS and operator safety screen.

Avoid operating in the reverse direction when possible. In situations where the boom and mower must be backed to access areas to be cut, make sure there are no persons or other foreign debris behind the tractor. When backing, operate the tractor at a much reduced ground speed to ensure complete control of the unit is maintained. OPS-B- 0007



Do not mow with two machines in the same area except with Cab tractors with the windows closed. (SGM-11)



Mow only in conditions where you have clear visibility in daylight or with adequate artificial lighting. Never mow in darkness or foggy conditions where you cannot clearly see at least 300 feet (90 m) in front and to the sides of the tractor and mower. Make sure that you can clearly see and identify passersby, steep slopes, ditches, drop-offs, overhead obstructions, power lines, debris and foreign objects. If you are unable to clearly see these type of items discontinue mowing. (SGM-01)

CD9F5HCB

WARNING

Avoid mowing in reverse direction when possible. Check to make sure there are no persons behind the mower and use extreme care when mowing in reverse. Mow only at a slow ground speed where you can safely operate and control the tractor and mower. Never mow an area that you have not inspected and removed debris or foreign material. (SGM-08)

WARNING

Never operate the mower head tilted down where the operator can see the blades of the mower. The blade could throw an object toward the operator causing serious injury or death. Never operate the mower without an Operator Protective Structure. Always wear safety glasses and a hard hat. (Ops-0005-MISC)

- %: cfYIJ b'8 YVfIq'< UnUFXg#Cj Yf\ YUX'CVqIi Wfcbg

An area to be cut must first be inspected for objects that could be thrown or that could damage the machine. Walk through the area looking for fences, boulders, rocks, culverts, stumps or metal objects. Mark the inspected area with flags. If the area is dense and cannot be walked thoroughly it may be necessary to inspect a smaller area as well as possible, then trim away the part that has been inspected and can safely be removed. Walk each new area again and repeat the inspection before cutting more away. Repeat as often as necessary until the area is cleared. It can be damaging and/or dangerous to work the cutter in an area that has not been visually inspected.

Place DANGER signs at least 300 feet beyond the perimeter of the area to be worked, not just 300 feet from where the machine started operating! It is convenient in many cases to work in 300 foot sections. Move the first Danger sign to the beginning of the freshly cleared area, place it, then take the first cutting area flag up to the end of the freshly cleared area 300 feet away. Walk and inspect the next 300 feet and place the second cutting area flag. Pick up the second DANGER sign, and take it a further 300 feet along the road or trail. Note that in many cases the DANGER area will extend in front of and behind the machine as well as along each side. Post signs accordingly. OPS-B- 0008

WARNING

Extreme care should be taken when operating near loose objects such as gravel, rocks, wire, and other debris. Inspect the area before mowing. Foreign objects should be removed from the site to prevent machine damage and/or bodily injury or even death. Any objects that cannot be removed must be clearly marked and carefully avoided by the operator. Stop mowing immediately if blades strike a foreign object. Repair all damage and make certain rotor or blade carrier is balanced before resuming mowing. (SGM-05)



WARNING

Many varied objects, such as wire, cable, rope, or chains, can become entangled in the operating parts of the mower head. These items could then swing outside the housing at greater velocities than the blades. Such a situation is extremely hazardous and could result in serious injury or even death. Inspect the cutting area for such objects before mowing. Remove any like object from the site. Never allow the cutting blades to contact such items. (SGM-06)

CD9F5HCB

CD9F5HCB

WARNING

Mow at the speed that you can safely operate and control the tractor and mower. The correct mowing speed depends on terrain condition and grass type, density, and height of cut. Normal ground speed range is from 2 to 5 mph(3-8 kph). Use slow mowing speeds when operating on or near steep slopes, ditches, drop-offs, overhead obstructions, power lines, or when debris and foreign objects are to be avoided. (SGM-07)

- "CdYfUhb['GdYYX'UbX': fci bX'GdYYX

Ground speed for mowing will depend upon the height, type, and density of vegetation to be cut. Do Not exceed 5 MPH while operating. Operate the mower at its full rated PTO speed to maintain blade speed for a clean cut. Refer to the tractor operator's manual or the tractor instrument panel for the engine speed and gear to provide the required operating and desired ground speed. Make sure that the mower is operating at its full rated speed before entering the vegetation to be cut. Always start and stop cutting blades with engine near idle.

Ground speed is achieved by transmission gear selection and not by the engine operating speed. The operator may be required to experiment with several gear range combinations to determine the best gear and range which provides the most ideal performance from the implement and most efficient tractor operation. As the severity of cutting conditions increase, the ground speed should be decreased. OPS-B- 0009

WARNING

Mow at the speed that you can safely operate and control the tractor and mower. The correct mowing speed depends on terrain condition and grass type, density, and height of cut. Normal ground speed range is from 2 to 5 mph(3-8 kph). Use slow mowing speeds when operating on or near steep slopes, ditches, drop-offs, overhead obstructions, power lines, or when debris and foreign objects are to be avoided. (SGM-07)

- " 'CdYfUhb['h Y'5 HUW YX'Ack Yf' < YUXg

The boom can attach to and operate multiple heads one at a time for a wide range of vegetation control applications. The attached heads are designed for different applications. The head should be selected based on the mowing application and the location that the unit is being operated.

Refer to the Assembly Section of this manual to ensure the head is properly attached to the boom hitch and hydraulic lines are properly connected. OPS-B- 0010

DANGER

There are obvious and hidden potential hazards in the operation of this Mower. REMEMBER! This machine is often operated in heavy brush and in heavy weeds. The Blades of this Mower can throw objects if shields are not properly installed and maintained. Serious injury or even death may occur unless care is taken to insure the safety of the operator, bystanders, or passersby in the area. Do not operate this machine with anyone in the immediate area. Stop mowing if anyone is within 300 feet of mower. (SGM-02)



CD9F5HCB

CD9F5HCB

- 'A ck Yf CdYfUjcb

The rotating parts in this machine have been designed and tested for rugged use. However, they could fail upon impact with heavy solid objects-such as steel guard rails, concrete abutments,etc., causing them to be thrown at a very high velocity. Never allow cutter head to contact such objects. Inspecting the cutting area for such objects and removing them prior to mowing can help eliminate these potential hazards.

Once on location, lower the mower deck slightly above the material to be cut, so the mower does not have to start under a load. With the tractor at an idle, engage mower. Bring tractor R.P.M. up to 1900-2200 R.P.M. and **gck`m**lower deck to ground level.

A flail mower deck should be carried so that the part of the deck weight is carried by the boom and part carried by the ground roller, when moving on the ground. When the flail mower is carried this way, the ground roller follows the contour of the ground more easily during mowing operations.

The rotary mower deck should always be carried rather than dragged on the skid shoes when mowing on the ground. Dragging the rotary mower deck increases the side loads on the boom, decreases the horsepower available to the cutter head, and reduces the ability of the accumulator the carry part of the weight of the boom during mowing operations.



When rotating parts are in motion, serious injury may occur if caution is not used or danger is not recognized. Never allow bystanders within ' \$\$' ZYh of the machine when in operation. Extreme care should be taken when operating near loose objects-such as gravel, rocks, and debris. These conditions should be avoided.

- ') \$I / '* \$I '6cca 'FchUfm

The 50" & 60" boom rotary brush mower was designed for cutting brush and foliage up to 6 inches in diameter or multiple branches that have a total cross section area equivalent to one 6 inch branch.

During mower operation, the hand throttle must be used to maintain engine speed at 1900-2200 R.P.M. This prevents radical changes in mower spindles speed, reducing the possi bility of cutter assembly damage.

The horizontal positioning action of the boom is designed to position the cutting head and provide a limited pressure relief when excessive pressure is applied to the boom. Do not force the cutting head into heavy branches or stumps. Damage to the unit may result.



When using the rotary cutting head for trimming trees and shrubs, let the mower saw into them. Do not lower the mower head down directly into a tree or stump. The mower blades are designed to cut with the end, and misuse can cause damage to the blade and a hazardous situation for the operator.



Powering the boom down, forcing mower deck onto ground may damage mower deck and it's attachment to the boom, creating a potentially hazardous situation.

To ensure a clean cut, engine speed should be maintained at approximately 1900-2200 R.P.M. If the tractor slows to less than 1800 R.P.M., shift to the next lower gear. DO NOT ride the clutch, this will cause premature clutch failure. H Y Yb[]bY'g[ci `X' bch'VY'cdYfUHYX' Uh'Ubmilja Y'Uh'a cfY'H Ub`& (\$\$'F'D'A "cb'h Y'fUWcf HJW ca YHf"

Boom

Operation Section 3-35

CD9F5HCB

For cutting brush, it is usually best to stop the tractor and swivel the boom and mower into foliage. The horizontal positioning action of the boom is designed to position the cutting head and provide a limited pressure relief when excessive pressure is applied to the boom.



8 C BCH use excessive force when positioning cutting head into heavy branches or stumps. Damage to the unit may result. It is best to let the cutter head “eat away” slowly at heavy cutting jobs.



If foliage falls on top of mower deck causing tractor to become unstable, move the boom “Forward” and “Out” to relieve tipping of the tractor. Lower mower deck to ground and shut down unit. After all motion stops, remove foliage from mower deck.

The mower will operate more efficiently in tougher conditions and with less power if the knives are kept sharp. If the mower begins to vibrate, stop the tractor, check for wire wrapped in the spindle or damaged knives. When replacing knives, replace all knives with new knives to ensure proper balance so the mower will not vibrate. Severe vibration will result, if knives with unequal wear are used.

Begin a pass at the top side of the trees and work down with each consecutive pass. When cutting trees and shrubs, use a lower speed to allow the knives time to cut as well as mulch the foliage.



If bystanders approach within 300 feet while mower is in operation turn mower switch “OFF” immediately! After shutdown, never leave the tractor or allow bystanders to approach within **99H** of the unit until all motion stops completely.

If cutter shaft jams and stops, turn mower switch to OFF, and swivel boom AFT. Normally this action will clear the cutter head. If not, roll mower deck until adjacent to the secondary boom, then lower boom to rest mower deck on ground. Shut off the tractor, set parking break, allow all motion to cease. At that point it is safe to leave the tractor and clear the cutter heads manually.

Begin each pass at the top side of the trees and work down with each consecutive pass. Use a low speed to allow the cutting blades time to mulch as well as cut the foliage. When the initial pass has been made, disengage the mower, and return boom to a safe travel position. Return to starting point and make next pass, etc..

After the first day of operation, all bolts should be checked and tightened securely. This should be done periodically to ensure the bolts do not become loose and cause damage to the tractor or mower, or injury to the operator.

CD9F5HCB

CD9F5HCB

When cutting trees and brush approach material to be cut with the head perpendicular to material. The cutting edge of the blades should be the only elements in contact with material. The blade bar should not contact with material. The mower head and blades should be moved perpendicularly into the material rather lowering the mower head on top of material. If the blade bar edges are gouged or rounded from wear, the mower head is being used incorrectly in an abusive manner. The blade bar is not intended to cut material or to be a wear item like the blades. Do Not allow the blades or blade bar to contact the ground, rocks or solid objects. Contact with the ground can result in rocks and solid objects being thrown out from under the mower head which can cause serious injuries to the operator and bystanders. This type of operation can lead to bent or broken blade bars, broken blade bolts and broken blade bar assembly bolts which can be dangerous to the operator and bystanders.

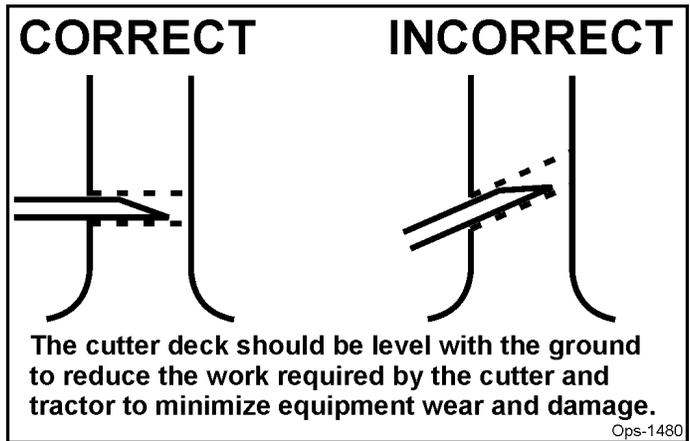

Ops-1480

(OPS-R-220)

50' boom flail mower

The 50' boom flail mower was designed for cutting brush and foliage up to 3 inches in diameter or multiple branches that have a total cross section area equivalent to one 3 inch branch. Cutting multiple limbs at the same time may overload the mower causing it to slow down or stall completely. Regardless of the size of material being cut, the cutter shaft speed must be maintained. To ensure that the cutter shaft is running at maximum speed, run the tractor at full throttle during mowing operations. If the cutter shaft slows to the point that the knives are folding back, move the mower head away from the foliage and allow the cutter shaft to regain full speed.



WARNING Operating the mower in a manner that allows the knives to continually fold back or allowing knife lugs to contact foliage will cause permanent damage to the cutter shaft drum, knives, and knife attachment parts.



WARNING The 50" boom flail cutter shaft is designed for standard rotation (same rotation as the tractor wheels during forward travel). **Operating this mower in reverse rotation may cause objects to be thrown out the front of the mower head.**



WARNING The 50" boom flail equipped with free swinging brush knives is intended for brush cutting only. Cutting grass is not recommended.

CD9F5 HCB

WARNING

Do not allow knives to cut down to the ground. Position ground roller to maintain knife arc at a minimum of 2 inches above the ground. Knife contact or lug contact with ground will cause permanent damage to cutter shaft, knives, and knife attachment parts.

63" Boom Flail Mower

The 63" boom flail mower was designed for cutting grass. The cutter shaft speed must be maintained for proper cutting. To insure that the cuttershaft is rotating at maximum speed, run tractor at full throttle during mowing operations. If cuttershaft slows to the point that the knives are folding back against the cutter shaft, move the mower head away from the foliage and allow the cuttershaft to regain full speed.



DANGER

The rotating parts of this machine have been designed and tested for rugged use. However, the blades could fail upon impact with heavy, solid objects such as metal guard rails and concrete structures. Such impact could cause the broken objects to be thrown outward at very high velocities. To reduce the possibility of property damage, serious injury, or even death, never allow the cutting blades to contact such obstacles. (SGM-4)

DANGER

All Safety Shields, Guards and Safety devices including (but not limited to) - the Deflectors, Chain Guards, Steel Guards, Gearbox Shields, PTO integral shields, and Retractable Door Shields should be used and maintained in good working condition. All safety devices should be inspected carefully at least daily for missing or broken components. Missing, broken, or worn items must be replaced at once to reduce the possibility of injury or death from thrown objects, entanglement, or blade contact. (SGM-3)

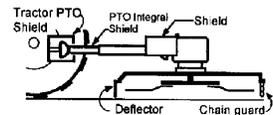

WARNING

Many varied objects, such as wire, cable, rope, or chains, can become entangled in the operating parts of the mower head. These items could then swing outside the housing at greater velocities than the blades. Such a situation is extremely hazardous and could result in serious injury or even death. Inspect the cutting area for such objects before mowing. Remove any like object from the site. Never allow the cutting blades to contact such items. (SGM-06)

CD9F5HCB

CD9F5HCB

Shutting Down the Tractor

To shut down attached mower head, first bring the tractor to a complete stop. Decrease engine RPM to idle then disengage cutterhead. The mower head will come to a complete stop within a suitable amount of time. Do not engage or disengage the cutterheads at a high RPM unless there is an emergency situation.



Park the tractor on a level surface, place the transmission in park or neutral and apply the parking brake, shut down the engine, remove the key, and wait for all motion to come to a complete stop before exiting the tractor. OPS-B-0011_D



BEFORE leaving the tractor seat, always set the parking brake and/or set the tractor transmission in parking gear, disengage the PTO, stop the engine, remove the key, and wait for all moving parts to stop. Place the tractor shift lever into a low range or parking gear to prevent the tractor from rolling. Never dismount a Tractor that is moving or while the engine is running. Operate the Tractor controls from the tractor seat only. (SG-9)

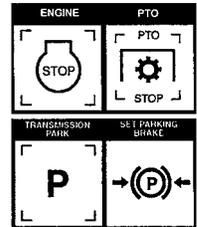

CD9F5HCB

CD9F5HCB

Preparation and Storage

Properly preparing and storing the unit at the end of the season is critical to maintaining its appearance and to help ensure years of dependable service. The following are suggested storage procedures:

- Thoroughly clean all debris from boom and head to prevent damage from rotting grass and standing water.
- Lubricate all grease points and fill oil levels according to the maintenance lubrication schedule.
- Tighten all bolts to the proper torque. Ensure all pins and other hardware are in place.
- Check the boom arm and head for worn and damaged parts. Perform repairs and make replacements so that the mower will be ready for use at the start of the next season.
- Store the unit in a clean and dry location.
- Use spray touch-up enamel where necessary on bare metal surfaces to prevent rust and to maintain the appearance of the mower.



OPS-B- 0012_C



Never allow children to play on or around Tractor or Implement. Children can slip or fall off the Equipment and be injured or killed. Children can cause the Implement to shift or fall crushing themselves or others. (SG-25)



BEFORE leaving the tractor seat, always set the parking brake and/or set the tractor transmission in parking gear, disengage the PTO, stop the engine, remove the key, and wait for all moving parts to stop. Place the tractor shift lever into a low range or parking gear to prevent the tractor from rolling. Never dismount a Tractor that is moving or while the engine is running. Operate the Tractor controls from the tractor seat only. (SG-9)

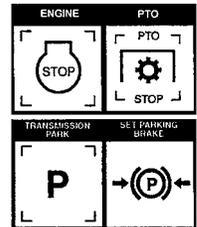

Perform service, repairs and lubrication according to the maintenance section. Ensure the unit is properly lubricated as specified in the lubrication schedule and all bolts and nuts are properly torqued. Failure to properly service, repair and maintain this Implement in good operating condition could cause component failure and possible serious injury or even death. (SG-35)

Transporting the Tractor and Implement

Inherent hazards of operating the tractor and implement and the possibility of accidents are not left behind when you finish working in an area. Therefore, the operator must employ good judgement and safe operation practices when transporting the tractor and implement between locations. By using good judgement and following safe transport procedures, the possibility of accidents while moving between locations can be substantially minimized. OPS-U- 0017

CD9F5HCB

CD9F5HCB

Before Transporting Tractor Between Locations

Before transporting tractor between locations, idle the tractor engine, disengage the attached head, and wait for all head motion to come to a complete stop. Place the boom in its storage cradle rest support and then turn the joystick master switch to the OFF position.



- Retract Deck Roll cylinder completely.
- Push Secondary cylinder approximately 1/2 way out.
- Raise Main boom approximately to 60°.
- Swing boom back slowly until it is straight back.
- For a 3-point boomrest or a single column boomrest, position the secondary in the cradle. Carefully avoid pinching any hoses.
- For an open stow style boomrest, lower the Main boom onto rest and bring the Secondary boom in until it is sitting on the boomrest.
- For a Legal Stow style boomrest, retract the secondary and knuckle cylinders completely. Lower the Main boom onto rest. Slowly extend the secondary cylinder until the secondary boom contracts the side of the boomrest saddle. Next, slowly extend the knuckle cylinder until the secondary sets on the bottom part of the boomrest saddle.



The boom is now in the transport position. Turn on any electronic travel locks at the switchbox.

To remove the boom from the boomrest, first turn off any electronic travel locks at the switchbox then retract the knuckle cylinder (if applicable) then swing the Secondary boom out. Raise the Main boom approximately 6 inches. Swivel the boom forward to the desired position. OPS-B- 0013_D

CD9F5HCB

CD9F5HCB

Extreme Caution When Transporting Tractor and Mower on Public Roadways

Extreme caution should be used when transporting the tractor and mower on public roadways. The tractor must be equipped with all required safety warning features including a SMV emblem and flashing warning lights to alert drivers of the tractor's presence. Remember that roadways are primarily designed for automotive drivers and most drivers will not be looking out for you, therefore, you must look out for them. Check your side view mirrors frequently and remember that vehicles will approach quickly because of the tractor's slower speed. Be extremely cautious when the piece of equipment that you are driving, is wider than the tractor tire width and/or extends beyond your lane of the road. OPS-B-0014

The SMV (Slow-Moving Vehicle) emblem is universal symbol used to alert drivers of the presence of equipment traveling on roadways at a slow speed. SMV signs are a triangular bright orange with reflective red trim for both easy day and night visibility. Make sure the SMV sign is clean and visible from the rear of the unit before transporting the tractor and implement on a public roadway. Replace the SMV emblem if faded, damaged, or no longer reflective. OPS-U-0020



Make sure that all tractor flashing warning lights, headlights, and brake/taillights are functioning properly before proceeding onto public roads. While newer model tractors have plenty of lighting to provide warning signals and operating lighting, most older models were only equipped with operating lights. Consult an authorized tractor dealer for lighting kits and modifications available to upgrade the lighting on older tractor models. OPS-B-0015



CD9F5HCB

CD9F5HCB

When operating on public roads, have consideration for other road users. Pull to the side of the road occasionally to allow all following traffic to pass. Do not exceed the legal speed limit set in your state or municipality for agricultural tractors. Always stay alert when transporting the tractor and mower on public roads. Especially in busy cities, the boom extends to right farther than the tractors width, so be careful there are no bystanders, poles, large obstructions or any vehicles that may be in path of the mower head or boom. Use caution and reduce speed if other vehicles or pedestrians are in the area. OPS-B-0016



Never allow children or other persons to ride on the Tractor or Implement. Falling off can result in serious injury or death. (SG-10)



Make certain that the "Slow Moving Vehicle" (SMV) sign is installed in such a way as to be clearly visible and legible. When transporting the Equipment use the Tractor flashing warning lights and follow all local traffic regulations. (SG-6+)

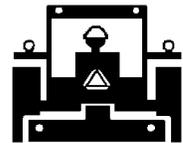

Reduce speed before turning or applying the brakes. Ensure that both brake pedals are locked together when operating on public roads. OPS-U-0023



CD9F5HCB

CD9F5HCB

Before Transporting a Loaded Tractor and Implement

Before transporting a loaded tractor and implement, measure the height and width dimensions and gross weight of the complete loaded unit. Ensure that the load will be in compliance with the legal limits set for the areas that will be traveled through. OPS-U-0024



⚠ DANGER

When transporting Boom Mower on a truck or trailer, the height or width may exceed legal limits when the boom is in the transport position. Contact with side or overhead structures or power lines can cause property damage or serious injury or death. If necessary lower boom to reduce height and/or remove mowing head to reduce width to the legal limits. (SBM-8)

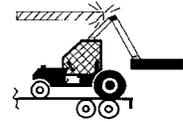

Use adequately sized and rated trailers and equipment to transport the tractor and implement. Consult an authorized dealer to determine the proper equipment required. Using adequately sized chains, heavy duty straps, cables and/or binders, securely tie down both the front and rear of the tractor utilizing the proper tie down locations as specified by the tractor manufacturer. OPS-U-0025



CD9F5HCB

Arrange the chains so that when tightened, the chains are pulling downward and against themselves. Carefully tighten the securing chains or other fasteners using boomers or binders to apply maximum tension. Use extreme care when attaching and removing the securing devices as the extreme tension involved when released has the potential to inflict serious injury.

While hauling the tractor and implement, make occasional stops to check that the tractor and implement have not moved or shifted and that the securing chains have maintained tension. If during transport a hard braking, sharp turning, or swerving action was performed, stop at the next safe location to inspect the security of the load. OPS-U-0026



CAUTION

If trailer is not perfectly level, the boom will tend to swing towards the lower side. Have other personnel ready to control its swinging motion when cylinder pin is removed. Make sure the personnel are not in a position to be hit or crushed by a swinging boom.

Retract swivel cylinder and secure to mainframe. Pivot boom forward to the center of flat bed. Lower deck onto the trailer bed, and shut off the tractor. The tractor and the mower head should now be chained down securely to the trailer bed.

CAUTION

If any part of this Operation Section, or any other section of this manual is not completely understood, contact your Tiger dealer or the address on the cover of this manual for assistance!

CD9F5 HCB

CD9F5 HCB

Boom

Operation Section 3-46

MAINTENANCE SECTION

Maintenance Section 4-1

MAINTENANCE

General Instructions

Tiger Mowers are designed for high performance and rugged durability, yet with simplified maintenance. The purpose of this section of the manual is to help the operator in the regular servicing of the mower. Regular maintenance at the intervals mentioned will result in the maximum efficiency and long life of the Tiger Mower.

When you purchase a Tiger Mower you also acquire another valuable asset, Tiger's parts organization. Our rapid and efficient service has guaranteed the customer satisfaction for many years. Tiger parts keep up with the demands for efficiency, safety and endurance expected of the Tiger Mower.

Maintenance Precautions

- Be sure end of grease gun and zerks are clean before using. Debris injected into bearings, etc. with grease will cause immediate damage.
- DO NOT use a power grease gun to lubricate bearings. These require very small and exact amounts of lubrication. Refer to the detailed maintenance section for specific lubrication instructions. DO NOT over-grease bearings.
- Lexan windows should be washed with mild soap or detergent and lukewarm water, using a soft clean sponge or soft cloth. DO NOT use abrasive or alkaline cleaners or metal scrapers on lexan windows!
- Be alert to maintenance indicators such as the in-tank filter pressure gauge, hydraulic reservoir sight gauge, etc. Take the required action to correct any problems immediately.
- Release of energy from pressurized systems may cause inadvertent actuation of cylinders, or sudden release of compressed springs. Before disconnecting any hoses, relieve pressure by shutting tractor off, setting cutter on ground and actuating lift valve handles.

WARNING

DO NOT use hands to check for suspected leaks in hydraulic hoses! Hydraulic fluid escaping under pressure can have sufficient force to penetrate skin and cause serious injury. If fluid is injected into skin, it must be surgically removed within a few hours or gangrene may result. Use a small piece of wood or cardboard, not hands, to search for pin hose leaks. Be sure all connections are tight and hoses and lines are not damaged before applying pressure.

Break in Period

In addition to following the break-in instructions for your particular tractor, the in-tank hydraulic fluid filter should be replaced after the first 50 hours of service. The reafter the filter should be replaced every 500 hours, or yearly, whichever ever comes first.

Re-torque wheel lugs after first five hours of operation and periodically thereafter. See torque specifications listed in the tractor's service manual for your particular model. **Wheel lugs must always be re-torqued whenever a wheel is removed and reinstalled.**

DANGER

Never work under the Implement, the framework, or any lifted component unless the Implement is securely supported or blocked up to prevent sudden or inadvertent falling which could cause serious injury or even death. (SG-14)



MAINTENANCE



Do not modify or alter this Implement. Do not permit anyone to modify or alter this Implement, any of its components or any Implement function. (SG-8)



Relieve hydraulic pressure prior to doing any maintenance or repair work on the Implement. Place the Mower Head on the ground or securely supported on blocks or stands, disengage the PTO, and turn off the engine. Push and pull the control Levers or Joystick several times to relieve pressure prior to starting any maintenance or repair work. (SBM-6)



Always disconnect the wire leads from the mower pump solenoid before performing service on the Tractor or Mower. Use caution when working on the Tractor or Mower. Tractor engine must be stopped before working on Mower or Tractor. The Mower Blades could inadvertently be turned on without warning and cause immediate dismemberment, injury or death. (SBM-12a)

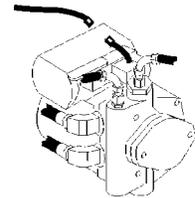

MAINTENANCE

MAINTENANCE OF CRANKSHAFT ADAPTER ASSEMBLY (RIGID ENGINE MOUNT TRACTORS ONLY)

If replacement of components of the crankshaft adapter assembly is required, follow the assembly procedures shown below. Seat rubber grommet completely into counterbore, then seat steel grommet completely into rubber grommet while rubber grommet is supported.

(ASM-JD-0051 CRANKSHAFT ADAPTER MAINTENANCE)

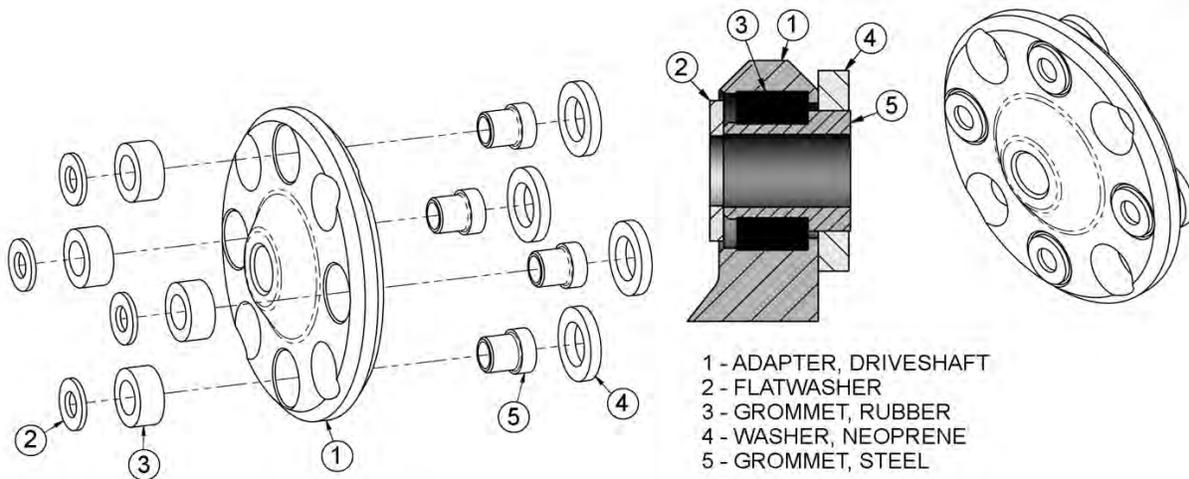

MAINTENANCE

Regular Maintenance

The intervals at which regular servicing should be done are based on hours of operation. Use the tractors hour meter to determine when regular servicing is required.

Refer to the Detailed Maintenance section for further instructions on greasing. Copy and use the Daily Maintenance sheet located at the end of this section.

Daily or Every 8 Hours

ITEM	SERVICE	COMMENTS
Drive Shaft Yoke, U-Joint & Stub Shaft	Grease	Grease as instructed in detailed maintenance section
Pump Drive Shaft Coupler	Check and Lube	Insure driveshaft end play
Crankshaft Adapter	Check rubber grommets	Replace grommets if damaged or missing
Pivot Points	Lubricate	Inject grease until it appears at end
Hydraulic Fittings	Check for leaks	Tighten when needed. Do Not use hands to check for leaks, see maint. precautions
Knives	Check	Inspect for missing or damaged knives, change as needed.
Spindle mounting bolts (spindle to deck)	Check	Torque to 315 ft. lbs. lubricated Torque to 357 ft. lbs. dry
Knife mounting bolts (knife to disk or blade bar)	Check	Pre-lubricate threads with anti-seize torque to 800 ft. lbs.
Disk/Blade Bar mounting bolts (disk/blade bar to spindle)	Check	Torque to 180 ft. lbs. lubricated Torque to 204 ft. lbs. dry
Belts	Check/Adjust	Check if broken, tighten as required
Main Frame and Deck	Check	Retorque bolts to torque specifications in this section
Hydraulic Fluid Level	Check	Add if required per fluid recommendations
Rear Flail Drive(if applicable) Bear Flange and Shaft Coupler	Lubricate	Grease as instructed in detailed maintenance section
Cutter Shaft and Ground Roller	Lubricate	Grease as instructed in detailed maintenance section

Boom

Maintenance Section 4-4

MAINTENANCE

MAINTENANCE

WEEKLY OR EVERY 40 HOURS

ITEM	SERVICE	COMMENTS
Rotary Spindle	Lubricate	Every 40 hours or weekly

WEEKLY OR EVERY 50 HOURS

ITEM	SERVICE	COMMENTS
In Tank Hyd. Fluid Filter 10 micron filter)	Change	Change after first 50 hours only, then every 500 hours or yearly
In-Line High Pressure Filter (10 micron filter)	Change	Change after first 50 hours only, then every 500 hours or yearly

MONTHLY OR EVERY 150 HOURS

ITEM	SERVICE	COMMENTS
Hydraulic Fluid Level	Check	Add as needed
Hyd. Tank Breather	Clean/Check/Replace	Clean or replace element as required
Rear Tire Type 480/80R38 18.4-34 18.4-38	Max P.S.I. 29 26 26	

YEARLY OR EVERY 500 HOURS

ITEM	SERVICE	COMMENTS
Spindle Grease Hyd. Tank Fluid In Tank Hyd. Fluid Filter (10 micron filter)	Change Change Change	
In-Line HP Filter (10 micron filter)	Change or	Change when indicated by restriction indicator.
Hyd. Tank Breather	Change	

Boom

Maintenance Section 4-5

MAINTENANCE

MAINTENANCE

TROUBLESHOOTING

SYMPTOMS	CAUSE	REMEDY
Vibration	<ol style="list-style-type: none"> 1. Loose bolts 2. Cutter assembly unbalanced 	<ol style="list-style-type: none"> 1. Check all bolts and tighten to recommended torque specs. 2a. Check for damaged blades, disc or cuttershaft. Replace if needed. 2b. Check for wire, rope, etc. entangled in the cutter assembly
Mower will not lift	<ol style="list-style-type: none"> 1. Hyd. Fluid Low 2. Leaks in line ROU 3. Faulty relief valve 5. Faulty cylinder 	<ol style="list-style-type: none"> 1. Check and refill hyd fluid 2. Tighten or replace fittings and hoses 3. Check pressure in line. Line pressure in control valve should be at least 2500 P.S.I. 5. Inspect, repair or replace cylinder
Mower will not start or run	<ol style="list-style-type: none"> 1. Blown fuse 2. Ball valves closed 3. Low oil level 4. Line leak 5. Electronic solenoid faulty 	<ol style="list-style-type: none"> 1. Check fuse between mower switch and ignition/replace 2. Make sure valves are open 3. Check hyd. tank and fill 4. Check all fittings and lines, re-tighten or replace 5a. Without the tractor running, turn the mower switch to on. A low audible click should be heard if the solenoid is engaging the solenoid spool. If click is not heard, leave switch in on position and with a screwdriver or other steel object, touch the small nut on the end of the solenoid. If the metallic object is not attracted to the nut, check the fuse and wiring for an open circuit. If the object is attracted but no "click" is heard, replace the solenoid. 5b. Remove the four bolts holding the small block to the main block. Lift and remove small block being careful not to damage O-rings/filter. Clean filter and re-install. 5c. Remove large nut on side of large valve block. Remove spring, and use needle nose vise grip to pull spool from block. Check block and spool for contaminants and scratches. Clean parts or replace if scratched.

MAINTENANCE

MAINTENANCE

TROUBLESHOOTING (CONTINUED)

SYMPTOMS	CAUSE	REMEDY
Motor runs but will not cut.	<ol style="list-style-type: none">1. Belts2. Tensioner	<ol style="list-style-type: none">1. Inspect belts and pulleys. Replace belts and repair as needed.2. Adjust tensioner nut flatwasher washer is flush with top of guide.
Mower turns slowly or not at all.	<ol style="list-style-type: none">1. Contaminants restricting spool movement in valve body.2. Suction lines obstructed3. Low oil level	<ol style="list-style-type: none">1. Remove large nut on side of large valve block. Remove spring, and use needle nose vise grip to pull spool from block. Check block and spool for contaminants and scratches. Clean parts or replace if scratched.2. Check for kinks or obstruction in suction hose.3. Check hyd. tank level and fill.
Pump will not work	<ol style="list-style-type: none">1. Excessive wear on internal parts	<ol style="list-style-type: none">1. Disassemble and repair.
Motor will not work	<ol style="list-style-type: none">1. Excessive wear on internal parts	<ol style="list-style-type: none">1. Disassemble and repair.

NOTE: If flow meter is available, check pressure and flow volume for all suspected hydraulic problems.

If the solution to your problem cannot be found in this section, call the Technical Service representative at the number shown on the front cover of this manual.

MAINTENANCE

MAINTENANCE

Torque for Standard Fasteners													
Nominal Dia. (in.)	threads per inch	 Grade 2			 Grade 5			 Grade 8			 Grade 9		
		Tightening Torque			Tightening Torque			Tightening Torque			Tightening Torque		
		Lubed	Dry Plated	Dry plain	Lubed	Dry Plated	Dry plain	Lubed	Dry Plated	Dry plain	Lubed	Dry Plated	Dry plain
		K = 0.15	K = 0.17	K = 0.20	K = 0.15	K = 0.17	K = 0.20	K = 0.15	K = 0.17	K = 0.20	K = 0.15	K = 0.17	K = 0.20
Unified Coarse Thread Series													
1/4	20	49 in-lbs	59 in-lbs	66 in-lbs	76 in-lbs	86 in-lbs	101 in-lbs	107 in-lbs	122 in-lbs	143 in-lbs	126 in-lbs	143 in-lbs	168 in-lbs
5/16	18	101	122	135	157	178	209	221	251	295	259	294	346
3/8	16	15 ft-lbs	18 ft-lbs	20 ft-lbs	23 ft-lbs	26 ft-lbs	31 ft-lbs	33 ft-lbs	37 ft-lbs	44 ft-lbs	39 ft-lbs	43 ft-lbs	51 ft-lbs
7/16	14	24	29	32	37	42	49	52	59	70	61	70	82
1/2	13	37	44	49	57	64	75	80	90	106	94	106	125
9/16	12	53	63	70	82	92	109	115	130	154	135	153	180
5/8	11	73	87	97	113	128	150	159	180	212	186	211	248
3/4	10	129	155	172	200	227	267	282	320	376	331	375	441
7/8	9	125	150	167	322	365	429	455	515	606	533	604	710
1	8	187	225	250	483	547	644	681	772	909	799	905	1065
1 1/8	7	266	319	354	596	675	794	836	966	1132	988	1132	1341
1 1/4	7	375	450	500	840	952	1121	1163	1345	1545	1345	1545	1830
1 1/2	6	652	783	869	1462	1657	1950	2037	2371	2779	2379	2779	3306
Fine Thread Series													
1/4	28	56 in-lbs	68 in-lbs	75 in-lbs	87 in-lbs	99 in-lbs	116 in-lbs	123 in-lbs	139 in-lbs	164 in-lbs	144 in-lbs	163 in-lbs	192 in-lbs
5/16	24	112	135	150	174	197	231	245	278	327	287	325	383
3/8	24	17 ft-lbs	20 ft-lbs	23 ft-lbs	26 ft-lbs	30 ft-lbs	35 ft-lbs	37 ft-lbs	42 ft-lbs	49 ft-lbs	43 ft-lbs	49 ft-lbs	58 ft-lbs
7/16	20	27	32	36	41	47	55	58	66	78	68	78	91
1/2	20	41	49	55	64	72	85	90	102	120	105	120	141
9/16	18	59	71	78	91	103	121	128	146	171	151	171	201
5/8	18	82	99	110	127	144	170	180	204	240	211	239	281
3/4	16	144	173	192	223	253	297	315	357	420	369	418	492
7/8	14	138	165	184	365	403	474	502	568	669	588	666	784
1	14	210	252	280	542	614	722	765	867	1020	896	1016	1195
1 1/8	12	298	357	397	668	757	890	1083	1227	1444	1269	1439	1693
1 1/4	12	415	498	553	930	1055	1241	1509	1710	2012	1768	2004	2358
1 1/2	12	734	880	978	1645	1865	2194	2668	3024	3557	3127	3544	4169

Torque values for 1/4 and 5/16-in series are in inch-pounds. All other torque values are in foot-pounds. K = 0.15 for "lubricated" conditions; K = 0.17 for zinc plated and dry conditions; K = 0.20 for plain and dry conditions. D = Nominal Diameter; F = Clamp Load. Torque values calculated from formula T=KDF, where

Torque-Tension Relationship for Metric Fasteners													
Nominal Dia. (mm)	Pitch	 Class 4.6			 Class 8.8			 Class 10.9			 Class 12.9		
		Tightening Torque			Tightening Torque			Tightening Torque			Tightening Torque		
		Lubed	Dry Plated	Dry plain	Lubed	Dry Plated	Dry plain	Lubed	Dry Plated	Dry plain	Lubed	Dry plain	
		K = 0.15	K = 0.17	K = 0.20	K = 0.15	K = 0.17	K = 0.20	K = 0.15	K = 0.17	K = 0.20	K = 0.15	K = 0.20	
3	0.5	0.28	0.32	0.38	0.73	0.82	0.97	1.0	1.2	1.4	1.2	1.8	
3.5	0.6	0.44	0.50	0.59	1.1	1.3	1.5	1.6	1.9	2.2	1.9	2.5	
4	0.7	0.66	0.74	0.87	1.7	1.9	2.3	2.4	2.7	3.2	2.8	3.8	
5	0.8	1.3	1.5	1.8	3.4	3.9	4.5	4.9	5.5	6.5	5.7	7.6	
6	1	2.3	2.6	3.0	5.8	6.6	7.7	8.3	9.4	11	9.7	13	
6	1.25	2.1	2.3	2.7	5.3	6.0	7.0	7.6	8.6	10	8.8	12	
7	1	3.8	4.3	5.0	9.7	11	13	14	16	19	16	22	
8	1	5.9	6.6	7.8	15	17	20	22	24	29	25	34	
8	1.25	5.5	6.2	7.3	14	16	19	20	23	27	24	31	
10	1.25	11	13	15	29	33	39	42	48	56	49	66	
10	1.5	11	12	14	28	32	37	40	45	53	47	62	
12	1.25	21	23	28	53	60	71	76	86	101	89	119	
12	1.5	20	22	26	51	58	68	73	82	97	85	113	
12	1.75	19	21	25	49	55	65	70	79	93	81	108	
14	1.25	26	29	34	66	75	89	95	108	127	111	148	
14	1.5	28	32	37	72	82	96	103	117	138	121	161	
14	2	30	34	40	78	88	104	111	126	148	130	173	
16	1.5	50	57	67	129	146	171	184	208	245	215	287	
16	2	47	53	62	121	137	161	173	196	230	202	269	
18	1.5	73	82	97	187	212	249	268	303	357	313	417	
18	2.5	65	73	86	167	189	222	239	270	318	279	372	
20	1.5	101	115	135	270	306	360	374	424	498	437	583	
20	2.5	91	104	122	238	267	314	337	382	449	394	525	

Clamp load calculated as 75% of the proof load for specified bolts. K = 0.15 for "lubricated" conditions; K = 0.17 for zinc plated, dry conditions; K = 0.20 for plain and dry conditions. D = Nominal Diameter; F = Clamp Load. Torque values calculated from formula T=KDF, where

Boom

Maintenance Section 4-8

MAINTENANCE

LUBRICATION RECOMMENDATIONS

MAINTENANCE

Description	Application	General Specification	Recommended Mobil Lubricant
Tractor Hydraulics	Reservoir	JD-20C MF M1135,M1141 FNHM2C134D (FNH201)	Mobilfluid 424
Mower Hydraulics Cold Temperatures 0° F Start-Up	Reservoir	ISO 46 Anti-Wear-Low Temp	Mobil DTE 15M
Normal Temperatures 10° F Start-Up		JD-20C MF M1135,M1141 FNH M2C134D(FNH201)	Mobilfluid 424
Normal Temperatures 15° F Start Up		ISO 46 Anti-Wear	Mobil DTE 25
High Operating Temp. Above 90° F		ISO 100 Anti-Wear	Mobil DTE 18M
Flail Rear Gearbox	Grease	PAO Synthetic Extreme Pressure Gear Lube	Mobil SHC 75W-90 Mobil 1 Synthetic Gear
Cutter Shaft & Ground Roller Shaft(Flail)	Grease Gun	Lithium-Complex Extreme Pressure NLGI-ISO 320	Mobilgrease CM-S
Drive Shaft Coupler (Flail and Rotary)	Grease Gun	Lithium-Complex Extreme Pressure NLGI2-ISO 320	Mobilgrease CM-S
Drive Shaft Yoke, U-joint & Stub Shaft	Grease Gun	Lithium-Complex Extreme Pressure NLGI2-ISO 320	Mobilgrease CM-S
Boom Swivel Boom Cylinder Pivots (Rotary & Flail Boom)	Grease Gun	Lithium Complex Extreme pressure NLGI2-ISO 320	Mobilgrease CM-S
Deck Boom Pivot & Deck Stop Adjustment Rotary & Flail)	Grease Gun	Lithium Complex Extreme Pressure NLGI-ISO 320	Mobilgrease CM-S
Deck Spindle(Rotary)	Grease Gun	Tiger Spindle Lubricant part number 06540000	Mobilith SHC 220

Boom

Maintenance Section 4-9

MAINTENANCE

MAINTENANCE

POLYCARBONATE CARE AND MAINTENANCE

The propriety UV and Abrasion Resistant Surface coating on SHIELDS SUPERCOATED polycarbonate significantly improves performance. Periodic cleaning using proper procedures and compatible cleaners are recommended to prolong service life. Tiger Corp. polycarbonate is SUPERCOATED on both sides.

CLEANING THE SUPERCOAT HARD-COAT

1. Wash with a mild solution of soap or detergent and lukewarm water.
2. Using a soft cloth or sponge, gently wash the sheet to loosen dirt and grime and rinse well with clean water.
3. To prevent water spotting, thoroughly dry with chamois or cellulose sponge.
4. Avoid the use of abrasive cleaners, squeegees and/or other cleaning implements that may mar or gouge the coating.

CLEANING AGENTS WHICH HAVE BEEN FOUND TO BE COMPATIBLE UNDER LABORATORY CONDITIONS:

Aqueous Solutions of Soaps and Detergents

Windex(1)	Top Job(2)	Joy(2)	Mr Clean(2)
Fantastik(3)	Formula 409(4)	Sumalight D12	Brucodecid

Organic Solvents

Butyl Cellosolve	Kerosene	Hexel, F.O. 554	Naphtha(VM&P grade)
Neleco-Placer	Turco 5042		

Alcohols

Methanol	Isopropyl
----------	-----------

All residual organic solvents should be removed with a secondary rinse.

GRAFFITI REMOVAL

Butyl cellosolve (for removal of paints, marking pen inks, lipstick, etc.) The use of masking tape, adhesive tape or lint removal tools work well for lifting off old weathered paints.

To remove labels, stickers, etc., the use of kerosene or VM&P naphtha is generally effective. When the solvent will not penetrate sticker material, apply heat (hair dryer) to soften the adhesive and promote removal.

IMPORTANT: If a material is found to be incompatible in a short-term test, it will usually be found to be incompatible in the field. The converse, however, is not always true. Favorable performance is no guarantee that actual end-use conditions have been duplicated. Therefore, these results should be used as a guide only and it is recommended that the user test the products under actual end-use conditions.

MAINTENANCE

MAINTENANCE

RECOMMENDED FILLING INSTRUCTIONS FOR HYDRAULIC RESERVOIRS

When filling or checking the oil level, the unit should be parked on a level surface, shut OFF, and allow sufficient time to cool to ambient temperature. Use caution when removing the pressurized breather. Do not place face over opening when removing breather.

If your reservoir has two sight glasses: The reservoir should be filled to the top of the lower sight glass on the side of the tank. Do not overfill. The reservoir has been overfilled when oil is visible in the upper sight glass. If tank has too much oil, the excess may be expelled through the pressurized breather.

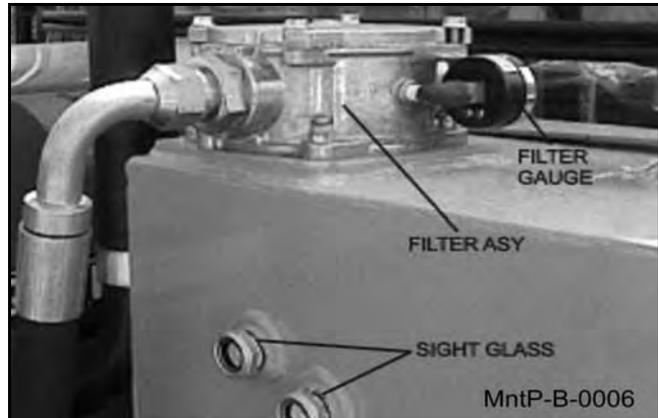

If your reservoir has one sight glass/temperature gage: The reservoir should be filled to the center of the sight glass on the side of the tank. Do not over-fill. If the tank has too much oil, the excess may be expelled through the pressurized breather.

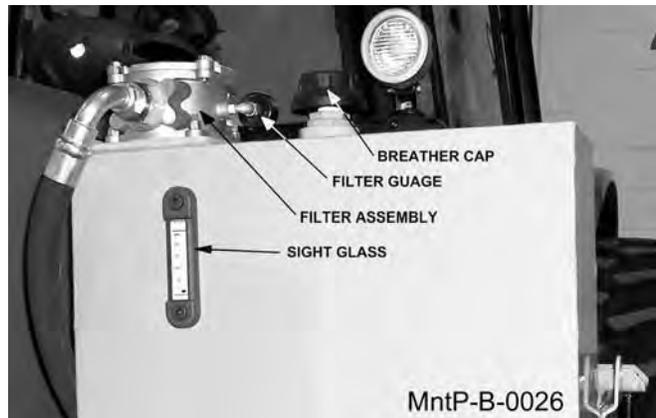

DETAILED MAINTENANCE

REPLACING IN-TANK HYDRAULIC FILTER:

Loosen the four bolts on the top cover of the filter housing. Turn cover counter-clockwise until cover is free. Remove and replace filter. Replace top cover and cover bolts in opposite order as removed.



MAINTENANCE

MAINTENANCE

DETAILED MAINTENANCE

REPLACING HIGH PRESSURE HYDRAULIC FILTER ELEMENT:

Ensure that the system has been shut down and de-pressurized. Locate High Pressure Filter housing. Confirm that the element that is about to be installed matches the element p/n on the filter model tag. *Example: V3.0510-06 (world line 100, HD049 model)* Locate the bottom of the High Pressure Bowl. Using the appropriate spanner wrench or ratchet, turn in a counter clockwise rotation, (looking at the bottom of the bowl) to remove the bowl from the head. The first couple of rotations will seem tight as the o-ring passes the sealing flats. Once the o-ring has cleared the sealing flats the bowl should spin freely. Taking care not to drop the bowl, finish removing the bowl from the head. **WARNING: bowl will be full of oil!**

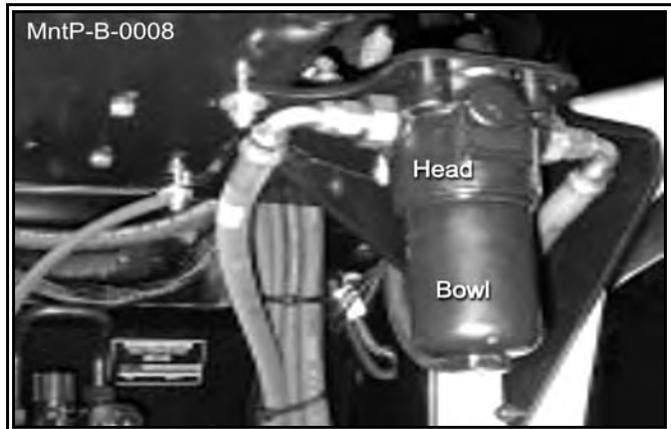

Pour the oil from the bowl into a container. This oil should be considered contaminated because the flow direction through the element is outside-in. Clean the inside of the bowl if "dirt" is present. Remove the old element from the filter head by pulling with a rotation motion. Dispose of the used element properly. Remove the new element from the packaging. Using your finger, dab and lubricate the o-ring in the top of the new element with oil. Install the new element into and on the mounting boss within the head. Ensure that the element is fully seated on the boss. Clean and inspect the o-ring that is affixed in the bowl and lubricate with oil. Using a clockwise rotation, screw the bowl back into the head, ensuring that the bowl has not been cross threaded into the head. Continue to tighten the bowl into the head, using the spanner wrench or ratchet. The rotation of the bowl will become tighter once the o-ring engages the sealing flats. Once the bowl has bottomed out, back-off the bowl by 1/6 turn. This ensures that the o-ring is seated properly within the sealing flats. Element change out and re-assembly is now complete. Start the machine and inspect the filter area, checking that there is no oil leaking from the filter assembly. Replace the filter element first at 50 hours of operation, then yearly (500 hours) or when indicated by restriction indicator.

GREASING CUTTERSHAFT -- FLAIL MOWERS

Locate grease zerks on each end of cuttershaft(s), these are located on the bearing cover. Normal conditions require one or two pumps in each bearing, using Lithium-Complex Extreme Pressure grease conforming to NLGI2-ISO 320 specifications. This is to be done with a standard grease gun daily or at **8 hour intervals**. **CAUTION: Over greasing may cause premature seal failure.**

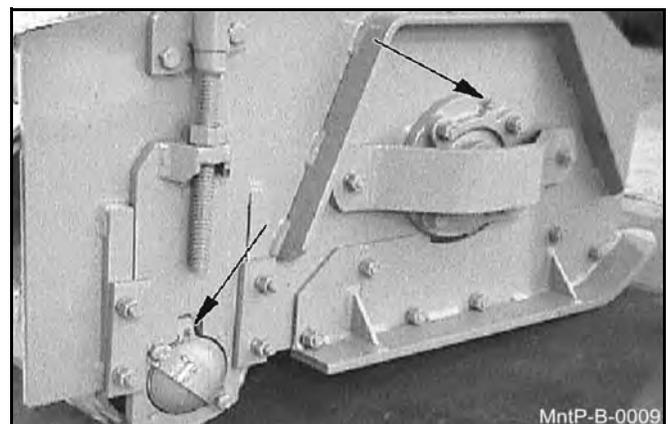

MAINTENANCE

MAINTENANCE

GREASING GROUND ROLLER SHAFT-- FLAIL

Locate grease zerks on each end of roller tube at lower end of head. Normal conditions require one or two pumps in each bearing, using Lithium-Complex Extreme Pressure grease conforming to NLGI2-ISO 320 specifications. This is to be done with a standard grease gun daily or at **8 hour intervals**. **CAUTION: Over greasing may cause premature seal failure.**



ADJUSTING/CHECKING BELT TENSION

To adjust belt tension or replace belts on flail cutter head, remove four bolts that secure the belt cover and remove cover. The hex nuts shown below can be adjusted to increase/decrease the belt tension as needed. (NOTE: Location of adjustment nuts may vary on flail cutter heads.) **Be sure to replace the belt cover BEFORE operating mower!**

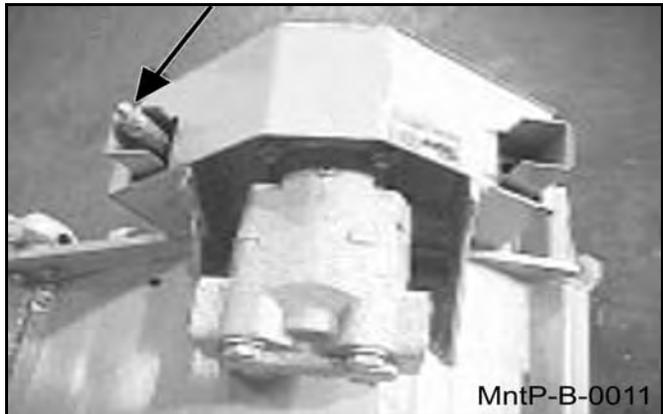

TIGHTENING KNIFE BOLTS AND DISK BOLTS:

After every 8 hours of operation or daily, the Knife Bolts and disk bolts should be tightened as follows:

Knife mounting bolts torque to 800 lubricated ft. lbs.

Disk mounting bolts (6ea.) torque to 204 dry or 180 lubricated ft. lbs.

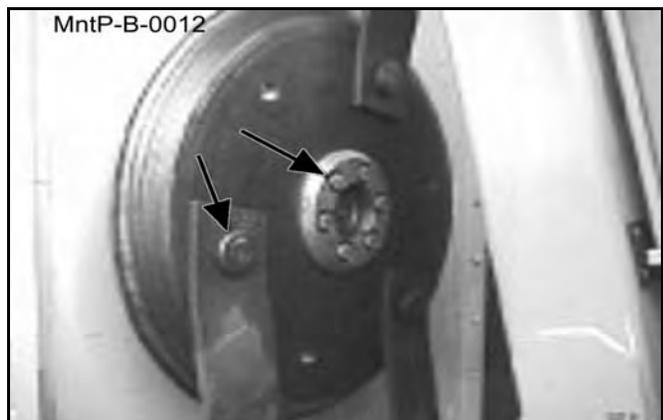

MAINTENANCE

MAINTENANCE

GREASING POINTS ON BOOM AND PIVOT

Locate grease zerks on deck pivot assembly, on the deck end of secondary boom, at main/secondary boom joint, and at swivel end of main boom. Inject Lithium-Complex Extreme Pressure grease conforming to NLGI2-ISO 320 specifications until grease begins to protrude from ends.

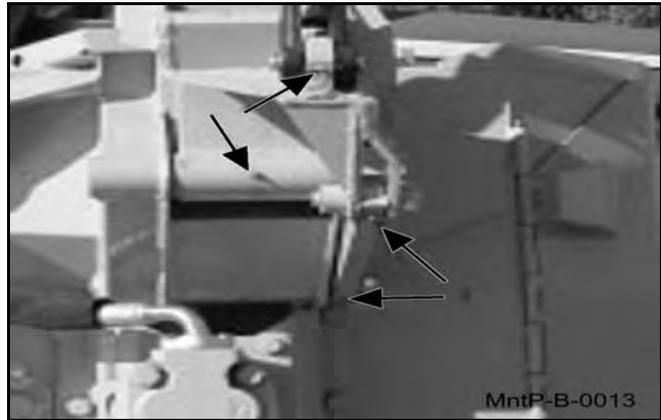

DECK STOP ADJUSTMENT

On boom flail, loosen locking nut. Turn adjustment bolt in, and run deck cylinder out to full extension. Adjust bolt out until the head just touches the boom, and tighten lock nut. **NOTE: Bolt should not hit boom before cylinder reaches full travel.**



GREASING SPINDLE

Locate grease fitting on inside of deck housing. Inject Tiger Spindle Lubricant, part number 06540000 into spindle housing. Fill with lubricant until lubricant weeps out of top spindle seal. Lubricate spindle weekly or every 40 hours of use.



MAINTENANCE

MAINTENANCE

TIGHTENING SPINDLE BOLTS

The spindle mounting bolts should be checked and retorqued daily or every 8 hours of service. Torque the (6) bolts shown below to 357 dry or 315 ft. lbs. lubricated.

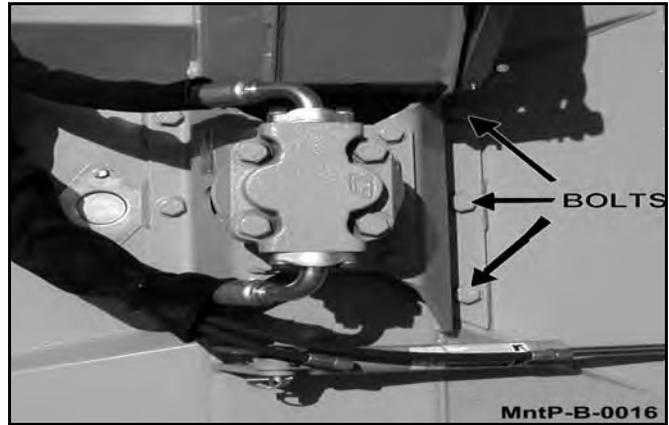

GREASING PUMP DRIVE SHAFT COUPLER

With engine stopped, ensure driveshaft alignment by grasping coupler and sliding back and forth. Coupler should slide freely with approximately 1/8" of end play. If coupler does not slide freely, inspect for loose pump mount bolts, or damaged or loose crankshaft adapter. Inject Lithium-Complex Extreme Pressure grease conforming to NLG12-ISO 320 specifications into coupler until grease begins to protrude from ends. Grease daily or every 8 hours. Do not over grease.



MAINTENANCE

MAINTENANCE

DRIVESHAFT YOKE, U-JOINT STUB SHAFT

With engine stopped, inject Lithium-Complex extreme pressure grease conforming to NLGI2-ISO 320 specifications into universal joints and slip yoke until grease appears at the seal. Grease them daily or every 8 hours.

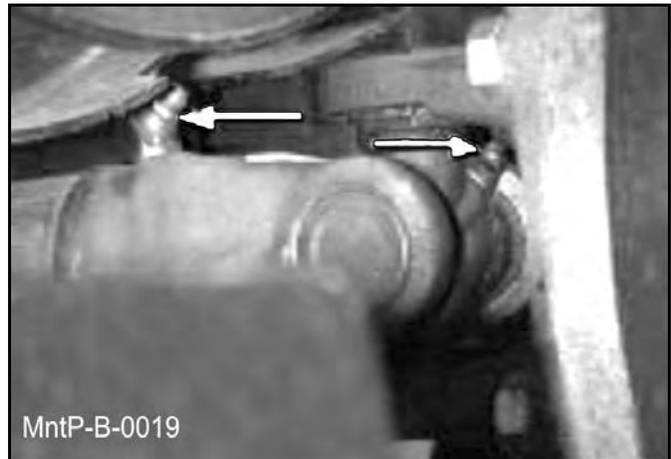
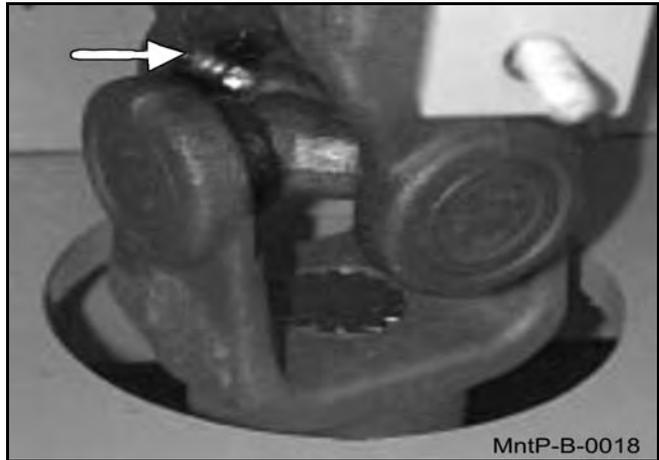

GREASING THE BOOM SWIVEL

Locate the zerks on the main swivel boss (if applicable), main boom pivot boss (if applicable) and on both ends of the boom swivel cylinder. Inject Lithium-Complex Extreme Pressure grease conforming to NLGI2-ISO 320 specification until grease begins to protrude from ends.

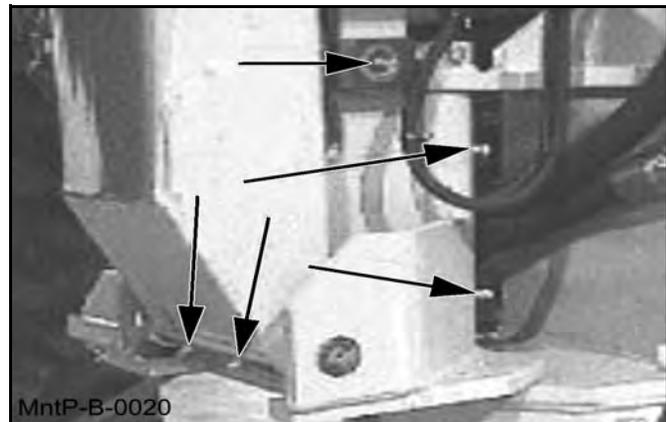

MAINTENANCE

MAINTENANCE

GREASING BOOM CYLINDER(S) PIVOT POINTS

Locate the zerk on the butt end tang of cylinder and on rod end tang. Inject Lithium-Complex Extreme Pressure grease conforming to NLGI2-ISO 320 specifications until grease begins to protrude from ends. This procedure is to be used on the main boom cylinder, secondary boom cylinder, deck pivot, and swivel cylinders daily or at 8 hour intervals.



BALL VALVES

The ball valve at the hydraulic reservoir may need to be closed during certain maintenance or repair procedures. **THE BALL VALVES MUST BE OPEN (handle parallel with valve) WHEN TRACTOR IS RE-STARTED OR PUMP IS COUPLED TO MOTOR OR PTO!** Failure to do so will result in component failure!

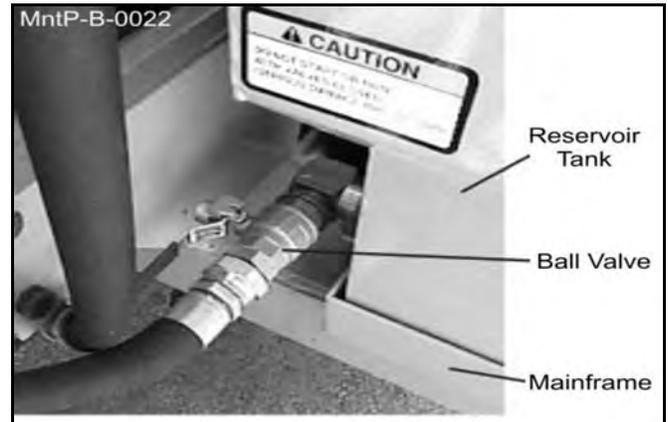

MAINTENANCE

MAINTENANCE

Blades

Check the Blades for cracks and wear and Blade Bolts for tightness, daily. Blades should be replaced when they are worn excessively, bent, deformed, or out of balance.

CAUTION

Blades should always be replaced in pairs. Blades of different weights can cause serious imbalance and damage to the machine and personnel. When replacing blades, take care to replace the blade bolts, nuts, and washers.

Important

Make sure the mower blades are turning clockwise when looking down from the top of the mower. Follow the color coding on the hydraulic hoses and fittings to make sure the motor and hydraulics hoses are assembled properly. Connect the red hose connection only to red fitting. Connect the blue hose connection only to the blue fitting. The blade rotation on the leading edge of the mower should discharge the cut material away from the tractor and operator.

WARNING

If the leading edge of the mower blades are rotating backwards they can discharge material toward the operator. If this occurs discontinue mowing immediately and reverse the direction of the motor rotation by correctly installing the motor pressure and return hoses. Contact your dealer or Alamo Industrial for specific information on the hose routing.



WARNING	ADVERTENCIA
<p>TO AVOID SERIOUS INJURY AND DEATH FROM THROWN OBJECTS:</p> <ul style="list-style-type: none"> ● MAKE CERTAIN blades rotate the correct direction. 	<p>PARA EVITAR LESION SERIA O MUERTE POR OBJETOS LANZADOS:</p> <ul style="list-style-type: none"> ● ASEGURE que las cuchillas giran en la dirección correcta.
<p>BLADE ROTATION</p> <p>ROTACIÓN DE CUCHILLAS</p>	
<p>Return Retorno BLUE</p>	<p>Pressure Presión RED</p>

D619

MAINTENANCE

ROTARY KNIFE REPLACEMENT

1. Be sure you have a complete matching set of new knives for replacement.
2. Remove knives and inspect holes for damage. Also watch for cracks in the disk (if applicable) around the holes.
3. Lube threads with anti-seize. Install bolts through knife and disk from bottom side of disk/blade bar. Install new self-locking nuts and torque them to 800 ft. lbs.
4. The knives should swing freely to absorb shocks from impact when striking objects.



WHEN CUTTING HEAVY BRUSH, KNIFE BOLTS SHOULD BE INSPECTED HOURLY AND RETORQUED TO 800 LUBRICATED FT. LBS.

REPLACEMENT OF ROTARY DISK/BLADE BAR



Failure to follow the following warnings and instructions may result in serious injury or damage to the equipment or property!

1. The bolts that attach the disk to the spindle must be grade 8. These 5/8 inch bolts are to be torqued to 204 dry or 184 ft. lbs lubricated with Loctite 271.
2. A thread locking agent may be applied to threads of all mounting bolts before they are installed.
3. **Disks must be inspected daily for hairline cracks between spindle mounting bolts or around the knife mounting bolts. These cracks indicate metal fatigue caused by severe abuse. If cracks are present the disk must be replaced.**
4. Inspect the disk mounting bolts daily when checking tightness of knife mounting bolts. If a disk mounting bolt is loose, it must be removed, threads cleaned, fresh thread locking agent applied, and tightened to proper torque value.
5. If a knife mounting bolt is loose, the self locking nut must be replaced as a safety precaution. Lubricate threads with anti-seize. Install bolts through knife and disk/blade bar from bottom side. Install self locking nuts and torque them to 800 ft. lbs.

MAINTENANCE

Flail Blades Inspection



Inspect the Blades daily for abnormal wear. REPLACE ALL BLADES on the carrier IMMEDIATELY if any blades have:

- Become bent or deformed from its original shape, or
- Wear inside the blade bolt hole, or
- Any cracks are visible, or
- Deep gouges in the blade's surface are present, or
- Gouges or chipped areas in the cutting edge are larger than 1/4"(8mm), or
- The material on the leading edge has been worn away by more than 1/4"(8mm)

DO NOT straighten, sharpen, weld or hard-face blades

Failure to replace worn or damaged blades may lead to catastrophic failure of the blades and ejection of the broken part with tremendous force which may cause serious bodily injury or death.

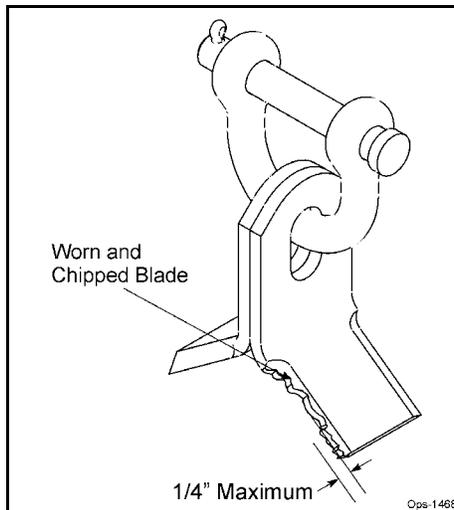

Always replace blades in sets

- Blades that are damaged may indicate severe service or abuse. If one blade is worn or damaged other blades on the same shaft will have been subjected to the same severe service or abuse.
- The Flail rotor turns at speeds exceeding 2000 RPM and is dynamically balanced at the factory. Differences in blade weight between used blades with loss of material from gouges or wear as compared to new blades can cause severe vibration and damage to the Flail rotor. Always replace blades as complete sets.

MAINTENANCE

Blade Pins and D-Ring Inspection

Inspect Blade Pins and D-Rings daily for wear or damage as follows:



Inspect the Blade pins and D-Rings daily for abnormal wear. Make sure the cotter pins are in place and properly spread. REPLACE BLADE Pins and D-Rings IMMEDIATELY if they have:

- Visible cracks or
- If a Pin or D-Ring has visible worn areas, or
- If a Pin or D-Ring has gouges or chipped areas

Failure to replace abnormally worn pins or D-Rings may lead to catastrophic failure and ejection of the broken part, which may cause serious bodily injury or death.

Always replace the pins and D-Rings whenever excessive wear is noticed.

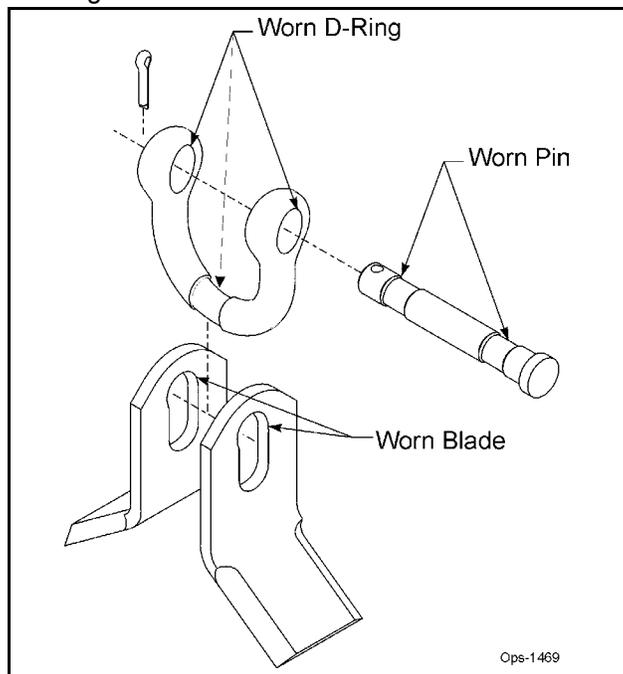

Important

If the cotter pins are broken by contact with other flail blades, remove the pin and reverse the direction the pin is inserted through the D-Ring so that the cotter pin is on the opposite side of the D-Ring. This will prevent the next set of blades from swinging back and hitting the cotter pin. OPS-U-0045

MAINTENANCE

MAINTENANCE

Flail Axe Blades Inspection



Inspect the Blades daily for ab normal wear. REPLACE ALL BLADES on the carrier IMMEDIATELY if any blades have:

- Become bent or deformed from its original shape, or
- Oval shape wear inside the blade bolt hole, or
- Any cracks are visible, or
- Deep gouges in the blade's surface are present, or
- Gouges or chipped areas in the cutting edge are larger than 1/4"(8mm), or
- The material on the leading edge has been worn away by more than 1/4"(8mm)

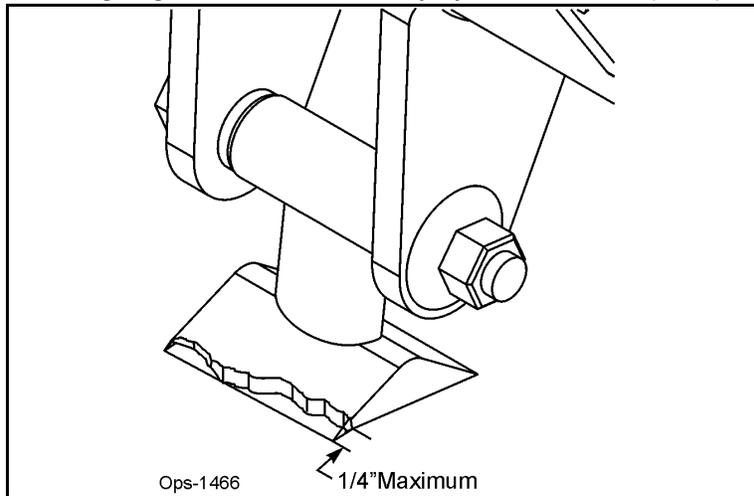

Failure to replace worn or damaged blades may lead to catastrophic failure of the blades and ejection of the broken part with tremendous force which may cause serious bodily injury or death.

Always replace blades in sets

- Blades that are damaged may indicate severe service or abuse. If one blade is worn or damaged other blades on the same shaft will have been subjected to the same severe service or abuse.
- The Flail Axe rotor turns at speeds exceeding 2000 RPM and is dynamically balanced at the factory. Differences in blade weight between used blades with loss of material from gouges or wear, as compared to new blades, can cause severe vibration and damage to the Flail Axe rotor. Always replace blades as complete sets.

Important

Use only genuine Alamo Industrial replacement blades, blade bolts and fasteners. Other blades and bolts may not meet the requirements of Alamo Industrial and may fail during operation, resulting in the part failing and being thrown out from under the mower.



Never attempt to sharpen blades. OPS-U-0042

MAINTENANCE

Flail Axe Blade Bolt Inspection

Inspect Blade Bolts daily for wear or damage as follows:



Inspect the Blade Bolt daily for abnormal wear. REPLACE ALL BLADE BOLTS on the carrier IMMEDIATELY if any bolts have:

- Visible cracks or
- If the blade bolt is worn or any recessed area is visible on the bolt, or
- If Blade Bolt has gouges or chipped areas. or
- If Bushing fits loose in the Rotor Shaft.

Failure to replace abnormally worn bolts or bushings may lead to catastrophic failure of the blades and ejection of the broken part, which may cause serious bodily injury or death.

Always replace Blade Bolts with new bolts and new bushings whenever replacing the Blades. To tighten bolts and nuts, first apply thread lock to nut. Make sure to tighten bolts and nuts just enough to allow the blades to swing freely and not bend the cuttershaft lugs. If cuttershaft lugs are bent together because of over tightening the blades will not swing freely. OPS-U-0043

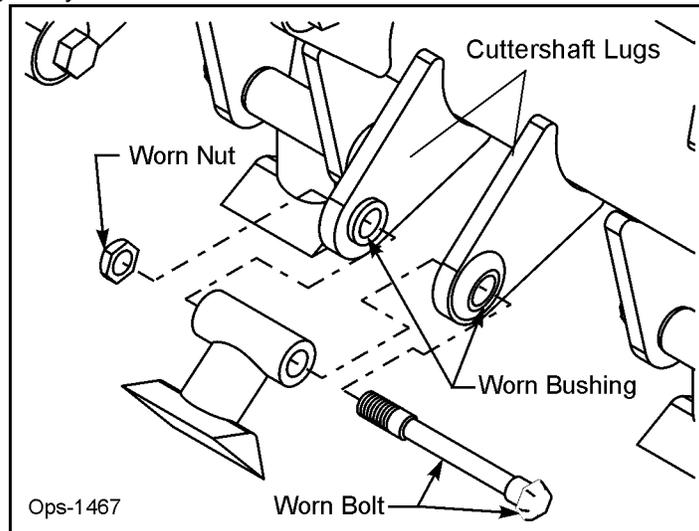

MAINTENANCE

MAINTENANCE

50" FLAIL KNIFE BLADE REPLACEMENT

1. If knives are damaged or badly worn, they will need to be replaced as a set. Replacing a single knife can cause severe vibration and possible damage to the mower. The knife should not be welded on for any reason.
2. Always replace the knife bolts when replacing the knives. DO NOT REUSE THE KNIFE BOLTS OR NUTS.
3. Assemble knives, bushings, bolts and nuts as shown in part section of the manual.
4. Install the locking hex nut so that the flat face of the nut is towards the knife.
5. Apply Loctite 271 or equivalent to threads.
6. Torque nut to 50 ft. lbs. Knife must swing freely.



DO NOT re-use the locking hex nuts for mounting the knives. If hex nut becomes loose, or required removal for knife replacement or any other reason, they must be discarded and replaced with new nuts.

63" BOOM FLAIL KNIFE REPLACEMENT

1. If knives are damaged or badly worn, they will need to be replaced as a set. Replacing a single knife can cause severe vibration and possible damage to the mower.
2. Assemble knives, clevis, bolts and nuts as shown in part section of manual.
3. Install locking hex nut so that the flat face of nut is towards the knife.
4. Apply Loctite 271 or equivalent to threads.
5. Torque nut to 35 FT. LBS. Knife must swing freely.



DO NOT re-use the locking hex nuts for mounting the knives. If hex nut become loose, or require removal for knife replacement or any other reason, they must be discarded and replaced with new nuts.



Knives should not be welded on for any reason.

HEAVY DUTY SPINDLE ASSEMBLY INSTALLATION AND BEARING ADJUSTMENT

WARNING! A press MUST be used to install bearing cups, bearing cones, and seals. DO NOT use a hammer to install races, bearings, or seals. The parts of assembly may be damaged.

NOTE: The grease zerk and gussets are located on the top side of the spindle housing. Be sure the spindle is assembled correctly.

Be sure to wear eye protection and other protective equipment as needed when working on spindle assembly.

MAINTENANCE

MAINTENANCE

THE SPINDLE ASSEMBLY

See the diagram below for identification of spindle parts, while servicing.

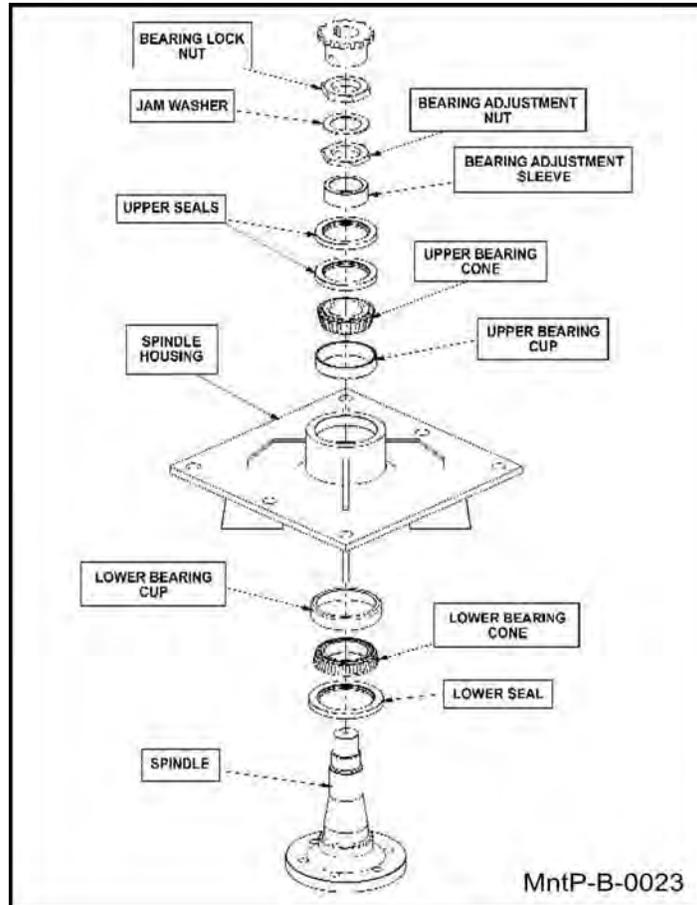

MAINTENANCE

BEARING INSTALLATION

1. Press upper bearing cup in to the spindle housing.
2. Turn the spindle housing over and press in the lower bearing cup.
3. Place the lower bearing cone in the bearing cup. Next press the seal into the spindle housing. The inner lip of the seal must be DOWN, towards the bearing, so lubricant is sealed inside the housing.
4. Install the spindle in the housing. Lightly press the spindle to seat the cone onto the spindle.
5. Support the bottom of the spindle and press the upper bearing cone and bearing adjustment sleeve onto the spindle.
6. **NOTE: The spindle housing must turn freely when seating the bearing cone and sleeve.**
7. Press the two upper seals into the spindle housing. The inner lip of the seals must be UP, away from the bearing, so excess lubricant can escape.
8. Install the bearing adjustment nut (thin nut) so there is 1-1/6" clearance between the nut and the sleeve. Install the jam washer, placing the tab into the key-way. Install the bearing lock nut (thin nut) and hand tighten against jam washer and adjustment nut. See the following section for bearing adjustment.
9. Position the spindle housing horizontally with the drain hole oriented "up". Grease through the zerk with Tiger Spindle Lubricant (part number 06540000) until the grease purges from the drain hole.
10. Install the plug into the drain hole.

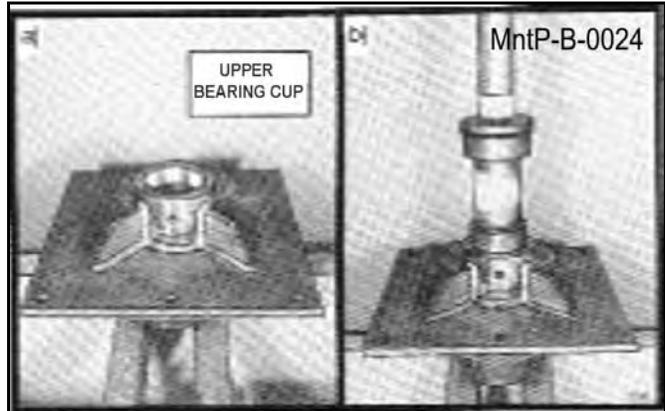

BEARING ADJUSTMENT

1. Clamp the bottom end of the spindle housing securely in a vise so the spindle housing turns freely.
2. Position a magnetic base dial indicator on the outer diameter of the spindle housing. Locate the end of the dial indicator against the flat end of the spindle shaft. The dial indicator will now measure accurately bearing end play.
3. Tighten the bearing adjustment nut until there is .012 inch movement when the spindle housing is pried upward away from the vise jaws.
4. When there is .012 inch free play between the spindle and housing, install the bearing lock nut (thick nut). Hold the adjusting nut securely and tighten the lock nut to 300 ft. lbs. of torque.
5. After the lock nut is tightened, there must be .001 inch to .003 inch of free play when lightly prying up on the spindle housing.

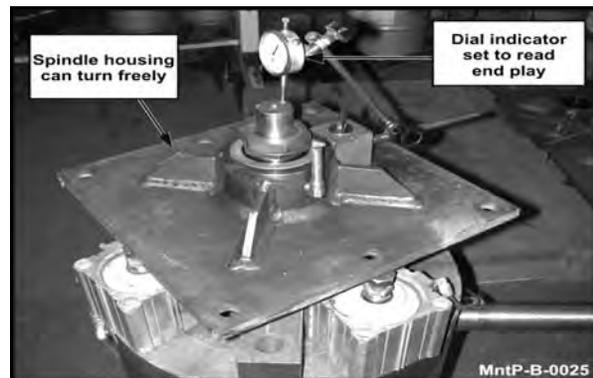

If the end play is correct, .001 inch to .003 inch, bend tabs up on jam washer to prevent the lock nut from loosening.

If the end play is NOT correct, loosen the lock nut and turn the adjustment nut as required and re-tighten the lock nut. Repeat first part of step 5.

MAINTENANCE

Boom Cylinder Removal and Replacement Instructions

1. Clear the area of all personnel before lowering the boom mower head.
2. From the tractor seat with your seat belt fastened around you, lower the boom mower head to the ground. Extend the boom to the furthest reach and lower the mower head flat on the ground. DO NOT attempt to replace the cylinders with the boom in the raised or transport position.
3. Shut off the tractor, engage the parking brake, place the tractor transmission in the park position, and remove the key before dismounting.
4. Allow the system to cool to room temperature before removing any hydraulic components
5. Wear safety glasses and impenetrable gloves when working with hydraulic hoses and fittings.
6. Release all oil pressure from the hydraulic circuit by manually stroking each valve section with the tractor engine off. Utilize the manual override function if the unit is equipped with an electric over hydraulic valve.
7. Utilize blocks, jack stands or a suitable over head hoist to support the weight of the boom section and remove pressure from the cylinder mounting pins.
8. Check to see that the cylinder to be replaced is not under pressure by moving the cylinder pins by hand. The pins should be loose and should slide from the pin bore easily. If the pins are tight and cannot be moved, the cylinder may be under pressure. Make sure the boom components are properly supported and that the pressure is relieved from the circuit.
9. Cylinder assemblies are heavy and can fall when the pins are removed. Support the hydraulic cylinder with a suitable hoist or jack.
10. Slowly loosen the hydraulic connections to the cylinder. Carefully unscrew hose fitting and allow any remaining pressure to bleed off. **Use extreme care.** Oil must be cool, and the technician should stand to the side to prevent exposure to any hydraulic oil. Always consult the Material Safety Data Sheet and wear any required Personal Protective Equipment. A catch pan may be required to retain any spilled oil.
11. Cap both ends of the fitting with suitably sized metal caps.
12. Remove the cylinder pins starting with the ROD end cylinder pin. Make sure the cylinder is properly supported, and remove the base end cylinder pin. The cylinder may be heavy-- use proper lifting techniques to lift and handle the cylinder. If needed, get assistance from another person to safely lift the cylinder from the machine.
13. Measure the distance between the cylinder pin holes and extend the new cylinder the correct length prior to attempting an installation.
14. Install the new cylinder in place and install both cylinder pins and retaining hardware.
15. Remove the metal caps and re-install the hydraulic hoses.
16. Check the hydraulic reservoir of the boom mower to ensure there is sufficient oil. Follow the manufacturer's recommendations for proper oil type and filtering techniques and requirements to add oil to the system.
17. Clear the area of all persons prior to starting the tractor.
18. Consult the Operator's Manual for instructions in regard to the proper operating procedure.
19. From the tractor seat, with the seat belt fastened, operate the boom to ensure proper operation of the boom function.
20. From the tractor seat, with the seat belt fastened, operate the boom controls to fully extend and retract the new cylinder several times to purge any trapped air from the system.
21. From the tractor seat, with the seat belt fastened, look for signs of an oil leak. If an oil leak is observed, shut the tractor down and follow the steps to remove pressure from the hydraulic circuit. Identify the source of the leak and resolve the issue.
22. Upon completion of the required repairs return to Step # 16 to recheck the cylinder for proper operation.

MAINTENANCE

CUTTERSHAFT BEARING REPLACEMENT

1. Remove existing cuttershaft, bearings and string guards.
2. Make sure that the end knives on each end of the cuttershaft are oriented as shown.
3. Apply anti-seize on cuttershaft as shown on next page.
4. Install non-drive side bearing first.
5. Install the top of the string guard on the non-drive side first. Use Loctite 271 or equivalent and torque (95 ft-lb or 104ft-lb if you use an extension).
6. Install the bearing and top string guard on the drive side.
7. Center the cuttershaft between the string guards. Use Loctite 271 or equivalent and torque (95ft-lb or 104ft-lb if you use an extension) the top string guard on the drive side.
8. Install, use Loctite 271 or equivalent, and torque (95ft-lb or 104ft-lb if you use an extension) the bottom string guard on both sides.
9. Make sure the cuttershaft is centered. On the non-drive side, tighten one set screw in the bearing onto the cuttershaft.
10. Remove the other set screw and drill a 5/16" hole into the cuttershaft 3/16" deep through the hole in the bearing. BE CAREFUL NOT TO DAMAGE THE THREADS IN THE BEARING HOLE.
11. Replace the set screw in the bearing, use Loctite 271 or equivalent, and tighten onto the cuttershaft through the new hole.
12. Remove the other set screw and repeat the drilling procedure (Step 10). Replace the set screw as stated in Step 11.
13. Repeat steps 9 through 12 on the drive side.
14. Grease both bearings properly.

See illustration on next page

MAINTENANCE

MAINTENANCE

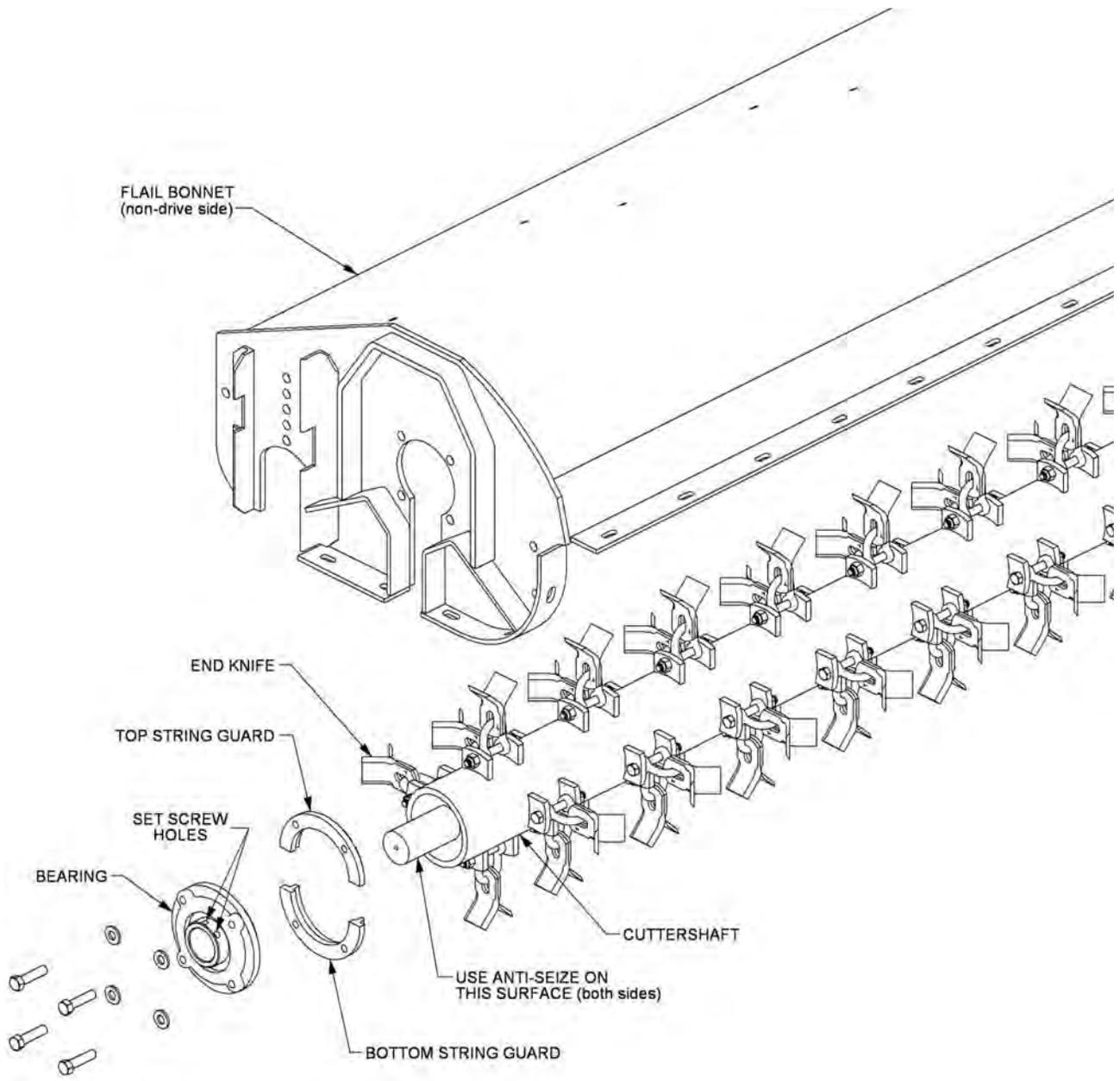

MAINTENANCE

MAINTENANCE

DAILY MAINTENANCE SCHEDULE

The following services should be performed daily or every 8 hours of service, following the detailed maintenance instructions in the operator's manual.

_____ Pump driveshaft: If required with drive shaft/coupler check for end play and lubricate at zerks.

_____ Crankshaft adapter: If equipped with rubber grommets check condition, replace if missing or damaged.

_____ Pivot points: Inject grease until it appears at ends.

_____ Hydraulic fittings: Check for leaks with paper or cardboard. Tighten fittings or replace hoses immediately.

_____ Knives: Inspect for missing or damaged knives, change (only complete sets) as needed.

_____ Belts: Check/tighten/replace belts as needed.

_____ Mainframe/deck: Unless otherwise specified retorque bolts according to torque specifications in this section.

_____ Hydraulic fluid level: Add, if required, per fluid recommendations.

_____ Rear flail drive, bearing flange and shaft couplers: Grease as instructed in the detailed maintenance section.

_____ Cuttershaft and ground roller: Grease as instructed in the detailed maintenance section.

Service performed by: _____ Date: ____/____/____ Hour

Meter: _____

Maintenance Section

**This page may be copied and used as part of the daily maintenance routine.

JD 6140-50M/R BENGAL

**PARTS
SECTION**

PARTS ORDERING GUIDE

The following instructions are offered to help eliminate needless delay and error in processing purchase orders for the equipment in this manual.

1. The Parts Section is prepared in logical sequence and grouping of parts that belong to the basic machine featured in this manual. Part Numbers and Descriptions are given to help locate the parts and quantities required.

2. The Purchase Order must indicate the **Name and Address** of the person or organization ordering the parts, **who should be charged**, and if possible, the **serial number of the machine** for which the parts are being ordered.

3. The purchase order must clearly list the **quantity of each part**, the complete and correct **part number**, and the basic **name of the part**.

4. The manufacturer reserves the right to substitute parts where applicable.

5. Some parts may be unlisted items which are special production items not normally stocked and are subject to special handling. Request a quotation for such parts before sending a purchase order.

6. The manufacturer reserves the right to change prices without prior notice.

NOTE: When ordering replacement decals, refer to the part numbers and descriptions listed in the safety section in the front of this manual.



1000

For maximum safety and to guarantee optimum product reliability, always use genuine **Tiger** replacement parts. The use of inferior replacement parts may cause premature or catastrophic failure which could result in serious injury or death.

Direct any questions regarding parts to:

Tiger Corporation
3301 N. Louise Ave.
Sioux Falls, SD 57107
1-800-843-6849
1-605-336-7900

PART NAME INDEX

TRACTOR MOUNT KIT.....	4
TRACTOR MOUNT KIT - HYDRAULICS.....	6
4 SPOOL CABLE CONTROL MOUNT.....	8
5 SPOOL CABLE CONTROL MOUNT.....	10
CABLE (MANUAL) LIFT VALVE - 4 SPOOL.....	12
CABLE (MANUAL) LIFT VALVE - 5 SPOOL.....	14
CABLE (MANUAL) LIFE VALVE BREAKDOWN - 06502038.....	16
CABLE (MANUAL) LIFT VALVE BREAKDOWN - 06502057.....	18
CABLE (MANUAL) LIFT VALVE BREAKDOWN - 06502093.....	20
ELECTRONIC PROPORTIONAL LIFT VALVE MOUNT.....	22
JOYSTICK AND SWITCHBOX MOUNT.....	24
BOOM MOUNT KIT.....	26
BOOMREST - OPEN STOW.....	28
BOOMREST - SINGLE COLUMN.....	30
PUMP DRIVESHAFT BREAKDOWN.....	32
NOTES.....	33
OPTIONAL COOLER ASSEMBLY.....	34
OPTIONAL COOLER MOUNT.....	36
FRONT AXLE STABILIZER OPTION.....	38
POLYCARBONATE SAFETY WINDOW.....	40
PANORAMIC SAFETY WINDOW FOR R SERIES.....	41
WHEEL SPACER.....	42
WHEEL WEIGHT.....	43
NOTES 1.....	44

TRACTOR MOUNT KIT

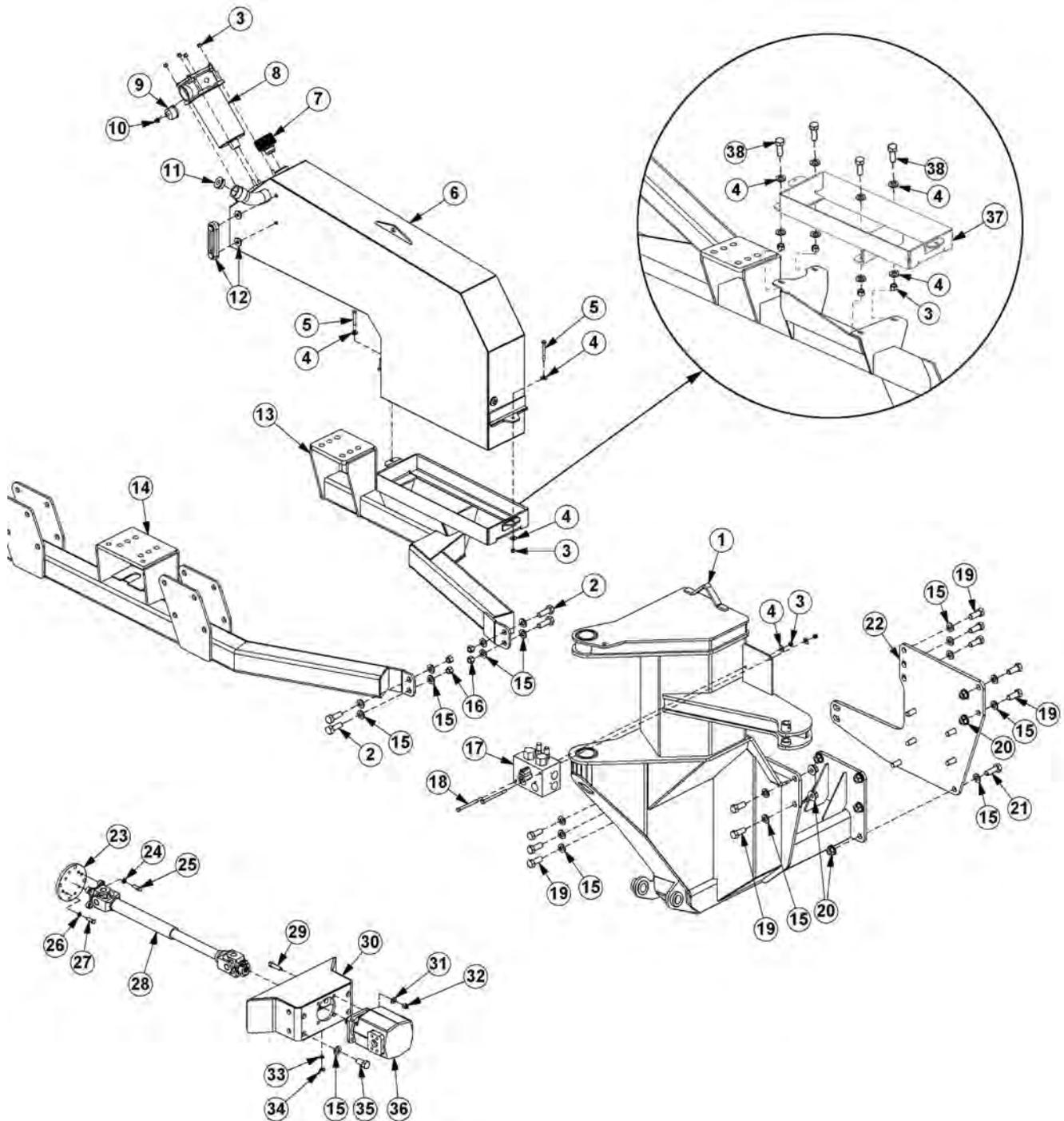

ITEM	PART NO.	QTY.	DESCRIPTION
1	06300251	1	MAINFRAME
2	21833	4	CAPSCREW,3/4" X 2-1/4",NC
3	21627	12	NYLOCK NUT,3/8",NC
4	22016	12	FLATWASHER,3/8"

TRACTOR MOUNT KIT

Continued...

ITEM	PART NO.	QTY.	DESCRIPTION
5	21639	2	CAPSCREW,3/8" X 3-1/4",NC
6	06700091	1	TANK,WHEEL WELL,ASSEMBLY
---	06380015	1	TANK,WHEEL WELL,WELDMENT
7	06505077	1	CAP,BREATHER,O-RING
8	06505044	1	FILTER,IN-TANK
9	6T0649	1	FILTER GAUGE
10	TF4888	1	STREET ELBOW,1/8"NPT
11	06505127	1	PLUG,#20 SAE
12	06505067	1	SIGHT GAUGE,LENZ
---	06503175	1	KIT,SEAL,SIGHT GAUGE
13	06300285	1	AXLE BRACE,LH
---	06300253	1	AXLE BRACE,LH (REAR STOW)
14	06300319	1	AXLE BRACE,RH (SINGLE COLUMN)
---	06300252	1	AXLE BRACE,RH (REAR STOW)
15	33880	28	FLATWASHER,3/4",SAE
16	21825	10	HEX NUT,3/4",NC
17	06510084	1	BRAKE VALVE
18	21644	2	CAPSCREW,3/8" X 5",NC
19	31731	10	CAPSCREW,20MM X 50MM,2.5P
20	31722	10	HEX NUT,20MM,FLNG,2.5P
21	27281	6	CAPSCREW,20MM X 60MM,2.5P
22	06402240	1	UPRIGHT,LH
23	34998	1	SPACER,DRIVESHAFT
24	21989	4	LOCKWASHER,7/16"
25	21680	4	CAPSCREW,7/16" X 1-1/4",NC
26	32691	4	LOCKWASHER,10MM
27	23113	4	CAPSCREW,10MM X 30MM,1.5P
28	34999	1	DRIVESHAFT,U-JOINT
29	21733	4	CAPSCREW,1/2" X 2",NC
30	34993	1	PUMP MOUNT
31	06533004	4	FLATWASHER,1/2",SAE
32	21727	4	NYLOCK NUT,1/2",NC
33	22014	1	FLATWASHER,1/4"
34	32519	1	WING NUT,1/4"
35	24860	4	CAPSCREW,20MM X 40MM,2.5P
36	23152	1	PUMP
37	06380060	1	MNT, TANK, WHL WLL, ADJ
38	21631	4	CAPSCREW, 3/8" X 1-1/4", NC GR8

TRACTOR MOUNT KIT - HYDRAULICS

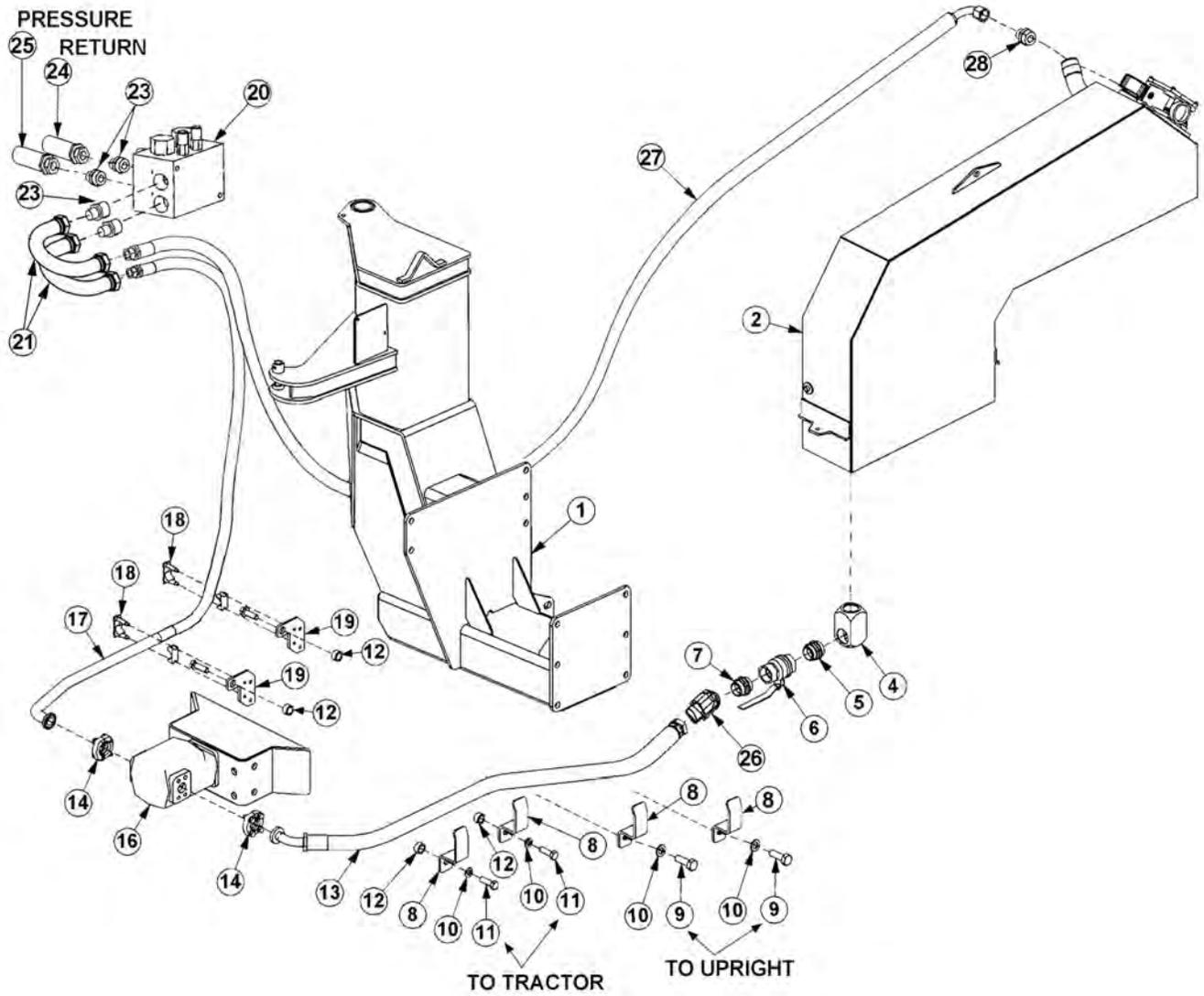

TRACTOR MOUNT KIT - HYDRAULICS

Continued...

ITEM	PART NO.	QTY.	DESCRIPTION
1	-----	-	MAIN FRAME *REFER TO TRACTOR MOUNT KIT
2	-----	-	HYDRAULIC TANK *REFER TO TRACTOR MOUNT KIT
4	06503084	1	ELBOW,1-1/2"FOR X 1-1/2"FOR
5	06503083	1	ADAPTER,1-1/2"MOR X 1-1/2"MOR
6	34309	1	BALL VALVE,1-1/2"FOR
7	34710	1	ADAPTER,1-1/2"MOR X 1-1/2"MJ
8	32382	4	BRACKET,HOSE
9	27281	2	CAPSCREW,20MMM X 60MM,2.5P
10	33880	4	FLATWASHER,3/4",SAE
11	30708	4	CAPSCREW,20MM X 90MM,2.5P
12	24849	4	SPACER
13	06500701	1	HOSE,1-1/2" X 126"
14	TF4852	2	KIT,FLANGE
16	23152	1	PUMP
17	06500581	1	HOSE,1" X 97"
18	06505017	2	CLAMP KIT,1"
19	34626	2	BRACKET,CLAMP
20	06510084	1	BRAKE VALVE
21	06506012	2	U-TUBE, PREFORMED
23	33555	4	ADAPTER,1"MB X 1"MJ
24	----	-	HOSE (RETURN)*REFER TO BOOM ASSEMBLY
25	---	-	HOSE (PRESSURE)*REFER TO BOOM ASSEMBLY
26	34117	1	ELBOW,1"MOR X 1"MJ
27	06500034	1	HOSE,1" X 186"
28	34064	1	ADAPTER,1-1/4"MOR X 1"MJ

4 SPOOL CABLE CONTROL MOUNT

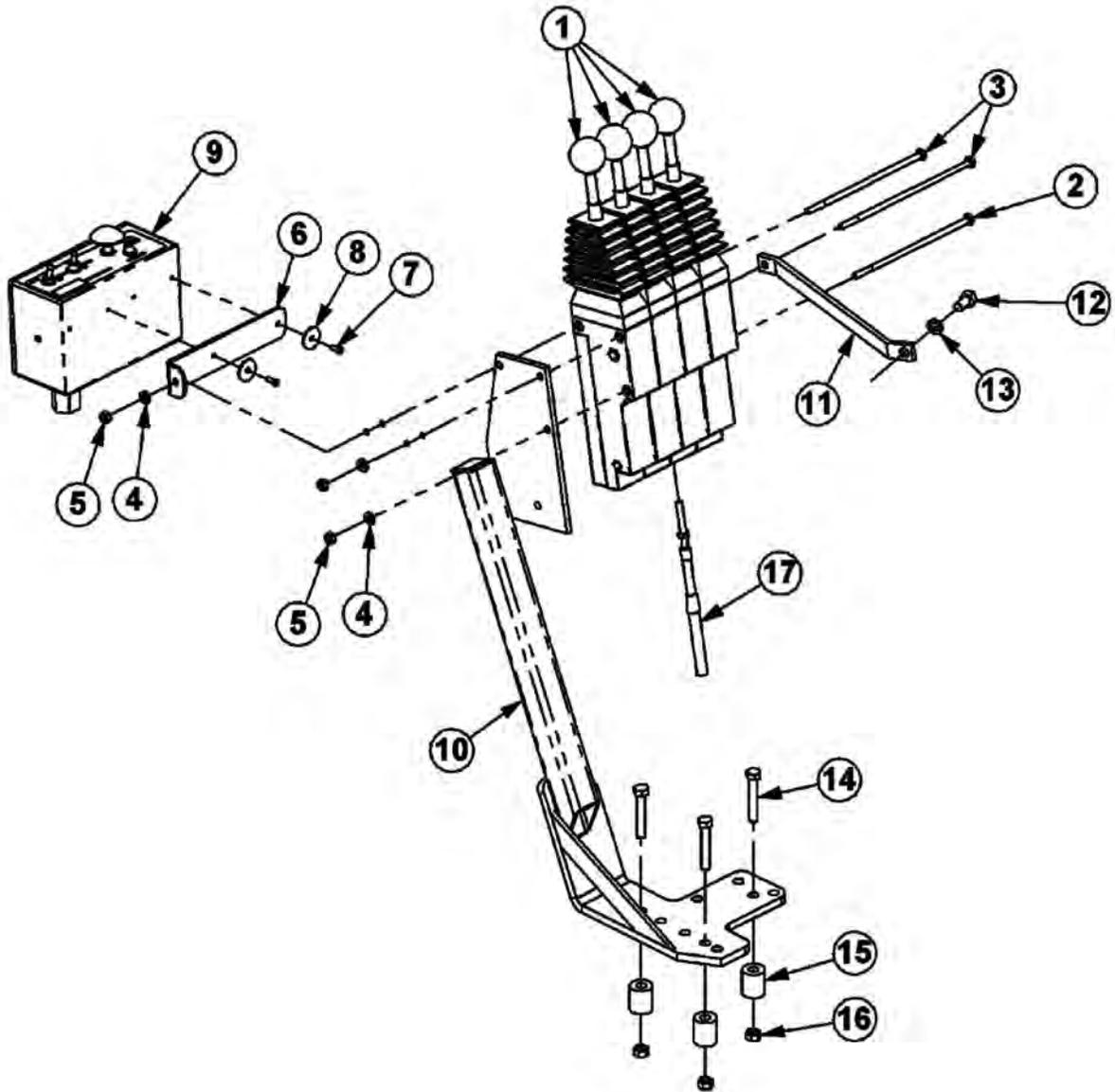

4 SPOOL CABLE CONTROL MOUNT

Continued...

ITEM	PART NO.	QTY.	DESCRIPTION
1	6T1251	4	CBL CTRL BOX,180 DEG
2	21546	1	CAPSCREW,1/4" X 7",NC
3	21547	2	CAPSCREW,1/4" X 8",NC
4	21986	3	LOCKWASHER,1/4"
5	21525	3	HEX NUT,1/4",NC
6	34496	1	BRKT,SWITCHBOX,UNI
7	6T3951	2	SCREW,MACHINE,8/32 X 1/2"
8	32360	2	LOCKWASHER,#8
9	06510100	1	SWITCHBOX,BOOM,GND
10	23865B	1	CBL CTRL MT BRKT
11	30750A	1	BRKT,CBL,CTRL,JD6000
12	33534	1	CAPSCREW,10MM X 20MM,1.5P
13	32691	1	LOCKWASHER,10MM
14	21636	3	CAPSCREW,3/8" X 2-1/2",NC
15	27082B	3	SPACER
16	21627	3	NYLOCK NUT,3/8",NC
17	34623	4	CBL,CNTRL,122"
	06510100	4	CBL,CNTRL,108"

5 SPOOL CABLE CONTROL MOUNT

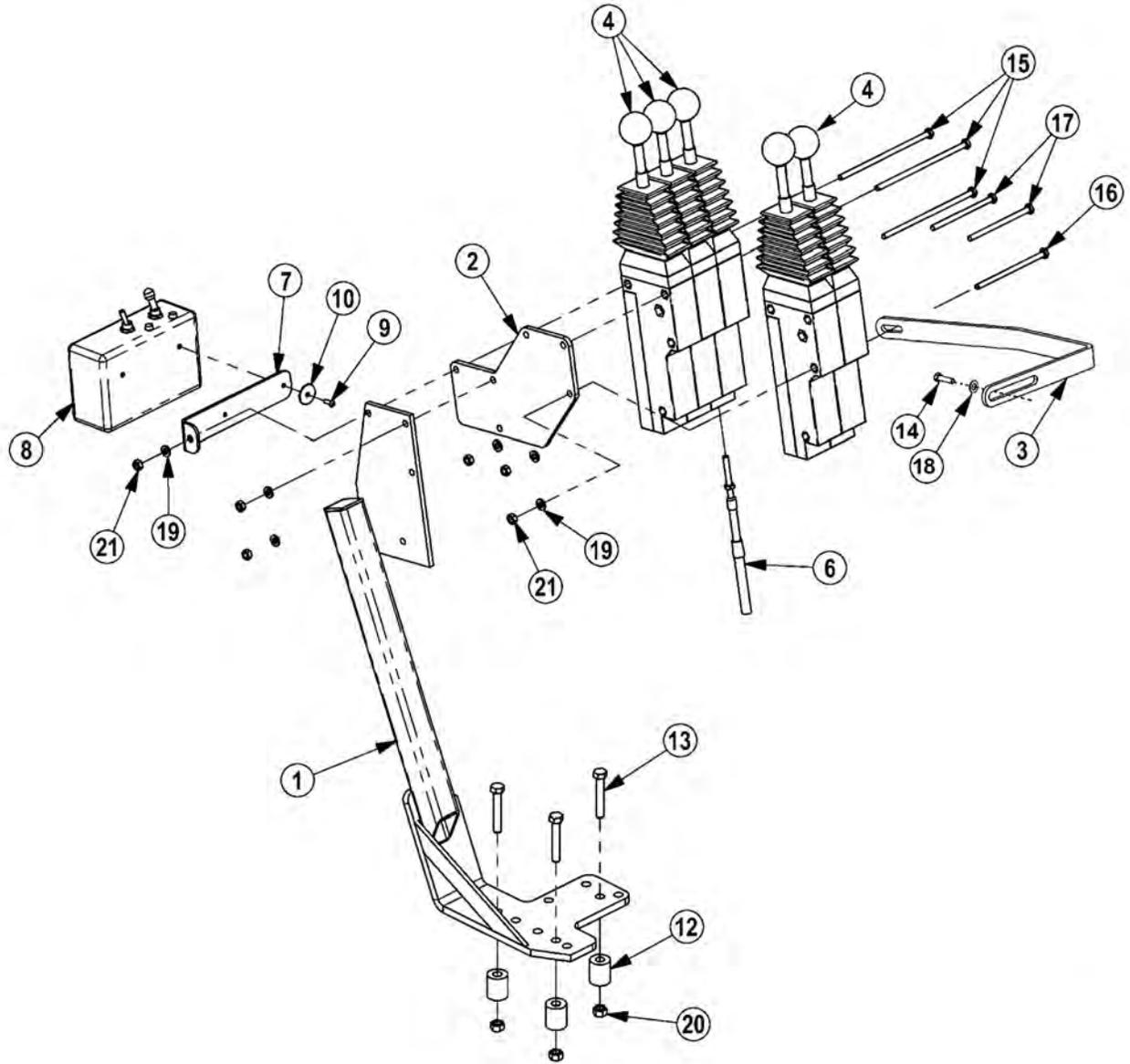

5 SPOOL CABLE CONTROL MOUNT

Continued...

ITEM	PART NO.	QTY.	DESCRIPTION
1	23865B	1	CBL CTRL MT BRK
2	06400179	1	MNT,ADPTR,CNTRL BOX,2 ROW
3	06410239	1	SUPPORT,MNT,CNTRL BOX,2 ROW
4	6T1251	5	CBL CTRL BOX,180 DEG
6	06505100	5	CBL,CNTRL,108
7	34496	1	BRKT,SWITCHBOX,UNI
8	06510100	1	SWITCHBOX ASSY,BOOM
9	6T3951	2	SCREW,MACHINE,8/32" X 1/2"
10	32360	2	LOCKWASHER,#8
12	27082B	3	SPACER
13	21636	3	CAPSCREW,3/8" X 2-1/2",NC
14	33534	1	CAPSCREW,10MM X 20MM,1.5PITCH
15	21545	3	CAPSCREW,1/4" X 6",NC
16	21543	1	CAPSCREW,1/4" X 4-1/2",NC
17	21542	2	CAPSCREW,1/4" X 4",NC
18	32691	1	LOCKWASHER,10MM
19	21986	6	LOCKWASHER,1/4"
20	21627	3	NYLOCK NUT,3/8",NC
21	21525	6	HEX NUT,1/4",NC

CABLE (MANUAL) LIFT VALVE - 4 SPOOL

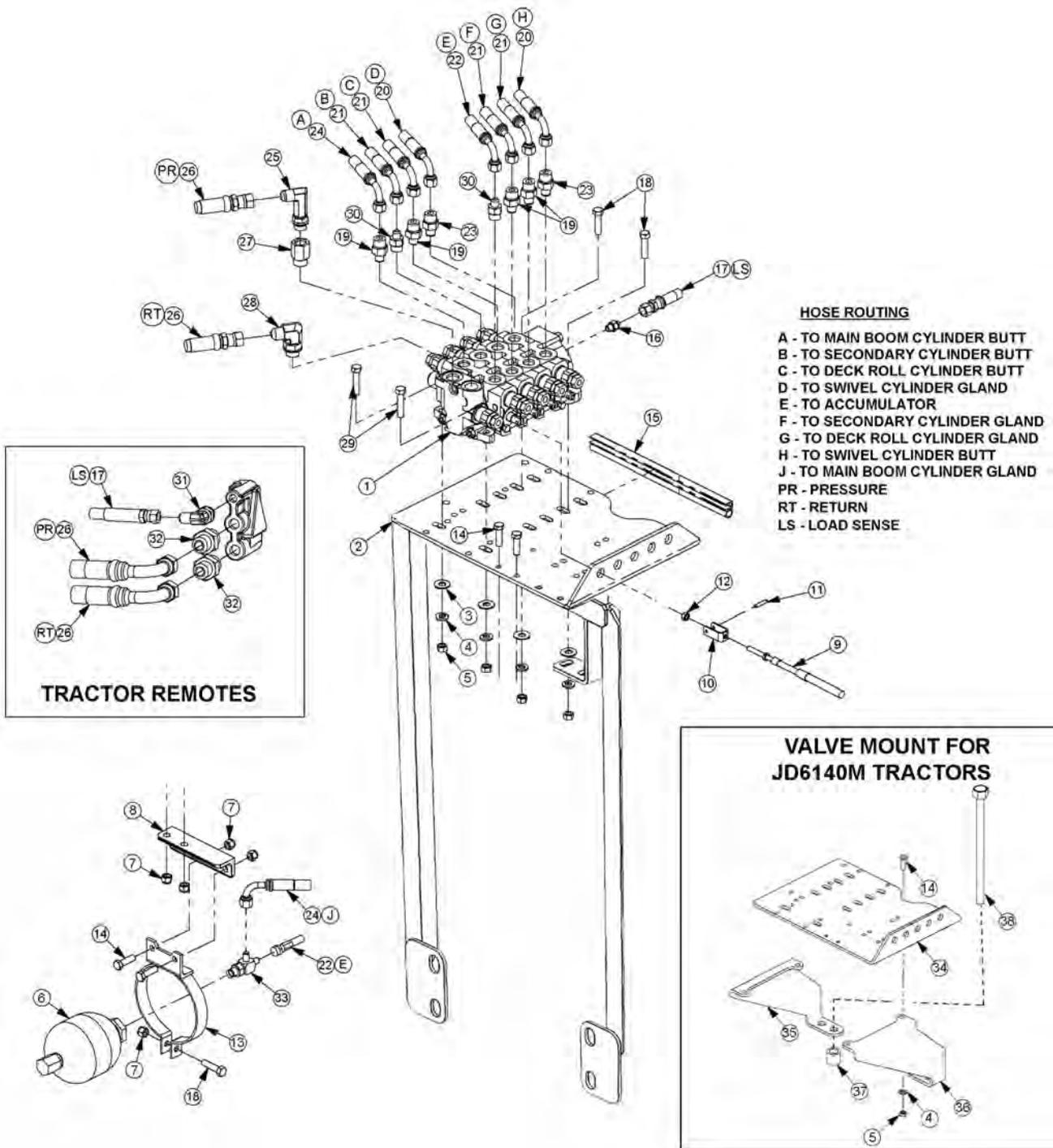

ITEM	PART NO.	QTY.	DESCRIPTION
1	06502057	1	VALVE,CABLE,4 SPOOL (FLAIL)
---	06502093	1	VALVE,CABLE,4 SPOOL (ROTARY)
2	06340048	1	PLATE,VALVE,REAR MNT
3	22016	4	FLATWASHER,3/8"

CABLE (MANUAL) LIFT VALVE - 4 SPOOL

Continued...

ITEM	PART NO.	QTY.	DESCRIPTION
4	21988	8	LOCKWASHER,3/8"
5	21625	8	HEX NUT,3/8",NC
6	24300	1	ACCUMULATOR
7	21627	5	NYLOCK NUT,3/8",NC
8	06460072	1	BRKT
9	06505100	4	CBL,CNTRL,108"
10	6T4411	4	CLEVIS,CBL CTRL,3/16"
11	6T3017	4	ROLLPIN,3/16" X 1"
12	21500	4	HEX NUT,1/4",NF
13	23888	1	BRKT,ACCUMULATOR
14	21631	8	CAPSCREW,3/8" X 1-1/4",NC
15	28053	1	TRM LK,9/16X1/8FN PBL*100-1/8
16	32901	1	ADAPTER,3/8"MOR X 3/8"MJ
17	06500350	1	HOSE,1/4" X 26"
18	21632	3	CAPSCREW,3/8" X 1-1/2",NC
19	33271	4	ADAPTER,1/2"MOR X 3/8"MJ
20	06500697	2	HOSE,1/4" X 210"
21	06500687	4	HOSE,1/4" X 268"
22	33744	1	HOSE,1/4" X 34"
23	34396	2	ADAPTER,RSTRCT,.06" OUT
24	06500688	2	HOSE,1/4" X 288"
25	33293	1	ELBOW,LONG
26	34612	2	HOSE,1/2" X 34"
27	32678	1	ADAPTER,5/8"MOR X 1/2"FOR
28	33383	1	ELBOW,5/8"MOR X 1/2"MJ
29	21633	2	CAPSCREW,3/8" X 1-3/4",NC
30	06502036	2	VLV,CHECK,W/.06" ORF,1/2"MOR
31	06503013	1	ELBOW,14MM MOR X 5/16"MJ
32	33463	2	ADAPTER,22MM MOR X 1/2"MJ
33	06503029	1	TEE,RUN
34	34622	1	PLATE,VALVE,REAR MNT
35	06410430	1	MOUNT, VALVE, LEFT
36	06410429	1	MOUNT, VALVE, RIGHT
37	34519	1	SPACER, 1-1/4" X 13/16" X 1-1/8"
38	06530514	1	CAPSCREW, 18MM X 290MM, 2.5P

CABLE (MANUAL) LIFT VALVE - 5 SPOOL

HOSE ROUTING

- A - TO MAIN BOOM CYLINDER BUTT
- B - TO SECONDARY CYLINDER BUTT
- C - TO DECK ROLL CYLINDER BUTT
- D - TO SWIVEL CYLINDER GLAND
- E - TO SHIELD CYLINDER BUTT
- F - TO ACCUMULATOR
- G - TO SECONDARY CYLINDER GLAND
- H - TO DECK ROLL CYLINDER GLAND
- J - TO SWIVEL CYLINDER BUTT
- K - TO SHIELD CYLINDER GLAND
- L - TO MAIN BOOM CYLINDER GLAND
- P - PRESSURE
- R - RETURN
- LS - LOAD SENSE

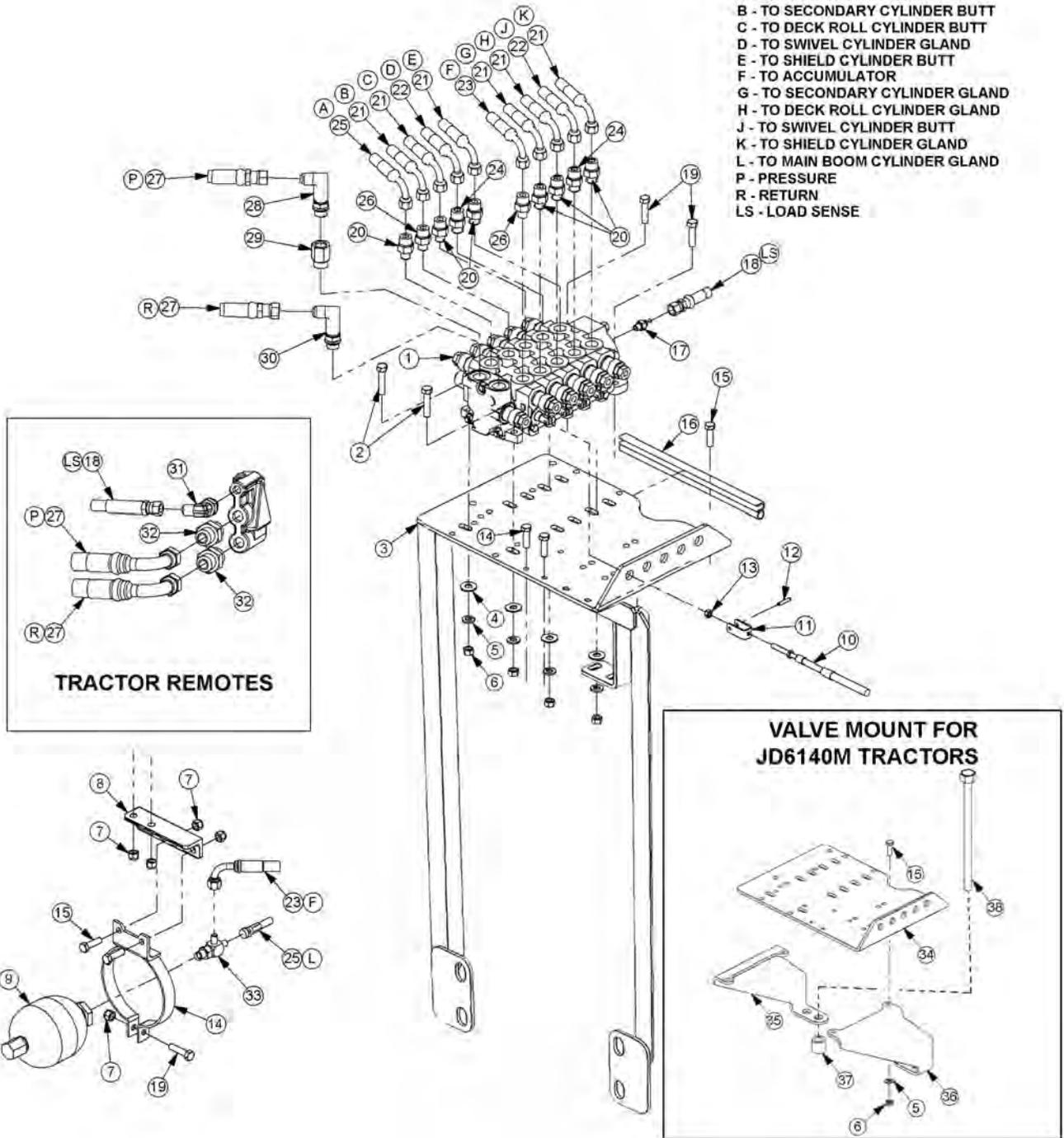

ITEM	PART NO.	QTY.	DESCRIPTION
1	06502038	1	VALVE,CABLE,5 SPOOL
2	21633	2	CAPSCREW,3/8" X 1-3/4",NC
3	06340048	1	PLATE,VALVE,REAR MNT

CABLE (MANUAL) LIFT VALVE - 5 SPOOL

Continued...

ITEM	PART NO.	QTY.	DESCRIPTION
4	22016	4	FLATWASHER,3/8"
5	21988	8	LOCKWASHER,3/8"
6	21625	8	HEX NUT,3/8",NC
7	21627	5	NYLOCK NUT,3/8",NC
8	06460072	1	BRKT
9	24300	1	ACCUMULATOR
10	06505100	5	CBL,CNTRL,108"
11	6T4411	5	CLEVIS,CBL CTRL,3/16"
12	6T3017	5	ROLLPIN,3/16" X 1"
13	21500	5	HEX NUT,1/4",NF
14	23888	1	BRKT,ACCUMULATOR
15	21631	8	CAPSCREW,3/8" X 1-1/4",NC
16	28053	1	TRM LK,9/16X1/8FN PBL*100-1/8
17	32901	1	ADAPTER,3/8"MOR X 3/8"MJ
18	06500350	1	HOSE,1/4" X 26"
19	21632	3	CAPSCREW,3/8" X 1-1/2",NC
20	33271	6	ADAPTER,1/2"MOR X 3/8"MJ
21	06500687	6	HOSE,1/4" X 268"
22	06500697	2	HOSE,1/4" X 210"
23	33744	1	HOSE,1/4" X 34"
24	34396	2	ADAPTER,RSTRCT,.06" OUT
25	06500688	2	HOSE,1/4" X 288"
26	06502036	2	VLV,CHECK,W/.06" ORF,1/2"MOR
27	34612	2	HOSE,1/2" X 34"
28	33293	1	ELBOW,LONG
29	32678	1	ADAPTER,5/8"MOR X 1/2"FOR
30	33383	1	ELBOW,LONG
31	06503013	1	ELBOW,14MM MOR X 5/16"MJ
32	33463	2	ADAPTER,22MM MOR X 1/2"MJ
33	06503029	1	TEE,RUN
34	34622	1	PLATE,VALVE,REAR MNT
35	06410430	1	MOUNT, VALVE, LEFT
36	06410429	1	MOUNT, VALVE, RIGHT
37	34519	1	SPACER, 1-1/4" X 13/16" X 1-1/8"
38	06530514	1	CAPSCREW, 18MM X 290MM, 2.5P

CABLE (MANUAL) LIFE VALVE BREAKDOWN - 06502038

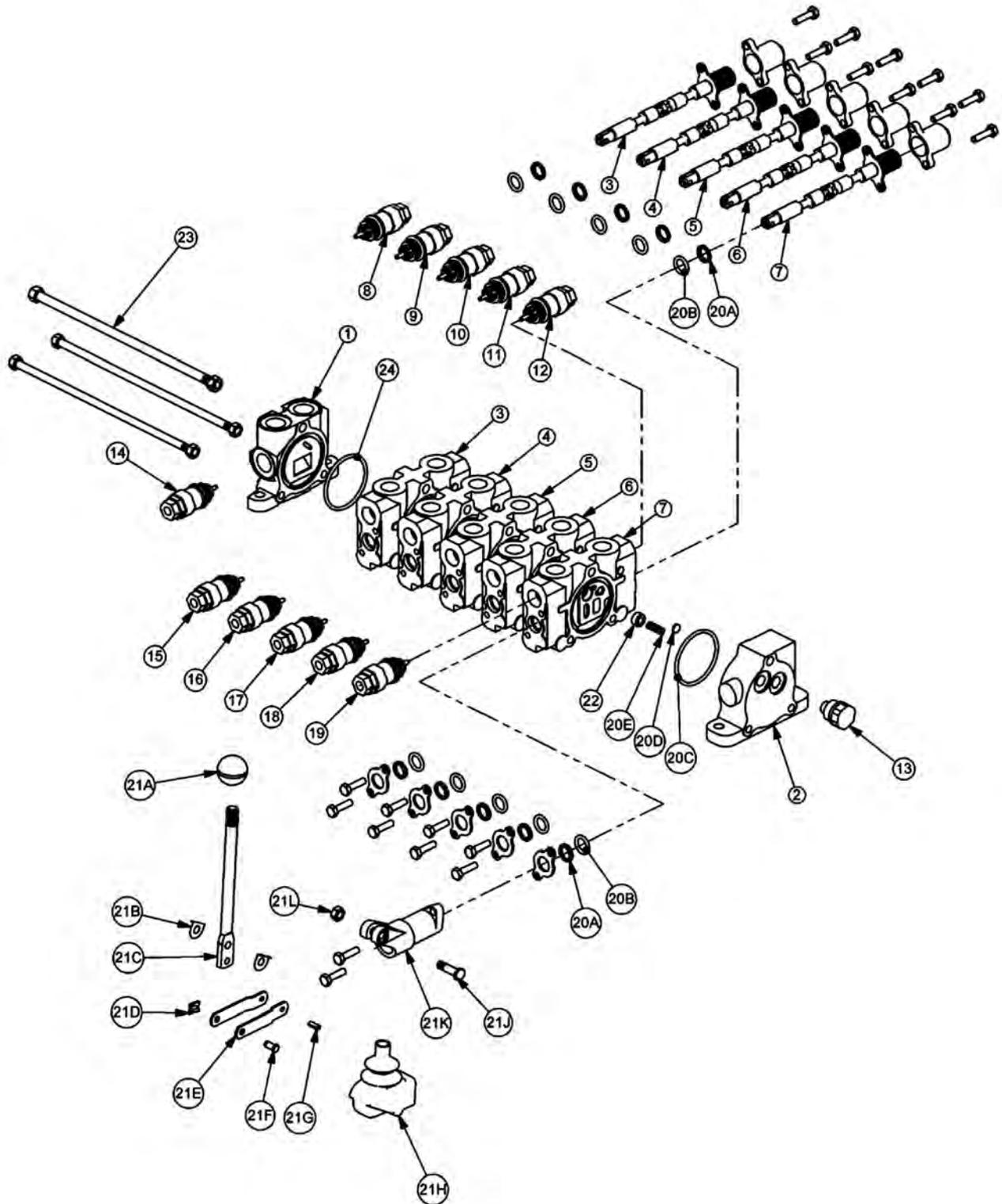

CABLE (MANUAL) LIFE VALVE BREAKDOWN - 06502038

Continued...

ITEM	PART NO.	QTY.	DESCRIPTION
1	31595	1	INLET END COVER
2	31594	1	END COVER, LOAD SENSE
3	31597	1	VALVE SECTION (DOUBLE ACTING, CENTER SPRING)
4	31597	1	VALVE SECTION (DOUBLE ACTING, CENTER SPRING)
5	31597	1	VALVE SECTION (DOUBLE ACTING, CENTER SPRING)
6	31598	1	VALVE SECTION (DOUBLE ACTING, CENTER SPRING, METERED)
7	31597	1	VALVE SECTION (DOUBLE ACTING, CENTER SPRING) (REMOVE SHUTTLE DISC)
8	TF4212	1	RELIEF VALVE, 200 PSI
9	TB1017K	1	RELIEF VALVE, 2150 PSI
10	TB1017J	1	RELIEF VALVE, 1800 PSI
11	06502089	1	RELIEF VALVE, 2400 PSI
12	22588	1	RELIEF VALVE, 500 PSI
13	06503068	1	#6 O-RING PLUG
14	6T4209	1	#10 O-RING PLUG
15	06502085	1	RELIEF VALVE, 3000 PSI
16	TB1017F	1	RELIEF VALVE, 1500 PSI
17	TB1017F	1	RELIEF VALVE, 1500 PSI
18	06502120	1	RELIEF VALVE, 2100 PSI
19	22588	1	RELIEF VALVE, 500 PSI
20	31593	5	VALVE SEAL KIT (FOR ONE SECTION)
20A	-----	2	WIPER
20B	-----	2	O-RING SMALL
20C	-----	1	O-RING LARGE
20D	-----	1	SHUTTLE DISC
20E	-----	1	SPRING
21	TB1017L	5	LEVER KIT (FOR ONE SECTION)
21A	-----	1	LEVER KNOB
21B	-----	1	LEVER
21C	-----	2	LEVER WASHER
21D	-----	1	LEVER CLIP
21E	-----	2	LINKAGE
21F	-----	1	LEVER PIN
21G	-----	1	ROLL PIN
21H	-----	1	LEVER BOOT
21J	-----	1	LEVER BOLT
21K	-----	1	LEVER DUST COVER
21L	-----	1	LEVER NUT
22	31603	5	COMPENSATOR
23	TB1017V	1	TIE ROD KIT
24	24214	1	O-RING, LARGE

CABLE (MANUAL) LIFT VALVE BREAKDOWN - 06502057

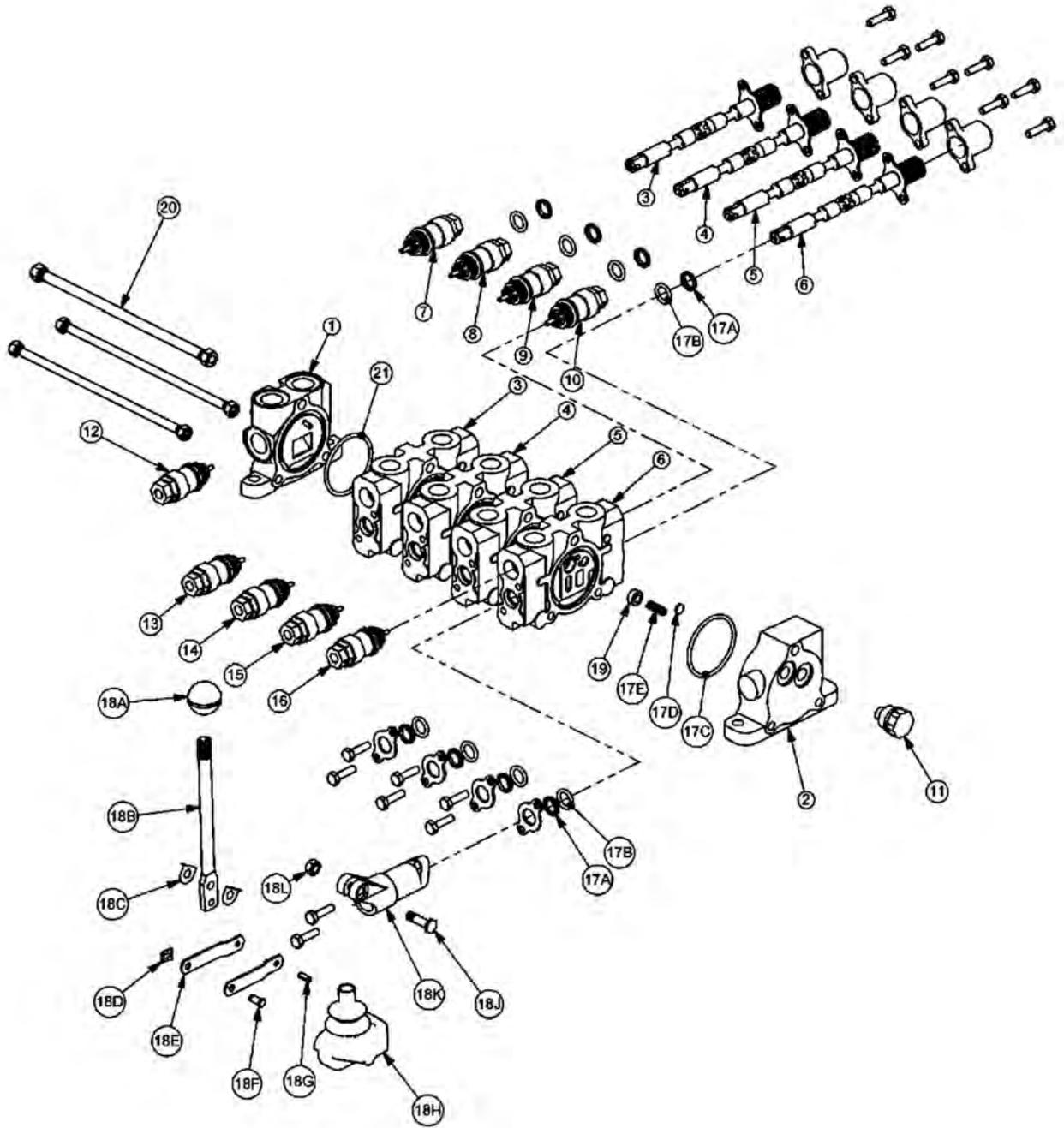

CABLE (MANUAL) LIFT VALVE BREAKDOWN - 06502057

Continued...

ITEM	PART NO.	QTY.	DESCRIPTION
1	31595	1	INLET END COVER
2	31594	1	END COVER, LOAD SENSE
3	31597	1	VALVE SECTION (DOUBLE ACTING, CENTER SPRING)
4	31597	1	VALVE SECTION (DOUBLE ACTING, CENTER SPRING)
5	31600	1	VALVE SECTION (DOUBLE ACTING, DETENT - FLOAT)
6	31598	1	VALVE SECTION (DOUBLE ACTING, CENTER SPRING, METERED) (REMOVE SHUTTLE DISC)
7	TF4212	1	RELIEF VALVE, 200 PSI
8	TB1017K	1	RELIEF VALVE, 2150 PSI
9	TB1017J	1	RELIEF VALVE, 1800 PSI
10	06502089	1	RELIEF VALVE, 2400 PSI
11	06503068	1	#6 O-RING PLUG
12	6T4209	1	#10 O-RING PLUG
13	06502085	1	RELIEF VALVE, 3000 PSI
14	TB1017F	1	RELIEF VALVE, 1500 PSI
15	TB1017F	1	RELIEF VALVE, 1500 PSI
16	6T3908	1	RELIEF VALVE, 2100 PSI
17	31593	4	VALVE SEAL KIT (FOR ONE SECTION)
17A	-----	2	WIPER
17B	-----	2	O-RING SMALL
17C	-----	1	O-RING LARGE
17D	-----	1	SHUTTLE DISC
17E	-----	1	SPRING
18	TB1017L	4	LEVER KIT (FOR ONE SECTION)
18A	-----	1	LEVER KNOB
18B	-----	1	LEVER
18C	-----	2	LEVER WASHER
18D	-----	1	LEVER CLIP
18E	-----	2	LINKAGE
18F	-----	1	LEVER PIN
18G	-----	1	ROLL PIN
18H	-----	1	LEVER BOOT
18J	-----	1	LEVER BOLT
18K	-----	1	LEVER DUST COVER
18L	-----	1	LEVER NUT
19	31603	4	COMPENSATOR
20	TB1017U	1	TIE ROD KIT
21	24214	1	O-RING, LARGE

CABLE (MANUAL) LIFT VALVE BREAKDOWN - 06502093

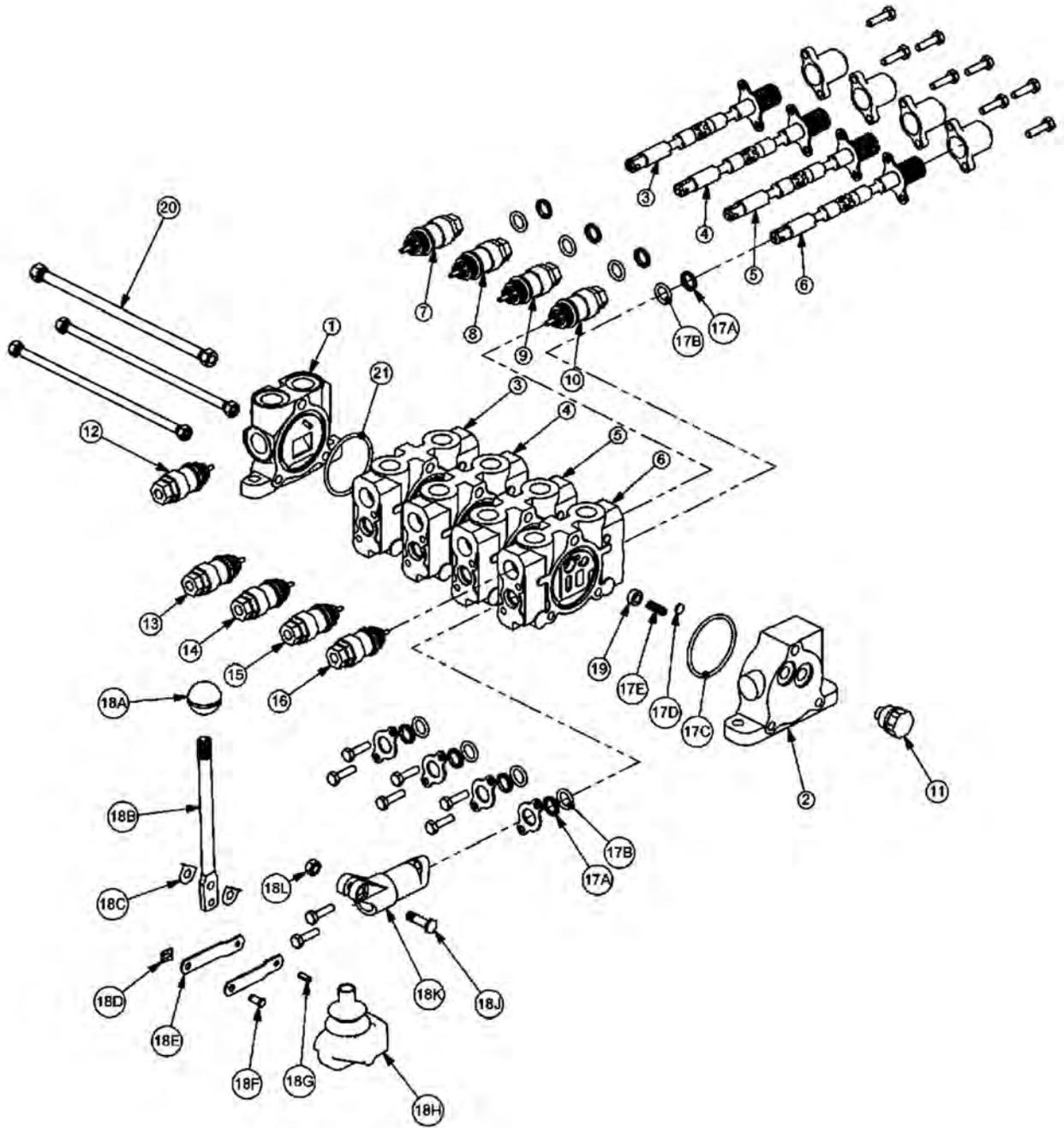

CABLE (MANUAL) LIFT VALVE BREAKDOWN - 06502093

Continued...

ITEM	PART NO.	QTY.	DESCRIPTION
1	31595	1	INLET END COVER
2	31594	1	END COVER, LOAD SENSE
3	31597	1	VALVE SECTION (DOUBLE ACTING, CENTER SPRING)
4	31597	1	VALVE SECTION (DOUBLE ACTING, CENTER SPRING)
5	31598	1	VALVE SECTION (DOUBLE ACTING, CENTER SPRING)
6	31598	1	VALVE SECTION (DOUBLE ACTING, CENTER SPRING, METERED) (REMOVE SHUTTLE DISC)
7	TF4212	1	RELIEF VALVE, 200 PSI
8	TB1017K	1	RELIEF VALVE, 2150 PSI
9	TB1017J	1	RELIEF VALVE, 1800 PSI
10	06502089	1	RELIEF VALVE, 2400 PSI
11	06503068	1	#6 O-RING PLUG
12	6T4209	1	#10 O-RING PLUG
13	06502085	1	RELIEF VALVE, 3000 PSI
14	TB1017F	1	RELIEF VALVE, 1500 PSI
15	TB1017F	1	RELIEF VALVE, 1500 PSI
16	6T3908	1	RELIEF VALVE, 2100 PSI
17	31593	4	VALVE SEAL KIT (FOR ONE SECTION)
17A	-----	2	WIPER
17B	-----	2	O-RING SMALL
17C	-----	1	O-RING LARGE
17D	-----	1	SHUTTLE DISC
17E	-----	1	SPRING
18	TB1017L	4	LEVER KIT (FOR ONE SECTION)
18A	-----	1	LEVER KNOB
18B	-----	1	LEVER
18C	-----	2	LEVER WASHER
18D	-----	1	LEVER CLIP
18E	-----	2	LINKAGE
18F	-----	1	LEVER PIN
18G	-----	1	ROLL PIN
18H	-----	1	LEVER BOOT
18J	-----	1	LEVER BOLT
18K	-----	1	LEVER DUST COVER
18L	-----	1	LEVER NUT
19	31603	4	COMPENSATOR
20	TB1017U	1	TIE ROD KIT
21	24214	1	O-RING, LARGE

ELECTRONIC PROPORTIONAL LIFT VALVE MOUNT

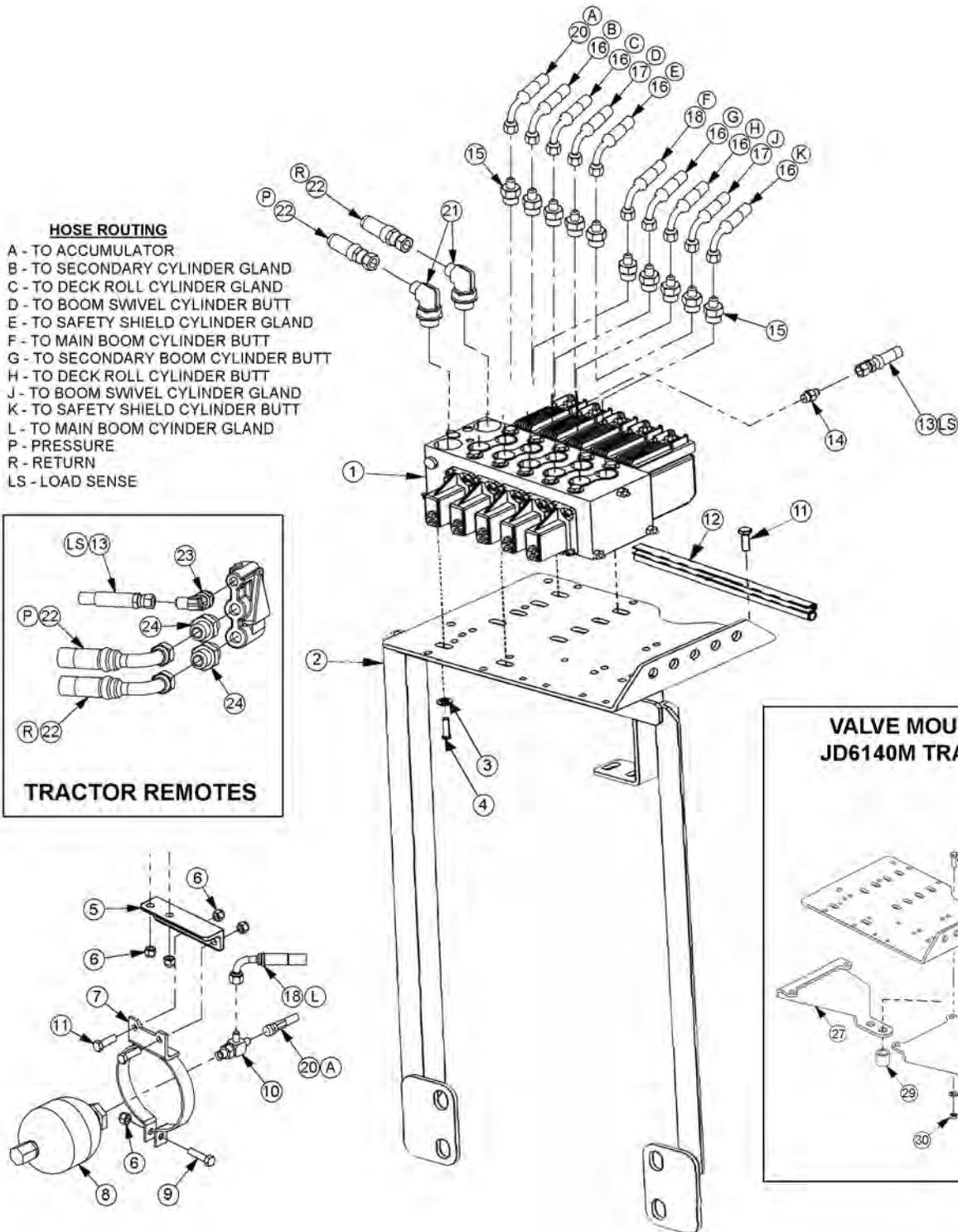

ITEM	PART NO.	QTY.	DESCRIPTION
1	06502097	1	ELECTRONIC LIFT VALVE
2	06340048	1	PLATE, VALVE, JD6XXXX

ELECTRONIC PROPORTIONAL LIFT VALVE MOUNT

Continued...

ITEM	PART NO.	QTY.	DESCRIPTION
3	21987	4	LOCKWASHER,5/16"
4	21579	4	CAPSCREW,5/16" X 3/4",NC
5	06460072	1	BRACKET
6	21627	5	NYLOCK NUT,3/8",NC
7	23888	1	BRKT,ACCUMULATOR
8	24300	1	ACCUMULATOR
9	21632	1	CAPSCREW,3/8" X 1-1/2",NC
10	06503029	1	TEE,RUN
11	21631	4	CAPSCREW,3/8" X 1-1/4",NC
12	28053	1	TRM LK,9/16" X 1/8"FN PBL*100-1/8
13	06500400	1	HOSE,1/4" X 30"
14	33392	1	ADAPTER
15	32807	10	ADAPTER
16	06500687	6	HOSE,1/4" X 268"
17	06500697	2	HOSE,1/4" X 210"
18	06500688	2	HOSE,1/4" X 288"
20	33744	1	HOSE,1/4" X 34"
21	33294	2	ELBOW
22	34612	2	HOSE,1/2" X 34"
23	06503013	1	ELBOW,14MM MOR X 5/16"MJ
24	33463	2	ADAPTER,22MM MOR X 1/2"MJ
25	34622	1	PLATE, VALVE, MOUNT
26	06560514	1	CAPSCREW, 18MM X 290MM, 2.5P
27	06410430	1	MOUNT, VALVE, LEFT
28	06410429	1	MOUNT, VALVE, RIGHT
29	34519	1	SPACER, 1-1/4" X 13/16" X 1-1/8"
30	21625	1	HEX NUT 3/8" NC
31	21988	1	LOCKWASHER 3/8"

JOYSTICK AND SWITCHBOX MOUNT

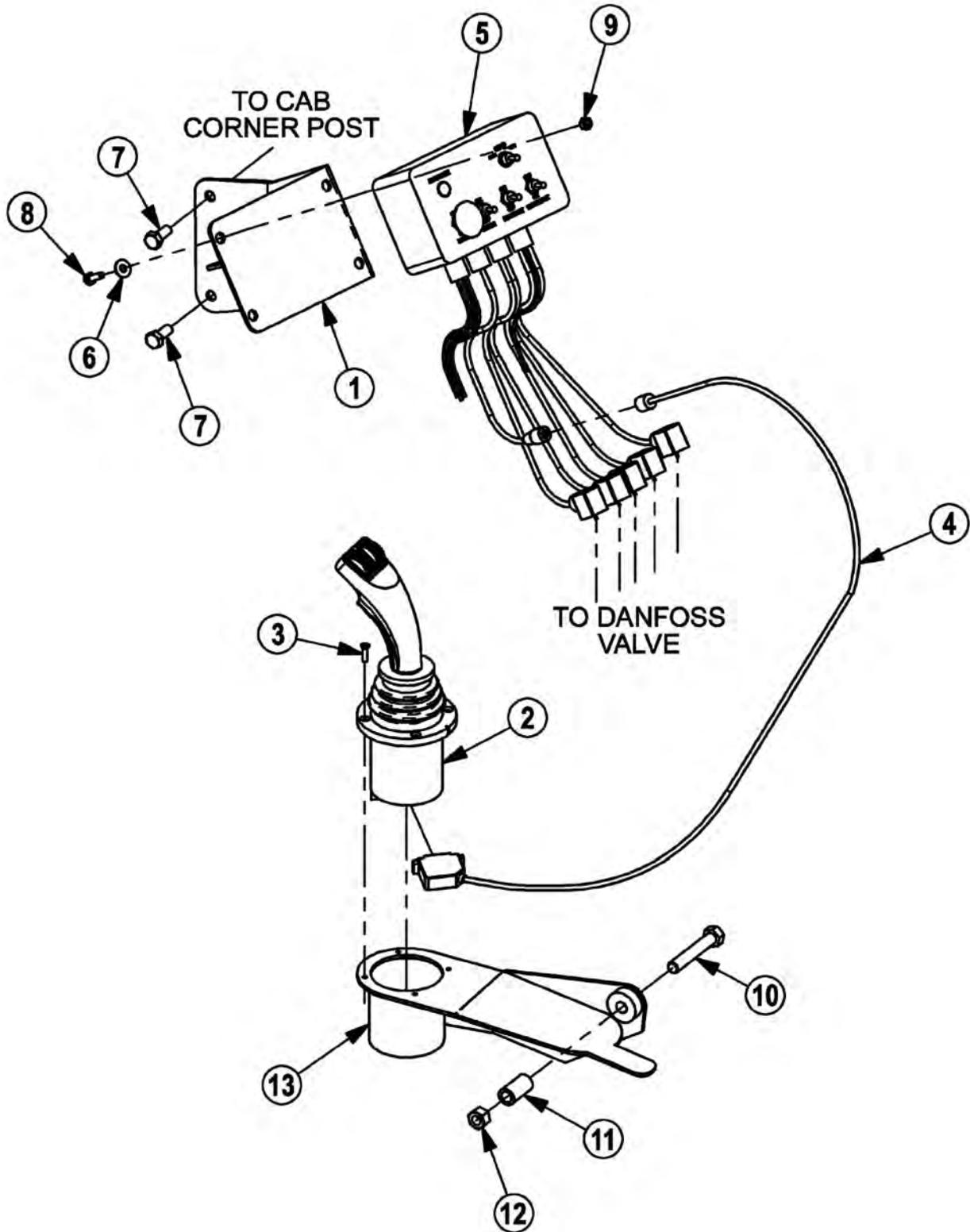

JOYSTICK AND SWITCHBOX MOUNT

Continued...

ITEM	PART NO.	QTY.	DESCRIPTION
1	33355	1	MNT,BRKT,SWITCH BOX
2	33691	1	JOYST,4AXIS,RH,DF
3	32829	4	SCREW,MACHINE,10-32 X 3/4",FLTHD
4	33693	1	CBL,EXT,4FT,JOYST
5	06510196	1	SWITCH BOX
6	22014	4	FLATWASHER,1/4"
7	27513	2	CAPSCREW,10MMX25MM(1.5 PITCH)
8	21529	4	CAPSCREW,1/4" X 3/4",NC
9	21527	4	NYLOCK NUT,1/4",NC
10	21737	1	CAPSCREW,1/2" X 3",NC
11	33359	1	TUBE,SPACER
12	21727	1	NYLOCK NUT,1/2",NC
13	33356	1	ARMREST,JOYSTICK

BOOM MOUNT KIT

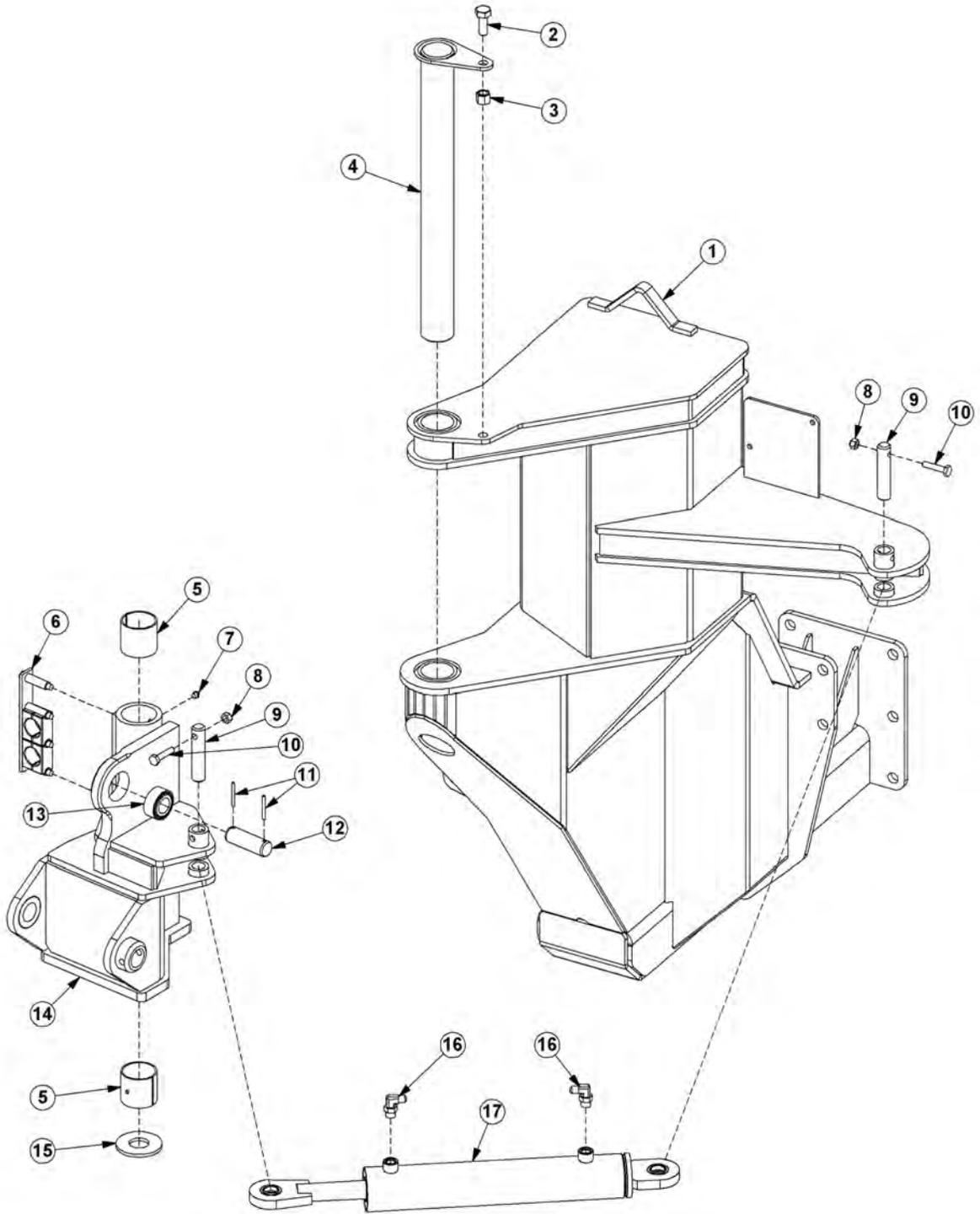

BOOM MOUNT KIT

Continued...

ITEM	PART NO.	QTY.	DESCRIPTION
1	-----	-	MAINFRAME *REFER TO TRACTOR MOUNT KIT
2	21782	1	CAPSCREW,5/8" X 1-3/4",NC
3	21777	1	NYLOCK NUT,5/8",NC
4	32381	1	PIN,CAPPED
5	32322	2	BUSHING
6	06505185	1	CLAMP KIT
7	6T3211	2	GREASE ZERK,1/8"NPT
8	21677	2	NYLOCK NUT,7/16",NC
9	32380	2	PIN,1"
10	21683	2	CAPSCREW,7/16" X 2",NC
11	TB1023	2	ROLL PIN
12	06420100	1	PIN,1-1/4"
13	-----	-	SPHERICAL BEARING *NOT FOR SALE
14	06700221	1	SWIVEL ASSEMBLY
---	06310190	1	SWIVEL WELDMENT
15	06520250	1	BEARING,WASHER
16	32810	2	ADAPTER,ELBOW
17	06501029	1	CYLINDER,3" X 13.88"

BOOMREST - OPEN STOW

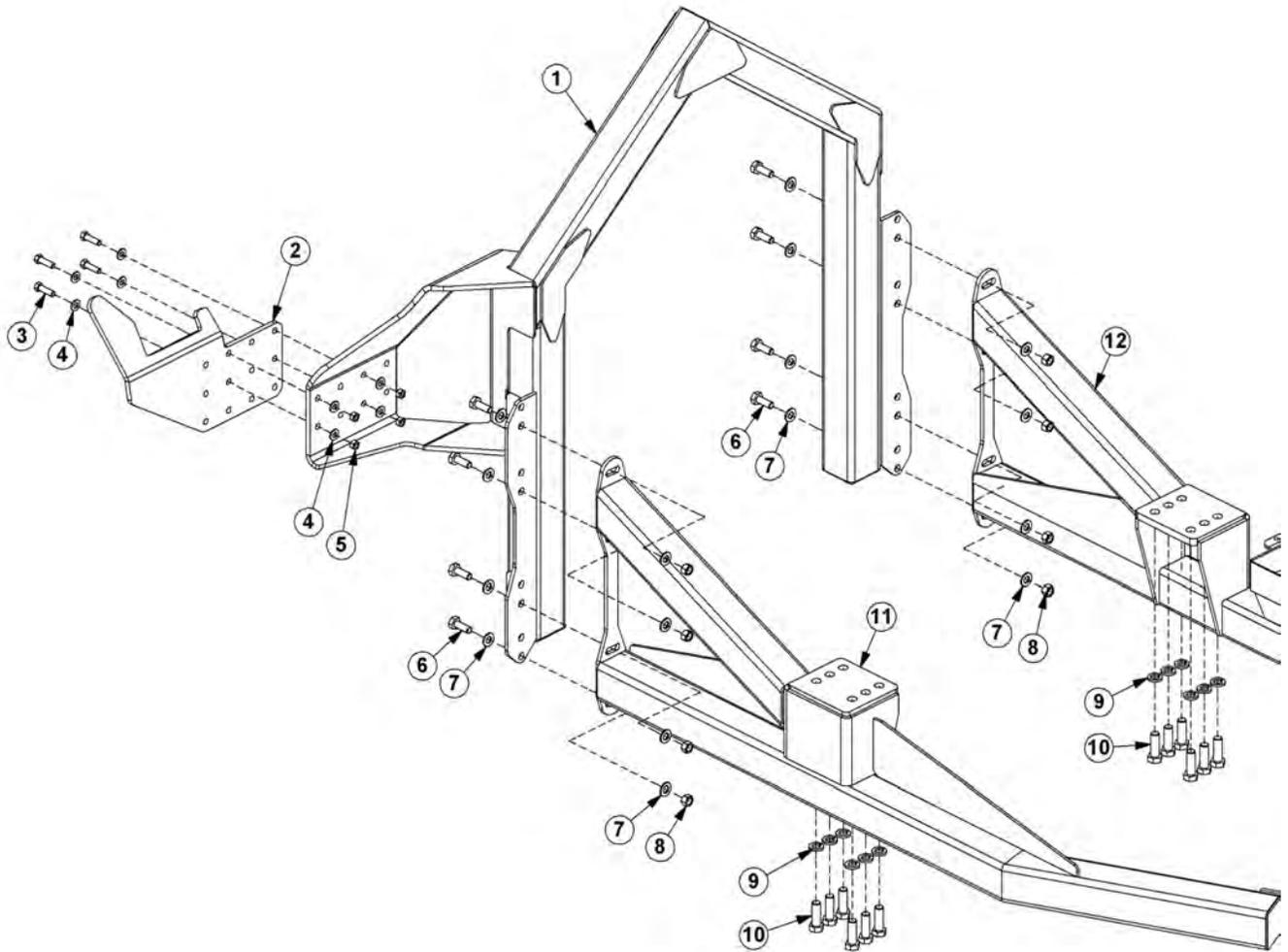

BOOMREST - OPEN STOW

Continued...

ITEM	PART NO.	QTY.	DESCRIPTION
1	06310155	1	BOOMREST,OS
2	06410968	1	SADDLE
3	21732	4	CAPSCREW,1/2" X 1-3/4",NC
4	06533004	8	FLATWASHER,1/2",SAE
5	21725	4	HEX NUT,1/2",NC
6	21782	8	CAPSCREW,5/8" X 1-3/4",NC
7	33764	16	FLATWASHER,5/8",SAE
8	21775	8	HEX NUT,5/8",NC
9	24881	12	LOCKWASHER,20MM
10	27281	12	CAPSCREW,20MM X 60MM,2.5P
11	06300019	1	AXLE BRACE,RH
12	06300256	1	AXLE BRACE,LH

BOOMREST - SINGLE COLUMN

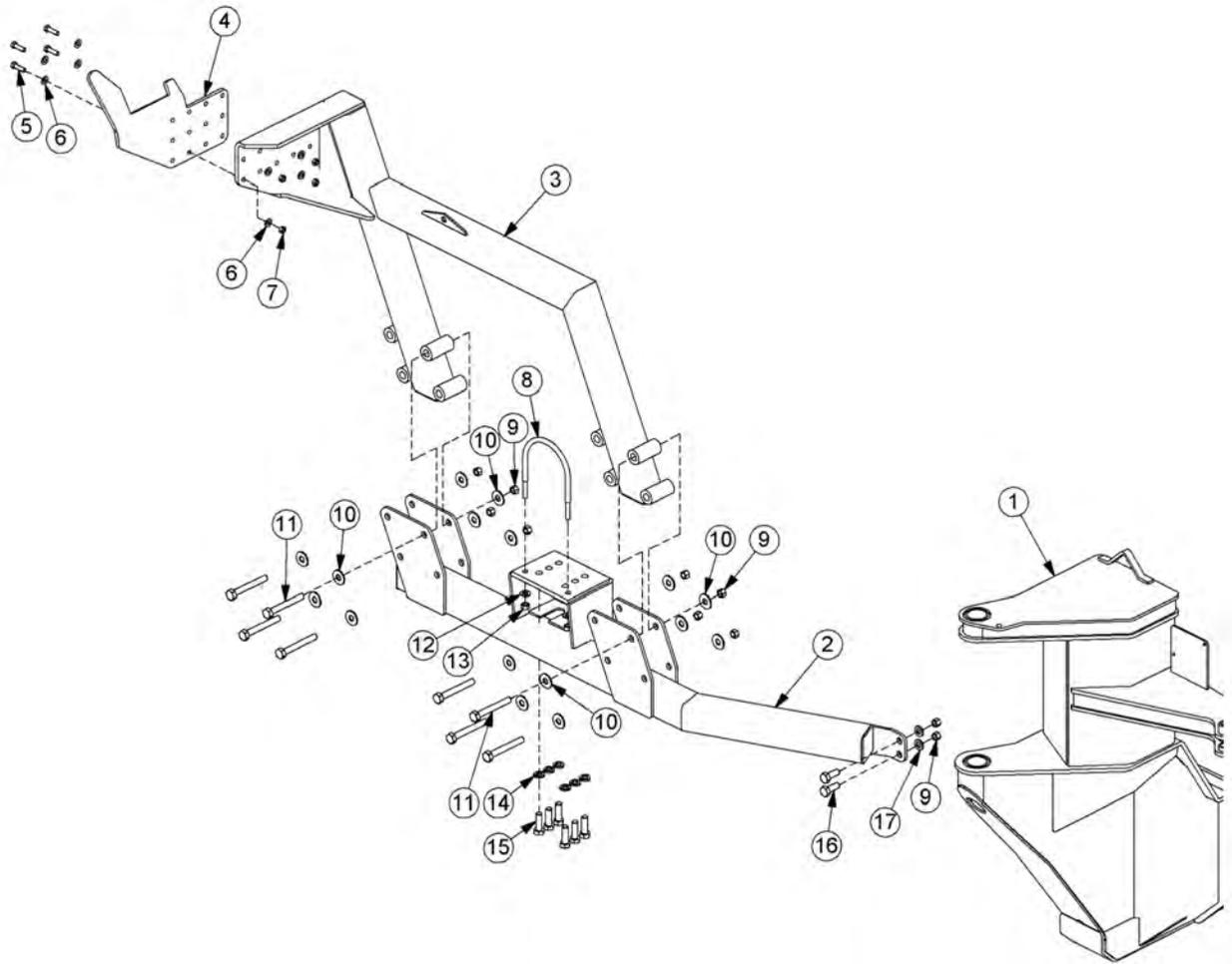

BOOMREST - SINGLE COLUMN

Continued...

ITEM	PART NO.	QTY.	DESCRIPTION
1	-----	-	MNFRM *REFER TO TRACTOR MOUNT KIT PAGE
2	06300131	1	AXLE BRACE,SC
3	06310074	1	BOOMREST,SINGLE COLUMN
4	06410968	1	BOOMREST PLATE
5	21732	4	CAPSCREW,1/2" X 1-3/4",NC
6	06533004	8	FLATWASHER,1/2",SAE,GR8
7	21725	4	HEX NUT,1/2",NC
8	06420127	1	U-BOLT,5/8"
9	21825	10	HEX NUT,1/2",NC
10	22021	16	FLATWASHER,3/4"
11	21843	8	CAPSCREW,3/4" X 6",NC
12	33764	2	FLATWASHER,5/8",GR8,SAE
13	6T2408	2	HEX NUT,5/8",NF,GR8
14	24881	6	LOCKWASHER,20MM
15	27281	6	CAPSCREW,20MM X 60MM,2.5P
16	21832	2	CAPSCREW,3/4" X 2",NC
17	33880	2	FLATWASHER,3/4",GR8,SAE

PUMP DRIVESHAFT BREAKDOWN

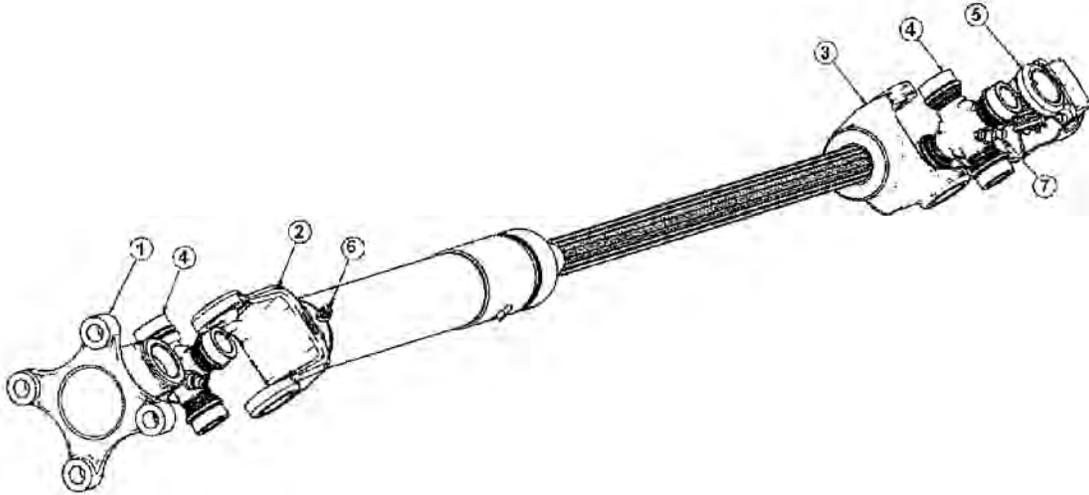

ITEM	PART NO.	QTY.	DESCRIPTION
---	34999	1	DRIVESHAFT,U-JOINT,ASSY
1	06505004	1	YOKE PULLEY
2	06505005	1	SLEEVE
3	06505006	1	SHAFT
4	06505007	2	CROSS
5	06505008	1	YOKE DRIVE
6	6T3203	1	GREASE ZERK,1/4" X 45
7	6T3207	3	GREASE ZERK,1/4" X STR

NOTES

NOTES

OPTIONAL COOLER ASSEMBLY

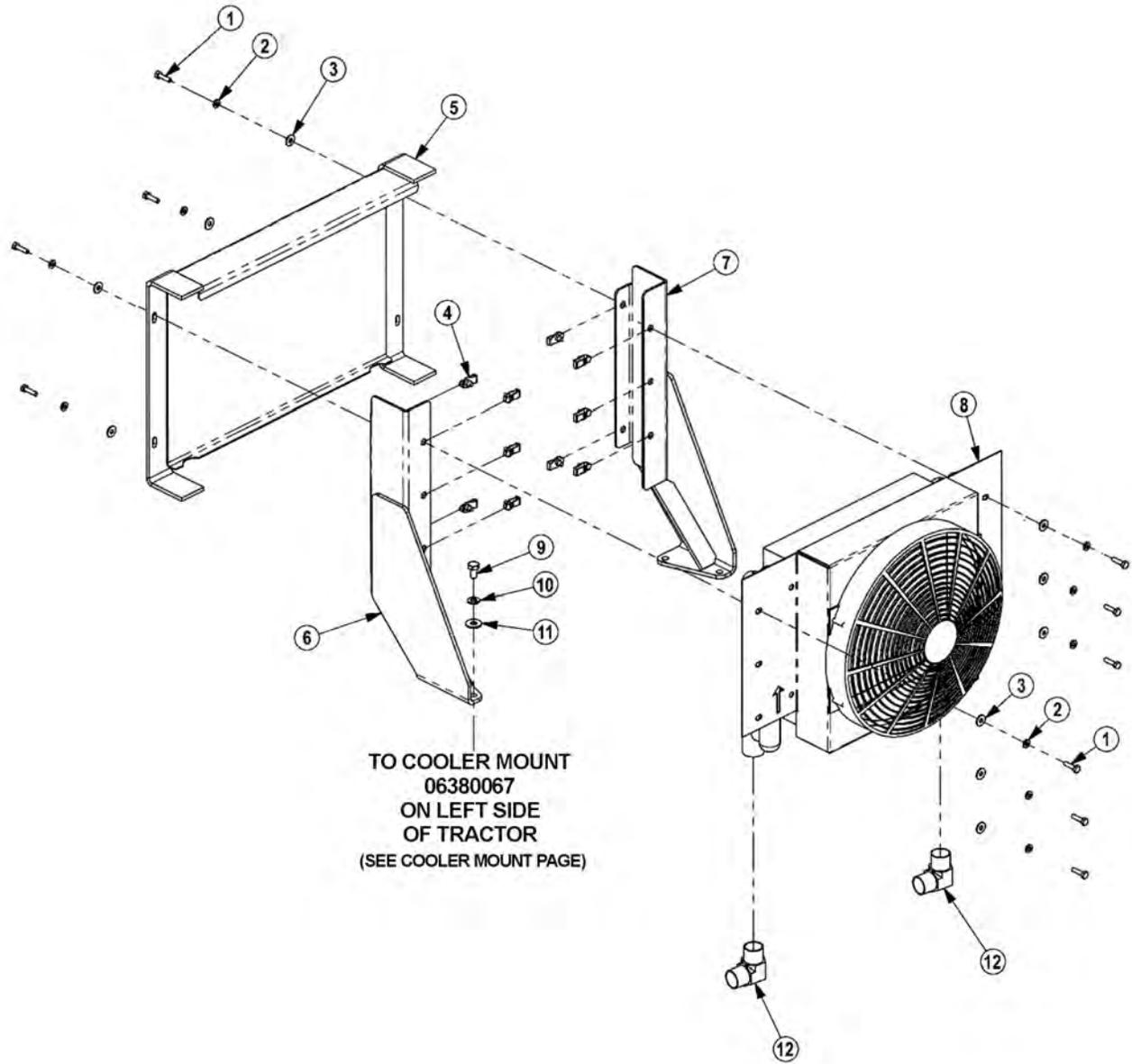

OPTIONAL COOLER ASSEMBLY

Continued...

ITEM	PART NO.	QTY.	DESCRIPTION
1	21530	10	CAPSCREW,1/4 X1 NC
2	21986	10	LOCKWASHER,1/4
3	22014	10	FLATWASHER,1/4
4	35176	10	1/4 U-NUT
5	06370015	1	SCREEN,COOLER,FRNT
6	06380006	1	MNT,COOLER,BUMPER TANK,RH
7	06380007	1	MNT,COOLER,BUMPER TANK,LH
8	06510026	1	COOLER,FRONT MNT
---	06510029	1	FAN ASSY, ONLY
9	21629	4	CAPSCREW,3/8 X 3/4 NC
10	21988	4	LOCKWASHER,3/8
11	22016	4	FLATWASHER,3/8
12	34117	2	ELBOW,1MOR X 1MJ90,FORGED

OPTIONAL COOLER MOUNT

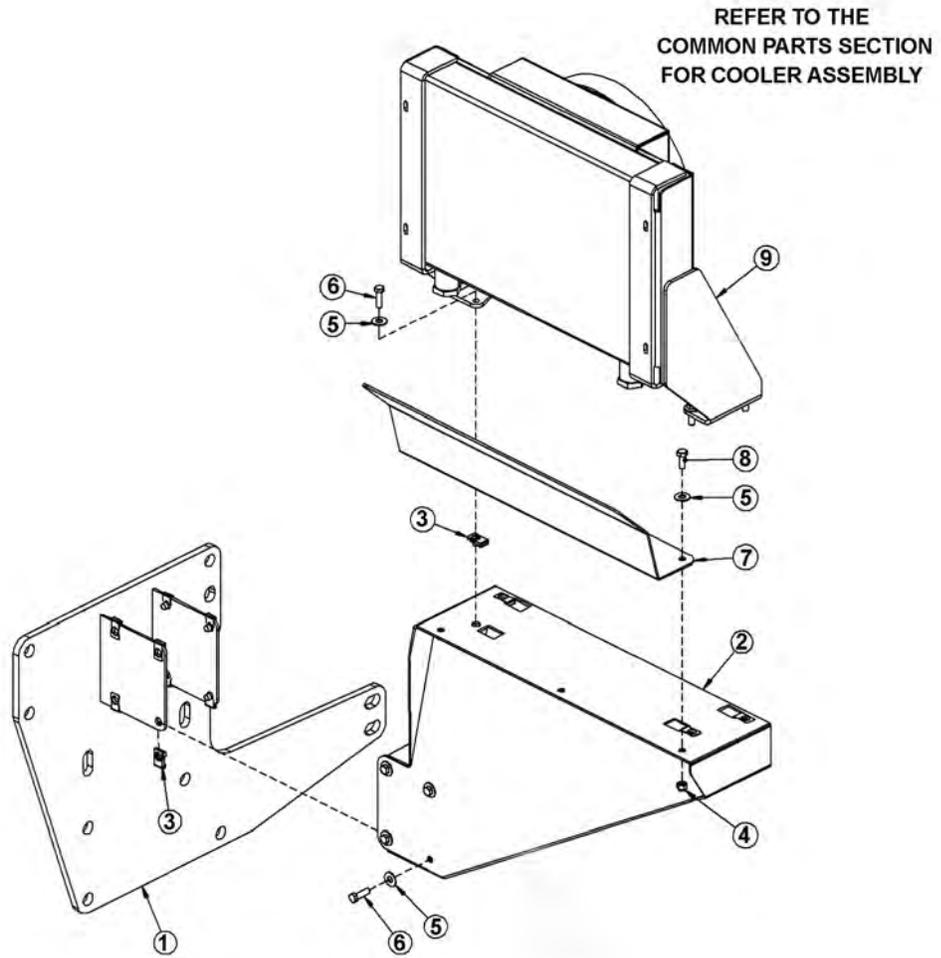

OPTIONAL COOLER MOUNT

Continued...

ITEM	PART NO.	QTY.	DESCRIPTION
1	06300226	1	MNFRM, LH, CLR MNT, JD6105/25R
2	06380067	1	COOLER MOUNT
3	06537029	12	U-NUT, 3/8" NC, 3/4" TO CENTER
4	21627	3	NYLOCK NUT, 3/8" NC
5	22016	15	FLATWASHER, 3/8", GR8
6	21631	12	CAPSCREW, 3/8" X 1-1/4", NC, GR8
7	06411443	1	MUD GUARD
8	21630	3	CAPSCREW, 3/8" X 1" NC
9	06510026	1	COOLER, FRONT MNT

FRONT AXLE STABILIZER OPTION

HOSE ROUTING KEY

- A- FROM 1B PORT ON LIFT VALVE TO STABILIZER CYLINDER GLAND
- B- FROM 1B PORT ON LIFT VALVE TO MAIN BOOM CYLINDER BUTT
- C- FROM 1A PORT ON LIFT VALVE TO ACCUMULATOR
- D- FROM ACCUMULATOR TO MAIN BOOM CYLINDER GLAND
- E- FROM STABILIZER CYLINDER BUTT TO ACCUMULATOR

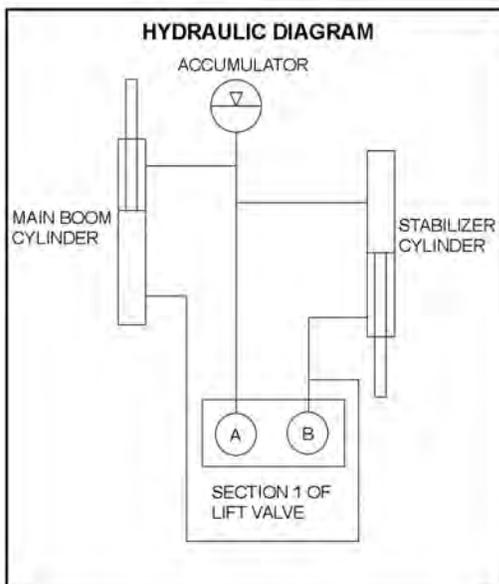
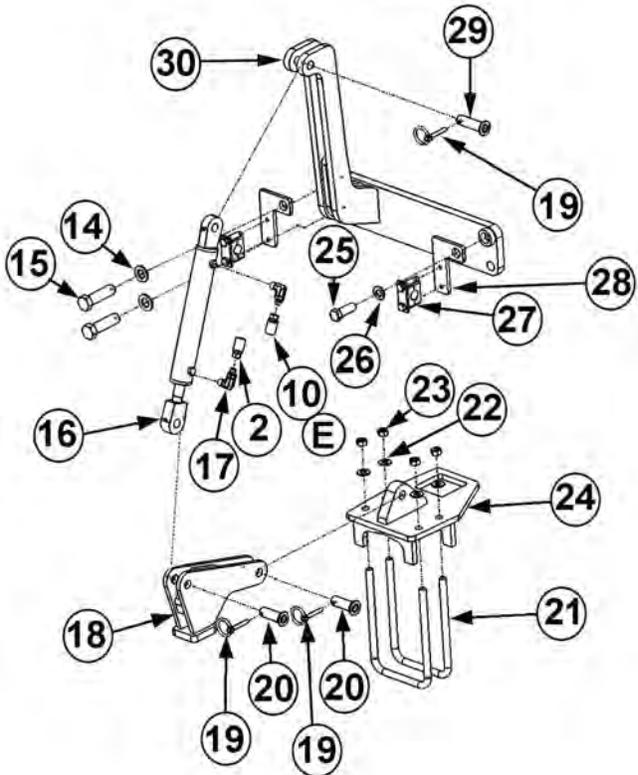
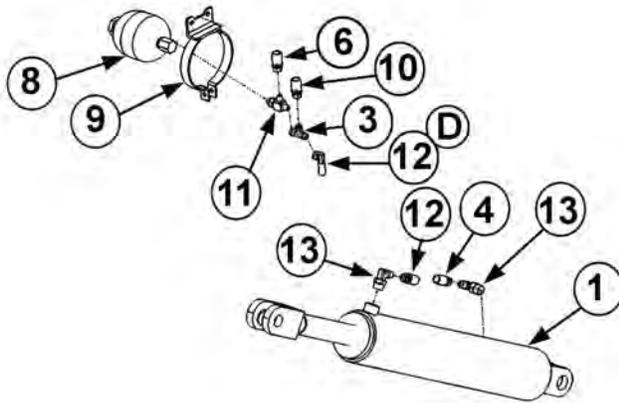
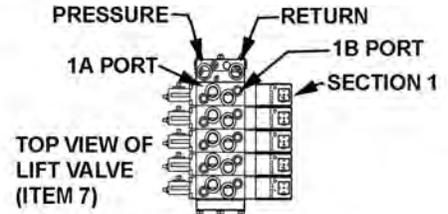
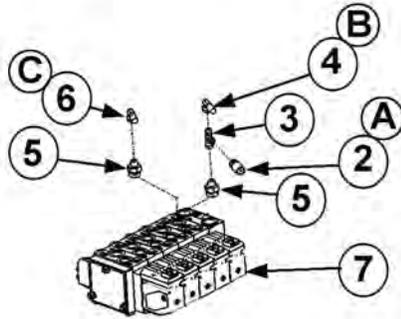

LOCATE HOLE IN ITEM 24 AROUND AXLE STOP ON RIGHT FRONT AXLE.
 USE ITEMS 21, 22, & 23 TO CLAMP ITEM 24 TO AXLE.
 AFTER INSTALLATION, ARTICULATE FRONT AXLE FROM STOP TO STOP AND EXTEND AND RETRACT CYLINDER FULLY TO ENSURE A PROPER FIT.

FRONT AXLE STABILIZER OPTION

Continued...

ITEM	PART NO.	QTY.	DESCRIPTION
1	-----	-	BOOM CYLINDER *REFER TO COMMON SECTION
2	06500149	1	HOSE,1/4" X 220"
3	06503048	2	RUN TEE,3/8"MJ X 3/8"FJX X 3/8"MJ
4	-----	-	HOSE *REFER TO LIFT VALVE PAGE
5	-----	-	ADAPTER *REFER TO LIFT VALVE PAGE
6	-----	-	HOSE *REFER TO LIFT VALVE PAGE
7	-----	-	LIFT VALVE *REFER TO LIFT VALVE PAGE
8	-----	-	ACCUMULATOR *REFER TO LIFT VALVE PAGE
9	-----	-	ACCUMULATOR BRKT *REFER TO LIFT VALVE PAGE
10	06500149	1	HOSE,1/4" X 220"
11	-----	-	RUN TEE *REFER TO LIFT VALVE PAGE
12	-----	-	HOSE *REFER TO LIFT VALVE PAGE
13	-----	-	ELBOW *REFER TO LIFT VALVE PAGE
14	33880	2	FLATWASHER,3/4",SAE
15	32703	2	CAPSCREW,20MM X 100MM,2.5P
16	33785	1	CYLINDER,1-1/2" X 8"
17	06503055	2	ELBOW,1/4"MOR X 3/8"MJ
18	06310132	1	LINK,PIVOT,STABILIZER
19	RD1032	3	LYNCH PIN
20	33984	2	PIN,3/4" X 2-7/16"
21	06420140	2	U-BOLT
22	06533004	4	FLATWASHER,1/2",SAE
23	21700	4	HEX NUT,1/2",UNC
24	06310176	1	MOUNT,AXLE
25	-----	-	CAPSCREW *REFER TO LIFT VALVE PAGE
26	-----	-	FLATWASHER *REFER TO LIFT VALVE PAGE
27	-----	-	CLAMP KIT *REFER TO LIFT VALVE PAGE
28	-----	-	BRACKET *REFER TO LIFT VALVE PAGE
29	34799	1	PIN,3/4" X 2-15/16"
30	06310177	1	STABILIZER,AXLE,CYL MNT

POLYCARBONATE SAFETY WINDOW

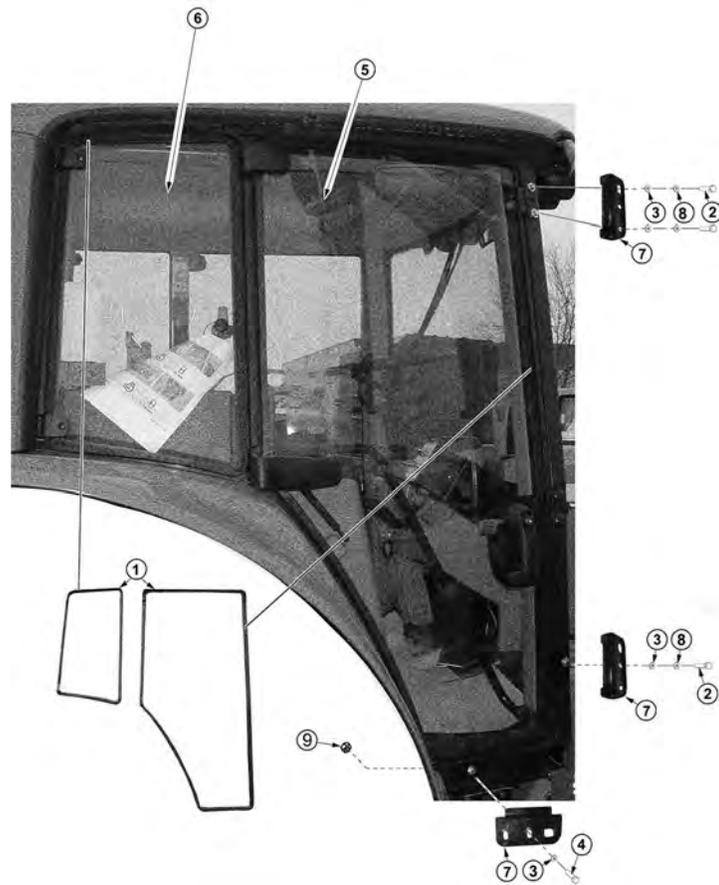

ITEM	PART NO.	QTY.	DESCRIPTION
1	31965	22	TRIM SEAL,3/8" CLIP X 3/4"OD (FEET)
2	27508	3	CAPSCREW,8MM X 20MM,1.25P
3	22015	4	FLATWASHER,5/16"
4	21581	1	CAPSCREW,5/16" X 1-1/4",NC
5	06490005	1	POLYCARB,FRMD,DOOR,RH
6	06490027	1	POLYCARB,FRMD,REAR,RH
7	06520040	3	BRKT,JD,POLY,RETAIN
8	6T2619	3	LOCKWASHER,8MM
9	21577	1	NYLOCK NUT,5/16",NC

PANORAMIC SAFETY WINDOW FOR R SERIES

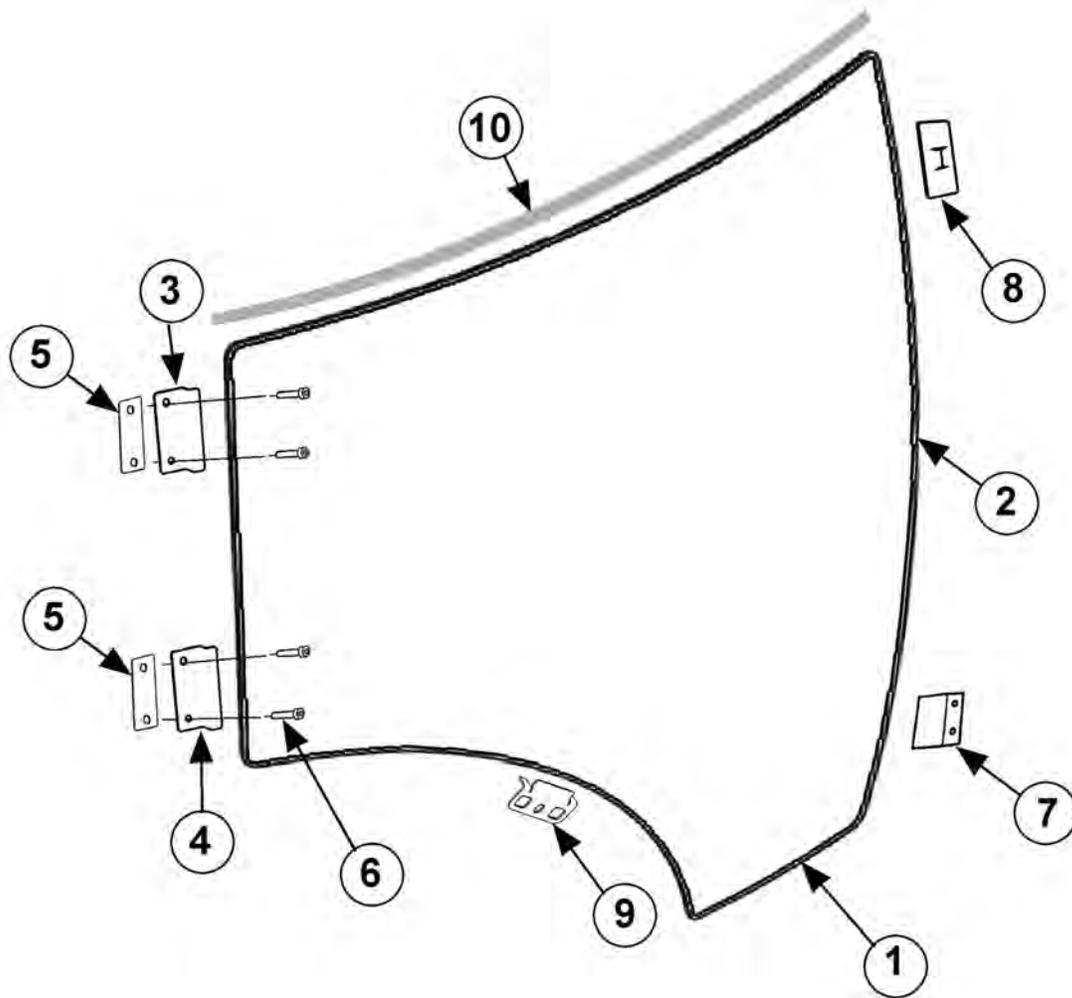

ITEM	PART NO.	QTY.	DESCRIPTION
1	06490047	1	POLYCARB, FRMD, JD6R,PAN, RH
2	06537005	1	ADHESIVE, WTHR STRP, BLK, 3M
3	06330042	1	BRKT, SFTY, SCRN, UPPR, JD61XXR
4	06330041	1	BRKT, SFTY, SCRN, LWR, JD61XXR
5	L171945	2	SEAL
6	19M7561	4	SCREW
7	L209050	1	BRACKET
8	L209049	1	BRACKET
9	06520040	1	BRKT, JD, POLY, RETAIN
10	----	1	RTV SILICONE ADHESIVE

WHEEL SPACER

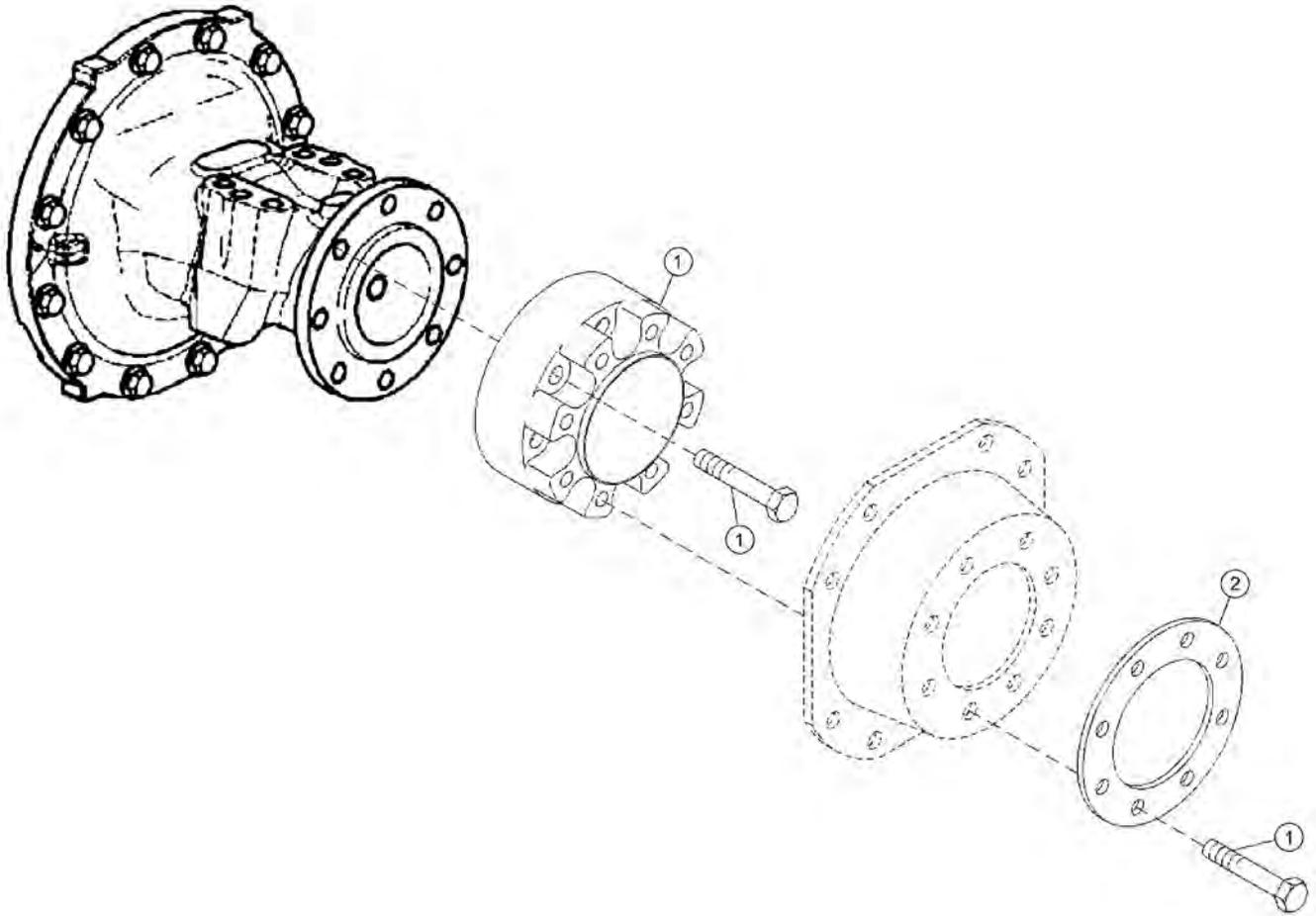

ITEM	PART NO.	QTY.	DESCRIPTION
1	06770025	1	KIT,SPCR,WHL,JD
2	06400919	1	RING,SPACER,WHEEL,JD

JD6140M-R BENGAL

WHEEL WEIGHT

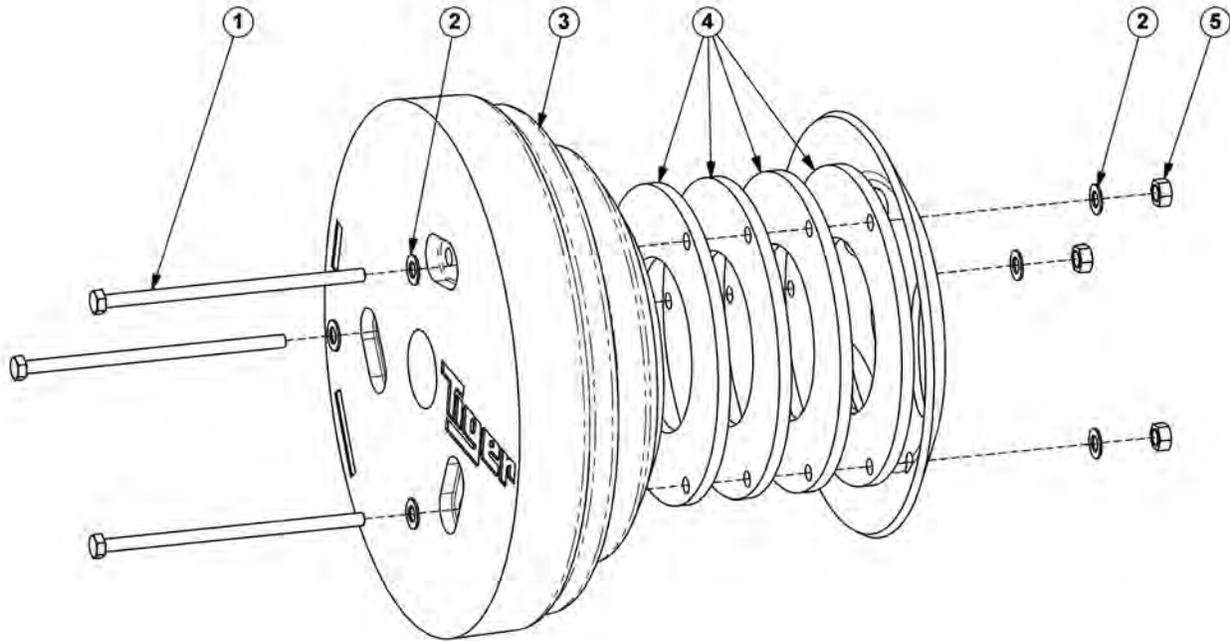

ITEM	PART NO.	QTY.	DESCRIPTION
1	06530213	3	CAPSCREW, 7/8" X 16", NC, GR8
2	06533000	6	FLATWASHER, 7/8", GR8
3	32517	1	WHEEL WEIGHT, 1700#
4	06400410	4	SPACER
5	06531000	3	HEX NUT, 7/8", NC, GR8

NOTES

PARTS SECTION

NOTES

PART NAME INDEX

PARTS ORDERING GUIDE.....	5
BOOM ASSY - BENGAL 18 T4.....	6
BOOM ASSY BENGAL STANDARD 22 T4.....	8
BOOM ASSY HYD BENGAL 22 T4.....	10
BOOM ASSY BENGAL EXT 24 T4.....	12
BOOM ASSY HYD BENGAL 24 T4.....	14
BOOMREST - OPEN STOW.....	16
50IN ROTARY MOWER ASSEMBLY.....	18
50IN ROTARY KNIVES AND DISH.....	20
50IN ROTARY BLADE BAR AND KNIVES.....	21
60IN ROTARY MOWER ASSEMBLY.....	22
60IN ROTARY KNIVES AND DISH.....	24
60IN ROTARY BLADE BAR AND KNIVES.....	25
ROTARY MOWER SPINDLE ASSEMBLY.....	26
BOOM ROTARY PIVOT ASSEMBLY.....	28
50IN FLAIL DRIVE ASSEMBLY.....	30
50IN FLAIL MOWER ASSEMBLY.....	32
50IN FLAIL MOWER ASSY, PASS-THROUGH KNIVES.....	34
63IN FLAIL DRIVE ASSEMBLY.....	36
63IN FLAIL MOWER ASSEMBLY.....	38
BOOM FLAIL PIVOT ASSEMBLY.....	40
3IN X 13-7/8 IN WELDED CYLINDER BREAKDOWN.....	42
3IN X 18IN WELDED CYLINDER BREAKDOWN.....	43
3-1/2IN X 20IN WELDED CYLINDER BREAKDOWN.....	44
4IN X 20IN WELDED CYLINDER BREAKDOWN.....	45
5IN X 20IN WELDED CYLINDER BREAKDOWN.....	46
NOTES.....	47
5 SPOOL ELECTRONIC VALVE - OPEN STOW,3PS.....	48
5 SPOOL ELECTRONIC VALVE - SIDE STOW.....	50
FRONT HYDRAULIC PUMP.....	52
50IN AND 60IN ROTARY MOTOR BREAKDOWN.....	54
FLAIL MOTOR BREAKDOWN.....	56
RESERVOIR TANK FILTER ASSEMBLY.....	58
PUMP AND GRILL GUARD OPTIONS.....	59
BOOM TRAVEL LOCK.....	60
MANUAL LIFT VALVE SWITCH BOX.....	61
MANUAL LIFT VALVE SCHEMATIC.....	62
ELECTRONIC LIFT VALVE SWITCH BOX.....	63
ELECTRONIC LIFT VALVE SCHEMATIC.....	64
SOLENOID SWITCH BOX AND WIRING.....	65

COMMON BENGAL T4

PART NAME INDEX

BRAKE VALVE ASSEMBLY.....	66
BRAKE VALVE HYDRAULIC SCHEMATIC.....	67
ELECTRICAL TROUBLESHOOTING GUIDE.....	68
HYDRAULIC TROUBLESHOOTING GUIDE.....	69
TROUBLESHOOTING.....	70
TROUBLESHOOTING - CONTINUED.....	71
WHEEL WEIGHT - BENGAL 18.....	72

PARTS ORDERING GUIDE

The following instructions are offered to help eliminate needless delay and error in processing purchase orders for the equipment in this manual.

1. The Parts Section is prepared in logical sequence and grouping of parts that belong to the basic machine featured in this manual. Part Numbers and Descriptions are given to help locate the parts and quantities required.
2. The Purchase Order must indicate the **Name and Address** of the person or organization ordering the parts, **who should be charged**, and if possible, the **serial number of the machine** for which the parts are being ordered.
3. The purchase order must clearly list the **quantity of each part**, the complete and correct **part number**, and the basic **name of the part**.
4. The manufacturer reserves the right to substitute parts where applicable.
5. Some parts may be unlisted items which are special production items not normally stocked and are subject to special handling. Request a quotation for such parts before sending a purchase order.
6. The manufacturer reserves the right to change prices without prior notice.

NOTE: When ordering replacement decals, refer to the part numbers and descriptions listed in the safety section in the front of this manual.

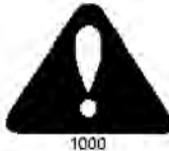

For maximum safety and to guarantee optimum product reliability, always use genuine **Tiger** replacement parts. The use of inferior replacement parts may cause premature or catastrophic failure which could result in serious injury or death.

Direct any questions regarding parts to:

Tiger Corporation
3301 N. Louise Ave.
Sioux Falls, SD 57107
1-800-843-6849
1-605-336-7900

BOOM ASSY - BENGAL 18 T4

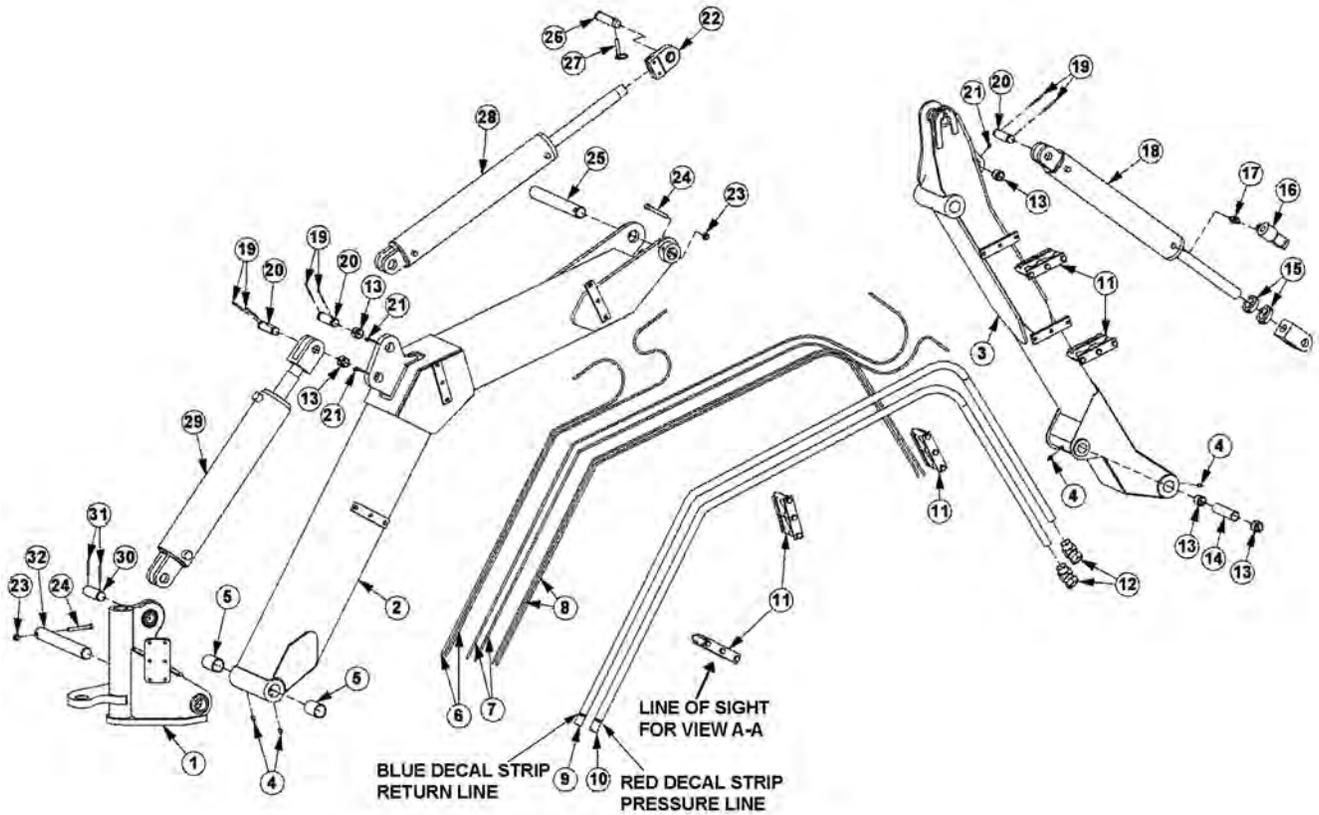

NOTES:

1. IMPORTANT: ALIGN GREASE HOLE OR GAP IN BEARING (ITEMS 5 & 13) WITH GREASE ZERK IN BOOM. MAINTAIN ALIGNMENT DURING BEARING INSTALLATION.
2. GREASE HINGE PIN ZERKS (ITEM 4) ON BOOM AFTER ASSEMBLY, ONCE UNDER LOAD WITH BOOM ELEVATED AND AGAIN AT REST WITH BOOM SUPPORTED.
3. ONLY ONE SET COLLAR (ITEM 15) NEEDED FOR ROTARY MOWERS.

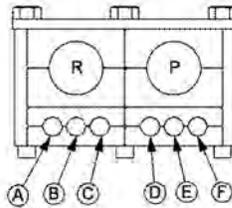

VIEW A-A

KEY

- A - SECONDARY BUTT
- B - SECONDARY GLAND
- C - DECK ROLL BUTT
- D - DECK ROLL GLAND
- E - SHIELD BUTT
- F - SHIELD GLAND
- R - RETURN
- P - PRESSURE

BOOM ASSY - BENGAL 18 T4

Continued...

ITEM	PART NO.	QTY.	DESCRIPTION
1	----	-	REAR STOW SWIVEL ASSY
2	06700167	-	MAIN BOOM ASSY
---	06310111	1	MAIN BOOM WELDMENT
3	06700168	-	SECONDARY BOOM ASSY
----	06310112	1	SECONDARY BOOM WELDMENT
4	6T3211	4	GREASE ZERK,1/8"
5	32321	2	BEARING, DX, 1-1/2" X 2"
6	06500499	2	HOSE,1/4" X 50"
7	06500500	2	HOSE,1/4" X 108"
8	06500502	2	HOSE,1/4" X 100"
9	06500713	1	HOSE,1" X 163"
10	06500714	1	HOSE,1" X 162"
11	06505116	2	CLAMP KIT
12	24724	2	SWIVEL,1MJ X 1FJX45
13	TB3010	3	BUSHING
14	TB1035	1	BUSHING,SPACER
15	35312	1	SET COLLAR
16	06510050	1	TRAVEL LOCK,METRIPACK COIL
17	31329	1	ADAPTER,1/2ORB X 1/2ORB ADJ
18	06501023	1	DECK ROLL CYLINDER,3" X 18"
19	06537021	6	ROLL PIN,5MM
20	TB1033	4	PIN,1"
21	6T3207	4	GREASE ZERK,1/4"
22	TB3033	1	CLEVIS WITH SPHERICAL BEARING
23	21677	2	NYLOCK NUT,7/16",NC
24	21688	2	CAPSCREW,7/16" X 3-1/4",NC
25	TB1025	1	PIN,1-1/2"
26	TB1036	1	PIN,1"
27	TF1143	1	PIN,LYNCH
28	06501024	1	SECONDARY CYLINDER,3-1/2" X 20"
29	06501022	1	MAIN CYLINDER,4" X 20"
30	06420100	1	PIN,1-1/4"
31	TB1023	2	ROLL PIN,7/32"
32	TB3013C	1	PIN,1-1/2"

COMMON BENGAL T4

BOOM ASSY BENGAL STANDARD 22 T4

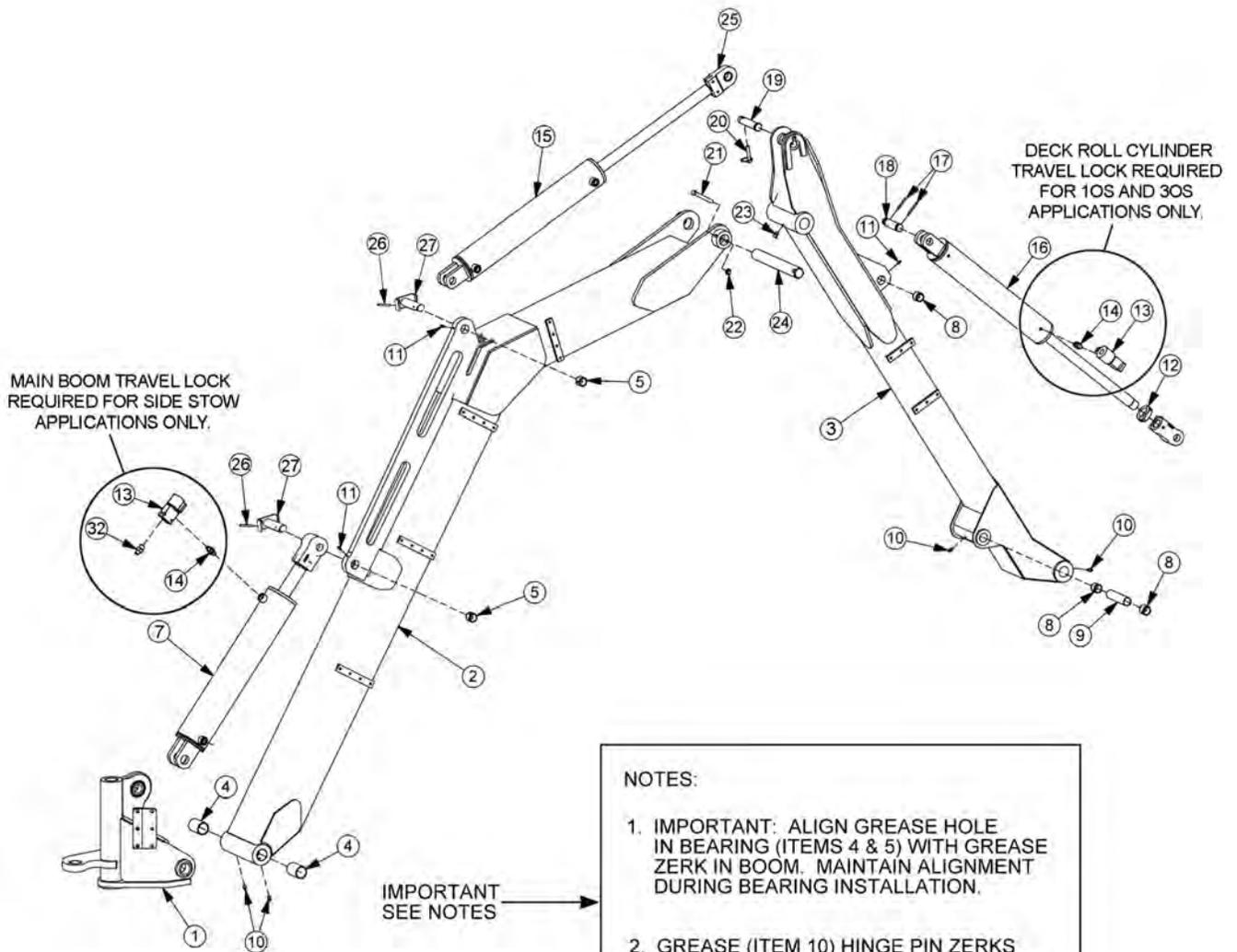

NOTES:

1. IMPORTANT: ALIGN GREASE HOLE IN BEARING (ITEMS 4 & 5) WITH GREASE ZERK IN BOOM. MAINTAIN ALIGNMENT DURING BEARING INSTALLATION.
2. GREASE (ITEM 10) HINGE PIN ZERKS ON BOOM AFTER ASSEMBLY, ONCE UNDER LOAD WITH BOOM ELEVATED AND AGAIN AT REST WITH BOOM SUPPORTED.

BOOM ASSY BENGAL STANDARD 22 T4

Continued...

ITEM	PART NO.	QTY.	DESCRIPTION
1	-----	-	SWIVEL ASSY *REFER TO TRACTOR MOUNT KIT
2	06700189	1	MAIN BOOM, T4
3	24517	1	SECONDARY BOOM ARM ASSY
4	32321	2	BEARING, DX, 1-1/2" X 2"
5	TB1044	2	BUSHING, 1-1/4"ID
7	06501020	1	CYLINDER, 5" X 20"
8	TB3010	3	BUSHING, 1"ID
9	TB1035	1	BUSHING,SPACER
10	6T3211	4	GREASE ZERK,1/8"
11	6T3207	3	GREASE ZERK,1/4
12	35312	1	SET COLLAR
13	06510050	1	TRAVEL LOCK,METRIPACK COIL
14	31329	1	ADAPTER,1/2ORB X 1/2ORB ADJ
15	06501022	1	CYLINDER, 4" X 20"
16	06501023	1	CYLINDER,3" X 18"
17	06537021	6	ROLL PIN,5MM
18	TB1033	1	PIN,1" X 4"
19	TB1036	1	PIN,1" X 4-11/16"
20	TF1143	1	PIN,LYNCH
21	21688	2	CAPSCREW,7/16" X 3-1/4",NC
22	21677	2	NYLOCK NUT,7/16",NC
23	6T3210	1	GREASE ZERK,1/8" X 90°
24	TB1025	1	PIN,1-1/2" X 12"
25	30172	1	CLEVIS,SPHERICAL
26	6T3014	2	ROLL PIN, 1/4" X 2"
27	TB1045B	2	PIN, PRIMARY CYLINDER

BOOM ASSY HYD BENGAL 22 T4

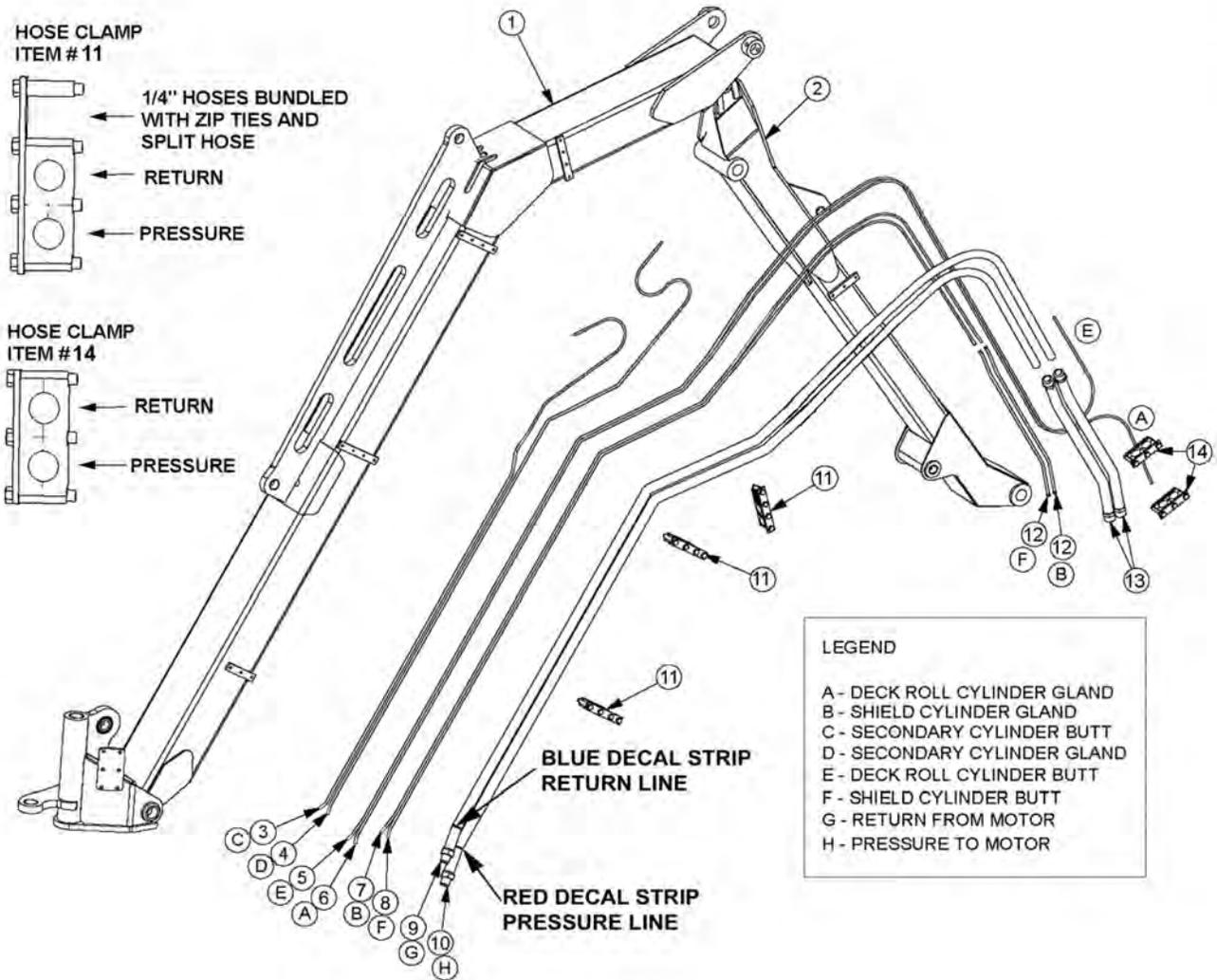

BOOM ASSY HYD BENGAL 22 T4

Continued...

ITEM	PART NO.	QTY.	DESCRIPTION
1	-----	-	MAIN BOOM *REFER TO BOOM ARM ASSY
2	-----	-	SECONDARY BOOM *REFER TO BOOM ARM ASSY
3	06500694	1	HOSE, 1/4" X 83"
4	---	1	HOSE, 1/4" X 83"
5	06500695	1	HOSE, 1/4" X 138"
6	----	1	HOSE, 1/4" X 138"
7	06500696	1	HOSE, 1/4" X 112"
8	---	1	HOSE, 1/4" X 112"
9	34645	1	HOSE, 1" X 182"
10	---	1	HOSE, 1" X 182"
11	06505019	3	CLAMP KIT,3 SECTION
12	34102	2	TUBE,PRFRMD,SEC BOOM
13	2403306	2	TUBE,PRFRMD,SEC BOOM,HP
14	30111	2	CLAMP KIT,2 SECTION

COMMON BENGAL T4

BOOM ASSY BENGAL EXT 24 T4

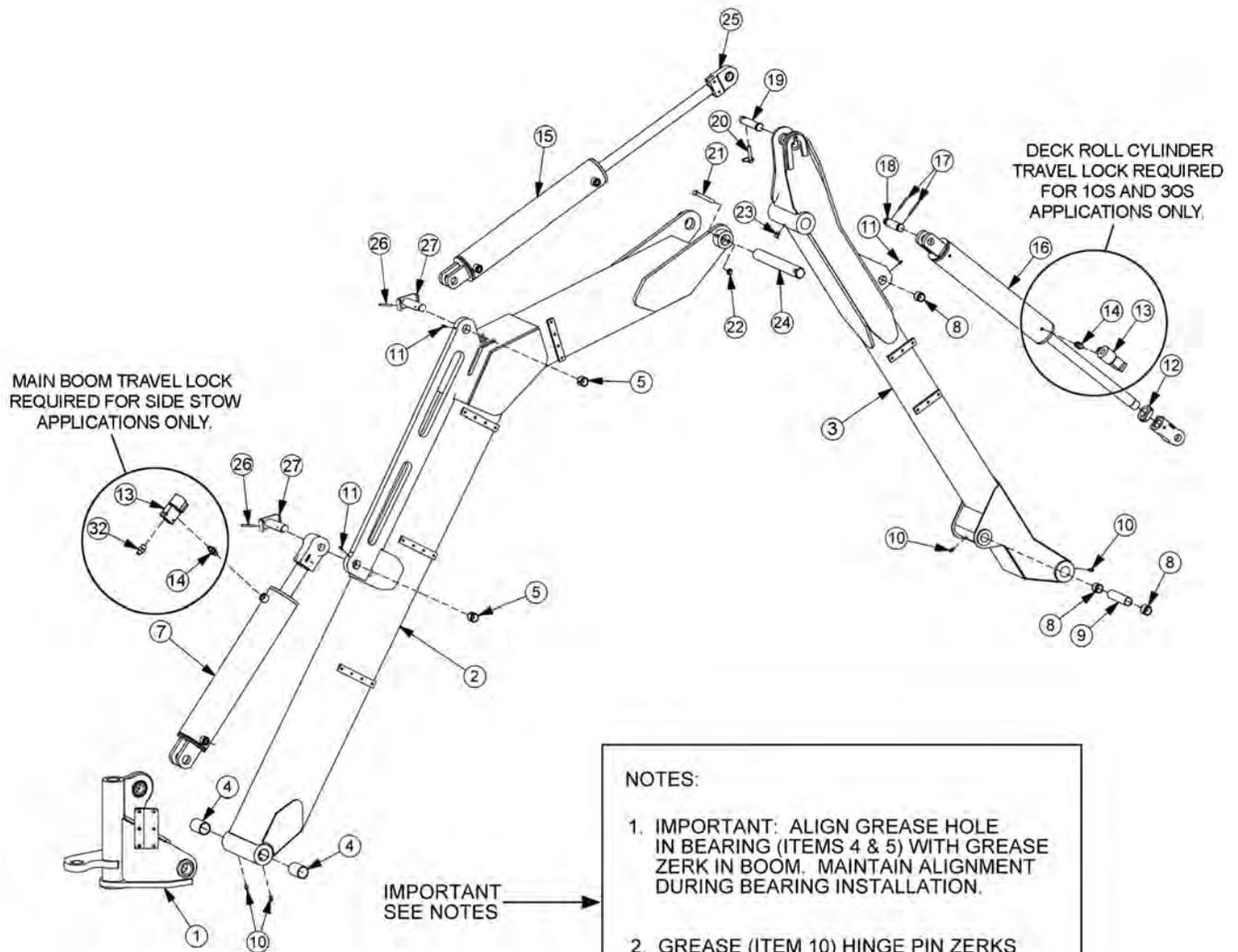

BOOM ASSY BENGAL EXT 24 T4

Continued...

ITEM	PART NO.	QTY.	DESCRIPTION
1	-----	-	SWIVEL ASSY *REFER TO TRACTOR MOUNT KIT
2	06700191	1	MAIN BOOM, EXT, T4
3	06700094	1	SECONDARY BOOM ARM ASSY, EXT, T4
4	32321	2	BEARING, DX, 1-1/2" X 2"
5	TB1044	2	BUSHING, 1-1/4"ID
7	06501020	1	CYLINDER, 5" X 20"
8	TB3010	3	BUSHING, 1"ID
9	TB1035	1	BUSHING,SPACER
10	6T3211	4	GREASE ZERK,1/8"
11	6T3207	3	GREASE ZERK,1/4
12	35312	1	SET COLLAR
13	06510050	1	TRAVEL LOCK,METRIPACK COIL
14	31329	1	ADAPTER,1/2ORB X 1/2ORB ADJ
15	06501022	1	CYLINDER, 4" X 20"
16	06501023	1	CYLINDER,3" X 18"
17	06537021	6	ROLL PIN,5MM
18	TB1033	1	PIN,1" X 4"
19	TB1036	1	PIN,1" X 4-11/16"
20	TF1143	1	PIN,LYNCH
21	21688	2	CAPSCREW,7/16" X 3-1/4",NC
22	21677	2	NYLOCK NUT,7/16",NC
23	6T3210	1	GREASE ZERK,1/8" X 90°
24	TB1025	1	PIN,1-1/2" X 12"
25	30172	1	CLEVIS,SPHERICAL
26	6T3014	2	ROLL PIN, 1/4" X 2"
27	TB1045B	2	PIN, PRIMARY CYLINDER

COMMON BENGAL T4

BOOM ASSY HYD BENGAL 24 T4

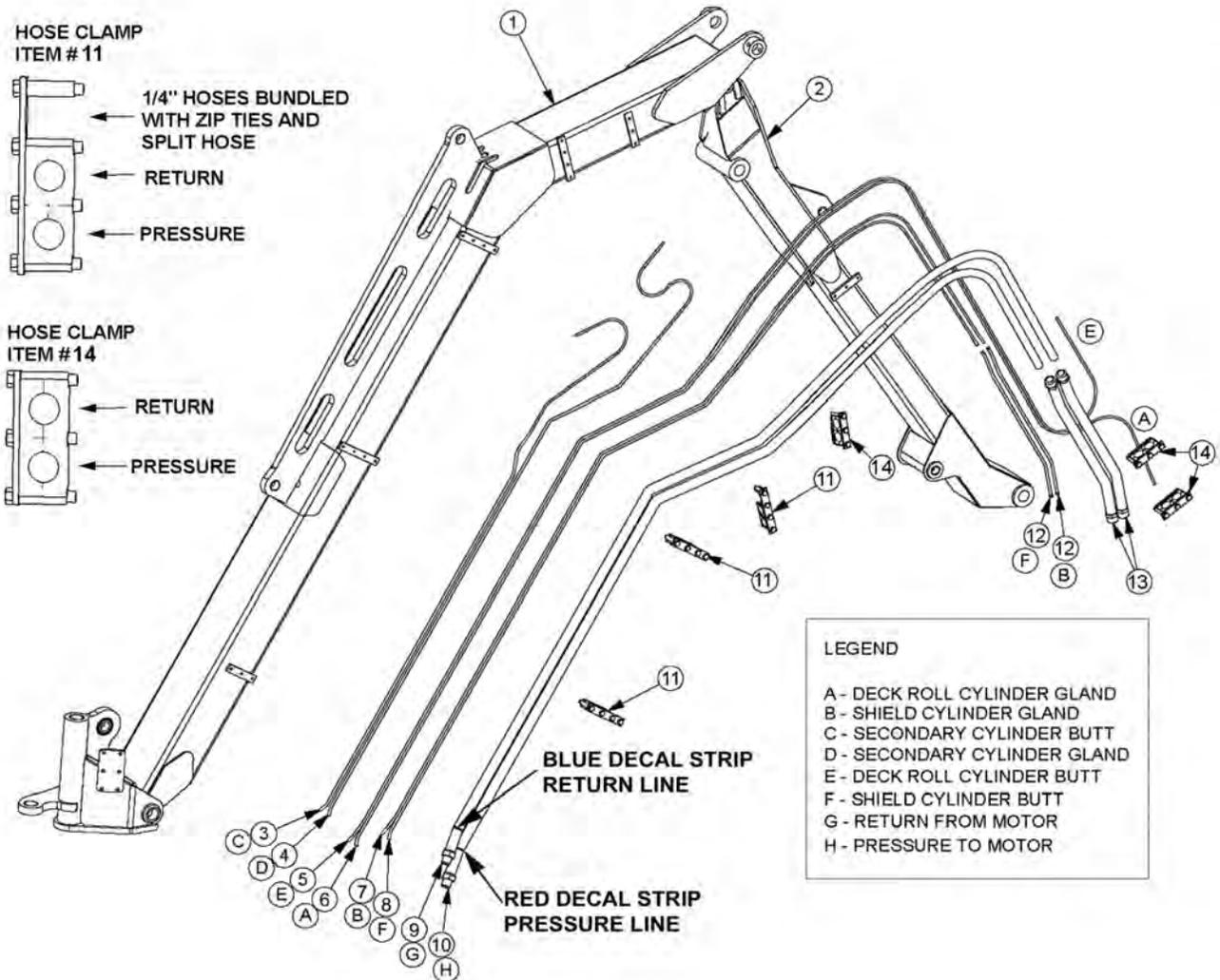

BOOM ASSY HYD BENGAL 24 T4

Continued...

ITEM	PART NO.	QTY.	DESCRIPTION
1	-----	-	MAIN BOOM *REFER TO BOOM ARM ASSY
2	-----	-	SECONDARY BOOM *REFER TO BOOM ARM ASSY
3	06500716	1	HOSE, 1/4" X 100"
4	---	1	HOSE, 1/4" X 100 "
5	06500717	1	HOSE, 1/4" X 170"
6	----	1	HOSE, 1/4" X 170"
7	06500718	1	HOSE, 1/4" X 130"
8	---	1	HOSE, 1/4" X 130"
9	06500715	1	HOSE, 1" X 198"
10	---	1	HOSE, 1" X 198"
11	06505019	3	CLAMP KIT,3 SECTION
12	34103	2	TUBE,PRFRMD,SEC BOOM
13	30169	2	TUBE,PRFRMD,SEC BOOM,HP
14	30111	2	CLAMP KIT,2 SECTION

COMMON BENGAL T4

BOOMREST - OPEN STOW

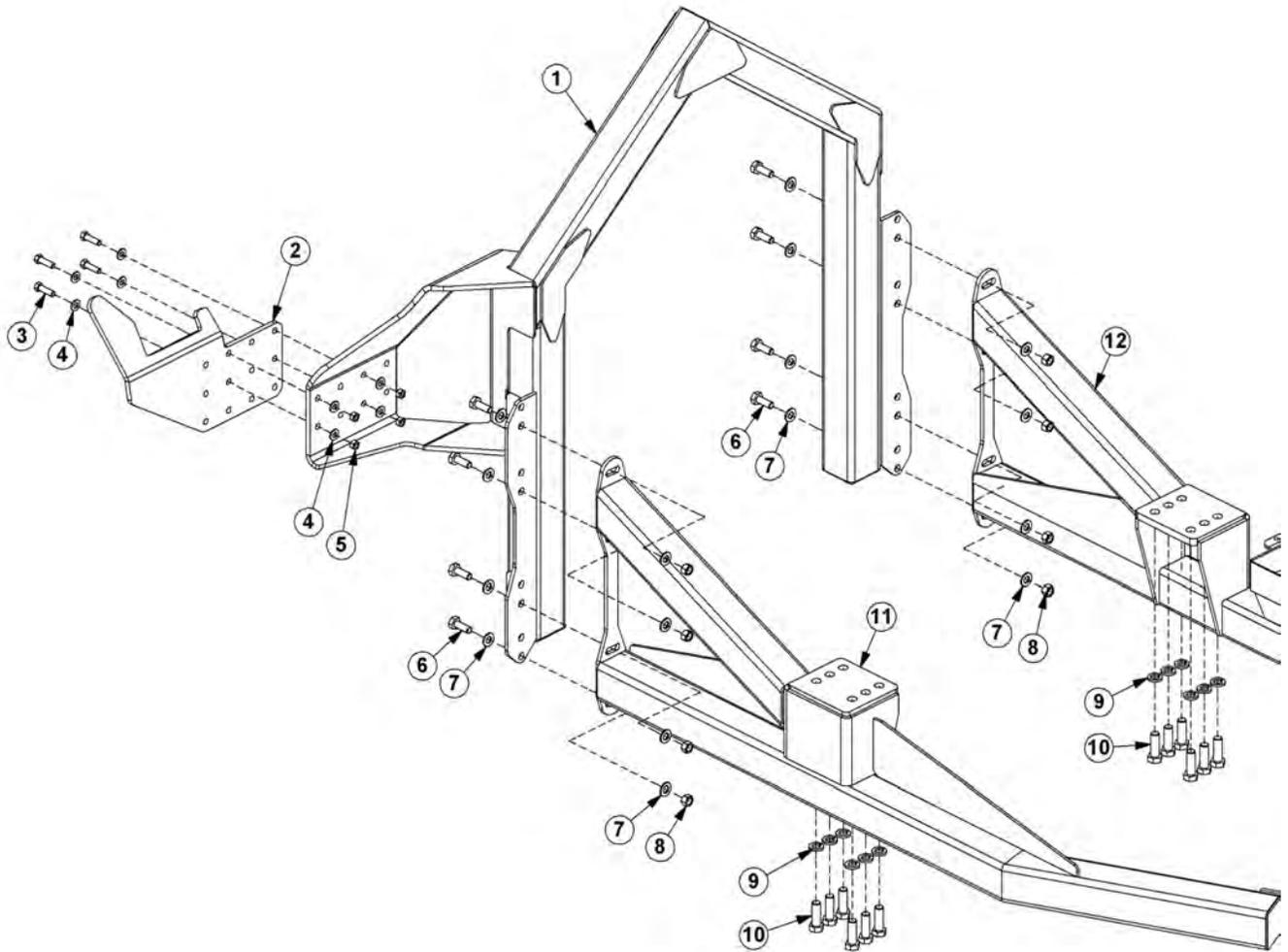

BOOMREST - OPEN STOW

Continued...

ITEM	PART NO.	QTY.	DESCRIPTION
1	06310159	1	BOOMREST,OS
2	06410968	1	SADDLE
3	21732	4	CAPSCREW,1/2" X 1-3/4",NC
4	06533004	8	FLATWASHER,1/2",SAE
5	21725	4	HEX NUT,1/2",NC
6	21782	8	CAPSCREW,5/8" X 1-3/4",NC
7	33764	16	FLATWASHER,5/8",SAE
8	21775	8	HEX NUT,5/8",NC
9	24881	12	LOCKWASHER,20MM
10	27281	12	CAPSCREW,20MM X 60MM,2.5P
11	06300019	1	AXLE BRACE,RH
12	06300256	1	AXLE BRACE,LH

50IN ROTARY MOWER ASSEMBLY

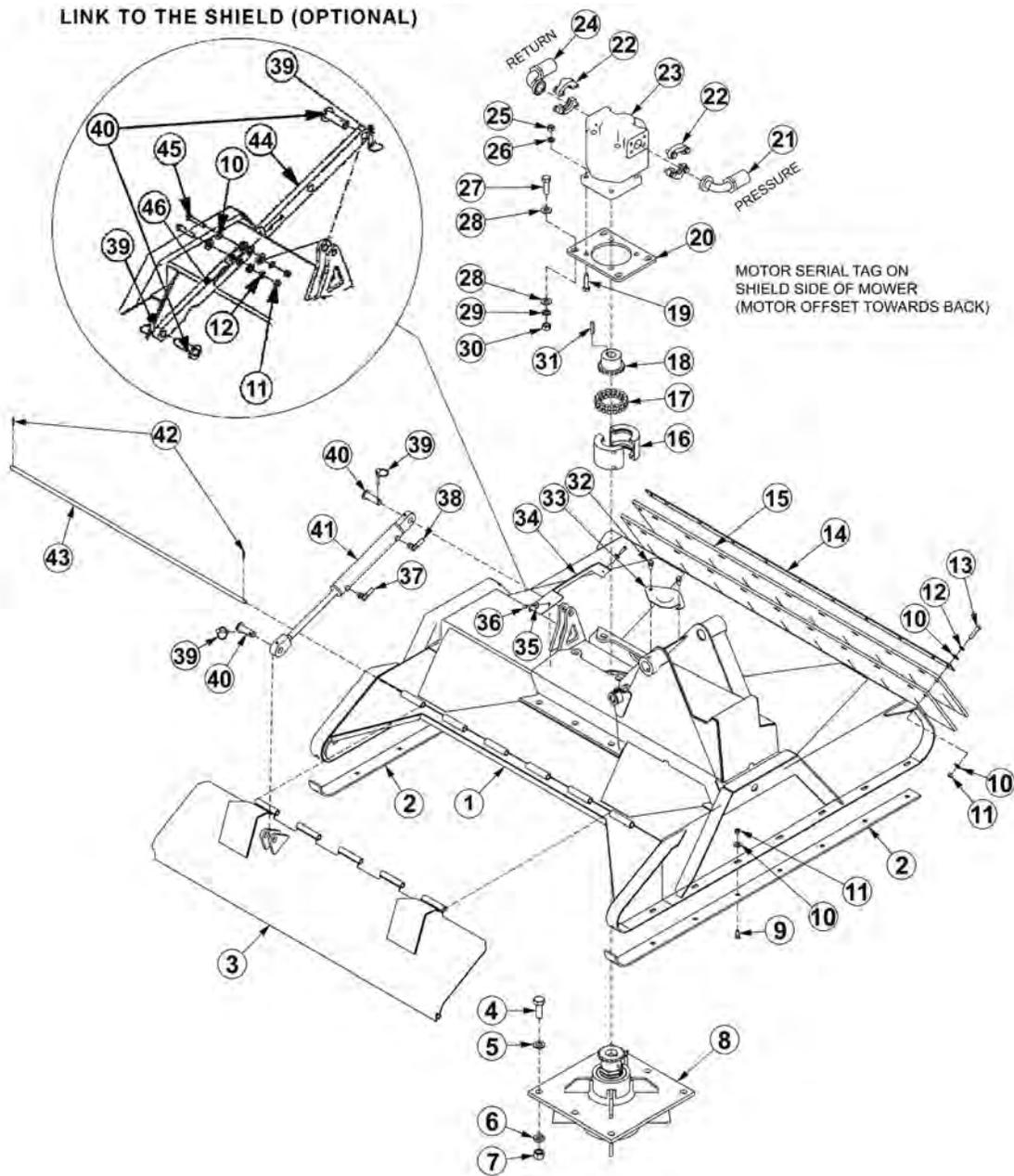

ITEM	PART NO.	QTY.	DESCRIPTION
1	33780	1	DECK,WLDMNT,50" RTRY
2	33777	2	SKID SHOE,50" RTRY
3	33754	1	SHIELD,50"RTRY
4	33879	6	CAPSCREW, 3/4 X 2 1/4,NF GR 8
5	33880	6	FLATWASHER,3/4",GR 8,SAE
6	21993	6	LOCKWASHER,3/4",GR 8
7	6T2413	6	HEX NUT,3/4,NF,GR 8
8	6T1024H5	1	SPINDLE ASSY,CPLT,HD,5/8 HOLES

50IN ROTARY MOWER ASSEMBLY

Continued...

ITEM	PART NO.	QTY.	DESCRIPTION
9	6T2270	16	PLOW BOLT,3/8" X 1" NC
10	22016	33	FLATWASHER,3/8"
11	21625	20	HEX NUT,3/8",NC
12	21988	11	LOCKWASHER, 3/8"
13	21633	11	CAPSCREW, 3/8 X 1 3/4,NC
14	33774	1	FLAP RETAINER,50" RTRY
15	33775	2	FLAP,50" RTRY
16	6T1033	1	COUPLER COVER
17	6T1029	1	COUPLER CHAIN
18	21223	1	SPROCKET
19	21733	4	CAPSCREW, 1/2 X 2,NC
20	33776	1	MOTOR MOUNT,PLATE,50" RTRY
21	24490	1	HOSE - PRESSURE
---	06500155	1	HOSE- PRESSURE (LRS ONLY)
22	TF4852	2	FLANGE KIT - #20
23	06504012	1	MOTOR
24	24489	1	HOSE - RETURN
---	06500154	1	HOSE-RETURN (LRS ONLY)
25	21725	4	HEX NUT, 1/2" NC
26	06533004	4	FLATWASHER, 1/2"
27	6T2290	4	CAPSCREW,5/8X2,NF GR 8
28	33764	8	FLATWASHER,5/8",GR 8,SAE
29	21992	4	LOCKWASHER, 5/8
30	6T2408	4	HEX NUT, 5/8, NF
31	TF1124	1	SQUARE KEY
32	33881	2	CAPSCREW,FLG, 3/8 X 3/4,NC
33	33779	1	PLATE,COVER,KNF HOLE
34	06410439	1	COVER
35	22014	2	FLATWASHER,1/4
36	21530	2	CAPSCREW,1/4 X 1,NC
37	34187	1	HOSE 1/4" X 75"
38	34186	1	HOSE 1/4" X 66"
39	RD1032	2	LYNCH PIN
40	33984	2	PIN,SHIELD,50"
41	33785	1	1-1/2" X 8", CYLINDER, WELDED
42	6T3017	2	ROLLPIN
43	33778	1	HINGE PIN,50" RTRY
44	33772	1	LINK, SHIELD 50" RTRY
45	21634	2	CAPSCREW, 3/8" X 2, NC
46	33773	1	LINK 2, SHIELD 50" RTRY

COMMON BENGAL T4

50IN ROTARY KNIVES AND DISH

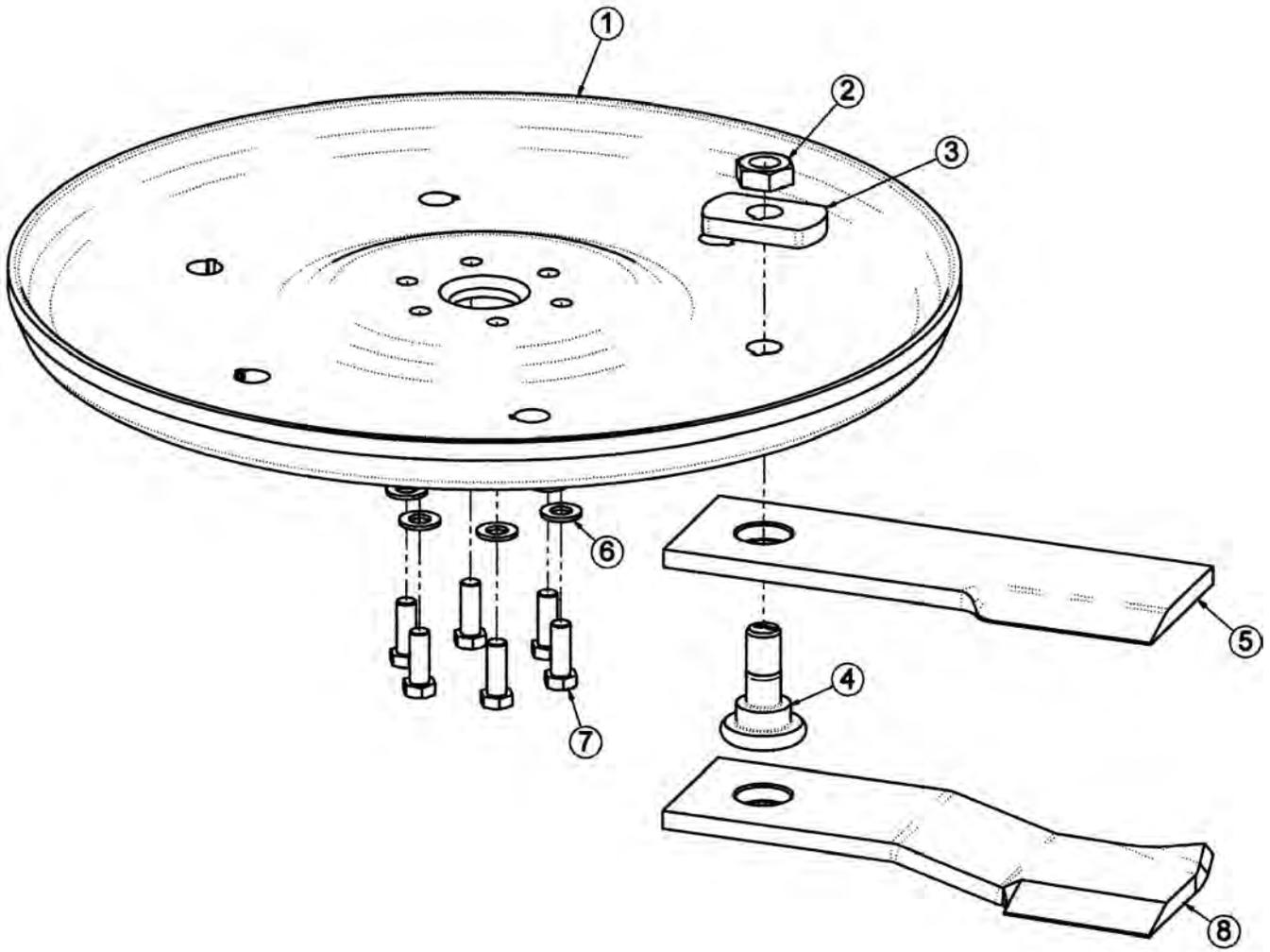

ITEM	PART NO.	QTY.	DESCRIPTION
-----	06700089	-	KIT,TRB50,DISK,W/BOLT KIT (INCLUDES ITEMS 1,3 & 7)
1	06770003	1	BLADE MOUNTING DISK
2	6T1023R	2	NYLOCK HEX NUT 1 1/8"
3	34878	2	SPACER
4	06538000	2	KNIFE MOUNTING BOLT
5	06521001	2	STANDARD KNIFE
6	33764	6	FLATWASHER
7	6T2259	6	CAPSCREW
-----	06770012	-	BOLT KIT (INCLUDES ITEMS 6, 7 & LOCTITE)
8	06521002	2	GRASS KNIFE (OPTIONAL)
-----	6T1825	-	LOCTITE - USED ON ALL DISK MOUNTING BOLTS

50IN ROTARY BLADE BAR AND KNIVES

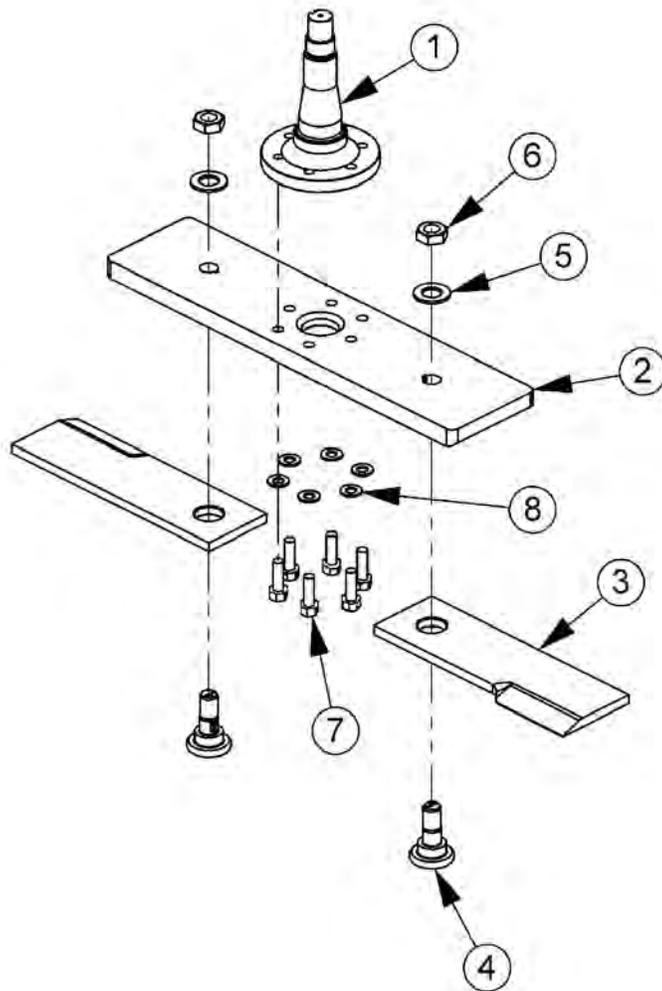

ITEM	PART NO.	QTY.	DESCRIPTION
1	PT1018H5	1	SPINDLE,5/8HOLES,HD,WO/TABS
2	06400388	1	BAR,BLADE,TRB
3	06521001	2	KNIFE,TRB50,5/8
4	06538000	2	KNIFE MTG BOLT,5/8 SHOULDER
5	06533002	2	FLATWASHER,1 1/8,GR 8
6	6T1023R	2	KNIFE MTG NUT,1 1/8,NF,GR8
7	6T2259	6	CAPSCREW,5/8X1-3/4,NF,GR8
8	33764	6	FLATWASHER,5/8,GR 8,SAE

60IN ROTARY MOWER ASSEMBLY

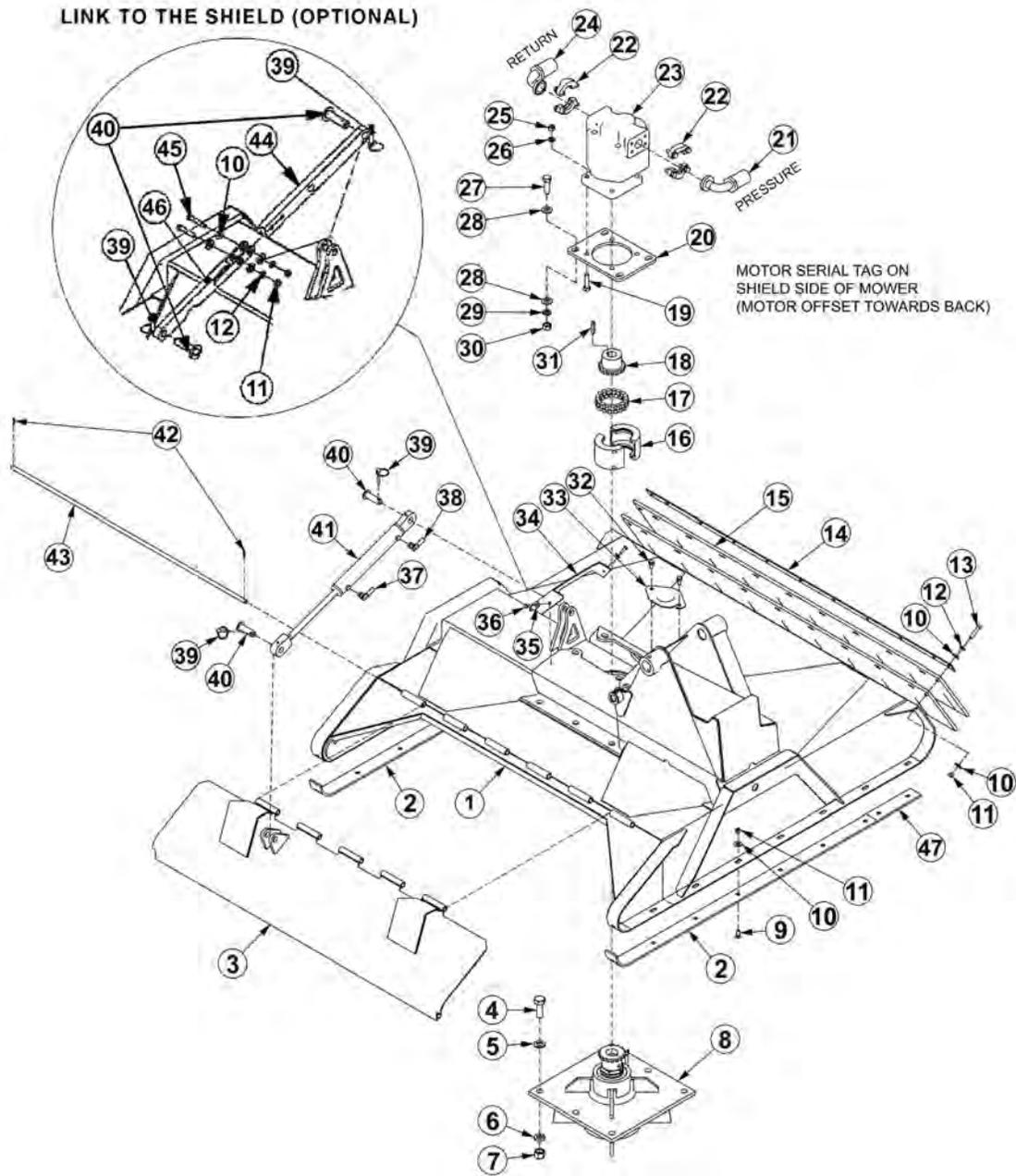

ITEM	PART NO.	QTY.	DESCRIPTION
1	06320159	1	DECK,WLDMNT,60" RTRY
2	33777	2	SKID SHOE,RTRY
3	06320162	1	SHIELD,60"RTRY
4	33879	6	CAPSCREW, 3/4 X 2 1/4,NF GR 8
5	33880	6	FLATWASHER,3/4",GR 8,SAE
6	21993	6	LOCKWASHER,3/4",GR 8
7	6T2413	6	HEX NUT,3/4,NF,GR 8
8	6T1024H5	1	SPINDLE ASSY,CPLT,HD,5/8 HOLES

COMMON BENGAL T4

60IN ROTARY MOWER ASSEMBLY

Continued...

ITEM	PART NO.	QTY.	DESCRIPTION
9	6T2270	16	PLOW BOLT,3/8" X 1" NC
10	22016	33	FLATWASHER,3/8"
11	21625	20	HEX NUT,3/8",NC
12	21988	11	LOCKWASHER, 3/8"
13	21633	11	CAPSCREW, 3/8 X 1 3/4,NC
14	6T0823	1	FLAP RETAINER,60" RTRY
15	06520238	2	FLAP,60" RTRY
16	6T1033	1	COUPLER COVER
17	6T1029	1	COUPLER CHAIN
18	21223	1	SPROCKET
19	21733	4	CAPSCREW, 1/2 X 2,NC
20	33776	1	MOTOR MOUNT,PLATE,RTRY
21	24490	1	HOSE - PRESSURE
---	06500155	1	HOSE-PRESSURE (LRS ONLY)
22	TF4852	2	FLANGE KIT - #20
23	6504011	1	MOTOR
24	24489	1	HOSE - RETURN
---	06500154	1	HOSE-RETURN (LRS ONLY)
25	21725	4	HEX NUT, 1/2" NC
26	06533004	4	FLATWASHER, 1/2"
27	6T2290	4	CAPSCREW,5/8X2,NF GR 8
28	33764	8	FLATWASHER,5/8",GR 8,SAE
29	21992	4	LOCKWASHER, 5/8
30	6T2408	4	HEX NUT, 5/8, NF
31	TF1124	1	SQUARE KEY
32	33881	2	CAPSCREW,FLG, 3/8 X 3/4,NC
33	33779	1	PLATE,COVER,KNF HOLE
34	06410439	1	COVER
35	22014	2	FLATWASHER,1/4
36	21530	2	CAPSCREW,1/4 X 1,NC
37	34187	1	HOSE 1/4" X 75"
38	34186	1	HOSE 1/4" X 66"
39	RD1032	2	LYNCH PIN
40	33984	2	PIN,SHIELD
41	33785	1	1-1/2" X 8", CYLINDER, WELDED
42	6T3017	2	ROLLPIN
43	06420139	1	HINGE PIN,60" RTRY
44	33772	1	LINK, SHIELD,RTRY
45	21634	2	CAPSCREW, 3/8" X 2, NC
46	33773	1	LINK 2, SHIELD,RTRY
47	06401245	2	SKID SHOE,TRB60

COMMON BENGAL T4

60IN ROTARY KNIVES AND DISH

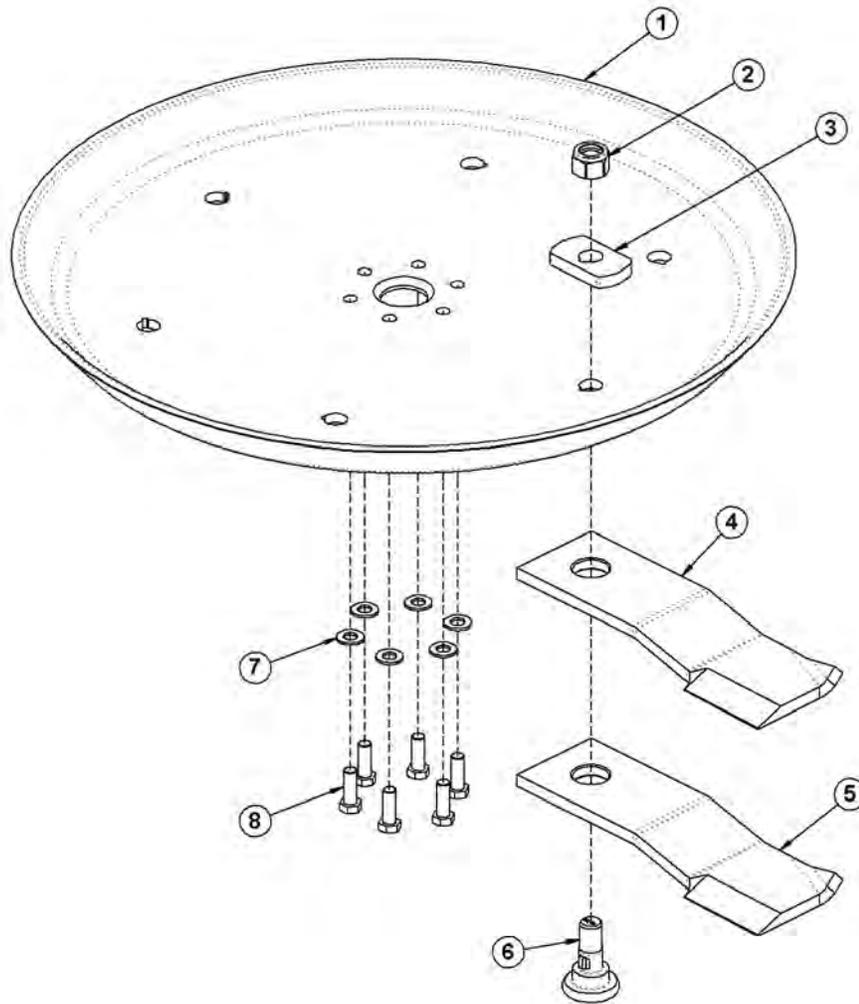

ITEM	PART NO.	QTY.	DESCRIPTION
1	34876	1	BLADE MOUNTING DISH,60"
2	6T1023R	2	NYLOCK NUT,1-1/8",NF
3	34878	2	SPACER
4	34684	2	STANDARD GRASS KNIFE
5	34685	2	HIGH SUCTION GRASS KNIFE (OPTIONAL)
6	34497	2	KNIFE MOUNTING BOLT
7	25270	6	FLATWASHER,5/8",GR8,USS
8	6T2259	6	CAPSCREW,5/8" X 1-3/4",NF,GR8
---	6T1825	1	LOCKTITE (USED ON ITEM 8)
---	27167	1	BOLT KIT (ITEMS 7 & 8)
---	33893	1	KNIFE KIT (ITEMS 2,4 & 6)

60IN ROTARY BLADE BAR AND KNIVES

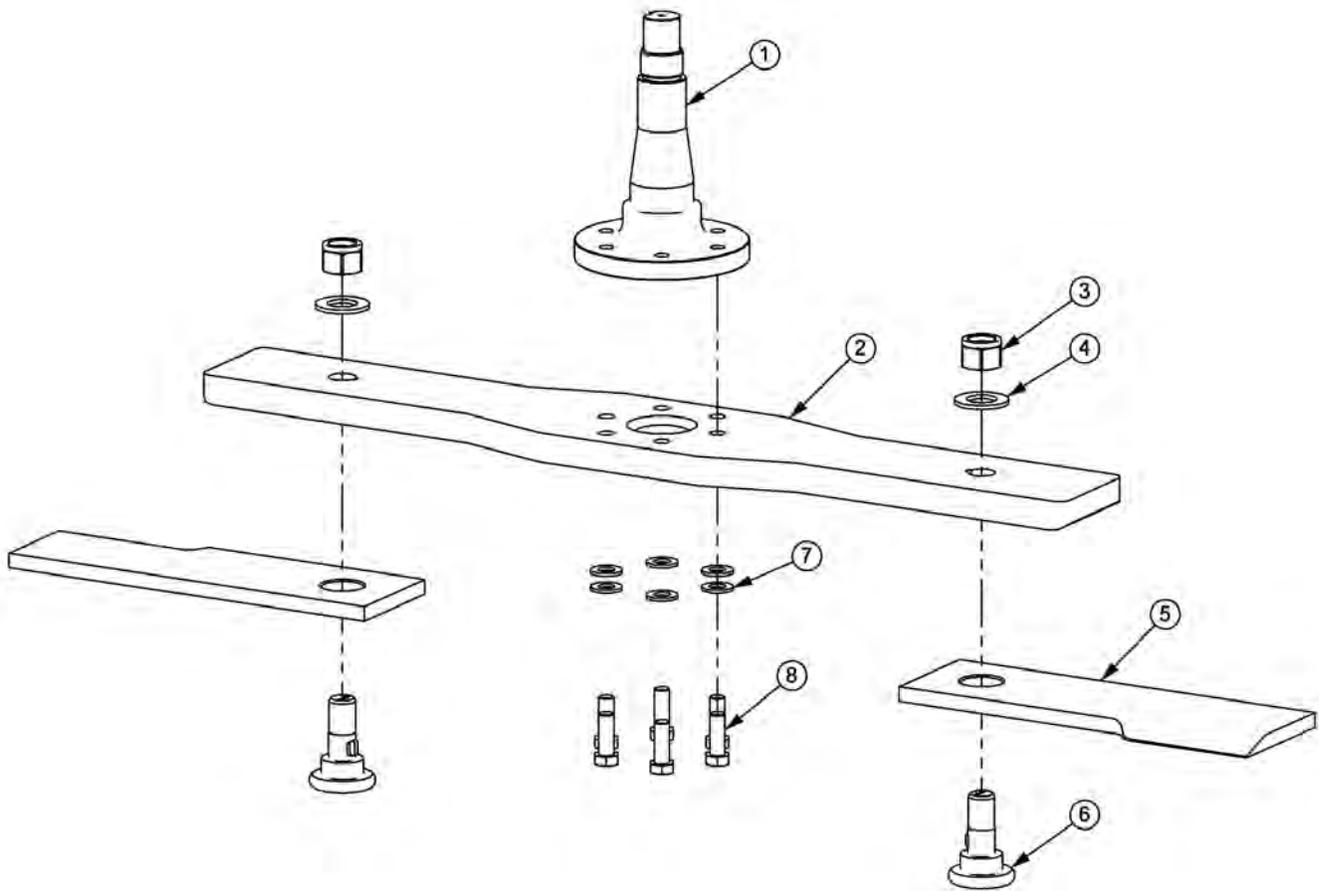

ITEM	PART NO.	QTY.	DESCRIPTION
1	PT1018H5	1	SPINDLE
2	06400690	1	BAR, BLADE, RTRY60
3	6T1023R	2	KNIFE MTG NUT, 1-1/8, NYLOCK, NF
4	06533002	2	FLATWASHER, 1-1/8, GR8
5	06521001	2	KNIFE, TRB50, 5/8
6	06538000	2	KNIFE MTG BOLT, 5/8 SHOULDER
7	33764	6	FLATWASHER, 5/8, GR 8, SAE
8	6T2259	6	CAPSCREW, 5/8 X 1-3/4, NF, GR8

ROTARY MOWER SPINDLE ASSEMBLY

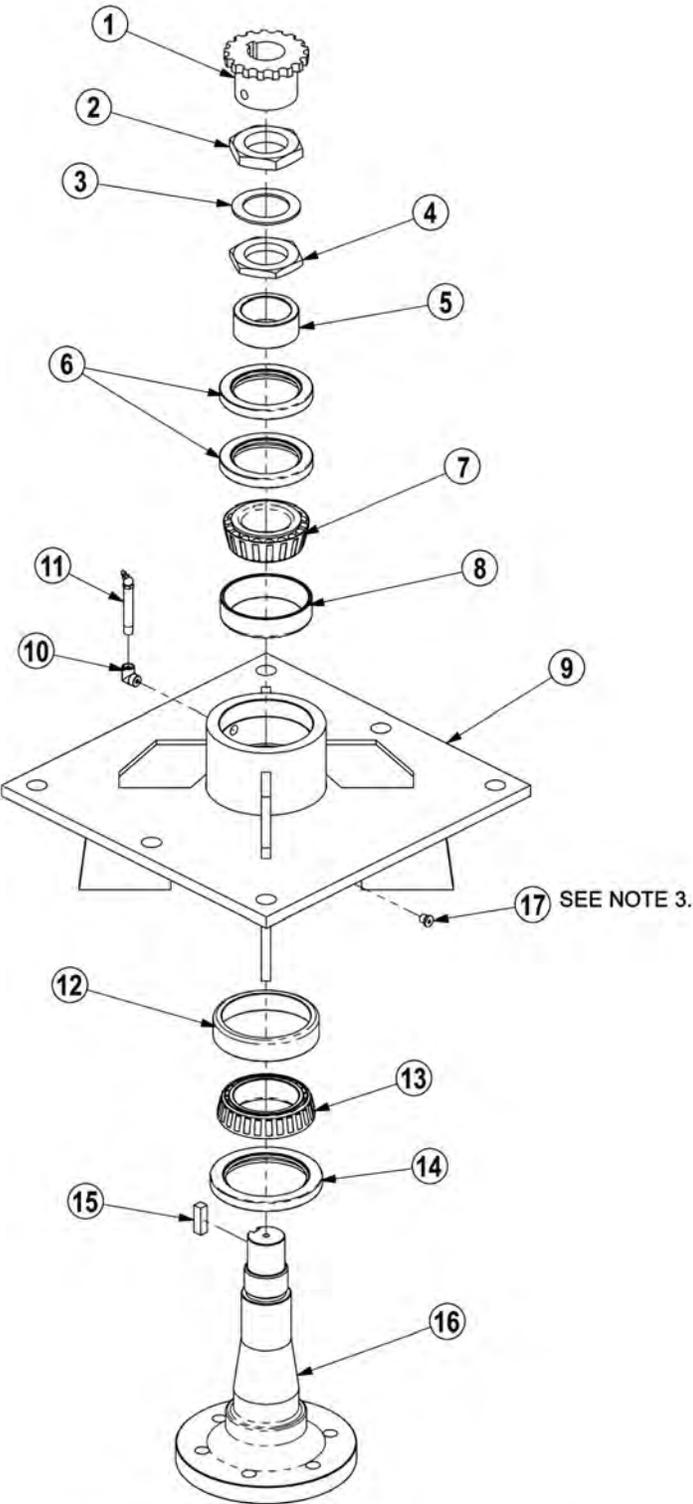

NOTES:

- 1. FREEPLAY: .001" - .003"
- 2. GREASE: FILL WITH MOBILITH SHC 220.
- 3. APPLY LOCTITE "271" TO O-RING PLUG THRDS.

ROTARY MOWER SPINDLE ASSEMBLY

Continued...

ITEM	PART NO.	QTY.	DESCRIPTION
-----	6T1024H5	-	SPINDLE ASSEMBLY COMPLETE
1	6T1031	1	SPROCKET
2	6T1016	1	BEARING LOCK NUT - THICK
3	22596	1	JAM WASHER
4	6T1015	1	BEARING ADJUSTMENT NUT - THIN
5	6T1014	1	BEARING ADJUSTMENT SLEEVE
6	6T1011	1	UPPER SEAL - SET OF 2
7	6T1012	1	BEARING CONE
8	6T1013	1	BEARING CUP
9	6T1010H	1	SPINDLE HOUSING
10	30570	1	FITTING STREET ELBOW
11	33990	1	GREASE ZERK
12	6T1013H	1	BEARING CUP
13	6T1012H	1	BEARING CONE
14	6T1011H	1	LOWER SEAL
15	6T1019	1	SPINDLE KEY
16	PT1018H5	1	SPINDLE
17	06503064	1	O-RING PLUG, 1/8"
-----	31771	-	SPINDLE REBUILD KIT (INCLUDES ITEMS 2 - 8 AND 12 - 15)

BOOM ROTARY PIVOT ASSEMBLY

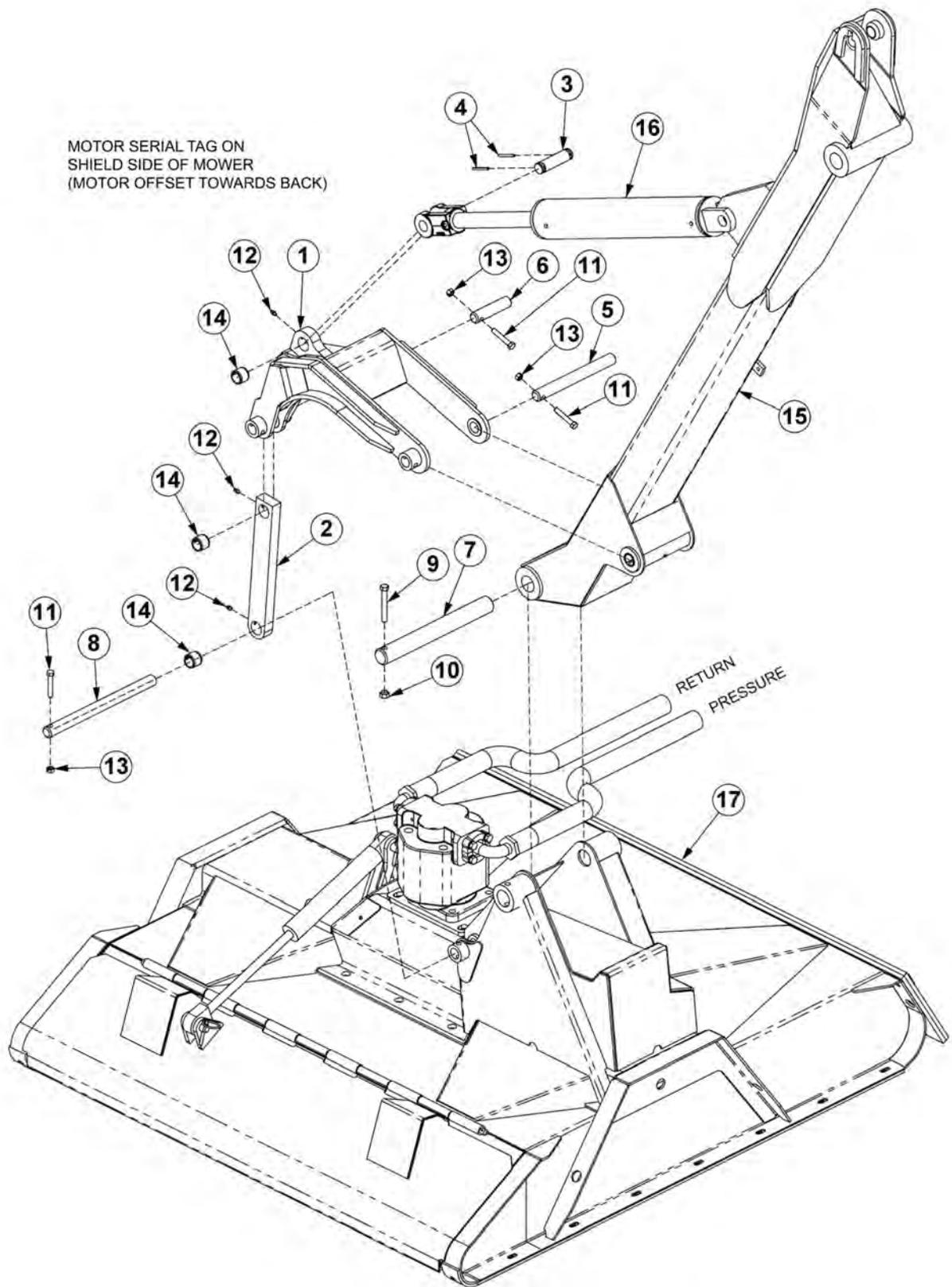

BOOM ROTARY PIVOT ASSEMBLY

Continued...

ITEM	PART NO.	QTY.	DESCRIPTION
1	TB1032	1	ROTARY PIVOT ASSY
2	TB1028	1	PIVOT ARM ASSY
3	TB1033	1	PIN,CLEVIS
4	06537021	2	ROLL PIN
5	TF3097	1	PIN
6	TB1030	1	PIN
7	33985	1	PIN
8	33986	1	PIN
9	21688	1	CAPSCREW,7/16 X 3-1/4,NC
10	21677	1	NYLOCK NUT,7/16 NC
11	21635	3	CAPSCREW,3/8 X 2-1/4
12	6T3207	3	GREASE ZERK
13	21627	3	NYLOCK NUT,3/8,NC
14	TB3010	3	BUSHING
15	-----	-	SECONDARY BOOM *REFER TO BOOM ARM ASSY
16	-----	-	CYLINDER *REFER TO BOOM ARM ASSY
17	-----	-	ROTARY MOWER HEAD *REFER TO ROTARY DECK

50IN FLAIL DRIVE ASSEMBLY

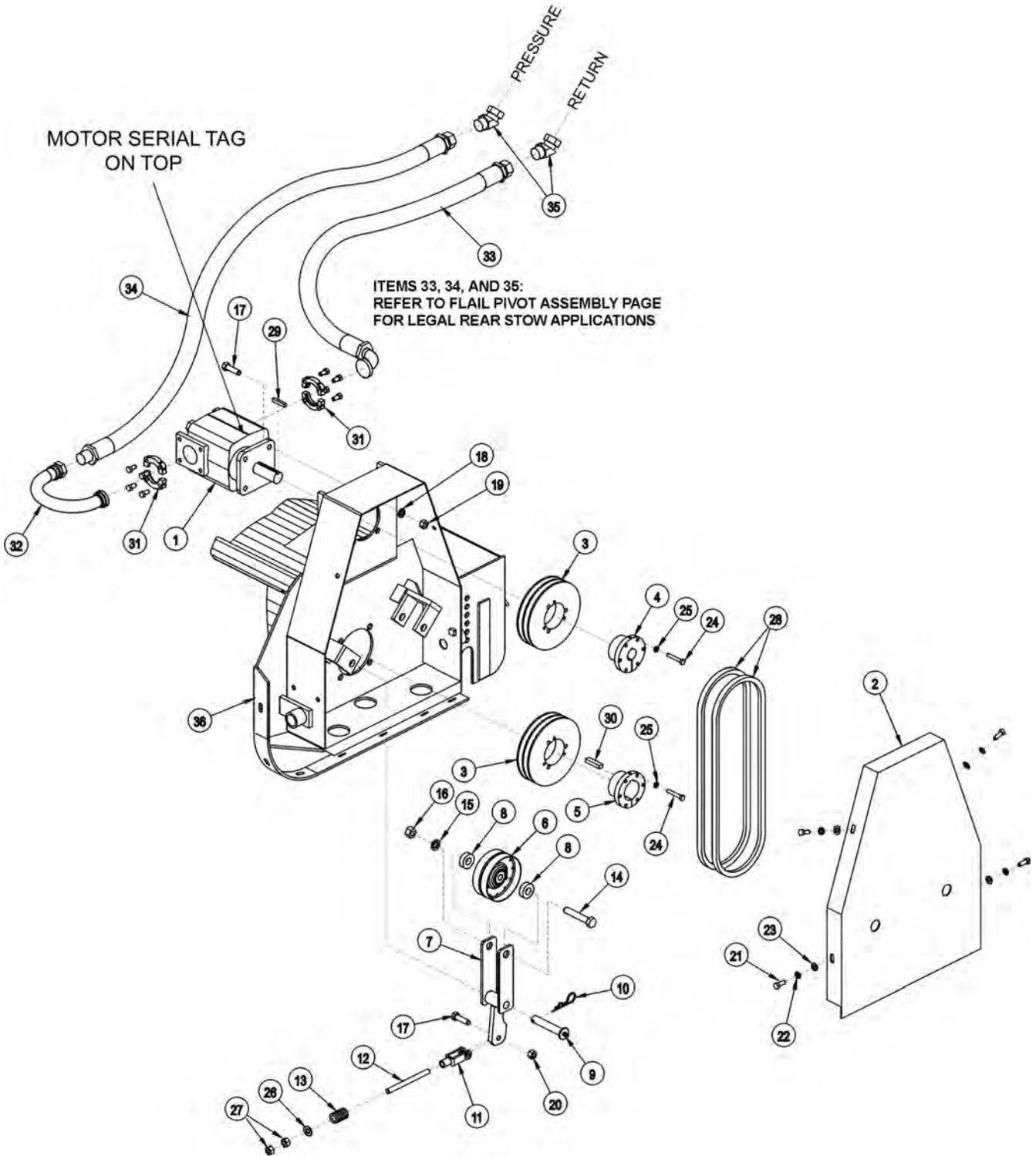

50IN FLAIL DRIVE ASSEMBLY

Continued...

ITEM	PART NO.	QTY.	DESCRIPTION
1	06504132	1	MOTOR (M350-1 3/4" GEAR)
2	TF3006	1	BELT GUARD
3	TF3043	2	SHEAVE
4	TF3013	1	BUSHING
5	TF3011	1	BUSHING
6	TF3034	1	IDLER PULLEY
7	TF3205	1	IDLER ARM
8	TF3206	2	IDLER PULLEY SPACER
9	TF3605	1	IDLER ARM PIN WITH ZERK
10	6T3004	1	R - CLIP
11	PT3611A	1	CLEVIS
12	32481	1	THREADED ROD
13	TF3620	1	COMPRESSION SPRING
14	21789	1	CAPSCREW 5/8" X 3 1/2"
15	21992	1	LOCKWASHER 5/8"
16	21775	1	HEX NUT 5/8"
17	21732	5	CAPSCREW 1/2" X 1 3/4"
18	21990	4	LOCKWASHER 1/2"
19	21725	4	HEX NUT 1/2"
20	6T2418	1	LOCK NUT 1/2"
21	21630	4	CAPSCREW 3/8" X 1"
22	21988	4	LOCKWASHER 3/8"
23	22016	4	FLATWASHER 3/8"
24	21584	6	CAPSCREW 5/16" X 2"
25	21987	6	LOCKWASHER 5/16"
26	27938	1	FLATWASHER 1/2"
27	21700	2	HEX NUT 1/2" NF
28	TF3021	2	BELT
29	TF1125	1	SQUARE KEY
30	TF1025	1	SQUARE KEY MOTOR
31	TF4852	2	FLANGE KIT
32	34227	1	PREFORMED TUBE
33	31218	1	HOSE - RETURN
34	34331	1	HOSE - PRESSURE
35	24724	2	SWIVEL FITTING
36	-----	-	CUTTER HEAD *REFER TO CUTTER HEAD ASSY

50IN FLAIL MOWER ASSEMBLY

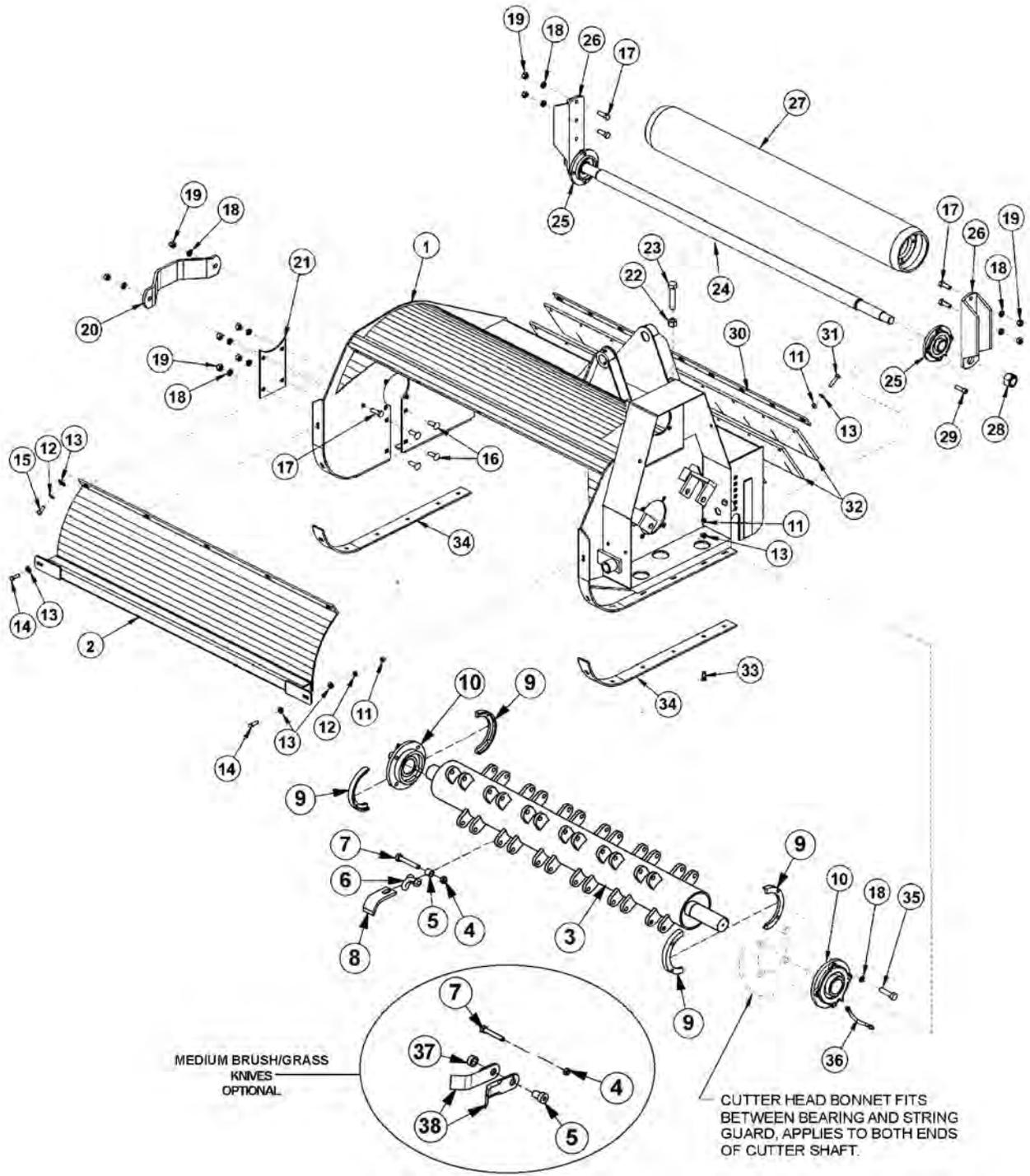

ITEM	PART NO.	QTY.	DESCRIPTION
---	34787	1	FLAIL,BOOM,50,BRUSH,CPLT ASSY (LIGHT BRUSH/GRASS)
	06742133	1	FLAIL,BOOM,50,MD GRASS,CPLT ASSY (MEDIUM BRUSH/GRASS)
1	TF3003F	1	CUTTER HEAD BONNET
2	TF3004	1	FRONT SHIELD

50IN FLAIL MOWER ASSEMBLY

Continued...

ITEM	PART NO.	QTY.	DESCRIPTION
3	34783	1	TBF50 (LIGHT BRUSH/GRASS KNIFE ASSY)
----	06700115	1	TBF50 (MEDIUM BRUSH/GRASS KNIFE ASSY)
4	6T2419	24	HEX NUT,9/16",NC,STOVER
5	06420182	24	BUSHING
6	34782	24	CLEVIS (LIGHT BRUSH/GRASS KNIVES)
7	34786	24	CAPSCREW,9/16" X 3-1/2",NC
8	34780	24	KNIFE (LIGHT BRUSH/GRASS CUTTING)
9	31204	2	STRING GUARD SET (2 PIECES PER SET)
10	TF1018	2	FLANGE BEARING,2-3/16"
11	21625	23	HEX NUT,3/8",NC
12	21988	7	LOCKWASHER,3/8"
13	22016	30	FLATWASHER,3/8"
14	21631	2	CAPSCREW,3/8" X 1-1/4",NC
15	21630	5	CAPSCREW,3/8" X 1",NC
16	6T7031D	4	PLOW BOLT,1/2" X 1-1/2",NC
17	21731	6	CAPSCREW,1/2" X 1-1/2",NC
18	21990	18	LOCKWASHER,1/2"
19	21725	10	HEX NUT,1/2",NC
20	TF1040	1	CUTTER SHAFT GUARD
21	TF3007A	1	COVER PLATE
22	21825	1	HEX NUT,5/8",NC
23	21838	1	CAPSCREW,3/4" X 3-1/2",NC
24	TF3406	1	GROUND ROLLER TIE ROD
25	TF1022	2	FLANGE BEARING,1-3/8"
26	TF3407	2	GROUND ROLLER ADJUSTMENT BRACKET
27	TF3405	1	GROUND ROLLER
28	6T1023R	2	NYLOCK NUT,1-1/8",NF
29	6T2330	8	CAPSCREW,7/16" X 1-1/2",SOCKET HEAD
30	TB1008	1	FLAP RETAINING BAR
31	21633	9	CAPSCREW,3/8" X 1-3/4",NC
32	TB1006A	2	DEFLECTOR FLAP
33	6T2270	12	PLOWBOLT,3/8" X 1",NC
34	TF3001	2	SKID SHOE
35	06530218	8	CAPSCREW,1/2" X 1-3/4",NC
36	TF1032	1	FLANGE BEARING GREASE HOSE
37	06420183	24	SPACER (MEDIUM BRUSHGRASS KNIVES)
38	06521007	48	KNIFE (MEDIUM BRUSH/GRASS CUTTING)

COMMON BENGAL T4

50IN FLAIL MOWER ASSY, PASS-THROUGH KNIVES

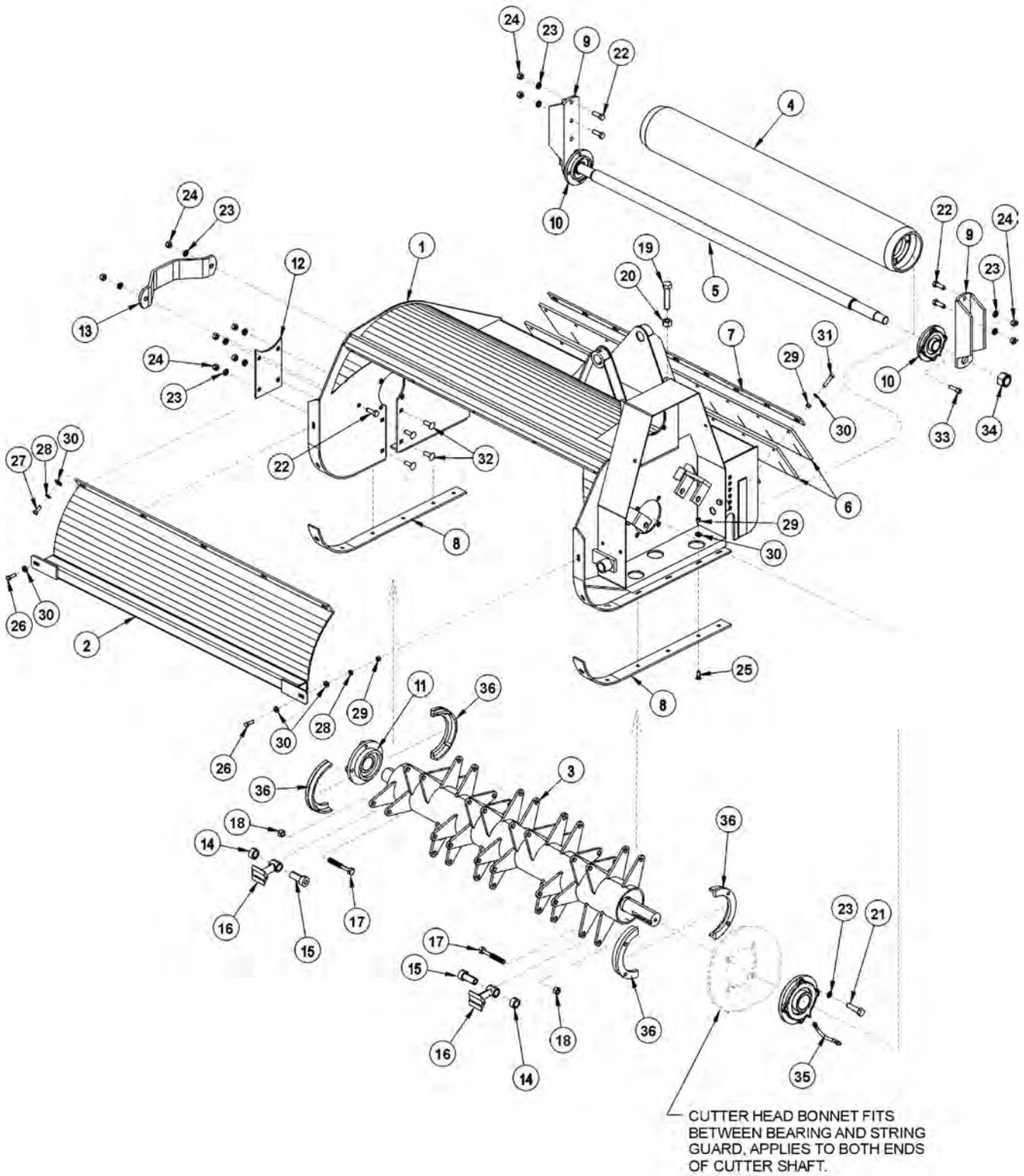

50IN FLAIL MOWER ASSY, PASS-THROUGH KNIVES

Continued...

ITEM	PART NO.	QTY.	DESCRIPTION
---	34172	1	FLAIL,BOOM,50,CPLT ASSY
1	TF3003F	1	CUTTER HEAD BONNET
2	TF3004	1	FRONT SHIELD
3	33717	1	TBF50,CUTTERSHAFT,PASS THRU KNIVES
4	TF3405	1	GROUND ROLLER
5	TF3406	1	GROUND ROLLER TIE ROD
6	TB1006A	2	DEFLECTOR FLAP
7	TB1008	1	FLAP RETAINING BAR
8	TF3001	2	SKID SHOE
9	TF3407	2	GROUND ROLLER ADJUSTMENT BRACKET
10	TF1022	2	FLANGE BEARING,1-3/8"
11	TF1018	2	FLANGE BEARING,2-3/16"
12	TF3007A	1	COVER PLATE
13	TF1040	1	CUTTER SHAFT GUARD
14	33858	24	SPACER,COLLAR
15	33857	24	SHOULDER,BUSHING
16	46399.01	24	KNIFE,FLAIL,FORGED
17	33854	24	CAPSCREW,5/8" X 4-1/2",NC
18	32674	24	HEX NUT,5/8",NC
19	21838	1	CAPSCREW,3/4" X 3-1/2",NC
20	21825	1	HEX NUT,5/8",NC
21	21732	8	CAPSCREW,1/2" X 1-3/4",NC
22	21731	6	CAPSCREW,1/2" X 1-1/2",NC
23	21990	18	LOCKWASHER,1/2"
24	21725	10	HEX NUT,1/2",NC
25	6T2270	12	PLOWBOLT,3/8" X 1",NC
26	21631	2	CAPSCREW,3/8" X 1-1/4",NC
27	21630	5	CAPSCREW,3/8" X 1",NC
28	21988	7	LOCKWASHER,3/8"
29	21625	23	HEX NUT,3/8",NC
30	22016	30	FLATWASHER,3/8"
31	21633	9	CAPSCREW,3/8" X 1-3/4",NC
32	6T7031D	4	PLOW BOLT,1/2" X 1-1/2",NC
33	6T2330	8	CAPSCREW,7/16" X 1-1/2",NC,SCKT HD
34	6T1023R	2	NYLOCK NUT,1-1/8",NF
35	TF1032	1	FLANGE BEARING GREASE HOSE
36	31204	2	STRING GUARD SET (2 PIECES PER SET)

63IN FLAIL DRIVE ASSEMBLY

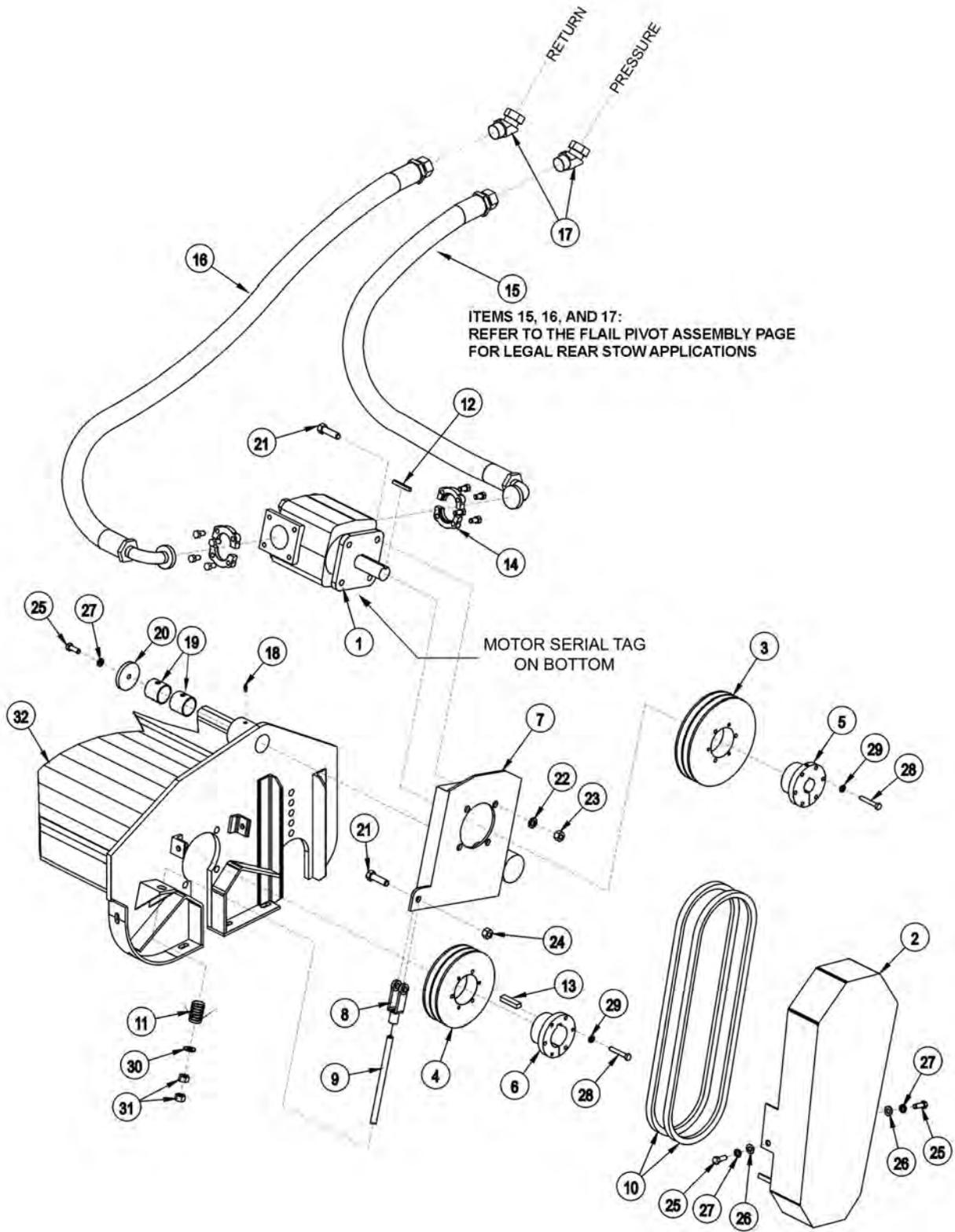

63IN FLAIL DRIVE ASSEMBLY

Continued...

ITEM	PART NO.	QTY.	DESCRIPTION
1	06504132	1	MOTOR (M350-1 3/4 GEAR)
2	32569	1	BELT GUARD
3	TF3044	1	UPPER SHEAVE
4	TF3040	1	LOWER SHEAVE
5	TF3013	1	BUSHING
6	28723	1	BUSHING
7	28679B	1	MOTOR CHANNEL
8	PT3611A	1	CLEVIS
9	40496	1	THREADED ROD
10	28702	2	BELT
11	TF3620A	1	TENSIONER SPRING
12	28572	1	SQUARE KEY
13	26142A	1	SQUARE KEY
14	TF4852	2	FLANGE KIT
15	30308	1	HOSE,1 X 69 - PRESSURE
16	30309	1	HOSE,1 X 78 - RETURN
17	24724	2	SWIVEL FITTING
18	TF1033	1	GREASE ZERK
19	27580	2	BUSHING
20	28682	1	MOTOR CHANNEL WASHER
21	21732	5	CAPSCREW 1/2" X 1 3/4"
22	21990	4	LOCKWASHER 1/2"
23	21725	4	HEX NUT 1/2"
24	6T2418	1	STOVER NUT 1/2"
25	21630	3	CAPSCREW 3/8" X 1"
26	22016	2	FLATWASHER 3/8"
27	21988	3	LOCKWASHER 3/8"
28	21584	6	CAPSCREW 5/16" X 2"
29	21987	6	LOCKWASHER 5/16"
30	27938	1	FLATWASHER 1/2"
31	21700	2	HEX NUT 1/2" NF
32	-----	-	CUTTER HEAD *REFER TO MOWER ASSY

63IN FLAIL MOWER ASSEMBLY

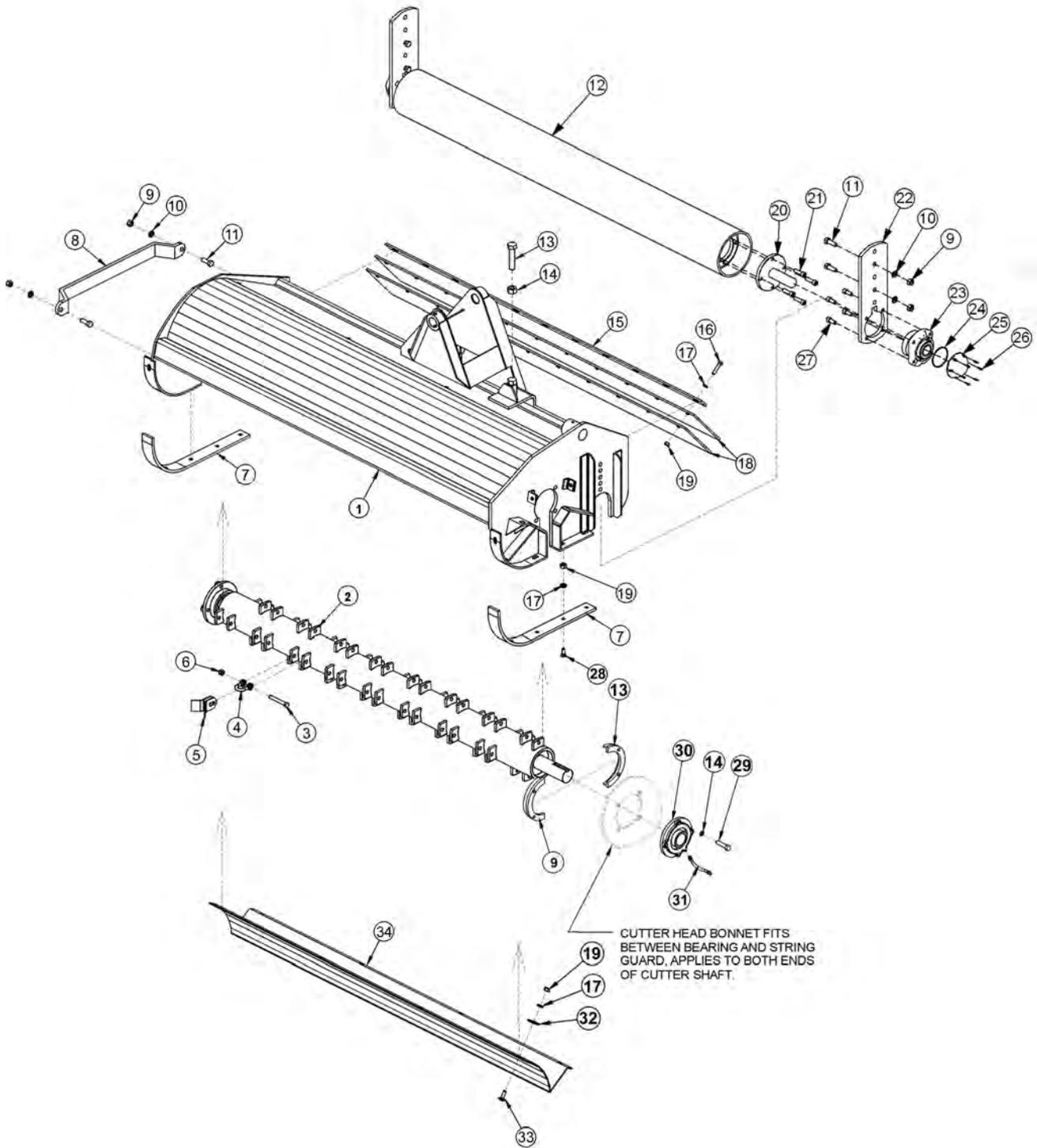

63IN FLAIL MOWER ASSEMBLY

Continued...

ITEM	PART NO.	QTY.	DESCRIPTION
-----	06200271	-	FLAIL,BOOM,63,GRASS,CPLT ASSY
1	28659H	1	CUTTER HEAD BONNET
2	28743	-	CUTTER SHAFT / KNIFE ASSY STANDARD GRASS
-----	28642C	1	CUTTER SHAFT,63,STD
3	34011	36	FLAIL KNIFE MOUNTING BOLT
4	TF1020	36	FLAIL KNIFE MOUNTING CLEVIS
5	33713	72	FLAIL KNIFE - STANDARD
6	21677	36	NYLOCK NUT
7	28086A	2	SKID SHOE
8	27975A	1	CUTTER SHAFT GUARD
9	21725	14	HEX NUT 1/2"
10	21990	14	LOCKWASHER 1/2"
11	21731	6	CAPSCREW 1/2" X 1 1/2"
12	06320240	1	GROUND ROLLER
13	33863	2	STRING GUARD,STD
14	06533006	8	FLATWASHER,1/2",SAE,L9
15	28700	1	FLAP RETAINING BAR
16	21633	11	CAPSCREW 3/8" X 1 3/4"
17	21988	28	LOCKWASHER 3/8"
18	28701	2	DEFLECTOR FLAP
19	21625	28	HEX NUT 3/8"
20	TF1045B	2	GROUND ROLLER STUB SHAFT
21	6T2330	8	CAPSCREW 7/16" X 1 1/2" SOCKET HEAD
22	28735	2	ADJUSTABLE ROLLER BRACKET
23	06520028	2	BEARING,FLANGE,1-3/8,GRNDRLLR
24	06520029	2	O-RING
25	06520027	2	CAP,BEARING,GROUNDROLLER
26	06530001	12	CAPSCREW,SKT HD,8-32 X 1/2,SS
27	6T2331	8	CAPSCREW 7/16" X 1" SOCKET HEAD
28	6T2270	10	PLOW BOLT 3/8" X 1 1/4"
29	06530217	8	CAPSCREW 1/2" X 2",L9
30	28683	2	FLANGE BEARING
31	TF1032	1	FLANGE BEARING GREASE HOSE
32	6T2615	7	FENDER WASHER 3/8"
33	6T2283	7	CARRIAGE BOLT 3/8" X 1"
34	28665A	1	BAFFLE (INSIDE UPPER REAR OF CUTTER HEAD)

COMMON BENGAL T4

BOOM FLAIL PIVOT ASSEMBLY

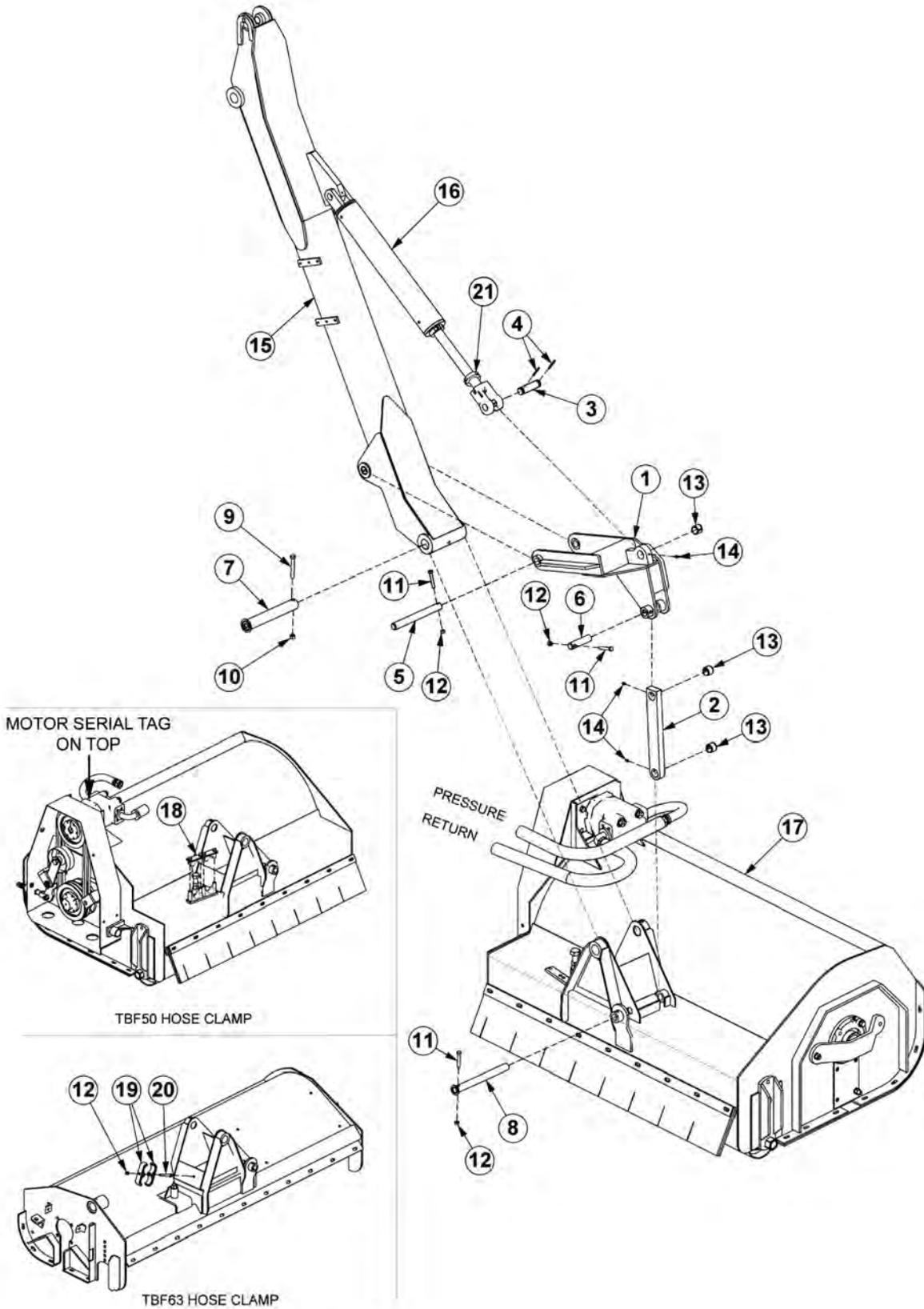

BOOM FLAIL PIVOT ASSEMBLY

Continued...

ITEM	PART NO.	QTY.	DESCRIPTION
1	TF3015	1	FLAIL PIVOT ASSY
2	TB1028	1	PIVOT ARM ASSY
3	TB1033	1	PIN CLEVIS
4	06537021	2	ROLL PIN
5	TF3097	1	PIN
6	TF3090	1	PIN
7	TB1024	1	PIN
8	TB1027	1	PIN
9	21688	1	CAPSCREW 7/16" X 3 1/4"
10	21677	1	NYLOCK NUT 7/16"
11	21635	3	CAPSCREW 3/8" X 2 1/4"
12	21627	4	NYLOCK NUT 3/8"
13	TB5030	3	BUSHING
14	6T3207	3	GREASE ZERK
15	-----	-	SECONDARY BOOM *REFER TO BOOM ARM ASSY
16	-----	-	CYLINDER - REFER TO BOOM ARM ASSY
17	-----	-	FLAIL MOWER HEAD *REFER TO FLAIL ASSY
18	31723	1	CLAMP KIT,TBF50 (USED ON 50" FLAIL)
19	TB3031	2	DOUBLE HOSE CLAMP (USED ON THE 63" FLAIL)
20	21638	1	CAPSCREW 3/8" X 3"
21	35312	2	SPLIT COLLAR

3IN X 13-7/8 IN WELDED CYLINDER BREAKDOWN

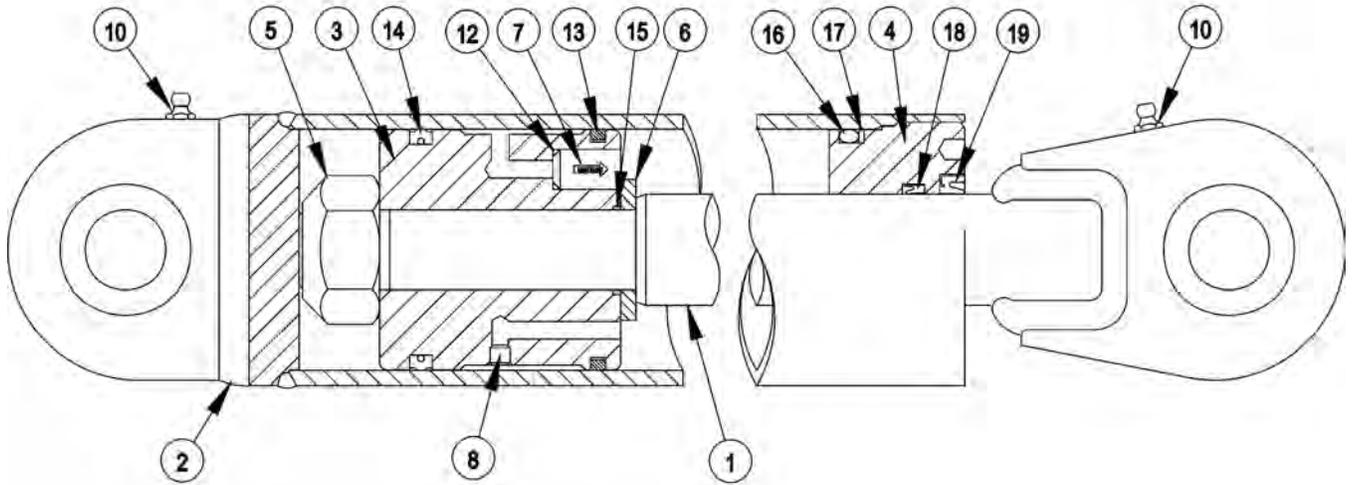

WARNING - MECHANICAL FASTENERS MUST BE TORQUED TO RECOMMENDED SPECIFICATIONS DURING REPAIR TO PREVENT PERSONAL INJURY OR EQUIPMENT DAMAGE.

ITEM	PART NO.	QTY.	DESCRIPTION
---	06501029	-	CYLINDER,WELDED,3" X 13.87"
1	06501630	1	PISTON ROD ASSY
2	06501648	1	BUTT & TUBE ASSY
3	06501649	1	PISTON
4	34574	1	GLAND
5	34575	1	LOCK NUT,1"-14 UNS (TORQUE TO 315 FT.LB.)
6	34576	1	SPACER
7	34577	1	CHECK VALVE,KEPNER
8	06501650	1	ORIFICE, ZERO LEAK, 0225
9	33761	1	SEAL KIT,PACKING (ITEMS 12 THRU 19)
10	-----	2	GREASE ZERK
12	-----	1	O - RING
13	-----	1	CAST IRON PISTON RING
14	-----	1	CROWN SEAL
15	-----	1	O - RING
16	-----	1	O - RING
17	-----	1	BACK - UP WASHER
18	-----	1	U - CUP
19	-----	1	WIPER
20	34334	-	SPHERICAL BEARING (NOT SHOWN)

3IN X 18IN WELDED CYLINDER BREAKDOWN

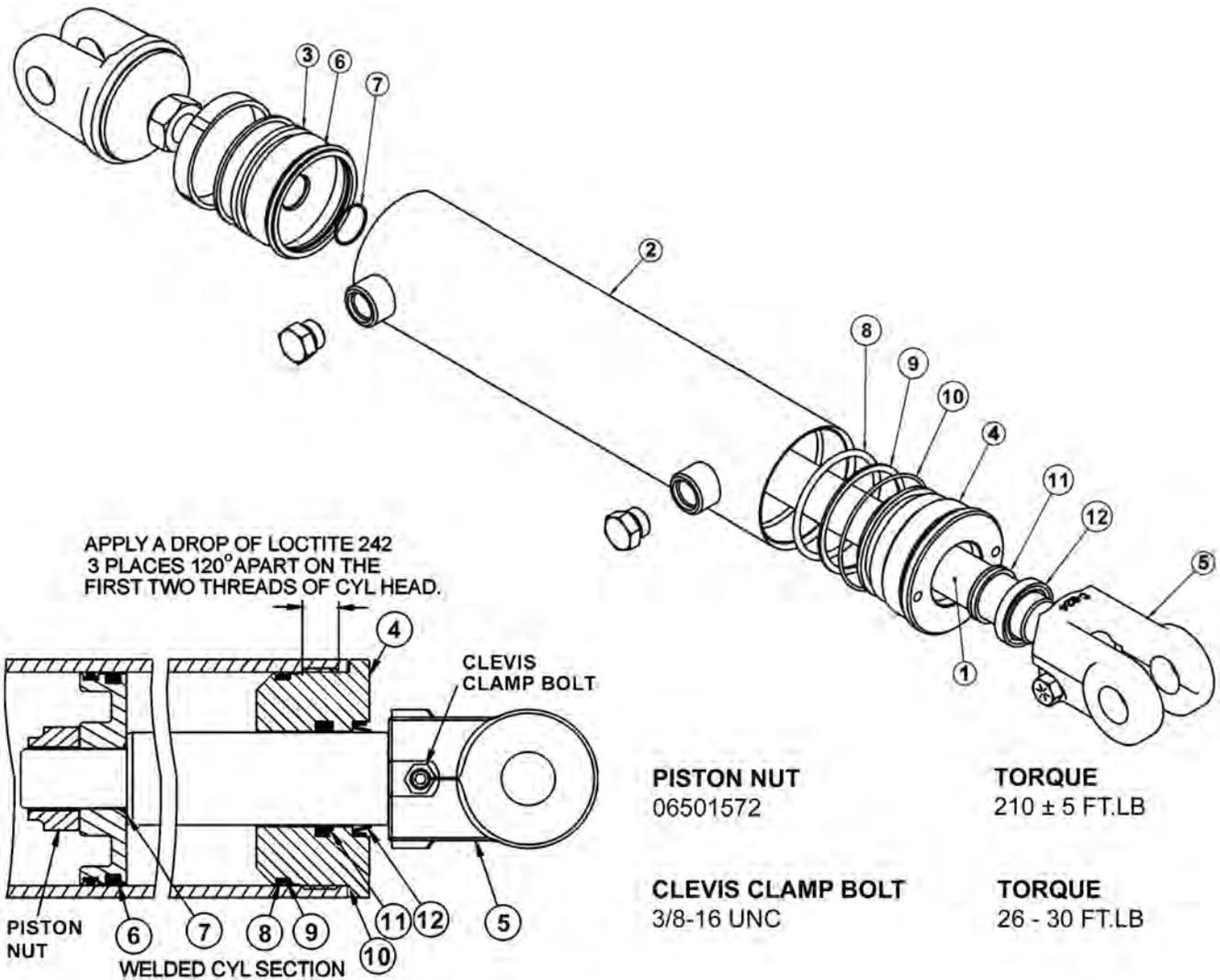

WARNING - MECHANICAL FASTENERS MUST BE TORQUED TO RECOMMENDED SPECIFICATIONS DURING REPAIR TO PREVENT PERSONAL INJURY OR EQUIPMENT DAMAGE.

ITEM	PART NO.	QTY.	DESCRIPTION
-----	06501023	-	HYDRAULIC CYLINDER COMPLETE
1	06501561	1	ROD
2	06501562	1	TUBE WELDMENT
3	06501552	1	PISTON
4	06501563	1	CYLINDER HEAD
5	06501554	1	CLEVIS
-----	06501564	-	SEAL REPAIR KIT (ITEMS 6 THROUGH 12)

3-1/2IN X 20IN WELDED CYLINDER BREAKDOWN

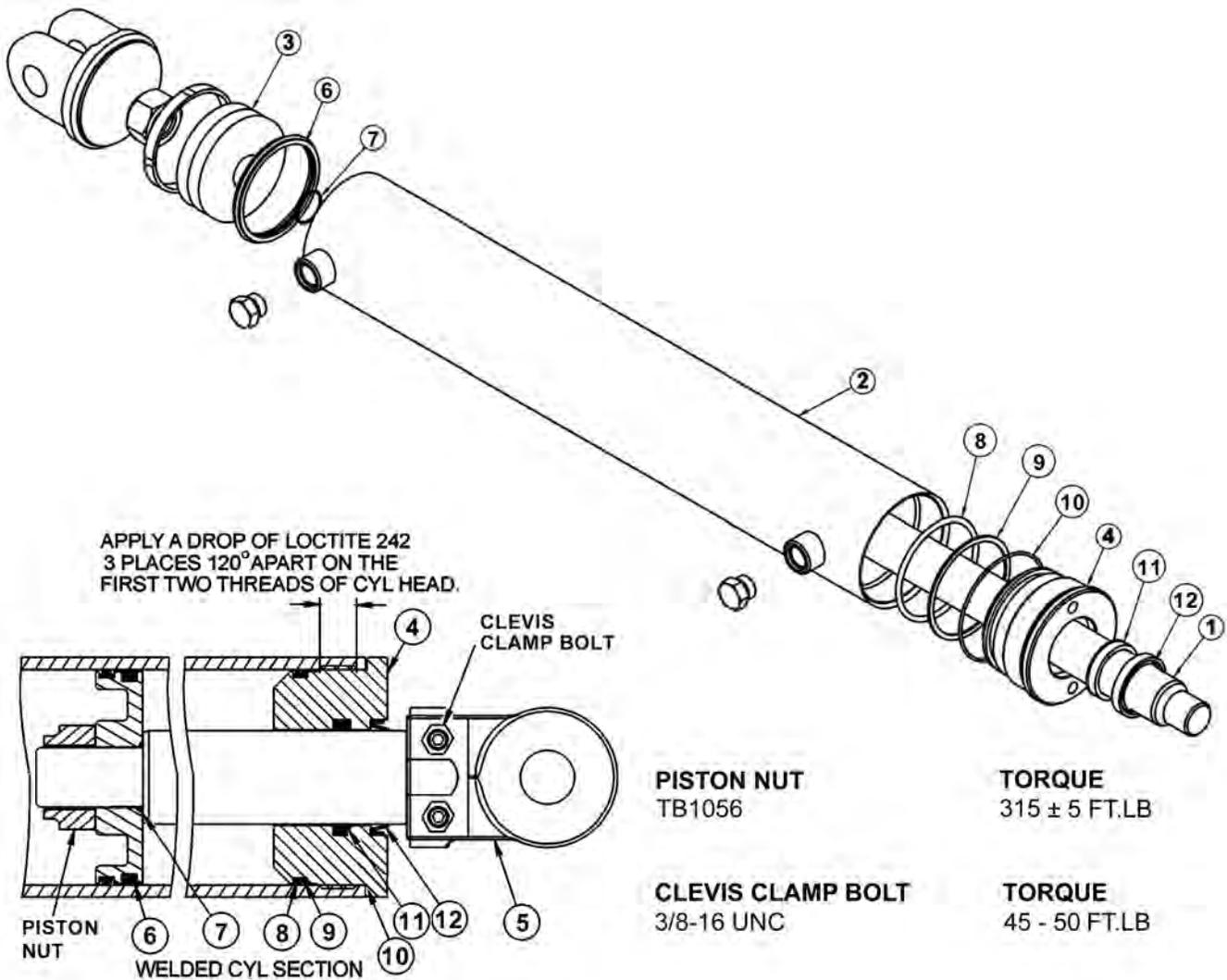

WARNING - MECHANICAL FASTENERS MUST BE TORQUED TO RECOMMENDED SPECIFICATIONS DURING REPAIR TO PREVENT PERSONAL INJURY OR EQUIPMENT DAMAGE.

ITEM	PART NO.	QTY.	DESCRIPTION
-----	06501024	-	HYDRAULIC CYLINDER COMPLETE
1	06501565	1	ROD
2	06501566	1	TUBE WELDMENT
3	06501567	1	PISTON
4	06501568	1	CYLINDER HEAD
5	TB3033	-	CLEVIS
-----	06501569	-	SEAL REPAIR KIT (ITEMS 6 THROUGH 12)

4IN X 20IN WELDED CYLINDER BREAKDOWN

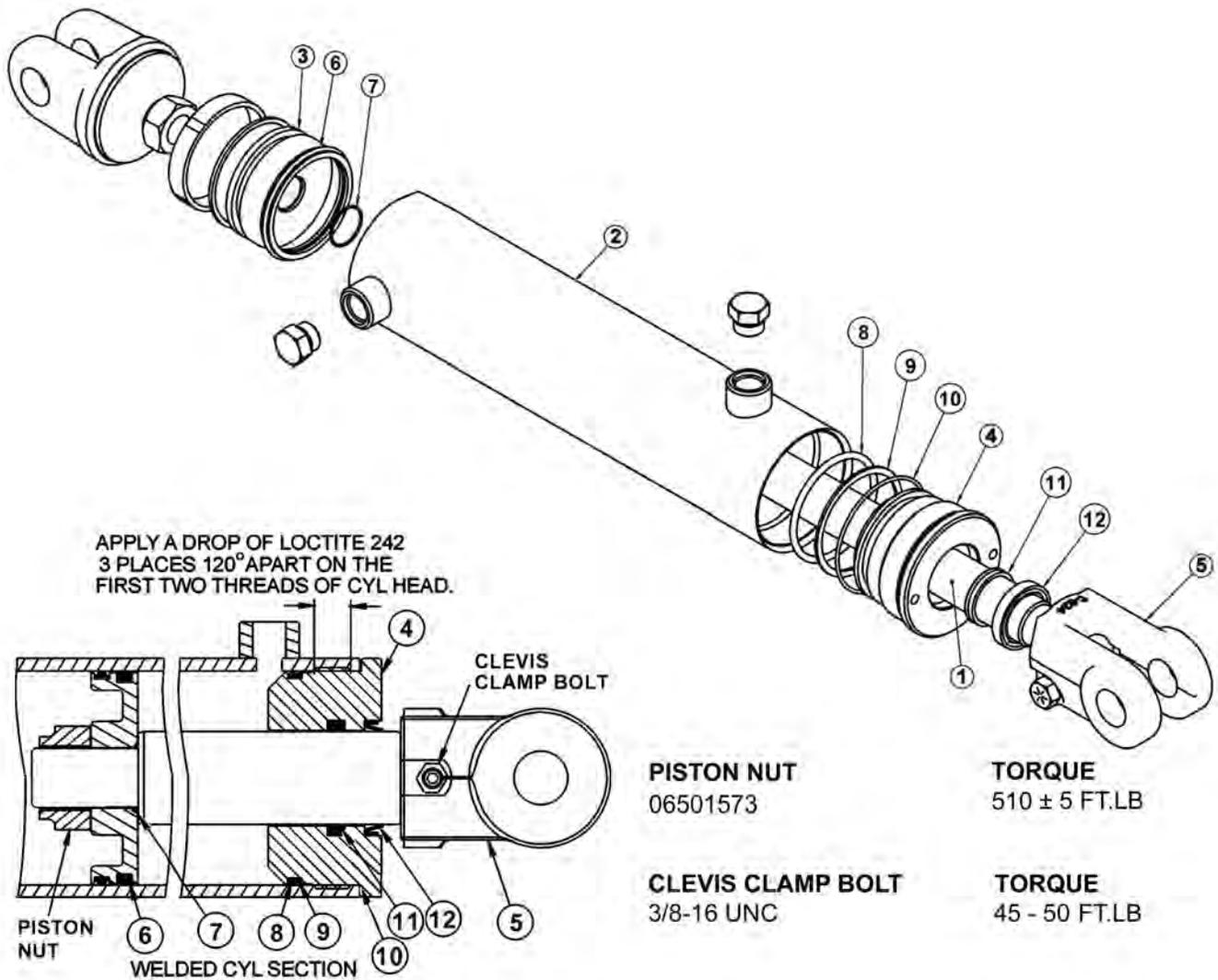

WARNING - MECHANICAL FASTENERS MUST BE TORQUED TO RECOMMENDED SPECIFICATIONS DURING REPAIR TO PREVENT PERSONAL INJURY OR EQUIPMENT DAMAGE.

ITEM	PART NO.	QTY.	DESCRIPTION
-----	06501022	-	HYDRAULIC CYLINDER COMPLETE
1	06501556	1	ROD
2	06501557	1	TUBE WELDMENT
3	06501558	1	PISTON
4	06501559	1	CYLINDER HEAD
5	6T0172	1	CLEVIS
5A	30172	-	CLEVIS (FOR EXTENDED BOOM)
-----	06501560	-	SEAL REPAIR KIT (ITEMS 6 THROUGH 12)

5IN X 20IN WELDED CYLINDER BREAKDOWN

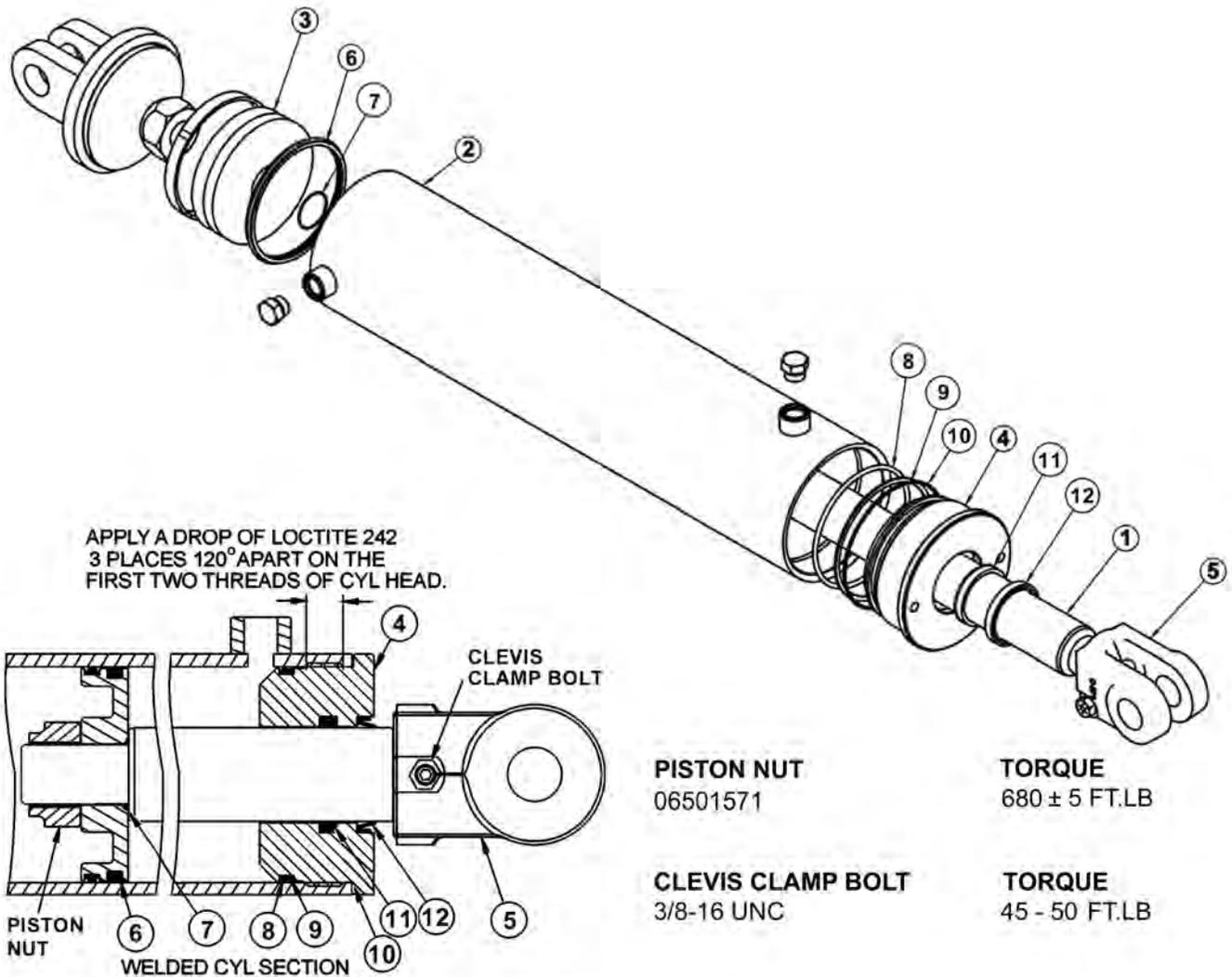

WARNING - MECHANICAL FASTENERS MUST BE TORQUED TO RECOMMENDED SPECIFICATIONS DURING REPAIR TO PREVENT PERSONAL INJURY OR EQUIPMENT DAMAGE.

ITEM	PART NO.	QTY.	DESCRIPTION
-----	06501020	-	HYDRAULIC CYLINDER COMPLETE
1	06501544	1	ROD
2	06501545	1	TUBE WELDMENT
3	06501546	1	PISTON
4	06501547	1	CYLINDER HEAD
5	06501548	1	CLEVIS
-----	06501549	-	SEAL REPAIR KIT (ITEMS 6 THROUGH 12)

NOTES

NOTES

5 SPOOL ELECTRONIC VALVE - OPEN STOW,3PS

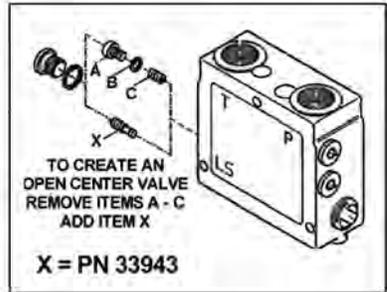
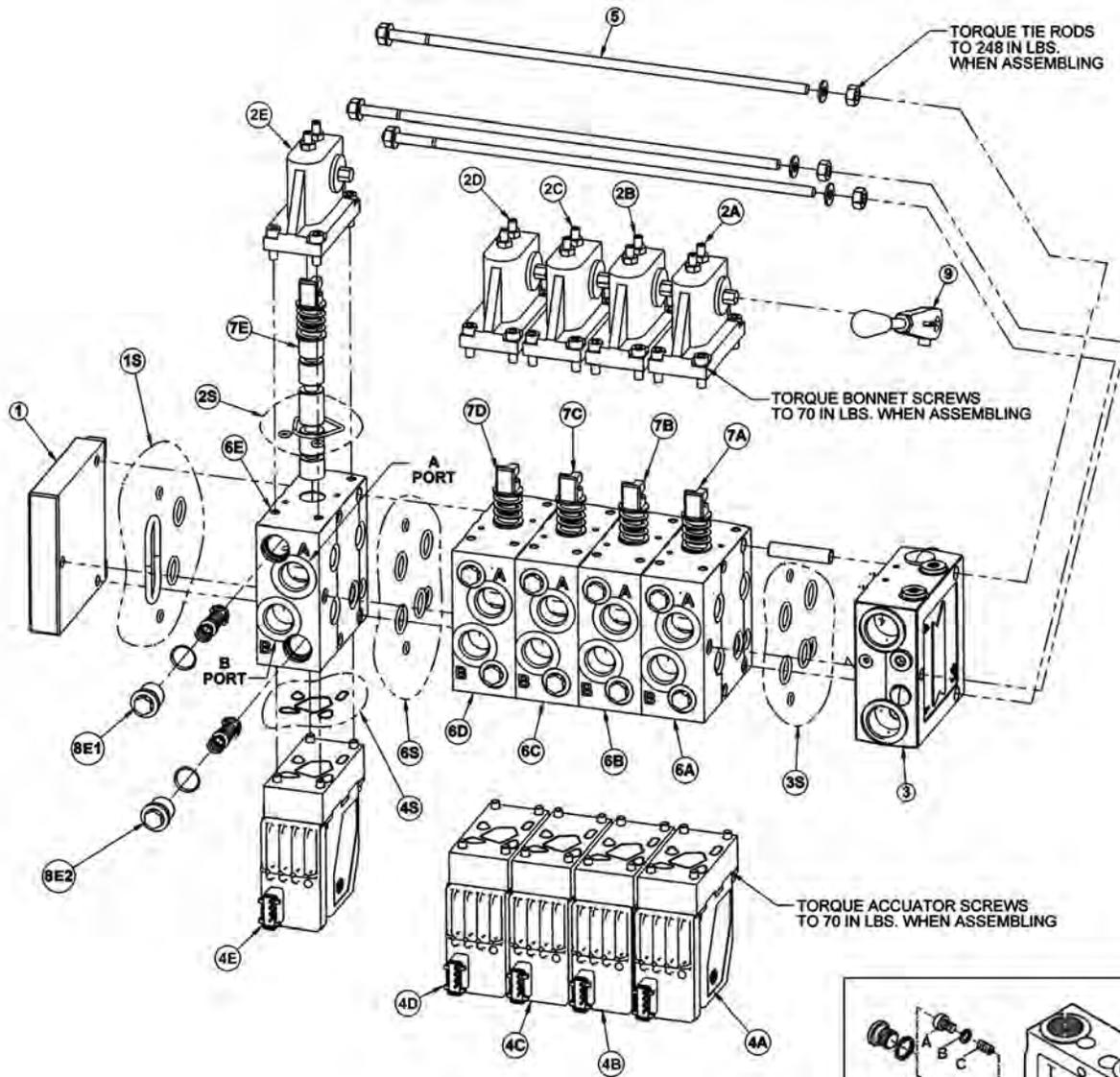

ITEM	PART NO.	QTY.	DESCRIPTION
----	06700224	-	VALVE, 5SP, OS
-----	06502097	-	VALVE, SUB-ASSEMBLY
1	06502074	1	END PLATE
1S	06505013	1	END PLATE SEAL KIT
2	-----	5	BONNET
2S	06505042	1	BONNET SEAL KIT

5 SPOOL ELECTRONIC VALVE - OPEN STOW,3PS

Continued...

ITEM	PART NO.	QTY.	DESCRIPTION
2A	42197	1	MAIN BOOM BONNET
2B	42197	1	SECONDARY BOOM BONNET
2C	42197	1	DECK ROLL BONNET
2D	42197	1	BOOM SWIVEL BONNET
2E	42197	1	DECK SHIELD BONNET
3	34308	1	INLET SECTION
3S	06505013	1	INLET SECTION SEAL KIT
4	-----	5	ELECTRONIC ACCUATOR
4A	06502101	1	MAIN BOOM ELECTRONIC ACCUATOR
4B	06502101	1	SECONDARY BOOM ELECTRONIC ACCUATOR
4C	06502100	1	DECK ROLL ELECTRONIC ACCUATOR
4D	06502101	1	BOOM SWIVEL ELECTRONIC ACCUATOR
4E	06502099	1	DECK SHIELD ELECTRONIC ACCUATOR
5	42202	1	TIE-BOLT KIT
6	-----	5	SECTION
6S	06505013	1	SECTION SEAL KIT
6A	42698	1	MAIN BOOM SECTION
6B	42698	1	SEC BOOM SECTION
6C	06502076	1	DECK ROLL SECTION
6D	42698	1	BOOM SWIVEL SECTION
6E	06502077	1	SHIELD SECTION
7	-----	5	SPOOL
7A	42697	1	MAIN BOOM SPOOL
7B	42697	1	SEC BOOM SPOOL
7C	4242106	1	DECK ROLL SPOOL
7D	06502073	1	BOOM SWIVEL SPOOL
7E	42201	1	DECK SHIELD SPOOL
8	-----	10	ANTI CAV/SHOCK RELIEF
8A1	06502084	1	MAIN BOOM A PORT RELIEF
8A2	06502081	1	MAIN BOOM B PORT RELIEF
8B1	42296	1	SEC BOOM A PORT RELIEF
8B2	06502082	1	SEC BOOM B PORT RELIEF
8C1	42295	1	DECK ROLL A PORT RELIEF
8C2	06502082	1	DECK ROLL B PORT RELIEF
8D1	06502070	1	BOOM SWIVEL A PORT RELIEF
8D2	06502083	1	BOOM SWIVEL B PORT RELIEF
8E1	06502081	1	DECK SHIELD A PORT RELIEF
8E2	06502081	1	DECK SHIELD B PORT RELIEF
9	33459	1	HANDLE

COMMON BENGAL T4

5 SPOOL ELECTRONIC VALVE - SIDE STOW

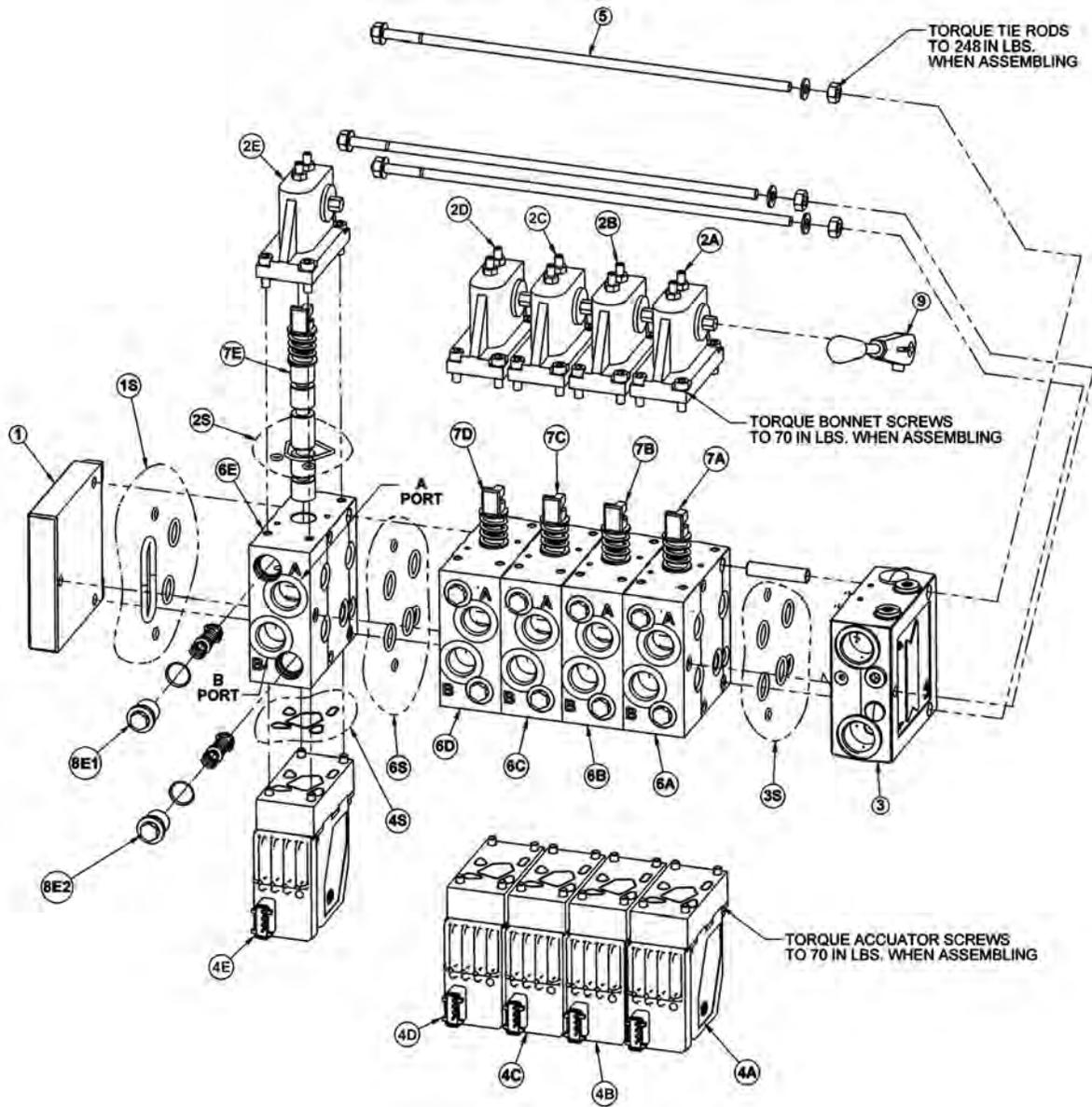

ITEM	PART NO.	QTY.	DESCRIPTION
-----	06502096	-	VLV,5SP,32PVG,SIDE STOW
1	06502074	1	END PLATE
1S	06505013	1	END PLATE SEAL KIT
2	-----	5	BONNET
2S	06505042	1	BONNET SEAL KIT
2A	42197	1	MAIN BOOM BONNET
2B	42197	1	SECONDARY BOOM BONNET
2C	42197	1	DECK ROLL BONNET
2D	42197	1	BOOM SWIVEL BONNET
2E	42197	1	DECK SHIELD BONNET

5 SPOOL ELECTRONIC VALVE - SIDE STOW

Continued...

ITEM	PART NO.	QTY.	DESCRIPTION
3	34308	1	INLET SECTION
3S	06505013	1	INLET SECTION SEAL KIT
4	-----	5	ELECTRONIC ACCUATOR
4A	06502101	1	MAIN BOOM ELECTRONIC ACCUATOR
4B	06502101	1	SECONDARY BOOM ELECTRONIC ACCUATOR
4C	06502100	1	DECK ROLL ELECTRONIC ACCUATOR
4D	06502101	1	BOOM SWIVEL ELECTRONIC ACCUATOR
4E	06502099	1	DECK SHIELD ELECTRONIC ACCUATOR
5	42202	1	TIE-BOLT KIT
6	-----	5	SECTION
6S	06505013	1	SECTION SEAL KIT
6A	42698	1	MAIN BOOM SECTION
6B	42698	1	SEC BOOM SECTION
6C	06502076	1	DECK ROLL SECTION
6D	42698	1	BOOM SWIVEL SECTION
6E	06502077	1	SHIELD SECTION
7	-----	5	SPOOL
7A	42697	1	MAIN BOOM SPOOL
7B	42697	1	SEC BOOM SPOOL
7C	4242106	1	DECK ROLL SPOOL
7D	06502073	1	BOOM SWIVEL SPOOL
7E	42201	1	DECK SHIELD SPOOL
8	-----	10	ANTI CAV/SHOCK RELIEF
8A1	42650	1	MAIN BOOM A PORT RELIEF
8A2	06502069	1	MAIN BOOM B PORT RELIEF
8B1	42650	1	SEC BOOM A PORT RELIEF
8B2	42295	1	SEC BOOM B PORT RELIEF
8C1	42296	1	DECK ROLL A PORT RELIEF
8C2	42295	1	DECK ROLL B PORT RELIEF
8D1	42295	1	BOOM SWIVEL A PORT RELIEF
8D2	42295	1	BOOM SWIVEL B PORT RELIEF
8E1	06502069	1	DECK SHIELD A PORT RELIEF
8E2	06502069	1	DECK SHIELD B PORT RELIEF
9	33459	1	HANDLE

FRONT HYDRAULIC PUMP

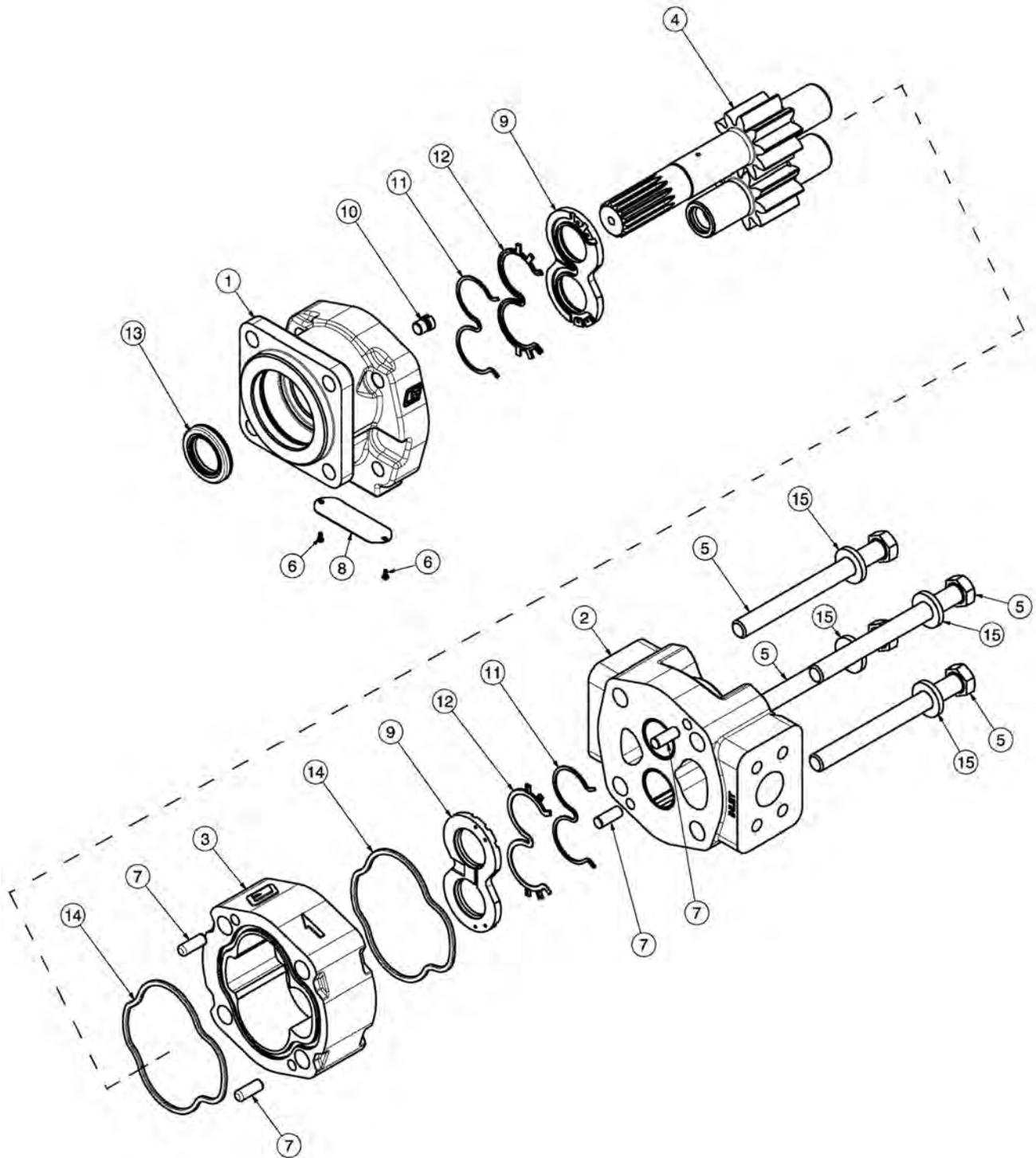

FRONT HYDRAULIC PUMP

Continued...

ITEM	PART NO.	QTY.	DESCRIPTION
---	23152	1	PUMP ASSEMBLY,1-3/4",COMPLETE
1	22766	1	SHAFT END COVER
2	22779	1	PORT END COVER
3	22774	1	GEAR HOUSING,1-3/4"
4	22771	1	GEAR SET
5	23824	4	CAPSCREW
6	06504078	2	SCREW,DRIVE
7	22773	4	DOWEL PINS
8	06504077	1	NAMEPLATE
9	22770	2	THRUST PLATE
10	22767	1	PLUG
11	06504075	2	SEAL,BK-UP
12	06504074	2	SEAL,CHAN
13	22765	1	SEAL,LIP
14	06504076	2	SEAL,SQ-R
15	02961917	4	WASHER
---	24150	1	SEAL KIT (INCLUDES 11, 12, 13 AND 14)

50IN AND 60IN ROTARY MOTOR BREAKDOWN

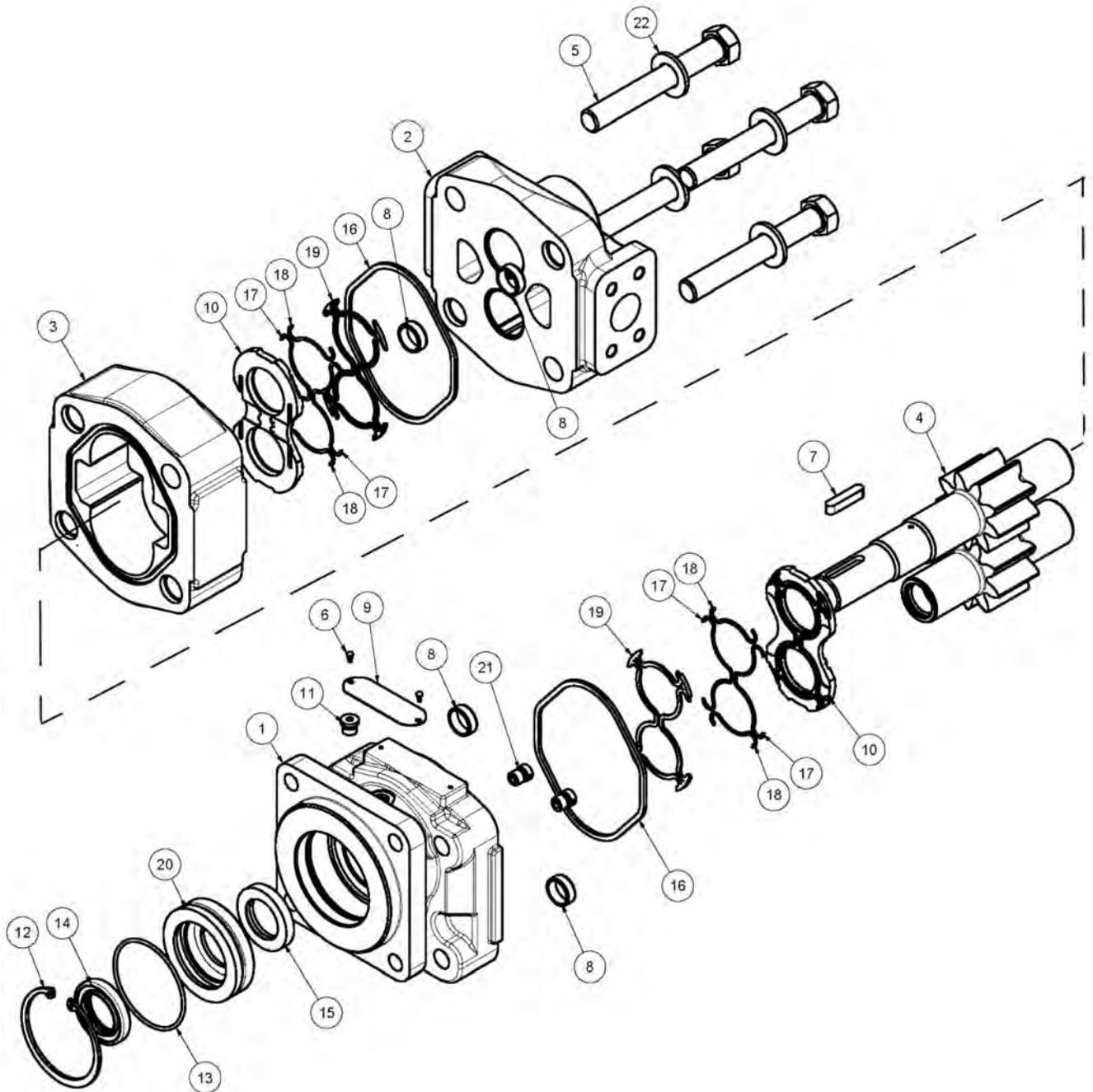

50IN AND 60IN ROTARY MOTOR BREAKDOWN

Continued...

ITEM	PART NO.	QTY.	DESCRIPTION
	06504011	-	MOTOR ASSEMBLY,TRB60
	06504012	-	MOTOR ASSEMBLY,TRB50
1	22790	1	HOUSING, SEC
2	06504088	1	HOUSING, PEC
3	06504062	1	HOUSING, GEAR,TRB60
-----	06504089	-	HOUSING, GEAR,TRB50
4	06504090	1	SET, GEAR SHAFT
5	06504104	4	CAP SCREW,TRB60
-----	06504091	-	CAP SCREW,TRB50
6	06504078	2	SCREW, DRIVE
7	06504092	1	KEY
8	06504093	4	PIN, DOWEL
9	06504094	1	NAME PLATE
10	06504095	2	THRPL
11	2961940	1	PLUG, ODT
12	2962200	1	RING, SNAP
13	06504096	1	O RING
14	6T5101	1	SEAL, LIP
15	06504097	1	SEAL, LIP
16	22797	2	SEAL, SQ-R
17	06504098	4	SEAL, SIDE CHAN
18	06504099	4	SEAL, END CHAN
19	06504100	2	SEAL, BK-UP
20	06504101	1	RTNR, SEAL
21	6T5809	2	CHECK ASS'Y
22	06504102	4	WASHER
-----	06504103	-	SEAL KIT

FLAIL MOTOR BREAKDOWN

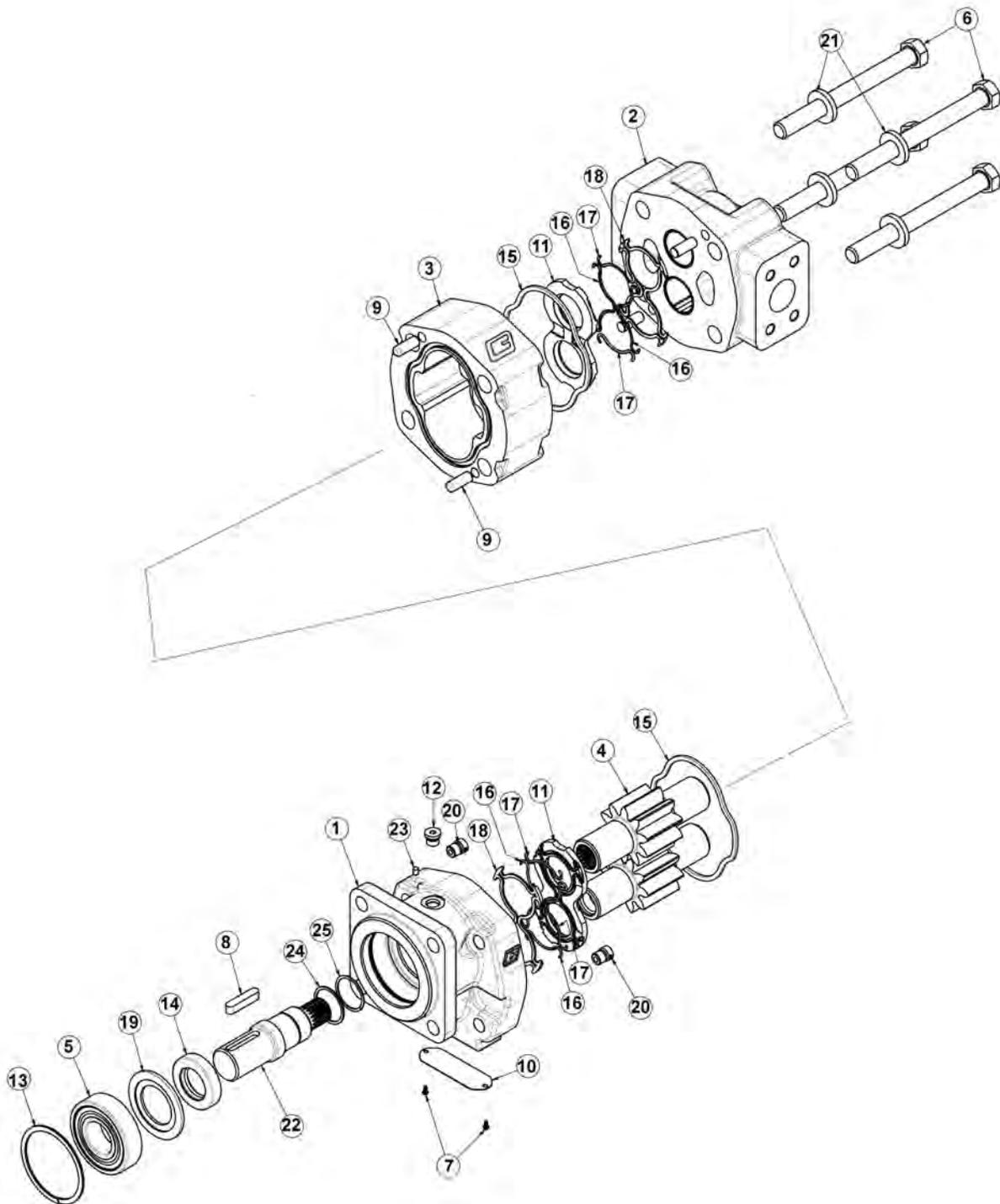

FLAIL MOTOR BREAKDOWN

Continued...

ITEM	PART NO.	QTY.	DESCRIPTION
*	06504132	-	MOTOR ASSEMBLY 350 - TBF50, TBF63
1	06504141	1	SHAFT END COVER
2	06504040	1	PORT END COVER
3	06504041	1	GEAR HOUSING
4	06504117	1	MATCHED GEAR SET
5	TF4402	1	BALL BEARING
6	06504043	4	CAP SCREW
7	06504044	2	SET SCREW
8	06504028	1	KEY
9	06504045	4	DOWEL PIN
10	*	1	NAMEPLATE
11	763759	1	THRUSTPLATE
12	2961940	1	PLUG, ODT (0.25)
13	TF4401	1	SNAP RING
14	06504142	1	LIP SEAL
15	TF4410	2	GASKET SEAL
16	06504046	4	SIDE SEAL
17	06504047	4	END SEAL
18	TF4407	2	BACK-UP SEAL
19	06504122	1	SEAL RETAINER
20	6T5809	2	CHECK ASSEMBLY
21	2961917	4	WASHER
22	06504140	1	SHAFT
23	06504139	1	BREATHER
24	06504121	1	SPACER, BRG
25	06504119	1	SNAP RING
*	06504022	-	SEAL KIT

RESERVOIR TANK FILTER ASSEMBLY

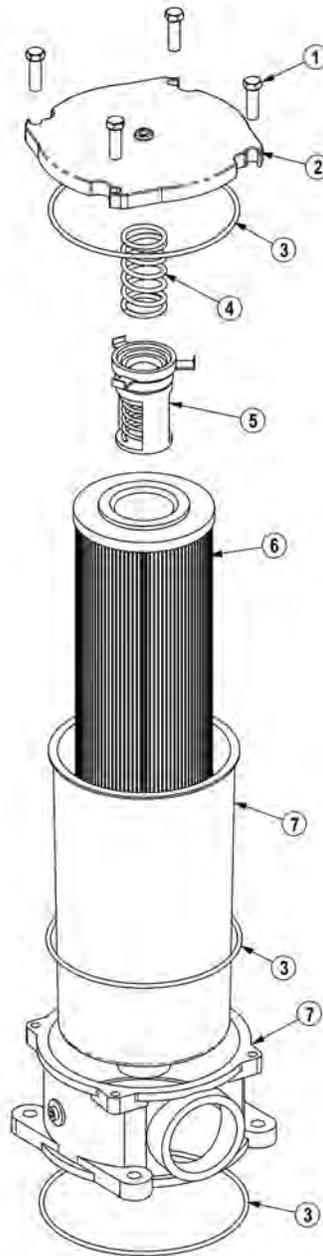

ITEM	PART NO.	QTY.	DESCRIPTION
-----	06505044	-	FILTER ASSY SAE 10 MICRON
1	28583	4	CAPSCREW,8MM X 25MM(1.25 PITCH)
2	06505045	1	COVER
3	06505046	1	SEAL KIT
4	06505047	1	SPRING
5	06505048	1	BYPASS
6	35259	1	FILTER,10 MIC,RETURN LINE
7	06505049	1	CAN/BODY

COMMON BENGAL T4

PUMP AND GRILL GUARD OPTIONS

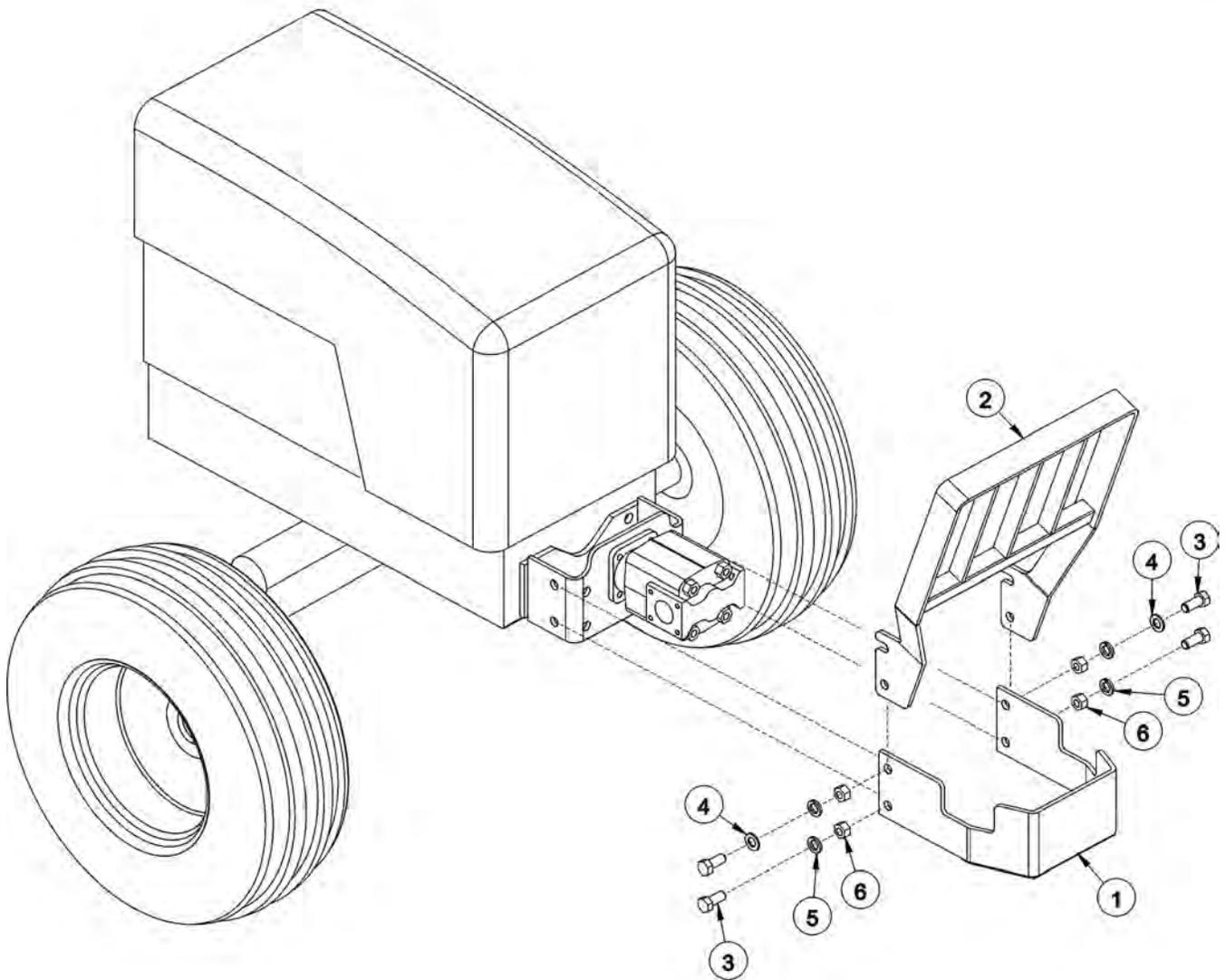

ITEM	PART NO.	QTY.	DESCRIPTION
1	32430	1	UNIVERSAL PUMP GUARD
2	32737	1	UNIVERSAL GRILL GUARD
3	21833	4	CAPSCREW,3/4" X 2-1/4",NC
4	22021	2	FLATWASHER,3/4"
5	21993	4	LOCKWASHER,3/4"
6	21825	4	HEX NUT,3/4",NC

BOOM TRAVEL LOCK

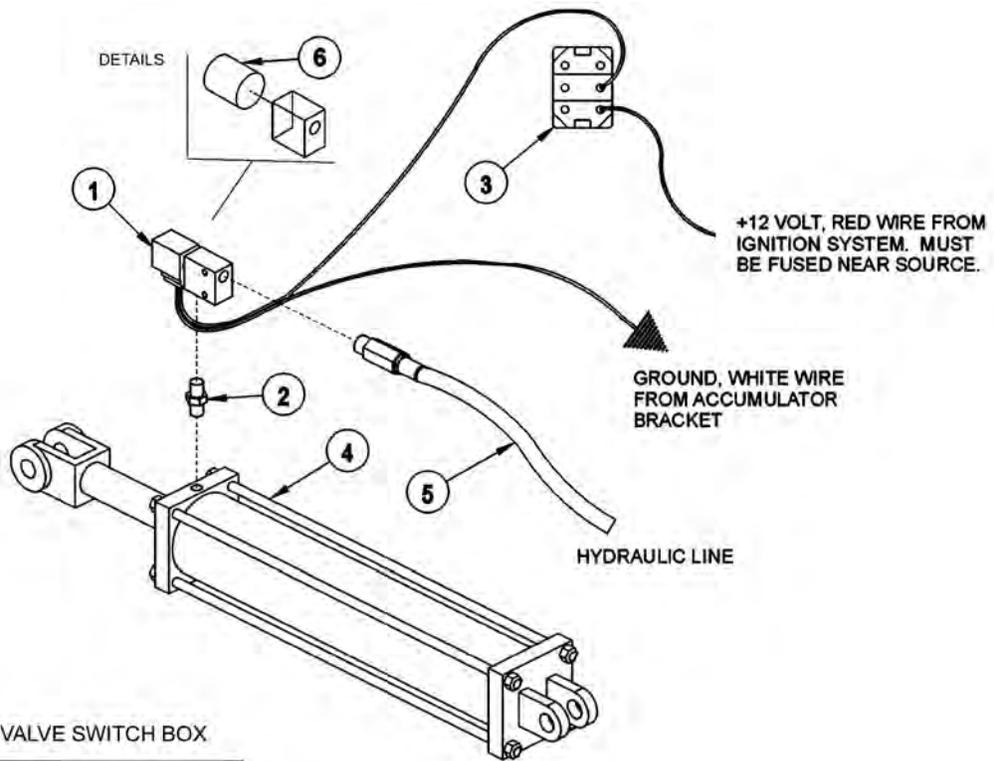

ELECTRONIC LIFT VALVE SWITCH BOX



TRAVEL LOCK SWITCH

MANUAL LIFT VALVE SWITCH BOX



TRAVEL LOCK SWITCH

ITEM	PART NO.	QTY.	DESCRIPTION
1	06510050	1	HYDRAULIC TRAVEL LOCK VALVE
2	31329	1	ADAPTER - STANDARD BOOM
-----	31611	1	ADAPTER - EXTENDED BOOM
3	34532	1	SWITCH,TRAVEL LOCK
4	-----	-	MAIN BOOM CYLINDER *REFER TO BOOM ASSY
5	-----	-	HOSE / FITTINGS *REFER TO BOOM HYD ASSY
6	06510092	1	COIL ,TRAVEL LOCK

MANUAL LIFT VALVE SWITCH BOX

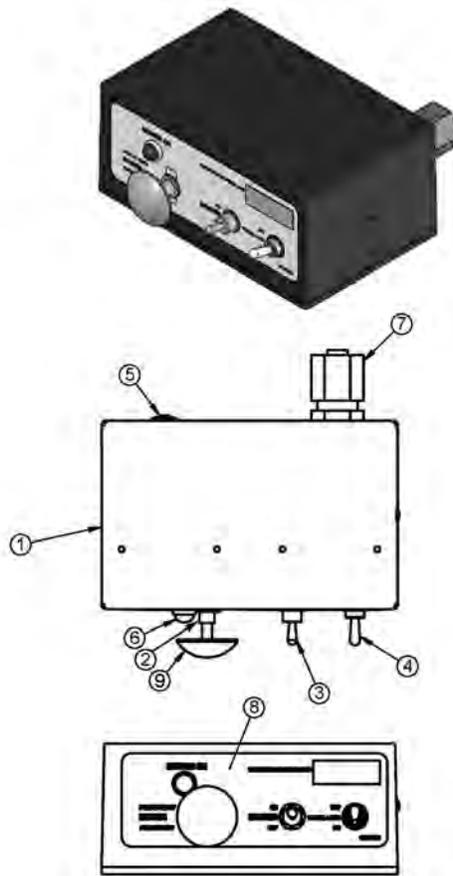

ITEM	PART NO.	QTY.	DESCRIPTION
1	06514012	1	SWBX,ALUM,BLK,06510100
2	35226	1	SWITCH,MOWER,COLEHERSEE
3	33811	1	SWITCH,MASTER/DECK FLOAT
4	34532	1	SWITCH,TRVL LCK
5	06514014	1	BREAKER,10A,SWBX
6	6T3923	1	INDICTATOR LIGHT,ON,RED
7	34540	1	STRAIN RELIEF,3/4,BLACK,NYLON
8	06550019	1	DECAL,SWTCHBX,BOOM,CG
9	02964063	1	KNOB,RED
10	35227	1	RELAY,DP,DT,12V,LY2F,35226

MANUAL LIFT VALVE SCHEMATIC

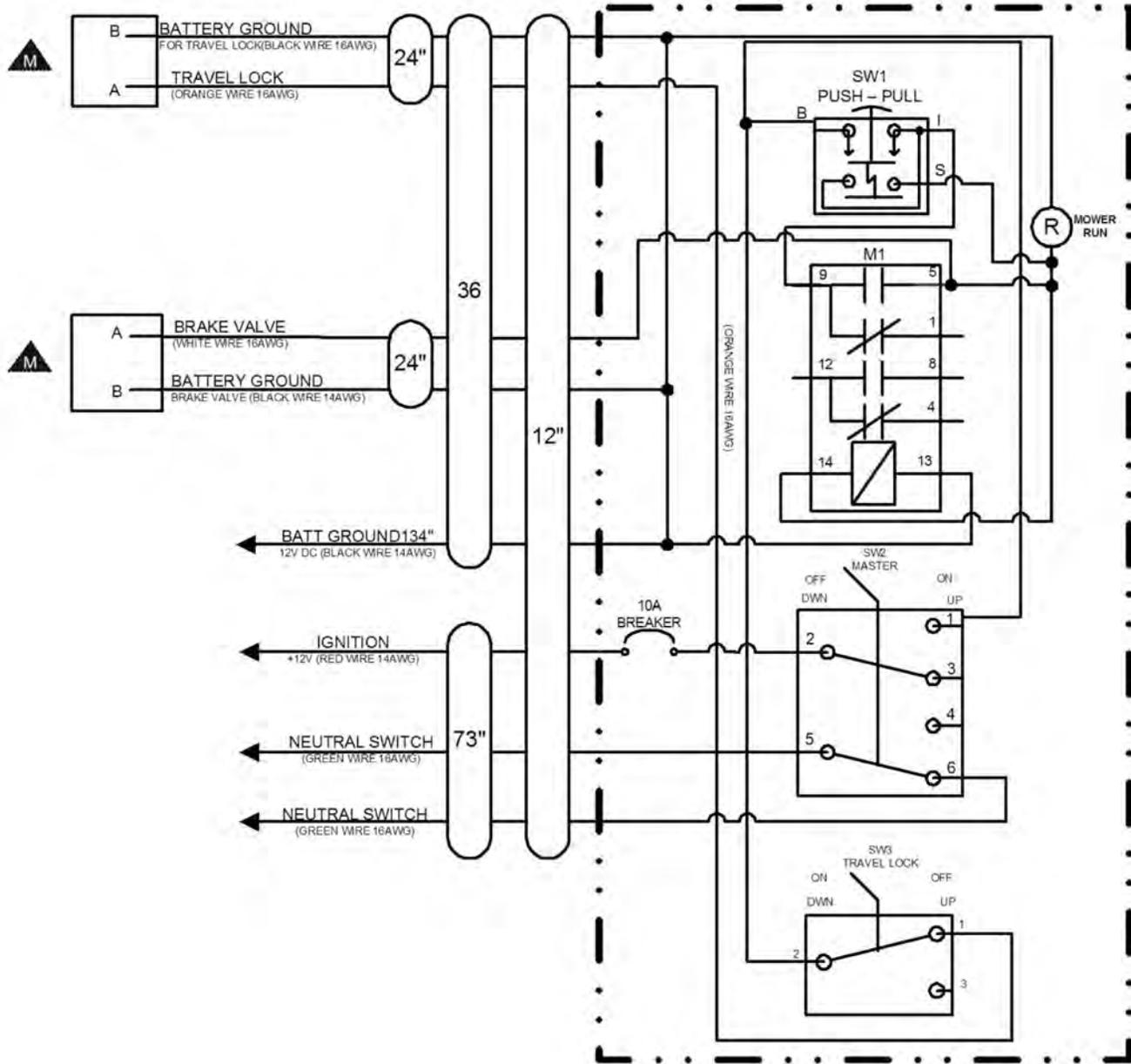

ELECTRONIC LIFT VALVE SWITCH BOX

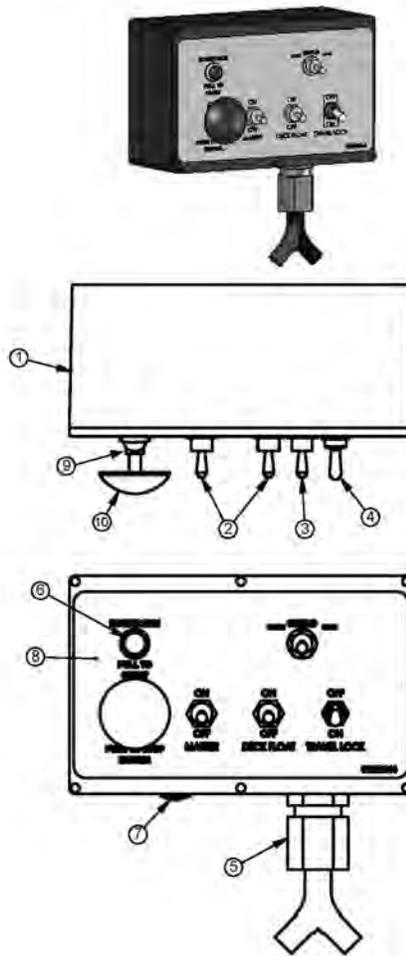

ITEM	PART NO.	QTY.	DESCRIPTION
1	06510196	1	SWBX,ASSY
2	33811	2	SWITCH,MASTER/DECK FLOAT
3	33813	1	SWITCH,SFTY SHIELD
4	34532	1	SWITCH,TRVL LCK
5	34540	1	STRAIN RELIEF,3/4",BLACK,NYLON
6	6T3923	1	INDICTATOR LIGHT,ON,RED
7	06514006	1	BREAKER,15A,SWBX
8	06550044	1	DECAL,SWBX,06510047
9	35226	1	SWITCH,MOWER,COLEHERSEE
10	02964063	1	KNOB,RED
11	35227	1	RELAY,DP,DT,12V,LY2F,35226

ELECTRONIC LIFT VALVE SCHEMATIC

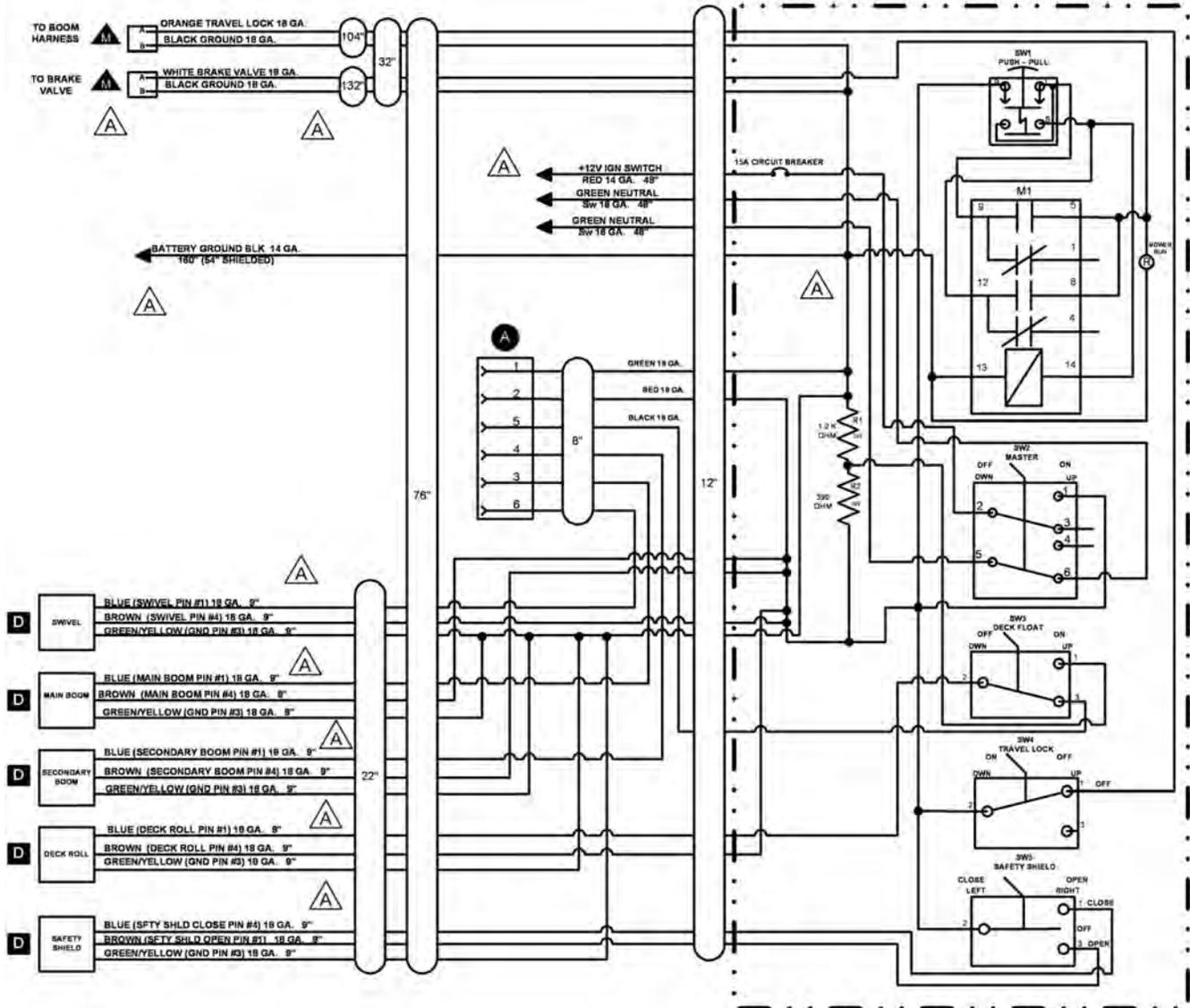

SOLENOID SWITCH BOX AND WIRING

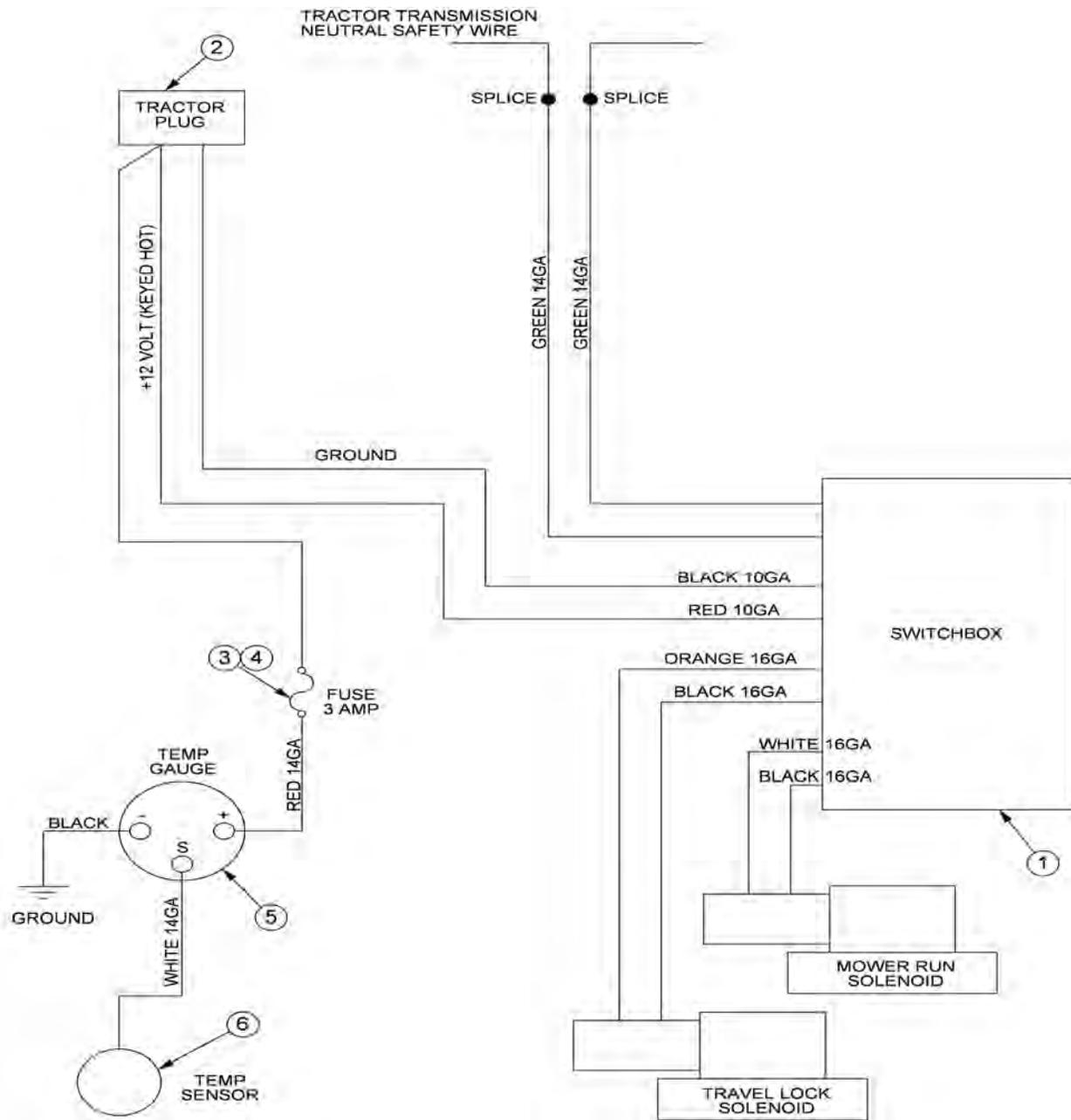

ITEM	PART NO.	QTY.	DESCRIPTION
1	-----	-	SWITCH BOX
2	RE37651	1	PLUG,AUX PWR
3	24204	-	FUSE HOLDER,IN-LINE (OPTION)
4	6T3965	-	FUSE,3AMP (OPTION)
5	6T3934	-	TEMPERATURE GAUGE (OPTION)
6	6T3931	-	TEMPERATURE SENSOR (OPTION)

BRAKE VALVE ASSEMBLY

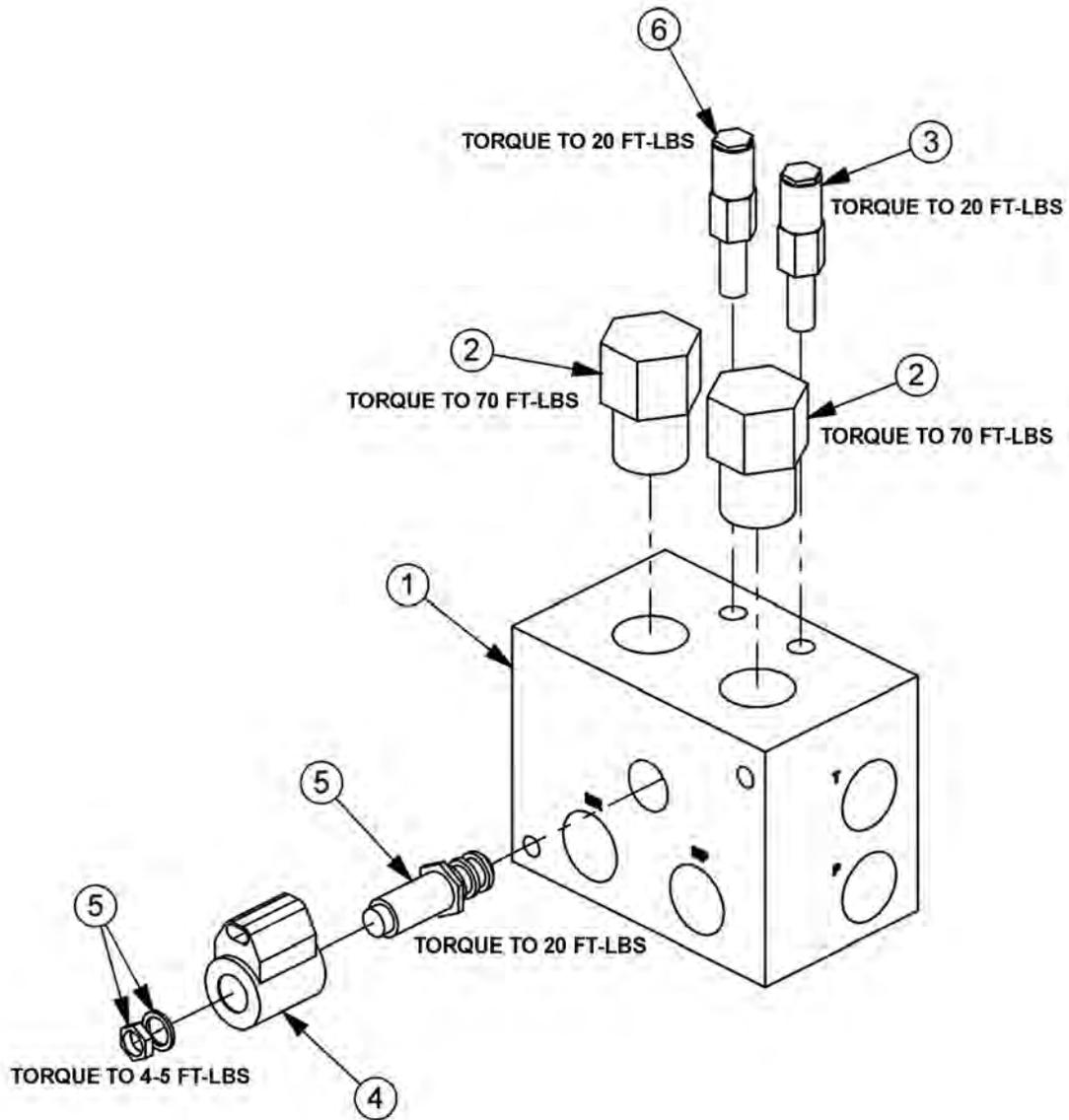

ITEM	PART NO.	QTY.	DESCRIPTION
---	06510083	1	BRAKE VALVE, ASSY
1	34092	1	BRAKE VALVE, BLANK
2	34094	2	LOGIC ELEMENT
3	34095	1	RELIEF VALVE, 3000 PSI
4	06510095	1	METRI PAK COIL
5	34093	1	CARTRIDGE, 2 POSITION, 3 WAY (WITH NUT & WASHER)
6	34091	1	RELIEF VALVE, 2600 PSI
---	34096	2	RELIEF SEAL KIT
----	34097	1	SOLENOID SEAL KIT
---	34098	2	ELEMENT SEAL KIT

BRAKE VALVE HYDRAULIC SCHEMATIC

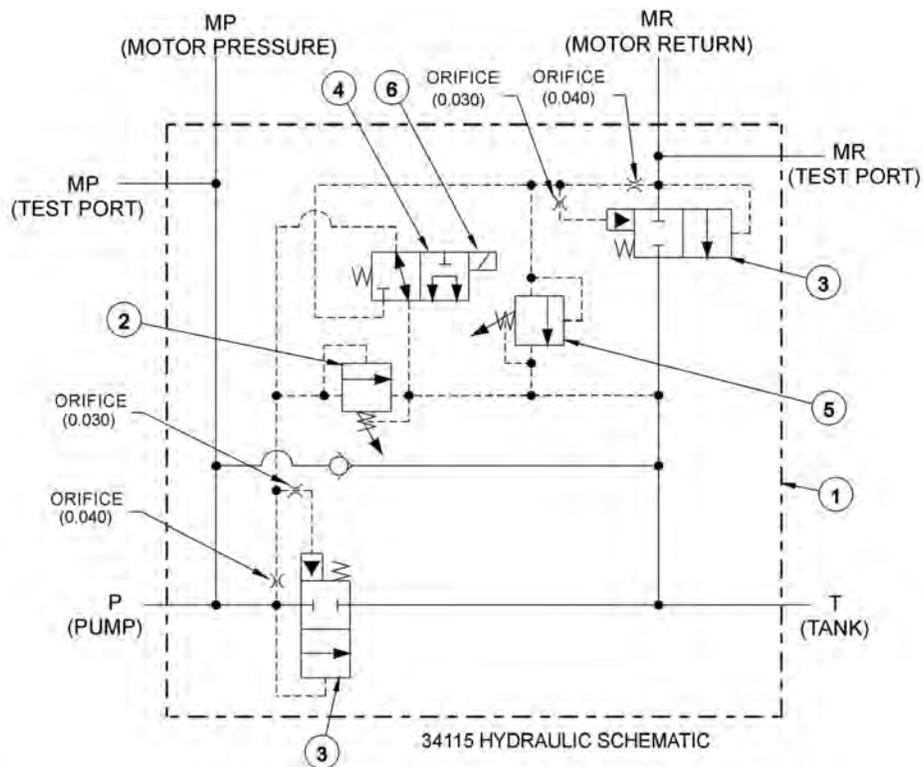

BRAKE VALVE TROUBLESHOOTING

FAILURE MODE:

- MOWER WILL NOT START - system pressure is low (engine not lugging).
- MOWER WILL NOT START - system pressure is high (engine lugging). "MR" port will be high pressure.
- MOWER WILL NOT ROTATE AT FULL SPEED - limited power.
- MOWER BLADE WILL NOT STOP - blade will not stop in proper time.

CHECK STEPS

- 1 thru 6
- 7
- 3 thru 5
- 7 thru 9

CORRECTIVE STEPS:

1. Check for voltage at solenoid (item 6), voltage must be between 10.2 volts and 13.8 volts.
2. Remove, inspect solenoid and cartridge (items 4, 6) for wear or contamination.
3. Remove, inspect logic elements near "P" port (item 3) for wear or contamination.
4. Remove, inspect 3000 psi relief valve (item 2) for wear or contamination.
5. Remove and inspect orifices near "P" port for contamination.
6. Remove "P" port hose and fitting, visually inspect for contamination, check ball for movement.
7. Remove and inspect orifices near "MR" port for contamination.
8. Remove, inspect 2600 psi relief valve (item 5) for wear of contamination.
9. Remove, inspect logic element near "MR" port (item 3) for wear or contamination.

ELECTRICAL TROUBLESHOOTING GUIDE

Joystick Electrical Troubleshooting guide

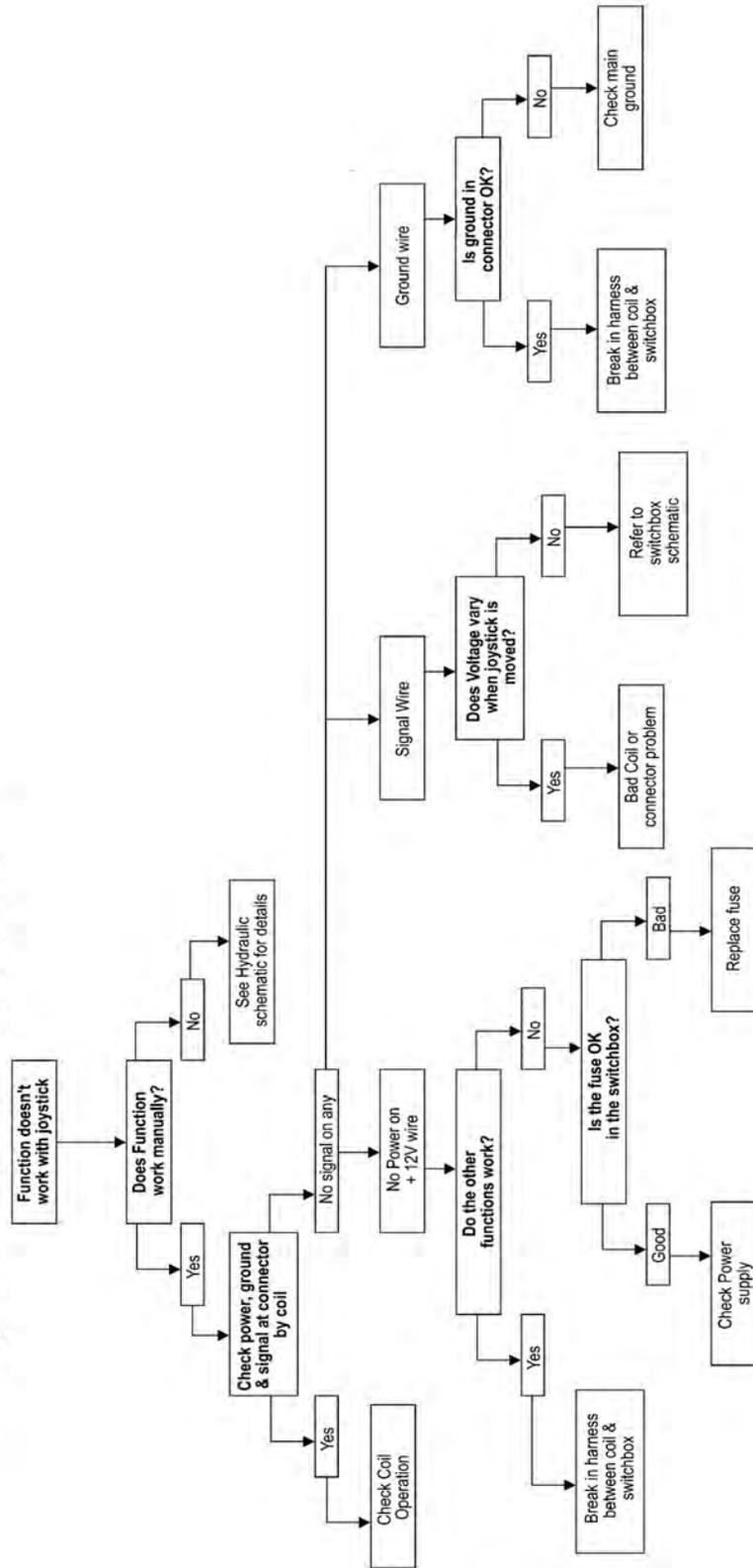

HYDRAULIC TROUBLESHOOTING GUIDE

Hydraulic Troubleshooting guide

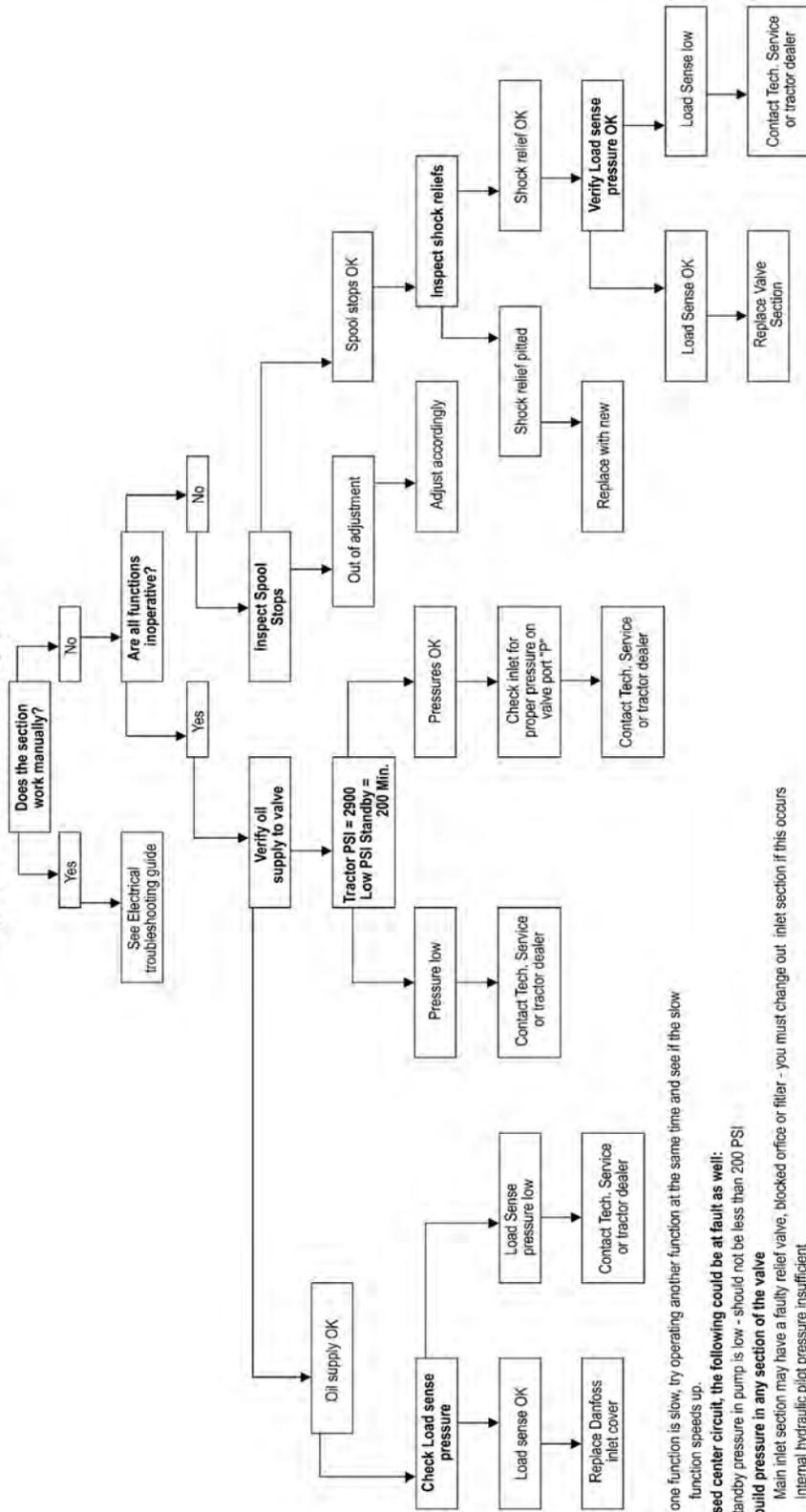

Notes: If one function is slow, try operating another function at the same time and see if the slow function speeds up.

On a closed center circuit, the following could be at fault as well:

Tractor standby pressure in pump is low - should not be less than 200 PSI

Cannot build pressure in any section of the valve

Main inlet section may have a faulty relief valve, blocked orifice or filter - you must change out inlet section if this occurs
Internal hydraulic pilot pressure insufficient

TROUBLESHOOTING

JOYSTICK TROUBLESHOOTING

Boom operation not responding to joystick movement.

Isolate hydraulic vs. electronic symptom.

Turn off electronic master switch (preventing electronic actuator on valve from attempting to hold spool in neutral position). With tractor engine running, operate the valve section with the manual handle. If function operates normally, continue with electronic inspection. If function does not operate normally, continue with hydraulic inspection.

Electronic inspection.

Connect a voltmeter to the cable connector of the valve section that is not operating. This will allow you to measure supply and signal voltage when the joystick is operated.

Main, Secondary, and Swivel Valves – signal voltage should be 50% of supply voltage with joystick in Neutral position, up to 75% of supply voltage in B direction, down to 25% of supply voltage in A direction. Signal voltage should change smoothly with lever movement.

Pin #1 – Signal Voltage, Pin #4 – Power Voltage, Pin #3 – Ground

Deck Roll Valve or Float Valve – signal voltage should be 50% of supply voltage with joystick in Neutral position, up to 65% of supply voltage in B direction, down to 35% of supply voltage in A direction. Signal voltage should change smoothly with lever movement. Signal voltage should be approximately 75% of supply voltage when float switch is operated.

Pin #1 – Signal Voltage, Pin #4 – Power Voltage, Pin #3 – Ground

Shield Valve or On/Off Valve – Voltage on pin #1 should be equal to supply voltage when switch is operated in A direction. Voltage on pin #4 should be equal to supply voltage when switch is operated in B direction.

Pin #1 – Signal Voltage (Shield Open), Pin #4 – Signal Voltage (Shield Close), Pin #3 – Ground

If none of the valve will operate with electrical signal, verify that there is oil pressure at the valve inlet. Electrical Valves must have pilot supply oil to move the spools.

Possible electronic problems.

Open circuit (broken wire, bad connection or loose connection in switchbox).

Shorted to positive, ground, or other.

Incorrect voltage signal from joystick.

Continued on next sheet

TROUBLESHOOTING - CONTINUED

Hydraulic inspection.

Install 3 pressure gauges, on the valve inlet (use M port, or tee into hose supplying oil from the pump to the inlet), on the workport that is not operating, and on the LS port.

With the spools in Neutral

Gear pump – P should be approximately 200 psi, LS = 0, workport – pressure on cylinder or function.

LS pump – P should equal pump standby pressure, LS = 0, workport – pressure on cylinder or function.

Pressure Comp pump – P should equal pump standby pressure, LS = 0, workport – pressure on cylinder or function.

Gear pump – P should be approximately 200 psi higher than LS, LS should equal workport, workport – pressure on cylinder or function.

LS pump – P should be LS + standby, LS should equal workport, workport – pressure on cylinder or function.

Pressure Comp pump – P should equal pump standby pressure, LS should equal workport, workport – pressure on cylinder or function.

Operate one spool, measure pressures with function at end of travel or stop

Gear pump – P should equal valve relief setting or workport shock valve setting. LS should equal workport. Workport should equal relief setting or workport shock valve setting.

LS pump – P should equal valve relief setting, pump max pressure setting, or workport shock valve setting. LS should equal workport. Workport should equal relief setting, pump max pressure setting, or workport shock valve setting.

Pressure Comp pump – P should equal pump standby pressure, LS should equal workport. Workport should equal pump standby pressure or workport shock valve setting.

Operate more than one spool.

Gear pump – P should approximately 200 psi higher than LS. LS should equal highest workport pressure. Workport – pressure on cylinder or function.

LS pump – P should be LS + standby pressure. LS should equal highest workport pressure. Workport – pressure on cylinder or function.

Pressure Comp pump. P should equal pump standby pressure. LS should equal highest workport pressure. Workport – pressure on cylinder or function.

Possible hydraulic problems.

Cylinder leak.

LS signal leaking to tank before reaching pump LS port.

Hydraulic system or pump not supplying flow to valve.

WHEEL WEIGHT - BENGAL 18

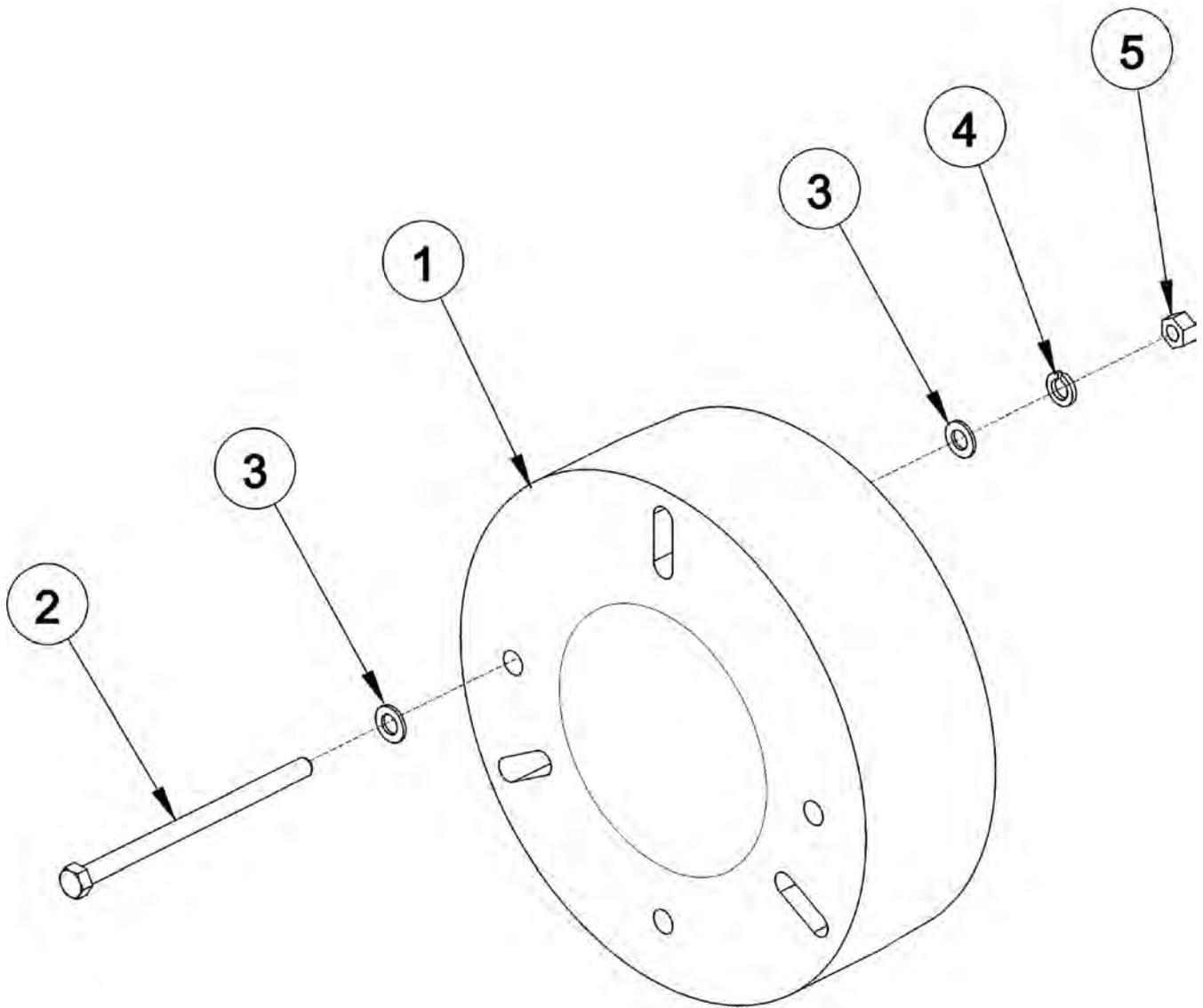

ITEM	PART NO.	QTY.	DESCRIPTION
1	30687	1	500# WHEEL WEIGHT
2	21956	4	CAPSCREW,3/4" X 13",NC
3	22021	8	FLATWASHER,3/4"
4	21993	4	LOCKWASHER,3/4"
5	21825	4	HEX NUT,3/4",NC

COMMON BENGAL T4



TIGER CORPORATION
WARRANTY INFORMATION

Tiger Corporation, 3301 N. Louise, Sioux Falls, South Dakota, warrants to the original Retail Customer, the new Tiger equipment is free of defects in material and workmanship. Any part of said equipment that in Tiger's adjustment, show evidence of such defects will be repaired or replaced without charge, provided that the failure of part(s) shall have occurred within twelve (12) months from the date of delivery of said equipment to the Retail Customer. Expendable components such as knives, oil, chain sprockets, skid shoes, knife mounting disks and the like are excluded but not limited to this warranty.

The Retail Customer must pay the transportation cost to and from the Tiger Dealer's service shop for warranty service. Warranty service will be performed by the Tiger Dealer from whom the equipment was purchased, in his service shop and during his regularly scheduled days and hours of operation.

All Tiger obligation under this warranty shall be terminated if the equipment is modified or altered in ways not approved in writing by Tiger, if repair parts other than genuine Tiger repair parts have been used, or if the equipment has been subject to misuse, neglect, accident, improper maintenance or improper operation.

Tiger Corporation reserves the right to make improvements in design or changes in specification at any time without incurring any obligation to owners of equipment previously sold.

No agent or person has authority to alter, add to or waive the above warranties which are agreed to be in the only warranties, representations or promises, expressed or implied, as to the quality or performance of the products covered and which do not include any implied warranty of merchantability or fitness. In no event will Tiger be liable for incidental or consequential damages or injuries, including, but not limited to, loss of profits, rental or substitute equipment or other commercial loss.

**THERE ARE NO WARRANTIES WHICH EXTEND
BEYOND THOSE EXPRESSED HEREIN.**

It is the Purchasers obligation to sign the warranty registration form **AFTER** he / she has Read and Understands the Operation and Safety Instructions stated within this manual.

ONE LAST WORD

This manual cannot possibly cover all of the potentially hazardous situations you will encounter. By being familiar, though, with the safety rules, operating and maintenance instructions in this manual you can help prevent accidents. The objective of this manual is to help make you a better operator. Remember, **SAFETY IS YOU!**



Your safety and the safety of those around you depends on **YOU**. Common sense should play a large role in the operation of this machine.

Since we at Tiger Corporation are constantly striving to improve our products, we reserve the right to change specifications or design at any time.