



# JD6105E T4F TRIPLE FLAIL

Current as of 03/01/21



## PARTS LISTING WITH MOUNTING AND OPERATING INSTRUCTIONS



**Tiger Corporation**  
3301 N. Louise Ave.  
Sioux Falls, SD 57107  
1-800-843-6849  
1-605-336-7900  
[www.tiger-mowers.com](http://www.tiger-mowers.com)

06011047

# TO THE OWNER / OPERATOR / DEALER

All implements with moving parts are potentially hazardous. There is no substitute for a cautious, safe-minded operator who recognizes the potential hazards and follows reasonable safety practices. The manufacturer has designed this implement to be used with all its safety equipment properly attached to minimize the chance of accidents.

**BEFORE YOU START!!** Read the safety messages on the implement and shown in this manual. Observe the rules of safety and use common sense!

**READ AND UNDERSTAND THIS MANUAL! Non-English speaking operators will need to GET THE MANUAL TRANSLATED as needed!**



# DANGER

**FAILING TO FOLLOW SAFETY MESSAGES AND OPERATING INSTRUCTIONS CAN CAUSE SERIOUS BODILY INJURY OR EVEN DEATH TO OPERATOR AND OTHERS IN THE AREA.**



1. Study and understand Operator's Manuals, Safety Decals, and Instructional Decals for tractor and implement to prevent misuse, abuse, and accidents. Practice before operating in a confined area or near passersby.  
● Learn how to stop engine suddenly in an emergency. Be alert for passersby and especially children

2. Allow no children on or near folding mower or tractor. Allow no riders on tractor or implement. Falling off may cause serious injury or death from being run over by tractor or mower or contact with rotating blades.

3. Operate only with tractor having Roll-Over Protective Structure (ROPS) and with seat belt securely fastened to prevent injury and possible death from falling off or tractor overturn.  
● Personal Protective Equipment such as Hard Hat, Safety Glasses, Safety Shoes, & Ear Plugs are recommended.

4. Block up or support raised machine and all lifted components securely before putting hands or feet under or working underneath any lifted component to prevent crushing injury or death from sudden dropping or inadvertent operation of controls. Make certain area is clear before lowering or folding

5. Before transporting, put Lift Lever in detent or full-lift position. Install Transport Safety Devices securely on folding mowers. Put Booms securely in Transport Rest.  
● Folding and Boom Mowers have raised center of gravity. Slow down when turning and on hillsides.

6. Make certain that SMV sign, warning lights, and reflectors are clearly visible. Follow local traffic codes.

7. Never operate with Cutting Head or Folding Section raised if passersby, bystanders, or traffic are in the area to reduce possibility of injury or death from objects thrown by Blades under Guards or mower structure.

8. Before dismounting, secure implement in transport position or lower to ground.  
● Put tractor in park or set brake, disengage PTO, stop engine, remove key, and wait until noise of rotation has ceased to prevent crushing by entanglement in rotating parts which could cause injury or death.  
● Never mount or dismount a moving vehicle. Crushing from runover may cause serious injury or death.

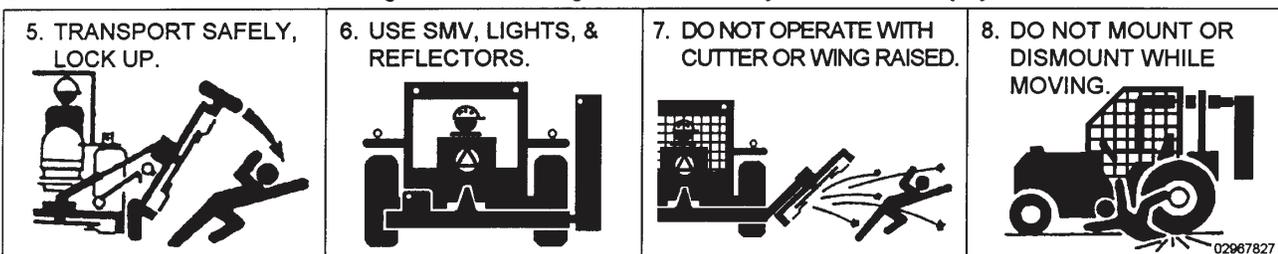

Warranty Information: Read and understand the complete Warranty Statement found in this manual. Fill out the Warranty Registration form in full and return it within 90 days. Make certain the Serial Number of the machine is recorded on the Warranty Card, and form that you retain.

# FORWARD

This manual contains information about many features of the Tiger mowing and roadside maintenance equipment. Some of these include: Safety precautions, Assembly instructions, Operations, Maintenance and Parts. This manual will also assist you in the proper break-in, daily care, and troubleshooting of your new mower.

We recommend that you read carefully the entire manual before operating the unit. Also, time spent in becoming fully acquainted with its performance features, adjustments, and maintenance schedules will be repaid in a long and satisfactory life of the equipment.

## **Troubleshooting - Please, before you call, help us to help you!**

Please look at the equipment to observe what is happening, then:

- Classify the problem
  - Hydraulic, electrical or mechanical - Read the trouble shooting section
  - Tractor or Truck chassis - Contact vehicle dealer
  
- If unable to correct the problem yourself, contact your local Tiger Dealer after gathering:
  - Machine model \_\_\_\_\_
  - Serial number \_\_\_\_\_
  - Dealer name \_\_\_\_\_
  - Detailed information about the problem including results of troubleshooting

**Attention Owner / Operator / Dealer:** It is your obligation to read, and understand, the warranty information section located at the back of this manual denoting that the purchaser understands the safety issues relating to this machine and has received and will read a copy of this manual.

If at any time, you have a service problem with your Tiger mower, Contact your local dealer for service and parts needed.

MANUFACTURED BY:

**Tiger Corporation**

3301 N. Louise Ave.

Sioux Falls, SD 57107

1-800-843-6849

1-605-336-7900

www.tiger-mowers.com

DISTRIBUTED BY:

\_\_\_\_\_

1- \_\_\_\_\_ - \_\_\_\_\_ - \_\_\_\_\_

1- \_\_\_\_\_ - \_\_\_\_\_ - \_\_\_\_\_



# TABLE OF CONTENTS

SAFETY SECTION_____	1
ASSEMBLY / MOUNTING SECTION_____	2
OPERATION SECTION_____	3
MAINTENANCE SECTION_____	4
PARTS SECTION_____	5
COMMON PARTS SECTION_____	6
WARRANTY INFORMATION_____	7



1012

**This symbol means:**

**CAUTION – YOUR SAFETY IS AT RISK!**

When you see this symbol, read and follow the associated instructions carefully or personal injury or damage may result.

Tiger is a registered trademark.





# **SAFETY SECTION**

Safety Section 1-1

# SAFETY

## GENERAL SAFETY INSTRUCTIONS AND PRACTICES

A careful operator is the best operator. Safety is of primary importance to the manufacturer and should be to the owner/operator. Most accidents can be avoided by being aware of your equipment, your surroundings, and observing certain precautions. The first section of this manual includes a list of Safety Messages that, if followed, will help protect the operator and bystanders from injury or death. Read and understand these Safety Messages before assembling, operating or servicing this Implement. This equipment should only be operated by those persons who have read the manual, who are responsible and trained, and who know how to do so responsibly.



The Safety Alert Symbol combined with a Signal Word, as seen below, is used throughout this manual and on decals which are attached to the equipment. The Safety Alert Symbol means: "ATTENTION! BECOME ALERT! YOUR SAFETY IS INVOLVED!" The Symbol and Signal Word are intended to warn the owner/operator of impending hazards and the degree of possible injury faced when operating this equipment.

**Practice all usual and customary safe working precautions and above all--- remember safety is up to YOU. Only YOU can prevent serious injury or death from unsafe practices.**



Indicates an imminently hazardous situation that, if not avoided, WILL result in DEATH OR VERY SERIOUS INJURY.



Indicates an imminently hazardous situation that, if not avoided, COULD result in DEATH OR SERIOUS INJURY.



Indicates an imminently hazardous situation that, if not avoided, MAY result in MINOR INJURY.



Identifies special instructions or procedures that, if not strictly observed, could result in damage to, or destruction of the machine, attachments or the environment.

**NOTE:** *Identifies points of particular interest for more efficient and convenient operation or repair.*

READ, UNDERSTAND, and FOLLOW the following Safety Messages. Serious injury or death may occur unless care is taken to follow the warnings and instructions stated in this Manual and in the Safety Messages on the implement. Always follow the instruction in this manual and use good common sense to avoid hazards.



**NOTE:** *If you want a translation of this safety section in one of the following Languages, please contact: Translations at 1502 E. Walnut Street Seguin, TX 78155; Fax: (830) 372-9529; Safety Section Translations are available in Spanish, Portuguese, French, German, Russian. PN GS01*



# SAFETY

## OPERATOR SAFETY

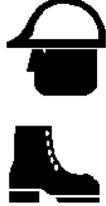
				
Read and understand Operator's Manual	Always wear Safety Glasses	Wear Hard Hat Safety Shoes	Never use Drugs or Alcohol when operating equipment	Wear Safety Vest when operating on or near roads



**TO AVOID SERIOUS INJURY OR DEATH DO THE FOLLOWING:**

- **READ, UNDERSTAND** and **FOLLOW** Operator's Manual instructions, Warnings and Safety Messages.
- **WEAR SAFETY GLASSES**, safety shoes, hard hat, hearing protection and gloves when operating or repairing equipment
- **WEAR** appropriate breathing respirator when operating in dusty conditions to avoid respiratory diseases.
- **DO NOT WEAR** loose clothing or jewelry to avoid rotating parts entanglement injury.
- **DO NOT USE DRUGS** or **ALCOHOL** before or while operating equipment.
- **DO NOT ALLOW** anyone to operate equipment under the influence of drug or alcohol.
- **CONSULT** medical professional for medication impairment side effects.
- **STAY ALERT**, prolonged operation can cause fatigue, **STOP** and **REST**.

## GENERAL OPERATING SAFETY

### **VISIBILITY CONDITIONS WHEN MOWING:**

- **OPERATE IN DAYLIGHT** or with lights that gives at least 100 yards clear visibility.
- **BE ABLE TO SEE** and identify passersby, steep slopes, ditches, drop-offs, overhead obstructions, power lines, debris and foreign objects.

### **GROUND SPEED WHEN MOWING:**

- **NORMAL SPEED** range is between 2 to 5mph.
- **ADJUST MOWING SPEED** for terrain conditions and grass type, density and cut height.
- **REDUCE MOWING SPEED** when near steep slopes, ditches, drop-offs, overhead obstructions, power lines and to avoid debris and foreign objects.

### **INSECT INFESTATION**

- Do Not operate in areas where bees or insects may attack unless you **WEAR PROTECTIVE CLOTHING** or use enclosed tractor cab.

### **PTO SPEED:**

- **DO NOT EXCEED IMPLEMENT RATED PTO SPEED**
- **AVOID** exceeding rated PTO speeds that may result in broken drivelines or blade failures.

### **SAFETY SIGNS:**

- **REPLACE** missing, damaged or unreadable safety signs immediately. *PN OS01*

# SAFETY

## CRUSHING HAZARDS

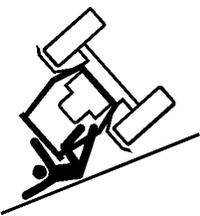
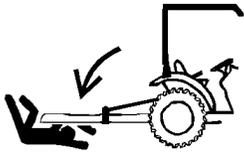
				
Crushing injury from roll over	Lock ROPS in up position	Always wear seatbelt	Crushing injury implement falling	Crushing injury wing falling

### **⚠ DANGER**

TO AVOID SERIOUS INJURY OR DEATH FROM FALLING OFF TRACTOR, EQUIPMENT RUN OVER, ROLLOVER AND CRUSHING BY FALLING WING OR IMPLEMENT:

- USE ROPS and SEAT BELT equipped tractors for mowing operations.
- KEEP ROPS lock in up position.
- ALWAYS BUCKLE UP seat belt when operating tractor and equipment.
- ONLY OPERATE tractor and equipment while seated in tractor seat.

#### WHEN RAISING OR LOWERING WINGS:

- Raise or lower ONLY WHILE SEATED in tractor seat with seat belt buckled.
- KEEP BYSTANDERS CLEAR of area TO AVOID crushing.
- KEEP sufficient clearance around implement and wings TO AVOID contacting buildings or overhead power lines.

LIFTED Equipment can fall from mechanical or hydraulic failure or inadvertent Control Lever movement.

### **⚠ WARNING**

TO AVOID EQUIPMENT FALLING while working near or under lifted wings, components and implements raised by 3-Pointed tractor hitch:

- SECURELY SUPPORT or block up raised equipment, wings and components.
- BLOCK UP and securely support equipment before putting hands, feet or body under raised equipment or lifted components.
- KEEP BYSTANDERS CLEAR of folded wings until wings are blocked or locked up.

#### WHEN PARKING Implement and Tractor:

- LOWER implement, LOCK or BLOCK lifted parts before leaving equipment.
- NEVER leave implement unattended in a raised position.

### **⚠ WARNING**

TO AVOID CHILDREN FALLING OFF OR BEING CRUSHED BY EQUIPMENT:

- NEVER ALLOW children to play on or around Tractor or Implement.

#### WHEN UNHITCHING IMPLEMENT:

- LOWER implement, LOCK or BLOCK lifted parts before leaving equipment.

#### BEFORE REMOVING Wing Retaining Lock:

- ATTACH hoses to tractor.
- FILL Wing Cylinders with oil. (*Refer to Instructions in Operation Section*)
- KEEP bystanders away before operating wings.
- LOWER WINGS slowly and carefully. PN CHFM-03

# SAFETY

## CONNECTING OR DISCONNECTING IMPLEMENT SAFETY

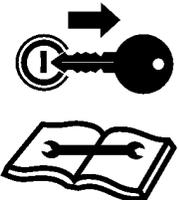
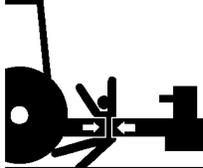
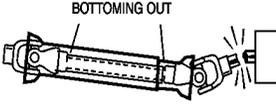
			 <p>PTO (Barra Gitatoria)</p>	 <p>BOTTOMING OUT</p>
<p>Stop Tractor Remove Key Read Manual</p>	<p>Crushing injury between tractor and implement</p>	<p>Crushing injury wing falling</p>	<p>Make sure PTO shaft is securely attached to tractor</p>	<p>Make sure PTO shaft are proper length</p>



**TO AVOID SERIOUS INJURY OR DEATH FROM BEING CRUSHED BY TRACTOR OR IMPLEMENT:**

**WHEN BACKING tractor to implement hitch:**

- **DO NOT ALLOW BYSTANDERS** between tractor and implement.

**BEFORE connecting and disconnecting implement hitch:**

- **STOP TRACTOR ENGINE**, place transmission into park, engage parking brake and remove key.

**WHEN connecting and disconnecting implement hitch:**

- **DO NOT** crawl or walk under raised mower or wing.

**WHEN CONNECTING IMPLEMENT DRIVELINE:**

**TO AVOID implement driveline coming loose during operation:**

- **LUBRICATE** yoke spring locking collar to ensure it freely slides on PTO shaft.
- **SECURELY** seat yoke locking balls in PTO shaft groove.
- **PUSH** and **PULL DRIVELINE** on both the tractor and implement **PTO SHAFTS** to ensure it is **SECURELY ATTACHED**.

**TO AVOID broken driveline during operations:**

- **CHECK** driveline for proper length between PTO shaft and implement gearbox shaft. *(Refer to Instructions in Operation Section)*
- Drivelines too short can pull apart or disengage.
- Drivelines too long can bottom out.
- Bottoming driveline telescoping assembly will stop sliding and become solid.
- Driveline bottoming can push through support bearings and break off PTO shaft.

**CONTACT DEALER if implement driveline does not match Tractor PTO shaft:**

- **DO NOT USE PTO ADAPTER.**  
Using a PTO adapter can cause:
  - Excessive vibration, thrown objects, blade and implement failures by doubling operating speed.
  - Increased working length exposing unshielded driveline areas and entanglement hazards.

**BEFORE REMOVING WING RETAINING LOCKS:**

- **FILL** Wing Cylinders with oil. *(Refer to Instructions in Operation Section)*
- **KEEP** bystanders clear of area before operating wings.
- **LOWER WINGS** slowly and carefully.

**DO NOT** connect the Mower to a tractor with the PTO directly connected to the Tractor transmission. *PN CDFM-03*

**SAFETY**

# SAFETY

## THROWN OBJECTS HAZARDS

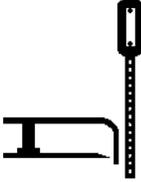
			
Mower Thrown Objects Hazard	Raised Mower Thrown Objects	Inspect Area remove foreign objects	Do not let blades contact solid objects



ROTARY MOWERS CAN THROW OBJECTS 300 FEET OR MORE UNDER ADVERSE CONDITIONS.

### TO AVOID SERIOUS INJURY OR DEATH TO OPERATOR OR BYSTANDERS FROM THROWN OBJECTS:

- KEEP bystanders 300 feet away

### STOP MOWING IF PASSERSBY ARE WITHIN 300 FEET UNLESS:

- **ALL THROWN OBJECT SHIELDING** including, Front and Rear Deflectors, Steel Guards, Bands, Side Skirts and Skid Shoes in place and in good condition when mowing.
- Mower sections or wing are adjusted to be close and parallel to ground without exposing blades.
- **MOWING AREA** has been inspected and foreign materials and debris have been removed.
- **PASSERSBY** are inside enclosed vehicle.

### INSPECT AREA FOR POTENTIAL THROWN OBJECTS BEFORE MOWING:

- **REMOVE** debris, rocks, wire, cable, metal objects and other foreign material from area. Wire, cable, rope, chains and metal objects can be thrown or swing outside deck with great velocity:
  1. **MARK** objects that cannot removed.
  2. **AVOID** these objects when mowing.

### HIGH GRASS and WEED AREA INSPECTION:

- **INSPECT** for and **REMOVE** any hidden large debris.
- **MOW** at Intermediate height
- **INSPECT** and remove remaining debris
- **MOW** at final height.

### MOWER THROWN OBJECT SHIELDING:

- **KEEP** all thrown object shielding including, Front and Rear Deflectors, Steel Guards, Bands, Side Skirts and Skid Shoes in place and in good condition when mowing.
- **DO NOT OPERATE** with any thrown object shielding missing, damaged or removed.

### RIGHT OF WAY (Highway) MOWING

- No shielding is 100% effective in preventing thrown objects. To Reduce Possibility of Injury:
  1. **MAINTAIN MOWER SHIELDING**, side skirts, skid shoes, and blades in good operational condition,
  2. **RAISE CUTTING HEIGHT** to **6 INCHES** minimum,
  3. **INSPECT AREA** thoroughly before mowing to **REMOVE** potential **THROWN OBJECT HAZARDS**,
  4. **NEVER ALLOW BLADES** to **CONTACT SOLID OBJECTS** like wire, rocks, post, curbs, guardrails, or ground while mowing. *PN TOFM-01*

# SAFETY

## THROWN OBJECTS HAZARD (CONTINUED)

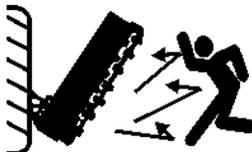
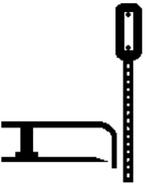
			
<p>Mower Thrown Objects Hazard</p>	<p>Raised Mower Thrown Objects</p>	<p>Inspect Area remove foreign objects</p>	<p>Do not let blades contact solid objects</p>

### MOWER OPERATION:

- **DO NOT** exceed mower's rated Cutting Capacity or cut non-vegetative material.
- **USE ENCLOSED TRACTOR CABS** when two or more mowers are operating in mowing area.
- **ADJUST** mower sections or wing close and parallel to ground without exposing blades
- **ADJUST** cutting **HEIGHT** to **AVOID BLADE CONTACT** with solid objects like wire, rocks, posts, curbs, guard rails and fixed obstructions.
- **DO NOT** operate mower when mower is raised or in transport position
- **STOP MOWING** immediately if blades strike heavy objects, fixed structures, metal guard rails and concrete structures:
  1. **BLADES CAN FAIL** from impact and objects can be thrown with great velocity.
  2. **INSPECT** and **REPLACE** any damaged blades.
  3. **CHECK** blade carrier balance and **REPLACE** if damaged.
- **DO NOT** mow in standing water **TO AVOID** possible **BLADE FAILURE**.
- **AVOID MOWING** in reverse:
  1. **STOP PTO** and back up mower.
  2. **LOWER** mower, engage **PTO** and mow forward.
- **STOP PTO** and **BLADES** when raising the mower to transport position.
- **DO NOT ENGAGE PTO** with mower in transport position.
- **STOP** mowing when **EXCESSIVE VIBRATION** occurs:
  1. **STOP PTO** and tractor **ENGINE**.
  2. **INSPECT** mower for vibration source
  3. **REPLACE** any damage parts and bent or damaged **BLADES**. *PN TOFM-02*

**SAFETY**

# SAFETY

## RUN OVER HAZARDS

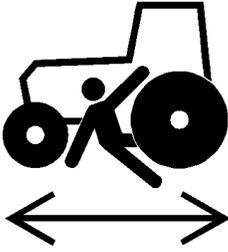
		
Operator run over hazard	Rider fall off run over hazard	Rider fall off run over hazard



**TO AVOID SERIOUS INJURY OR DEATH FROM FALLING OFF TRACTOR OR EQUIPMENT RUN OVER:**

- **USE ROPS** and **SEAT BELT** equipped tractors for mowing operations.
- **KEEP ROPS** locked in **UP** position.
- **ONLY** start tractor while seated in tractor seat.
- **ALWAYS BUCKLE UP** seat belt when operating tractor and equipment.
- **ONLY OPERATE** tractor and equipment while seated in tractor seat.
- **NEVER ALLOW RIDERS** on tractor or implement.

### **WHEN MOUNTING AND DISMOUNTING TRACTOR:**

- **ONLY** mount or dismount when tractor and moving parts are stopped.
- **STOP ENGINE AND PTO**, engage parking brake, lower implement, allow all moving parts to stop and remove key before dismounting from tractor. *PN R001*

# SAFETY

SAFETY

## PTO ENTANGLEMENT HAZARDS

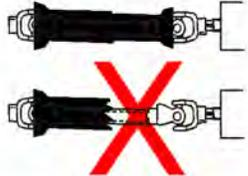
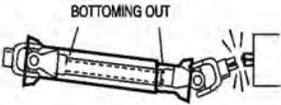
			
<p>Entanglement hazard Do Not approach or touch a rotating PTO driveshaft</p>	<p>Make sure PTO shaft is securely attached Do Not Use PTO Adapter</p>	<p>DO NOT Operate if PTO shields are damaged or missing</p>	<p>Make sure PTO shafts are proper length</p>



**KEEP AWAY FROM ROTATING DRIVELINES AND ELEMENTS TO AVOID SERIOUS INJURY OR DEATH:**

**STAY AWAY** and **KEEP** hands, feet and body **AWAY** from rotating blades, drivelines and parts until all moving elements have stopped.

- **STOP, LOOK** and **LISTEN** before approaching the mower to make sure all rotating motion has stopped.
- **ROTATING COMPONENTS CONTINUE** to **ROTATE** after the PTO is shut off.

### PTO SHIELDING:

#### TO AVOID SERIOUS INJURY OR DEATH FROM ENTANGLEMENT WHEN OPERATING IMPLEMENT:

- **KEEP PTO** shields, integral driveline shields and input shields installed
- **DO NOT OPERATE** mower without shields and guards in place or missing
- **REPAIR OR REPLACE** if damage, broken or missing
- **ALWAYS REPLACE GUARDS** that have been removed for service or maintenance.
- Do Not use PTO or PTO guard as a step.

#### TO AVOID broken driveline during operations:

- **CHECK** driveline for proper length between PTO shaft and implement gearbox shaft. (*Refer to Instructions in Operation Section*)
- Drivelines too short can pull apart or disengage.
- Drivelines too long can bottom out.  
Bottoming driveline telescoping assembly will stop sliding and become solid.
- Driveline bottoming can push through support bearings and break off PTO shaft
- **AVOID** sharp turns or lift mower to heights to cause driveline "knocking".
- Lubricate driveshaft-telescoping components weekly.

#### CONTACT DEALER if implement driveline does not match Tractor PTO shaft:

- **DO NOT USE PTO ADAPTER.**

Using a PTO adapter can cause excessive vibration, thrown objects, blade and implement failures by doubling operating speed. Increased working length exposing unshielded driveline areas. *PN PE01*

# SAFETY

## MOWER BLADE CONTACT HAZARDS

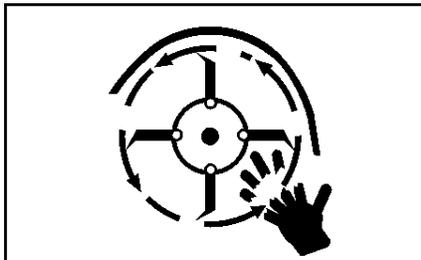

Do not put fingers underneath mower

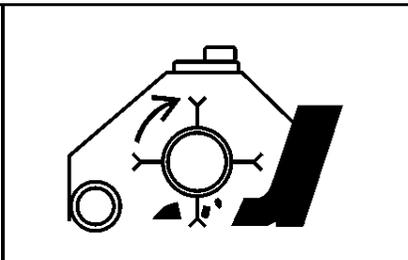

Do not put foot underneath mower

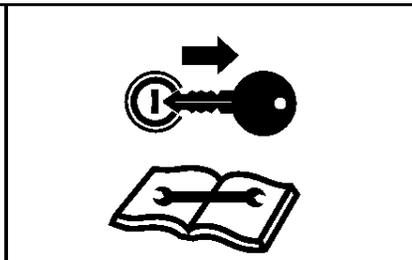

Stop Tractor Remove Key  
Read Manual



**KEEP AWAY FROM ROTATING BLADES TO AVOID SERIOUS INJURY OR DEATH FROM BLADE CONTACT:**

- **STAY AWAY** and **KEEP HANDS, FEET** and **BODY AWAY** from rotating blades, drivelines and parts until all moving elements have stopped.
- **DO NOT** put hands or feet under mower decks
- **STOP** rotating **BLADES** disengage PTO and wait for blade to stop rotating before raising mower deck or wings
- **STOP LOOK** and **LISTEN** before approaching the mower to make sure all rotating motion has stopped. *PN MBFM-01*



# SAFETY

## HIGH PRESSURE OIL LEAK HAZARD

			
High pressure oil penetrating skin	High pressure oil eroding skin	Using cardboard to check for oil leaks	Tank contents under pressure. Allow oil to cool before slowly removing cap



**TO AVOID SERIOUS INJURY OR DEATH FROM HIGH PRESSURE HYDRAULIC OIL LEAKS PENETRATING SKIN:**

- **DO NOT OPERATE** equipment with oil or fuel leaks.
- **KEEP** all hydraulic hoses, lines and connections in **GOOD CONDITION** and **TIGHT** before applying system pressure.
- **RELIEVE HYDRAULIC PRESSURE** before disconnecting lines or working on the system.
- **REMOVE** and replace hose if you suspect it leaks. Have dealer test it for leaks.

### **HIGH PRESSURE FLUID LEAKS CAN BE INVISIBLE.**

#### **WHEN CHECKING FOR HYDRAULIC LEAKS AND WORKING AROUND HYDRAULIC SYSTEMS:**

- **ALWAYS WEAR** safety glasses and impenetrable gloves.
- **USE** paper or cardboard to search for leaks.
- **DO NOT USE** hands or body parts to search for leak.
- **KEEP** hands and body **AWAY** from pin holes and nozzles ejecting hydraulic fluid.
- Hydraulic fluid may cause gangrene if not surgically removed immediately by a doctor familiar with this form of injury.

#### **Use Caution when removing Hydraulic Tank cap.**

- Tank content maybe under pressure.
- Allow oil to cool before removing cap.
- Relieve oil pressure before removing cap slowly.
- Stay away from hot oil that may spray from tank.

*PN HPFM-01*

**SAFETY**

# SAFETY

## ELECTRICAL & FIRE HAZARDS

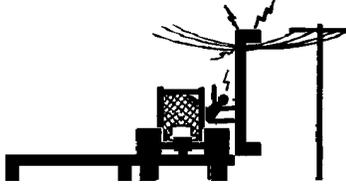
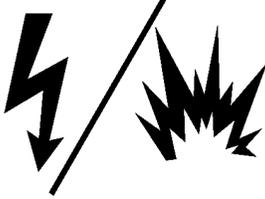
		
Wing contacting overhead electrical lines	Strike and explosion Hazard Blades Contacting Utility or Gas Lines	Do not operate near fires. Keep mower deck clear of debris

**⚠ DANGER** TO AVOID SERIOUS INJURY OR DEATH FROM ELECTRICAL CONTACT WHEN WORKING AROUND ELECTRICAL POWER LINES, GAS LINES AND UTILITY LINES:

- **INSPECT** mowing area for overhead or underground electrical power lines, obstructions, gas lines, cables and Utility, Municipal, or other type structure.
- **KEEP** all raised wings at a 10 feet or greater distance from all power lines and overhead obstructions.
- **DO NOT** allow mower to contact with any Utility, Municipal, or type of structures and obstructions.
- **CALL 811** and 1-800-258-0808 for identify buried utility lines.

**FIRE PREVENTION GUIDELINES while Operating, Servicing, and Repairing Mower and Tractor to reduce equipment and grass fire Risk:**

- **EQUIP** Tractor with a **FIRE EXTINGUISHER**
- **DO NOT OPERATE** mower on a tractor equipped with under frame exhaust
- **DO NOT SMOKE** or have open flame near Mower or Tractor
- **DO NOT DRIVE** into burning debris or freshly burnt area
- **AVOID FIRE IGNITION** by not allowing mower blade to contact solid objects like metal or rock.
- **ADJUST SLIP CLUTCHES** to avoid excessive slippage and clutch plate heating.
- **CLEAR** any grass clippings or debris buildup around mower drivelines, slip clutches, and gearboxes.
- **SHUT OFF ENGINE** while refueling.
- Do not operate if oil is leaking. Repair oil leak and remove all accumulated oil before operating.
- **CLEAR** any grass clippings or debris buildup around mower hydraulic pumps, valves or tanks. *PN EFFM-01*

# SAFETY

## TRANSPORTING HAZARDS

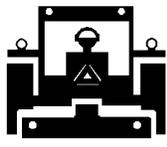
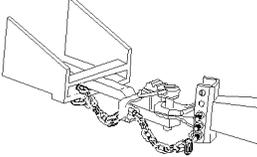
				
Use SMV signs and Flashing Lights	Loss of Control Stopping Hazard	Loss of Control Speeding Hazard	Use Safety Tow Chain - Tractor to Implement	Engage Transport Locks

### **WARNING**

TO AVOID SERIOUS INJURY AND DEATH WHEN TOWING OR TRANSPORTING EQUIPMENT:

- **KEEP** transport speed **BELOW** 20 mph to maintain control of equipment.
- **REDUCE SPEED** on inclines, on turns and in poor towing conditions.
- **DO NOT TOW** with trucks or other vehicles.
- **USE** only properly sized and equipped tractor for towing equipment.
- **FOLLOW** all local traffic regulations.

#### **TRACTOR REQUIREMENTS FOR TOWING OR TRANSPORTING IMPLEMENTS:**

- **ONLY TRANSPORT** with tractor with **ROPS** in the raised position.
- **USE** properly sized and equipped tractor that exceeds implement weight by at least 20%.
- **KEEP** 20% of tractor weight on front wheels to maintain safe steering.

#### **BEFORE TRANSPORTING OR TOWING IMPLEMENT:**

##### **TRACTOR INSPECTION:**

- **CHECK** steering and braking for proper operation and in good condition.
- **CHECK SMV** sign, reflectors and warning lights for proper operation and visibility behind unit.
- **CHECK** that your driving vision is not impaired by tractor, cab, or implement while seated in tractor seat.
- **ADJUST** your operating position, mirrors, and implement transport for clear vision for traveling and traffic conditions.

#### **PREPARE IMPLEMENT FOR TRANSPORTING OR TOWING:**

##### **ENGAGE TRANSPORT LOCKS AND SAFETY CHAINS:**

- **RAISE MOWER** and **ENGAGE** center axle cylinder transport stops or pins.
- **RAISE WINGS** and **ENGAGE TRANSPORT LOCKS** or pins.
- **ATTACH** implement **SAFETY CHAIN** to tractor.
- **REMOVE** any cut material collected on mower deck.

#### **DETERMINE STOPPING CHARACTERISTICS OF TRACTOR AND IMPLEMENT FOR TRANSPORTING OR TOWING:**

##### **BRAKING TESTS:**

- **INSTALL** center axle cylinder transport stops or pins.
- Observe **STOPPING** distances increases with increased speeds.
- **DETERMINE** the maximum safe transport speed that does not exceed 20 mph.

#### **DETERMINE MAXIMUM TURNING SPEED BEFORE OPERATING ON ROADS OR UNEVEN GROUND:**

- **TEST** equipment in slowly increasing speed in turns to determine it can be operated at higher speeds.
- **USE REDUCED** turning speeds in sharp turns to avoid equipment turning over.

#### **WHEN TOWING OR TRANSPORTING EQUIPMENT:**

- Always **WEAR SEAT BELT** when operating or transporting mower.
- **USE** low speeds to avoid overturn with raised wings.
- **USE** low speeds and gradual steering on curves, hills, rough or uneven surfaces and on wet roads.
- **TURN ON** tractor **FLASHING WARNING LIGHTS**.
- **ALLOW** clearance for implement swing while turning.

**KEEP** all raised wings at 10 feet or greater distance from all power lines and overhead obstructions. *PN TH01*

# SAFETY

## HAZARDS WITH MAINTENANCE OF IMPLEMENT

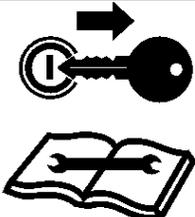
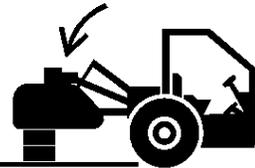
				
Periodically inspect all moving parts, lubricate drivelines, and tighten all fasteners	Stop engine remove key before conducting maintenance	Block up implement before servicing Use large blocks on soft or wet soil	Engage cylinder transport locks	Inspect Blades for damage or cracks

**WARNING** AVOID SERIOUS INJURY OR DEATH FROM COMPONENT FAILURE BY KEEPING IMPLEMENT IN GOOD OPERATING CONDITION IN PERFORMING PROPER SERVICE, REPAIRS AND MAINTENANCE.

**BEFORE PERFORMING SERVICE, REPAIRS AND MAINTENANCE ON THE IMPLEMENT:**

- **STOP ENGINE AND PTO**, engage parking brake, lower implement, allow all moving parts to stop and remove key before dismantling from tractor.
- **PLACE** implement on ground or securely block up raised equipment. Use large blocks on soft or wet soil.
- **PUSH** and **PULL** Remote Hydraulic Cylinder lever to relieve hydraulic pressure.
- **DISCONNECT IMPLEMENT** driveline from tractor **PTO SHAFT**.

**WEAR SAFETY GLASSES, PROTECTIVE GLOVES** and follow **SAFETY PROCEDURES** when performing service, repairs and maintenance on the implement:

- Always **WEAR** protective **GLOVES** when handling blades, knives, cutting edges or worn component with sharp edges.
- Always **WEAR GLOVES** and **SAFETY GLASSES** when servicing hot components
- **AVOID CONTACT** with hot hydraulic oil tanks, pumps, motors, valves and hose connection surfaces.
- **SECURELY** support or **BLOCK UP** raised implement, framework and lifted components before working underneath equipment.
- **STOP** any implement movements and **SHUT-OFF TRACTOR** engine before doing any work procedures.
- **USE** ladder or raised stands to reach high equipment areas inaccessible from ground.
- **ENSURE** good footing by standing on solid flat surfaces when getting on implement to perform work.
- **FOLLOW** manufacturer's instructions in handling oils, solvents, cleansers, and other chemical agents.
- **DO NOT** change any factory-set hydraulic calibrations to avoid component or equipment failures.
- **DO NOT** modify or alter implement, functions or components.
- **DO NOT WELD** or repair rotating mower components. These may cause vibrations and component failures being thrown from mower.

**PERFORM SERVICE, REPAIRS, LUBRICATION AND MAINTENANCE OUTLINED IN IMPLEMENT MAINTENANCE SECTION:**

- **INSPECT** for loose fasteners, worn or broken parts, leaky or loose fittings, missing or broken cotter keys and washers on pins, and all moving parts for wear.
- **REPLACE** any worn or broken parts with authorized service parts.
- **LUBRICATE** unit as specified by lubrication schedule
- **NEVER** lubricate, adjust or remove material while it is running or in motion.
- **TORQUE** all bolts and nuts as specified.

**BLADE INSPECTION:**

- **REPLACE** bent, damage, cracked or broken blades immediately with new blades.
- **AVOID** blade failures and thrown broken blades. **DO NOT** straighten, weld, or weld hard-facing blades.

**SAFETY SHIELDS, GUARDS AND SAFETY DEVICES INSPECTION:**

- **KEEP** all Deflectors, Steel Guards, Gearbox Shields, and PTO integral shields, Bands, Side Skirts and Skid Shoes in place and in good condition.
- **REPLACE** any missing, broken or worn safety shields, guards and safety devices.
- Engine Exhaust, some of its constituents, and certain vehicle components contain or emit chemicals known to the state of California to cause cancer, birth defects or other reproductive harm.
- Battery posts, terminals and related accessories contain lead and lead compounds, chemicals known to the state of California to cause cancer, birth defects or other reproductive harm.
- **DISCONNECT** Pump solenoid valve or PTO driveline connection before servicing mower head.
- **FOLLOW INSTRUCTIONS** in maintenance section when replacing hydraulic cylinders to prevent component falling.

PN HMFM-02

# SAFETY

## **PARTS INFORMATION**

### PARTS INFORMATION

Tiger mowers use balanced and matched system components for blade carriers, blades, cuttershafts, knives, knife hangers, rollers, drivetrain components, and bearings. These parts are made and tested to Tiger specifications. Non-genuine "will fit" parts do not consistently meet these specifications. The use of "will fit" parts may reduce mower performance, void mower warranties, and present a safety hazard. Use genuine Tiger mower parts for economy and safety. (SPTM-1)

**SEE YOUR TIGER DEALER**

## **Decal Location**

**NOTE:** Tiger supplies safety decals on this product to promote safe operation. Damage to the decals may occur while in shipping, use, or reconditioning. Tiger cares about the safety of its customers, operators, and bystanders, and will replace the safety decals on this product in the field, free of charge (Some shipping and handling charges may apply). Contact your Tiger dealer to order replacement decals.

**SAFETY**

# SAFETY

## SAFETY

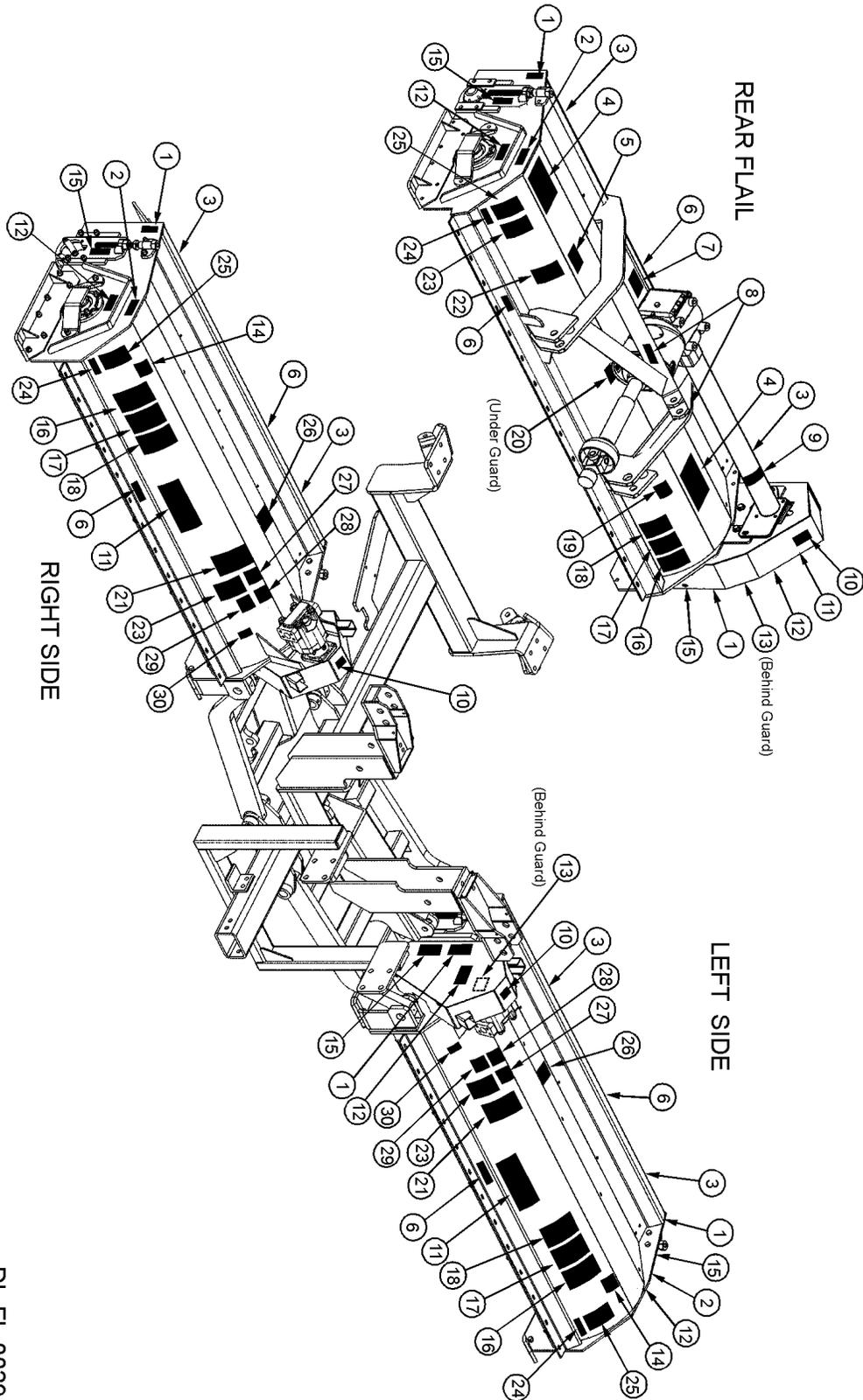

DL-FL-0029

Safety Section 1-16

# SAFETY

**SAFETY**

ITEM	PART NO.	QTY.	TYPE	DESCRIPTION
1.	6T3261	6	INSTRUCT	Greasing Instructions
2.	22839	3	INSTRUCT	Do not lubricate with automatic grease gun
3.	42399	6	REFLECTOR	Red Reflector
4.	31523	2	LOGO	Tiger Logo (18.25"x 10")
5.	D708	1	WARNING	Clear away grass or debris
6.	24028	6	DANGER	Thrown Object Hazard
7.	6T-3240	1	IMPORTANT	Use Synthetic Gear Lube
8.	TF-1112	2	IMPORTANT	Place tractor lift arm link pins in vertical position
9.	D713	1	WARNING	Do not operate without guards
10.	00758194	3	WARNING	Pinch Point Hazard
11.	31522	3	LOGO	Tiger Logo (10"x 5.5")
12.	6T3249A	6	INSTRUCT	Greasing Instructions-Cutter Shaft Bearing
13.	D646	3	DANGER	Guard Missing, Do not Operate
14.	D706	1	INSTRUCT	Lubrication Chart - Right/Left Flail
15.	21405	6	INSTRUCT	Standard/Smooth Cut Measurements
16.	D686	3	DANGER	Thrown Object / Crushing Hazard
17.	D687	3	DANGER	Entanglement / Run Over Hazard
18.	D696	3	DANGER	Multi-Hazard
19.	D700	1	INSTRUCT	Lubrication Chart - Rear Flail
20.	D546	1	DANGER	Guard Missing, Do Not Operate
21.	D699	2	WARNING	Multi-Hazard
22.	D547	1	DANGER	Driveline Hazard
23.	32709	3	WARNING	Use Tiger Genuine Parts
24.	42400	3	REFLECTOR	Yellow Reflector
25.	6T3236	3	LOGO	Made in the USA
26.	D703	2	DANGER	Crushing Hazard
27.	02962765	2	DANGER	Crushing Hazard & Pinch Points
28.	02965262	2	WARNING	Oil Leak Hazard
29.	D698	2	DANGER	Crushing Hazard-Injury or Death
30.	6T3221	2	IMPORTANT	Lubricate spindle every 40 hours

# SAFETY

SAFETY

## Decal Description

<b>⚠ WARNING</b>	<b>⚠ ADVERTENCIA</b>	
<p><b>TO AVOID EQUIPMENT AND GRASS FIRES:</b></p> <ul style="list-style-type: none"> <li>• CLEAR AWAY grass or debris from slip clutches, gearboxes, drivelines and decks.</li> </ul> <p><b>TO AVOID FIRE IGNITION:</b></p> <ul style="list-style-type: none"> <li>• DO NOT ALLOW BLADES TO CONTACT rocks, metal or solid objects.</li> </ul>		<p><b>PARA EVITAR INCIENDOS DE EQUIPO Y CÉSPED:</b></p> <ul style="list-style-type: none"> <li>• QUITE el césped o escombros de embrague deslizante, caja de engranajes, líneas de conducción y cubiertas.</li> </ul> <p><b>PARA EVITAR INCIENDOS POR IGNICIÓN:</b></p> <ul style="list-style-type: none"> <li>• NO PERMITA QUE LAS LAMINAS CONTACTEN piedras, metal o objetos sólidos.</li> </ul> <p style="text-align: right;">D708</p>

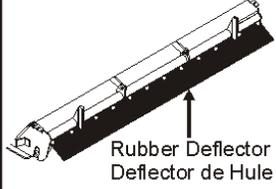
<b>⚠ DANGER</b>	<b>⚠ PELIGRO</b>	
<p style="text-align: center;"><b>THROWN OBJECT HAZARD</b></p> <p><b>TO AVOID SERIOUS INJURY OR DEATH:</b> DO NOT OPERATE if Thrown Object Shielding is damaged or missing.</p> <ul style="list-style-type: none"> <li>• Maintain Rubber Deflectors in good condition.</li> <li>• Inspect Rubber Deflectors frequently.</li> </ul>	 <p style="text-align: center;">Rubber Deflector Deflector de Hule</p>	<p style="text-align: center;"><b>RIESGO DE OBJETOS LANZADOS</b></p> <p><b>PARA EVITAR LESION SERIA O MUERTE:</b> NO OPERE si la Cubierta de Objetos Lanzados esta dañada o falta.</p> <ul style="list-style-type: none"> <li>• Mantenga Los Deflectores de Hule en buenas condiciones.</li> <li>• Inspeccione Los Deflectores de Hule con frecuencia.</li> </ul> <p style="text-align: right;">24028</p>

<b>⚠ WARNING</b>	<b>⚠ ADVERTENCIA</b>	
<p style="text-align: center;"><b>PINCH POINT HAZARD</b></p> <p><b>TO AVOID SERIOUS INJURY:</b></p> <ul style="list-style-type: none"> <li>• DO NOT OPERATE with Belt Shield removed.</li> </ul>		<p style="text-align: center;"><b>RIESGO DE PUNTOS DE PELLIZCO</b></p> <p><b>PARA EVITAR LESION SERIA:</b></p> <ul style="list-style-type: none"> <li>• NO OPERE con la cubierta de correa ausente.</li> </ul> <p style="text-align: right;">00758194</p>



# SAFETY



SAFETY



# SAFETY

**SAFETY**

<b>⚠ DANGER</b>	<b>⚠ PELIGRO</b>	
<b>KEEP AWAY THROWN OBJECTS HAZARD</b>	<b>CONSERVESE LEJOS OBJETOS LANZADOS</b>	
<p>Mower can throw objects up to 300 feet. <b>TO AVOID SERIOUS INJURY OR DEATH to operator or bystanders:</b></p> <ul style="list-style-type: none"> <li>• STOP mowing if bystanders or traffic come within 300 feet.</li> <li>• <b>DO NOT OPERATE</b> with thrown object shielding removed.</li> <li>• <b>KEEP</b> thrown object shielding in place and in good condition during operation.</li> <li>• <b>INSPECT</b> area for potential mower thrown object hazards before mowing.</li> <li>• Remove and <b>AVOID</b> objects such as wire, cable, metal objects and all other foreign material.</li> <li>• <b>DO NOT ALLOW</b> blades to contact solid objects like wire, rocks, posts, curbs or guard rails.</li> <li>• <b>DO NOT OPERATE</b> in transport position or with wings off ground.</li> </ul>	 <p style="text-align: center;"><b>TRASH BASURA</b></p>	<p>Cortacésped puede lanzar objetos hasta 300 pies. <b>PARA EVITAR LESION SERIA O MUERTE a operadores y personas presentes:</b></p> <ul style="list-style-type: none"> <li>• Pare de segar si personas o trafico se acercan entre 300 pies del area de segar.</li> <li>• <b>NO OPERE</b> sin la cubierta para objetos lanzados.</li> <li>• <b>MANTENGA</b> la cubierta para objeto lanzado en su lugar y en buenas condiciones.</li> <li>• <b>INSPECCIONE</b> el área por si hay riesgos potenciales de objetos lanzados antes de segar.</li> <li>• <b>REMUEVA</b> y <b>EVITE</b> objetos come alambre, cable, objetos de metal y todo otro material extranjero.</li> <li>• <b>NO DEJE</b> que las cuchillas contacten los objetos sólidos como alambre, rocas, postes, borde de banquetta, o barandillas.</li> <li>• <b>NO OPERE</b> en posicion de transporte o con las alas levantadas.</li> </ul> <p style="text-align: right; font-size: small;">D686_1</p>

<b>⚠ DANGER</b>	<b>⚠ PELIGRO</b>	
<b>Crushing Hazard Injury or Death</b>	<b>Riesgo de Aplastamiento Lesion o Muerte</b>	
<p><b>TO AVOID SERIOUS INJURY OR DEATH:</b></p> <ul style="list-style-type: none"> <li>• USE tractor equipped with <b>Rollover Protective Structure ("ROPS")</b> including roll bar and seat belt. Keep roll bar in raised position.</li> <li>• <b>KEEP ALERT</b> and <b>AVOID</b> hitting stumps, holes, ruts, and uneven terrain.</li> <li>• <b>ALWAYS BUCKLE UP</b> seat belt.</li> <li>• <b>STAND CLEAR</b> when removing transport latch, lowering or raising wings.</li> <li>• <b>CLEAR AREA</b> of bystanders before lowering implement wings.</li> <li>• <b>IMPLEMENT CAN FALL</b> from hydraulic failure or accidental operation of controls.</li> <li>• <b>BLOCK UP</b> and securely support equipment before putting hands, feet or body under raised equipment or lifted components.</li> </ul> <p style="text-align: right; font-size: small;">D686_3</p>		<p><b>PARA EVITAR LESION SERIA O MUERTE:</b></p> <ul style="list-style-type: none"> <li>• USE un tractor equipado con Estructura Protectora Contra Vuelcos ("ROPS") incluyendo barra antivuelco y cinturón de seguridad. Mantenga la barra antivuelco en la posición elevada.</li> <li>• <b>MANTENGASE ALERTO</b> y <b>EVITE</b> golpes en troncos, agujeros, pozos o terreno en desnivel.</li> <li>• <b>SIEMPRE ABROCHE</b> el cinturón de seguridad.</li> <li>• <b>PERMANEZCA ALEJADO</b> al quitar el seguro de transporte, y al bajar o subir las alas.</li> <li>• <b>DESOCUPE</b> el <b>ÁREA</b> de personas presentes antes de bajar las alas del implemento.</li> <li>• <b>EL IMPLEMENTO SE PUEDE CAER</b> por el mal funcionamiento hidraulico o operacion accidental de los controles.</li> <li>• <b>BLOQUEE</b> y soporte con seguridad el equipo antes de poner manos, pies o cuerpo debajo del equipo o componentes levantados.</li> </ul>

# SAFETY

SAFETY

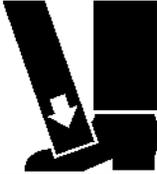
<b>⚠ DANGER</b>			
<b>CRUSHING HAZARD AND PINCH POINTS</b>			
			
<b>TO AVOID SERIOUS INJURY OR DEATH:</b>			
<ul style="list-style-type: none"><li>• KEEP AWAY from moving machinery parts that can pinch, crush or fall.</li></ul>			
<b>⚠ PELIGRO</b>			
<b>RIESGOS DE APLASTAMIENTO Y PUNTOS DE PELLIZCO</b>			
<b>PARA EVITAR LESION SERIA O MUERTE:</b>			
<ul style="list-style-type: none"><li>• MANTENGASE ALEJADO de piezas moviles de la maquina que pueden peliscar, aplastar o caerse.</li></ul>			
02962765			

	<b>⚠ DANGER</b>
	Crushing Hazard Transport Latch RAISE AND SECURELY LOCK Wing Transport Latch before transporting mower on roadways or working under wing.
	<b>⚠ PELIGRO</b>
	Riesgo de Aplastamiento <span style="float: right;">D703</span> Cierre de Transporte LEVANTE Y DE FORMA SEGURA ATRANQUE el cierre de ala de transporte antes de transportarel cortacépedes en carretera o trabajando abajo de la ala.

# SAFETY

SAFETY

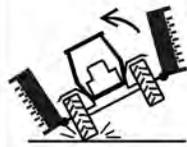
<b>⚠ WARNING</b>		<b>⚠ ADVERTENCIA</b>	
<p><b>TO AVOID SERIOUS INJURY AND DEATH DURING TRANSPORTATION:</b></p> <ul style="list-style-type: none"> <li>• ALWAYS BUCKLE UP seat belt.</li> <li>• PLACE wing securely in Transport latch and turn off master switch.</li> <li>• CHECK SMV sign, reflectors and warning lights for visibility behind unit.</li> <li>• TURN ON tractor flashing warning lights.</li> </ul> <p><b>TO AVOID LOSS OF TRANSPORTATION CONTROL:</b></p> <ul style="list-style-type: none"> <li>• DO NOT travel at speeds over 20 mph.</li> <li>• REDUCE SPEED on inclines, in turns and in poor weather conditions.</li> </ul>		<p><b>PARA EVITAR LESION SERIA Y MUERTE DURANTE LA TRANSPORTACION:</b></p> <ul style="list-style-type: none"> <li>• SIEMPRE ABROCHE el cinturón de seguridad.</li> <li>• COLOQUE el brazo seguramente en transporte y apague el interruptor principal.</li> <li>• VERIFIQUE QUE EL SMV, reflectors, y luces intermitentes de advertencia pueden ser vistos claramente por detras de la unidad.</li> <li>• PRIENDA las luces intermitentes de advertencia.</li> </ul> <p><b>PARA EVITAR LA PÉRDIDA DEL CONTROL DE TRANSPORTACION:</b></p> <ul style="list-style-type: none"> <li>• NO remolque en velocidades arriba de 20 mph.</li> <li>• REDUZCA LA VELOCIDAD en inclinas, en vueltas y en pobres condiciones de remolque.</li> </ul>	
		D699_1	

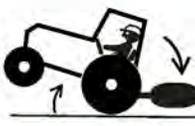
<b>⚠ WARNING</b>		<b>⚠ ADVERTENCIA</b>	
<p><b>TO AVOID SERIOUS INJURY AND DEATH DURING OPERATION:</b></p> <ul style="list-style-type: none"> <li>• DO NOT lift implement while on steep slopes.</li> <li>• KEEP AWAY from soft ditch banks and holes.</li> <li>• ALWAYS MAINTAIN 20% of tractor weight on front wheels.</li> <li>• DO NOT start or accelerate suddenly.</li> <li>• KEEP mower AT LEAST 10 FEET AWAY from electric lines and pipe lines.</li> </ul>		<p><b>PARA EVITAR LESION SERIA Y MUERTE DURANTE LA OPERACION:</b></p> <ul style="list-style-type: none"> <li>• NO levante el implemento al estar en pendientes pronunciados..</li> <li>• MANTENGASE ALEJADO DE agujeros y zanjas blandas..</li> <li>• MANTENGA SIEMPRE el 20% de peso del tractor en las ruedas delanteras.</li> <li>• NO comience ni acelere repentinamente.</li> <li>• MANTENGA la unidad, por lo menos 10 pies de distancia de las líneas electricas y líneas de tubo.</li> </ul>	
		D699_2	

<b>⚠ WARNING</b>		<b>⚠ ADVERTENCIA</b>	
<p><b>TO AVOID EQUIPMENT AND GRASS FIRES:</b></p> <ul style="list-style-type: none"> <li>• CLEAR AWAY grass or debris from hydraulic lines, circuits and decks.</li> </ul> <p><b>TO AVOID FIRE IGNITION:</b></p> <ul style="list-style-type: none"> <li>• DO NOT ALLOW BLADES TO CONTACT rocks, metal or solid objects.</li> <li>• DO NOT ALLOW OIL TO SPRAY on hot equipment or components.</li> </ul>		<p><b>PARA EVITAR INCENDIOS DE EQUIPO Y CÉSPED:</b></p> <ul style="list-style-type: none"> <li>• QUITE el césped y escombros de las líneas hidraulicas, circuito, y las cubiertas.</li> </ul> <p><b>PARA EVITAR INCENDIOS POR IGNICIÓN:</b></p> <ul style="list-style-type: none"> <li>• NO PERMITA QUE LAS CUCHILLAS CONTACTEN piedras, metal o objetos solidos.</li> <li>• NO PERMITA QUE EL ACEITE CAIGA en el equipo o componentes calientes.</li> </ul>	
D699_3		D699	

# SAFETY

SAFETY

<b>⚠ DANGER</b>		<b>⚠ PELIGRO</b>	
<b>KEEP AWAY</b>		<b>MANTENGASE ALEJADO</b>	
<b>Entanglement Hazard</b>		<b>Riesgo de Enredamiento</b>	
<p><b>TO AVOID SERIOUS INJURY OR DEATH:</b></p> <ul style="list-style-type: none"> <li>• DO NOT operate without guards in place and in good condition.</li> <li>• STAY AWAY and KEEP hands, feet and body AWAY from rotating blades, drivelines and parts that continue to move after power shut-off. WAIT until all moving elements have stopped.</li> <li>• STOP, LOOK and LISTEN for rotating motion before approaching implement.</li> <li>• STOP ENGINE and PTO, engage parking brake, lower implement, allow all moving parts to stop and remove key before dismounting from tractor.</li> </ul>	   	<p><b>PARA EVITAR LESION SERIA O MUERTE:</b></p> <ul style="list-style-type: none"> <li>• NO opere sin la cubierta protectora en su lugar y en buen estado.</li> <li>• MANTENGASE ALEJADO y MANTENGA manos, pies y cuerpo LEJOS de las cuchillas girando, líneas de conducción, y partes que siguen moviéndose después de que el poder es apagado. ESPERE hasta que todos los elementos móviles se han parado.</li> <li>• DETENGASE, OBSERVE y ESCUCHE por el movimiento de rotación antes de acercarse al implemento.</li> <li>• PARE EL MOTOR y el Toma De Fuerza (Barra Gitaloria) active el freno de mano, baje el implemento, y permita que todas las partes móviles se paren y quite la llave antes de desmontar del tractor.</li> </ul>	
		D687_1	

<b>⚠ DANGER</b>		<b>⚠ PELIGRO</b>	
<b>Run Over Hazard</b>		<b>Riesgo de Atropello</b>	
<b>Injury or Death</b>		<b>Lesión o Muerte</b>	
<p><b>TO AVOID SERIOUS INJURY OR DEATH:</b></p> <ul style="list-style-type: none"> <li>• ALWAYS USE Roll Over Protective Structure ("ROPS") including ROLL BAR and SEAT BELT equipped tractors for mowing operations.</li> <li>• ONLY START Tractor while seated in the operator's seat.</li> <li>• DO NOT MOUNT or DISMOUNT Tractor in motion.</li> <li>• NEVER ALLOW riders on tractor or implement.</li> <li>• NEVER ALLOW children to operate or ride on tractor or implement.</li> <li>• KEEP BYSTANDERS CLEAR of area before moving tractor or implement.</li> <li>• STOP ENGINE AND PTO, engage parking brake, lower implement, allow all moving parts to stop and remove key before dismounting from tractor.</li> </ul>	  	<p><b>PARA EVITAR LESION SERIA O MUERTE:</b></p> <ul style="list-style-type: none"> <li>• SIEMPRE USE tractors equipados con una Estructura Protectora Contra Vuelcos ("ROPS") incluyendo BARRA ANTIVUELCOS y CINTURON DE SEGURIDAD al segar.</li> <li>• SOLO ENCIENDA el tractor mientras que esta sentado en el asiento del operador.</li> <li>• NO MONTE o DESMONTE el tractor en movimiento.</li> <li>• NUNCA PERMITA pasajeros en el tractor o implemento.</li> <li>• NUNCA PERMITA que niños operen o se monten en el tractor o implemento.</li> <li>• MANTENGA LAS PERSONAS PRESENTES LEJOS de la area antes de mover el tractor o implemento.</li> <li>• PARE EL MOTOR Y Toma De Fuerza (Barro Gitaloria), aplique el freno de mano, baje el implemento, y deje que todas las partes movíl paren completamente, y quite la llave antes de desmontar el tractor.</li> </ul>	
		D687	

# SAFETY

<b>⚠ DANGER</b>	<b>⚠ PELIGRO</b>
<p><b>TO AVOID SERIOUS INJURY OR DEATH FROM ENTANGLEMENT AND THROWN OBJECTS:</b></p> <ul style="list-style-type: none"> <li>• DO NOT OPERATE mower without shields and guards in place and in good condition.</li> <li>• DO NOT OPERATE with thrown object shielding or guards missing.</li> <li>• Thrown objects shielding, PTO and gearbox guarding are <b>SUBJECT TO WEAR</b>.</li> <li>• REPAIR OR REPLACE shielding if damaged, broken or missing. See Operator's Manual for all Shields and Guards.</li> <li>• ALWAYS REPLACE GUARDS that have been removed for service or maintenance.</li> <li>• DO NOT STEP ON drivelines or guards. <small>D696_1</small></li> </ul>	<div style="text-align: center;">  <p>Tractor PTO Guard (Cubierta del PTO) Implement PTO Guard (Cubierta del PTO) Shields (Cubiertas)</p> </div> <p><b>PARA EVITAR LESION SERIA O MUERTE POR ENREDAMIENTO Y OBJETOS LANZADOS:</b></p> <ul style="list-style-type: none"> <li>• NO OPERE la unidad sin cubiertas maya protectoras en su lugar y en buenas condiciones.</li> <li>• NO OPERE sin las cubiertas de objetos lanzados o si faltan las maya protectoras.</li> <li>• Cubierta de Objetos Lanzados, Toma De Fuerza (Barra Gitorial) y guardias de caja de engranaje son <b>SUJETO AL DESGASTE</b>.</li> <li>• REPARE O REEMPLACE cubiertas si son dañadas, quebradas, o si faltan.</li> <li>• SIEMPRE REEMPLACE CUBIERTAS que han sido quitadas para servicio o mantenimiento.</li> <li>• NO PISE EN las líneas de conducción o cubiertas.</li> </ul>

<b>⚠ DANGER</b>	<b>⚠ PELIGRO</b>
<p><b>TO AVOID SERIOUS INJURY OR DEATH:</b></p> <ul style="list-style-type: none"> <li>• READ AND UNDERSTAND the provided Operator's Manuals, safety signs and information decals for tractor and implement before operating equipment.</li> <li>• CONTACT DEALER immediately if you do not have manuals.</li> <li>• CONTACT DEALER to explain any instructions not fully understood.</li> <li>• KNOW HOW to stop tractor and equipment quickly for an emergency.</li> <li>• ALWAYS WEAR safety glasses.</li> <li>• WEAR hard hat, safety shoes and gloves for protection when operating equipment. <small>D696_2</small></li> </ul>	<div style="text-align: center;">  </div> <p><b>PARA EVITAR LESION SERIA O MUERTE:</b></p> <ul style="list-style-type: none"> <li>• LEA Y ENTIENDA el Manual de Operador proporcionado, signos de seguridad y calcomanias informativas para el tractor y implemento antes de operar el equipo.</li> <li>• CONTACTE AL DISTRIBUIDOR inmediatamente si no tiene los manuales.</li> <li>• CONTACTE AL DISTRIBUIDOR para que le explique cualquier instrucciones que no entiende completamente.</li> <li>• ENTIENDA COMO parar el tractor y equipo rapidamente en caso de una emergencia.</li> <li>• SIEMPRE USE lentes de seguridad.</li> <li>• USE un casco, zapatos de seguridad y guantes para su protection cuando esta operando el equipo. <small>D696</small></li> </ul>

# SAFETY

SAFETY

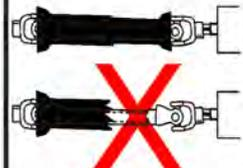
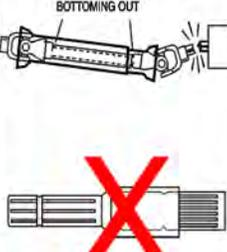
<b>⚠ DANGER</b>	<b>⚠ PELIGRO</b>	
<p><b>TO AVOID SERIOUS INJURY OR DEATH FROM DRIVELINE CONTACT, DRIVELINE SEPARATION OR PTO STUB SHAFT FAILURE:</b></p> <ul style="list-style-type: none"> <li>• STOP, LOOK and LISTEN for rotating motion before approaching implement.</li> <li>• STAY AWAY and KEEP hands, feet and body AWAY from rotating parts until all moving elements have stopped.</li> <li>• ALWAYS shut off PTO before dismounting.</li> <li>• DO NOT operate if PTO shields are damaged or missing.</li> <li>• LOCK DRIVELINE locking collar YOKE to tractor PTO Shaft.</li> <li>• PUSH AND PULL on yoke until collar clicks and locks yoke in place.</li> <li>• USE CORRECT length drivelines for implement. (See Operator's Manuals for procedure)</li> <li>• CHECK driveline guards for free rotation and sufficient overlap to avoid unshielded areas.</li> <li>• DO NOT USE PTO ADAPTER</li> </ul> <p style="text-align: right; font-size: small;">D547-1</p>	<div style="text-align: center;">  </div> <div style="text-align: center;">  </div> <div style="text-align: center;"> <p>PTO (Barra Gitorialia)</p>  </div> <div style="text-align: center;"> <p>BOTTOMING OUT</p>  </div>	<p><b>PARA EVITAR LESION SERIA O MUERTE POR CONTACTO A LA LÍNEA DE CONDUCCIÓN, SEPARACION DE LÍNEA DE CONDUCCIÓN O EL FRACASO DEL EJE DE PTO:</b></p> <ul style="list-style-type: none"> <li>• PARE, MIRE y ESCUCHE por el movimiento de rotación antes de acercarse al implemento.</li> <li>• MANTENGASE ALEJADO y MANTENGA manos, pies y cuerpo LEJOS de partes girando, hasta que todos los elementos de movimiento se han parado.</li> <li>• SIEMPRE apague la Toma De Fuerza (Barra Gitorialia) antes de desmontar.</li> <li>• NO opere si las cubiertas de Toma De Fuerza (Barra Gitorialia) estan dañadas.</li> <li>• TRABE el YUGO de collar de fijación del la LÍNEA DE CONDUCCIÓN al eje de PTO (Barra Gitorialia) del tractor.</li> <li>• EMPUJE Y JALE el yugo hasta que el collar de fijación hace clic y el yugo se traba en lugar.</li> <li>• USE la longitud de línea de conducción CORRECTA para el implemento. (Vea el Manual de Operador para el Procedimiento)</li> <li>• REVISE las guardias de línea de conducción por giracion libre y suficiente traslape para evitar areas sin cobertura.</li> <li>• NO UTILICE UN ADAPTOR PARA LA TOMA DE FUERZA (Barra Gitorialia).</li> </ul>

<b>⚠ WARNING</b>	<b>⚠ ADVERTENCIA</b>
<p>OPERATE THIS MACHINE AT <b>540 RPM</b> TRACTOR PTO SPEED ONLY. Overspeeding PTO may cause component failure resulting in bodily injury. TRACTOR PTO ROTATION: CLOCKWISE</p> <p style="text-align: right; font-size: small;">D547-2</p>	<div style="text-align: center;">  </div> <p>OPERE ESTA MÁQUINA A <b>540 RPM</b> SOLAMENTE OPERE ESTA MÁQUINA A LA VELOCIDAD DE PTO (TOMA DE FUERZA O BARRA GITATORIA) DEL TRACTOR DE 540 RPM. El sobre exceso de velocidad de PTO puede causar el fracaso de componente que resultara en lesión. ROTACION DE PTO DEL TRACTOR: EN SENTIDO HORARIO</p> <p style="text-align: right; font-size: small;">D547</p>

# SAFETY

SAFETY

<b>⚠ WARNING</b>		<b>⚠ ADVERTENCIA</b>	
<p><b>TO AVOID SERIOUS INJURY OR DEATH FROM HIGH PRESSURE HYDRAULIC OIL LEAKS PENETRATING SKIN:</b></p> <ul style="list-style-type: none"> <li>• DO NOT OPERATE equipment with oil or fuel leaks.</li> <li>• KEEP all hydraulic hoses, lines and connections in good condition and tight before applying system pressure.</li> <li>• Relieve hydraulic pressure before disconnecting lines or working on the system.</li> <li>• REMOVE and replace hose if you suspect it leaks. Have dealer test it for leaks.</li> </ul> <p><b>HIGH PRESSURE FLUID LEAKS CAN BE INVISIBLE. WHEN CHECKING FOR HYDRAULIC LEAKS AND WORKING AROUND HYDRAULIC SYSTEMS:</b></p> <ul style="list-style-type: none"> <li>• DO NOT use hands to check for leaks.</li> <li>• ALWAYS WEAR safety glasses and impenetrable gloves.</li> <li>• USE paper or cardboard to search for leaks.</li> <li>• KEEP hands and body AWAY from pin holes and nozzles ejecting hydraulic fluid.</li> <li>• Hydraulic fluid may cause gangrene if not surgically removed immediately by a doctor familiar with this form of injury.</li> </ul>	    	<p><b>PARA EVITAR LESION SERIA O MUERTE POR LA PENETRACION A LA PIEL POR ALTA PRESION DE ACEITE HIDRÁULICO:</b></p> <ul style="list-style-type: none"> <li>• NO OPERE el equipo con fugas de aceite o combustible.</li> <li>• MANTENGA todas las mangueras hidráulicas, líneas y conexiones en buenas condiciones y apretadas antes de aplicar presión al sistema.</li> <li>• Releve la presión hidráulica antes de desconectar las líneas o trabajar en le sistema.</li> <li>• QUITE y reemplace la manguera si sospecha que hay fuga.</li> </ul> <p><b>FUGAS DE ALTA PRESIÓN PUEDEN SER INVISIBLE. AL VERIFICAR POR FUGAS HIDRAULICAS Y TRABAJANDO ALREDEDOR DE SISTEMAS HIDRAULICOS:</b></p> <ul style="list-style-type: none"> <li>• NO use las manos para verificar si hay agujeros.</li> <li>• SIEMPRE USE lentes de seguridad y guantes impenetrables.</li> <li>• USE papel o un cartón para buscar agujeros.</li> <li>• NO USE las manos o partes del cuerpo para buscar agujeros.</li> <li>• MANTENGA manos y cuerpo LEJOS de agujeros de alfiler y boquillas que expulsan el liquido hidráulicos.</li> </ul>	<p>02965262</p>

<b>⚠ DANGER</b>		<b>⚠ PELIGRO</b>	
<b>Crushing Hazard - Injury or Death</b>		<b>Riesgo de Aplastamiento Lesion o Muerte</b>	
<p><b>TO AVOID SERIOUS INJURY OR DEATH:</b></p> <ul style="list-style-type: none"> <li>• STAND CLEAR when removing transport latch, lowering or raising wings.</li> <li>• CLEAR AREA of bystanders before lowering implement wings.</li> <li>• IMPLEMENT CAN FALL from hydraulic failure or accidental operation of controls.</li> <li>• BLOCK UP and securely support equipment before putting hands, feet or body under raised equipment or lifted components.</li> <li>• SECURELY ENGAGE transport latch before transportation or working under wing.</li> <li>• FILL CYLINDERS with oil before attempting to lower implement wings.</li> <li>• DO NOT OPERATE in transport position or with wings off ground.</li> </ul>	  	<p><b>PARA EVITAR LESION SERIA O MUERTE:</b></p> <ul style="list-style-type: none"> <li>• MANTENGASE LEJOS al quitar el cierre de transporte, bajando y devantando las alas.</li> <li>• DESOCUPE EL AREA de personas presentes antes de bajar las alas del implemento.</li> <li>• EL IMPLEMENTO PUEDE CAER del fracaso hidráulico o por operación accidental de controles.</li> <li>• BLOQUEE y soporte con seguridad antes de poner manos, pies o cuerpo debajo del equipo de componentes levantados.</li> <li>• CON SEGURIDAD ACTIVE el cierre de transporte antes de la transportacion o trabajar debajo de las alas.</li> <li>• LLENE LOS CILINDROS con aceite antes de intentar de bajar las alas del implemento.</li> <li>• NO OPERE en posicion de transporte o con las alas devantadas del la tierra.</li> </ul>	<p>D698</p>



# SAFETY

## Federal Laws and Regulations

This section is intended to explain in broad terms the concept and effect of federal laws and regulations concerning employer and employee equipment operators. This section is not intended as a legal interpretation of the law and should not be considered as such.

### Employer-Employee Operator Regulations

U.S. Public Law 91-596 (The Williams-Steiger Occupational and Health Act of 1970) OSHA

#### This Act Seeks:

“...to assure so far as possible every working man and woman in the nation safe and healthful working conditions and to preserve our human resources...”

#### DUTIES

Sec. 5 (a) Each employer-

- (1) shall furnish to each of his employees employment and a place of employment which are free from recognized hazards that are causing or are likely to cause death or serious physical harm to his employees;
- (2) shall comply with occupational safety and health standards promulgated under this Act.
- (b) Each employee shall comply with occupational safety and health standards and all rules, regulations and orders issued pursuant to this Act which are applicable to his own actions and conduct.

### OSHA Trainings Requirements

**Title 29, Code of Federal Regulations Part 1928.57(a)(6).** [www.osha.gov](http://www.osha.gov)

Operator instructions. At the time of initial assignment and at least annually thereafter, the employer shall instruct every employee who operates an agricultural tractor and implements in the safe operating practices and servicing of equipment with which they are or will be involved, and of any other practices dictated by the work environment.

Keep all guards in place when the machine is in operation;

Permit no riders on equipment

Stop engine, disconnect the power source, and wait for all machine movement to stop before servicing, adjusting, cleaning or unclogging the equipment, except where the machine must be running to be properly serviced or maintained, in which case the employer shall instruct employees as to all steps and procedures which are necessary to safely service or maintain the equipment.

Make sure everyone is clear of machinery before starting the engine, engaging power, or operating the machine.

### Employer Responsibilities:

To ensure employee safety during Tractor and Implement operation, it is the employer's responsibility to:

1. Train the employee in the proper and safe operation of the Tractor and Implement.
2. Require that the employee read and fully understand the Tractor and Implement Operator's manual.
3. Permit only qualified and properly trained employees to operate the Tractor and Implement.
4. Maintain the Tractor and Implement in a safe operational condition and maintain all shields and guards on the equipment.
5. Ensure the Tractor is equipped with a functional ROPS and seat belt and require that the employee operator securely fasten the safety belt and operate with the ROPS in the raised position at all times.
6. Forbid the employee operator to carry additional riders on the Tractor or Implement.
7. Provide the required tools to maintain the Tractor and Implement in a good safe working condition and provide the necessary support devices to secure the equipment safely while performing repairs and service.
8. Require that the employee operator stop operation if bystanders or passersby come within 300 feet.

### Child Labor Under 16 Years of Age

Some regulations specify that no one under the age of 16 may operate power machinery. It is your responsibility to know what these regulations are in your own area or situation. (Refer to U.S. Dept. of Labor, Employment Standard Administration, Wage & Home Division, Child Labor Bulletin #102.)



# **ASSEMBLY SECTION**

# ASSEMBLY

**Before attempting to mount your Tiger mower, it is important to read and understand all of the safety messages in the Safety Section of this manual.**

Check complete shipment list against the packing list to make sure there are no shortages. Make certain the tractor model is the appropriate one for the mower received!



Always use a floor jack, hoist or fork lift to lift and raise heavy parts.

Read and understand the entire Assembly Section instructions before attempting to mount your Tiger mower. Refer to the Parts Section of this manual for detailed illustrations to locate all parts. (ASM-C-0001)

## TRACTOR PREPARATION

- A. Remove right and left hand steps.
- B. Disconnect battery cables from both batteries.
- C. Remove engine side panels, or raise hood to access front pulley.
- D. Remove plugs from tractor casting where mainframe and pump mount will be attached.
- E. Remove any front weights and weight supports.
- F. Raise the tractor onto jack-stands and remove the right and left rear wheels.

(ASM-JD-0001)

## ADJUSTING REAR WHEELS

Raise rear of tractor onto jack-stands. **Follow the instructions in the tractor owner's manual for adjusting tires and rims.** The back wheels **MUST** be adjusted to the widest setting. **NOTE:** This may require switching the wheels to opposite sides of tractor. Also take note of any width restrictions when transporting by trailer. (For ease of installation, it is best to leave the rear wheels removed during installation of the mower.) (ASM-B-0001)



## ASSEMBLY

### APPLICATION OF LOCTITE 2047 MOWER MAINFRAME MOUNTING BOLTS

All mower mainframe mounting bolts shall be secured utilizing Loctite 2047 and torqued per the Torque Chart in the maintenance section. Shake bottle for 60 seconds before use. To prevent clogging of nozzle, do not allow tip to touch metal surfaces during application. If tip of nozzle becomes clogged, cut off tip as required. If female threads are contaminated or rusty, clean threads by using a thread chaser prior to installation of bolts. Apply thread locker to threads of bolts as shown below. The allowable fixture time is (1) hour maximum. Therefore bolts must be torqued within this time limit. The cure time is 72 hours at room temperature, therefore machine is not to be used in actual application, except for function testing, until the Loctite is allowed to cure.

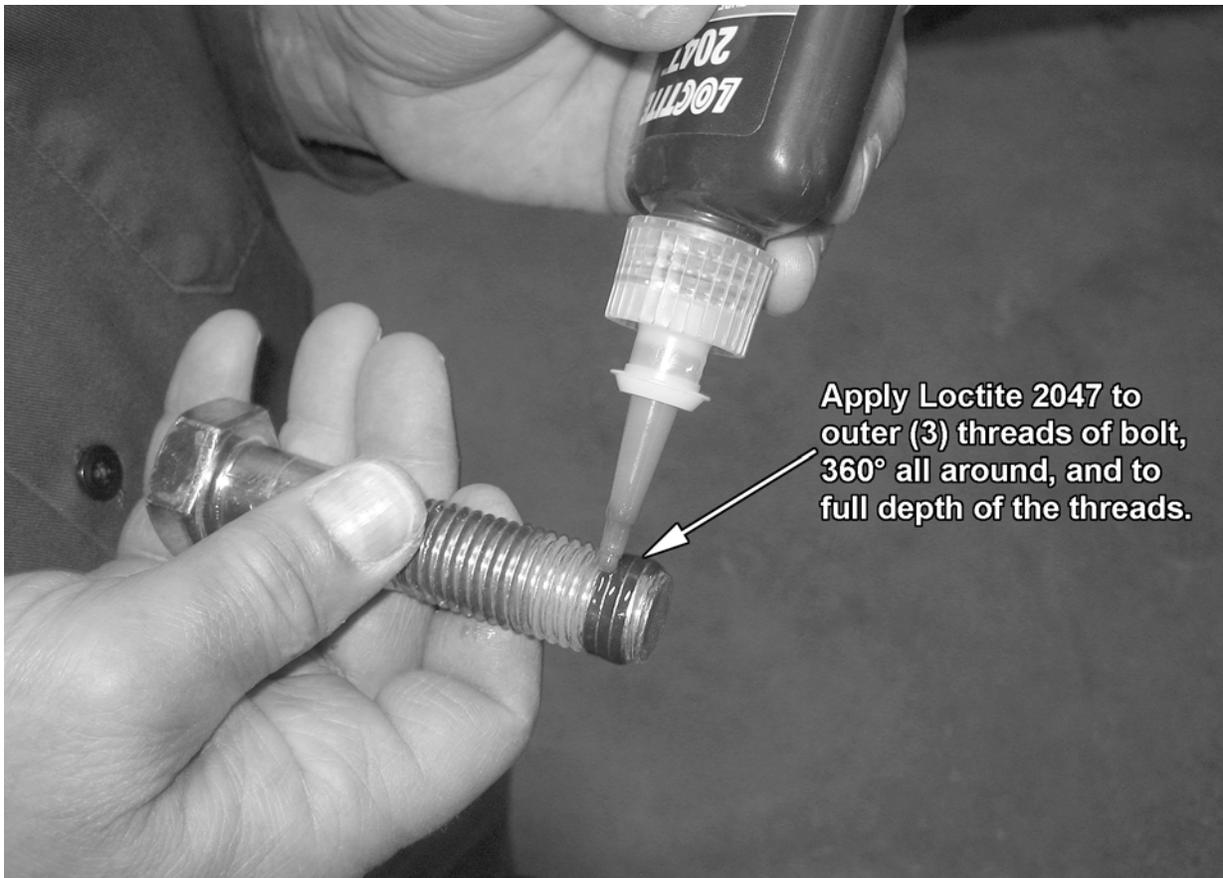

Apply Loctite 2047 to  
outer (3) threads of bolt,  
360° all around, and to  
full depth of the threads.

(ASM-C-LOCTITE MNT BOLTS)



# ASSEMBLY

## DRIVESHAFT AND FRONT PUMP MOUNTING

Install driveshaft into the crankshaft adapter.

Slide splined driveshaft coupler onto the pump driveshaft. Install the pump onto the mounting bracket. NOTE: the pump is offset to one direction and the pump should be installed with the offset side on top. Install hardware for securing pump to the pump mount, DO NOT tighten.

Install pump and align so that splined coupling can be moved (FREE PLAY) back and forth by hand. Rotate coupler and check free play every 1/4 turn. Tighten pump mounting bolts in succession, rechecking for spline coupling free play. Remove the pump mounting bracket bolts one at a time and apply a thread locking agent. Tighten these bolts in succession, again checking for free play in the driveshaft. After all bolts are torqued, the end play on the driveshaft should be 1/16" to 1/8", and coupler should move freely with hand pressure. If end play is less than 1/16", grind the end of the shaft to achieve the proper end play. If there is more than 1/4" of end play, return the shaft with specifications for a longer shaft.

**CAUTION: DO NOT START THE TRACTOR UNTIL ALL HOSES ARE ATTACHED,**

## HYDRAULIC TANK INSTALLATION

Install the tank mounting brackets with the hardware provided, as shown in the Parts Section. DO NOT tighten. Using a hoist or lift, raise the tank into position. Line up the holes on the tank with the holes on the mounting brackets and install the hardware. Once all mounting hardware is in place and secured, tighten the capscrews.

The pressure gauge is installed in the filter assembly with a street elbow. The breather cap is screwed into the bung hole in the front of the bumper tank. (ASM-JDT3F-0002a)



# ASSEMBLY

## COOLER MOUNTING

Mount the cooler mounting brackets on the top right side of the bumper hydraulic tank. Locate bolt plates on the top of the tank and secure the appropriate cooler bracket to the tank with the hardware provided. Attach the screen and cooler to the brackets. Refer to the Parts Section to connect the hoses to the cooler. (ASM-JD-0006a)



# ASSEMBLY

## REPLACING LEFT SIDE FUEL TANK

Drain the left hand fuel tank. Remove the hoses and the wire connection to the fuel gauge. Remove and re-use the fuel level sending unit, the gasket and hardware. The gasket has a unique hole pattern and is marked to match the fuel sending unit. Remove the tank straps and the lower cross bar and discard.

To add the tank fuel sending unit to the Tiger tank, first place the gasket that you removed from the original tank on the sending unit and match up the holes. Insert the unit into the top hole in the tank. Secure the gauge with the existing hardware.

Install the Fuel Tank Bracket to the side of the tractor frame as shown in the Parts Section. Place the Tiger tank on the Fuel Tank Bracket and the T-frame, and line up with the mounting holes. Use rubber shims as needed to adjust the location of the tank and ensure that the tank does not rest against the inside wall of the wheel well. Secure the tank using the hardware provided as shown in the Parts Section. Install fuel filler hose from top of Tiger tank to the rear of the wheel well, as shown below.

Finally, attach the proper hoses to the corresponding holes and add the wires for the fuel gauge. Refer to the Parts Section for hardware used and dimensions. (ASM-JD-0253\_6E)

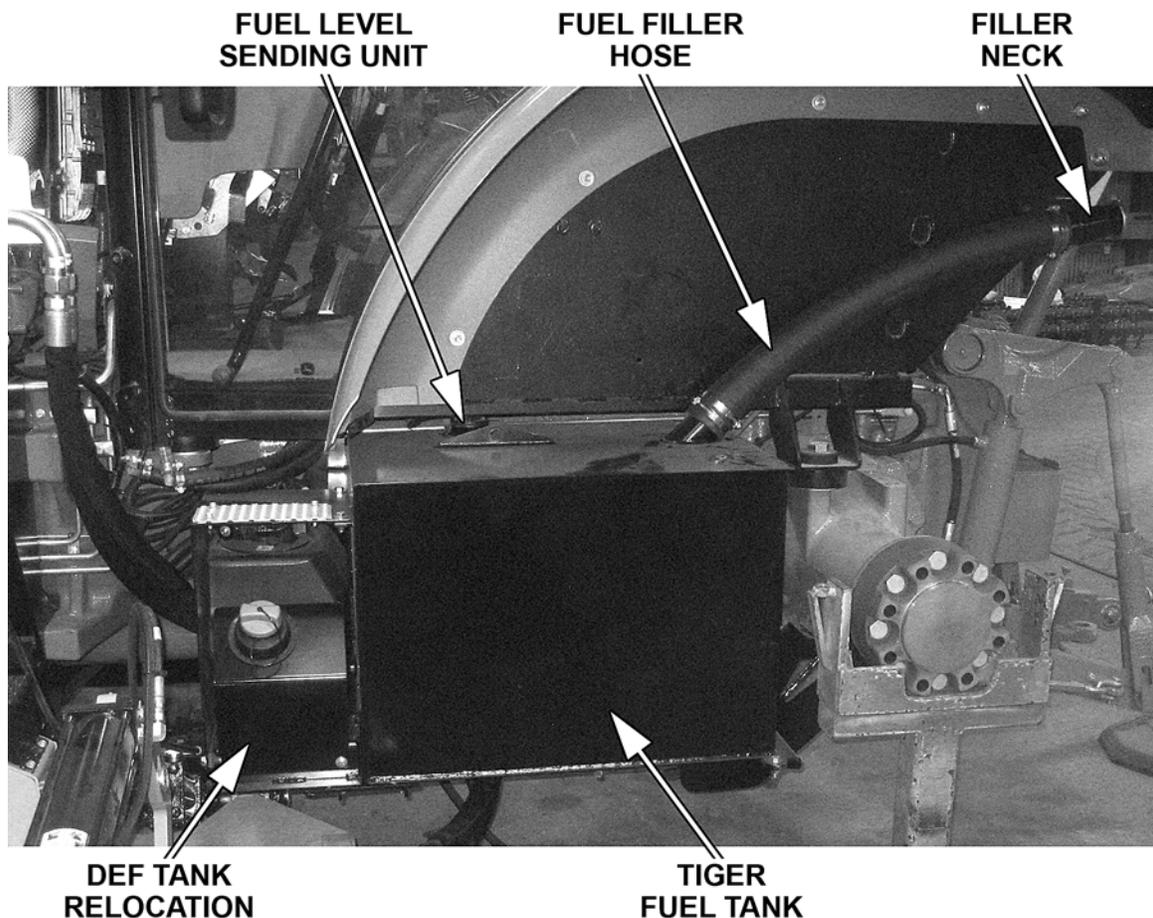



# ASSEMBLY

## CABLE CONTROL LEVER STAND

Place the cable control bracket on the floor so that the bracket is 4" from the front window. Also the outer rear corner (heel) of the bracket is 5" from the edge of the door. The middle corner of the bracket should be 2" from the edge of the door. See image below. Be sure that the location of the stand will allow the operation of all control levers in the tractor and that the door will not strike the stand when shut. Double check under the cab for cables and wires that may be cut when drilling. And before drilling double check location of the stand for proper placement of holes. Drill 3 holes to match control bracket and secure with capscrews and nylock nuts noted in Parts Section.

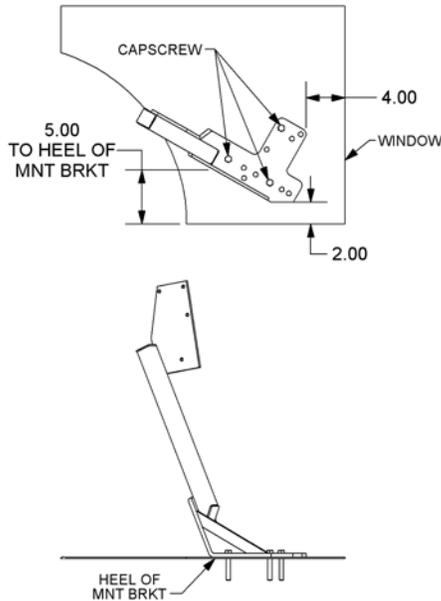

The rubber boot under the rear window can be cut in a crosshair pattern and, if necessary, the bottom cut through to allow it to slip over the cables and back into position. These cables will be routed to the lift valve mounted on the valve mounting plate, and should not have any sharp bends or kinks in them. Secure cables with zip ties and apply RTV sealer in and around individual cables, inside and outside of the cab for a water tight seal. Do not allow excess cable to hang unsecured on the outside of the cab. (ASM-JD-0239).



# ASSEMBLY

## SWITCHBOX WIRING

Route the green wires and the red wire (with the 10amp fuse) from the switchbox to the front console panel. Refer to the Parts Section for wiring diagram to hook up the switchbox. Cover the wires from the switchbox with plastic wire wrap provided. Remove the console panel under the steering wheel to access wires. Locate the neutral safety brown colored wire. **Use a test light or meter to verify** this wire is the neutral safety wire. Cut the brown neutral safety wire labeled "571" and connect the green wires from the switchbox as shown in the wiring diagram.

Run the white and black wire to the solenoid valve. Route the wires through the back window with the cable control wires. Use the rubber grommet in the window to protect the wire, and route the wire out of the cab down to the 1/4" hydraulic hoses. Follow the hydraulic hoses through the wheel well to the front of the tractor.

Route the Red 14ga wire, keyed hot, from the auxillary plug to the signal post of the continuous duty solenoid. **NOTE: Be certain that the power taken for the switchbox is "HOT" only when the tractor ignition is "ON".**

The black wire from the switchbox should be routed to the auxillary plug.

The wires from the switch box are longer than needed and should carefully cut and spliced as required. Zip ties should be used to secure the wires to the tractor framework and hoses to eliminate vibration and rubbing. (ASM-JD-0224)

**WIRES FROM SWITCHBOX  
TO CONSOLE**



**AUXILLARY  
PLUG**



**REAR WINDOW WITH  
RUBBER GROMMET**



# ASSEMBLY

## WEATHER-PACK / METRI-PACK ASSEMBLY

These instructions apply to both Weather-Pack and Metri-Pack connectors.

**NOTE: Use the specific tool for the type of connector you are assembling.**

(ASM-C-0009)

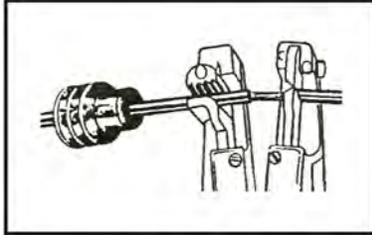

1. Apply seal to cable, before stripping insulation.



2. Align seal with cable insulation.

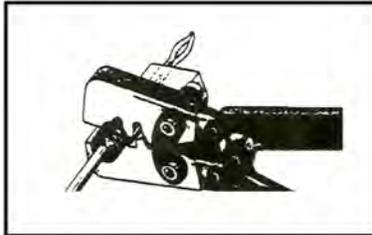

3. Put terminal in crimping tool, then position wire and seal in place.

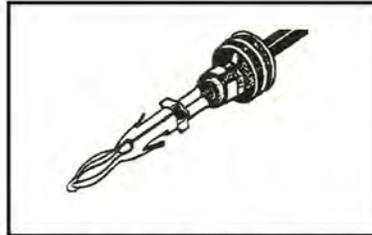

4. Crimp and visually inspect for a good crimp before installing in connector body.

## SIDE MIRROR REMOVAL

On JD6E tractors, to prevent interference with the left hand mower when raised to the stow position, the left side mirror must be removed.

(ASM-JDT3F 0055)



# ASSEMBLY

## VALVE MOUNTING

Attach the rear valve mounting bracket to the fender of the tractor by removing the two rear bolts on the left fender and the two rear bolts on the right fender. See illustration below. Drill the square holes in the fenders to accept 3/8" capscrews. Use the hardware noted in the Parts Section to attach the valve mounting bracket to the tractor.

Next, attach the valve mounting plate to the mounting bracket. Align the holes on the plate to the holes on the bracket. Use the hardware shown in the Parts Section to attach the plate to the valve mounting bracket. Finally, place the valve on the valve mounting plate as shown in the Parts Section. Align the holes on the valve assembly to the holes in the plate. Use the hardware provided to secure the valve to the plate. Refer to the Parts Section for the placement of the valve and the hardware used. **Please handle the lift valve with care. It is extremely heavy and contains small parts.** (ASM-JD-0065)

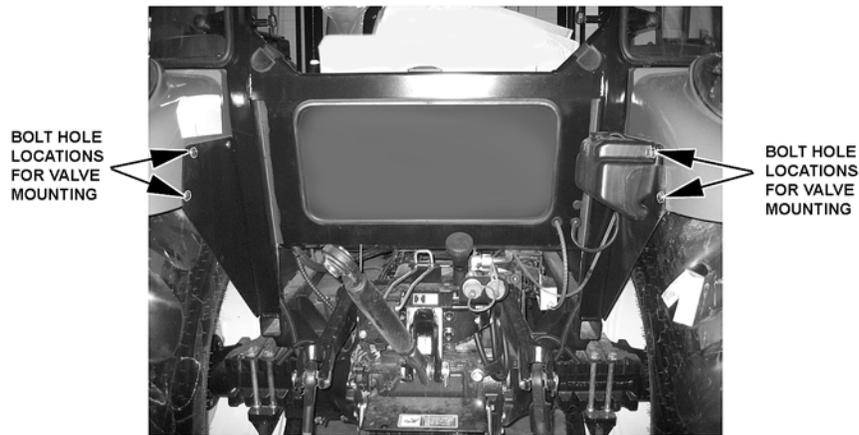

# ASSEMBLY

## EGRESS SYSTEM

When the left hand flail mower is in the stored position for transport, access to the tractor cab is available using the egress control switchbox. The egress control switchbox is located on the front of the tractor, in the well area of the Tiger hydraulic tank. See the Parts Section for more information. (ASM-JD6xxxE T3F EGRESS)

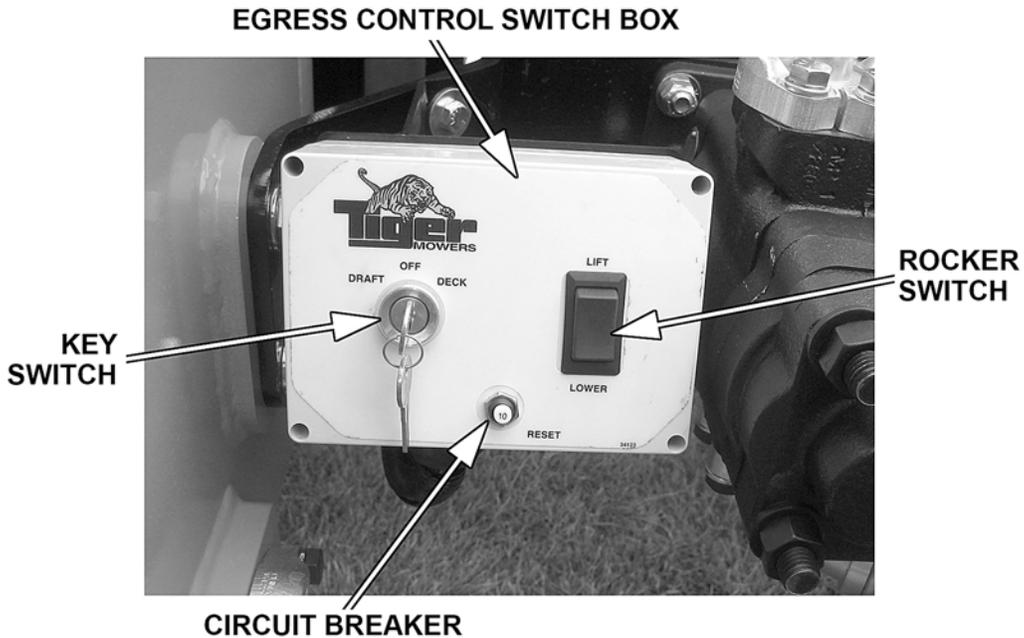
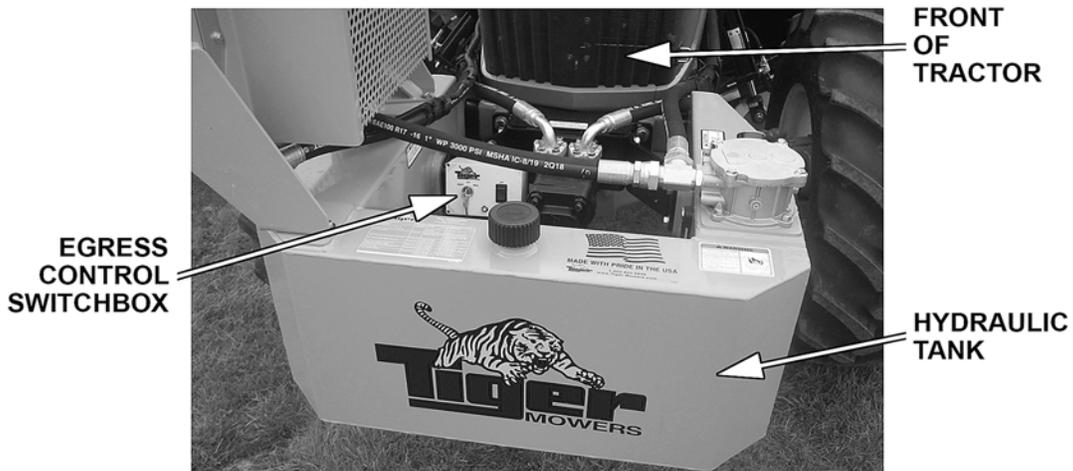

# ASSEMBLY

## LEFT SIDE HANDRAIL REPLACEMENT

To prevent interference with the stored left side flail, the left side handrail on the cab will need to be replaced with Tiger Part #06370279. Remove and discard the handrail on the left side of the cab. Save the hardware from the rail and use to attach the new Tiger rail.

*(ASM-JD6E Triple Handrail)*

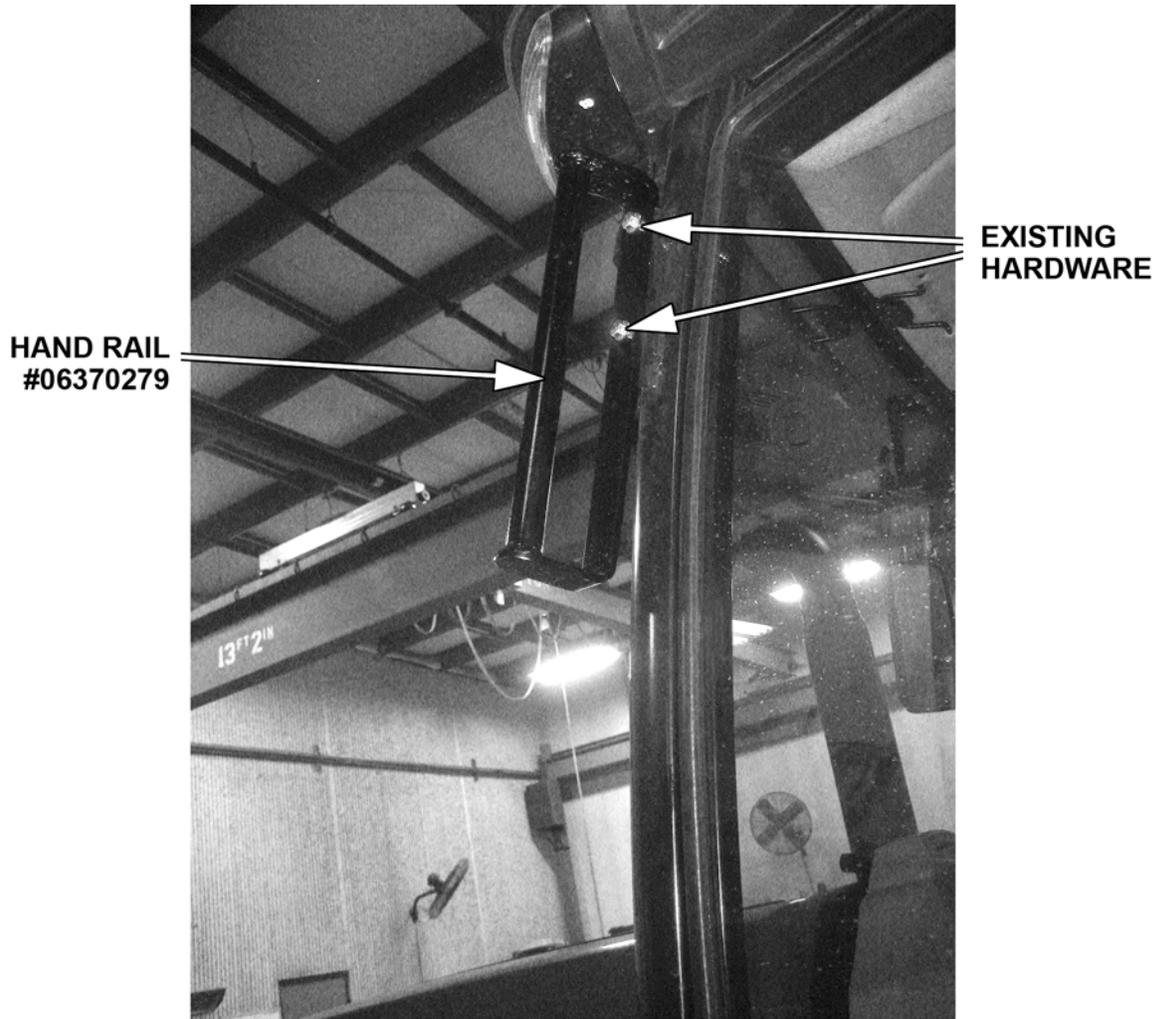

# ASSEMBLY

## TRACTOR PLUMBING

Remove the stock pressure line to the remote valve. It will be necessary to temporarily remove other hoses and tubes that block access to connect the hoses. Install the pressure hose to the tractor pressure port. Install hose #06500783 from the power beyond port of the lift valve to the tractor SCV valve. Install pressure hose #06500782 from the tractor pressure on the side of the tractor to the upper port on the lift valve inlet. Install return hose #06500782 from lower port on lift valve inlet to the return filter on the tractor. See the Parts Section for parts used.

(ASM-JD-0242 6xxxD)

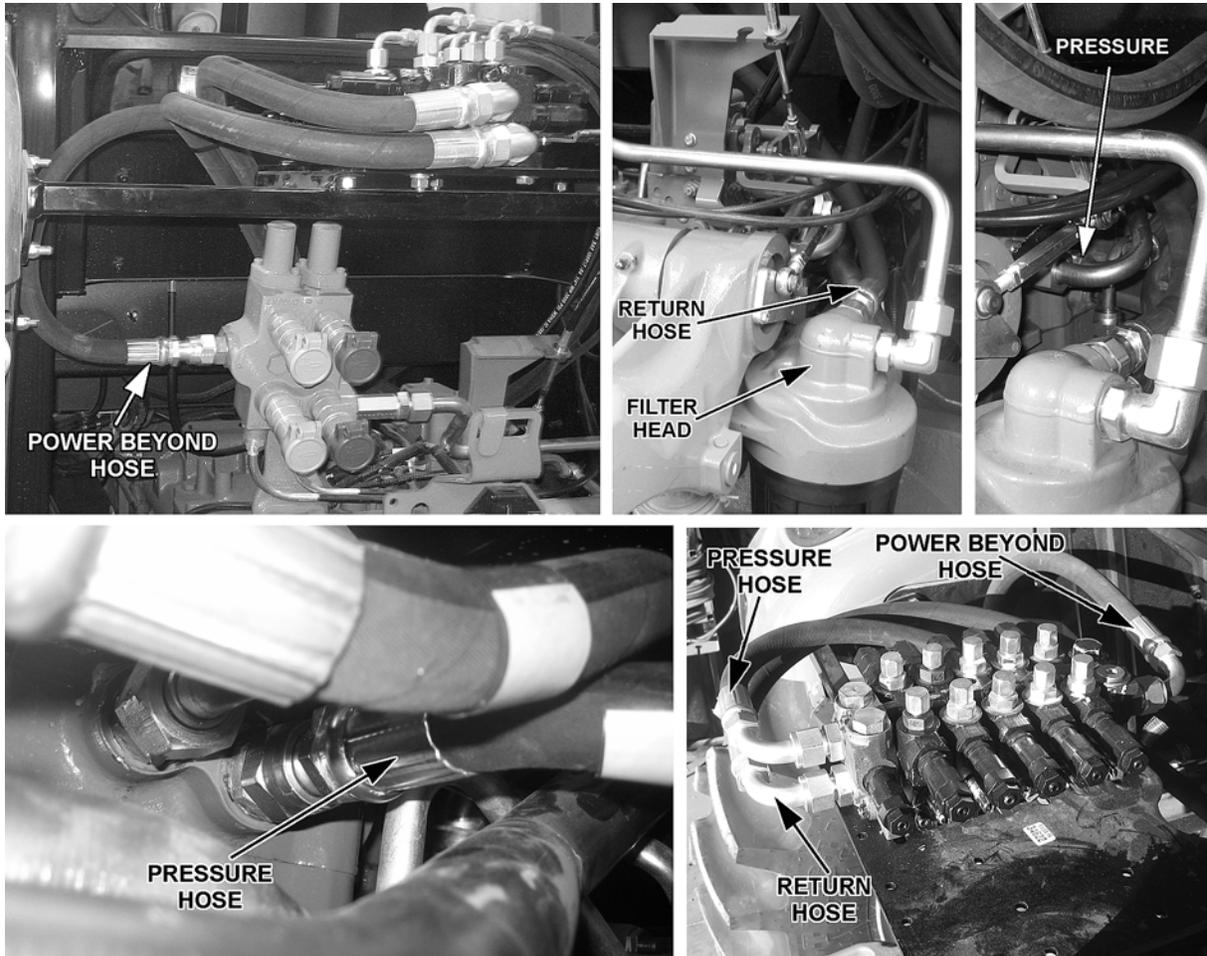

# ASSEMBLY

## MANUAL LIFT VALVE PORTS

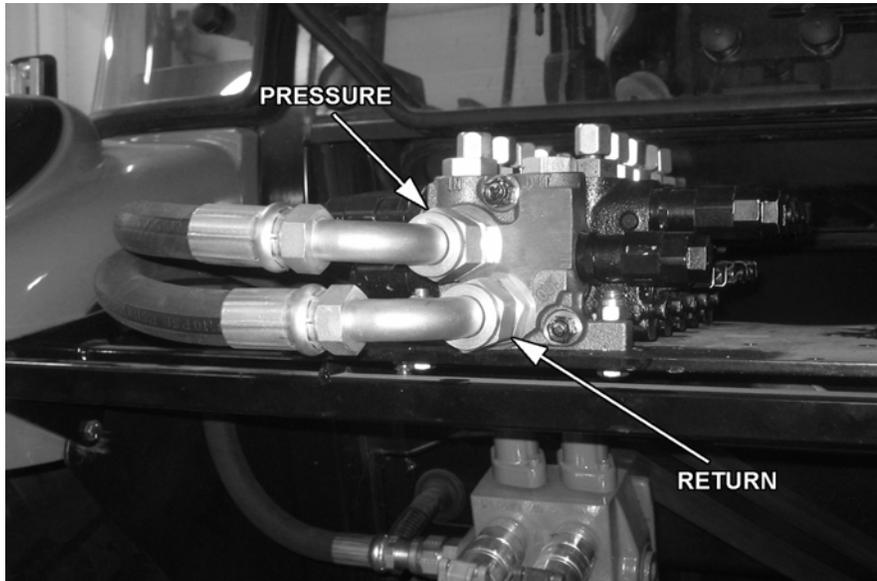

(ASM-C-0102 JD6xxxD)





# ASSEMBLY

## MANUAL SWITCHBOX MOUNTING

The switchbox is to be secured to the operator's side of the control handles, or valve stand. When the front cross member switchbox support bracket is installed, apply clear RTV (silicon) sealant around the outside of the bracket for a water tight seal. Refer to the Parts Section for assembly and components needed. (ASM-C-0071 T3F JD6E)

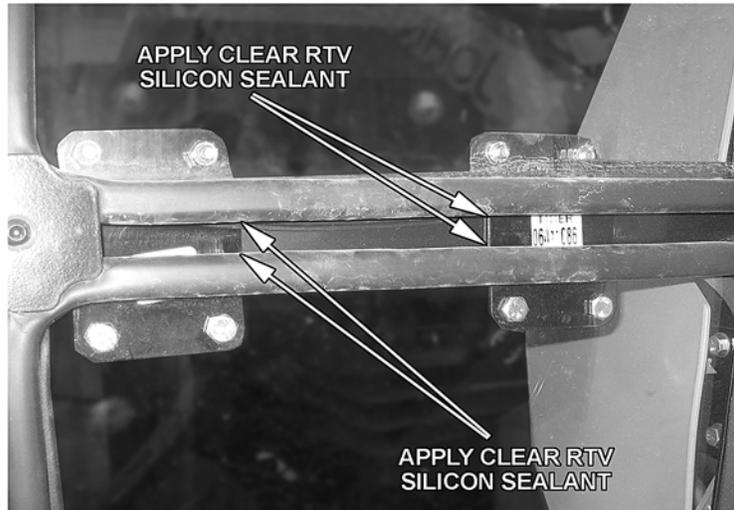

# ASSEMBLY

## \*NOTE ON HUSCO CONTROL VALVES\*

Manual, cable controlled (Husco control valve) boom mowers require check valves with integral restricting orifice (#06502036) installed in the control valve work ports that are connected to the gland ends of the main and secondary boom cylinders. This check valve allows oil to free flow into the gland end of the main and secondary boom cylinders, but restricts flow out of the cylinder, thereby providing proper boom control. This check valve, #06502036 (Vendor #1968R-.063) is similar in appearance to hose adapter #33271 and Adapter #34396, with .06 orifice. These components can be identified as follows, and are to be installed per Parts Section for the lift valve. (ASM-HUSCO-0001)

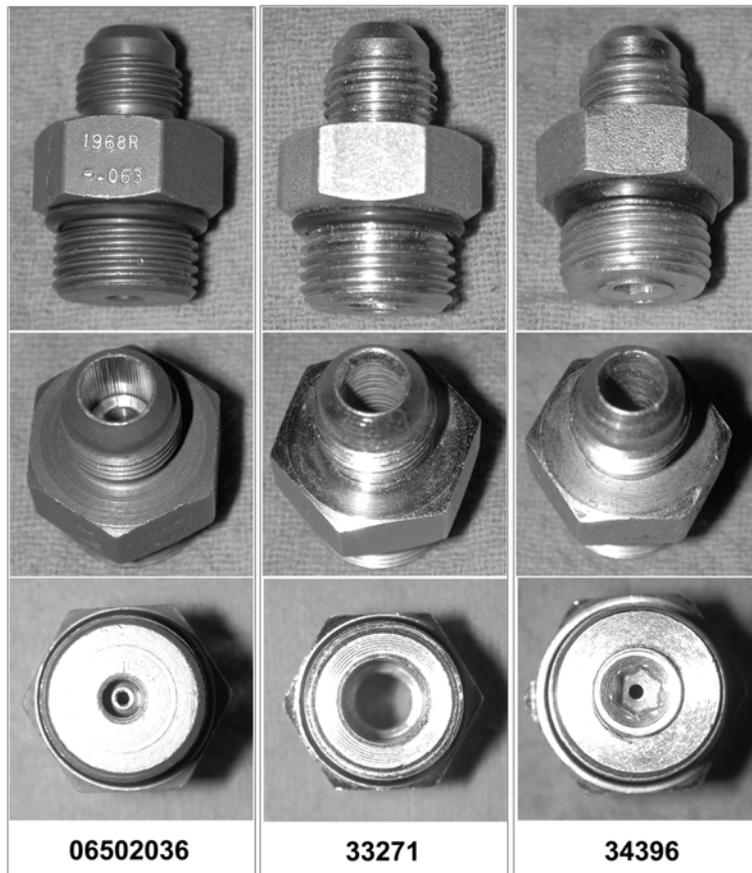

# ASSEMBLY

## HOSE AND WIRE ROUTING

Attach two clamps to the right rear wheel well for proper hose/wire routing. Drill one hole for each clamp. Use the lower rear corner of the wheel well as an origin for measuring. The holes should be 10mm or 3/8" reamed to accept 3/8" hardware.

Measure along the back edge of the wheel well 10-1/2" from the origin. Use a square to measure 2-1/2" up, from the last mark. Refer to the image below to see the first hole.

The second hole should run parallel to the bottom edge of the wheel well. Mark the hole 22" from the origin and 3-1/2" from the bottom edge. Use the images below for reference.

**NOTE: DO NOT CUT INTO TUBES / HOSES / WIRES WHEN DRILLING THROUGH METAL OR PLASTIC!** (ASM-JD-0068)

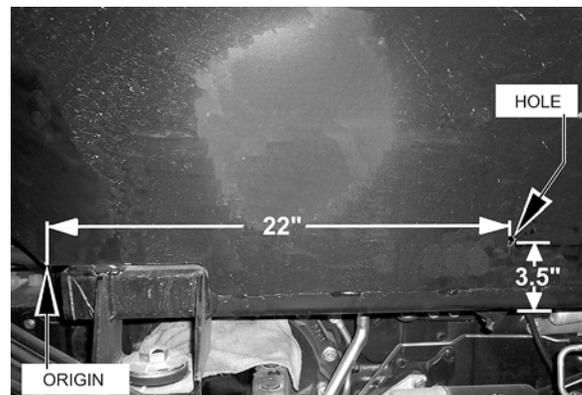
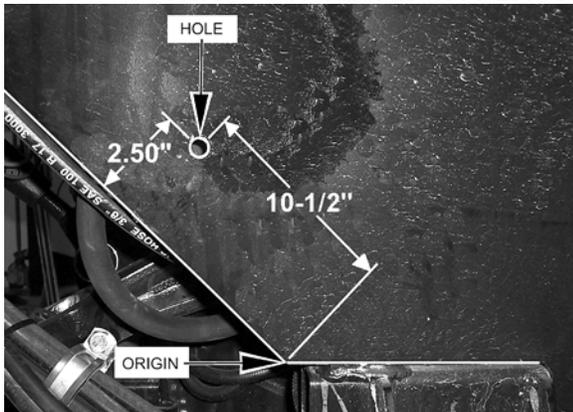

Place as many hoses in the clamp as will fit without compromising pressure. Then secure the (2) HOSE CLAMP (06520013) to the holes drilled with (1 EACH) CAPSCREW, 3/8 X 1 NC (21630) and (1 EACH) NYLOCK NUT, 3/8 NC (21627). The hoses that don't fit into the clamp are to be secured to the others with zip ties. For protection of hoses in contact with metal edges, wrap hoses with split hose sections and fasten with hose clamps or zip ties as needed.

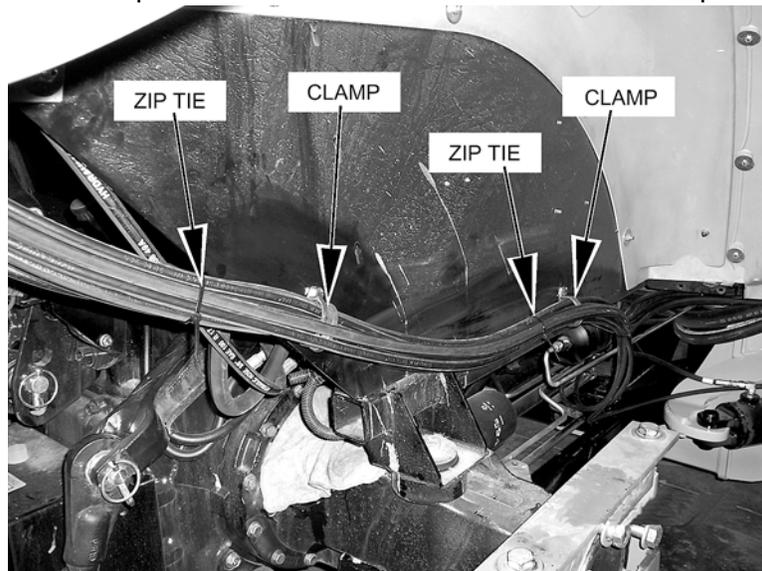

# ASSEMBLY

## WHEEL SPACER WITH WHEEL WELL TANK

When the left wheel is off, a spacer kit is needed with the wheel well tank (part# 06200637.) Attach the spacer to the left wheel portion of the axle with the hardware provided. When you are ready to re-attach the left wheel, the wheel goes on first then the reinforcement ring and finally the hardware provided. (ASM-JD-0070)

## INSTALLING O-RING FITTINGS

Installing straight, 45° and 90° O-rings requires that the O-ring and washer be up against the swivel body. Insert the swivel and turn in until the swivel is pointed in the desired direction and O-ring contact is made. Hold swivel in set direction with a wrench and turn the O-ring nut away from the swivel body and carefully tighten. (ASM-C-0056)

## INSTALLING NATIONAL PIPE FITTINGS

Whenever installing a pipe fitting, wrap the threads clockwise (looking at the end) with teflon tape. In this way, the tape will be tightened when installed. NOTE: It is not necessary to tape O-ring fittings, or those installed in swivels. (ASM-C-0088)

## GENERAL HOSE INSTALLATION

Refer to the Parts Section for detailed information about hoses and fittings for this application. (ASM-C-0011)

## HOSE COVERING

Secure hoses together with zip ties wherever loose. Wrap the hoses between the swivel and main boom with the hose cover provided. Wrap the hoses between the main boom and secondary boom with the hose cover provided. Where hoses may contact the frame or other edges, wrap with split hose and secure with hose clamps or zip ties.

On non-cab units, the pressure and return hoses from the control valve will also need to be routed inside the protective hose wrap. Cover the valve and valve fittings with the hose cover and secure with the string provided. (ASM-C-0058)

## SOLENOID BRAKE VALVE

Install a solenoid valve on the mounting bracket with the supplied hardware as shown in the Parts Section in this manual. While installing the fittings to the brake valve, the electrical coil on the spool may have to be removed to make room. When reinstalling the coil, it is important to use no more than 5 ft. lbs. (or 60in. lbs.) torque. **WARNING: OVER TORQUE TO THE COIL WILL RESULT IN HYDRAULIC FAILURE OF SPOOL.** (ASM-C-0025)

## TEMPERATURE GAUGE MOUNTING (OPTIONAL)

Mount the temperature gauge where it is clearly visible to the operator. Attach the green (-) wire from the negative post on the gauge to a grounded bolt on the tractor frame. Remove paint if needed to make a good ground. Remove the pipe plug from the side of the hydraulic reservoir and install the temperature sensor using thread sealing tape. Run the white wire from the (s) sensor post of the gauge to the temperature sensor on the hydraulic reservoir tank. (ASM-C-0051)



# ASSEMBLY

## CONTINUOUS DUTY SOLENOID SWITCH

To mount the solenoid switch, use the existing holes in location shown below. The bottom hole may need to be ground to obtain the correct hole spacing to match the solenoid switch mount. Secure with provided 5/16" x 1" capscrews, lockwashers, and hex nuts.



**MOUNTING LOCATION  
OF SOLENOID SWITCH**

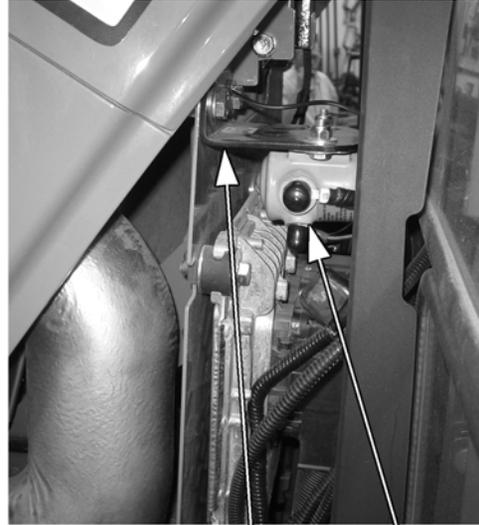

**MOUNTING BRACKET  
SOLENOID SWITCH**

Route wires to and from the Continuous Duty Solenoid Switch as shown below.

- A.) ORANGE 10 GA. wire from terminal (A) to +12V battery fusible link.
- B.) RED 14 GA. wire from terminal (B) to tractor plug in cab.
- C.) BLACK 14 GA. wire from terminal (C) to -12V battery post.
- D.) RED 10 GA. wire from terminal (D) to switchbox.
- E.) RED 14 GA. wire from terminal (D) to temperature gauge. (optional). (ASM-JD-0083 JD6E)

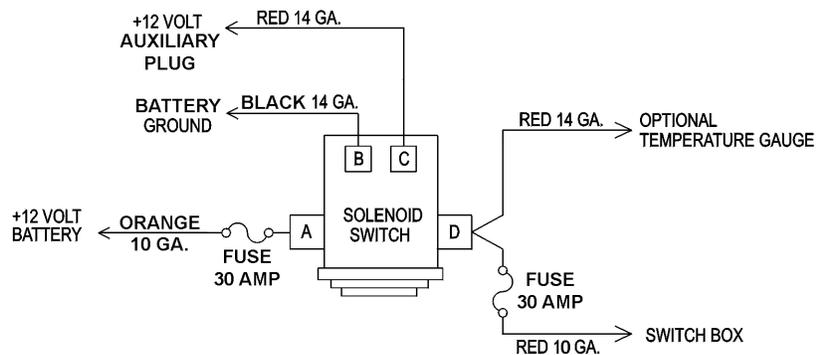

# ASSEMBLY

## TRIPLE FLAIL HYDRAULIC DIAGRAM

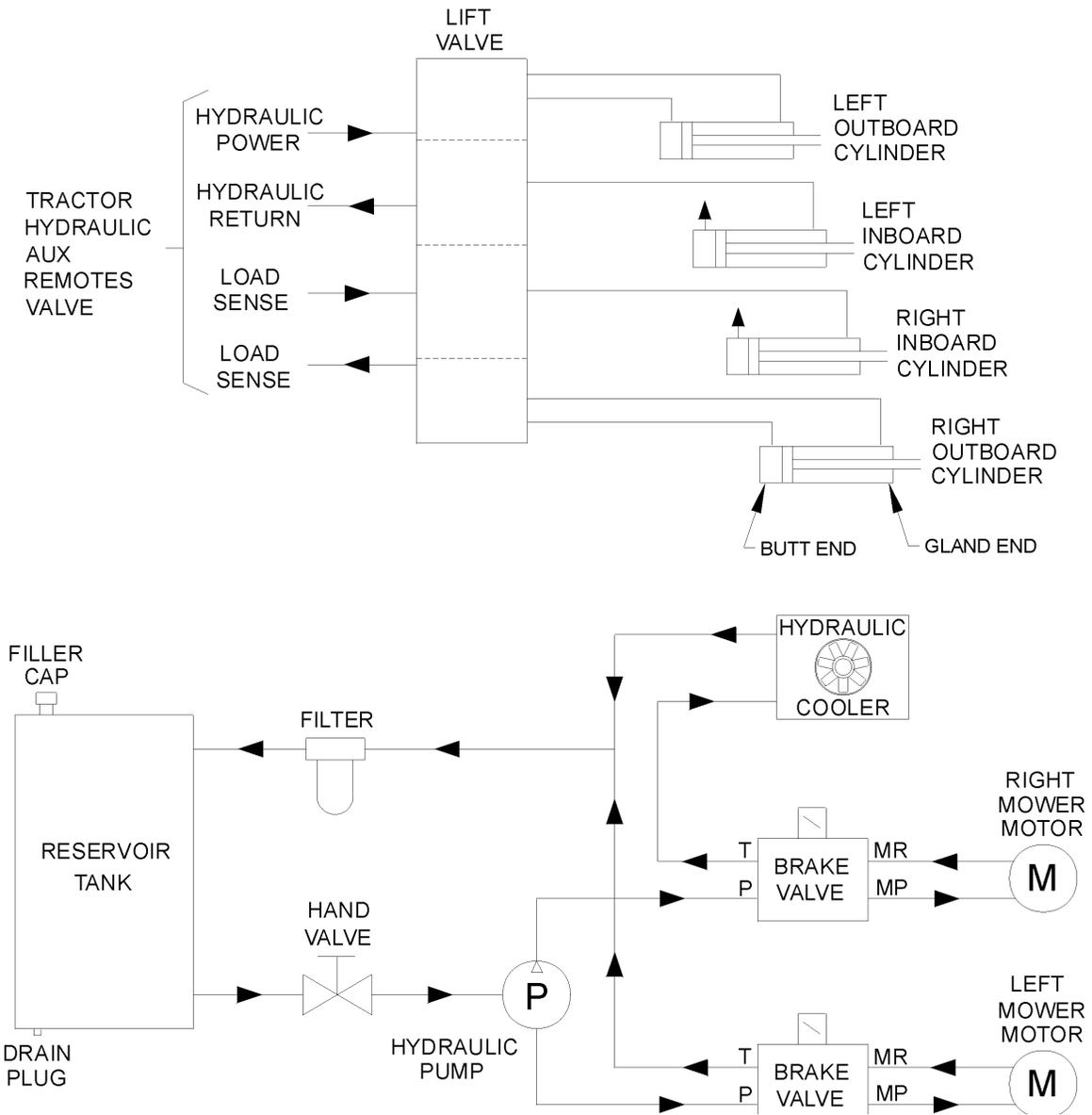

(ASM-T3F-0020)



# ASSEMBLY

## DRAFT BEAM INSTALLATION

Install ½" O-ring breather into butt port of inboard cylinder. Install fittings in the rod end of the cylinder according to the diagram in the Common Parts section. These fittings should be positioned to face the butt end of the cylinder.

Next turn the clevis onto the rod of the cylinder until it is tight against the shoulder and lock into place with locking bolt on clevis.

The inboard cylinder can now be installed into the main frame mast with the pin, flatwasher and R-clip as shown below.

Install all fittings in the outboard cylinder and adjust to point towards the butt end of the cylinder. Attach the hoses as specified in the Parts Section. Slide the cylinder into the draft beam from the outside of the draft beam and attach cylinder to the draft beam with clevis pin and rollpins. (ASM-C-0076 Berm Draft Beam JD6E)

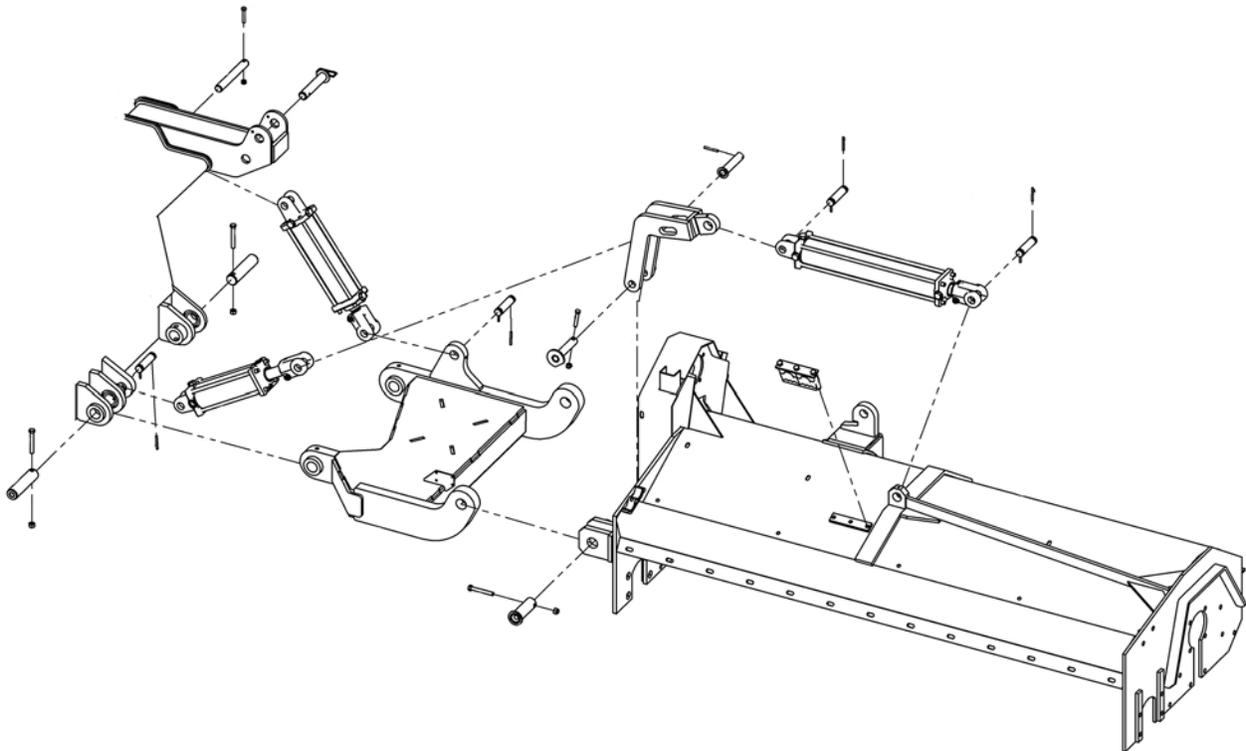

## DRAFT BEAM MOUNTING

Pull the inboard cylinder piston rod down to the extreme extended position. Slide the draft beam under the cylinder

Using the inboard cylinder as a pivot point, slide the draft beam under the tractor and install draft beam pin. Align hole in draft beam pin with holes in mainframe boss and install capscrew and nylock nut. (ASM-C-0078)



# ASSEMBLY

## LIMIT SWITCH MOUNTING

### ASSEMBLING LIMIT SWITCH

Mount bracket 1-5/8" down from top edge on the inside of the rear arm of the draft beam, (Fig. A) square with inside corner as shown with the square corners against arm. Weld plate no more than 5/8" x 1/4" on top as shown.

Assemble limit switch with wheel on body side of arm and with the rear of arm mount aligned with fourth notch on arm as shown in Fig. C. Fasten limit switch cam to bonnet with the 7/16" x 3-1/2" pin bolt and flatwasher as shown in Fig. D.

### ADJUSTING LIMIT SWITCH

To adjust switch do as follows:

1. With cam in place and pin bolt installed, raise mower to desired shutoff angle.
2. With pin bolt loosened turn cam until roller follower just reaches peak (see Figure E) and tighten pin bolt.
3. With switch arm mount screw (see Figure C) loose turn shaft (see Fig. E) with screwdriver in direction of follower rise while holding follower against cam peak until switch clicks off and hold while tightening arm mount screw.

### WIRING LIMIT SWITCH

Remove top cover on switch to expose terminals. Connect red wire to either of the back terminals, and the black wire to the other back terminal. Cut the white wire to solenoid valve at a place closest to the tilt-angle switch. Connect the red wire to one of the cut ends and the black wire to the other end. This connects the switch in series with the solenoid valve. (ASM-C-0028)

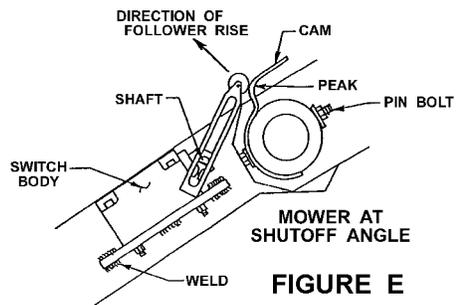
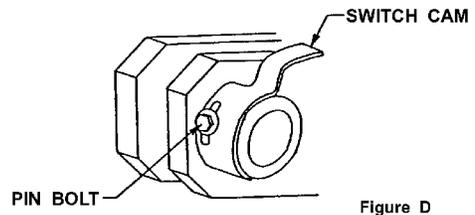
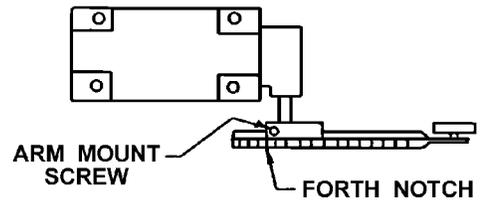
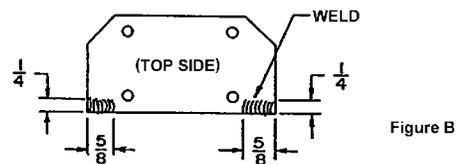
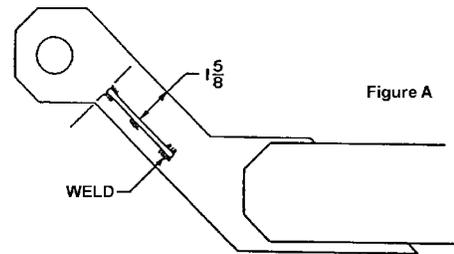



# ASSEMBLY

## LEFT SIDE FLAIL STEPS

To prevent damaging equipment and to prevent possible injury while mounting the tractor, step plates need to be installed on the left side flail and above the new DEF tank location. The steps need to be placed as shown below and secured to the flail using the supplied 1/4" X 3/4" self-tapping machine screws #42335. (ASM-T3F-0024 JD6E)

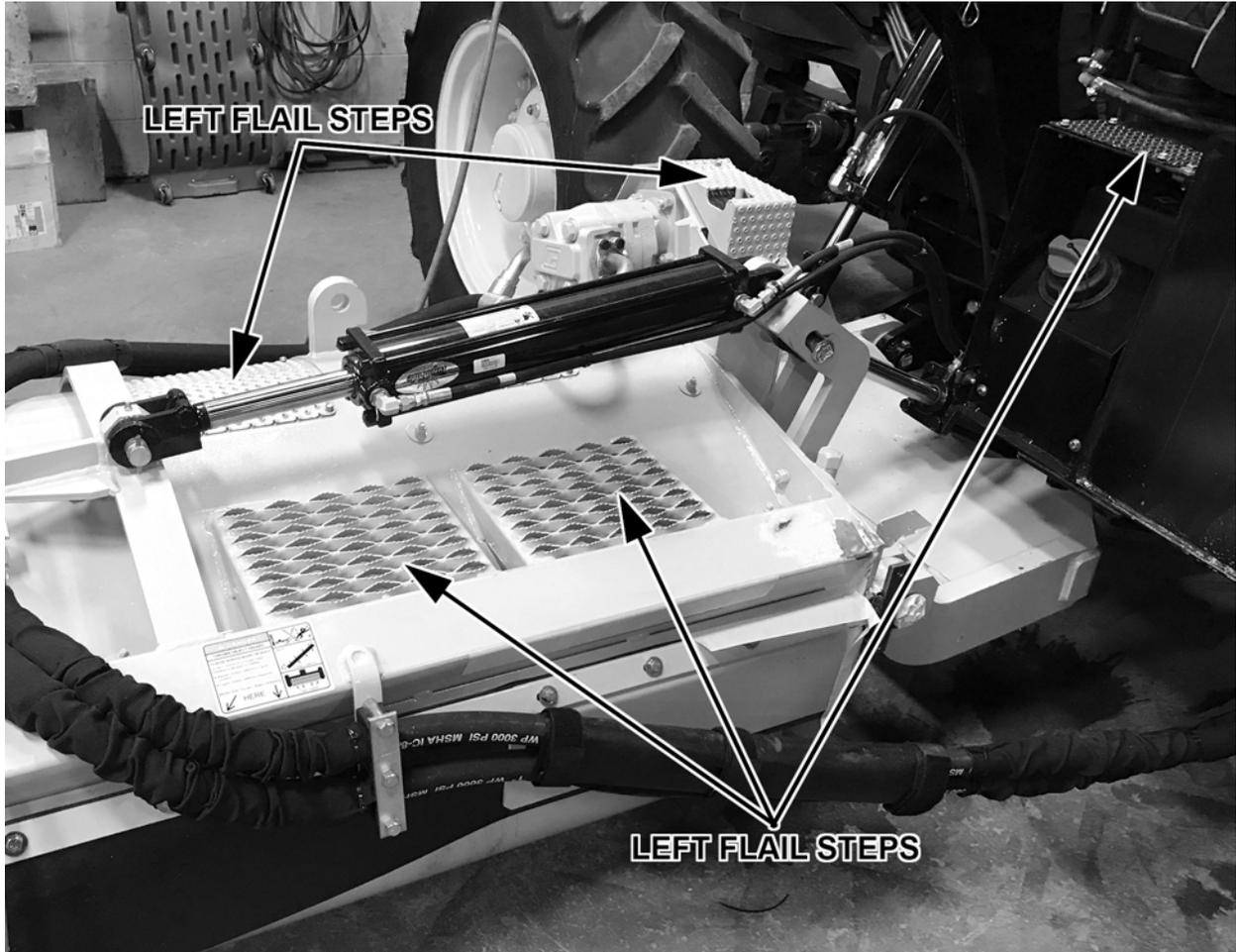

# ASSEMBLY

## MOWER MOUNTING

Check that all grease zerks have been installed in the draft beams pivot arm, left linkage arm, right linkage arm, and cylinder mounting ears.

Using a clevis pin and roll pins, connect the pivot arm to clevis on draft beam. **NOTE:** Make sure the longer distance between the cutout and the end of the pivot arm is closest to the draft beam pivot ears on the center tube as shown in the diagram below. Also make sure the cutout on the pivot arm faces into tube of draft beam. (*ASM-C-0077Berm Draft Beam*)

Slide other end of pivot arm with short distance between the cutout and the end of the pivot arm, into the cylinder clevis. Next, line up the holes of the left and right lift linkage arms outside of the cylinder clevis holes. Connect with linkage pin, shims (as required), boss, capscrew, lockwasher and hex nut as shown.

To connect the bonnet to the draft beam, slide the extension arms of the draft beam between the mounting ears on the inner end of the bonnet. Line up the holes and secure with swivel pin, capscrew, lockwasher, and hex nut (both sides). See Parts Section illustration.

Next, slide the left and right linkage arms up to the slotted ear on the side of the deck. Secure with linkage pin, shims, boss, capscrew, lockwasher and hex nut. See illustration in Parts Section.

## LIFT CONTROL FEEDLINES

Hose lengths will vary between tractor applications such as cab and non-cab units. See the Parts Section that pertains to your tractor for hose applications.

Install a hose from the bottom or inner valve port (behind cab for cab units, on stand for non-cab units) to the restrictor on the inboard cylinder gland.

Install a hose from the upper or outer valve port to the restrictor on the outboard cylinder butt. See Parts Section for part numbers and hose routing illustrations. (*ASM-C-0093*)



# ASSEMBLY

## TRAVEL LOCK INSTALLATION

Your side flail bonnet(s) may have come without the travel lock hook welded on. This is done after assembly to ensure a proper fit to your equipment. Follow the following steps to attach the travel lock. Make sure to wear the proper personal protection equipment.

1. Mount the left and/or right travel lock brackets loosely to each side of the mast frame. Refer to the Parts Section in this manual for part information.
2. Raise flail bonnets up to their highest position.
3. Lower draft beam cylinders 1-1/2 inches for travel lock hook clearance.
4. Mount the hook to the travel lock bracket with travel lock pin in place.
5. Line up the travel lock plate so that it is centered with the travel lock hook on each side.
6. Weld the plates to the bonnets.
7. Weld the hooks to the plates. (ASM-T3F-0025a)

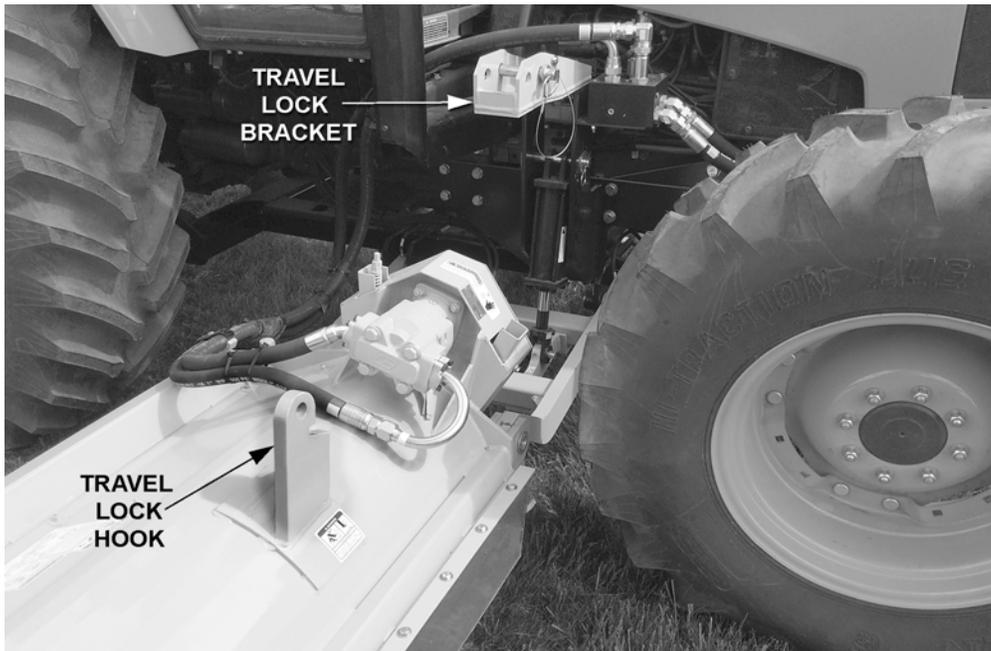

# ASSEMBLY

## DECK / MOTOR FEEDLINE

Install the 1" hoses from the motor to the solenoid valve. Refer to the Parts Section for detailed information about hoses and fittings for this application.

Install split hoses around hydraulic hoses where they contact sharp edges, or any other edges that may rub hoses.

Be sure that all grease zerks are installed in the draft beam pin bosses. Grease all areas of the draft beam according to the instructions in the Maintenance Section. Re-check all fittings for tightness.

Fill hydraulic tank with fluid as recommended in the Maintenance Section. **BE SURE TO OPEN THE BALL VALVES.** Start the tractor and operate the inboard cylinder through the entire stroke and the outboard cylinder through the bottom  $\frac{3}{4}$  stroke repeatedly to clear the lines of air. **DO NOT run outboard cylinder out to full stroke until stop bolt has been adjusted!**

Check for oil leaks at all fittings and connections using a piece of paper or cardboard. If a leak is found, you must shut down the tractor and set the cutter head on the ground. Before attempting to fix the leak, you must actuate the lift valve handles several times to relieve any pressure in the lines. **DO NOT USE HANDS TO CHECK FOR FLUID LEAKS!**

Raise the three point hitch and check the tractor internal hydraulics, fill to proper level if needed. (ASM-C-0079)



# ASSEMBLY

## FINAL PREPARATION FOR OPERATION

Place operator's safety and operation decals on the steering column and side console where they are clearly visible to the operator. These decals should be understood by each operator of the machine in conjunction with the Safety and Operation Sections of this book. The decals are to be maintained in good condition as a reminder to the operator, and should be replaced if damaged.

All bosses, pins and pivot points will need to be greased as instructed in the Maintenance Section of this manual. The hydraulic reservoir can also be filled with the recommended fluid (see Maintenance Section) and the filter installed in the top of the tank. Double check all fittings and fasteners BEFORE starting tractor. Also secure any loose hoses together with zip ties and wrap with split hoses where friction may occur on the hoses.



**BEFORE** starting or operating the tractor you must read and understand the Safety and Operation Sections of this manual completely.

**BE SURE THE BALL VALVES ARE OPEN!** Start tractor and allow instruments to stabilize. Using a piece of paper or cardboard as noted in the Safety and Maintenance Sections, check all fittings and connections for hydraulic leaks.

If a leak is found, you must shut down the tractor and set the cutter on the ground. Before attempting to fix the leak, you must actuate the lift valve handles several times to relieve any pressure in the lines.

**Before operating the mower**, the cutter head and boom should be slowly moved throughout the full range of motion. Watch for any condition that would cause pinching or excess stress on the hoses. The steering and front axle travel should also be carefully moved through their full range of motion. If any condition occurs in which the hoses contact the tires, the steering and / or front axle travel may need to be limited as described in the tractor operator's manual. This should also be done if the tires rub, or are extremely close to any other part of the mower, such as the hydraulic tank or draft beam. This may include adding shims or adjusting stop bolts in the tractor front to solve the problem. While checking motion, you should also check that the control circuits are connected according to the operator's decal for the valve handles.

## MOWER TESTING

Take the tractor to a place free of loose objects on the ground. Operate the cylinders through their full range of motion again, to clear the lines of air. Follow the instructions in the Operation Section to operate the mower. Vibration of the mower should be minimal at all times. After a 5 minute test run, the knife bolts should be retorqued, and retorqued once again after the first few hours of operation.

**If any parts of this Assembly Section, or any other section of this manual are not clearly understood you must contact your dealer or the address on the front of this manual for assistance!** *(ASM-C-0010)*



# ASSEMBLY



# OPERATION SECTION

Operation Section 3-1

# OPERATION

## TIGER TRIPLE FLAIL MOWER OPERATING INSTRUCTIONS

Tiger Triple flail mowers are manufactured with quality material by skilled workers. These mowers are designed for cutting grass and small weeds. The mower is equipped with protective deflectors to prevent objects being thrown from the mower by the blades, however, no shielding is 100% effective. All shields, guards, and deflectors equipped on the mower must be maintained in good operational condition.

It is the operator's responsibility to be knowledgeable of all potential operating hazards and to take every reasonable precaution to ensure oneself, others, animals, and property are not injured or damaged by the mower, tractor, or a thrown object. Do not operate the mower if passersby, pets, livestock, or property are within 100 yards of the unit.

This section of the Operator's Manual is designed to familiarize, instruct, and educate safe and proper mower use to the operator. Pictures contained in this section are intended to be used as a visual aid to assist in explaining the operation of a Triple flail mower and are not specific to any model. Some pictures may show shields removed for picture clarity. NEVER operate implement without all shields in place and in good operational condition. The operator must be familiar with the mower and tractor and all associated safety practices before operating the mower and tractor. Proper operation of the mower, as detailed in this manual, will help ensure years of safe and satisfactory use of the mower.

**IMPORTANT:** To avoid mower damage, retorque all bolts after the first 10 hours of operation. Refer to the Torque Chart at the end of the Maintenance Section to ensure bolts are properly tightened.

**READ AND UNDERSTAND THE ENTIRE OPERATING INSTRUCTIONS AND SAFETY SECTION OF THIS MANUAL AND THE TRACTOR MANUAL BEFORE ATTEMPTING TO USE THE TRACTOR AND IMPLEMENT.** If you do not understand any of the instructions, contact your nearest authorized dealer for a full explanation. Pay close attention to all safety signs and safety messages contained in this manual and those affixed to the implement and tractor. (OPS-U-0001)

READ, UNDERSTAND, and FOLLOW the following Safety Messages. Serious injury or death may occur unless care is taken to follow the warnings and instructions stated in the Safety Messages. Always use good common sense to avoid hazards. (SG-2)

**SAFETY  
INSTRUCTIONS**



**PELIGRO**

Si no lee ingles, pida ayuda a alguien que si lo lea para que le traduzca las medidas de seguridad. (SG-3)

**¡ LEA EL  
INSTRUCTIVO!**





# OPERATION

## 1. OPERATOR REQUIREMENTS

Safe operation of the unit is the responsibility of a qualified operator. A qualified operator has read and understands the implement and tractor Operator's Manuals and is experienced in implement and tractor operation and all associated safety practices. In addition to the safety messages contained in this manual, safety signs are affixed to the implement and tractor. If any part of the operation and safe use of this equipment is not completely understood, consult an authorized dealer for a complete explanation.

If the operator cannot read the manuals for themselves or does not completely understand the operation of the equipment, it is the responsibility of the supervisor to read and explain the manuals, safety practices, and operating instructions to the operator.

Safe operation of equipment requires that the operator wear approved Personal Protective Equipment (PPE) for the job conditions when attaching, operating, servicing, and repairing the equipment. PPE is designed to provide operator protection and includes the following safety wear:

### PERSONAL PROTECTIVE EQUIPMENT (PPE)

- Always Wear Safety Glasses
- Hard Hat
- Steel Toe Safety Footwear
- Gloves
- Hearing Protection
- Close Fitting Clothing
- Respirator or Filter Mask (depends on operating conditions) (OPS-U-0002)

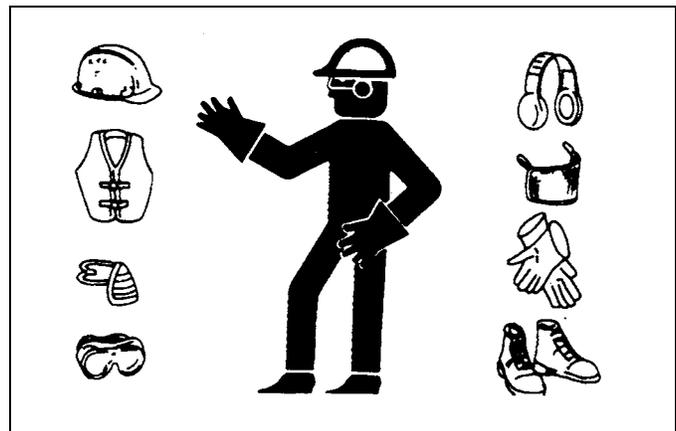

NEVER use drugs or alcohol immediately before or while operating the Tractor and Implement. Drugs and alcohol will affect an operator's alertness and coordination and therefore affect the operator's ability to operate the equipment safely. Before operating the Tractor or Implement, an operator on prescription or over-the-counter medication must consult a medical professional regarding any side effects of the medication that would hinder their ability to operate the Equipment safely. NEVER knowingly allow anyone to operate this equipment when their alertness or coordination is impaired. Serious injury or death to the operator or others could result if the operator is under the influence of drugs or alcohol. (SG-27)



# OPERATION

## **2. TRACTOR REQUIREMENTS**

In addition to tractor horsepower and size required to operate the unit, the tractor must also be properly equipped to provide operator protection, to alert approaching vehicle drivers of the tractor's presence, and to ensure tractor stability when mowing.

### **Tractor Requirements and Capabilities**

- ASABE approved Roll-Over Protective Structure (ROPS) or ROPS cab and seat belt.
- Tractor Safety Devices ..... Slow Moving Vehicle (SMV) emblem, lighting, PTO master shield
- Tractor Horsepower..... 65 HP Min Recommended
- Power Take Off..... 540 RPM

### **2.1 ROPS and Seat Belt**

The tractor must be equipped with a Roll-Over-Protective-Structure (ROPS) (tractor cab or roll-bar) and seat belt to protect the operator from falling off the tractor, especially during a roll over where the driver could be crushed and killed. Only operate the tractor with the ROPS in the raised position and seat belt fastened. Tractor models not equipped with a ROPS and seat belt should have these life saving features installed by an authorized dealer. *OPS-U- 0003*



Operate this Equipment only with a Tractor equipped with an approved roll-over-protective system (ROPS). Always wear seat belts. Serious injury or even death could result from falling off the tractor--particularly during a turnover when the operator could be pinned under the ROPS. (SG-7)



### **2.2 Tractor Safety Devices**

If transporting or operating the tractor and implement near a public roadway, the tractor must be equipped with proper warning lighting and a Slow Moving Vehicle (SMV) emblem which are clearly visible from the rear of the unit. Lights and a SMV emblem must be equipped directly on implements if the visibility of the tractor warning signals are obscured.

Maintain all manufacturer equipped safety shields and guards. Always replace shields and guards that were removed for access to connect, service, or repair the tractor or implement. Never operate the tractor PTO with the PTO master shield missing or in the raised position. *OPS-U- 0004*

### **2.3 Tractor Horsepower**

The horsepower required to operate the mower depends on many factors including the vegetation to be cut, terrain condition, operator experience, and condition of the mower and tractor. For most mowing condition, the Triple Flail mowers require a tractor with at least 65HP. Operating the mower with a tractor that does not have adequate power may damage the tractor engine.

# OPERATION



**DO NOT** use a PTO adapter to attach a non-matching Implement driveline to a Tractor PTO. Use of an adapter can double the operating speed of the Implement resulting in excessive vibration, thrown objects, and blade and implement failure. Adapter use will also change the working length of the driveline exposing unshielded driveline areas. Serious bodily injury and/or equipment failure can result from using a PTO adapter. Consult an authorized dealer for assistance if the Implement driveline does not match the Tractor PTO. (S3PT-14)



For non-independent PTO tractors - Never operate the Tractor and Mower if the Implement input driveline is directly connected to the Tractor transmission. Tractor braking distances can be substantially increased by the momentum of the rotating Mower blades driving the Tractor transmission even though the Tractor clutch has been disengaged. Install an over running clutch between the Tractor PTO and the Mower driveline to prevent this potentially dangerous situation. (S3PT-16\_A)

## **3. GETTING ON AND OFF THE TRACTOR**

Before getting onto the tractor, the operator must read and completely understand the implement and tractor operator manuals. If any part of either manual is not completely understood, consult an authorized dealer for a complete explanation. OPS-U- 0007



Do not mount or dismount the Tractor while the tractor is moving. Mount the Tractor only when the Tractor and all moving parts are completely stopped. (SG-12)



### **3.1 Boarding the Tractor**

Use both hands and equipped handrails and steps for support when boarding the tractor. Never use control levers for support when mounting the tractor. Seat yourself in the operator's seat and secure the seat belt around you.

Never allow passengers to ride on the tractor or attached equipment. Riders can easily fall off and be seriously injured or killed from falling off and being run over. It is the operator's responsibility to forbid all extra riders at all times. OPS-U- 0008



Never allow children to operate, ride on, or come close to the Tractor or Implement. Usually, 16-17 year-old children who are mature and responsible can operate the implement with adult supervision, if they have read and understand the Operator's Manuals, been trained in proper operation of the tractor and Implement, and are physically large enough to reach and operate the controls easily. (SG-11)



# OPERATION



Never allow children or other persons to ride on the Tractor or Implement. Falling off can result in serious injury or death. (SG-10)



Do not mount or dismount the Tractor while the tractor is moving. Mount the Tractor only when the Tractor and all moving parts are completely stopped. (SG-12)



OPERATION

## 3.2 Dismounting the Tractor

Before dismounting the tractor, idle the tractor engine down, disengage the head and raise the side mower to the transport position. Park the tractor on a level surface, place the transmission in neutral and set the parking brake. Shut down the tractor engine, remove the key, and wait for all motion to come to a complete stop before exiting the operator's seat. NEVER leave the seat until the tractor, its engine, and mower head movement have come to a complete stop.

Use hand rails and extra steps when exiting the tractor. Be careful of your step and use extra caution when mud, ice, snow, and other matter has accumulated on the steps and handrails. Never rush or jump off the tractor. OPS-B- 0002\_A



BEFORE leaving the tractor seat, always set the parking brake and/or set the tractor transmission in parking gear, disengage the PTO, stop the engine, remove the key, and wait for all moving parts to stop. Place the tractor shift lever into a low range or parking gear to prevent the tractor from rolling. Never dismount a Tractor that is moving or while the engine is running. Operate the Tractor controls from the tractor seat only. (SG-9)

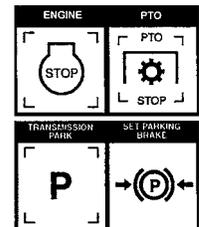

# OPERATION

## 4. STARTING THE TRACTOR

The operator must have a complete understanding of the placement, function, and operational use of all tractor controls before starting the tractor. Review the tractor operator's manual and consult an authorized dealer for tractor operation instructions if needed.

Essential Tractor Controls:

- Locate the ignition key/switch
- Locate the engine shut off control
- Locate the hydraulic control levers
- Locate the light control lever
- Locate the brake pedals and clutch
- Locate the PTO control
- Locate the 3 point hitch control lever
- Locate the operating controls

Before starting the tractor ensure the following:

- Conduct all pre-start operation inspection and service according to the tractor operator's manual.
- Make sure all guards, shields, and other safety devices are securely in place.
- The parking brake is on.
- The tractor transmission levers are in park or neutral.
- The mower operating controls are in the neutral and off position.
- The PTO control lever is disengaged.
- The hydraulic remote control levers are in the neutral position.

Refer to the tractor owner's manual for tractor starting procedures. Only start the tractor while seated and belted in the tractor operator's seat. Never bypass the ignition switch by short circuiting the starter solenoid. After the tractor engine is running, avoid accidental contact with the tractor transmission to prevent sudden and unexpected tractor movement. OPS-B- 0003\_A



Never run the Tractor engine in a closed building or without adequate ventilation. The exhaust fumes can be hazardous to your health. (SG-23)



Start tractor only when properly seated in the Tractor seat. Starting a tractor in gear can result in injury or death. Read the Tractor operators manual for proper starting instructions. (SG-13)



## 5. CONNECTING THE MOWER TO THE TRACTOR

Use extreme caution when connecting the mower to the tractor. The mower should be securely resting at ground level or setting on blocks. Keep hands and feet from under the mower deck and clear of pinch points between the tractor hitch arms and mower pins. OPS-R-0001

# OPERATION

## **⚠ DANGER**

Always shut the Tractor completely down, place the transmission in park, and set the parking brake before you or anyone else attempts to connect or disconnect the Implement and Tractor hitches. (S3PT-15)

### **5.1 Connecting the Rear Flail to the Tractor**

1. Make sure the tractor is equipped with the correct PTO shaft. Change shafts if needed.
2. Shorten or remove the tractor drawbar to avoid interference when raising and lowering the mower.
3. Board the tractor and start the engine. Position the tractor to the mower with the 3-point lift arms positioned between the respective set of mower A-frame lift lugs. **Note:** Set the 3-point lift control to "Position Control" so that the lift arms maintain a constant height when attaching the mower. See the tractor Operator's Manual for correct settings when attaching 3-point equipment.
4. Turn off the tractor engine and dismount.
5. One lift arm at a time, align arm end hole between the set of A-frame lift lugs. Insert hitch pin through the lug and arm holes and insert retaining pin into hitch pin.
6. Walk around to opposite side and repeat procedure for remaining lift arm and hitch pin.
7. Extend or retract 3-point top link to align its end hole with the holes of the mower's top link. Insert the top link hitch pin and insert retaining pin into hitch pin.
8. Adjust any lower link check chains, guide blocks, or sway blocks to prevent the mower from swaying side to side and possible contact with tractor rear tires.



# OPERATION

## 5.2 Connecting the Side Flails to the Tractor

1. Install the Draft Beam onto the Main Frame.
2. Raise the Draft Beam to line up with the the 'ears' on the Side Flail and install Pins and hardware.
3. Connect the Linkage and Cylinder to the Side Flail for a Combo Lift set-up or route and connect the cable to the Side Flail if it's a Cable Lift set-up.
4. Route and connect the hydraulic lines to the cylinders and from the Brake Valve to the Side Flail motor.



### **WARNING**

Do not operate this Equipment with hydraulic oil or fuel leaking. Oil and fuel are explosive and their presence could present a hazard. Do not check for leaks with your hand! High-pressure oil streams from breaks in the line could penetrate the skin and cause tissue damage including gangrene. To check for a hose leak, SHUT the unit ENGINE OFF and remove all hydraulic pressure. Wear oil impenetrable gloves, safety glasses and use Cardboard to check for evidence of oil leaks. If you suspect a leak, REMOVE the HOSE and have it tested at a Dealer. If oil does penetrate the skin, have the injury treated immediately by a physician knowledgeable and skilled in this procedure. (SG-15)



### **WARNING**

Avoid contact with hot surfaces including hydraulic oil tanks, pumps, motors, valves and hose connections. Relieve hydraulic pressure before performing maintenance or repairs. Use gloves and eye protection when servicing hot components. Contact with a hot surface or fluid can cause serious injury from burns or scalding. (SG-34)

### **DANGER**

**DO NOT** allow any person under a side mower unless mower is securely locked up or supported. **DO NOT** approach the Implement unless the Tractor is turned off and all motion has ceased. Never work under the frame work, or any lifted component unless the implement is securely supported or blocked up. A sudden or inadvertent fall by any of these components could cause serious injury or even death. (STI-03\_A)



# OPERATION

## 6. SETTING THE MOWER

Properly setting the cutting height is essential for efficient and safe operation. A properly set mower will make a more uniform cut, distribute clippings more evenly, require minimal tractor work, and follow the contour of uneven terrain. **NOTE:** Avoid very low cutting heights, striking the ground with the blades gives the most damaging shock loads and will cause damage to the mower and drive. Blades contacting the ground may cause objects to be thrown out from under the mower deck. Always avoid operating the mower at a height which causes the blades to contact the ground. OPS-U- 0010



Never work under the Implement, the framework, or any lifted component unless the Implement is securely supported or blocked up to prevent sudden or inadvertent falling which could cause serious injury or even death. (SG-14)



### 6.1 Roller Height Adjustment

5. The mower's cutting height is set by positioning the roller assembly for each mower section. Each section must be set at the same height to ensure an even cut across the entire width of the mower.
6. Place the tractor and mower on a level surface and completely lower the mower to the ground.
7. Shut down the tractor, place the transmission in park, and set the parking brake before dismounting.
8. One section at a time, place lifting device (scissors jack or hydraulic jack) under center of cutter housing.
9. Remove hex nuts, washers and carriage bolts from brackets at each end of roller. Make certain that roller bracket is free to move once the fasteners are removed. A stuck roller could drop unexpectedly and cause injury.
10. For Standard Duty flails, use lifting device to reposition cutter housing to desired cutting height. Align bracket holes with cutter housing, then reinstall hardware.
11. For Heavy Duty flails, loosen the Adjustment rod lock nut and adjust height by turning the Adjustment Rod. Retighten the Adjustment rod lock nut and then reinstall hardware.
12. Lower cutter housing to the ground and remove lifting device.
13. Set cutting height according to procedures above for remaining two cutter sections. Make sure that all three rollers are set at the same height to ensure a even cut across the entire width of the mower.

Standard Duty

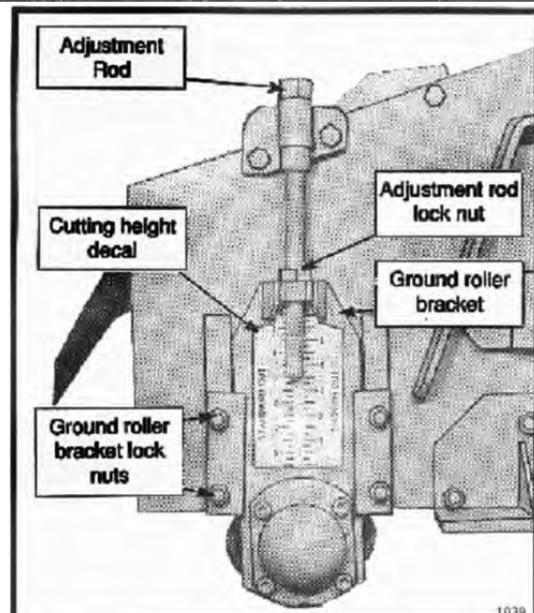
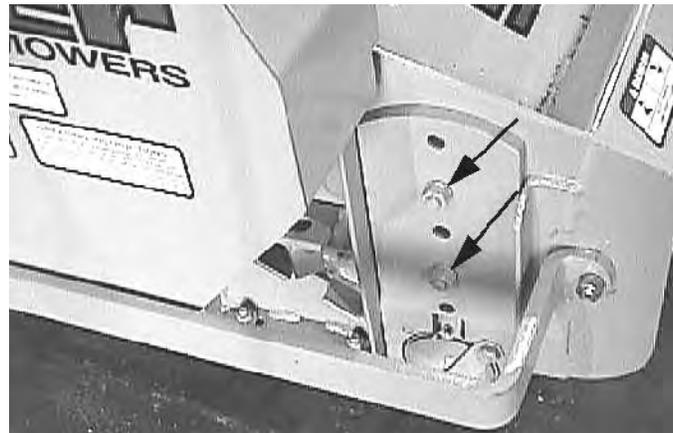

Heavy Duty

TRIPLE FLAIL

Operation Section 3-10



# OPERATION

## 6.2 Leveling Deck

To facilitate a safe and efficient mowing operation, the mower should be operated parallel to the ground at all times. Never operate if front or rear of mower is tilted upward. Objects may be discharged at high speeds causing possible injury or even death.

Adjust Top Link to level mower roller adjustment. Side Skid Shoes should always be parallel to ground throughout the full adjustment range. Adjust cutting height of machine by raising or lowering rear roller as specified in Operation Section.

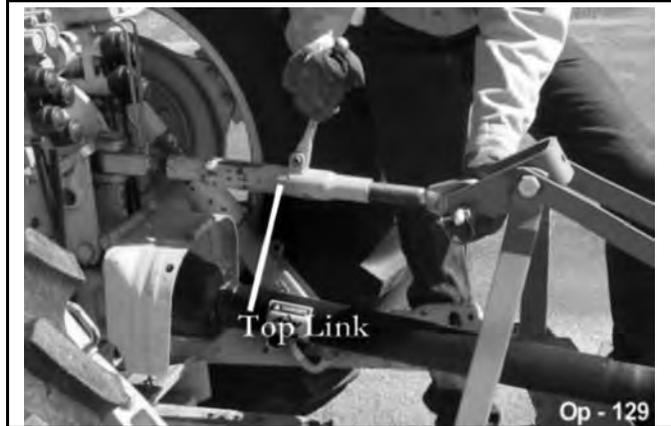

**WARNING** Do not let the Blades turn when the Mower Deck is raised for any reason, including clearance or for turning. Raising the Mower deck exposes the Cutting Blades which creates a potentially serious hazard and could cause serious injury or even death from objects thrown from the Blades. (SRM-07)



## 7. DRIVELINE ATTACHMENT

The driveline yoke and tractor PTO shaft must be dirt free and greased for attachment.

To connect the mower driveline to the tractor PTO output shaft, pull the driveline yoke collar back and align the grooves and splines of the yoke with those of the PTO shaft. Push the driveline yoke onto the PTO shaft, release the locking collar, and position the yoke until the locking collar balls are seated onto the PTO shaft. Push and pull the driveline back and forth several times to ensure a secure attachment.



After the driveline is securely attached, place the tractor PTO master shield back in the operating position. OPS-R-0003

### Driveline Length Check



**WARNING** Before operating the Implement, check to make sure the Implement input driveline will not bottom out or become disengaged. Bottoming out occurs when the inner shaft penetrates the outer housing until the assembly becomes solid-it can shorten no more. Bottoming out can cause serious damage to the Tractor PTO by pushing the PTO into the Tractor and through the support bearings or downward onto the PTO shaft, breaking it off. A broken driveline can cause personal injury. (S3PT-18)

# OPERATION

When fitting the mower to the tractor, the telescoping driveline must be inspected to ensure that at its most compressed position, the profiles do not “bottom out”, and when at its farthest extended position, there is sufficient engagement between the profiles to operate safely. At its shortest length, there must be at least a 1” clearance between each profile end and opposite profile universal joint. At its farthest operating extension, a minimum profile engagement of 12” must be maintained.

## “Bottoming Out” Check Procedure

- Disconnect driveline from the tractor and slide the profiles together until fully compressed.
- Place a mark on the inner shield 1/8” from the end of the outer shield and reattach the driveline to the PTO Shaft.
- With the **PTO NOT TURNING**, slowly drive the tractor with mower attached through the sharpest turn possible and watch shaft movement. With the **PTO NOT TURNING**, slowly drive the tractor with the mower attached through the most severe terrain conditions expected and watch shaft movement.
- If the distance between the mark and the outer shield becomes less than 2” at any point there is a potential problem bottoming out the driveline and the driveline should be shortened.  
*OPS-F-0001*

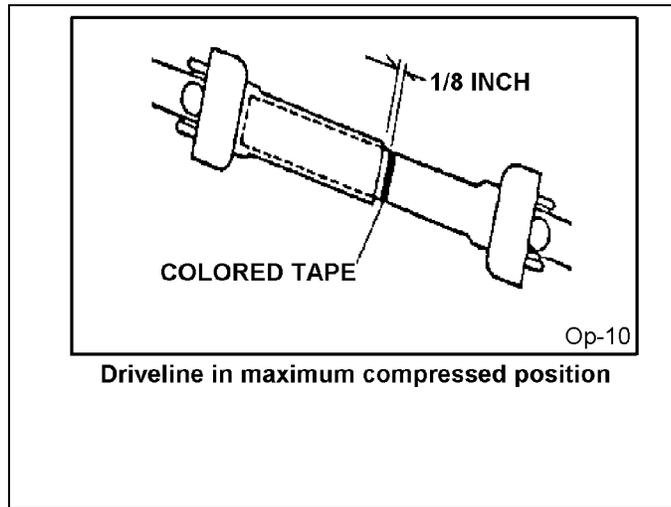

# OPERATION

## Shorten the driveline profiles as follows:

- Remove the driveline from the tractor.
- Position the mower to the point with the shortest distance between the tractor PTO shaft and cutter gearbox. Shut down the tractor and securely block the mower in this position.
- Pull driveline apart and reattach yoke to PTO shaft.
- Hold driveline sections parallel to one another and measure back 1" from yoke of each shaft and place mark on opposite section. Cut this length off with a saw.
- Round off all sharp edges and debur.
- Thoroughly grease then reinstall the driveline.
- Recheck for proper operation.

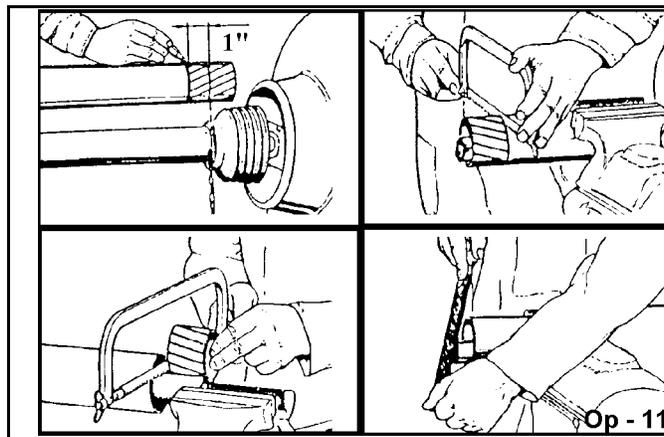

## Engagement Check Procedure

- With the driveline attached, position the mower to the point where the telescoping driveline is at its maximum extension. Completely shut down the tractor and secure in position.
- Mark the inner driveline shield 1/8" from the end of the outer shield.
- Disconnect the driveline from the tractor and separate the two driveline halves.
- Measure the distance from the mark to the end of the inner profile. This length is the amount the driveline profiles were engaged.
- If the engaged length is less than 12" the shaft is considered too short and should be replaced with a longer shaft. Consult an authorized dealer to purchase the required driveline length.

**NOTE:** If the driveline cannot be shortened and still maintain the required profile engagement, the operator must be made aware of terrain conditions and avoid situations which pose a potential problem to avoid damaging the driveline. OPS-F-0002

## 8. PRE-OPERATION INSPECTION AND SERVICE

Before each use, a pre-operation inspection and service of the implement and tractor must be performed. This includes routine maintenance and scheduled lubrication, inspecting that all safety devices are equipped and functional, and performing needed repairs. DO NOT operate the unit if the pre-operation inspection reveals any condition affecting safe operation. Perform repairs and replacement of damaged and missing parts as soon as noticed. By performing a thorough pre-operation inspection and service, valuable down time and repair cost can be avoided. OPS-U-0029



Always disconnect the main PTO Driveline from the Tractor before performing service on the Mower. Never work on the Mower with the tractor PTO driveline connected and running. Blades or Drivelines could turn without warning and cause immediate entanglement, injury or death. (SRM-3)

# OPERATION

## **⚠ DANGER**

**DO NOT** allow any person under a side mower unless mower is securely locked up or supported. **DO NOT** approach the Implement unless the Tractor is turned off and all motion has ceased. Never work under the frame work, or any lifted component unless the implement is securely supported or blocked up. A sudden or inadvertent fall by any of these components could cause serious injury or even death. (STI-03\_A)



## **⚠ WARNING**

Periodically inspect all moving parts for wear and replace when necessary with authorized service parts. Look for loose fasteners, worn or broken parts, and leaky or loose fittings. Make sure all pins have attaching hardware. Serious injury may occur from not maintaining this machine in good working order. (SG-21\_A)

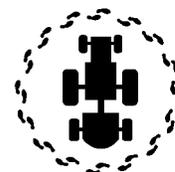

## **8.1 Tractor Pre-Operation Inspection/Service**

Refer to the tractor operator's manual to ensure a complete pre-operation inspection and scheduled service is performed according to the manufacturers recommendations. The following are some of the items that require daily service and inspection:

- Tire condition/air pressure
- Wheel lug bolts
- Steering linkage
- PTO shield
- SMV sign is clean and visible
- Tractor's lights are clean and functional
- Tractor Seat belt is in good condition
- Tractor ROPS is in good condition
- ROPS is in the raised position
- No tractor oil leaks
- Radiator free of debris
- Engine oil level and condition
- Engine coolant level and condition
- Power brake fluid level
- Power steering fluid level
- Fuel condition and level
- Sufficient lubrication at all lube points
- Air filter condition *OPS-U-0030*



# OPERATION

## 8.2 Mower Pre-Operation Inspection/Service

Before each mower use, a complete inspection and service is required to ensure the mower is in a good and safe working condition. Damaged and/or broken parts should be repaired and/or replaced immediately. To ensure the mower is ready for operation, conduct the following. OPS-R-0007



All Safety Shields, Guards and Safety devices including (but not limited to) - the Deflectors, Steel Guards, Gearbox Shields, PTO integral shields, and Retractable Door Shields should be used and maintained in good working condition. All safety devices should be inspected carefully at least daily for missing or broken components. Missing, broken, or worn items must be replaced at once to reduce the possibility of injury or death from thrown objects, entanglement, or blade contact. (SFL-5)

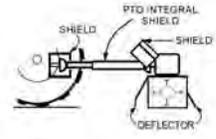

Replace bent or broken blades with new blades. NEVER ATTEMPT TO STRAIGHTEN, WELD, OR WELD HARDFACING ON BLADES SINCE THIS WILL LIKELY CRACK OR OTHERWISE DAMAGE THE BLADE WITH SUBSEQUENT FAILURE AND POSSIBLY CAUSE SERIOUS INJURY FROM THROWN BLADES. (SGM-10)

The operator's manual and safety signs affixed on the unit contain important instructions on the safe and proper use of the equipment. Maintain these important safety features on the implement in good condition to ensure the information is available to the operator at all times.

- Ensure all safety signs are in place and legible. Replace missing, damaged, and illegible decals. OPS-U-0011\_A



- Check that the main driveline securely attached to the tractor and the locking collar is seated in the groove of the PTO Shaft.
- Ensure side mower hydraulics are secure at both ends. OPS-F-0003\_A



# OPERATION

## OPERATION

- Ensure rubber deflectors are in position and not damaged. Replace worn, broken, and missing sections immediately.
- Ensure the rollers are in good condition and rotate freely.
- Ensure the driveline integral shield is in good condition and rotate freely.
- Inspect that all bolts and screws are in position and are properly torqued. *OPS-F- 0004*



Op-255

- Inspect the condition of the side mowers and rear mower drive belts.
- Ensure the slip clutch (rear mower section only) is properly adjusted and the friction plates are not frozen together. Reference the Maintenance Section for proper slip clutch maintenance.
- Ensure the slip clutch shield and drive belts shields are in place and in good repair.
- Ensure the tractor PTO master shield is in place, lowered and in good condition. *OPS-F- 0005\_A*

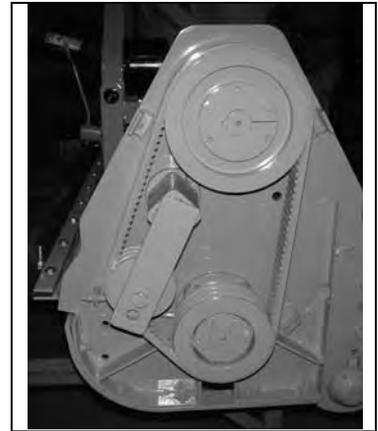

- Inspect oil level in gearbox and replenish if needed. A low oil level is a warning sign that the gearbox may be cracked or its seal is damaged and needs to be replaced.
- Check the oil level in tank and replenish if need. **NOTE:** Do not fill the tank with oil above the level of the sight gauge. Over filling the tank with oil after initial filling may result in oil being discharged through the breather cap on the top of the hydraulic tank.
- Perform scheduled lubrication as specified in the maintenance section. *OPS-F- 0006\_A*

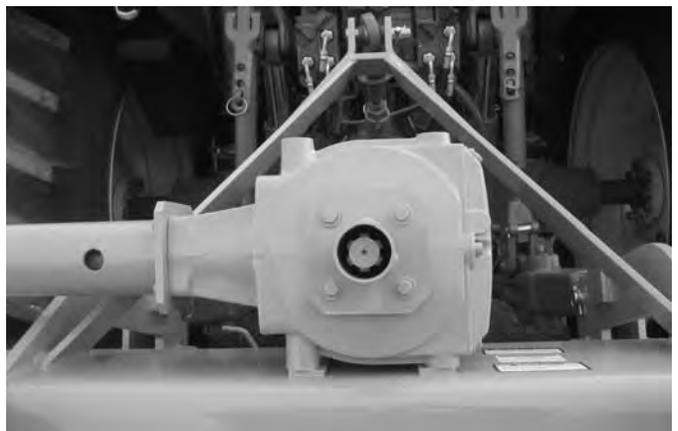

## OPERATION

- Inspect cutter knives and knife pins for looseness and excessive wear. Make sure the mower is securely blocked up before crawling beneath. Replace damaged, worn, and missing knives as complete sets to maintain cuttershaft balance.
- Remove any grass or other debris which may be wrapped around the cuttershafts.
- Inspect the condition of deck skid shoes and hardware. *OPS-F- 0007*



OPERATION

# OPERATION

## Tractor PRE-OPERATION Inspection



Mower ID# \_\_\_\_\_ Make \_\_\_\_\_

Date: \_\_\_\_\_ Shift \_\_\_\_\_



**Before conducting the inspection, make sure the tractor engine is off, all rotation has stopped and the tractor is in park with the parking brake engaged. Make sure the mower is resting on the ground or securely blocked up and all hydraulic pressure has been relieved.**

**OPERATION**

Item	Condition at Start of Shift	Specific Comments if not O.K.
The flashing lights function properly		
The SMV Sign is clean and visible		
The tires are in good condition with proper pressure		
The wheel lug bolts are tight		
The tractor brakes are in good condition		
The steering linkage is in good condition		
There are no visible oil leaks		
The hydraulic controls function properly		
The ROPS or ROBS Cab is in good condition		
The seatbelt is in place and in good condition		
The 3-point hitch is in good condition		
The drawbar pins are securely in place		
The PTO master shield is in place		
The engine oil level is full		
The brake fluid level is full		
The power steering fluid level is full		
The fuel level is adequate		
The engine coolant fluid level is full		
The radiator is free of debris		
The air filter is in good condition		

Operator's Signature: \_\_\_\_\_

**DO NOT OPERATE an UNSAFE TRACTOR or MOWER**

This Inspection Form may be freely duplicated for extra copies.



# OPERATION

## Flail Mower PRE-OPERATION Inspection



Mower ID# \_\_\_\_\_ Make \_\_\_\_\_

Date: \_\_\_\_\_ Shift \_\_\_\_\_



**Before conducting the inspection, make sure the tractor engine is off, all rotation has stopped and the tractor is in park with the parking brake engaged. Make sure the mower is resting on the ground or securely blocked up and all hydraulic pressure has been relieved.**

Item	Condition at Start of Shift	Specific Comments if not O.K.
The Operator's Manual is in the canister		
All safety decals are in place and legible		
The Mounting frame bolts are in place and tight		
The connection bolts & pins are tight		
There are no cracks in mower		
The Hydraulic Cylinders pins are tight		
The Hydraulic Pump hose connections are tight		
The Hydraulic Valve hose connections are tight		
The Hydraulic Valve controls function properly		
There are no leaking or damaged hoses		
The Hydraulic Oil level is full		
There is no evidence of Hydraulic leaks		
The Blades are not chipped, cracked or bent		
The Blade bolts are tight		
The Deflectors are in place and in good condition		
The shields are in place and in good condition		
The Skid shoes are in good condition & tight		
The Hyd. motor mounting bolts are tight		

Operator's Signature: \_\_\_\_\_

**DO NOT OPERATE an UNSAFE TRACTOR or MOWER**

**OPERATION**

# OPERATION

## 9. DRIVING THE TRACTOR AND IMPLEMENT

Safe tractor transport requires the operator possess a thorough knowledge of the model being operated and precautions to take while driving with an attached implement. Ensure the tractor has the capacity to handle the weight of the implement and the tractor operating controls are set for safe transport. To ensure safety while driving the tractor with an attached implement, review the following. *OPS-U- 0012*



This Implement may be wider than the Tractor. Be careful when operating or transporting this equipment to prevent the Implement from running into or striking sign posts, guard rails, concrete abutments or other solid objects. Such an impact could cause the Implement and Tractor to pivot violently resulting in loss of steering control, serious injury, or even death. Never allow the Implement to contact obstacles. (S3PT-12)



Transport only at speeds where you can maintain control of the equipment. Serious accidents and injuries can result from operating this equipment at high speeds. Understand the Tractor and Implement and how it handles before transporting on streets and highways. Make sure the Tractor steering and brakes are in good condition and operate properly.



Before transporting the Tractor and Implement, determine the proper transport speeds for you and the equipment. Make sure you abide by the following rules:

Test the tractor at a slow speed and increase the speed slowly. Apply the Brakes smoothly to determine the stopping characteristics of the Tractor and Implement. As you increase the speed of the Tractor the stopping distance increases. Determine the maximum transport speed not to exceed 20 mph (30 kph) for transporting this equipment.

Test the equipment at a slow speed in turns. Increase the speed through the turn only after you determine that the equipment can be operated at a higher speed. Use extreme care and reduce your speed when turning sharply to prevent the tractor and implement from turning over. Determine the maximum turning speed for you and this equipment before operating on roads or uneven ground.

Only transport the Tractor and Implement at the speeds which allow you to properly control the equipment.

Be aware of the operating conditions. Do not operate the Tractor with weak or faulty brakes or worn tires. When operating down a hill or on wet or rain slick roads, the braking distance increases: use extreme care and reduce your speed. When operating in traffic always use the Tractor's flashing warning lights and reduce your speed. Be aware of traffic around you and watch out for the other guy. (SG-19)



# OPERATION

## **9.1 Starting the Tractor**

The procedure to start the tractor is model specific. Refer to the tractor operator's manual for starting procedures for your particular tractor. Consult an authorized dealer if the starting procedure is unclear. Ensure the 3-point control lever is in the lowered position and the PTO is disengaged before starting the tractor. OPS-U-0033



## **9.2 Brake and Differential Lock Setting**

Make sure the tractor brakes are in good operating condition. Tractor brakes can be set to operate independently allowing single rear wheel braking action or locked together to provide simultaneous rear wheel braking. FOR MOST DRIVING AND OPERATING CONDITIONS, THE BRAKE PEDALS SHOULD BE LOCKED TOGETHER TO PROVIDE THE MOST EFFECTIVE BRAKING ACTION.

Always disengage the tractor differential lock when turning. When engaged the differential lock will prevent or limit the tractor from turning. During normal cutting conditions, locking the differential provides no benefit and should not be used.

OPS-U-0013



OPERATING THE SIDE MOWERS

## **9.3 Transport Position**

# OPERATION

## OPERATION

1. With tractor engine running, place ON/OFF switch(s) in "OFF" position and wait for cuttershaft(s) to stop rotating.
2. Pull LIFT control lever rearward until lift frame is as high as it will go.
3. Pull TILT control lever rearward until bracket on unit is above travel lock bracket on lift cylinder support. It takes some effort to pull TILT lever from "FLOAT" position.
4. Push LIFT control lever forward enough to lower unit slowly. Install the travel lock pin. It must pass through bracket on unit as shown in **Figure Op-258\_A**.
5. Make certain that all control levers are in "HOLD" position when transporting unit.



The mower's center of gravity is raised making the mower more prone to tipping when the side mowers are in the raised position. Use extreme caution when in the transport position and avoid uneven terrain which could upset the mower.



### **⚠ DANGER**

When the side mowers are folded for transport, the center of gravity is raised and the possibility of overturn is increased. Drive slowly and use extreme caution when turning on hillsides. Overturning the Implement could cause the Implement to overturn the Tractor and vice versa resulting in serious injury or even death. Never fold side mowers on a hillside...the Implement or unit may overturn. (STI-02\_A)

# OPERATION

## **9.4 Operating Position**

Ensure that ON/OFF switch(es) is (are) in "OFF" position. Remove travel lock pin. With tractor engine running, pull LIFT control lever rearward until bracket on cutter unit clears the travel lock bracket on lift cylinder support. Push TILT control lever forward until cutter unit is level with ground. Push LIFT lever forward enough to slowly lower unit until it touches ground, then push both levers forward to "FLOAT" position.

**NOTE:** For best mowing results and longer roller life, both LIFT and TILT levers should be in "FLOAT" position while mowing.

It takes some effort to pull TILT lever from "FLOAT" position because of detent spring.



The mower must be operated with the cutter sections fully lowered and the hydraulic control lever in the float detent to ensure the mower follows the contour of the ground and to prevent sections from creeping up. NEVER attempt to raise the mower while the mower is operating.

# OPERATION

## **9.5 Driving the Tractor and Implements**

Start off driving at a slow speed and gradually increase your speed while maintaining complete control of the tractor and units. Moving slowly at first will also prevent the tractor from rearing up and loss of steering control. The tractor should never be operated at speeds that cannot be safely handled or which will prevent the operator from stopping quickly during an emergency. If the power steering or engine ceases operating, stop the tractor immediately as the tractor will be difficult to control.

Drive the tractor with the 3-Point lift arms in the raised position and lock the control lever in the transport detent position to prevent damage to the mower driveline when turning.

Perform turns with the tractor and units at slow speeds to determine how the tractor with an attached mower handles a turn. Determine the safe speed to maintain proper control of the tractor when making turns.

To avoid overturns, drive the tractor with care and at safe speeds, especially when operating over rough ground, crossing ditches or slopes, and turning corners. Tractor wheel tread spacing should be increased when working on inclines or rough ground to reduce the possibility of tipping.

Use extreme caution when operating on steep slopes. Keep the tractor in a low gear when going downhill. DO NOT coast or free-wheel downhill.  
*OPS-F- 0009\_A*



## **9.6 Crossing Ditches and Steep Inclines**

# OPERATION

When crossing ditches with steep banks or going up sharp inclines, it is possible that the main driveline inner profile will penetrate into the outer housing to its maximum depth until the assembly becomes solid (driveline is at its extreme shortest length). This type of abusive operation can cause serious damage to the tractor and mower drive by pushing the PTO into the tractor and through the support bearings or downward onto the PTO shaft, breaking it off.

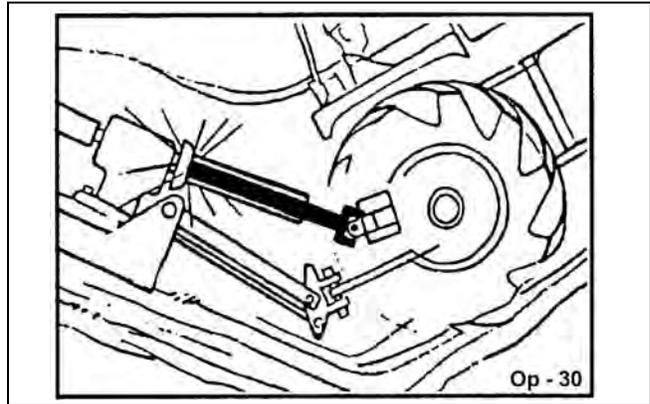

## **WARNING**

Damage resulting from over-collapse of the driveline's inner profile and its outer housing may allow the driveline to come loose from the Tractor which could cause bodily injury to the operator or bystanders and/or extensive damage to the Tractor or Implement. OPS-R-0020

When confronted with an incline or ditch, do not approach from an angle which is perpendicular or straight on as damaged to over collapse of the driveline may occur.

When crossing such terrain, the implement should be fully lowered for a lower center of gravity and added stability. OPS-R-0021

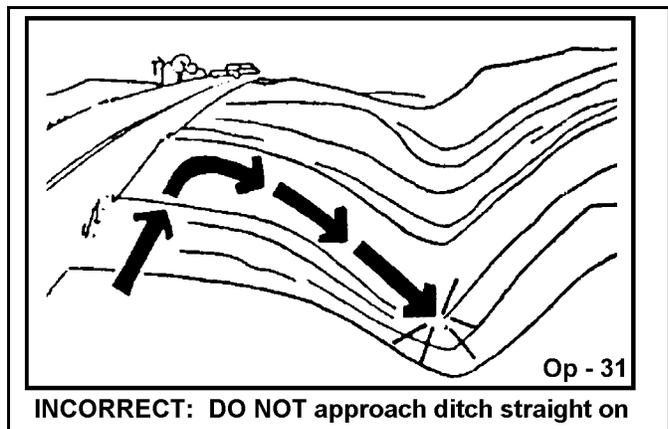

# OPERATION

Inclines and ditches should be approached along a line which is at an angle as shown. This type of path will reduce the possibility of over-collapse of the driveline and resulting damage. If the gradient is so steep that such an approach increases the possibility of a tractor roll-over, select an alternate crossing path.

When operating the tractor and mower across slopes and inclines, through ditches, and other uneven terrain conditions, it is important to maintain sufficient deck to ground clearance. Blade contact with the ground may cause soil, rocks and other debris to be thrown out from under the mower resulting in possible injury and/or property damage. Ground contact also produces a severe shock load on the mower drive and to the mower blades resulting in possible damage and premature wear.

OPS-R-0022

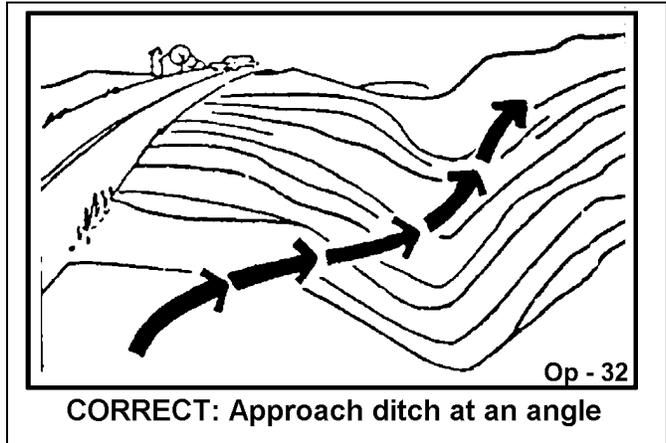

## 10. OPERATING THE TRACTOR AND IMPLEMENT

**THE OPERATOR MUST COMPLETELY UNDERSTAND HOW TO OPERATE THE TRACTOR AND IMPLEMENT AND ALL CONTROLS BEFORE ATTEMPTING TO OPERATE.** The operator must read and understand the Safety and Operation Sections of the implement and tractor operator's manuals. These manuals must be read and explained to any operator who cannot read. Never allow someone to operate the implement and tractor without complete operating instructions.

Before starting any operation, the operator must become familiar with the area to be worked in and any obstacles and hazards contained within to ensure safety to the operator, bystanders, and equipment. Special attention should be paid to foreign debris, rough terrain, steep slopes, and passersby and animals in the area.

OPS-U-0015



Extreme care should be taken when operating near loose objects such as gravel, rocks, wire, and other debris. Inspect the area before mowing. Foreign objects should be removed from the site to prevent machine damage and/or bodily injury or even death. Any objects that cannot be removed must be clearly marked and carefully avoided by the operator. Stop mowing immediately if blades strike a foreign object. Repair all damage and make certain rotor or blade carrier is balanced before resuming mowing. (SGM-05)





# OPERATION

## **⚠️ WARNING**

Many varied objects, such as wire, cable, rope, or chains, can become entangled in the operating parts of the mower head. These items could then swing outside the housing at greater velocities than the blades. Such a situation is extremely hazardous and could result in serious injury or even death. Inspect the cutting area for such objects before mowing. Remove any like object from the site. Never allow the cutting blades to contact such items.

(SGM-06)

### **10.1 Foreign Debris Hazards**

Before mowing, inspect the area to make sure there are no foreign objects that the mower blades could hit or become entangled with. Remove all foreign objects and debris. If objects are too big to remove, mark them clearly and be sure to prevent the mower blades from contacting them.

If you hit a solid object or foreign debris, stop the mower and tractor at once. Immediately idle the engine speed and disengage the PTO. Wait for all mower rotating motion to stop, then raise the mower and move the tractor and implement off the object. Inspect the area and remove, or mark the location of the debris. Inspect the condition of the mower and make any needed repairs immediately. Make sure the blades are not damaged and the carrier is balanced before resuming operation.



Always wear your seat belt securely fastened and only operate the tractor and mower with the ROPS in the raised position. If the tractor or mower hits a tree stump, rock, or bump, a sudden movement could throw you off of the seat and under the tractor and/or mower. The seat belt is your best protection from falling off the tractor and the ROPS provides protection from being crushed during a tractor roll-over. OPS-F-0010



### **10.2 Bystanders/Passersby Precautions**

If a bystander comes within 300 feet of the tractor while the mower is being operated, stop the tractor at once, idle the engine and disengage the PTO. Do not engage the PTO again until all bystanders are well past the 300 foot distance. OPS-R-0024

# OPERATION



Flail Mowers are capable under adverse conditions of throwing objects for great distances (300 feet or more) and causing serious injury or death. Follow safety messages carefully.



## STOP MOWING IF PASSERSBY ARE WITHIN 300 FEET UNLESS:

- Front and Rear Deflectors, Chain Guards, or Bands are installed and in good, workable condition;
- Mower sections are running close to and parallel to the ground without exposed Blades;
- All areas have been thoroughly inspected and all foreign material such as rocks, cans, glass, and general debris has been removed.

**NOTE:** *Where there are grass and weeds high enough to hide debris that could be struck by the blades, the area should be: inspected and large debris removed, mowed at an intermediate height, inspected closely with any remaining debris being removed, and mowed again at desired final height. (This will also reduce power required to mow, reduce wear and tear on the Mower drivetrain, spread cut material better, eliminate streaking, and make the final cut more uniform.)* (SFL-6\_A)

## 10.3 Engaging the Power Take Off (PTO)

Before engaging the PTO, make certain that the area is clear of bystanders and passersby. The implement must be completely lowered and the deck positioned at a safe operating height. NEVER engage the PTO with the implement in the raised position.

Set the tractor engine speed at approximately 1,000 RPM before engaging the PTO. Shift the PTO control to the on position, and slowly increase the engine speed until the PTO is operating at the rated speed. If you hear unusual noises or see or feel abnormal vibrations, disengage the PTO immediately. Inspect the implement to determine the cause of the noise or vibration and repair the abnormality. OPS-U- 0027



Do not let the Blades turn when the Mower Deck is raised for any reason, including clearance or for turning. Raising the Mower deck exposes the Cutting Blades which creates a potentially serious hazard and could cause serious injury or even death from objects thrown from the Blades. (SRM-07)



Do not put hands or feet under mower decks. Blade Contact can result in serious injury or even death. Stay away until all motion has stopped and the decks are securely blocked up. (SGM-09)

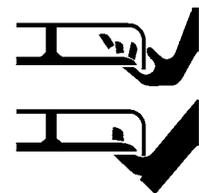

# OPERATION

## **10.4 PTO RPM and Ground Speed**

Ground speed for mowing will depend upon the height, type, and density of vegetation to be cut. Recommended speed for efficient mower performance is between 2 and 5 mph(3-8 kph). Operate the mower at its full rated PTO speed to maintain blade speed for a clean cut. Refer to the tractor operator's manual or the tractor instrument panel for the engine speed and gear to provide the required PTO and desired ground speed. Make sure that the mower is operating at its full rated speed before entering the vegetation to be cut. If it becomes necessary to temporarily regulate engine speed, increase or decrease the throttle gradually.

Ground speed is achieved by transmission gear selection and not by the engine operating speed. The operator may be required to experiment with several gear range combinations to determine the best gear and range which provides the most ideal performance from the mower and most efficient tractor operation. As the severity of cutting conditions increase, the ground speed should be decreased by selecting a lower gear to maintain the proper operating PTO speed. OPS-R-0025



Do not exceed the rated PTO speed for the Implement. Excessive PTO speeds can cause Implement driveline or blade failures resulting in serious injury or death. (SG-26)



Mow at the speed that you can safely operate and control the tractor and mower. The correct mowing speed depends on terrain condition and grass type, density, and height of cut. Normal ground speed range is from 2 to 5 mph(3-8 kph). Use slow mowing speeds when operating on or near steep slopes, ditches, drop-offs, overhead obstructions, power lines, or when debris and foreign objects are to be avoided. (SGM-07)

T3F DECAL

OPERATION

# OPERATION

## 11. CONTROL LOCATION AND FUNCTIONS

The left and right mower height is controlled with a four spool valve and is coordinated as shown below. Always mow with the controls in the float position. Be sure to install the travel lock pins whenever the mower is to be transported by truck and trailer.

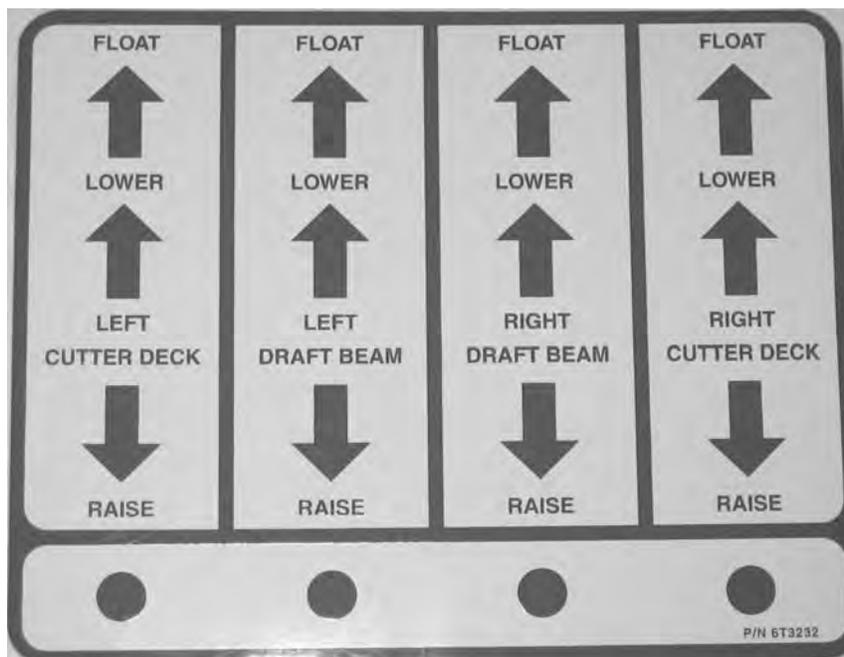

The rear mower height is controlled with the 3-point hitch control lever. Follow the instructions for this control in the tractor operator's manual. The tilt of the rear mower is controlled with the third spool in the lift valve and is coordinated as shown above.

The left and right mower ON/OFF switches are mounted to the four spool valve or the cable controls for cab and non-cab units respectively. Read and follow the mower operation section closely for instructions on how to operate them.

This machine may be equipped with an auxiliary oil temperature gauge, an amp gauge or oil pressure gauge. If oil temperature reaches 200 degrees Fahrenheit, stop mowers and see **Troubleshooting** in **Maintenance Section** for possible causes. Keep an eye on all gauges for indication of problems.

# OPERATION

## 11.1 Operating the Mower



When rotating parts are in motion, serious injury may occur if caution is not used or danger is not recognized. Never allow bystanders within 300 feet of the machine when in operation. Extreme care should be taken when operating near loose objects – such as gravel, rocks and debris. These conditions should be avoided.

The rotating parts in this machine have been designed and tested for rugged use. However, they could fail upon impact with heavy solid objects – such as steel guard rails, concrete abutments, etc., causing them to be thrown at a very high velocity. Never allow cutter head to contact such objects. Inspecting the cutting area for such objects prior to mowing can help eliminate these potential hazards.

Once on location, lower the mower deck slightly above the material to be cut, so the mower does not have to start under a load. Bring the R.P.M. of the tractor up to 1200 and engage the side mower. If a rear mower is being used, allow the R.P.M. to return to 1200 before engaging the rear mower.

The flail mower deck should be carried so that part of the weight is carried by the ground roller. When the flail is carried this way, the roller also follows the contour of the ground more easily during mowing operations.

When cutting small shrubs or brush, begin each pass at the top of the material and work down with each consecutive pass. Use a low speed to allow the cutting blades time to mulch as well as cut the foliage. When the initial pass has been made, disengage the mower and return the mower to the travel position. Return to the starting point and make next pass, etc. The flail head is not intended for cutting heavy brush, or for continually cutting brush. Wear or damage of the blades will occur rapidly when the flail cutter is used this way.

To ensure a clean cut, engine speed should be maintained at approximately 1800 – 2200 R.P.M. If the tractor slows to less than 1800 R.P.M., shift to the next lower gear. **DO NOT** ride the clutch, this will cause premature clutch failure. **The engine should not be operated at any time at more than 2400 R.P.M. on the tractor tachometer.**

The mower will operate more efficiently in tougher conditions and with less power if the knives are kept sharp. If mower begins to vibrate, stop the tractor, check for wire wrapped around the cuttershaft or damaged knives. When replacing knives, replace all knives with new knives to ensure proper balance so the mower will not vibrate. Severe vibration will result, if knives with unequal wear are used. Follow the instructions in the maintenance section closely when replacing knife blades.



If bystanders approach within 300 feet while mower is in operation turn mower switch “OFF” immediately! After shutdown, never leave the tractor or allow bystanders to approach within **300 feet** of the unit until all motion stops completely.

When encountering a very severe condition which causes the tractor to stall, disengage mower, start tractor, raise the mower from the cut. Shut off tractor and inspect the mower, blades and cuttershaft for damage before engaging mower again.

If the blades jam or stop, disengage the clutch and raise the head slightly or back the tractor up. Normally, this will clear the cutter head. If not, shut off the mower(s), raise the cutter heads, turn off the tractor and set the parking brake. After all motion stops completely, leave the tractor and clear the cutting heads manually.

After the first day of operation, all bolts should be checked and tightened securely. This should be done periodically to ensure the bolts do not become loose and cause damage to the tractor or mower, or injury to the operator. Also, be sure to lubricate the unit as instructed in the **Maintenance Section**.

# OPERATION

## **11.2 Shutting Down the Implement**

To shut down the implement, first bring the tractor to a complete stop. Then slow down the implement by reducing the engine speed before disengaging the PTO. Wait for all motion to stop before proceeding to drive or shut down the tractor.



Park the tractor on a level surface, place the transmission in park or neutral and apply the parking brake, lower the attached implement to the ground, shut down the engine, remove the key, and wait for all motion to come to a complete stop before exiting the tractor. OPS-F- 0011



## **12. DISCONNECTING THE MOWER FROM THE TRACTOR**

Before disconnecting the mower, the PTO must be disengaged and all motion at a complete stop. Move the mower to a level storage location and lower both side mowers to the ground. If the mower will be stored with the sections in the raised position, be sure that the travel locks are engaged. If the mower is not resting securely on the ground, block the mower up securely before attempting to disconnect it from the tractor. Use extreme care to keep feet and hands from under the mower and clear of any pinch points. OPS-F-0012\_A



# OPERATION

After disconnecting the 3 lift points, remove the mower driveline from the tractor PTO shaft. Lay the driveline down carefully to avoid damaging the driveline or its shield. Do not let the driveline fall into mud or dirt, which can contaminate the bearing and shorten the life of the driveline.  
*OPS-F-0013*



**⚠ DANGER**

Never work under the Implement, the framework, or any lifted component unless the Implement is securely supported or blocked up to prevent sudden or inadvertent falling which could cause serious injury or even death. (SG-14)



# OPERATION

## 13. MOWER STORAGE

It is recommended that the mower be stored with the center section and both side mowers fully lowered to ground level. If the mower is stored with the side mowers in the raised position, select a level area and engage travel locks and travel lock pins to prevent the side mowers from falling BEFORE disconnecting the mower rear mower.

Properly preparing and storing the mower at the end of the season is critical to maintaining its appearance and to help ensure years of dependable service. The following are suggested storage procedures:

- Thoroughly clean all debris off the mower to prevent damage from rotting grass and standing water.
- Lubricate all mower grease points and fill gearbox oil levels as detailed in the maintenance section.
- Tighten all bolts and pins to the recommended torque.
- Check the mower for worn and damaged parts. Perform repairs and make replacements immediately so that the mower will be ready for use at the start of the next season.
- Store the mower in a clean, dry place with the mower housing resting securely on blocks or at ground level.
- Keep the driveline yoke from sitting in water, dirt and other contaminants.
- Use spray touch-up enamel where necessary to prevent rust and maintain the appearance of the mower.



It is critical that driveline clutches slip when an obstacle or heavy load is encountered to avoid mower and/or tractor damage. If the mower sits outside for an extended period of time or is exposed to rain and/or humid air, the clutch lining plates must be inspected to ensure they are not frozen together from rust or corrosion. If the mower has been exposed to such conditions, at the start of each mowing season, and any time it is suspected that the slip clutch plates may be frozen together, readjust the slip clutch as detailed in Seasonal Clutch Maintenance of the maintenance section in this manual. OPS-F-0014\_A



Never allow children to play on or around Tractor or Implement. Children can slip or fall off the Equipment and be injured or killed. Children can cause the Implement to shift or fall crushing themselves or others. (SG-25)



# OPERATION

## 14. TRANSPORTING THE TRACTOR AND IMPLEMENT

Inherent hazards of operating the tractor and implement and the possibility of accidents are not left behind when you finish working in an area. Therefore, the operator must employ good judgement and safe operation practices when transporting the tractor and implement between locations. By using good judgement and following safe transport procedures, the possibility of accidents while moving between locations can be substantially minimized. *OPS-U- 0017*



Never allow children or other persons to ride on the Tractor or Implement. Falling off can result in serious injury or death. (SG-10)



OPERATION

Before transporting the tractor and mower, idle the tractor engine, disengage the PTO and wait for all mower moving parts to come to a complete stop. Raise the mower sections and ensure travel locks engage and install the travel lock pins..



# OPERATION

Before transporting the tractor on a public roadway or boarding a trailer for transport, the tractor brake pedals should be locked together. Locking the pedals ensures that both wheels brake simultaneously while stopping, especially when making an emergency stop.



Use extreme caution and avoid hard applications of the tractor brakes when carrying equipment at road speeds. Never haul the implement at speeds greater than 20 MPH (32 kph). OPS-U- 0018\_A

If the tractor's hydraulic pump is not independent of the tractor PTO, or if the tractor PTO has to be run to have hydraulic power, disconnect the mower driveline from the tractor PTO output shaft. Secure the driveline to the mower deck to prevent driveline damage or loss during transport.

## 14.1 Transporting on Public Roadways

Extreme caution should be used when transporting the tractor and implement on public roadways. The tractor must be equipped with all required safety warning features including a SMV emblem and flashing warning lights to alert drivers of the tractor's presence. Remember that roadways are primarily designed for automotive drivers and most drivers will not be looking out for you, therefore, you must look out for them. Check your side view mirrors frequently and remember that vehicles will approach quickly because of the tractor's slower speed. Be extremely cautious when the piece of equipment that you are carrying is wider than the tractor tire width and/or extends beyond your lane of the road. OPS-U- 0019\_A

**NOTE:** Ensure that the mower sections are fully raised and that the travel locks are engaged for each section.

### WARNING

Only carry the Implement behind a properly sized and equipped Tractor which exceeds the weight of the Implement by at least 20%. DO NOT carry the Implement behind a truck or other type of vehicle. Never carry the Implement and another Implement connected in tandem. Never carry the Implement at speeds over 20 MPH. (STI-06\_A)



### DANGER

Never allow children or other persons to ride on the Tractor or Implement. Falling off can result in serious injury or death. (SG-10)



# OPERATION

## **WARNING**

Make certain that the "Slow Moving Vehicle" (SMV) sign is installed in such a way as to be clearly visible and legible. When transporting the Equipment use the Tractor flashing warning lights and follow all local traffic regulations. (SG-6)

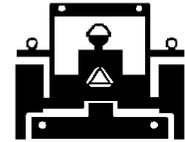

The SMV (Slow-Moving Vehicle) emblem is universal symbol used to alert drivers of the presence of equipment traveling on roadways at a slow speed. SMV signs are a triangular bright orange with reflective red trim for both easy day and night visibility. Make sure the SMV sign is clean and visible from the rear of the unit before transporting the tractor and implement on a public roadway. Replace the SMV emblem if faded, damaged, or no longer reflective. OPS-U- 0020



Make sure that all tractor flashing warning lights, headlights, and brake/tail lights are functioning properly before proceeding onto public roads. While newer model tractors have plenty of lighting to provide warning signals and operating lighting, most older models are only equipped with operating lights. Consult an authorized tractor dealer for lighting kits and modifications available to upgrade the lighting on older tractor models. OPS-U- 0021



When operating on public roads, have consideration for other road users. Pull to the side of the road occasionally to allow all following traffic to pass. Do not exceed the legal speed limit set in your country for agricultural tractors. Always stay alert when transporting the tractor and implement on public roads. Use caution and reduce speed if other vehicles or pedestrians are in the area. OPS-U- 0022



# OPERATION

Reduce speed before turning or applying the brakes. Ensure that both brake pedals are locked together when operating on public roads. *OPS-U- 0023*



## **14.2 Hauling the Tractor and Implement**

Before transporting a loaded tractor and implement, measure the height and width dimensions and gross weight of the complete loaded unit. Ensure that the load will be in compliance with the legal limits set for the areas that will be traveled through. *OPS-U- 0024*



Use adequately sized and rated trailers and equipment to transport the tractor and implement. Consult an authorized dealer to determine the proper equipment required. Using adequately sized chains, heavy duty straps, cables and/or binders, securely tie down both the front and rear of the tractor utilizing the proper tie down locations as specified by the tractor manufacturer. *OPS-U- 0025*



# OPERATION

## 15. TROUBLESHOOTING GUIDE

<b>PROBLEM</b>	<b>POSSIBLE CAUSE</b>	<b>REMEDY</b>
Excessive Vibrations	Check gearbox bolts. Check for missing knives on cutter shaft. Check to see if knives are free swinging. Blade broken or bent. Cuttershaft bent. Drivelines not phased correctly. Implements & Tractor yokes must be in line.	Tighten if loose. Replace missing knives.  Free knives so they swing.  Replace blades. Replace cuttershaft. Replace driveline.
Gearbox Overheating	Low on lubricant. Improper type lubricant. Excessive trash build-up around gearbox. Bearing or gears set up improperly.	Fill to level plug. Replace with proper lubricant. Remove trash.  Consult your Dealer.
Gearbox Noisy	Rough Gears. Worn Bearing.	Run-in or change gears. Replace bearing.
Noise	Damaged Belt Shield (Rubbing on pulleys or belt). Worn Bearing or Gear.	Straighten or replace shields.
Gearbox Leaking	Damage oil seal. Bent shaft. Shaft rough in oil seal area. Oil seal installed wrong. Oil seal not sealing in the housing. Oil level too high. Sand hole in casting. Gasket damaged. Bolts loose.	Replace seal. Replace oil seal and shaft. Replace or repair shaft. Replace seal. Replace seal or use a sealant on OD of Seal. Drain oil to proper level. Replace castings or gearbox. Replace gasket. Tighten bolts.

# OPERATION

## OPERATION

Clutch Slips Excessively	Clutch linings badly worn or plates warped. Too much power for clutch.  Oil on facings. Friction facings glazed.	Repair clutch per maintenance section of manuals. Reduce ground speed and material intake. Replace facings. Clean with emery cloth.
Knives Wear Too Fast	Cutting in sandy conditions. Cutting in rocky conditions. Soft "will fit" knives.	Increase cutting height. Increase cutting height. Use genuine Tiger knives.
Hydraulic Cylinder Will Not Operate	Not enough pressure. Valve not connected properly. Quick coupler not completely connected.	Check Pressure. Re-plumb valve. Complete connection.
Oil squirting from Breather Vent Hole	Oil leaking by piston ring.  Piston "O" Ring worn. Cylinder wall scored or pitted. Wrong piston ring on piston.	Do not carry cutter on cylinder. Small leakage amount is normal. Replace piston "O" Ring. Replace cylinder. Use correct piston ring.
Discharging Bunches	Belt installed improperly. Blades dull. Grass too wet. Grass too long. Travel speed too fast. PTO RPM too low.	Check belt for correct set up. Check blades for sharpness. Wait for grass to dry. Mow at 3-1/2" and re-cut lower. Use a lower tractor gear. Mow at engine RPM to match 540 PTO RPM.
Blades Scalping High Places	Mowing too low. Rough, uneven ground.  Turning Tractor too fast.	Raise height of cut. Use a slower speed. Lower rollers. Slow down when turning.

# OPERATION

Uneven Cut	Travel speed too fast. Mower deck not level. Blades dull or unbalanced. Deck underside plugged. Grass too high.	Use a slower speed. Level the mowing deck. Sharpen or balance blades. Clean underside of deck. Mow at 3-1/2" and re-cut lower.
Grass Clippings Windrow or Clump	Grass too wet. Grass too high. Housing plugged.	Wait for grass to dry. Mow at 3-1/2" and re-cut lower. Clean underside of deck.
Grass Not Being Cut Evenly	Belt worn or slipping. Spring broke and belt off idler. Housing plugged. Debris around pulleys.  Grass too high.	Replace or adjust belt. Replace spring or adjust belt. Clean underside of housing. Remove deck belt shield and clean out debris. Mow at 3-1/2" and re-cut lower.

# OPERATION

# OPERATION

TRIPLE FLAIL

Operation Section 3-42



# **MAINTENANCE SECTION**

Maintenance Section 4-1

# MAINTENANCE

## GENERAL INSTRUCTIONS

Tiger Mowers are designed for high performance and rugged durability, yet with simplified maintenance. The purpose of this section of the manual is to help the operator in the regular servicing of the mower. Regular maintenance at the intervals mentioned will result in the maximum efficiency and long life of the Tiger Mower.

When you purchase a Tiger Mower you also acquire another valuable asset, Tiger's parts organization. Our rapid and efficient service has guaranteed the customer satisfaction for many years. Tiger parts keep up with the demands for efficiency, safety and endurance expected of the Tiger Mower.

## MAINTENANCE PRECAUTIONS

- Be sure the end of the grease gun and fittings are clean before using. Debris injected into bearings, etc. with grease will cause immediate damage.
- DO NOT use a power grease gun to lubricate bearings. These require very small and exact amounts of lubrication. Refer to the detailed maintenance section for specific lubrication instructions. DO NOT over-grease bearings.
- Lexan windows should be washed with mild soap or detergent and luke warm water, using a soft clean sponge or soft cloth. DO NOT use abrasive or alkaline cleaners or metal scrapers on lexan windows!
- Be alert to maintenance indicators such as the in-tank filter pressure gauge, hydraulic reservoir sight gauge, etc. Take the required action to correct any problems immediately.
- Release of energy from pressurized systems may cause inadvertent actuation of cylinders, or sudden release of compressed springs. Before disconnecting any hoses relieve pressure by shutting tractor off, setting cutter on ground and actuating lift valve handles.

### **⚠ WARNING**

DO NOT use hands to check for suspected leaks in hydraulic hoses! Hydraulic fluid escaping under pressure can have sufficient force to penetrate skin and cause serious injury. If fluid is injected into skin, it must be surgically removed within a few hours or gangrene may result. Use a small piece of wood or cardboard, not hands, to search for pin hose leaks. Be sure all connections are tight and hoses and lines are not damaged before applying pressure.

## BREAK IN PERIOD

In addition to following the break in instructions for your particular tractor, the in-tank hydraulic fluid filter should be replaced after the first 50 hours of service. Thereafter the filter should be replaced every 500 hours, or yearly, whichever comes first.

Re-torque wheel lugs after first five hours of operation and periodically thereafter. See torque specifications listed in the tractor's service manual for your particular model. **Wheel lugs must always be re-torqued whenever a wheel is removed and reinstalled.**

### **⚠ DANGER**

Never work under the Implement, the framework, or any lifted component unless the Implement is securely supported or blocked up to prevent sudden or inadvertent falling which could cause serious injury or even death. (SG-14)



# MAINTENANCE



Do not modify or alter this Implement. Do not permit anyone to modify or alter this Implement, any of its components or any Implement function. (SG-8)



Always disconnect the wire leads from the mower pump solenoid before performing service on the Tractor or Mower. Use caution when working on the Tractor or Mower. Tractor engine must be stopped before working on Mower or Tractor. The Mower Blades could inadvertently be turned on without warning and cause immediate dismemberment, injury or death. (SBM-12a)

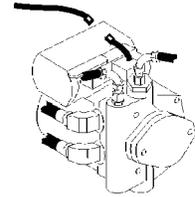

**MAINTENANCE**

## REGULAR MAINTENANCE

The intervals at which regular servicing should be done are based on hours of operation. Use the tractors hour meter to determine when regular servicing is required.

### Daily or Every 8 Hours

ITEM	SERVICE	COMMENTS
Drive Shaft Yoke, U-Joint & Stub Shaft	Grease	Grease as instructed in detailed maint. section
Pump Drive Shaft Coupler	Check and Lube	Insure drive shaft end play
Crankshaft Adapter	Check rubber grommets	Replace grommets if damaged or missing
Pivot Points	Lubricate	Inject grease until it appears at ends
Hydraulic Fittings	Check for leaks	Tighten when needed. Do Not use hands to check for leaks, see Maintenance Precautions

# MAINTENANCE

## MAINTENANCE

ITEM	SERVICE	COMMENTS
Knives	Check	Inspect for missing or damaged knives, change as needed
Spindle mounting bolts (spindle to deck)	Check	3/4" x 2" or 3/4" x 2-1/2" bolts torque to 331 ft. lbs.
Knife mounting bolts (knife to disk)	Check	Pre-lubricate threads, then torque to 800 ft. lbs. Saber - Torque 1-3/4" knife bolts to 2,000 ft. lbs.
Disk mounting bolts (disk to spindle)	Check	5/8" x 1-3/4" or 5/8" x 2" bolts - torque to 204 dry / 184 oiled ft. lbs.
Belts	Check/Adjust	Check if broken, tighten as required.
Main Frame and Deck	Check	Retorque bolts to torque specifications in this section
Hydraulic Fluid Level	Check	Add if required per fluid recommendations
Rear Flail Drive (if applicable) Bearing Flange and Shaft Coupler	Lubricate	Grease as instructed in detailed maintenance section
Cutter Shaft	Lubricate	Grease as instructed in detailed maintenance section
Ground Roller Bearings	Lubricate	Grease as instructed in detailed maintenance section

TRIPLE FLAIL

Maintenance Section 4-4

# MAINTENANCE

## WEEKLY OR EVERY 50 HOURS

ITEM	SERVICE	COMMENTS
In Tank Hyd. Fluid Filter <b>(10 micron filter)</b>	Change	Change after first 50 hours only, then every 500 hours or yearly
In-Line High Pressure Filter <b>(10 micron filter)</b>	Change	Change after first 50 hours only then every 500 hours or yearly

## MONTHLY OR EVERY 150 HOURS

ITEM	SERVICE	COMMENTS
Hydraulic Fluid Level	Check	Add as needed
Hyd. Tank Breather	Clean/Check/Replace	Clean or replace Element as required
Rear Tire Type		Max P.S.I.
480/80R38		29
18.4-34		26
18.4-38		26

## YEARLY OR EVERY 500 HOURS

ITEM	SERVICE	COMMENTS
Hydraulic Tank Fluid	Change	
In Tank Hyd. Fluid Filter <b>(10 micron filter)</b>	Change	
In-Line High Pressure Filter <b>(10 micron filter)</b>	Change or	Change when indicated by restriction indicator.
Hyd. Tank Breather	Change	
Motor to Cuttershaft Spline Connection	Change	

TRIPLE FLAIL Maintenance Section 4-5

**MAINTENANCE**

# MAINTENANCE

MAINTENANCE

## TROUBLESHOOTING

SYMPTOMS	CAUSE	REMEDY
Vibration	Loose Bolts	Check all bolts and tighten to recommended torque specs.
	Cutter assembly Unbalanced	Check for damaged blades, disc or cuttershaft. Replace if needed. Check for wire, rope, etc. entangled in the cutter assembly
Mower will not lift	Hydraulic Fluid Low Leaks in line	Check and refill hydraulic fluid Tighten or replace fittings and hoses
	Faulty relief valve	Check pressure in line. Line pressure should be at least 2500 PSI
	Kinked or blocked Faulty cylinder	Clean or replace lines Inspect, repair or replace cylinder
Oil temperature rises above 200°F	Low oil level Kinked/ blocked hoses Worn pump/ motor	Bring oil to proper level Inspect, repair or replace Disable and repair
Mower will not start or run	Blown fuse	Check fuse between mower switch and ignition/replace
	Ball valves closed Low oil level Line leak	Make sure valves are open Check hydraulic tank and fill Check all fittings and lines, re-tighten or replace
	Electronic solenoid faulty	<b>Without</b> the tractor running, turn the mower switch to on. A low audible click should be heard if the solenoid is engaging the solenoid spool. If click is not heard, leave switch in ON position and with a screwdriver or other steel object, touch the small nut on the end of the solenoid. If the metallic object is not attracted to the nut, check the fuse and wiring for an open circuit. If the object is attracted but no “click” is heard, replace the solenoid.

# MAINTENANCE

Remove the four bolts holding the small block to the main block. Lift and remove small block being careful not to damage O-rings/ filter. Clean filter and re-install.

Remove large nut on side of large valve block. Remove spring, and use needle nose vise grip to pull spool from block. Check block and spool for contaminants and scratches. Clean parts or replace if scratched.

Motor runs but will not cut.

Belts  
Tensioner

Inspect belts and pulleys. Replace belts and repair as needed.  
Adjust tensioner nut until flatwasher is flush with top of guide.

Mower turns slowly or not at all.

Contaminants restricting spool movement in valve body

Remove large nut on side of large valve block. Remove spring, and use needle nose vise grip to pull spool from block. Check block and spool for contaminants and scratches. Clean parts or replace if scratched.

Suction lines obstructed

Check for kinks or obstruction in suction hose.

Low oil level

Check Hydraulic tank level and fill.

Pump will not work

Excessive wear on internal parts.

Disassemble and repair.

Motor will not work

Excessive wear on internal parts

Disassemble and repair.

**NOTE:** *If flow meter is available, check pressure and flow volume for all suspected hydraulic problems.*

**If the solution to your problem cannot be found in this section, call the Technical Service representative at the number shown on the front cover of this manual.**

# MAINTENANCE

MAINTENANCE

## TORQUE SPECIFICATIONS

Torque for Standard Fasteners													
Nominal Dia. (in.)	threads per inch	Grade 2			Grade 5			Grade 8			Grade 9		
		Tightening Torque			Tightening Torque			Tightening Torque			Tightening Torque		
		Lubed K = 0.15	Dry Plated K = 0.17	Dry plain K = 0.20	Lubed K = 0.15	Dry Plated K = 0.17	Dry plain K = 0.20	Lubed K = 0.15	Dry Plated K = 0.17	Dry plain K = 0.20	Lubed K = 0.15	Dry Plated K = 0.17	Dry plain K = 0.20
Unified Coarse Thread Series													
1/4	20	49 in-lbs	59 in-lbs	66 in-lbs	76 in-lbs	86 in-lbs	101 in-lbs	107 in-lbs	122 in-lbs	143 in-lbs	126 in-lbs	143 in-lbs	168 in-lbs
5/16	18	101	122	135	157	178	209	221	251	295	259	294	346
3/8	16	15 ft-lbs	18 ft-lbs	20 ft-lbs	23 ft-lbs	26 ft-lbs	31 ft-lbs	33 ft-lbs	37 ft-lbs	44 ft-lbs	38 ft-lbs	43 ft-lbs	51 ft-lbs
7/16	14	24	29	32	37	42	49	52	59	70	61	70	82
1/2	13	37	44	49	57	64	75	80	90	106	94	106	125
9/16	12	53	63	70	82	92	109	115	130	154	135	153	180
5/8	11	73	87	97	113	128	150	159	180	212	186	211	248
3/4	10	129	155	172	200	227	267	282	320	376	331	375	441
7/8	9	125	150	167	322	365	429	455	515	606	533	604	710
1	8	187	225	250	483	547	644	681	772	909	799	905	1065
1 1/8	7	266	319	354	596	675	794	831	1095	1288	1132	1283	1510
1 1/4	7	375	450	500	840	952	1121	1163	1545	1817	1597	1810	2130
1 1/2	6	652	783	869	1462	1657	1950	2031	2688	3162	2779	3150	3706
Fine Thread Series													
1/4	28	56 in-lbs	68 in-lbs	75 in-lbs	87 in-lbs	99 in-lbs	116 in-lbs	123 in-lbs	139 in-lbs	164 in-lbs	144 in-lbs	163 in-lbs	192 in-lbs
5/16	24	112	135	150	174	197	231	245	278	327	287	325	383
3/8	24	17 ft-lbs	20 ft-lbs	23 ft-lbs	26 ft-lbs	30 ft-lbs	35 ft-lbs	37 ft-lbs	42 ft-lbs	49 ft-lbs	43 ft-lbs	49 ft-lbs	58 ft-lbs
7/16	20	27	32	36	41	47	55	58	66	78	68	78	91
1/2	20	41	49	55	64	72	85	90	102	120	105	120	141
9/16	18	59	71	78	91	103	121	128	146	171	151	171	201
5/8	18	82	99	110	127	144	170	180	204	240	211	239	281
3/4	16	144	173	192	223	253	297	315	357	420	369	418	492
7/8	14	138	165	184	355	403	474	502	568	669	588	666	784
1	14	210	252	280	542	614	722	765	867	1020	896	1016	1195
1 1/8	12	296	357	397	668	757	890	1083	1227	1444	1269	1439	1693
1 1/4	12	415	498	553	930	1055	1241	1509	1710	2012	1768	2004	2358
1 1/2	12	734	880	978	1645	1865	2194	2668	3024	3557	3127	3544	4169

Torque values for 1/4 and 5/16 in series are in inch-pounds. All other torque values are in foot-pounds. K = 0.15 for "lubricated" conditions D = Nominal Diameter  
 Torque values calculated from formula T=KDF, where K = 0.17 for zinc plated and dry conditions F = Clamp Load  
 K = 0.20 for plain and dry conditions

Torque-Tension Relationship for Metric Fasteners													
Nominal Dia. (mm)	Pitch	Class 4.6			Class 8.8			Class 10.9			Class 12.9		
		Tightening Torque			Tightening Torque			Tightening Torque			Tightening Torque		
		Lubed K = 0.15	Dry Plated K = 0.17	Dry plain K = 0.20	Lubed K = 0.15	Dry Plated K = 0.17	Dry plain K = 0.20	Lubed K = 0.15	Dry Plated K = 0.17	Dry plain K = 0.20	Lubed K = 0.15	Dry plain K = 0.20	
3	0.5	0.28	0.32	0.38	0.73	0.82	0.97	1.0	1.2	1.4	1.2	1.6	
3.5	0.6	0.44	0.50	0.59	1.1	1.3	1.5	1.6	1.9	2.2	1.9	2.5	
4	0.7	0.66	0.74	0.87	1.7	1.9	2.3	2.4	2.7	3.2	2.8	3.8	
5	0.8	1.3	1.5	1.8	3.4	3.9	4.5	4.9	5.5	6.5	5.7	7.6	
6	1	2.3	2.6	3.0	5.8	6.6	7.7	8.3	9.4	11	9.7	13	
6	1.25	2.1	2.3	2.7	5.3	6.0	7.0	7.6	8.6	10	8.8	12	
7	1	3.8	4.3	5.0	9.7	11	13	14	16	19	16	22	
8	1	5.9	6.6	7.8	15	17	20	22	24	29	25	34	
8	1.25	5.5	6.2	7.3	14	16	19	20	23	27	24	31	
10	1.25	11	13	15	29	33	39	42	48	56	49	66	
10	1.5	11	12	14	28	32	37	40	45	53	47	62	
12	1.25	21	23	28	53	60	71	76	86	101	89	119	
12	1.5	20	22	26	51	58	68	73	82	97	85	113	
12	1.75	19	21	25	49	55	65	70	79	93	81	108	
14	1.25	26	29	34	66	75	89	95	108	127	111	148	
14	1.5	28	32	37	72	82	96	103	117	138	121	161	
14	2	30	34	40	78	88	104	111	126	148	130	173	
16	1.5	50	57	67	129	146	171	184	208	245	215	287	
16	2	47	53	62	121	137	161	173	196	230	202	269	
18	1.5	73	82	97	187	212	249	268	303	357	313	417	
18	2.5	65	73	86	167	189	222	239	270	318	279	372	
20	1.5	101	115	135	270	306	360	374	424	498	437	583	
20	2.5	91	104	122	236	267	314	337	382	449	394	525	

Clamp load calculated as 75% of the proof load for specified bolts. K = 0.15 for "lubricated" conditions D = Nominal Diameter  
 All torque values are listed in foot-pounds K = 0.17 for zinc plated, dry conditions F = Clamp Load  
 Torque values calculated from formula T=KDF, where K = 0.20 for plain and dry conditions



# MAINTENANCE

**MAINTENANCE**

## LUBRICATION RECOMMENDATIONS

Description	Application	General Specification	Recommended Mobil Lubricant
Tractor Hydraulics	Reservoir	JD-20C MF M1135, M1141 FNHM2C134D	Mobilfluid 424
Mower Hydraulics	Reservoir		
	Cold Temperatures 0°F Start-Up	ISO 46 Anti-Wear-Low Temp JD20C	Mobil DTE 15M Mobilfluid 424
	Normal Temperatures 10°F Start-Up	MF M1135, M1141 FNH M2C134D (FNH201)	
	Normal Temperatures 15°F Start-Up	ISO 46 Anti-Wear	Mobil DTE 25
	High Operating Temp. Above 90°F	ISO 100 Anti-Wear	Mobil DTE 18M
Flail Rear Gearbox	Reservoir	PAO Synthetic Extreme Pressure Gear Lube	Mobil SHC 75W-90 Mobil 1 Synthetic Gear
Cutter Shaft & Ground Roller Shaft (Flail)	Grease Gun	Lithium-Complex Extreme Pressure NLGI-2 - ISO 320	Mobilgrease CM-S
Drive Shaft Coupler (Flail and Rotary)	Grease Gun	Lithium-Complex Extreme Pressure NLGI2 - ISO 320	Mobilgrease CM-S

# MAINTENANCE

## POLYCARBONATE CARE & MAINTENANCE

The propriety UV and Abrasion Resistant surface coating on SHIELDS® SUPERCOATED™ polycarbonate significantly improves performance. Periodic cleaning using proper procedures and compatible cleaners are recommended to prolong service life. Tiger Corp. polycarbonate is SUPERCOATED™ on both sides.

### CLEANING THE SUPERCOAT™ HARD-COAT

1. Wash with a mild solution of soap or detergent and lukewarm water.
2. Using a soft cloth or sponge, gently wash the sheet to loosen dirt and grime and rinse well with clean water.
3. To prevent water spotting, thoroughly dry with chamois or cellulose sponge.
4. Avoid the use of abrasive cleaners, squeegees and/or other cleaning implements that may mar or gouge the coating.

### CLEANING AGENTS WHICH HAVE BEEN FOUND TO BE COMPATIBLE UNDER LABORATORY CONDITIONS:

- Aqueous Solutions of Soaps and Detergents

Windex	Top Job	Joy	Mr. Clean
Fantastik	Formula 409	Sumalight D12	Brucodecid

- Organic Solvents

Butyl Cellosolve	Kerosene	Hexel, F.O. 554	Naphtha (VM&P grade)
Neleco-Placer	Turco 5042		

- Alcohols

Methanol	Isopropyl
----------	-----------

All residual organic solvents should be removed with a secondary rinse.

## GRAFFITI REMOVAL

Butyl cellosolve (for removal of paints, marking pen inks, lipstick, etc.). The use of masking tape, adhesive tape or link removal tools works well for lifting off old weathered paints.

To remove labels, stickers, etc., the use of kerosene or VM&P naphtha are generally effective. When the solvent will not penetrate sticker material, apply heat (hair dryer) to soften the adhesive and promote removal.

If a material is found to be incompatible in a short-term test, it will usually be found to be incompatible in the field. The converse, however, is not always true. Favorable performance is no guarantee that actual end-use conditions have been duplicated. Therefore, these results should be used as a guide-only, and it is recommended that the user test the products under actual end-use conditions.

# MAINTENANCE

MAINTENANCE

## RECOMMENDED FILLING INSTRUCTIONS FOR HYDRAULIC RESERVOIRS

When filling or checking the oil level, the unit should be parked on a level surface., shut "OFF", and allow sufficient time to cool to ambient temperature. Use caution when removing the pressurized breather. Do not place face over opening when removing breather.

If your reservoir has two sight glasses: The reservoir should be filled to the top of the lower sight glass on the side of the tank. Do not over-fill. The reservoir has been over-filled when oil is visible in the upper sight glass. If tank has too much oil, the excess may be expelled through the pressurized breather.

If your reservoir has one sight glass/temperature gage: The reservoir should be filled to the center of the sight glass on the side of the tank. Do not over-fill. If the tank has too much oil, the excess may be expelled through the pressurized breather.

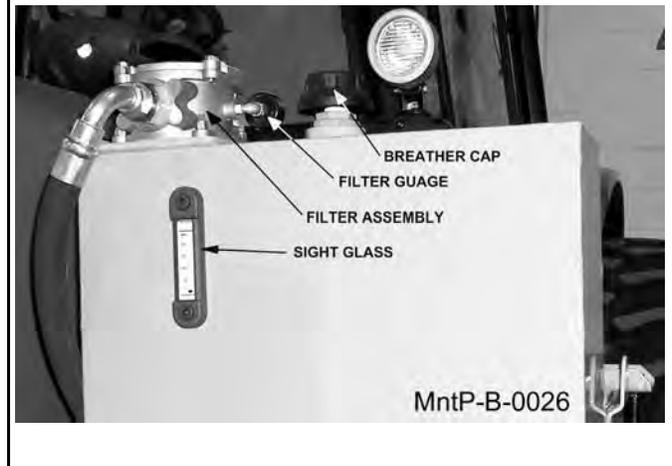
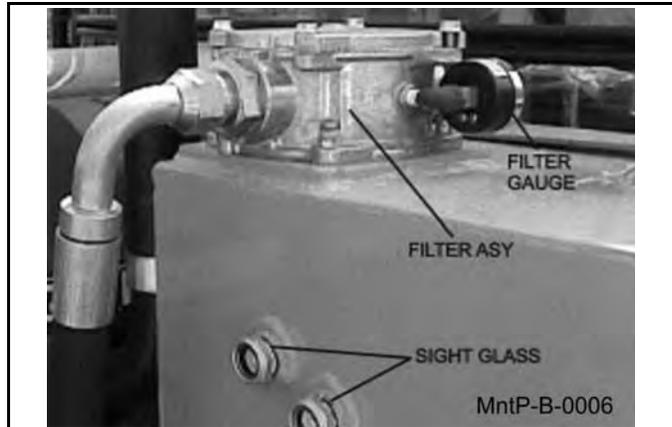

## REPLACING IN-TANK HYDRAULIC FILTER

Loosen the four bolts on the top cover of the filter housing. Turn cover counter-clockwise until cover is free. Remove and replace filter. Replace top cover and cover bolts in opposite order as removed.



# MAINTENANCE

## REPLACING HIGH PRESSURE HYDRAULIC FILTER ELEMENT

Ensure that the system has been shut down and depressurized. Locate the High Pressure Filter housing. Confirm that the element to be installed matches the element p/n on the filter model tag. *Example: V3.0510-06 (world line 100, HD049 model).* Locate the bottom of the High Pressure Bowl, and using the appropriate spanner wrench or ratchet and turning in a counterclockwise rotation, (looking at the bottom of the bowl) remove the bowl from the head. The first couple rotations will seem tight as the o-ring passes the sealing flats. Once the o-ring has cleared the sealing flats the bowl should spin freely. Taking care not to drop the bowl, finish removing the bowl from the head.

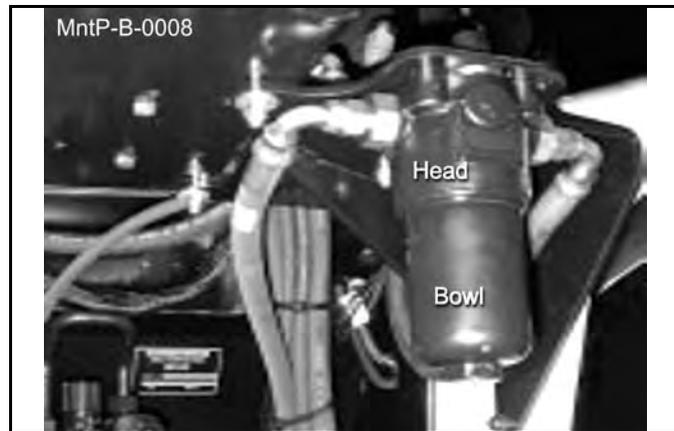

**WARNING: Bowl will be full of oil!** Pour the oil from the bowl into a container. This oil should be considered contaminated due to the outside-in flow direction through the element. Clean the inside of the bowl if “dirt” is present. Remove the old element from the filter head by pulling with a rotation motion. Dispose of the used element properly. Remove the new element from the packaging. Using your finger, dab and lubricate the o-ring in the top of the new element with oil. Install the new element into and on the mounting boss within the head. Ensure that the element is fully seated on the boss. Clean and inspect the o-ring that is affixed in the bowl and lubricate with oil. Using a clockwise rotation, screw the bowl back into the head, ensuring that the bowl has not been cross-threaded into the head. Continue to tighten the bowl into the head, using the spanner wrench or ratchet. The rotation of the bowl will become tighter once the o-ring engages the sealing flats. Once the bowl has bottomed out, back-off the bowl by 1/6 turn. This ensures that the o-ring is seated properly with in the sealing flats. Element change out and re-assembly is now complete. Start the machine and inspect the filter area checking that there is no oil leaking from the filter assembly. Replace the element first at 50 hours of operation, then yearly (500 hours) or when indicated by restriction indicator.

MAINTENANCE

# MAINTENANCE

MAINTENANCE

## GREASING INNER AND OUTER DRAFT BEAM PIVOT POINTS

Locate the grease zerks on the inner and outer draft beam pivot bosses. Inject Lithium-Complex Extreme Pressure grease conforming to NLGI2-ISO 320 specifications into each zerk until grease protrudes from joints. Grease all pivot points daily or every 8 hours of service.

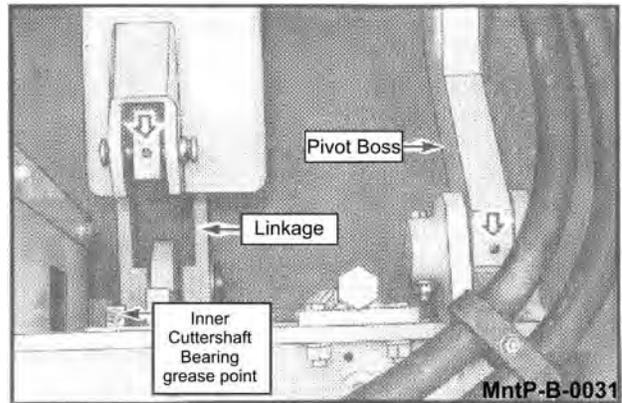
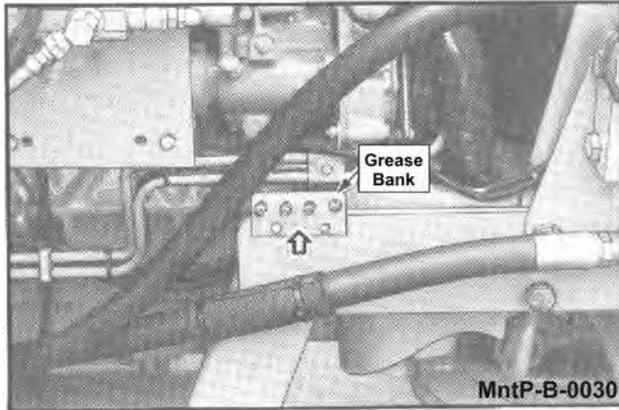

With the cutter head lowered, locate the grease zerks on the linkage and pivot bosses. Inject Lithium-Complex Extreme Pressure grease conforming to NLGI2-ISO 320 specifications until it protrudes from the ends. With the cutter head in this position, it is also possible to grease the draft beam cylinder anchors and pins. Now, raise the cutter head to expose the remaining zerks on the deck tilt linkages and on the other end of the cylinder.

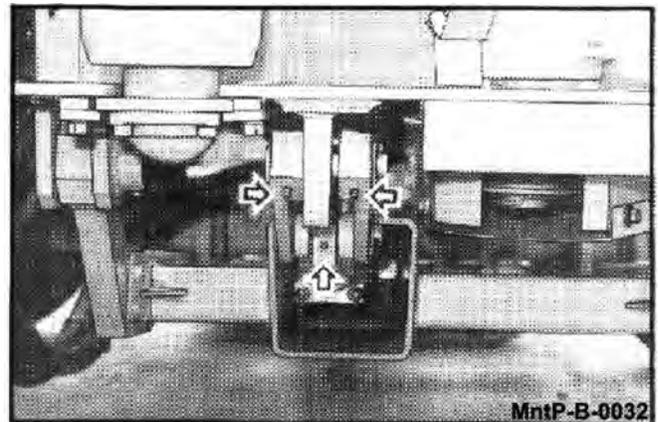

# MAINTENANCE

MAINTENANCE

## GREASING THE REAR DRIVE BEARING AND EXTENSION COUPLER SHAFT

Locate the grease zerks for the rear flail drive extension shaft. Make sure the zerks are clean before injecting grease. One pump of grease into flange zerk and shaft coupler once every day or for every 8 hours of service.

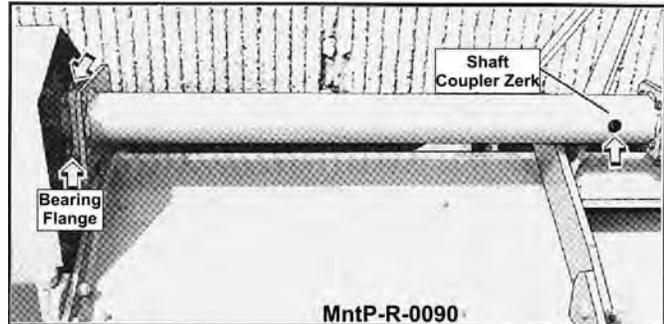

## GREASING PUMP DRIVE SHAFT COUPLER

With engine stopped, ensure drive shaft alignment by grasping coupler and sliding back and forth. Coupler should slide freely with approximately 1/8" of end play. If coupler does not slide freely, inspect for loose pump mount bolts, or damaged or loose crank shaft adapter. Inject-Lithium Complex Extreme Pressure grease conforming to NLGI2-ISO 320 specifications into coupler until grease begins to protrude from ends. Grease daily or every 8 hours. Do not over grease.

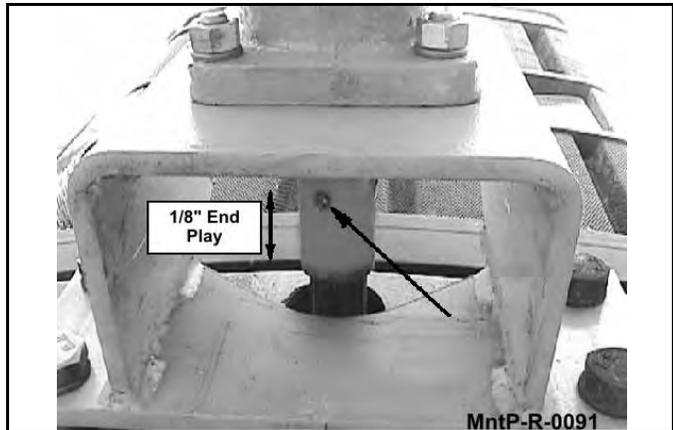

# MAINTENANCE

MAINTENANCE

## ADJUSTING THE CUTTING HEIGHT

Loosen the four ground roller bracket locknuts. Loosen the adjustment rod locknut and turn the adjustment rod to adjust the cutting height. The cutting height is indicated by the end of the adjustment rod on the cutting height decal. When cutting height has been achieved, tighten the ground roller bracket locknuts and the adjustment rod locknut securely. Be sure both sides of the flail are adjusted the same.

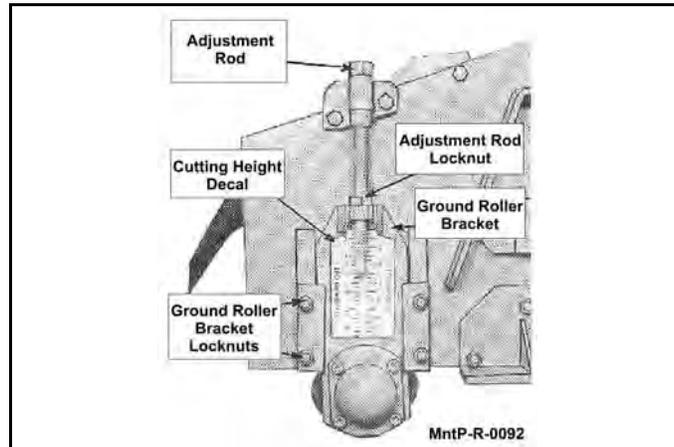

## ADJUSTING STANDARD DUTY CUT HEIGHT

To adjust the cutting height of the standard duty flail head the two nuts on the roller shaft brackets must be taken off and moved to the desired location/height. Be sure that both sides of the shaft are adjusted to corresponding holes so the shaft remains level.

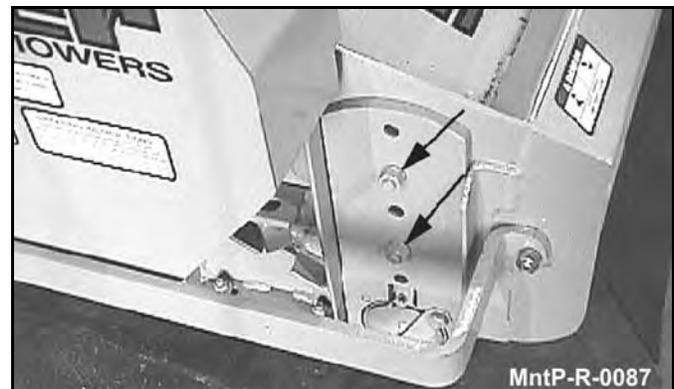

## GREASING P.T.O. SHAFTS

After bringing the tractor to a complete stop, shut off the engine and remove the PTO shaft from the tractor. Slide the shaft apart to expose the grease zerk. Grease the shaft with 5 pumps of grease and the U-joints until grease protrudes from caps per the scheduled interval in the maintenance section.

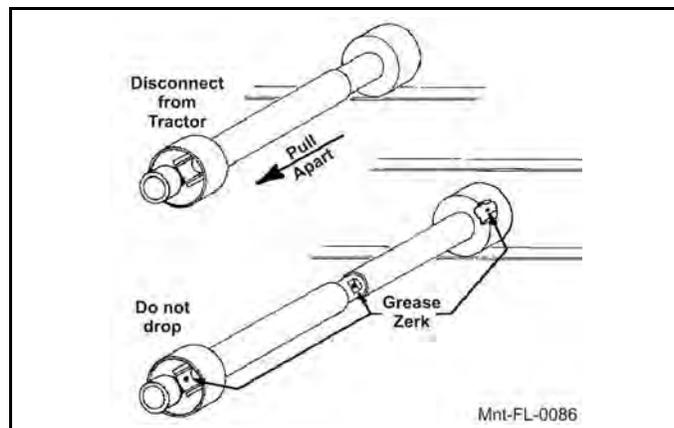

# MAINTENANCE

MAINTENANCE

## BALL VALVES

The ball valve at the hydraulic reservoir may need to be closed during certain maintenance or repair procedures. **THE BALL VALVE MUST BE OPEN (handle parallel with valve) WHEN TRACTOR IS RE-STARTED OR PUMP IS COUPLED TO MOTOR OR P.T.O.!** Failure to do so will result in component failure!

BALL VALVE



## GREASING CUTTER SHAFT-FLAIL MOWERS

Locate grease zerks on each end of cutter shaft(s). These are located on the bearing cover. Normal conditions require one or two pumps in each bearing, using Lithium-Complex Extreme Pressure grease conforming to NLGI2-ISO 320 specifications. This is to be done with a standard grease gun daily or at **8 hour intervals**. **CAUTION: Over greasing may cause premature seal failure.**

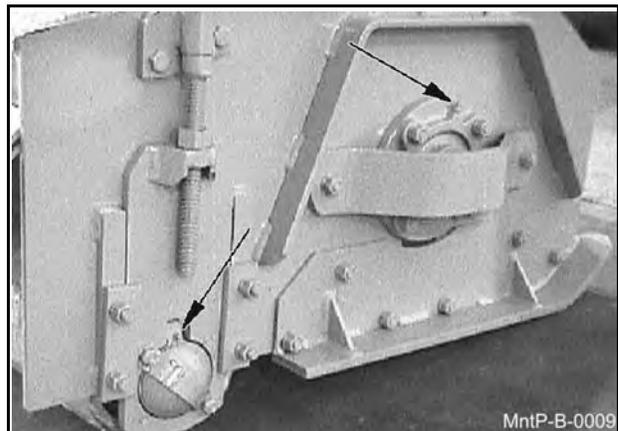

## GREASING GROUND ROLLER SHAFT-FLAIL

Locate grease zerks on each end of roller tube at lower rear of head. Normal conditions require one or two pumps in each bearing, using Lithium-Complex Extreme Pressure grease conforming to NLGI2-ISO 320 specifications. This is to be done with a standard grease gun daily or at **8 hours intervals**. **CAUTION: Over greasing may cause premature seal failure.**

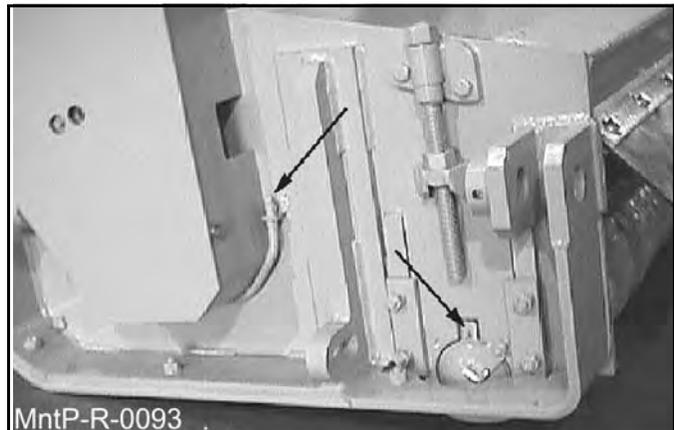



# MAINTENANCE

MAINTENANCE

## GREASING THE IDLER TENSION ARMS

Locate the access holes and grease zerks in the belt shields of the side and rear flails. Normal conditions require one pump daily or every 8 hours of service with multi purpose grease.

## IDLER TENSION

Locate the idler tensioning rod for each flail. Loosen the locking nut. Turn the adjusting nut until the washer between the spring and nuts are flush with the spring housing or guide. Tighten locking nut securely. For standard cut on side flail adjust until the spring washer is flush with the top of the spring housing. Use the same method to adjust hydraulically driven rear flails. **MntP-R-0094**

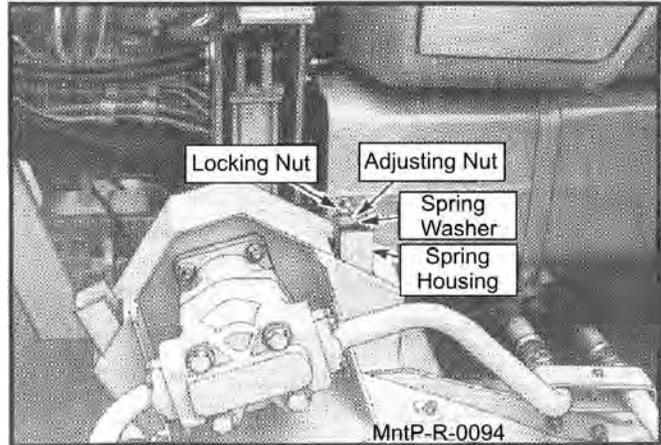

For standard cut on the mechanically driven rear flail mower, adjust so that the spring washer is flush with the spring guide. **MntP-R-0095**

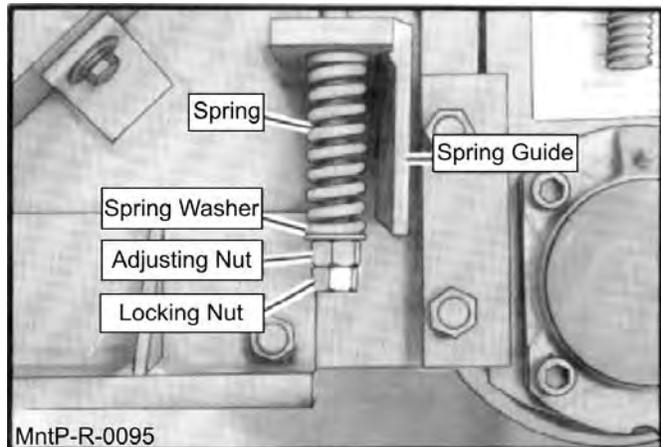

# MAINTENANCE

MAINTENANCE

## ROSTA TENSIONER

### STANDARD DUTY REAR FLAILS

Remove the shield guard over the belt shield. Next, remove the belt shield that covers the tensioner, belt and sheaves.

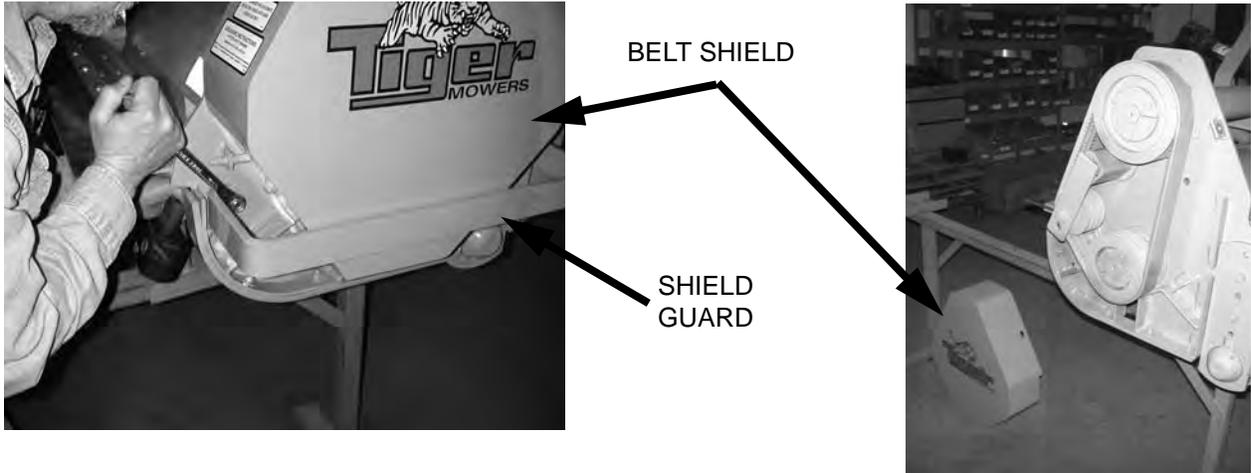

Place a straight edge over both sheaves and measure the belt tension (See TENSIONER MEASUREMENT PROCEDURE). To adjust the Rosta Tensioner, first, loosen the Rosta Stop and Rosta Bolt that secures the Rosta to the flail. Next use the Wrench (P/N 06401023 available) to adjust the tension of the belt. After the tension has been set, secure the Rosta Stop and re-torque the Rosta Bolt to specs.

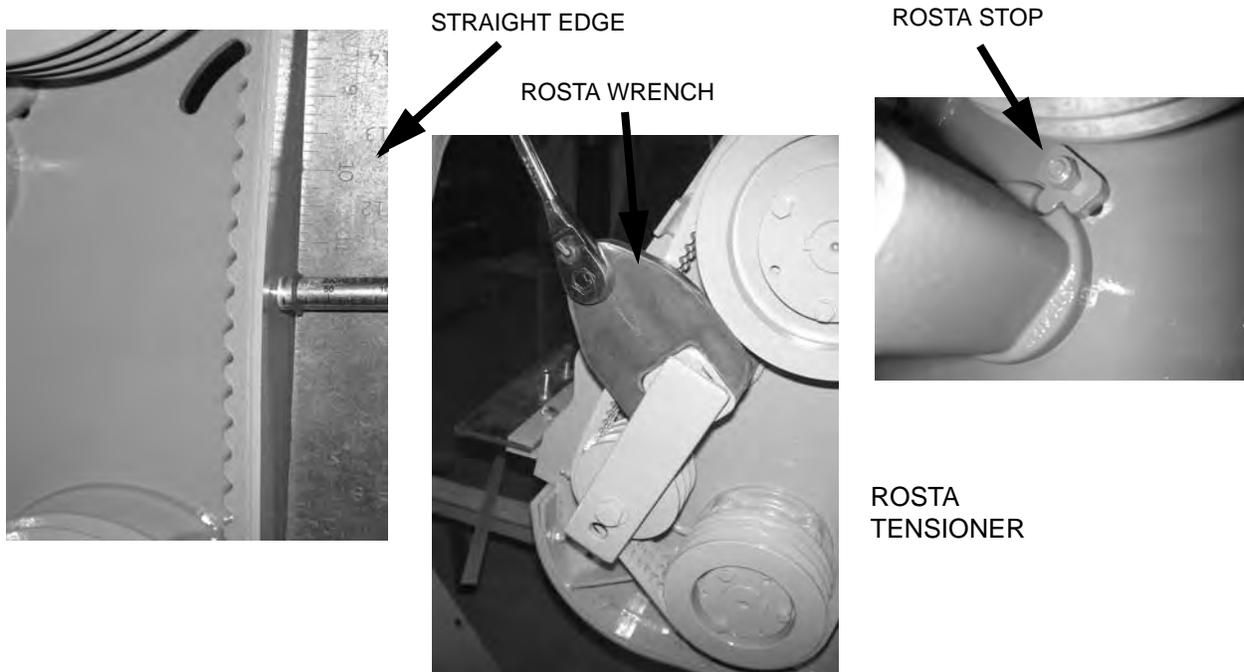

TRIPLE FLAIL

Maintenance Section 4-18

# MAINTENANCE

## TENSIONER MEASUREMENT PROCEDURE

1. Measure the Belt Span (SEE SKETCH).
2. Position the bottom of the Large "O" Ring on the Span Scale at the measured Belt Span.
3. Set the Small "O" Ring on the Deflection Force Scale to Zero.
4. Place the tension gauge squarely on the belt at the center of the belt span. Apply a force on the plunger perpendicular to the belt span until the bottom of the Large "O" Ring is even with the bottom of a straight edge laid across the sheaves.
5. Remove the tension gauge and read the force applied from the bottom of the Small "O" Ring on the Deflection Force Scale.
6. Compare the force denoted by the Small "O" Ring with the values shown. The force should be between the values given for either a New Belt or Used Belt.
7. Make sure to use the force values in pounds if the span is measured in inches. Use kilograms of force if the span is measured in centimeters.

NOTE: The ratio of the deflection to belt span is 1/64 in either units of measurements.

### Deflection Force Values - Standard Duty

**New Belt: 20 to 25 pounds**

**Used Belt: 12 to 20 pounds**

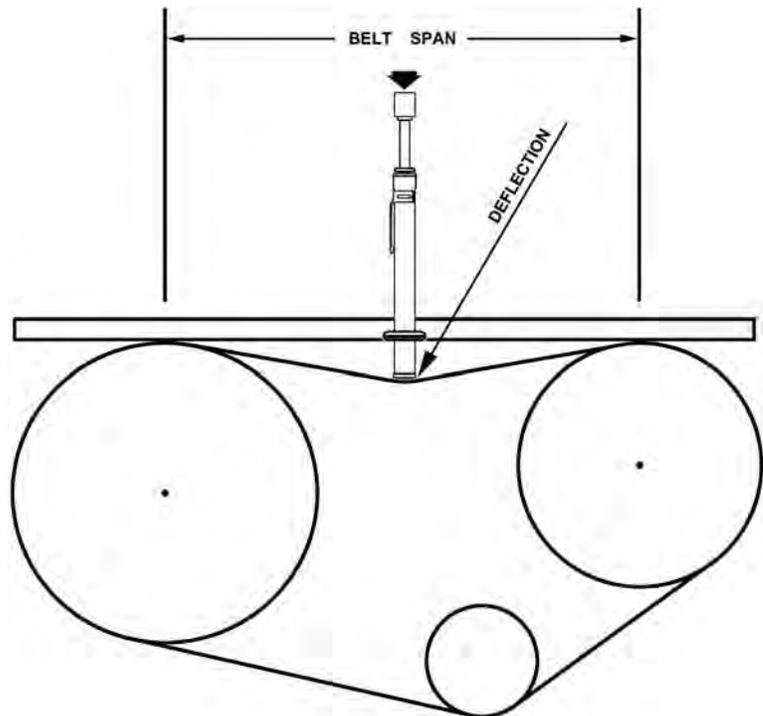
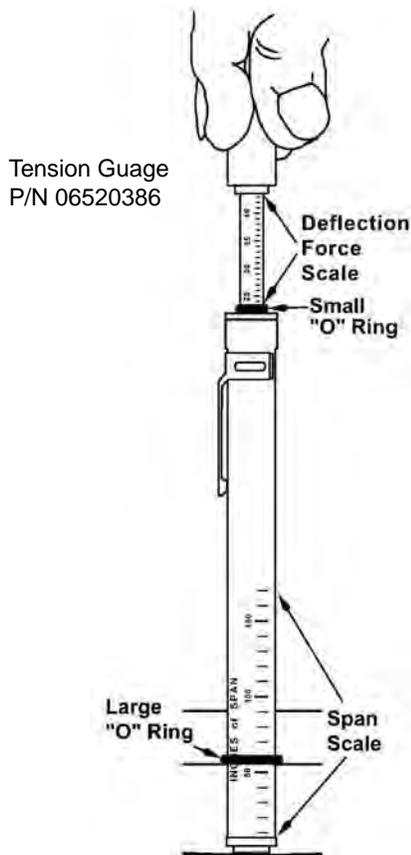

# MAINTENANCE

## REVERSING MOWER ROTATION OF SIDE AND REAR FLAIL MOWERS

To reverse the rotation of the side and hydraulically driven rear flail, a different idler arm is needed only for side flail. Part No. TF4346 is used in standard rotation. Part No. TF4345 is used in reverse rotation.

Before attempting this procedure, be sure all dirt is cleaned away from the motor and around all hose connections. This will prevent the oil from becoming contaminated.

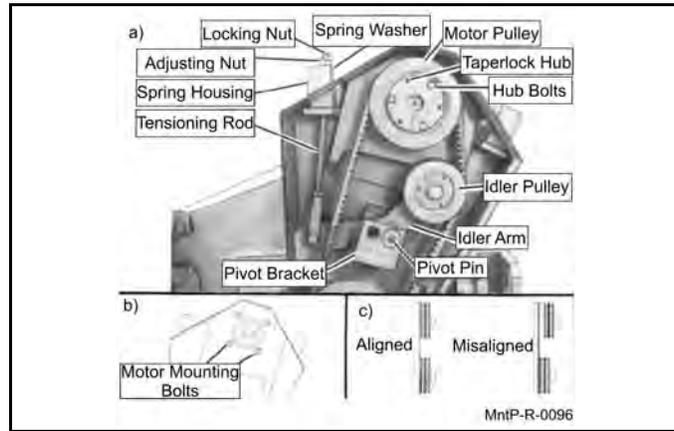

1. Start by removing the belt shield from the flail mower.
2. Remove the locking and adjusting nut, spring washer and spring from the idler tensioning rod.
3. Disconnect the tensioning rod from the idler arm.
4. Remove the idler arm with the pulley attached.
5. Remove the idler pulley from the idler arm and reinstall in the short end of the new idler arm.

Reinstall the idler arm and pivot pin. The pivot pin is installed into the hole in the pivot bracket closest to the idler pulley. When assembling for **standard** cut rotation, the idler arm is installed with the idler pulley toward the front of the mower with the pivot pin in the front hole. When assembling for **reverse** rotation, with smooth cut knives, the idler arm is installed with the pulley toward the rear of the mower with the pivot pin in the rear hole.

Now disconnect the hoses and fittings from the motor and remove the taper-lock hub and pulley from the motor by removing the three hub bolts from the existing positions and inserting simultaneously into the threaded holes. Remove the four bolts holding the motor. Rotate the motor 180° so the hump is opposite the prior position. Reinstall the motor bolts and torque to 75 ft. lbs. Reconnect the hoses and fittings to the motor in the same configuration as before, i.e. the hose that was connected to the front port on the motor should now be connected to the port that is now facing the front.

Reinstall the taper-lock hub and pulley on the motor by installing the hub bolts in the original holes and tightening until the hub just contacts the pulley. Then, position the pulley on the motor shaft approximately 3/16" beyond the idler pulley and tighten and torque the hub bolts to 18 ft./lbs. Be sure the pulleys are vertically aligned when tight (see **Figure MntP-R-0096**), loosen and readjust if needed.

Reinstall the belts and idler tensioning rod. Tighten and lock the tensioning rod as shown previously in the maintenance section. Reinstall the belt shield.

With the motor rotation changed, now all of the knives on the cutter shaft must be changed as required. The cutter shaft rotates in the same direction as the tractor tires when going forward for standard cut knives. The shaft rotates opposite to standard rotation for smooth cut knives. Smooth cut knives should be installed so the cutting edge is forward.

# MAINTENANCE

MAINTENANCE

When operating in standard rotation, the front shield must be removed and the baffle installed. When operating in reverse rotation, remove the baffle and install the front shield. Finally, reposition the wear pads on the hoses and replace the zip ties as needed to prevent the hydraulic hoses from rubbing or chafing.

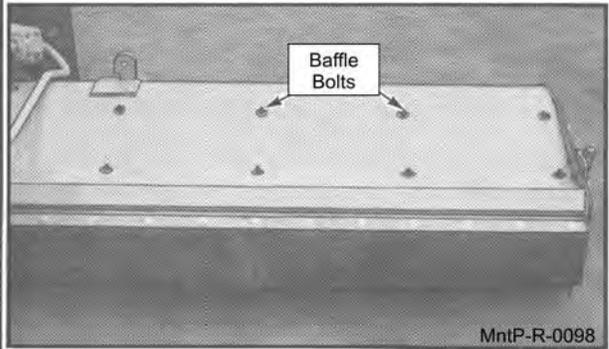
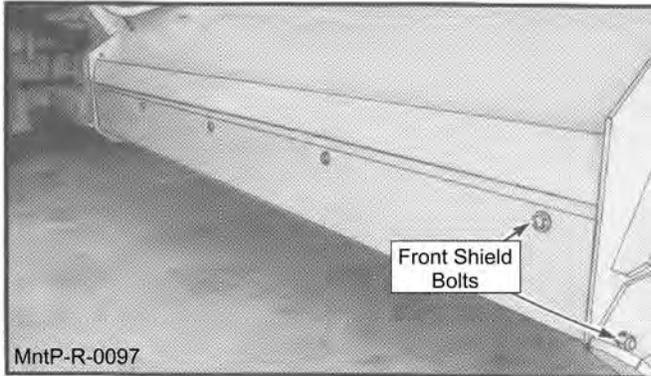

## REVERSING MOWER ROTATION OF SD REAR FLAIL MOWERS

Remove the shield guard and belt shield. Next, remove the Rosta stop and loosen the Rosta Tensioner (**CAUTION:** the Rosta Tensioner is under belt pressure. Sudden release of this pressure may cause serious injury). Remove the Rosta Tensioner and relocate to the Reverse Rotation Tensioner location. Using the Rosta wrench, tension the belt, then tighten the Rosta bolt. Check the tension and adjust as needed. When the correct tension is achieved install the Rosta stop and torque the bolts appropriately

Rosta Tensioner

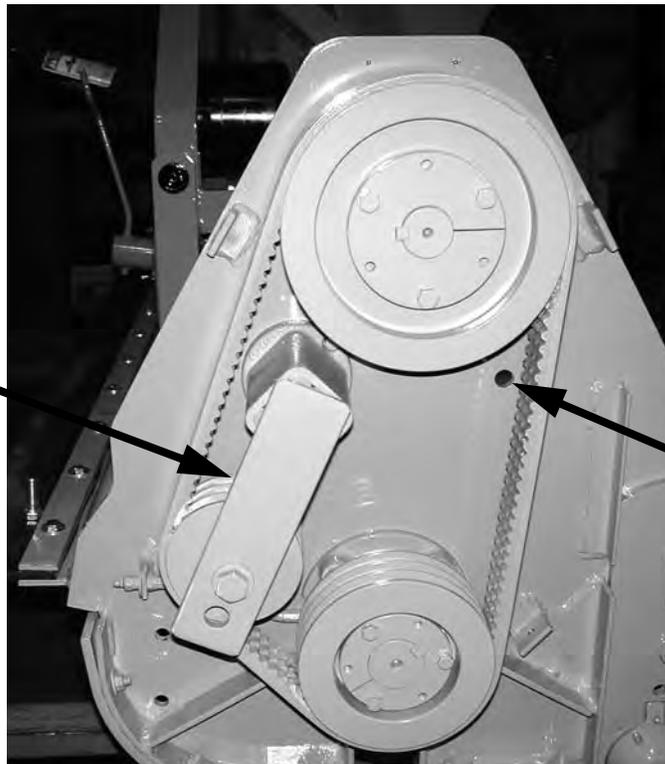

Reverse Rotation Tensioner location

# MAINTENANCE

MAINTENANCE

## REVERSING MOWER ROTATION REAR MECHANICAL DRIVEN FLAIL MOWERS

Remove the rear shaft guard and disconnect the chain coupling to the shaft. Disconnect the P.T.O. drive shaft from the right angle gear box. Remove the gear box from the flail frame and lay down flat so that gear oil does not leak out.

Switch the top breather vent plug with the drain plug on the bottom. Remove the input shaft guard. The input shaft must be pressed through or turned around so the rear extension is equal to what the original front dimension was. Turn the gear box 180° and install on the flail frame so the frame so the chain coupling sprockets are side by side and the breather vent plug is on the top of the case.

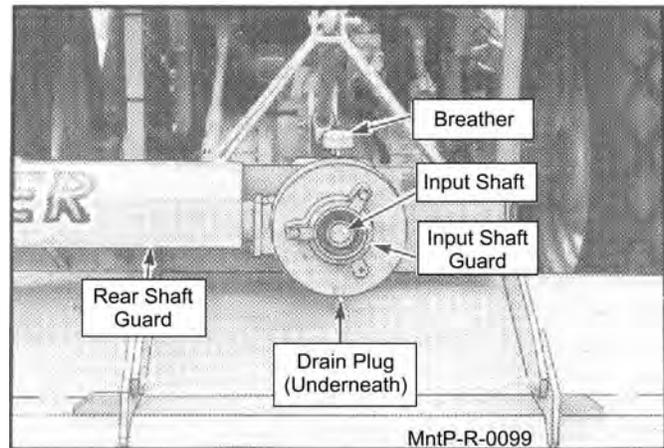

The sprocket must be aligned and spaced approximately 3/8" apart. When changing from standard cut to smooth cut rotation, a spacer plate may have to be installed between the gear box and the frame. When changing from smooth cut to standard cut rotation the spacer plate is to be omitted. Install the chain for the chain coupling. If there is any binding, or not free movement in the chain, the bearing next to the coupler may be shimmed as required to eliminate the chain binding.

Change all the knives on the cutter shaft as required. The cutter shaft rotates in the same direction as the tractor tires when going forward for standard knives. The cutter shaft rotates opposite the tractor tires for smooth cut knives.

Remove the belt shield. Then remove the adjusting nuts, washer and spring from the idler tensioning rod. Remove the clevis rod and small bushing from the idler arm. Remove the idler arm with the pulley attached. Remove the idler pulley from the idler arm and install the pulley on the other end of the idler arm. Reinstall the idler arm in the pivot bracket. For standard cut rotation the pulley is toward the front, for reverse rotation with smooth knives, the idler pulley is toward the rear. Install the small bushing in the idler arm and connect the idler tensioning rod.

Tightening the adjusting nuts for the idler arm tensioner as shown previously in the maintenance section. Install the belt shield, the shaft guard and P.T.O. shaft guards.

When operating the mower in reverse rotation with smooth cut knives, remove the baffle and install the front shield. When operating the mower in standard rotation with standard cut knives, remove the front shield and install the baffle.

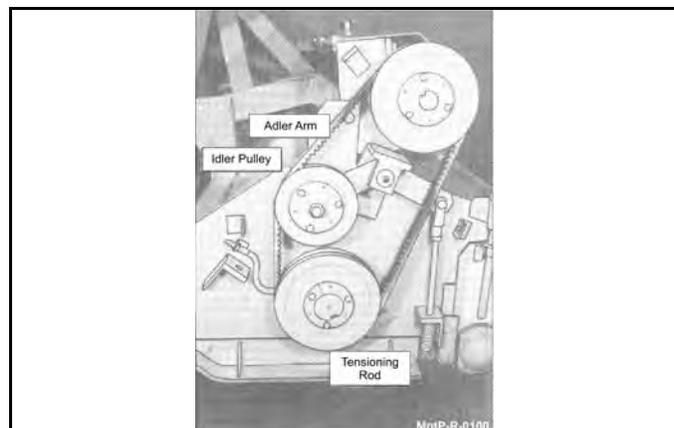

# MAINTENANCE

## Flail Blades Inspection



Inspect the Blades daily for abnormal wear. REPLACE ALL BLADES on the carrier IMMEDIATELY if any blades have:

- Become bent or deformed from its original shape, or
- Wear inside the blade bolt hole, or
- Any cracks are visible, or
- Deep gouges in the blade's surface are present, or
- Gouges or chipped areas in the cutting edge are larger than 1/4"(8mm), or
- The material on the leading edge has been worn away by more than 1/4"(8mm)

**DO NOT** straighten, sharpen, weld or hard-face blades

Failure to replace worn or damaged blades may lead to catastrophic failure of the blades and ejection of the broken part with tremendous force which may cause serious bodily injury or death.

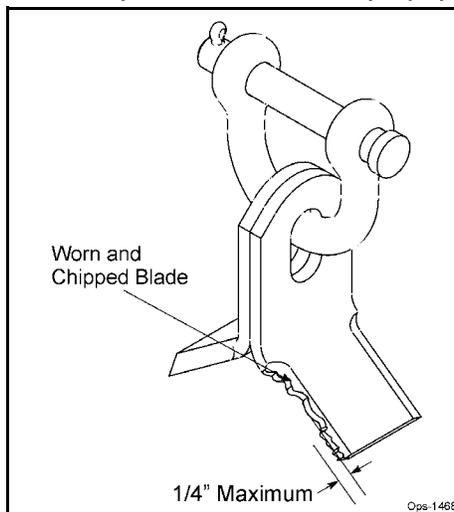

Always replace blades in sets

- Blades that are damaged may indicate severe service or abuse. If one blade is worn or damaged other blades on the same shaft will have been subjected to the same severe service or abuse.
- The Flail rotor turns at speeds exceeding 2000 RPM and is dynamically balanced at the factory. Differences in blade weight between used blades with loss of material from gouges or wear as compared to new blades can cause severe vibration and damage to the Flail rotor. Always replace blades as complete sets.

### Important

Use only genuine Alamo Industrial replacement blades and fasteners. Other blades and fasteners may not meet the Alamo Industrial requirements and could fail during operation resulting in part being thrown out from under the mower.



Never attempt to sharpen blades. OPS-U-0044

# MAINTENANCE

## Blade Pins and D-Ring Inspection

Inspect Blade Pins and D-Rings daily for wear or damage as follows:



Inspect the Blade pins and D-Rings daily for abnormal wear. Make sure the cotter pins are in place and properly spread. REPLACE BLADE Pins and D-Rings IMMEDIATELY if they have:

- Visible cracks or
- If a Pin or D-Ring has visible worn areas, or
- If a Pin or D-Ring has gouges or chipped areas

Failure to replace abnormally worn pins or D-Rings may lead to catastrophic failure and ejection of the broken part, which may cause serious bodily injury or death.

Always replace the pins and D-Rings whenever excessive wear is noticed.

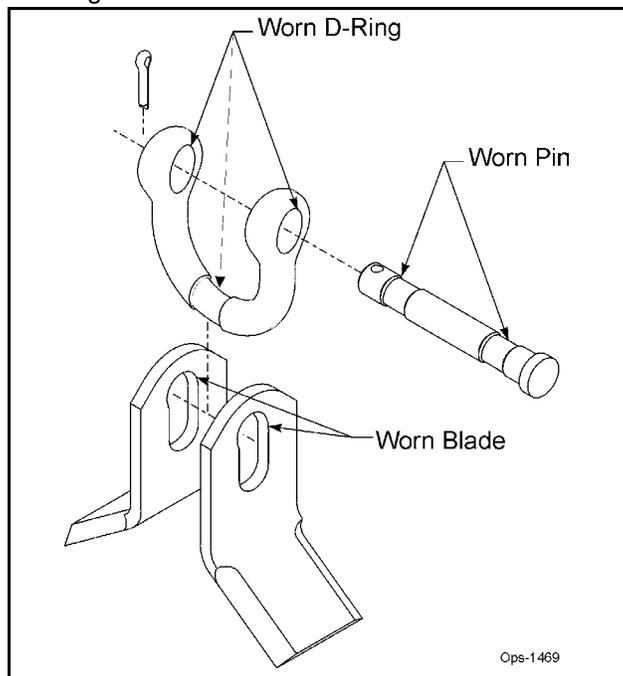

### **Important**

If the cotter pins are broken by contact with other flail blades, remove the pin and reverse the direction the pin is inserted through the D-Ring so that the cotter pin is on the opposite side of the D-Ring. This will prevent the next set of blades from swinging back and hitting the cotter pin. OPS-U-0045



# MAINTENANCE

## Flail Axe Blades Inspection



Inspect the Blades daily for abnormal wear. REPLACE ALL BLADES on the carrier IMMEDIATELY if any blades have:

- Become bent or deformed from its original shape, or
- Oval shape wear inside the blade bolt hole, or
- Any cracks are visible, or
- Deep gouges in the blade's surface are present, or
- Gouges or chipped areas in the cutting edge are larger than 1/4"(8mm), or
- The material on the leading edge has been worn away by more than 1/4"(8mm)

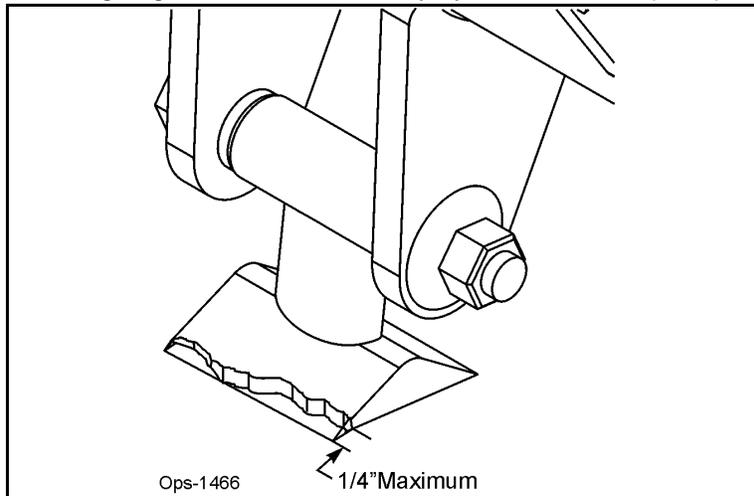

Failure to replace worn or damaged blades may lead to catastrophic failure of the blades and ejection of the broken part with tremendous force which may cause serious bodily injury or death.

Always replace blades in sets

- Blades that are damaged may indicate severe service or abuse. If one blade is worn or damaged other blades on the same shaft will have been subjected to the same severe service or abuse.
- The Flail Axe rotor turns at speeds exceeding 2000 RPM and is dynamically balanced at the factory. Differences in blade weight between used blades with loss of material from gouges or wear, as compared to new blades, can cause severe vibration and damage to the Flail Axe rotor. Always replace blades as complete sets.



Use only genuine Alamo Industrial replacement blades, blade bolts and fasteners. Other blades and bolts may not meet the requirements of Alamo Industrial and may fail during operation, resulting in the part failing and being thrown out from under the mower.



Never attempt to sharpen blades. OPS-U-0042

# MAINTENANCE

## Flail Axe Blade Bolt Inspection

Inspect Blade Bolts daily for wear or damage as follows:



Inspect the Blade Bolt daily for abnormal wear. REPLACE ALL BLADE BOLTS on the carrier IMMEDIATELY if any bolts have:

- Visible cracks or
- If the blade bolt is worn or any recessed area is visible on the bolt, or
- If Blade Bolt has gouges or chipped areas. or
- If Bushing fits loose in the Rotor Shaft.

Failure to replace abnormally worn bolts or bushings may lead to catastrophic failure of the blades and ejection of the broken part, which may cause serious bodily injury or death.

Always replace Blade Bolts with new bolts and new bushings whenever replacing the Blades. To tighten bolts and nuts, first apply thread lock to nut. Make sure to tighten bolts and nuts just enough to allow the blades to swing freely and not bend the cuttershaft lugs. If cuttershaft lugs are bent together because of over tightening the blades will not swing freely. OPS-U-0043

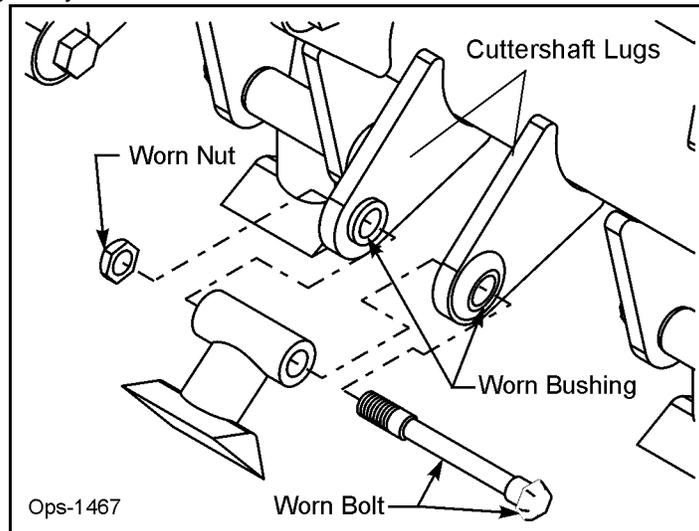

# MAINTENANCE

## STANDARD OR HEAVY DUTY SIDE OR REAR FLAIL KNIFE REPLACEMENT

1. If knives are damaged or badly worn, they will need to be replaced as a set. Replacing a single knife can cause severe vibration and possible damage to the mower.
2. Assemble knives, clevis, bolts and nuts as shown in parts manual.
3. Install locking hex nut so that the flat face of nut is towards the knife.
4. Apply loctite "271" or equivalent to threads.
5. Torque nut to 52 FT. LBS. Knife must swing freely.



DO NOT re-use the locking hex nuts for mounting the knives. If hex nut become loose, or require removal for knife replacement or any other reason, they must be discarded and replaced with new nuts.



Knives should not be welded on for any reason.

## RECOMMENDED FILLING INSTRUCTIONS FOR REAR FLAIL GEARBOX

When filling or checking the fluid level, the unit should be parked on a level surface with rear flail down on surface, shut "OFF", and cold, (at ambient temperature).

Remove the fluid level plug located on the side of the gear box. The gear box should be filled to the bottom of the fluid level hole. If necessary, use 75-90 wt. PAO Synthetic Extreme Pressure Gear Lube to raise level to bottom of the hole.

**Do not over-fill.** Excessive gear oil will run back out of the hole. Reinstall fluid level plug into gearbox. If gearbox has been over-filled, the excess may be expelled through the pressurized breather.

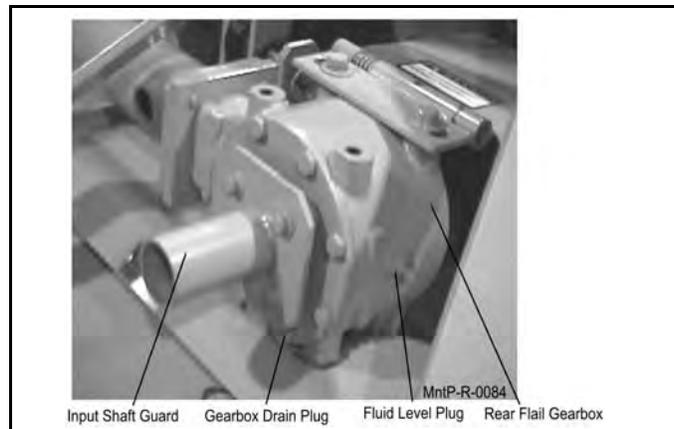

# MAINTENANCE

## MAINTENANCE

### CUTTERSHAFT BEARING REPLACEMENT

1. Remove existing cuttershaft, bearings and string guards.
2. Make sure that the end knives on each end of the cuttershaft are oriented as shown.
3. Apply anti-seize on cuttershaft as shown on next page.
4. Before installation the bearings must be fully greased per the following protocol: 1. Add 2 or 3 pumps of grease, 2. Spin the bearing 2 or 3 times. 3. Add 2 or 3 pumps of grease. 4. Spin the bearing 2 or 3 times. 5. Add 2 or three pumps of grease. Continue this procedure until you can visually confirm that grease is purging from the entire circumference of the seal.
5. Install non-drive side bearing first.
6. Install the top of the string guard on the non-drive side first. Use Loctite 271 or equivalent and torque (95 ft-lb or 104ft-lb if you use an extension).
7. Install the bearing and top string guard on the drive side.
8. Center the cuttershaft between the string guards. Use Loctite 271 or equivalent and torque (95ft-lb or 104ft-lb if you use an extension) the top string guard on the drive side.
9. Install, use Loctite 271 or equivalent, and torque (95ft-lb or 104ft-lb if you use an extension) the bottom string guard on both sides.
10. Make sure the cuttershaft is centered. On the non-drive side, tighten one set-screw in the bearing onto the cuttershaft.
11. Remove the other set screw and drill a 5/16" hole into the cuttershaft 3/16" deep through the hole in the bearing. **BE CAREFUL NOT TO DAMAGE THE THREADS IN THE BEARING HOLE.**
12. Replace the set screw in the bearing, use Loctite 271 or equivalent, and tighten onto the cuttershaft through the new hole.
13. Remove the other set screw and repeat the drilling procedure (Step 10). Replace the set screw as stated in Step 11.
14. Repeat steps 9 through 12 on the drive side.

**See illustration on next page**

# MAINTENANCE

## MAINTENANCE

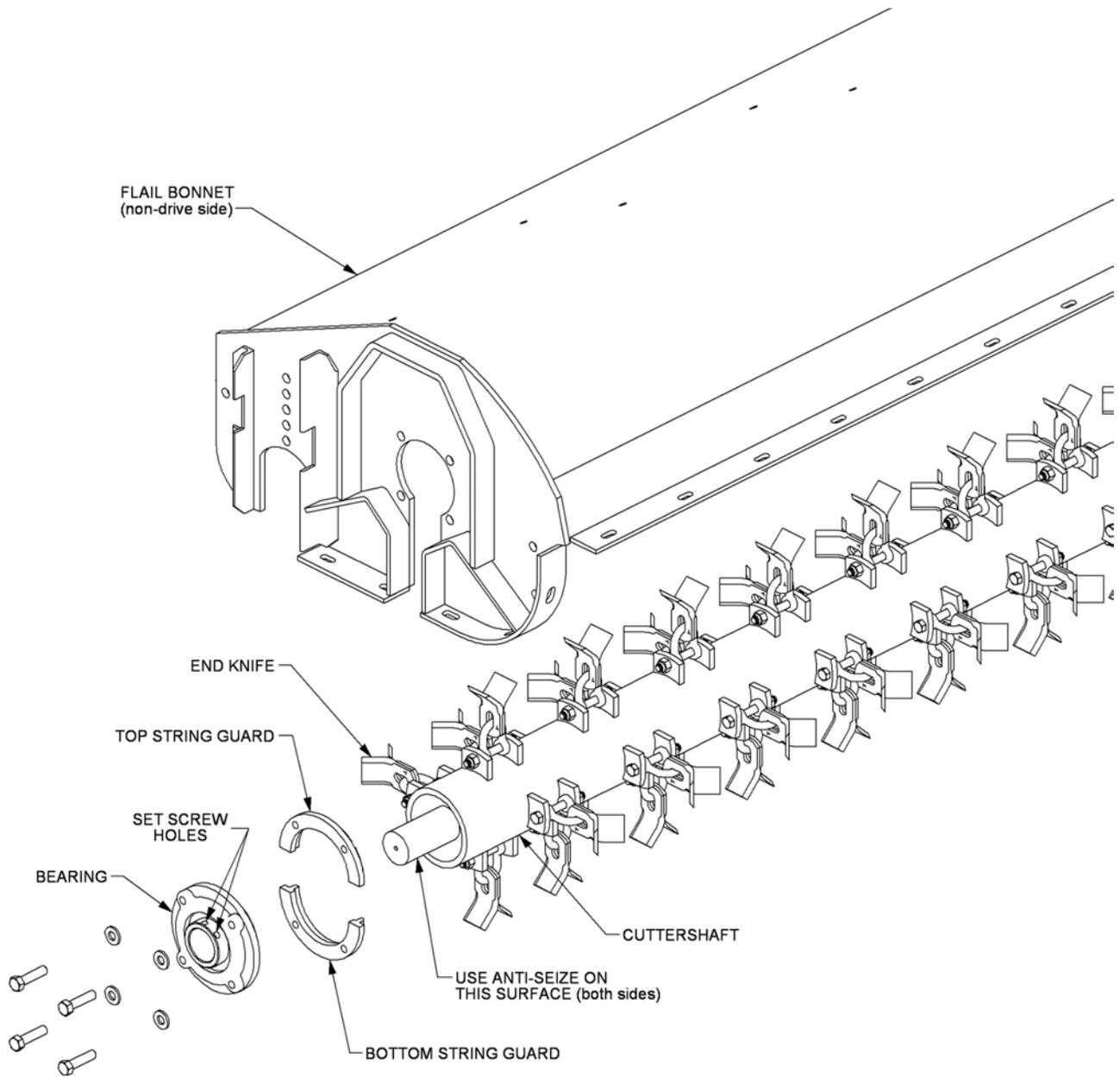

TRIPLE FLAIL

Maintenance Section 4-30

# MAINTENANCE

## MAINTENANCE

### GROUND ROLLER BEARING REPLACEMENT

1. Remove existing ground roller brackets, bearings, and ground roller.
2. Remove bearings from stub shafts and ground roller brackets.
3. Clean stub shafts thoroughly, and apply anti-seize to O.D. of outer end.
4. Before installation, bearings must be fully greased per the following protocol: 1. Add 2 or 3 pumps of grease, 2. Spin the bearing 2 to 3 times. 3. Add 2 or 3 pumps of grease. 4. Spin the bearing 2 to 3 times. 5. Add 2 or 3 pumps of grease. Continue this procedure until you can visually confirm that grease is purging from the entire circumference of the seal.
5. Install bearing onto ground roller brackets using existing hardware and Loctite 271.
6. Slide bearing-ground roller bracket assemblies onto stub shafts of ground roller.
7. Install ground roller brackets onto flail bonnet using existing hardware.
8. Insure that ground roller brackets are set to the same elevation on both sides.
9. Center ground roller in bearings.
10. Tighten one setscrew in one bearing onto stub shaft of ground roller.
11. At the other end, remove the setscrew collar and drill 5/16" holes in both setscrew locations into the stub shaft 3/16" deep (or align setscrew holes in bearing collar with existing countersinks in stub shaft).
12. Reinstall setscrew collar on drilled-end. Remove both setscrews, apply Loctite 271 or equivalent, and tighten setscrews into stub shaft.
13. Then remove setscrew collar from other end, and repeat the drilling procedure from Step 11. Reinstall setscrew collar and install setscrews per Step 12.

**See illustrations in the Common Parts Section.**

# MAINTENANCE

## DAILY MAINTENANCE SCHEDULE

The following services should be performed daily or every 8 hours of service, following the detailed maintenance instructions in the operator's manual.

\_\_\_\_\_ Pump driveshaft: If required with drive shaft/coupler check for end play and lubricate at zerks.

\_\_\_\_\_ Crankshaft adapter: If equipped with rubber grommets check condition, replace if missing or damaged.

\_\_\_\_\_ Pivot points: Inject grease until it appears at ends.

\_\_\_\_\_ Hydraulic fittings: Check for leaks with paper or cardboard. Tighten fittings or replace hoses immediately.

\_\_\_\_\_ Knives: Inspect for missing or damaged knives, change (only complete sets) as needed.

\_\_\_\_\_ Belts: Check/tighten/replace belts as needed.

\_\_\_\_\_ Mainframe/deck: Unless otherwise specified retorque bolts according to torque specifications in this section.

\_\_\_\_\_ Hydraulic fluid level: Add, if required, per fluid recommendations.

\_\_\_\_\_ Rear flail drive, bearing flange and shaft couplers: Grease as instructed in the detailed maintenance section.

\_\_\_\_\_ Cuttershaft and ground roller: Grease as instructed in the detailed maintenance section.

Service performed by: \_\_\_\_\_ Date: \_\_\_\_/\_\_\_\_/\_\_\_\_ Hour

Meter: \_\_\_\_\_

Maintenance Section

\*\*This page may be copied and used as part of the daily maintenance routine.

# MAINTENANCE

## MAINTENANCE OF CRANKSHAFT ADAPTER ASSEMBLY (RIGID ENGINE MOUNT TRACTORS ONLY)

If replacement of components of the crankshaft adapter assembly is required, follow the assembly procedures shown below. Seat rubber grommet completely into counterbore, then seat steel grommet completely into rubber grommet while rubber grommet is supported.

(ASM-JD-0051 CRANKSHAFT ADAPTER MAINTENANCE)

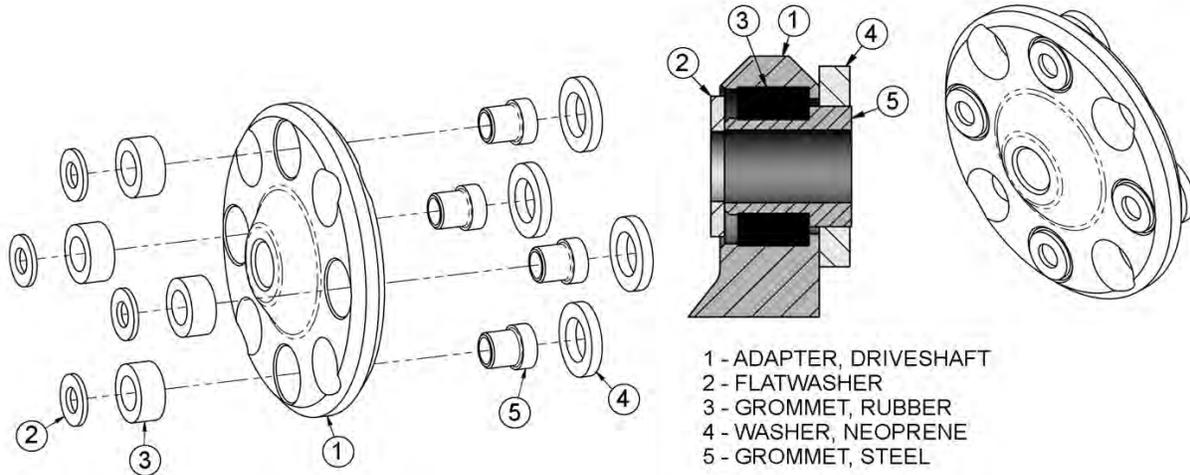

MAINTENANCE



# MAINTENANCE

MAINTENANCE

## DAILY MAINTENANCE SCHEDULE

The following services should be performed **daily** or every **8 hours** of service, following the detailed maintenance instructions in the operators manual.

- \_\_\_\_\_ Pump Drive Shaft: Check for end play in driveshaft / coupler and lubricate at zerks.
- \_\_\_\_\_ Crankshaft adapter: If equipped with rubber grommets check condition, replace if missing or damaged.
- \_\_\_\_\_ Pivot points: Inject grease until it appears at ends.
- \_\_\_\_\_ Hydraulic fittings: Check for leaks with paper or cardboard. Tighten fittings or replace hoses immediately.
- \_\_\_\_\_ Knives: Inspect for missing or damaged knives, change (only complete sets) as needed.
- \_\_\_\_\_ Belts: Check/Tighten/Replace belts as needed.
- \_\_\_\_\_ Main Frame/Deck: Unless otherwise specified retorque bolts according to torque specifications in this section.
- \_\_\_\_\_ Hydraulic Fluid Level: Add, if required, per fluid recommendations.
- \_\_\_\_\_ Rear Flail Drive, Bearing Flange and Shaft Couplers (if applicable): Grease as instructed in the detailed maintenance section.
- \_\_\_\_\_ Cutter Shaft and Ground Roller: Grease as instructed in the detailed maintenance section.

Service performed by: \_\_\_\_\_ Date: \_\_\_\_/\_\_\_\_/\_\_\_\_ Hour

Meter: \_\_\_\_\_

Maintenance Section

\*\*This page may be copied and used as part of the daily maintenance routine.

# MAINTENANCE

# MAINTENANCE

TRIPLE FLAIL

Maintenance Section 4-32

# PARTS SECTION

## PART NAME INDEX

PARTS ORDERING GUIDE.....	3
TRACTOR MOUNT KIT.....	4
TRACTOR MOUNT KIT - HYDRAULICS.....	6
BUMPER TANK MOUNT.....	8
COOLER ASSEMBLY.....	10
CABLE (MANUAL) LIFT VALVE MOUNT.....	12
4 SPOOL CABLE CONTROL MOUNT.....	14
FUEL AND DEF TANK MOUNT.....	16
BATTERY RELOCATION.....	18
DRAFT BEAMS.....	20
DRAFT BEAM HYDRAULICS - RIGHT HAND.....	22
DRAFT BEAM HYDRAULICS - LEFT HAND.....	23
SIDE FLAIL DRIVE ASSEMBLY.....	24
75IN SIDE FLAIL - STANDARD ROTATION.....	26
75IN SIDE FLAIL - REVERSE ROTATION.....	28
110IN REAR FLAIL DRIVE ASSEMBLY.....	30
110IN REAR FLAIL - STANDARD ROTATION.....	32
110IN REAR FLAIL - REVERSE ROTATION.....	34
EGRESS MOUNTING.....	36
EGRESS MOUNTING, CONTINUED.....	37
EGRESS PUMP MOUNT.....	38
EGRESS PUMP BREAKDOWN.....	40
EGRESS SCHEMATIC.....	42
EGRESS SWITCHBOX.....	43
EGRESS TROUBLESHOOTING.....	44
NOTES.....	45
3 X 8 HYDRAULIC CYLINDER BREAKDOWN.....	46
3 X 10 HYDRAULIC CYLINDER BREAKDOWN.....	48
3 X 18 HYDRAULIC CYLINDER BREAKDOWN.....	49
NOTES 1.....	50

## PARTS ORDERING GUIDE

The following instructions are offered to help eliminate needless delay and error in processing purchase orders for the equipment in this manual.

1. The Parts Section is prepared in logical sequence and grouping of parts that belong to the basic machine featured in this manual. Part Numbers and Descriptions are given to help locate the parts and quantities required.
2. The Purchase Order must indicate the **Name and Address** of the person or organization ordering the parts, **who should be charged**, and if possible, the **serial number of the machine** for which the parts are being ordered.
3. The purchase order must clearly list the **quantity of each part**, the complete and correct **part number**, and the basic **name of the part**.
4. The manufacturer reserves the right to substitute parts where applicable.
5. Some parts may be unlisted items which are special production items not normally stocked and are subject to special handling. Request a quotation for such parts before sending a purchase order.
6. The manufacturer reserves the right to change prices without prior notice.

NOTE: When ordering replacement decals, refer to the part numbers and descriptions listed in the safety section in the front of this manual.

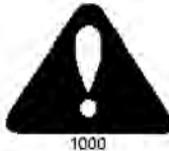

For maximum safety and to guarantee optimum product reliability, always use genuine **Tiger** replacement parts. The use of inferior replacement parts may cause premature or catastrophic failure which could result in serious injury or death.

Direct any questions regarding parts to:

**Tiger Corporation**  
3301 N. Louise Ave.  
Sioux Falls, SD 57107  
1-800-843-6849  
1-605-336-7900

# TRACTOR MOUNT KIT

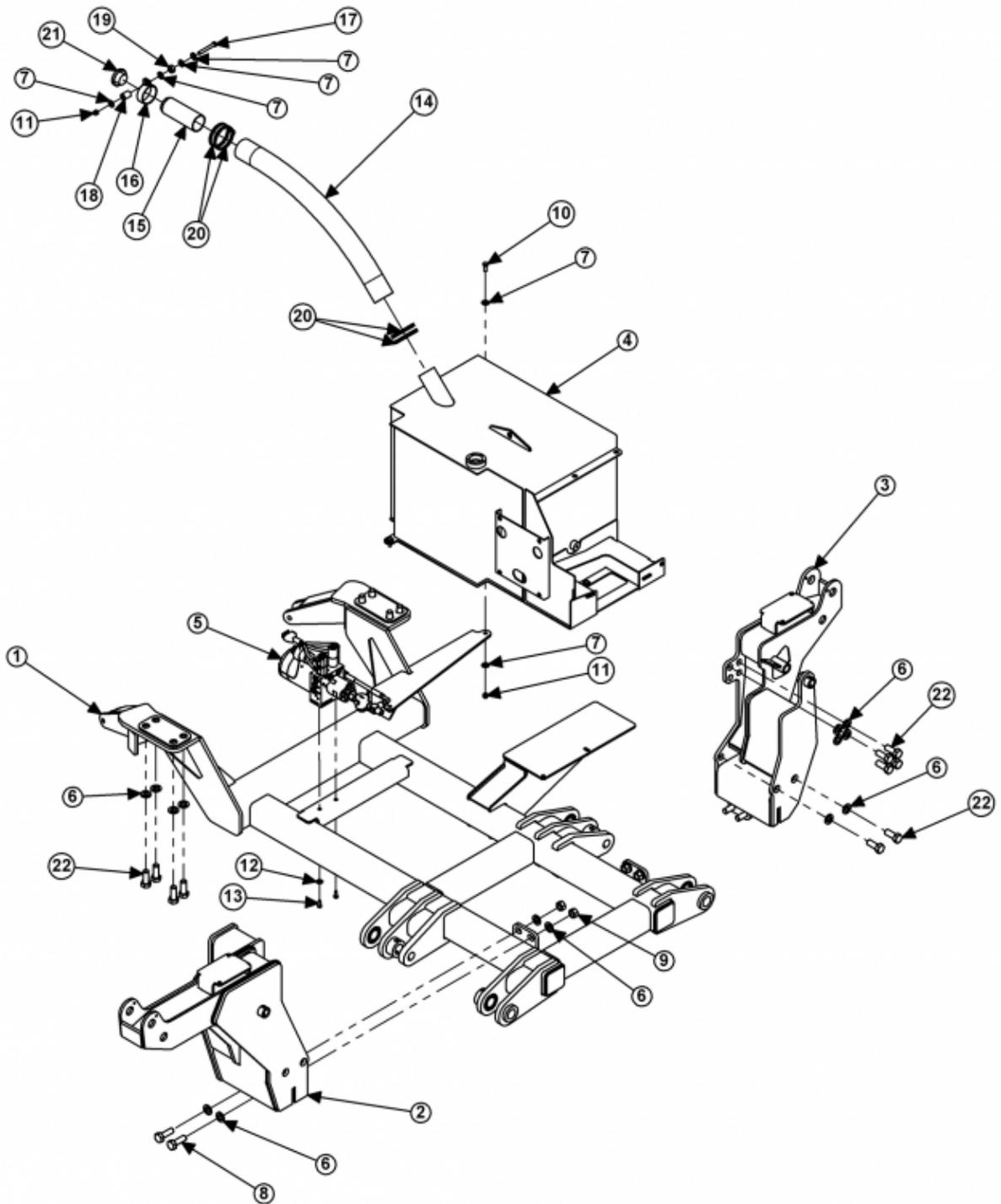

## TRACTOR MOUNT KIT

Continued...

ITEM	PART NO.	QTY.	DESCRIPTION
1	06300429	1	T3F FRAME, JD6E
2	06300430	1	MAST FRAME, RH, JD6E
3	06300446	1	MAST FRAME, LH, JD6E
4	06370197	1	TANK, FUEL, JD6105-35E
5	06510066	1	HYDRO UNIT, EGRESS, HYTOS, T3F
6	33880	28	FLATWASHER, 3/4", GR8, SAE
7	220016	10	FLATWASHER, 3/4" GR8
8	06530237	4	CAPSCREW, 3/4" X 2-1/4", NC, GR8
9	06531008	4	HEX NUT, 3/4" NC, GR8
10	21630	3	CAPSCREW, 3/8" X 1" NC
11	21627	4	NYLOCK NUT, 3/8" NC
12	22015	2	FLATWASHEER, 5/16"
13	21579	2	CAPSCREW, 5/16" X 3/4" NC
14	31064	1	HOSE, SUCTION, 2.50I.D. BULK
15	31058A	1	FUEL TANK SPOUT
16	31146A	1	CLAMP
17	21638	1	CAPSCREW, 3/8" X 3" NC
18	27082B	1	SPACER, .88X50X1.19
19	27081A	1	SPACER
20	31065	4	CLAMP, HOSE, #48
21	31206	1	CAP, FUEL, LOCKING
22	31731	20	CAPSCREW, 20MM X 50MM (2.5 PITCH)

# TRACTOR MOUNT KIT - HYDRAULICS

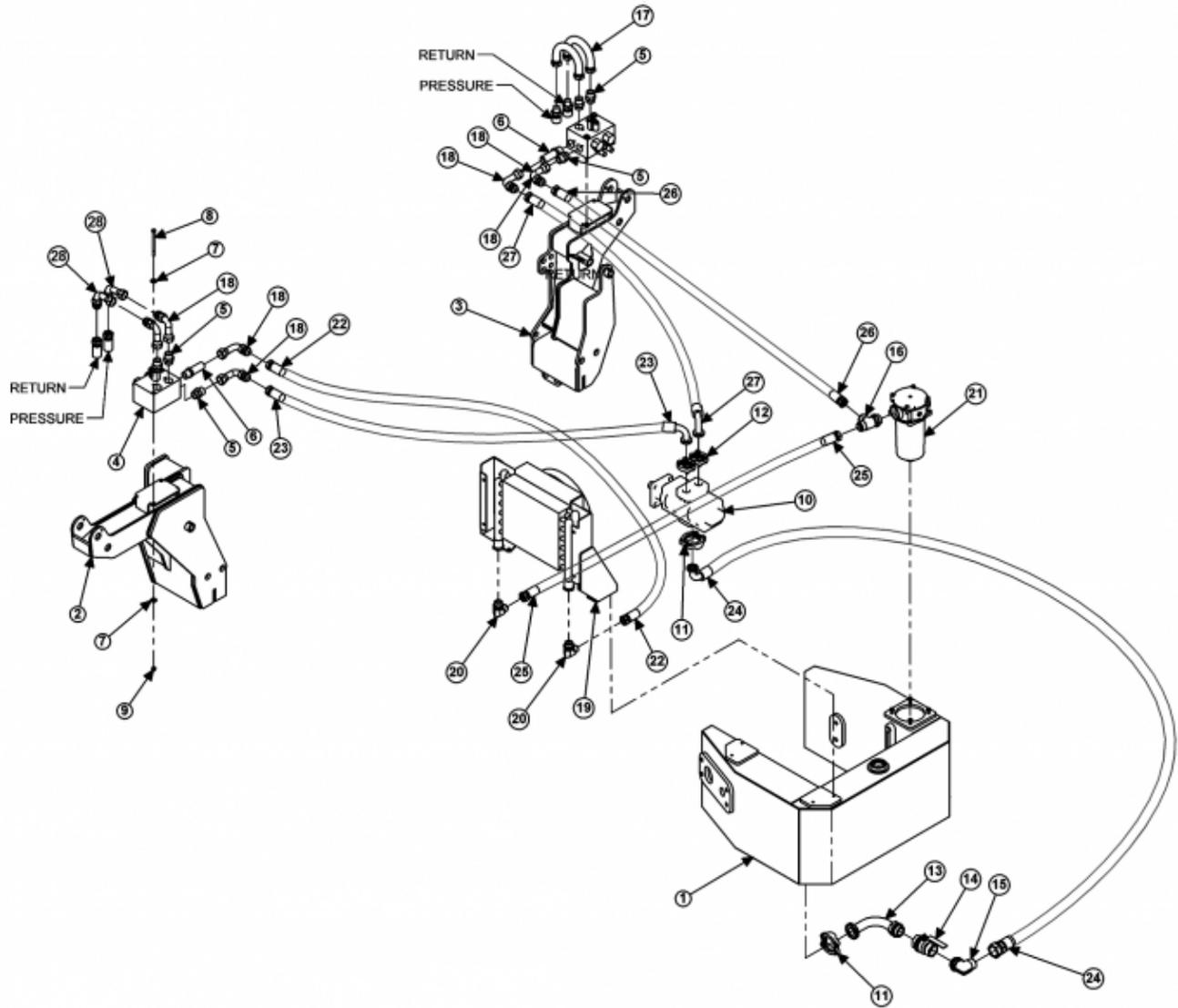



## TRACTOR MOUNT KIT - HYDRAULICS

Continued...

ITEM	PART NO.	QTY.	DESCRIPTION
1	34666	1	BUMPER TANK
2	06300430	1	MAST, FRM, RH, JD6E
3	06300446	1	MAST, FRM, LH, JD6E
4	06510083	2	BRAKE VALVE
5	33555	6	NIPPLE, MALE, LONG, 1MOR X 1MJ
6	32869	2	NIPPLE, MALE, LONG, 1MOR X 1 MJ
7	22016	8	FLATWASHER, 3/8" GR8
8	21644	4	CAPSCREW, 3/8" X 5" NC
9	21627	4	NYLOCK NUT, 3/8" NC
10	TF4450	7	PUMP, TANDEM
11	TF4431	2	KIT, FLANGE, #32
12	TF4852	2	KIT, FLANGE, #20
13	34389	1	ELBOW, 1-1/2ORB X 32FLG
14	34309	1	BALL VALVE, 1-1/2FOR
15	34655	1	ELBOW, 1-1/2ORB X 1-1/2MJ
16	34656	1	TEE, RUN 1-1/4ORB X 1-1/4MJ X 1-1/4MJ
17	06506012	2	PREFORMED BRKVLV, 4X1FJX X 1FJX(180)
18	06503200	8	ELBOW, 16MJ X 16FJX X BT90
19	06700166	1	COOLER, ELECT TERM, ASSY
20	34117	2	ELBOW, 1MOR X 1MJ90 FORGED
21	35269	1	IN TANK, FILTER ASSY, 10 MICRON
22	06500664	1	HOSE, 1" X 81"
23	24489	1	HOSE, 1" X 64"
24	06500119	1	HOSE, 1-1/2" X 28"
25	06500260	1	HOSE, 1" X 31"
26	06501225	1	HOSE, 1" X 77"
27	06500037	1	HOSE, 1" X 72"
28	06503222	2	ELBOW, 16MJ X 16FJ X BT90, L

# BUMPER TANK MOUNT

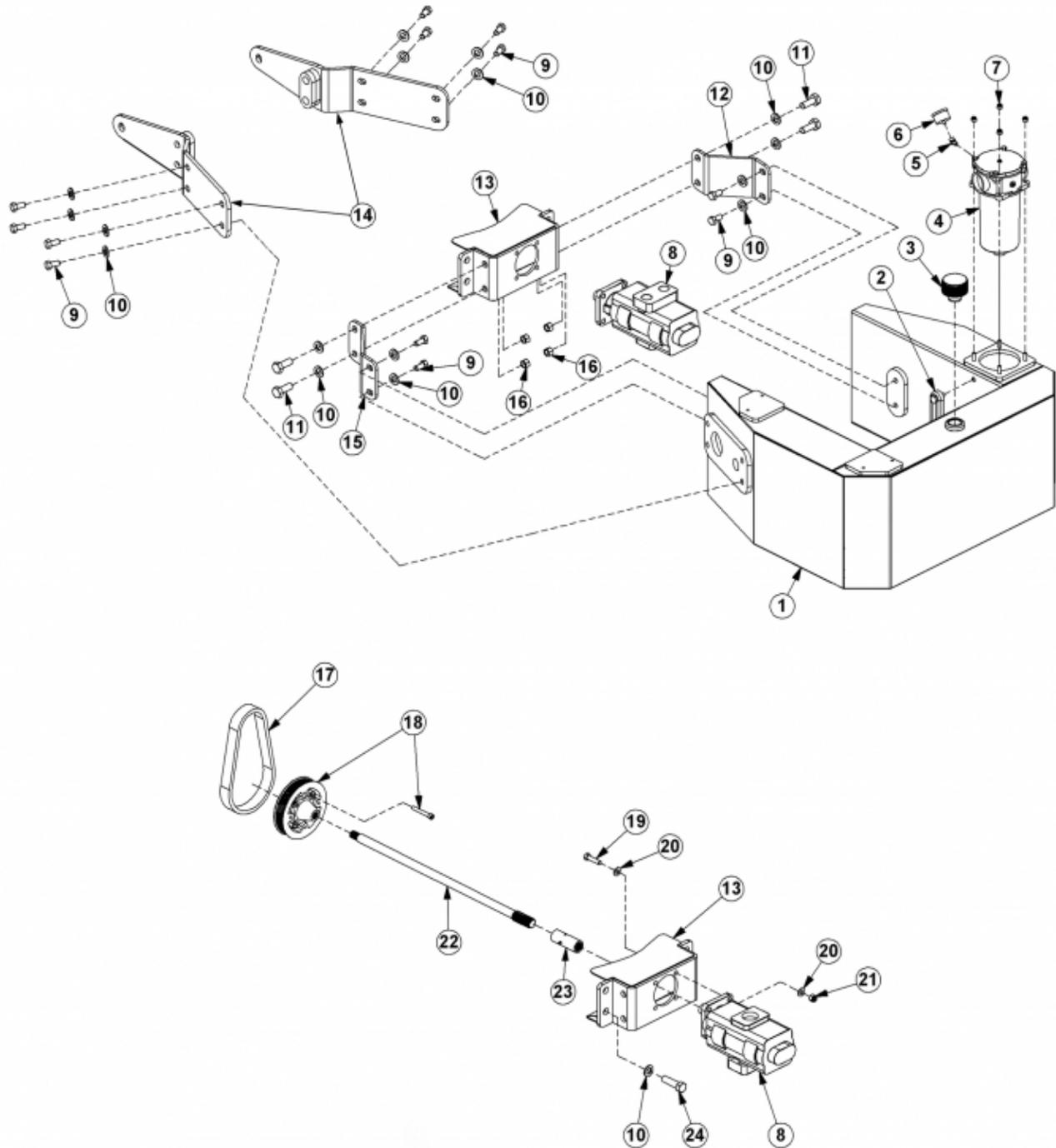

## BUMPER TANK MOUNT

Continued...

ITEM	PART NO.	QTY.	DESCRIPTION
1	-----	-	TANK,BUMPER *REFER TO TRACTOR MOUNT KIT,HYD
2	06505067	1	SIGHT GLASS
3	06505077	1	CAP,BREATHER,FILLER
4	06505044	1	FILTER,RETURN
---	35259	1	ELEMENT,FILTER
5	TF4887	1	STREET ELBOW,1/8"
6	6T0649	1	INDICATOR,FILTER
7	21627	4	NYLOCK NUT,3/8",NC
8	-----	-	PUMP,TANDEM *REFER TO TRACTOR MOUNT KIT,HYD
9	21780	12	CAPSCREW,5/8" X 1-1/4",NC
10	33880	20	FLATWASHER,3/4",SAE
11	21832	4	CAPSCREW,3/4" X 2",NC
12	06411962	1	MNT,LH,TANK
13	-----	-	MNT,PUMP *REFER TO TRACTOR MOUNT KIT,HYD
14	-----	-	HANGER FRAME *REFER TO TRACTOR MOUNT KIT
15	06411963	1	MNT,RH,TANK
16	21825	4	HEX NUT,3/4",NC
17	T208891	1	JOHN DEERE BELT
18	SJ23950	1	JOHN DEERE PULLEY KIT
19	21733	4	CAPSCREW,1/2" X 2",NC
20	06533004	8	FLATWASHER,1/2",SAE
21	21727	4	NYLOCK NUT,1/2",NC
22	06420166	1	DRIVESHAFT
23	6T0375B	1	COUPLING
24	25341	4	CAPSCREW,20MM X 70MM,2.5P

# COOLER ASSEMBLY

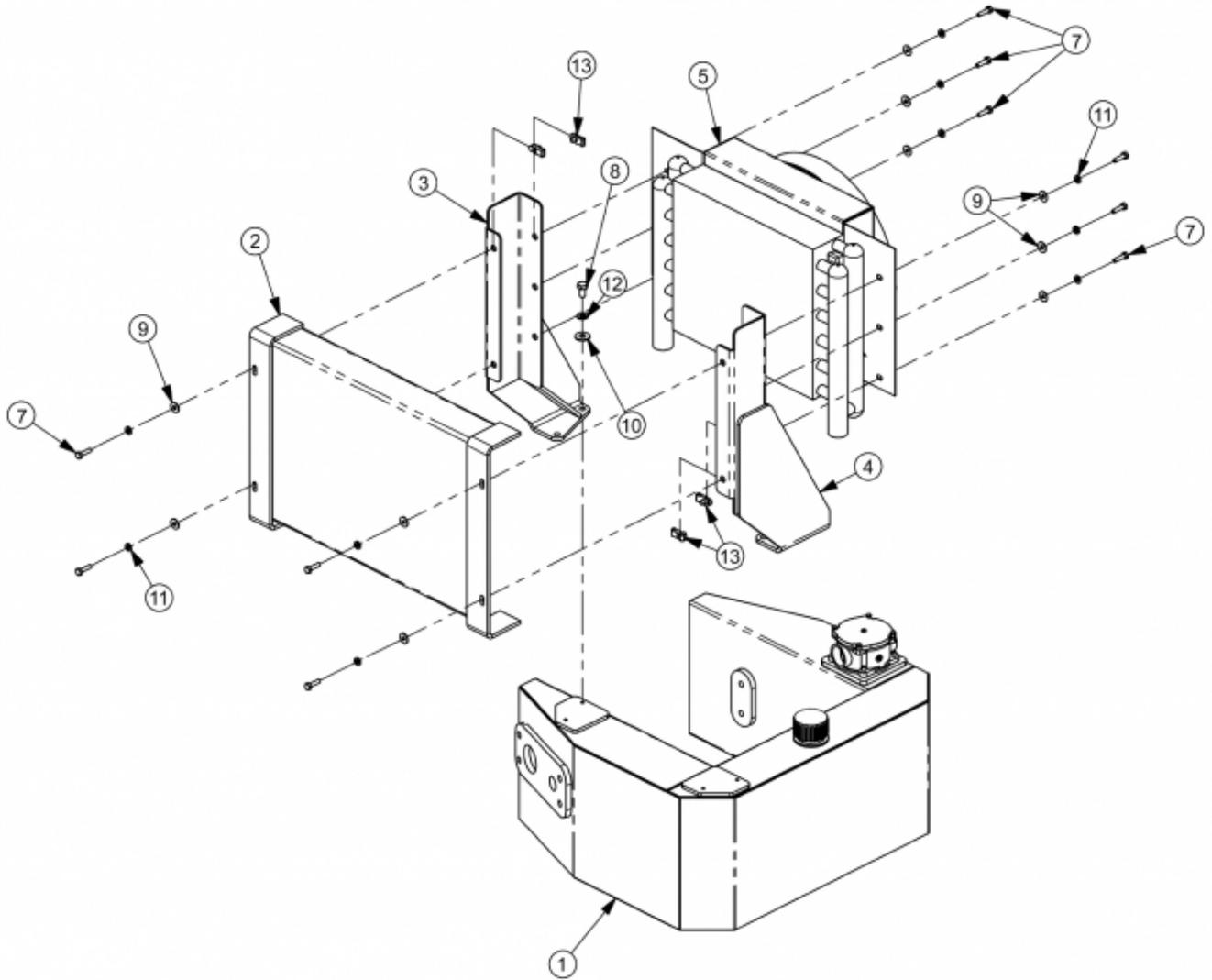

## COOLER ASSEMBLY

Continued...

ITEM	PART NO.	QTY.	DESCRIPTION
1	34666	1	TANK,RES,BUMPER,ASSY
2	06370015	1	SCREEN,COOLER,FRNT
3	06380007	1	MNT,COOLER,BUMPER TANK,LH
4	06380006	1	MNT,COOLER,BUMPER TANK,RH
5	06510350	1	COOLER,FRONT MNT
7	21530	10	CAPSCREW,1/4" X 1",NC
8	21629	4	CAPSCREW,3/8" X 3/4",NC
9	22014	10	FLATWASHER,1/4"
10	22016	4	FLATWASHER,3/8"
11	21986	10	LOCKWASHER,1/4"
12	21988	4	LOCKWASHER,3/8"
13	35176	10	U-NUT,1/4",NC

# CABLE (MANUAL) LIFT VALVE MOUNT

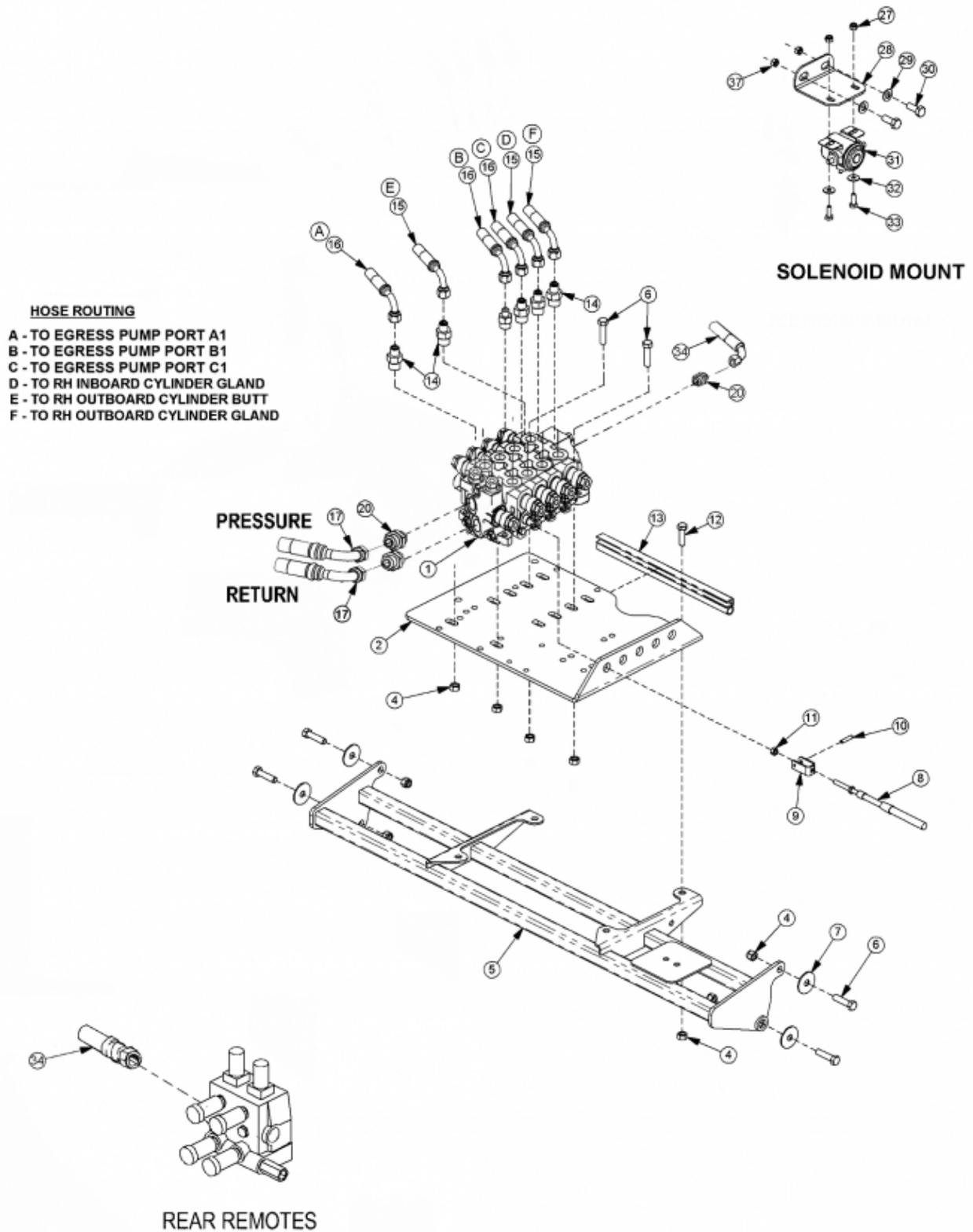

## CABLE (MANUAL) LIFT VALVE MOUNT

Continued...

ITEM	PART NO.	QTY.	DESCRIPTION
1	06502159	1	VALVE,4SP,HSC
2	34622	1	PLATE,VALVE,REAR MNT
4	21627	12	NYLOCK NUT,3/8",NC
5	06340033	1	VALVE MNT
6	21632	6	CAPSCREW,3/8" X 1-1/2",NC
7	6T2615	4	WASHER,FENDER,3/8"
8	06505100	4	CABLE CONTROL,108"
9	6T4411	4	CLEVIS
10	6T3017	4	ROLLPIN,3/16" X 1"
11	21500	4	HEX NUT,1/4",NF
12	21631	2	CAPSCREW,3/8" X 1-1/4",NC
13	28053	1	TRIM LOCK
14	33271	6	ADAPTER,1/2"MOR X 3/8"MJ
15	33492	3	HOSE,1/4" X 138"
16	33560	3	HOSE,1/4" X 93"
17	06500782	2	HOSE, 3/4" X 70"
18	06500467	1	HOSE,1/2" X 31"
19	32678	1	ADAPTER,5/8"MOR X 1/2"FOR
20	06503023	1	ELBOW,3/4"MOR X 3/4"FJX
22	21633	2	CAPSCREW,3/8" X 1-3/4",NC
23	RE267820	1	ADAPTER,PB
24	06503130	1	TEE,BRANCH
25	06500533	1	HOSE,3/4" X 37" *REPLACES TRACTOR HARD-LINE
26	-----	-	ELBOW *EXISTING TRACTOR PART
27	21527	2	NYLOCK NUT,1/4",NC
28	06411085	1	BRKT,MNT,SOLENOID
29	22015	2	FLATWASHER,5/16"
30	21579	2	CAPSCREW,5/16" X 3/4"
31	6T3927	1	CONTINUOUS DUTY SOLENOID
32	22014	2	FLATWASHER,1/4"
33	21529	2	CAPSCREW,1/4" X 3/4",NC
34	06500783	1	HOSE, 3/4" X 30"
35	06500300	1	HOSE, 1/4" X 148"
36	06500311	1	HOSE, 1/4" X 156"
37	21577	2	NYLOCK NUT, 5/16" NC

# 4 SPOOL CABLE CONTROL MOUNT

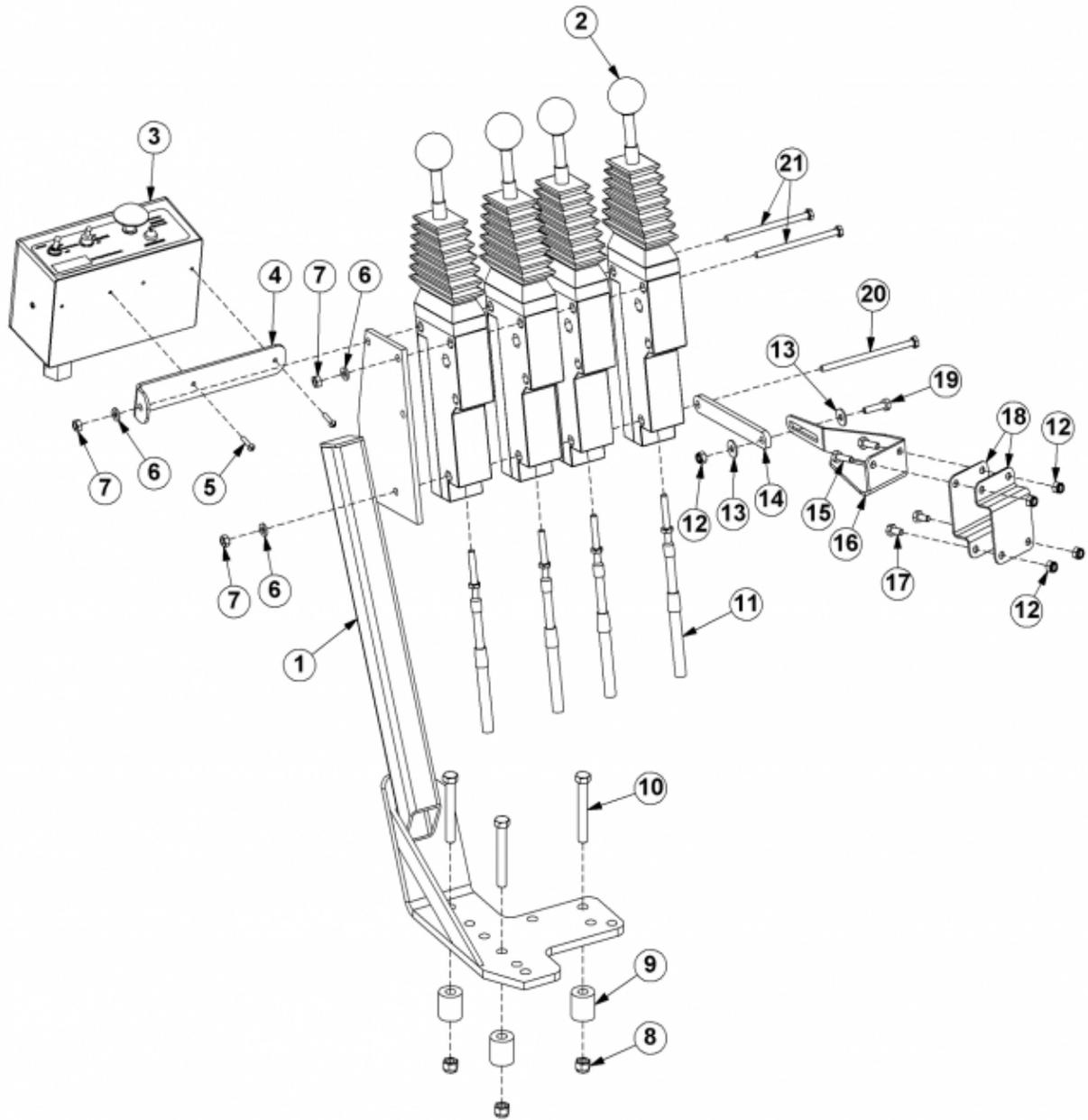



## 4 SPOOL CABLE CONTROL MOUNT

Continued...

ITEM	PART NO.	QTY.	DESCRIPTION
1	23865B	1	BRKT,CTRL,CBL
2	6T1251	4	CBL CTRL BOX,180 DEG
3	06510097	1	SWITCH BOX,TRIPLE
4	34496	1	BRKT,SWITCH BOX
5	6T3951	2	SCREW,MACHINE,8-32 X 1/2"
6	21986	3	LOCKWASHER,1/4"
7	21525	3	HEX NUT,1/4",NC
8	21627	3	NYLOCK NUT,3/8",NC
9	27082B	3	SPACER
10	21636	3	CAPSCREW,3/8" X 2-1/2",NC
11	06505100	4	CBL,CNTRL,108"
12	21527	5	NYLOCK NUT,1/4",NC
13	22014	2	FLATWASHER,1/4"
14	06402045	1	SUPPORT,STAND
15	21529	2	CAPSCREW,1/4" X 3/4",NC
16	06411087	1	BRKT,STABILIZER
17	21528	2	CAPSCREW,1/4" X 1/2",NC
18	06411086	2	BRKT,MNT
19	21534	1	CAPSCREW,1/4" X 2",NC
20	21547	1	CAPSCREW,1/4" X 8",NC
21	21546	2	CAPSCREW,1/4" X 7",NC

JD6E TRIPLE

# FUEL AND DEF TANK MOUNT

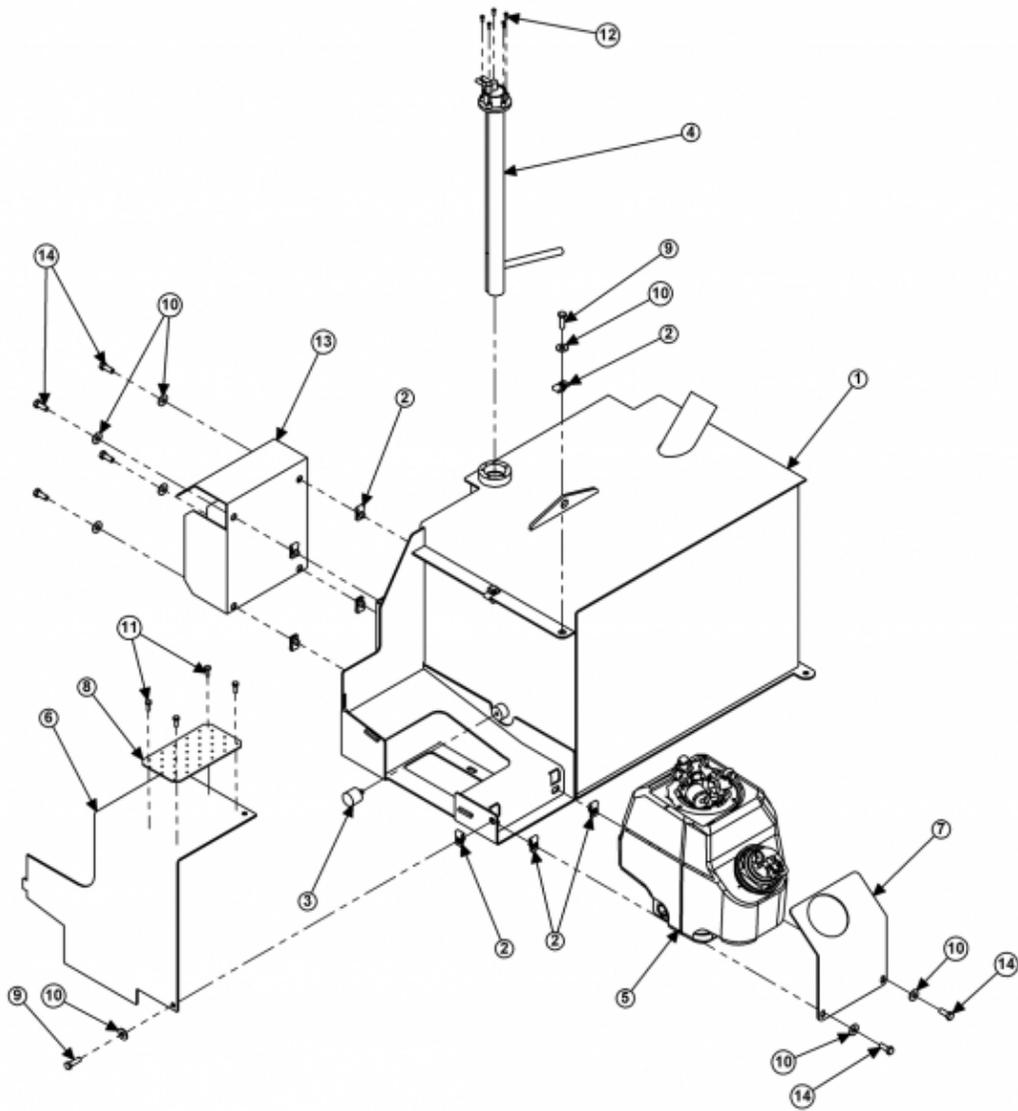

## FUEL AND DEF TANK MOUNT

Continued...

ITEM	PART NO.	QTY.	DESCRIPTION
1	06370197	1	TANK, FUEL, JD6105-35E
2	06337029	9	U-NUT, 3/8"NC, 3/4" TO CENTER
3	06520603	1	VIBRATION ISO, 3/8"NC
4	----	1	JD6105E FUEL SENDING UNIT (EXISTING)
5	---	1	DEF TANK (EXISTING)
6	06412644	1	COVER, DEF, JD6E, T3F
7	06412635	1	MOUNT, DEF, JD6E, T3F
8	06402229	1	TREAD PLATE
9	21631	3	CAPSCREW, 3/8"X1-1/4", NC, GR8
10	22016	9	FLATWASHER, 3/8" GR8
11	06537036	4	CAPSCREW, #10 X 3/4", SLF TAP
12	-----	5	CAPSCREW (EXISTING)
13	-----	1	DEF TANK PUMP (EXISTING)
14	21630	6	CAPSCREW, 3/8" X 1" NC

# BATTERY RELOCATION

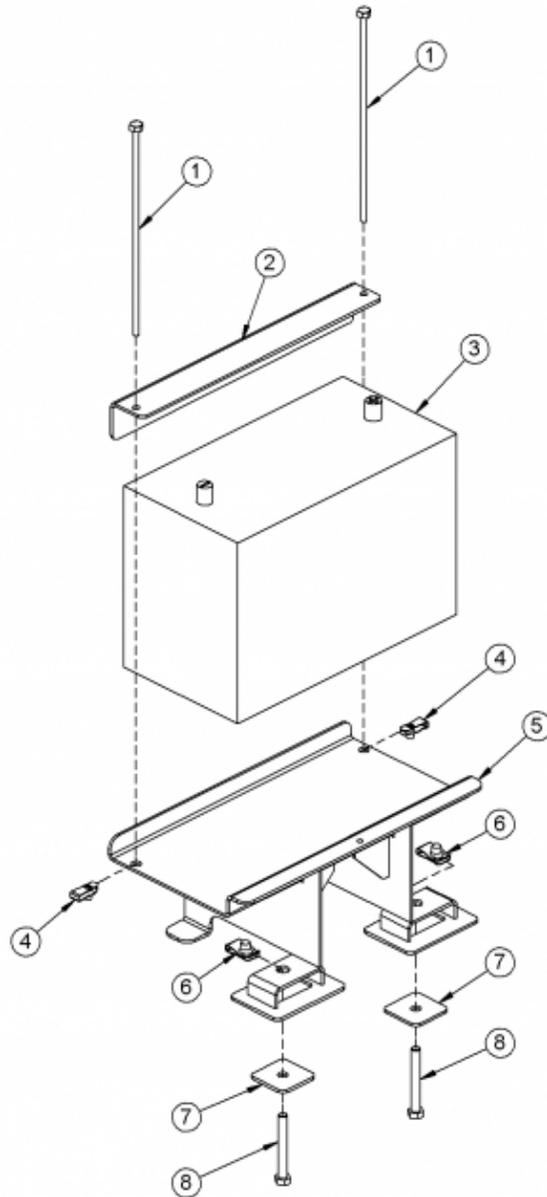

## BATTERY RELOCATION

Continued...

ITEM	PART NO.	QTY.	DESCRIPTION
1	06530234	2	CAPSCREW,1/4" X 10",NC
2	06411429	1	ANGLE
3	-----	-	BATTERY *EXISTING PART
4	35176	2	NUT CLIP,1/4",NC
5	06370231	1	RELOCATION BRACKET
6	06537029	2	NUT CLIP,3/8",NC
7	06401784	2	SQUARE PLATE
8	21638	2	CAPSCREW,3/8" X 3",NC

# DRAFT BEAMS

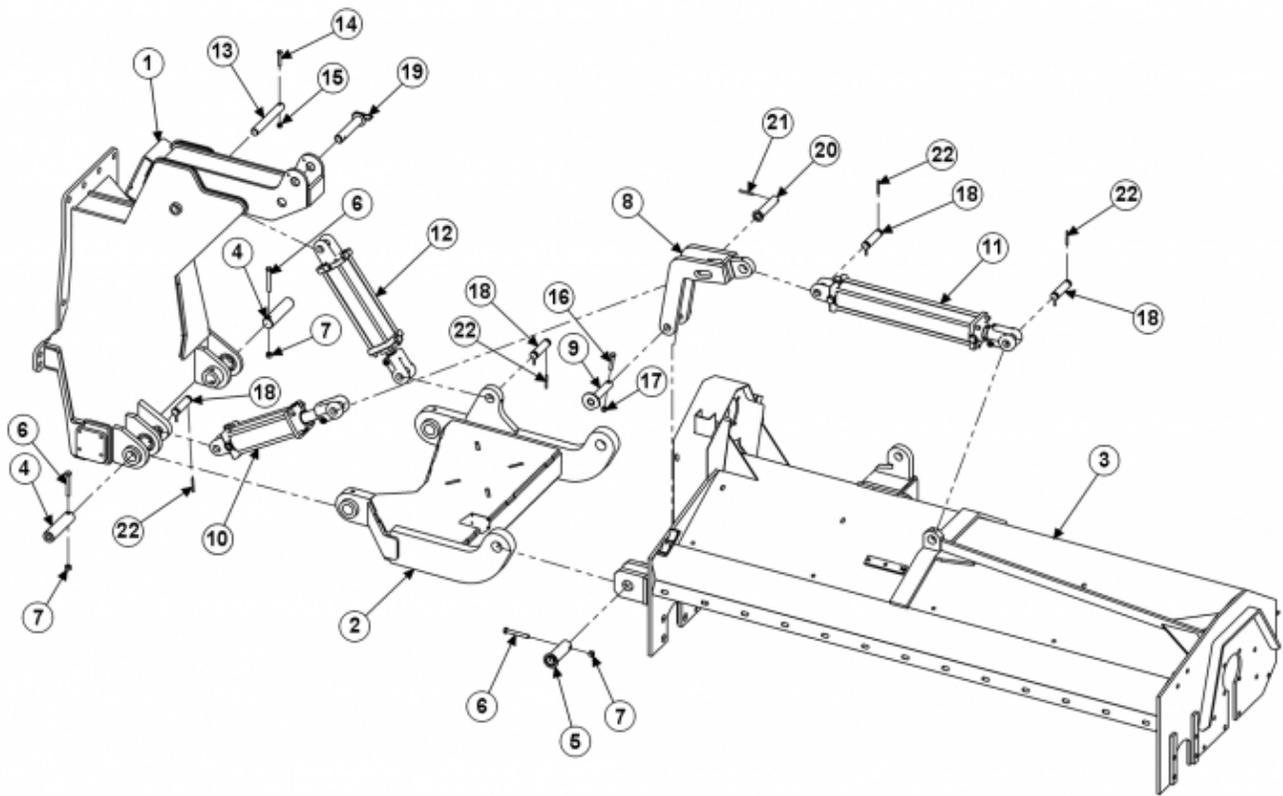

## DRAFT BEAMS

Continued...

ITEM	PART NO.	QTY.	DESCRIPTION
1	06300430	1	MAST FRAME, RH
	06300446	1	MAST FRAME, LH
2	06350019	2	DRAFT BEAM, BERM
	06350018	1	DRAFT BEAM BERM, LH
3	06320298	1	BONNET, 75 XD, RH, BERM
	06320299	1	BONNET, 75 XD, LH, BERM
4	06420203	2	PIN, 1.50 X 6.19 W/.47 PULL
5	TF4514A	2	PIN, SWIVEL, 1-1/2" X 4-1/2" (CAPPED)
6	21688	4	CAPSCREW, 7/16 X 3-1/4, NC
7	21677	4	NYLOCK NUT, 7/16" NC
8	23833A	1	TILT LINK 1030, T3F, RT
9	23829	1	PIN, LINK, TILT, LOWER
10	30481	1	CYLINDER, 3X8
11	6T0150	1	CYLINDER, 3X18
12	6T0151R	1	CYLINDER, 3X10, RTRY, TOP PORT
13	06420204	1	PIN, 1.00 X 7.75 W/ .38 HOLE
14	21584	1	CAPSCREW, 5/16" X 2" NC
15	21577	1	HEX NUT, NYLOCK, 5/16" NC
16	21635	1	CAPSCREW, 3/8" X 2-1/4" NC
17	21627	1	NYLOCK NUT, 3/8" NC
18	TB1033	4	PIN, CLEVIS, 1X4
19	TF4250	1	PIN, TRAVEL LOCK
20	23827C	1	PIN, CAPPED, 1"X4-15/16" CRS
21	TB1023	1	ROLLPIN, 7/32" X 2"
22	06537021	8	ROLLPIN, 5MM X 50MM

## DRAFT BEAM HYDRAULICS - RIGHT HAND

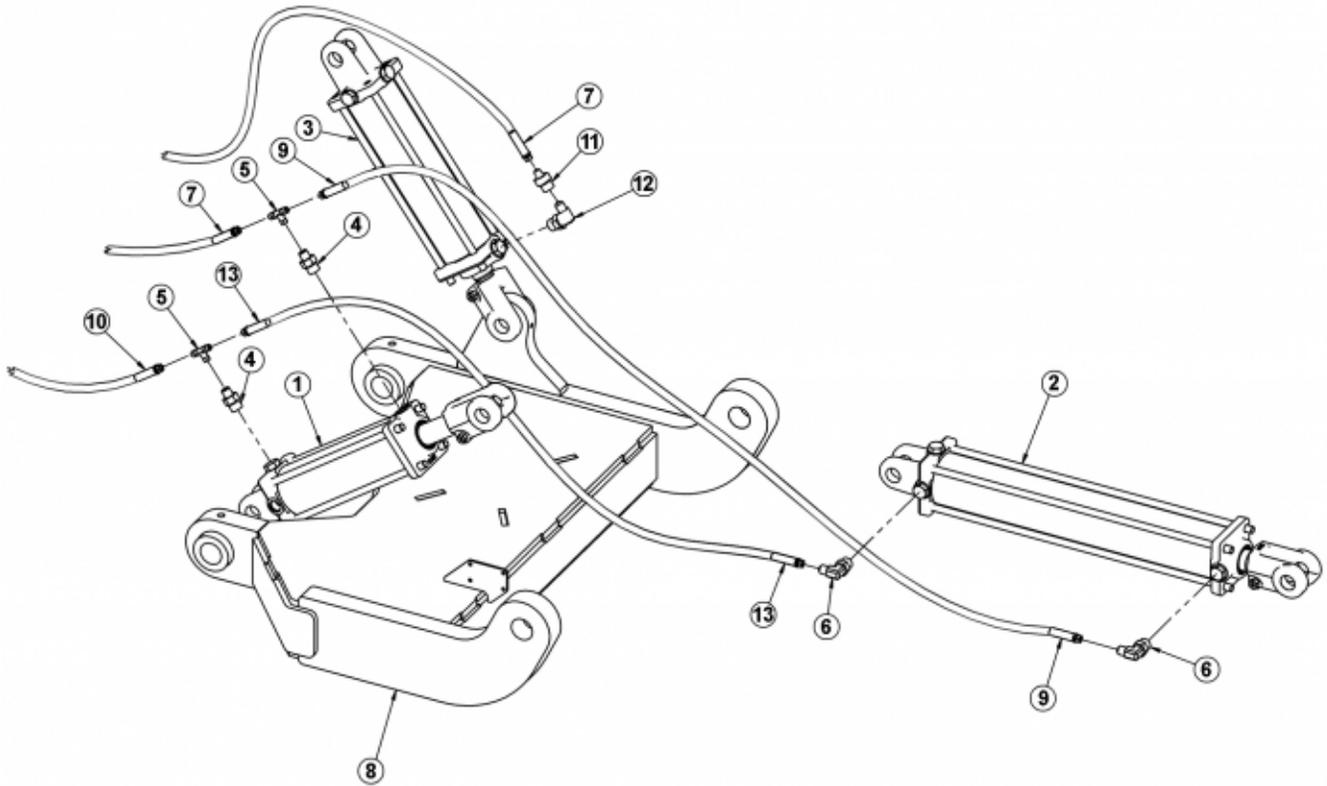

ITEM	PART NO.	QTY.	DESCRIPTION
1	30481	1	CYLINDER 3" X 8"
2	610150	1	CYLINDER 3" X 18"
3	6T1051R	1	CYLINDER 3" X 10" RTRY TOP PORT
4	33271	2	ADAPTER, 1/2" X 3/8"
5	34128	2	TEE, BRANCH, 3/8" MJ X 3/8" FJX X 3/8" MJ
6	32810	3	ELBOW, 1/2" X 3/8"
7	33492	3	HOSE, 1/4" X 138"
8	06350019	1	DRAFT BEAM, BERM
9	06500848	2	HOSE, 1/4" X 46"
11	34396	1	ADAPTER, RSTRCTR, 1/2ORB X 3/8MJ
12	34233	1	ELBOW, 1/2MB X 1/2FB
13	06500849	1	HOSE, 1/4" X 36"



## DRAFT BEAM HYDRAULICS - LEFT HAND

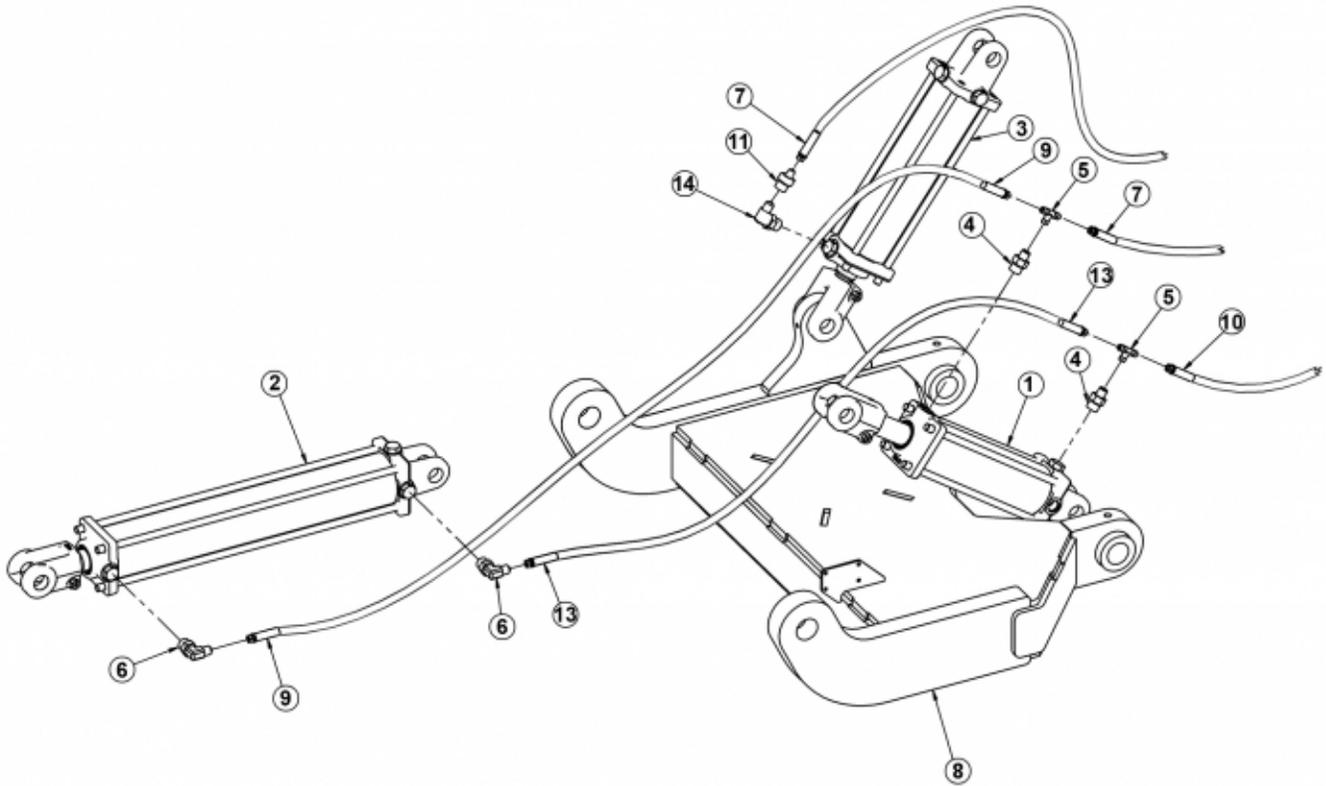

ITEM	PART NO.	QTY.	DESCRIPTION
1	30481	1	CYLINDER 3" X 8"
2	610150	1	CYLINDER 3" X 18"
3	6T1051R	1	CYLINDER 3" X 10" RTRY TOP PORT
4	33271	2	ADAPTER, 1/2" X 3/8"
5	34128	2	TEE, BRANCH, 3/8" MJ X 3/8" FJX X 3/8" MJ
6	32810	3	ELBOW, 1/2" X 3/8"
7	06501219	1	HOSE, 1/4" X 83"
8	06350019	1	DRAFT BEAM, BERM
9	06500848	2	HOSE, 1/4" X 46"
10	06501220	1	HOSE, 1/4" X 71"
11	34396	1	ADAPTER, RSTRCTR, 1/2ORB X 3/8MJ
12	34244	1	ELBOW, 1/2MB X 1/2FB
13	06500849	1	HOSE, 1/4" X 36"
14	34461	1	HOSE, 1/4" X 82"

# SIDE FLAIL DRIVE ASSEMBLY

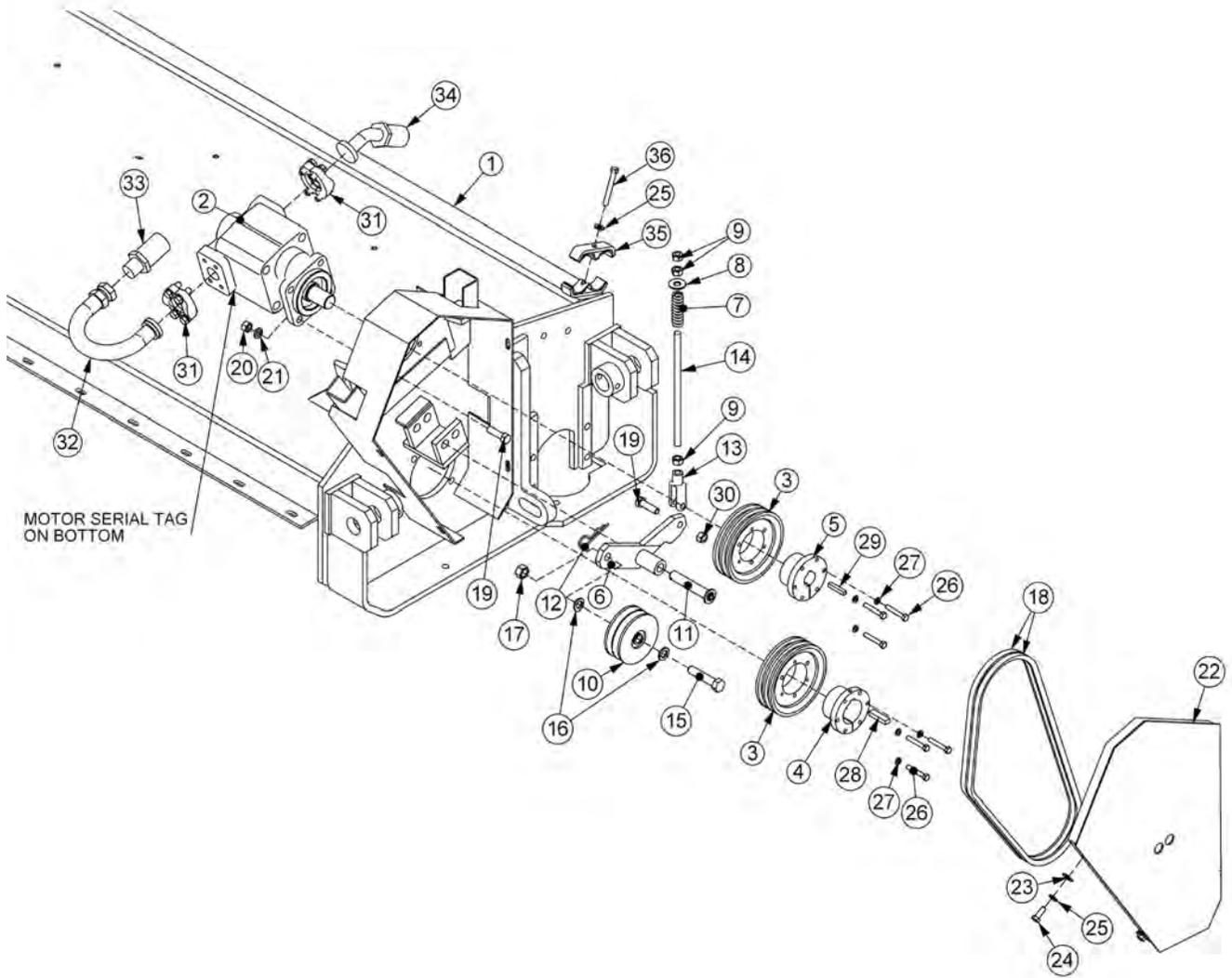

## SIDE FLAIL DRIVE ASSEMBLY

Continued...

ITEM	PART NO.	QTY.	DESCRIPTION
1	-----	-	BONNET *REFER TO FLAIL PARTS
2	06504132	1	MOTOR,TSF
3	TF3040	2	SHEAVE,6.3
4	TF3011	1	BUSHING,QD,SK,2-3/16"
5	TF3013	1	BUSHING,QD,SK 1-1/4"
6	TF4346	1	IDLER ARM (STANDARD ROTATION)
-----	TF4345	-	IDLER ARM (REVERSE ROTATION - NOT SHOWN)
7	TF3620A	1	SPRING,TENSIONER
8	22018	1	FLATWASHER,1/2",WIDE
9	21700	3	HEX NUT, 1/2", NF
10	31293	1	SHEAVE,IDLER ASSY, 4.4 O.D.
11	TF3605	1	PIN,IDLER ARM 3/4"X4-1/4"
12	6T3004	1	R-CLIP (HAIRPIN COTTER, 3/16")
13	PT3611A	1	CLEVIS,6"
14	32494	1	ROD, THREADED, 1/2-20NF
15	21787	1	CAPSCREW,5/8" X 3", NC
16	21992	2	LOCKWASHER, 5/8
17	21775	1	HEX NUT, 5/8
18	TF3020	2	V-BELT, (530)
19	21732	5	CAPSCREW, 1/2 X 1 3/4,NC
20	21725	4	HEX NUT, 1/2" NC
21	21990	4	LOCKWASHER, 1/2"
22	TF4564	1	BELT SHEILD (RIGHT)
23	22016	4	FLATWASHER,3/8"
24	21630	4	CAPSCREW, 3/8 X 1,NC
25	21988	5	LOCKWASHER, 3/8"
26	21584	6	CAPSCREW, 5/16 X 2,NC
27	21987	6	LOCKWASHER, 5/16"
28	TF1025	1	KEY,1/4" X 1/2" X 1-7/8" SQ
29	TF1125	1	KEY,3/8" X 1/2" X 1-7/8" SQ
30	21727	1	NYLOCK NUT, 1/2
31	TF4852	2	KIT,FLANGE,#20
32	34227	1	PREFORMED TUBE
33	-----	-	HOSE (RETURN FOR STANDARD ROTATION)
34	-----	-	HOSE (PRESSURE FOR STANDARD ROTATION)
35	TB3031	1	CLAMP,HOSE
36	21638	1	CAPSCREW,3/8 X 3,NC

## 75IN SIDE FLAIL - STANDARD ROTATION

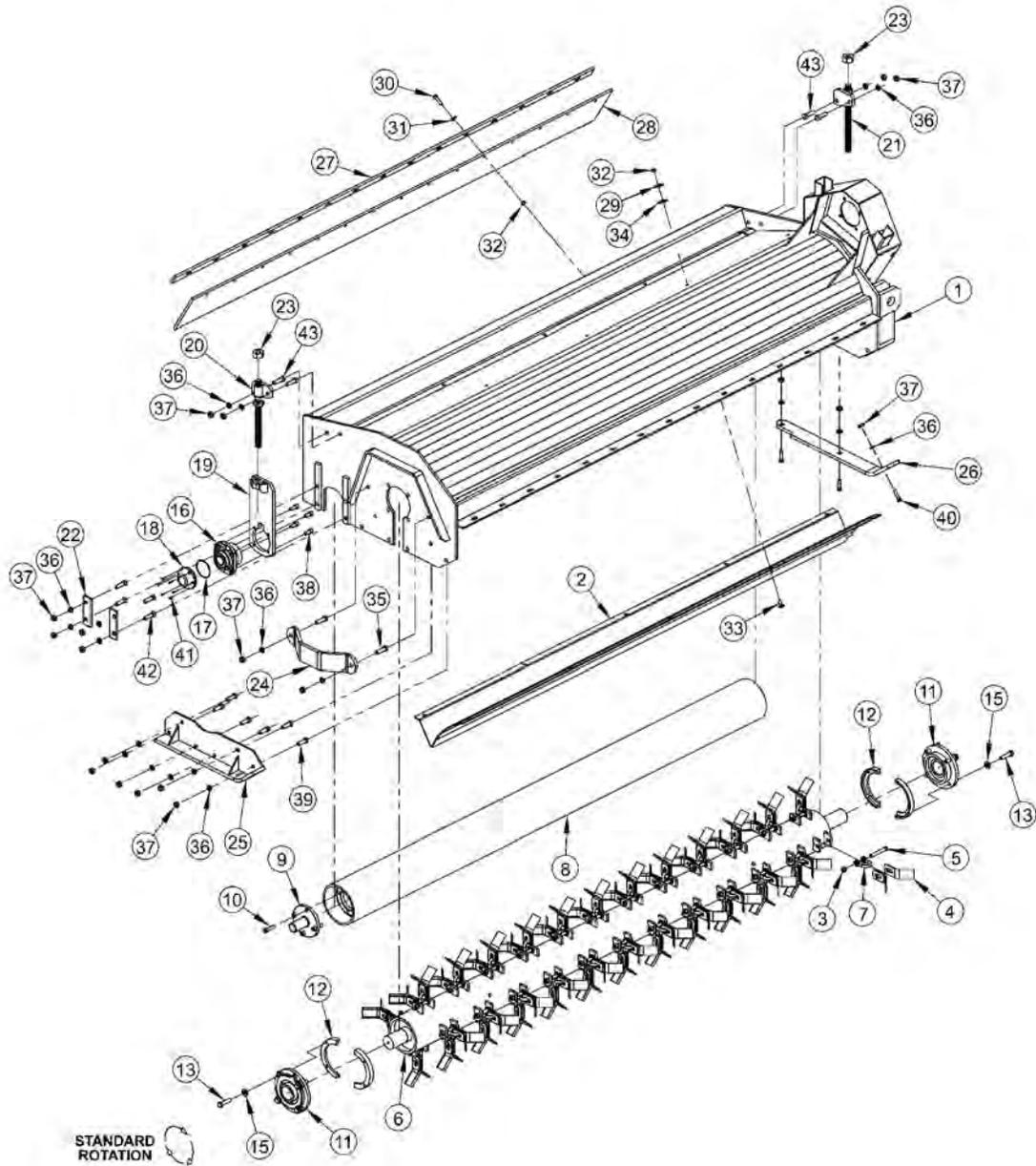

ITEM	PART NO.	QTY.	DESCRIPTION
1	21499A	1	BONNET,75,HD,T3F,RT
2	TF1402A	1	BAFFLE,FLAIL,75HD,STD ROT
-----	TF1002A	1	CUTSFT ASSY,75HD,STD KNIVES
3	21677	40	NYLOCK NUT,7/16 NC

## 75IN SIDE FLAIL - STANDARD ROTATION

Continued...

ITEM	PART NO.	QTY.	DESCRIPTION
4	33714	80	KNIFE,FLAIL,STANDARD
5	34011	40	CAPSCREW,7/16X3 7/16,NC GR8
6	TF1002	1	CUTTERSHAFT,75,HD
7	TF1020	40	KNIFE MTG CLEVIS,FLAIL
8	28738	1	GROUND ROLLER,75
9	TF1045B	2	STUB SHAFT,GROUND ROLLER
10	6T2330	8	CAPSCREW,SKT HD,7/16X1-1/2NC
11	TF1018	2	BEARING,FLANGE,2-3/16
-----	06200347	-	STRING GUARD,KIT,HD(ITEMS 12,13,15)
12	31204	2	STRING GUARD, HD
13	06530217	8	CAPSCREW,1/2 X 2,NC,L9
15	06533006	12	FLATWASHER,1/2,SAE,L9
16	06520028	2	BEARING,FLANGE,1 3/8,GRNDRLR
17	06520029	2	O-RING,2 3/4X3/32,AS568A-148
18	06520027	2	CAP,BEARING,GRNDRLR
19	TF4333A	2	GROUND ROLLER ADJ,BRKT
20	TF4334	1	ROD,GROUND ROLLER ADJ,RT
21	TF4335	1	ROD,GROUND ROLLER ADJ,LF
22	TF4336	4	PLATE,GROUND ROLLER LOCK
23	21399	2	HEX NUT,3/4 (ACME) BULK
24	TF1040	1	GUARD,CUTTER SHAFT
25	TF4371	1	SKID SHOE,L/PROFILE-OUTER
26	23272A	1	SKID SHOE,T3F,INNER
27	TF1029	2	BAR,FLAP,TSF/TRF 75
28	TF1016	1	FLAP,DEFLECTOR,TSF/TRF 75
29	06520242	1	FLAP,75",FRONT
30	21632	30	CAPSCREW,3/8 X 1-1/2 NC
31	22016	60	FLATWASHER,3/8
32	21625	40	HEX NUT,3/8 NC
33	6T2283	10	CARRIAGE BOLT,3/8 X 1 NC
34	6T2615	10	WASHER,FENDER 3/8
35	21732	2	CAPSCREW,1/2 X 1-3/4 NC
36	21990	23	LOCKWASHER,1/2
37	21725	23	HEX NUT,1/2 NC
38	6T2331	8	CAPSCREW,SKT HD,7/16 X 1 NC
39	21730	6	CAPSCREW,1/2 X 1-1/4 NC
40	23293	3	PLOW,BOLT,1/2 X 1-3/4 NC
41	06530001	12	CAPSCREW,SKT HD,8-32X1/2,SS
42	6T2291	8	PLOW BOLT,1/2 X 2 NC GR5
43	21731	4	CAPSCREW,1/2 X 1-1/2 NC

JD6E TRIPLE

## 75IN SIDE FLAIL - REVERSE ROTATION

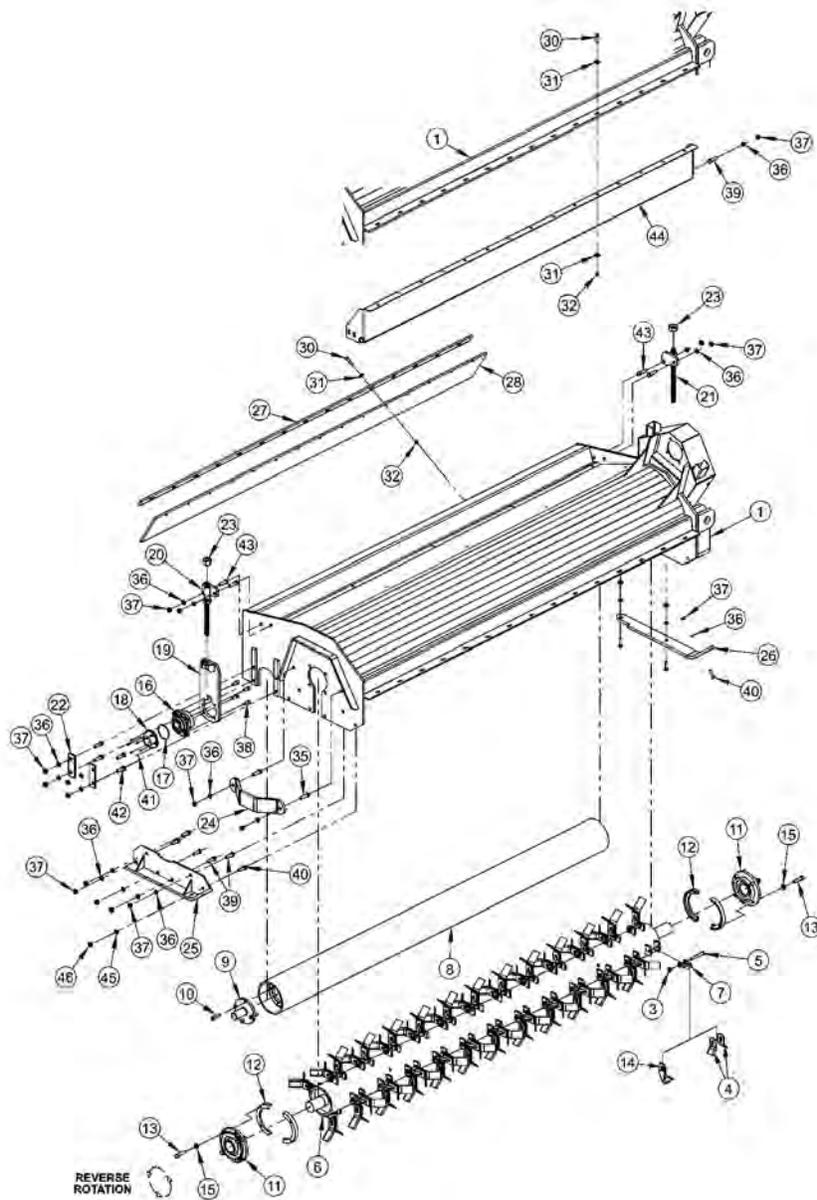

ITEM	PART NO.	QTY.	DESCRIPTION
1	21499A	1	BONNET,75,HD,T3F,RT
-----	TF1002A	-	CUTSHFT ASSY,75HD,STD KNIVE
3	21677	40	NYLOCK NUT,7/16 NC
4	33714	80	KNIFE,FLAIL,STANDARD
5	34011	40	CAPSCREW,7/16X3 7/16,NC GR8
6	TF1002	1	CUTTERSHAFT,75,HD
7	TF1020	40	KNIFE MTG CLEVIS,FLAIL
8	28738	1	GROUND ROLLER,75
9	TF1045B	2	STUB SHAFT,GROUND ROLLER
10	6T2330	8	CAPSCREW,SKT HD,7/16X1-1/2NC

## 75IN SIDE FLAIL - REVERSE ROTATION

Continued...

ITEM	PART NO.	QTY.	DESCRIPTION
11	TF1018	2	BEARING,FLANGE,2-3/16
-----	06200347	-	STRING GUARD,KIT,HD(ITEMS 12,13,15)
12	31204	2	STRING GUARD, HD
13	06530217	8	CAPSCREW,1/2 X 2,NC,L9
14	TF1019F	40	KNIFE,FLAIL (SMOOTH CUT)
15	06533006	12	FLATWASHER,1/2,SAE,L9
16	06520028	2	BEARING,FLANGE,1 3/8,GRNDRLR
17	06520029	2	O-RING,2 3/4X3/32,AS568A-148
18	06520027	2	CAP,BEARING,GRNDRLR
19	TF4333A	2	GROUND ROLLER ADJ,BRKT
20	TF4334	1	ROD,GROUND ROLLER ADJ,RT
21	TF4335	1	ROD,GROUND ROLLER ADJ,LF
22	TF4336	4	PLATE,GROUND ROLLER LOCK
23	21399	2	HEX NUT,3/4 (ACME) BULK
24	TF1040	1	GUARD,CUTTER SHAFT
25	TF4371	1	SKID SHOE,L/PROFILE-OUTER
26	23272A	1	SKID SHOE,T3F,INNER
27	TF1029	1	BAR,FLAP,TSF/TRF 75
28	TF1016	1	FLAP,DEFLECTOR,TSF/TRF 75
29	06520242	1	FLAP,75",FRONT
30	21632	30	CAPSCREW,3/8 X 1-1/2 NC
31	22016	60	FLATWASHER,3/8
32	21625	40	HEX NUT,3/8 NC
33	6T2283	10	CARRIAGE BOLT,3/8 X 1 NC
34	6T2615	10	WASHER,FENDER 3/8
35	21732	2	CAPSCREW,1/2 X 1-3/4 NC
36	21990	23	LOCKWASHER,1/2
37	21725	23	HEX NUT,1/2 NC
38	6T2331	8	CAPSCREW,SKT HD,7/16 X 1 NC
39	21730	6	CAPSCREW,1/2 X 1-1/4 NC
40	23293	3	PLOW,BOLT,1/2 X 1-3/4 NC
41	06530001	12	CAPSCREW,SKT HD,8-32X1/2,SS
42	6T2291	8	PLOW BOLT,1/2 X 2 NC GR5
43	21731	4	CAPSCREW,1/2 X 1-1/2 NC
44	TF1403	1	TRASH GUARD,75REV ROT-HD
45	22018	1	FLATWASHER,1/2,WIDE
46	21727	1	NYLOCK NUT,1/2 NC

# 110IN REAR FLAIL DRIVE ASSEMBLY

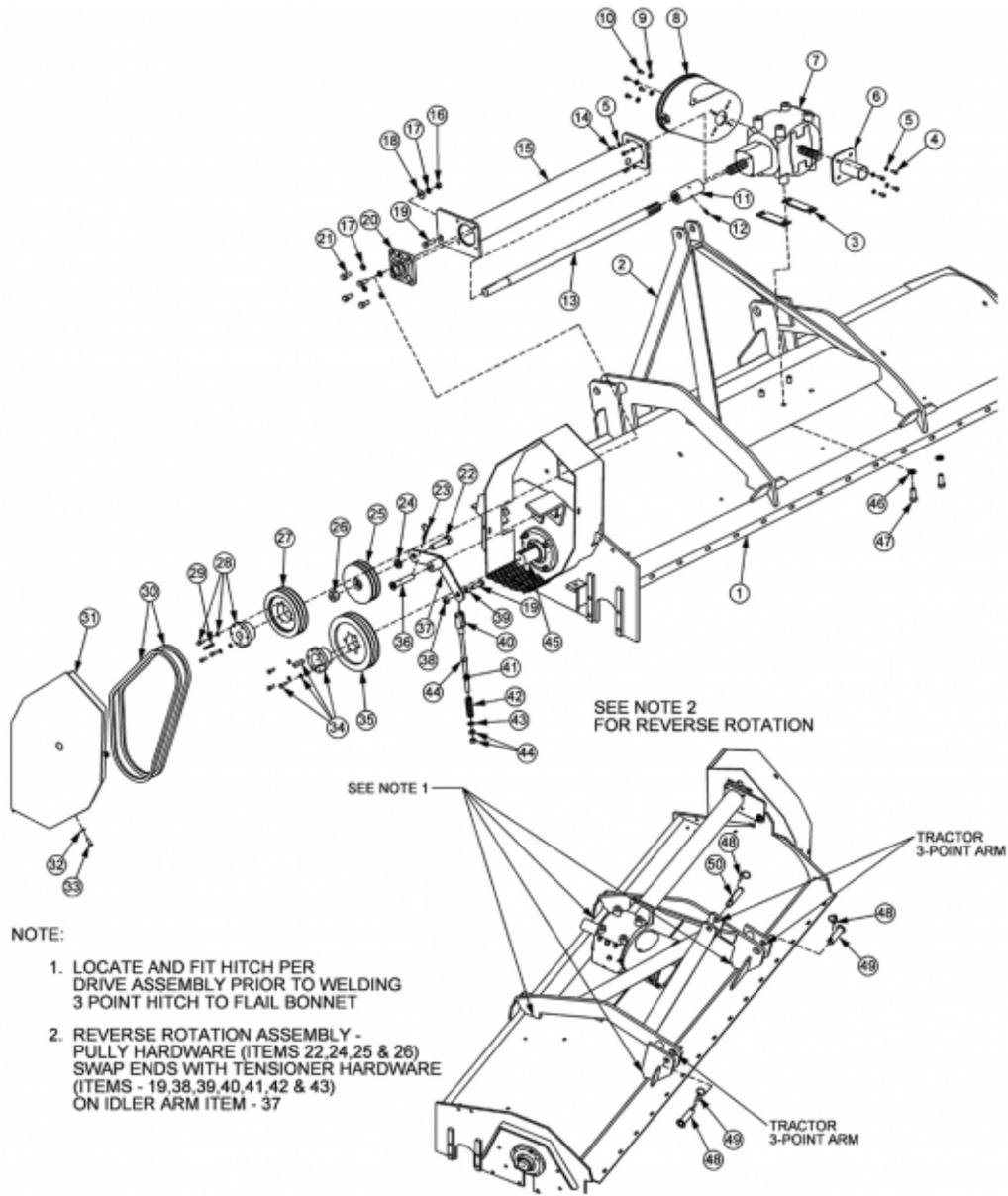

ITEM	PART NO.	QTY.	DESCRIPTION
1	06320031	1	BONNET,110",HD
2	31279A	1	HITCH,3-POINT
3	40454	2	SPACER
4	27508	4	CAPSCREW,8MM X 20MM(1.25)
5	6T2619	8	LOCKWASHER,8MM
6	28447E	1	GUARD,OUTPUT SHAFT
7	28505	1	GEARBOX,REAR FLAIL,COMER T22A
8	06520181	1	GUARD,PTO,GRBX
9	34948	4	FLATWASHER,8MM
10	27507	4	CAPSCREW,8MM X 15MM(1.25)



## 110IN REAR FLAIL DRIVE ASSEMBLY

Continued...

ITEM	PART NO.	QTY.	DESCRIPTION
11	28914	1	COUPLING,6 SPLINE
12	6T3208	1	GREASE ZERK,1/8" X 45
13	28421A	1	OUTPUT EXTENSION SHAFT,110"RCM
14	30162	4	CAPSCREW,SKT HD,8MM X 20MM(1.25)
15	28429A	1	SHAFT GRD,HD,102"RCM
16	21725	1	HEX NUT,1/2",NC
17	21990	5	LOCKWASHER,1/2"
18	22018	1	FLATWASHER,1/2",WIDE
19	21732	2	CAPSCREW,1/2" X 1-3/4",NC
20	28571	1	BEARING,FLANGE,1-1/4"
21	21730	4	CAPSCREW,1/2" X 1-1/4",NC
22	28399	1	CAPSCREW,20MM X 80MM(2.5),GR10.9
23	6T3004	1	R-CLIP,HAIRPIN COTTER,3/16"
24	24881	1	LOCKWASHER,20MM
25	31295	1	SHEAVE,IDLER ASSY,6.3"
26	31740	1	NYLOCK NUT,20MM(2.5)
27	TF3043	1	SHEAVE,7.5"
28	30049	2	BUSHING,QD,SK 1-1/4",1/4" KEY
29	28572	1	KEY,1/4"SQ X 2"
30	TF3023	2	V-BELT(630)
31	31286A	1	SHIELD,BELT
32	21988	4	LOCKWASHER,3/8"
33	21630	4	CAPSCREW,3/8" X 1",NC
34	TF3011	1	BUSHING,QD,SK 2-3/16"
35	28570	1	SHEAVE,9.0"
36	TF3605	1	PIN,IDLER ARM
37	TF1180	1	IDLER ARM
38	6T2418	1	HEX NUT,1/2",NC,GR8(STOVER)
39	TF3610	1	BUSHING,IDLER
40	PT3611A	1	CLEVIS
41	32482	1	ROD,THREADED,1/2-20,NF,12-1/2"
42	TF3620A	1	SPRING,TENSIONER
43	27938	1	BUSHING,MACH,14GA
44	21700	3	HEX NUT,1/2",NF
45	06700237	1	CUTTERSHAFT W/ KNIVES
46	6T2625	4	LOCKWASHER,16MM
47	22421	4	CAPSCREW,16MM X 40MM(2.0),GR10.9
48	TF1143	3	LYNCH PIN
49	TF1120	2	PIN,CAPPED
50	TB1036	1	PIN

JD6E TRIPLE

# 110IN REAR FLAIL - STANDARD ROTATION

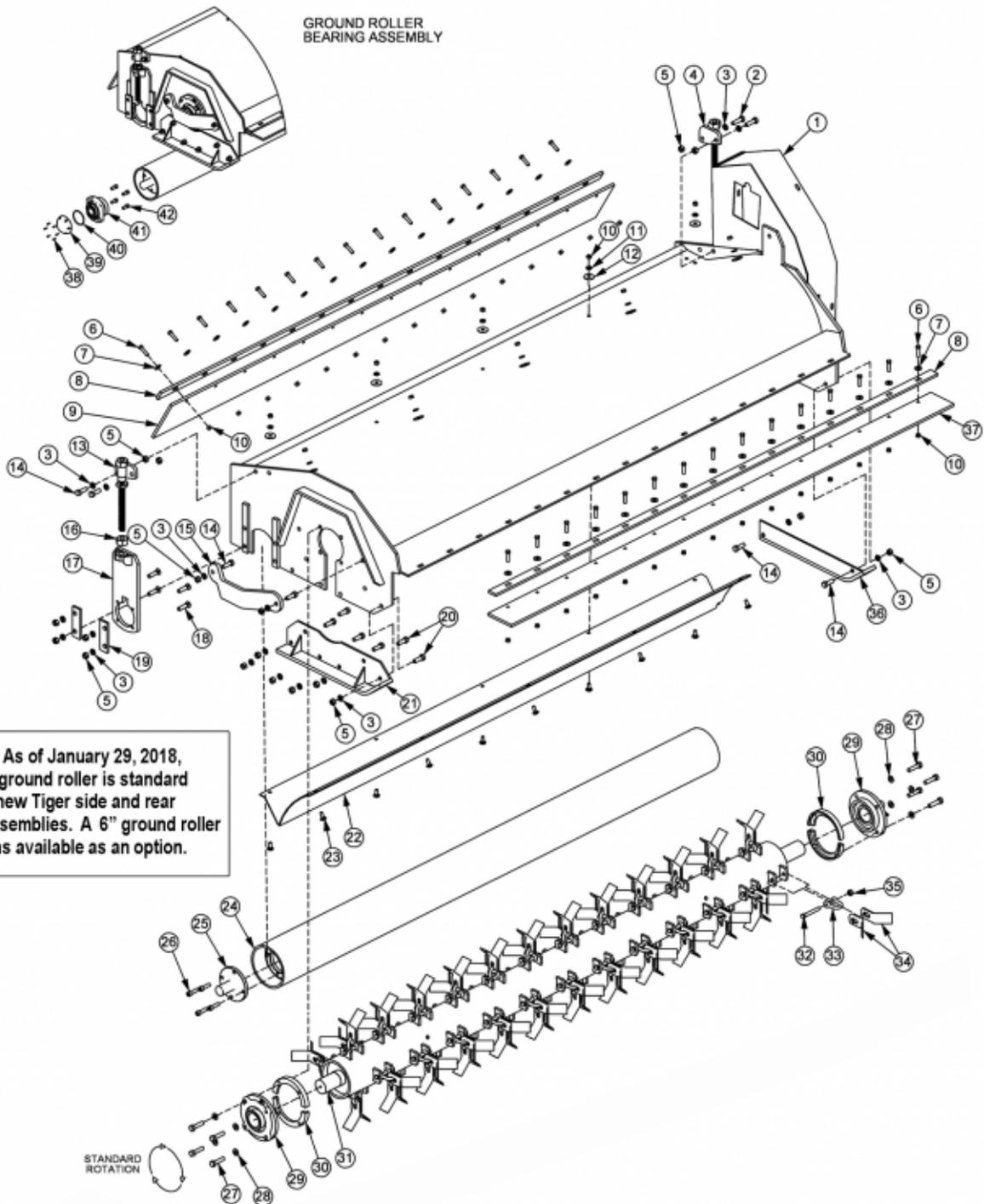

ITEM	PART NO.	QTY.	DESCRIPTION
1	06320031	1	BONNET,110",HD
2	21732	2	CAPSCREW,1/2" X 1-3/4",NC
3	21990	22	LOCKWASHER,1/2"
4	TF4335	1	ROD,GROUND ROLLER ADJ,LF

## 110IN REAR FLAIL - STANDARD ROTATION

Continued...

ITEM	PART NO.	QTY.	DESCRIPTION
5	21725	22	HEX NUT,1/2",NC
6	21632	36	CAPSCREW,3/8" X 1-1/2",NC
7	22016	36	FLATWASHER,3/8"
8	06403587	2	BAR,FLAP,TSF/TRF,110"
9	06499023	1	FLAP,DEFLECTOR,TSF/TRF,110"
10	21625	46	HEX NUT,3/8",NC
11	21988	10	LOCKWASHER,3/8"
12	6T2615	10	WASHER,FENDER,3/8"
13	TF4334	1	ROD,GROUND ROLLER ADJ,RT
14	21731	6	CAPSCREW,1/2" X 1-1/2",NC
15	TF1040	1	GUARD,CUTTERSHAFT
16	21399	2	HEX NUT,3/4",ACME THRD
17	TF4333A	2	GROUND ROLLER ADJ BRKT
18	6T2291	8	PLOW BOLT,1/2" X 2",GR5
19	TF4336	4	PLATE,GROUND ROLLER LOCK
20	21730	6	CAPSCREW,1/2" X 1-1/4",NC
21	TF4371	1	SKID SHOE,L/PROFILE-OUTER
22	06320036	1	BAFFLE,FLAIL,110",HD
23	6T2283	10	CARRIAGE BOLT,3/8" X 1",NC
24	06320241	1	GROUND ROLLER,110"
25	TF1045B	2	GRND ROLLER STUB SHAFT
26	6T2330	8	CAPSCREW,7/16" X 1-1/2", SKT HD
27	06530217	8	CAPSCREW,1/2" X 2",NC,L9
28	06533006	8	FLATWASHER,1/2",SAE,L9
29	TF1018	2	BEARING,FLANGE,2-3/16"
30	31204	2	STRING GUARD,HD
31	06700237	1	CUTTERSHAFT,110",HD
32	30411	60	KNIFE MOUNTING BOLT,FLAIL
33	TF1020	60	KNIFE MTG CLEVIS,FLAIL
34	33714	120	KNIFE,FLAIL,STANDARD CUT
35	21677	60	NYLOCK NUT,7/16",NC
36	TF4365	1	SKID SHOE,L/PROFILE-INNER
37	06499032	1	FLAP,FRONT,110"
38	06530001	12	CAPSCREW,SKT HD
39	06520027	2	CAP,BEARING
40	06520029	2	O-RING,2-3/4" X 3/32"
41	06520028	2	BEARING,FLANGE,1-3/8"
42	6T2331	8	CAPSCREW,7/16" X 1",SKT HD

# 110IN REAR FLAIL - REVERSE ROTATION

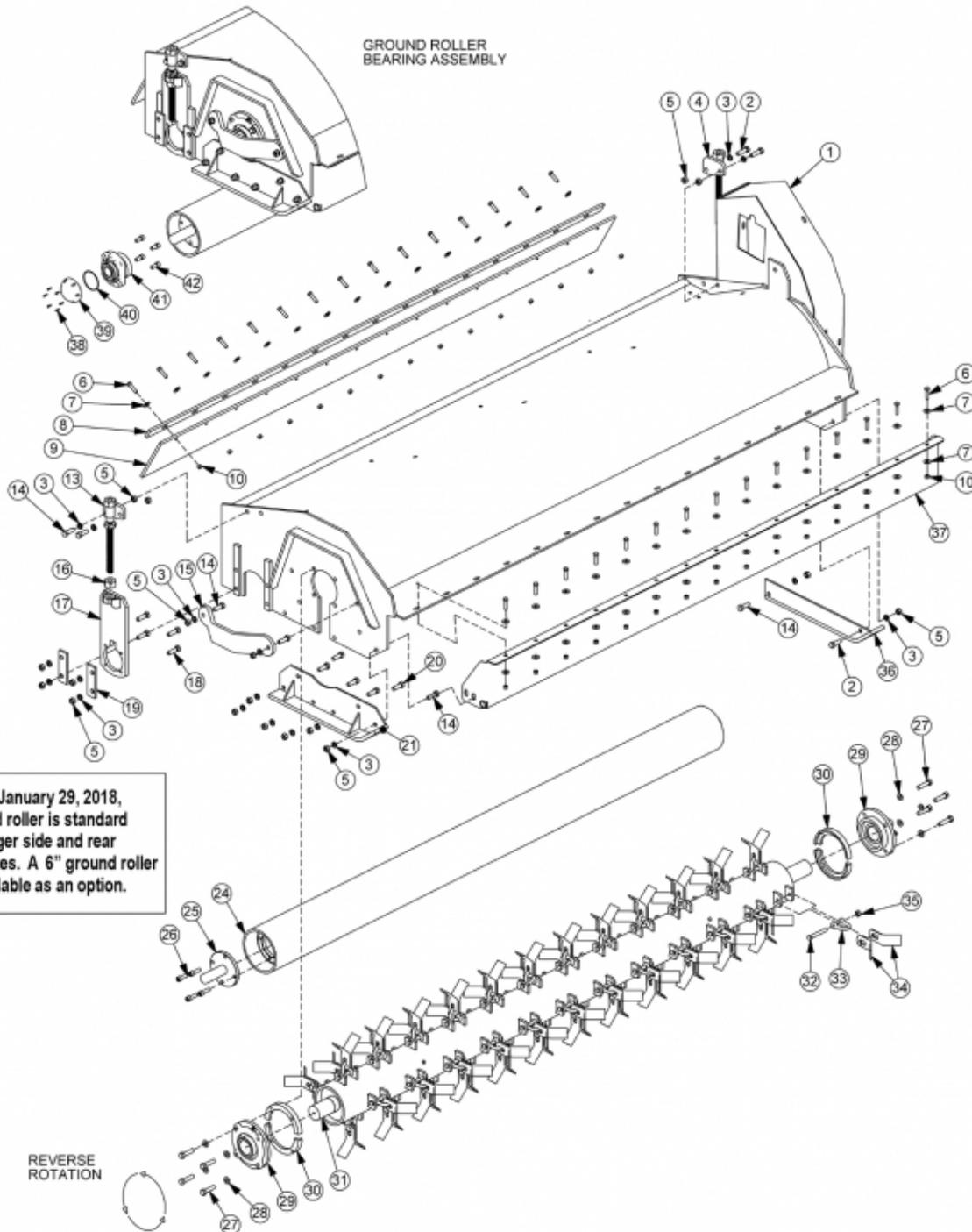

ITEM	PART NO.	QTY.	DESCRIPTION
1	06320031	1	BONNET,110",HD
2	21732	3	CAPSCREW,1/2" X 1-3/4",NC
3	21990	22	LOCKWASHER,1/2"
4	TF4335	1	ROD,GROUND ROLLER ADJ,LF

## 110IN REAR FLAIL - REVERSE ROTATION

Continued...

ITEM	PART NO.	QTY.	DESCRIPTION
5	21725	22	HEX NUT,1/2",NC
6	21632	36	CAPSCREW,3/8" X 1-1/2",NC
7	22016	36	FLATWASHER,3/8"
8	06403587	1	BAR,FLAP,TSF/TRF,110"
9	06499023	1	FLAP,DEFLECTOR,TSF/TRF,110"
10	21625	46	HEX NUT,3/8",NC
13	TF4334	1	ROD,GROUND ROLLER ADJ,RT
14	21731	6	CAPSCREW,1/2" X 1-1/2",NC
15	TF1040	1	GUARD,CUTTERSHAFT
16	21399	2	HEX NUT,3/4",ACME THRD
17	TF4333A	2	GROUND ROLLER ADJ BRKT
18	6T2291	8	PLOW BOLT,1/2" X 2",GR5
19	TF4336	4	PLATE,GROUND ROLLER LOCK
20	21730	5	CAPSCREW,1/2" X 1-1/4",NC
21	TF4371	1	SKID SHOE,L/PROFILE-OUTER
24	06320241	1	GROUND ROLLER,110"
25	TF1045B	2	GRND ROLLER STUB SHAFT
26	6T2330	8	CAPSCREW,7/16" X 1-1/2", SKT HD
27	06530217	8	CAPSCREW,1/2" X 2",NC,L9
28	06533006	8	FLATWASHER,1/2",SAE,L9
29	TF1018	2	BEARING,FLANGE,2-3/16"
30	31204	2	STRING GUARD,HD
31	TF1707	1	CUTTERSHAFT,102",HD
32	30411	60	KNIFE MOUNTING BOLT,FLAIL
33	TF1020	60	KNIFE MTG CLEVIS,FLAIL
34	33714	120	KNIFE,FLAIL,STANDARD CUT
35	21677	60	NYLOCK NUT,7/16",NC
36	TF4365	1	SKID SHOE,L/PROFILE-INNER
37	TF1701	1	FRONT TRASH GUARD
38	06530001	12	CAPSCREW,SKT HD
39	06520027	2	CAP,BEARING
40	06520029	2	O-RING,2-3/4" X 3/32"
41	06520028	2	BEARING,FLANGE,1-3/8"
42	6T2331	8	CAPSCREW,7/16" X 1",SKT HD

## TRIPLE EGRESS MOUNTING

Park the tractor on a flat, hard, level surface. Lower both side decks down onto the hard surface. Make sure the engine is off and the park brake has been set. Operate the lift controls several times to release any pressure contained in the hydraulic lift system. Disconnect the positive battery cable from the battery. Then remove the right rear wheel from the tractor. Next remove the left side deck lift hoses from the lift valve and both lift cylinders, mark or label valve ports and cylinders as hoses are removed.

Install the egress switch box brackets on the left side of the mower pump mounting bracket, using hardware supplied. See pictures on next page. After the bracket is secured, then remove the front cover from the switch box, and install the switch box back half to the switch box bracket with (4) 8/32 x 1/2" machine screws. Reinstall the front cover onto the switch box.

Install the egress pump mounting bracket onto the right side of the tractor located under the cab in front of the right rear axle using hardware provided. Next preassemble the rear half of the pump cover onto the egress pump with the hardware provided, do not tighten bolt at this time. Connect the hoses for the C1 port to the egress pump port only. Do not tighten hoses at this time. The pump is now ready to be mounted to the pump mounting bracket. Secure egress pump to the bracket with the hardware provided.

Locate the ports on the egress pump labeled "A1", "A2", "B1", "B2", "C1" and "C2", these ports will be the connection points for the hydraulic lift lines.

- A1 port - to lift valve -- left hand outboard cylinder butt
- A2 port - to cylinder -- left hand outboard cylinder butt
- B1 port - to lift valve -- left hand outboard cylinder gland
- B2 port - to cylinder -- left hand outboard cylinder gland
- C1 port - to lift valve -- left hand inboard cylinder gland
- C2 port - to cylinder -- left hand inboard cylinder gland

Route the hoses to the lift valve and or cylinder as specified above, tighten all hose fittings. Refer to the Parts section for the location of hose connections on the lift valve.

Now that the hydraulic lines are installed, connect the power cable from the positive post of the egress pump solenoid to the tractor starter solenoid positive post. Also connect the ground cable from the negative post on the egress pump electric motor to a bracket mounting bolt on the frame. Then route the cable from the switch box along the tractor to the egress pump and connect the male to the female plug. Secure cable with cable tie.

Next remove the drain plug on the bottom of the tractors transmission, **CAUTION** hydraulic oil will come out and maybe hot. Oil loss can be reduced by attaching a shop vacuum to the tractor transmission fill neck. Install fittings into the transmission drain hole, refer to part section for parts and illustrations. Connect the suction hose from the filter to the fittings on the tractor transmission, cut the hose to the required length. Install a hose clamp both end of the hose.

Install the front half of the cover onto the egress pump with provided hardware. Make sure all mounting hardware and hose connections are tight. Check hydraulic oil level and add if required. Reinstall the right rear wheel and reconnect the positive battery cable to the battery.

## TRIPLE EGRESS MOUNTING CONTINUED

**NOTE:** Use the egress pump **ONLY** to lifting or lowering the head for storage, or transportation by trailer. When the egress pump is not in use make sure the switch box key is in the "off" position and key has been removed.

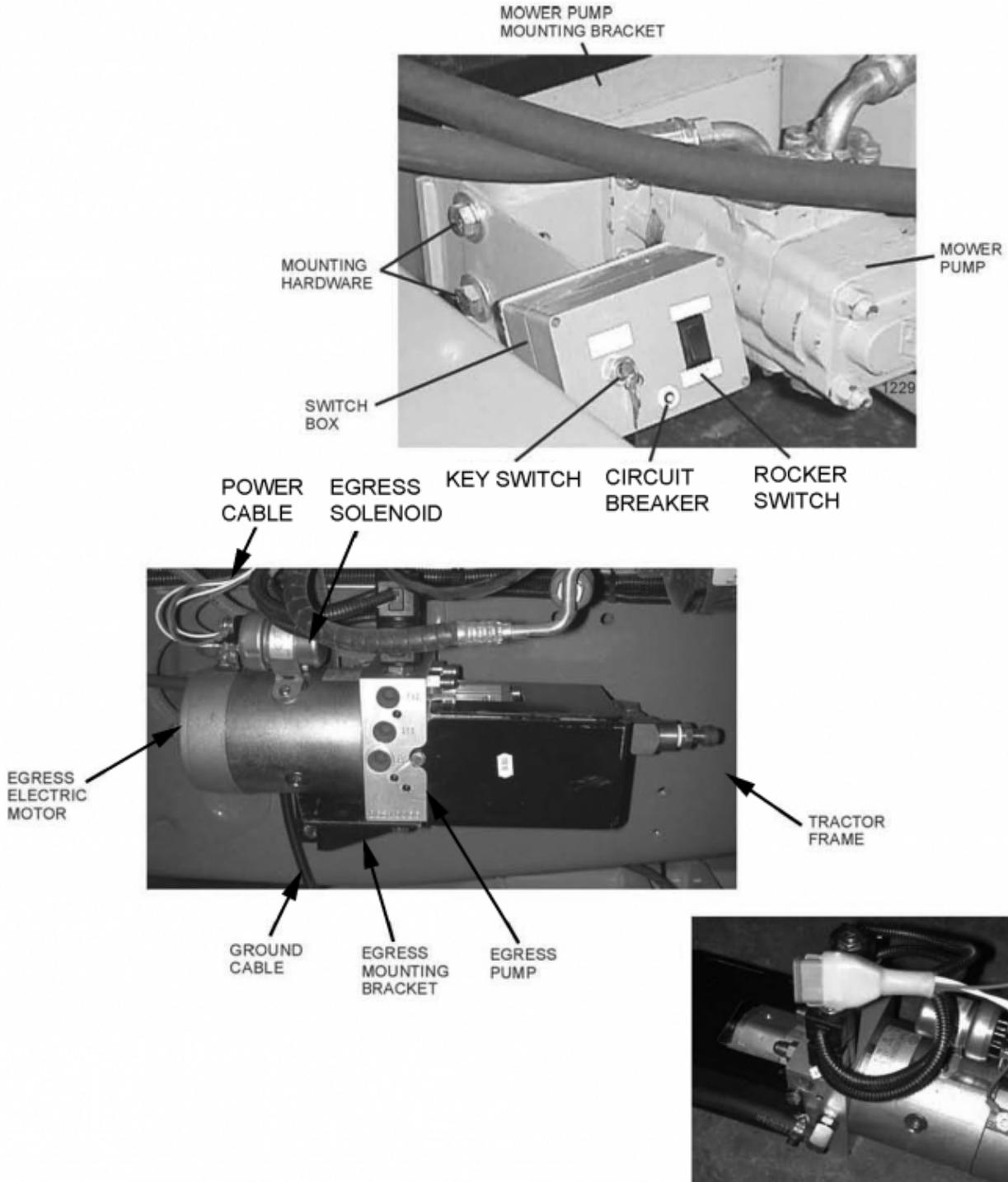

## EGRESS PUMP MOUNT

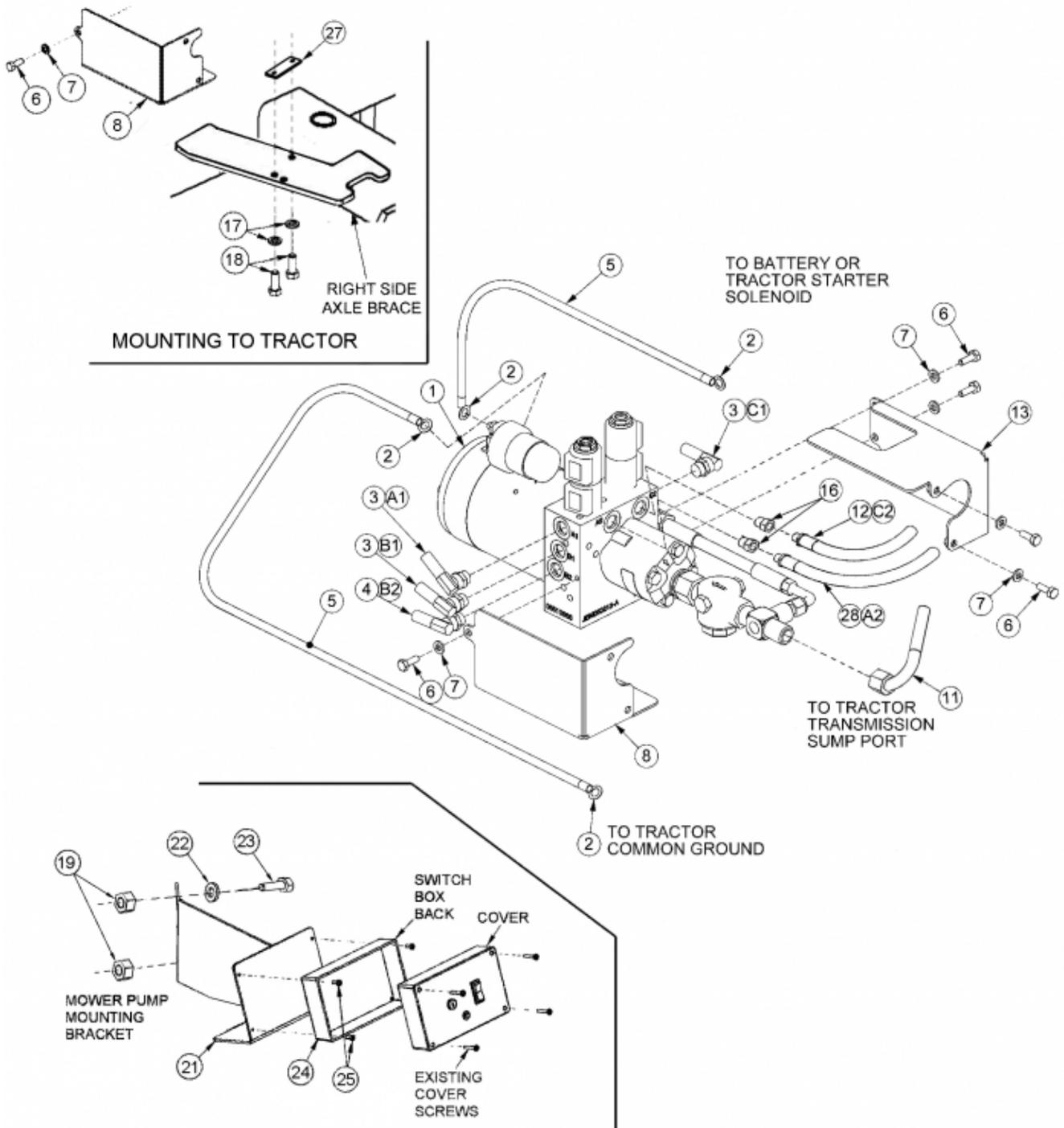

### HOSE ROUTING

- A1 PORT - TO LIFT VALVE -- LEFT HAND OUTBOARD CYLINDER BUTT
- A2 PORT - CYLINDER -- LEFT HAND OUTBOARD CYLINDER BUTT
- B1 PORT - TO LIFT VALVE -- LEFT HAND OUTBOARD CYLINDER GLAND
- B2 PORT - TO CYLINDER -- LEFT HAND OUTBOARD CYLINDER GLAND
- C1 PORT - TO LIFT VALVE -- LEFT HAND INBOARD CYLINDER GLAND
- C2 PORT - TO CYLINDER -- LEFT HAND INBOARD CYLINDER GLAND



## EGRESS PUMP MOUNT

Continued...

ITEM	PART NO.	QTY.	DESCRIPTION
1	06510066	1	EGRESS PUMP
2	23572	4	RING CONNECTOR,3/8" STUD
3	33560	3	HOSE,1/4" X 93"
4	06501219	1	HOSE,1/4" X 83"
5	24201	12	WIRE,RED,#6GA (IN FEET)
6	21529	5	CAPSCREW,1/4" X 3/4",NC
7	21986	5	LOCKWASHER,1/4"
8	34306	1	COVER,FRONT HALF
11	06500477	1	HOSE,1/2" X 32"
12	34461	1	HOSE,1/4" X 82"
13	34307	1	COVER,REAR HALF
16	06300306	1	AXLE BRACE, RH, JD5085-100E, T3F
17	21988	2	LOCKWASHER,3/8"
18	21629	2	CAPSCREW,3/8" X 3/4",NC
19	21825	2	HEX NUT, 3/4" NC
21	34124	1	MOUNT,SWITCH BOX,EGRESS
22	22021	2	FLATWASHER,3/4"
23	21833	1	CAPSCREW,3/4" X 2-3/4",NC
24	34123	1	SWITCH BOX,EGRESS,T3F
25	6T3951	4	SCREW MACHINE,8-32UNC X 1/2"
27	06402699	1	SPACER
28	06501220	1	HOSE, 1/4" X 71"

# EGRESS PUMP BREAKDOWN

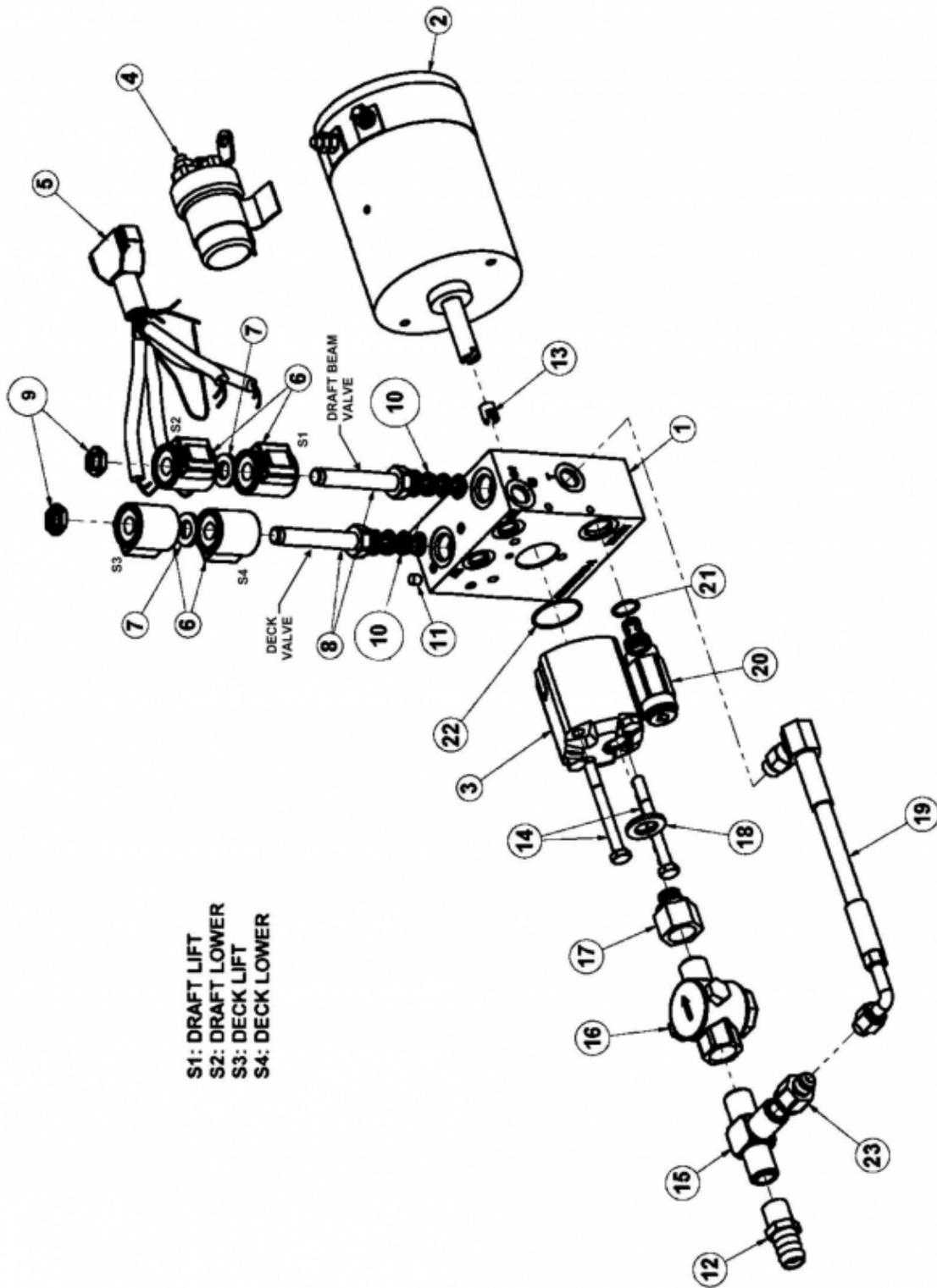

S1: DRAFT LIFT  
S2: DRAFT LOWER  
S3: DECK LIFT  
S4: DECK LOWER

## EGRESS PUMP BREAKDOWN

Continued...

ITEM	PART NO.	QTY.	DESCRIPTION
---	06510066	1	PUMP,ASSY,EGRESS
1	06510067	1	MANIFOLD
2	06510068	1	MOTOR
3	06510070	1	PUMP
4	06510170	1	RELAY
5	06510171	1	HARNESS
6	06510172	4	COIL
7	06510173	2	SPACER
8	06510174	2	SPOOL
9	06510175	2	NUT
10	06510176	6	SEAL KIT,06510174
11	06510177	1	PLUG
12	06510179	1	ADAPTER,BARB
13	06510180	1	COUPLING
14	06510181	2	BOLT
15	06510182	1	TEE
16	06510183	1	FILTER
17	06510184	1	ADAPTER,BARB
18	06510185	1	WASHER
19	06510186	1	HOSE
20	06510187	1	RELIEF
21	06510188	1	SEAL
22	06510189	1	SEAL KIT,06510066
---	06510178	1	O-RING
23	33380	1	ADAPTER,3/8" MOR X 1/2" FOR



## EGRESS SWITCHBOX

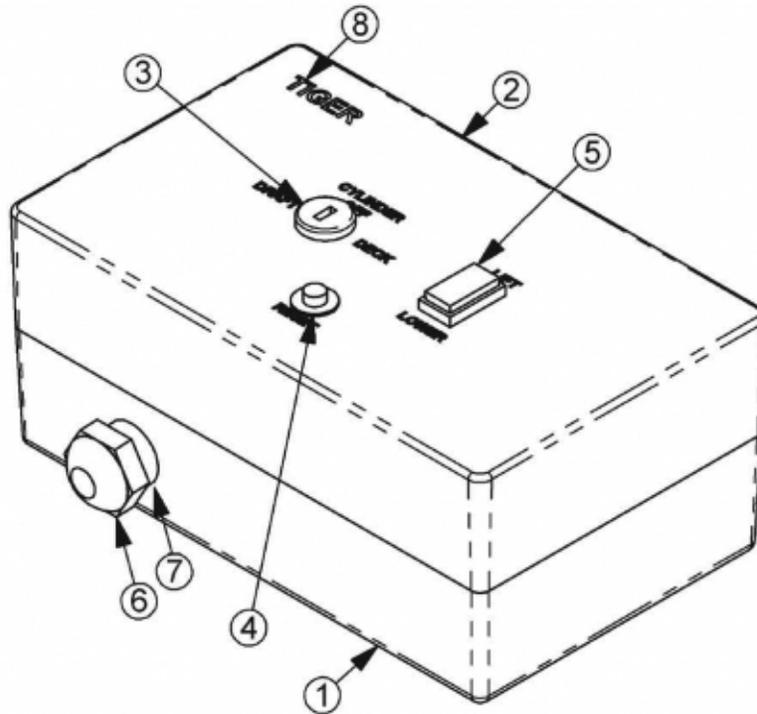

ITEM	PART NO.	QTY.	DESCRIPTION
1	34934	1	BOTTOM,EGRESS SWITCH BOX
2	34933	1	TOP,EGRESS SWITCH BOX
3	34937	1	KEY,SWITCH
4	34936	1	CIRCUIT BREAKER,10AMP
5	34935	1	ROCKER SWITCH
6	34938	1	STRAIN RELIEF
7	34939	1	LOCK NUT,3/4"
8	34940	1	DECAL,TIGER

## EGRESS TROUBLESHOOTING

### FAILURE MODE:

- DECK OR DRAFT CYLINDER ONLY GOES ONE WAY.
- DECK OR DRAFT CYLINDER WILL NOT STAY IN POSITION.
- WILL OPERATE WITH LIFT VALVE, BUT NOT WITH EGRESS.
- EGRESS DOES NOT OPERATE AS FAST AS IT USED TO.

### CHECK STEPS

- 1 and 2
- 1 and 2
- 3 and 5
- 3 and 4

### CORRECTIVE STEPS:

1. Remove relief valve installed on tractor lift valve. Visually inspect for contamination.
2. Remove solenoid valve (S1, S2, S3, S4) from egress unit and verify spool shift.
3. Remove relief valve from egress unit and visually inspect for contamination.
4. Inspect suction strainer for contamination.
- 5a. Verify supply voltage at pump motor posts on egress.
- 5b. Verify voltage at pump motor relay while switches are activated.
- 5c. Verify voltage at solenoid valve (S1, S2, S3, S4) on egress unit.
- 5d. Check or reset circuit breaker.

### NOTE:

1. All voltage readings must be between 10.2 volts and 13.8 volts.

**NOTES**

**NOTES**

### 3 X 8 HYDRAULIC CYLINDER BREAKDOWN

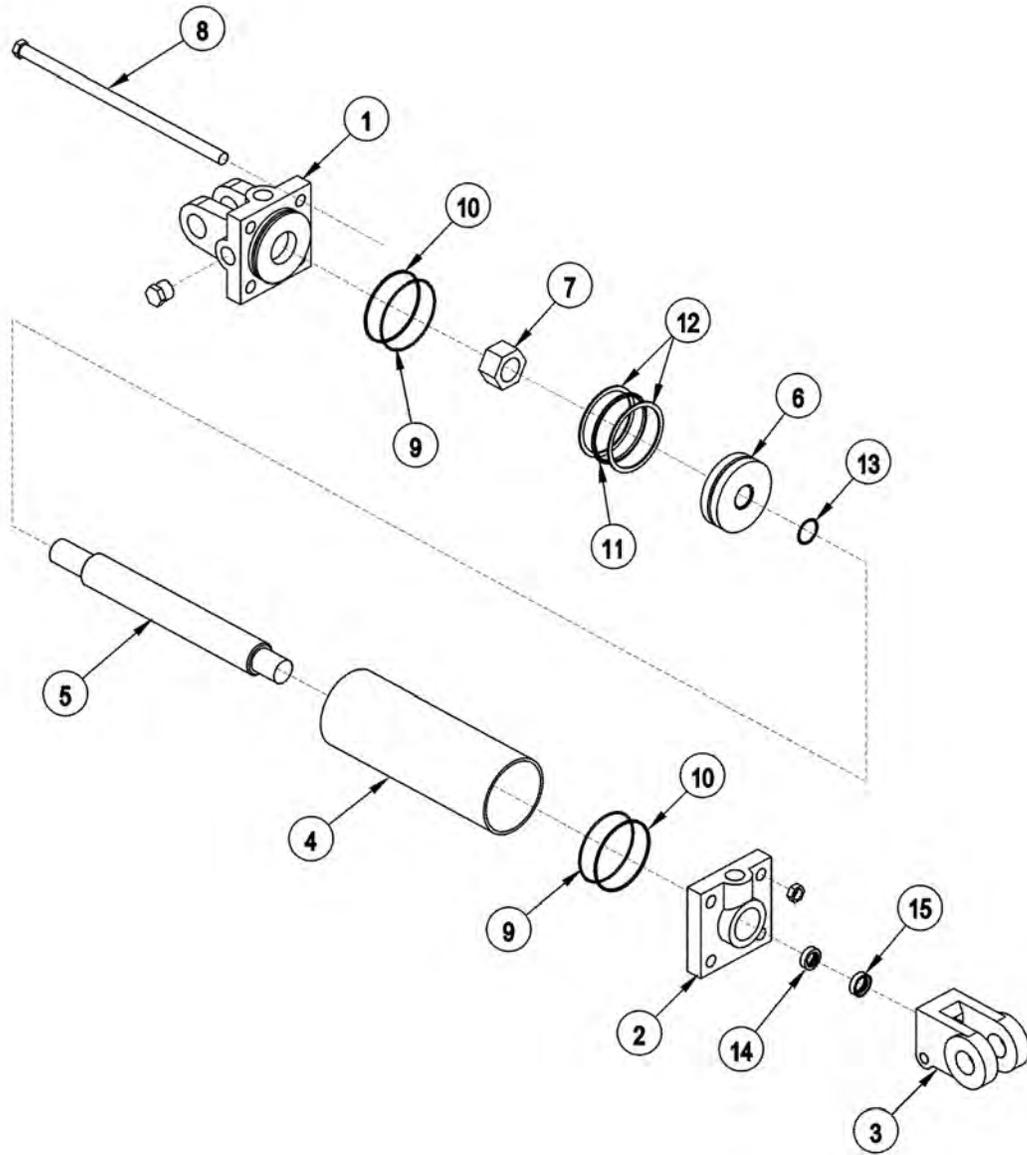



### 3 X 8 HYDRAULIC CYLINDER BREAKDOWN

Continued...

ITEM	PART NO.	QTY.	DESCRIPTION
---	30481	1	CYLINDER 3" X 8"
1	6T0167	1	CYLINDER BUTT
2	6T0170	1	CYLINDER GLAND
3	6T0178	1	CLEVIS END
4	23870	1	CYLINDER TUBE
5	23869	1	PISTON ROD
6	6T0173	1	PISTON
7	6T0179	1	LOCKNUT
8	23871	4	TIE ROD ASY
---	6T0187	1	SEAL KIT
9	-----	2	O - RING
10	-----	2	BACK - UP WASHER
11	-----	1	O - RING
12	-----	2	BACK - UP WASHER
13	-----	1	O - RING
14	-----	1	U - CUP
15	-----	1	WIPER

### 3 X 10 HYDRAULIC CYLINDER BREAKDOWN

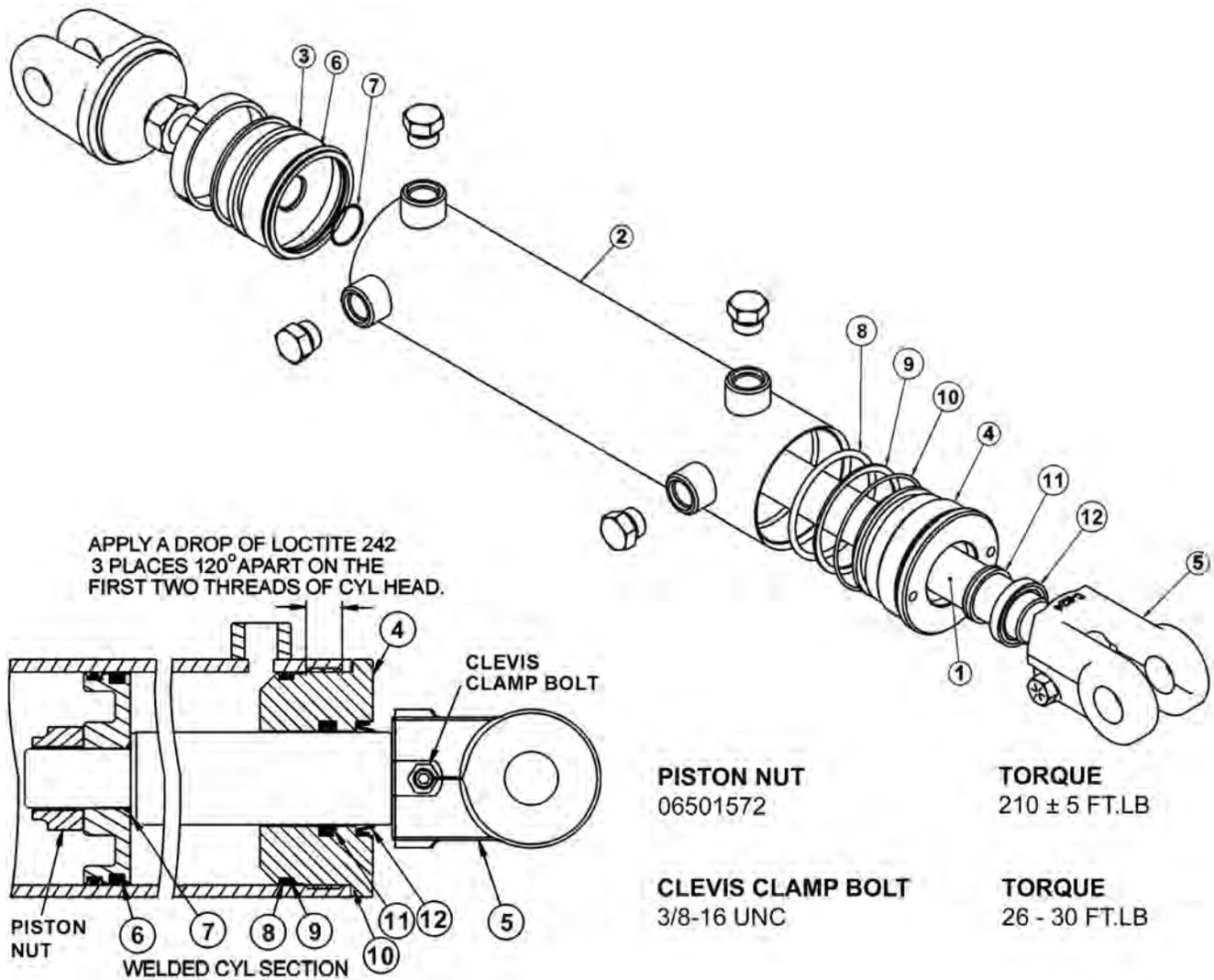

**WARNING - MECHANICAL FASTENERS MUST BE TORQUED TO RECOMMENDED SPECIFICATIONS DURING REPAIR TO PREVENT PERSONAL INJURY OR EQUIPMENT DAMAGE.**

ITEM	PART NO.	QTY.	DESCRIPTION
-----	06501021	-	HYDRAULIC CYLINDER COMPLETE
1	06501550	1	ROD
2	06501551	1	TUBE WELDMENT
3	06501552	1	PISTON
4	06501553	1	CYLINDER HEAD
5	06501554	1	CLEVIS
-----	06501555	-	SEAL REPAIR KIT (ITEMS 6 THROUGH 12)

## 3 X 18 HYDRAULIC CYLINDER BREAKDOWN

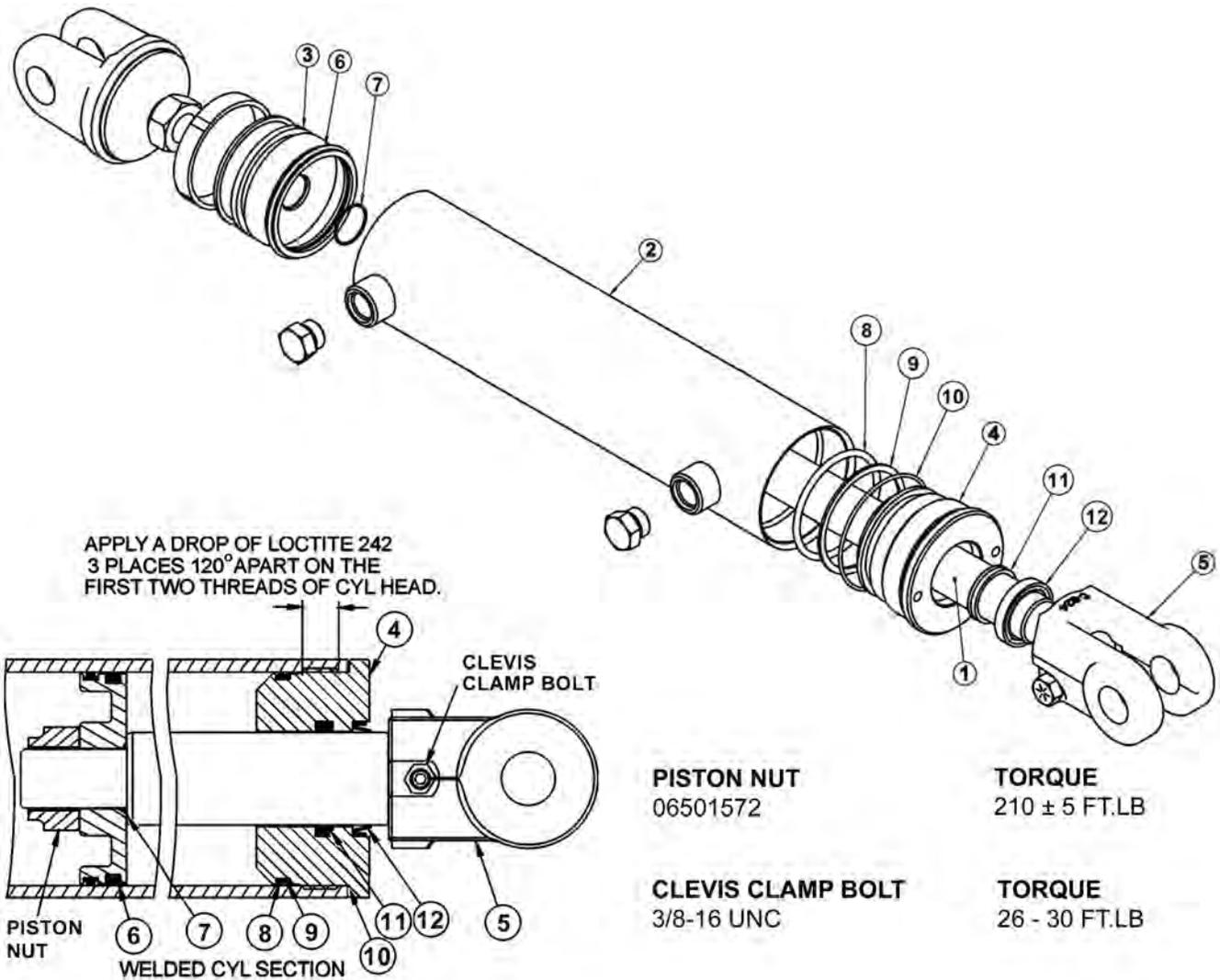

**WARNING - MECHANICAL FASTENERS MUST BE TORQUED TO RECOMMENDED SPECIFICATIONS DURING REPAIR TO PREVENT PERSONAL INJURY OR EQUIPMENT DAMAGE.**

ITEM	PART NO.	QTY.	DESCRIPTION
-----	06501023	-	HYDRAULIC CYLINDER COMPLETE
1	06501561	1	ROD
2	06501562	1	TUBE WELDMENT
3	06501552	1	PISTON
4	06501563	1	CYLINDER HEAD
5	06501554	1	CLEVIS
-----	06501564	-	SEAL REPAIR KIT (ITEMS 6 THROUGH 12)

# NOTES

**COMMON TRIPLE**

**PARTS SECTION**

# NOTES



## PART NAME INDEX

PARTS ORDERING GUIDE.....	5
DRAFT BEAM - RIGHT HAND.....	6
DRAFT BEAM - LEFT HAND.....	8
SUPER DUTY 63IN SIDE FLAIL - STD ROT.....	10
SUPER DUTY 63IN SIDE FLAIL - REV ROT.....	12
SUPER DUTY 75IN SIDE FLAIL - STD ROT.....	14
SUPER DUTY 75IN SIDE FLAIL - REV ROT.....	16
SUPER DUTY SIDE FLAIL DRIVE ASSY.....	18
SUPER DUTY SIDE FLAIL MOTOR BREAKDOWN.....	20
EXTREME DUTY 60IN SIDE FLAIL - STD ROT.....	22
EXTREME DUTY 60IN SIDE FLAIL - REV ROT.....	24
EXTREME DUTY 75IN SIDE FLAIL - STD ROT.....	26
EXTREME DUTY 75IN SIDE FLAIL - REV ROT.....	28
EXTREME DUTY 90IN SIDE FLAIL - STD ROT.....	30
EXTREME DUTY 90IN SIDE FLAIL - REV ROT.....	32
DIRECT DRIVE 90IN SIDE FLAIL - REV ROT.....	34
DIRECT DRIVE 90IN SIDE FLAIL - MOTOR AND HOSES.....	36
FRONT FLAPS, XD FLAIL - STANDARD ROTATION.....	38
EXTREME DUTY SIDE FLAIL DRIVE ASSY.....	40
EXTREME DUTY SIDE FLAIL MOTOR BREAKDOWN.....	42
SUPER DUTY 75IN REAR FLAIL - STD ROT.....	44
SUPER DUTY 75IN REAR FLAIL - REV ROT.....	46
SUPER DUTY 90IN REAR FLAIL - STD ROT.....	48
SUPER DUTY 90IN REAR FLAIL - REV ROT.....	50
SUPER DUTY REAR FLAIL DRIVE ASSY.....	52
SUPER DUTY PTO DRIVE ASSY.....	54
SUPER DUTY REAR GEAR BOX ASSY.....	56
EXTREME DUTY 75IN REAR FLAIL - STD ROT.....	58
EXTREME DUTY 75IN REAR FLAIL - REV ROT.....	60
EXTREME DUTY 75IN REAR FLAIL DRIVE ASSY.....	62
EXTREME DUTY 90IN REAR FLAIL - STD ROT.....	64
EXTREME DUTY 90IN REAR FLAIL - REV ROT.....	66
EXTREME DUTY 90IN REAR FLAIL DRIVE ASSY.....	68
EXTREME DUTY 96IN REAR FLAIL - STD ROT.....	70
EXTREME DUTY 96IN REAR FLAIL - REV ROT.....	72
EXTREME DUTY 96IN REAR FLAIL DRIVE ASSY.....	74
EXTREME DUTY 102IN REAR FLAIL - STD ROT.....	76
EXTREME DUTY 102IN REAR FLAIL - REV ROT.....	78
EXTREME DUTY 102IN REAR FLAIL DRIVE ASSY.....	80
EXTREME DUTY REAR GEAR BOX ASSY.....	82

COMMON TRIPLE

## PART NAME INDEX

PTO SHAFT ASSEMBLY.....	84
PTO SHAFT ASSEMBLY WITH CLUTCH.....	85
CLUTCH ASSEMBLY.....	86
NOTES 1.....	87
RESERVOIR TANK FILTER ASSEMBLY.....	88
FRONT HYDRAULIC PUMP BREAKDOWN.....	90
3IN X 8IN TIE-ROD CYLINDER - 31211.....	92
3IN X 12IN TIE-ROD CYLINDER - 25343.....	94
3IN X 12IN TIE-ROD CYLINDER - 32215.....	96
4 SPOOL CABLE (MANUAL) LIFT VALVE - 31190.....	98
4 SPOOL CABLE (MANUAL) LIFT VALVE - 06502046.....	100
COOLER ASSEMBLY.....	102
CASTER WHEEL ASSEMBLY.....	104
SIDE FLAIL TRAVEL LOCK.....	106
BRAKE VALVE ASSEMBLY.....	107
BRAKE VALVE HYDRAULIC SCHEMATIC.....	108
SWITCHBOX SERVICE PARTS.....	109
SWITCHBOX SCHEMATIC.....	110
PTO STAND.....	111
NOTES 2.....	112



## PARTS ORDERING GUIDE

The following instructions are offered to help eliminate needless delay and error in processing purchase orders for the equipment in this manual.

1. The Parts Section is prepared in logical sequence and grouping of parts that belong to the basic machine featured in this manual. Part Numbers and Descriptions are given to help locate the parts and quantities required.
2. The Purchase Order must indicate the **Name and Address** of the person or organization ordering the parts, **who should be charged**, and if possible, the **serial number of the machine** for which the parts are being ordered.
3. The purchase order must clearly list the **quantity of each part**, the complete and correct **part number**, and the basic **name of the part**.
4. The manufacturer reserves the right to substitute parts where applicable.
5. Some parts may be unlisted items which are special production items not normally stocked and are subject to special handling. Request a quotation for such parts before sending a purchase order.
6. The manufacturer reserves the right to change prices without prior notice.

NOTE: When ordering replacement decals, refer to the part numbers and descriptions listed in the safety section in the front of this manual.

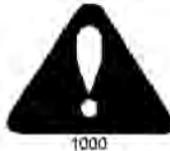

1000

For maximum safety and to guarantee optimum product reliability, always use genuine **Tiger** replacement parts. The use of inferior replacement parts may cause premature or catastrophic failure which could result in serious injury or death.

Direct any questions regarding parts to:

**Tiger Corporation**  
3301 N. Louise Ave.  
Sioux Falls, SD 57107  
1-800-843-6849  
1-605-336-7900

## DRAFT BEAM - RIGHT HAND

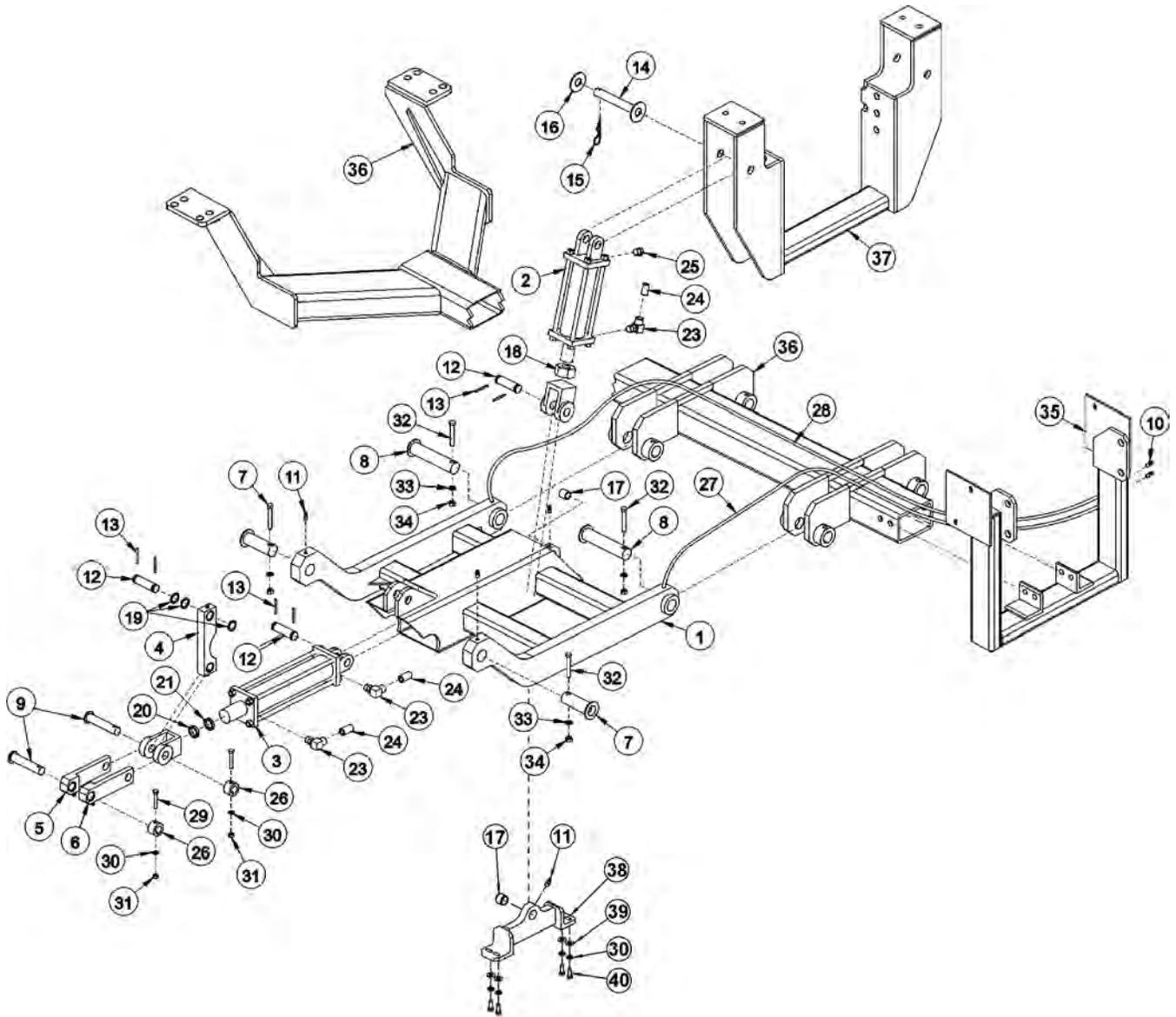

ITEM	PART NO.	QTY.	DESCRIPTION
1	-----	-	DRAFT BEAM - REFER TO TRACTOR PARTS SECTION
2	31211	1	INBOARD CYLINDER
3	25343	1	OUTBOARD CYLINDER - XD
---	32215	1	OUTBOARD CYLINDER - SD
4	TF4500A	1	PIVOT ARM
5	TF4506B	1	LIFT ARM - LH

COMMON TRIPLE

## DRAFT BEAM - RIGHT HAND

Continued...

ITEM	PART NO.	QTY.	DESCRIPTION
6	TF4507B	1	LIFT ARM - RH
7	TF4514A	2	PIN
8	TF4515	2	PIN,1-1/2" X 6-3/4"
9	TF4519	2	PIN
10	TF1033	2	GREASE ZERK,1/8"
11	6T3207	4	GREASE ZERK,1/4"
12	TB1033	3	CLEVIS PIN
13	06537021	6	ROLL PIN
14	6T3005	1	CYLINDER PIN
15	6T3004	1	R-CLIP
16	22023	1	FLATWASHER
17	TB3010	2	BUSHING
18	31208	1	SPACER
19	23724	3	SHIM
20	22076	1	SPACER (AS REQUIRED)
21	22077	1	SPACER (AS REQUIRED)
23	34244	3	FITTING
24	34396	3	RESTRICTOR
25	6T4258	1	BREATHER
26	22847A	2	BOSS
27	22851	1	HOSE,3/16" X 37"
28	22860	1	HOSE,3/16" X 70"
29	21635	2	CAPSCREW,3/8" X 2-1/4",NC
30	21988	6	LOCKWASHER,3/8"
31	21625	2	HEX NUT,3/8",NC
32	21688	4	CAPSCREW,7/16" X 3-1/4",NC
33	21989	4	LOCKWASHER,7/16"
34	21675	4	HEX NUT,7/16",NC
35	-----	-	HANGER - REFER TO TRACTOR PARTS SECTION
36	-----	-	FRAME - REFER TO TRACTOR PARTS SECTION
37	-----	-	MAST - REFER TO TRACTOR PARTS SECTION
38	06350000	1	CYLINDER ANCHOR
39	22016	4	FLATWASHER,3/8"
40	21630	4	CAPSCREW,3/8" X 1",NC

COMMON TRIPLE

## DRAFT BEAM - LEFT HAND

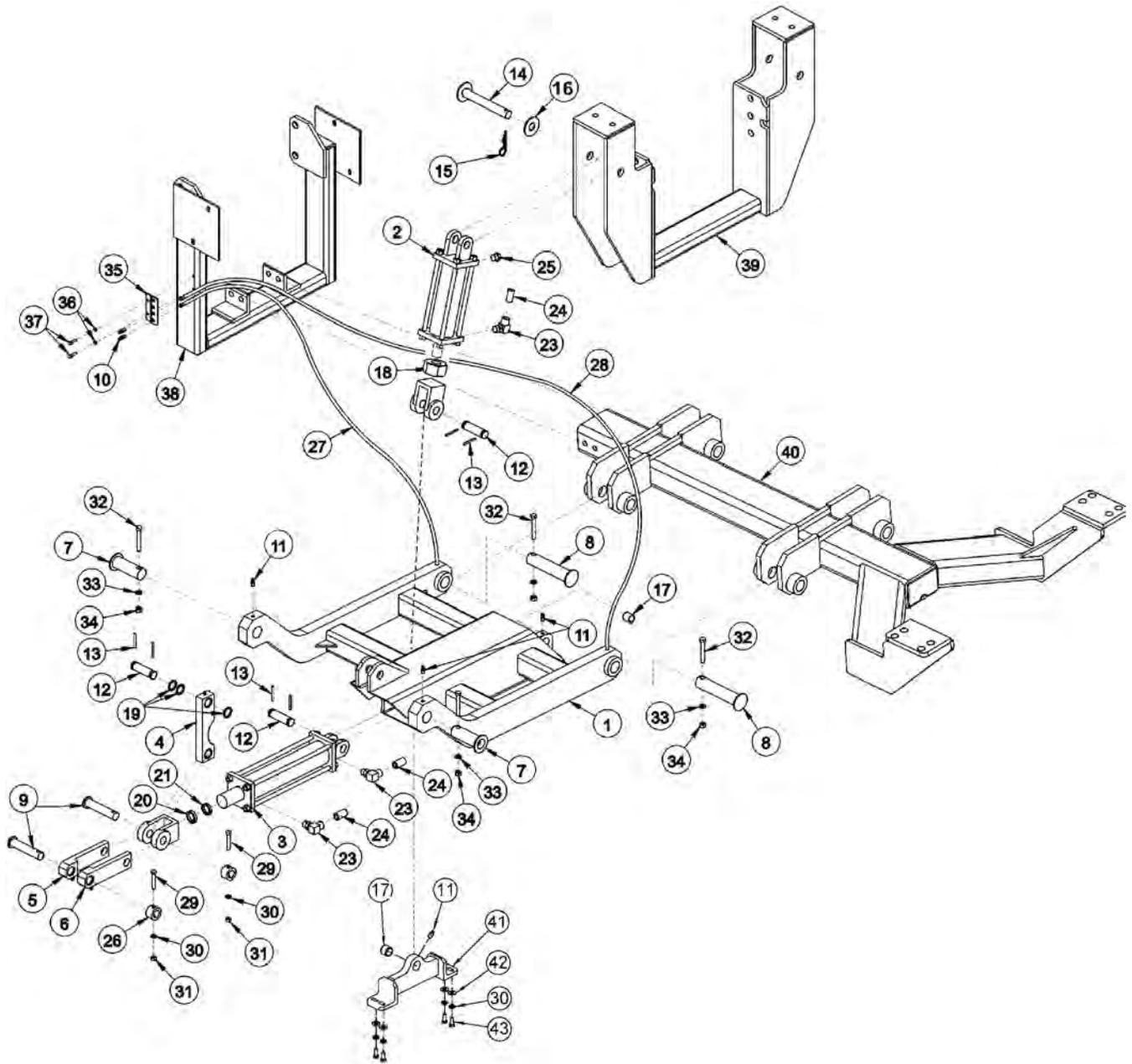

ITEM	PART NO.	QTY.	DESCRIPTION
1	-----	-	DRAFT BEAM - REFER TO TRACTOR PARTS SECTION
2	31211	1	INBOARD CYLINDER
3	25343	1	OUTBOARD CYLINDER - XD
---	32215	1	OUTBOARD CYLINDER - SD
4	TF4500A	1	PIVOT ARM
5	TF4506B	1	LIFT ARM - LH

COMMON TRIPLE

## DRAFT BEAM - LEFT HAND

Continued...

ITEM	PART NO.	QTY.	DESCRIPTION
6	TF4507B	1	LIFT ARM - RH
7	TF4514A	2	PIN
8	TF4515	2	PIN,1-1/2" X 6-3/4"
9	TF4519	2	PIN
10	TF1033	2	GREASE ZERK,1/8"
11	6T3207	4	GREASE ZERK,1/4"
12	TB1033	3	CLEVIS PIN
13	06537021	6	ROLL PIN
14	6T3005	1	CYLINDER PIN
15	6T3004	1	R-CLIP
16	22023	1	FLATWASHER
17	TB3010	2	BUSHING
18	31208	1	SPACER
19	23724	3	SHIM
20	22076	1	SPACER (AS REQUIRED)
21	22077	1	SPACER (AS REQUIRED)
23	34244	3	FITTING
24	34396	3	RESTRICTOR
25	6T4258	1	BREATHER
26	22847A	2	BOSS
27	22851	1	HOSE,3/16" X 37"
28	22660	1	HOSE,3/16" X 70"
29	21635	2	CAPSCREW,3/8" X 2-1/4",NC
30	21988	6	LOCKWASHER,3/8"
31	21625	2	HEX NUT,3/8",NC
32	21688	4	CAPSCREW,7/16" X 3-3/4",NC
33	21989	4	LOCKWASHER,7/16"
34	21675	4	HEX NUT,7/16",NC
35	22625	1	GREASE HOSE BRACKET
36	21986	2	LOCKWASHER,1/4"
37	21529	2	CAPSCREW,1/4" X 3/4",NC
38	-----	-	HANGER - REFER TO TRACTOR PARTS SECTION
39	-----	-	MAST - REFER TO TRACTOR PARTS SECTION
40	-----	-	FRAME - REFER TO TRACTOR PARTS SECTION
41	06350000	1	CYLINDER ANCHOR
42	22016	4	FLATWASHER,3/8"
43	21630	4	CAPSCREW,3/8" X 1",NC

COMMON TRIPLE

# SUPER DUTY 63IN SIDE FLAIL - STD ROT

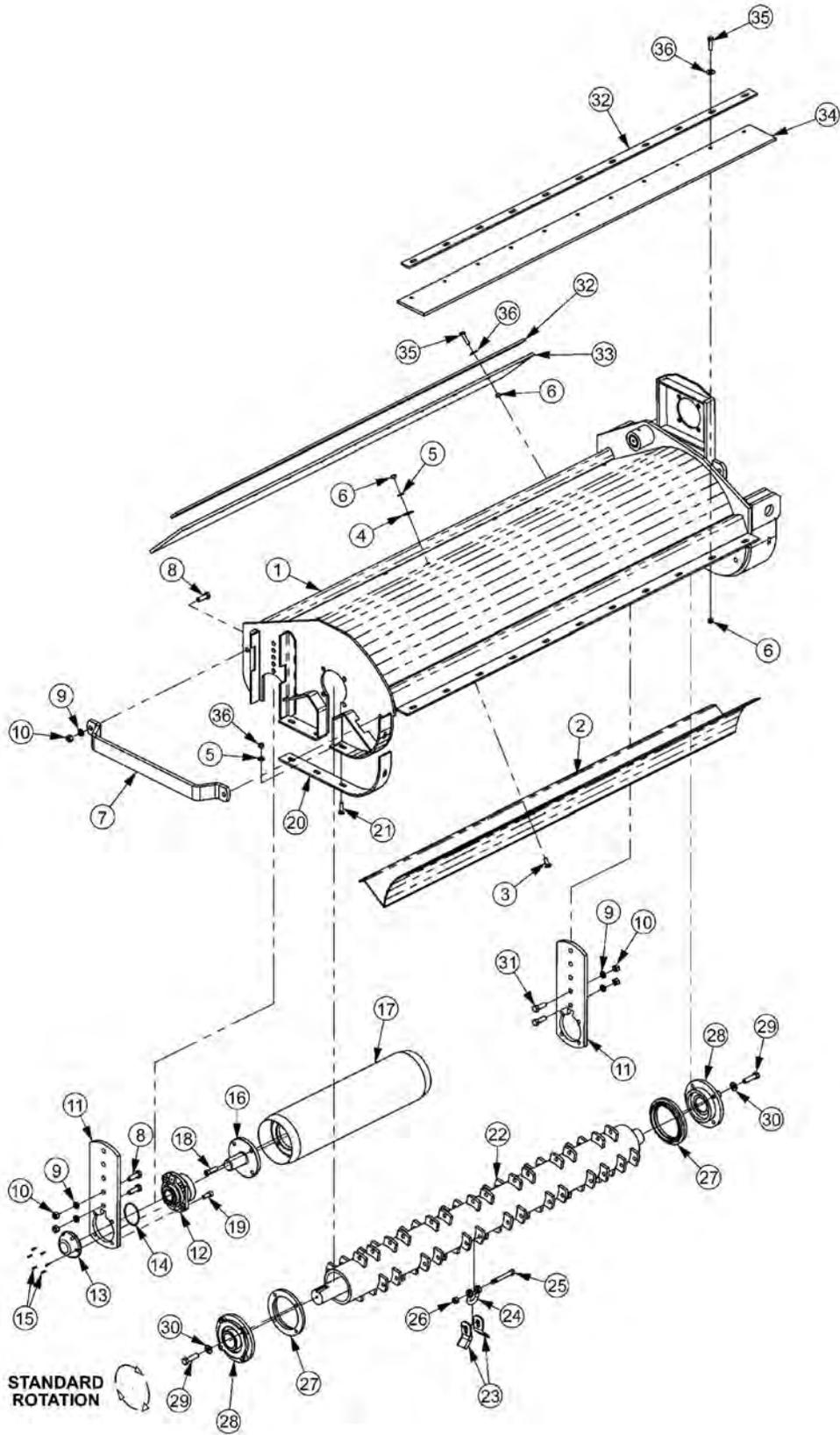

COMMON TRIPLE

**SUPER DUTY 63IN SIDE FLAIL - STD ROT**

**Continued...**

<b>ITEM</b>	<b>PART NO.</b>	<b>QTY.</b>	<b>DESCRIPTION</b>
1	32433	1	BONNET,63",STD,T3F (RIGHT FLAIL)
---	32224	1	BONNET,63",STD,T3F (LEFT FLAIL)
2	28665A	1	BAFFLE,63",STD ROT
3	6T2283	8	CARRIAGE BOLT,3/8" X 1",NC
4	6T2615	8	WASHER,FENDER 3/8"
5	21988	8	LOCKWASHER,3/8"
6	21625	40	HEX NUT,3/8",NC
7	27975A	1	GUARD,CUTTERSHAFT
8	21731	4	CAPSCREW,1/2" X 1-1/2",NC
9	21990	6	LOCKWASHER,1/2"
10	21725	6	HEX NUT,1/2",NC
11	28735	2	GROUND ROLLER ADJ BRKT,STD DTY
12	06520028	2	BEARING,FLANGE,1-3/8",GRNDRLR
13	06520027	2	CAP,BEARING,GRNDRLR
14	06520029	2	O-RING,2-3/4" X 3/32",AS568A-148
15	06530001	12	CAPSCREW,SKT HD,8-32 X 1/2",SS
16	TF1045B	2	STUB SHAFT,GROUND ROLLER
17	28650A	1	GROUND ROLLER,63"
18	6T2330	8	CAPSCREW,SKT HD,7/16" X 1-1/2",NC
19	6T2331	8	CAPSCREW,SKT HD,7/16" X 1",NC
20	28086A	2	SKID SHOE,STD DUTY REAR FLAIL
21	30013	10	PLOW BOLT,3/8" X 1-1/4",NC,GR5
---	28743	-	CUTTERSHAFT ASSY,STANDARD
22	28642C	1	CUTTERSHAFT,63"
23	33713	64	KNIFE,FLAIL,SHORT,FORGES GORCE
24	TF1020	32	KNIFE MTG CLEVIS,FLAIL
25	34011	32	CAPSCREW,7/16" X 3-7/16",NC,GR8
26	21677	32	NYLOCK NUT,7/16",NC
27	33863	2	STRING GUARD,STD
28	28683	2	BEARING,FLANGE,1-15/16",STD,TSF
29	06530217	8	CAPSCREW,1/2" X 2",NC,L9
30	06533006	8	FLATWASHER,1/2",SAE,L9
31	21732	2	CAPSCREW,1/2" X 1-3/4",NC
32	28700	2	BAR,FLAP,TSF/TBF,63"
33	28701	1	FLAP,DEFLECTOR,TSF,63"
34	06520241	1	FLAP,63",FRONT
35	21632	22	CAPSCREW,3/8" X 1-1/2",NC
36	22016	32	FLATWASHER,3/8"

COMMON TRIPLE

# SUPER DUTY 63IN SIDE FLAIL - REV ROT

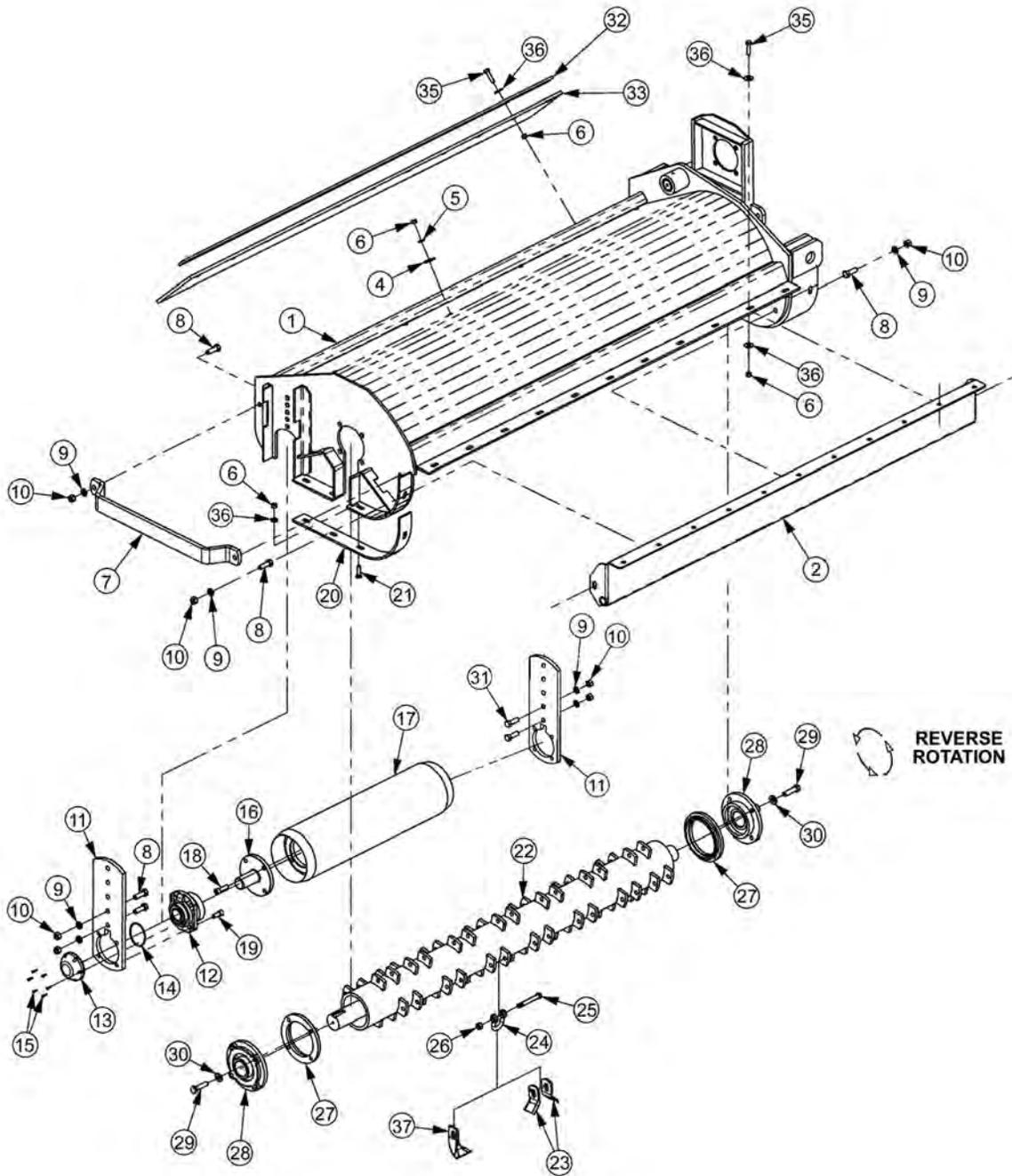

COMMON TRIPLE



**SUPER DUTY 63IN SIDE FLAIL - REV ROT**

**Continued...**

<b>ITEM</b>	<b>PART NO.</b>	<b>QTY.</b>	<b>DESCRIPTION</b>
1	32433	1	BONNET,63",STD,T3F (RIGHT FLAIL)
---	32224	1	BONNET,63",STD,T3F (LEFT FLAIL)
2	28969A	1	TRASH GUARD,63",REV ROT
3	6T2283	8	CARRIAGE BOLT,3/8" X 1",NC
4	6T2615	8	WASHER,FENDER,3/8"
5	21988	8	LOCKWASHER,3/8"
6	21625	40	HEX NUT,3/8",NC
7	27975A	1	GUARD,CUTTERSHAFT
8	21731	6	CAPSCREW,1/2" X 1-1/2",NC
9	21990	8	LOCKWASHER,1/2"
10	21725	8	HEX NUT,1/2",NC
11	28735	2	GROUND ROLLER ADJ BRKT,STD DTY
12	06520028	2	BEARING,FLANGE,1-3/8",GRNDRLR
13	06520027	2	CAP,BEARING,GRNDRLR
14	06520029	2	O-RING,2-3/4" X 3/32",AS568A-148
15	06530001	12	CAPSCREW,SKT HD,8-32 X 1/2",SS
16	TF1045B	2	STUB SHAFT,GROUND ROLLER
17	28650A	1	GROUND ROLLER,63"
18	6T2330	8	CAPSCREW,SKT HD,7/16" X 1-1/2",NC
19	6T2331	8	CAPSCREW,SKT HD,7/16" X 1",NC
20	28086A	2	SKID SHOE,STD DUTY REAR FLAIL
21	30013	10	PLOW BOLT,3/8" X 1-1/4",NC,GR5
---	28743	-	CUTTERSHAFT ASSY,STANDARD CUT
----	28744	-	CUTTERSHAFT ASSY,SMOOTH CUT
22	28642C	1	CUTTERSHAFT,63"
23	33713	64	FLAIL KNIVES (STANDARD CUT)
24	TF1020	32	KNIFE MTG CLEVIS,FLAIL
25	34011	32	CAPSCREW,7/16" X 3-7/16",NC,GR8
26	21677	32	NYLOCK NUT,7/16",NC
27	33863	2	STRING GUARD,STD
28	28683	2	BEARING,FLANGE,1-15/16",STD,TSF
29	06530217	8	CAPSCREW,1/2" X 2",NC,L9
30	06533006	8	FLATWASHER,1/2",SAE,L9
31	21732	2	CAPSCREW,1/2" X 1-3/4",NC
32	28700	1	BAR,FLAP,TSF/TBF,63"
33	28701	1	FLAP,DEFLECTOR,TSF,63"
35	21632	22	CAPSCREW,3/8" X 1-1/2",NC
36	22016	43	FLATWASHER,3/8"
37	28184A	32	FLAIL KNIVES (SMOOTH CUT)

COMMON TRIPLE

# SUPER DUTY 75IN SIDE FLAIL - STD ROT

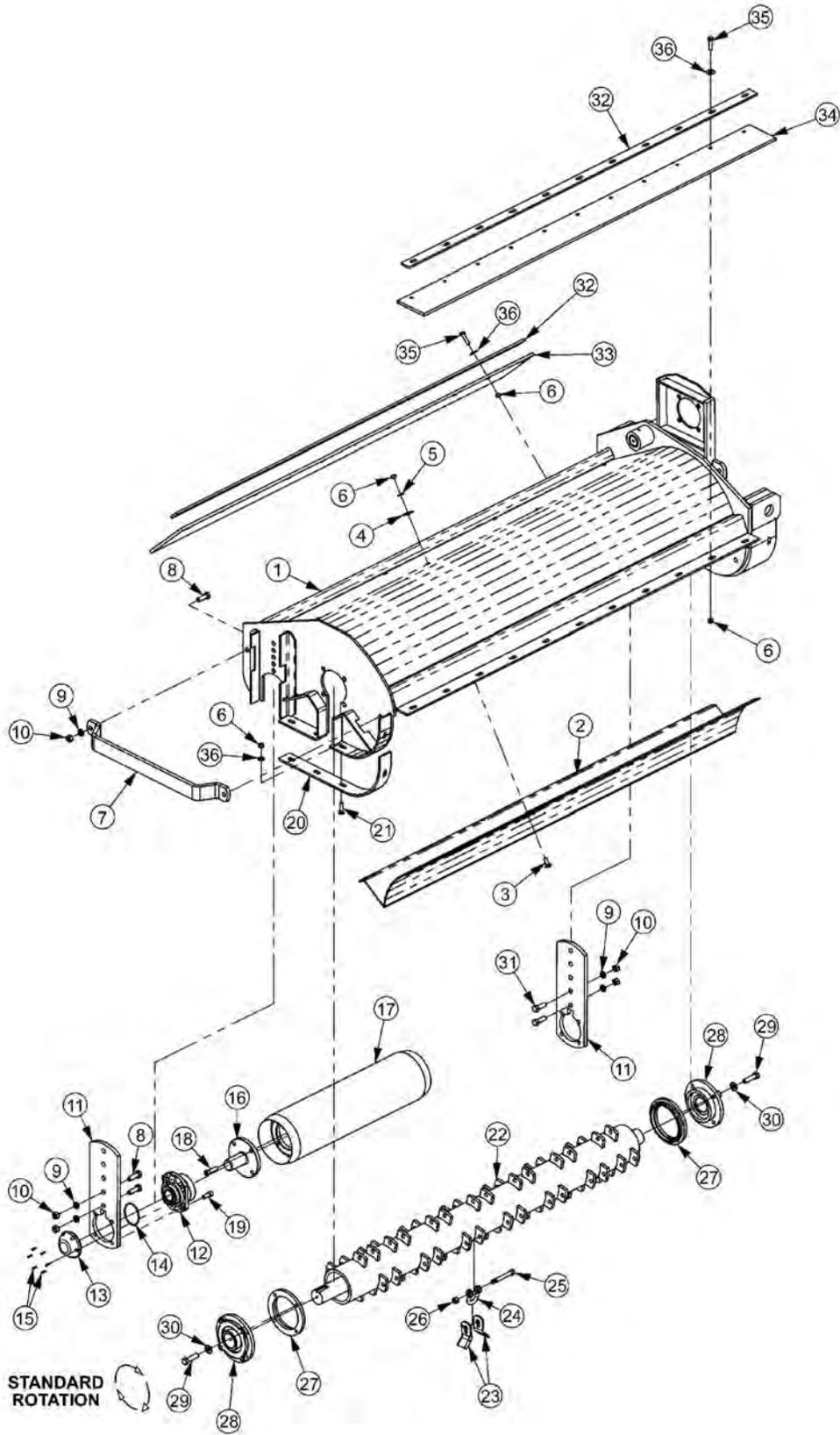

COMMON TRIPLE

**SUPER DUTY 75IN SIDE FLAIL - STD ROT**

**Continued...**

<b>ITEM</b>	<b>PART NO.</b>	<b>QTY.</b>	<b>DESCRIPTION</b>
1	06320109	1	BONNET,75",STD,T3F (RIGHT FLAIL)
---	06320108	1	BONNET,75",STD,T3F (LEFT FLAIL)
2	28737	1	BAFFLE,75",STD ROT-STD
3	6T2283	10	CARRIAGE BOLT,3/8" X 1",NC
4	6T2615	10	WASHER,FENDER,3/8"
5	21988	10	LOCKWASHER,3/8"
6	21625	46	HEX NUT,3/8",NC
7	27975A	1	GUARD,CUTTERSHAFT
8	21731	4	CAPSCREW,1/2" X 1-1/2",NC
9	21990	6	LOCKWASHER,1/2"
10	21725	6	HEX NUT,1/2",NC
11	28735	2	GROUND ROLLER ADJ BRKT,STD DTY
12	06520028	2	BEARING,FLANGE,1-3/8,GRNDRLR
13	06520027	2	CAP,BEARING,GRNDRLR
14	06520029	2	O-RING,2-3/4 X 3/32",AS568A-148
15	06530001	12	CAPSCREW,SKT HD,8-32 X 1/2",SS
16	TF1045B	2	STUB SHAFT,GROUND ROLLER
17	28738	1	GROUND ROLLER,75"
18	6T2330	8	CAPSCREW,SKT HD,7/16" X 1-1/2",NC
19	6T2331	8	CAPSCREW,SKT HD,7/16" X 1",NC
20	28086A	2	SKID SHOE,STD DUTY REAR FLAIL
21	30013	10	PLOW BOLT,3/8" X 1-1/4",NC,GR5
---	28747	-	CUTTERSHAFT ASSY,STANDARD
22	28643B	1	CUTTERSHAFT,75"
23	33713	80	KNIFE,FLAIL,SHORT,FORGES GORCE
24	TF1020	40	KNIFE MTG CLEVIS,FLAIL
25	34011	40	CAPSCREW,7/16" X 3-7/16",NC,GR8
26	21677	40	NYLOCK NUT,7/16",NC
---	06200639	-	STRING GUARD KIT,SD (ITEMS 27,29,30)
27	33863	2	STRING GUARD,STD
28	28683	2	BEARING,FLANGE,1-15/16",STD,TSF
29	06530217	8	CAPSCREW,1/2" X 2",NC,L9
30	06533006	8	FLATWASHER,1/2",SAE,L9
31	21732	2	CAPSCREW,1/2" X 1-3/4",NC
32	TF1029	2	BAR,FLAP,TSF/TBF,75"
33	TF1016	1	FLAP,DEFLECTOR,TSF,75"
34	06520242	1	FLAP,75",FRONT
35	21632	26	CAPSCREW,3/8" X 1-1/2",NC
36	22016	36	FLATWASHER,3/8"

COMMON TRIPLE

# SUPER DUTY 75IN SIDE FLAIL - REV ROT

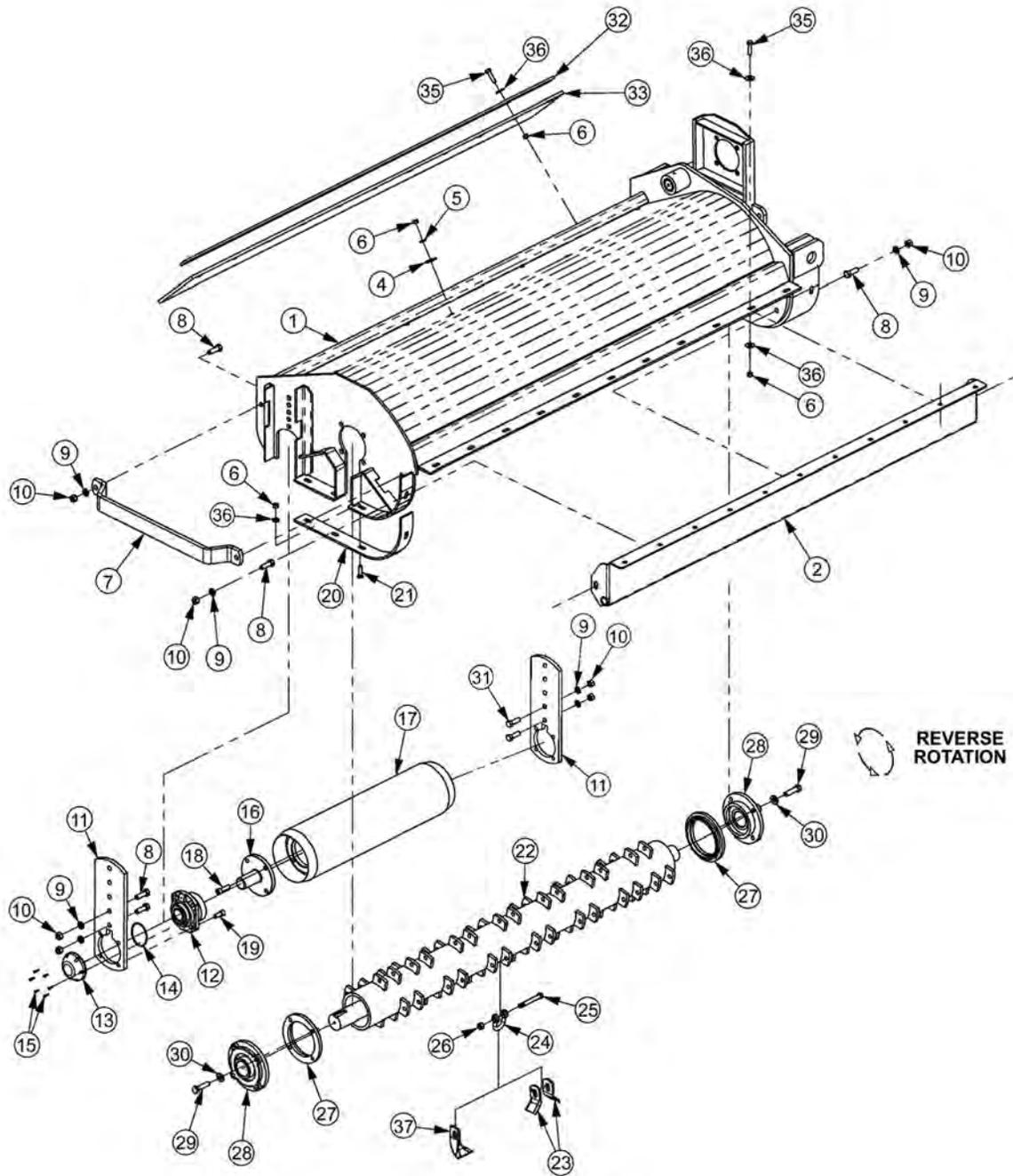

COMMON TRIPLE

## SUPER DUTY 75IN SIDE FLAIL - REV ROT

Continued...

ITEM	PART NO.	QTY.	DESCRIPTION
1	06320109	1	BONNET,75,STD,T3F (RIGHT FLAIL)
---	06320108	1	BONNET,75,STD,T3F (LEFT FLAIL)
2	28968A	1	TRASH GUARD,75"
3	6T2283	10	CARRIAGE BOLT,3/8" X 1",NC
4	6T2615	10	WASHER,FENDER,3/8"
5	21988	10	LOCKWASHER,3/8"
6	21625	36	HEX NUT,3/8",NC
7	27975A	1	GUARD,CUTTERSHAFT
8	21731	6	CAPSCREW,1/2" X 1-1/2",NC
9	21990	8	LOCKWASHER,1/2"
10	21725	8	HEX NUT,1/2",NC
11	28735	2	GROUND ROLLER ADJ BRKT,STD DTY
12	06520028	2	BEARING,FLANGE,1-3/8",GRNDRLR
13	06520027	2	CAP,BEARING,GRNDRLR
14	06520029	2	O-RING,2-3/4" X 3/32",AS568A-148
15	06530001	12	CAPSCREW,SKT HD,8-32 X 1/2",SS
16	TF1045B	2	STUB SHAFT,GROUND ROLLER
17	28738	1	GROUND ROLLER,75"
18	6T2330	8	CAPSCREW,SKT HD,7/16" X 1-1/2",NC
19	6T2331	8	CAPSCREW,SKT HD,7/16" X 1",NC
20	28086A	2	SKID SHOE,STD DUTY REAR FLAIL
21	30013	10	PLOW BOLT,3/8" X 1-1/4",NC,GR5
---	28747	-	CUTTERSHAFT ASSY,STANDARD (22, 23, 24, 25 & 26)
----	28748	-	CUTTERSHAFT ASSY,SMOOTH (22, 23, 24, 25 & 37)
22	28643B	1	CUTTERSHAFT,75"
23	33713	80	FLAIL KNIVES (STANDARD CUT)
24	TF1020	40	KNIFE MTG CLEVIS,FLAIL
25	34011	40	CAPSCREW,7/16" X 3-7/16",NC,GR8
26	21677	40	NYLOCK NUT,7/16",NC
---	06200639	-	STRING GUARD KIT, SD (ITEMS 27,29,30)
27	33863	2	STRING GUARD,STD
28	28683	2	BEARING,FLANGE,1-15/16",STD,TSF
29	06530217	8	CAPSCREW,1/2" X 2",NC,L9
30	06533006	8	FLATWASHER,1/2",SAE,L9
31	21732	2	CAPSCREW,1/2" X 1-3/4",NC
32	TF1029	1	BAR,FLAP,TSF/TBF,75"
33	TF1016	1	FLAP,DEFLECTOR,TSF,75"
35	21632	22	CAPSCREW,3/8" X 1-1/2",NC
36	22016	46	FLATWASHER,3/8"
37	28184A	40	FLAIL KNIVES (SMOOTH CUT)

COMMON TRIPLE

# SUPER DUTY SIDE FLAIL DRIVE ASSY

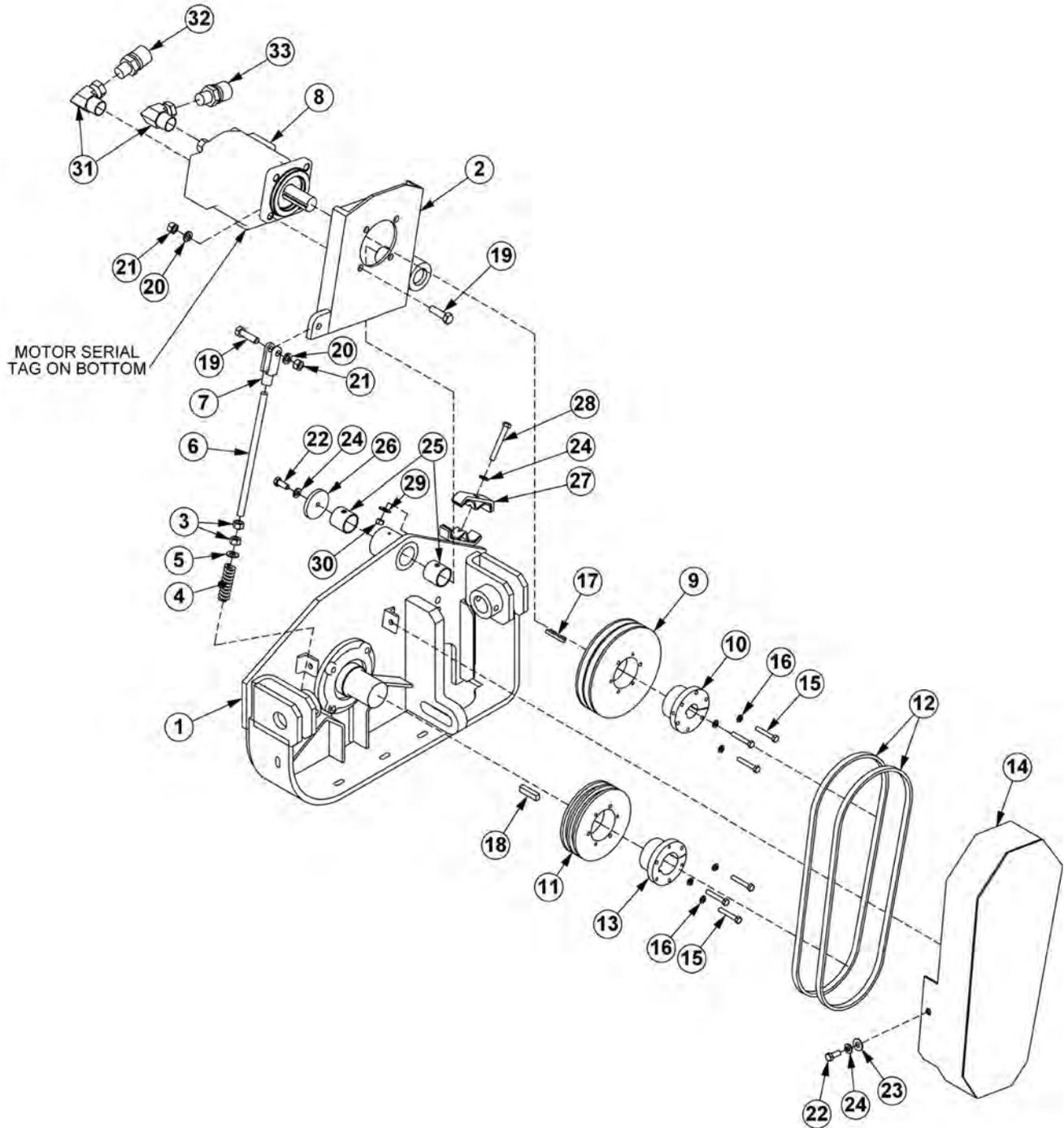

COMMON TRIPLE

## SUPER DUTY SIDE FLAIL DRIVE ASSY

Continued...

ITEM	PART NO.	QTY.	DESCRIPTION
1	-----	-	BONNET *REFER TO HEAD PARTS
2	32287	1	MOTOR CHANNEL (RIGHT FLAIL)
---	32286	1	MOTOR CHANNEL (LEFT FLAIL)
3	21700	2	HEX NUT, 1/2", NF
4	TF3620A	1	SPRING,TENSIONER
5	27938	1	BUSHING,MACH,1ODX1/2IDX14GA.
6	40496	1	ROD,THREADED,1/2NFX8
7	PT3611A	1	CLEVIS,6"
8	06504065	1	MOTOR, M350-1 GEAR
9	TF3041	1	SHEAVE,6.7
10	TF3013	1	BUSHING,QD,SK 1-1/4,1/4 KEY
11	TF3040	1	SHEAVE,6.3
12	32252	2	V-BELT,(470)
13	28723	1	BUSHING,QD,SK 1-15/16
14	32569	1	GUARD,BELT, RH
---	32568	1	GUARD, BELT, LH
15	21584	6	CAPSCREW, 5/16 X 2,NC
16	21987	6	LOCKWASHER, 5/16"
17	06504028	1	KEY (KEY FROM MOTOR)
18	26142A	1	KEY,1/2 X 1/2 X 2
19	21732	5	CAPSCREW, 1/2 X 1 3/4,NC
20	21990	5	LOCKWASHER, 1/2"
21	21725	5	HEX NUT,1/2 NC
22	21630	3	CAPSCREW, 3/8 X 1,NC
23	22016	2	FLATWASHER,3/8"
24	21988	4	LOCKWASHER, 3/8"
25	27580	2	BEARING,DX,1-1/2",GRM
26	28682	1	RETAINING,WASHER 2-1/2 X 5/16
27	TB3031	1	CLAMP,TUBE
28	21638	1	CAPSCREW,3/8" X 3",NC
29	22016	1	FLATWASHER,3/8",GR8
30	21625	1	HEX NUT,3/8",NC
31	34117	2	ELBOW,1MOR X 1MJIC
32	-----	-	HOSE (RETURN FOR STANDARD ROTATION)
33	-----	-	HOSE (PRESSURE OF STANDARD ROTATION)

COMMON TRIPLE





## SUPER DUTY SIDE FLAIL MOTOR BREAKDOWN

Continued...

ITEM	PART NO.	QTY.	DESCRIPTION
---	06504065	-	MOTOR ASSEMBLY 350 - TSF
1	06504039	1	SHAFT END COVER
2	06504060	1	PORT END COVER
3	06504055	1	GEAR HOUSING
4	06504056	1	MATCHED GEAR SET
5	TF4402	1	BALL BEARING
6	06504057	4	CAP SCREW
7	06504044	2	SET SCREW
9	06504045	4	DOWEL PIN
10	-----	1	NAMEPLATE
11	763759	2	THRUSTPLATE
12	02961940	1	HEX PLUG
13	TF4401	1	SNAP RING
14	06504049	1	LIP SEAL (INCLUDED IN SEAL KIT)
15	TF4410	2	GASKET SEAL (INCLUDED IN SEAL KIT)
16	06504046	4	SIDE SEAL (INCLUDED IN SEAL KIT)
17	06504047	4	END SEAL (INCLUDED IN SEAL KIT)
18	TF4407	2	BACK-UP SEAL (INCLUDED IN SEAL KIT)
19	029661932	1	SEAL RETAINER
20	6T5809	2	CHECK ASSEMBLY
21	02961917	4	WASHER
---	06504023	-	SEAL KIT (INCLUDES 14, 15, 16, 17, AND 18)

COMMON TRIPLE

## EXTREME DUTY 60IN SIDE FLAIL - STD ROT

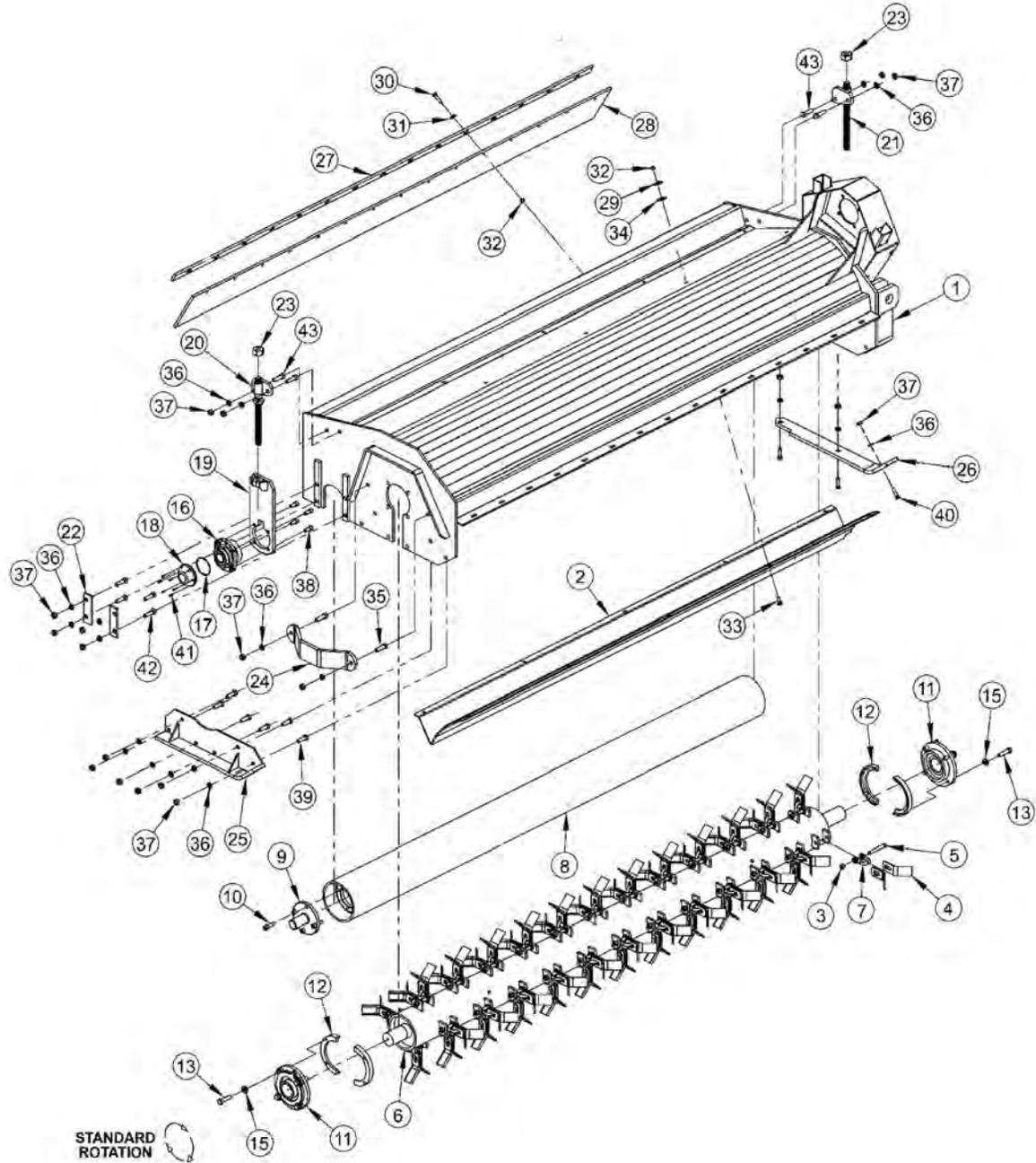

ITEM	PART NO.	QTY.	DESCRIPTION
1	33913	1	BONNET,60,HD,T3F (RIGHT FLAIL)
---	06320015	1	BONNET,60,HD,T3F (LEFT FLAIL)
2	TF1802A	1	BAFFLE,FLAIL,60HD,STD ROT
---	TF1807A	-	CUTSHT ASSY,60HD,STD KNIVES (ITEMS 3, 4, 5, 6 & 7)
3	21677	32	NYLOCK NUT,7/16 NC
4	33714	64	KNIFE,FLAIL,STANDARD

COMMON TRIPLE

**EXTREME DUTY 60IN SIDE FLAIL - STD ROT**

**Continued...**

<b>ITEM</b>	<b>PART NO.</b>	<b>QTY.</b>	<b>DESCRIPTION</b>
5	34011	32	CAPSCREW,7/16X3 7/16,NC GR8
6	TF1807	1	CUTTERSHAFT,60,HD
7	TF1020	32	KNIFE MTG CLEVIS,FLAIL
8	30277	1	GROUND ROLLER,60
9	TF1045B	2	STUB SHAFT,GROUND ROLLER
10	6T2330	8	CAPSCREW,SKT HD,7/16X1-1/2NC
11	TF1018	2	BEARING,FLANGE,2-3/16
---	06200347	-	STRING GUARD,KIT,HD(ITEMS 12,13,15)
12	31204	2	STRING GUARD, HD
13	06530217	8	CAPSCREW,1/2 X 2,NC,L9
15	06533006	8	FLATWASHER,1/2,SAE,L9
16	06520028	2	BEARING,FLANGE,1 3/8,GRNDRLR
17	06520029	2	O-RING,2 3/4X3/32,AS568A-148
18	06520027	2	CAP,BEARING,GRNDRLR
19	TF4333A	2	GROUND ROLLER ADJ,BRKT
20	TF4334	1	ROD,GROUND ROLLER ADJ,RT
21	TF4335	1	ROD,GROUND ROLLER ADJ,LF
22	TF4336	4	PLATE,GROUND ROLLER LOCK
23	21399	2	HEX NUT,3/4 (ACME) BULK
24	TF1040	1	GUARD,CUTTER SHAFT
25	TF4371	1	SKID SHOE,OUTER (RIGHT FLAIL)
---	TF4370	1	SKID SHOE,OUTER (LEFT FLAIL)
26	23272A	1	SKID SHOE,INNER (RIGHT FLAIL)
---	27526	1	SKID SHOE,INNER (LEFT FLAIL)
27	TF1803	1	BAR,FLAP,TSF/TRF 60
28	TF1804	1	FLAP,DEFLECTOR,TSF/TRF 60
29	21988	10	LOCKWASHER,3/8
30	21632	10	CAPSCREW,3/8 X 1-1/2 NC
31	22016	10	FLATWASHER,3/8
32	21625	18	HEX NUT,3/8 NC
33	6T2283	8	CARRIAGE BOLT,3/8 X 1 NC
34	6T2615	8	WASHER,FENDER 3/8
35	21732	2	CAPSCREW,1/2 X 1-3/4 NC
36	21990	23	LOCKWASHER,1/2
37	21725	23	HEX NUT,1/2 NC
38	6T2331	8	CAPSCREW,SKT HD,7/16 X 1 NC
39	21730	6	CAPSCREW,1/2 X 1-1/4 NC
40	23293	3	PLOW,BOLT,1/2 X 1-3/4 NC
41	06530001	12	CAPSCREW,SKT HD,8-32X1/2,SS
42	6T2291	8	PLOW BOLT,1/2 X 2 NC GR5
43	21731	4	CAPSCREW,1/2 X 1-1/2 NC

COMMON TRIPLE

## EXTREME DUTY 60IN SIDE FLAIL - REV ROT

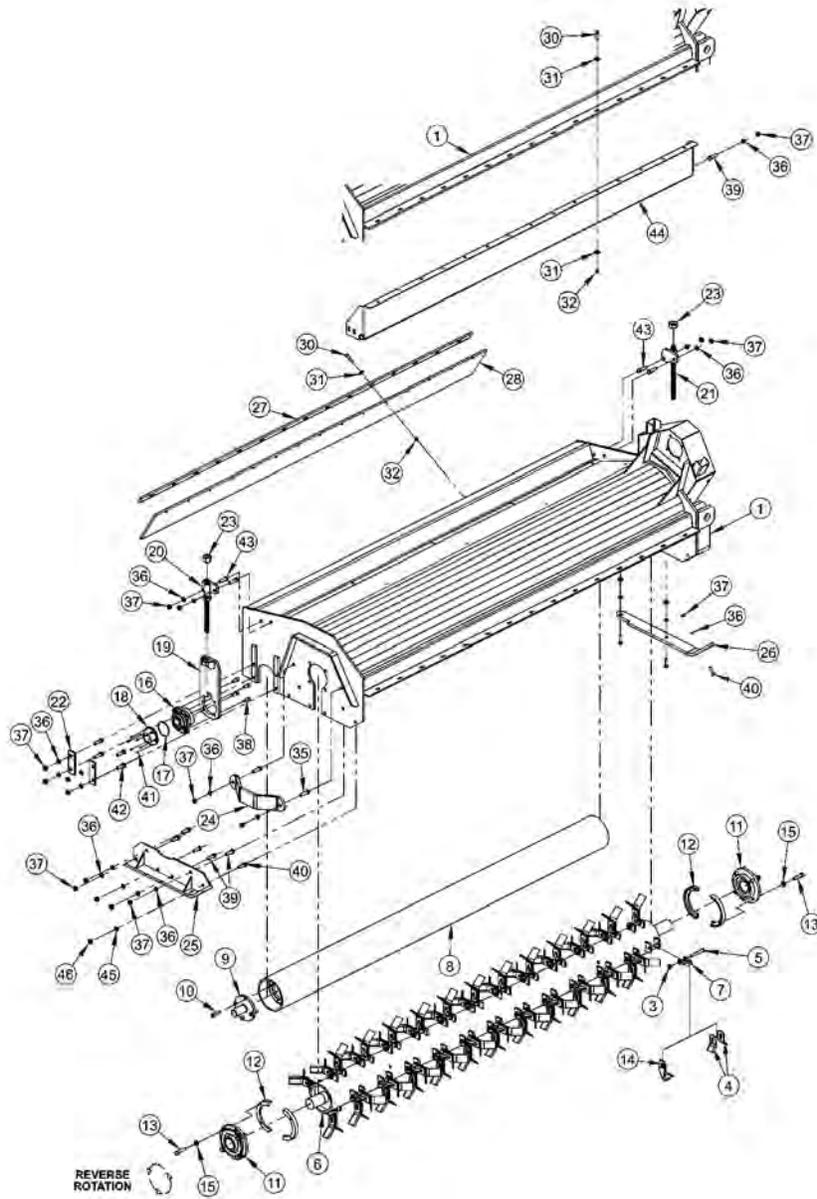

ITEM	PART NO.	QTY.	DESCRIPTION
1	33913	1	BONNET,60,HD,T3F (RIGHT FLAIL)
---	06320015	1	BONNET,60,HD,T3F (LEFT FLAIL)
2	TF1807A	-	CUTSFT ASSY,60HD (STANDARD CUT) (ITEMS 3, 4, 5, 6 & 7)
---	TF1807B	-	CUTSFT ASSY,60HD (SMOOTH CUT) (ITEMS 3, 5, 6, 7 & 14)
3	21677	32	NYLOCK NUT,7/16 NC
4	33714	64	KNIFE,FLAIL (STANDARD CUT)
5	34011	32	CAPSCREW,7/16X3 7/16,NC GR8
6	TF1807	1	CUTTERSHAFT,60,HD
7	TF1020	32	KNIFE MTG CLEVIS,FLAIL
8	30277	1	GROUND ROLLER,60

COMMON TRIPLE

## EXTREME DUTY 60IN SIDE FLAIL - REV ROT

Continued...

ITEM	PART NO.	QTY.	DESCRIPTION
9	TF1045B	2	STUB SHAFT,GROUND ROLLER
10	6T2330	8	CAPSCREW,SKT HD,7/16X1-1/2NC
11	TF1018	2	BEARING,FLANGE,2-3/16
---	06200347	-	STRING GUARD,KIT,HD(ITEMS 12,13,15)
12	31204	2	STRING GUARD, HD
13	06530217	8	CAPSCREW,1/2 X 2,NC,L9
14	TF1019F	32	KNIFE,FLAIL (SMOOTH CUT)
15	06533006	12	FLATWASHER,1/2,SAE,L9
16	06520028	2	BEARING,FLANGE,1 3/8,GRNDRLR
17	06520029	2	O-RING,2 3/4X3/32,AS568A-148
18	06520027	2	CAP,BEARING,GRNDRLR
19	TF4333A	2	GROUND ROLLER ADJ,BRKT
20	TF4334	1	ROD,GROUND ROLLER ADJ,RT
21	TF4335	1	ROD,GROUND ROLLER ADJ,LF
22	TF4336	4	PLATE,GROUND ROLLER LOCK
23	21399	2	HEX NUT,3/4 (ACME) BULK
24	TF1040	1	GUARD,CUTTER SHAFT
25	TF4371	1	SKID SHOE, OUTER (RIGHT FLAIL)
---	TF4370	1	SKID SHOE, OUTER (LEFT FLAIL)
26	23272A	1	SKID SHOE, INNER (RIGHT FLAIL)
---	27526	1	SKID SHOE, INNER (LEFT FLAIL)
27	TF1803	1	BAR,FLAP,TSF/TRF 60
28	TF1804	1	FLAP,DEFLECTOR,TSF/TRF 60
30	21632	20	CAPSCREW,3/8 X 1-1/2 NC
31	22016	30	FLATWASHER,3/8
32	21625	20	HEX NUT,3/8 NC
35	21732	2	CAPSCREW,1/2 X 1-3/4 NC
36	21990	23	LOCKWASHER,1/2
37	21725	23	HEX NUT,1/2 NC
38	6T2331	8	CAPSCREW,SKT HD,7/16 X 1 NC
39	21730	6	CAPSCREW,1/2 X 1-1/4 NC
40	23293	3	PLOW,BOLT,1/2 X 1-3/4 NC
41	06530001	12	CAPSCREW,SKT HD,8-32X1/2,SS
42	6T2291	8	PLOW BOLT,1/2 X 2 NC GR5
43	21731	4	CAPSCREW,1/2 X 1-1/2 NC
44	TF1801	1	TRASH GUARD,60REV ROT-HD
45	22018	1	FLATWASHER,1/2,WIDE
46	21727	1	NYLOCK NUT,1/2 NC

COMMON TRIPLE

## EXTREME DUTY 75IN SIDE FLAIL - STD ROT

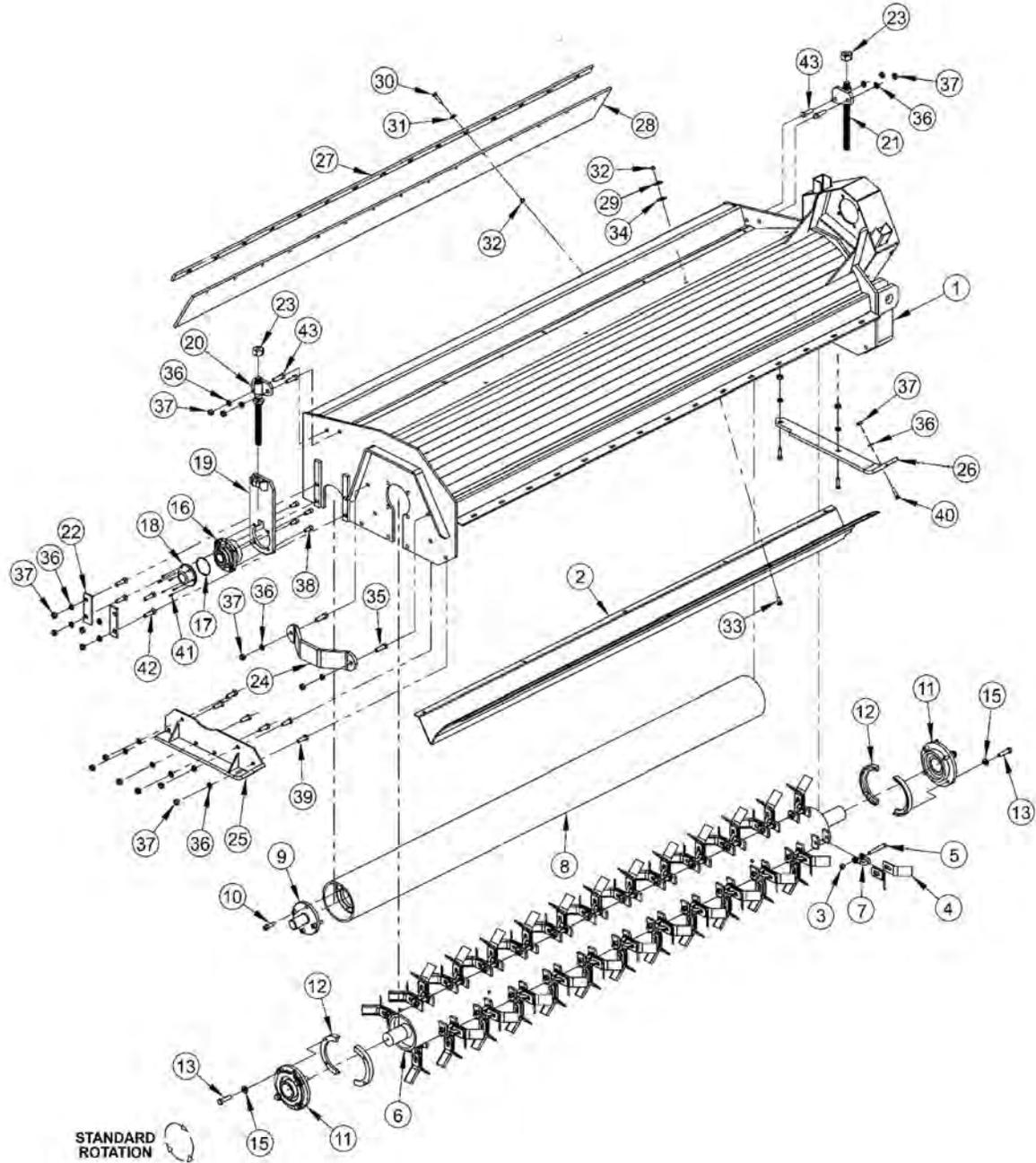

ITEM	PART NO.	QTY.	DESCRIPTION
1	21499A	1	BONNET,75,HD,T3F (RIGHT FLAIL)
---	21478A	1	BONNET,75,HD,T3F (LEFT FLAIL)
2	TF1402A	1	BAFFLE,FLAIL,75HD,STD ROT
---	TF1002A	-	CUTSHFT ASSY,75HD,STD KNIVES (ITEMS 3, 4, 5, 6 & 7)
3	21677	40	NYLOCK NUT,7/16 NC
4	33714	80	KNIFE,FLAIL,STANDARD

COMMON TRIPLE

## EXTREME DUTY 75IN SIDE FLAIL - STD ROT

Continued...

ITEM	PART NO.	QTY.	DESCRIPTION
5	34011	40	CAPSCREW,7/16X3 7/16,NC GR8
6	TF1002	1	CUTTERSHAFT,75,HD
7	TF1020	40	KNIFE MTG CLEVIS,FLAIL
8	28738	1	GROUND ROLLER,75
9	TF1045B	2	STUB SHAFT,GROUND ROLLER
10	6T2330	8	CAPSCREW,SKT HD,7/16X1-1/2NC
11	TF1018	2	BEARING,FLANGE,2-3/16
---	06200347	-	STRING GUARD,KIT,HD(ITEMS 12,13,15)
12	31204	2	STRING GUARD, HD
13	06530217	8	CAPSCREW,1/2 X 2,NC,L9
15	06533006	8	FLATWASHER,1/2,SAE,L9
16	06520028	2	BEARING,FLANGE,1 3/8,GRNDRLR
17	06520029	2	O-RING,2 3/4X3/32,AS568A-148
18	06520027	2	CAP,BEARING,GRNDRLR
19	TF4333A	2	GROUND ROLLER ADJ,BRKT
20	TF4334	1	ROD,GROUND ROLLER ADJ,RT
21	TF4335	1	ROD,GROUND ROLLER ADJ,LF
22	TF4336	4	PLATE,GROUND ROLLER LOCK
23	21399	2	HEX NUT,3/4 (ACME) BULK
24	TF1040	1	GUARD,CUTTER SHAFT
25	TF4371	1	SKID SHOE,OUTER (RIGHT FLAIL)
---	TF4370	1	SKID SHOE,OUTER (LEFT FLAIL)
26	23272A	1	SKID SHOE,INNER (RIGHT FLAIL)
---	27526	1	SKID SHOE,INNER (LEFT FLAIL)
27	TF1029	1	BAR,FLAP,TSF/TRF 75
28	TF1016	1	FLAP,DEFLECTOR,TSF/TRF 75
29	21988	10	LOCKWASHER,3/8
30	21632	13	CAPSCREW,3/8 X 1-1/2 NC
31	22016	13	FLATWASHER,3/8
32	21625	23	HEX NUT,3/8 NC
33	6T2283	10	CARRIAGE BOLT,3/8 X 1 NC
34	6T2615	10	WASHER,FENDER 3/8
35	21732	2	CAPSCREW,1/2 X 1-3/4 NC
36	21990	23	LOCKWASHER,1/2
37	21725	23	HEX NUT,1/2 NC
38	6T2331	8	CAPSCREW,SKT HD,7/16 X 1 NC
39	21730	6	CAPSCREW,1/2 X 1-1/4 NC
40	23293	3	PLOW,BOLT,1/2 X 1-3/4 NC
41	06530001	12	CAPSCREW,SKT HD,8-32X1/2,SS
42	6T2291	8	PLOW BOLT,1/2 X 2 NC GR5
43	21731	4	CAPSCREW,1/2 X 1-1/2 NC

COMMON TRIPLE

## EXTREME DUTY 75IN SIDE FLAIL - REV ROT

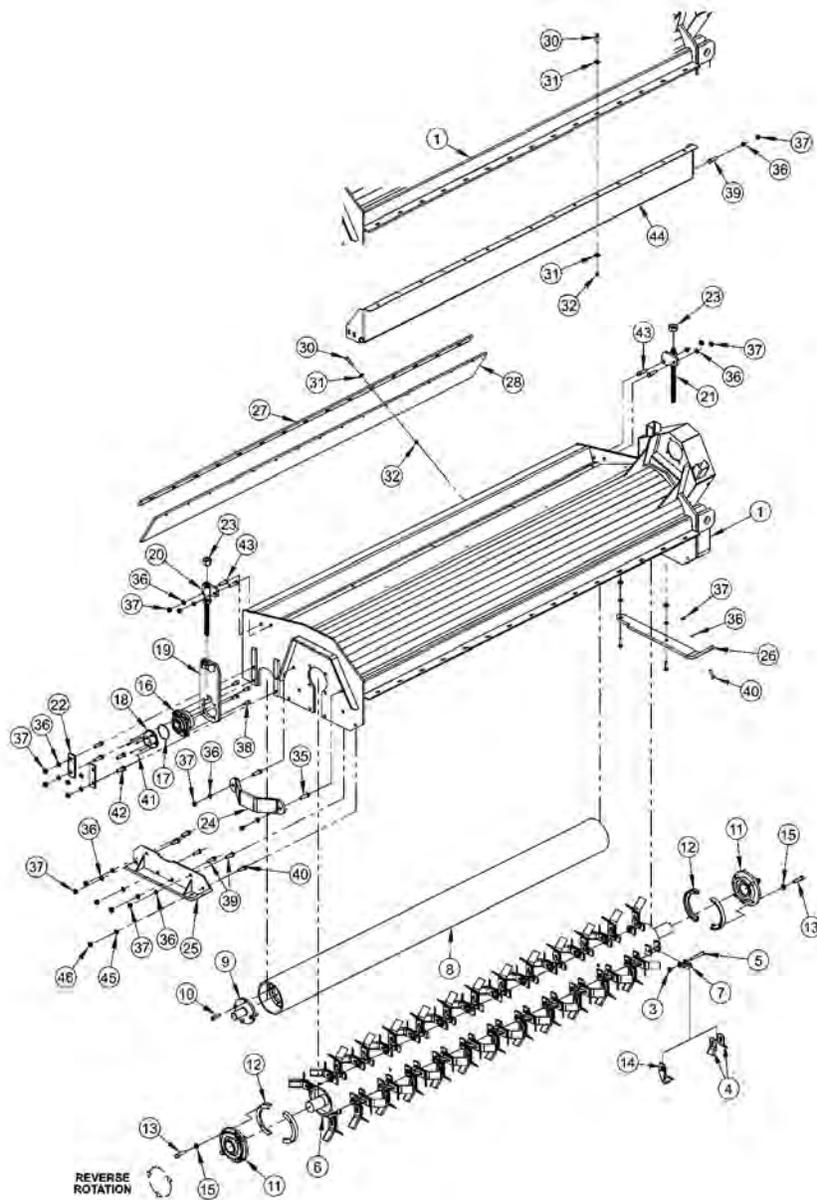

ITEM	PART NO.	QTY.	DESCRIPTION
1	21499A	1	BONNET,75,HD,T3F (RIGHT FLAIL)
---	21478A	1	BONNET,75,HD,T3F (LEFT FLAIL)
2	TF1002A	-	CUTSHT ASSY,75HD (STANDARD CUT) (ITEMS 3, 4, 5, 6 & 7)
---	TF1002B	-	CUTSHT ASSY,75HD (SMOOTH CUT) (ITEMS 3, 5, 6, 7 & 14)
3	21677	40	NYLOCK NUT,7/16 NC
4	33714	80	KNIFE,FLAIL (STANDARD CUT)
5	34011	40	CAPSCREW,7/16X3 7/16,NC GR8
6	TF1002	1	CUTTERSHAFT,75,HD
7	TF1020	40	KNIFE MTG CLEVIS,FLAIL
8	28738	1	GROUND ROLLER,75

COMMON TRIPLE



## EXTREME DUTY 75IN SIDE FLAIL - REV ROT

Continued...

ITEM	PART NO.	QTY.	DESCRIPTION
9	TF1045B	2	STUB SHAFT,GROUND ROLLER
10	6T2330	8	CAPSCREW,SKT HD,7/16X1-1/2NC
11	TF1018	2	BEARING,FLANGE,2-3/16
---	06200347	-	STRING GUARD,KIT,HD(ITEMS 12,13,15)
12	31204	2	STRING GUARD, HD
13	06530217	8	CAPSCREW,1/2 X 2,NC,L9
14	TF1019F	40	KNIFE,FLAIL (SMOOTH CUT)
15	06533006	8	FLATWASHER,1/2,SAE,L9
16	06520028	2	BEARING,FLANGE,1 3/8,GRNDRLR
17	06520029	2	O-RING,2 3/4X3/32,AS568A-148
18	06520027	2	CAP,BEARING,GRNDRLR
19	TF4333A	2	GROUND ROLLER ADJ,BRKT
20	TF4334	1	ROD,GROUND ROLLER ADJ,RT
21	TF4335	1	ROD,GROUND ROLLER ADJ,LF
22	TF4336	4	PLATE,GROUND ROLLER LOCK
23	21399	2	HEX NUT,3/4 (ACME) BULK
24	TF1040	1	GUARD,CUTTER SHAFT
25	TF4371	1	SKID SHOE, OUTER (RIGHT FLAIL)
---	TF4370	1	SKID SHOE, OUTER (LEFT FLAIL)
26	23272A	1	SKID SHOE, INNER (RIGHT FLAIL)
---	27526	1	SKID SHOE, INNER (LEFT FLAIL)
27	TF1029	1	BAR,FLAP,TSF/TRF 75
28	TF1016	1	FLAP,DEFLECTOR,TSF/TRF 75
30	21632	26	CAPSCREW,3/8 X 1-1/2 NC
31	22016	39	FLATWASHER,3/8
32	21625	26	HEX NUT,3/8 NC
35	21732	2	CAPSCREW,1/2 X 1-3/4 NC
36	21990	23	LOCKWASHER,1/2
37	21725	23	HEX NUT,1/2 NC
39	21730	6	CAPSCREW,1/2 X 1-1/4 NC
40	23293	3	PLOW,BOLT,1/2 X 1-3/4 NC
41	06530001	12	CAPSCREW,SKT HD,8-32X1/2,SS
42	6T2291	8	PLOW BOLT,1/2 X 2 NC GR5
43	21731	4	CAPSCREW,1/2 X 1-1/2 NC
44	TF1403	1	TRASH GUARD,75REV ROT-HD
45	22018	1	FLATWASHER,1/2,WIDE
46	21727	1	NYLOCK NUT,1/2 NC

COMMON TRIPLE

## EXTREME DUTY 90IN SIDE FLAIL - STD ROT

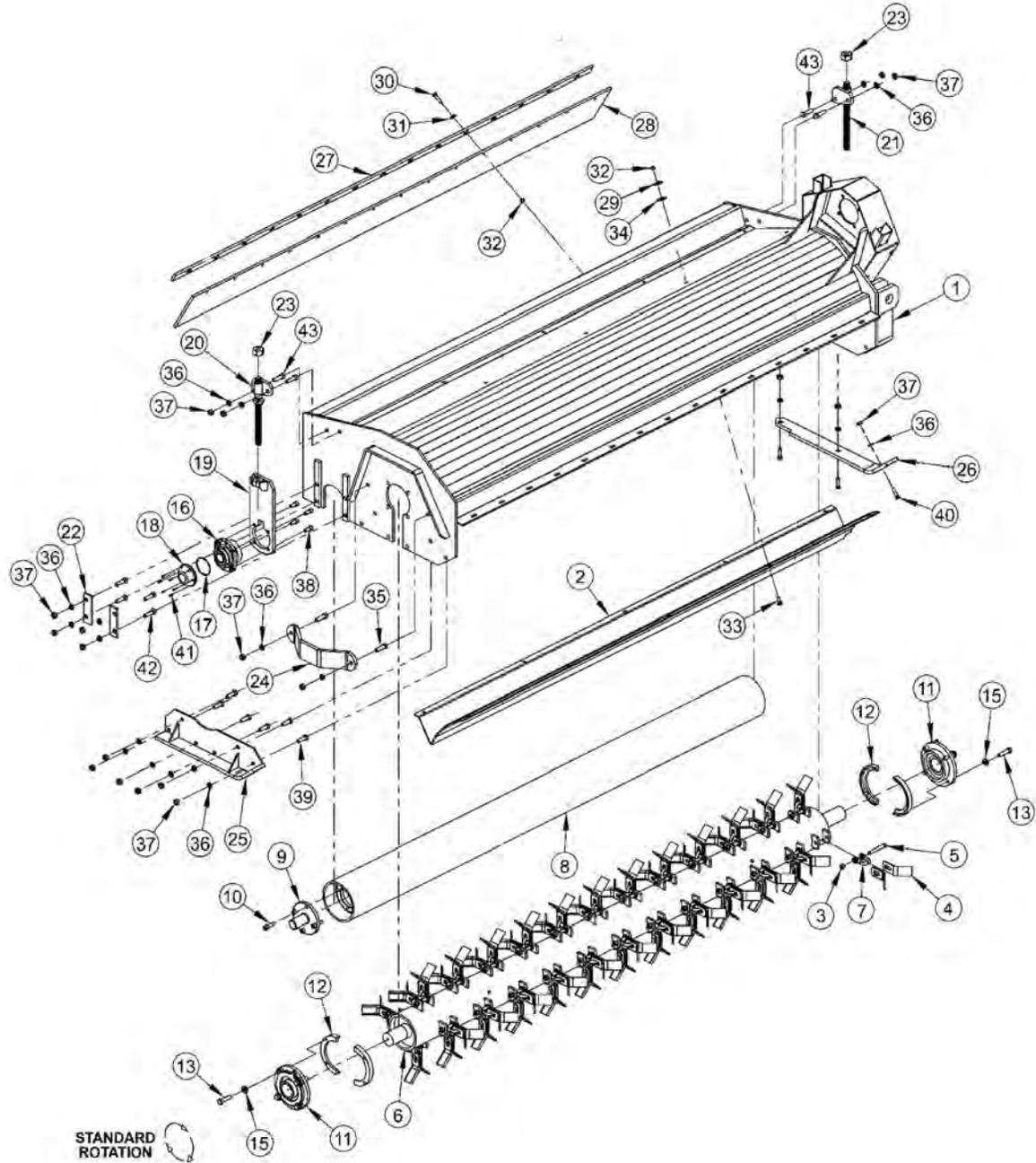

ITEM	PART NO.	QTY.	DESCRIPTION
1	22083A	1	BONNET,90,HD,T3F (RIGHT FLAIL)
---	22084A	1	BONNET,90,HD,T3F (LEFT FLAIL)
2	TF1502A	1	BAFFLE,FLAIL,90HD,STD ROT
---	TF1102A	-	CUTSHT ASSY,90HD,STD KNIVES (ITEMS 3, 4, 5, 6 & 7)
3	21677	48	NYLOCK NUT,7/16 NC
4	33714	96	KNIFE,FLAIL,STANDARD

COMMON TRIPLE

**EXTREME DUTY 90IN SIDE FLAIL - STD ROT**

**Continued...**

<b>ITEM</b>	<b>PART NO.</b>	<b>QTY.</b>	<b>DESCRIPTION</b>
5	34011	48	CAPSCREW,7/16X3 7/16,NC GR8
6	TF1102	1	CUTTERSHAFT,90,HD
7	TF1020	48	KNIFE MTG CLEVIS,FLAIL
8	27972A	1	GROUND ROLLER,90
9	TF1045B	2	STUB SHAFT,GROUND ROLLER
10	6T2330	8	CAPSCREW,SKT HD,7/16X1-1/2NC
11	TF1018	2	BEARING,FLANGE,2-3/16
---	06200347	-	STRING GUARD,KIT,HD(ITEMS 12,13,15)
12	31204	2	STRING GUARD, HD
13	06530217	8	CAPSCREW,1/2 X 2,NC,L9
15	06533006	8	FLATWASHER,1/2,SAE,L9
16	06520028	2	BEARING,FLANGE,1 3/8,GRNDRLR
17	06520029	2	O-RING,2 3/4X3/32,AS568A-148
18	06520027	2	CAP,BEARING,GRNDRLR
19	TF4333A	2	GROUND ROLLER ADJ,BRKT
20	TF4334	1	ROD,GROUND ROLLER ADJ,RT
21	TF4335	1	ROD,GROUND ROLLER ADJ,LF
22	TF4336	4	PLATE,GROUND ROLLER LOCK
23	21399	2	HEX NUT,3/4 (ACME) BULK
24	TF1040	1	GUARD,CUTTER SHAFT
25	TF4371	1	SKID SHOE, OUTER (RIGHT FLAIL)
---	TF4370	1	SKID SHOE, OUTER (LEFT FLAIL)
26	23272A	1	SKID SHOE, INNER (RIGHT FLAIL)
---	27526	1	SKID SHOE, INNER (LEFT FLAIL)
27	TF1135	1	BAR,FLAP,TSF/TRF 90
28	TF1116	1	FLAP,DEFLECTOR,TSF/TRF 90
29	21988	10	LOCKWASHER,3/8
30	21632	15	CAPSCREW,3/8 X 1-1/2 NC
31	22016	15	FLATWASHER,3/8
32	21625	25	HEX NUT,3/8 NC
33	6T2283	10	CARRIAGE BOLT,3/8 X 1 NC
34	6T2615	10	WASHER,FENDER 3/8
35	21732	2	CAPSCREW,1/2 X 1-3/4 NC
36	21990	23	LOCKWASHER,1/2
37	21725	23	HEX NUT,1/2 NC
38	6T2331	8	CAPSCREW,SKT HD,7/16 X 1 NC
39	21730	6	CAPSCREW,1/2 X 1-1/4 NC
40	23293	3	PLOW,BOLT,1/2 X 1-3/4 NC
41	06530001	12	CAPSCREW,SKT HD,8-32X1/2,SS
42	6T2291	8	PLOW BOLT,1/2 X 2 NC GR5
43	21731	4	CAPSCREW,1/2 X 1-1/2 NC

COMMON TRIPLE

## EXTREME DUTY 90IN SIDE FLAIL - REV ROT

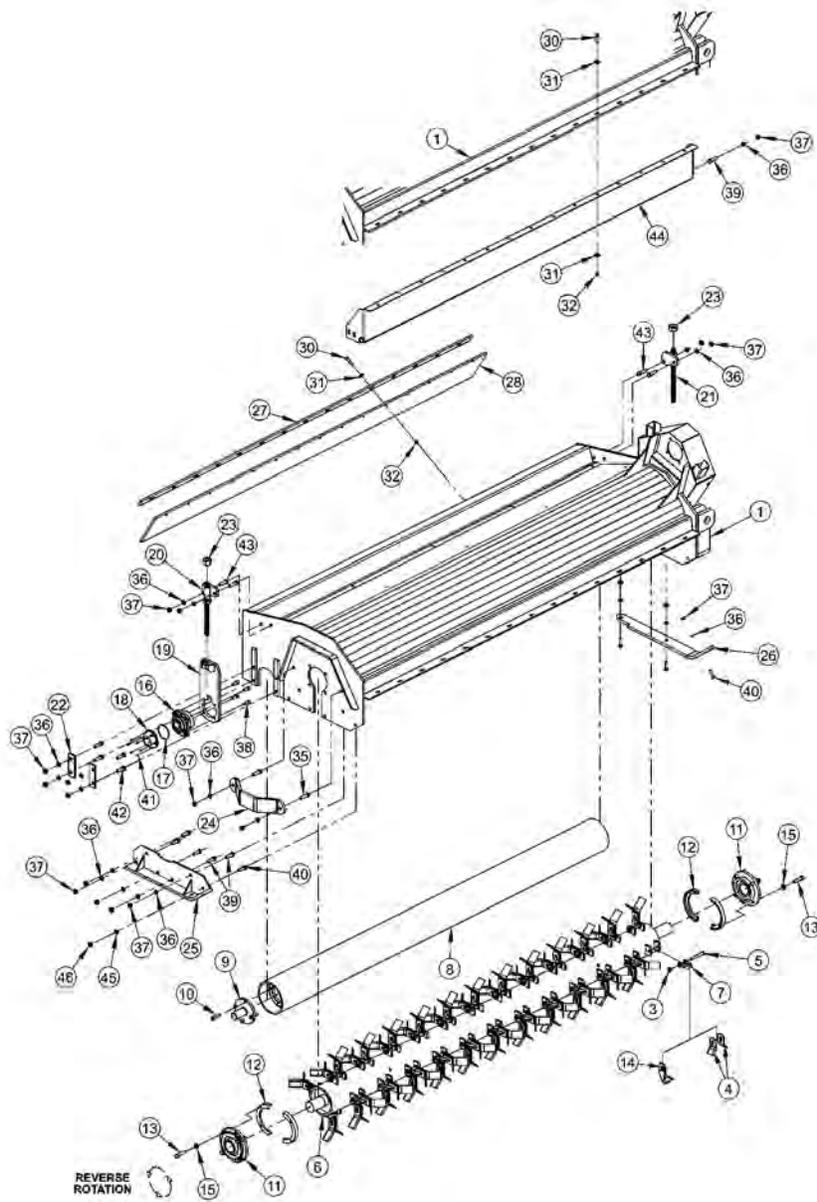

ITEM	PART NO.	QTY.	DESCRIPTION
1	22083A	1	BONNET,90,HD,ASSY (RIGHT FLAIL)
---	22084A	1	BONNET,90,HD,ASSY (LEFT FLAIL)
2	TF1102A	-	CUTSFT ASSY,90HD (STANDARD CUT) (ITEMS 3, 4, 5, 6 & 7)
---	TF1102B	-	CUTSFT ASSY,90HD (SMOOTH CUT) (ITEMS 3, 5, 6, 7 & 14)
3	21677	48	NYLOCK NUT,7/16 NC
4	33714	96	KNIFE,FLAIL (STANDARD CUT)
5	34011	48	CAPSCREW,7/16X3 7/16,NC GR8
6	TF1102	1	CUTTERSHAFT,90,HD
7	TF1020	48	KNIFE MTG CLEVIS,FLAIL
8	27972A	1	GROUND ROLLER,90

COMMON TRIPLE

**EXTREME DUTY 90IN SIDE FLAIL - REV ROT**

**Continued...**

<b>ITEM</b>	<b>PART NO.</b>	<b>QTY.</b>	<b>DESCRIPTION</b>
9	TF1045B	2	STUB SHAFT,GROUND ROLLER
10	6T2330	8	CAPSCREW,SKT HD,7/16X1-1/2NC
11	TF1018	2	BEARING,FLANGE,2-3/16
---	06200347	-	STRING GUARD,KIT,HD(ITEMS 12,13,15)
12	31204	2	STRING GUARD, HD
13	06530217	8	CAPSCREW,1/2 X 2,NC,L9
14	TF1019F	48	KNIFE,FLAIL (SMOOTH CUT)
15	06533006	8	FLATWASHER,1/2,SAE,L9
16	06520028	2	BEARING,FLANGE,1 3/8,GRNDRLR
17	06520029	2	O-RING,2 3/4X3/32,AS568A-148
18	06520027	2	CAP,BEARING,GRNDRLR
19	TF4333A	2	GROUND ROLLER ADJ,BRKT
20	TF4334	1	ROD,GROUND ROLLER ADJ,RT
21	TF4335	1	ROD,GROUND ROLLER ADJ,LF
22	TF4336	4	PLATE,GROUND ROLLER LOCK
23	21399	2	HEX NUT,3/4 (ACME) BULK
24	TF1040	1	GUARD,CUTTER SHAFT
25	TF4371	1	SKID SHOE, OUTER (RIGHT FLAIL)
---	TF4370	1	SKID SHOE, OUTER (LEFT FLAIL)
26	23272A	1	SKID SHOE, INNER (RIGHT FLAIL)
---	27526	1	SKID SHOE, INNER (LEFT FLAIL)
27	TF1135	1	BAR,FLAP,TSF/TRF 90
28	TF1116	1	FLAP,DEFLECTOR,TSF/TRF 90
30	21632	30	CAPSCREW,3/8 X 1-1/2 NC
31	22016	45	FLATWASHER,3/8
32	21625	30	HEX NUT,3/8 NC
35	21732	2	CAPSCREW,1/2 X 1-3/4 NC
36	21990	23	LOCKWASHER,1/2
37	21725	23	HEX NUT,1/2 NC
38	6T2331	8	CAPSCREW,SKT HD,7/16 X 1 NC
39	21730	6	CAPSCREW,1/2 X 1-1/4 NC
40	23293	3	PLOW,BOLT,1/2 X 1-3/4 NC
41	06530001	12	CAPSCREW,SKT HD,8-32X1/2,SS
42	6T2291	8	PLOW BOLT,1/2 X 2 NC GR5
43	21731	4	CAPSCREW,1/2 X 1-1/2 NC
44	TF1503	1	TRASH GUARD,90REV ROT-HD
45	22018	1	FLATWASHER,1/2,WIDE
46	21727	1	NYLOCK NUT,1/2 NC

COMMON TRIPLE

## DIRECT DRIVE 90IN SIDE FLAIL - REV ROT

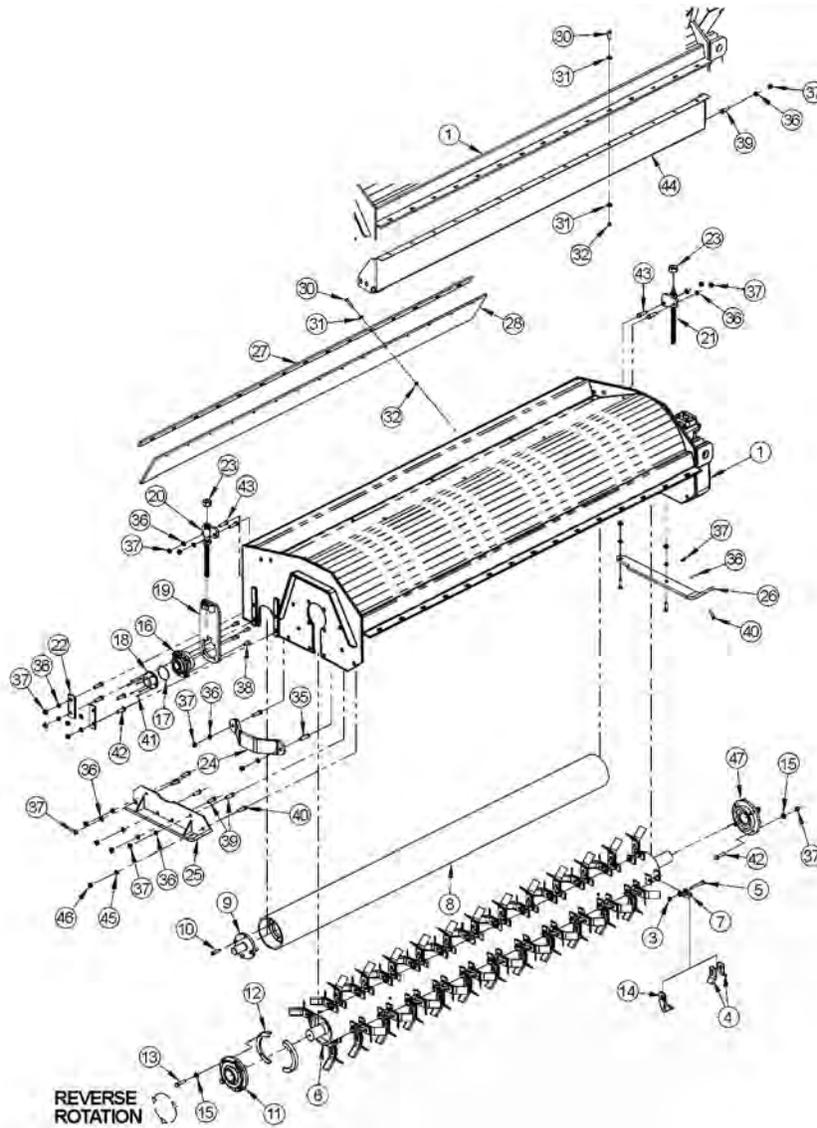

ITEM	PART NO.	QTY.	DESCRIPTION
1	06320032	1	BONNET,90, HD, TDF, DD (RIGHT FLAIL)
*	06320035	1	BONNET,90,HD, TDF, DD (LEFT FLAIL)
2	063700063	-	CUTSHFT ASSY,90HD DD, STD
*	06700075	-	CUTSHFT ASSY,90HD, SMC, RH
	06700081	-	CUTTERSHAFT, ASSY, 90HD, DD, SMC, LH
3	21677	48	NYLOCK NUT,7/16 NC
4	33714	96	KNIFE,FLAIL (STANDARD CUT)
5	34011	48	CAPSCREW,7/16X3 7/16,NC GR8
6	06320052	1	CUTTERSHAFT,90, DD, INSERT
7	TF1020	48	KNIFE MTG CLEVIS,FLAIL
8	27972A	1	GROUND ROLLER,90
9	TF1045B	2	STUB SHAFT,GROUND ROLLER

COMMON TRIPLE

## DIRECT DRIVE 90IN SIDE FLAIL - REV ROT

Continued...

ITEM	PART NO.	QTY.	DESCRIPTION
10	6T2330	8	CAPSCREW,SKT HD,7/16X1-1/2NC
11	TF1018	2	BEARING,FLANGE,2-3/16
-----	06200347	-	STRING GUARD,KIT,HD(ITEMS 12,13,15)
12	31204	2	STRING GUARD, HD
13	06530217	8	CAPSCREW,1/2 X 2,NC,L9
14	TF1019F	48	KNIFE,FLAIL (SMOOTH CUT)
15	06533006	12	FLATWASHER,1/2,SAE,L9
16	06520028	2	BEARING,FLANGE,1 3/8,GRNDRLR
17	06520029	2	O-RING,2 3/4X3/32,AS568A-148
18	06520027	2	CAP,BEARING,GRNDRLR
19	TF4333A	2	GROUND ROLLER ADJ,BRKT
20	TF4334	1	ROD,GROUND ROLLER ADJ,RT
21	TF4335	1	ROD,GROUND ROLLER ADJ,LF
22	TF4336	4	PLATE,GROUND ROLLER LOCK
23	21399	2	HEX NUT,3/4 (ACME) BULK
24	TF1040	1	GUARD,CUTTER SHAFT
25	TF4371	1	SKID SHOE, OUTER (RIGHT FLAIL)
*	TF4370	1	SKID SHOE, OUTER (LEFT FLAIL)
26	23272A	1	SKID SHOE, INNER (RIGHT FLAIL)
*	27526	1	SKID SHOE, INNER (LEFT FLAIL)
27	TF1135	1	BAR,FLAP,TSF/TRF 90
28	TF1116	1	FLAP,DEFLECTOR,TSF/TRF 90
29	06520243	1	FLAP,90",FRONT
30	21632	30	CAPSCREW,3/8 X 1-1/2 NC
31	22016	60	FLATWASHER,3/8
32	21625	40	HEX NUT,3/8 NC
33	6T2283	10	CARRIAGE BOLT,3/8 X 1 NC
34	6T2615	10	WASHER,FENDER 3/8
35	21732	2	CAPSCREW,1/2 X 1-3/4 NC
36	21990	23	LOCKWASHER,1/2
37	21725	23	HEX NUT,1/2 NC
38	6T2331	8	CAPSCREW,SKT HD,7/16 X 1 NC
39	21730	6	CAPSCREW,1/2 X 1-1/4 NC
40	23293	3	PLOW,BOLT,1/2 X 1-3/4 NC
41	06530001	12	CAPSCREW,SKT HD,8-32X1/2,SS
42	6T2291	8	PLOW BOLT,1/2 X 2 NC GR5
43	21731	4	CAPSCREW,1/2 X 1-1/2 NC
44	TF1503	1	TRASH GUARD,90REV ROT-HD
45	22018	1	FLATWASHER,1/2,WIDE
46	21727	1	NYLOCK NUT,1/2 NC
47	06520190	1	BEARING, W/HSNG, 2/19, DRIVE,DD

COMMON TRIPLE

# DIRECT DRIVE 90IN SIDE FLAIL -RH MOTOR AND HOSES

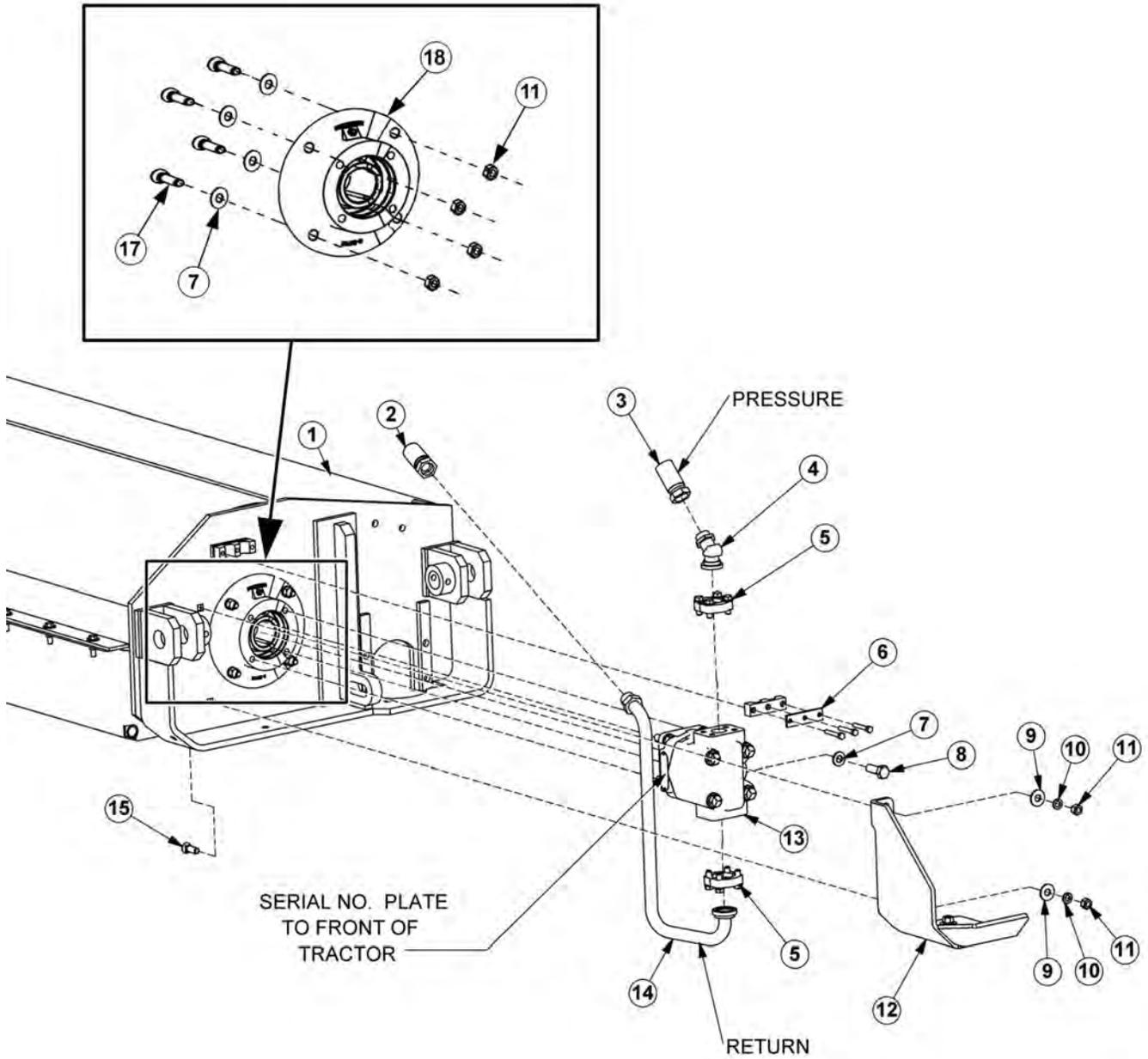

FRONT OF TRACTOR



## DIRECT DRIVE 90IN SIDE FLAIL -RH MOTOR AND HOSES

Continued...

ITEM	PART NO.	QTY.	DESCRIPTION
1	-----	-	BONNET *REFER TO BONNET ASSY
2	06500394	1	HOSE,1" X 120" (RETURN)
3	06500385	1	HOSE,1" X 117" (PRESSURE)
4	06503058	1	ELBOW,1 1/4" FLG 45° X 1" MJ
5	TF4852	2	KIT,FLANGE, 1 1/4"
6	06505014	1	CLAMP KIT
7	06533006	8	FLATWASHER,1/2",SAE,L9
8	06530218	4	CAPSCREW,1/2 X 1 3/4,NC,L9
9	22018	2	FLATWASHER,1/2",WIDE
10	21990	2	LOCKWASHER,1/2"
11	21725	6	HEX NUT,1/2", NC
12	06410500	1	MOTOR GUARD,RH
13	06504143	1	MOTOR,DD
14	06506035	1	TUBE,PREFRMD,1 1/4"FLG 180° X 1" MJ,RH
15	23293	2	PLOW BOLT,1/2"X1-3/4",NC
17	6T2291	4	PLOW BOLT, 1/2" X 2" NC GR5
18	06520190	1	BEARING, W/HSNG 2.19, DRIVE DD

COMMON TRIPLE

FRONT FLAPS, XD FLAIL - STANDARD ROTATION

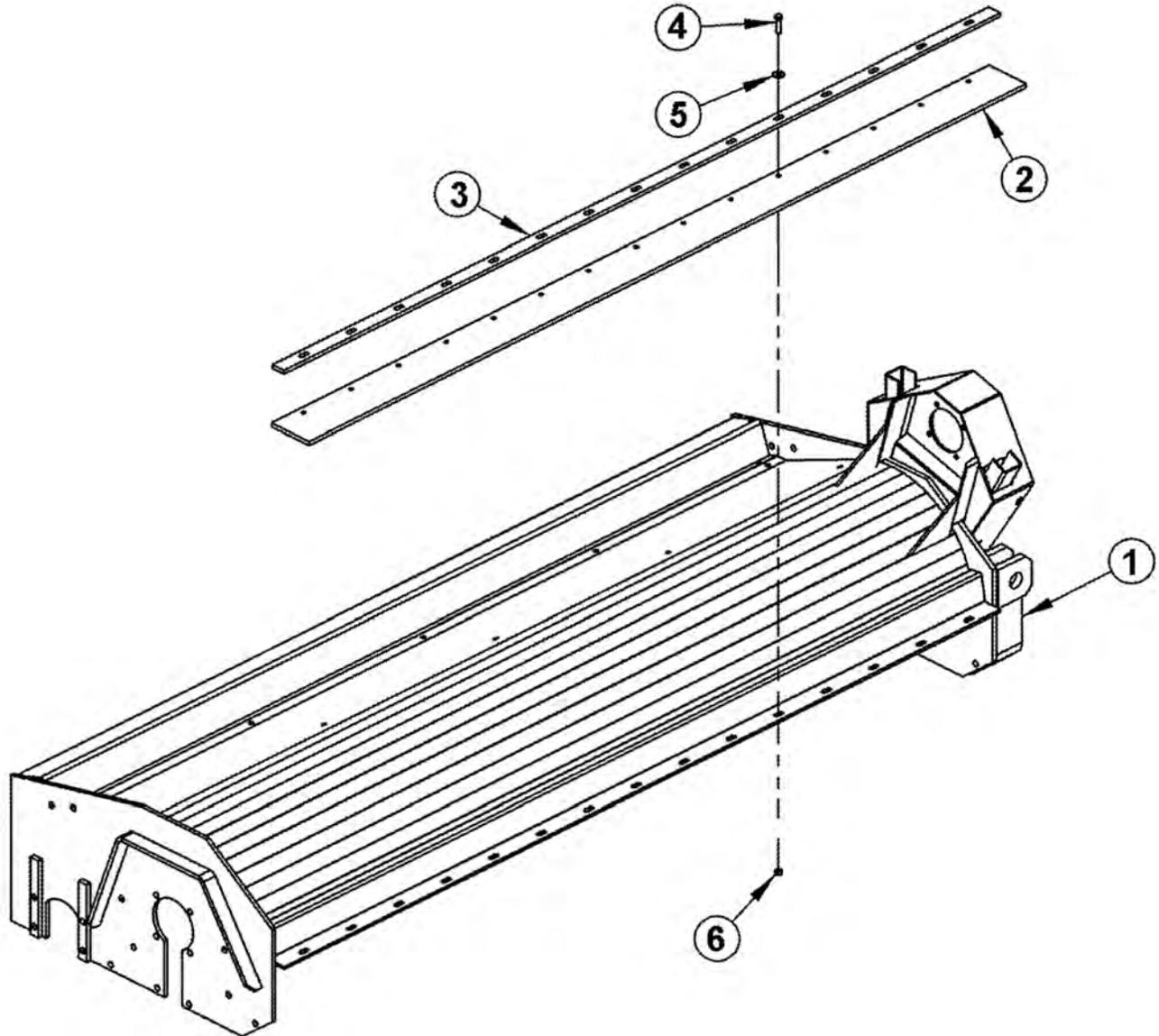

COMMON TRIPLE

**FRONT FLAPS, XD FLAIL - STANDARD ROTATION**

**Continued...**

<b>ITEM</b>	<b>PART NO.</b>	<b>QTY.</b>	<b>DESCRIPTION</b>
1	-----	-	BONNET *REFER TO HEAD ASSEMBLY
2	06520240	1	FLAP,FRONT,60IN
---	06520242	1	FLAP,FRONT,75IN
----	06520243	1	FLAP,FRONT,90IN
3	TF1803	1	BAR,FLAP,60IN
---	TF1029	1	BAR,FLAP,75IN
----	TF1135	1	BAR,FLAP,90IN
4	21632	10	CAPSCREW,3/8" X 1-1/2",NC (60IN FLAIL)
---	-----	13	CAPSCREW,3/8" X 1-1/2",NC (75IN FLAIL)
	-----	15	CAPSCREW,3/8" X 1-1/2",NC (90IN FLAIL)
5	22016	20	FLATWASHER,3/8" (60IN FLAIL)
---	-----	26	FLATWASHER,3/8" (75IN FLAIL)
----	-----	30	FLATWASHER,3/8" (90IN FLAIL)
6	21625	10	HEX NUT,3/8",NC (60IN FLAIL)
---	-----	13	HEX NUT,3/8",NC (75IN FLAIL)
----	-----	15	HEX NUT,3/8",NC (90IN FLAIL)

COMMON TRIPLE

# EXTREME DUTY SIDE FLAIL DRIVE ASSY

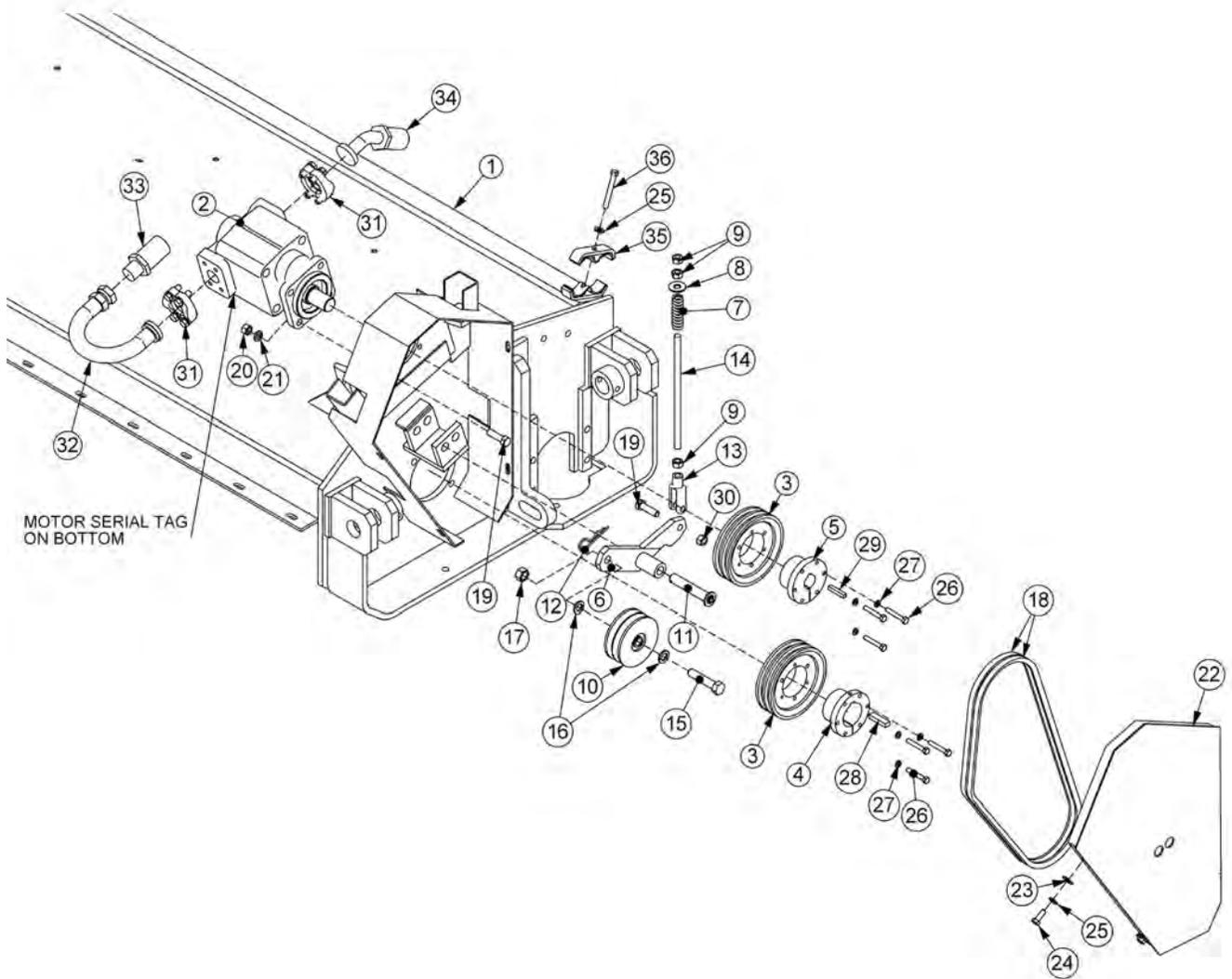

COMMON TRIPLE

## EXTREME DUTY SIDE FLAIL DRIVE ASSY

Continued...

ITEM	PART NO.	QTY.	DESCRIPTION
1	-----	-	BONNET *REFER TO FLAIL PARTS
2	06504066	1	MOTOR,T3F
3	TF3040	2	SHEAVE,6.3
4	TF3011	1	BUSHING,QD,SK,2-3/16"
5	TF3013	1	BUSHING,QD,SK 1-1/4"
6	TF4346	1	IDLER ARM (RIGHT FLAIL - STD ROT / LEFT FLAIL - REV ROT)
---	TF4345	-	IDLER ARM (RIGHT FLAIL - REV ROT / LEFT FLAIL - STD ROT)
7	TF3620A	1	SPRING,TENSIONER
8	22018	1	FLATWASHER,1/2",WIDE
9	21700	3	HEX NUT, 1/2", NF
10	31293	1	SHEAVE,IDLER ASSY, 4.4 O.D.
11	TF3605	1	PIN,IDLER ARM 3/4"X4-1/4"
12	6T3004	1	R-CLIP (HAIRPIN COTTER, 3/16")
13	PT3611A	1	CLEVIS,6"
14	32494	1	ROD, THREADED, 1/2-20NF
15	21787	1	CAPSCREW,5/8" X 3", NC
16	21992	2	LOCKWASHER, 5/8
17	21775	1	HEX NUT, 5/8
18	TF3020	2	V-BELT, (530)
19	21732	5	CAPSCREW, 1/2 X 1 3/4,NC
20	21725	4	HEX NUT, 1/2" NC
21	21990	4	LOCKWASHER, 1/2"
22	TF4564	1	BELT SHEILD (RIGHT)
---	TF4565	1	BELT SHEILD (LEFT)
23	22016	4	FLATWASHER,3/8"
24	21630	4	CAPSCREW, 3/8 X 1,NC
25	21988	5	LOCKWASHER, 3/8"
26	21584	6	CAPSCREW, 5/16 X 2,NC
27	21987	6	LOCKWASHER, 5/16"
28	TF1025	1	KEY,1/4" X 1/2" X 1-7/8" SQ
29	TF1125	1	KEY,3/8" X 1/2" X 1-7/8" SQ
30	21727	1	NYLOCK NUT, 1/2
31	TF4853	2	KIT,FLANGE,#16
32	32920	1	PREFORMED TUBE
33	-----	-	HOSE (RETURN FOR STANDARD ROTATION)
34	-----	-	HOSE (PRESSURE FOR STANDARD ROTATION)
35	TB3031	1	CLAMP,HOSE
36	21638	1	CAPSCREW,3/8 X 3,NC

COMMON TRIPLE



## EXTREME DUTY SIDE FLAIL MOTOR BREAKDOWN

Continued...

ITEM	PART NO.	QTY.	DESCRIPTION
---	06504066	-	MOTOR ASSEMBLY 350 - TSF
1	06504039	1	SHAFT END COVER
2	06504054	1	PORT END COVER
3	06504055	1	GEAR HOUSING
4	06504056	1	MATCHED GEAR SET
5	TF4402	1	BALL BEARING
6	06504057	4	CAP SCREW
7	06504044	2	SET SCREW
9	06504045	4	DOWEL PIN
10	-----	1	NAMEPLATE
11	763759	2	THRUSTPLATE
12	02961940	1	HEX PLUG
13	TF4401	1	SNAP RING
14	06504049	1	LIP SEAL (INCLUDED IN SEAL KIT)
15	TF4410	2	GASKET SEAL (INCLUDED IN SEAL KIT)
16	06504046	4	SIDE SEAL (INCLUDED IN SEAL KIT)
17	06504047	4	END SEAL (INCLUDED IN SEAL KIT)
18	TF4407	2	BACK-UP SEAL (INCLUDED IN SEAL KIT)
19	02961932	1	SEAL RETAINER
20	6T5809	2	CHECK ASSEMBLY
21	02961917	4	WASHER
---	06504023	-	SEAL KIT (INCLUDES 14, 15, 16, 17, AND 18)

COMMON TRIPLE

# SUPER DUTY 75IN REAR FLAIL - STD ROT

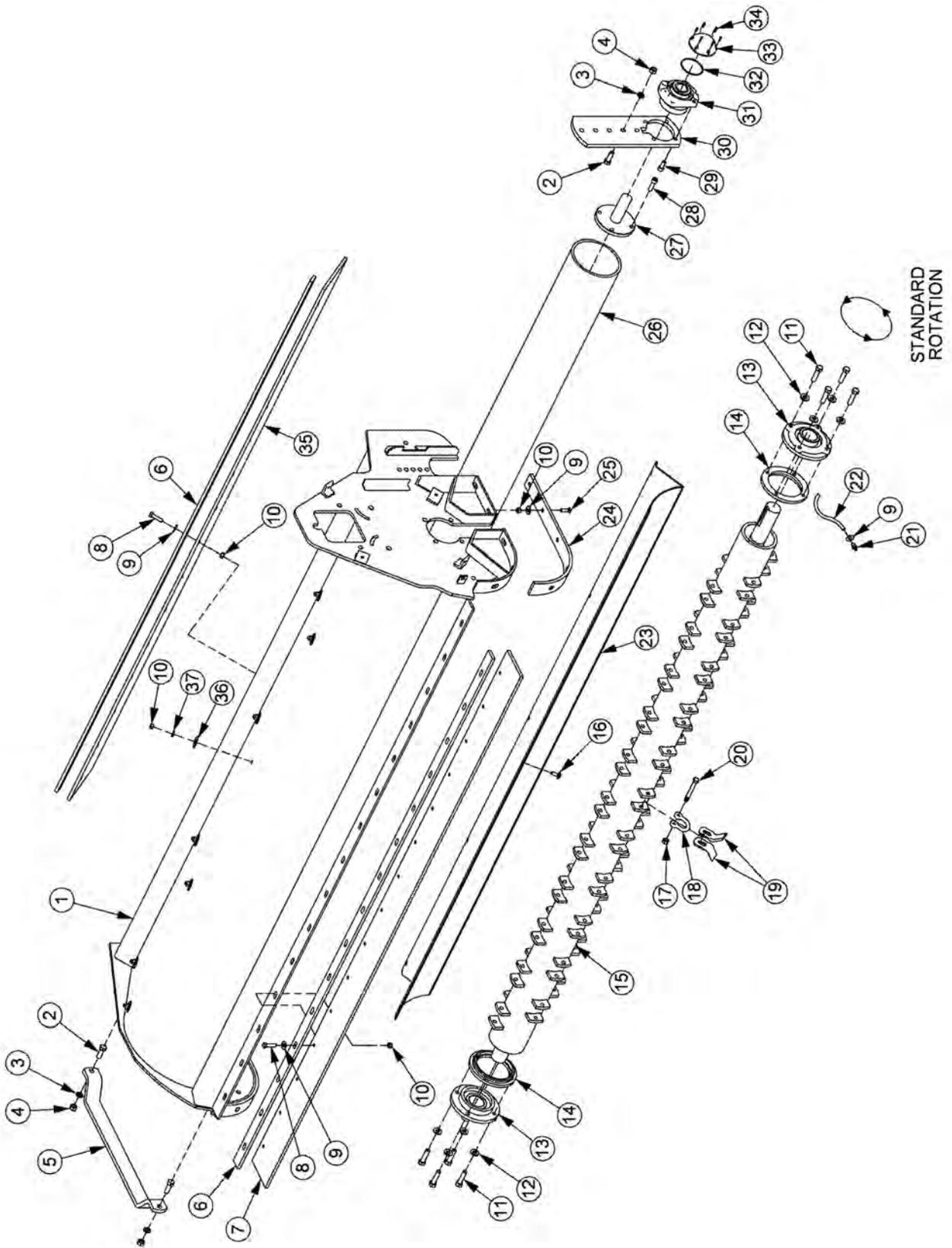

COMMON TRIPLE



**SUPER DUTY 75IN REAR FLAIL - STD ROT**

**Continued...**

<b>ITEM</b>	<b>PART NO.</b>	<b>QTY.</b>	<b>DESCRIPTION</b>
---	06742090	-	75" REAR FLAIL,SD,STD ROT
1	06320134	1	BONNET,75",STD,ROSTA
2	21731	6	CAPSCREW,1/2" X 1-1/2",NC
3	21990	6	LOCKWASHER,1/2"
4	21725	6	HEX NUT,1/2",NC
5	27975A	1	GUARD,CUTTERSHAFT
6	TF1029	2	BAR,FLAP,TSF/TRF 75"
7	06520242	1	FLAP,75",FRONT
8	21632	20	CAPSCREW,3/8" X 1-1/2",NC
9	22016	37	FLATWASHER,3/8",GR8
10	21625	46	HEX NUT,3/8",NC
---	06200639	-	KIT,STRING GUARD (ITEMS 11, 12 & 14)
11	06530217	8	CAPSCREW,3/4" X 2-1/2",GR8,NC
12	06533006	8	FLATWASHER,1/2",SAE,L9
13	28683	2	BEARING,FLANGE,1-15/16",STD
14	33863	2	STRING GUARD,STD
---	28747	-	CUTTERSHAFT ASSY (STANDARD CUT) (ITEMS 15, 17, 18, 19 & 20)
15	28643B	1	CUTTERSHAFT,75"STD,W/EARS
16	6T2283	10	CARRIAGE BOLT,3/8" X 1",NC
17	21677	40	NYLOCK NUT,7/16",NC
18	TF1020	40	KNIFE MTG CLEVIS,FLAIL
19	33713	80	KNIFE,FLAIL (STANDARD CUT)
20	34011	40	CAPSCREW,7/16" X 3-7/16",GR8,NC
21	TF1033	1	GREASE ZERK,1/8" FPT
22	TF1032	1	GRS HOSE,3/16" X 8"
23	28737	1	BAFFLE,75",STD ROT-STD
24	28086A	2	SKID SHOE,STD DUTY,REAR FLAIL
25	30013	10	PLOW BOLT,3/8" X 1-1/4",GR5,NC
26	28738	1	GROUND ROLLER,75"
27	TF1045B	2	STUB SHAFT,GROUND ROLLER
28	6T2330	8	CAPSCREW,SKT HD,7/16" X 1-1/2",NC
29	6T2331	4	CAPSCREW,SKT HD,7/16" X 1",NC
30	28735	2	GROUND ROLLER ADJ BRKT,STD DTY
31	06520028	2	BEARING,FLANGE,1-3/8",GRNDRLLR
32	06520029	2	O-RING,2-3/4" X 3/32"
33	06520027	2	CAP,BEARING,GRNDRLLR
34	06530001	12	CAPSCREW,SKT HD,8-32 X 1/2",SS
35	TF1016	1	FLAP,DEFLECTOR,75"
36	6T2615	10	WASHER,FENDER,3/8"
37	21988	10	LOCKWASHER,3/8"

COMMON TRIPLE



**SUPER DUTY 75IN REAR FLAIL - REV ROT**

**Continued...**

<b>ITEM</b>	<b>PART NO.</b>	<b>QTY.</b>	<b>DESCRIPTION</b>
---	06742091	-	75IN REAR FLAIL,SD,RR (STANDARD CUT)
----	06742092	-	75IN REAR FLAIL,SD,RR (SMOOTH CUT)
1	06320134	1	BONNET,75",STD,ROSTA
2	21731	8	CAPSCREW,1/2" X 1-1/2",NC
3	21990	8	LOCKWASHER,1/2"
4	21725	8	HEX NUT,1/2",NC
5	27975A	1	GUARD,CUTTERSHAFT
7	21632	20	CAPSCREW,3/8" X 1-1/2",NC
8	28968A	1	TRASH GUARD,75"
9	22016	50	FLATWASHER,3/8",GR8
10	21625	40	HEX NUT,3/8",NC
---	06200639	-	KIT,STRING GUARD (ITEMS 11, 12 & 14)
11	06530217	8	CAPSCREW,3/4" X 2-1/2",GR8,NC
12	06533006	8	FLATWASHER,1/2",SAE,L9
13	28683	2	BEARING,FLANGE,1-15/16",STD
14	33863	2	STRING GUARD,STD
---	28747	-	CUTTERSHAFT,ASSY (STANDARD CUT) (ITEMS 15, 16, 17, 18 & 19)
----	28748	-	CUTTERSHAFT,ASSY (SMOOTH CUT) (ITEMS 15, 16, 17, 18A & 19)
15	28643B	1	CUTTERSHAFT,75"STD,W/EARS
16	21677	40	NYLOCK NUT,7/16",NC
17	TF1020	40	KNIFE MTG CLEVIS,FLAIL
18	33713	80	KNIFE,FLAIL (STANDARD CUT)
18A	28184A	40	KNIFE,FLAIL (SMOOTH CUT)
19	34011	40	CAPSCREW,7/16" X 3-7/16",GR8,NC
20	TF1033	1	GREASE ZERK,1/8" FPT
21	TF1032	1	GRS HOSE,3/16" X 8"
22	28086A	2	SKID SHOE,STD DUTY,REAR FLAIL
23	30013	10	PLOW BOLT,3/8" X 1-1/4",GR5,NC
24	28738	1	GROUND ROLLER,75"
25	TF1045B	2	STUB SHAFT,GROUND ROLLER
26	6T2330	8	CAPSCREW,SKT HD,7/16" X 1-1/2",NC
27	6T2331	4	CAPSCREW,SKT HD,7/16" X 1",NC
28	28735	2	GROUND ROLLER ADJ BRKT,STD DTY
29	06520028	2	BEARING,FLANGE,1-3/8",GRNDRLLR
30	06520029	2	O-RING,2-3/4" X 3/32"
31	06520027	2	CAP,BEARING,GRNDRLLR
32	06530001	12	CAPSCREW,SKT HD,8-32 X 1/2",SS
33	TF1016	1	FLAP,DEFLECTOR,75"
34	TF1029	1	BAR,FLAP,TSF/TRF,75"

COMMON TRIPLE

# SUPER DUTY 90IN REAR FLAIL - STD ROT

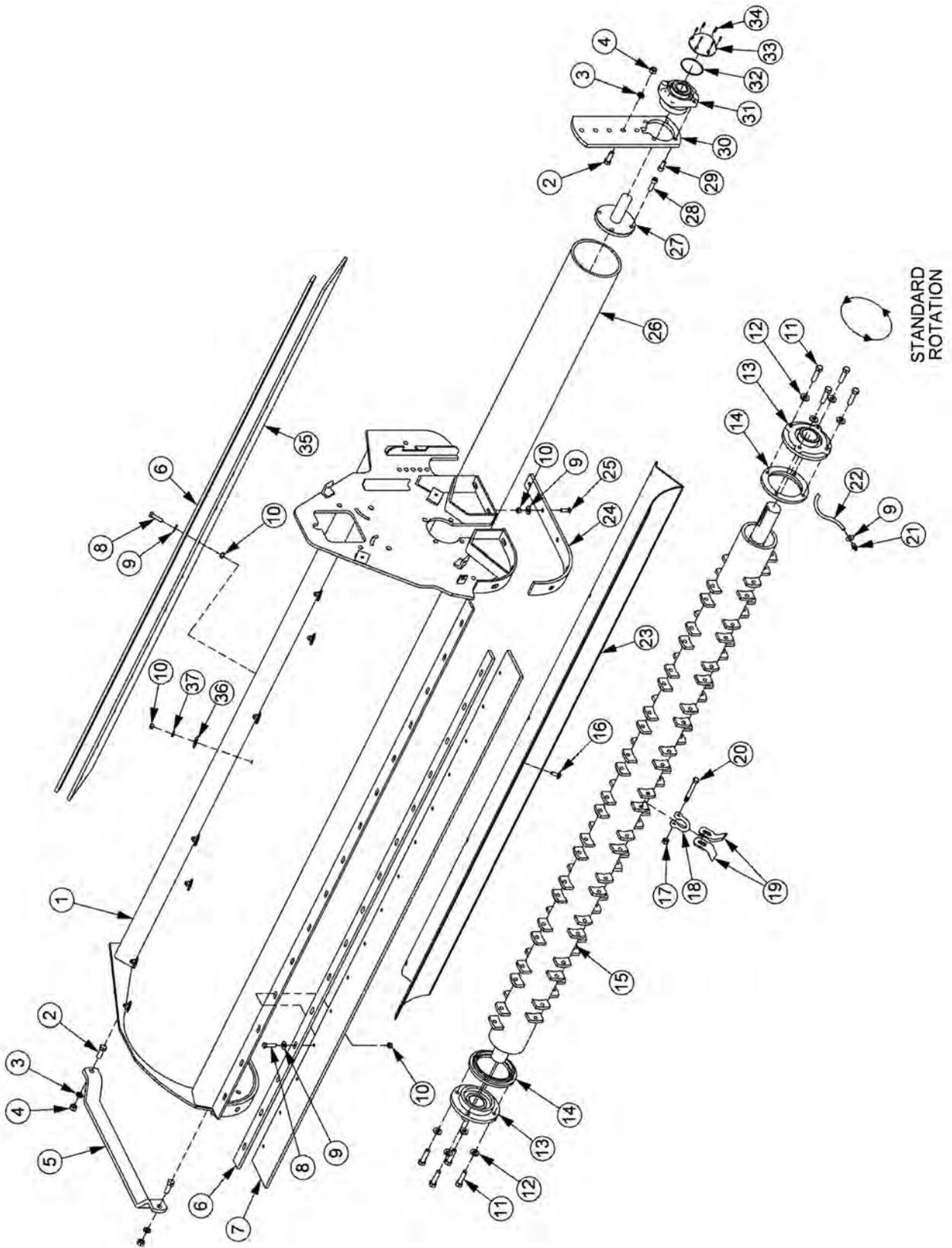

COMMON TRIPLE

**SUPER DUTY 90IN REAR FLAIL - STD ROT**

**Continued...**

<b>ITEM</b>	<b>PART NO.</b>	<b>QTY.</b>	<b>DESCRIPTION</b>
---	06742080	-	90" REAR FLAIL,SD,STD ROT
1	06320115	1	BONNET,90",STD,ROSTA
2	21731	6	CAPSCREW,1/2" X 1-1/2",NC
3	21990	6	LOCKWASHER,1/2"
4	21725	6	HEX NUT,1/2",NC
5	27975A	1	GUARD,CUTTERSHAFT
6	TF1135	2	BAR,FLAP,TSF/TRF 90"
7	06520243	1	FLAP,90",FRONT
8	21632	20	CAPSCREW,3/8" X 1-1/2",NC
9	22016	41	FLATWASHER,3/8",GR8
10	21625	50	HEX NUT,3/8",NC
---	06200639	-	KIT,STRING GUARD (ITEMS 11, 12 & 14)
11	06530217	8	CAPSCREW,3/4" X 2-1/2",GR8,NC
12	06533006	8	FLATWASHER,1/2",SAE,L9
13	28683	2	BEARING,FLANGE,1-15/16",STD
14	33863	2	STRING GUARD,STD
---	28745	-	CUTTERSHAFT ASSY (ITEMS 15, 17, 18, 19 & 20)
15	27964C	1	CUTTERSHAFT,90"STD,W/EARS
16	6T2283	10	CARRIAGE BOLT,3/8" X 1",NC
17	21677	48	NYLOCK NUT,7/16",NC
18	TF1020	48	KNIFE MTG CLEVIS,FLAIL
19	33713	96	KNIFE,FLAIL,SHORT
20	34011	48	CAPSCREW,7/16" X 3-7/16",GR8,NC
21	TF1033	1	GREASE ZERK,1/8" FPT
22	TF1032	1	GRS HOSE,3/16" X 8"
23	27971	1	BAFFLE,90",STD ROT-STD
24	28086A	2	SKID SHOE,STD DUTY,REAR FLAIL
25	30013	10	PLOW BOLT,3/8" X 1-1/4",GR5,NC
26	27972A	1	GROUND ROLLER,90"
27	TF1045B	2	STUB SHAFT,GROUND ROLLER
28	6T2330	8	CAPSCREW,SKT HD,7/16" X 1-1/2",NC
29	6T2331	4	CAPSCREW,SKT HD,7/16" X 1",NC
30	28735	2	GROUND ROLLER ADJ BRKT,STD DTY
31	06520028	2	BEARING,FLANGE,1-3/8",GRNDRLLR
32	06520029	2	O-RING,2-3/4" X 3/32"
33	06520027	2	CAP,BEARING,GRNDRLLR
34	06530001	12	CAPSCREW,SKT HD,8-32 X 1/2",SS
35	TF1116	1	FLAP,DEFLECTOR,90"
36	6T2615	10	WASHER,FENDER,3/8"
37	21988	10	LOCKWASHER,3/8"

COMMON TRIPLE

# SUPER DUTY 90IN REAR FLAIL - REV ROT

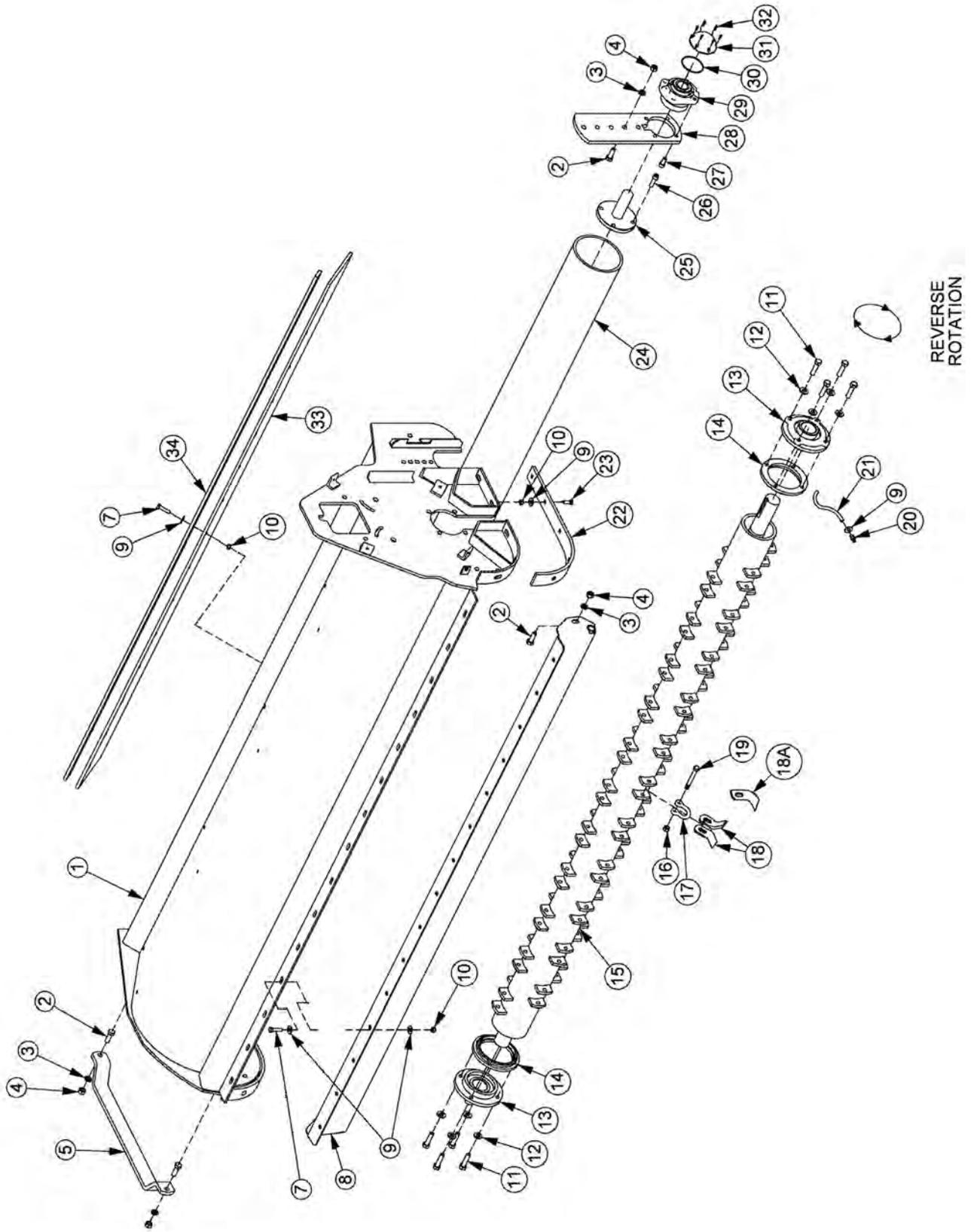

COMMON TRIPLE

## SUPER DUTY 90IN REAR FLAIL - REV ROT

Continued...

ITEM	PART NO.	QTY.	DESCRIPTION
---	06742083	-	90" REAR FLAIL,SD (STANDARD CUT)
----	06742084	-	90" REAR FLAIL,SD (SMOOTH CUT)
1	06320115	1	BONNET,90",STD,ROSTA
2	21731	8	CAPSCREW,1/2" X 1-1/2",NC
3	21990	8	LOCKWASHER,1/2"
4	21725	8	HEX NUT,1/2",NC
5	27975A	1	GUARD,CUTTERSHAFT
7	21632	20	CAPSCREW,3/8" X 1-1/2",NC
8	28967A	1	TRASH GUARD,90"
9	22016	56	FLATWASHER,3/8",GR8
10	21625	40	HEX NUT,3/8",NC
---	06200639	-	KIT,STRING GUARD (ITEMS 11, 12 & 14)
11	06530217	8	CAPSCREW,3/4" X 2-1/2",GR8,NC
12	06533006	8	FLATWASHER,1/2",SAE,L9
13	28683	2	BEARING,FLANGE,1-15/16",STD
14	33863	2	STRING GUARD,STD
---	28745	-	CUTTERSHAFT ASSY (STANDARD CUT) (ITEMS 15, 16, 17, 18 & 19)
----	28746	-	CUTTERSHAFT ASSY (SMOOTH CUT) (ITEMS 15, 16, 17, 18A & 19)
15	27964C	1	CUTTERSHAFT,90"STD,W/EARS
16	21677	48	NYLOCK NUT,7/16",NC
17	TF1020	48	KNIFE MTG CLEVIS,FLAIL
18	33713	96	KNIFE,FLAIL (STANDARD CUT)
18A	28184A	48	KNIFE,FLAIL (SMOOTH CUT)
19	34011	48	CAPSCREW,7/16" X 3-7/16",GR8,NC
20	TF1033	1	GREASE ZERK,1/8" FPT
21	TF1032	1	GRS HOSE,3/16" X 8"
22	28086A	2	SKID SHOE,STD DUTY,REAR FLAIL
23	30013	10	PLOW BOLT,3/8" X 1-1/4",GR5,NC
24	27972A	1	GROUND ROLLER,90"
25	TF1045B	2	STUB SHAFT,GROUND ROLLER
26	6T2330	8	CAPSCREW,SKT HD,7/16" X 1-1/2",NC
27	6T2331	4	CAPSCREW,SKT HD,7/16" X 1",NC
28	28735	2	GROUND ROLLER ADJ BRKT,STD DTY
29	06520028	2	BEARING,FLANGE,1-3/8",GRNDRLLR
30	06520029	2	O-RING,2-3/4" X 3/32"
31	06520027	2	CAP,BEARING,GRNDRLLR
32	06530001	12	CAPSCREW,SKT HD,8-32 X 1/2",SS
33	TF1116	1	FLAP,DEFLECTOR,90"
34	TF1035	1	BAR,FLAP,TSF/TRF,90"

COMMON TRIPLE

# SUPER DUTY REAR FLAIL DRIVE ASSY

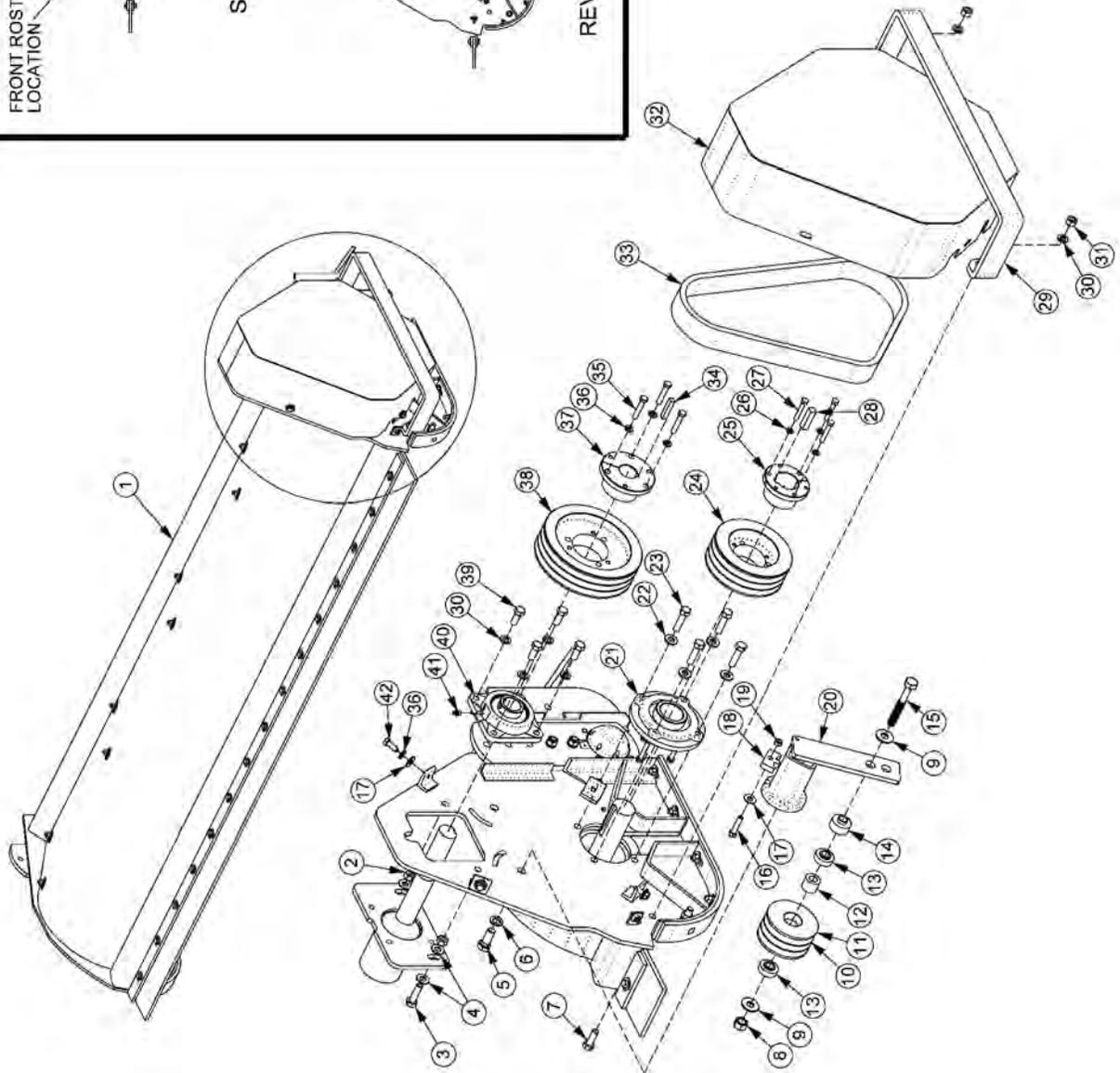
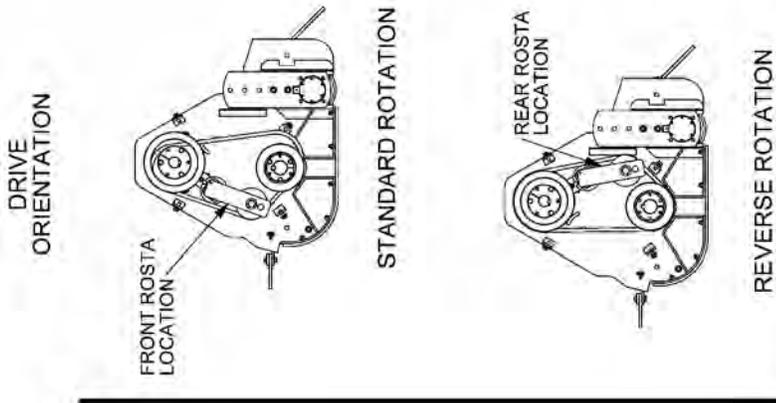

ITEM	PART NO.	QTY.	DESCRIPTION
1	-----	-	BONNET *REFER TO CUTTER ASSEMBLY
2	21727	2	NYLOCK NUT, 1/2", NC
3	21732	2	CAPSCREW, 1/2" X 1-3/4", NC
4	22018	4	FLATWASHER, 1/2", WIDE

COMMON TRIPLE



## SUPER DUTY REAR FLAIL DRIVE ASSY

Continued...

ITEM	PART NO.	QTY.	DESCRIPTION
5	22421	-	CAPSCREW,16MM X 40MM(2.0P)
6	31956	-	FLATWASHER,16MM,HARDENED
7	21731	2	CAPSCREW,1/2" X 1-1/2",NC
8	32838	1	HEX NUT,5/8-11 UNC,GR8
9	25270	2	FLATWASHER,5/8",GR8,USS
10	06700092	-	ASSY,SHEAVE,IDLER,3 GRV
11	06420072	1	SHEAVE,IDLER,3 GRV
12	06430072	1	SPACER, 1.25" X .69" X 1.03"
13	31298	2	BRG, FAFNIR, 203KRR2
14	06420094	1	SPACER,1.00" X 1.63" X .64"
15	33854	1	CAPSCREW,5/8" X 4-1/2",GR8,NC
16	21632	1	CAPSCREW,3/8" X 1-1/2",NC
17	22016	5	FLATWASHER,3/8",GR8
18	06400717	1	STOP,ROSTA
19	21627	1	NYLOCK NUT,3/8",NC
20	06520306	1	TNSNR,ROSTA,SE38,W/MTG BOLT
21	28683	2	BEARING,FLANGE,1-15/16",STD
22	06533006	8	FLATWASHER,1/2",L9,SAE
23	06530217	8	CAPSCREW,1/2" X 2",L9,NC
24	06520218	1	SHEAVE,6.7",3G5V,QD,SK
25	28723	1	BUSHING,QD,SK 1-15/16"
26	21987	3	LOCKWASHER,5/16"
27	21584	3	CAPSCREW,5/16" X 2",NC
28	26142A	1	KEY,1/2"SQ X 2"
29	06410723	1	BAR,RUB
30	21990	6	LOCKWASHER,1/2"
31	21725	2	HEX NUT,1/2",NC
32	06320114	1	SHIELD,BELT,WLDMNT,STD
33	06520312	1	BELT,BANDED,3/5VX560
34	28224	1	KEY,3/8"SQ X 2"
35	21634	3	CAPSCREW,3/8" X 2",NC
36	21988	3	LOCKWASHER,3/8"
37	06520304	1	BUSHING,QD,SF 1-1/2",3/8" KEY
38	02967325	1	SHEAVE,8.5",3G5V
39	21730	4	CAPSCREW,1/2" X 1-1/4",NC
40	06520308	1	BRNG,FLNG,1-1/2",GRIP-TIGHT
41	6T3208	1	ZERK,1/8" X 45°
42	21630	4	CAPSCREW,3/8" X 1",NC
43	06520386	-	GAGE,TENSION,PLUNGER (NOT SHOWN)
44	06401023	-	WRENCH,ROSTA

COMMON TRIPLE

# SUPER DUTY PTO DRIVE ASSY

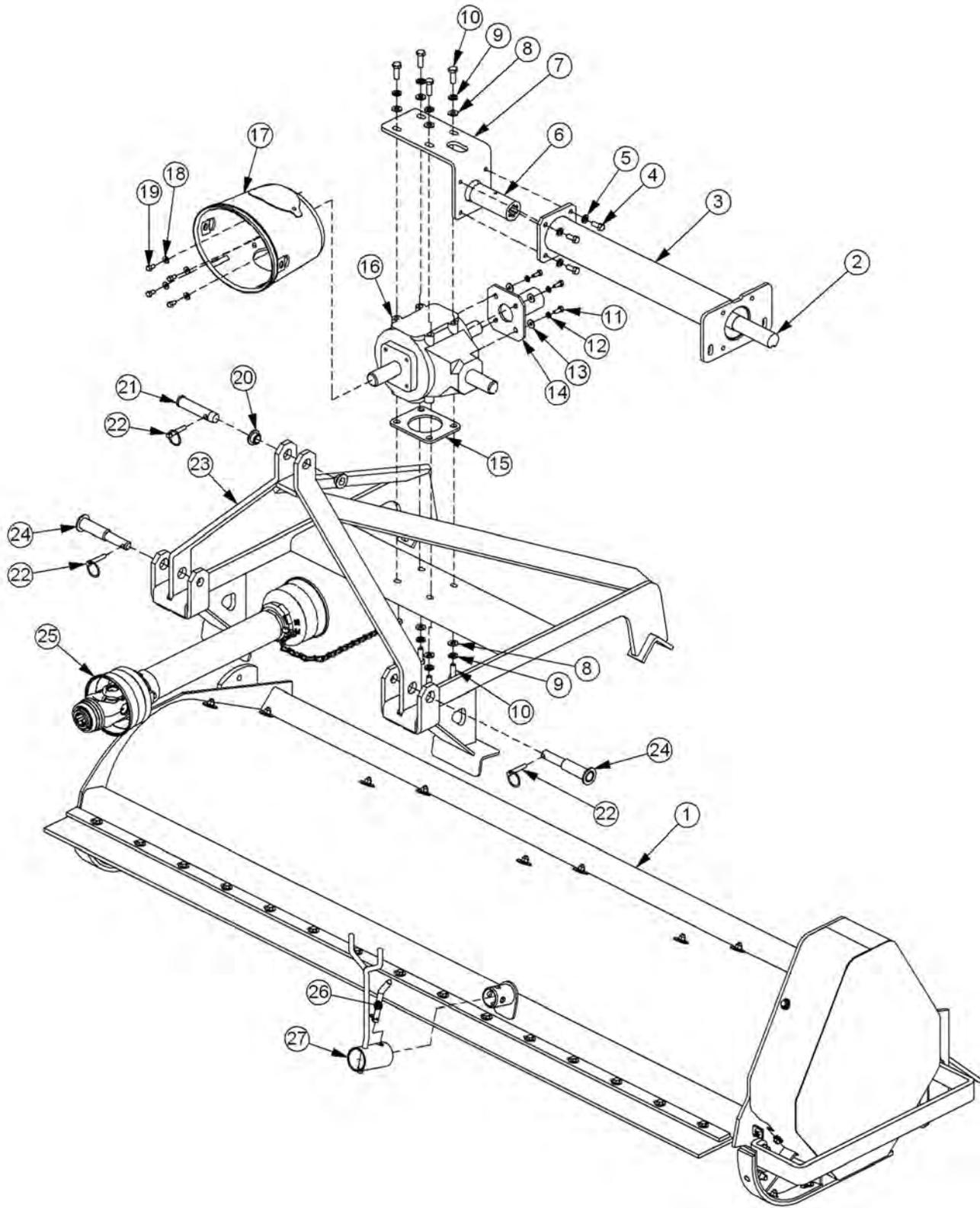

COMMON TRIPLE

## SUPER DUTY PTO DRIVE ASSY

Continued...

ITEM	PART NO.	QTY.	DESCRIPTION
1	06320134	1	BONNET,75,STD,ROSTA
---	06320115	-	BONNET,90,STD,ROSTA
2	06420110	1	SHAFT,OUTPUT,TRF75
----	06420109	-	SHAFT,OUTPUT,TRF75 (OFFSET)
---	06420092	-	SHAFT,OUTPUT,TRF90
----	06420109	-	SHAFT,OUTPUT,TRF90 (OFFSET)
3	06320133	1	TUBE,SAFETY,75,SD
----	06320119	1	TUBE,SAFETY,75 (OFFSET)
---	06320117	-	TUBE,SAFETY,90,SD
----	06320119	-	TUBE,SAFETY,90 (OFFSET)
4	21679	4	CAPSCREW,7/16 X 1,NC
5	21989	4	LOCKWASHER,7/16
6	28914	1	COUPLING,6 SPLINE W/ZERK
7	33204	1	PLATE,MNT,GUARD
8	27724	8	LOCKWASHER,12MM
9	22017	4	FLATWASHER,7/16
10	34890	8	CAPSCREW,12MM X 35MM(1.75P)
11	27508	4	CAPSCREW,8MM X 20MM(1.25P)
12	6T2619	4	LOCKWASHER,8MM
13	22015	4	FLATWASHER,5/16
14	28447E	1	GUARD,TRF,OUTPUT SHAFT
15	06400018	1	SPACER,REAR FLAIL (IF NECESSARY)
16	28950	1	GEAR BOX,540 RPM
17	06520181	1	SHIELD,PTO
18	34948	4	FLATWASHER,3/8
19	27507	4	CAPSCREW,8MM X 15MM(1.25P)
20	28235A	2	BUSHING,3PT,CAT II TO CAT I
21	TB1036	1	PIN,SEC BOOM SWIV 1 X 4-11/16
22	TF1143	3	PIN,LYNCH,7/16 X 2
23	06370154	1	FRM,3PT,STD
24	28234B	2	PIN,3PT,TRF,STD
25	06520414	1	PTO,DRV SHFT,TRF
---	06520415	-	PTO,DRV SHFT,TRF,W/ CLUTCH
26	06520048	1	PIN,.5 X 2.5,BENT,W/R-CLIP
27	06370022	1	SUPPORT,PTO

COMMON TRIPLE

# SUPER DUTY REAR GEAR BOX ASSY

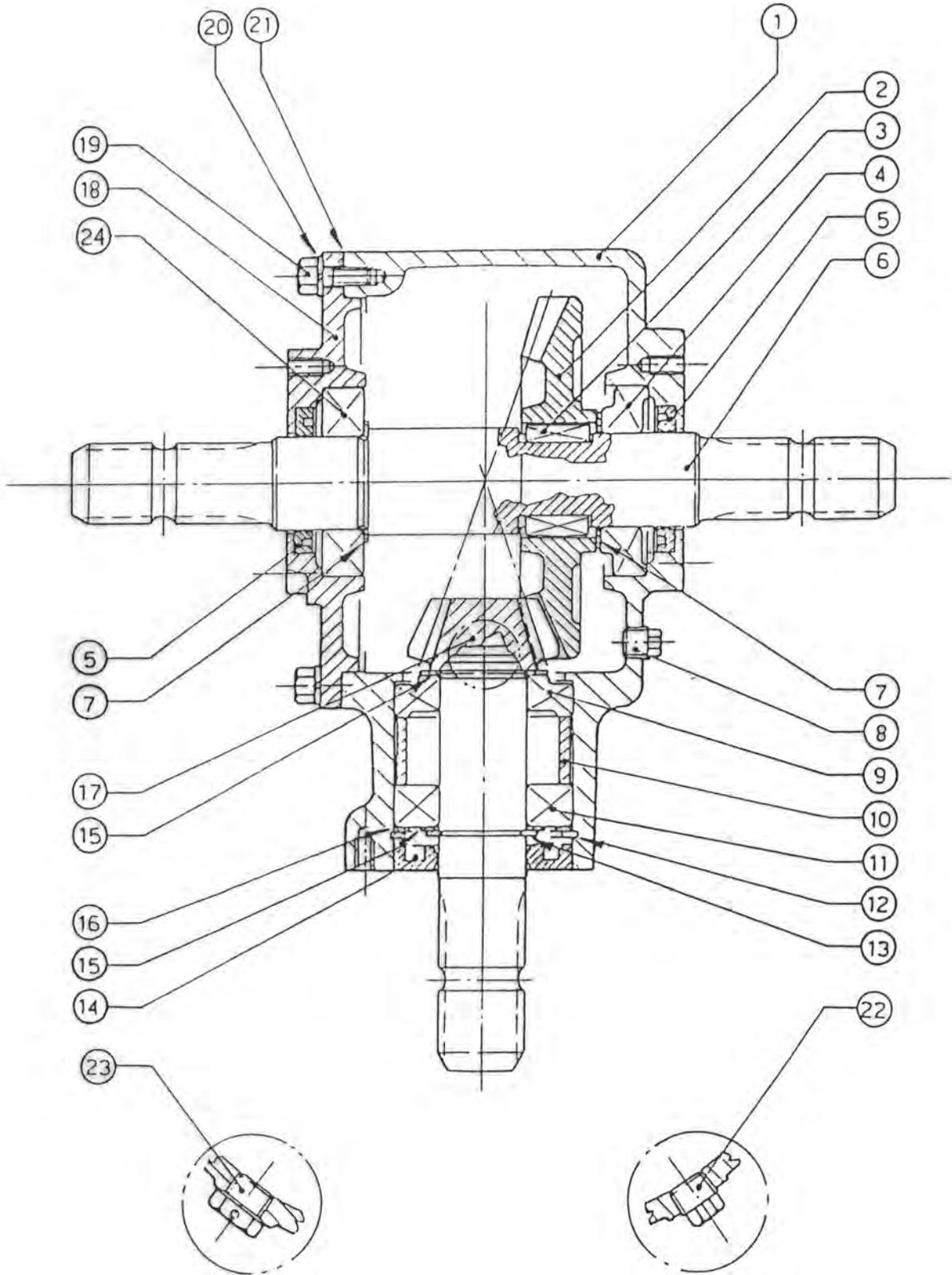

COMMON TRIPLE

## SUPER DUTY REAR GEAR BOX ASSY

Continued...

ITEM	PART NO.	QTY.	DESCRIPTION
1	30133	1	CASING
2	30134	1	CROWNWHEEL Z30
3	30135	2	PARALLEL KEY
4	28604	1	BEARING 30208
5	30136	2	OIL SEAL 40 X 62 X 7
6	30137	1	SHAFT
7	28603	2	SHIM
8	30138	1	PLUG
9	30139	1	BEARING 30207
10	30140	1	SPACER
11	30141	1	BEARING 6207
12	30142	1	INTERNAL CIRCLIP 72
13	30143	1	EXTERNAL CIRCLIP 35
14	30144	2	OIL SEAL 35 X 72 X 10
15	30145	1	SHIM
16	30146	1	SHIM
17	30147	1	PINION Z10
18	30148	1	COVER
19	30149	6	HEX BOLT M8 X 22
20	30150	6	WASHER
21	30151	1	SEAL
22	30152	1	PLUG
23	30153	1	OIL FILLER PLUG
24	30154	1	BEARING 6208

COMMON TRIPLE

# EXTREME DUTY 75IN REAR FLAIL - STD ROT

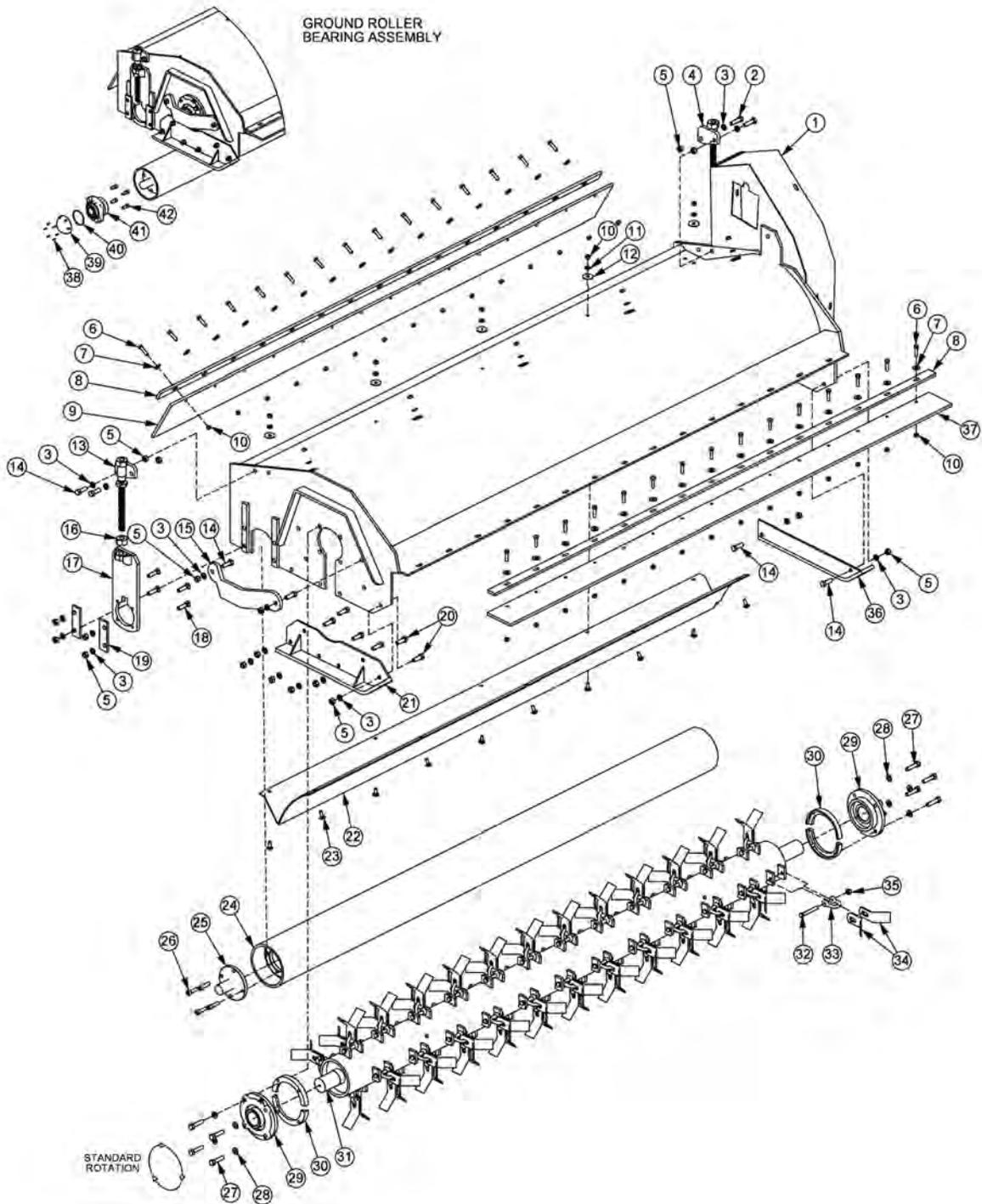

ITEM	PART NO.	QTY.	DESCRIPTION
---	33036	-	75" REAR FLAIL ASSY,HD,STD ROT
1	22043J	1	BONNET,75",HD
2	21732	2	CAPSCREW,1/2" X 1-3/4",NC
3	21990	22	LOCKWASHER,1/2"

COMMON TRIPLE

## EXTREME DUTY 75IN REAR FLAIL - STD ROT

Continued...

ITEM	PART NO.	QTY.	DESCRIPTION
4	TF4335	1	ROD,GROUND ROLLER ADJ,LF
5	21725	22	HEX NUT,1/2",NC
6	21632	26	CAPSCREW,3/8" X 1-1/2",NC
7	22016	26	FLATWASHER,3/8"
8	TF1029	2	BAR,FLAP,TSF/TRF,75"
9	TF1016	1	FLAP,DEFLECTOR,TSF/TRF,75"
10	21625	36	HEX NUT,3/8",NC
11	21988	10	LOCKWASHER,3/8"
12	6T2615	10	WASHER,FENDER,3/8"
13	TF4334	1	ROD,GROUND ROLLER ADJ,RT
14	21731	6	CAPSCREW, 1/2" X 1-1/2",NC
15	TF1040	1	GUARD,CUTTERSHAFT
16	21399	2	HEX NUT,3/4",ACME THRD
17	TF4333A	2	GROUND ROLLER ADJ BRKT
18	6T2294	8	PLOW BOLT,1/2" X 2",NC
19	TF4336	4	PLATE,GROUND ROLLER LOCK
20	21730	6	CAPSCREW,1/2" X 1-1/4",NC
21	TF4371	1	SKID SHOE,L/PROFILE-OUTER
22	TF1402A	1	BAFFLE,FLAIL,75",HD
23	6T2283	10	CARRIAGE BOLT,3/8" X 1",NC
24	28738	1	GROUND ROLLER,75"
25	TF1045B	2	GRND ROLLER STUB SHAFT
26	6T2330	8	CAPSCREW, 7/16" X 1-1/2", SKT HD
---	06200347	-	KIT,STRING GUARD (ITEMS 27, 28 & 30)
27	06530217	8	CAPSCREW,1/2" X 2",NC,L9
28	06533006	8	FLATWASHER,1/2",SAE,L9
29	TF1018	2	BEARING,FLANGE,2-3/16"
30	31204	2	STRING GUARD,HD
---	TF1002A	-	CUTTERSHAFT ASSY,75IN
31	TF1002	1	CUTTERSHAFT,75IN
32	30411	40	KNIFE MOUNTING BOLT,FLAIL
33	TF1020	40	KNIFE MTG CLEVIS,FLAIL
34	33714	80	KNIFE,FLAIL,STANDARD CUT
35	21677	40	NYLOCK NUT,7/16",NC
36	TF4365	1	SKID SHOE,L/PROFILE-INNER
37	06520242	1	FLAP,FRONT,75"
38	06530001	12	CAPSCREW,SKT HD
39	06520027	2	CAP,BEARING
40	06520029	2	O-RING,2-3/4" X 3/32"
41	06520028	2	BEARING,FLANGE,1-3/8"
42	6T2331	8	CAPSCREW,7/16" X 1",SKT HD

COMMON TRIPLE

# EXTREME DUTY 75IN REAR FLAIL - REV ROT

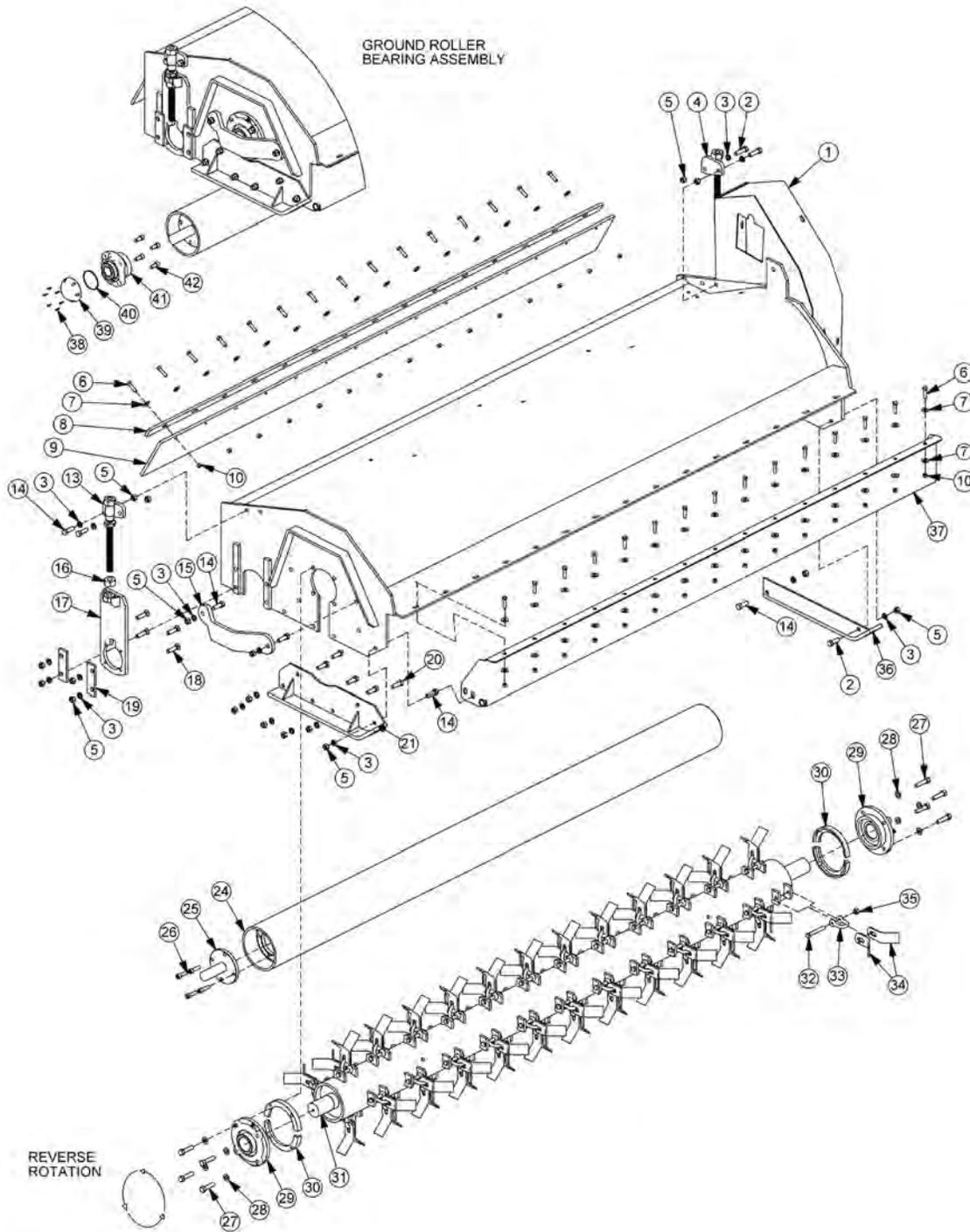

ITEM	PART NO.	QTY.	DESCRIPTION
---	33038	-	REAR FLAIL,75IN,ASSY (STANDARD CUT)
----	33040	-	REAR FLAIL,75IN,ASSY (SMOOTH CUT)
1	22043J	1	BONNET,75",HD
2	21732	3	CAPSCREW,1/2" X 1-3/4",NC

COMMON TRIPLE



## EXTREME DUTY 75IN REAR FLAIL - REV ROT

Continued...

ITEM	PART NO.	QTY.	DESCRIPTION
3	21990	22	LOCKWASHER,1/2"
4	TF4335	1	ROD,GROUND ROLLER ADJ,LF
5	21725	22	HEX NUT,1/2",NC
6	21632	26	CAPSCREW,3/8" X 1-1/2",NC
7	22016	39	FLATWASHER,3/8"
8	TF1029	1	BAR,FLAP,TSF/TRF,75"
9	TF1016	1	FLAP,DEFLECTOR,TSF/TRF,75"
10	21625	36	HEX NUT,3/8",NC
13	TF4334	1	ROD,GROUND ROLLER ADJ,RT
14	21731	6	CAPSCREW, 1/2" X 1-1/2",NC
15	TF1040	1	GUARD,CUTTERSCHAFT
16	21399	2	HEX NUT,3/4",ACME THRD
17	TF4333A	2	GROUND ROLLER ADJ BRKT
18	6T2294	8	PLOW BOLT,1/2" X 2",NC
19	TF4336	4	PLATE,GROUND ROLLER LOCK
20	21730	5	CAPSCREW,1/2" X 1-1/4",NC
21	TF4371	1	SKID SHOE,L/PROFILE-OUTER
24	28738	1	GROUND ROLLER,75"
25	TF1045B	2	GRND ROLLER STUB SHAFT
26	6T2330	8	CAPSCREW, 7/16" X 1-1/2", SKT HD
---	06200347	-	KIT,STRING GUARD (ITEMS 27, 28 & 30)
27	06530217	8	CAPSCREW,1/2" X 2",NC,L9
28	06533006	8	FLATWASHER,1/2",SAE,L9
29	TF1018	2	BEARING,FLANGE,2-3/16"
30	31204	2	STRING GUARD,HD
---	TF1002A	-	CUTTERSCHAFT,ASSY,75IN (STANDARD CUT) (ITEMS 31, 32, 33, 34 & 35)
----	TF1002B	-	CUTTERSCHAFT,ASSY,75IN (SMOOTH CUT) (ITEMS 31, 32, 33, 34 & 35)
31	TF1002	1	CUTTERSCHAFT,75",HD
32	30411	40	KNIFE MOUNTING BOLT,FLAIL
33	TF1020	40	KNIFE MTG CLEVIS,FLAIL
34	33714	80	KNIFE,FLAIL,STANDARD CUT
34A	TF1019F	40	KNIFE,FLAIL,SMOOTH CUT (NOT SHOWN)
35	21677	40	NYLOCK NUT,7/16",NC
36	TF4365	1	SKID SHOE,L/PROFILE-INNER
37	TF1403	1	FRONT TRASH GUARD
38	06530001	12	CAPSCREW,SKT HD
39	06520027	2	CAP,BEARING
40	06520029	2	O-RING,2-3/4" X 3/32"
41	06520028	2	BEARING,FLANGE,1-3/8"
42	6T2331	8	CAPSCREW,7/16" X 1",SKT HD

COMMON TRIPLE

## EXTREME DUTY 75IN REAR FLAIL DRIVE ASSY

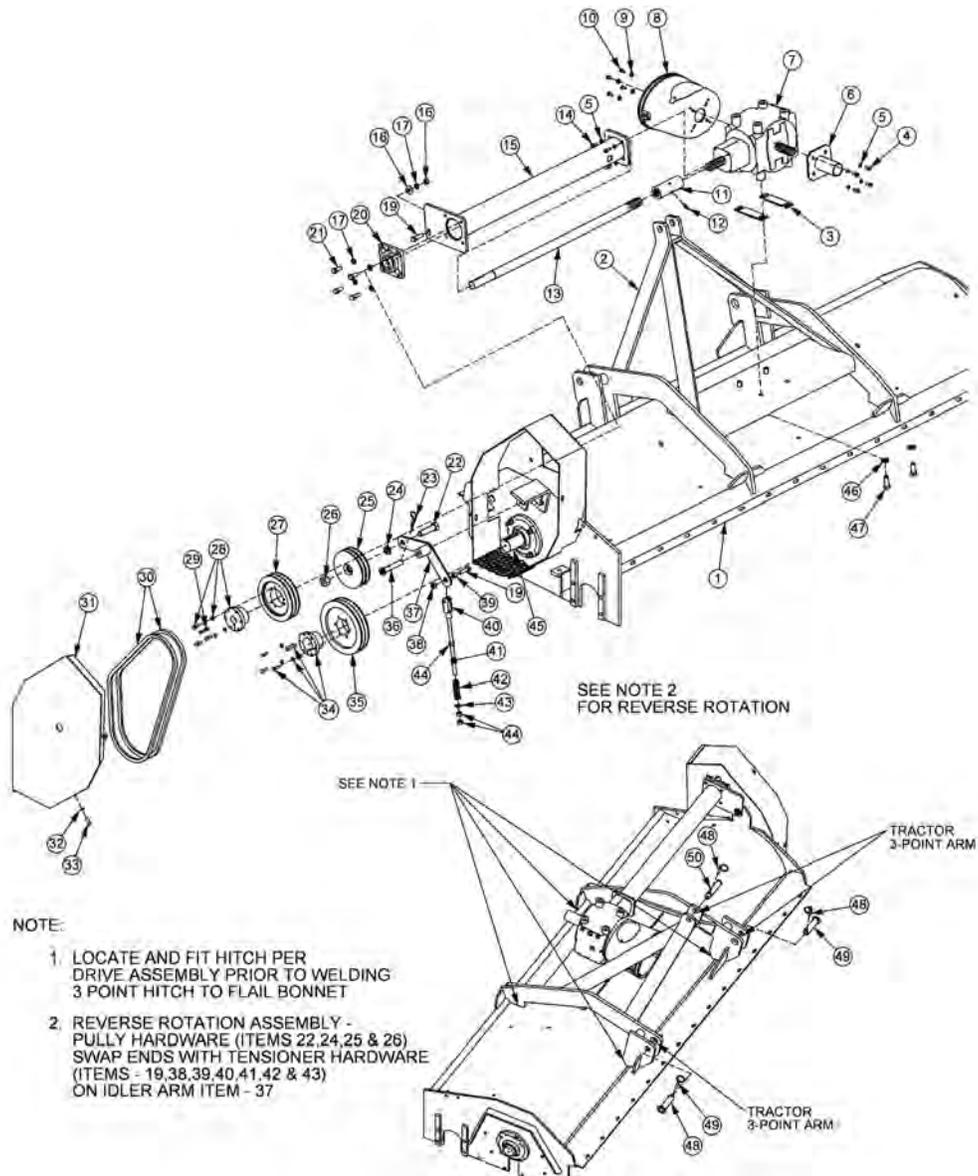

**NOTE:**

1. LOCATE AND FIT HITCH PER DRIVE ASSEMBLY PRIOR TO WELDING 3 POINT HITCH TO FLAIL BONNET
2. REVERSE ROTATION ASSEMBLY - PULLY HARDWARE (ITEMS 22,24,25 & 26) SWAP ENDS WITH TENSIONER HARDWARE (ITEMS - 19,38,39,40,41,42 & 43) ON IDLER ARM ITEM - 37

ITEM	PART NO.	QTY.	DESCRIPTION
1	-----	1	BONNET *REFER TO CUTTER ASSY
2	31279A	1	HITCH,3-POINT
3	40454	2	SPACER
4	27508	4	CAPSCREW,8MM X 20MM(1.25)
5	6T2619	8	LOCKWASHER,8MM
6	28447E	1	GUARD,OUTPUT SHAFT
7	28505	1	GEARBOX,REAR FLAIL,COMER T22A
8	06520181	1	GUARD,PTO,GRBX
9	34948	4	FLATWASHER,8MM
10	27507	4	CAPSCREW,8MM X 15MM(1.25)
11	28914	1	COUPLING,6 SPLINE

COMMON TRIPLE

## EXTREME DUTY 75IN REAR FLAIL DRIVE ASSY

Continued...

ITEM	PART NO.	QTY.	DESCRIPTION
12	6T3209	1	GREASE ZERK,1/4" DRIVE
13	28414A	1	OUTPUT EXTENSION SHAFT,75"RCM
---	28416B	-	OUTPUT EXTENSION SHAFT,75"OFF
14	30162	4	CAPSCREW,SKT HD,8MM X 20MM(1.25)
15	28422A	1	SHAFT GRD,HD,75"RCM
---	28424B	-	SHAFT GRD,HD,75"OFF
16	21725	1	HEX NUT,1/2",NC
17	21990	5	LOCKWASHER,1/2"
18	22018	1	FLATWASHER,1/2",WIDE
19	21732	2	CAPSCREW,1/2" X 1-3/4",NC
20	28571	1	BEARING,FLANGE,1-1/4"
21	21730	4	CAPSCREW,1/2" X 1-1/4",NC
22	28399	1	CAPSCREW,20MM X 80MM(2.5),GR10.9
23	6T3004	1	R-CLIP,HAIRPIN COTTER,3/16"
24	24881	1	LOCKWASHER,20MM
25	31295	1	SHEAVE,IDLER ASSY,6.3"
26	31740	1	NYLOCK NUT,20MM(2.5)
27	TF3043	1	SHEAVE,7.5"
28	30049	2	BUSHING,QD,SK 1-1/4",1/4" KEY
29	28572	1	KEY,1/4"SQ X 2"
30	TF3023	2	V-BELT(630)
31	31286A	1	SHIELD,BELT
32	21988	4	LOCKWASHER,3/8"
33	21630	4	CAPSCREW,3/8" X 1",NC
34	TF3011	1	BUSHING,QD,SK 2-3/16"
35	28570	1	SHEAVE,9.0"
36	TF3605	1	PIN,IDLER ARM
37	TF1180	1	IDLER ARM
38	6T2418	1	HEX NUT,1/2",NC,GR8(STOVER)
39	TF3610	1	BUSHING,IDLER
40	PT3611A	1	CLEVIS
41	32482	1	ROD,THREADED,1/2-20,NF,12-1/2"
42	TF3620A	1	SPRING,TENSIONER
43	27938	1	BUSHING,MACH,14GA
44	21700	3	HEX NUT,1/2",NF
45	-----	1	CUTTERSHAFT *REFER TO CUTTER ASSY
46	6T2625	4	LOCKWASHER,16MM
47	22421	4	CAPSCREW,16MM X 40MM(2.0),GR10.9
48	TF1143	3	LYNCH PIN
49	TF1120	2	PIN,CAPPED
50	TB1036	1	PIN

COMMON TRIPLE

# EXTREME DUTY 90IN REAR FLAIL - STD ROT

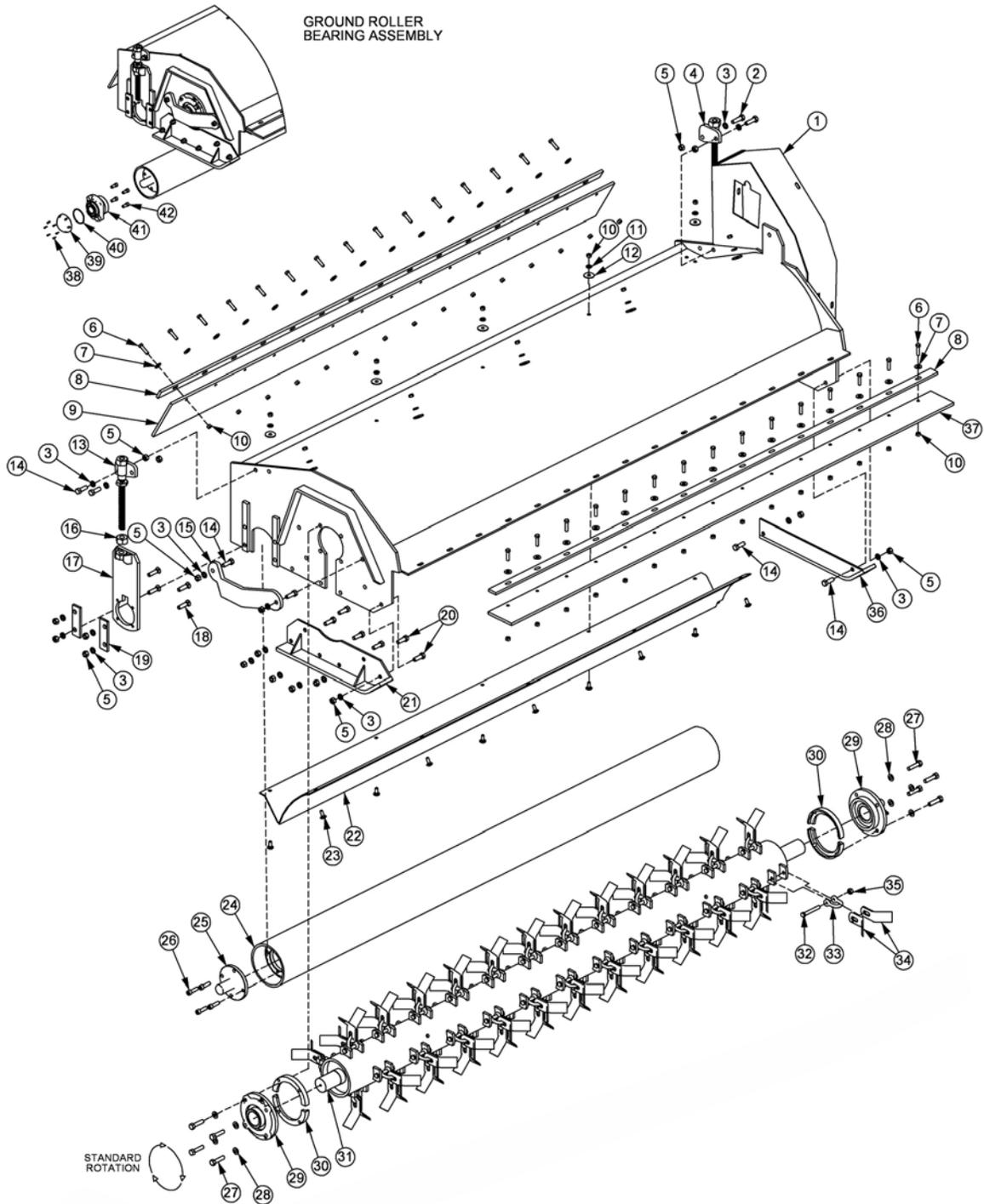

ITEM	PART NO.	QTY.	DESCRIPTION
---	33002	-	REAR FLAIL ASSY,90IN
1	22044J	1	BONNET,90",HD
2	21732	2	CAPSCREW,1/2" X 1-3/4",NC
3	21990	22	LOCKWASHER,1/2"

COMMON TRIPLE

**EXTREME DUTY 90IN REAR FLAIL - STD ROT**

**Continued...**

<b>ITEM</b>	<b>PART NO.</b>	<b>QTY.</b>	<b>DESCRIPTION</b>
4	TF4335	1	ROD,GROUND ROLLER ADJ,LF
5	21725	22	HEX NUT,1/2",NC
6	21632	30	CAPSCREW,3/8" X 1-1/2",NC
7	22016	30	FLATWASHER,3/8"
8	TF1135	2	BAR,FLAP,TSF/TRF,90"
9	TF1116	1	FLAP,DEFLECTOR,TSF/TRF,90"
10	21625	40	HEX NUT,3/8",NC
11	21988	10	LOCKWASHER,3/8"
12	6T2615	10	WASHER,FENDER,3/8"
13	TF4334	1	ROD,GROUND ROLLER ADJ,RT
14	21731	6	CAPSCREW,1/2" X 1-1/2",NC
15	TF1040	1	GUARD,CUTTERSHAFT
16	21399	2	HEX NUT,3/4",ACME THRD
17	TF4333A	2	GROUND ROLLER ADJ BRKT
18	6T2294	8	PLOW BOLT,1/2" X 2",NC
19	TF4336	4	PLATE,GROUND ROLLER LOCK
20	21730	6	CAPSCREW,1/2" X 1-1/4",NC
21	TF4371	1	SKID SHOE,L/PROFILE-OUTER
22	TF1502A	1	BAFFLE,FLAIL,90",HD
23	6T2283	10	CARRIAGE BOLT,3/8" X 1",NC
24	27972A	1	GROUND ROLLER,90"
25	TF1045B	2	GRND ROLLER STUB SHAFT
26	6T2330	8	CAPSCREW, 7/16" X 1-1/2", SKT HD
---	06200347	-	KIT,STRING GUARD (ITEMS 27, 28 & 30)
27	06530217	8	CAPSCREW,1/2" X 2",NC,L9
28	06533006	8	FLATWASHER,1/2",SAE,L9
29	TF1018	2	BEARING,FLANGE,2-3/16"
30	31204	2	STRING GUARD,HD
---	TF1102A	-	CUTTERSHAFT ASSY,90IN
31	TF1102	1	CUTTERSHAFT,90"
32	30411	48	KNIFE MOUNTING BOLT,FLAIL
33	TF1020	48	KNIFE MTG CLEVIS,FLAIL
34	33714	96	KNIFE,FLAIL,STANDARD CUT
35	21677	48	NYLOCK NUT,7/16",NC
36	TF4365	1	SKID SHOE,L/PROFILE-INNER
37	06520243	1	FLAP,FRONT,90"
38	06530001	12	CAPSCREW,SKT HD
39	06520027	2	CAP,BEARING
40	06520029	2	O-RING,2-3/4" X 3/32"
41	06520028	2	BEARING,FLANGE,1-3/8"
42	6T2331	8	CAPSCREW,7/16" X 1",SKT HD

COMMON TRIPLE

# EXTREME DUTY 90IN REAR FLAIL - REV ROT

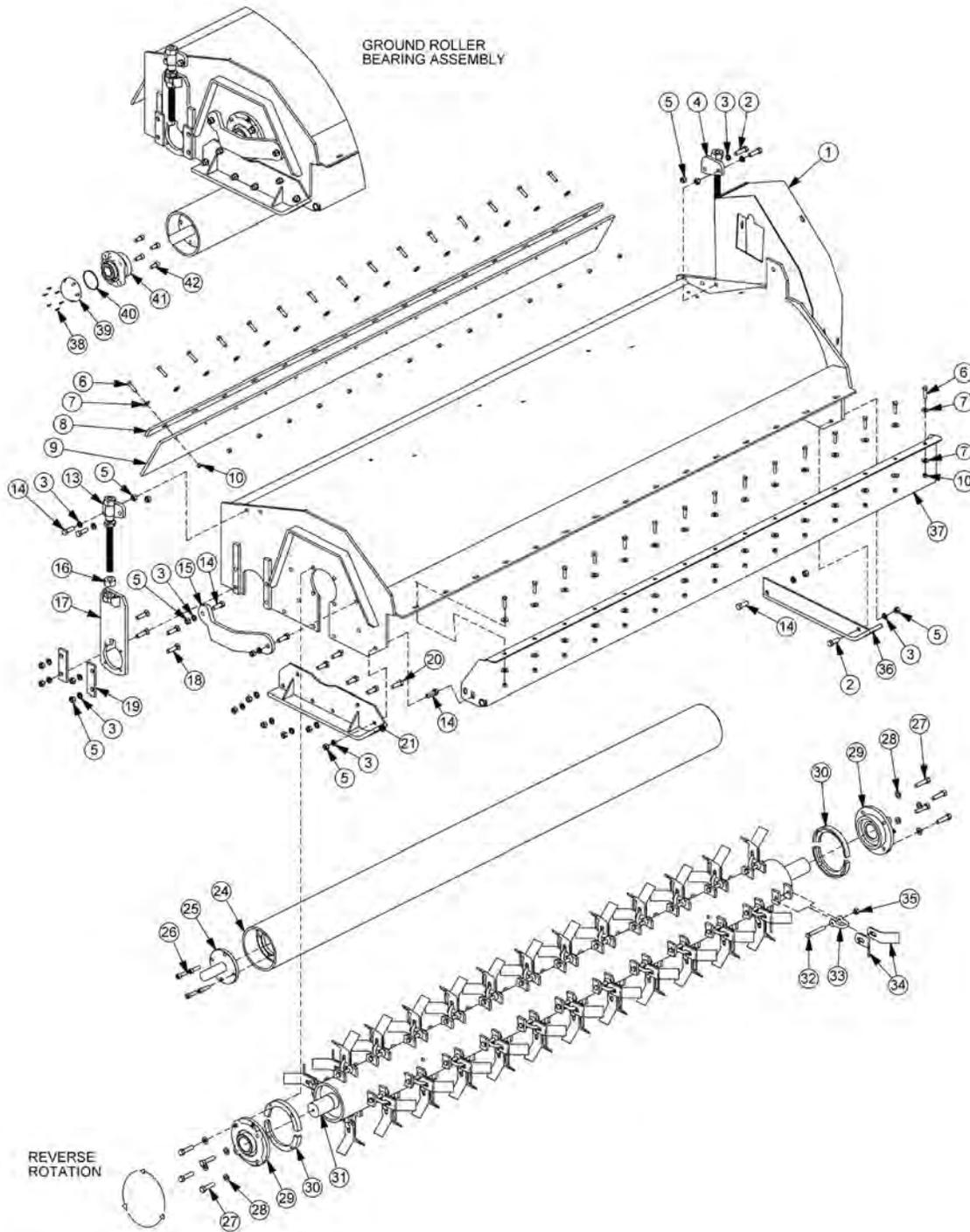

ITEM	PART NO.	QTY.	DESCRIPTION
---	33009	-	90IN REAR FLAIL ASSY (STANDARD CUT)
----	33011	-	90IN REAR FLAIL ASSY (SMOOTH CUT)
1	22044J	1	BONNET,90"
2	21732	3	CAPSCREW,1/2" X 1-3/4",NC

COMMON TRIPLE

## EXTREME DUTY 90IN REAR FLAIL - REV ROT

Continued...

ITEM	PART NO.	QTY.	DESCRIPTION
3	21990	22	LOCKWASHER,1/2"
4	TF4335	1	ROD,GROUND ROLLER ADJ,LF
5	21725	22	HEX NUT,1/2",NC
6	21632	30	CAPSCREW,3/8" X 1-1/2",NC
7	22016	45	FLATWASHER,3/8"
8	TF1135	1	BAR,FLAP,TSF/TRF,90"
9	TF1116	1	FLAP,DEFLECTOR,TSF/TRF,90"
10	21625	40	HEX NUT,3/8",NC
13	TF4334	1	ROD,GROUND ROLLER ADJ,RT
14	21731	6	CAPSCREW,1/2" X 1-1/2",NC
15	TF1040	1	GUARD,CUTTERSHAFT
16	21399	2	HEX NUT,3/4",ACME THRD
17	TF4333A	2	GROUND ROLLER ADJ BRKT
18	6T2294	8	PLOW BOLT,1/2" X 2",NC
19	TF4336	4	PLATE,GROUND ROLLER LOCK
20	21730	5	CAPSCREW,1/2" X 1-1/4",NC
21	TF4371	1	SKID SHOE,L/PROFILE-OUTER
24	27972A	1	GROUND ROLLER,90"
25	TF1045B	2	GRND ROLLER STUB SHAFT
26	6T2330	8	CAPSCREW,7/16" X 1-1/2", SKT HD
---	06200347	-	KIT,STRING GUARD (ITEMS 27, 28 & 30)
27	06530217	8	CAPSCREW,1/2" X 2",NC,L9
28	06533006	8	FLATWASHER,1/2",SAE,L9
29	TF1018	2	BEARING,FLANGE,2-3/16"
30	31204	2	STRING GUARD
---	TF1102A	-	CUTTERSHAFT ASSY (STANDARD CUT) (ITEMS 31, 32, 33, 34 & 35)
----	TF1102B	-	CUTTERSHAFT ASSY (SMOOTH CUT) (ITEMS 31, 32, 33, 34A & 35)
31	TF1102	1	CUTTERSHAFT,90"
32	30411	48	KNIFE MOUNTING BOLT,FLAIL
33	TF1020	48	KNIFE MTG CLEVIS,FLAIL
34	33714	96	KNIFE,FLAIL,STANDARD CUT
34A	TF1019F	48	KNIFE,FLAIL,SMOOTH CUT (NOT SHOWN)
35	21677	48	NYLOCK NUT,7/16",NC
36	TF4365	1	SKID SHOE,L/PROFILE-INNER
37	TF1503	1	FRONT TRASH GUARD
38	06530001	12	CAPSCREW,SKT HD
39	06520027	2	CAP,BEARING
40	06520029	2	O-RING,2-3/4" X 3/32"
41	06520028	2	BEARING,FLANGE,1-3/8"
42	6T2331	8	CAPSCREW,7/16" X 1",SKT HD

COMMON TRIPLE

## EXTREME DUTY 90IN REAR FLAIL DRIVE ASSY

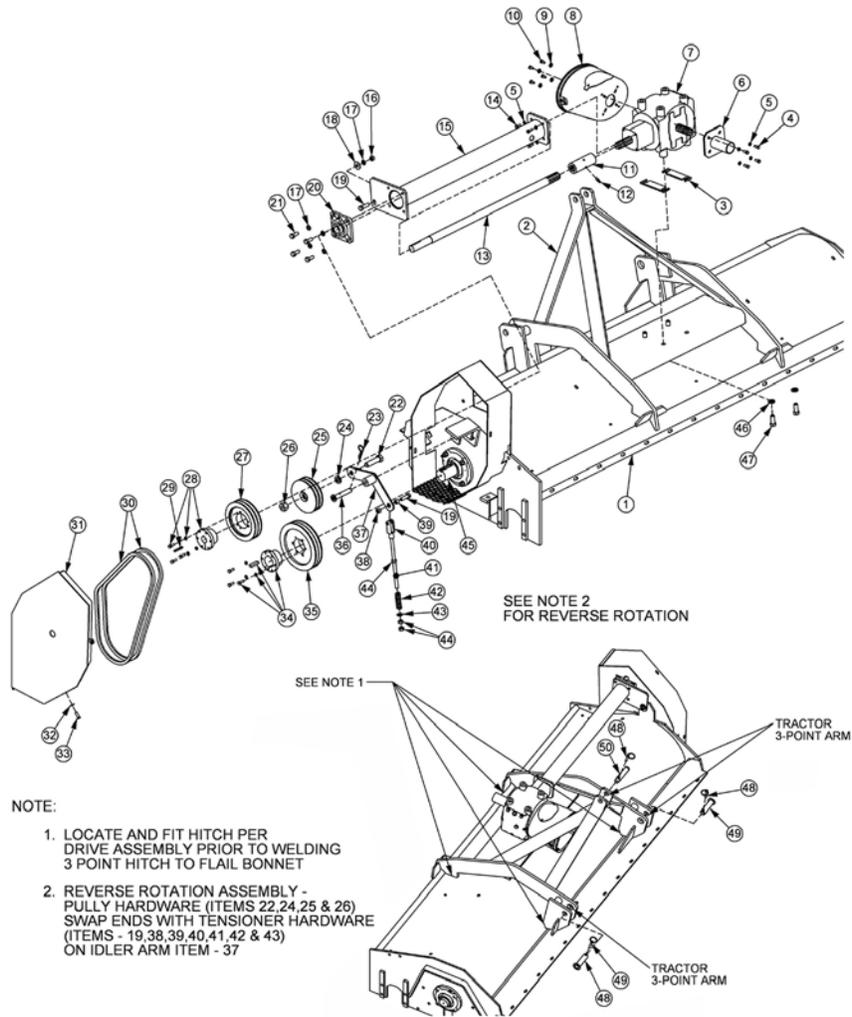

ITEM	PART NO.	QTY.	DESCRIPTION
1	-----	1	BONNET *REFER TO CUTTER ASSY
2	31279A	1	HITCH,3-POINT
3	40454	2	SPACER
4	27508	4	CAPSCREW,8MM X 20MM(1.25)
5	6T2619	8	LOCKWASHER,8MM
6	28447E	1	GUARD,OUTPUT SHAFT
7	28505	1	GEARBOX,REAR FLAIL,COMER T22A
8	06520181	1	GUARD,PTO,GRBX
9	34948	4	FLATWASHER,8MM
10	27507	4	CAPSCREW,8MM X 15MM(1.25)
11	28914	1	COUPLING,6 SPLINE
12	6T3209	1	GREASE ZERK,1/4" DRIVE
13	28415A	1	OUTPUT EXTENSION SHAFT,90"RCM
---	28416B	-	OUTPUT EXTENSION SHAFT,90"R6F
----	28420B	-	OUTPUT EXTENSION SHAFT,90"OFF

COMMON TRIPLE



## EXTREME DUTY 90IN REAR FLAIL DRIVE ASSY

Continued...

ITEM	PART NO.	QTY.	DESCRIPTION
14	30162	4	CAPSCREW,SKT HD,8MM X 20MM(1.25)
15	28423A	1	SHAFT GRD,HD,90"RCM
---	28424B	-	SHAFT GRD,HD,90"R6F
----	28428B	-	SHAFT GRD,HD,90"OFF
16	21725	1	HEX NUT,1/2",NC
17	21990	5	LOCKWASHER,1/2"
18	22018	1	FLATWASHER,1/2",WIDE
19	21732	2	CAPSCREW,1/2" X 1-3/4",NC
20	28571	1	BEARING,FLANGE,1-1/4"
21	21730	4	CAPSCREW,1/2" X 1-1/4",NC
22	28399	1	CAPSCREW,20MM X 80MM(2.5),GR10.9
23	6T3004	1	R-CLIP,HAIRPIN COTTER,3/16"
24	24881	1	LOCKWASHER,20MM
25	31295	1	SHEAVE,IDLER ASSY,6.3"
26	31740	1	NYLOCK NUT,20MM(2.5)
27	TF3043	1	SHEAVE,7.5"
28	30049	2	BUSHING,QD,SK 1-1/4",1/4" KEY
29	28572	1	KEY,1/4"SQ X 2"
30	TF3023	2	V-BELT(630)
31	31286A	1	SHIELD,BELT
32	21988	4	LOCKWASHER,3/8"
33	21630	4	CAPSCREW,3/8" X 1",NC
34	TF3011	1	BUSHING,QD,SK 2-3/16"
35	28570	1	SHEAVE,9.0"
36	TF3605	1	PIN,IDLER ARM
37	TF1180	1	IDLER ARM
38	6T2418	1	HEX NUT,1/2",NC,GR8(STOVER)
39	TF3610	1	BUSHING,IDLER
40	PT3611A	1	CLEVIS
41	32482	1	ROD,THREADED,1/2-20,NF,12-1/2"
42	TF3620A	1	SPRING,TENSIONER
43	27938	1	BUSHING,MACH,14GA
44	21700	3	HEX NUT,1/2",NF
45	-----	1	CUTTERSHAFT *REFER TO CUTTER ASSY
46	6T2625	4	LOCKWASHER,16MM
47	22421	4	CAPSCREW,16MM X 40MM(2.0),GR10.9
48	TF1143	3	LYNCH PIN
49	TF1120	2	PIN,CAPPED
50	TB1036	1	PIN

COMMON TRIPLE

# EXTREME DUTY 96IN REAR FLAIL - STD ROT

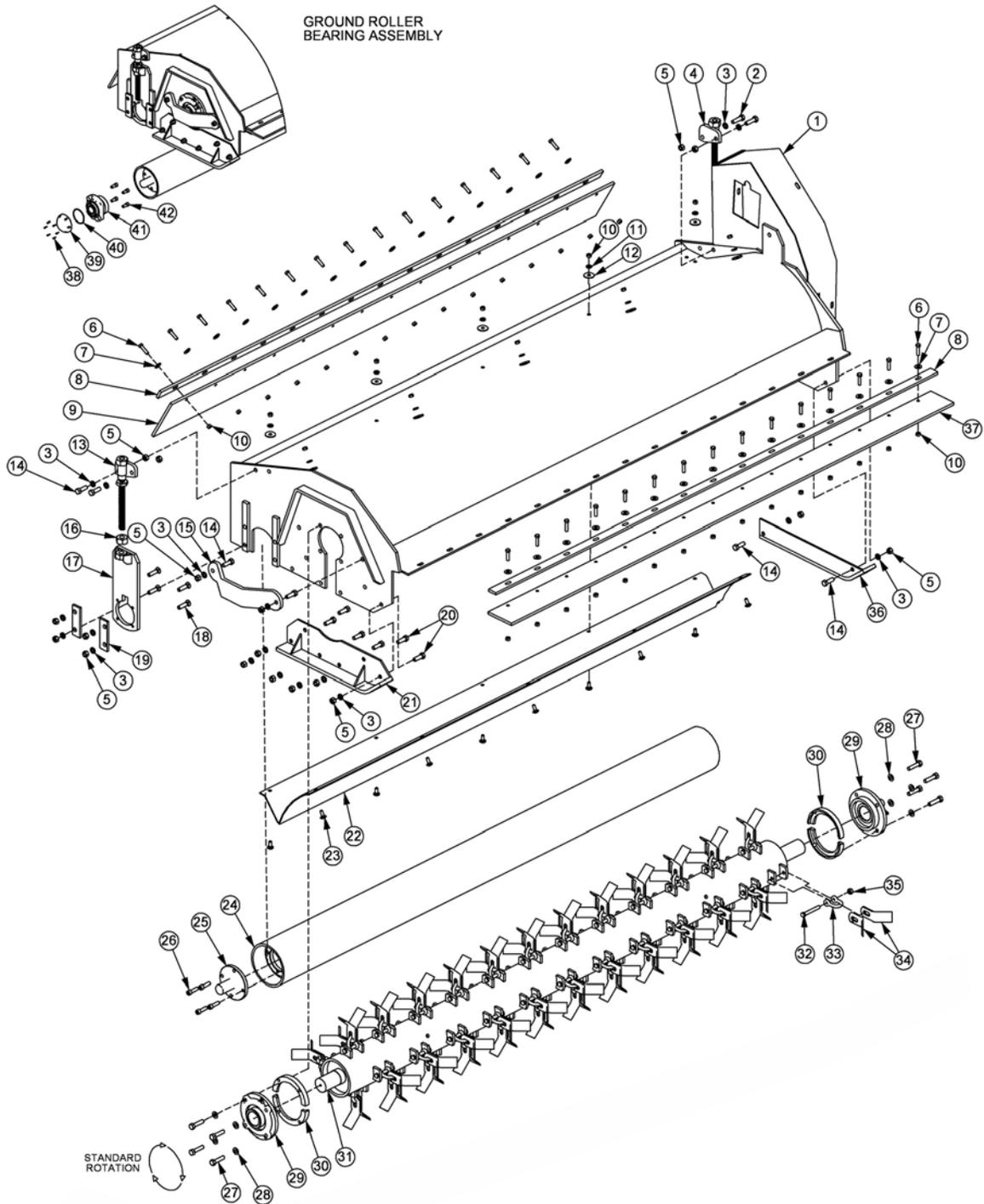

ITEM	PART NO.	QTY.	DESCRIPTION
---	33005	-	REAR FLAIL ASSY,96IN
1	22045J	1	BONNET,96"
2	21732	2	CAPSCREW,1/2" X 1-3/4",NC
3	21990	22	LOCKWASHER,1/2"

COMMON TRIPLE

## EXTREME DUTY 96IN REAR FLAIL - STD ROT

Continued...

ITEM	PART NO.	QTY.	DESCRIPTION
4	TF4335	1	ROD,GROUND ROLLER ADJ,LF
5	21725	22	HEX NUT,1/2",NC
6	21632	34	CAPSCREW,3/8" X 1-1/2",NC
7	22016	34	FLATWASHER,3/8"
8	TF1606	2	BAR,FLAP,TSF/TRF,96"
9	TF1605	1	FLAP,DEFLECTOR,TSF/TRF,96"
10	21625	44	HEX NUT,3/8",NC
11	21988	10	LOCKWASHER,3/8"
12	6T2615	10	WASHER,FENDER,3/8"
13	TF4334	1	ROD,GROUND ROLLER ADJ,RT
14	21731	6	CAPSCREW,1/2" X 1-1/2",NC
15	TF1040	1	GUARD,CUTTERSHAFT
16	21399	2	HEX NUT,3/4",ACME THRD
17	TF4333A	2	GROUND ROLLER ADJ BRKT
18	6T2294	8	PLOW BOLT,1/2" X 2",NC
19	TF4336	4	PLATE,GROUND ROLLER LOCK
20	21730	6	CAPSCREW,1/2" X 1-1/4",NC
21	TF4371	1	SKID SHOE,L/PROFILE-OUTER
22	TF1607	1	BAFFLE,FLAIL,96",HD
23	6T2283	10	CARRIAGE BOLT,3/8" X 1",NC
24	30000	1	GROUND ROLLER,96"
25	TF1045B	2	GRND ROLLER STUB SHAFT
26	6T2330	8	CAPSCREW,7/16" X 1-1/2", SKT HD
---	06200347	-	KIT,STRING GUARD (ITEMS 27, 28 & 30)
27	06530217	8	CAPSCREW,1/2" X 2",NC,L9
28	06533006	8	FLATWASHER,1/2",SAE,L9
29	TF1018	2	BEARING,FLANGE,2-3/16"
30	31204	2	STRING GUARD,HD
---	TF1602A	-	CUTTERSHAFT ASSY,96IN
31	TF1602B	1	CUTTERSHAFT,96"
32	30411	52	KNIFE MOUNTING BOLT,FLAIL
33	TF1020	52	KNIFE MTG CLEVIS,FLAIL
34	33714	104	KNIFE,FLAIL,STANDARD CUT
35	21677	52	NYLOCK NUT,7/16",NC
36	TF4365	1	SKID SHOE,L/PROFILE-INNER
37	06520244	1	FLAP,FRONT,96"
38	06530001	12	CAPSCREW,SKT HD
39	06520027	2	CAP,BEARING
40	06520029	2	O-RING,2-3/4" X 3/32"
41	06520028	2	BEARING,FLANGE,1-3/8"
42	6T2331	8	CAPSCREW,7/16" X 1",SKT HD

COMMON TRIPLE

# EXTREME DUTY 96IN REAR FLAIL - REV ROT

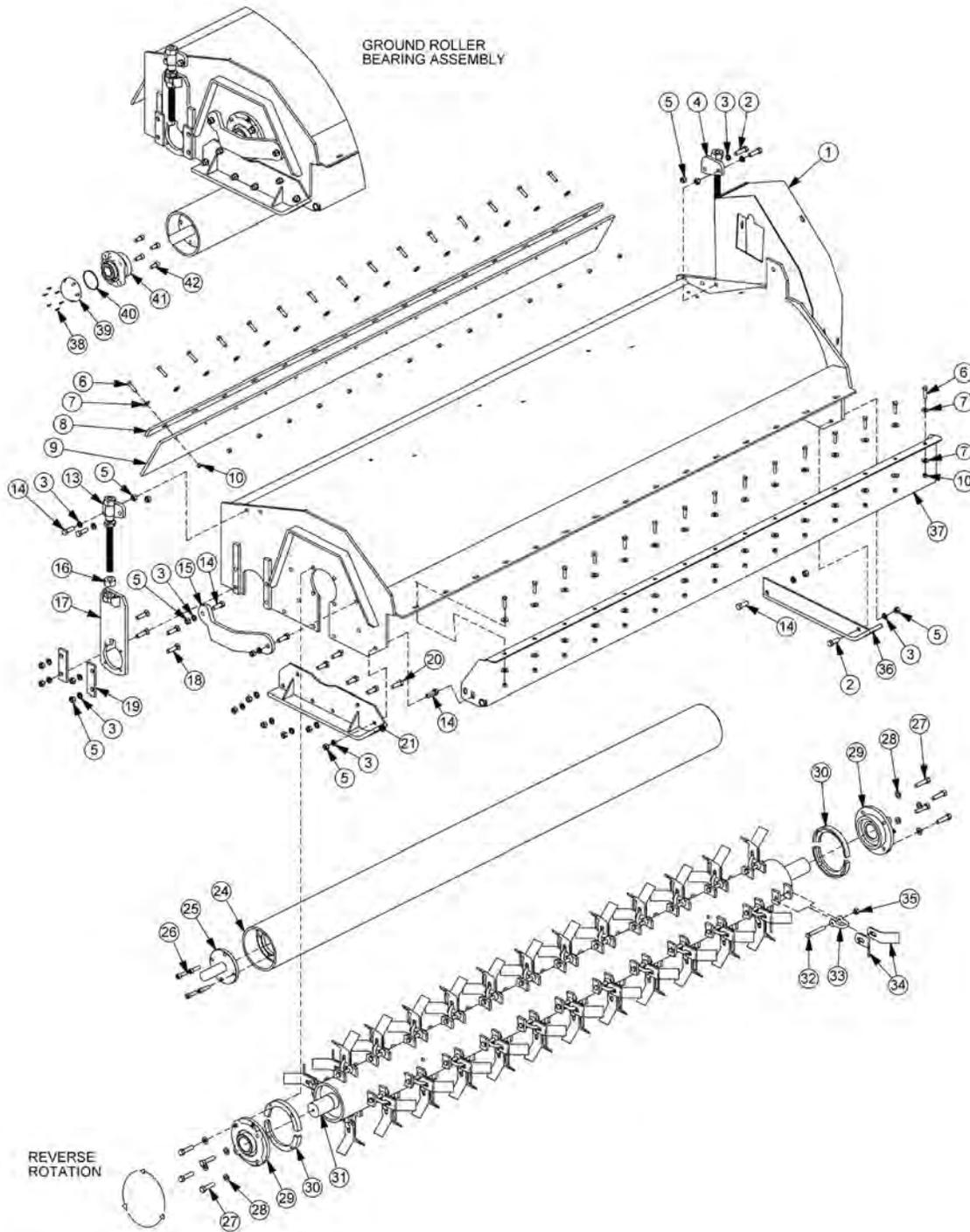

ITEM	PART NO.	QTY.	DESCRIPTION
---	33007	-	96IN REAR FLAIL ASSY (STANDARD CUT)
----	33013	-	96IN REAR FLAIL ASSY (SMOOTH CUT)
1	22045J	1	BONNET,96"
2	21732	3	CAPSCREW,1/2" X 1-3/4",NC

COMMON TRIPLE

## EXTREME DUTY 96IN REAR FLAIL - REV ROT

Continued...

ITEM	PART NO.	QTY.	DESCRIPTION
3	21990	22	LOCKWASHER,1/2"
4	TF4335	1	ROD,GROUND ROLLER ADJ,LF
5	21725	22	HEX NUT,1/2",NC
6	21632	34	CAPSCREW,3/8" X 1-1/2",NC
7	22016	51	FLATWASHER,3/8"
8	TF1606	1	BAR,FLAP,TSF/TRF,96"
9	TF1605	1	FLAP,DEFLECTOR,TSF/TRF,96"
10	21625	44	HEX NUT,3/8",NC
13	TF4334	1	ROD,GROUND ROLLER ADJ,RT
14	21731	6	CAPSCREW,1/2" X 1-1/2",NC
15	TF1040	1	GUARD,CUTTERSHAFT
16	21399	2	HEX NUT,3/4",ACME THRD
17	TF4333A	2	GROUND ROLLER ADJ BRKT
18	6T2294	8	PLOW BOLT,1/2" X 2",NC
19	TF4336	4	PLATE,GROUND ROLLER LOCK
20	21730	5	CAPSCREW,1/2" X 1-1/4",NC
21	TF4371	1	SKID SHOE,L/PROFILE-OUTER
24	30000	1	GROUND ROLLER,96"
25	TF1045B	2	GRND ROLLER STUB SHAFT
26	6T2330	8	CAPSCREW,7/16" X 1-1/2", SKT HD
---	06200347	-	KIT,STRING GUARD (ITEMS 37, 38 & 30)
27	06530217	8	CAPSCREW,1/2" X 2",NC,L9
28	06533006	8	FLATWASHER,1/2",SAE,L9
29	TF1018	2	BEARING,FLANGE,2-3/16"
30	31204	2	STRING GUARD,HD
---	TF1602A	-	CUTTERSHAFT ASSY (STANDARD CUT) (ITEMS 31, 32, 33, 34 & 35)
----	TF1602B	-	CUTTERSHAFT ASSY (SMOOTH CUT) (ITEMS 31, 32, 33, 34A & 35)
31	TF1602B	1	CUTTERSHAFT,96"
32	30411	52	KNIFE MOUNTING BOLT,FLAIL
33	TF1020	52	KNIFE MTG CLEVIS,FLAIL
34	33714	104	KNIFE,FLAIL,STANDARD CUT
34A	TF1019F	52	KNIFE,FLAIL,SMOOTH CUT (NOT SHOWN)
35	21677	52	NYLOCK NUT,7/16",NC
36	TF4365	1	SKID SHOE,L/PROFILE-INNER
37	TF1608	1	FLAP TRASH GUARD
38	06530001	12	CAPSCREW,SKT HD
39	06520027	2	CAP,BEARING
40	06520029	2	O-RING,2-3/4" X 3/32"
41	06520028	2	BEARING,FLANGE,1-3/8"
42	6T2331	8	CAPSCREW,7/16" X 1",SKT HD

COMMON TRIPLE

## EXTREME DUTY 96IN REAR FLAIL DRIVE ASSY

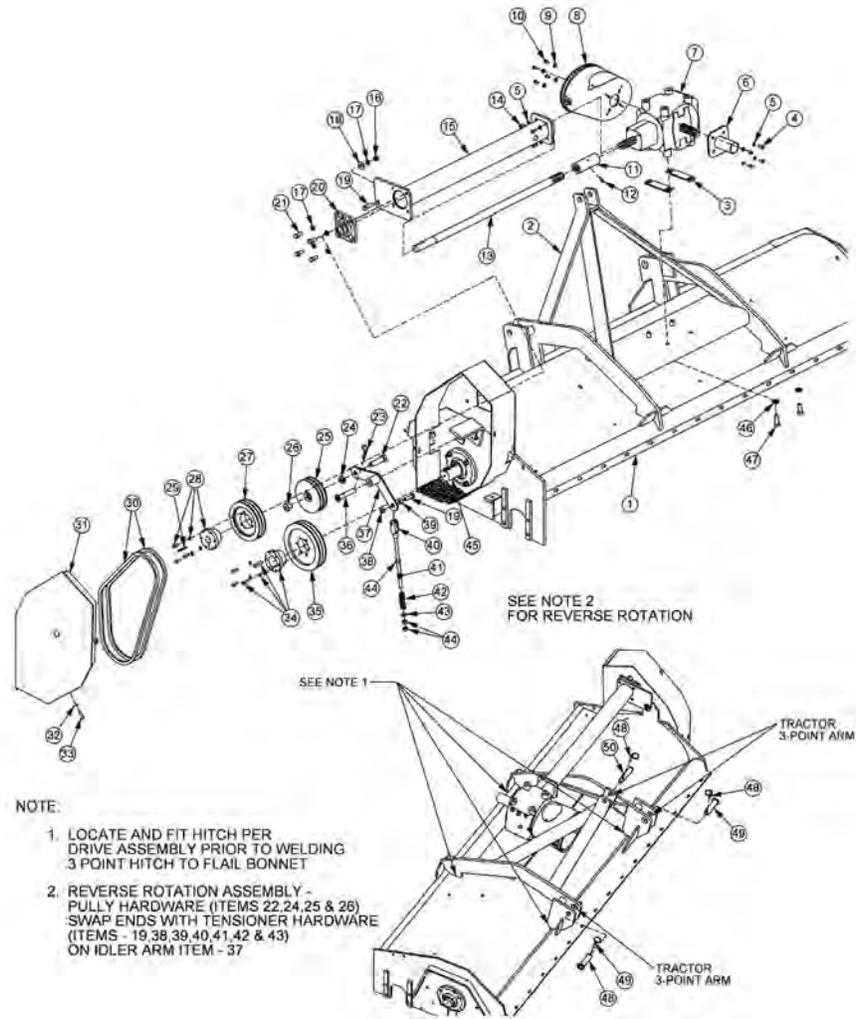

**NOTE:**

1. LOCATE AND FIT HITCH PER DRIVE ASSEMBLY PRIOR TO WELDING 3 POINT HITCH TO FLAIL BONNET
2. REVERSE ROTATION ASSEMBLY - PULLY HARDWARE (ITEMS 22,24,25 & 26) SWAP ENDS WITH TENSIONER HARDWARE (ITEMS - 19,38,39,40,41,42 & 43) ON IDLER ARM ITEM - 37

ITEM	PART NO.	QTY.	DESCRIPTION
1	-----	1	BONNET *REFER TO CUTTER ASSY
2	31279A	1	HITCH,3-POINT
3	40454	2	SPACER
4	27508	4	CAPSCREW,8MM X 20MM(1.25)
5	6T2619	8	LOCKWASHER,8MM
6	28447E	1	GUARD,OUTPUT SHAFT
7	28505	1	GEARBOX,REAR FLAIL,COMER T22A
8	06520181	1	GUARD,PTO,GRBX
9	34948	4	FLATWASHER,8MM
10	27507	4	CAPSCREW,8MM X 15MM(1.25)
11	28914	1	COUPLING,6 SPLINE
12	6T3209	1	GREASE ZERK,1/4" DRIVE
13	28418A	1	OUTPUT EXTENSION SHAFT,96"RCM
---	28420B	-	OUTPUT EXTENSION SHAFT,96"R6F
	28416B	-	OUTPUT EXTENSION SHAFT,96"RXF

COMMON TRIPLE

## EXTREME DUTY 96IN REAR FLAIL DRIVE ASSY

Continued...

ITEM	PART NO.	QTY.	DESCRIPTION
	28419B	-	OUTPUT EXTENSION SHAFT,96"OFF
14	30162	4	CAPSCREW,SKT HD,8MMX20MM(1.25)
15	28426A	1	SHAFT GRD,HD,96"RCM
---	28428B	-	SHAFT GRD,HD,96"R6F
	28424B	-	SHAFT GRD,HD,96"RXF
	28427B	-	SHAFT GRD,HD,96"OFF
16	21725	1	HEX NUT,1/2",NC
17	21990	5	LOCKWASHER,1/2"
18	22018	1	FLATWASHER,1/2",WIDE
19	21732	2	CAPSCREW,1/2" X 1-3/4",NC
20	28571	1	BEARING,FLANGE,1-1/4"
21	21730	4	CAPSCREW,1/2" X 1-1/4",NC
22	28399	1	CAPSCREW,20MM X 80MM(2.5),GR10.9
23	6T3004	1	R-CLIP,HAIRPIN COTTER,3/16"
24	24881	1	LOCKWASHER,20MM
25	31295	1	SHEAVE,IDLER ASSY,6.3"
26	31740	1	NYLOCK NUT,20MM(2.5)
27	TF3043	1	SHEAVE,7.5"
28	30049	2	BUSHING,QD,SK 1-1/4",1/4" KEY
29	28572	1	KEY,1/4"SQ X 2"
30	TF3023	2	V-BELT(630)
31	31286A	1	SHIELD,BELT
32	21988	4	LOCKWASHER,3/8"
33	21630	4	CAPSCREW,3/8" X 1",NC
34	TF3011	1	BUSHING,QD,SK 2-3/16"
35	28570	1	SHEAVE,9.0"
36	TF3605	1	PIN,IDLER ARM
37	TF1180	1	IDLER ARM
38	6T2418	1	HEX NUT,1/2",NC,GR8(STOVER)
39	TF3610	1	BUSHING,IDLER
40	PT3611A	1	CLEVIS
41	32482	1	ROD,THREADED,1/2-20,NF,12-1/2"
42	TF3620A	1	SPRING,TENSIONER
43	27938	1	BUSHING,MACH,14GA
44	21700	3	HEX NUT,1/2",NF
45	-----	1	CUTTERSHAFT *REFER TO CUTTER ASSY
46	6T2625	4	LOCKWASHER,16MM
47	22421	4	CAPSCREW,16MM X 40MM(2.0),GR10.9
48	TF1143	3	LYNCH PIN
49	TF1120	2	PIN,CAPPED
50	TB1036	1	PIN

COMMON TRIPLE

# EXTREME DUTY 102IN REAR FLAIL - STD ROT

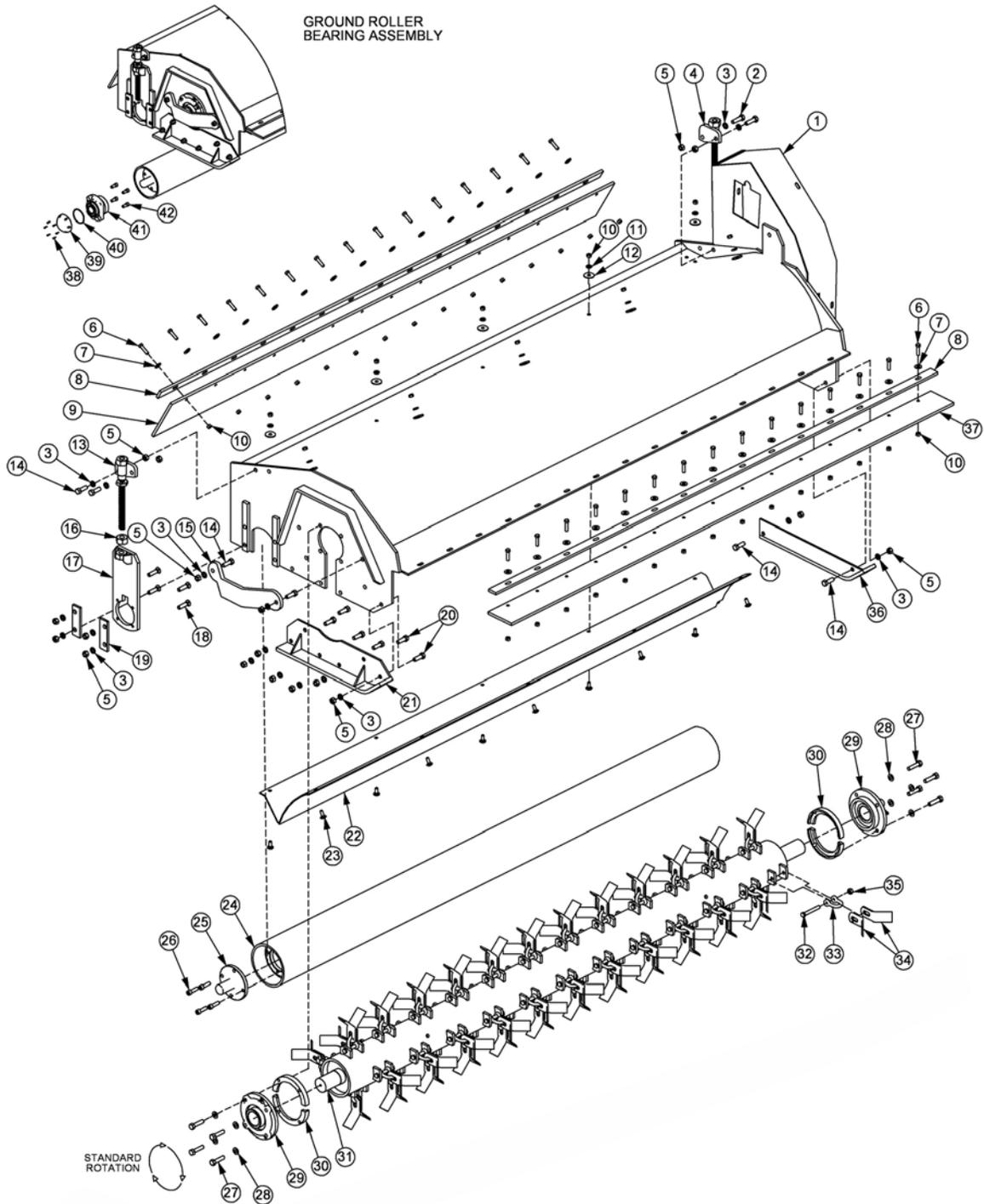

ITEM	PART NO.	QTY.	DESCRIPTION
---	33027	-	REAR FLAIL ASSY,102IN
1	22046J	1	BONNET,102"
2	21732	2	CAPSCREW,1/2" X 1-3/4",NC
3	21990	22	LOCKWASHER,1/2"

COMMON TRIPLE



**EXTREME DUTY 102IN REAR FLAIL - STD ROT**

**Continued...**

<b>ITEM</b>	<b>PART NO.</b>	<b>QTY.</b>	<b>DESCRIPTION</b>
4	TF4335	1	ROD,GROUND ROLLER ADJ,LF
5	21725	22	HEX NUT,1/2",NC
6	21632	36	CAPSCREW,3/8" X 1-1/2",NC
7	22016	36	FLATWASHER,3/8"
8	TF1703	2	BAR,FLAP,TSF/TRF,102"
9	TF1704A	1	FLAP,DEFLECTOR,TSF/TRF,102"
10	21625	46	HEX NUT,3/8",NC
11	21988	10	LOCKWASHER,3/8"
12	6T2615	10	WASHER,FENDER,3/8"
13	TF4334	1	ROD,GROUND ROLLER ADJ,RT
14	21731	6	CAPSCREW,1/2" X 1-1/2",NC
15	TF1040	1	GUARD,CUTTERSHAFT
16	21399	2	HEX NUT,3/4",ACME THRD
17	TF4333A	2	GROUND ROLLER ADJ BRKT
18	6T2294	8	PLOW BOLT,1/2" X 2",NC
19	TF4336	4	PLATE,GROUND ROLLER LOCK
20	21730	6	CAPSCREW,1/2" X 1-1/4",NC
21	TF4371	1	SKID SHOE,L/PROFILE-OUTER
22	TF1702	1	BAFFLE,FLAIL,102",HD
23	6T2283	10	CARRIAGE BOLT,3/8" X 1",NC
24	28999	1	GROUND ROLLER,102"
25	TF1045B	2	GRND ROLLER STUB SHAFT
26	6T2330	8	CAPSCREW,7/16" X 1-1/2", SKT HD
---	06200347	-	KIT,STRING GUARD
27	06530217	8	CAPSCREW,1/2" X 2",NC,L9
28	06533006	8	FLATWASHER,1/2",SAE,L9
29	TF1018	2	BEARING,FLANGE,2-3/16"
30	31204	2	STRING GUARD,HD
---	TF1707A	-	CUTTERSHAFT ASSY,102"
31	TF1707	1	CUTTERSHAFT,102"
32	30411	56	KNIFE MOUNTING BOLT,FLAIL
33	TF1020	56	KNIFE MTG CLEVIS,FLAIL
34	33714	112	KNIFE,FLAIL,STANDARD CUT
35	21677	56	NYLOCK NUT,7/16",NC
36	TF4365	1	SKID SHOE,L/PROFILE-INNER
37	06520245	1	FLAP,FRONT,102"
38	06530001	12	CAPSCREW,SKT HD
39	06520027	2	CAP,BEARING
40	06520029	2	O-RING,2-3/4" X 3/32"
41	06520028	2	BEARING,FLANGE,1-3/8"
42	6T2331	8	CAPSCREW,7/16" X 1",SKT HD

COMMON TRIPLE

# EXTREME DUTY 102IN REAR FLAIL - REV ROT

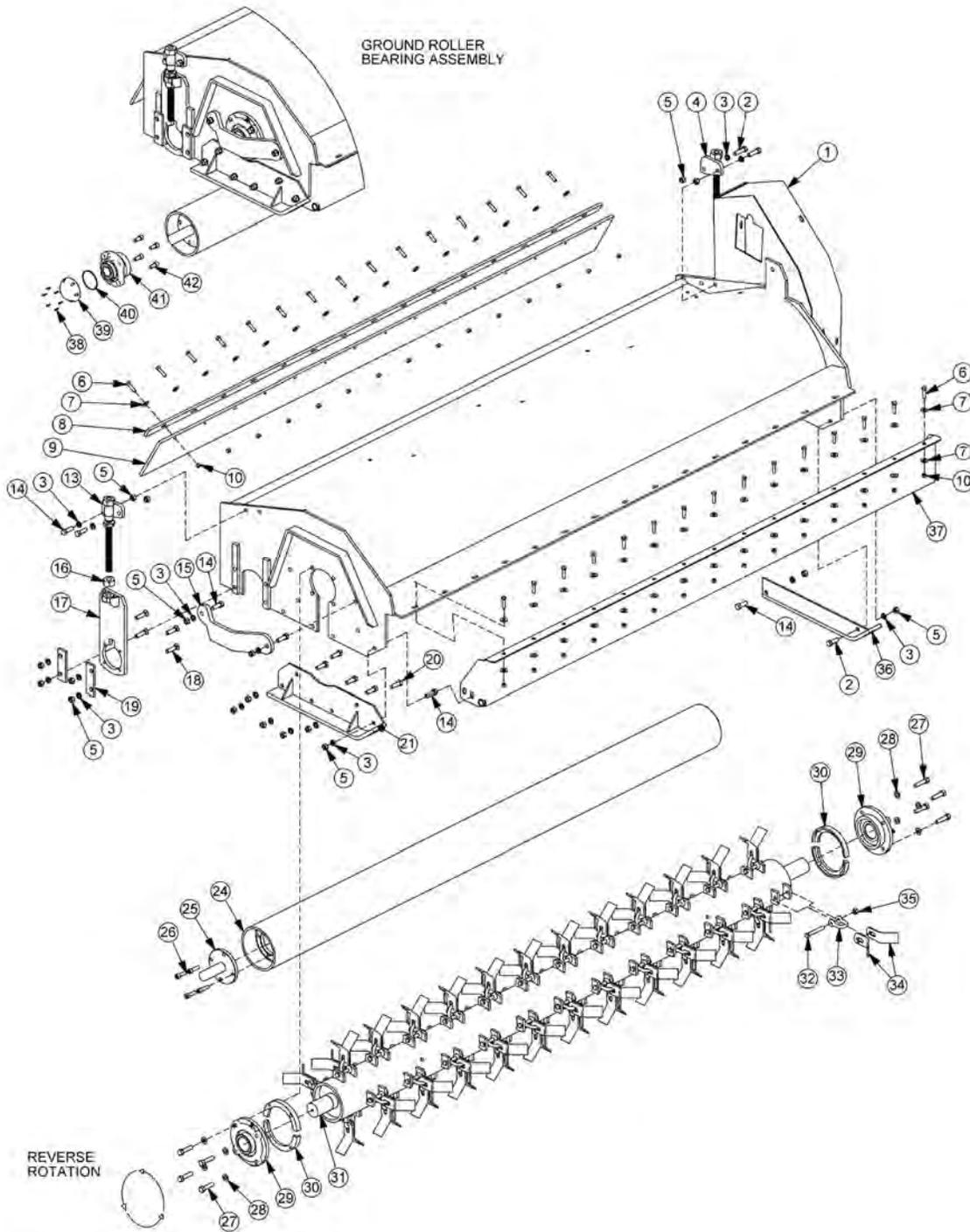

ITEM	PART NO.	QTY.	DESCRIPTION
---	33030	-	102IN REAR FLAIL ASSY (STANDARD CUT)
----	33033	-	102IN REAR FLAIL ASSY (SMOOTH CUT)
1	22046J	1	BONNET,102"
2	21732	3	CAPSCREW,1/2" X 1-3/4",NC

COMMON TRIPLE

## EXTREME DUTY 102IN REAR FLAIL - REV ROT

Continued...

ITEM	PART NO.	QTY.	DESCRIPTION
3	21990	22	LOCKWASHER,1/2"
4	TF4335	1	ROD,GROUND ROLLER ADJ,LF
5	21725	22	HEX NUT,1/2",NC
6	21632	36	CAPSCREW,3/8" X 1-1/2",NC
7	22016	51	FLATWASHER,3/8"
8	TF1703	1	BAR,FLAP,TSF/TRF,102"
9	TF1704A	1	FLAP,DEFLECTOR,TSF/TRF,102"
10	21625	46	HEX NUT,3/8",NC
13	TF4334	1	ROD,GROUND ROLLER ADJ,RT
14	21731	6	CAPSCREW,1/2" X 1-1/2",NC
15	TF1040	1	GUARD,CUTTERSHAFT
16	21399	2	HEX NUT,3/4",ACME THRD
17	TF4333A	2	GROUND ROLLER ADJ BRKT
18	6T2294	8	PLOW BOLT,1/2" X 2",NC
19	TF4336	4	PLATE,GROUND ROLLER LOCK
20	21730	5	CAPSCREW,1/2" X 1-1/4",NC
21	TF4371	1	SKID SHOE,L/PROFILE-OUTER
24	28999	1	GROUND ROLLER,102"
25	TF1045B	2	GRND ROLLER STUB SHAFT
26	6T2330	8	CAPSCREW,7/16" X 1-1/2", SKT HD
---	06200347	-	KIT,STRING GUARD (ITEMS 27, 28 & 30)
27	06530217	8	CAPSCREW,1/2" X 2",NC,L9
28	06533006	8	FLATWASHER,1/2",SAE,L9
29	TF1018	2	BEARING,FLANGE,2-3/16"
30	31204	2	STRING GUARD
---	TF1707A	-	CUTTERSHAFT ASSY (STANDARD CUT) (ITEMS 31, 32, 33, 34 & 35)
----	TF1707B	-	CUTTERSHAFT ASSY (SMOOTH CUT) (ITEMS 31, 32, 33, 34A & 35)
31	TF1707	1	CUTTERSHAFT,102"
32	30411	56	KNIFE MOUNTING BOLT,FLAIL
33	TF1020	56	KNIFE MTG CLEVIS,FLAIL
34	33714	112	KNIFE,FLAIL,STANDARD CUT
34A	TF1019F	56	KNIFE,FLAIL,SMOOTH CUT (NOT SHOWN)
35	21677	56	NYLOCK NUT,7/16",NC
36	TF4365	1	SKID SHOE,L/PROFILE-INNER
37	TF1701	1	FRONT TRASH GUARD
38	06530001	12	CAPSCREW,SKT HD
39	06520027	2	CAP,BEARING
40	06520029	2	O-RING,2-3/4" X 3/32"
41	06520028	2	BEARING,FLANGE,1-3/8"
42	6T2331	8	CAPSCREW,7/16" X 1",SKT HD

COMMON TRIPLE

# EXTREME DUTY 102IN REAR FLAIL DRIVE ASSY

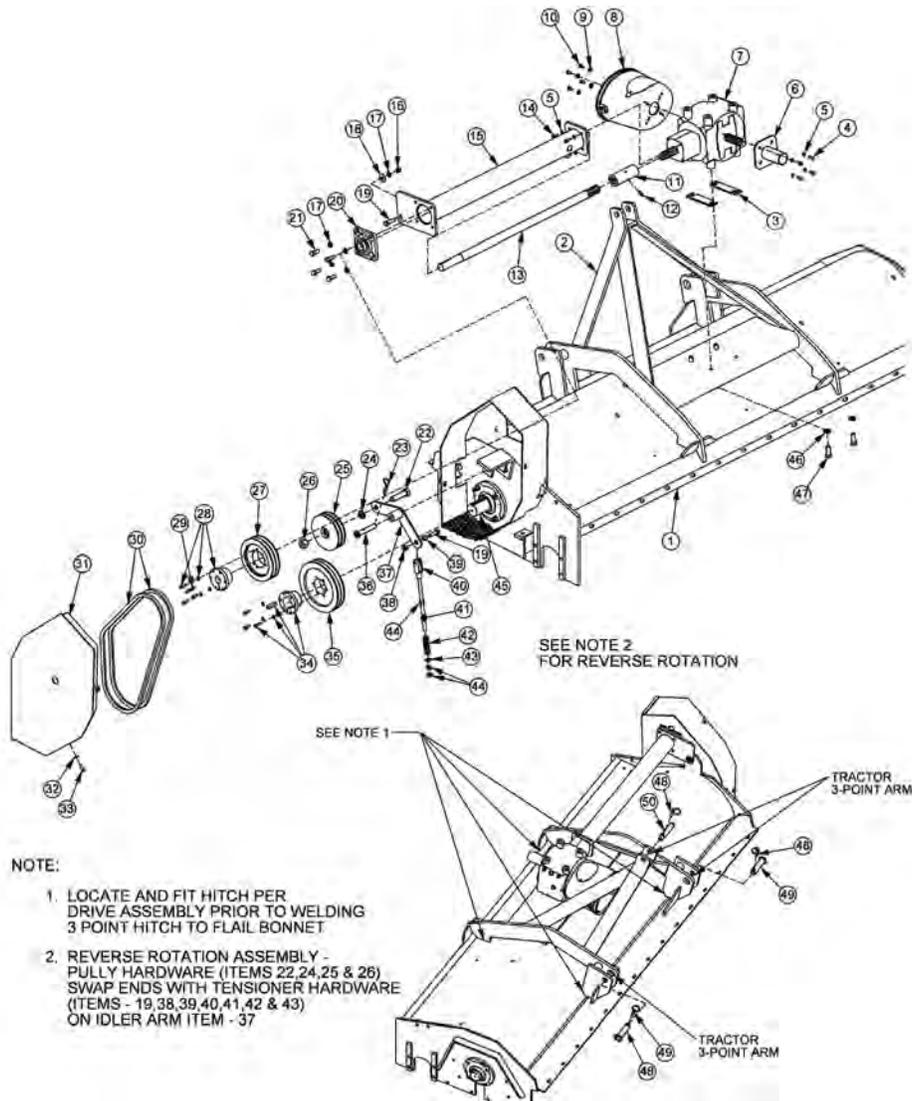

ITEM	PART NO.	QTY.	DESCRIPTION
1	-----	1	BONNET *REFER TO CUTTER ASSY
2	31279A	1	HITCH,3-POINT
3	40454	2	SPACER
4	27508	4	CAPSCREW,8MM X 20MM(1.25)
5	6T2619	8	LOCKWASHER,8MM
6	28447E	1	GUARD,OUTPUT SHAFT
7	28505	1	GEARBOX,REAR FLAIL,COMER T22A
8	06520181	1	GUARD,PTO,GRBX
9	34948	4	FLATWASHER,8MM
10	27507	4	CAPSCREW,8MM X 15MM(1.25)
11	28914	1	COUPLING,6 SPLINE
12	6T3209	1	GREASE ZERK,1/4" DRIVE
13	28421A	1	OUTPUT EXTENSION SHAFT,102"RCM

COMMON TRIPLE

## EXTREME DUTY 102IN REAR FLAIL DRIVE ASSY

Continued...

ITEM	PART NO.	QTY.	DESCRIPTION
---	28417B	-	OUTPUT EXTENSION SHAFT,102"R6F
----	28419B	-	OUTPUT EXTENSION SHAFT,102"OFF
14	30162	4	CAPSCREW,SKT HD,8MM X 20MM(1.25)
15	28429A	1	SHAFT GRD,HD,102"RCM
---	28425B	-	SHAFT GRD,HD,102"R6F
----	28427B	-	SHAFT GRD,HD,102"ROFF
16	21725	1	HEX NUT,1/2",NC
17	21990	5	LOCKWASHER,1/2"
18	22018	1	FLATWASHER,1/2",WIDE
19	21732	2	CAPSCREW,1/2" X 1-3/4",NC
20	28571	1	BEARING,FLANGE,1-1/4"
21	21730	4	CAPSCREW,1/2" X 1-1/4",NC
22	28399	1	CAPSCREW,20MM X 80MM(2.5),GR10.9
23	6T3004	1	R-CLIP,HAIRPIN COTTER,3/16"
24	24881	1	LOCKWASHER,20MM
25	31295	1	SHEAVE,IDLER ASSY,6.3"
26	31740	1	NYLOCK NUT,20MM(2.5)
27	TF3043	1	SHEAVE,7.5"
28	30049	2	BUSHING,QD,SK 1-1/4",1/4" KEY
29	28572	1	KEY,1/4"SQ X 2"
30	TF3023	2	V-BELT(630)
31	31286A	1	SHIELD,BELT
32	21988	4	LOCKWASHER,3/8"
33	21630	4	CAPSCREW,3/8" X 1",NC
34	TF3011	1	BUSHING,QD,SK 2-3/16"
35	28570	1	SHEAVE,9.0"
36	TF3605	1	PIN,IDLER ARM
37	TF1180	1	IDLER ARM
38	6T2418	1	HEX NUT,1/2",NC,GR8(STOVER)
39	TF3610	1	BUSHING,IDLER
40	PT3611A	1	CLEVIS
41	32482	1	ROD,THREADED,1/2-20,NF,12-1/2"
42	TF3620A	1	SPRING,TENSIONER
43	27938	1	BUSHING,MACH,14GA
44	21700	3	HEX NUT,1/2",NF
45	-----	1	CUTTERSHAFT *REFER TO CUTTER ASSY
46	6T2625	4	LOCKWASHER,16MM
47	22421	4	CAPSCREW,16MM X 40MM(2.0),GR10.9
48	TF1143	3	LYNCH PIN
49	TF1120	2	PIN,CAPPED
50	TB1036	1	PIN

COMMON TRIPLE

# EXTREME DUTY REAR GEAR BOX ASSY

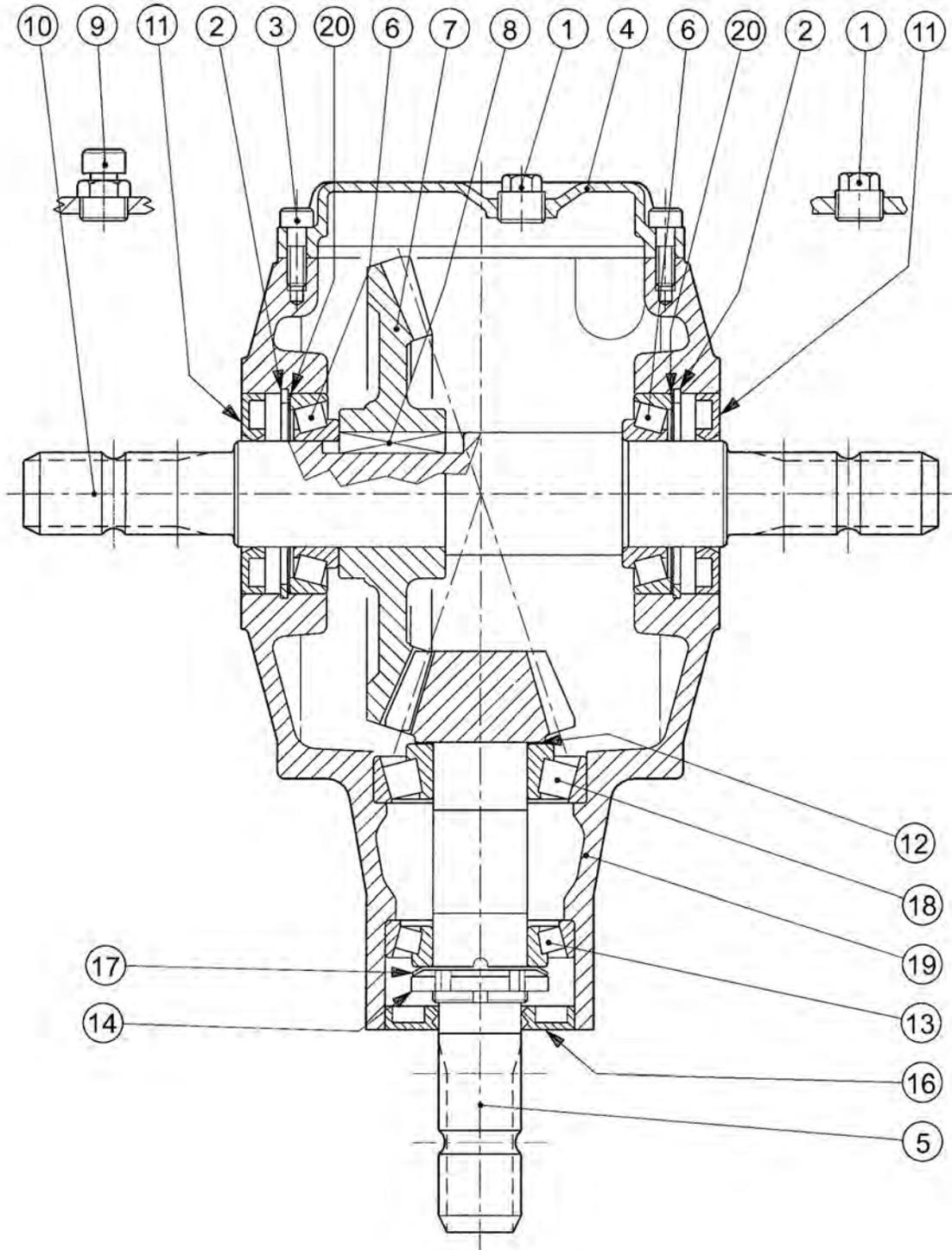

COMMON TRIPLE

## EXTREME DUTY REAR GEAR BOX ASSY

Continued...

ITEM	PART NO.	QTY.	DESCRIPTION
---	28505	-	GEAR BOX,REAR FLAIL,HD
1	28592	2	PLUG,1/2",GAS
2	28593	2	SNAP RING
3	28594	6	CAPSCREW,8MM X 25MM
4	28595	1	SHIM
6	28597	2	BEARING
7	28598	1	GEAR
8	28599	1	PARALLEL KEY
9	28600	1	OIL FILLER PLUG
10	28601	1	SHAFT
11	28602	2	OIL SEAL
12	28603	1	SHIM
13	28604	1	BEARING
14	28605	1	LOCK NUT
15	28606	1	PINION
16	28607	1	DOUBLE LIP SEAL
17	28608	1	SPRING WASHER
18	28609	1	BEARING
19	28591	1	CASTING
20	28596	2	SHIM

COMMON TRIPLE

## PTO SHAFT ASSEMBLY

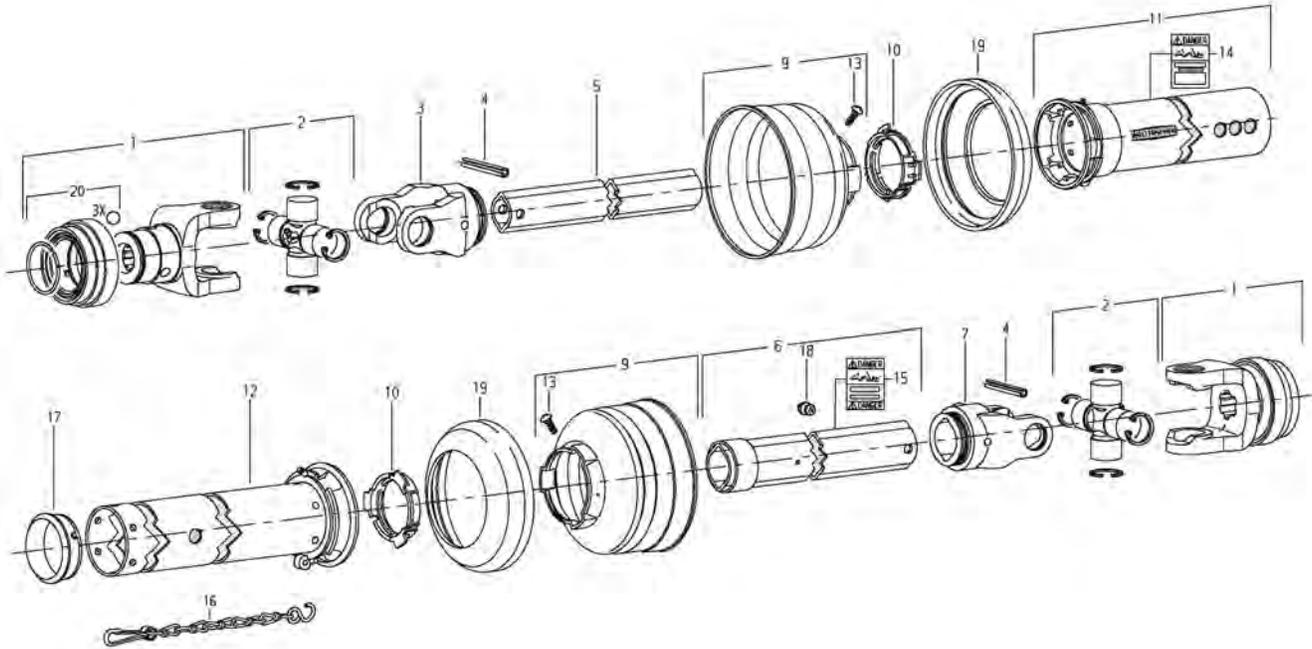

ITEM	PART NO.	QTY.	DESCRIPTION
---	06520414	-	PTO,DRV SHFT,TRF
1	00775353	2	YOKE 1-3/8"-6 SPL.
2	00189700	2	CROSS & BEARING KIT
3	00775317	1	INBOARD YOKE 1B
4	00756934	2	SPRING PIN
5	-----	1	INNER PROFILE 1B
6	-----	1	PROFILE & SLEEVE
7	00775318	1	INBOARD YOKE 2A
9	06505010	2	GUARD CONE
10	8393	2	BEARING RING
11	-----	1	GUARD TUBE,OUTER
12	-----	1	GUARD TUBE,INNER
13	00759217	2	SCREW (ITEM 9)
14	00756005	1	DECAL,OUTER (ITEM 11)
15	00756004	1	DECAL,INNER (ITEM 6)
16	1416412	1	RESTRAINT CHAIN
17	-----	1	SUPPORT BEARING
18	-----	1	ZERK (ITEM 6)
19	-----	2	REINFORCING COLLAR
20	00767954	-	KIT,COLLAR (ITEM 1)

COMMON TRIPLE



## PTO SHAFT ASSEMBLY WITH CLUTCH

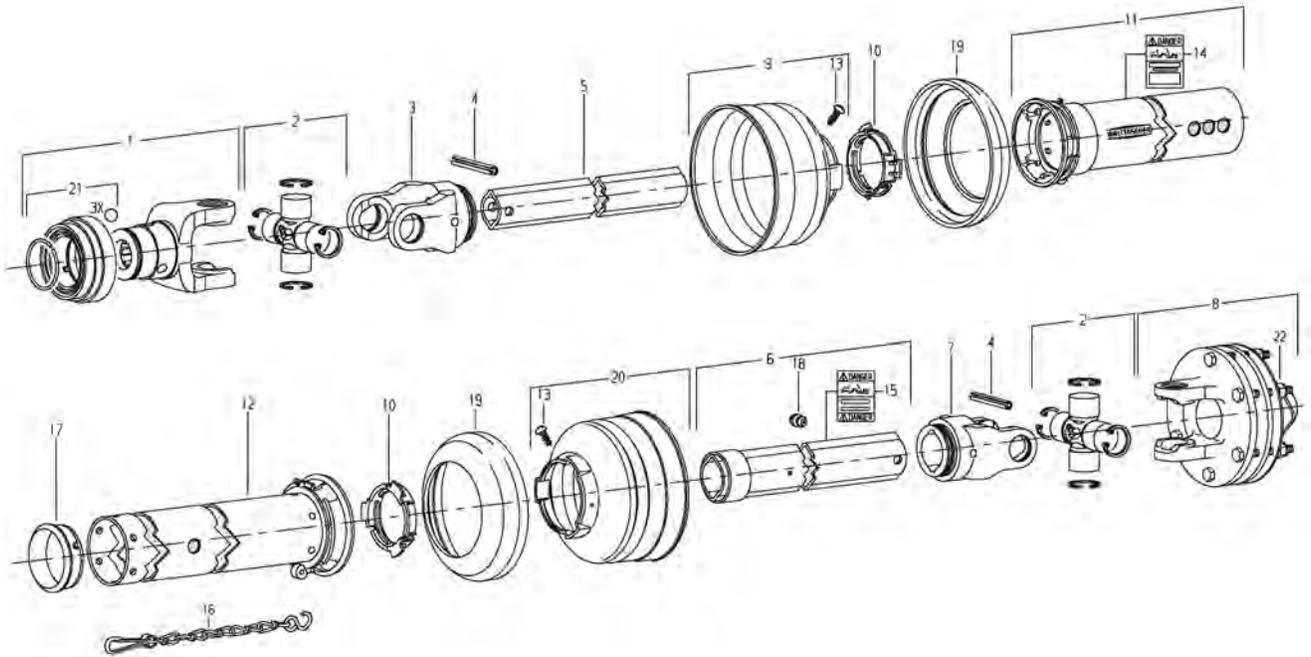

ITEM	PART NO.	QTY.	DESCRIPTION
---	06520415	-	PTO,DRV SHFT,TRF,CLUTCH
1	00775353	1	YOKE 1-3/8"-6 SPL.
2	00189700	2	CROSS & BEARING KIT
3	00775317	1	INBOARD YOKE 1B
4	00756934	2	SPRING PIN
5	-----	1	INNER PROFILE 1B
6	-----	1	PROFILE & SLEEVE
7	00775318	1	INBOARD YOKE 2A
8	00775365	1	FRICITION CLUTCH
9	06505010	2	GUARD CONE
10	8393	2	BEARING RING
11	-----	1	GUARD TUBE,OUTER
12	-----	1	GUARD TUBE,INNER
13	00759217	2	SCREW (ITEM 9)
14	00756005	1	DECAL,OUTER (ITEM 11)
15	00756004	1	DECAL,INNER (ITEM 6)
16	1416412	1	RESTRAINT CHAIN
17	-----	1	SUPPORT BEARING
18	-----	1	ZERK (ITEM 6)
19	-----	2	REINFORCING COLLAR
20	-----	1	GUARD CONE
21	00767954	-	KIT,COLLAR (ITEM 1)
22	0921000470	-	KIT,FLANGE (ITEM 8)

COMMON TRIPLE

## CLUTCH ASSEMBLY

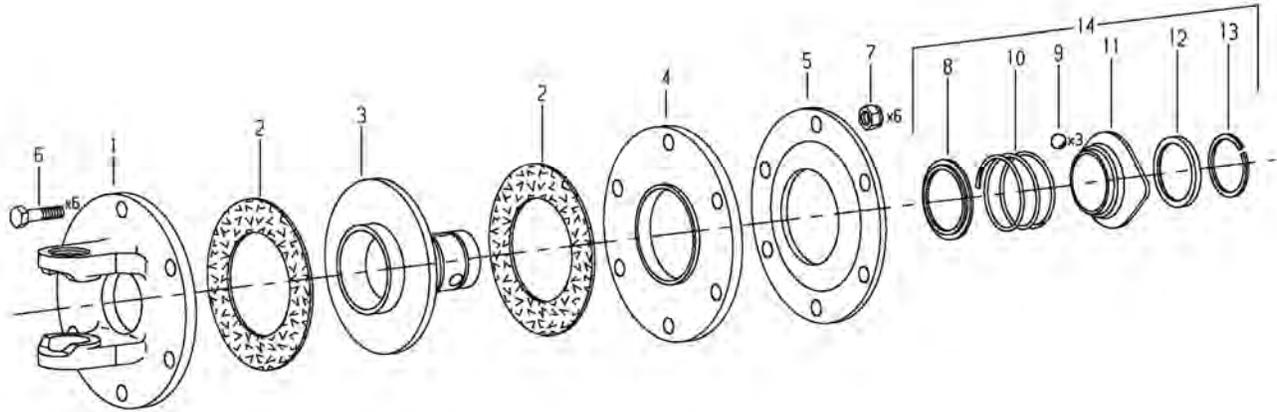

ITEM	PART NO.	QTY.	DESCRIPTION
---	00775365	-	CLUTCH ASSY
1	-----	1	FLANGE YOKE
2	-----	2	FRICTION DISC
3	-----	1	HUB
4	-----	1	THRUST PLATE
5	-----	1	BELLE VILLE SPRING
6	-----	6	HEX BOLT
7	-----	6	HEX LOCKNUT
8	-----	1	BACK-UP RING
9	-----	3	BALL
10	-----	1	COMPRESSION SPRING
11	-----	1	LOCK COLLAR
12	-----	1	BACK-UP RING
13	-----	1	SNAP RING
14	0921000470	-	KIT(ITEMS 8 THRU 13)

COMMON TRIPLE

# NOTES

# RESERVOIR TANK FILTER ASSEMBLY

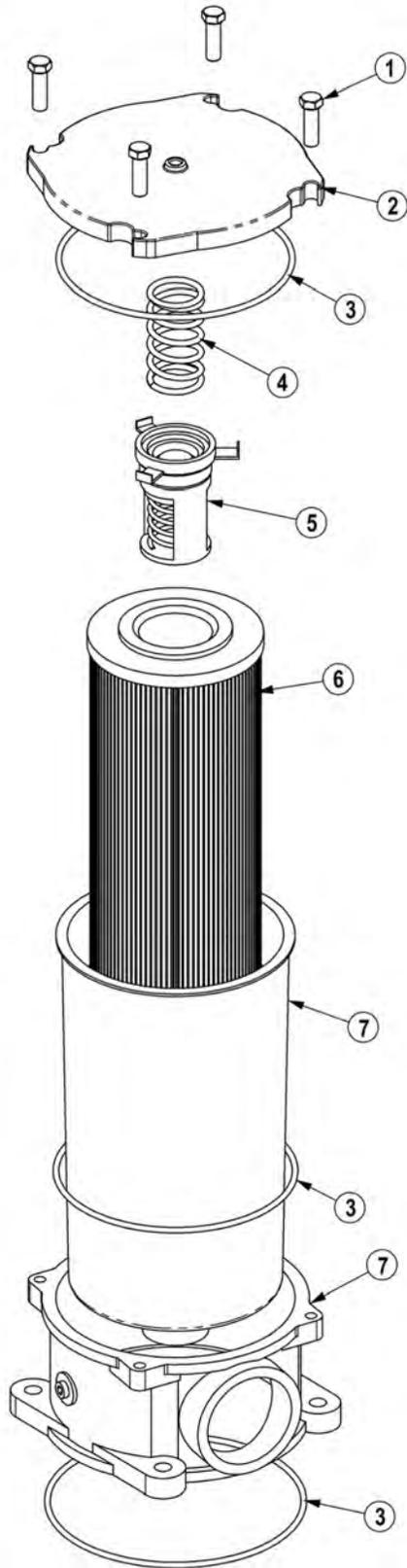

COMMON TRIPLE

## RESERVOIR TANK FILTER ASSEMBLY

Continued...

ITEM	PART NO.	QTY.	DESCRIPTION
---	06505044	-	FILTER ASSY SAE 10 MICRON
1	28583	4	CAPSCREW,8MM X 25MM(1.25 PITCH)
2	06505045	1	COVER
3	06505046	1	SEAL KIT
4	06505047	1	SPRING
5	06505048	1	BYPASS
6	35259	1	FILTER,10 MIC,RETURN LINE
7	06505049	1	CAN/BODY

COMMON TRIPLE

# FRONT HYDRAULIC PUMP BREAKDOWN

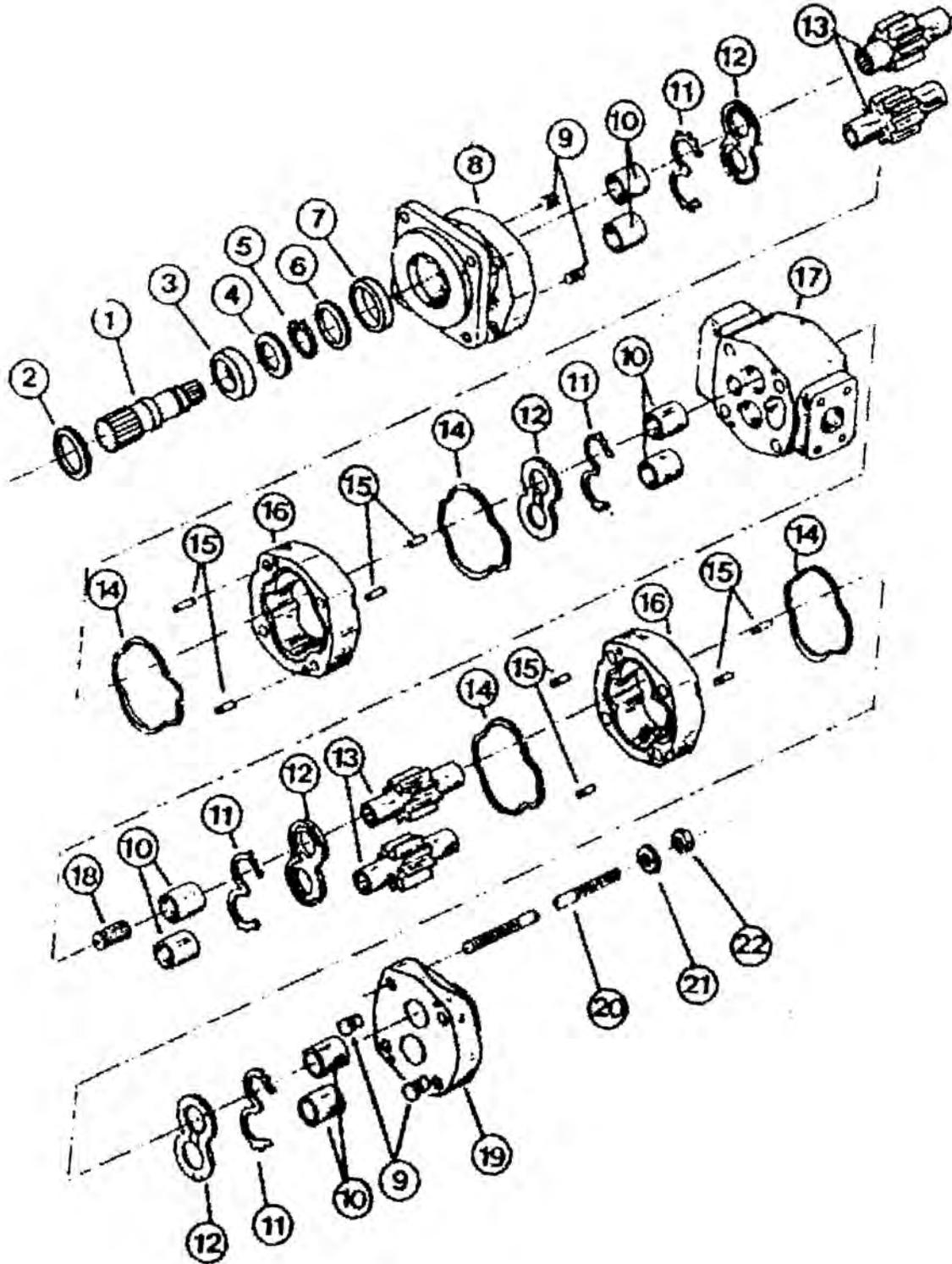

COMMON TRIPLE

## FRONT HYDRAULIC PUMP BREAKDOWN

Continued...

ITEM	PART NO.	QTY.	DESCRIPTION
---	TF4450	1	FRONT MOUNTED PUMP P330
1	TF4459	1	CONTINENTAL SHAFT
2	TF4451	1	SNAP RING
3	TF4452	1	OUTBOARD BEARING
4	TF4467	1	BEARING RETAINER RING
5	TF4472	1	RETAINING RING
6	TF4473	1	SPACER
7	TF4453	1	LIP SEAL
8	TF4454	1	SHAFT END COVER
9	TF4455	4	PLUG
10	TF4456	8	BUSHING
11	TF4457	4	CHANNEL SEAL
12	TF4458	4	THRUST PLATE
13	TF4466	-	MATCHED GEAR SET
14	TF4460	4	GASKET SEAL
15	TF4461	8	DOWEL PINS
16	TF4462	2	GEAR HOUSING (FOR 1-1/2" GEARS)
17	TF4463	1	BEARING CARRIER
18	TF4465	1	CONNECTING SHAFT
19	TF4468	1	PORT END COVER
20	TF4469	4	STUD
21	TF4415	4	WASHER
22	TF4471	4	NUT
---	TF4474	1	SEAL KIT (INCLUDES ITEM 7, 11, AND 14)

COMMON TRIPLE

3IN X 8IN TIE-ROD CYLINDER - 31211

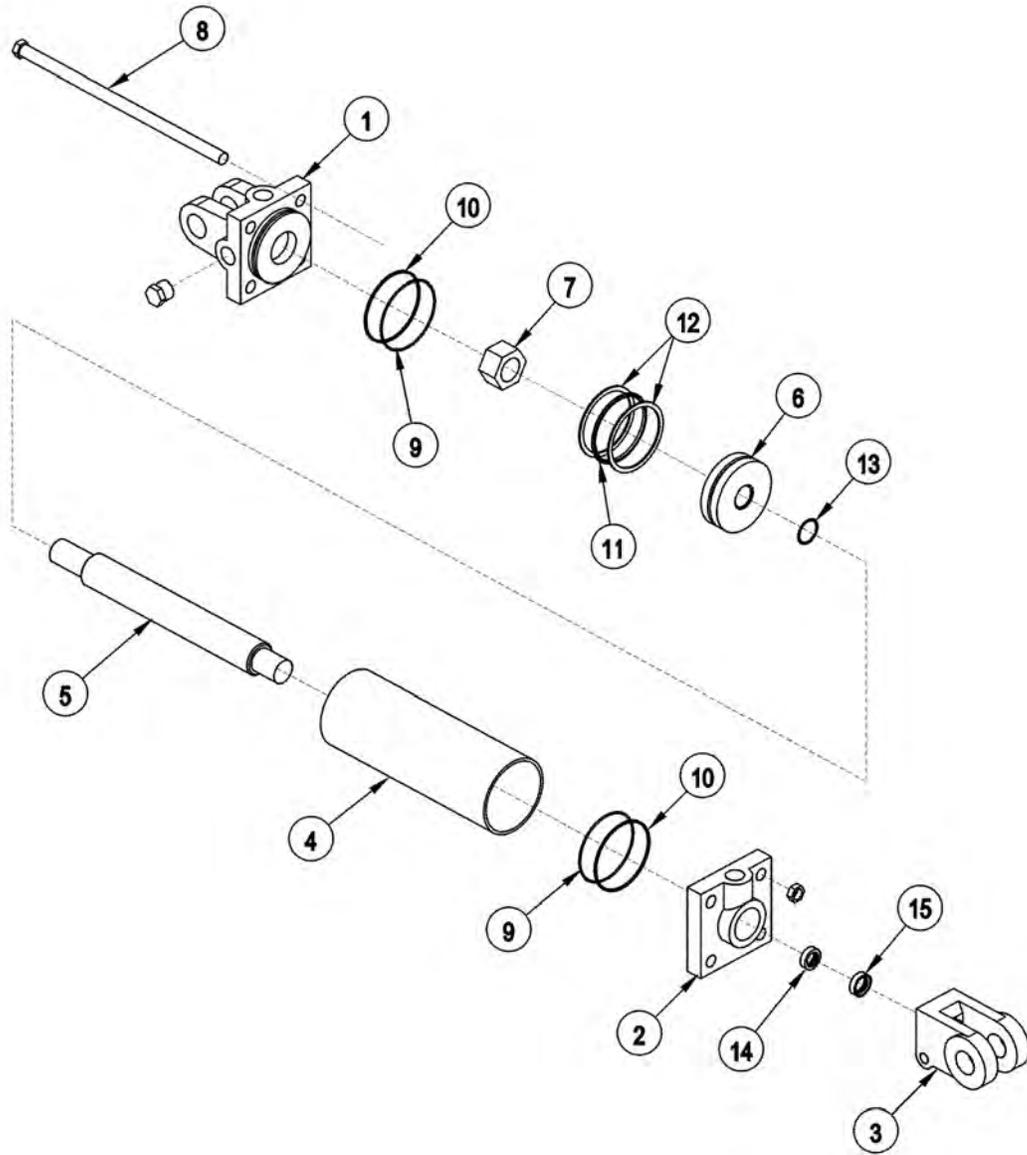

COMMON TRIPLE



### 3IN X 8IN TIE-ROD CYLINDER - 31211

Continued...

ITEM	PART NO.	QTY.	DESCRIPTION
---	31211	-	CYLINDER 3" X 8"
1	6T0167	1	CYLINDER BUTT
2	6T0170	1	CYLINDER GLAND
3	6T0178	1	CLEVIS END
4	23870	1	CYLINDER TUBE
5	23869	1	PISTON ROD
6	6T0173	1	PISTON
7	6T0179	1	LOCKNUT
8	21749	4	TIE ROD ASY
---	06501579	-	SEAL KIT
9	-----	2	O - RING
10	-----	2	BACK - UP WASHER
11	-----	1	O - RING
12	-----	2	BACK - UP WASHER
13	-----	1	O - RING
14	-----	1	U - CUP
15	-----	1	WIPER

COMMON TRIPLE

3IN X 12IN TIE-ROD CYLINDER - 25343

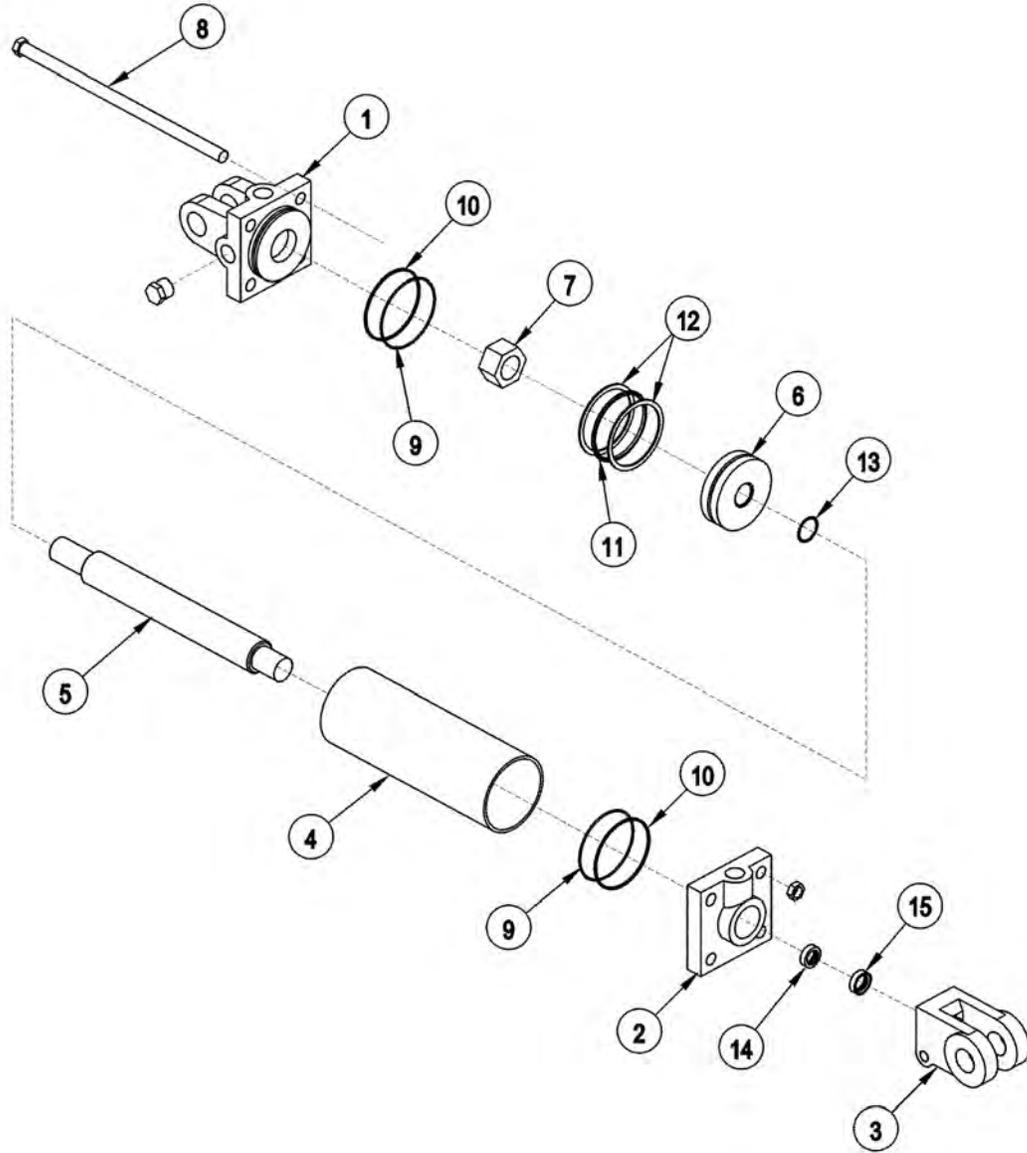

COMMON TRIPLE

### 3IN X 12IN TIE-ROD CYLINDER - 25343

Continued...

ITEM	PART NO.	QTY.	DESCRIPTION
---	25343	-	CYLINDER 3" X 12"
1	6T0167	1	CYLINDER BUTT
2	6T0170	1	CYLINDER GLAND
3	6T0178	1	CLEVIS END
4	23870	1	CYLINDER TUBE
5	23869	1	PISTON ROD
6	6T0173	1	PISTON
7	6T0179	1	LOCKNUT
8	21749	4	TIE ROD ASY
---	6T0187	-	SEAL KIT
9	-----	2	O - RING
10	-----	2	BACK - UP WASHER
11	-----	1	O - RING
12	-----	2	BACK - UP WASHER
13	-----	1	O - RING
14	-----	1	U - CUP
15	-----	1	WIPER

COMMON TRIPLE

3IN X 12IN TIE-ROD CYLINDER - 32215

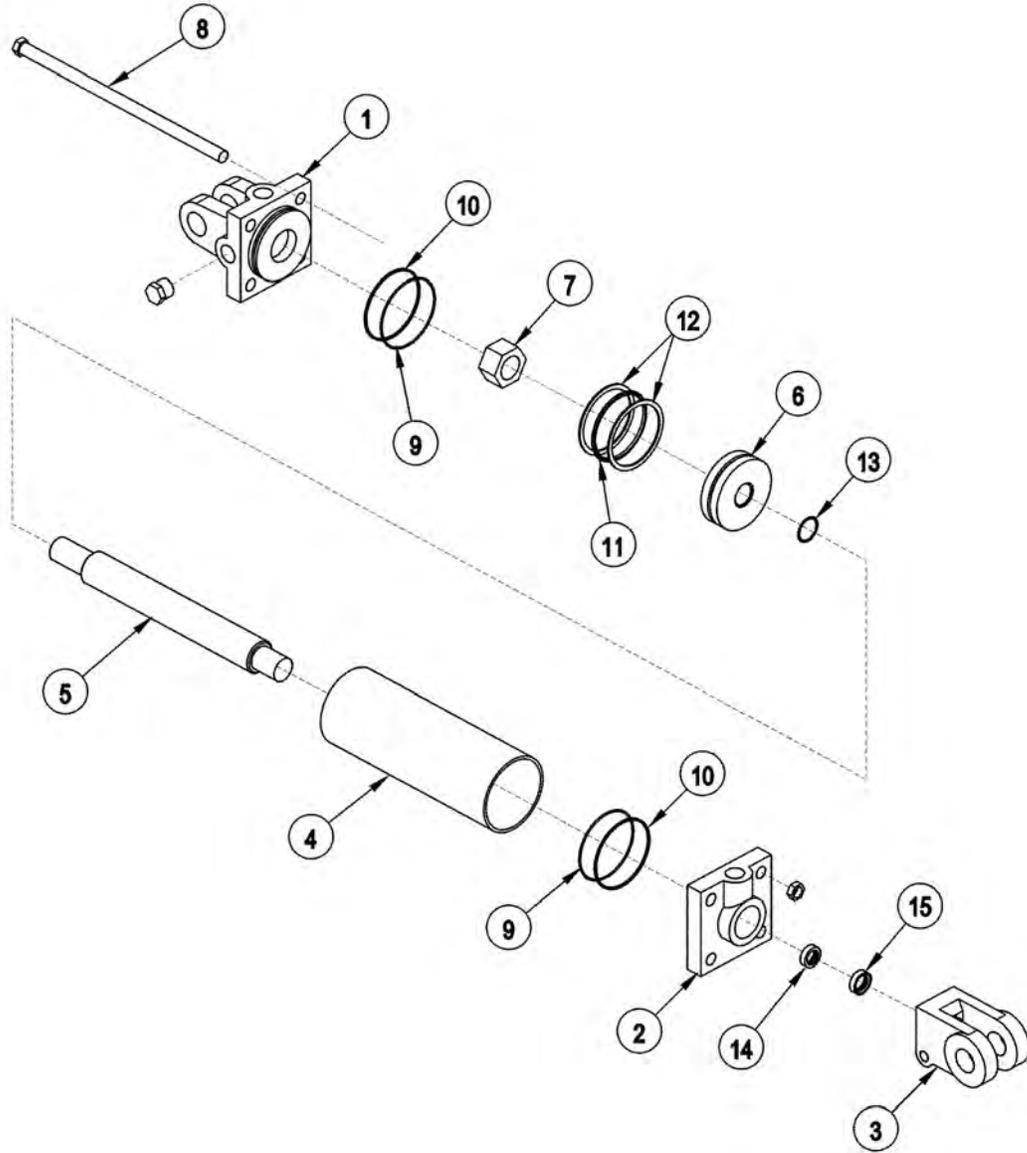

COMMON TRIPLE

## 3IN X 12IN TIE-ROD CYLINDER - 32215

Continued...

ITEM	PART NO.	QTY.	DESCRIPTION
---	32215	-	CYLINDER 3" X 12"
1	6T0167	1	CYLINDER BUTT
2	6T0170	1	CYLINDER GLAND
3	6T0178	1	CLEVIS END
4	6T0204	1	CYLINDER TUBE
5	6T0203	1	PISTON ROD
6	6T0173	1	PISTON
7	6T0179	1	LOCKNUT
8	6T0205	4	TIE ROD ASY
---	6T0187	-	SEAL KIT
9	-----	2	O - RING
10	-----	2	BACK - UP WASHER
11	-----	1	O - RING
12	-----	2	BACK - UP WASHER
13	-----	1	O - RING
14	-----	1	U - CUP
15	-----	1	WIPER

COMMON TRIPLE

4 SPOOL CABLE (MANUAL) LIFT VALVE - 31190

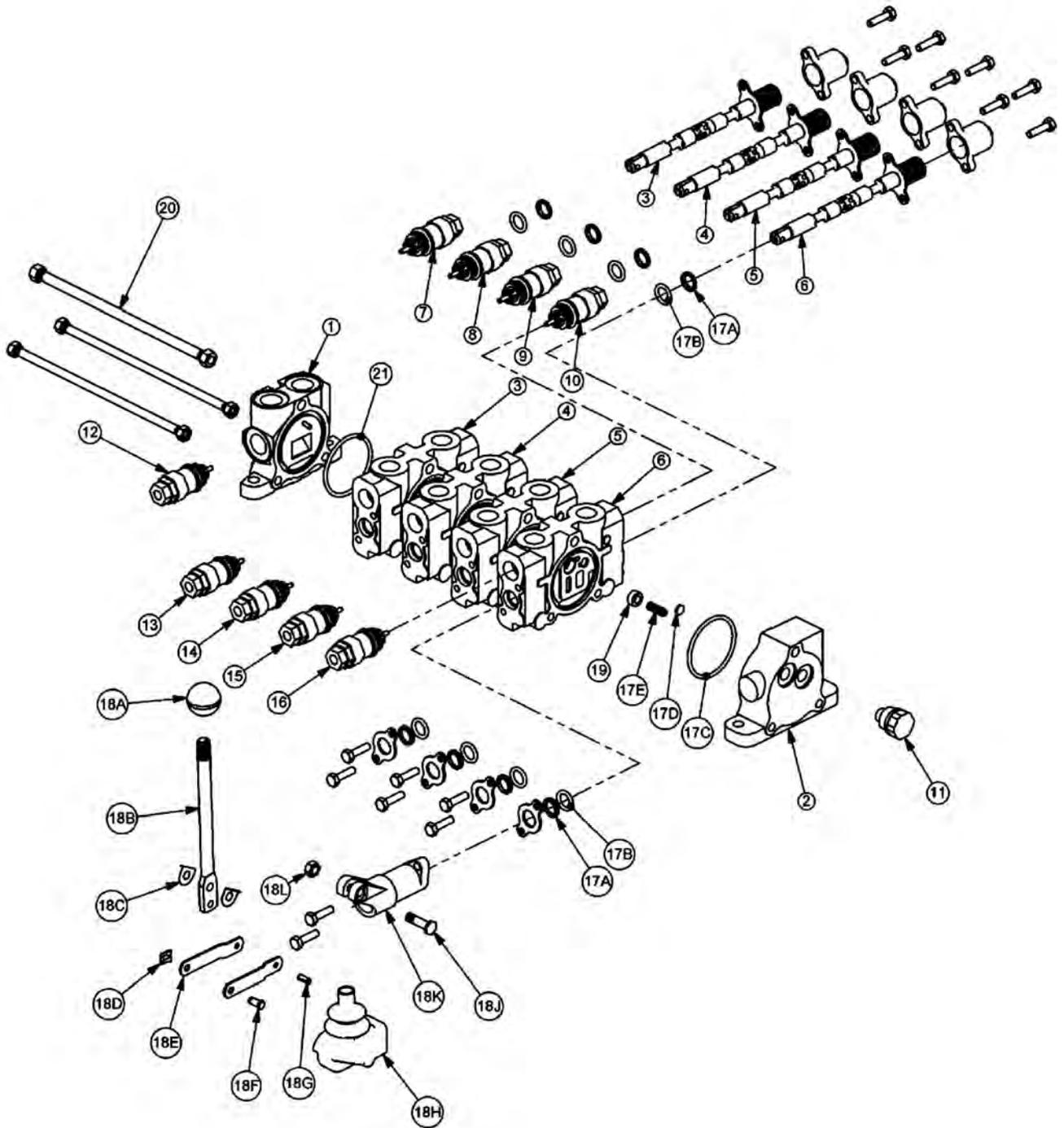

COMMON TRIPLE

## 4 SPOOL CABLE (MANUAL) LIFT VALVE - 31190

Continued...

ITEM	PART NO.	QTY.	DESCRIPTION
---	31190	-	VALVE,4 SPOOL,LOAD SENSE
1	31595	1	INLET END COVER
2	31594	1	END COVER, LOAD SENSE
3	31600	1	VALVE SECTION (DOUBLE ACTING, DETENT - FLOAT)
4	31600	1	VALVE SECTION (DOUBLE ACTING, DETENT - FLOAT)
5	31600	1	VALVE SECTION (DOUBLE ACTING, DETENT - FLOAT)
6	31600	1	VALVE SECTION (DOUBLE ACTING, DETENT - FLOAT)
7	31861	1	RELIEF VALVE, 360 PSI
8	06503067	1	#10 O-RING PLUG
9	06503067	1	#10 O-RING PLUG
10	31861	1	RELIEF VALVE, 360 PSI
11	06503068	1	#6 O-RING PLUG
12	6T4209	1	#10 O-RING PLUG
13	31862	1	RELIEF VALVE, 2175 PSI
14	31862	1	RELIEF VALVE, 2175 PSI
15	31862	1	RELIEF VALVE, 2175 PSI
16	31862	1	RELIEF VALVE, 2175 PSI
17	31593	4	VALVE SEAL KIT (FOR ONE SECTION)
17A	-----	2	WIPER
17B	-----	2	O-RING SMALL
17C	-----	1	O-RING LARGE
17D	-----	1	SHUTTLE DISC
17E	-----	1	SPRING
18	TB1017L	4	LEVER KIT (FOR ONE SECTION)
18A	-----	1	LEVER KNOB
18B	-----	1	LEVER
18C	-----	2	LEVER WASHER
18D	-----	1	LEVER CLIP
18E	-----	2	LINKAGE
18F	-----	1	LEVER PIN
18G	-----	1	ROLL PIN
18H	-----	1	LEVER BOOT
18J	-----	1	LEVER BOLT
18K	-----	1	LEVER DUST COVER
18L	-----	1	LEVER NUT
19	31603	4	COMPENSATOR
20	TB1017U	1	TIE ROD KIT
21	24214	1	O-RING, LARGE

COMMON TRIPLE

4 SPOOL CABLE (MANUAL) LIFT VALVE - 06502046

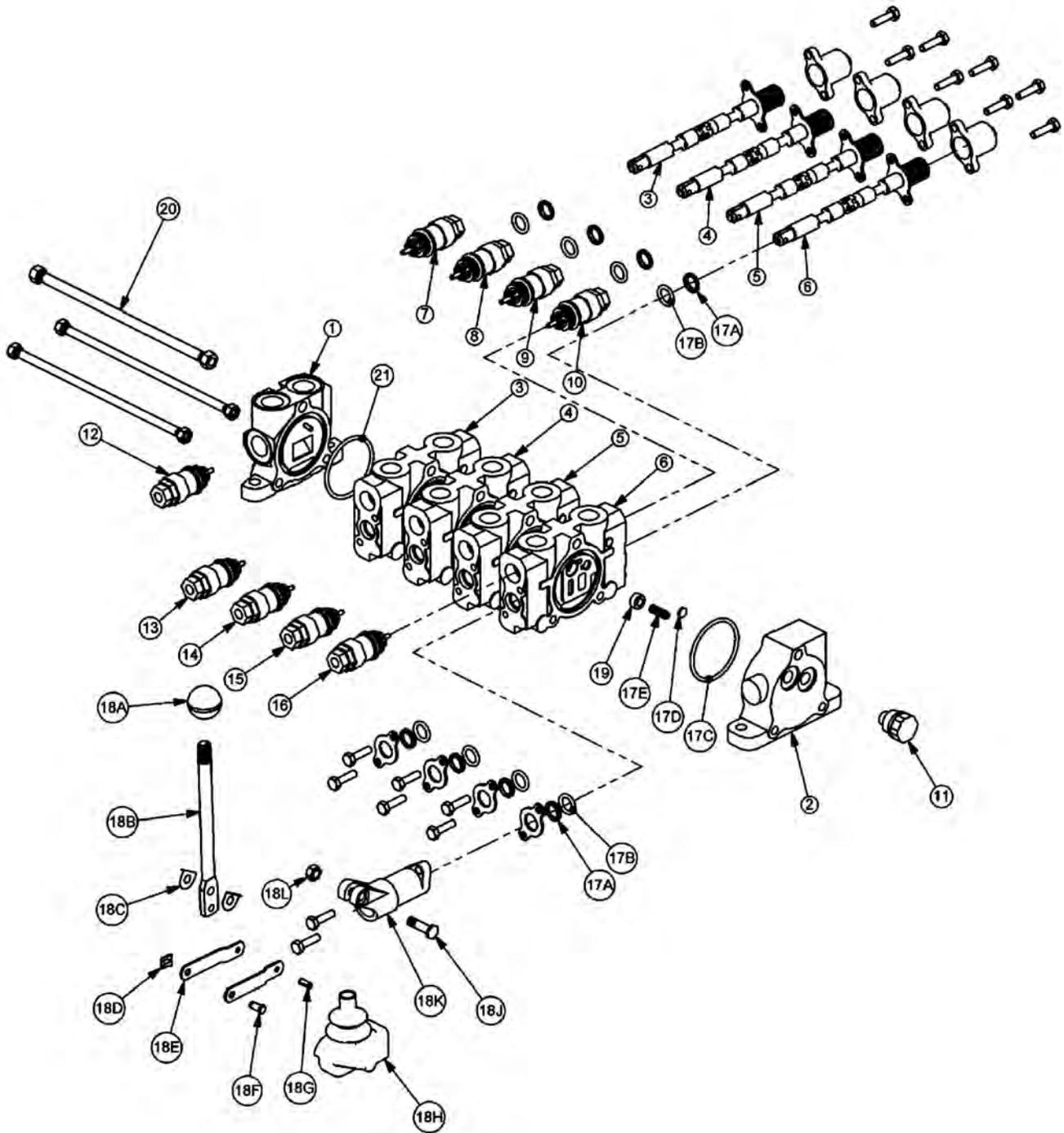

COMMON TRIPLE



## 4 SPOOL CABLE (MANUAL) LIFT VALVE - 06502046

Continued...

ITEM	PART NO.	QTY.	DESCRIPTION
---	06502046	-	VALVE,4 SPOOL,LOAD SENSE
1	31595	1	INLET END COVER
2	31594	1	END COVER, LOAD SENSE
3	31600	1	VALVE SECTION (DOUBLE ACTING, DETENT - FLOAT)
4	31600	1	VALVE SECTION (DOUBLE ACTING, DETENT - FLOAT)
5	31600	1	VALVE SECTION (DOUBLE ACTING, DETENT - FLOAT)
6	31600	1	VALVE SECTION (DOUBLE ACTING, DETENT - FLOAT)
7	31861	1	RELIEF VALVE, 360 PSI
8	06503067	1	#10 O-RING PLUG
9	06503067	1	#10 O-RING PLUG
10	31861	1	RELIEF VALVE, 360 PSI
11	06503068	1	#6 O-RING PLUG
12	6T4209	1	#10 O-RING PLUG
13	31862	1	RELIEF VALVE, 2175 PSI
14	31862	1	RELIEF VALVE, 2175 PSI
15	31862	1	RELIEF VALVE, 2175 PSI
16	31862	1	RELIEF VALVE, 2175 PSI
17	31593	4	VALVE SEAL KIT (FOR ONE SECTION)
17A	-----	2	WIPER
17B	-----	2	O-RING SMALL
17C	-----	1	O-RING LARGE
17D	-----	1	SHUTTLE DISC
17E	-----	1	SPRING
18	TB1017L	4	LEVER KIT (FOR ONE SECTION)
18A	-----	1	LEVER KNOB
18B	-----	1	LEVER
18C	-----	2	LEVER WASHER
18D	-----	1	LEVER CLIP
18E	-----	2	LINKAGE
18F	-----	1	LEVER PIN
18G	-----	1	ROLL PIN
18H	-----	1	LEVER BOOT
18J	-----	1	LEVER BOLT
18K	-----	1	LEVER DUST COVER
18L	-----	1	LEVER NUT
19	31603	4	COMPENSATOR
20	TB1017U	1	TIE ROD KIT
21	24214	1	O-RING, LARGE

COMMON TRIPLE

# COOLER ASSEMBLY

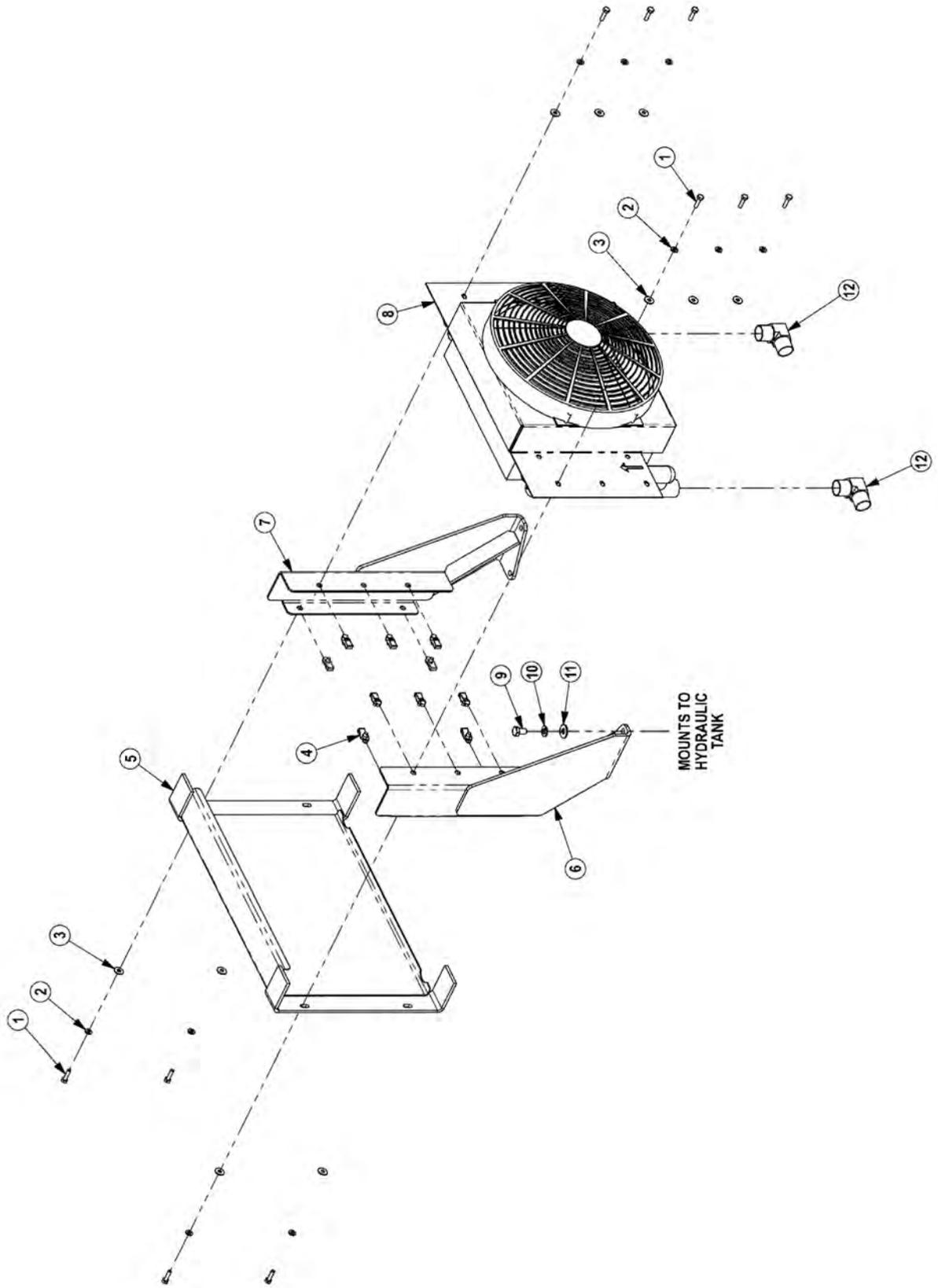

COMMON TRIPLE

## COOLER ASSEMBLY

Continued...

ITEM	PART NO.	QTY.	DESCRIPTION
1	21530	10	CAPSCREW,1/4 X1 NC
2	21986	10	LOCKWASHER,1/4
3	22014	10	FLATWASHER,1/4
4	35176	10	1/4 U-NUT
5	06370015	1	SCREEN,COOLER,FRNT
6	06380006	1	MNT,COOLER,BUMPER TANK,RH
7	06380007	1	MNT,COOLER,BUMPER TANK,LH
8	06510026	1	COOLER,FRONT MNT
---	06510029	1	FAN ASSY ONLY
9	21629	4	CAPSCREW,3/8 X 3/4 NC
10	21988	4	LOCKWASHER,3/8
11	22016	4	FLATWASHER,3/8
12	34117	2	ELBOW,1MOR X 1MJ90,FORGED

COMMON TRIPLE

# CASTER WHEEL ASSEMBLY

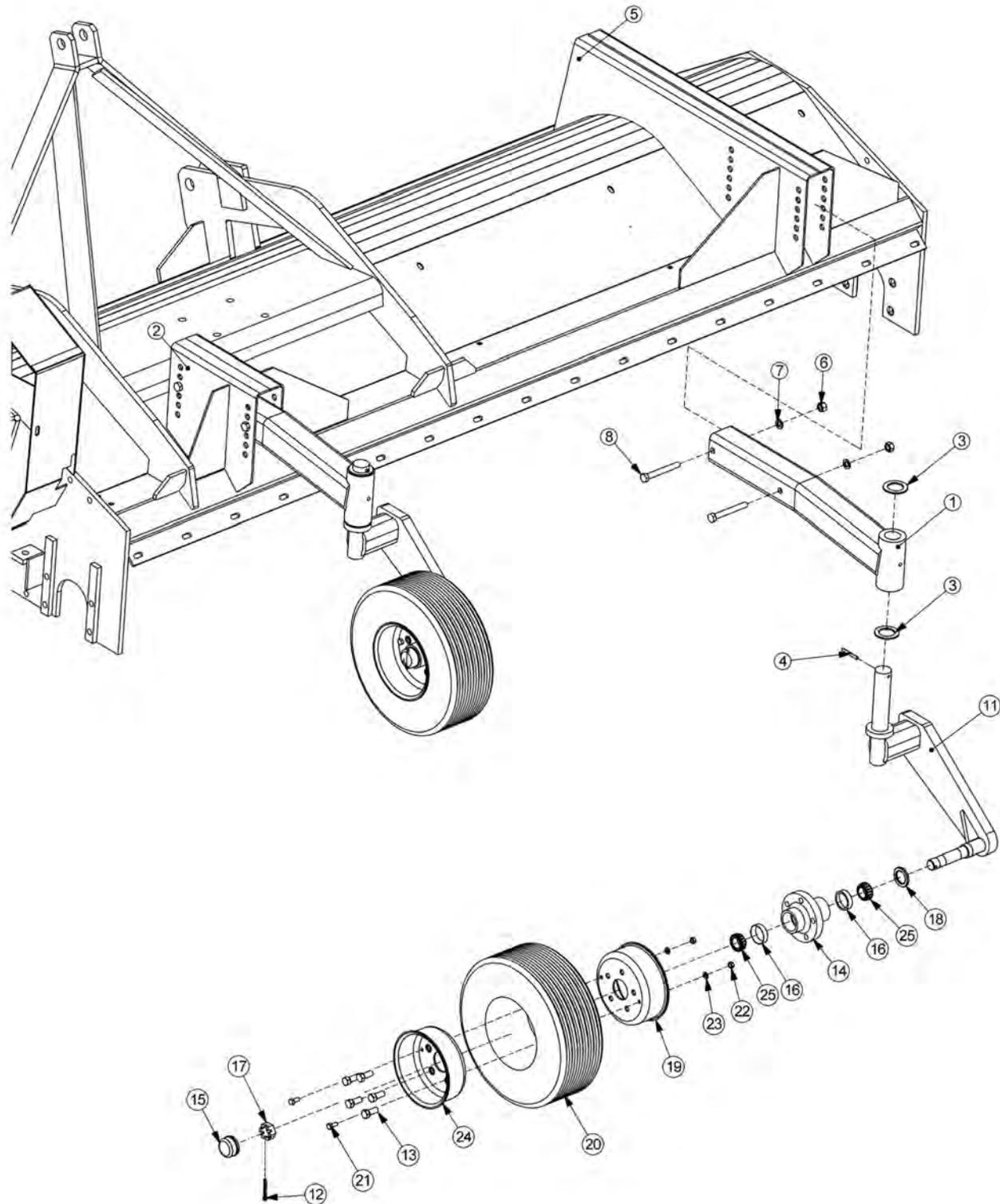

COMMON TRIPLE

## CASTER WHEEL ASSEMBLY

Continued...

ITEM	PART NO.	QTY.	DESCRIPTION
1	TF3060	2	CASTER WHL ARM,FLAIL
2	TF3052A	1	BRKT,REAR CASTER ADJ,LF
3	6T2617	4	BUSHING,MACH,1-1/2"ID X 2-1/4"OD
4	6T3014	2	ROLL PIN,1/4" X 2"
5	TF3053	1	BRKT,REAR CASTER ADJ,RT
6	21725	4	HEX NUT,1/2",NC
7	21990	4	LOCKWASHER,1/2"
8	21741	4	CAPSCREW,1/2" X 5",NC
11	22057	2	SPINDLE,CASTER AXLE,ASSY
12	22533	2	COTTER PIN,3/16" X 2"
13	22071	10	HUB STUD
14	22066	2	HUB,CASTER
15	22070	2	DUST CAP
16	6T0836	4	CUP,CASTER WHEEL
17	22073	2	HEX NUT,1",NF(SLOTTED JAM NUT)
18	6T0838	2	SEAL
19	22696	2	RIM,REAR ROTARY CASTER
20	21416	2	TIRE,SOLID,RR-RTRY
21	21579	4	CAPSCREW,5/16" X 3/4",NC
22	21575	4	HEX NUT,5/16",NC
23	21987	4	LOCKWASHER,5/16"
24	22697	2	RIM,OUTER/RR RTRY CASTER ASSY
25	6T0830	4	BEARING,CONE,CASTER WHEEL

COMMON TRIPLE

## SIDE FLAIL TRAVEL LOCK

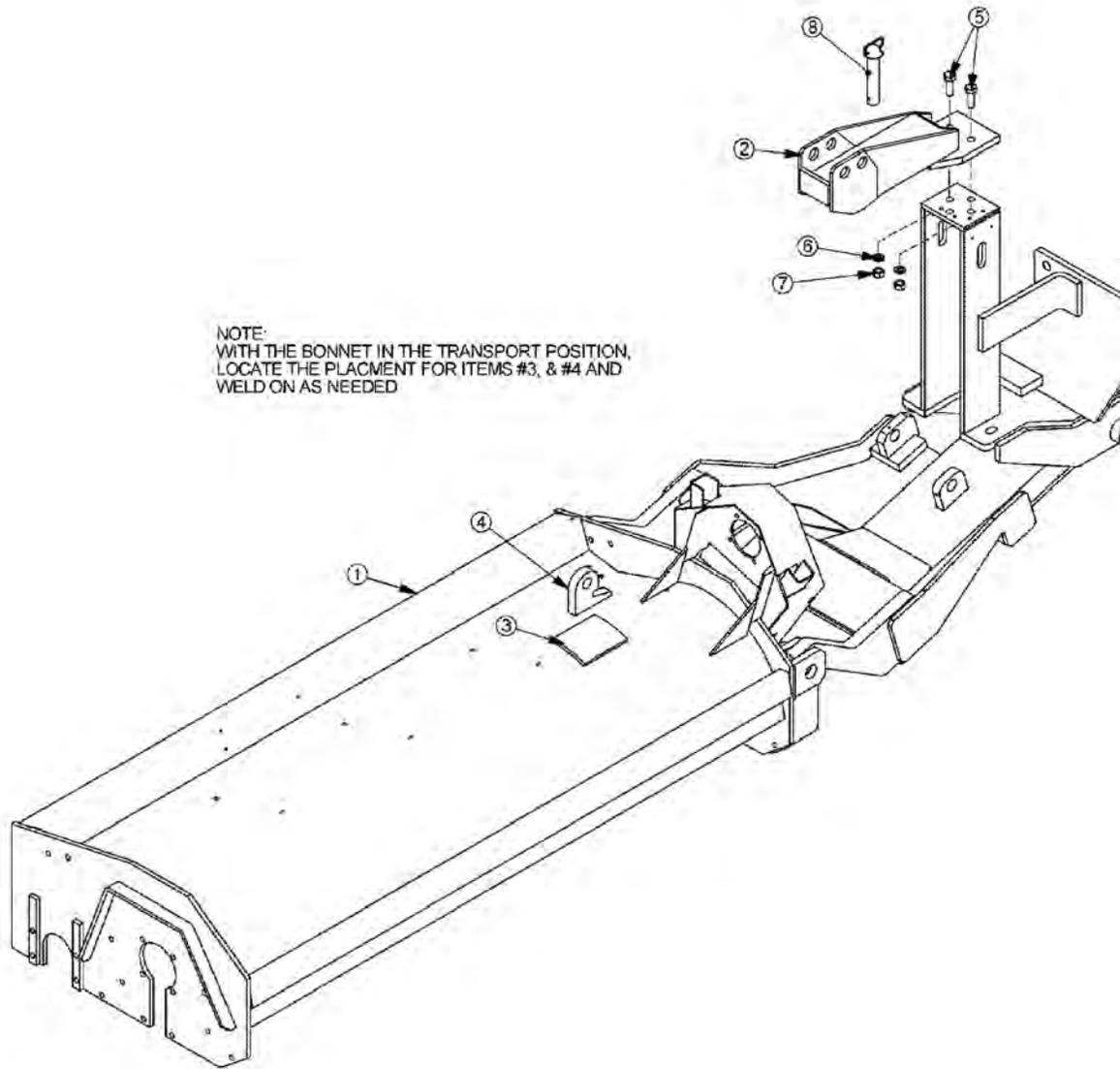

ITEM	PART NO.	QTY.	DESCRIPTION
1	-----	-	BONNET *REFER TO FLAIL ASSEMBLY
2	28276	1	BRACKET, TRAVEL LOCK, TRIPLE
3	TF4248	1	PLATE, TRAVEL LOCK
4	23745	1	TRAVEL LOCK HOOK
5	21783	2	CAPSCREW, 5/8" X 2" NC
6	21992	2	LOCKWASHER, 5/8"
7	21775	2	HEX NUT, 5/8" NC
8	TF4250	1	PIN, TRAVEL LOCK

COMMON TRIPLE

## BRAKE VALVE ASSEMBLY

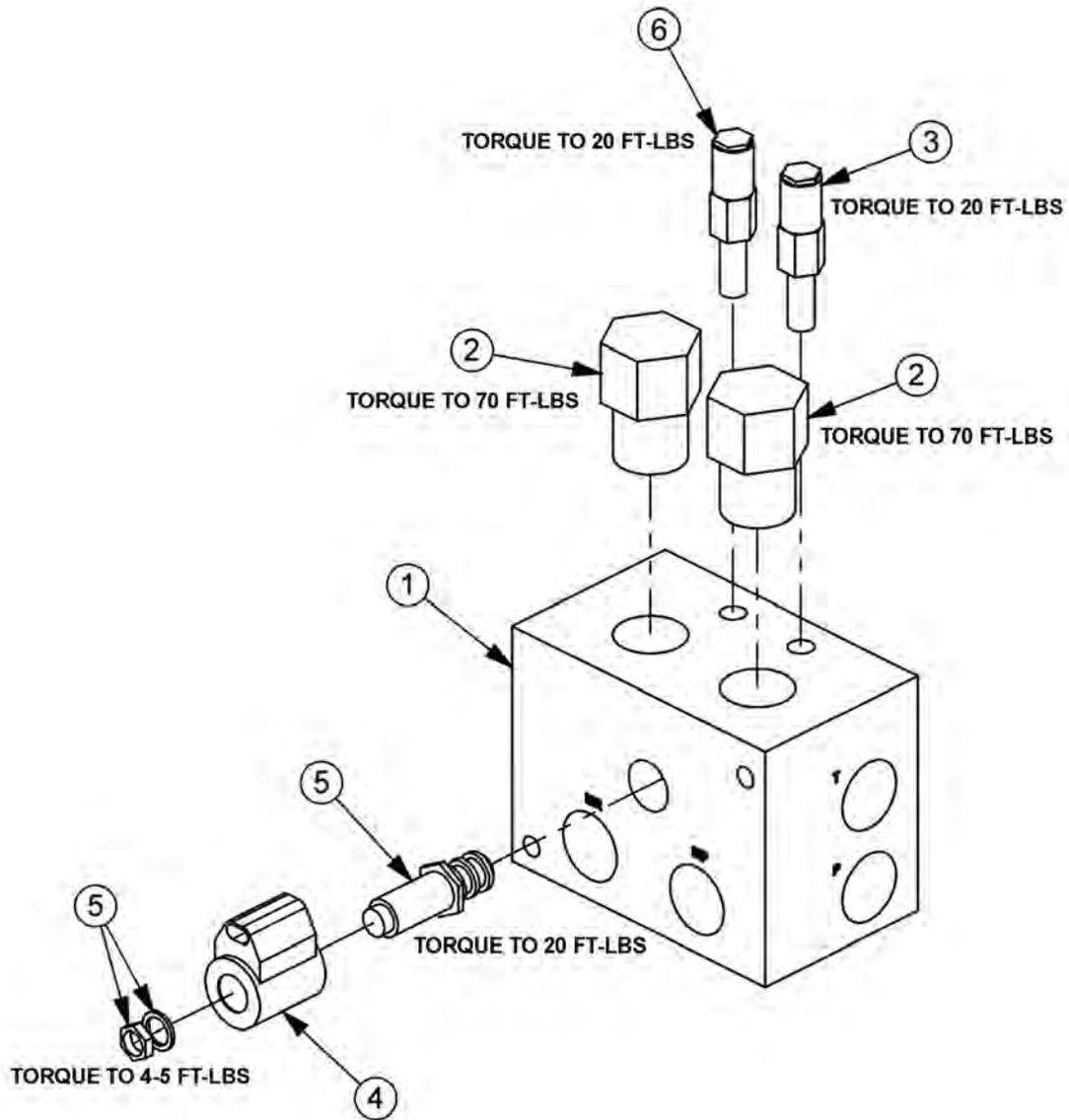

ITEM	PART NO.	QTY.	DESCRIPTION
---	06510083	1	BRAKE VALVE, ASSY
1	34092	1	BRAKE VALVE, BLANK
2	34094	2	LOGIC ELEMENT
3	34095	1	RELIEF VALVE, 3000 PSI
4	06510095	1	METRI PAK COIL
5	34093	1	CARTRIDGE, 2 POSITION, 3 WAY (WITH NUT & WASHER)
6	34091	1	RELIEF VALVE, 2600 PSI
---	34096	2	RELIEF SEAL KIT
----	34097	1	SOLENOID SEAL KIT
---	34098	2	ELEMENT SEAL KIT

COMMON TRIPLE





## SWITCHBOX SERVICE PARTS

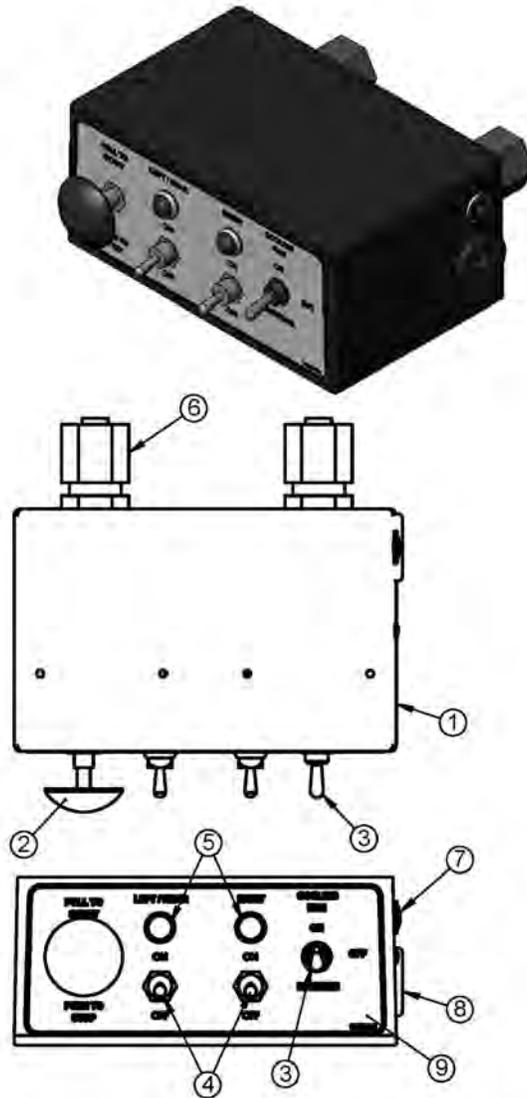

ITEM	PART NO.	QTY.	DESCRIPTION
---	06510097	-	SWITCHBOX ASSEMBLY
1	06514011	1	SWBX,ALUM,BLK
2	35226	1	SWITCH,MOWER,COLEHERSEE
3	06510028	1	SWITCH,FORWARD/BRAKE/REV
4	33811	2	SWITCH,MASTER/DECK FLOAT
5	6T3923	2	INDICTATOR LIGHT,ON,RED
6	34540	2	STRAIN RELIEF,3/4,BLACK,NYLON
7	06514006	1	BREAKER,15A,SWBX
8	06514015	1	ALARM,SWBX,REVERSER
9	06550002	1	DECAL,SWTCHBX,TWIN/T3F,REV FAN
10	35227	1	RELAY,DP,DT,12V,LY2F,35226

COMMON TRIPLE

# SWITCHBOX SCHEMATIC

## 06510097 SCHEMATIC COMMON GROUND SWITCHBOX TWIN / TRIPLE MOWER

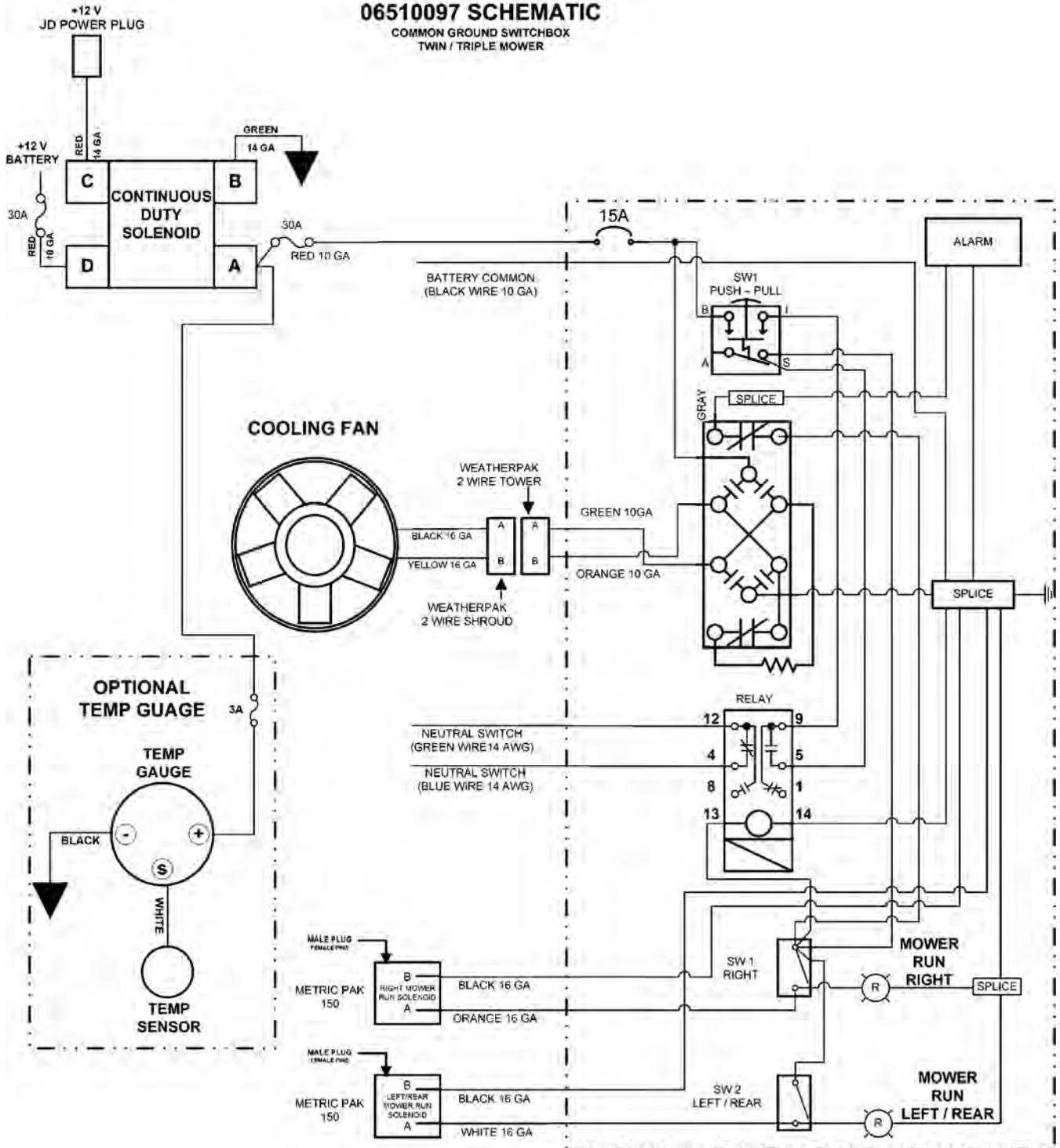

COMMON TRIPLE

# PTO STAND

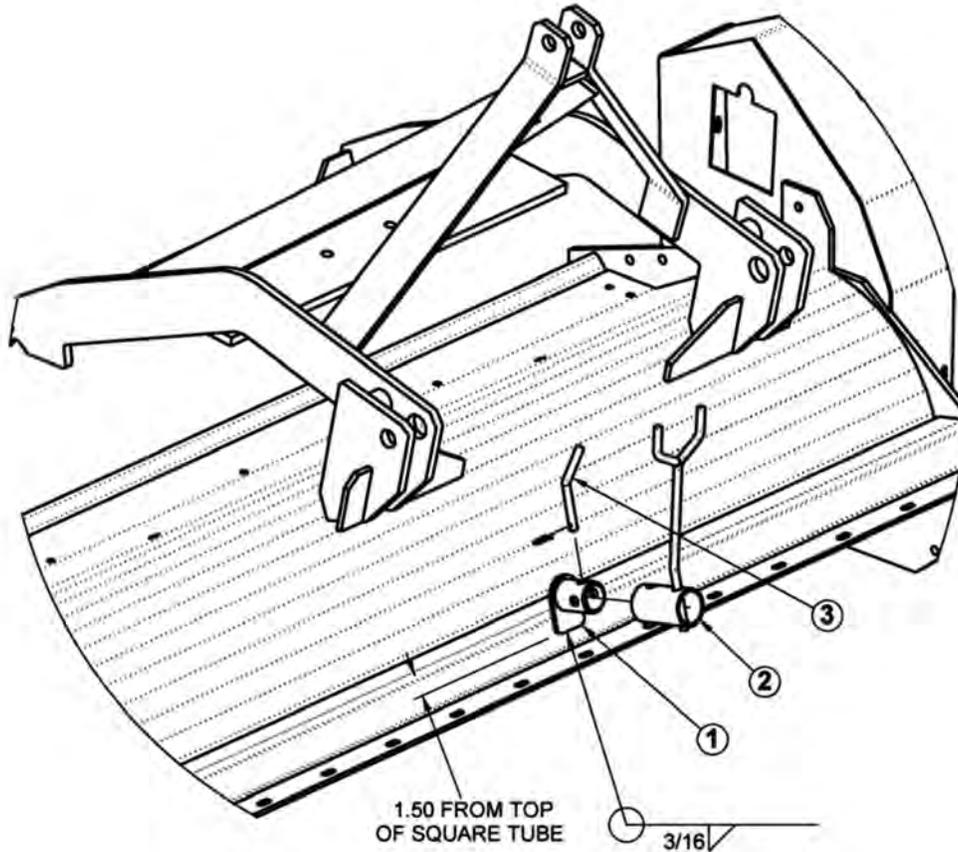

**NOTES:**

1. LOCATE ITEM 1 ON TUBE AS SHOWN, CENTER ON GEAR BOX SHAFT.
2. WELD ITEM 1 AS SHOWN AFTER LOCATING
3. AFTER WELDING, PIN ITEM 2 IN PLACE WITH ITEM 3.

ITEM	PART NO.	QTY.	DESCRIPTION
1	06370080	1	BRACKET,SUPPORT
2	06370022	1	SUPPORT,PTO
3	06520048	1	PIN,BENT,W/ R-CLIP

# NOTES

**WARRANTY  
SECTION**



## WARRANTY INFORMATION

Tiger Corporation, 3301 N. Louise, Sioux Falls, South Dakota, warrants to the original Retail Customer, the new Tiger equipment is free of defects in material and workmanship. Any part of equipment that in Tiger's judgement, show evidence of such defects will be repaired or replaced without charge, provided that the failure of part(s) shall have occurred within twelve (12) months from the date of delivery of said equipment to the Retail Customer. Expendable components such as knives, oil, chain sprockets, skid shoes, knife mounting disks and the like are excluded but not limited to this warranty.

The Retail Customer must pay the transportation cost to and from the Tiger Dealer's service shop for warranty service. Warranty service will be performed by the Tiger Dealer from whom the equipment was purchased, during service shop regularly scheduled days and hours of operation.

All Tiger obligation under this warranty shall be terminated if the equipment is modified or altered in ways not approved in writing by Tiger, if repair parts other than genuine Tiger repair parts have been used, or if the equipment has been subject to misuse, neglect, accident, improper maintenance or improper operation.

Tiger Corporation reserves the right to make improvements in design or changes in specification at any time without incurring any obligation to owners of equipment previously sold.

No agent or person has authority to alter, add to or waive the above warranties which are agreed to be in the only warranties, representations or promises, expressed or implied, as to the quality or performance of the products covered and which do not include any implied warranty of merchantability or fitness. In no event will Tiger be liable for incidental or consequential damages or injuries, including, but not limited to, loss of profits, rental or substitute equipment or other commercial loss.

**THERE ARE NO WARRANTIES WHICH EXTEND  
BEYOND THOSE EXPRESSED HEREIN.**

It is the Purchasers obligation to sign the warranty registration form **AFTER** he / she has Read and Understands the Operation and Safety Instructions stated within this manual.

## **ONE LAST WORD**

This manual cannot possibly cover all of the potentially hazardous situations you will encounter. By being familiar with the safety rules, operating and maintenance instructions in this manual you can help prevent accidents. The objective of this manual is to help make you a better operator. Remember, **SAFETY IS YOU!**



1012

Your safety and the safety of those around you depends on **YOU**. Common sense should play a large role in the operation of this machine.

Since we at Tiger Corporation are constantly striving to improve our products, we reserve the right to change specifications or design at any time.



## TO THE OWNER / OPERATOR / DEALER



To keep your implement running efficiently and safely, read your manual thoroughly and follow these directions and the Safety Messages in this manual and on the machine. The table of contents clearly identifies each section where you can easily find the information you need.

The Occupational Safety and Health Act (OSHA 1928.51 subpart C) makes the following minimum requirements for tractor operators.

### **OWNER REQUIREMENTS:**

1. Provide a Roll-Over-Protective Structure that meets the requirements of this Standard; and
2. Provide Seatbelts that meet the requirements of this Standard and SAE J3C; and
3. Ensure that each employee uses such Seatbelt while the tractor is moving; and
4. Ensure that each employee tightens the Seatbelt sufficiently to confine the employee to the protected area provided by the ROPS.

### **OPERATOR REQUIREMENTS:**

1. Securely fasten seatbelt if the tractor has a ROPS.
2. Where possible, avoid operating the tractor near steep ditches, embankments, and holes.
3. Reduce speed when turning, crossing slopes, and on rough, slick, or muddy surfaces.
4. Stay off slopes too steep for safe operation.
5. Watch where you are going – especially at row ends, on roads, and around trees.
6. Do Not permit others to ride.
7. Operate the tractor smoothly – no jerky turns, starts, or stops.
8. Hitch only to the draw-bar and hitch points recommended by the tractor manufacturer.
9. When the tractor is stopped, set brakes securely and use park lock, if available



Printed in USA  
© Tiger Corporation