



BENGAL ASSEMBLIES

JD6xxxE T4F

Current as of 02/24/2021



PARTS LISTING WITH MOUNTING AND OPERATING INSTRUCTIONS

Tiger Corporation
3301 N. Louise Ave.
Sioux Falls, SD 57107
1-800-843-6849
1-605-336-7900
www.tiger-mowers.com

06011033

TO THE OWNER / OPERATOR / DEALER

All implements with moving parts are potentially hazardous. There is no substitute for a cautious, safe-minded operator who recognizes the potential hazards and follows reasonable safety practices. The manufacturer has designed this implement to be used with all its safety equipment properly attached to minimize the chance of accidents.

BEFORE YOU START!! Read the safety messages on the implement and shown in this manual. Observe the rules of safety and use common sense!

READ AND UNDERSTAND THIS MANUAL! Non-English speaking operators will need to GET THE MANUAL TRANSLATED as needed!



DANGER

FAILING TO FOLLOW SAFETY MESSAGES AND OPERATING INSTRUCTIONS CAN CAUSE SERIOUS BODILY INJURY OR EVEN DEATH TO OPERATOR AND OTHERS IN THE AREA.



1. Study and understand Operator's Manuals, Safety Decals, and Instructional Decals for tractor and implement to prevent misuse, abuse, and accidents. Practice before operating in a confined area or near passersby.

● Learn how to stop engine suddenly in an emergency. Be alert for passersby and especially children

2. Allow no children on or near folding mower or tractor. Allow no riders on tractor or implement. Falling off may cause serious injury or death from being run over by tractor or mower or contact with rotating blades.

3. Operate only with tractor having Roll-Over Protective Structure (ROPS) and with seat belt securely fastened to prevent injury and possible death from falling off or tractor overturn.

● Personal Protective Equipment such as Hard Hat, Safety Glasses, Safety Shoes, & Ear Plugs are recommended.

4. Block up or support raised machine and all lifted components securely before putting hands or feet under or working underneath any lifted component to prevent crushing injury or death from sudden dropping or inadvertent operation of controls. Make certain area is clear before lowering or folding

5. Before transporting, put Lift Lever in detent or full-lift position. Install Transport Safety Devices securely on folding mowers. Put Booms securely in Transport Rest.

● Folding and Boom Mowers have raised center of gravity. Slow down when turning and on hillsides.

6. Make certain that SMV sign, warning lights, and reflectors are clearly visible. Follow local traffic codes.

7. Never operate with Cutting Head or Folding Section raised if passersby, bystanders, or traffic are in the area to reduce possibility of injury or death from objects thrown by Blades under Guards or mower structure.

8. Before dismounting, secure implement in transport position or lower to ground.

● Put tractor in park or set brake, disengage PTO, stop engine, remove key, and wait until noise of rotation has ceased to prevent crushing by entanglement in rotating parts which could cause injury or death.

● Never mount or dismount a moving vehicle. Crushing from rollover may cause serious injury or death.

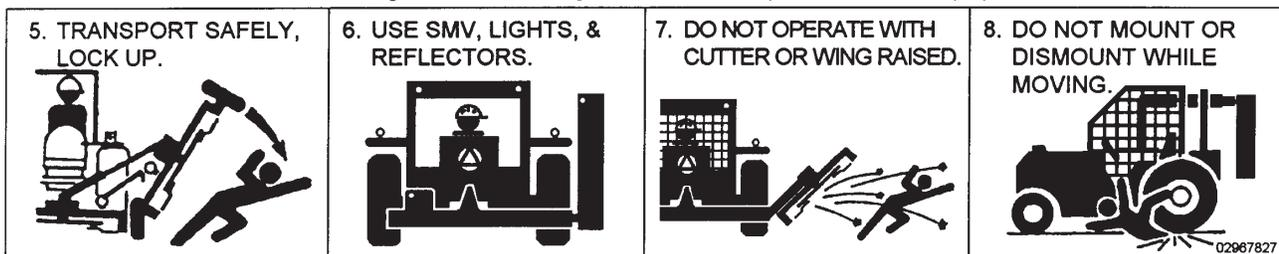

02967827

Warranty Information: Read and understand the complete Warranty Statement found in this manual. Fill out the Warranty Registration form in full and return it within 90 days. Make certain the Serial Number of the machine is recorded on the Warranty Card, and form that you retain.

FORWARD

This manual contains information about many features of the Tiger mowing and roadside maintenance equipment. Some of these include: Safety precautions, Assembly instructions, Operations, Maintenance and Parts. This manual will also assist you in the proper break-in, daily care, and troubleshooting of your new mower.

We recommend that you read carefully the entire manual before operating the unit. Also, time spent in becoming fully acquainted with its performance features, adjustments, and maintenance schedules will be repaid in a long and satisfactory life of the equipment.

Troubleshooting - Please, before you call, help us to help you!

Please look at the equipment to observe what is happening, then:

- Classify the problem
 - Hydraulic, electrical or mechanical - Read the trouble shooting section
 - Tractor or Truck chassis - Contact vehicle dealer

- If unable to correct the problem yourself, contact your local Tiger Dealer after gathering:
 - Machine model _____
 - Serial number _____
 - Dealer name _____
 - Detailed information about the problem including results of troubleshooting

Attention Owner / Operator / Dealer: It is your obligation to read, and understand, the warranty information section located at the back of this manual denoting that the purchaser understands the safety issues relating to this machine and has received and will read a copy of this manual.

If at any time, you have a service problem with your Tiger mower, Contact your local dealer for service and parts needed.

MANUFACTURED BY:

Tiger Corporation

3301 N. Louise Ave.

Sioux Falls, SD 57107

1-800-843-6849

1-605-336-7900

www.tiger-mowers.com

DISTRIBUTED BY:

1- _____ - _____ - _____

1- _____ - _____ - _____

TABLE OF CONTENTS

SAFETY SECTION_____	1
ASSEMBLY / MOUNTING SECTION_____	2
OPERATION SECTION_____	3
MAINTENANCE SECTION_____	4
PARTS SECTION_____	5
COMMON PARTS SECTION_____	6
WARRANTY INFORMATION_____	7



1012

This symbol means:

CAUTION – YOUR SAFETY IS AT RISK!

When you see this symbol, read and follow the associated instructions carefully or personal injury or damage may result.

Tiger is a registered trademark.



SAFETY SECTION

Safety Section 1-1

SAFETY

GENERAL SAFETY INSTRUCTIONS AND PRACTICES

A careful operator is the best operator. Safety is of primary importance to the manufacturer and should be to the owner/operator. Most accidents can be avoided by being aware of your equipment, your surroundings, and observing certain precautions. The first section of this manual includes a list of Safety Messages that, if followed, will help protect the operator and bystanders from injury or death. Read and understand these Safety Messages before assembling, operating or servicing this Implement. This equipment should only be operated by those persons who have read the manual, who are responsible and trained, and who know how to do so responsibly.



The Safety Alert Symbol combined with a Signal Word, as seen below, is used throughout this manual and on decals which are attached to the equipment. The Safety Alert Symbol means: "ATTENTION! BECOME ALERT! YOUR SAFETY IS INVOLVED!" The Symbol and Signal Word are intended to warn the owner/operator of impending hazards and the degree of possible injury faced when operating this equipment.

Practice all usual and customary safe working precautions and above all--- remember safety is up to YOU. Only YOU can prevent serious injury or death from unsafe practices.



Indicates an imminently hazardous situation that, if not avoided, WILL result in DEATH OR VERY SERIOUS INJURY.



Indicates an imminently hazardous situation that, if not avoided, COULD result in DEATH OR SERIOUS INJURY.



Indicates an imminently hazardous situation that, if not avoided, MAY result in MINOR INJURY.



Identifies special instructions or procedures that, if not strictly observed, could result in damage to, or destruction of the machine, attachments or the environment.

NOTE: *Identifies points of particular interest for more efficient and convenient operation or repair.*

READ, UNDERSTAND, and FOLLOW the following Safety Messages. Serious injury or death may occur unless care is taken to follow the warnings and instructions stated in this Manual and in the Safety Messages on the implement. Always follow the instruction in this manual and use good common sense to avoid hazards.



NOTE: *If you want a translation of this safety section in one of the following Languages, please contact: Translations at 1502 E. Walnut Street Seguin, TX 78155; Fax: (830) 372-9529; Safety Section Translations are available in Spanish, Portuguese, French, German, Russian. PN GS01*

SAFETY

Operator Safety

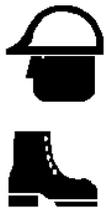
				
Read and understand Operator's Manual	Always wear Safety Glasses	Wear Hard Hat Safety Shoes	Never use Drugs or Alcohol when operating equipment	Wear Safety Vest when operating on or near roads

WARNING

TO AVOID SERIOUS INJURY OR DEATH DO THE FOLLOWING:

- **READ, UNDERSTAND** and **FOLLOW** Operator's Manual instructions, Warnings and Safety Messages.
- **WEAR SAFETY GLASSES**, safety shoes, hard hat, hearing protection and gloves when operating or repairing equipment
- **WEAR** appropriate breathing respirator when operating in dusty conditions to avoid respiratory diseases.
- **DO NOT WEAR** loose clothing or jewelry to avoid rotating parts entanglement injury.
- **DO NOT USE DRUGS** or **ALCOHOL** before or while operating equipment.
- **DO NOT ALLOW** anyone to operate equipment under the influence of drug or alcohol.
- **CONSULT** medical professional for medication impairment side effects.
- **STAY CLEAR** of hot surfaces such as Mufflers, hydraulic pumps, valves and tanks.
- **STAY ALERT**, prolonged operation can cause fatigue, **STOP** and **REST**.

GENERAL OPERATING SAFETY

VISIBILITY CONDITIONS WHEN MOWING:

- **OPERATE IN DAYLIGHT** or with lights that gives at least 100 yards clear visibility.
- **BE ABLE TO SEE** and identify passersby, steep slopes, ditches, drop-offs, overhead obstructions, power lines, debris and foreign objects.
- Avoid backing up while mowing, vision may be limited, severe damage or injury can occur.
- **DO NOT** run tractor in enclosed building without adequate exhaust ventilation.

GROUND SPEED WHEN MOWING:

- **NORMAL SPEED** range is between 1 to 2 mph(1-3 kph).
- **ADJUST MOWING SPEED** for terrain conditions and grass type, density and cut height.
- **REDUCE MOWING SPEED** when near steep slopes, ditches, drop-offs, overhead obstructions, power lines and to avoid debris and foreign objects.

TRACTOR and MOWER

- **DO NOT** operate the tractor or mower unless the equipment is maintained and operating properly.
- **DISCONTINUE OPERATION** if tractor or mower electrical and hydraulic controls do no function properly.
- **DISCONTINUE OPERATION** of the tractor if the braking or steering systems do not function properly.
- **DO NOT** operate the tractor or mower if there are any hydraulic leaks.

INSECT INFESTATION

- **DO NOT** operate in areas where bees or insects may attack unless you **WEAR PROTECTIVE CLOTHING** or use enclosed tractor cab.

PTO SPEED:

- **DO NOT EXCEED IMPLEMENT RATED PTO SPEED**
- **AVOID** exceeding rated PTO speeds that may result in broken drivelines or blade failures.

SAFETY SIGNS:

- **REPLACE** missing, damaged or unreadable safety signs immediately. **PN OSBM-01**

SAFETY

CRUSHING HAZARDS

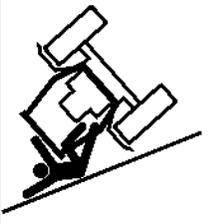
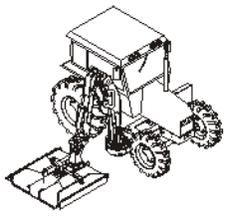
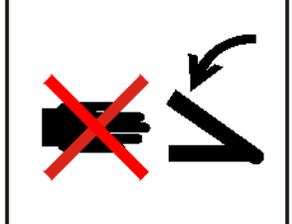
				
Crushing injury from roll over	Use Cab Tractor With Boom Mowers	Always wear seatbelt	Pinch Point Hazard Keep Hands and body parts clear of pinch points	Crushing injury from boom or mower head falling



TO AVOID SERIOUS INJURY OR DEATH FROM FALLING OFF TRACTOR, EQUIPMENT RUN OVER, ROLLOVER AND CRUSHING BY FALLING WING OR IMPLEMENT:

- USE ROPS and SEAT BELT equipped tractors for mowing operations.
- KEEP ROPS lock in up position.
- ALWAYS BUCKLE UP seat belt when operating tractor and equipment.
- ONLY OPERATE tractor and equipment while seated in tractor seat.

WHEN RAISING BOOM MOWER:

- Raise or lower ONLY WHILE SEATED in tractor seat with seat belt buckled.
- KEEP BYSTANDERS CLEAR of area TO AVOID crushing.
- KEEP sufficient clearance around implement and wings TO AVOID contacting buildings or overhead power lines.

LIFTED Equipment can fall from mechanical or hydraulic failure or inadvertent Control Lever movement.



TO AVOID EQUIPMENT FALLING while working near or under lifted boom, components and Mower Head:

- SECURELY SUPPORT or block up raised equipment, wings and components.
- BLOCK UP and securely support equipment before putting hands, feet or body under raised equipment or lifted components.
- KEEP BYSTANDERS CLEAR of raised boom or mower head until securely blocked up.

WHEN PARKING Implement and Tractor:

- LOWER Mower Head to the ground or BLOCK lifted parts before leaving equipment.
- NEVER leave implement unattended in a raised position.



TO AVOID CHILDREN FALLING OFF OR BEING CRUSHED BY EQUIPMENT:

- NEVER ALLOW children to play on or around Tractor or Implement.
- DO NOT operate without operator CAB or OVERHEAD protection. Falling limbs and debris can cause injuries. *PN CHBM-01*

SAFETY

CONNECTING OR DISCONNECTING IMPLEMENT SAFETY

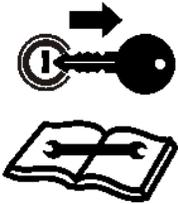
			
<p>Stop Tractor Remove Key Read Manual</p>	<p>Crushing Hazard Do Not get under boom when connecting mower head to boom</p>	<p>Stability Hazard Ensure 20% of tractor weight is on front wheels</p>	<p>Stability Hazard Ensure 1500lbs down force on left tire with boom extended</p>



TO AVOID SERIOUS INJURY OR DEATH FROM BEING CRUSHED BY TRACTOR OR IMPLEMENT:

WHEN connecting mower head to the boom:

- **KEEP BYSTANDERS AWAY** from tractor and mower.
- Ensure there is enough room to lift and swing the boom with out hitting objects

BEFORE connecting and disconnecting the mower head or boom:

- **STOP TRACTOR ENGINE**, place transmission into park, engage parking brake and remove key.

WHEN connecting and disconnecting the mower head or boom:

- **DO NOT** crawl or walk under raised mower head or boom. (*Refer to Instructions in Operation Section*)

WHEN CONNECTING IMPLEMENT DRIVELINE:(If equipped)

TO AVOID implement driveline coming loose during operation:

- **LUBRICATE** yoke spring locking collar to ensure it freely slides on PTO shaft.
- **SECURELY** seat yoke locking balls in PTO shaft groove.
- **PUSH** and **PULL DRIVELINE** on both the tractor and implement **PTO SHAFTS** to ensure it is **SECURELY ATTACHED**.

TO AVOID broken driveline during operations:

- **CHECK** driveline for proper length between PTO shaft and implement gearbox shaft. (*Refer to Instructions in Operation Section*)
- Drivelines too short can pull apart or disengage.
- Drivelines too long can bottom out.
- Bottoming driveline telescoping assembly will stop sliding and become solid.
- Driveline bottoming can push through support bearings and break off PTO shaft.

CONTACT DEALER if implement driveline does not match Tractor PTO shaft:

- **DO NOT USE PTO ADAPTER.**
Using a PTO adapter can cause:
 - Excessive vibration, thrown objects, blade and implement failures by doubling operating speed.
 - Increased working length exposing unshielded driveline areas and entanglement hazards. *PN CDBM-01*

SAFETY

SAFETY

THROWN OBJECTS HAZARDS

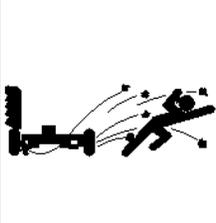
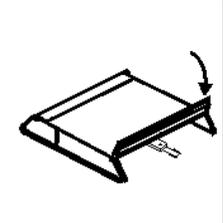
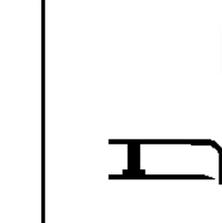
				
Mower Thrown Objects Hazard	Raised Mower Thrown Objects	Keep mower door closed when traffic comes within 300 feet	Inspect Area remove foreign objects	Do not let blades contact solid objects



ROTARY MOWERS CAN THROW OBJECTS 300 FEET OR MORE UNDER ADVERSE CONDITIONS.

TO AVOID SERIOUS INJURY OR DEATH TO OPERATOR OR BYSTANDERS FROM THROWN OBJECTS:

- KEEP bystanders 300 feet away

STOP MOWING IF PASSERSBY ARE WITHIN 300 FEET UNLESS:

- **ALL THROWN OBJECT SHIELDING** including, Front and Rear Deflectors, Chains Guards, Steel Guards, Bands, Side Skirts and Skid Shoes in place and in good condition when mowing.
- Mower is close and parallel to ground without exposing blades.
- **MOWING AREA** has been inspected and foreign materials and debris have been removed.
- **DO NOT** shred or mow loose or previously cut material if **BYSTANDERS** are within 300 feet.
- **PASSERSBY** are inside enclosed vehicle.

INSPECT AREA FOR POTENTIAL THROWN OBJECTS BEFORE MOWING:

- **REMOVE** debris, rocks, wire, cable, metal objects and other foreign material from area.
Wire, cable, rope, chains and metal objects can be thrown or swing outside deck with great velocity:
 1. **MARK** objects that cannot removed.
 2. **AVOID** these objects when mowing.

HIGH GRASS and WEED AREA INSPECTION:

- **INSPECT** for and **REMOVE** any hidden large debris.
- **MOW** at Intermediate height
- **INSPECT** and remove remaining debris
- **MOW** at final height.

MOWER THROWN OBJECT SHIELDING:

- **KEEP** all thrown object shielding including, Front and Rear Deflectors, Chains Guards, Steel Guards, Bands, Side Skirts and Skid Shoes in place and in good condition when mowing.
- **DO NOT OPERATE** with any thrown object shielding missing, damaged or removed.

RIGHT OF WAY (Highway) MOWING

- Stop mowing if any bystander comes within 300 feet of the mower.
- No shielding is 100% effective in preventing thrown objects. To Reduce Possibility of Injury:
 1. **MAINTAIN MOWER SHIELDING**, side skirts, skid shoes, and blades in good operational condition,
 2. **RAISE CUTTING HEIGHT** to **6 INCHES** minimum,
 3. **INSPECT AREA** thoroughly before mowing to **REMOVE** potential **THROWN OBJECT HAZARDS**,
 4. **NEVER ALLOW BLADES** to **CONTACT SOLID OBJECTS** like wire, rocks, post, curbs, guardrails, or ground while mowing. *PN TOBM-01*

SAFETY

THROWN OBJECTS HAZARDS (Continued)

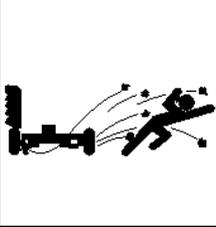
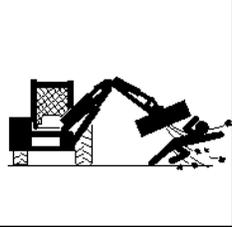
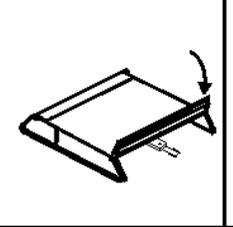
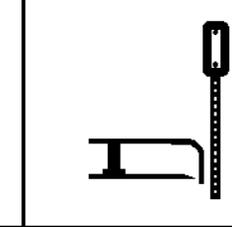
				
Mower Thrown Objects Hazard	Raised Mower Thrown Objects	Keep mower door closed when traffic comes within 300 feet	Inspect Area remove foreign objects	Do not let blades contact solid objects

MOWER OPERATION:

- **DO NOT** exceed mower's rated Cutting Capacity or cut non-vegetative material.
- **USE ENCLOSED TRACTOR CABS** when two or more mowers are operating in mowing area.
- Do Not mow in areas where bees or insects may attack unless you **WEAR PROTECTIVE CLOTHING** or use enclosed tractor cab.
- **ADJUST** mower head close and parallel to ground without exposing blades.
- **ADJUST** cutting **HEIGHT** to **AVOID BLADE CONTACT** with solid objects like wire, rocks, posts, curbs, guard rails and fixed obstructions.
- **CLOSE** Mower door and stop operating if bystanders come within 300 feet of the mower.
- Keep mower door closed when cutting close to the ground.
- Open door only to cut large brush or tree limbs. Close door immediately after cutting limb.
- **DO NOT** push mower head down onto material to cut it, use the front tips of the mower blades to cut into the material.
- **DO NOT** operate mower when mower is in transport position.
- **STOP MOWING** immediately if blades strike heavy objects, fixed structures, metal guard rails and concrete structures:
 1. **BLADES CAN FAIL** from impact and objects can be thrown with great velocity.
 2. **INSPECT** and **REPLACE** any damaged blades.
 3. **CHECK** blade carrier and **REPLACE** if damaged.
- **DO NOT** mow in standing water **TO AVOID** possible **BLADE FAILURE**.
- **AVOID MOWING** in reverse:
 1. **STOP PTO** and back up mower.
 2. **LOWER** mower, engage **PTO** and mow forward.
- **DISENGAGE** mower head and wait until **BLADES** stop rotating before raising mower to transport position.
- **DO NOT ENGAGE PTO** with mower in transport position.
- **STOP** mowing when **EXCESSIVE VIBRATION** occurs:
 1. **STOP PTO** and tractor **ENGINE**.
 2. **INSPECT** mower for vibration source.
 3. **REPLACE** any damage parts and bent or damaged **BLADES**. *PN TOBM-02*

SAFETY

SAFETY

RUN OVER HAZARDS

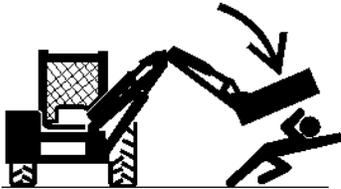
		
Operator run over hazard	Rider fall off run over hazard	Bystander run over hazard



TO AVOID SERIOUS INJURY OR DEATH FROM FALLING OFF TRACTOR OR EQUIPMENT RUN OVER:

- **USE ROPS** and **SEAT BELT** equipped tractors for mowing operations.
- **KEEP ROPS** locked in **UP** position.
- **ONLY** start tractor while seated in tractor seat.
- **ALWAYS BUCKLE UP** seat belt when operating tractor and equipment.
- **ONLY OPERATE** tractor and equipment while seated in tractor seat.
- **NEVER ALLOW RIDERS** on tractor or implement.
- When not mowing stow Boom and Mower head in transport location before moving.

WHEN MOUNTING AND DISMOUNTING TRACTOR:

- **ONLY** mount or dismount when tractor and moving parts are stopped.
- **STOP ENGINE AND PTO**, engage parking brake, lower implement, allow all moving parts to stop and remove key before dismounting from tractor. *PN ROBM-01*

SAFETY

SAFETY

PTO ENTANGLEMENT HAZARDS

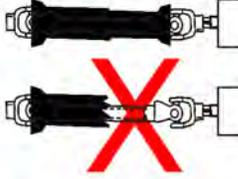
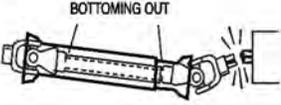
	 <p>PTO (Barra Gitoria)</p>		 <p>BOTTOMING OUT</p>
<p>Entanglement hazard Do Not approach or touch a rotating PTO driveshaft</p>	<p>Make sure PTO shaft is securely attached Do Not Use PTO Adapter</p>	<p>DO NOT Operate if PTO shields are damaged or missing</p>	<p>Make sure PTO shafts are proper length</p>



KEEP AWAY FROM ROTATING DRIVELINES AND ELEMENTS TO AVOID SERIOUS INJURY OR DEATH:

STAY AWAY and **KEEP** hands, feet and body **AWAY** from rotating blades, drivelines and parts until all moving elements have stopped.

- **STOP, LOOK** and **LISTEN** before approaching the mower to make sure all rotating motion has stopped.
- **ROTATING COMPONENTS CONTINUE** to **ROTATE** after the PTO is shut off.

PTO SHIELDING:

TO AVOID SERIOUS INJURY OR DEATH FROM ENTANGLEMENT WHEN OPERATING IMPLEMENT:

- **KEEP PTO** shields, integral driveline shields and input shields installed
- **DO NOT OPERATE** mower without shields and guards in place or missing
- **REPAIR OR REPLACE** if damage, broken or missing
- **ALWAYS REPLACE GUARDS** that have been removed for service or maintenance.
- Do Not use PTO or PTO guard as a step.

TO AVOID broken driveline during operations:

- **CHECK** driveline for proper length between PTO shaft and implement gearbox shaft. *(Refer to Instructions in Operation Section)*
- Drivelines too short can pull apart or disengage.
- Drivelines too long can bottom out.
Bottoming driveline telescoping assembly will stop sliding and become solid.
- Driveline bottoming can push through support bearings and break off PTO shaft
- **AVOID** sharp turns or lift mower to heights to cause driveline "knocking".
- Lubricate driveshaft-telescoping components weekly.

CONTACT DEALER if implement driveline does not match Tractor PTO shaft:

- **DO NOT USE PTO ADAPTER.**

Using a PTO adapter can cause excessive vibration, thrown objects, blade and implement failures by doubling operating speed. Increased working length exposing unshielded driveline areas. *PN PE01*

SAFETY

MOWER BLADE CONTACT HAZARDS

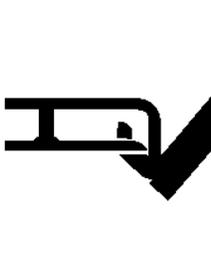
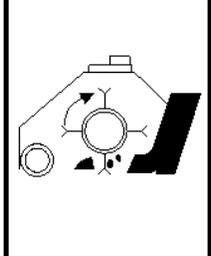
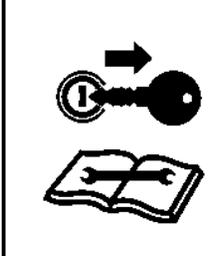
					
Do not put fingers underneath mower	Do not put hands underneath Flail Mower	Do not put foot underneath mower	Do not put foot underneath Flail Mower	Shearing Hazard from Sickle blades	Stop Tractor Remove Key Read Manual

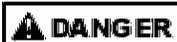

KEEP AWAY FROM ROTATING BLADES TO AVOID SERIOUS INJURY OR DEATH FROM BLADE CONTACT:

- **STAY AWAY** and **KEEP HANDS, FEET** and **BODY AWAY** from rotating blades, drivelines and parts until all moving elements have stopped.
- **DO NOT** put hands or feet under mower decks
- **STOP** rotating **BLADES** disengage mower switch and PTO and wait for blade to stop rotating before raising mower head.
- **DO NOT** approach Sickle Bar head until Tractor Engine has been shut off.
- **STOP LOOK** and **LISTEN** before approaching the mower to make sure all rotating motion has stopped. *PN MBBM-01*

SAFETY

HIGH PRESSURE OIL LEAK HAZARD

			
<p>High pressure oil penetrating skin</p>	<p>High pressure oil eroding skin</p>	<p>Using cardboard to check for oil leaks</p>	<p>Tank contents under pressure. Allow oil to cool before slowly removing cap</p>



TO AVOID SERIOUS INJURY OR DEATH FROM HIGH PRESSURE HYDRAULIC OIL LEAKS PENERATING SKIN:

- **DO NOT OPERATE** equipment with oil or fuel leaks.
- **KEEP** all hydraulic hoses, lines and connections in **GOOD CONDITION** and **TIGHT** before applying system pressure.
- **RELIEVE HYDRAULIC PRESSURE** before disconnecting lines or working on the system.
- **REMOVE** and replace hose if you suspect it leaks. Have dealer test it for leaks.

HIGH PRESSURE FLUID LEAKS CAN BE INVISIBLE.

WHEN CHECKING FOR HYDRAULIC LEAKS AND WORKING AROUND HYDRAULIC SYSTEMS:

- **ALWAYS WEAR** safety glasses and impenetrable gloves.
- **USE** paper or cardboard to search for leaks.
- **DO NOT USE** hands or body parts to search for leak.
- **KEEP** hands and body **AWAY** from pin holes and nozzles ejecting hydraulic fluid.
- Hydraulic fluid may cause gangrene if not surgically removed immediately by a doctor familiar with this form of injury.

Use caution when removing Hydraulic Tank cap.

- Tank contents maybe under pressure
- Allow oil to cool before removing cap.
- Relieve oil pressure before removing cap slowly.
- Stay away from hot oil that may spray from tank.

PN HPBM-01

SAFETY

ELECTRICAL & FIRE HAZARDS

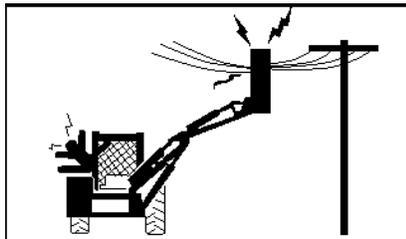

Mower head or Boom contacting overhead electrical lines



Strike and explosion Hazard
Blades Contacting Utility or Gas Lines

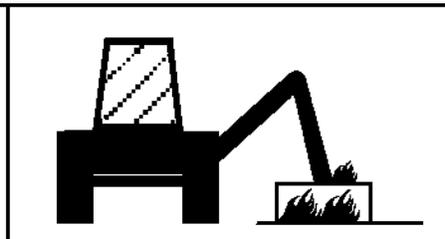

Fire Hazard Do Not operate near fires. Keep debris away from hydraulic pumps and valves



TO AVOID SERIOUS INJURY OR DEATH FROM ELECTRICAL CONTACT WHEN WORKING AROUND ELECTRICAL POWER LINES, GAS LINES AND UTILITY LINES:

- **INSPECT** mowing area for overhead or underground electrical power lines, obstructions, gas lines, cables and Utility, Municipal, or other type structure.
- **KEEP** all raised wings at a 10 feet or greater distance from all power lines and overhead obstructions.
- **DO NOT** allow mower to contact with any Utility, Municipal, or type of structures and obstructions.
- **CALL 811** and 1-800-258-0808 for identify buried utility lines.

FIRE PREVENTION GUIDELINES while Operating, Servicing, and Repairing Mower and Tractor to reduce equipment and grass fire Risk:

- **EQUIP** Tractor with a **FIRE EXTINGUISHER**
- **DO NOT OPERATE** mower on a tractor equipped with under frame exhaust
- **DO NOT SMOKE** or have open flame near Mower or Tractor
- **DO NOT DRIVE** into burning debris or freshly burnt area
- **AVOID FIRE IGNITION** by not allowing mower blade to contact solid objects like metal or rock.
- **DO NOT** operate if oil is leaking. Repair oil leak and remove all accumulated oil before operating.
- **CLEAR** any grass clippings or debris buildup around mower hydraulic pumps, valves or tanks.
- **SHUT OFF ENGINE** while refueling. *PN EFBM-01*

SAFETY

TRANSPORTING HAZARDS

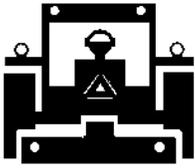
		
<p>Use SMV signs and Flashing Lights</p>	<p>Loss of Control Stopping Hazard</p>	<p>Loss of Control Speeding Hazard</p>

WARNING

TO AVOID SERIOUS INJURY AND DEATH WHEN TOWING OR TRANSPORTING EQUIPMENT:

- **KEEP** transport speed **BELOW** 20 mph to maintain control of equipment.
- **REDUCE SPEED** on inclines, on turns and in poor towing conditions.
- **DO NOT TOW** with trucks or other vehicles.
- **USE** only properly sized and equipped tractor for towing equipment.
- **FOLLOW** all local traffic regulations.

TRACTOR REQUIREMENTS FOR TOWING OR TRANSPORTING IMPLEMENTS:

- **ONLY TRANSPORT** with tractor with **ROPS** in the raised position.
- **USE** properly sized and equipped tractor that exceeds implement weight by at least 20%.
- **KEEP** 20% of tractor weight on front wheels to maintain safe steering.

BEFORE TRANSPORTING OR TOWING IMPLEMENT:

TRACTOR INSPECTION:

- **CHECK** steering and braking for proper operation and in good condition.
- **CHECK SMV** sign, reflectors and warning lights for proper operation and visibility behind unit.
- **CHECK** that your driving vision is not impaired by tractor, cab, or implement while seated in tractor seat.
- **ADJUST** your operating position, mirrors, and implement transport for clear vision for traveling and traffic conditions.

PREPARE IMPLEMENT FOR TRANSPORTING OR TOWING:

- Store Boom and Mower in transport positions and engage transport locks if equipped.

DETERMINE STOPPING CHARACTERISTICS OF TRACTOR AND IMPLEMENT FOR TRANSPORTING OR TOWING:

BRAKING TESTS:

- Stopping distance with implement attached may increase
- Observe **STOPPING** distances increases with increased speeds.
- **DETERMINE** the maximum safe transport speed that does not exceed 20 mph.
- Reduce travel speed in wet or icy roads, stopping distances increase.

DETERMINE MAXIMUM TURNING SPEED BEFORE OPERATING ON ROADS OR UNEVEN GROUND:

- **TEST** equipment in slowly increasing speed in turns to determine it can be operated at higher speeds.
- **USE REDUCED** turning speeds in sharp turns to avoid equipment turning over.

WHEN TOWING OR TRANSPORTING EQUIPMENT:

- Always **WEAR SEAT BELT** when operating or transporting mower.
- **USE** low speeds to avoid overturn with raised wings.
- **USE** low speeds and gradual steering on curves, hills, rough or uneven surfaces and on wet roads.
- **TURN ON** tractor **FLASHING WARNING LIGHTS**.
- **ALLOW** clearance for implement swing while turning.

KEEP raised boom mower 10 feet or greater distance from all power lines and overhead obstructions. PN THBM-01

SAFETY

SAFETY

HAZARDS WITH MAINTENANCE OF IMPLEMENT

				
Periodically inspect all moving parts, lubricate drivelines, and tighten all fasteners	Lower mower head to ground or block up before servicing	Stop engine remove key before conducting maintenance	Set mower head securely on the ground before servicing blades	Thrown Objects Hazard Ensure blades rotate clockwise viewed from above mower head

WARNING

AVOID SERIOUS INJURY OR DEATH FROM COMPONENT FAILURE BY KEEPING IMPLEMENT IN GOOD OPERATING CONDITION IN PERFORMING PROPER SERVICE, REPAIRS AND MAINTENANCE.

BEFORE PERFORMING SERVICE, REPAIRS AND MAINTENANCE ON THE IMPLEMENT:

- **STOP ENGINE AND PTO**, engage parking brake, lower implement, allow all moving parts to stop and remove key before dismounting from tractor.
- **PLACE** implement on ground or securely block up raised equipment. Use large blocks on soft or wet soil.
- **PUSH** and **PULL** Remote Hydraulic Cylinder lever to relieve hydraulic pressure.
- **DISCONNECT Pump solenoid valve or PTO driveline connection before servicing mower head.**
- **WEAR SAFETY GLASSES, PROTECTIVE GLOVES** and follow **SAFETY PROCEDURES** when performing service, repairs and maintenance on the implement:
- Always **WEAR** protective **GLOVES** when handling blades, knives, cutting edges or worn component with sharp edges.
- Always **WEAR GLOVES** and **SAFETY GLASSES** when servicing hot components
- **AVOID CONTACT** with hot hydraulic oil tanks, pumps, motors, valves and hose connection surfaces.
- **SECURELY** support or **BLOCK UP** raised implement, framework and lifted components before working underneath equipment.
- **FOLLOW INSTRUCTIONS** in maintenance section when replacing hydraulic cylinders to prevent component falling.
- **STOP** any implement movements and **SHUT-OFF TRACTOR** engine before doing any work procedures.
- **USE** ladder or raised stands to reach high equipment areas inaccessible from ground.
- **ENSURE** good footing by standing on solid flat surfaces when getting on implement to perform work.
- **FOLLOW** manufacturer's instructions in handling oils, solvents, cleansers, and other chemical agents.
- **DO NOT** change any factory-set hydraulic calibrations to avoid component or equipment failures.
- **DO NOT** modify or alter implement, functions or components.
- **DO NOT WELD** or repair rotating mower components. These may cause vibrations and component failures being thrown from mower.

PERFORM SERVICE, REPAIRS, LUBRICATION AND MAINTENANCE OUTLINED IN IMPLEMENT MAINTENANCE SECTION:

- **INSPECT** for loose fasteners, worn or broken parts, leaky or loose fittings, missing or broken cotter keys and washers on pins, and all moving parts for wear.
- **REPLACE** any worn or broken parts with authorized service parts.
- Inspect mower blade spindle to ensure bearing preload. If loose repair before operating.
- **LUBRICATE** unit as specified by lubrication schedule
- **NEVER** lubricate, adjust or remove material while it is running or in motion.
- **TORQUE** all bolts and nuts as specified.

BLADE INSPECTION:

- Inspect blade carrier and blades daily.
- Check blade and blade carrier **BOLT TORQUE** daily. Loose bolts can cause blade or blade bolt failures.
- **REPLACE**, bent, damage, cracked and broken blades immediately with new blades.
- **AVOID** blade failures and thrown broken blades. **DO NOT** straighten, weld, or weld hard-facing blades.

SAFETY SHIELDS, GUARDS AND SAFETY DEVICES INSPECTION:

- **KEEP** all Deflectors, Chain Guards, Steel Guards, Gearbox Shields, and PTO integral shields, Bands, Side Skirts and Skid Shoes in place and in good condition.
- **REPLACE** any missing, broken or worn safety shields, guards and safety devices.
- Engine Exhaust, some of its constituents, and certain vehicle components contain or emit chemicals known to the state of California to cause cancer, birth defects or other reproductive harm.
- Battery posts, terminals and related accessories contain lead and lead compounds, chemicals known to the state of California to cause cancer, birth defects or other reproductive harm. **PN HMBM-01**

SAFETY

PARTS INFORMATION

PARTS INFORMATION

Tiger mowers use balanced and matched system components for blade carriers, blades, cuttershafts, knives, knife hangers, rollers, drivetrain components, and bearings. These parts are made and tested to Tiger specifications. Non-genuine "will fit" parts do not consistently meet these specifications. The use of "will fit" parts may reduce mower performance, void mower warranties, and present a safety hazard. Use genuine Tiger mower parts for economy and safety. (SPTM-1)

SEE YOUR TIGER DEALER

Operator's & Parts Manuals



www.algqr.com/tpm

SAFETY

SAFETY

Decal Location

NOTE: Tiger supplies safety decals on this product to promote safe operation. Damage to the decals may occur while in shipping, use, or reconditioning. Tiger cares about the safety of its customers, operators, and bystanders, and will replace the safety decals on this product in the field, free of charge (Some shipping and handling charges may apply). Contact your Tiger dealer to order replacement decals.

Boom Arm

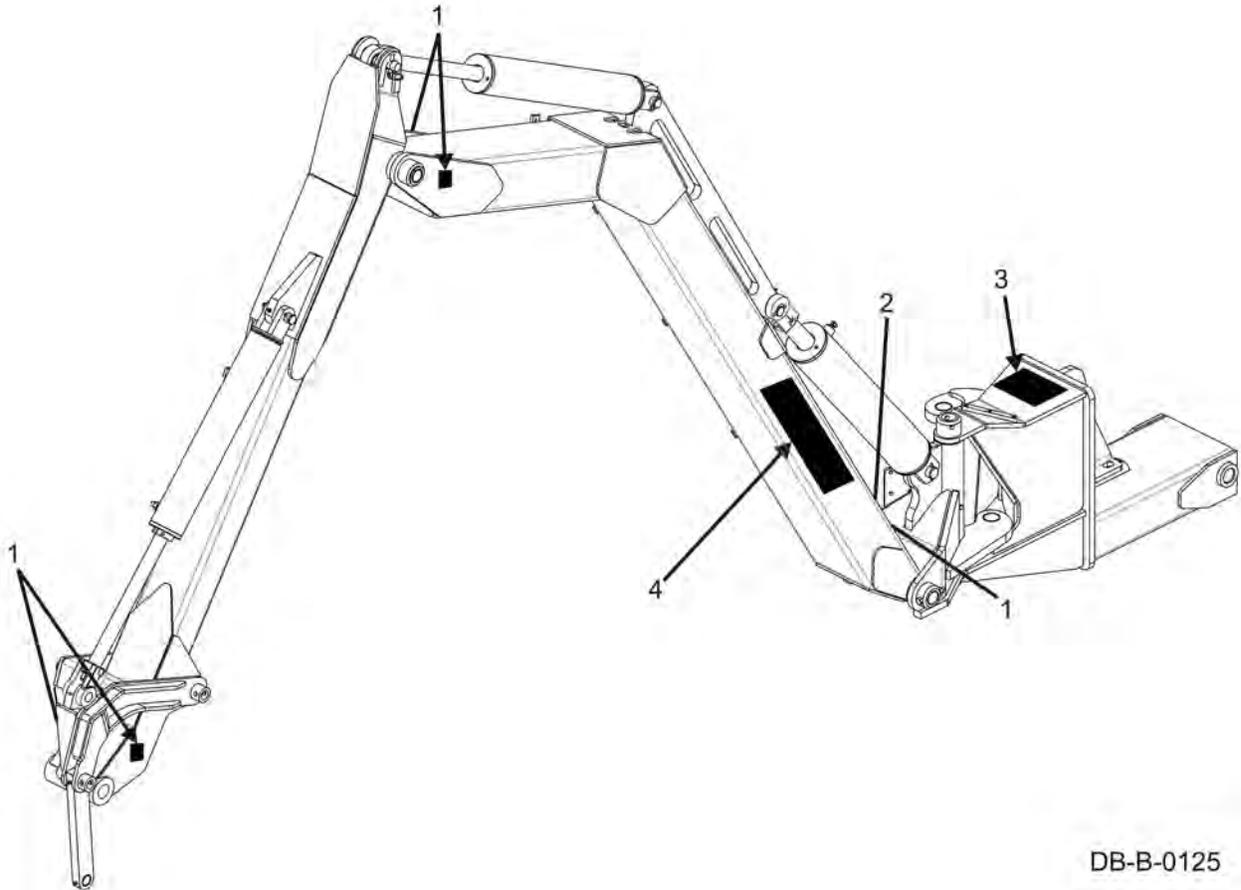

DB-B-0125

ITEM	PART NO.	QTY.	TYPE	DESCRIPTION
1.	02962764	5	WARNING	Pinch Points
2.	02965262	1	WARNING	Hydraulic Oil Hazard
3.	02962765	1	DANGER	Crushing Hazard
4.		1	LOGO	Name

SAFETY

50" & 60" Rotary

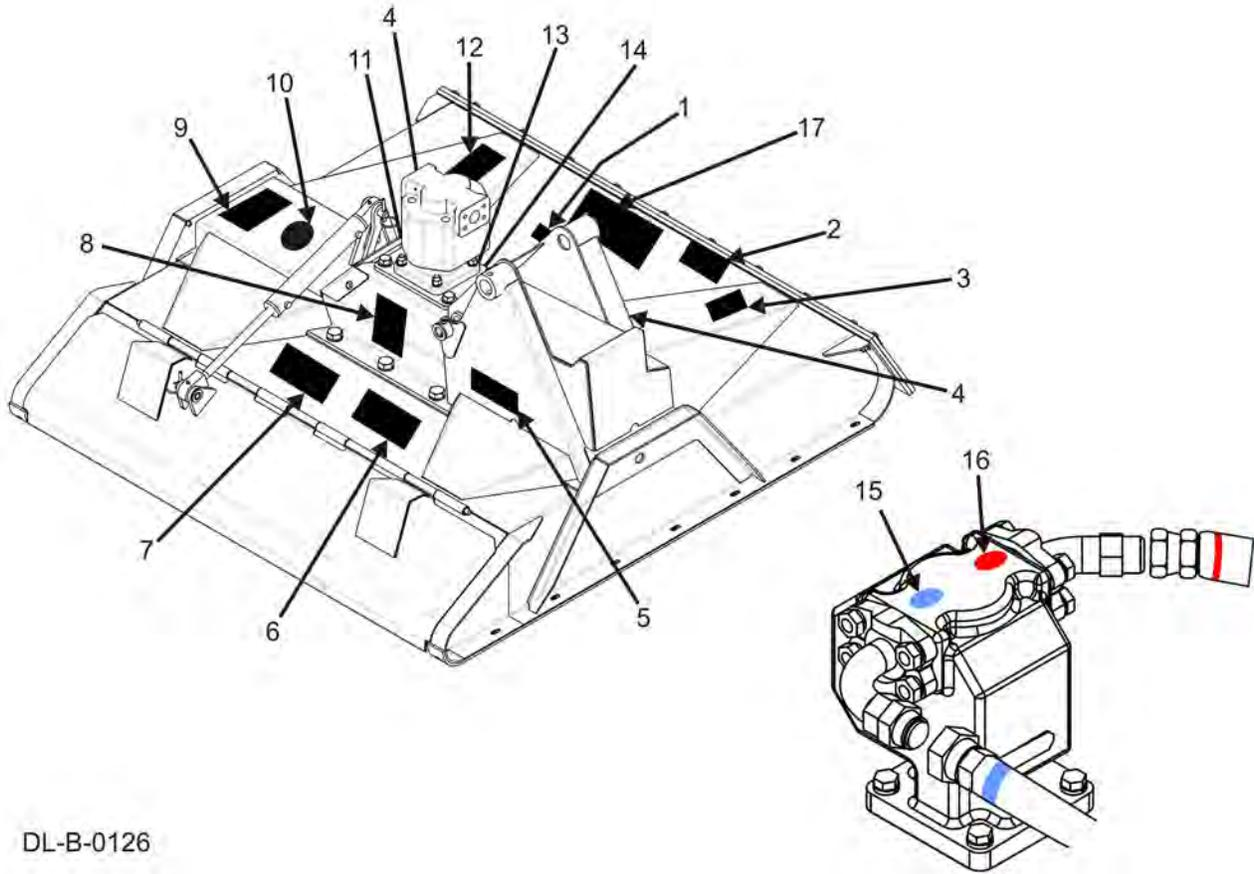

DL-B-0126

SAFETY

ITEM	PART NO.	QTY.	TYPE	DESCRIPTION
1.	6T3237	1	WARNING	Replace Blades
2.	24028	1	WARNING	Thrown Object Hazard
3.	D637	1	WARNING	Disconnect Hydraulic Solenoid
4.	42399	2	REFLECT	Red Reflector
5.	4240006	1	REFLECT	Amber Reflector
6.	D668	1	INSTRUCT	Lubrication Chart
7.	33224	1	DANGER	Blades, Thrown Object
8.	D619	1	WARNING	Blade Rotation
9.		1	LOGO	Made in the USA
10.		1	LOGO	Tiger Genuine Parts
11.	22839	1	INSTRUCT	Use Hand Grease Gun
12.	32709	1	WARNING	Use Genuine Tiger Parts
13.	6T3221	1	INSTRUCT	Lubrication Instructions
14.	nfs	1	SERIAL PLATE	Serial Number Plate
15.	06550058	1	INSTRUCT	Blue Dot
16.	06550057	1	INSTRUCT	Red Dot
17.		1	LOGO	Name

BOOM

Safety Section 1-17

SAFETY

50" & 63" Flail

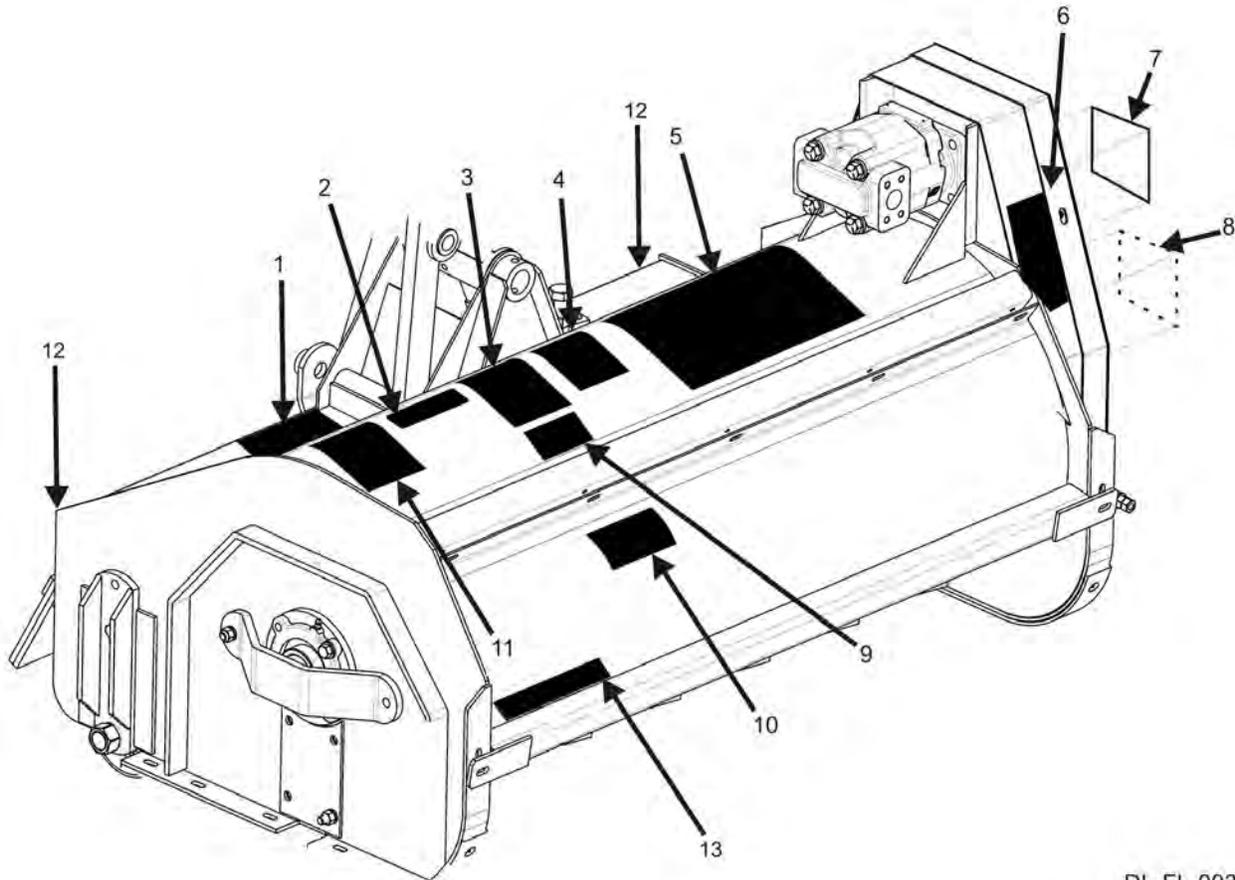

DL-FL-0031

ITEM	PART NO.	QTY.	TYPE	DESCRIPTION
1.	24028	1	DANGER	Thrown Object Hazard, Deflectors
2.	32709	1	WARNING	Use Genuine Tiger Parts
3.	33224	1	DANGER	Blades, Thrown Object
4.	D637	1	WARNING	Disconnect Hydraulic Solenoid
5.		1	LOGO	Tiger Logo
6.	00758194	1	WARNING	Pinch Point Hazard
7.		1	LOGO	50" Logo
		1	LOGO	63" Logo
8.	D646	1	DANGER	Guard Missing, Do Not Operate
9.	D655	1	INSTRUCT	Lube Chart
10.	TB1011	1	DANGER	Thrown Object Hazard, Shield
11.	6T3236	1	LOGO	Made in the USA
12.	42399	2	REFLECT	Red Reflector
13.	4240006	1	REFLECT	Amber Reflector
14.	nfs	1	SERIAL PLATE	Serial Number Plate

SAFETY

SAFETY



WARNING

TO AVOID SERIOUS INJURY OR DEATH FROM HIGH PRESSURE HYDRAULIC OIL LEAKS PENETRATING SKIN:

- DO NOT OPERATE equipment with oil or fuel leaks.
- KEEP all hydraulic hoses, lines and connections in good condition and tight before applying system pressure.
- Relieve hydraulic pressure before disconnecting lines or working on the system.
- REMOVE and replace hose if you suspect it leaks. Have dealer test it for leaks.

HIGH PRESSURE FLUID LEAKS CAN BE INVISIBLE. WHEN CHECKING FOR HYDRAULIC LEAKS AND WORKING AROUND HYDRAULIC SYSTEMS:

- DO NOT use hands to check for leaks.
- ALWAYS WEAR safety glasses and impenetrable gloves.
- USE paper or cardboard to search for leaks.
- KEEP hands and body AWAY from pin holes and nozzles ejecting hydraulic fluid.
- Hydraulic fluid may cause gangrene if not surgically removed immediately by a doctor familiar with this form of injury.

02965262

DANGER
CRUSHING AND PINCH POINTS
02962765

MOVING MACHINERY PARTS CAN PINCH OR CRUSH OR FALL-WHICH MAY CAUSE INJURY OR DEATH.

SAFETY

SAFETY

SAFETY

⚠ DANGER

THROWN OBJECT HAZARD

TO AVOID SERIOUS INJURY OR DEATH:
DO NOT OPERATE if Thrown Object Shielding is damaged or missing.

- Maintain Rubber Deflectors in good condition.
- Inspect Rubber Deflectors frequently.

MAINTAIN Thrown Object Shielding

HERE



24028



Rubber Deflector

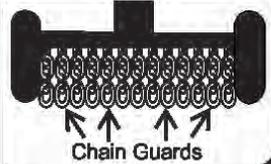

Chain Guards

⚠ WARNING

TO AVOID SERIOUS INJURY OR DEATH FROM INADVERTENT MOWER HEAD START UP:

- Disconnect the hydraulic solenoid BEFORE servicing the tractor or mower.

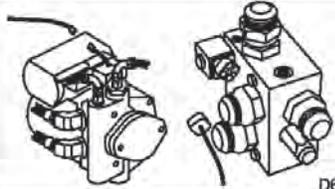

D637

⚠ WARNING

TO AVOID SERIOUS INJURY OR DEATH FROM BLADE ATTACHMENT FAILURE:

- Torque 1-1/8" blade bolt to 800 ft lbs.
- ALWAYS replace blades in pairs.
- ALWAYS replace blades with new bolts and nuts.

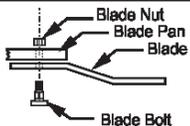

Blade Nut
Blade Pan
Blade
Blade Bolt

6T3237

⚠ WARNING

TO AVOID SERIOUS INJURY AND DEATH FROM THROWN OBJECTS:

- MAKE CERTAIN blades rotate the correct direction.

BLADE ROTATION

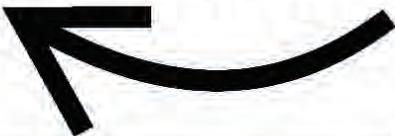

D619

Gear Motor **Piston Motor**

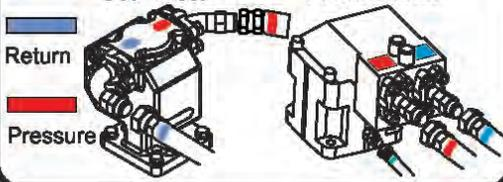

Return
Pressure

SAFETY

SAFETY

⚠ DANGER

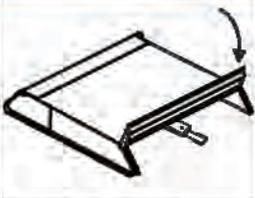

THROWN OBJECTS HAZARD

Mower can throw objects up to 300 feet. TO AVOID SERIOUS INJURY OR DEATH to operator or bystanders:

- CLOSE MOWER DOOR and STOP operating if bystanders or traffic come within 300 feet.
- KEEP door fully closed when cutting grass and weeds.
- OPEN door ONLY to cut large brush. Close door immediately after.
- DO NOT operate with door removed.
- KEEP door in place and in good condition during operation.
- Deflectors are SUBJECT TO WEAR. Replace if worn or damaged.
- ALWAYS transport with door closed. 33224

ENTANGLEMENT HAZARD



- STAY AWAY and KEEP hands, feet and body AWAY from rotating blades, drivelines and parts that continue to move after power shut-off. WAIT until all moving elements have stopped.
- STOP, LOOK and LISTEN for rotating motion before approaching implement.

SAFETY

⚠ WARNING

Non-genuine parts can fail catastrophically. TO AVOID SERIOUS INJURY OR DEATH:

- ONLY use genuine TIGER replacement parts.
- Non-genuine parts can fail creating hazardous conditions for operator and bystanders.

Contact local dealer or TIGER about repair parts at:

3301 N. LOUISE AVE.,
SIOUX FALLS, SD 57107 www.algqr.com/tpm
Customer Service: 800-843-6849.
Email: feedback@tiger-mowers.com 32709 1



IMPORTANT

BE AWARE BE ALERT BE ALIVE	BE TRAINED Before Operating this Mower
---	---

To prevent serious injury to yourself and/or bystanders, be trained in Safe Mowing Practices. Alamo Group Companies as well as AEM and FEMA provide training material that is critical for your Safety and the Safety of others when operating this equipment. www.algqr.com/tbv

Make these Safety Procedures an important part of every workday. Read and understand the Operator's Manual. Do not let untrained individuals operate this equipment. Contact your Dealer, AEM (www.aem.org), FEMA (314-878-2304, www.FarmEquip.org), or Alamo Group (www.Alamo-Group.com) for information on training material or courses that provide training in Safer Operating Practices for Mowers. 32709 2 32709



SAFETY

⚠ WARNING	
PINCH POINT HAZARD	
TO AVOID SERIOUS INJURY: <ul style="list-style-type: none">• DO NOT OPERATE with Belt Shield removed. 00758194	

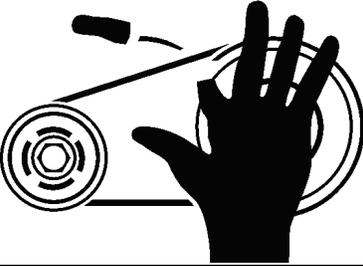
⚠ DANGER
 D646
GUARD MISSING DO NOT OPERATE

⚠ DANGER	
THROWN OBJECTS HAZARD	
Mower can throw objects up to 300 feet. TO AVOID SERIOUS INJURY OR DEATH to operator or bystanders: <ul style="list-style-type: none">• DO NOT operate with Shield removed.• KEEP Shield in place and in good condition during operation. Tb1011	

SAFETY

SAFETY

Federal Laws and Regulations

This section is intended to explain in broad terms the concept and effect of federal laws and regulations concerning employer and employee equipment operators. This section is not intended as a legal interpretation of the law and should not be considered as such.

Employer-Employee Operator Regulations

U.S. Public Law 91-596 (The Williams-Steiger Occupational and Health Act of 1970) OSHA

This Act Seeks:

“...to assure so far as possible every working man and woman in the nation safe and healthful working conditions and to preserve our human resources...”

DUTIES

Sec. 5 (a) Each employer-

- (1) shall furnish to each of his employees employment and a place of employment which are free from recognized hazards that are causing or are likely to cause death or serious physical harm to his employees;
- (2) shall comply with occupational safety and health standards promulgated under this Act.
- (b) Each employee shall comply with occupational safety and health standards and all rules, regulations and orders issued pursuant to this Act which are applicable to his own actions and conduct.

OSHA Training Requirements

Title 29, Code of Federal Regulations Part 1928.57(a)(6). www.osha.gov

Operator instructions. At the time of initial assignment and at least annually thereafter, the employer shall instruct every employee who operates an agricultural tractor and implements in the safe operating practices and servicing of equipment with which they are or will be involved, and of any other practices dictated by the work environment.

Keep all guards in place when the machine is in operation;

Permit no riders on equipment

Stop engine, disconnect the power source, and wait for all machine movement to stop before servicing, adjusting, cleaning or unclogging the equipment, except where the machine must be running to be properly serviced or maintained, in which case the employer shall instruct employees as to all steps and procedures which are necessary to safely service or maintain the equipment.

Make sure everyone is clear of machinery before starting the engine, engaging power, or operating the machine.

Employer Responsibilities:

To ensure employee safety during Tractor and Implement operation, it is the employer's responsibility to:

1. Train the employee in the proper and safe operation of the Tractor and Implement.
2. Require that the employee read and fully understand the Tractor and Implement Operator's manual.
3. Permit only qualified and properly trained employees to operate the Tractor and Implement.
4. Maintain the Tractor and Implement in a safe operational condition and maintain all shields and guards on the equipment.
5. Ensure the Tractor is equipped with a functional ROPS and seat belt and require that the employee operator securely fasten the safety belt and operate with the ROPS in the raised position at all times.
6. Forbid the employee operator to carry additional riders on the Tractor or Implement.
7. Provide the required tools to maintain the Tractor and Implement in a good safe working condition and provide the necessary support devices to secure the equipment safely while performing repairs and service.
8. Require that the employee operator stop operation if bystanders or passersby come within 300 feet.

Child Labor Under 16 Years of Age

Some regulations specify that no one under the age of 16 may operate power machinery. It is your responsibility to know what these regulations are in your own area or situation. (Refer to U.S. Dept. of Labor, Employment Standard Administration, Wage & Home Division, Child Labor Bulletin #102.)

ASSEMBLY SECTION

ASSEMBLY

Before attempting to mount your Tiger mower, it is important to read and understand all of the safety messages in the Safety Section of this manual.

Check complete shipment list against the packing list to make sure there are no shortages. Make certain the tractor model is the appropriate one for the mower received!



Always use a floor jack, hoist or fork lift to lift and raise heavy parts.

Read and understand the entire Assembly Section instructions before attempting to mount your Tiger mower. Refer to the Parts Section of this manual for detailed illustrations to locate all parts. *(ASM-C-0001)*

TRACTOR PREPARATION

- A. Remove right and left hand steps.
- B. Disconnect battery cables from both batteries.
- C. Remove engine side panels, or raise hood to access front pulley.
- D. Remove plugs from tractor casting where mainframe and pump mount will be attached.
- E. Remove any front weights and weight supports.
- F. Raise the tractor onto jack-stands and remove the right and left rear wheels.

(ASM-JD-0001)

CRANKSHAFT ADAPTER

For JD6xxxD tractors with a front pump mount, install the John Deere pulley kit P/N: LVB24989 and follow the instructions. *(ASM-JD-0250)*



ASSEMBLY

DRIVESHAFT AND FRONT PUMP MOUNTING

Install driveshaft into the crankshaft adapter.

Slide splined driveshaft coupler onto the pump driveshaft. Install the pump onto the mounting bracket. NOTE: the pump is offset to one direction and the pump should be installed with the offset side on top. Install hardware for securing pump to the pump mount, DO NOT tighten.

Install pump and align so that splined coupling can be moved (FREE PLAY) back and forth by hand. Rotate coupler and check free play every 1/4 turn. Tighten pump mounting bolts in succession, rechecking for spline coupling free play. Remove the pump mounting bracket bolts one at a time and apply a thread locking agent. Tighten these bolts in succession, again checking for free play in the driveshaft. After all bolts are torqued, the end play on the driveshaft should be 1/16" to 1/8", and coupler should move freely with hand pressure. If end play is less than 1/16", grind the end of the shaft to achieve the proper end play. If there is more than 1/4" of end play, return the shaft with specifications for a longer shaft.

CAUTION: DO NOT START THE TRACTOR UNTIL ALL HOSES ARE ATTACHED,

ADJUSTING REAR WHEELS

Raise rear of tractor onto jack-stands. Follow the instructions in the tractor owner's manual for adjusting tires and rims. The back wheels MUST be adjusted to the widest setting. NOTE: This may require switching the wheels to opposite sides of tractor. Also take note of any width restrictions when transporting by trailer. (For ease of installation, it is best to leave the rear wheels removed during installation of the mower.) (ASM-B-0001)

POLYCARBONATE SAFETY WINDOW

NOTE: Installing a boom mower requires that all right side windows be replaced or shielded by a lexan safety window. In most cases this should be done before mounting the mainframe. Carefully remove the existing right side cab windows, to be replaced with the matching polycarbonate windows provided.

Clean all of the surfaces around the window opening, once the right side windows are removed. Peel back the protective paper from the area around the window that will contact the window frame. Apply a bead of urethane window adhesive, supplied in kit, around the window opening. Carefully position the new window into position. Fill the remainder of the gap around the window with the adhesive to finish. Be sure to follow the instructions on the adhesive label when installing window.

Next, install the upper and lower door hinges along with the existing cab door hinges. To do this, you will remove the existing hinge hardware and install the existing hardware on the polycarbonate as shown in the Parts Section. Set the safety screen assembly on the hinges and attach the door to the tractor frame. Install the brackets with the hardware shown in the Parts Section. Assemble the rod with the vibration isolator and nuts and attach them to the brackets. Adjust the vibration isolator on the upper and lower brackets to achieve a good fit with the window. (ASM-JD-0061)



ASSEMBLY

APPLICATION OF LOCTITE 2047 MOWER MAINFRAME MOUNTING BOLTS

All mower mainframe mounting bolts shall be secured utilizing Loctite 2047 and torqued per the Torque Chart in the maintenance section. Shake bottle for 60 seconds before use. To prevent clogging of nozzle, do not allow tip to touch metal surfaces during application. If tip of nozzle becomes clogged, cut off tip as required. If female threads are contaminated or rusty, clean threads by using a thread chaser prior to installation of bolts. Apply thread locker to threads of bolts as shown below. The allowable fixture time is (1) hour maximum. Therefore bolts must be torqued within this time limit. The cure time is 72 hours at room temperature, therefore machine is not to be used in actual application, except for function testing, until the Loctite is allowed to cure.

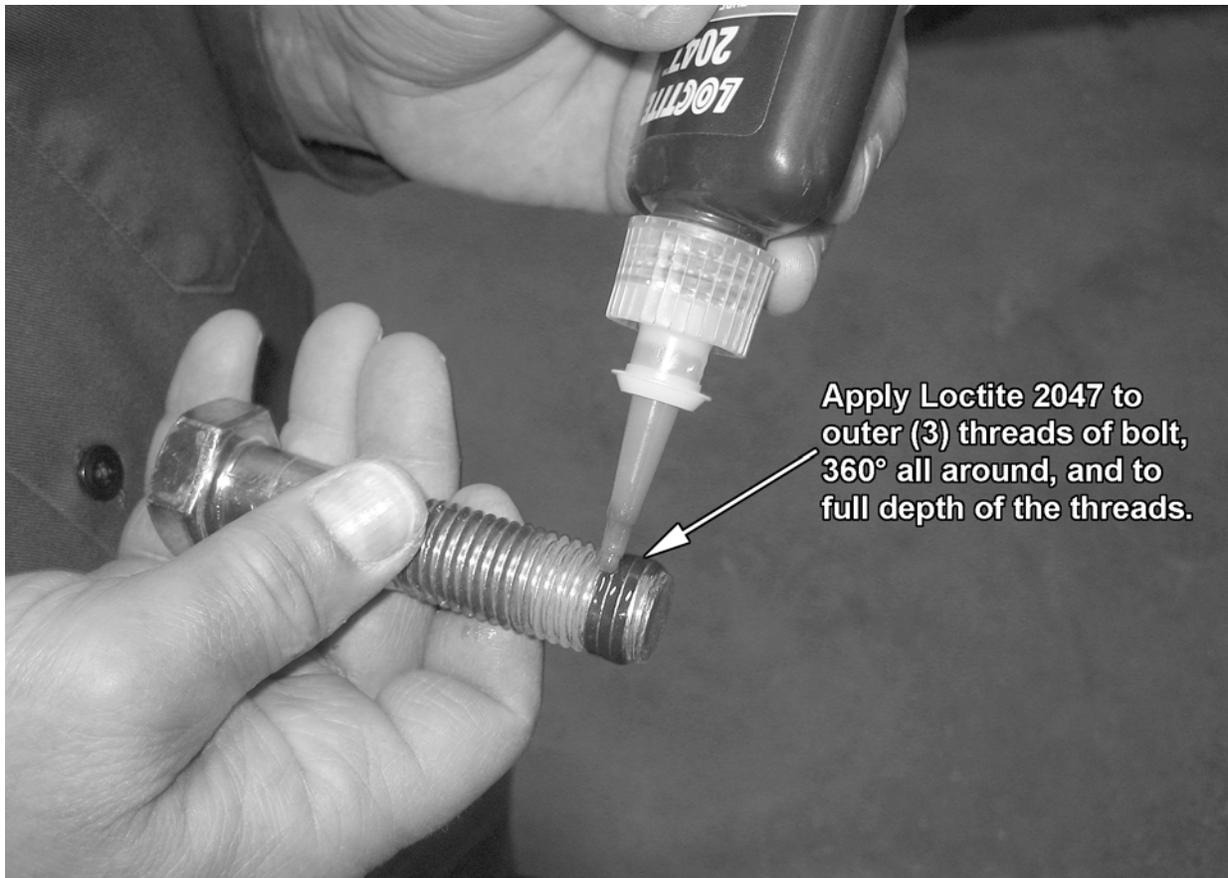

Apply Loctite 2047 to outer (3) threads of bolt, 360° all around, and to full depth of the threads.

(ASM-C-LOCTITE MNT BOLTS)



ASSEMBLY

MAINFRAME INSTALLATION

With an overhead hoist and / or jack-stands, raise one side of the frame up to the correctly matching mounting holes. Install capscrews and other hardware to secure the sides of the mainframe to the tractor casting, as shown on the tractor mount kit page in the Parts Section. **DO NOT** tighten at this time. Remove the capscrews one at a time and apply a thread locking agent. Reinsert the capscrews and tighten / torque to values noted in the torque chart located in the Maintenance Section of this manual. *(ASM-C-0003)*



ASSEMBLY

SWITCHBOX WIRING

Cover all wires with plastic wire wrap provided. Route the green wires along switchbox bracket and cab frame to the steering wheel console. Route the rest of the wires along the base of the right hand console and up to the rubber boot in the bottom right corner in the rear window of the cab. The red and black wires will be connected to the auxillary power plug in the back of the cab. After all wiring is complete, secure all wires to the console with zip ties and push mounts. Take up most of the slack so the wires are out of the way and tighten the zip ties.

With the panel under the steering wheel removed to access the wires, locate the brown wire and verify that this is the neutral safety wire with a test light or meter. Then cut the brown wire and connect a green wire from the switchbox to each end of the brown wire as shown in the wiring diagram. Cut a small hole for the green wires and the wire wrap to fit through and replace the console.

The red and black wires access power for the switchbox through a John Deere auxillary power plug in the rear of the cab.

NOTE: The RED wire from the JD power plug should not be used because it is ALWAYS "Hot". +12 VOLTS ELECTRICAL POWER MUST BE TAKEN FROM A SOURCE LOCATION WHERE IT IS LIVE ONLY WHEN THE IGNITION SWITCH IS IN THE "ON" POSITION. THE RED WIRE MUST BE FUSED AT THE SOURCE LOCATION WITH A CLOSED END CONNECTOR (# 34538).

Connect the red wire from the switchbox to the orange wire from the JD power plug. Connect the black wire from the switchbox to the black wire from the JD power plug.

Two sets of wires have Metri-Pak ends on them. The white and black wires plug into the brake valve. The orange and black wires plug into the travel lock.

Cut a crosshair pattern in the rubber boot in the right bottom corner of the rear window. The wires can be routed through and the rubber falls back into position. The hole should only be large enough for the wires to go through easily.

Route the Metri-Pak wires from the window boot to their location on the unit. Coil the excess wire and secure it to the tractor frame with zip ties to eliminate vibration and rubbing. (ASM-JD-0078)

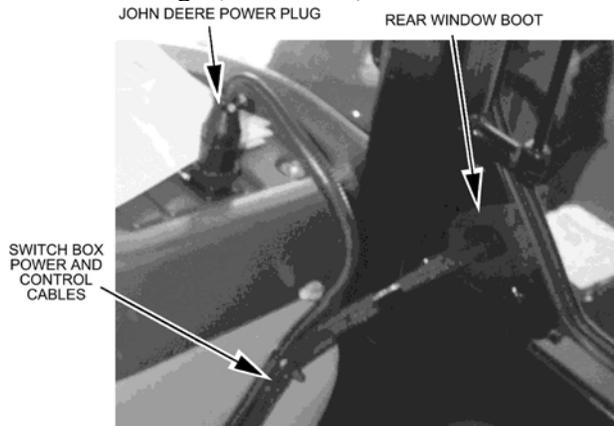

34538 - CLOSED END CONNECTOR



NOTE: When cutting or drilling a hole, be sure not to damage existing wires running behind panels.



ASSEMBLY

WEATHER-PACK / METRI-PACK ASSEMBLY

These instructions apply to both Weather-Pack and Metri-Pack connectors.

NOTE: Use the specific tool for the type of connector you are assembling.

(ASM-C-0009)

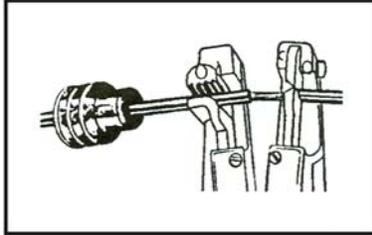

1. Apply seal to cable, before stripping insulation.



2. Align seal with cable insulation.

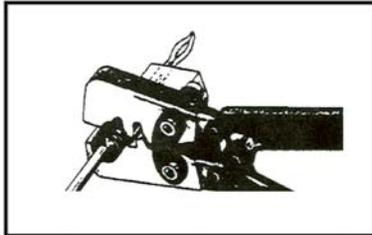

3. Put terminal in crimping tool, then position wire and seal in place.

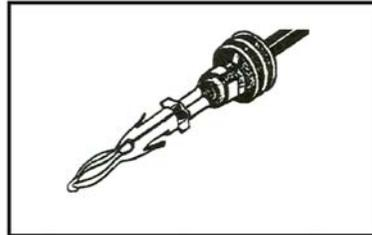

4. Crimp and visually inspect for a good crimp before installing in connector body.



ASSEMBLY

MANUAL SWITCHBOX MOUNTING

The switchbox is to be secured to the operator's side of the control handles, or valve stand. When the front cross member switchbox support bracket is installed, apply clear RTV (silicon) sealant around the outside of the bracket for a water tight seal. Refer to the Parts Section for mounting assembly and components needed .

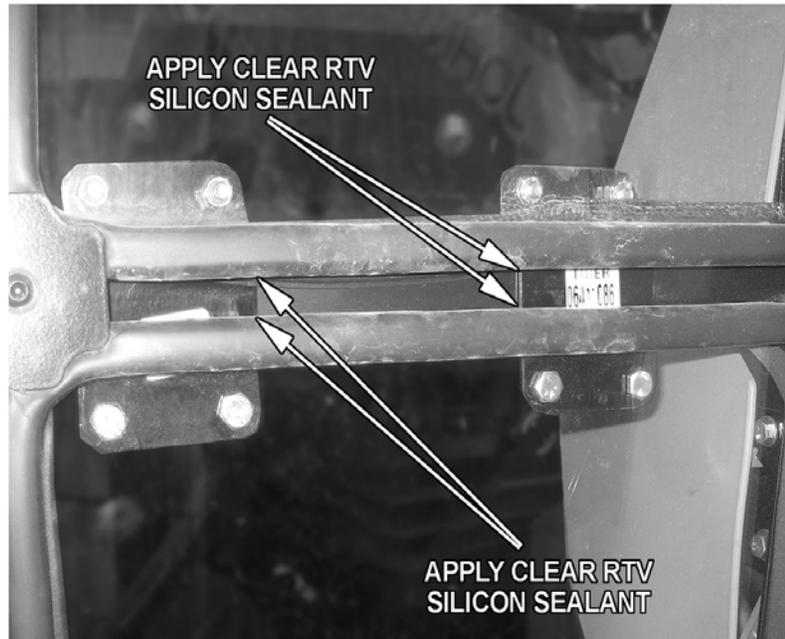

(ASM-C-0053 JD6xxxET4F)



ASSEMBLY

VALVE MOUNTING BRACKET

Attach the rear valve mounting bracket to the fender of the tractor by removing the two rear bolts on the left fender and the two rear bolts on the right fender. Use the hardware noted in the Parts Section to attach the valve mounting bracket to the tractor.

Next, attach the valve mounting plate to the mounting bracket. Align the holes on the plate to the holes on the bracket. Use the hardware shown in the Parts Section to attach the plate to the valve mounting bracket. Finally, place the valve on the valve mounting plate as shown in the Parts Section. Align the holes on the valve assembly to the holes on the plate. Use the hardware provided to secure the valve to the plate. Refer to the Parts Section for the placement of the valve and the hardware used.

Please handle the lift valve with care. It is extremely heavy and contains small parts. (ASM-JD-0088 JD5E T4F boom)

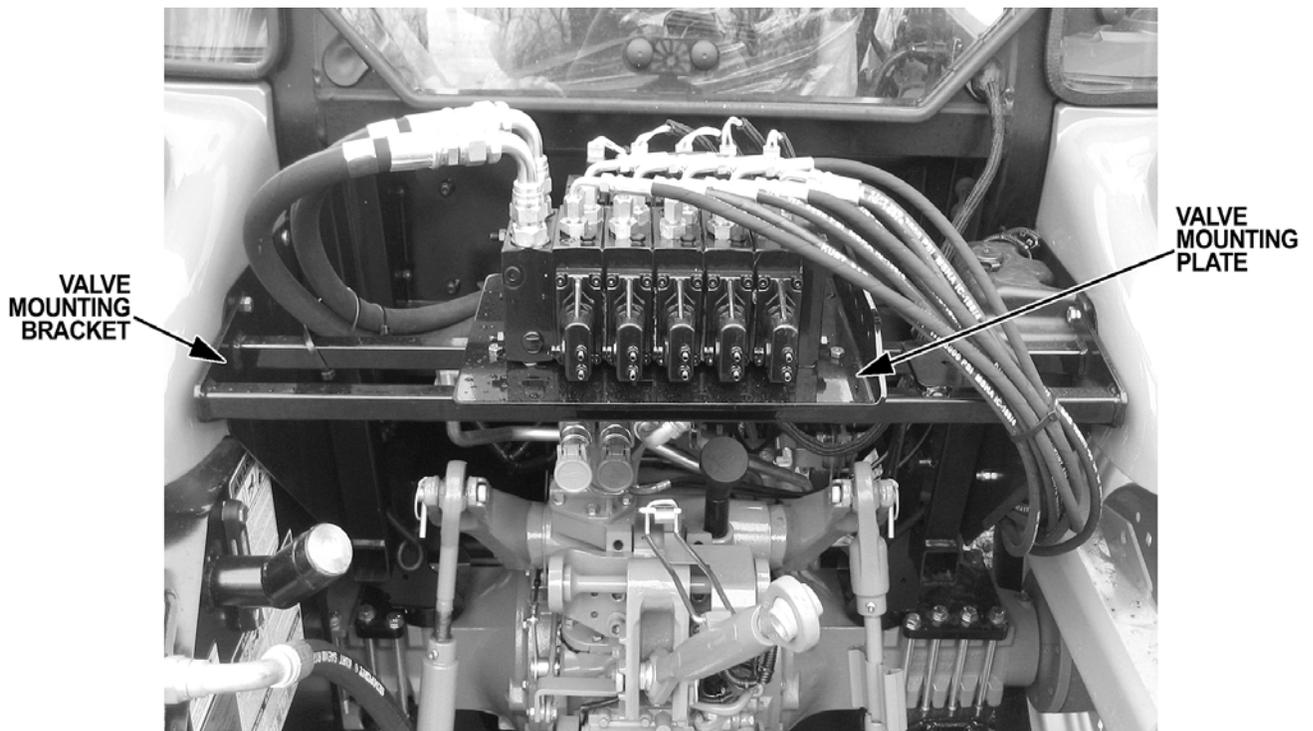

ASSEMBLY

HOSE AND WIRE ROUTING

Attach two clamps to the right rear wheel well for proper hose/wire routing. Drill one hole for each clamp. Use the lower rear corner of the wheel well as an origin for measuring. The holes should be 10mm or 3/8" reamed to accept 3/8" hardware.

Measure along the back edge of the wheel well 10-1/2" from the origin. Use a square to measure 2-1/2" up, from the last mark. Refer to the image below to see the first hole.

The second hole should run parallel to the bottom edge of the wheel well. Mark the hole 22" from the origin and 3-1/2" from the bottom edge. Use the images below for reference.

NOTE: DO NOT CUT INTO TUBES / HOSES / WIRES WHEN DRILLING THROUGH METAL OR PLASTIC! (ASM-JD-0068)

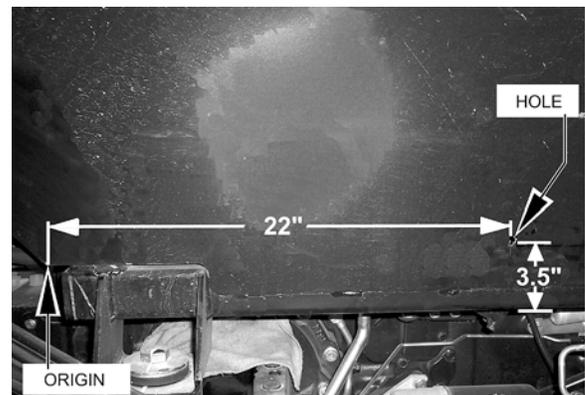
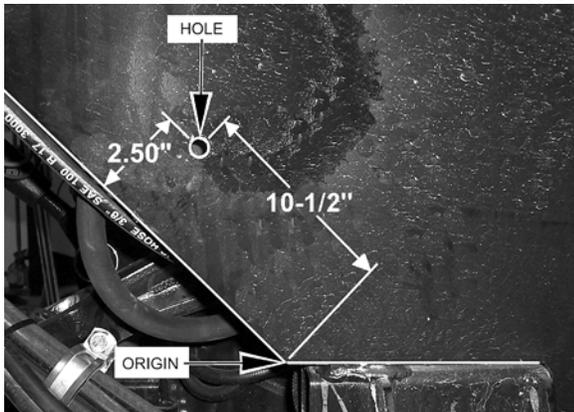

Place as many hoses in the clamp as will fit without compromising pressure. Then secure the (2) HOSE CLAMP (06520013) to the holes drilled with (1 EACH) CAPSCREW, 3/8 X 1 NC (21630) and (1 EACH) NYLOCK NUT, 3/8 NC (21627). The hoses that don't fit into the clamp are to be secured to the others with zip ties. For protection of hoses in contact with metal edges, wrap hoses with split hose sections and fasten with hose clamps or zip ties as needed.

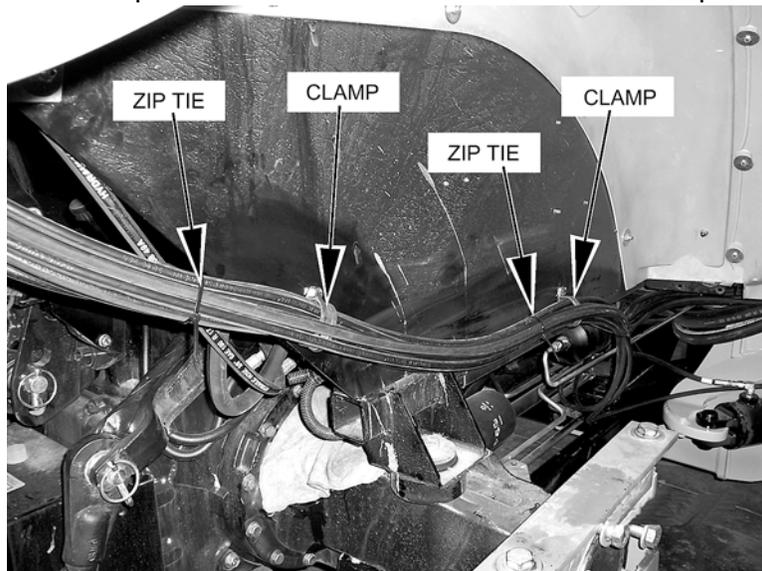

ASSEMBLY

CABLE CONTROL LEVER STAND

Place the cable control bracket on the floor so that the bracket is 4" from the front window. Also the outer rear corner (heel) of the bracket is 5" from the edge of the door. The middle corner of the bracket should be 2" from the edge of the door. See image below. Be sure that the location of the stand will allow the operation of all control levers in the tractor and that the door will not strike the stand when shut. Double check under the cab for cables and wires that may be cut when drilling. And before drilling double check location of the stand for proper placement of holes. Drill 3 holes to match control bracket and secure with capscrews and nylock nuts noted in Parts Section.

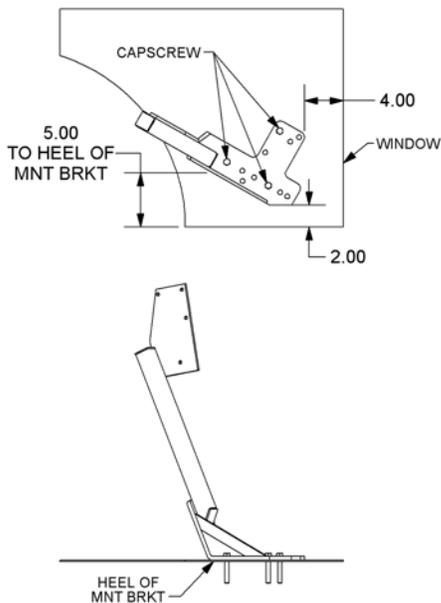

The rubber boot under the rear window can be cut in a crosshair pattern and, if necessary, the bottom cut through to allow it to slip over the cables and back into position. These cables will be routed to the lift valve mounted on the valve mounting plate, and should not have any sharp bends or kinks in them. Secure cables with zip ties and apply RTV sealer in and around individual cables, inside and outside of the cab for a water tight seal. Do not allow excess cable to hang unsecured on the outside of the cab. (ASM-JD-0239).



ASSEMBLY

NOTE ON HUSCO CONTROL VALVES

Manual, cable controlled (Husco control valve) boom mowers require check valves with integral restricting orifice (#06502036) installed in the control valve work ports that are connected to the gland ends of the main and secondary boom cylinders. This check valve allows oil to free flow into the gland end of the main and secondary boom cylinders, but restricts flow out of the cylinder, thereby providing proper boom control. This check valve, #06502036 (Vendor #1968R-.063) is similar in appearance to hose adapter #33271 and Adapter #34396, with .06 orifice. These components can be identified as follows, and are to be installed per Parts Section for the lift valve. (ASM-HUSCO-0001)

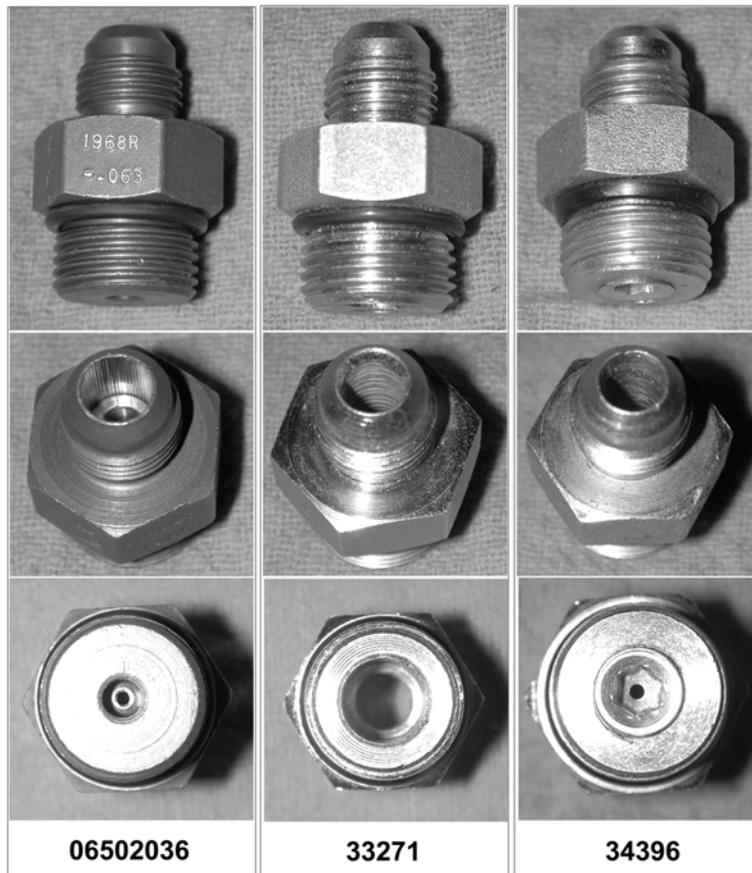

ASSEMBLY

ELECTRONIC LIFT VALVE PORTS

(ASM-C-0089)

DANFOSS VALVE

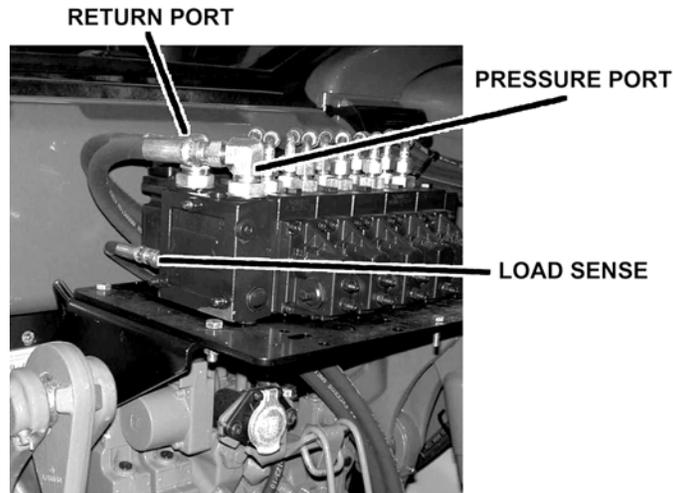

JOYSTICK CONTROL MOUNTING

The joystick is mounted to the right hand center cab post. Find the two existing bolts above the area where the post bumps out. See the image below. Mount the joystick mounting bracket to the cab post with hardware provided. Assemble the parts as shown in the Parts Section. When operating the joystick, make sure it is positioned where the rest of the controls are fully operational. (ASM-JD-0075)

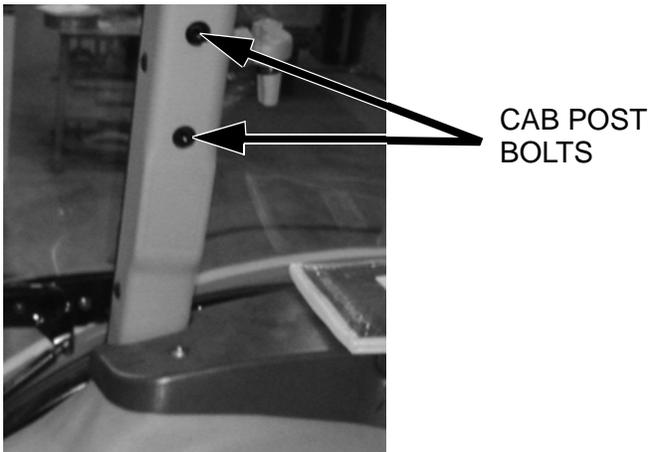

ASSEMBLY

JOYSTICK SWITCHBOX MOUNTING

Locate the right side front cross member of the cab frame. Clamp the switchbox mounting brackets to the cross member. See illustration below. Mount the brackets and switchbox using the hardware supplied, as noted in the Parts Section. When the front cross member switchbox support bracket is installed, apply clear RTV (silicon) sealant around the outside of the bracket for a water tight seal. (ASM-JD-0020)

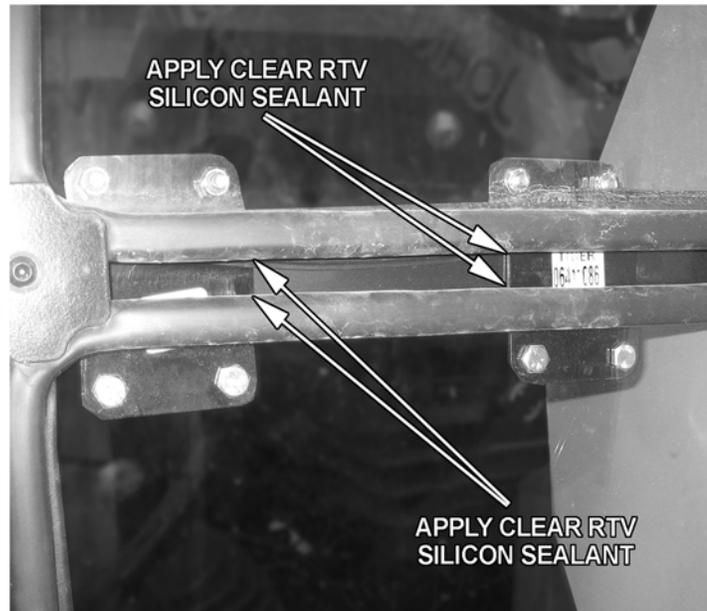
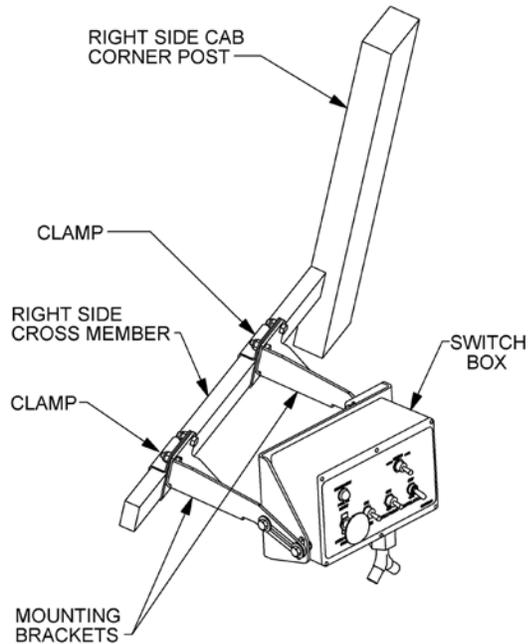

ASSEMBLY

BOOM JOYSTICK CONTROL CALIBRATION

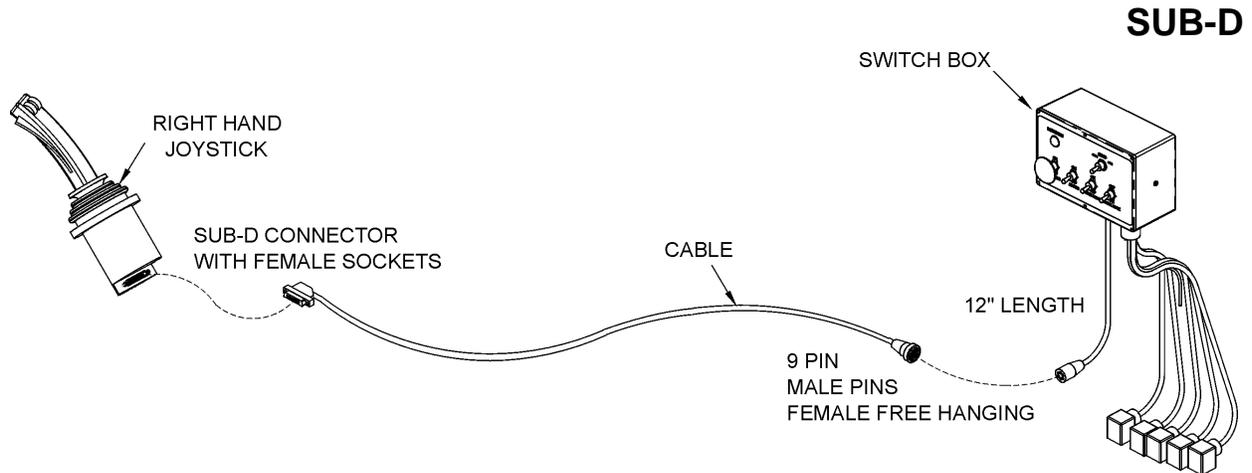

This Electronic control valve is now equipped with higher-resolution actuators on Main Boom, Secondary Boom, Deck Roll, and Swivel functions. These actuators have active fault monitoring. The Deck Shield section does not have active fault monitoring. The joystick is unchanged and provides a ratio-metric voltage signal. The neutral signal voltage is half or 50% of tractor supply voltage. A 25% signal voltage will shift the valve spool to full A-Port, and 75% signal voltage will shift the spool to full B-Port in the Main, Secondary, and Swivel valve sections. On the Deck Roll function a 34% signal voltage will shift the valve spool to full A-Port and a 68% signal voltage will shift the spool to full B-port. If an actuator with active fault monitoring receives a signal from the joystick that is less than 15% or greater than 85% of supply voltage the actuator will “fault out” and shut down. Also, if there is an internal failure in the actuator or if the spool position is greater than that specified by the signal voltage from the joystick, the actuator will “fault out” and shut down. An “active fault” condition causes the actuator to drive the spool to neutral, shut down, and activate a red LED on the top of the actuator. The active fault can be canceled by simply cycling the Master Switch OFF and then ON, which resets the fault monitoring, and causes the LED on top of the actuator to be green again.



The joystick control is equipped with signal adaption potentiometers.

These provide the capability to individually adjust the oil flow to each boom function. It is important that the boom functions do not travel too fast. Excessive boom speed can reduce the stability of the unit and decrease operator control.

Note: Use a Phillips screwdriver and be sure to adjust the screws carefully! DO NOT turn the potentiometers beyond their stopping point, potentiometers are very delicate! Turning the “A” or “B” port potentiometers clockwise increases the oil flow to increase the boom function speed, and turning them counterclockwise decreases the oil flow to decrease the boom function speed. See the graphic on the next few pages for help in adjusting.



ASSEMBLY

BOOM JOYSTICK CONTROL CALIBRATION (CONTINUED)

Run tractor at normal operating RPM to adjust the settings as follows.

Set the dead band compensation potentiometer first.

Set the dead band compensation potentiometer at 50%, or halfway between full clockwise and full counterclockwise.

Setting Signal Adaptation Potentiometers:

Disconnect the Deutsch connectors from the actuators of the valve. Use a Volt/Ohm meter to measure signal voltage and adjust the signal adaptation potentiometers as needed. Pin #4 is tractor supply voltage. Pin #1 is signal voltage from the joystick, and pin #3 is ground. First, measure supply voltage between pins 4 and 3. Then measure signal voltage between pins 1 and 3 while indexing the joystick function fully in both the "A" and "B" port direction. Divide the signal voltage by the supply voltage to get signal voltage as a % of supply voltage. This percentage should not be less than 25% or greater than 75% for the Main Boom, Secondary Boom, or Swivel function. This percentage should not be less than 30% or greater than 62% for the Deck Roll function. Note these initial settings for the Deck Roll function should prevent the spool from shifting into float. *After making this first adjustment to deck roll if the spool still goes into float, adjust the "B" port screw additionally counterclockwise.*

Reconnect Deutsch connectors on control cables to actuators on Electronic valve. Run tractor until hydraulic system is at operating temperature. Now refine the adjustments of the signal adaptation potentiometers for both "A" and "B" ports for all proportional functions to achieve the following function times. Note: turning potentiometer clockwise increases the flow or the function speed, and turning them counterclockwise decreases the flow or the function speed. Note, if during this procedure the trim potentiometer is set to full counterclockwise but the function is still too fast, use the mechanical stops at the manual actuator end of the valve section to further limit flow. Turn limit screw in or clockwise to limit flow. The upper limit screw limits flow to B-port, and the lower limit screw limits flow to A-port. However DO NOT adjust the limit screw on B-port of deck roll function. Limiting B-port will prevent float function.



ASSEMBLY

BOOM JOYSTICK CONTROL CALIBRATION (CONTINUED)

MAIN BOOM: “A” Port, Boom Up: 8-10 Seconds

(Note: Extend secondary boom completely; roll deck to be level with ground, and lower main boom until deck is on ground. Now index main boom “up” function and determine the time required for main boom to rise completely.)

“B” Port, Boom Down: 6-8 Seconds

(Note: Extend secondary boom completely, roll deck to be level with ground, and raise the main boom to “full up”. Then index the main boom “down” function to determine the amount of time required for the deck to contact the ground. CAUTION: Stop the boom just as the deck contacts the ground.)

SECONDARY

BOOM: “A” Port, Boom Out: 8-10 Seconds

(Position main boom full up, roll deck out until deck cylinder is fully retracted, and bring secondary boom in completely. Then index the secondary boom “out” function and determine the time required for boom to extend out completely.)

“B” Port, Boom In: 8-10 Seconds

(Position the main boom full up, roll deck out until deck cylinder is fully retracted, and extend secondary boom completely. Then index the secondary boom “in” function and determine the time required for boom to come in.)

DECK ROLL: “A” Port, Deck Out: 7-9 Seconds

(Raise main boom to vertical, extend secondary boom out slightly so that deck can be articulated without contacting the main boom, and roll deck in until deck cylinder is completely extended. Then index the deck roll “out” function and determine the time required for the deck to roll out.)

“B” Port, Deck In: Target 7-9 Seconds (but DO NOT use Limit Screw)

(Raise main boom to vertical, extend secondary boom out slightly so that deck can be articulated without contacting the main boom, and roll deck out until deck cylinder is completely retracted. Then index the deck roll “in” function and determine the time required for the deck to roll in.)

BOOM

SWIVEL: “A” Port, Boom Aft: 14-16 Seconds for 3PS, 3OS, SS

(Extend booms completely; rotate head to be level with ground, lower main boom until deck is just above ground, and swivel boom full forward. Then index the boom swivel “aft” function and determine the time required for the boom to swivel full aft. Use caution when doing this, stop boom before main boom contacts tire.)

“B” Port, Boom Forward: 14-16 Seconds for 3PS, 3OS, SS

(Extend booms completely, rotate head to be level with ground, lower main boom until deck is just above ground, and swivel boom aft until near tire. Then index the boom swivel “forward” function and determine the time required for the boom to swivel full forward.)

(ASM-C-0082)



ASSEMBLY

BOOM JOYSTICK DIAGRAM (ASM-C-0082A)

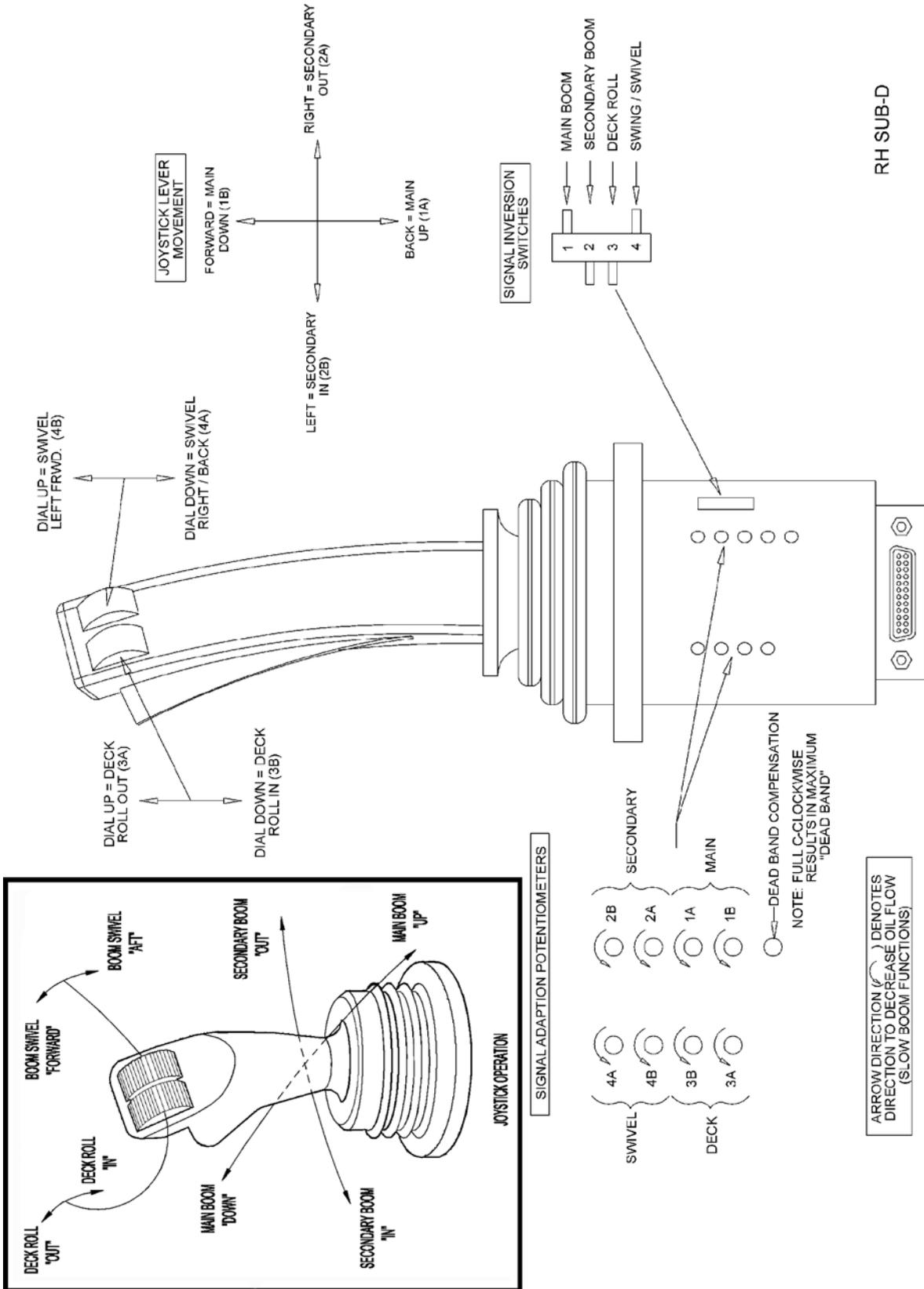

RH SUB-D



ASSEMBLY

REAR STOW BENGAL HOSE ROUTING

WARNING NOTE: The sudden release of hydraulic pressure could cause the sudden movement of very heavy parts. Anyone in the way of these parts could be severely hurt or killed. DO NOT ALLOW these hydraulic hoses to BREAK or BURST. To prevent hydraulic failure make sure the hoses do not pinch or stretch as boom moves. Measure TWICE, check TWICE then proceed with caution.

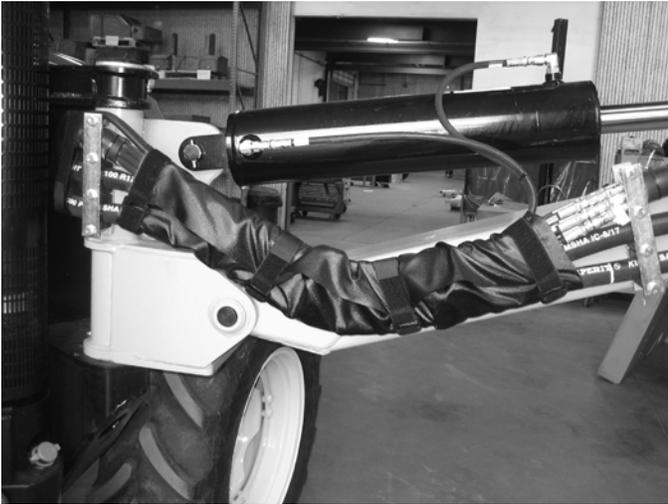

Route the hoses through the space between the swivel and the mainframe. Connect the hoses to the brake valve. Assemble the swivel clamp and place the return hose for the motor in the middle and the pressure line on the bottom. Place the 1/4" hoses in the top clamp and wrap the hoses with a split hose before tightening the clamp. If not all of the 1/4" hoses fit, route two of the hoses above the clamp and secure them to the other hoses with a zip tie. Make sure there is enough slack for all hoses to pivot at the joint where the main boom arm bends in the swivel, and tighten the hoses in the clamp. Wrap the hoses on either side of the clamp with the hose wrap. This will protect the hoses from abrasion and heat. (ASM-T4 HOSE ROUTING-0001)



ASSEMBLY

(ASM-C-0023)

BOOM HYDRAULIC DIAGRAM

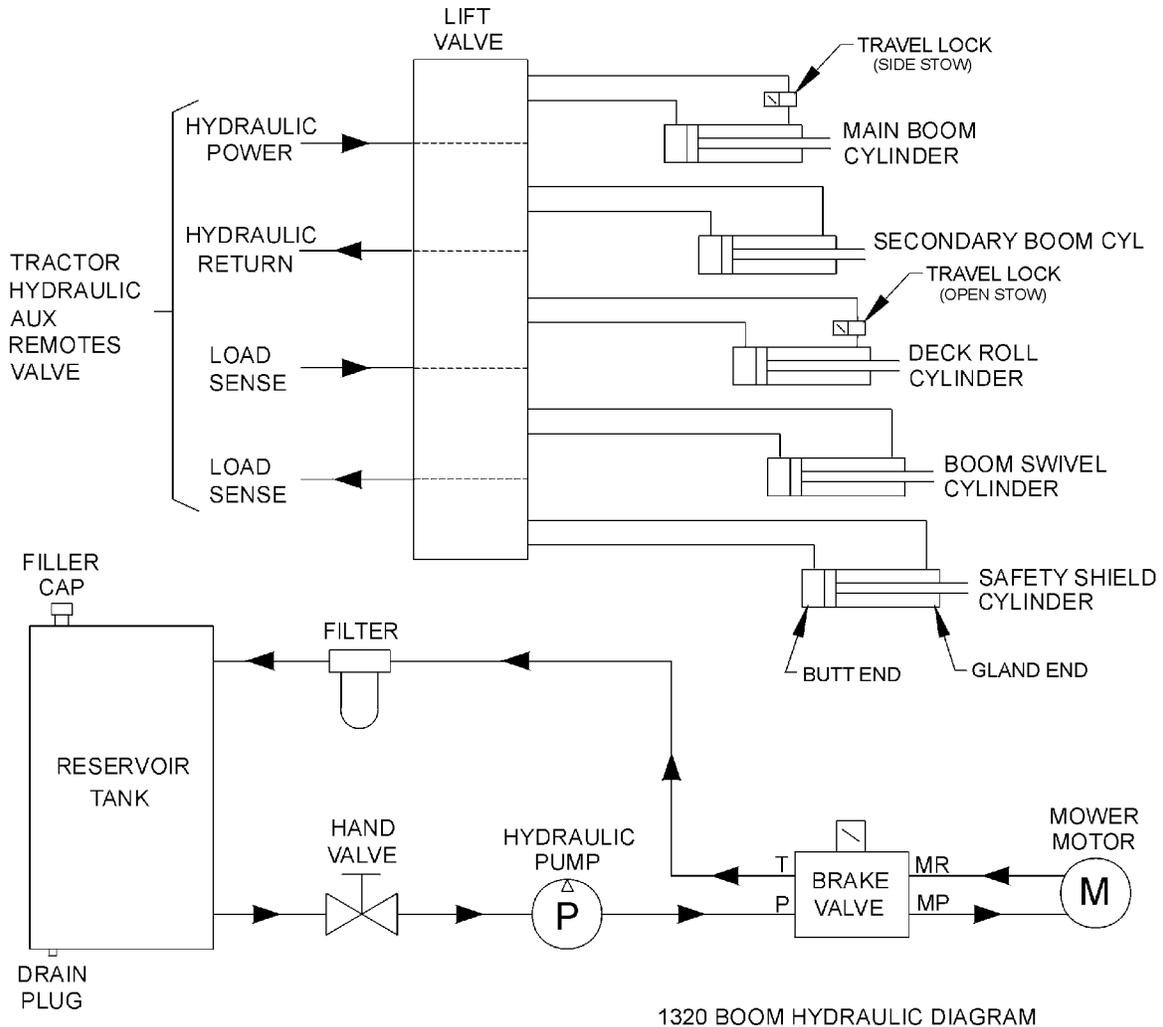

FILLING HYDRAULIC RESERVOIR

Refer to the Maintenance Section for filling specifications and hydraulic oil requirements.

NOTE: Starting or running your Tiger mower before filling reservoir will cause serious damage to the hydraulic pump.

(ASM-C-0004hydro resrv)



ASSEMBLY

WHEEL WELL HYDRAULIC TANK INSTALLATION

Install all fittings and tubes into tank and tank filter as shown in the Parts Section illustration. Insert tank sight glass onto the tractor side of the tank.

Place the tank in the mounting bracket on the axle brace as shown in the Parts Section. Secure the tank with the hardware provided.

Install the filter gauge into the filter housing so that it points to the rear of the tractor and is clearly visible to the operator. The tank breather cap is ready for use as the tank is filled. Some of these items may already be installed. (ASM-C-0103)

WHEEL SPACERS

When mounting a boom mower, a spacer kit is needed for both rear wheels (part # 06200637). After removing the wheels attach the spacer to the wheel portion of the axle with the hardware provided. When you are ready to re-attach the wheel, the wheel goes on first then the reinforcement ring and finally the hardware provided. (ASM-JD-0099)

INSTALLING O-RING FITTINGS

Installing straight, 45° and 90° O-rings requires that the O-ring and washer be up against the swivel body. Insert the swivel and turn in until the swivel is pointed in the desired direction and O-ring contact is made. Hold swivel in set direction with a wrench and turn the O-ring nut away from the swivel body and carefully tighten. (ASM-C-0056)

INSTALLING NATIONAL PIPE FITTINGS

Whenever installing a pipe fitting, wrap the threads clockwise (looking at the end) with teflon tape. In this way, the tape will be tightened when installed. NOTE: It is not necessary to tape O-ring fittings, or those installed in swivels. (ASM-C-0088)

PREFORMED TUBE INSTALLATION

Lay booms on floor so that the side with the clamp plates is up. Locate all tube clamps and install them loosely onto the clamp plates.

Arrange the tubes and hoses as outlined in the Common Parts Section. Install the tubes closest to the boom arm first, being careful not to pinch the tubes. Place the other tubes outside of the first tubes. Snug all clamp bolts, but do not tighten. Check all tubes for correct alignment and that none are pinched or bent. The clamp bolts can now be tightened. (ASM-C-0085)

GENERAL HOSE INSTALLATION

Refer to the Parts Section for detailed information about hoses and fittings for this application. (ASM-C-0011)

HOSE COVERING

Secure hoses together with zip ties wherever loose. Wrap the hoses between the swivel and main boom with the hose cover provided. Wrap the hoses between the main boom and secondary boom with the hose cover provided. Where hoses may contact the frame or other edges, wrap with split hose and secure with hose clamps or zip ties.

On non-cab units, the pressure and return hoses from the control valve will also need to be routed inside the protective hose wrap. Cover the valve and valve fittings with the hose cover and secure with the string provided. (ASM-C-0058)



ASSEMBLY

ACCUMULATOR INSTALLATION

Install the accumulator bracket on the right mainframe mast or lift valve mount, if applicable, with the capscrews, lockwashers and spacers, if applicable, as shown in the Parts Section. Install the accumulator in the bracket and secure with the hardware shown. Install fittings and hoses to the cylinder and control valve as shown in the Parts Section. **Use teflon tape on all pipe fittings (except O-rings).** (ASM-C-0012)

SOLENOID BRAKE VALVE

Install a solenoid valve on the mounting bracket with the supplied hardware as shown in the Parts Section in this manual. While installing the fittings to the brake valve, the electrical coil on the spool may have to be removed to make room. When reinstalling the coil, it is important to use no more than 5 ft. lbs. (or 60in. lbs.) torque. **WARNING: OVER TORQUE TO THE COIL WILL RESULT IN HYDRAULIC FAILURE OF SPOOL.** (ASM-C-0025)

TEMPERATURE GAUGE MOUNTING (OPTIONAL)

Mount the temperature gauge where it is clearly visible to the operator. Attach the green (-) wire from the negative post on the gauge to a grounded bolt on the tractor frame. Remove paint if needed to make a good ground. Remove the pipe plug from the side of the hydraulic reservoir and install the temperature sensor using thread sealing tape. Run the white wire from the (s) sensor post of the gauge to the temperature sensor on the hydraulic reservoir tank. (ASM-C-0051)

WHEEL WEIGHT MOUNTING

For all tractors using a boom mower, a wheel weight will be required for the rear left side wheel. It will be necessary to mount the weight in the wheel using the long capscrews, lockwashers, flatwashers, spacers (if applicable), and hex nuts per the diagram in the Parts Section.

Installation is most easily done with a fork lift, inserting a fork in the center slot of the wheel weight. The head of the capscrews is to be toward the OUTSIDE of the weight, with flatwashers on both the inside and outside of the assembly.

The left rear tire may also be filled with a mixture of water and calcium chloride at about five pounds per gallon. Tire air pressure should be maintained according to the Maintenance Section. (ASM-C-0055)

AXLE BRACE INSTALLATION

With the tractor on jack-stands, remove the existing hardware on the rear axle where the axle braces will be mounted. Use a hoist to raise the axle braces to the correctly matching mounting holes on the rear axle and the mainframe. Use the hardware shown in the Parts Section to attach the braces to the tractor, DO NOT tighten until the mainframe has been positioned onto the axle braces. The mainframe hardware will not be tightened at this time.

When the mainframe is in position, remove the capscrews one at a time and apply a thread locking agent. Reinsert the capscrews and tighten / torque to values noted in the torque chart located in the Maintenance Section of this manual. (ASM-MF-0013)



ASSEMBLY

SINGLE COLUMN BOOMREST MOUNTING

Carefully lower the boomrest and align the holes with those of the axle brace. Now install all attaching hardware, as shown in the Parts Section, loosely, to allow for the alignment with the axle brace. Tighten / torque all hardware on the axle brace and the boomrest.. (ASM-JD-0244)

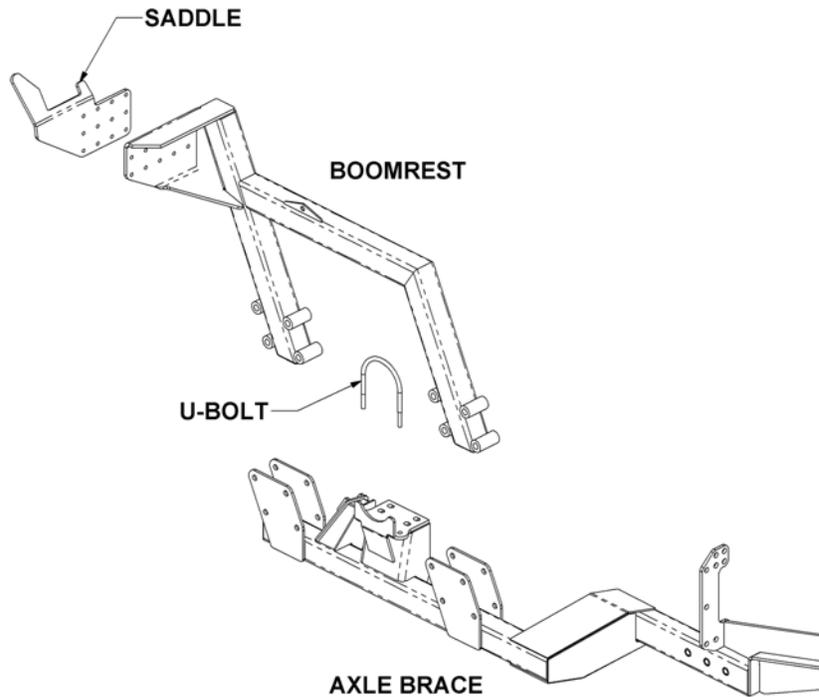

ASSEMBLY

OS AXLE BRACE MOUNTING

The open stow axle braces are to be mounted under the rear axle of the tractor. The other end of the axle brace mounts on the outside of the lower rear corners of the mainframe. After attaching the boomrest, it should fit tightly and level under the tractor. Attach the axle brace(s) to the mainframe with hardware shown in the Parts Section and tighten. Attach the axle braces to the rear axle using the mounting hardware shown in the Parts Section, but **DO NOT** tighten.

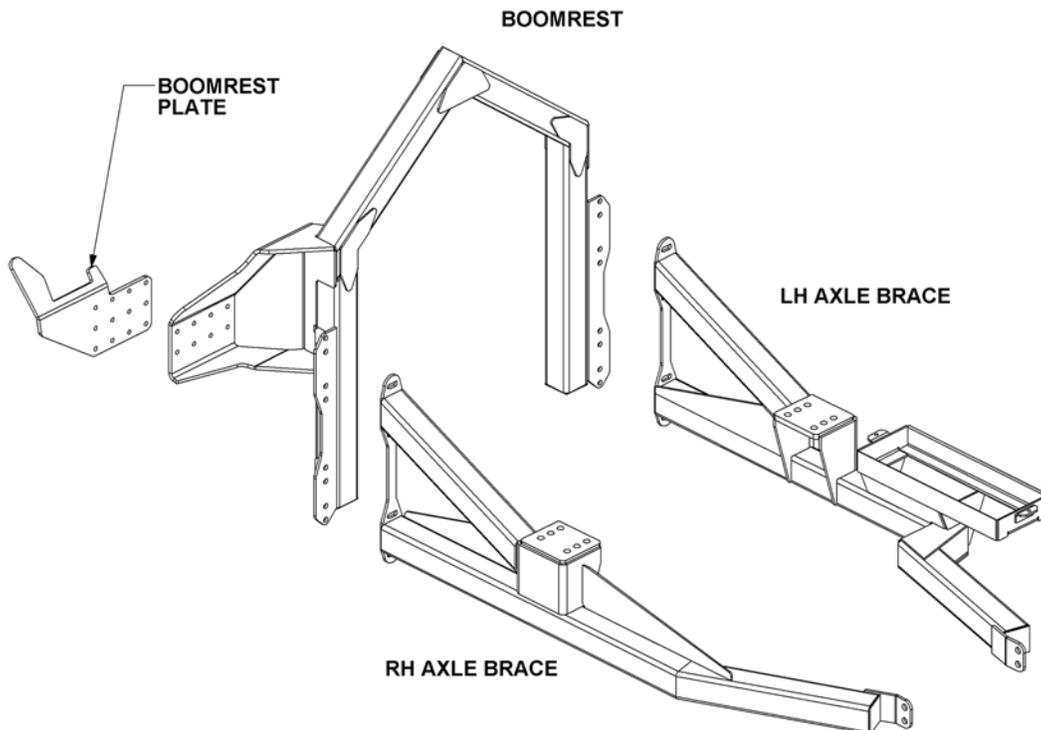

OS BOOMREST MOUNTING

Carefully raise the open stow boomrest and align the holes with those of the axle brace. Now install all attaching hardware, as shown in the Parts Section, loosely, to allow for the alignment with the left and right axle brace. Tighten / torque all hardware on the brace and the boomrest. Finally, add the boomrest plate to the boomrest as shown in the Parts Section. (ASM-JD-0246)



ASSEMBLY

FINAL PREPARATION FOR OPERATION

Place operator's safety and operation decals on the steering column and side console where they are clearly visible to the operator. These decals should be understood by each operator of the machine in conjunction with the Safety and Operation Sections of this book. The decals are to be maintained in good condition as a reminder to the operator, and should be replaced if damaged.

All bosses, pins and pivot points will need to be greased as instructed in the Maintenance Section of this manual. The hydraulic reservoir can also be filled with the recommended fluid (see Maintenance Section) and the filter installed in the top of the tank. Double check all fittings and fasteners BEFORE starting tractor. Also secure any loose hoses together with zip ties and wrap with split hoses where friction may occur on the hoses.



BEFORE starting or operating the tractor you must read and understand the Safety and Operation Sections of this manual completely.

BE SURE THE BALL VALVES ARE OPEN! Start tractor and allow instruments to stabilize. Using a piece of paper or cardboard as noted in the Safety and Maintenance Sections, check all fittings and connections for hydraulic leaks.

If a leak is found, you must shut down the tractor and set the cutter on the ground. Before attempting to fix the leak, you must actuate the lift valve handles several times to relieve any pressure in the lines.

Before operating the mower, the cutter head and boom should be slowly moved throughout the full range of motion. Watch for any condition that would cause pinching or excess stress on the hoses. The steering and front axle travel should also be carefully moved through their full range of motion. If any condition occurs in which the hoses contact the tires, the steering and / or front axle travel may need to be limited as described in the tractor operator's manual. This should also be done if the tires rub, or are extremely close to any other part of the mower, such as the hydraulic tank or draft beam. This may include adding shims or adjusting stop bolts in the tractor front to solve the problem. While checking motion, you should also check that the control circuits are connected according to the operator's decal for the valve handles.

MOWER TESTING

Take the tractor to a place free of loose objects on the ground. Operate the cylinders through their full range of motion again, to clear the lines of air. Follow the instructions in the Operation Section to operate the mower. Vibration of the mower should be minimal at all times. After a 5 minute test run, the knife bolts should be retorqued, and retorqued once again after the first few hours of operation.

If any parts of this Assembly Section, or any other section of this manual are not clearly understood you must contact your dealer or the address on the front of this manual for assistance!*(ASM-C-0010)*



ASSEMBLY



OPERATION SECTION

Operation Section 3-1

OPERATION

TIGER BOOM MOWER OPERATING INSTRUCTIONS

Tiger Booms are manufactured with quality material by skilled workers. The Boom is designed to attach to a tractor and operate various heads for a wide range of vegetative maintenance applications. The boom and heads are equipped with safety warning decals, protective deflectors, shields, and other safety features to provide operator and passerby protection, however, no shielding is 100% accurate. ALL safety equipment and safety warning decals must be maintained on the unit in good operational condition at all times.

It is the operator's responsibility to be knowledgeable of all potential operating hazards and to take every reasonable precaution to ensure oneself, others, animals, and property are not injured or damaged by the boom unit, tractor or a thrown object. Do not operate the boom and attached head if bystanders, passersby, pets or livestock are within 300 feet of the unit.

This section of the Operator's Manual is designed to familiarize, instruct, and educate operators to the safe and proper use of the boom and attached head. Pictures contained in this section are intended to be used as a visual aid to assist in explaining the operation of a Boom and are not specific to a Boom. Some pictures may show shields removed to enhance visual clarity. NEVER operate the boom unit without all safety equipment in place and in good operational condition. The operator must be familiar with the boom unit and tractor operation and all safety practices before beginning operation. Proper operation, as detailed in this manual, will help ensure years of safe and satisfactory use of the Boom

READ AND UNDERSTAND THE ENTIRE OPERATING INSTRUCTIONS AND SAFETY SECTION OF THIS MANUAL AND THE TRACTOR MANUAL BEFORE ATTEMPTING TO USE THE TRACTOR AND IMPLEMENT. If you do not understand any of the instructions, contact your nearest authorized dealer for a full explanation. Pay close attention to all safety signs and safety messages contained in this manual and those affixed to the implement and tractor. (OPS-U-0001)

READ, UNDERSTAND, and FOLLOW the following Safety Messages. Serious injury or death may occur unless care is taken to follow the warnings and instructions stated in the Safety Messages. Always use good common sense to avoid hazards. (SG-2)



Si no lee ingles, pida ayuda a alguien que si lo lea para que le traduzca las medidas de seguridad. (SG-3)



OPERATION

1. OPERATOR REQUIREMENTS

Safe operation of the unit is the responsibility of a qualified operator. A qualified operator has read and understands the implement and tractor Operator's Manuals and is experienced in implement and tractor operation and all associated safety practices. In addition to the safety messages contained in this manual, safety signs are affixed to the implement and tractor. If any part of the operation and safe use of this equipment is not completely understood, consult an authorized dealer for a complete explanation.

If the operator cannot read the manuals for themselves or does not completely understand the operation of the equipment, it is the responsibility of the supervisor to read and explain the manuals, safety practices, and operating instructions to the operator.

Safe operation of equipment requires that the operator wear approved Personal Protective Equipment (PPE) for the job conditions when attaching, operating, servicing, and repairing the equipment. PPE is designed to provide operator protection and includes the following safety wear:

PERSONAL PROTECTIVE EQUIPMENT (PPE)

- Always Wear Safety Glasses
- Hard Hat
- Steel Toe Safety Footwear
- Gloves
- Hearing Protection
- Close Fitting Clothing
- Respirator or Filter Mask (depends on operating conditions) (OPS-U-0002)

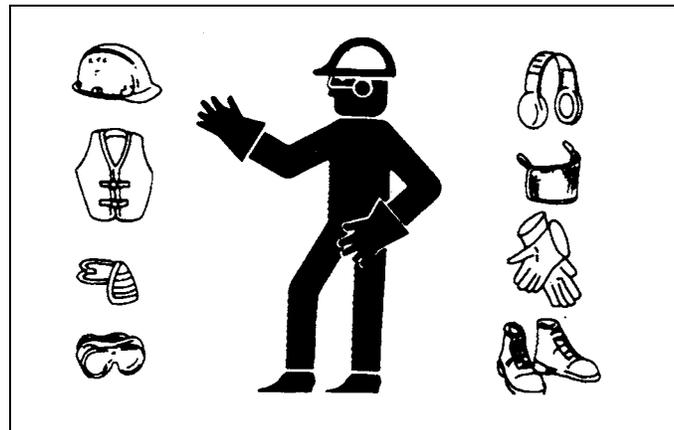

NEVER use drugs or alcohol immediately before or while operating the Tractor and Implement. Drugs and alcohol will affect an operator's alertness and coordination and therefore affect the operator's ability to operate the equipment safely. Before operating the Tractor or Implement, an operator on prescription or over-the-counter medication must consult a medical professional regarding any side effects of the medication that would hinder their ability to operate the Equipment safely. NEVER knowingly allow anyone to operate this equipment when their alertness or coordination is impaired. Serious injury or death to the operator or others could result if the operator is under the influence of drugs or alcohol. (SG-27)

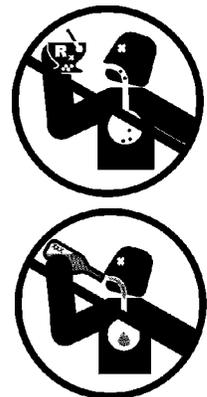

OPERATION

2.TRACTOR REQUIREMENTS

In addition to tractor horsepower and size required to operate the boom unit, the tractor must also be properly equipped to provide operator protection, to alert approaching vehicle drivers of the tractor's presence, and to ensure tractor stability when mowing with the boom fully extended.

Tractor Requirements and Capabilities

- ASAE approved Roll-Over Protective Structure (ROPS) or ROPS cab and seat belt.
- Operator Protection Tractor must be equipped with protective structure such as operatorcage or lexan window to protect operator from thrown object and falling objects
- Tractor Safety Devices Slow Moving Vehicle (SMV) emblem, lighting,
- Tractor Ballast As required to maintain at least 1500 lbs. on left rear tire

2.1 ROPS and Seat Belt

The tractor must be equipped with a Roll-Over-Protective-Structure (ROPS) (tractor cab or roll-bar) and seat belt to protect the operator from falling off the tractor, especially during a roll over where the driver could be crushed and killed. Only operate the tractor with the ROPS in the raised position and seat belt fastened. Tractor models not equipped with a ROPS and seat belt should have these life saving features installed by an authorized dealer. *OPS-U- 0003*



Operate this Equipment only with a Tractor equipped with an approved roll-over-protective system (ROPS). Always wear seat belts. Serious injury or even death could result from falling off the tractor--particularly during a turnover when the operator could be pinned under the ROPS. (SG-7)



2.2 Operator Thrown Object Protection

The tractor must be equipped with protective equipment to shield the operator from falling and thrown objects. For cab tractors, the tractor must be equipped with an operator safety screen on its right side or the right side windows must be fitted with a shatter resistant safety window. For non-cab tractors, the tractor must be equipped with a ROPS and operator protective safety cage that provides protection to the right and above the operator seat. DO NOT remove the ROPS from non-cab tractors to equip a safety cage.

OPS-B- 0001



OPERATION



Never operate the Tractor and Mower Unit without an OPS (Operators Protective Structure) or Cab to prevent injury from objects thrown from ground or from overhead trimming. Stop mowing if workers or passersby are within 300 feet. (SBM-9)



2.3 Tractor Lighting and SMV Emblem

If the tractor will be operated near or traveled on a public roadway it must be equipped with proper warning lighting and a Slow Moving Vehicle (SMV) emblem which are clearly visible from the rear of the unit. Most tractor's have different settings for operating and transporting lighting. Refer to the tractor operator's manual for using the tractor's light switch and operating the turn signals.

OPS-B- 0017



OPERATION

OPERATION

OPERATION

2.4 Tractor Ballast

To ensure tractor stability when operating on flat surfaces the left rear tractor tire MUST exert a minimum down force (weight) of 1500 lbs. on the ground when the tractor is on level ground, its boom is fully extended and the mower head is horizontal and two feet above the ground. For units which have the ability to operate on either side of the tractor, these requirements must also be met for the right side tire when the boom is extended to the left side as described above. A tractor that does not meet this criteria is DANGEROUS and should not be operated as upset of the unit can occur resulting in possible serious injury and property damage. NOTE: All factory mounted units are tested and meet the ballast requirement before shipment; further testing is not required unless the unit is operated in a manner other than what is considered standard operating conditions.

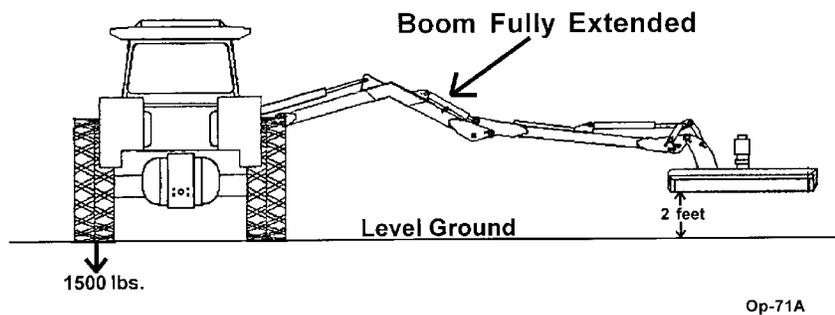

If the unit is operated on slopes greater than 5°, additional counterweight will be required. Operation of the unit on slopes greater than 11 percent (6.4 degrees) is not recommended under any circumstances. On a tractor with a 96" outside to outside tire spread, an 11 percent (6.4 degrees) slope occurs when one rear tractor tire is about 8" lower than the other rear tire. OPS-B- 0018

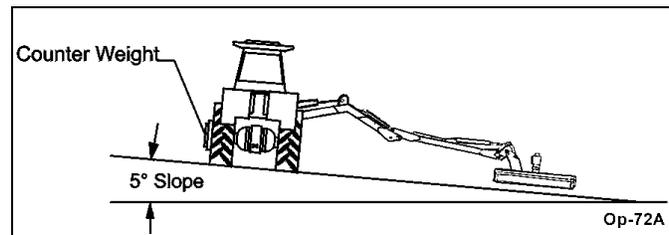

3.GETTING ON AND OFF THE TRACTOR

Before getting onto the tractor, the operator must read and completely understand the implement and tractor operator manuals. If any part of either manual is not completely understood, consult an authorized dealer for a complete explanation. OPS-U- 0007



Do not mount or dismount the Tractor while the tractor is moving. Mount the Tractor only when the Tractor and all moving parts are completely stopped. (SG-12)



OPERATION

3.1 Boarding the Tractor

Use both hands and equipped handrails and steps for support when boarding the tractor. Never use control levers for support when mounting the tractor. Seat yourself in the operator's seat and secure the seat belt around you.

Never allow passengers to ride on the tractor or attached equipment. Riders can easily fall off and be seriously injured or killed from falling off and being ran over. It is the operator's responsibility to forbid all extra riders at all times. OPS-U- 0008



Never allow children to operate, ride on, or come close to the Tractor or Implement. Usually, 16-17 year-old children who are mature and responsible can operate the implement with adult supervision, if they have read and understand the Operator's Manuals, been trained in proper operation of the tractor and Implement, and are physically large enough to reach and operate the controls easily. (SG-11)



Never allow children or other persons to ride on the Tractor or Implement. Falling off can result in serious injury or death. (SG-10)



Do not mount or dismount the Tractor while the tractor is moving. Mount the Tractor only when the Tractor and all moving parts are completely stopped. (SG-12)



3.2 Dismounting the Tractor

Before dismounting the tractor, idle the tractor engine down, disengage the head and retract the boom arm to the transport position. Park the tractor on a level surface, place the transmission in neutral and set the parking brake. Shut down the tractor engine, remove the key, and wait for all motion to come to a complete stop before exiting the operator's seat. NEVER leave the seat until the tractor, its engine, and mower head movement have come to a complete stop.

Use hand rails and extra steps when exiting the tractor. Be careful of your step and use extra caution when mud, ice, snow, and other matter has accumulated on the steps and handrails. Never rush or jump off the tractor. OPS-B- 0002



BEFORE leaving the tractor seat, always set the parking brake and/or set the tractor transmission in parking gear, disengage the PTO, stop the engine, remove the key, and wait for all moving parts to stop. Place the tractor shift lever into a low range or parking gear to prevent the tractor from rolling. Never dismount a Tractor that is moving or while the engine is running. Operate the Tractor controls from the tractor seat only. (SG-9)

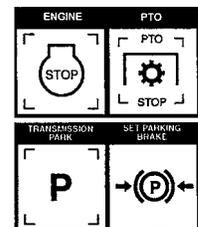

OPERATION

4.STARTING THE TRACTOR

The operator must have a complete understanding of the placement, function, and operational use of all tractor controls before starting the tractor. Review the tractor operator's manual and consult an authorized dealer for tractor operation instructions if needed.

Essential Tractor Controls:

- Locate the ignition key/switch
- Locate the engine shut off control
- Locate the hydraulic control levers
- Locate the light control lever
- Locate the brake pedals and clutch
- Locate the PTO control
- Locate the 3 point hitch control lever
- Locate the boom operating controls (joystick or valve bank)

Before starting the tractor ensure the following:

- Conduct all pre-start operation inspection and service according to the tractor operator's manual.
- Make sure all guards, shields, and other safety devices are securely in place.
- The parking brake is on.
- The tractor transmission levers are in park or neutral.
- The boom operating controls are in the neutral and off position.
- The PTO control lever is disengaged.
- The hydraulic remote control levers are in the neutral position.

Refer to the tractor owner's manual for tractor starting procedures. Only start the tractor while seated and belted in the tractor operator's seat. Never bypass the ignition switch by short circuiting the starter solenoid. After the tractor engine is running, avoid accidental contact with the tractor transmission to prevent sudden and unexpected tractor movement. OPS-B- 0003



Never run the Tractor engine in a closed building or without adequate ventilation. The exhaust fumes can be hazardous to your health. (SG-23)



Start tractor only when properly seated in the Tractor seat. Starting a tractor in gear can result in injury or death. Read the Tractor operators manual for proper starting instructions. (SG-13)



OPERATION

5.CONNECTING ATTACHING HEADS TO THE BOOM

1. Start by attaching the pivot bracket(3) to the boom(1) using pin(5) and hardware. Next attach the cylinder to the pivot bracket(3) using pin(8) and roll pins.
2. Then attach the dogleg(4) to the mower(2) using pin(7) and hardware.
3. Use a hoist to lower the boom(1) down to the mower(2). Insert the upper pin(6) through the end of the boom and the mower. Attach with hardware.
4. Then align the dogleg(4) and the pivot bracket(3). Attach with pin(9) and hardware.
5. Finally make sure all bolts, nuts, and pins are tightened to recommended torque. OPS-B- 0004_D

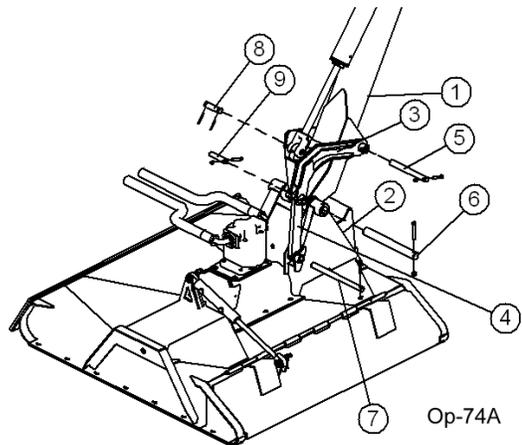

WARNING

Avoid contact with hot surfaces including hydraulic oil tanks, pumps, motors, valves and hose connections. Relieve hydraulic pressure before performing maintenance or repairs. Use gloves and eye protection when servicing hot components. Contact with a hot surface or fluid can cause serious injury from burns or scalding. (SG-34)

WARNING

Do not operate this Equipment with hydraulic oil or fuel leaking. Oil and fuel are explosive and their presence could present a hazard. Do not check for leaks with your hand! High-pressure oil streams from breaks in the line could penetrate the skin and cause tissue damage including gangrene. To check for a hose leak, SHUT the unit ENGINE OFF and remove all hydraulic pressure. Wear oil impenetrable gloves, safety glasses and use Cardboard to check for evidence of oil leaks. If you suspect a leak, REMOVE the HOSE and have it tested at a Dealer. If oil does penetrate the skin, have the injury treated immediately by a physician knowledgeable and skilled in this procedure. (SG-15)



6.PRE-OPERATION INSPECTION AND SERVICE

Before each use, a pre-operation inspection and service of the implement and tractor must be performed. This includes routine maintenance and scheduled lubrication, inspecting that all safety devices are equipped and functional, and performing needed repairs. DO NOT operate the unit if the pre-operation inspection reveals any condition affecting safe operation. Perform repairs and replacement of damaged and missing parts as soon as noticed. By performing a thorough pre-operation inspection and service, valuable down time and repair cost can be avoided. OPS-U-0029

OPERATION

WARNING

Periodically inspect all moving parts for wear and replace when necessary with authorized service parts. Look for loose fasteners, worn or broken parts, and leaky or loose fittings. Make sure all pins have attaching hardware. Serious injury may occur from not maintaining this machine in good working order. (SG-21_A)



DANGER

All Safety Shields, Guards and Safety devices including (but not limited to) - the Deflectors, Chain Guards, Steel Guards, Gearbox Shields, PTO integral shields, and Retractable Door Shields should be used and maintained in good working condition. All safety devices should be inspected carefully at least daily for missing or broken components. Missing, broken, or worn items must be replaced at once to reduce the possibility of injury or death from thrown objects, entanglement, or blade contact. (SGM-3)

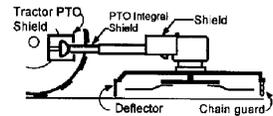

6.1 Tractor Pre-Operation Inspection/Service

Refer to the tractor operator's manual to ensure a complete pre-operation inspection and scheduled service is performed according to the manufacturers recommendations. The following are some of the items that require daily service and inspection:

- Tire condition/air pressure
- Wheel lug bolts
- Steering linkage
- PTO shield
- SMV sign is clean and visible
- Tractor's lights are clean and functional
- Tractor Seat belt is in good condition
- Tractor ROPS is in good condition
- ROPS is in the raised position
- No tractor oil leaks
- Radiator free of debris
- Engine oil level and condition
- Engine coolant level and condition
- Power brake fluid level
- Power steering fluid level
- Fuel condition and level
- Sufficient lubrication at all lube points
- Air filter condition OPS-U-0030



OPERATION

6.2 Boom Unit Pre-Operation Inspection and Service

Inspect and service the boom arm and head prior to operation. Damaged and/or broken parts should be repaired and/or replaced immediately. To ensure the unit is ready for operation, conduct the following: OPS-B- 0020



Periodically inspect all moving parts for wear and replace when necessary with authorized service parts. Look for loose fasteners, worn or broken parts, and leaky or loose fittings. Make sure all pins have attaching hardware. Serious injury may occur from not maintaining this machine in good working order. (SG-21_A)



OPERATION

The operator's manual and safety signs affixed on the unit contain important instructions on the safe and proper use of the equipment. Maintain these important safety features on the implement in good condition to ensure the information is available to the operator at all times.

- Ensure all safety signs are in place and legible. Replace missing, damaged, and illegible decals. OPS-U- 0011_A



FRAME ASSEMBLY

- Inspect condition of mounting frame weldment.
- Inspect condition of Swivel Assy.
- Ensure all bolts and screws are in position and are properly torqued.
- Ensure all pins are in place and fastened with screws.
- Ensure frame is properly mounted to tractor and hardware is properly installed and tightened. OPS-B- 0021_D



OPERATION

WARNING

Relieve hydraulic pressure prior to doing any maintenance or repair work on the Implement. Place the Mower Head on the ground or securely supported on blocks or stands, disengage the PTO, and turn off the engine. Push and pull the control Levers or Joystick several times to relieve pressure prior to starting any maintenance or repair work. (SBM-6)

WARNING

Never Leave the mower unattended while the head is in the raised position. The mower could fall causing serious injury to anyone who might inadvertently be under the mower (SBM-4)



OPERATION

BOOM ARM ASSEMBLY

- Inspect condition of each arm section weldment
- Ensure all pins are in place.
- Ensure all bolts, nuts and rollpins are properly installed.
- Check condition of bushings at boom pivot points and hydraulic cylinder tangs.
- Ensure each hydraulic cylinder is installed and retained correctly. Ensure the proper size pins are used to retain the cylinders in place and are secured properly. OPS-B- 0022_D



WARNING

Never attempt to lubricate, adjust, or remove material from the Implement while it is in motion or while tractor engine is running. (SG-20)

HYDRAULIC LINE INSPECTION

- Check for hydraulic leaks along hoses, cylinders and fittings. **IMPORTANT:** DO NOT use your hands to check for oil leaks. Use a piece of heavy paper or cardboard to check for hydraulic oil leaks.
- Inspect the condition of the valve mounting.
- Ensure fittings are properly connected. OPS-B- 0023_D

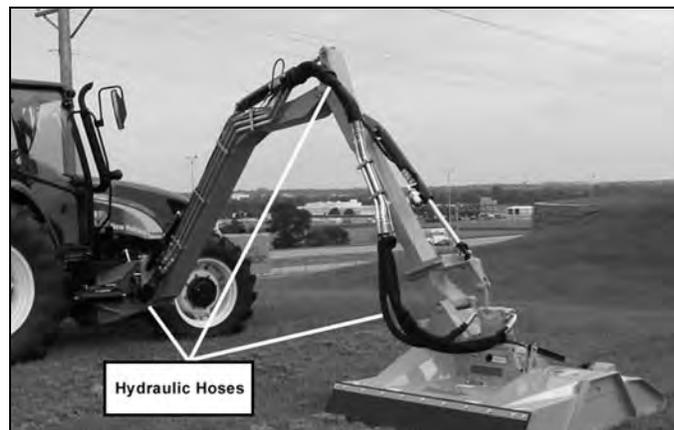

OPERATION

WARNING

Do not operate this Equipment with hydraulic oil or fuel leaking. Oil and fuel are explosive and their presence could present a hazard. Do not check for leaks with your hand! High-pressure oil streams from breaks in the line could penetrate the skin and cause tissue damage including gangrene. To check for a hose leak, SHUT the unit ENGINE OFF and remove all hydraulic pressure. Wear oil impenetrable gloves, safety glasses and use Cardboard to check for evidence of oil leaks. If you suspect a leak, REMOVE the HOSE and have it tested at a Dealer. If oil does penetrate the skin, have the injury treated immediately by a physician knowledgeable and skilled in this procedure. (SG-15)



OPERATION

HYDRAULIC PUMP/OIL RESERVOIR

- Check oil reservoir level and oil condition. (Add specific type oil if low)
- Change hydraulic oil filter and hydraulic oil according to maintenance schedule.
- Ensure there are no oil leaks and fitting are properly connected
- Inspect overall condition of hydraulic pump.
- Inspect pump drive shaft.



Check the fluid level in the Hydraulic Tank on the Tractor, and add oil if required. As the air has been forced out of the Cylinders and Hoses, it goes into the Hydraulic Tank and reduces the volume of oil. Maintain the oil level within the sight gauge located on the side of the reservoir. Never fill the tank above the sight gauge to allow for the expansion of the oil. The tank maintains pressure after the mower has been run. Stand off to one side when removing the breather cap element to prevent possible injury. OPS-B 0024_E

WARNING

Attention: Oil Filler Cap is also the Pressure Relief Cap.

Remove cap slowly to relieve pressure before removing cap completely. Stay clear to prevent being scalded with hot oil that may spray out of the tank that is still pressurized and may cause serious injury to eyes, face, and exposed skin. (Ops-0001-MISC)

WARNING

Avoid contact with hot surfaces including hydraulic oil tanks, pumps, motors, valves and hose connections. Relieve hydraulic pressure before performing maintenance or repairs. Use gloves and eye protection when servicing hot components. Contact with a hot surface or fluid can cause serious injury from burns or scalding. (SG-34)

OPERATION

ROTARY HEAD INSPECTION

- Inspect blades and blade bolts for looseness and excessive wear. Rotate to 90° to make for checking easier. Replace damaged, worn, and missing blades as complete sets to maintain rotary balance.
- Ensure motor bolts and nuts are tightened to the appropriate torque.
- Ensure rubber deflectors are in position and not damaged. Replace worn, broken, and missing sections immediately.
- Ensure hydraulic lines are properly connected to the hydraulic motor. Check for hydraulic leaks along hoses and fittings. **DO NOT** use your hands to check for oil leaks. Use a piece of heavy paper or cardboard to check for hydraulic oil leaks.
- Inspect the condition of deck skid shoes and hardware. *OPS-B- 0025*



WARNING

Do not put hands or feet under mower decks. Blade Contact can result in serious injury or even death. Stay away until all motion has stopped and the decks are securely blocked up. (SGM-09)



DANGER

All Safety Shields, Guards and other safety devices including (but not limited to) - Deflectors, Steel Guards and Gearbox Shields must be used and maintained in good working condition. All safety devices should be inspected carefully at least daily for missing or broken components. Missing, broken, or worn items must be replaced at once to reduce the possibility of injury or death from thrown objects, entanglement, or blade contact. (SSM-07)

OPERATION

FLAIL HEAD INSPECTION

- Inspect blades and blade bolts for looseness and excessive wear. Rotate to 90° to make for checking easier. Replace damaged, worn, and missing blades as complete sets to maintain cuttershaft balance.
- Ensure rubber deflectors are in position and not damaged. Replace worn, broken, and missing sections immediately.
- Ensure the rollers are in good condition and rotate freely.
- Inspect that all bolts and screws are in position and are properly torqued.
- Ensure hydraulic lines are properly connected to the hydraulic motor. Check for hydraulic leaks along hoses and fittings. DO NOT use your hands to check for oil leaks. Use a piece of heavy paper or cardboard to check for hydraulic oil leaks.
- Inspect the condition of the drive belts.
- Ensure the drive belt shields are in place and in good repair.
- Remove any grass or other debris which may be wrapped around the cuttershafts ends.
- Inspect the condition of deck skid shoes and hardware. OPS-B- 0026_B



Do not put hands or feet under mower decks. Blade Contact can result in serious injury or even death. Stay away until all motion has stopped and the decks are securely blocked up. (SFL-2)



All Safety Shields, Guards and other safety devices including (but not limited to) - Deflectors, Steel Guards and Gearbox Shields must be used and maintained in good working condition. All safety devices should be inspected carefully at least daily for missing or broken components. Missing, broken, or worn items must be replaced at once to reduce the possibility of injury or death from thrown objects, entanglement, or blade contact. (SSM-07)

OPERATION

OPERATION

6.3 Cutting Component Inspection

Inspect blade pan and blade assembly for the following: OPS-U-0031

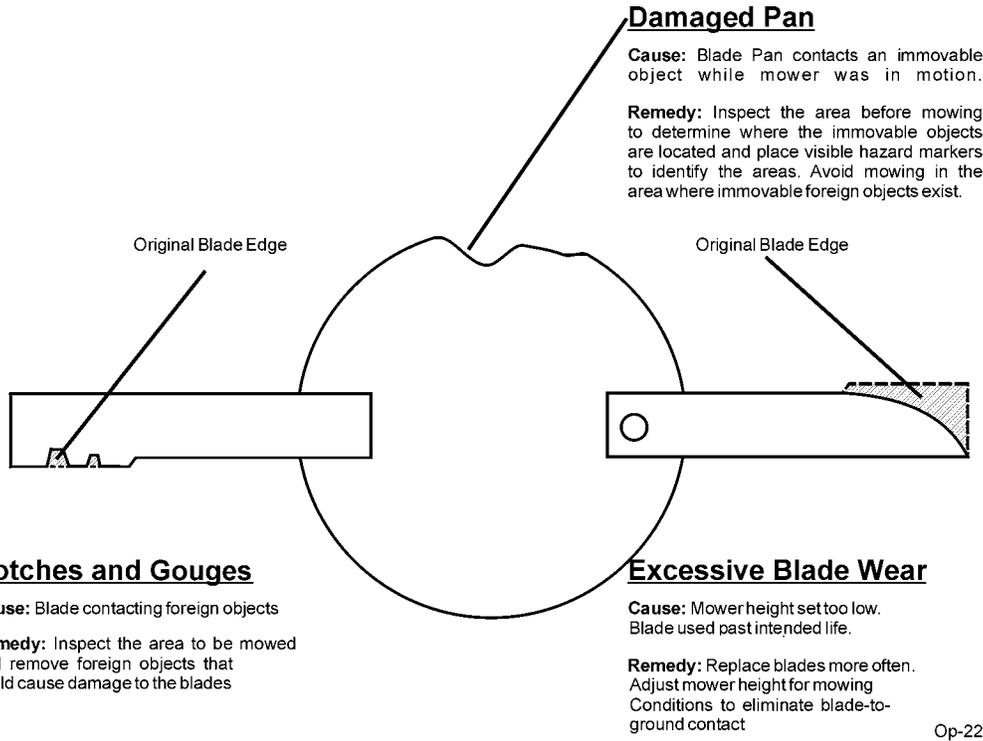

Inspect the Blades daily for abnormal wear. REPLACE BOTH BLADES on that carrier IMMEDIATELY if either blade has:

- Become bent or deformed from it's original shape or
- Any cracks are visible, or
- Deep gouges in the blade's surface are present, or
- Gouges or chipped areas in the cutting edge are larger than 1/2"(12.7mm), or
- The material on the leading edge has been worn away by more than 1/2(12.7mm)"

Failure to replace abnormally worn blades may lead to catastrophic failure of the blades and ejection of the broken part with tremendous force which may cause serious bodily injury or death. OPS-U-0032

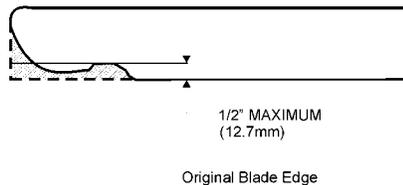

NOTE:
Replace Blades in pairs after no more than 1/2" (12.7mm) wear
Op-23

OPERATION

Tractor PRE-OPERATION Inspection



Mower ID# _____ Make _____

Date: _____ Shift _____



Before conducting the inspection, make sure the tractor engine is off, all rotation has stopped and the tractor is in park with the parking brake engaged. Make sure the mower is resting on the ground or securely blocked up and all hydraulic pressure has been relieved.

OPERATION

Item	Condition at Start of Shift	Specific Comments if not O.K.
The flashing lights function properly		
The SMV Sign is clean and visible		
The tires are in good condition with proper pressure		
The wheel lug bolts are tight		
The tractor brakes are in good condition		
The steering linkage is in good condition		
There are no visible oil leaks		
The hydraulic controls function properly		
The ROPS or ROBS Cab is in good condition		
The seatbelt is in place and in good condition		
The 3-point hitch is in good condition		
The drawbar pins are securely in place		
The PTO master shield is in place		
The engine oil level is full		
The brake fluid level is full		
The power steering fluid level is full		
The fuel level is adequate		
The engine coolant fluid level is full		
The radiator is free of debris		
The air filter is in good condition		

Operator's Signature: _____

DO NOT OPERATE an UNSAFE TRACTOR or MOWER

This Inspection Form may be freely duplicated for extra copies.

OPERATION

Boom PRE-OPERATION Inspection



Mower ID# _____ Make _____
 Date: _____ Shift _____



Before conducting the inspection, make sure the tractor engine is off, all rotation has stopped and the tractor is in park with the parking brake engaged. Make sure the mower is resting on the ground or securely blocked up and all hydraulic pressure has been relieved.

Table 1:

Item	Condition at Start of Shift	Specific Comments if not O.K.
The Operator's Manual is in the tractor		
All safety decals are in place and legible		
The mounting frame bolts are in place and tight		
The boom connection bolts & pins are tight		
There are no cracks in boom		
The hydraulic cylinders pins are tight		
The hydraulic pump hose connections are tight		
The hydraulic valve controls function properly		
There are no leaking or damaged hoses		
The hydraulic oil level is full		
There is no evidence of hydraulic leaks		
The blades are not chipped, cracked or bent		
The blade bolts are tight		
The deflectors are in place and in good condition		
The boom shields are in place and in good condition		
The skid shoes are in good condition and tight		
There are no cracks or holes in boom deck		
The hydraulic motor mounting bolts are tight		
The boom head spindle housing is tight and lubricated		

Operator's Signature: _____

DO NOT OPERATE an UNSAFE TRACTOR or MOWER

OPERATION

Cable Controlled Mowers

A control lever decal similar to the one shown below should be near the control valve to remind the operator of the lever functions.

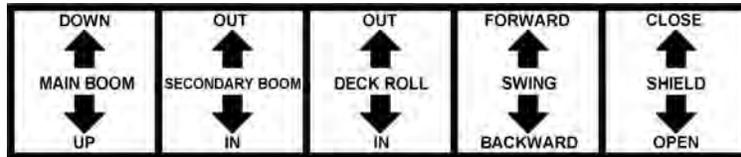

The main control valve on the Tiger Boom Mower has four sections with tapered spools, located near the right side of the steering wheel. The malfunction of a section of the valve does not necessitate the replacement of the entire "bank", only the faulty section. Each section of the valve controls a certain position of the boom or deck. Seated in the operators seat, the controls from left to right are #1-primary (main) boom, #2-secondary boom, #3 -deck roll, #4-boom (swivel) swing), and #5- boom (safety) shield.

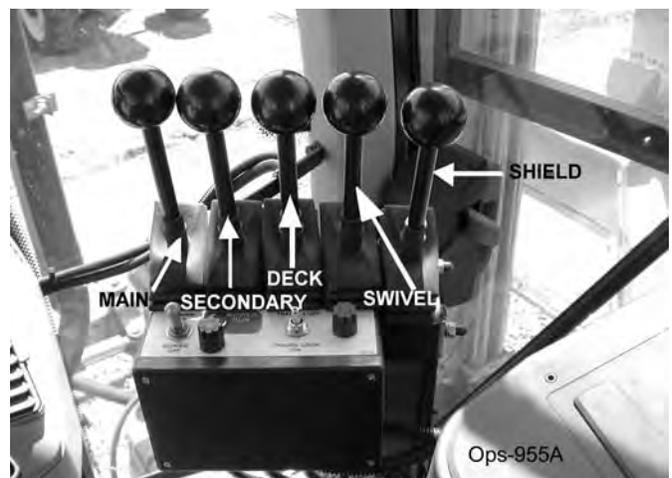
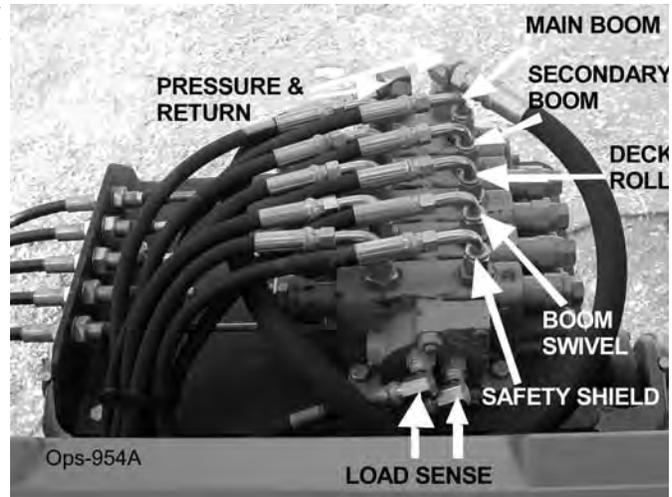

OPERATION

OPERATION

OPERATION

6.4 Switchbox

The Safety Shield lever opens and closes the shield located on the front of the cutter head. When moving at or near the ground, always have the shield in the closed position. When mowing in the brush or in trees above ground level the shield may be opened for easier cutting. Read and follow the warnings on the decal shown below. Do not run the cutter head into material larger than 6" diameter.

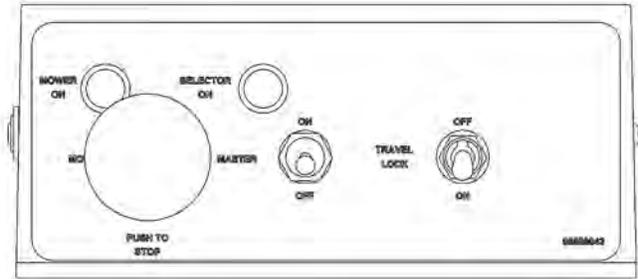

 DANGER	
SAFETY SHIELD & DEFLECTOR OPERATION	
 <p>SAFETY SHIELD</p> <p>DEFLECTOR</p>	<ul style="list-style-type: none">• Failure to close Safety Shield and Deflector may allow objects to be thrown outward with great force which can cause property damage, bodily injury, or death. <ol style="list-style-type: none">1. Keep Safety Shield and Deflector fully closed when cutting grass and weeds to reduce possibility of objects being thrown outward by the Blades if persons are in the area.2. Before Cutting brush, trimming limbs, or other such operations, raise the Deflector and Safety Shield fully to allow the blades to contact the material if area is clear of passerby. Operator must stop cutting and close shield if passerby enters the thrown objects area or blade contact area.3. Repair or replace Safety Shield and Deflectors as needed.4. Always transport with Safety Shield and Deflector closed.
02967867	

OPERATION

LEVER #1 MAIN BOOM

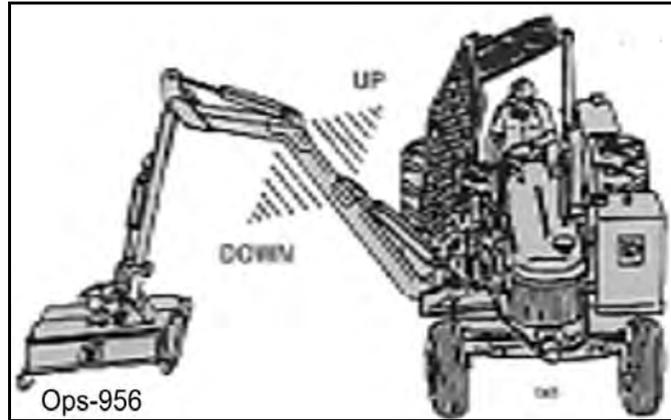

LEVER #2 SECONDARY BOOM

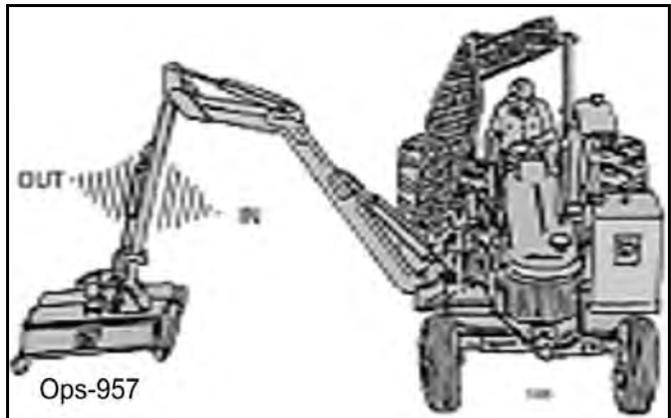

LEVER #3 DECK ROLL

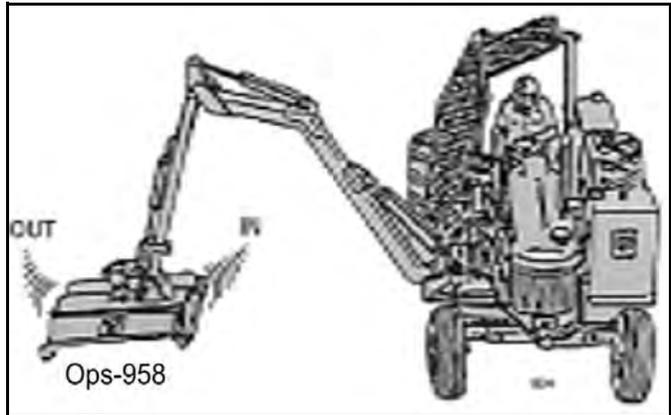

OPERATION

OPERATION

LEVER #4 BOOM SWIVEL

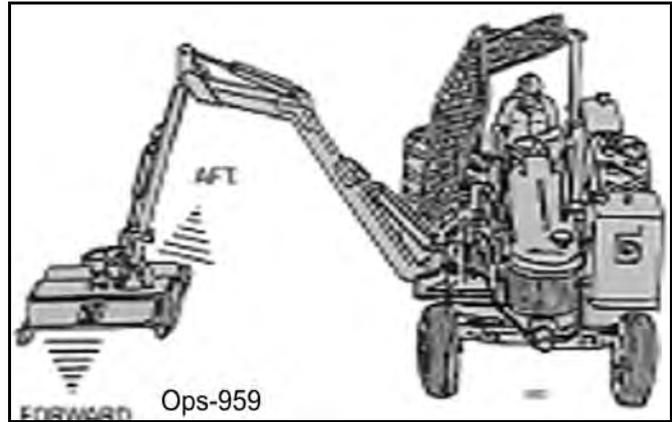

LEVER #5 BOOM SHIELD

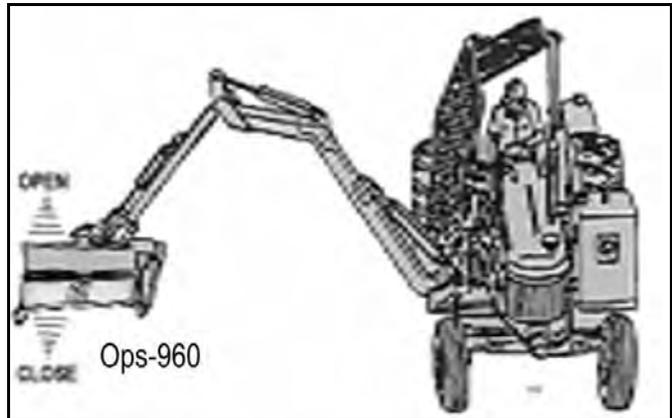

Boom

Operation Section 3-22

OPERATION

7. Joystick Controlled Mowers



NOTE: DO NOT operate mower head while boom mower is in the boom rest, or in the stored position! Red "Mower Run" light indicates mower is "ON".

The boom functions are controlled by an electronic joystick. The Joystick Master Switch enables the joystick control for controlling the boom motion functions. This switch is to be in the "OFF" position when starting the tractor and when boom is stowed for transporting the machine.



If the joystick control is not operating properly, turn the master switch to the "OFF" position. Install the manual valve handle onto valve and operate the functions individually to stow boom. After boom is stowed in rest, transport the unit to the maintenance facility and contact your Tiger dealer for assistance.



DO NOT attempt to operate the valve manually for mowing operations!

Note: Pushing manual valve handles "out" or "away" from the tractor cab will bring the main boom "up", secondary boom "out", roll deck "out", and swivel boom "aft". Pulling manual handles toward cab will let main boom "down", bring secondary boom "in", roll deck "in", and swivel boom "forward".

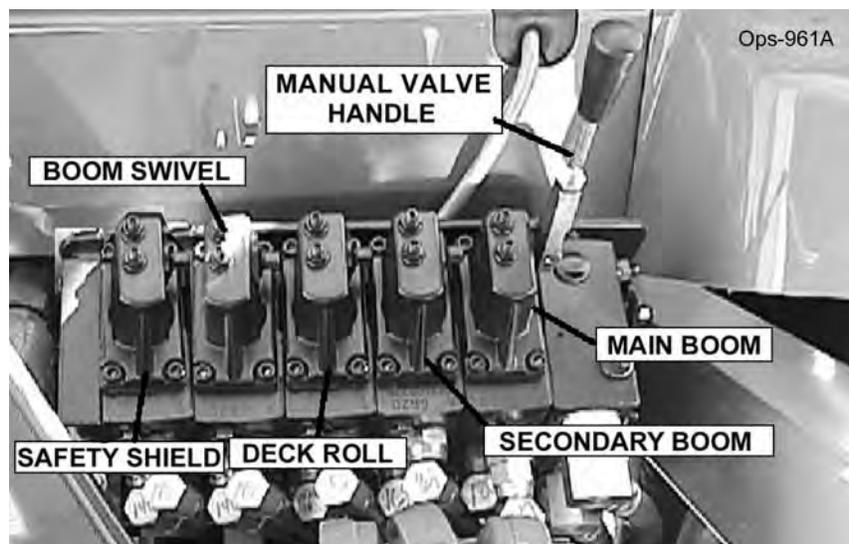

OPERATION

7.1 Switch Box and Joystick Control

The diagrams below and on the next page show the functions that are performed through the use of the joystick controller.

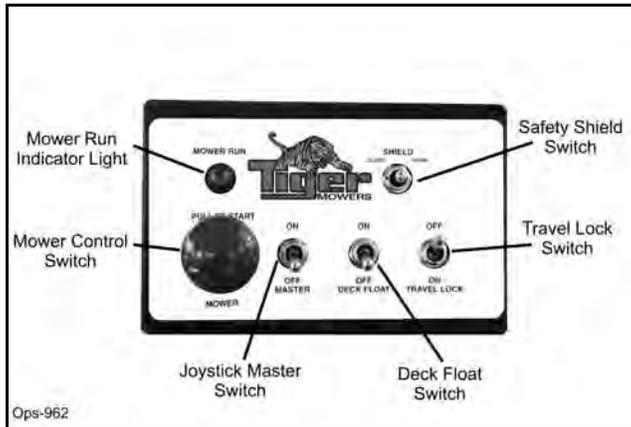

The Safety Shield switch opens and closes the shield located on the front of the cutter head. When moving at or near the ground, always have the shield in the closed position. When moving in brush or in trees above ground level the shield may be opened for easier cutting. Read and follow the warnings on the decal shown below. **Do not run the cutter into material larger than 6" diameter.**



OPERATION

Joystick Control

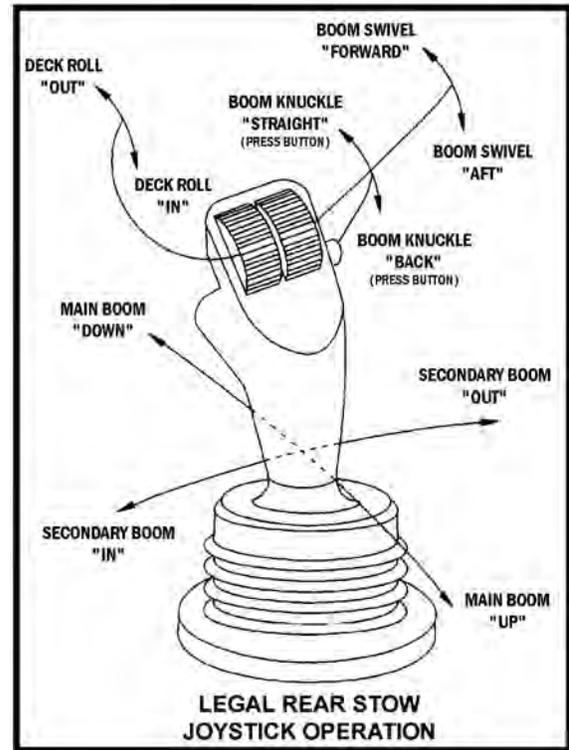
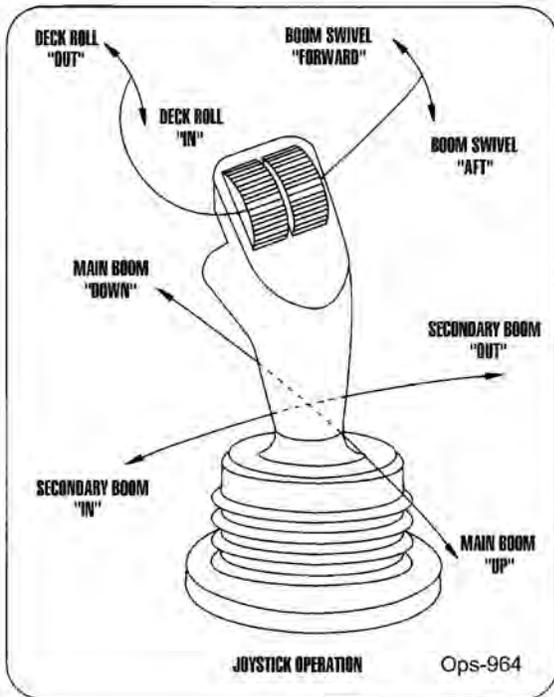

JOYSTICK FWD/BACK MOVES MAIN BOOM

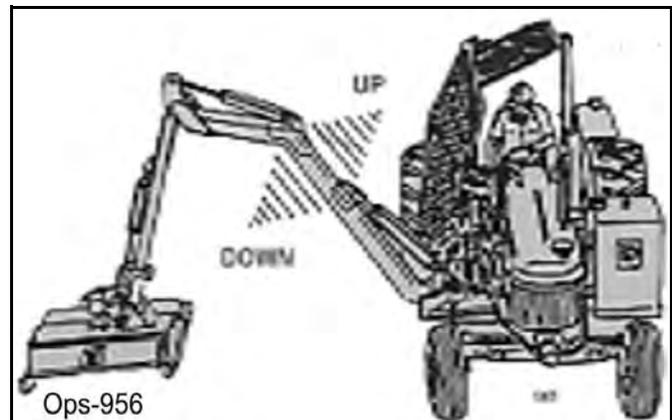

OPERATION

OPERATION

JOYSTICK LEFT/RIGHT MOVES SECONDARY BOOM

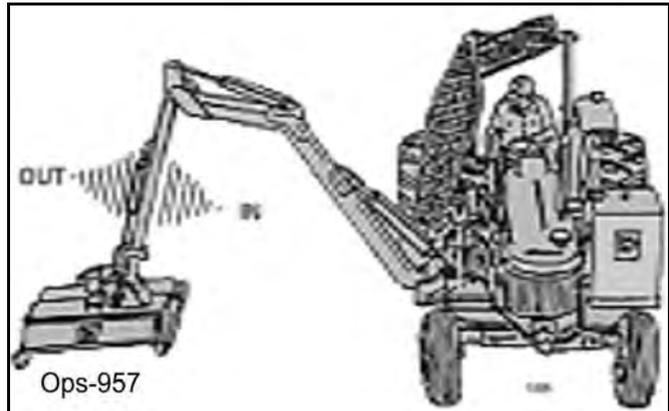

LEFT JOYSTICK ROLLER MOVES DECK ROLL

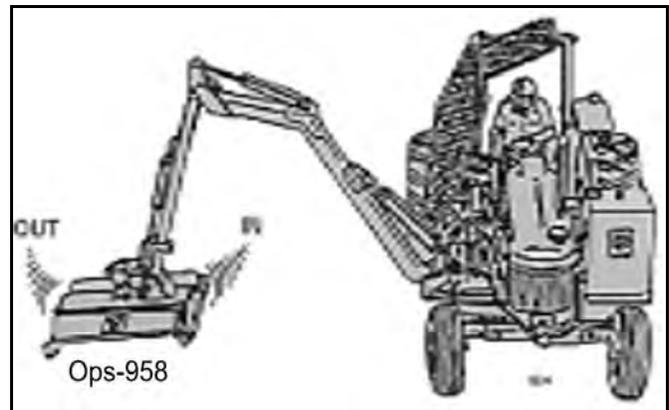

RIGHT JOYSTICK ROLLER MOVES BOOM SWIVEL

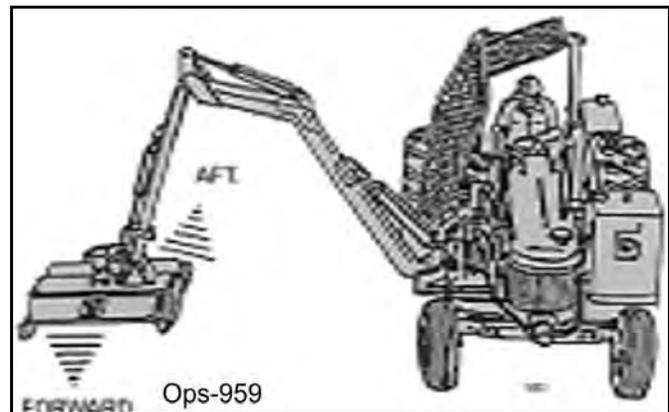

OPERATION

RIGHT JOYSTICK ROLLER WHILE PRESSING BUTTON MOVES BOOM KNUCKLE ON A LEGAL REAR STOW BOOM

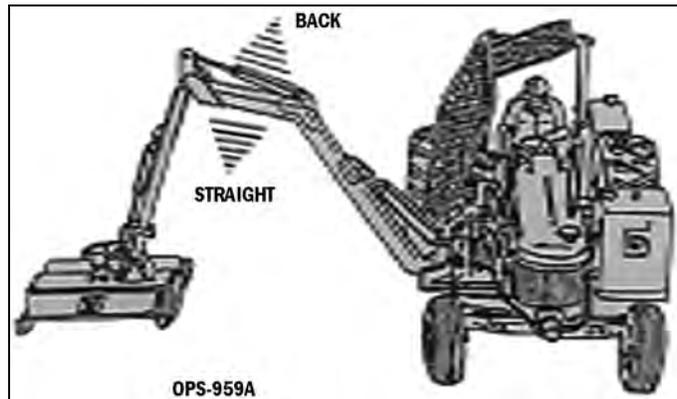

SHIELD SWITCH(on switch box) OPERATES SAFETY SHIELD

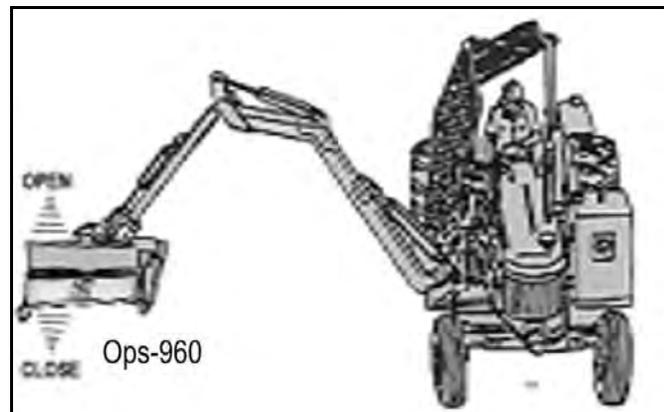

OPERATION

8.DRIVING THE TRACTOR AND IMPLEMENT

Safe tractor transport requires the operator to possess a thorough knowledge of the model being operated and precautions to take while driving with an attached implement. Ensure the tractor has the capacity to handle the weight of the boom and the tractor operating controls are set for safe transport. To ensure safety while driving the tractor with a boom, review the following.

Read all safety instructions. Decals on the Boom warn you of particular and multiple hazards. Some decals are attached close to part of the Boom where there is a possible hazard. Read and make sure you understand the safety messages before you operate the implement. Keep all decals clean and readable. Replace lost or damaged decals, refer to safety section for more information.

Keep all person's well clear of mower since blades can throw objects with great velocity for a considerable distance! KEEP CLEAR! OPS-B- 0005

OPERATION

⚠ DANGER

Never operate the Tractor or Implement until you have read and completely understand this Manual, the Tractor Operator's Manual, and each of the Safety Messages found in the Manual or on the Tractor and Implement. Learn how to stop the tractor engine suddenly in an emergency. Never allow inexperienced or untrained personnel to operate the Tractor or Implement without supervision. Make sure the operator has fully read and understood the manuals prior to operation. (SG-4)



⚠ WARNING

Always maintain the safety signs in good readable condition. If the safety signs are missing, damaged, or unreadable, obtain and install replacement safety signs immediately. (SG-5)

⚠ DANGER

BEFORE leaving the tractor seat, always set the parking brake and/or set the tractor transmission in parking gear, disengage the PTO, stop the engine, remove the key, and wait for all moving parts to stop. Place the tractor shift lever into a low range or parking gear to prevent the tractor from rolling. Never dismount a Tractor that is moving or while the engine is running. Operate the Tractor controls from the tractor seat only. (SG-9)

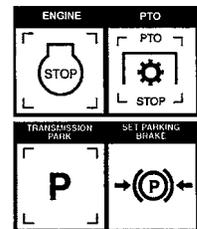

OPERATION

WARNING

Transport only at speeds where you can maintain control of the equipment. Serious accidents and injuries can result from operating this equipment at high speeds. Understand the Tractor and Implement and how it handles before transporting on streets and highways. Make sure the Tractor steering and brakes are in good condition and operate properly.



Before transporting the Tractor and Implement, determine the proper transport speeds for you and the equipment. Make sure you abide by the following rules:

Test the tractor at a slow speed and increase the speed slowly. Apply the Brakes smoothly to determine the stopping characteristics of the Tractor and Implement. As you increase the speed of the Tractor the stopping distance increases. Determine the maximum transport speed not to exceed 20 mph (30 kph) for transporting this equipment.

Test the equipment at a slow speed in turns. Increase the speed through the turn only after you determine that the equipment can be operated at a higher speed. Use extreme care and reduce your speed when turning sharply to prevent the tractor and implement from turning over. Determine the maximum turning speed for you and this equipment before operating on roads or uneven ground.

Only transport the Tractor and Implement at the speeds which allow you to properly control the equipment.

Be aware of the operating conditions. Do not operate the Tractor with weak or faulty brakes or worn tires. When operating down a hill or on wet or rain slick roads, the braking distance increases: use extreme care and reduce your speed. When operating in traffic always use the Tractor's flashing warning lights and reduce your speed. Be aware of traffic around you and watch out for the other guy. (SG-19)



OPERATION

8.1 Starting the Tractor

The procedure to start the tractor is model specific. Refer to the tractor operator's manual for starting procedures for your particular tractor. Consult an authorized dealer if the starting procedure is unclear. Ensure the 3-point control lever is in the lowered position and the PTO is disengaged before starting the tractor. OPS-U-0033



OPERATION

8.2 Brake and Differential Lock Setting

Make sure the tractor brakes are in good operating condition. Tractor brakes can be set to operate independently allowing single rear wheel braking action or locked together to provide simultaneous rear wheel braking. **FOR MOST DRIVING AND OPERATING CONDITIONS, THE BRAKE PEDALS SHOULD BE LOCKED TOGETHER TO PROVIDE THE MOST EFFECTIVE BRAKING ACTION.**



Always disengage the tractor differential lock when turning. When engaged the differential lock will prevent or limit the tractor from turning. During normal cutting conditions, locking the differential provides no benefit and should not be used.

OPS-U- 0013

WARNING

Be aware of the operating conditions. Do not operate the Tractor with weak or faulty brakes. When operating down a hill or on wet or rain slick roads, the braking distance increases; use extreme care and reduce your speed in these conditions. When operating in traffic, always use the Tractor's flashing warning lights and reduce your speed. Be aware of traffic around you and watch out for the other guy. (Ops-0004-MISC)

DANGER

BEFORE leaving the tractor seat, always set the parking brake and/or set the tractor transmission in parking gear, disengage the PTO, stop the engine, remove the key, and wait for all moving parts to stop. Place the tractor shift lever into a low range or parking gear to prevent the tractor from rolling. Never dismount a Tractor that is moving or while the engine is running. Operate the Tractor controls from the tractor seat only. (SG-9)

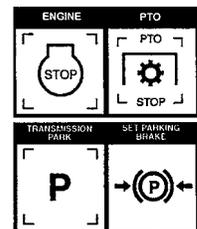

OPERATION

8.3 Driving the Tractor and Boom

Start off driving at a slow speed and gradually increase your speed while maintaining complete control of the tractor. Never operate the tractor at speeds that cannot be safely handled or which will prevent the operator from stopping quickly during an emergency. If the power steering or engine ceases operating, stop the tractor immediately as the tractor will be difficult to control.

Perform turns with the tractor and mower at slow speeds to determine how the tractor with and attached implement handles a turn. Determine the safe speed to maintain proper control of the tractor when making turns. When turning with the implement the overall working length and width of the unit is increased. Allow additional clearance for the unit when turning or when passing large obstructions.



To avoid overturns, drive the tractor with care and at safe speeds, especially when operating over rough ground, crossing ditches or slopes, and turning corners. Use extreme caution when operating on steep slopes. Keep the tractor in a low gear when going downhill. DO NOT coast or free-wheel downhill.

OPS-B- 0006



OPERATION

OPERATION

WARNING

Never Leave the mower unattended while the head is in the raised position. The mower could fall causing serious injury to anyone who might inadvertently be under the mower (SBM-4)



DANGER

Always keep a careful lookout and use extreme care when working around overhead obstructions. Never allow the Mower head or boom within 10 feet of any power line. When working close to overhead power lines consult your electric company for a safe code of operation. (SBM-7)



OPERATION

9. OPERATING THE BOOM UNIT AND ATTACHED HEAD

THE OPERATOR MUST COMPLETELY UNDERSTAND HOW TO OPERATE THE TRACTOR AND MOWER AND ALL CONTROLS BEFORE ATTEMPTING TO MOW. The operator must read and understand the Safety and Operation Sections of this manual and the tractor operator's manuals. These manuals must be read and explained to any operator who cannot read. Never allow someone to operate the unit without complete operating instructions.

To ensure safety to the operator, bystanders, and equipment and before starting any mowing operation. The operator must become familiar with the area to be mowed, and any obstacles and hazards contained within. Special attention should be paid to foreign debris, overhead obstructions, rough terrain, steep slopes, passersby and animals in the area.

Only operate the mower head from the tractor operator's seat with the seatbelt securely fastened. Only operate a boom and equipped head on cabbed tractor that is equipped with a polycarbonate safety-protected right side window or a non cabbed tractor equipped with a ROPS and operator safety screen.

Avoid operating in the reverse direction when possible. In situations where the boom and mower must be backed to access areas to be cut, make sure there are no persons or other foreign debris behind the tractor. When backing, operate the tractor at a much reduced ground speed to ensure complete control of the unit is maintained. OPS-B- 0007

WARNING

Do not mow with two machines in the same area except with Cab tractors with the windows closed. (SGM-11)

WARNING

Mow only in conditions where you have clear visibility in daylight or with adequate artificial lighting. Never mow in darkness or foggy conditions where you cannot clearly see at least 300 feet (90 m) in front and to the sides of the tractor and mower. Make sure that you can clearly see and identify passersby, steep slopes, ditches, drop-offs, overhead obstructions, power lines, debris and foreign objects. If you are unable to clearly see these type of items discontinue mowing. (SGM-01)

OPERATION

WARNING

Avoid mowing in reverse direction when possible. Check to make sure there are no persons behind the mower and use extreme care when mowing in reverse. Mow only at a slow ground speed where you can safely operate and control the tractor and mower. Never mow an area that you have not inspected and removed debris or foreign material. (SGM-08)

WARNING

Never operate the mower head tilted down where the operator can see the blades of the mower. The blade could throw an object toward the operator causing serious injury or death. Never operate the mower without an Operator Protective Structure. Always wear safety glasses and a hard hat. (Ops-0005-MISC)

9.1 Foreign Debris Hazards/Overhead Obstructions

An area to be cut must first be inspected for objects that could be thrown or that could damage the machine. Walk through the area looking for fences, boulders, rocks, culverts, stumps or metal objects. Mark the inspected area with flags. If the area is dense and cannot be walked thoroughly it may be necessary to inspect a smaller area as well as possible, then trim away the part that has been inspected and can safely be removed. Walk each new area again and repeat the inspection before cutting more away. Repeat as often as necessary until the area is cleared. It can be damaging and/or dangerous to work the cutter in an area that has not been visually inspected.

Place DANGER signs at least 300 feet beyond the perimeter of the area to be worked, not just 300 feet from where the machine started operating! It is convenient in many cases to work in 300 foot sections. Move the first Danger sign to the beginning of the freshly cleared area, place it, then take the first cutting area flag up to the end of the freshly cleared area 300 feet away. Walk and inspect the next 300 feet and place the second cutting area flag. Pick up the second DANGER sign, and take it a further 300 feet along the road or trail. Note that in many cases the DANGER area will extend in front of and behind the machine as well as along each side. Post signs accordingly. OPS-B- 0008

WARNING

Extreme care should be taken when operating near loose objects such as gravel, rocks, wire, and other debris. Inspect the area before mowing. Foreign objects should be removed from the site to prevent machine damage and/or bodily injury or even death. Any objects that cannot be removed must be clearly marked and carefully avoided by the operator. Stop mowing immediately if blades strike a foreign object. Repair all damage and make certain rotor or blade carrier is balanced before resuming mowing. (SGM-05)



WARNING

Many varied objects, such as wire, cable, rope, or chains, can become entangled in the operating parts of the mower head. These items could then swing outside the housing at greater velocities than the blades. Such a situation is extremely hazardous and could result in serious injury or even death. Inspect the cutting area for such objects before mowing. Remove any like object from the site. Never allow the cutting blades to contact such items. (SGM-06)

OPERATION

WARNING

Mow at the speed that you can safely operate and control the tractor and mower. The correct mowing speed depends on terrain condition and grass type, density, and height of cut. Normal ground speed range is from 2 to 5 mph(3-8 kph). Use slow mowing speeds when operating on or near steep slopes, ditches, drop-offs, overhead obstructions, power lines, or when debris and foreign objects are to be avoided. (SGM-07)

9.2 Operating Speed and Ground Speed

Ground speed for mowing will depend upon the height, type, and density of vegetation to be cut. Do Not exceed 5 MPH while operating. Operate the mower at its full rated PTO speed to maintain blade speed for a clean cut. Refer to the tractor operator's manual or the tractor instrument panel for the engine speed and gear to provide the required operating and desired ground speed. Make sure that the mower is operating at its full rated speed before entering the vegetation to be cut. Always start and stop cutting blades with engine near idle.

Ground speed is achieved by transmission gear selection and not by the engine operating speed. The operator may be required to experiment with several gear range combinations to determine the best gear and range which provides the most ideal performance from the implement and most efficient tractor operation. As the severity of cutting conditions increase, the ground speed should be decreased. OPS-B- 0009

WARNING

Mow at the speed that you can safely operate and control the tractor and mower. The correct mowing speed depends on terrain condition and grass type, density, and height of cut. Normal ground speed range is from 2 to 5 mph(3-8 kph). Use slow mowing speeds when operating on or near steep slopes, ditches, drop-offs, overhead obstructions, power lines, or when debris and foreign objects are to be avoided. (SGM-07)

9.3 Operating the Attached Mower Heads

The boom can attach to and operate multiple heads one at a time for a wide range of vegetation control applications. The attached heads are designed for different applications. The head should be selected based on the mowing application and the location that the unit is being operated.

Refer to the Assembly Section of this manual to ensure the head is properly attached to the boom hitch and hydraulic lines are properly connected. OPS-B- 0010

DANGER

There are obvious and hidden potential hazards in the operation of this Mower. REMEMBER! This machine is often operated in heavy brush and in heavy weeds. The Blades of this Mower can throw objects if shields are not properly installed and maintained. Serious injury or even death may occur unless care is taken to insure the safety of the operator, bystanders, or passersby in the area. Do not operate this machine with anyone in the immediate area. Stop mowing if anyone is within 300 feet of mower. (SGM-02)



OPERATION

9.4 Mower Operation

The rotating parts in this machine have been designed and tested for rugged use. However, they could fail upon impact with heavy solid objects-such as steel guard rails, concrete abutments,etc., causing them to be thrown at a very high velocity. Never allow cutter head to contact such objects. Inspecting the cutting area for such objects and removing them prior to mowing can help eliminate these potential hazards.

Once on location, lower the mower deck slightly above the material to be cut, so the mower does not have to start under a load. With the tractor at an idle, engage mower. Bring tractor R.P.M. up to 1900-2200 R.P.M. and **slowly** lower deck to ground level.

A flail mower deck should be carried so that the part of the deck weight is carried by the boom and part carried by the ground roller, when moving on the ground. When the flail mower is carried this way, the ground roller follows the contour of the ground more easily during mowing operations.

The rotary mower deck should always be carried rather than dragged on the skid shoes when mowing on the ground. Dragging the rotary mower deck increases the side loads on the boom, decreases the horsepower available to the cutter head, and reduces the ability of the accumulator to carry part of the weight of the boom during mowing operations.



When rotating parts are in motion, serious injury may occur if caution is not used or danger is not recognized. Never allow bystanders within **300 feet** of the machine when in operation. Extreme care should be taken when operating near loose objects-such as gravel, rocks, and debris. These conditions should be avoided.

9.5 50" & 60" Boom Rotary

The 50" & 60" boom rotary brush mower was designed for cutting brush and foliage up to 6 inches in diameter or multiple branches that have a total cross section area equivalent to one 6 inch branch.

During mower operation, the hand throttle must be used to maintain engine speed at 1900-2200 R.P.M. This prevents radical changes in mower spindles speed, reducing the possibility of cutter assembly damage.

The horizontal positioning action of the boom is designed to position the cutting head and provide a limited pressure relief when excessive pressure is applied to the boom. Do not force the cutting head into heavy branches or stumps. Damage to the unit may result.



When using the rotary cutting head for trimming trees and shrubs, let the mower saw into them. Do not lower the mower head down directly into a tree or stump. The mower blades are designed to cut with the end, and misuse can cause damage to the blade and a hazardous situation for the operator.



Powering the boom down, forcing mower deck onto ground may damage mower deck and it's attachment to the boom, creating a potentially hazardous situation.

To ensure a clean cut, engine speed should be maintained at approximately 1900-2200 R.P.M. If the tractor slows to less than 1800 R.P.M., shift to the next lower gear. **DO NOT** ride the clutch, this will cause premature clutch failure. **The engine should not be operated at any time at more than 2400 R.P.M. on the tractor tachometer.**



OPERATION

For cutting brush, it is usually best to stop the tractor and swivel the boom and mower into foilage. The horizontal positioning action of the boom is designed to position the cutting head and provide a limited pressure relief when excessive pressure is applied to the boom.



DO NOT use excessive force when positioning cutting head into heavy branches or stumps. Damage to the unit may result. It is best to let the cutter head “eat away” slowly at heavy cutting jobs.



If foliage falls on top of mower deck causing tractor to become unstable, move the boom “Forward” and “Out” to relieve tipping of the tractor. Lower mower deck to ground and shut down unit. After all motion stops, remove foliage from mower deck.

The mower will operate more efficiently in tougher conditions and with less power if the knives are kept sharp. If the mower begins to vibrate, stop the tractor, check for wire wrapped in the spindle or damaged knives. When replacing knives, replace all knives with new knives to ensure proper balance so the mower will not vibrate. Severe vibration will result, if knives with unequal wear are used.

Begin a pass at the top side of the trees and work down with each consecutive pass. When cutting trees and shrubs, use a lower speed to allow the knives time to cut as well as mulch the foliage.



If bystanders approach within 300 feet while mower is in operation turn mower switch “OFF” immediately! After shutdown, never leave the tractor or allow bystanders to approach within **300 FEET** of the unit until all motion stops completely.

If cutter shaft jams and stops, turn mower switch to “OFF”, and swivel boom “AFT”. Normally this action will clear the cutter head. If not, roll mower deck until adjacent to the secondary boom, then lower boom to rest mower deck on ground. Shut off the tractor, set parking break, allow all motion to cease. At that point it is safe to leave the tractor and clear the cutter heads manually.

Begin each pass at the top side of the trees and work down with each consecutive pass. Use a low speed to allow the cutting blades time to mulch as well as cut the foliage. When the initial pass has been made, disengage the mower, and return boom to a safe travel position. Return to starting point and make next pass, etc..

After the first day of operation, all bolts should be checked and tightened securely. This should be done periodically to ensure the bolts do not become loose and cause damage to the tractor or mower, or injury to the operator.

OPERATION

When cutting trees and brush approach material to be cut with the head perpendicular to material. The cutting edge of the blades should be the only elements in contact with material. The blade bar should not contact with material. The mower head and blades should be moved perpendicularly into the material rather lowering the mower head on top of material. If the blade bar edges are gouged or rounded from wear, the mower head is being used incorrectly in an abusive manner. The blade bar is not intended to cut material or to be a wear item like the blades. Do Not allow the blades or blade bar to contact the ground, rocks or solid objects. Contact with the ground can result in rocks and solid objects being thrown out from under the mower head which can cause serious injuries to the operator and bystanders. This type of operation can lead to bent or broken blade bars, broken blade bolts and broken blade bar assembly bolts which can be dangerous to the operator and bystanders.

(OPS-R-220)

9.6 50" Boom Flail

The 50' boom flail mower was designed for cutting brush and foliage up to 3 inches in diameter or multiple branches that have a total cross section area equivalent to one 3 inch branch. Cutting multiple limbs at the same time may overload the mower causing it to slow down or stall completely. Regardless of the size of material being cut, the cutter shaft speed must be maintained. To ensure that the cutter shaft is running at maximum speed, run the tractor at full throttle during mowing operations. If the cutter shaft slows to the point that the knives are folding back, move the mower head away from the foliage and allow the cutter shaft to regain full speed.

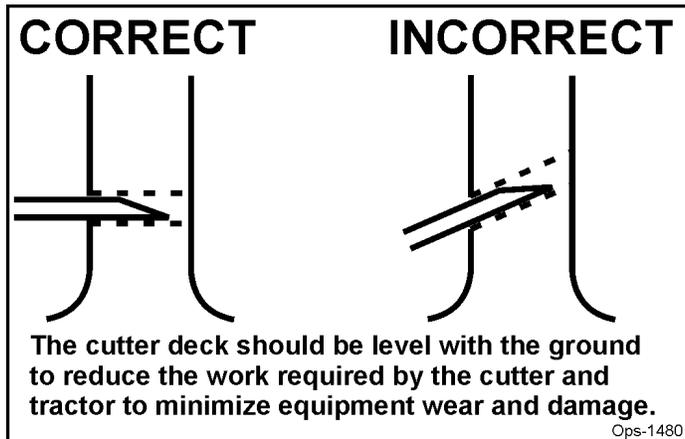

Operating the mower in a manner that allows the knives to continually fold back or allowing knife lugs to contact foliage will cause permanent damage to the cutter shaft drum, knives, and knife attachment parts.



The 50" boom flail cutter shaft is designed for standard rotation (same rotation as the tractor wheels during forward travel). **Never operate the cutter shaft in reverse rotation.** Operating this mower in reverse rotation may cause objects to be thrown out the front of the mower head.



The 50" boom flail equipped with free swinging brush knives is intended for brush cutting only. Cutting grass is not recommended.

OPERATION



Do not allow knives to cut down to the ground. Position ground roller to maintain knife arc at a minimum of 2 inches above the ground. Knife contact or lug contact with ground will cause permanent damage to cutter shaft, knives, and knife attachment parts.

9.7 63" Boom Flail

The 63" boom flail mower was designed for cutting grass. The cutter shaft speed must be maintained for proper cutting. To insure that the cutter shaft is rotating at maximum speed, run tractor at full throttle during mowing operations. If cutter shaft slows to the point that the knives are folding back against the cutter shaft, move the mower head away from the foliage and allow the cutter shaft to regain full speed.



The rotating parts of this machine have been designed and tested for rugged use. However, the blades could fail upon impact with heavy, solid objects such as metal guard rails and concrete structures. Such impact could cause the broken objects to be thrown outward at very high velocities. To reduce the possibility of property damage, serious injury, or even death, never allow the cutting blades to contact such obstacles. (SGM-4)



All Safety Shields, Guards and Safety devices including (but not limited to) - the Deflectors, Chain Guards, Steel Guards, Gearbox Shields, PTO integral shields, and Retractable Door Shields should be used and maintained in good working condition. All safety devices should be inspected carefully at least daily for missing or broken components. Missing, broken, or worn items must be replaced at once to reduce the possibility of injury or death from thrown objects, entanglement, or blade contact. (SGM-3)

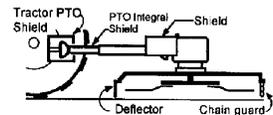

Many varied objects, such as wire, cable, rope, or chains, can become entangled in the operating parts of the mower head. These items could then swing outside the housing at greater velocities than the blades. Such a situation is extremely hazardous and could result in serious injury or even death. Inspect the cutting area for such objects before mowing. Remove any like object from the site. Never allow the cutting blades to contact such items. (SGM-06)

OPERATION

9.8 Shutting Down the Attached Head- For Standard Equipment

To shut down attached mower head, first bring the tractor to a complete stop. Decrease engine RPM to idle then disengage cutterhead. The mower head will come to a complete stop within a suitable amount of time. Do not engage or disengage the cutterheads at a high RPM unless there is an emergency situation.



Park the tractor on a level surface, place the transmission in park or neutral and apply the parking brake, shut down the engine, remove the key, and wait for all motion to come to a complete stop before exiting the tractor. OPS-B- 0011_D



BEFORE leaving the tractor seat, always set the parking brake and/or set the tractor transmission in parking gear, disengage the PTO, stop the engine, remove the key, and wait for all moving parts to stop. Place the tractor shift lever into a low range or parking gear to prevent the tractor from rolling. Never dismount a Tractor that is moving or while the engine is running. Operate the Tractor controls from the tractor seat only. (SG-9)

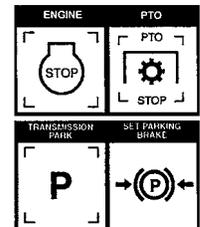

OPERATION

10.TRACTOR, BOOM, AND ATTACHED HEAD STORAGE

Properly preparing and storing the unit at the end of the season is critical to maintaining its appearance and to help ensure years of dependable service. The following are suggested storage procedures:

- Thoroughly clean all debris from boom and head to prevent damage from rotting grass and standing water.
- Lubricate all grease points and fill oil levels according to the maintenance lubrication schedule.
- Tighten all bolts to the proper torque. Ensure all pins and other hardware are in place.
- Check the boom arm and head for worn and damaged parts. Perform repairs and make replacements so that the mower will be ready for use at the start of the next season.
- Store the unit in a clean and dry location.
- Use spray touch-up enamel where necessary on bare metal surfaces to prevent rust and to maintain the appearance of the mower.



OPS-B- 0012_C



Never allow children to play on or around Tractor or Implement. Children can slip or fall off the Equipment and be injured or killed. Children can cause the Implement to shift or fall crushing themselves or others. (SG-25)



BEFORE leaving the tractor seat, always set the parking brake and/or set the tractor transmission in parking gear, disengage the PTO, stop the engine, remove the key, and wait for all moving parts to stop. Place the tractor shift lever into a low range or parking gear to prevent the tractor from rolling. Never dismount a Tractor that is moving or while the engine is running. Operate the Tractor controls from the tractor seat only. (SG-9)

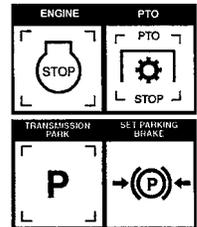

Perform service, repairs and lubrication according to the maintenance section. Ensure the unit is properly lubricated as specified in the lubrication schedule and all bolts and nuts are properly torqued. Failure to properly service, repair and maintain this Implement in good operating condition could cause component failure and possible serious injury or even death. (SG-35)

11.TRANSPORTING THE TRACTOR AND IMPLEMENT

Inherent hazards of operating the tractor and implement and the possibility of accidents are not left behind when you finish working in an area. Therefore, the operator must employ good judgement and safe operation practices when transporting the tractor and implement between locations. By using good judgement and following safe transport procedures, the possibility of accidents while moving between locations can be substantially minimized. OPS-U- 0017

OPERATION

11.1 Placing Boom Arm on Boom Arm Rest - For Standard Equipment

Before transporting tractor between locations, idle the tractor engine, disengage the attached head, and wait for all head motion to come to a complete stop. Place the boom in its storage cradle rest support and then turn the joystick master switch to the OFF position.



- Retract Deck Roll cylinder completely.
- Push Secondary cylinder approximately 1/2 way out.
- Raise Main boom approximately to 60°.
- Swing boom back slowly until it is straight back.
- For a 3-point boomrest or a single column boomrest, position the secondary in the cradle. Carefully avoid pinching any hoses.
- For a open stow style boomrest, lower the Main boom onto rest and bring the Secondary boom in until it is sitting on the boomrest.
- For a Legal Stow style boomrest, retract the secondary and knuckle cylinders completely. Lower the Main boom onto rest. Slowly extend the secondary cylinder until the secondary boom contracts the side of the boomrest saddle. Next, slowly extend the knuckle cylinder until the secondary sets on the bottom part of the boomrest saddle.



The boom is now in the transport position. Turn on any electronic travel locks at the switchbox.

To remove the boom from the Boom Rest, first turn off any electronic travel locks at the switchbox then retract the knuckle cylinder (if applicable) then swing the Secondary boom out. Raise the Main boom approximately 6 inches. Swivel the boom forward to the desired position. OPS-B- 0013_D

OPERATION

11.2 Transporting on Public Roadways

Extreme caution should be used when transporting the tractor and mower on public roadways. The tractor must be equipped with all required safety warning features including a SMV emblem and flashing warning lights to alert drivers of the tractor's presence. Remember that roadways are primarily designed for automotive drivers and most drivers will not be looking out for you, therefore, you must look out for them. Check your side view mirrors frequently and remember that vehicles will approach quickly because of the tractor's slower speed. Be extremely cautious when the piece of equipment that you are driving, is wider than the tractor tire width and/or extends beyond your lane of the road. *OPS-B- 0014*

The SMV (Slow-Moving Vehicle) emblem is universal symbol used to alert drivers of the presence of equipment traveling on roadways at a slow speed. SMV signs are a triangular bright orange with reflective red trim for both easy day and night visibility. Make sure the SMV sign is clean and visible from the rear of the unit before transporting the tractor and implement on a public roadway. Replace the SMV emblem if faded, damaged, or no longer reflective. *OPS-U- 0020*



Make sure that all tractor flashing warning lights, headlights, and brake/taillights are functioning properly before proceeding onto public roads. While newer model tractors have plenty of lighting to provide warning signals and operating lighting, most older models were only equipped with operating lights. Consult an authorized tractor dealer for lighting kits and modifications available to upgrade the lighting on older tractor models. *OPS-B-0015*



OPERATION

When operating on public roads, have consideration for other road users. Pull to the side of the road occasionally to allow all following traffic to pass. Do not exceed the legal speed limit set in your state or municipality for agricultural tractors. Always stay alert when transporting the tractor and mower on public roads. Especially in busy cities, the boom extends to right farther than the tractors width, so be careful there are no bystanders, poles, large obstructions or any vehicles that may be in path of the mower head or boom. Use caution and reduce speed if other vehicles or pedestrians are in the area. OPS-B- 0016



Never allow children or other persons to ride on the Tractor or Implement. Falling off can result in serious injury or death. (SG-10)



Make certain that the "Slow Moving Vehicle" (SMV) sign is installed in such a way as to be clearly visible and legible. When transporting the Equipment use the Tractor flashing warning lights and follow all local traffic regulations. (SG-6)

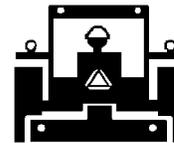

Reduce speed before turning or applying the brakes. Ensure that both brake pedals are locked together when operating on public roads. OPS-U- 0023



OPERATION

11.3 Hauling the Tractor and Implement

Before transporting a loaded tractor and implement, measure the height and width dimensions and gross weight of the complete loaded unit. Ensure that the load will be in compliance with the legal limits set for the areas that will be traveled through. *OPS-U- 0024*



⚠ DANGER

When transporting Boom Mower on a truck or trailer, the height or width may exceed legal limits when the boom is in the transport position. Contact with side or overhead structures or power lines can cause property damage or serious injury or death. If necessary lower boom to reduce height and/or remove mowing head to reduce width to the legal limits. (SBM-8)

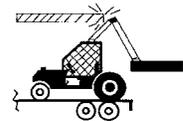

Use adequately sized and rated trailers and equipment to transport the tractor and implement. Consult an authorized dealer to determine the proper equipment required. Using adequately sized chains, heavy duty straps, cables and/or binders, securely tie down both the front and rear of the tractor utilizing the proper tie down locations as specified by the tractor manufacturer. *OPS-U- 0025*



OPERATION

Arrange the chains so that when tightened, the chains are pulling downward and against themselves. Carefully tighten the securing chains or other fasteners using boomers or binders to apply maximum tension. Use extreme care when attaching and removing the securing devices as the extreme tension involved when released has the potential to inflict serious injury.

While hauling the tractor and implement, make occasional stops to check that the tractor and implement have not moved or shifted and that the securing chains have maintained tension. If during transport a hard braking, sharp turning, or swerving action was performed, stop at the next safe location to inspect the security of the load. *OPS-U- 0026*



OPERATION

CAUTION

If trailer is not perfectly level, the boom will tend to swing towards the lower side. Have other personnel ready to control its swinging motion when cylinder pin is removed. Make sure the personnel are not in a position to be hit or crushed by a swinging boom.

Retract swivel cylinder and secure to main frame. Pivot boom forward to the center of flat bed. Lower deck onto the trailer bed, and shut off the tractor. The tractor and the mower head should now be chained down securely to the trailer bed.

CAUTION

If any part of this operating section, or any other section of this manual is not completely understood, contact your Tiger dealer or the address on the cover of this manual for assistance!

OPERATION

OPERATION

Boom

Operation Section 3-46

MAINTENANCE SECTION

Maintenance Section 4-1

MAINTENANCE

General Instructions

Tiger Mowers are designed for high performance and rugged durability, yet with simplified maintenance. The purpose of this section of the manual is to help the operator in the regular servicing of the mower. Regular maintenance at the intervals mentioned will result in the maximum efficiency and long life of the Tiger Mower.

When you purchase a Tiger Mower you also acquire another valuable asset, Tiger's parts organization. Our rapid and efficient service has guaranteed the customer satisfaction for many years. Tiger parts keep up with the demands for efficiency, safety and endurance expected of the Tiger Mower.

Maintenance Precautions

- Be sure end of grease gun and zerks are clean before using. Debris injected into bearings, etc. with grease will cause immediate damage.
- DO NOT use a power grease gun to lubricate bearings. These require very small and exact amounts of lubrication. Refer to the detailed maintenance section for specific lubrication instructions. DO NOT over-grease bearings.
- Lexan windows should be washed with mild soap or detergent and lukewarm water, using a soft clean sponge or soft cloth. DO NOT use abrasive or alkaline cleaners or metal scrapers on lexan windows!
- Be alert to maintenance indicators such as the in-tank filter pressure gauge, hydraulic reservoir sight gauge, etc. Take the required action to correct any problems immediately.
- Release of energy from pressurized systems may cause inadvertent actuation of cylinders, or sudden release of compressed springs. Before disconnecting any hoses, relieve pressure by shutting tractor off, setting cutter on ground and actuating lift valve handles.

WARNING

DO NOT use hands to check for suspected leaks in hydraulic hoses! Hydraulic fluid escaping under pressure can have sufficient force to penetrate skin and cause serious injury. If fluid is injected into skin, it must be surgically removed within a few hours or gangrene may result. Use a small piece of wood or cardboard, not hands, to search for pin hose leaks. Be sure all connections are tight and hoses and lines are not damaged before applying pressure.

Break in Period

In addition to following the break-in instructions for your particular tractor, the in-tank hydraulic fluid filter should be replaced after the first 50 hours of service. Thereafter the filter should be replaced every 500 hours, or yearly, whichever comes first.

Re-torque wheel lugs after first five hours of operation and periodically thereafter. See torque specifications listed in the tractor's service manual for your particular model. **Wheel lugs must always be re-torqued whenever a wheel is removed and reinstalled.**

DANGER

Never work under the Implement, the framework, or any lifted component unless the Implement is securely supported or blocked up to prevent sudden or inadvertent falling which could cause serious injury or even death. (SG-14)



MAINTENANCE



Do not modify or alter this Implement. Do not permit anyone to modify or alter this Implement, any of its components or any Implement function. (SG-8)



Relieve hydraulic pressure prior to doing any maintenance or repair work on the Implement. Place the Mower Head on the ground or securely supported on blocks or stands, disengage the PTO, and turn off the engine. Push and pull the control Levers or Joystick several times to relieve pressure prior to starting any maintenance or repair work. (SBM-6)



Always disconnect the wire leads from the mower pump solenoid before performing service on the Tractor or Mower. Use caution when working on the Tractor or Mower. Tractor engine must be stopped before working on Mower or Tractor. The Mower Blades could inadvertently be turned on without warning and cause immediate dismemberment, injury or death. (SBM-12a)

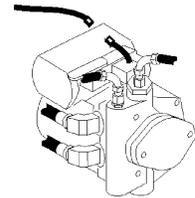

MAINTENANCE

MAINTENANCE OF CRANKSHAFT ADAPTER ASSEMBLY (RIGID ENGINE MOUNT TRACTORS ONLY)

If replacement of components of the crankshaft adapter assembly is required, follow the assembly procedures shown below. Seat rubber grommet completely into counterbore, then seat steel grommet completely into rubber grommet while rubber grommet is supported.

(ASM-JD-0051 CRANKSHAFT ADAPTER MAINTENANCE)

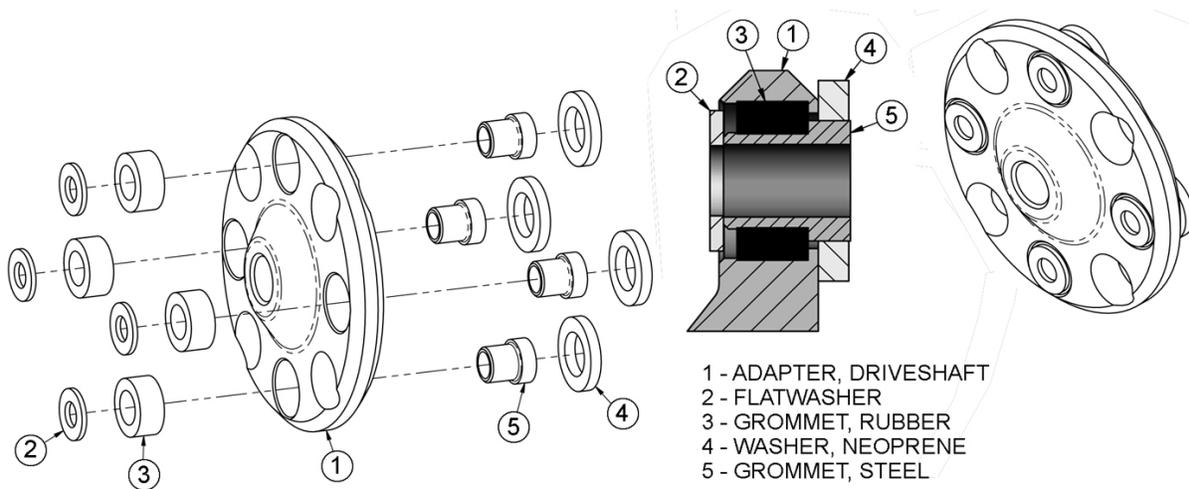

MAINTENANCE

MAINTENANCE

Regular Maintenance

The intervals at which regular servicing should be done are based on hours of operation. Use the tractors hour meter to determine when regular servicing is required.

Refer to the Detailed Maintenance section for further instructions on greasing. Copy and use the Daily Maintenance sheet located at the end of this section.

Daily or Every 8 Hours

ITEM	SERVICE	COMMENTS
Drive Shaft Yoke, U-Joint & Stub Shaft	Grease	Grease as instructed in detailed maintenance section
Pump Drive Shaft Coupler	Check and Lube	Insure driveshaft end play
Crankshaft Adapter	Check rubber grommets	Replace grommets if damaged or missing
Pivot Points	Lubricate	Inject grease until it appears at end
Hydraulic Fittings	Check for leaks	Tighten when needed. Do Not use hands to check for leaks, see maint. precautions
Knives	Check	Inspect for missing or damaged knives, change as needed.
Spindle mouting bolts (spindle to deck)	Check	Torque to 315 ft. lbs. lubricated Torque to 357 ft. lbs. dry
Knife mounting bolts (knife to disk or blade bar)	Check	Pre-lubricate threads with anti-seize torque to 800 ft. lbs.
Disk/Blade Bar mounting bolts (disk/blade bar to spindle)	Check	Torque to 180 ft. lbs. lubricated Torque to 204 ft. lbs. dry
Belts	Check/Adjust	Check if broken, tighten as required
Main Frame and Deck	Check	Retorque bolts to torque specifications in this section
Hydraulic Fluid Level	Check	Add if required per fluid recommendations
Rear Flail Drive(if applicable) Bear Flange and Shaft Coupler	Lubricate	Grease as instructed in detailed maintenance section
Cutter Shaft and Boom	Lubricate	Grease as instructed in Maintenance Section 4-4

MAINTENANCE

MAINTENANCE

Ground Roller detailed maintenance section

WEEKLY OR EVERY 40 HOURS

ITEM	SERVICE	COMMENTS
Rotary Spindle	Lubricate	Every 40 hours or weekly

WEEKLY OR EVERY 50 HOURS

ITEM	SERVICE	COMMENTS
In Tank Hyd. Fluid Filter (10 micron filter)	Change	Change after first 50 hours only, then every 500 hours or yearly
In-Line High Pressure Filter (10 micron filter)	Change	Change after first 50 hours only, then every 500 hours or yearly

MONTHLY OR EVERY 150 HOURS

ITEM	SERVICE	COMMENTS
Hydraulic Fluid Level	Check	Add as needed
Hyd. Tank Breather	Clean/Check/Replace	Clean or replace element as required
Rear Tire Type 480/80R38 18.4-34 18.4-38	Max P.S.I. 29 26 26	

YEARLY OR EVERY 500 HOURS

ITEM	SERVICE	COMMENTS
Spindle Grease Hyd. Tank Fluid In Tank Hyd. Fluid Filter (10 micron filter)	Change Change Change	
In-Line HP Filter (10 micron filter)	Change or	Change when indicated by restriction indicator.
Hyd. Tank Breather	Change	

Boom Maintenance Section 4-5

MAINTENANCE

TROUBLESHOOTING

SYMPTOMS	CAUSE	REMEDY
Vibration	1. Loose bolts	1. Check all bolts and tighten to recommended torque specs.
	2. Cutter assembly unbalanced	2a. Check for damaged blades, disc or cuttershaft. Replace if needed. 2b. Check for wire, rope, etc. entangled in the cutter assembly
Mower will not lift	1. Hyd. Fluid Low	1. Check and refill hyd fluid
	2. Leaks in line ROU 3. Faulty relief valve	2. Tighten or replace fittings and hoses 3. Check pressure in line. Line pressure in control valve should be at least 2500 P.S.I.
	5. Faulty cylinder	5. Inspect, repair or replace cylinder
Mower will not start or run	1. Blown fuse	1. Check fuse between mower switch and ignition/replace
	2. Ball valves closed	2. Make sure valves are open
	3. Low oil level	3. Check hyd. tank and fill
	4. Line leak	4. Check all fittings and lines, re-tighten or replace
	5. Electronic solenoid faulty	5a. Without the tractor running, turn the mower switch to on. A low audible click should be heard if the solenoid is engaging the solenoid spool. If click is not heard, leave switch in on position and with a screwdriver or other steel object, touch the small nut on the end of the solenoid. If the metallic object is not attracted to the nut, check the fuse and wiring for an open circuit. If the object is attracted but no "click" is heard, replace the solenoid. 5b. Remove the four bolts holding the small block to the main block. Lift and remove small block being careful not to damage O-rings/filter. Clean filter and re-install. 5c. Remove large nut on side of large valve block. Remove spring, and use needle nose vise grip to pull spool from block. Check block and spool for contaminants and scratches.

MAINTENANCE

Clean parts or replace if scratched.

TROUBLESHOOTING (CONTINUED)

SYMPTOMS	CAUSE	REMEDY
Motor runs but will not cut.	1. Belts	1. Inspect belts and pulleys. Replace belts and repair as needed.
	2. Tensioner	2. Adjust tensioner nut flatwasher washer is flush with top of guide.
Mower turns slowly or not at all.	1. Contaminants restricting spool movement in valve body.	1. Remove large nut on side of large valve block. Remove spring, and use needle nose vise grip to pull spool from block. Check block and spool for contaminants and scratches. Clean parts or replace if scratched.
	2. Suction lines obstructed	2. Check for kinks or obstruction in suction hose.
	3. Low oil level	3. Check hyd. tank level and fill.
Pump will not work	1. Excessive wear on internal parts	1. Disassemble and repair.
Motor will not work	1. Excessive wear on internal parts	1. Disassemble and repair.

NOTE: If flow meter is available, check pressure and flow volume for all suspected hydraulic problems.

If the solution to your problem cannot be found in this section, call the Technical Service representative at the number shown on the front cover of this manual.

MAINTENANCE

MAINTENANCE

Torque for Standard Fasteners													
Nominal Dia. (in.)	threads per inch	Grade 2			Grade 5			Grade 8			Grade 9		
		Tightening Torque			Tightening Torque			Tightening Torque			Tightening Torque		
		Lubed	Dry Plated	Dry plain	Lubed	Dry Plated	Dry plain	Lubed	Dry Plated	Dry plain	Lubed	Dry Plated	Dry plain
		K = 0.15	K = 0.17	K = 0.20	K = 0.15	K = 0.17	K = 0.20	K = 0.15	K = 0.17	K = 0.20	K = 0.15	K = 0.17	K = 0.20
Unified Coarse Thread Series													
1/4	20	49 in-lbs	59 in-lbs	66 in-lbs	76 in-lbs	86 in-lbs	101 in-lbs	107 in-lbs	122 in-lbs	143 in-lbs	126 in-lbs	143 in-lbs	168 in-lbs
5/16	18	101	122	135	157	178	209	221	251	295	259	294	346
3/8	16	15 ft-lbs	18 ft-lbs	20 ft-lbs	23 ft-lbs	26 ft-lbs	31 ft-lbs	33 ft-lbs	37 ft-lbs	44 ft-lbs	38 ft-lbs	43 ft-lbs	51 ft-lbs
7/16	14	24	29	32	37	42	49	52	59	70	61	70	82
1/2	13	37	44	49	57	64	75	80	90	106	94	106	125
9/16	12	53	63	70	82	92	109	115	130	154	135	153	180
5/8	11	73	87	97	113	128	150	159	180	212	186	211	248
3/4	10	129	155	172	200	227	267	282	320	376	331	375	441
7/8	9	125	150	167	322	365	429	455	515	606	533	604	710
1	8	187	225	250	483	547	644	681	772	909	799	905	1065
1 1/8	7	266	319	354	596	675	794	836	966	1095	1288	1132	1283
1 1/4	7	375	450	500	840	952	1121	1363	1545	1817	1597	1810	2130
1 1/2	6	652	783	869	1462	1657	1950	2371	2688	3162	2779	3150	3706
Fine Thread Series													
1/4	28	56 in-lbs	68 in-lbs	75 in-lbs	87 in-lbs	99 in-lbs	116 in-lbs	123 in-lbs	139 in-lbs	164 in-lbs	144 in-lbs	163 in-lbs	192 in-lbs
5/16	24	112	135	150	174	197	231	245	278	327	287	325	383
3/8	24	17 ft-lbs	20 ft-lbs	23 ft-lbs	26 ft-lbs	30 ft-lbs	35 ft-lbs	37 ft-lbs	42 ft-lbs	49 ft-lbs	43 ft-lbs	49 ft-lbs	58 ft-lbs
7/16	20	27	32	36	41	47	55	58	66	78	68	78	91
1/2	20	41	49	55	64	72	85	90	102	120	105	120	141
9/16	18	59	71	78	91	103	121	128	146	171	151	171	201
5/8	18	82	99	110	127	144	170	180	204	240	211	239	281
3/4	16	144	173	192	223	253	297	315	357	420	369	418	492
7/8	14	138	165	184	355	403	474	502	568	669	588	666	784
1	14	210	252	280	542	614	722	765	867	1020	896	1016	1195
1 1/8	12	298	357	397	668	757	890	1083	1227	1444	1269	1439	1693
1 1/4	12	415	498	553	930	1055	1241	1509	1710	2012	1768	2004	2358
1 1/2	12	734	880	978	1645	1865	2194	2668	3024	3557	3127	3544	4169

Torque values for 1/4 and 5/16-in series are in inch-pounds. All other torque values are in foot-pounds. K = 0.15 for "lubricated" conditions D = Nominal Diameter
 Torque values calculated from formula T=KDF, where K = 0.17 for zinc plated and dry conditions F = Clamp Load
 K = 0.20 for plain and dry conditions

Torque-Tension Relationship for Metric Fasteners													
Nominal Dia. (mm)	Pitch	Class 4.6			Class 8.8			Class 10.9			Class 12.9		
		Tightening Torque			Tightening Torque			Tightening Torque			Tightening Torque		
		Lubed	Dry Plated	Dry plain	Lubed	Dry Plated	Dry plain	Lubed	Dry Plated	Dry plain	Lubed	Dry Plated	Dry plain
		K = 0.15	K = 0.17	K = 0.20	K = 0.15	K = 0.17	K = 0.20	K = 0.15	K = 0.17	K = 0.20	K = 0.15	K = 0.20	
		(ft-lbs)	(ft-lbs)	(ft-lbs)	(ft-lbs)	(ft-lbs)	(ft-lbs)	(ft-lbs)	(ft-lbs)	(ft-lbs)	(ft-lbs)	(ft-lbs)	
3	0.5	0.28	0.32	0.38	0.73	0.82	0.97	1.0	1.2	1.4	1.2	1.6	
3.5	0.6	0.44	0.50	0.59	1.1	1.3	1.5	1.6	1.9	2.2	1.9	2.5	
4	0.7	0.66	0.74	0.87	1.7	1.9	2.3	2.4	2.7	3.2	2.8	3.8	
5	0.8	1.3	1.5	1.8	3.4	3.9	4.5	4.9	5.5	6.5	5.7	7.6	
6	1	2.3	2.6	3.0	5.8	6.6	7.7	8.3	9.4	11	9.7	13	
6	1.25	2.1	2.3	2.7	5.3	6.0	7.0	7.6	8.6	10	8.8	12	
7	1	3.8	4.3	5.0	9.7	11	13	14	16	19	16	22	
8	1	5.9	6.6	7.8	15	17	20	22	24	29	25	34	
8	1.25	5.5	6.2	7.3	14	16	19	20	23	27	24	31	
10	1.25	11	13	15	29	33	39	42	48	56	49	66	
10	1.5	11	12	14	28	32	37	40	45	53	47	62	
12	1.25	21	23	28	53	60	71	76	86	101	89	119	
12	1.5	20	22	26	51	58	68	73	82	97	85	113	
12	1.75	19	21	25	49	55	65	70	79	93	81	108	
14	1.25	26	29	34	66	75	89	95	108	127	111	148	
14	1.5	28	32	37	72	82	96	103	117	138	121	161	
14	2	30	34	40	78	88	104	111	126	148	130	173	
16	1.5	50	57	67	129	146	171	184	208	245	215	287	
16	2	47	53	62	121	137	161	173	196	230	202	269	
18	1.5	73	82	97	187	212	249	268	303	357	313	417	
18	2.5	65	73	86	167	189	222	239	270	318	279	372	
20	1.5	101	115	135	270	306	360	374	424	498	437	583	
20	2.5	91	104	122	236	267	314	337	382	449	394	525	

Clamp load calculated as 75% of the proof load for specified bolts. K = 0.15 for "lubricated" conditions D = Nominal Diameter
 All torque values are listed in foot-pounds K = 0.17 for zinc plated, dry conditions F = Clamp Load
 Torque values calculated from formula T=KDF, where K = 0.20 for plain and dry conditions

MAINTENANCE

LUBRICATION RECOMMENDATIONS

MAINTENANCE

Description	Application	General Specification	Recommended Mobil Lubricant
Tractor Hydraulics	Reservoir	JD-20C MF M1135,M1141 FNHM2C134D (FNH201)	Mobilfluid 424
Mower Hydraulics Cold Temperatures 0° F Start-Up	Reservoir	ISO 46 Anti-Wear-Low Temp	Mobil DTE 15M
Normal Temperatures 10° F Start-Up		JD-20C MF M1135,M1141 FNH M2C134D(FNH201)	Mobilfluid 424
Normal Temperatures 15° F Start Up		ISO 46 Anti-Wear	Mobil DTE 25
High Operating Temp. Above 90° F		ISO 100 Anti-Wear	Mobil DTE 18M
Flail Rear Gearbox	Grease	PAO Synthetic Extreme Pressure Gear Lube	Mobil SHC 75W-90 Mobil 1 Synthetic Gear
Cutter Shaft & Ground Roller Shaft(Flail)	Grease Gun	Lithium-Complex Extreme Pressure NLGI-ISO 320	Mobilgrease CM-S
Drive Shaft Coupler (Flail and Rotary)	Grease Gun	Lithium-Complex Extreme Pressure NLGI2-ISO 320	Mobilgrease CM-S
Drive Shaft Yoke, U-joint & Stub Shaft	Grease Gun	Lithium-Complex Extreme Pressure NLGI2-ISO 320	Mobilgrease CM-S
Boom Swivel Boom Cylinder Pivots (Rotary & Flail Boom)	Grease Gun	Lithium Complex Extreme pressure NLGI2-ISO 320	Mobilgrease CM-S
Deck Boom Pivot & Deck Stop Adjustment Rotary & Flail)	Grease Gun	Lithium Complex Extreme Pressure NLGI-ISO 320	Mobilgrease CM-S
Deck Spindle(Rotary)	Grease Gun	Tiger Spindle Lubricant part number 06540000	Mobilith SHC 220

Boom

Maintenance Section 4-9

MAINTENANCE

POLYCARBONATE CARE AND MAINTENANCE

The propriety UV and Abrasion Resistant Surface coating on SHIELDS SUPERCOATED polycarbonate significantly improves performance. Periodic cleaning using proper procedures and compatible cleaners are recommended to prolong service life. Tiger Corp. polycarbonate is SUPERCOATED on both sides.

CLEANING THE SUPERCOAT HARD-COAT

1. Wash with a mild solution of soap or detergent and lukewarm water.
2. Using a soft cloth or sponge, gently wash the sheet to loosen dirt and grime and rinse well with clean water.
3. To prevent water spotting, thoroughly dry with chamois or cellulose sponge.
4. Avoid the use of abrasive cleaners, squeegees and/or other cleaning implements that may mar or gouge the coating.

CLEANING AGENTS WHICH HAVE BEEN FOUND TO BE COMPATIBLE UNDER LABORATORY CONDITIONS:

Aqueous Solutions of Soaps and Detergents

Windex(1)	Top Job(2)	Joy(2)	Mr Clean(2)
Fantastik(3)	Formula 409(4)	Sumalight D12	Brucodecid

Organic Solvents

Butyl Cellosolve	Kerosene	Hexel, F.O. 554	Naphtha(VM&P grade)
Neleco-Placer	Turco 5042		

Alcohols

Methanol	Isopropyl
----------	-----------

All residual organic solvents should be removed with a secondary rinse.

GRAFFITI REMOVAL

Butyl cellosolve (for removal of paints, marking pen inks, lipstick, etc.) The use of masking tape, adhesive tape or lint removal tools work well for lifting off old weathered paints.

To remove labels, stickers, etc., the use of kerosene or VM&P naphtha is generally effective. When the solvent will not penetrate sticker material, apply heat (hair dryer) to soften the adhesive and promote removal.

IMPORTANT: If a material is found to be incompatible in a short-term test, it will usually be found to be incompatible in the field. The converse, however, is not always true. Favorable performance is no guarantee that actual end-use conditions have been duplicated. Therefore, these results should be used as a guide only and it is recommended that the user test the products under actual end-use conditions.

MAINTENANCE

RECOMMENDED FILLING INSTRUCTIONS FOR HYDRAULIC RESERVOIRS

When filling or checking the oil level, the unit should be parked on a level surface., shut OFF, and allow sufficient time to cool to ambient temperature. Use caution when removing the pressurized breather. Do not place face over opening when removing breather.

If your reservoir has two sight glasses: The reservoir should be filled to the top of the lower sight glass on the side of the tank. Do not overfill. The reservoir has been overfilled when oil is visible in the upper sight glass. If tank has too much oil, the excess may be expelled through the pressurized breather.

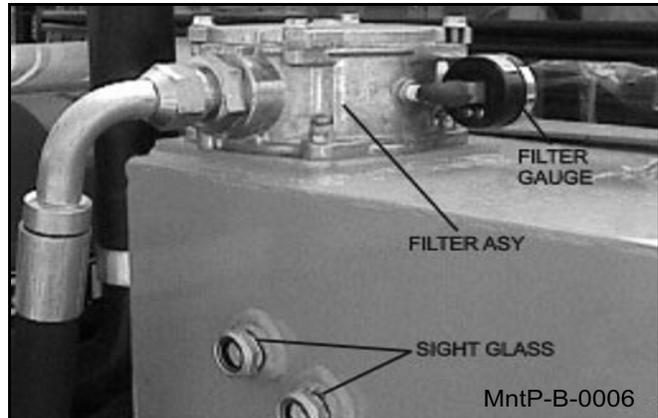

If your reservoir has one sight glass/temperature gage: The reservoir should be filled to the center of the sight glass on the side of the tank. Do not over-fill. If the tank has too much oil, the excess may be expelled through the pressurized breather.

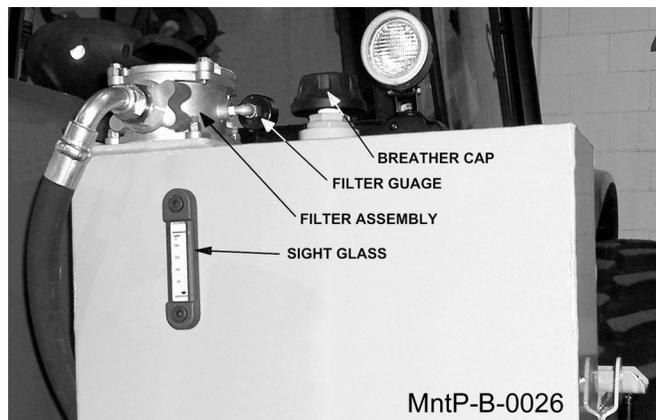

DETAILED MAINTENANCE

REPLACING IN-TANK HYDRAULIC FILTER:

Loosen the four bolts on the top cover of the filter housing. Turn cover counter-clockwise until cover is free. Remove and replace filter. Replace top cover and cover bolts in opposite order as removed.



MAINTENANCE

MAINTENANCE

GREASING CUTTERSHAFT -- FLAIL MOWERS

Locate grease zerks on each end of cuttershaft(s), these are located on the bearing cover. Normal conditions require one or two pumps in each bearing, using Lithium-Complex Extreme Pressure grease confirming to NLGI2-ISO 320 specifications. This is to be done with a standard grease gun daily or at **8 hour intervals**. **CAUTION: Over greasing may cause premature seal failure.**

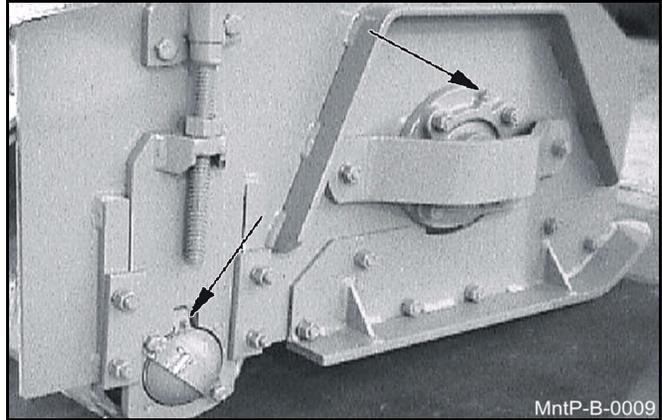

MAINTENANCE

GREASING GROUND ROLLER SHAFT-- FLAIL

Locate grease zerks on each end of roller tube at lower end of head. Normal conditions require one or two pumps in each bearing, using Lithium-Complex Extreme Pressure grease conforming to NLGI2-ISO 320 specifications. This is to be done with a standard grease gun daily or at **8 hour intervals**. **CAUTION: Over greasing may cause premature seal failure.**

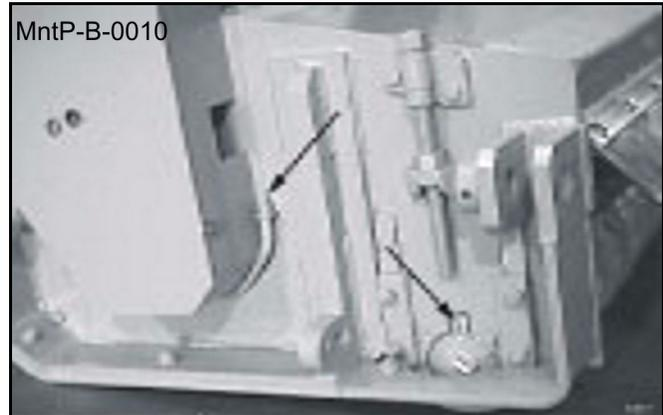

ADJUSTING/CHECKING BELT TENSION

To adjust belt tension or replace belts on flail cutter head, remove four bolts that secure the belt cover and remove cover. The hex nuts shown below can be adjusted to increase/decrease the belt tension as needed. (NOTE: Location of adjustment nuts may vary on flail cutter heads.) **Be sure to replace the belt cover BEFORE operating mower!**

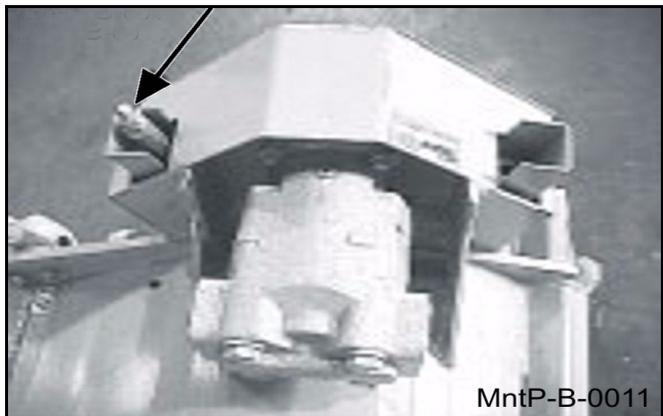

TIGHTENING KNIFE BOLTS AND DISK BOLTS:

After every 8 hours of operation or daily, the Knife Bolts and disk bolts should be tightened as follows:

Knife mounting bolts torque to 800 lubricated ft. lbs.

Disk mounting bolts (6ea.) torque to 204 dry or 180 lubricated ft. lbs.

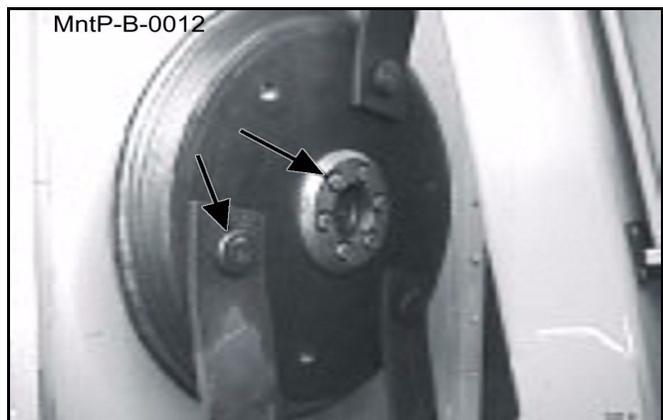

MAINTENANCE

MAINTENANCE

GREASING POINTS ON BOOM AND PIVOT

Locate grease zerks on deck pivot assembly, on the deck end of secondary boom, at main/secondary boom joint, and at swivel end of main boom. Inject Lithium-Complex Extreme Pressure grease conforming to NLGI2-ISO 320 specifications until grease begins to protrude from ends.

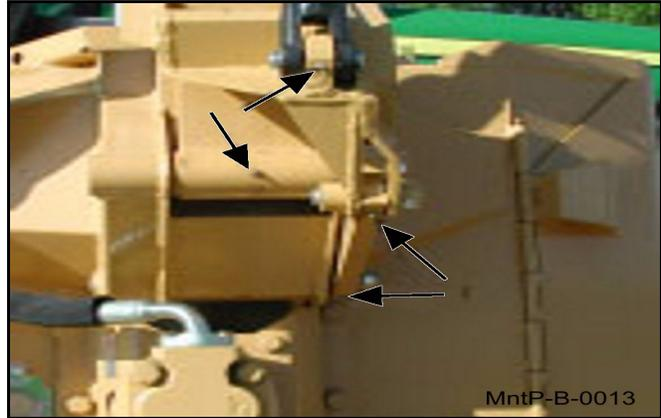

DECK STOP ADJUSTMENT

On boom flail, loosen locking nut. Turn adjustment bolt in, and run deck cylinder out to full extension. Adjust bolt out until the head just touches the boom, and tighten lock nut. **NOTE: Bolt should not hit boom before cylinder reaches full travel.**

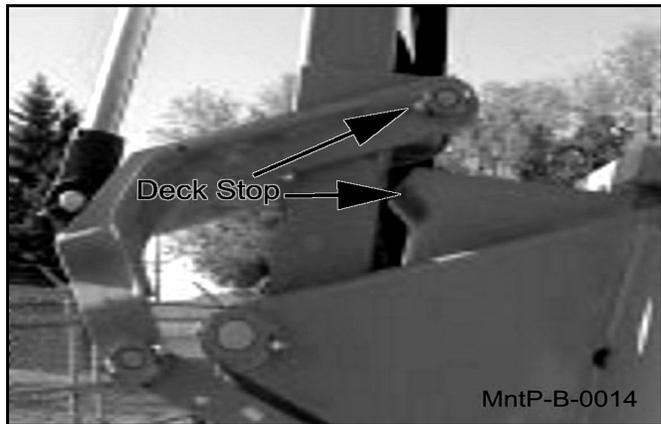

GREASING SPINDLE

Locate grease fitting on inside of deck housing. Inject Tiger Spindle Lubricant, part number 06540000 into spindle housing. Fill with lubricant until lubricant weeps out of top spindle seal. Lubricate spindle weekly or every 40 hours of use.



MAINTENANCE

MAINTENANCE

TIGHTENING SPINDLE BOLTS

The spindle mounting bolts should be checked and retorqued daily or every 8 hours of service. Torque the (6) bolts shown below to 357 dry or 315 ft. lbs. lubricated.

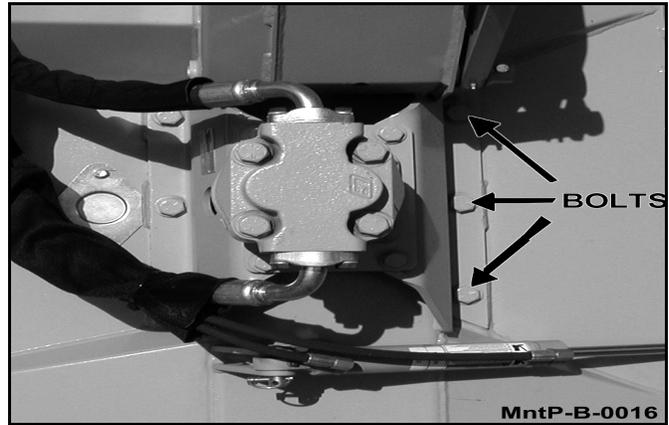

GREASING PUMP DRIVE SHAFT COUPLER

With engine stopped, ensure driveshaft alignment by grasping coupler and sliding back and forth. Coupler should slide freely with approximately 1/8" of end play. If coupler does not slide freely, inspect for loose pump mount bolts, or damaged or loose crankshaft adapter. Inject Lithium-Complex Extreme Pressure grease conforming to NLG12-ISO 320 specifications into coupler until grease begins to protrude from ends. Grease daily or every 8 hours. Do not over grease.



MAINTENANCE

MAINTENANCE

DRIVESHAFT YOKE, U-JOINT STUB SHAFT

With engine stopped, inject Lithium-Complex extreme pressure grease conforming to NLGI2-ISO 320 specifications into universal joints and slip yoke until grease appears at the seal. Grease them daily or every 8 hours.

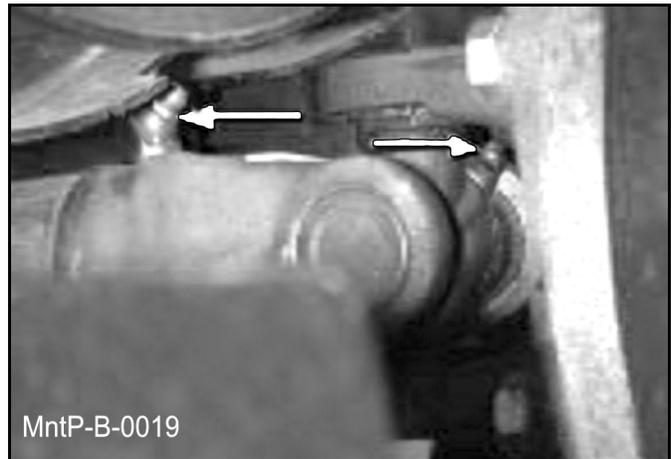
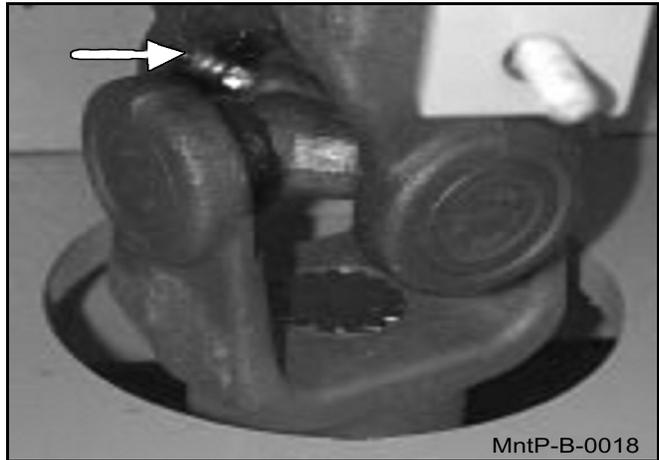

GREASING THE BOOM SWIVEL

Locate the zerks on the main swivel boss (if applicable), main boom pivot boss (if applicable) and on both ends of the boom swivel cylinder. Inject Lithium-Complex Extreme Pressure grease conforming to NLGI2-ISO 320 specification until grease begins to protrude from ends.

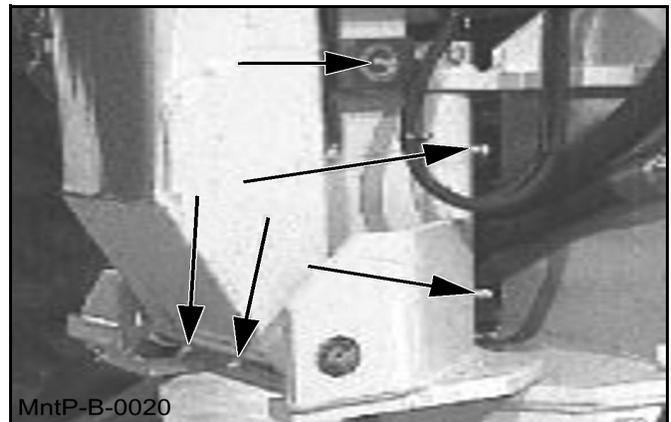

MAINTENANCE

MAINTENANCE

GREASING BOOM CYLINDER(S) PIVOT POINTS

Locate the zerk on the butt end tang of cylinder and on rod end tang. Inject Lithium-Complex Extreme Pressure grease conforming to NLGI2-ISO 320 specifications until grease begins to protrude from ends. This procedure is to be used on the main boom cylinder, secondary boom cylinder, deck pivot, and swivel cylinders daily or at 8 hour intervals.

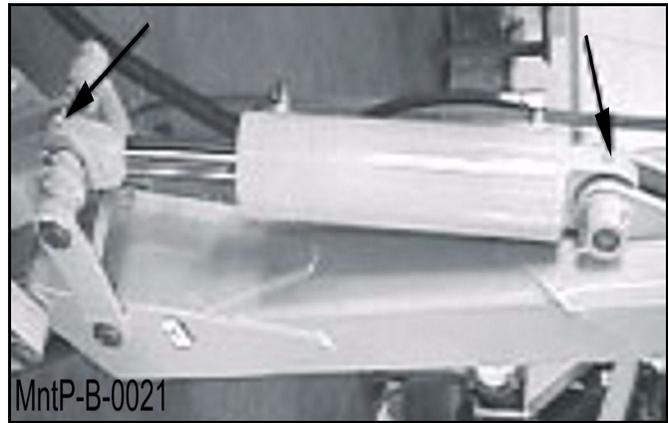

BALL VALVES

The ball valve at the hydraulic reservoir may need to be closed during certain maintenance or repair procedures. **THE BALL VALVES MUST BE OPEN (handle parallel with valve) WHEN TRACTOR IS RE-STARTED OR PUMP IS COUPLED TO MOTOR OR PTO!** Failure to do so will result in component failure!

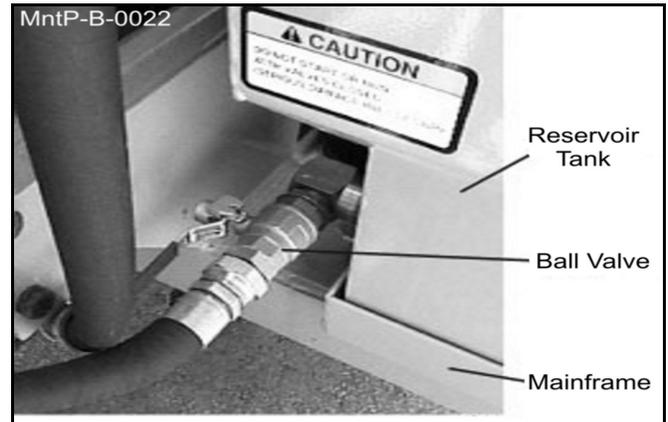

MAINTENANCE

MAINTENANCE

Blades

Check the Blades for cracks and wear and Blade Bolts for tightness, daily. Blades should be replaced when they are worn excessively, bent, deformed, or out of balance.

CAUTION

Blades should always be replaced in pairs. Blades of different weights can cause serious imbalance and damage to the machine and personnel. When replacing blades, take care to replace the blade bolts, nuts, and washers.

Important

Make sure the mower blades are turning clockwise when looking down from the top of the mower. Follow the color coding on the hydraulic hoses and fittings to make sure the motor and hydraulics hoses are assembled properly. Connect the red hose connection only to red fitting. Connect the blue hose connection only to the blue fitting. The blade rotation on the leading edge of the mower should discharge the cut material away from the tractor and operator.

WARNING

If the leading edge of the mower blades are rotating backwards they can discharge material toward the operator. If this occurs discontinue mowing immediately and reverse the direction of the motor rotation by correctly installing the motor pressure and return hoses. Contact your dealer or Alamo Industrial for specific information on the hose routing.

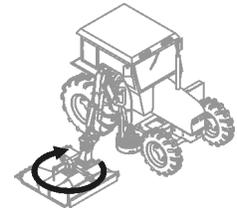

WARNING	ADVERTENCIA
TO AVOID SERIOUS INJURY AND DEATH FROM THROWN OBJECTS: <ul style="list-style-type: none">● MAKE CERTAIN blades rotate the correct direction.	PARA EVITAR LESION SERIA O MUERTE POR OBJETOS LANZADOS: <ul style="list-style-type: none">● ASEGURE que las cuchillas giran en la dirección correcta.
BLADE ROTATION  ROTACIÓN DE CUCHILLAS	
 Return Retorno BLUE	 Pressure Presión RED

D619

MAINTENANCE

ROTARY KNIFE REPLACEMENT

1. Be sure you have a complete matching set of new knives for replacement.
2. Remove knives and inspect holes for damage. Also watch for cracks in the disk (if applicable) around the holes.
3. Lube threads with anti-seize. Install bolts through knife and disk from bottom side of disk/blade bar. Install new self-locking nuts and torque them to 800 ft. lbs.
4. The knives should swing freely to absorb shocks from impact when striking objects.



WHEN CUTTING HEAVY BRUSH, KNIFE BOLTS SHOULD BE INSPECTED HOURLY AND RETORQUED TO 800 LUBRICATED FT. LBS.

REPLACEMENT OF ROTARY DISK/BLADE BAR



Failure to follow the following warnings and instructions may result in serious injury or damage to the equipment or property!

1. The bolts that attach the disk to the spindle must be grade 8. These 5/8 inch bolts are to be torqued to 204 dry or 184 ft. lbs lubricated with Loctite 271.
2. A thread locking agent may be applied to threads of all mounting bolts before they are installed.
3. **Disks must be inspected daily for hairline cracks between spindle mounting bolts or around the knife mounting bolts. These cracks indicate metal fatigue caused by severe abuse. If cracks are present the disk must be replaced.**
4. Inspect the disk mounting bolts daily when checking tightness of knife mounting bolts. If a disk mounting bolt is loose, it must be removed, threads cleaned, fresh thread locking agent applied, and tightened to proper torque value.
5. If a knife mounting bolt is loose, the self locking nut must be replaced as a safety precaution. Lubricate threads with anti-seize. Install bolts through knife and disk/blade bar from bottom side. Install self locking nuts and torque them to 800 ft. lbs.

MAINTENANCE

Flail Blades Inspection



Inspect the Blades daily for abnormal wear. REPLACE ALL BLADES on the carrier IMMEDIATELY if any blades have:

- Become bent or deformed from its original shape, or
- Wear inside the blade bolt hole, or
- Any cracks are visible, or
- Deep gouges in the blade's surface are present, or
- Gouges or chipped areas in the cutting edge are larger than 1/4"(8mm), or
- The material on the leading edge has been worn away by more than 1/4"(8mm)

DO NOT straighten, sharpen, weld or hard-face blades

Failure to replace worn or damaged blades may lead to catastrophic failure of the blades and ejection of the broken part with tremendous force which may cause serious bodily injury or death.

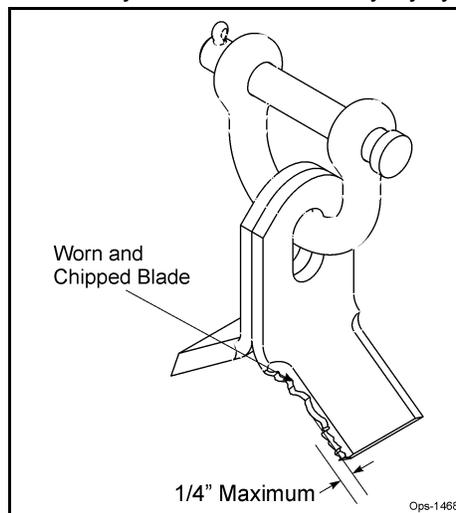

Always replace blades in sets

- Blades that are damaged may indicate severe service or abuse. If one blade is worn or damaged other blades on the same shaft will have been subjected to the same severe service or abuse.
- The Flail rotor turns at speeds exceeding 2000 RPM and is dynamically balanced at the factory. Differences in blade weight between used blades with loss of material from gouges or wear as compared to new blades can cause severe vibration and damage to the Flail rotor. Always replace blades as complete sets.

MAINTENANCE

Blade Pins and D-Ring Inspection

Inspect Blade Pins and D-Rings daily for wear or damage as follows:



Inspect the Blade pins and D-Rings daily for abnormal wear. Make sure the cotter pins are in place and properly spread. REPLACE BLADE Pins and D-Rings IMMEDIATELY if they have:

- Visible cracks or
- If a Pin or D-Ring has visible worn areas, or
- If a Pin or D-Ring has gouges or chipped areas

Failure to replace abnormally worn pins or D-Rings may lead to catastrophic failure and ejection of the broken part, which may cause serious bodily injury or death.

Always replace the pins and D-Rings whenever excessive wear is noticed.

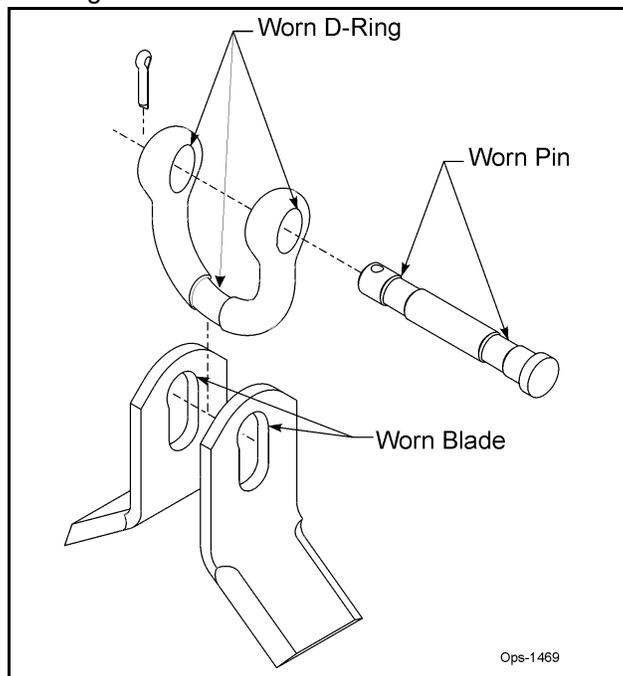

Important

If the cotter pins are broken by contact with other flail blades, remove the pin and reverse the direction the pin is inserted through the D-Ring so that the cotter pin is on the opposite side of the D-Ring. This will prevent the next set of blades from swinging back and hitting the cotter pin. OPS-U-0045

MAINTENANCE

MAINTENANCE

Flail Axe Blades Inspection



Inspect the Blades daily for abnormal wear. REPLACE ALL BLADES on the carrier IMMEDIATELY if any blades have:

- Become bent or deformed from its original shape, or
- Oval shape wear inside the blade bolt hole, or
- Any cracks are visible, or
- Deep gouges in the blade's surface are present, or
- Gouges or chipped areas in the cutting edge are larger than 1/4"(8mm), or
- The material on the leading edge has been worn away by more than 1/4"(8mm)

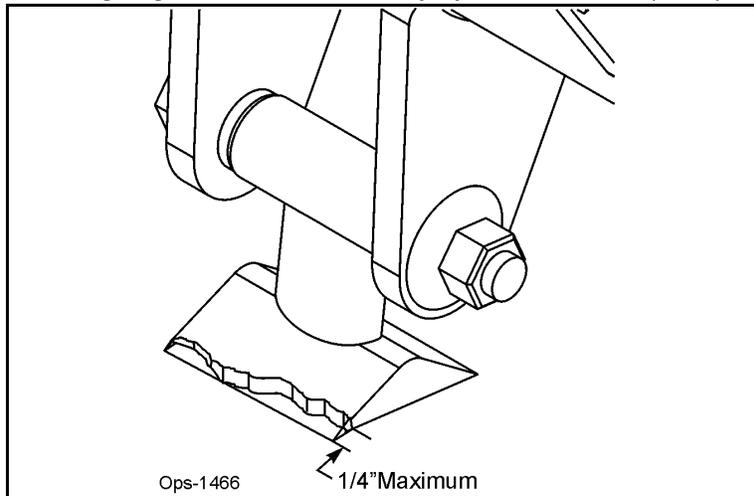

Failure to replace worn or damaged blades may lead to catastrophic failure of the blades and ejection of the broken part with tremendous force which may cause serious bodily injury or death.

Always replace blades in sets

- Blades that are damaged may indicate severe service or abuse. If one blade is worn or damaged other blades on the same shaft will have been subjected to the same severe service or abuse.
- The Flail Axe rotor turns at speeds exceeding 2000 RPM and is dynamically balanced at the factory. Differences in blade weight between used blades with loss of material from gouges or wear, as compared to new blades, can cause severe vibration and damage to the Flail Axe rotor. Always replace blades as complete sets.

Important

Use only genuine Alamo Industrial replacement blades, blade bolts and fasteners. Other blades and bolts may not meet the requirements of Alamo Industrial and may fail during operation, resulting in the part failing and being thrown out from under the mower.



Never attempt to sharpen blades. OPS-U-0042

MAINTENANCE

Flail Axe Blade Bolt Inspection

Inspect Blade Bolts daily for wear or damage as follows:



Inspect the Blade Bolt daily for abnormal wear. REPLACE ALL BLADE BOLTS on the carrier IMMEDIATELY if any bolts have:

- Visible cracks or
- If the blade bolt is worn or any recessed area is visible on the bolt, or
- If Blade Bolt has gouges or chipped areas. or
- If Bushing fits loose in the Rotor Shaft.

Failure to replace abnormally worn bolts or bushings may lead to catastrophic failure of the blades and ejection of the broken part, which may cause serious bodily injury or death.

Always replace Blade Bolts with new bolts and new bushings whenever replacing the Blades. To tighten bolts and nuts, first apply thread lock to nut. Make sure to tighten bolts and nuts just enough to allow the blades to swing freely and not bend the cuttershaft lugs. If cuttershaft lugs are bent together because of over tightening the blades will not swing freely. OPS-U-0043

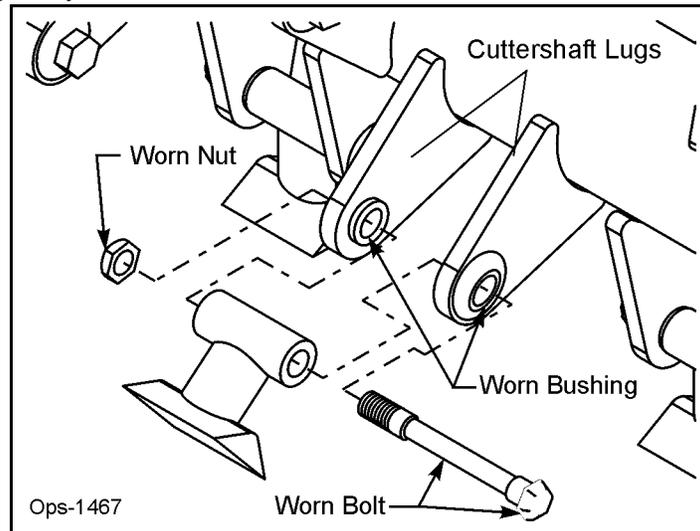

MAINTENANCE

MAINTENANCE

50" FLAIL KNIFE BLADE REPLACEMENT (Light Brush Grass)

1. If knives are damaged or badly worn, they will need to be replaced as a set. Replacing a single knife can cause severe vibration and possible damage to the mower. The knife should not be welded on for any reason.
2. Always replace the knife bolts when replacing the knives. DO NOT REUSE THE KNIFE BOLTS OR NUTS.
3. Assemble knives, bushings, bolts and nuts as shown in Parts Section of the manual.
4. Install the locking hex nut so that the flat face of the nut is towards the knife.
5. Apply Loctite 271 or equivalent to threads.
6. Torque nut to 50 ft. lbs. Knife must swing freely.



DO NOT re-use the locking hex nuts for mounting the knives. If hex nut becomes loose, or required removal for knife replacement or any other reason, they must be discarded and replaced with new nuts.

50" FLAIL KNIFE BLADE REPLACEMENT (Medium Brush Grass)

7. If knives are damaged or badly worn, they will need to be replaced as a set. Replacing a single knife can cause severe vibration and possible damage to the mower. The knife should not be welded on for any reason.
8. Always replace the knife bolts when replacing the knives. DO NOT REUSE THE KNIFE BOLTS OR NUTS.
9. Assemble knives, bushings, bolts and nuts as shown in Parts Section of the manual.
10. Install the locking hex nut so that the flat face of the nut is towards the knife.
11. Apply Loctite 271 or equivalent to threads.
12. Torque nut to 120 ft. lbs. Knife must swing freely.



DO NOT re-use the locking hex nuts for mounting the knives. If hex nut becomes loose, or required removal for knife replacement or any other reason, they must be discarded and replaced with new nuts.

50" FLAIL KNIFE BLADE REPLACEMENT (Heavy Duty Brush)

13. If knives are damaged or badly worn, they will need to be replaced as a set. Replacing a single knife can cause severe vibration and possible damage to the mower. The knife should not be welded on for any reason.
14. Always replace the knife bolts when replacing the knives. DO NOT REUSE THE KNIFE BOLTS OR NUTS.
15. Assemble knives, bushings, bolts and nuts as shown in Parts Section of the manual.
16. Install the locking hex nut so that the flat face of the nut is towards the knife.
17. Apply Loctite 271 or equivalent to threads.
18. Torque nut to 176 ft. lbs. Knife must swing freely.



DO NOT re-use the locking hex nuts for mounting the knives. If hex nut becomes loose, or required removal for knife replacement or any other reason, they must be discarded and replaced with new nuts.

MAINTENANCE

63" BOOM FLAIL KNIFE REPLACEMENT

1. If knives are damaged or badly worn, they will need to be replaced as a set. Replacing a single knife can cause severe vibration and possible damage to the mower.
2. Assemble knives, clevis, bolts and nuts as shown in part section of manual.
3. Install locking hex nut so that the flat face of nut is towards the knife.
4. Apply Loctite 271 or equivalent to threads.
5. Torque nut to 35 FT. LBS. Knife must swing freely.



DO NOT re-use the locking hex nuts for mounting the knives. If hex nut become loose, or require removal for knife replacement or any other reason, they must be discarded and replaced with new nuts.



Knives should not be welded on for any reason.

HEAVY DUTY SPINDLE ASSEMBLY INSTALLATION AND BEARING ADJUSTMENT

WARNING! A press **MUST** be used to install bearing cups, bearing cones, and seals. **DO NOT** use a hammer to install races, bearings, or seals. The parts of assembly may be damaged.

NOTE: The grease zerk and gussets are located on the top side of the spindle housing. Be sure the spindle is assembled correctly.

Be sure to wear eye protection and other protective equipment as needed when working on spindle assembly.

MAINTENANCE

THE SPINDLE ASSEMBLY

See the diagram below for identification of spindle parts, while servicing.

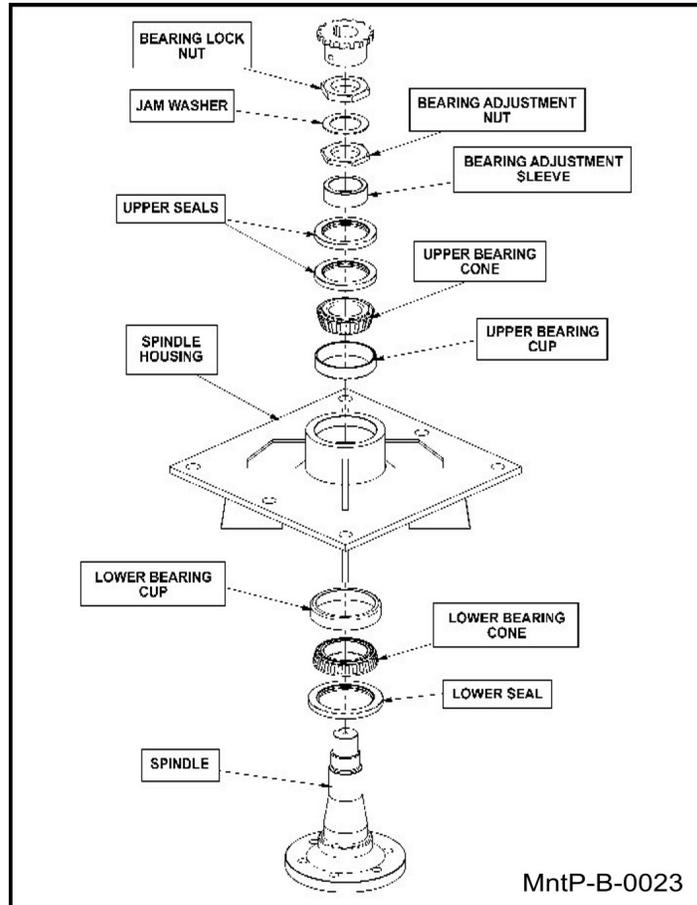

MAINTENANCE

MAINTENANCE

MAINTENANCE

BEARING INSTALLATION

1. Press upper bearing cup into the spindle housing.
2. Turn the spindle housing over and press in the lower bearing cup.
3. Place the lower bearing cone in the bearing cup. Next press the seal into the spindle housing. The inner lip of the seal must be DOWN, towards the bearing, so lubricant is sealed inside the housing.
4. Install the spindle in the housing. Lightly press the spindle to seat the cone onto the spindle.
5. Support the bottom of the spindle and press the upper bearing cone and bearing adjustment sleeve onto the spindle.
6. **NOTE: The spindle housing must turn freely when seating the bearing cone and sleeve.**
7. Press the two upper seals into the spindle housing. The inner lip of the seals must be UP, away from the bearing, so excess lubricant can escape.
8. Install the bearing adjustment nut (thin nut) so there is 1-1/6" clearance between the nut and the sleeve. Install the jam washer, placing the tab into the key-way. Install the bearing lock nut (thin nut) and hand tighten against jam washer and adjustment nut. See the following section for bearing adjustment.
9. Position the spindle housing horizontally with the drain hole oriented "up". Grease through the zerk with Tiger Spindle Lubricant (part number 06540000) until the grease purges from the drain hole.
10. Install the plug into the drain hole.

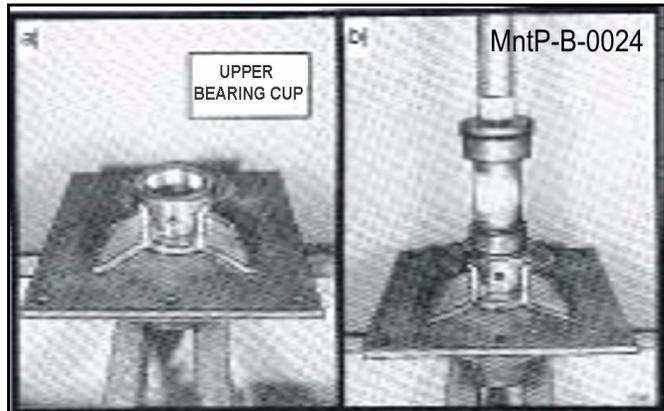

BEARING ADJUSTMENT

1. Clamp the bottom end of the spindle housing securely in a vise so the spindle housing turns freely.
2. Position a magnetic base dial indicator on the outer diameter of the spindle housing. Locate the end of the dial indicator against the flat end of the spindle shaft. The dial indicator will now measure accurately bearing end play.
3. Tighten the bearing adjustment nut until there is .012 inch movement when the spindle housing is pried upward away from the vise jaws.
4. When there is .012 inch free play between the spindle and housing, install the bearing lock nut (thick nut). Hold the adjusting nut securely and tighten the lock nut to 300 ft. lbs. of torque.
5. After the lock nut is tightened, there must be .001 inch to .003 inch of free play when lightly prying up on the spindle housing.

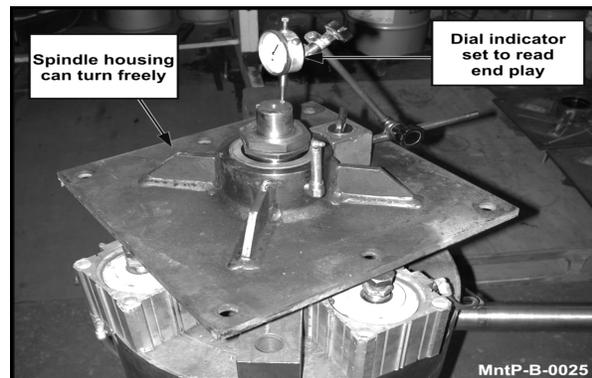

If the end play is correct, .001 inch to .003 inch, bend tabs up on jam washer to prevent the lock nut from loosening.

If the end play is NOT correct, loosen the lock nut and turn the adjustment nut as required and re-tighten the lock nut. Repeat first part of step 5.

MAINTENANCE

Boom Cylinder Removal and Replacement Instructions

1. Clear the area of all personnel before lowering the boom mower head.
2. From the tractor seat with your seat belt fastened around you, lower the boom mower head to the ground. Extend the boom to the furthest reach and lower the mower head flat on the ground. **DO NOT** attempt to replace the cylinders with the boom in the raised or transport position.
3. Shut off the tractor, engage the parking brake, place the tractor transmission in the park position, and remove the key before dismounting.
4. Allow the system to cool to room temperature before removing any hydraulic components
5. Wear safety glasses and impenetrable gloves when working with hydraulic hoses and fittings.
6. Release all oil pressure from the hydraulic circuit by manually stroking each valve section with the tractor engine off. Utilize the manual override function if the unit is equipped with an electric over hydraulic valve.
7. Utilize blocks, jack stands or a suitable over head hoist to support the weight of the boom section and remove pressure from the cylinder mounting pins.
8. Check to see that the cylinder to be replaced is not under pressure by moving the cylinder pins by hand. The pins should be loose and should slide from the pin bore easily. If the pins are tight and cannot be moved, the cylinder may be under pressure. Make sure the boom components are properly supported and that the pressure is relieved from the circuit.
9. Cylinder assemblies are heavy and can fall when the pins are removed. Support the hydraulic cylinder with a suitable hoist or jack.
10. Slowly loosen the hydraulic connections to the cylinder. Carefully unscrew hose fitting and allow any remaining pressure to bleed off. **Use extreme care.** Oil must be cool, and the technician should stand to the side to prevent exposure to any hydraulic oil. Always consult the Material Safety Data Sheet and wear any required Personal Protective Equipment. A catch pan may be required to retain any spilled oil.
11. Cap both ends of the fitting with suitably sized metal caps.
12. Remove the cylinder pins starting with the ROD end cylinder pin. Make sure the cylinder is properly supported, and remove the base end cylinder pin. The cylinder may be heavy-- use proper lifting techniques to lift and handle the cylinder. If needed, get assistance from another person to safely lift the cylinder from the machine.
13. Measure the distance between the cylinder pin holes and extend the new cylinder the correct length prior to attempting an installation.
14. Install the new cylinder in place and install both cylinder pins and retaining hardware.
15. Remove the metal caps and re-install the hydraulic hoses.
16. Check the hydraulic reservoir of the boom mower to ensure there is sufficient oil. Follow the manufacturer's recommendations for proper oil type and filtering techniques and requirements to add oil to the system.
17. Clear the area of all persons prior to starting the tractor.
18. Consult the Operator's Manual for instructions in regard to the proper operating procedure.
19. From the tractor seat, with the seat belt fastened, operate the boom to ensure proper operation of the boom function.
20. From the tractor seat, with the seat belt fastened, operate the boom controls to fully extend and retract the new cylinder several times to purge any trapped air from the system.
21. From the tractor seat, with the seat belt fastened, look for signs of an oil leak. If an oil leak is observed, shut the tractor down and follow the steps to remove pressure from the hydraulic circuit. Identify the source of the leak and resolve the issue.
22. Upon completion of the required repairs return to Step # 16 to recheck the cylinder for proper operation.

MAINTENANCE

CUTTERSHAFT BEARING REPLACEMENT

1. Remove existing cuttershaft, bearings and string guards.
2. Make sure that the end knives on each end of the cuttershaft are oriented as shown.
3. Apply anti-seize on cuttershaft as shown on next page.
4. Before installation the bearings must be fully greased per the following protocol: 1. Add 2 or 3 pumps of grease, 2. Spin the bearing 2 or 3 times. 3. Add 2 or 3 pumps of grease. 4. Spin the bearing 2 or 3 times. 5. Add 2 or three pumps of grease. Continue this procedure until you can visually confirm that grease is purging from the entire circumference of the seal.
5. Install non-drive side bearing first.
6. Install the top of the string guard on the non-drive side first. Use Loctite 271 or equivalent and torque (95 ft-lb or 104ft-lb if you use an extension).
7. Install the bearing and top string guard on the drive side.
8. Center the cuttershaft between the string guards. Use Loctite 271 or equivalent and torque (95ft-lb or 104ft-lb if you use an extension) the top string guard on the drive side.
9. Install, use Loctite 271 or equivalent, and torque (95ft-lb or 104ft-lb if you use an extension) the bottom string guard on both sides.
10. Make sure the cuttershaft is centered. On the non-drive side, tighten one set-screw in the bearing onto the cuttershaft.
11. Remove the other set screw and drill a 5/16" hole into the cuttershaft 3/16" deep through the hole in the bearing. **BE CAREFUL NOT TO DAMAGE THE THREADS IN THE BEARING HOLE.**
12. Replace the set screw in the bearing, use Loctite 271 or equivalent, and tighten onto the cuttershaft through the new hole.
13. Remove the other set screw and repeat the drilling procedure (Step 10). Replace the set screw as stated in Step 11.
14. Repeat steps 9 through 12 on the drive side.

See illustration on next page

MAINTENANCE

MAINTENANCE

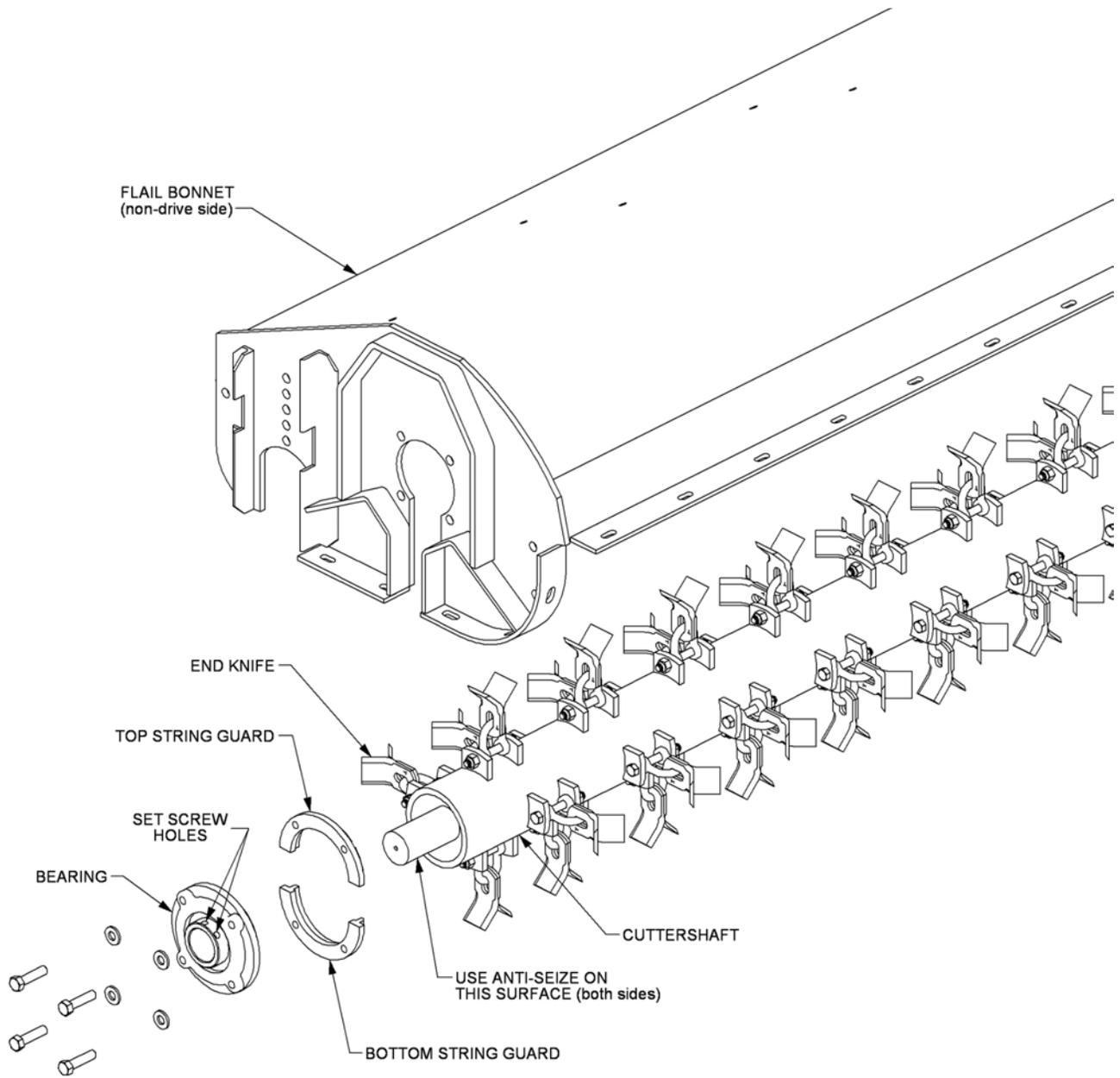

MAINTENANCE

MAINTENANCE

GROUND ROLLER BEARING REPLACEMENT

1. Remove existing ground roller brackets, bearings, and ground roller.
2. Remove bearings from stub shafts and ground roller brackets.
3. Clean stub shafts thoroughly, and apply anti-seize to O.D. of outer end.
4. Before installation, bearings must be fully greased per the following protocol: 1. Add 2 or 3 pumps of grease, 2. Spin the bearing 2 to 3 times. 3. Add 2 or 3 pumps of grease. 4. Spin the bearing 2 to 3 times. 5. Add 2 or 3 pumps of grease. Continue this procedure until you can visually confirm that grease is purging from the entire circumference of the seal.
5. Install bearing onto ground roller brackets using existing hardware and Loctite 271.
6. Slide bearing-ground roller bracket assemblies onto stub shafts of ground roller.
7. Install ground roller brackets onto flail bonnet using existing hardware.
8. Insure that ground roller brackets are set to the same elevation on both sides.
9. Center ground roller in bearings.
10. Tighten one setscrew in one bearing onto stub shaft of ground roller.
11. At the other end, remove the setscrew collar and drill 5/16" holes in both setscrew locations into the stub shaft 3/16" deep (or align setscrew holes in bearing collar with existing countersinks in stub shaft).
12. Reinstall setscrew collar on drilled-end. Remove both setscrews, apply Loctite 271 or equivalent, and tighten setscrews into stub shaft.
13. Then remove setscrew collar from other end, and repeat the drilling procedure from Step 11. Reinstall setscrew collar and install setscrews per Step 12.

See illustrations in the Common Parts Section.

MAINTENANCE

DAILY MAINTENANCE SCHEDULE

The following services should be performed daily or every 8 hours of service, following the detailed maintenance instructions in the operator's manual.

_____ Pump driveshaft: If required with drive shaft/coupler check for end play and lubricate at zerks.

_____ Crankshaft adapter: If equipped with rubber grommets check condition, replace if missing or damaged.

_____ Pivot points: Inject grease until it appears at ends.

_____ Hydraulic fittings: Check for leaks with paper or cardboard. Tighten fittings or replace hoses immediately.

_____ Knives: Inspect for missing or damaged knives, change (only complete sets) as needed.

_____ Belts: Check/tighten/replace belts as needed.

_____ Mainframe/deck: Unless otherwise specified retorque bolts according to torque specifications in this section.

_____ Hydraulic fluid level: Add, if required, per fluid recommendations.

_____ Rear flail drive, bearing flange and shaft couplers: Grease as instructed in the detailed maintenance section.

_____ Cuttershaft and ground roller: Grease as instructed in the detailed maintenance section.

Service performed by: _____ Date: ____/____/____ Hour

Meter: _____

Maintenance Section

**This page may be copied and used as part of the daily maintenance routine.

PARTS SECTION

PART NAME INDEX

PARTS ORDERING GUIDE.....	3
TRACTOR MOUNT KIT.....	4
TRACTOR MOUNT KIT - HYDRAULICS.....	6
COOLER MOUNT.....	8
BOOM MOUNT KIT.....	10
ELECTRONIC PROPORTIONAL LIFT VALVE MOUNT.....	12
JOYSTICK AND SWITCHBOX MOUNT.....	14
CABLE (MANUAL) LIFT VALVE - 5 SPOOL.....	16
5 SPOOL CABLE CONTROL MOUNT.....	18
BATTERY RELOCATION.....	20
BOOMREST - SINGLE COLUMN.....	22
BOOMREST - OPEN STOW.....	23
POLYCARBONATE SAFETY WINDOW.....	24
FIRE EXTINGUISHER OPTION.....	26
BULKHEAD HYDRAULICS - BOOM MOWER.....	28
BULKHEAD DIAGRAM.....	30
AXLE STABILIZER.....	31
WHEEL WEIGHT.....	32

PARTS ORDERING GUIDE

The following instructions are offered to help eliminate needless delay and error in processing purchase orders for the equipment in this manual.

1. The Parts Section is prepared in logical sequence and grouping of parts that belong to the basic machine featured in this manual. Part Numbers and Descriptions are given to help locate the parts and quantities required.
2. The Purchase Order must indicate the **Name and Address** of the person or organization ordering the parts, **who should be charged**, and if possible, the **serial number of the machine** for which the parts are being ordered.
3. The purchase order must clearly list the **quantity of each part**, the complete and correct **part number**, and the basic **name of the part**.
4. The manufacturer reserves the right to substitute parts where applicable.
5. Some parts may be unlisted items which are special production items not normally stocked and are subject to special handling. Request a quotation for such parts before sending a purchase order.
6. The manufacturer reserves the right to change prices without prior notice.

NOTE: When ordering replacement decals, refer to the part numbers and descriptions listed in the safety section in the front of this manual.

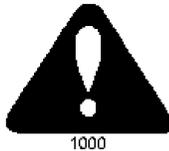

For maximum safety and to guarantee optimum product reliability, always use genuine **Tiger** replacement parts. The use of inferior replacement parts may cause premature or catastrophic failure which could result in serious injury or death.

Direct any questions regarding parts to:

Tiger Corporation
3301 N. Louise Ave.
Sioux Falls, SD 57107
1-800-843-6849
1-605-336-7900

TRACTOR MOUNT KIT

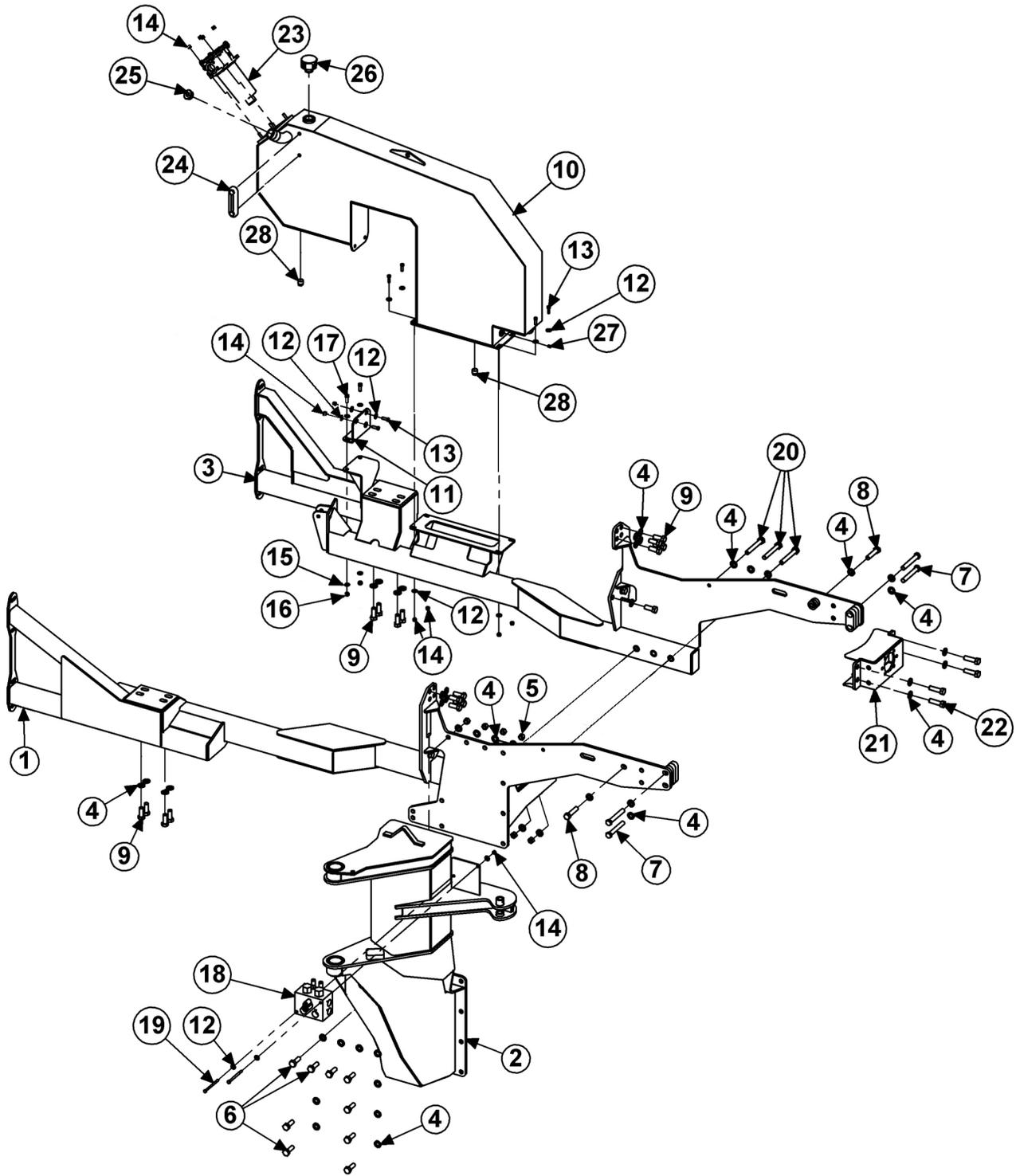

TRACTOR MOUNT KIT

Continued...

ITEM	PART NO.	QTY.	DESCRIPTION
1	06300317	1	MNFRM,MNT,JD6E,RS,T4F
2	06300323	1	MNFRM,TB,JD6E,T4F
3	06300318	1	AXL BRC,LH,JD6E,RS,T4F
4	33880	54	FLATWASHER,3/4",GR8,SAE
5	21825	12	HEX NUT,3/4",NC
6	21833	9	CAPSCREW, 3/4" X 2 1/4",NC
7	6530542	4	CAPSCREW,20MM X 140MM
8	30708	2	CAPSCREW,20MM X 90MM(2.5 PITCH)
9	31731	20	CAPSCREW,20MM X 50MM(2.5 PITCH)
10	06380089	1	TANK,RES,JD6E T4F
11	06411779	1	MNT,06380089
12	22016	16	FLATWASHER,3/8",GR8
13	21631	6	CAPSCREW, 3/8" X 1-1/4",NC,GR8
14	21627	12	NYLOCK NUT,3/8",NC
15	22017	4	FLATWASHER,7/16"
16	21677	2	NYLOCK NUT,7/16" NC
17	21680	2	CAPSCREW, 7/16" X 1-1/4",NC
18	06510083	1	VALVE,BRAKE,SOL,3000PSI
19	21644	2	CAPSCREW,3/8" X 5" NC
20	6T2309	3	CAPSCREW, 3/4" X 5-1/2" NC
21	06380061	1	MNT,PUMP,HYDRO,T4,JD6XXXD
22	25341	4	CAPSCREW,20MM X 70MM(2.5 PITCH)
23	06505044	1	FILTER ASSY, IN-TANK
24	06505067	1	SIGHT GAGE
25	06505127	1	PLUG,SAE #20
26	06505077	1	CAP,BREATHER,1-5/8" MB
27	6T4197	1	PLUG,PIPE 1/8"
28	6T4200	2	PLUG,PIPE 3/4"

TRACTOR MOUNT KIT - HYDRAULICS

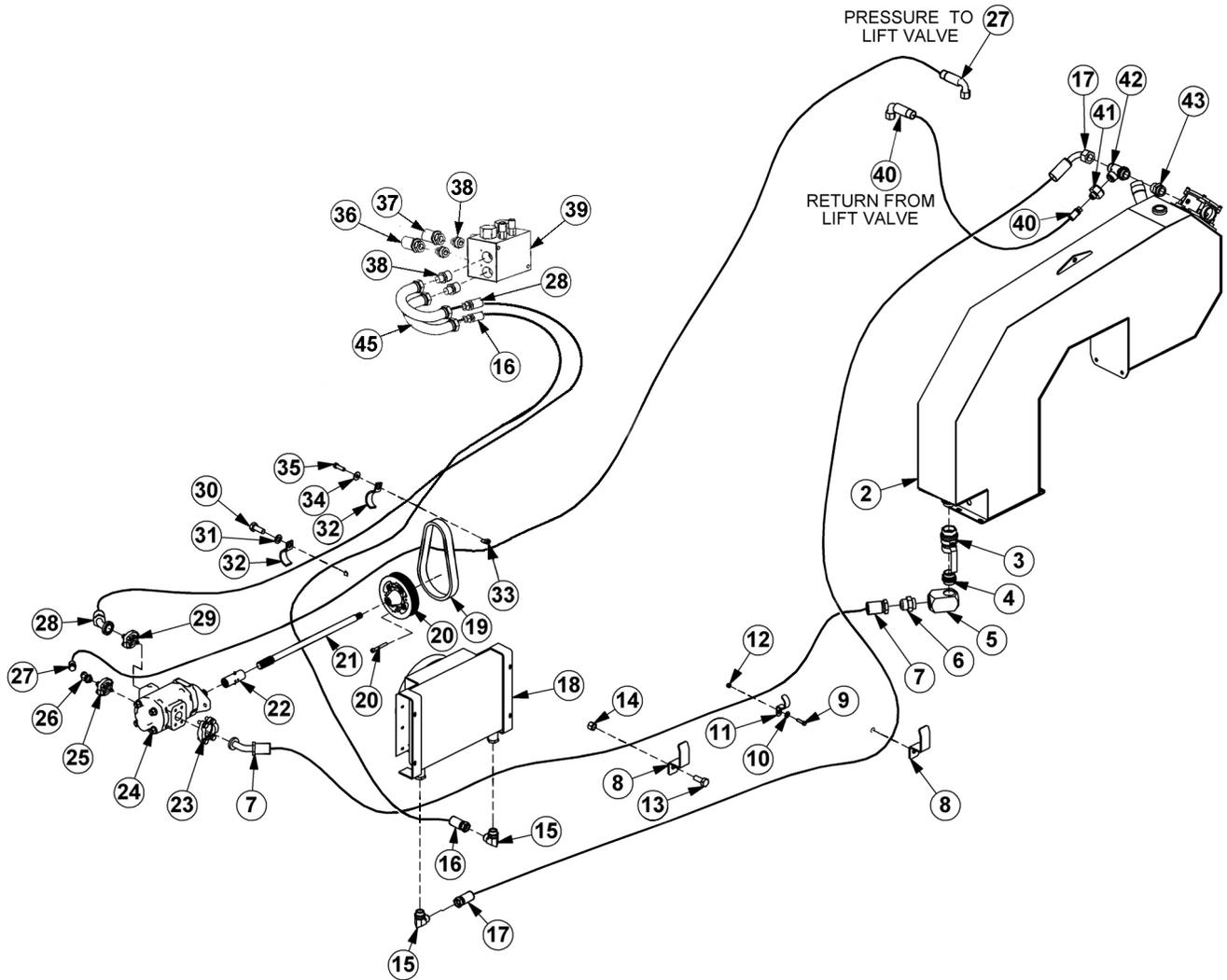

ITEM	PART NO.	QTY.	DESCRIPTION
1	06300323	1	MAINFRAME
2	06700228	1	TANK, HYDRAULIC, WHEEL WELL
3	34309	1	BALL VALVE, 1 - 1/2" FOR
4	06503083	1	ADAPTER, 1-1/2" ORB X 1-1/2" ORB
5	06503084	1	ELBOW, 1-1/2" FB X 1-1/2" FB
6	34710	1	ADAPTER, 1-1/2" ORB X 1-1/2" MJ
7	06500746	1	HOSE, 2" X 107
8	32382	2	BRACKET, HOSE
9	21632	1	CAPSCREW, 3/8" X 1-1/2", NC
10	22016	1	FLATWASHER, 3/8"

TRACTOR MOUNT KIT - HYDRAULICS

Continued...

ITEM	PART NO.	QTY.	DESCRIPTION
11	06411136	1	BRACKET,HOSE
12	21627	1	NYLOCK NUT,3/8", NC
13	21832	1	CAPSCREW,3/4" X 2", NC
14	21827	1	NYLOCK NUT,3/4", NC
15	34117	2	ELBOW,1"MB X 1"MJ,FORGED
16	06500581	1	HOSE,1" X 97"
17	06400812	1	HOSE,1" X 197"
18	---	1	COOLER,FRONT MNT ASSEMBLY
19	----	1	JOHN DEERE BELT (EXISTING)
20	SJ23950	1	PULLEY KIT
21	06420116	1	DRIVE SHAFT
	06420166	1	DRIVE SHAFT
22	6T0375B	1	COUPLING
23	TF4854	1	KIT,FLANGE #24
24	23438	1	PUMP
25	06503174	1	KIT,FLANGE,#12
26	06503198	1	ELBOW,3/4" MJ X 12FL45°
27	06500811	1	HOSE,1" X 182"
28	06500746	1	HOSE,1-1/2" X 107"
29	TF4852	1	KIT,FLANGE,#20
30	30708	1	CAPSCREW,20MM X 90MM, 2.5P
31	33880	1	FLATWASHER,3/4"
32	TB3012	2	CLAMP,CROSSOVER TUBE
33	21727	1	NYLOCK NUT,1/2", NC
34	22018	1	FLATWASHER,1/2",WIDE
35	21732	1	CAPSCREW,1/2" X 1- 3/4" NC
36	----	1	HOSE (SEE BOOM MOUNT KIT)
37	---	1	HOSE (SEE BOOM MOUNT KIT)
38	33555	4	ADAPTER,1"MB X 1"MJ
39	06510083	1	BRAKE VALVE
40	06500496	1	HOSE,3/4" X 50"
41	35280	1	ADAPTER, 1-1/4"FJ X 3/4" MJ
42	34656	1	TEE,RUN,1-1/4" ORB X 1-1/4" MJ X 1-1/4"
43	34067	1	ADAPTER,1-1/4" MOR X 1-1/4" MJ
44	33259	2	ELBOW,1" MJ X 1" FJX 90°
45	06506012	2	U-TUBE, PREFORMED

JD6XXXE BENGAL

COOLER MOUNT

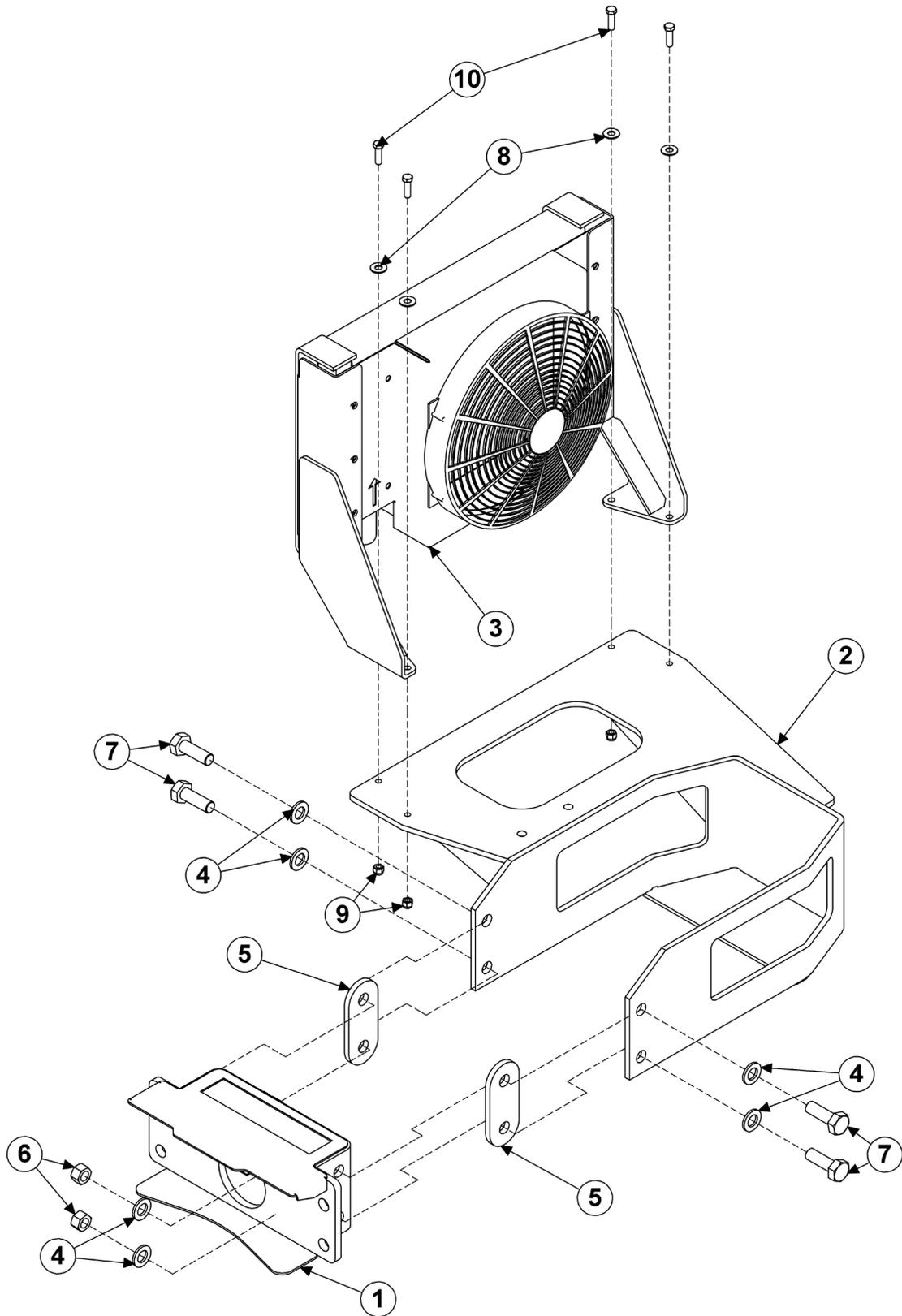

COOLER MOUNT

Continued...

ITEM	PART NO.	QTY.	DESCRIPTION
1	06380061	1	MNT, PUMP, HYDRO, T4, JD6XXXD
2	06380072	1	MNT, COOLER, FRONT
3	06510350	1	COOLER, ADAMS, LEGACY
4	33880	8	FLATWASHER, 3/4" GR8 SAE
5	06400165	2	SPACER, COOLER, FRONT
6	21825	4	HEX NUT, 3/4" NC
7	21833	4	CAPSCREW, 3/4" X 2-1/4" NC
8	22016	4	FLATWASHER, 3/8" GR8
9	21627	4	NYLOCK NUT, 3/8" NC
10	21631	4	CAPSCREW, 3/8" X 1/4" NC, GR8

BOOM MOUNT KIT

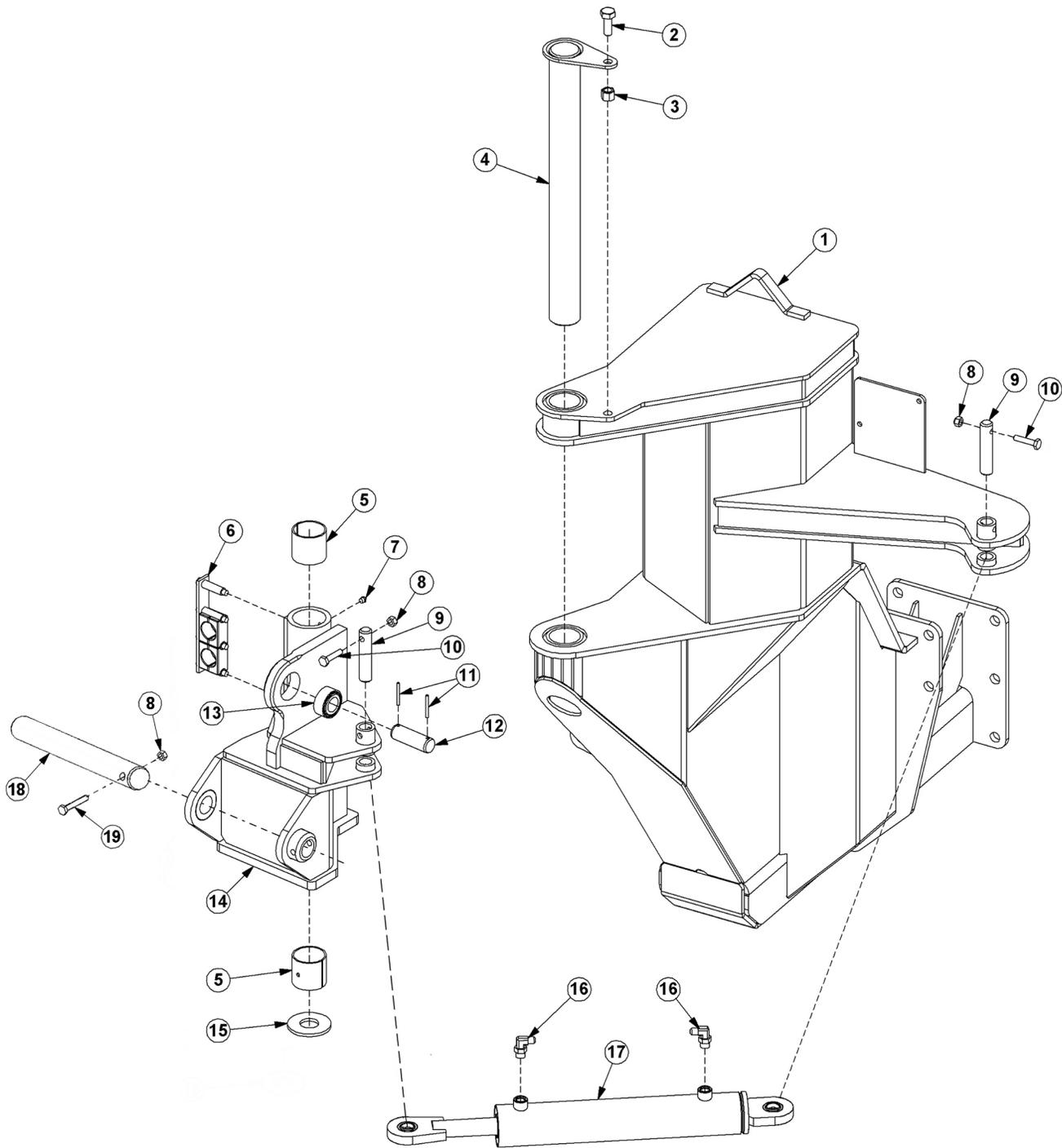

BOOM MOUNT KIT

Continued...

ITEM	PART NO.	QTY.	DESCRIPTION
1	-----	-	MAINFRAME *REFER TO TRACTOR MOUNT KIT
2	21782	1	CAPSCREW,5/8" X 1-3/4",NC
3	21777	1	NYLOCK NUT,5/8",NC
4	32381	1	PIN,CAPPED
5	32322	2	BUSHING
6	06505185	1	CLAMP KIT
7	6T3211	2	GREASE ZERK,1/8"NPT
8	21677	3	NYLOCK NUT,7/16",NC
9	32380	2	PIN,1"
10	21683	2	CAPSCREW,7/16" X 2",NC
11	TB1023	2	ROLL PIN
12	06420100	1	PIN,1-1/4"
13	-----	-	SPHERICAL BEARING *NOT FOR SALE
14	06700221	1	SWIVEL, T4F, BNGL, CPLT
15	06520250	1	BEARING,WASHER
16	32810	2	ADAPTER,ELBOW
17	06501029	1	CYLINDER,3" X 13.88"
18	06420022	1	PIN, 1/5" X 12"
19	21688	1	CAPSCREW, 7/16" X 3-1/4"

ELECTRONIC PROPORTIONAL LIFT VALVE MOUNT

HOSE ROUTING

- A - TO MAIN BOOM CYLINDER GLAND
- B - TO MAIN BOOM CYLINDER BUTT
- E - LINE FROM LIFT VALVE TO ACCUMULATOR
- F - TO SECONDARY BOOM CYLINDER BUTT
- G - TO SECONDARY BOOM CYLINDER GLAND
- H - TO DECK ROLL CYLINDER BUTT
- J - TO DECK ROLL CYLINDER GLAND
- K - TO BOOM SWIVEL CYLINDER BUTT
- L - TO BOOM SWIVEL CYLINDER GLAND
- M - TO SAFETY SHIELD CYLINDER GLAND
- N - TO SAFETY SHIELD CYLINDER BUTT

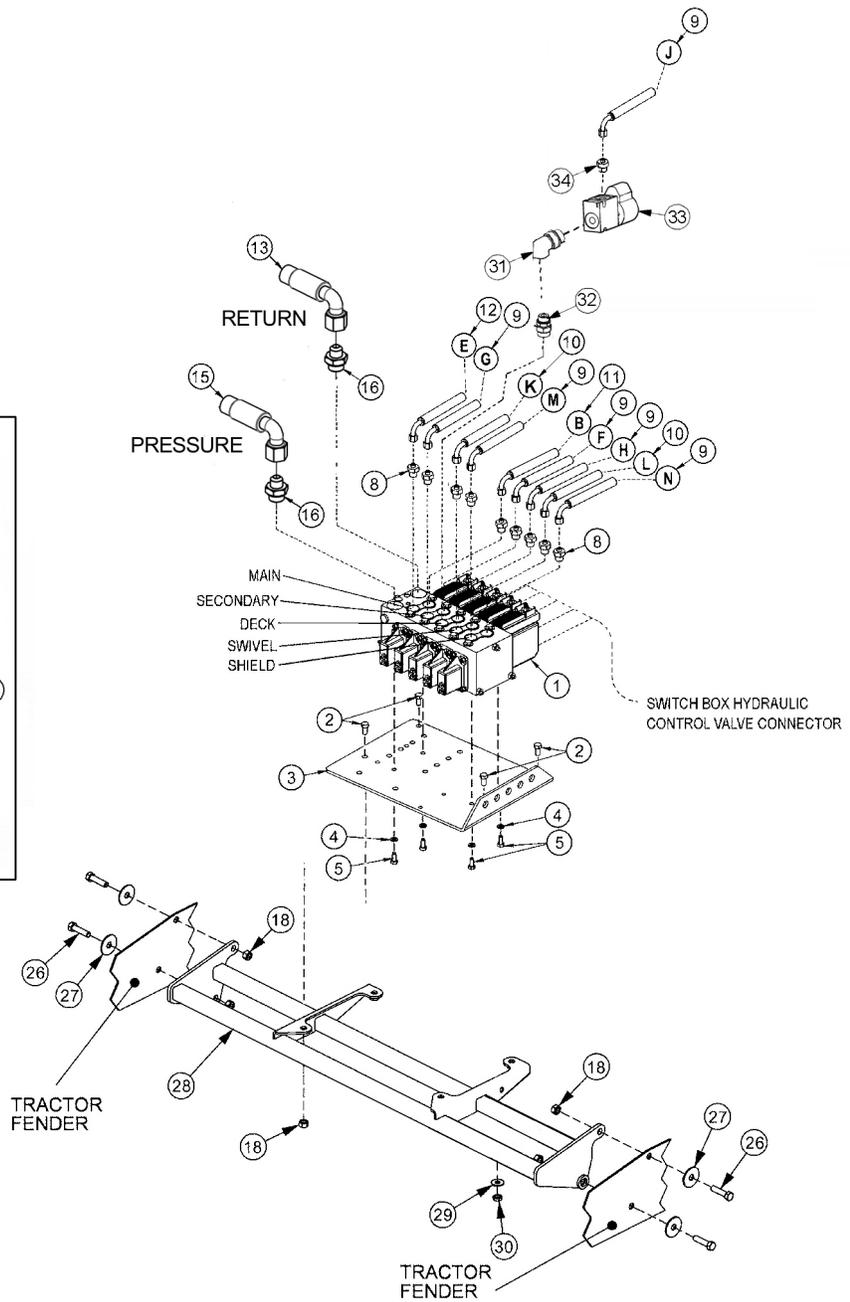
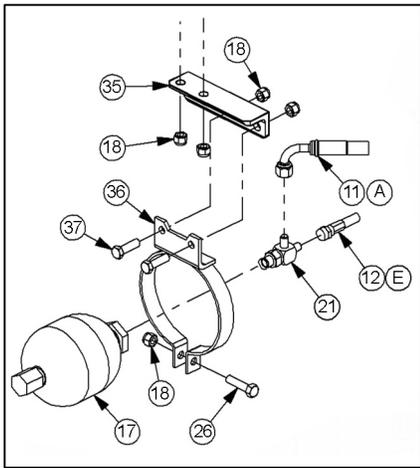

ITEM	PART NO.	QTY.	DESCRIPTION
1	06700224	1	ELECTRONIC VALVE
2	21630	4	CAPSCREW, 3/8" X 1", NC
3	34622	1	PLATE, VALVE, REAR MNT
4	21987	4	LOCKWASHER, 5/16"
5	21579	4	CAPSCREW, 5/16" X 3/4", NC
8	32807	9	ADAPTER, 5/8" MB X 3/8" MJ
9	06500687	6	HOSE, 1/4" X 268"

ELECTRONIC PROPORTIONAL LIFT VALVE MOUNT

Continued...

ITEM	PART NO.	QTY.	DESCRIPTION
10	06500697	2	HOSE,1/4" X 210"
11	06500688	2	HOSE,1/4" X 288"
12	33411	1	HOSE,1/4" X 24"
13	06500496	1	HOSE,3/4" X 52"
15	06500811	1	HOSE, 3/4" X 182
16	33280	1	ELBOW,3/4" MJ X 3/4" MB ADJUSTABLE
17	24300	1	ACCUMULATOR
18	21627	9	NYLOCK NUT,3/8",NC
19	-----	-	CAPSCREW *REFER TO BOOM MNT KIT PAGE
21	0503029	1	TEE,RUN,1/2" MB X 3/8" MJ X 3/8" MJ
26	21632	4	CAPSCREW,3/8" X 1-1/2",NC
27	6T2615	4	WASHER,FENDER,3/8"
28	06340033	1	VALVE MOUNT
29	22015	1	FLATWASHER,5/16"
30	21577	1	NYLOCK NUT,5/16",NC
31	33382	1	ELBOW, 1/2" MB X 1/2" MJ
32	06503041	1	ADAPTER, 5/8" ORB X 1/2" FJX
33	06510050	1	TRAVEL LOCK, METRIPACK COIL
34	33271	1	ADAPTER, 1/2" MOR X 3/8" MJ
35	06500072	1	BRACKET
36	23888	1	BRACKET, ACCUMULATOR
37	21631	1	CAPSCREW, 3/8" X 1-1/4" NC

JOYSTICK AND SWITCHBOX MOUNT

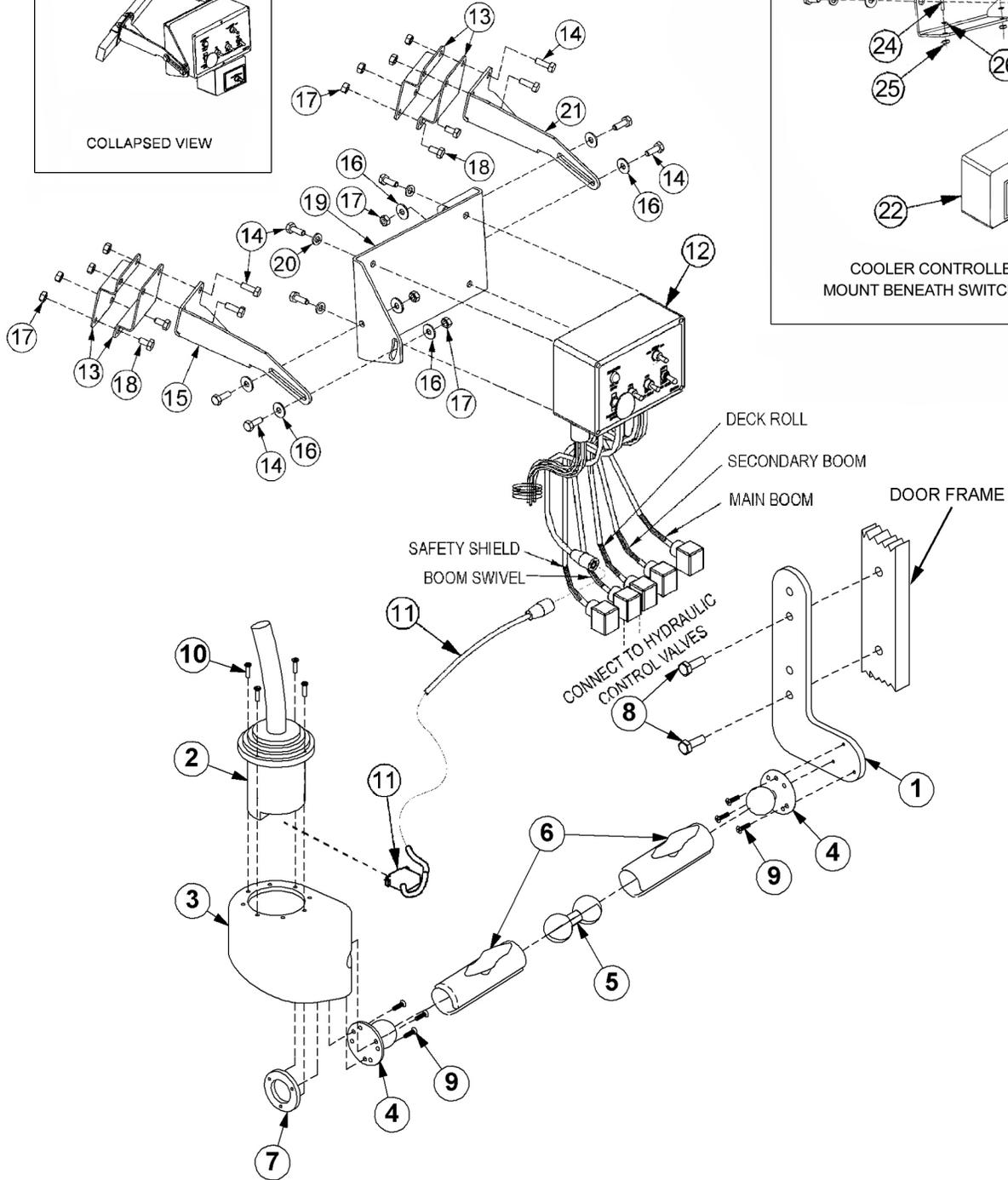
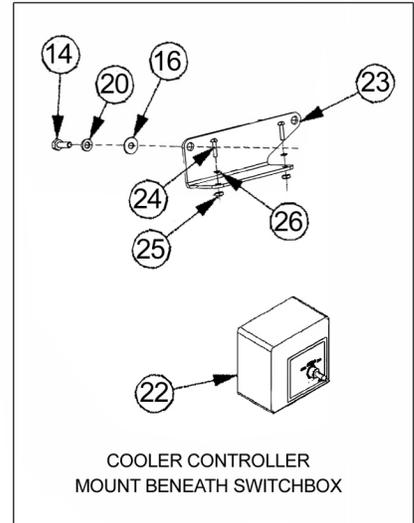
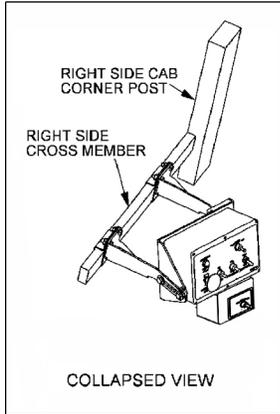

JOYSTICK AND SWITCHBOX MOUNT

Continued...

ITEM	PART NO.	QTY.	DESCRIPTION
1	06340031	1	MT,BRKT,JYSTK
2	33691	1	JOYSTICK
3	06770022	1	CAN,JOYSTICK
4	06520019	2	MOUNT,RAM BALL,1-1/2",FLANGE
5	06520290	1	MOUNT,RAM,BALL,DBL,1-1/2"
6	06520020	2	MOUNT,RAM,ARM,1-1/2" X 4-5/8",STD
7	06400882	1	RING,BOLT,MNT,JYSTK
8	23113	2	CAPSCREW,10MM X 30MM,1.5P
9	32990	6	SCREW,MACHINE,10-32 X 1/2",RD HD
10	32829	4	SCREW,MACHINE,10-32 X 3/4",FLT HD
11	33693	1	CBL,EXT,4FT
12	06510196	1	SWITCH BOX,DF,BOOM
13	06411086	4	BRKT,MNT
14	21529	10	CAPSCREW,1/4" X 3/4",NC
15	06411087	1	BRKT,STABILIZING,LT
16	22014	10	FLATWASHER,1/4"
17	21527	12	NYLOCK NUT,1/4",NC
18	21528	4	CAPSCREW,1/4" X 1/2",NC
19	06411116	1	BRKT,MNT,SWITCH BOX
20	21986	6	LOCKWASHER,1/4"
21	06411378	1	BRKT,STABILIZING,RT
22	06510045	1	CONTROLLER, COOLER FAN
23	06412310	1	MNT, 06380080
24	32359	2	SCREW, MACHINE, 8-32 X 3/4"
25	32360	2	LOCKWASHER, #8
26	32361	2	HEX NUT, #8 (INSIDE BOX)

CABLE (MANUAL) LIFT VALVE - 5 SPOOL

HOSE ROUTING

- A - TO MAIN BOOM CYLINDER BUTT
- B - TO SECONDARY CYLINDER GLAND
- C - TO DECK ROLL CYLINDER GLAND
- D - TO SWIVEL CYLINDER GLAND
- E - TO SHIELD CYLINDER GLAND
- F - TO ACCUMULATOR
- G - TO SECONDARY CYLINDER BUTT
- H - TO DECK ROLL CYLINDER BUTT
- J - TO SWIVEL CYLINDER BUTT
- K - TO SHIELD CYLINDER BUTT
- M - TO MAIN BOOM CYLINDER GLAND

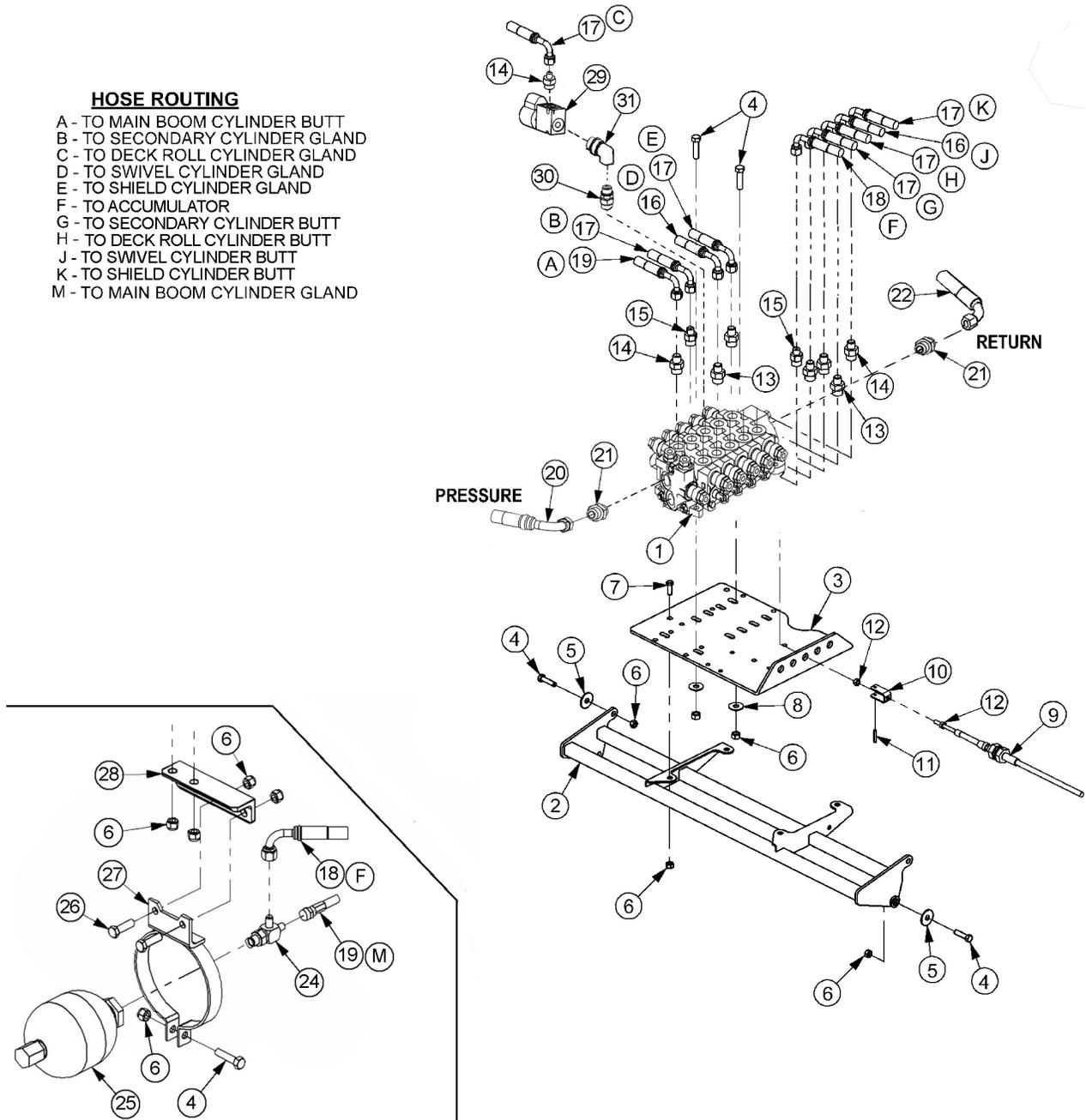

CABLE (MANUAL) LIFT VALVE - 5 SPOOL

Continued...

ITEM	PART NO.	QTY.	DESCRIPTION
1	06502182	1	VALVE,5SP,OC
2	06340033	1	VALVE MNT
3	34622	1	PLATE,VALVE,REAR MNT
4	21632	8	CAPSCREW,3/8" X 1-1/2",NC
5	6T2615	4	WASHER,FENDER,3/8"
6	21627	12	NYLOCK NUT,3/8",NC
7	21630	4	CAPSCREW,3/8" X 1",NC
8	22016	4	FLATWASHER,3/8"
9	06505100	5	CBL,CNTRL,108"
10	6T4411	5	CLEVIS,CBL CTRL,3/16"
11	6T3017	5	ROLLPIN,3/16" X 1"
12	21500	5	HEX NUT,1/4",NF
13	34396	2	ADAPTER,.06"RSTRCTR,1/2"MOR X 3/8"MJ
14	33271	6	ADAPTER,1/2"MOR X 3/8"MJ
15	06502036	2	VLV,CHECK,W/.06"MOR X 1/2"MOR X 3/8"
16	06500688	2	HOSE,1/4" X 288"
17	06500687	6	HOSE,1/4" X 268"
18	33411	1	HOSE,1/4" X 24"
19	06500697	2	HOSE,1/4" X 210"
20	06500811	2	HOSE, 3/4" X 182"
21	06503023	3	ADAPTER, 3/4" ORB X 3/4" MJ
22	06500496	1	HOSE, 3/4" X 50"
24	06503029	-	TEE,RUN,1/2"MOR X 3/8"MJ X 3/8"MJ
25	24300	1	ACCUMULATOR
26	21631	2	CAPSCREW,3/8" X 1-1/4",NC
27	23888	1	BRACKET, ACCUMULATOR
28	06460072	1	BRACKET
29	06510050	1	TRAVEL LOCK, METRIPACK COIL
30	06503041	1	ADAPTER, 5/8" ORB X 1/2" FJX
31	33382	1	ELBOW, 1/2" MB X 1/2" MJ

5 SPOOL CABLE CONTROL MOUNT

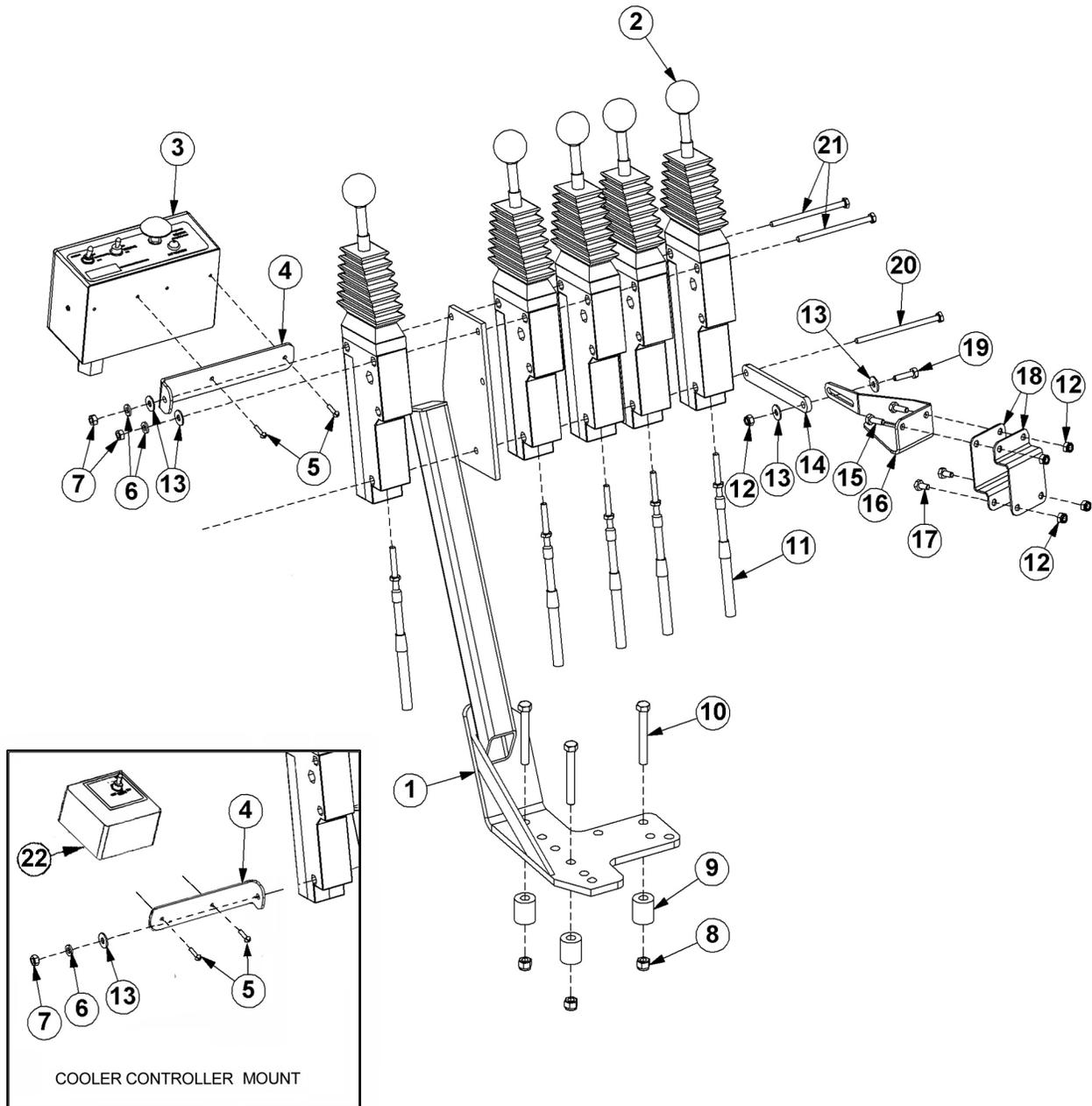

5 SPOOL CABLE CONTROL MOUNT

Continued...

ITEM	PART NO.	QTY.	DESCRIPTION
1	23865B	1	BRKT,CTRL,CBL
2	6T1251	5	CBL CTRL BOX,180 DEG
3	06510100	1	SWITCH BOX,BOOM
4	34496	2	BRKT,SWITCH BOX
5	6T3951	4	SCREW,MACHINE,8-32 X 1/2"
6	21986	3	LOCKWASHER,1/4"
7	21525	3	HEX NUT,1/4",NC
8	21627	3	NYLOCK NUT,3/8",NC
9	27082B	3	SPACER
10	21636	3	CAPSCREW,3/8" X 2-1/2",NC
11	06505100	5	CBL,CNTRL,108"
12	21527	5	NYLOCK NUT,1/4",NC
13	22014	5	FLATWASHER,1/4"
14	06402045	1	SUPPORT,STAND
16	06411087	1	BRKT,STABILIZER
17	21528	2	CAPSCREW,1/4" X 1/2",NC
18	06411086	2	BRKT,MNT
19	21530	1	CAPSCREW,1/4" X 1",NC
20	34332	1	CAPSCREW,1/4" X 9-1/4",NC
21	21548	2	CAPSCREW,1/4" X 9",NC
22	06510045	1	CONTROLLER, COOLER FAN

BATTERY RELOCATION

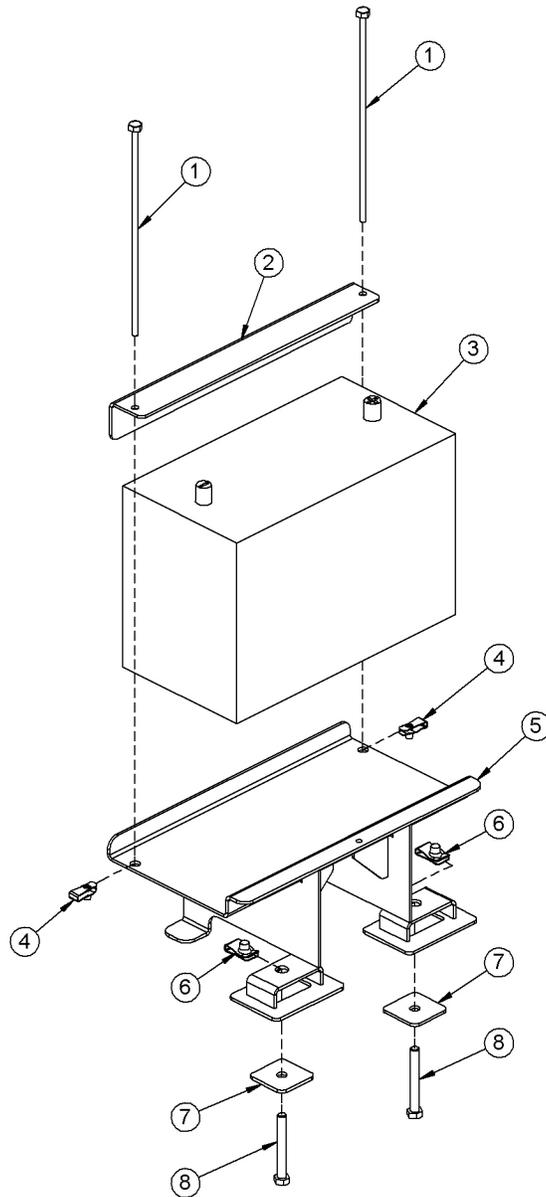

BATTERY RELOCATION

Continued...

ITEM	PART NO.	QTY.	DESCRIPTION
1	06530234	2	CAPSCREW,1/4" X 10",NC
2	06411429	1	ANGLE
3	-----	-	BATTERY *EXISTING PART
4	35176	2	NUT CLIP,1/4",NC
5	06370231	1	RELOCATION BRACKET
6	06537029	2	NUT CLIP,3/8",NC
7	06401784	2	SQUARE PLATE
8	21638	2	CAPSCREW,3/8" X 3",NC

BOOMREST - SINGLE COLUMN

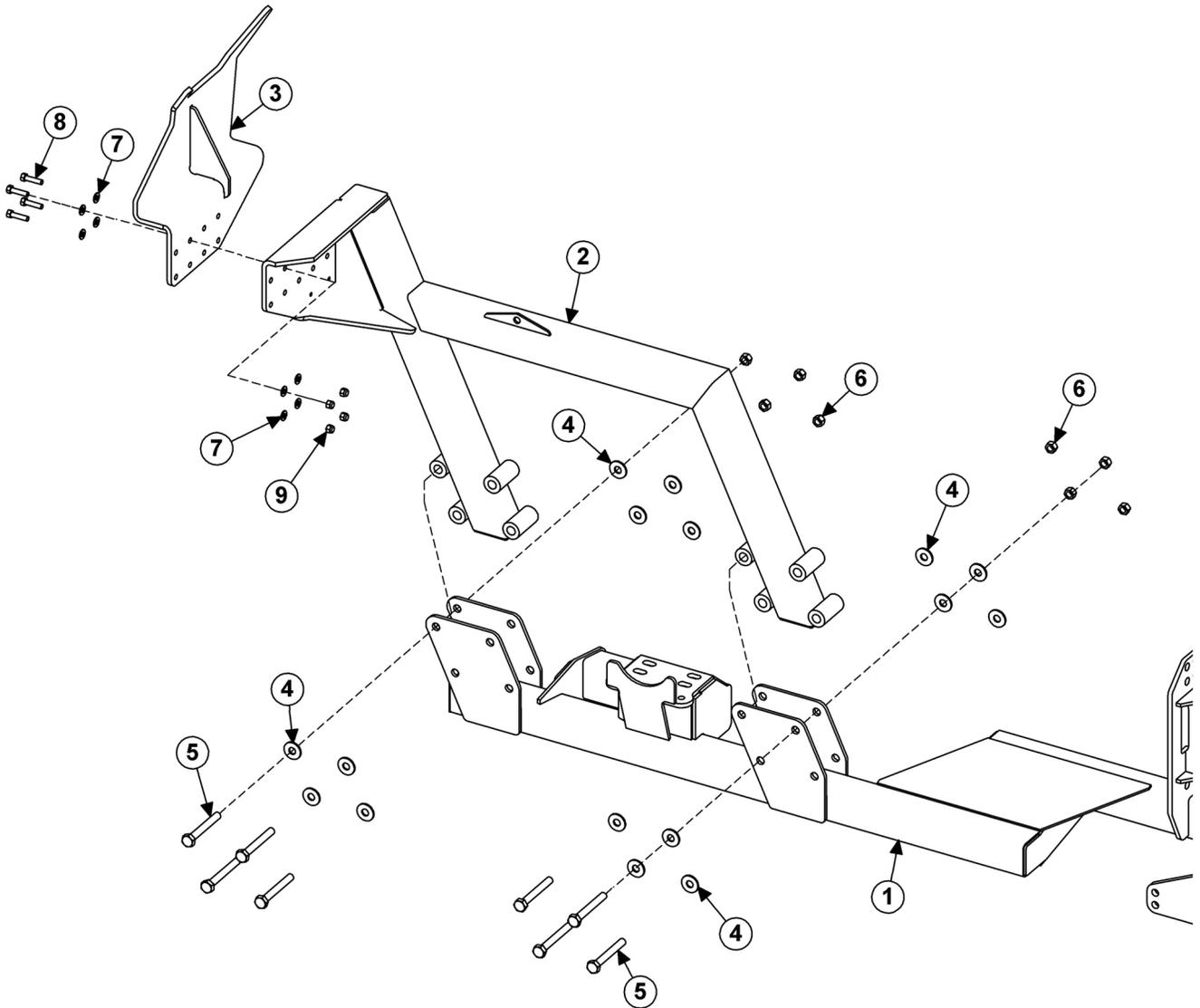

ITEM	PART NO.	QTY.	DESCRIPTION
1	06300324	1	MAINFRAME MNT, JD6E, SC, T4F
2	06310074	1	BOOMREST, SC
3	06310113	1	SADDLE, BOOMREST, 222
4	22021	16	FLATWASHER, 3/4"
5	21843	8	CAPSCREW, 3/4" X 6" NC
6	21825	8	HEX NUT, 3/4" NC
7	06533004	8	FLATWASHER, 1/2", SAE, GR8
8	21733	4	CAPSCREW, 1/2" X 2" NC
9	21727	4	NYLOCK NUT, 1/2" NC

BOOMREST - OPEN STOW

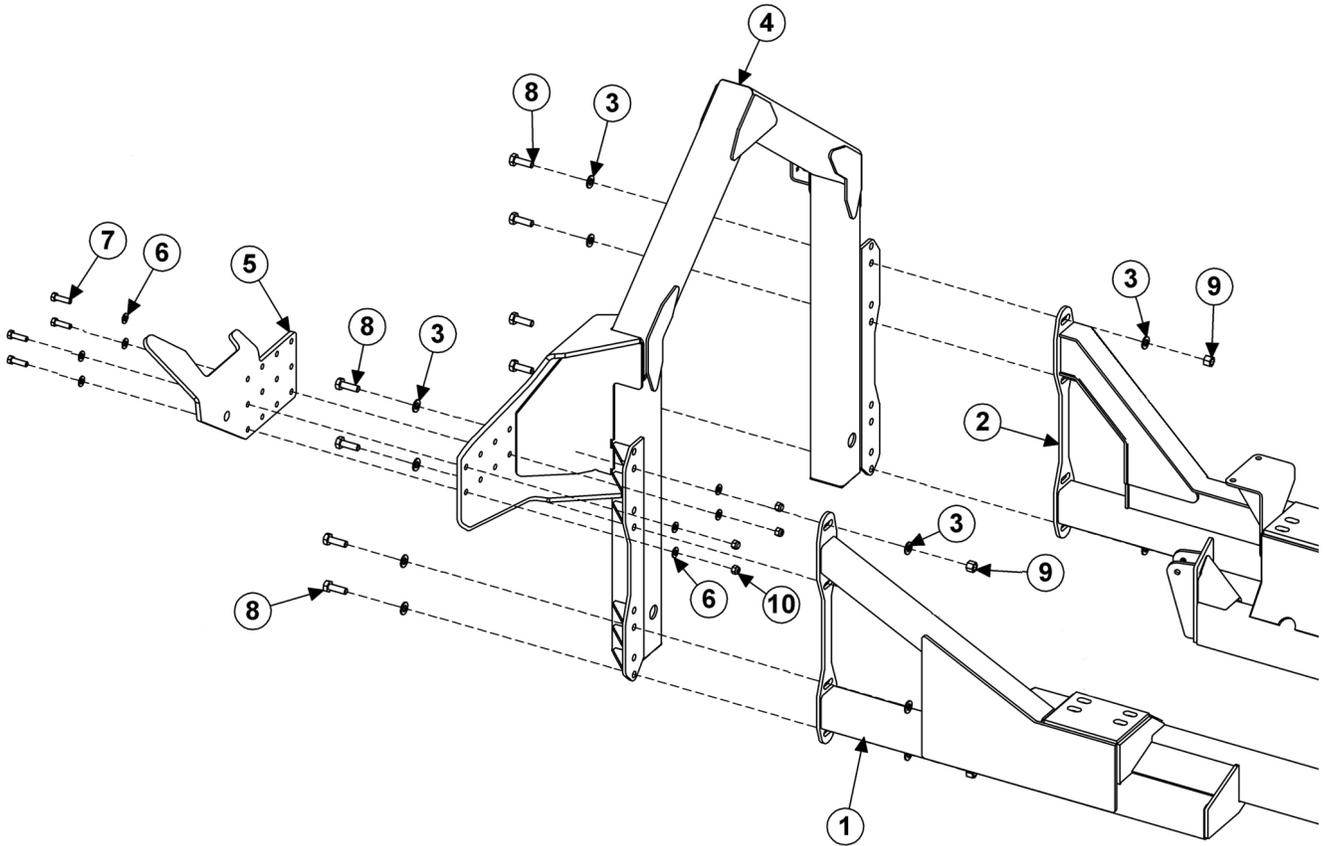

ITEM	PART NO.	QTY.	DESCRIPTION
1	06300317	1	MAINFRAME MNT, JD6E, RS, T4F
2	06300318	1	AXLE BRACE, LH, JD6E, RS, T4F
3	33764	16	FLATWASHER, 5/8", GR8, SAE
4	06310157	1	BOOMREST, OS, T4
5	06411166	1	SADDLE, T4, BENGAL
6	06533004	8	FLATWASHER, 1/2", SAE, GR 8
7	21732	4	CAPSCREW, 1/2" X 1-3/4" NC
8	21783	8	CAPSCREW, 5/8" X 2" NC
9	21777	8	NYLOCK HEX NUT, 5/8"
10	21727	4	NYLOCK NUT, 1/2" NC

POLYCARBONATE SAFETY WINDOW

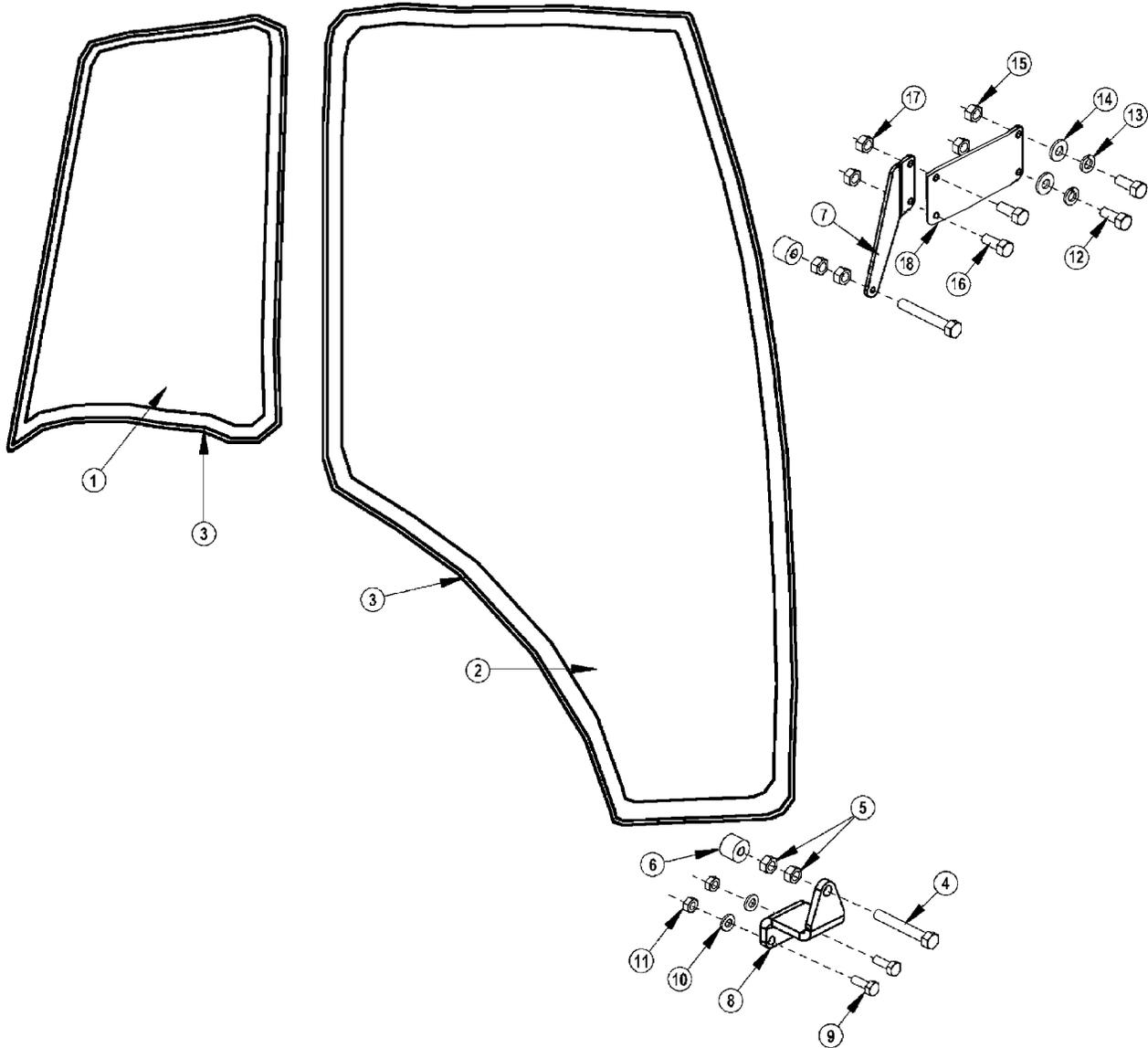

POLYCARBONATE SAFETY WINDOW

Continued...

ITEM	PART NO.	QTY.	DESCRIPTION
1	06490014	1	POLYCARB, FRMD, REAR
2	06490013	1	POLYCARB, FRMD, DOOR
3	31965	25	TRIM SEAL (IN FEET)
4	21584	2	CAPSCREW, 5/16" X 2",NC
5	21575	6	HEX NUT, 5/16" NC
6	33477	2	VIBRATION ISOLATOR
7	06410268	1	TOP BRACKET
8	06410269	1	BOTTOM BRACKET
9	21529	2	CAPSCREW, 1/4" X 3/4",NC
10	21986	2	LOCKWASHER, 1/4"
11	21525	2	HEX NUT, 1/4",NC
12	21581	2	CAPSCREW, 5/16" X 1-1/4",NC
13	6T2619	2	LOCKWASHER, 8MM
14	34948	2	WASHER, 8MM
15	21577	2	NYLOCK NUT, 5/16",NC
---	06537005	1	3M ADHESIVE
16	6T2491	2	CAPSCREW, 8MM X 30MM, 1.25P
17	-----	-	HEX NUT (EXISTING HARDWARE)
18	06402263	1	BRKT, MIRROR, RELOCATING

FIRE EXTINGUISHER OPTION

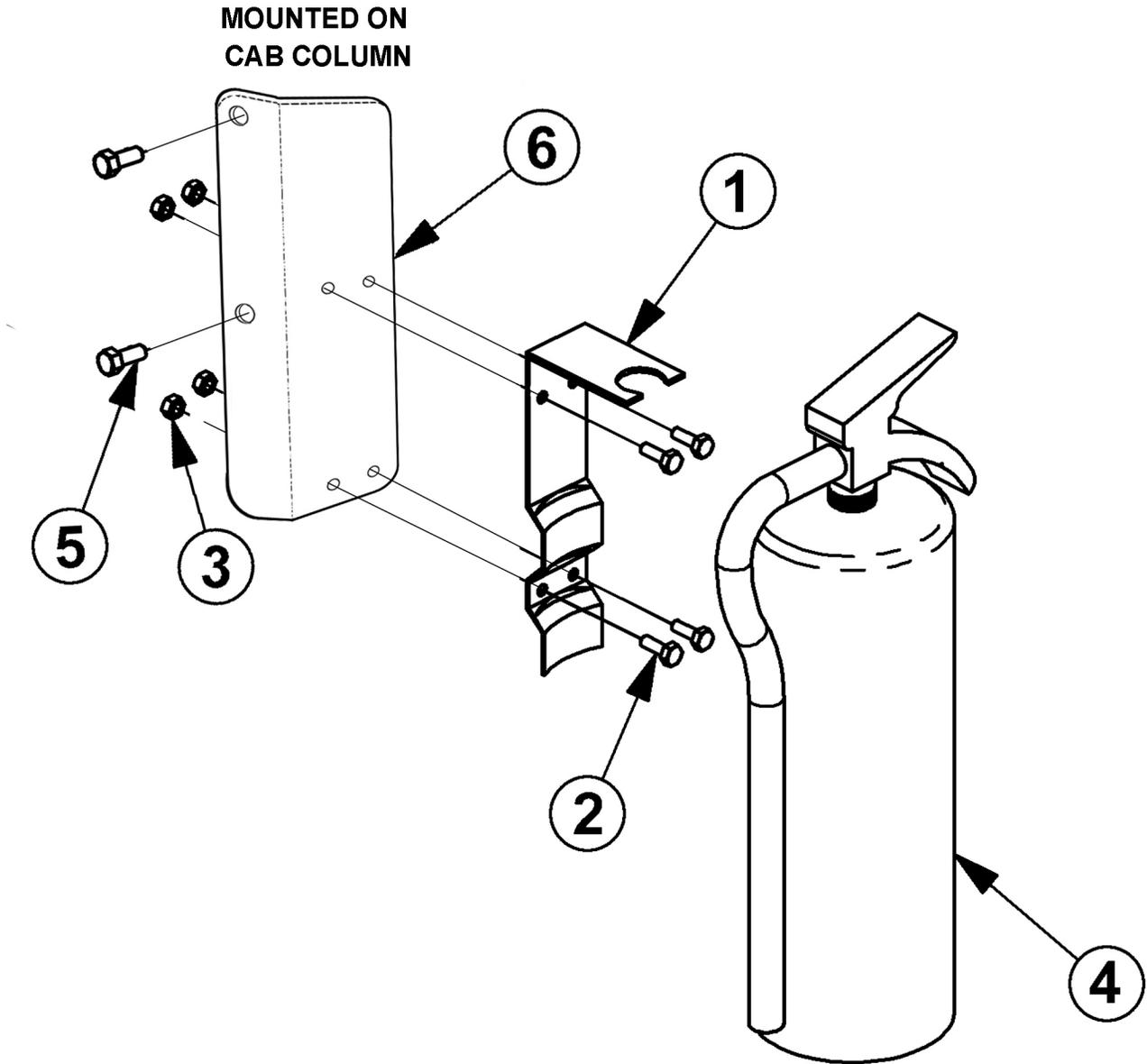

FIRE EXTINGUISHER OPTION

Continued...

ITEM	PART NO.	QTY.	DESCRIPTION
1	32212	1	FIRE EXTINGUISHER BRACKET
2	21529	4	CAPSCREW, 1/4" X 3/4" NC
3	21527	4	HEX NUT, NYLOCK, 1/4" NC
4	32212	1	FIRE EXTINGUISHER
5	33524	2	CAPSCREW, 10MM X 20MM
6	06410962	1	MNT, FIRE EXTINGUISHER

BULKHEAD HYDRAULICS - BOOM MOWER

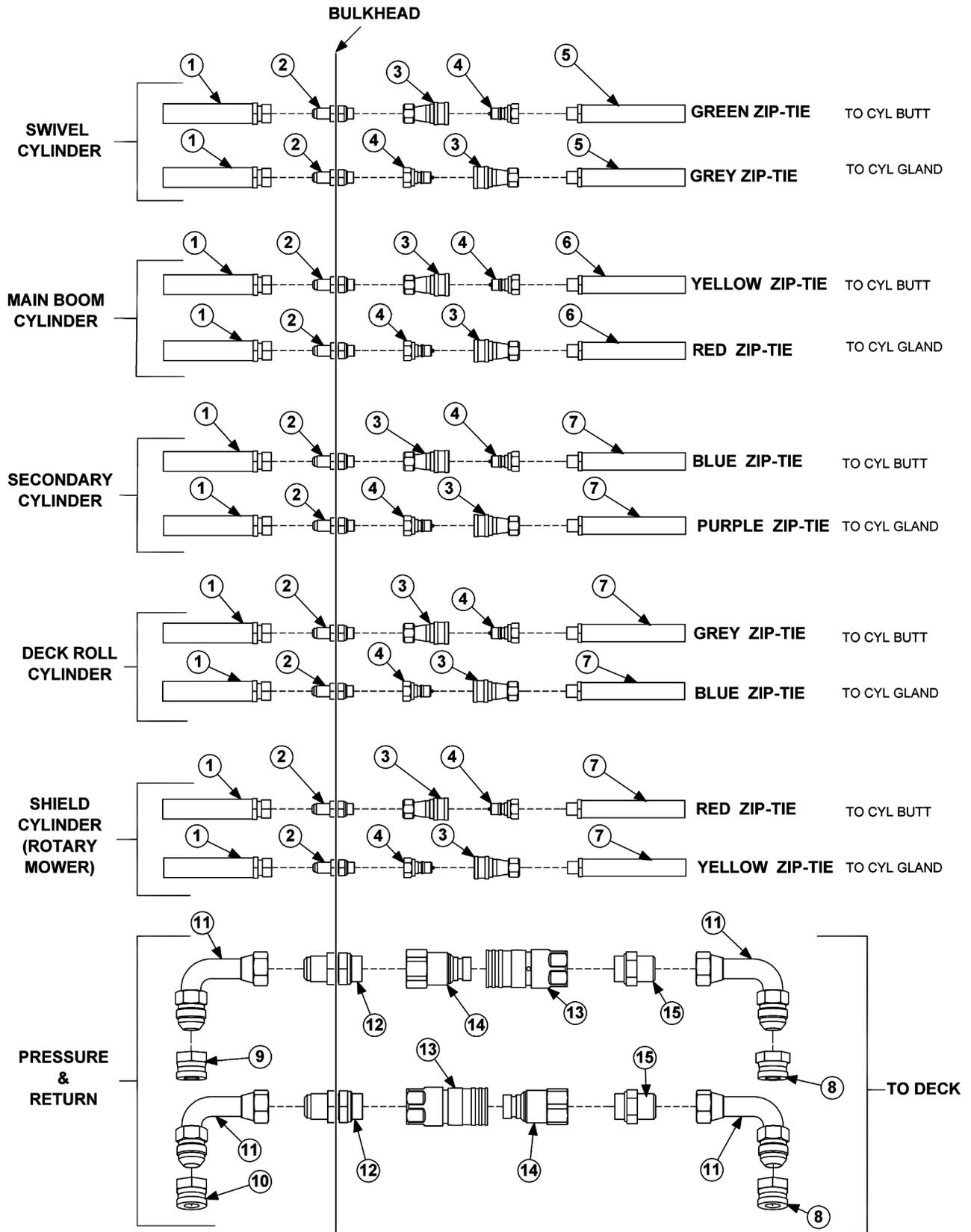

BULKHEAD HYDRAULICS - BOOM MOWER

Continued...

ITEM	PART NO.	QTY.	DESCRIPTION
1	33745	10	HOSE,#4X100(6FJX90X6FJX)
2	33289	10	FITTING,BULKHEAD,3/8MJX3/8MOR
3	06520408	10	CAP,QCK CPLR,#6X4,FEM,06503126
4	06520407	10	CAP,QCK CPLR,#6X4,MALE,6503125
5	06500892	2	HOSE,#4X71(6MBX6FJX)
6	06500892	2	HOSE,#4X71(6MBX6FJX)
7	06500890	6	HOSE,#4X77(5MJX6MB)
8	06500395	2	HOSE,#16X149(16FJXX16FJX)
9	34383	1	HOSE,#16X100(16FJXX16FJX90)
10	06500209	1	HOSE,#16X138(16FJXX20FL45)
11	06503200	2	ELBOW,16MJX16FJX,BT90
12	33287	2	FITTING,BULKHEAD,1MJX1MOR
13	06503027	2	QCK CPLR,#16,FEM,FLAT
14	06503028	4	QCK CPLR,#16,MALE,FLAT
15	33555	2	ADAPTER,1MBX1MJ

BULKHEAD DIAGRAM

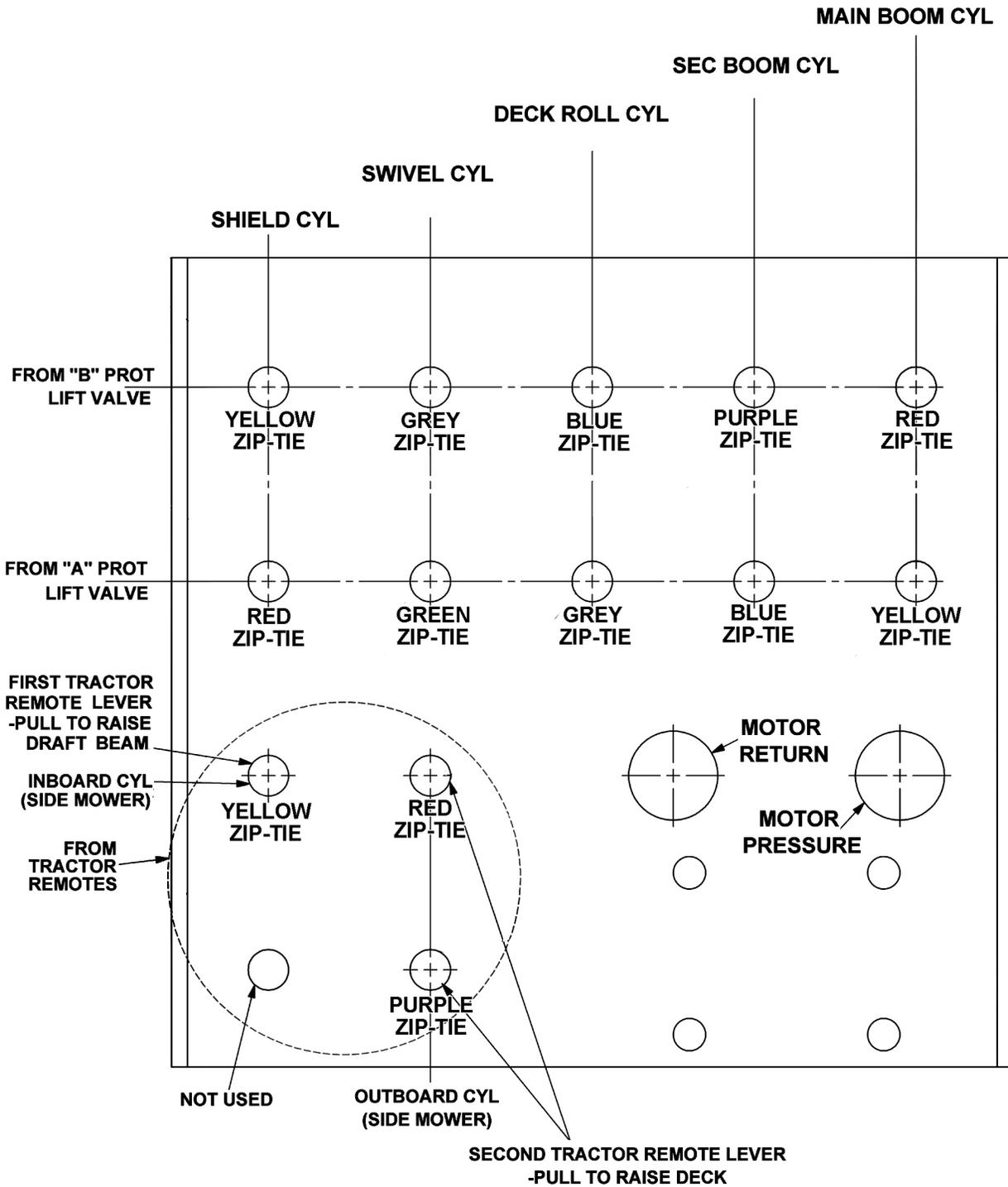

AXLE STABILIZER

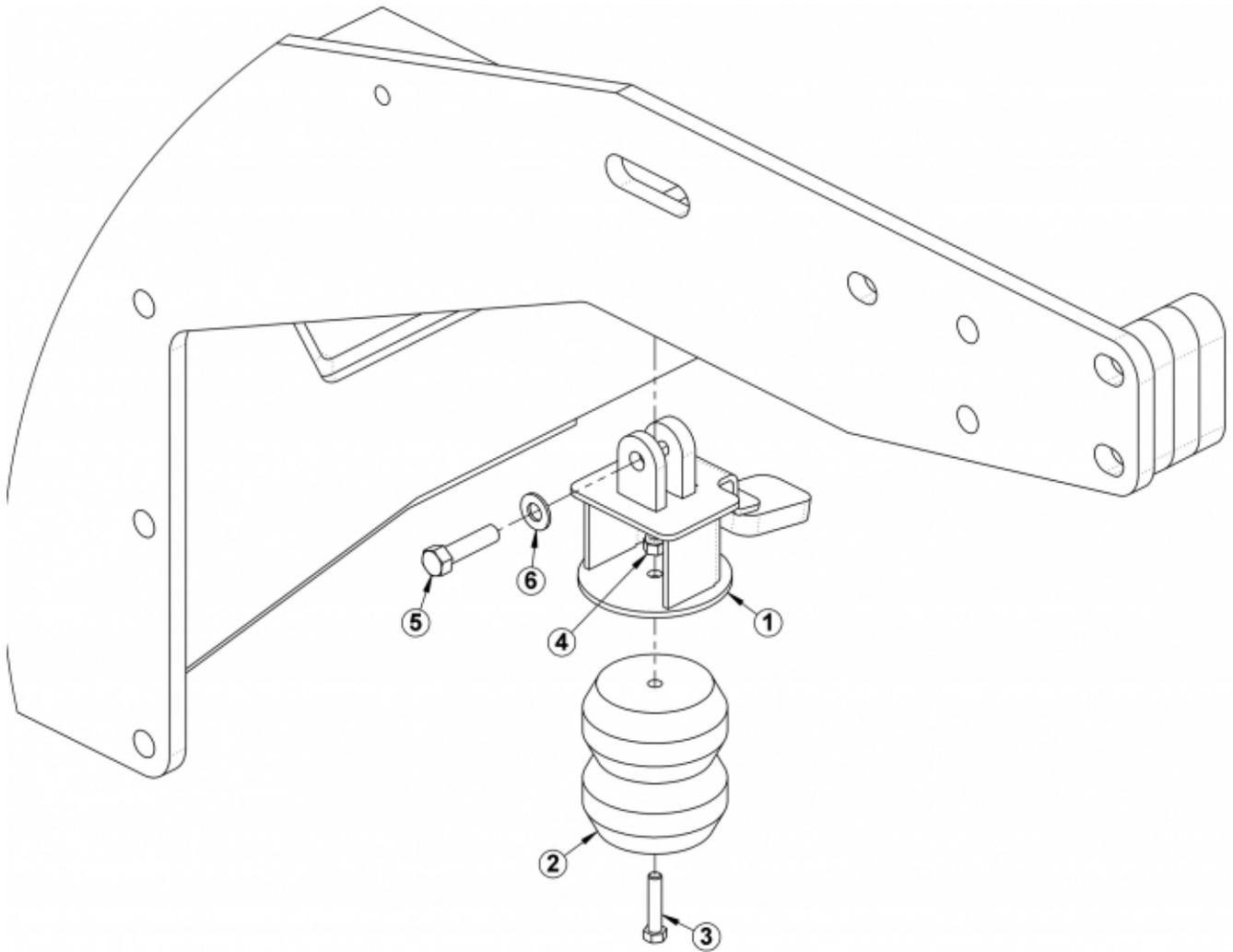

ITEM	PART NO.	QTY.	DESCRIPTION
1	06370313	1	MNT,TIMBREN,JD6E
2	06520579	1	SUSPENSION,TIMBREN,AEON
3	21633	1	CAPSCREW,3/8X1 3/4NC,GR8
4	21627	1	NYLOCK NUT,3/8",NC
5	21733	1	CAPSCREW, 1/2 X 2,NC
6	06533004	1	FLAT WASHER,1/2,SAE,GR 8

WHEEL WEIGHT

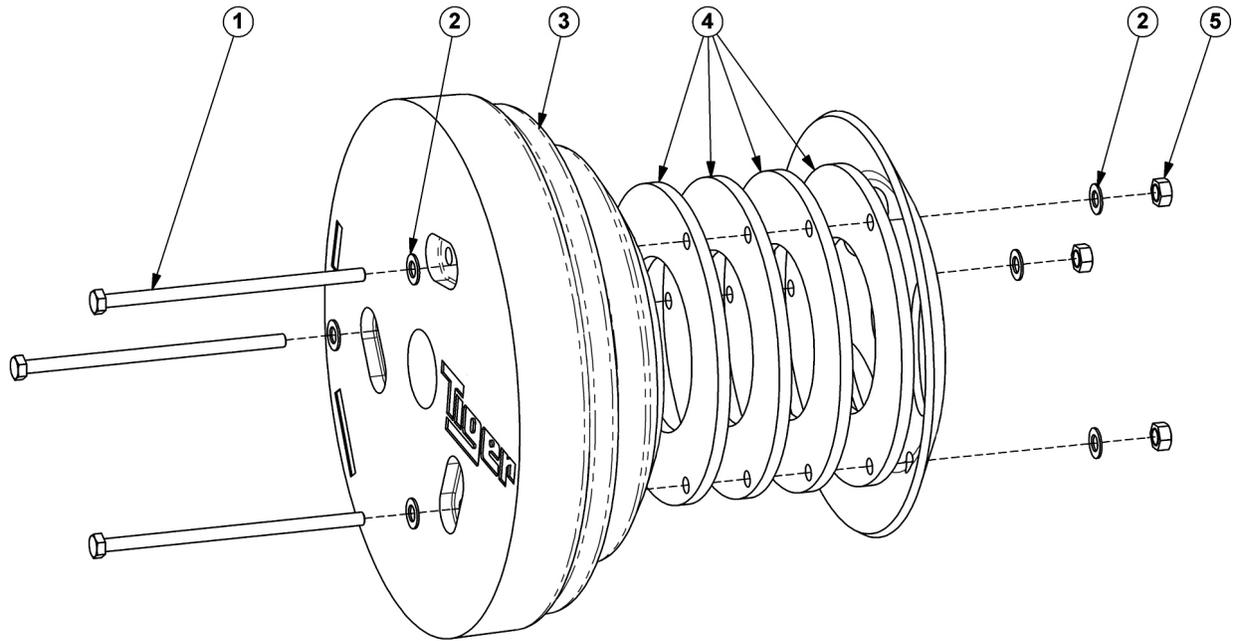

ITEM	PART NO.	QTY.	DESCRIPTION
1	06530213	3	CAPSCREW, 7/8" X 16", NC, GR8
2	06533000	6	FLATWASHER, 7/8", GR8
3	32517	1	WHEEL WEIGHT, 1700#
4	06400410	4	SPACER
5	06531000	3	HEX NUT, 7/8", NC, GR8

PARTS SECTION

NOTES

PART NAME INDEX

PARTS ORDERING GUIDE.....	5
BOOM ASSY - BENGAL 18 T4.....	6
BOOM ASSY BENGAL STANDARD 22 T4.....	8
BOOM ASSY HYD BENGAL 22 T4.....	10
BOOM ASSY BENGAL EXT 24 T4.....	12
BOOM ASSY HYD BENGAL 24 T4.....	14
BOOMREST - OPEN STOW.....	16
50IN ROTARY MOWER ASSEMBLY.....	18
50IN ROTARY KNIVES AND DISH.....	20
50IN ROTARY BLADE BAR AND KNIVES.....	21
60IN ROTARY MOWER ASSEMBLY.....	22
60IN ROTARY KNIVES AND DISH.....	24
60IN ROTARY BLADE BAR AND KNIVES.....	25
ROTARY MOWER SPINDLE ASSEMBLY.....	26
BOOM ROTARY PIVOT ASSEMBLY.....	28
50IN FLAIL DRIVE ASSEMBLY.....	30
50IN FLAIL MOWER ASSEMBLY.....	32
50IN FLAIL MOWER ASSY, PASS-THROUGH KNIVES.....	34
63IN FLAIL DRIVE ASSEMBLY.....	36
63IN FLAIL MOWER ASSEMBLY.....	38
BOOM FLAIL PIVOT ASSEMBLY.....	40
3IN X 13-7/8 IN WELDED CYLINDER BREAKDOWN.....	42
3IN X 18IN WELDED CYLINDER BREAKDOWN.....	43
3-1/2IN X 20IN WELDED CYLINDER BREAKDOWN.....	44
4IN X 20IN WELDED CYLINDER BREAKDOWN.....	45
5IN X 20IN WELDED CYLINDER BREAKDOWN.....	46
NOTES.....	47
5 SPOOL ELECTRONIC VALVE - OPEN STOW,3PS.....	48
5 SPOOL ELECTRONIC VALVE - SIDE STOW.....	50
FRONT HYDRAULIC PUMP.....	52
50IN AND 60IN ROTARY MOTOR BREAKDOWN.....	54
FLAIL MOTOR BREAKDOWN.....	56
RESERVOIR TANK FILTER ASSEMBLY.....	58
PUMP AND GRILL GUARD OPTIONS.....	59
BOOM TRAVEL LOCK.....	60
MANUAL LIFT VALVE SWITCH BOX.....	61
MANUAL LIFT VALVE SCHEMATIC.....	62
ELECTRONIC LIFT VALVE SWITCH BOX.....	63
ELECTRONIC LIFT VALVE SCHEMATIC.....	64
SOLENOID SWITCH BOX AND WIRING.....	65

COMMON BENGAL T4

PART NAME INDEX

BRAKE VALVE ASSEMBLY.....	66
BRAKE VALVE HYDRAULIC SCHEMATIC.....	67
ELECTRICAL TROUBLESHOOTING GUIDE.....	68
HYDRAULIC TROUBLESHOOTING GUIDE.....	69
TROUBLESHOOTING.....	70
TROUBLESHOOTING - CONTINUED.....	71
WHEEL WEIGHT - BENGAL 18.....	72

PARTS ORDERING GUIDE

The following instructions are offered to help eliminate needless delay and error in processing purchase orders for the equipment in this manual.

1. The Parts Section is prepared in logical sequence and grouping of parts that belong to the basic machine featured in this manual. Part Numbers and Descriptions are given to help locate the parts and quantities required.
2. The Purchase Order must indicate the **Name and Address** of the person or organization ordering the parts, **who should be charged**, and if possible, the **serial number of the machine** for which the parts are being ordered.
3. The purchase order must clearly list the **quantity of each part**, the complete and correct **part number**, and the basic **name of the part**.
4. The manufacturer reserves the right to substitute parts where applicable.
5. Some parts may be unlisted items which are special production items not normally stocked and are subject to special handling. Request a quotation for such parts before sending a purchase order.
6. The manufacturer reserves the right to change prices without prior notice.

NOTE: When ordering replacement decals, refer to the part numbers and descriptions listed in the safety section in the front of this manual.

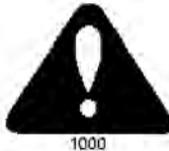

For maximum safety and to guarantee optimum product reliability, always use genuine **Tiger** replacement parts. The use of inferior replacement parts may cause premature or catastrophic failure which could result in serious injury or death.

Direct any questions regarding parts to:

Tiger Corporation
3301 N. Louise Ave.
Sioux Falls, SD 57107
1-800-843-6849
1-605-336-7900

BOOM ASSY - BENGAL 18 T4

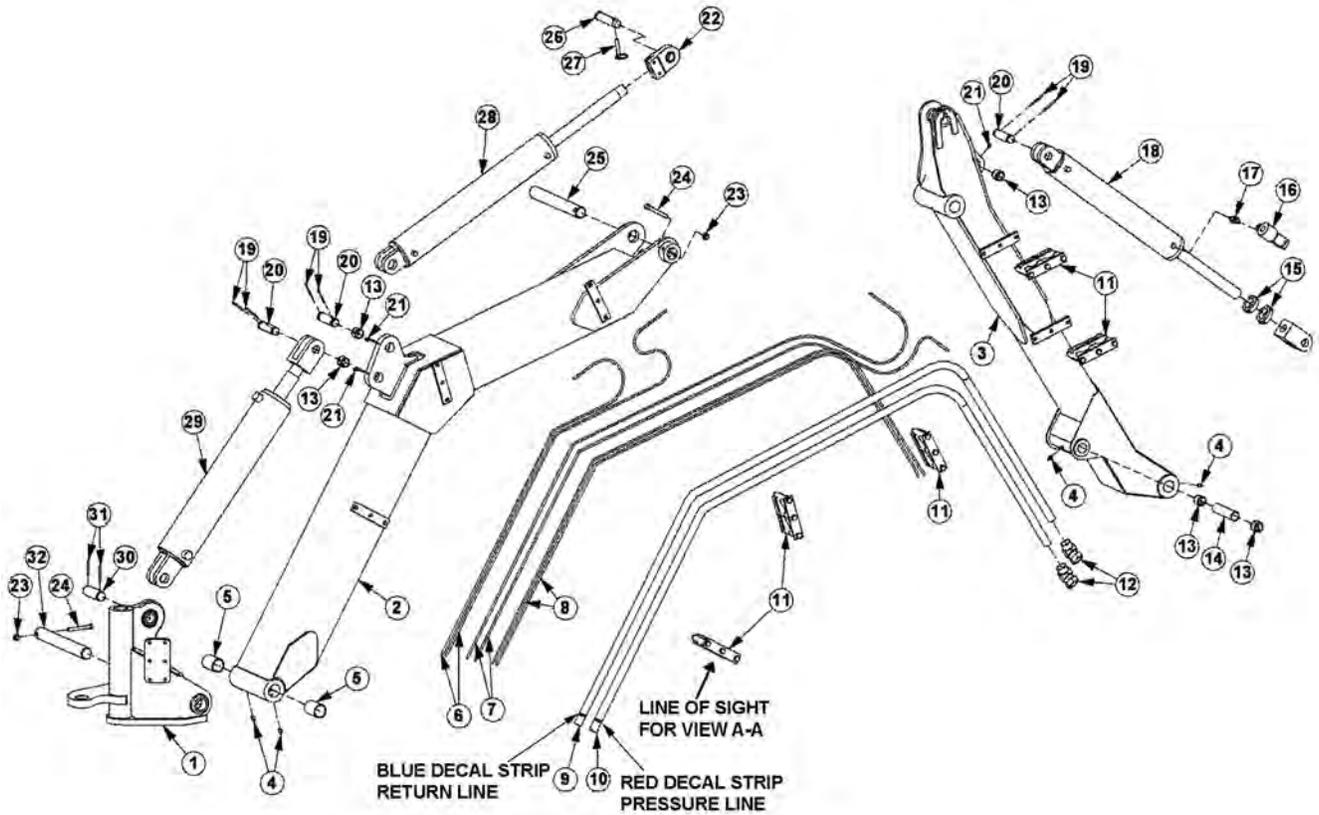

NOTES:

1. IMPORTANT: ALIGN GREASE HOLE OR GAP IN BEARING (ITEMS 5 & 13) WITH GREASE ZERK IN BOOM. MAINTAIN ALIGNMENT DURING BEARING INSTALLATION.
2. GREASE HINGE PIN ZERKS (ITEM 4) ON BOOM AFTER ASSEMBLY, ONCE UNDER LOAD WITH BOOM ELEVATED AND AGAIN AT REST WITH BOOM SUPPORTED.
3. ONLY ONE SET COLLAR (ITEM 15) NEEDED FOR ROTARY MOWERS.

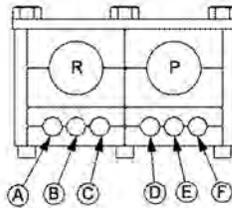

VIEW A-A

KEY

- A - SECONDARY BUTT
- B - SECONDARY GLAND
- C - DECK ROLL BUTT
- D - DECK ROLL GLAND
- E - SHIELD BUTT
- F - SHIELD GLAND
- R - RETURN
- P - PRESSURE

BOOM ASSY - BENGAL 18 T4

Continued...

ITEM	PART NO.	QTY.	DESCRIPTION
1	----	-	REAR STOW SWIVEL ASSY
2	06700167	-	MAIN BOOM ASSY
---	06310111	1	MAIN BOOM WELDMENT
3	06700168	-	SECONDARY BOOM ASSY
----	06310112	1	SECONDARY BOOM WELDMENT
4	6T3211	4	GREASE ZERK,1/8"
5	32321	2	BEARING, DX, 1-1/2" X 2"
6	06500499	2	HOSE,1/4" X 50"
7	06500500	2	HOSE,1/4" X 108"
8	06500502	2	HOSE,1/4" X 100"
9	06500713	1	HOSE,1" X 163"
10	06500714	1	HOSE,1" X 162"
11	06505116	2	CLAMP KIT
12	24724	2	SWIVEL,1MJ X 1FJX45
13	TB3010	3	BUSHING
14	TB1035	1	BUSHING,SPACER
15	35312	1	SET COLLAR
16	06510050	1	TRAVEL LOCK,METRIPACK COIL
17	31329	1	ADAPTER,1/2ORB X 1/2ORB ADJ
18	06501023	1	DECK ROLL CYLINDER,3" X 18"
19	06537021	6	ROLL PIN,5MM
20	TB1033	4	PIN,1"
21	6T3207	4	GREASE ZERK,1/4"
22	TB3033	1	CLEVIS WITH SPHERICAL BEARING
23	21677	2	NYLOCK NUT,7/16",NC
24	21688	2	CAPSCREW,7/16" X 3-1/4",NC
25	TB1025	1	PIN,1-1/2"
26	TB1036	1	PIN,1"
27	TF1143	1	PIN,LYNCH
28	06501024	1	SECONDARY CYLINDER,3-1/2" X 20"
29	06501022	1	MAIN CYLINDER,4" X 20"
30	06420100	1	PIN,1-1/4"
31	TB1023	2	ROLL PIN,7/32"
32	TB3013C	1	PIN,1-1/2"

COMMON BENGAL T4

BOOM ASSY BENGAL STANDARD 22 T4

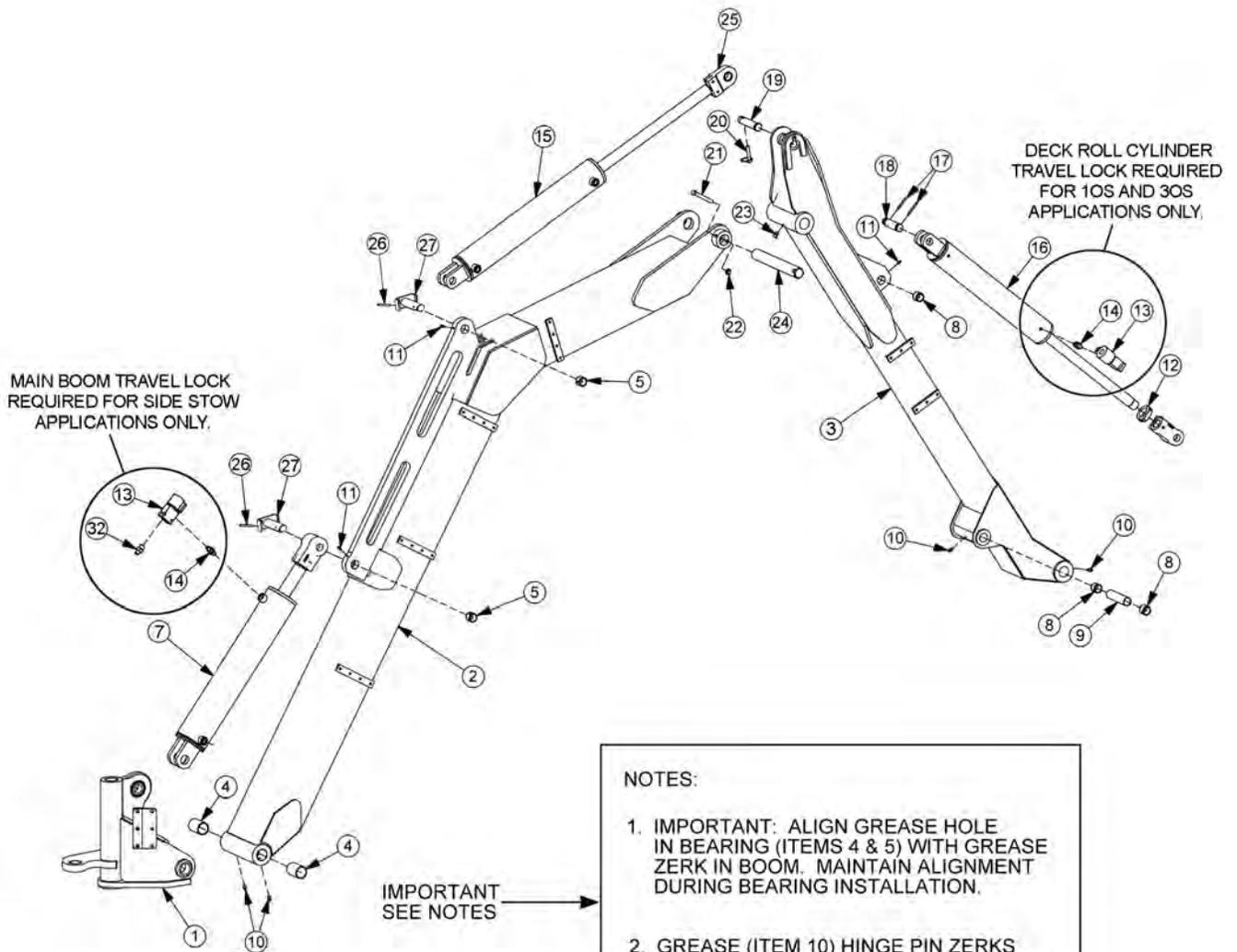

NOTES:

1. IMPORTANT: ALIGN GREASE HOLE IN BEARING (ITEMS 4 & 5) WITH GREASE ZERK IN BOOM. MAINTAIN ALIGNMENT DURING BEARING INSTALLATION.
2. GREASE (ITEM 10) HINGE PIN ZERKS ON BOOM AFTER ASSEMBLY, ONCE UNDER LOAD WITH BOOM ELEVATED AND AGAIN AT REST WITH BOOM SUPPORTED.

BOOM ASSY BENGAL STANDARD 22 T4

Continued...

ITEM	PART NO.	QTY.	DESCRIPTION
1	-----	-	SWIVEL ASSY *REFER TO TRACTOR MOUNT KIT
2	06700189	1	MAIN BOOM, T4
3	24517	1	SECONDARY BOOM ARM ASSY
4	32321	2	BEARING, DX, 1-1/2" X 2"
5	TB1044	2	BUSHING, 1-1/4"ID
7	06501020	1	CYLINDER, 5" X 20"
8	TB3010	3	BUSHING, 1"ID
9	TB1035	1	BUSHING,SPACER
10	6T3211	4	GREASE ZERK,1/8"
11	6T3207	3	GREASE ZERK,1/4
12	35312	1	SET COLLAR
13	06510050	1	TRAVEL LOCK,METRIPACK COIL
14	31329	1	ADAPTER,1/2ORB X 1/2ORB ADJ
15	06501022	1	CYLINDER, 4" X 20"
16	06501023	1	CYLINDER,3" X 18"
17	06537021	6	ROLL PIN,5MM
18	TB1033	1	PIN,1" X 4"
19	TB1036	1	PIN,1" X 4-11/16"
20	TF1143	1	PIN,LYNCH
21	21688	2	CAPSCREW,7/16" X 3-1/4",NC
22	21677	2	NYLOCK NUT,7/16",NC
23	6T3210	1	GREASE ZERK,1/8" X 90
24	TB1025	1	PIN,1-1/2" X 12"
25	30172	1	CLEVIS,SPHERICAL
26	6T3014	2	ROLL PIN, 1/4" X 2"
27	TB1045B	2	PIN, PRIMARY CYLINDER

BOOM ASSY HYD BENGAL 22 T4

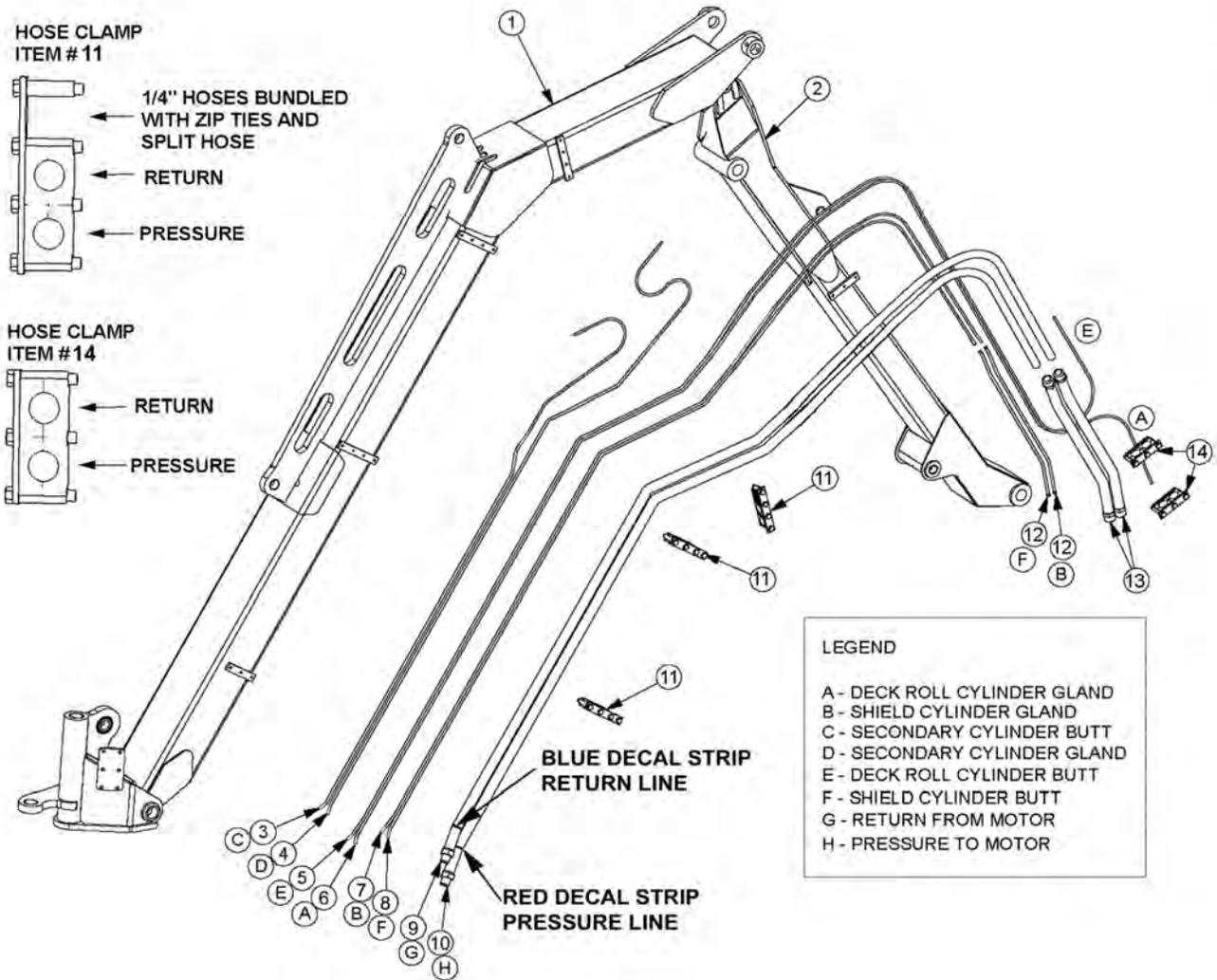

BOOM ASSY HYD BENGAL 22 T4

Continued...

ITEM	PART NO.	QTY.	DESCRIPTION
1	-----	-	MAIN BOOM *REFER TO BOOM ARM ASSY
2	-----	-	SECONDARY BOOM *REFER TO BOOM ARM ASSY
3	06500694	1	HOSE, 1/4" X 83"
4	---	1	HOSE, 1/4" X 83"
5	06500695	1	HOSE, 1/4" X 138"
6	----	1	HOSE, 1/4" X 138"
7	06500696	1	HOSE, 1/4" X 112"
8	---	1	HOSE, 1/4" X 112"
9	06500859	1	HOSE, 1" X 182"
10	---	1	HOSE, 1" X 182"
11	06505019	3	CLAMP KIT,3 SECTION
12	34102	2	TUBE,PRFRMD,SEC BOOM
13	2403306	2	TUBE,PRFRMD,SEC BOOM,HP
14	30111	2	CLAMP KIT,2 SECTION

COMMON BENGAL T4

BOOM ASSY BENGAL EXT 24 T4

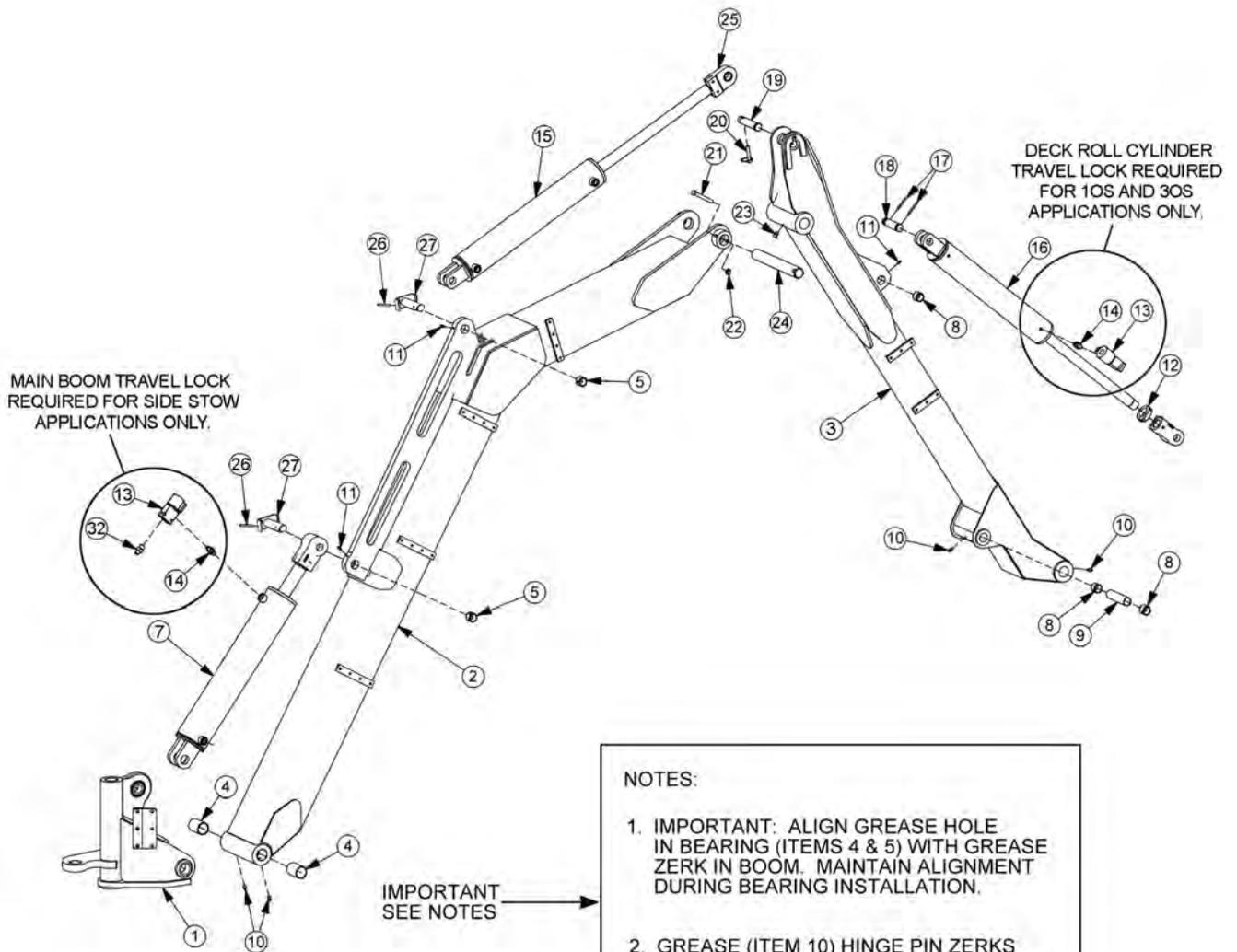

NOTES:

1. IMPORTANT: ALIGN GREASE HOLE IN BEARING (ITEMS 4 & 5) WITH GREASE ZERK IN BOOM. MAINTAIN ALIGNMENT DURING BEARING INSTALLATION.
2. GREASE (ITEM 10) HINGE PIN ZERKS ON BOOM AFTER ASSEMBLY, ONCE UNDER LOAD WITH BOOM ELEVATED AND AGAIN AT REST WITH BOOM SUPPORTED.

BOOM ASSY BENGAL EXT 24 T4

Continued...

ITEM	PART NO.	QTY.	DESCRIPTION
1	-----	-	SWIVEL ASSY *REFER TO TRACTOR MOUNT KIT
2	06700191	1	MAIN BOOM, EXT, T4
3	06700094	1	SECONDARY BOOM ARM ASSY, EXT, T4
4	32321	2	BEARING, DX, 1-1/2" X 2"
5	TB1044	2	BUSHING, 1-1/4"ID
7	06501020	1	CYLINDER, 5" X 20"
8	TB3010	3	BUSHING, 1"ID
9	TB1035	1	BUSHING,SPACER
10	6T3211	4	GREASE ZERK,1/8"
11	6T3207	3	GREASE ZERK,1/4
12	35312	1	SET COLLAR
13	06510050	1	TRAVEL LOCK,METRIPACK COIL
14	31329	1	ADAPTER,1/2ORB X 1/2ORB ADJ
15	06501022	1	CYLINDER, 4" X 20"
16	06501023	1	CYLINDER,3" X 18"
17	06537021	6	ROLL PIN,5MM
18	TB1033	1	PIN,1" X 4"
19	TB1036	1	PIN,1" X 4-11/16"
20	TF1143	1	PIN,LYNCH
21	21688	2	CAPSCREW,7/16" X 3-1/4",NC
22	21677	2	NYLOCK NUT,7/16",NC
23	6T3210	1	GREASE ZERK,1/8" X 90
24	TB1025	1	PIN,1-1/2" X 12"
25	30172	1	CLEVIS,SPHERICAL
26	6T3014	2	ROLL PIN, 1/4" X 2"
27	TB1045B	2	PIN, PRIMARY CYLINDER

COMMON BENGAL T4

BOOM ASSY HYD BENGAL 24 T4

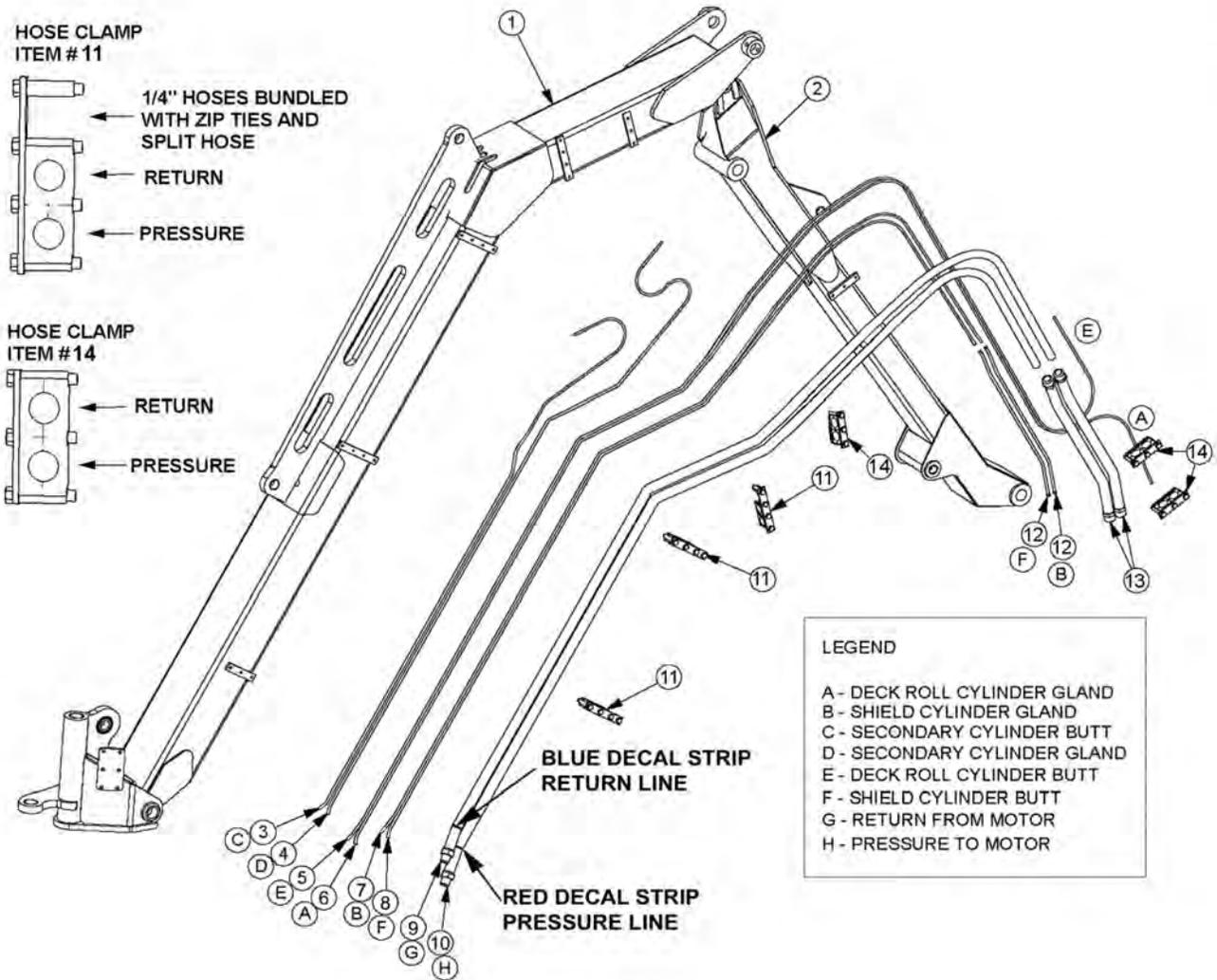

BOOM ASSY HYD BENGAL 24 T4

Continued...

ITEM	PART NO.	QTY.	DESCRIPTION
1	-----	-	MAIN BOOM *REFER TO BOOM ARM ASSY
2	-----	-	SECONDARY BOOM *REFER TO BOOM ARM ASSY
3	06500716	1	HOSE, 1/4" X 100"
4	---	1	HOSE, 1/4" X 100 "
5	06500717	1	HOSE, 1/4" X 170"
6	----	1	HOSE, 1/4" X 170"
7	06500718	1	HOSE, 1/4" X 130"
8	---	1	HOSE, 1/4" X 130"
9	06500715	1	HOSE, 1" X 198"
10	---	1	HOSE, 1" X 198"
11	06505019	3	CLAMP KIT,3 SECTION
12	34103	2	TUBE,PRFRMD,SEC BOOM
13	30169	2	TUBE,PRFRMD,SEC BOOM,HP
14	30111	2	CLAMP KIT,2 SECTION

COMMON BENGAL T4

BOOMREST - OPEN STOW

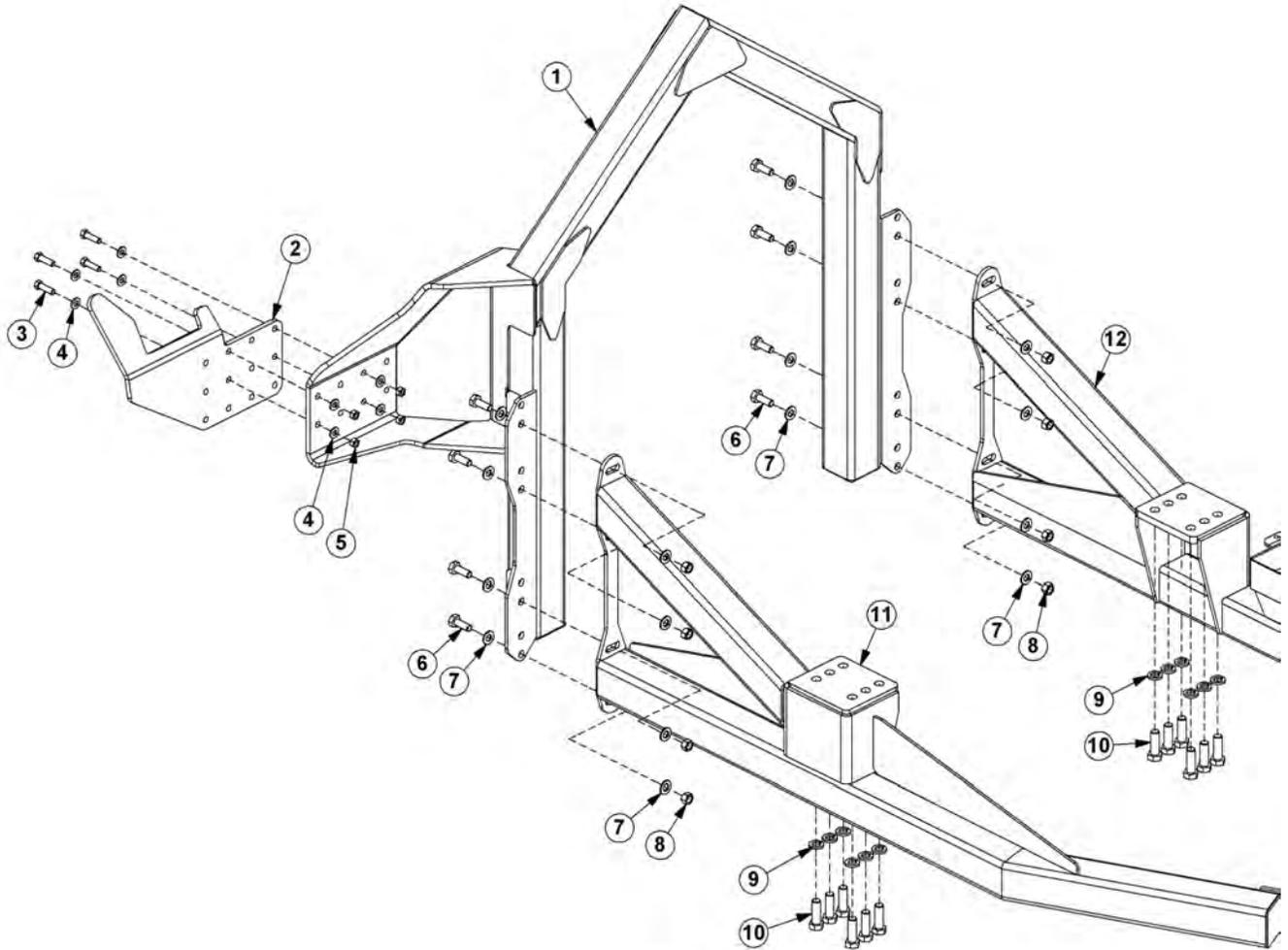

BOOMREST - OPEN STOW

Continued...

ITEM	PART NO.	QTY.	DESCRIPTION
1	06310157	1	BOOMREST,OS
2	06410968	1	SADDLE
3	21732	4	CAPSCREW,1/2" X 1-3/4",NC
4	06533004	8	FLATWASHER,1/2",SAE
5	21725	4	HEX NUT,1/2",NC
6	21782	8	CAPSCREW,5/8" X 1-3/4",NC
7	33764	16	FLATWASHER,5/8",SAE
8	21775	8	HEX NUT,5/8",NC
9	24881	12	LOCKWASHER,20MM
10	27281	12	CAPSCREW,20MM X 60MM,2.5P
11	---	1	AXLE BRACE,RH
12	----	1	AXLE BRACE,LH

COMMON BENGAL T4

50IN ROTARY MOWER ASSEMBLY

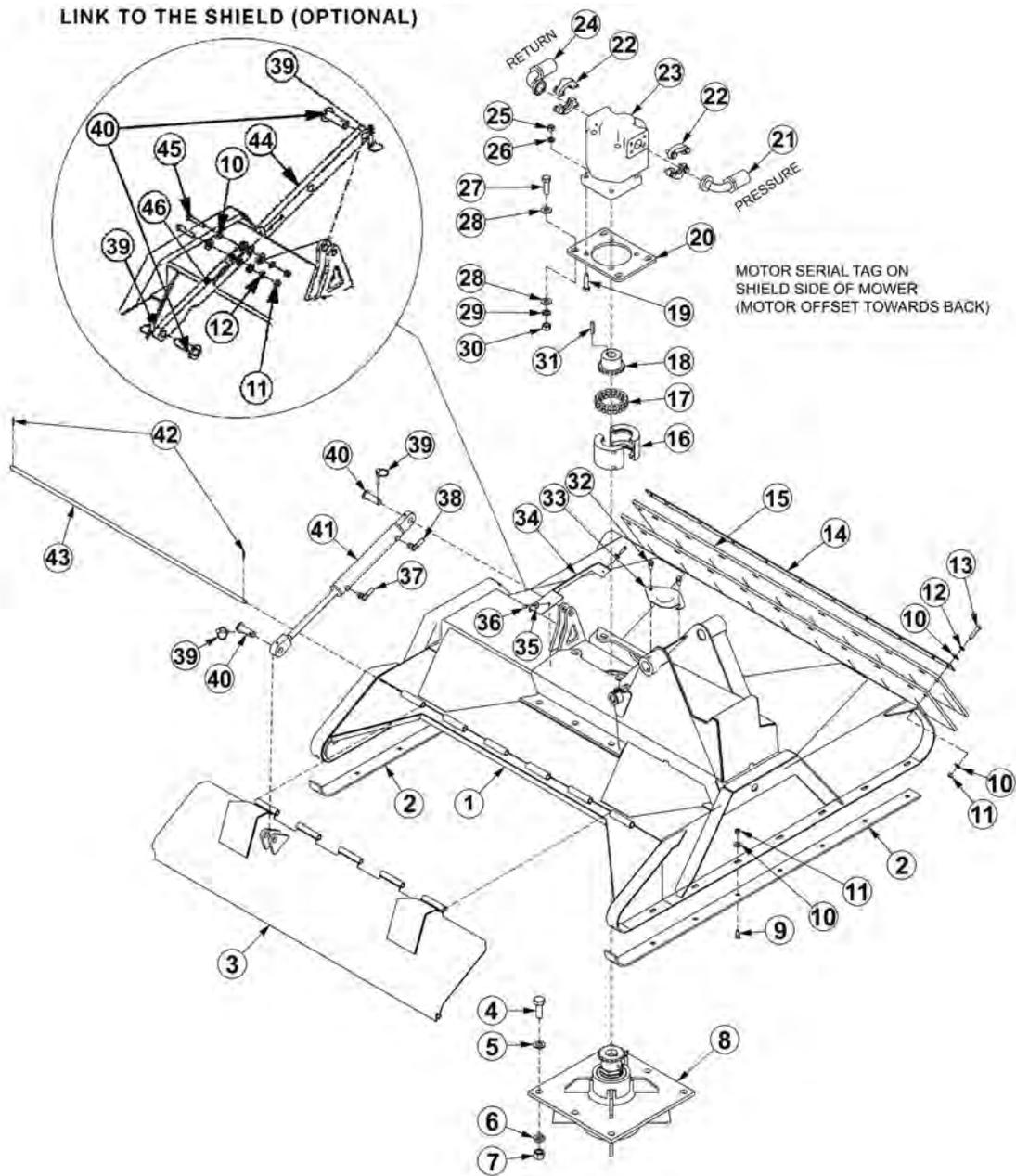

ITEM	PART NO.	QTY.	DESCRIPTION
1	33780	1	DECK,WLDMNT,50" RTRY
2	33777	2	SKID SHOE,50" RTRY
3	33754	1	SHIELD,50"RTRY
4	33879	6	CAPSCREW, 3/4 X 2 1/4,NF GR 8
5	33880	6	FLATWASHER,3/4",GR 8,SAE
6	21993	6	LOCKWASHER,3/4",GR 8
7	6T2413	6	HEX NUT,3/4,NF,GR 8
8	6T1024H5	1	SPINDLE ASSY,CPLT,HD,5/8 HOLES

50IN ROTARY MOWER ASSEMBLY

Continued...

ITEM	PART NO.	QTY.	DESCRIPTION
9	6T2270	16	PLOW BOLT,3/8" X 1" NC
10	22016	33	FLATWASHER,3/8"
11	21625	20	HEX NUT,3/8",NC
12	21988	11	LOCKWASHER, 3/8"
13	21633	11	CAPSCREW, 3/8 X 1 3/4,NC
14	33774	1	FLAP RETAINER,50" RTRY
15	33775	2	FLAP,50" RTRY
16	6T1033	1	COUPLER COVER
17	6T1029	1	COUPLER CHAIN
18	21223	1	SPROCKET
19	21733	4	CAPSCREW, 1/2 X 2,NC
20	33776	1	MOTOR MOUNT,PLATE,50" RTRY
21	24490	1	HOSE - PRESSURE
---	06500155	1	HOSE- PRESSURE (LRS ONLY)
22	TF4852	2	FLANGE KIT - #20
23	06504012	1	MOTOR
24	24489	1	HOSE - RETURN
---	06500154	1	HOSE-RETURN (LRS ONLY)
25	21725	4	HEX NUT, 1/2" NC
26	06533004	4	FLATWASHER, 1/2"
27	6T2290	4	CAPSCREW,5/8X2,NF GR 8
28	33764	8	FLATWASHER,5/8",GR 8,SAE
29	21992	4	LOCKWASHER, 5/8
30	6T2408	4	HEX NUT, 5/8, NF
31	TF1124	1	SQUARE KEY
32	33881	2	CAPSCREW,FLG, 3/8 X 3/4,NC
33	33779	1	PLATE,COVER,KNF HOLE
34	06410439	1	COVER
35	22014	2	FLATWASHER,1/4
36	21530	2	CAPSCREW,1/4 X 1,NC
37	34187	1	HOSE 1/4" X 75"
38	34186	1	HOSE 1/4" X 66"
39	RD1032	2	LYNCH PIN
40	33984	2	PIN,SHIELD,50"
41	33785	1	1-1/2" X 8", CYLINDER, WELDED
42	6T3017	2	ROLLPIN
43	33778	1	HINGE PIN,50" RTRY
44	33772	1	LINK, SHIELD 50" RTRY
45	21634	2	CAPSCREW, 3/8" X 2, NC
46	33773	1	LINK 2, SHIELD 50" RTRY

COMMON BENGAL T4

50IN ROTARY KNIVES AND DISH

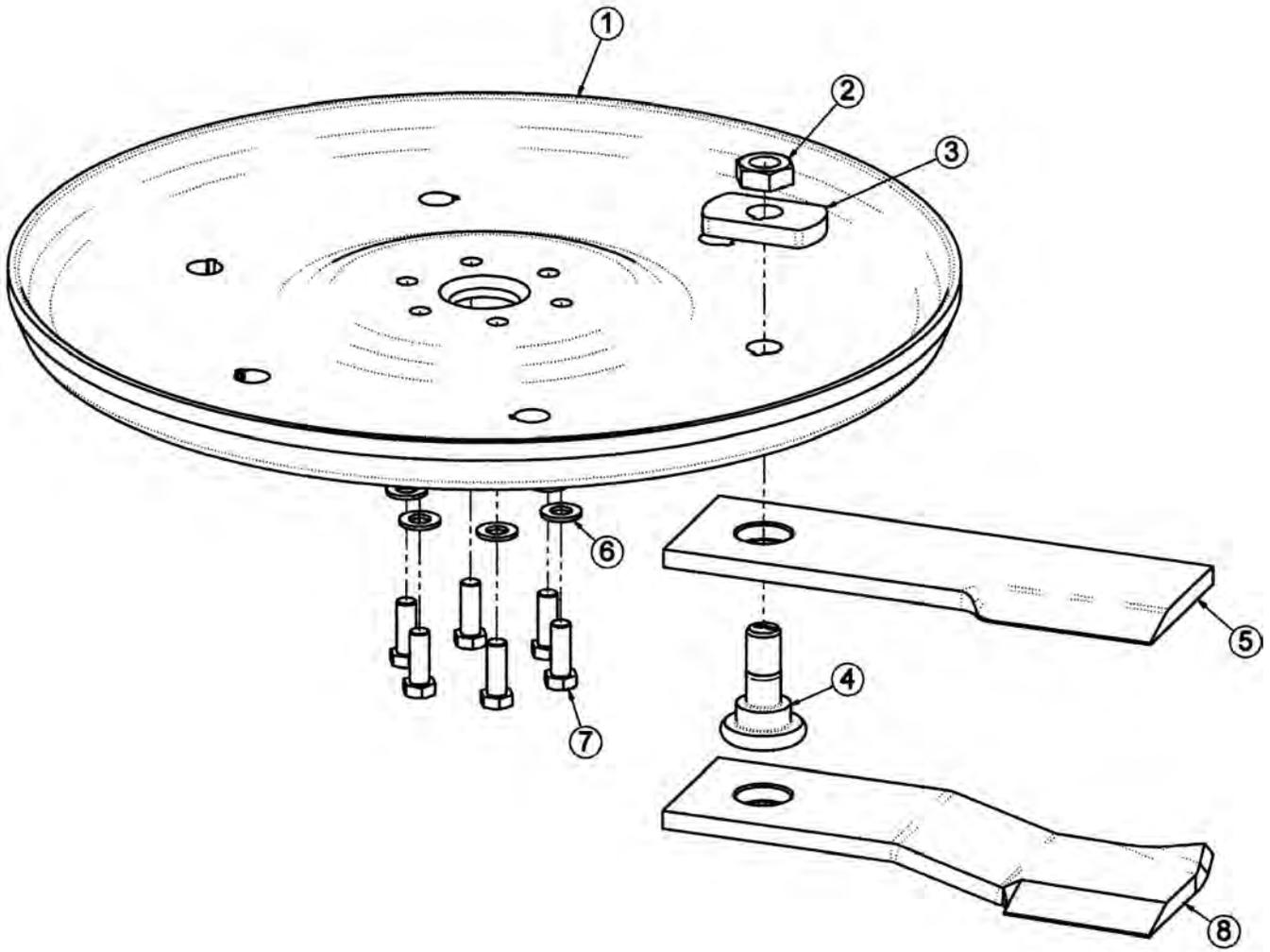

ITEM	PART NO.	QTY.	DESCRIPTION
-----	06700089	-	KIT,TRB50,DISK,W/BOLT KIT (INCLUDES ITEMS 1,3 & 7)
1	06770003	1	BLADE MOUNTING DISK
2	6T1023R	2	NYLOCK HEX NUT 1 1/8"
3	34878	2	SPACER
4	06538000	2	KNIFE MOUNTING BOLT
5	06521001	2	STANDARD KNIFE
6	33764	6	FLATWASHER
7	6T2259	6	CAPSCREW
-----	06770012	-	BOLT KIT (INCLUDES ITEMS 6, 7 & LOCTITE)
8	06521002	2	GRASS KNIFE (OPTIONAL)
-----	6T1825	-	LOCTITE - USED ON ALL DISK MOUNTING BOLTS

50IN ROTARY BLADE BAR AND KNIVES

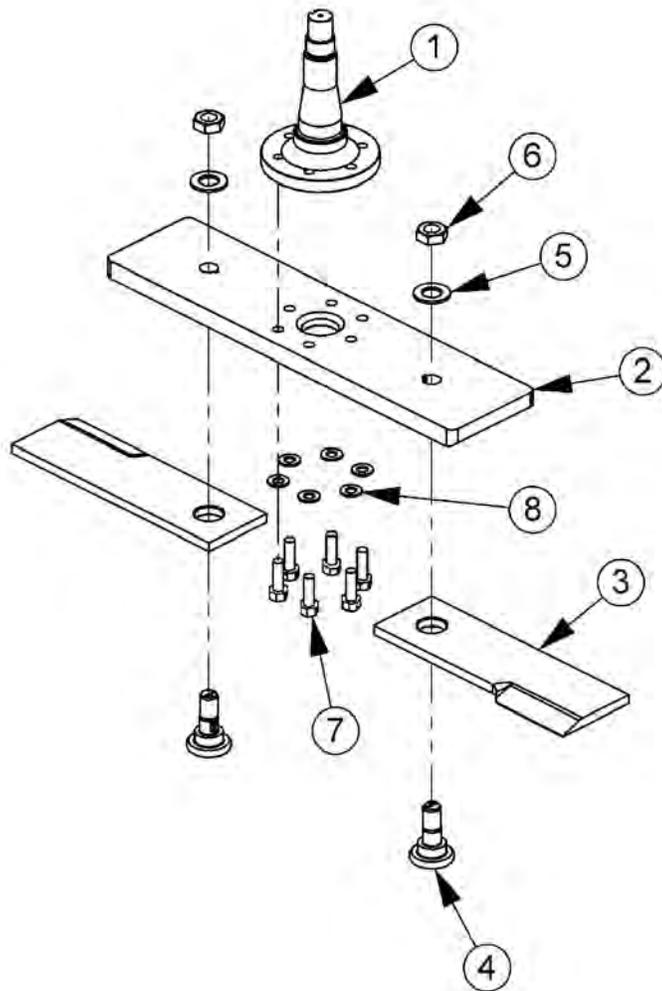

ITEM	PART NO.	QTY.	DESCRIPTION
1	PT1018H5	1	SPINDLE,5/8HOLES,HD,WO/TABS
2	06400388	1	BAR,BLADE,TRB
3	06521001	2	KNIFE,TRB50,5/8
4	06538000	2	KNIFE MTG BOLT,5/8 SHOULDER
5	06533002	2	FLATWASHER,1 1/8,GR 8
6	6T1023R	2	KNIFE MTG NUT,1 1/8,NF,GR8
7	6T2259	6	CAPSCREW,5/8X1-3/4,NF,GR8
8	33764	6	FLATWASHER,5/8,GR 8,SAE

60IN ROTARY MOWER ASSEMBLY

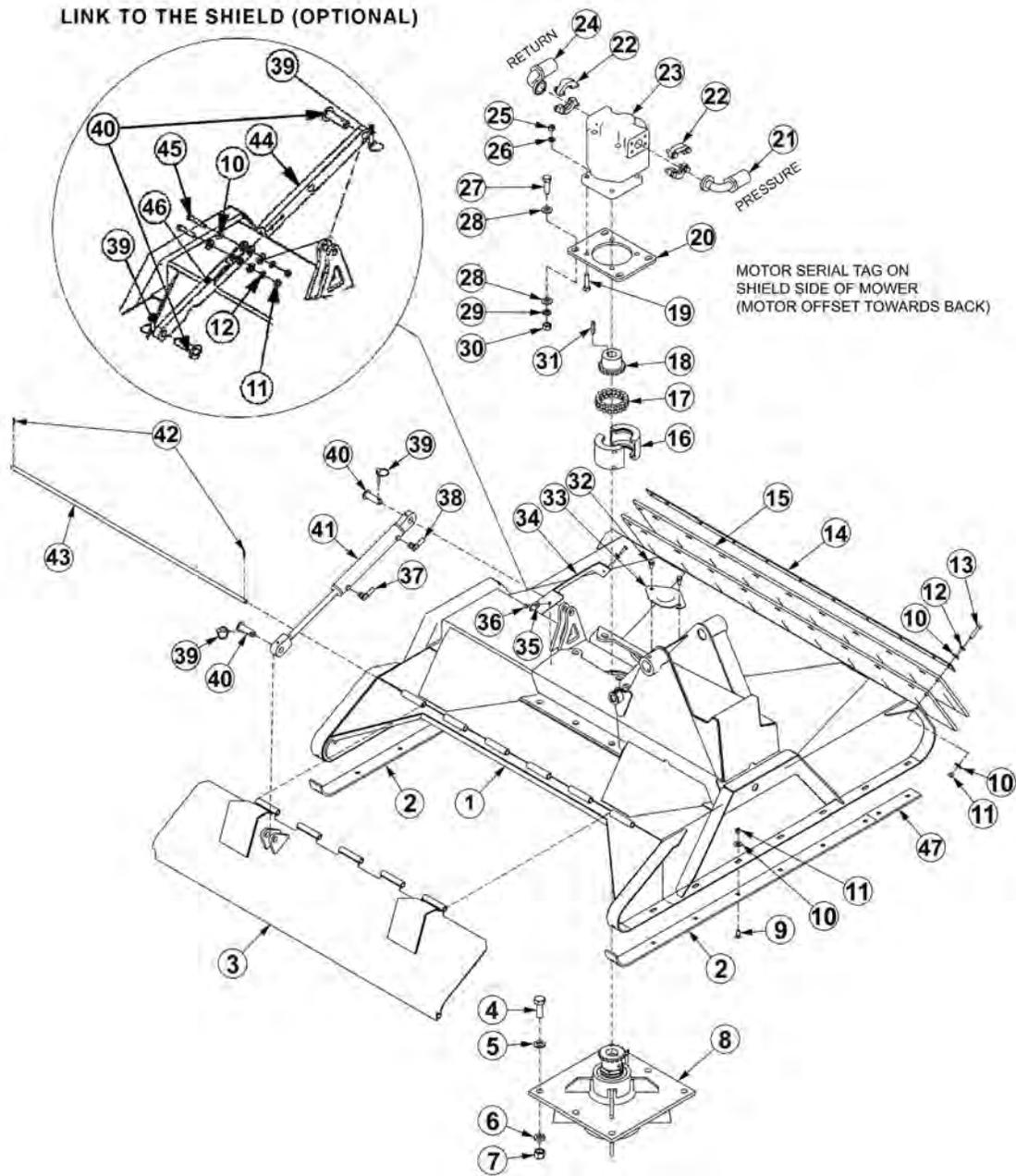

ITEM	PART NO.	QTY.	DESCRIPTION
1	06320159	1	DECK,WLDMNT,60" RTRY
2	33777	2	SKID SHOE,RTRY
3	06320162	1	SHIELD,60"RTRY
4	33879	6	CAPSCREW, 3/4 X 2 1/4,NF GR 8
5	33880	6	FLATWASHER,3/4",GR 8,SAE
6	21993	6	LOCKWASHER,3/4",GR 8
7	6T2413	6	HEX NUT,3/4,NF,GR 8
8	6T1024H5	1	SPINDLE ASSY,CPLT,HD,5/8 HOLES

60IN ROTARY MOWER ASSEMBLY

Continued...

ITEM	PART NO.	QTY.	DESCRIPTION
9	6T2270	16	PLOW BOLT,3/8" X 1" NC
10	22016	33	FLATWASHER,3/8"
11	21625	20	HEX NUT,3/8",NC
12	21988	11	LOCKWASHER, 3/8"
13	21633	11	CAPSCREW, 3/8 X 1 3/4,NC
14	6T0823	1	FLAP RETAINER,60" RTRY
15	06520238	2	FLAP,60" RTRY
16	6T1033	1	COUPLER COVER
17	6T1029	1	COUPLER CHAIN
18	21223	1	SPROCKET
19	21733	4	CAPSCREW, 1/2 X 2,NC
20	33776	1	MOTOR MOUNT,PLATE,RTRY
21	24490	1	HOSE - PRESSURE
---	06500155	1	HOSE-PRESSURE (LRS ONLY)
22	TF4852	2	FLANGE KIT - #20
23	6504011	1	MOTOR
24	24489	1	HOSE - RETURN
---	06500154	1	HOSE-RETURN (LRS ONLY)
25	21725	4	HEX NUT, 1/2" NC
26	06533004	4	FLATWASHER, 1/2"
27	6T2290	4	CAPSCREW,5/8X2,NF GR 8
28	33764	8	FLATWASHER,5/8",GR 8,SAE
29	21992	4	LOCKWASHER, 5/8
30	6T2408	4	HEX NUT, 5/8, NF
31	TF1124	1	SQUARE KEY
32	33881	2	CAPSCREW,FLG, 3/8 X 3/4,NC
33	33779	1	PLATE,COVER,KNF HOLE
34	06410439	1	COVER
35	22014	2	FLATWASHER,1/4
36	21530	2	CAPSCREW,1/4 X 1,NC
37	34187	1	HOSE 1/4" X 75"
38	34186	1	HOSE 1/4" X 66"
39	RD1032	2	LYNCH PIN
40	33984	2	PIN,SHIELD
41	33785	1	1-1/2" X 8", CYLINDER, WELDED
42	6T3017	2	ROLLPIN
43	06420139	1	HINGE PIN,60" RTRY
44	33772	1	LINK, SHIELD,RTRY
45	21634	2	CAPSCREW, 3/8" X 2, NC
46	33773	1	LINK 2, SHIELD,RTRY
47	06401245	2	SKID SHOE,TRB60

COMMON BENGAL T4

60IN ROTARY KNIVES AND DISH

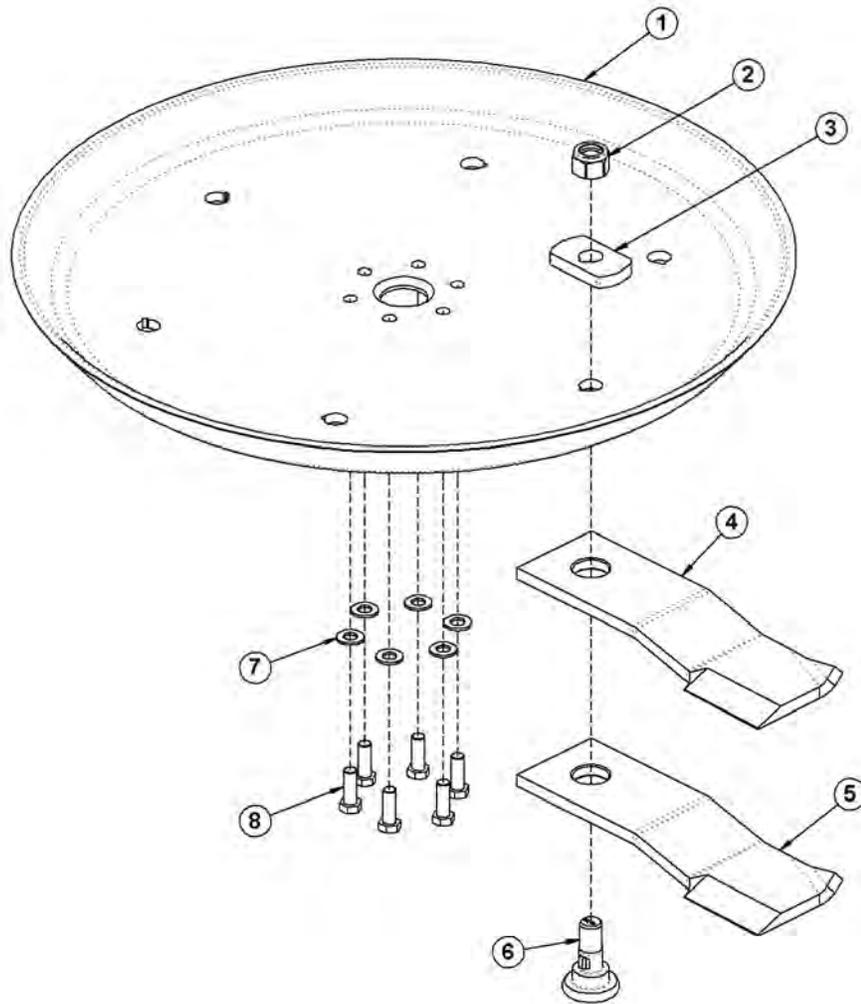

ITEM	PART NO.	QTY.	DESCRIPTION
1	34876	1	BLADE MOUNTING DISH,60"
2	6T1023R	2	NYLOCK NUT,1-1/8",NF
3	34878	2	SPACER
4	34684	2	STANDARD GRASS KNIFE
5	34685	2	HIGH SUCTION GRASS KNIFE (OPTIONAL)
6	34497	2	KNIFE MOUNTING BOLT
7	25270	6	FLATWASHER,5/8",GR8,USS
8	6T2259	6	CAPSCREW,5/8" X 1-3/4",NF,GR8
---	6T1825	1	LOCTITE (USED ON ITEM 8)
---	27167	1	BOLT KIT (ITEMS 7 & 8)
---	33893	1	KNIFE KIT (ITEMS 2,4 & 6)

60IN ROTARY BLADE BAR AND KNIVES

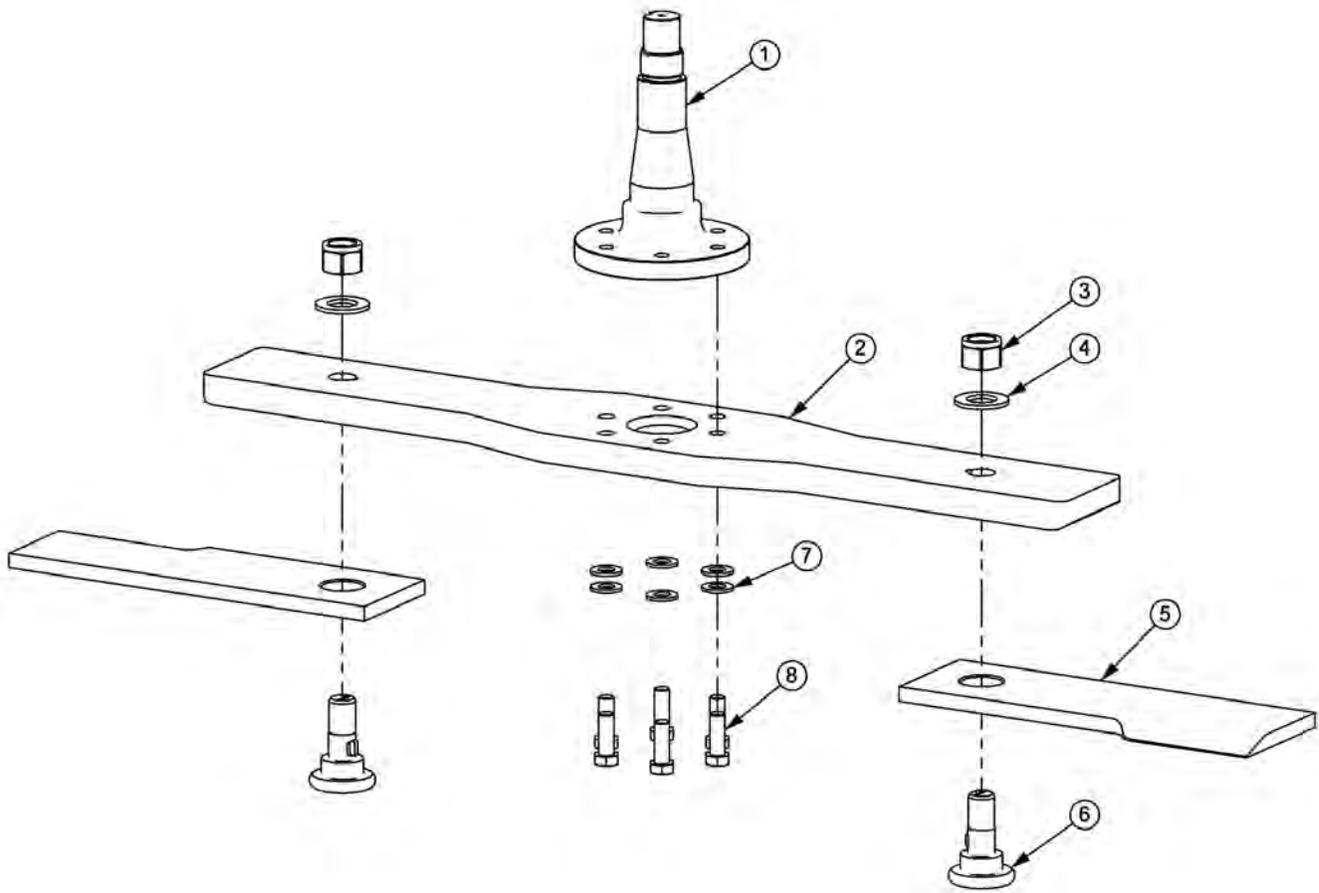

ITEM	PART NO.	QTY.	DESCRIPTION
1	PT1018H5	1	SPINDLE
2	06400690	1	BAR, BLADE, RTRY60
3	6T1023R	2	KNIFE MTG NUT, 1-1/8, NYLOCK, NF
4	06533002	2	FLATWASHER, 1-1/8, GR8
5	06521001	2	KNIFE, TRB50, 5/8
6	06538000	2	KNIFE MTG BOLT, 5/8 SHOULDER
7	33764	6	FLATWASHER, 5/8, GR 8, SAE
8	6T2259	6	CAPSCREW, 5/8 X 1-3/4, NF, GR8

ROTARY MOWER SPINDLE ASSEMBLY

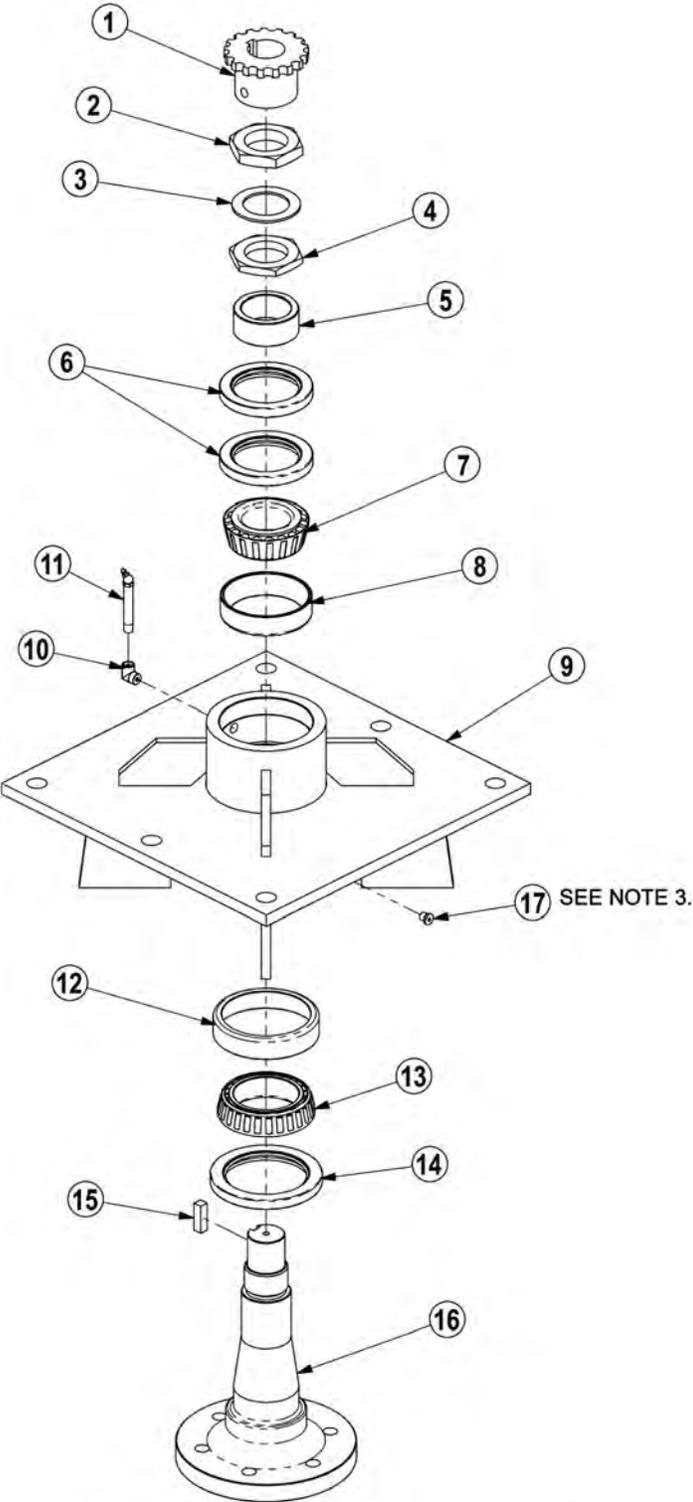

- NOTES:
1. FREEPLAY: .001" - .003"
 2. GREASE: FILL WITH MOBILITH SHC 220.
 3. APPLY LOCTITE "271" TO O-RING PLUG THRDS.

ROTARY MOWER SPINDLE ASSEMBLY

Continued...

ITEM	PART NO.	QTY.	DESCRIPTION
-----	6T1024H5	-	SPINDLE ASSEMBLY COMPLETE
1	6T1031	1	SPROCKET
2	6T1016	1	BEARING LOCK NUT - THICK
3	22596	1	JAM WASHER
4	6T1015	1	BEARING ADJUSTMENT NUT - THIN
5	6T1014	1	BEARING ADJUSTMENT SLEEVE
6	6T1011	1	UPPER SEAL - SET OF 2
7	6T1012	1	BEARING CONE
8	6T1013	1	BEARING CUP
9	6T1010H	1	SPINDLE HOUSING
10	30570	1	FITTING STREET ELBOW
11	33990	1	GREASE ZERK
12	6T1013H	1	BEARING CUP
13	6T1012H	1	BEARING CONE
14	6T1011H	1	LOWER SEAL
15	6T1019	1	SPINDLE KEY
16	PT1018H5	1	SPINDLE
17	06503064	1	O-RING PLUG, 1/8"
-----	31771	-	SPINDLE REBUILD KIT (INCLUDES ITEMS 2 - 8 AND 12 - 15)

BOOM ROTARY PIVOT ASSEMBLY

Continued...

ITEM	PART NO.	QTY.	DESCRIPTION
1	TB1032	1	ROTARY PIVOT ASSY
2	TB1028	1	PIVOT ARM ASSY
3	TB1033	1	PIN,CLEVIS
4	06537021	2	ROLL PIN
5	TF3097	1	PIN
6	TB1030	1	PIN
7	33985	1	PIN
8	33986	1	PIN
9	21688	1	CAPSCREW,7/16 X 3-1/4,NC
10	21677	1	NYLOCK NUT,7/16 NC
11	21635	3	CAPSCREW,3/8 X 2-1/4
12	6T3207	3	GREASE ZERK
13	21627	3	NYLOCK NUT,3/8,NC
14	TB3010	3	BUSHING
15	-----	-	SECONDARY BOOM *REFER TO BOOM ARM ASSY
16	-----	-	CYLINDER *REFER TO BOOM ARM ASSY
17	-----	-	ROTARY MOWER HEAD *REFER TO ROTARY DECK

50IN FLAIL DRIVE ASSEMBLY

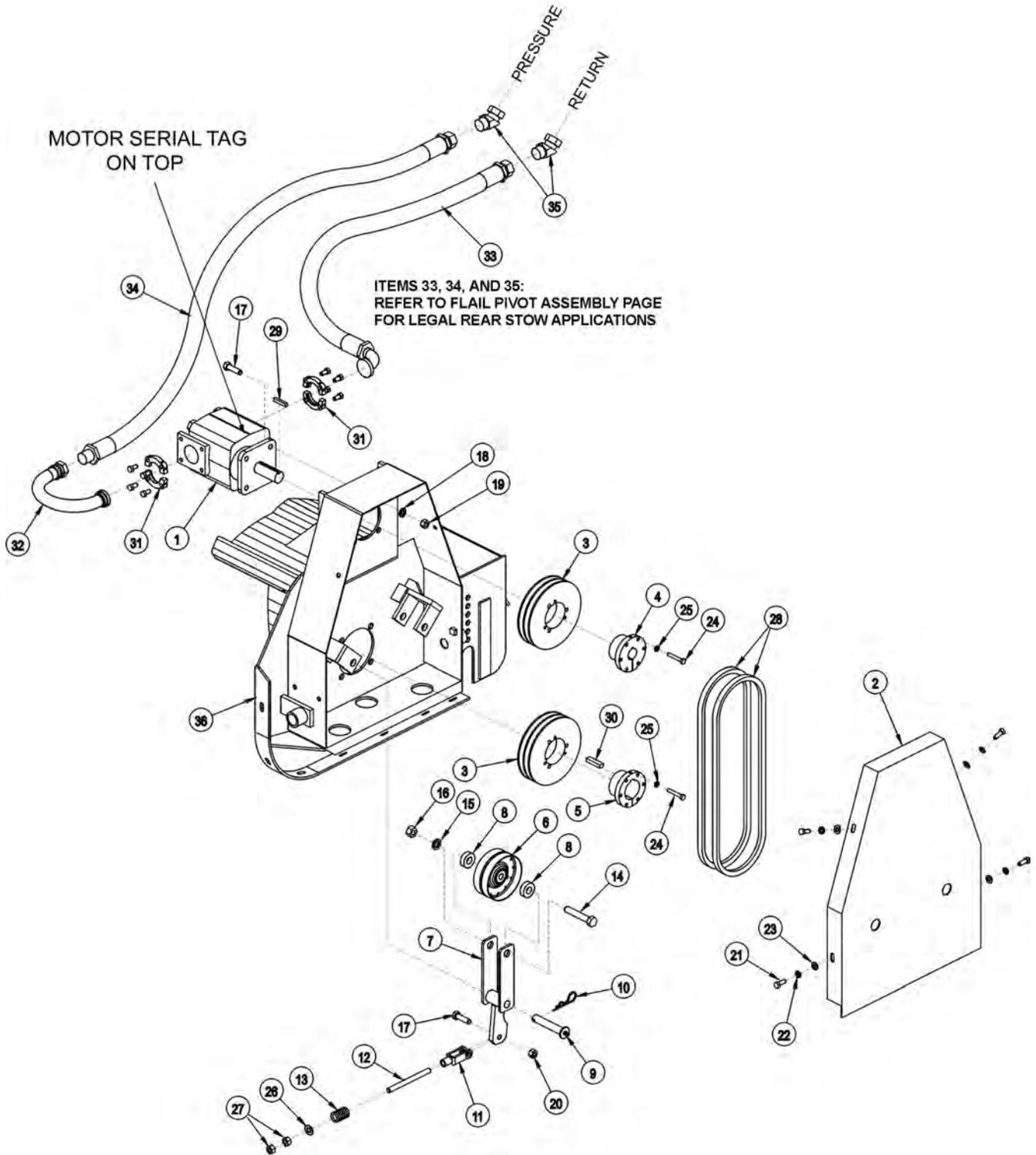

50IN FLAIL DRIVE ASSEMBLY

Continued...

ITEM	PART NO.	QTY.	DESCRIPTION
1	06504132	1	MOTOR (M350-1 3/4" GEAR)
2	TF3006	1	BELT GUARD
3	TF3043	2	SHEAVE
4	TF3013	1	BUSHING
5	TF3011	1	BUSHING
6	TF3034	1	IDLER PULLEY
7	TF3205	1	IDLER ARM
8	TF3206	2	IDLER PULLEY SPACER
9	TF3605	1	IDLER ARM PIN WITH ZERK
10	6T3004	1	R - CLIP
11	PT3611A	1	CLEVIS
12	32481	1	THREADED ROD
13	TF3620	1	COMPRESSION SPRING
14	21789	1	CAPSCREW 5/8" X 3 1/2"
15	21992	1	LOCKWASHER 5/8"
16	21775	1	HEX NUT 5/8"
17	21732	5	CAPSCREW 1/2" X 1 3/4"
18	21990	4	LOCKWASHER 1/2"
19	21725	4	HEX NUT 1/2"
20	6T2418	1	LOCK NUT 1/2"
21	21630	4	CAPSCREW 3/8" X 1"
22	21988	4	LOCKWASHER 3/8"
23	22016	4	FLATWASHER 3/8"
24	21584	6	CAPSCREW 5/16" X 2"
25	21987	6	LOCKWASHER 5/16"
26	27938	1	FLATWASHER 1/2"
27	21700	2	HEX NUT 1/2" NF
28	TF3021	2	BELT
29	TF1125	1	SQUARE KEY
30	TF1025	1	SQUARE KEY MOTOR
31	TF4852	2	FLANGE KIT
32	34227	1	PREFORMED TUBE
33	31218	1	HOSE - RETURN
34	34331	1	HOSE - PRESSURE
35	24724	2	SWIVEL FITTING
36	-----	-	CUTTER HEAD *REFER TO CUTTER HEAD ASSY

50IN FLAIL MOWER ASSEMBLY

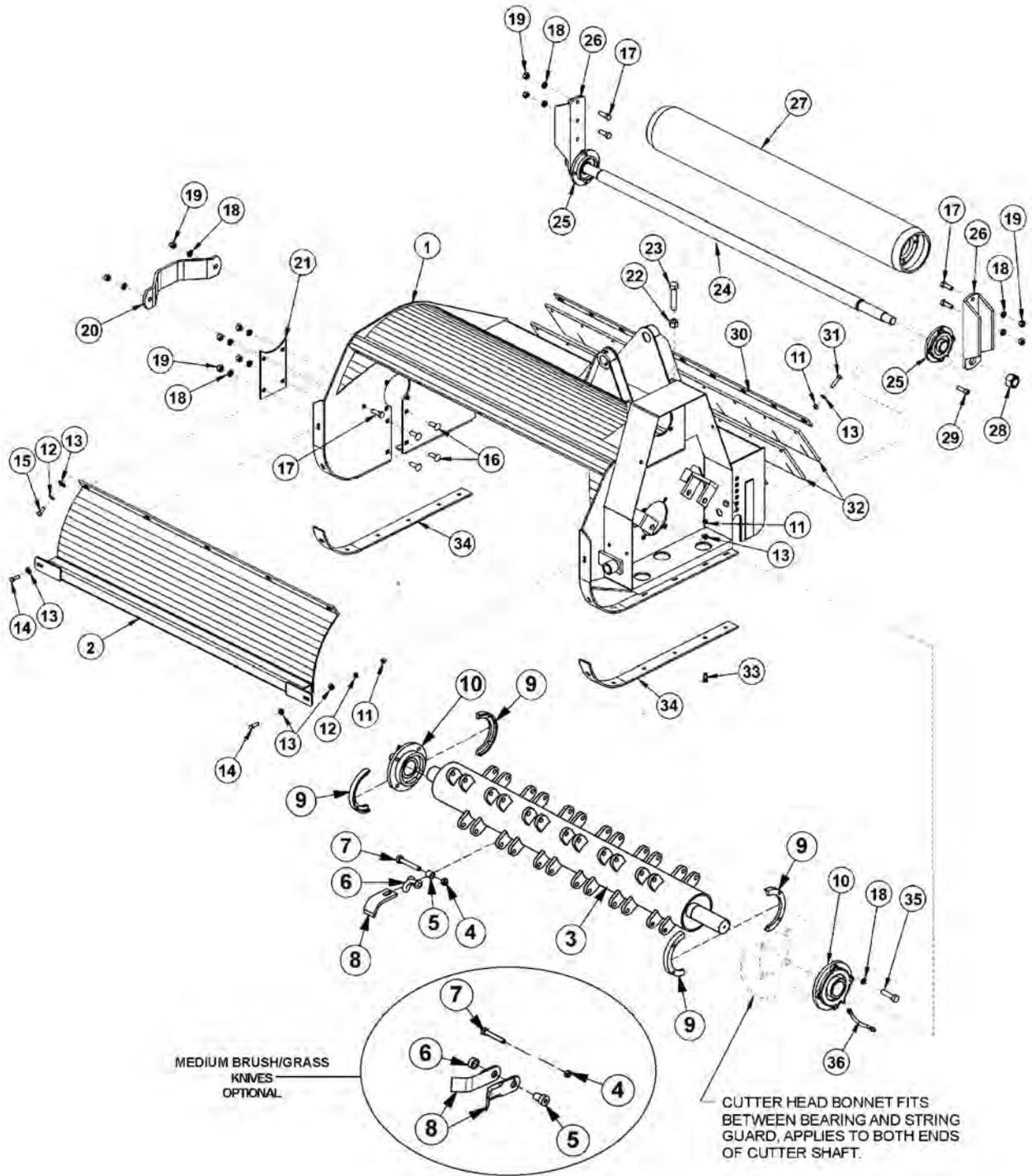

ITEM	PART NO.	QTY.	DESCRIPTION
---	34787	1	FLAIL,BOOM,50,BRUSH,CPLT ASSY (LIGHT BRUSH/GRASS)
	06742133	1	FLAIL,BOOM,50,MD GRASS,CPLT ASSY (MEDIUM BRUSH/GRASS)
1	TF3003F	1	CUTTER HEAD BONNET
2	TF3004	1	FRONT SHIELD

50IN FLAIL MOWER ASSEMBLY

Continued...

ITEM	PART NO.	QTY.	DESCRIPTION
3	34783	1	TBF50 (LIGHT BRUSH/GRASS KNIFE ASSY)
----	06700115	1	TBF50 (MEDIUM BRUSH/GRASS KNIFE ASSY)
4	6T2419	24	HEX NUT,9/16",NC,STOVER
5	06420182	24	BUSHING
6	34782	24	CLEVIS (LIGHT BRUSH/GRASS KNIVES)
----	06420183	24	SPACER (MEDIUM BRUSH/GRASS KNIVES)
7	34786	24	CAPSCREW,9/16" X 3-1/2",NC
8	34780	24	KNIFE (LIGHT BRUSH/GRASS CUTTING)
----	06521007	48	KNIFE (MEDIUM BRUSH/GRASS CUTTING)
9	31204	2	STRING GUARD SET (2 PIECES PER SET)
10	TF1018	2	FLANGE BEARING,2-3/16"
11	21625	23	HEX NUT,3/8",NC
12	21988	7	LOCKWASHER,3/8"
13	22016	30	FLATWASHER,3/8"
14	21631	2	CAPSCREW,3/8" X 1-1/4",NC
15	21630	5	CAPSCREW,3/8" X 1",NC
16	6T7031D	4	PLOW BOLT,1/2" X 1-1/2",NC
17	21731	6	CAPSCREW,1/2" X 1-1/2",NC
18	21990	18	LOCKWASHER,1/2"
19	21725	10	HEX NUT,1/2",NC
20	TF1040	1	CUTTER SHAFT GUARD
21	TF3007A	1	COVER PLATE
22	21825	1	HEX NUT,5/8",NC
23	21838	1	CAPSCREW,3/4" X 3-1/2",NC
24	TF3406	1	GROUND ROLLER TIE ROD
25	TF1022	2	FLANGE BEARING,1-3/8"
26	TF3407	2	GROUND ROLLER ADJUSTMENT BRACKET
27	TF3405	1	GROUND ROLLER
28	6T1023R	2	NYLOCK NUT,1-1/8",NF
29	6T2330	8	CAPSCREW,7/16" X 1-1/2",SOCKET HEAD
30	TB1008	1	FLAP RETAINING BAR
31	21633	9	CAPSCREW,3/8" X 1-3/4",NC
32	TB1006A	2	DEFLECTOR FLAP
33	6T2270	12	PLOWBOLT,3/8" X 1",NC
34	TF3001	2	SKID SHOE
35	06530218	8	CAPSCREW,1/2" X 1-3/4",NC
36	TF1032	1	FLANGE BEARING GREASE HOSE

COMMON BENGAL T4

50IN FLAIL MOWER ASSY, PASS-THROUGH KNIVES

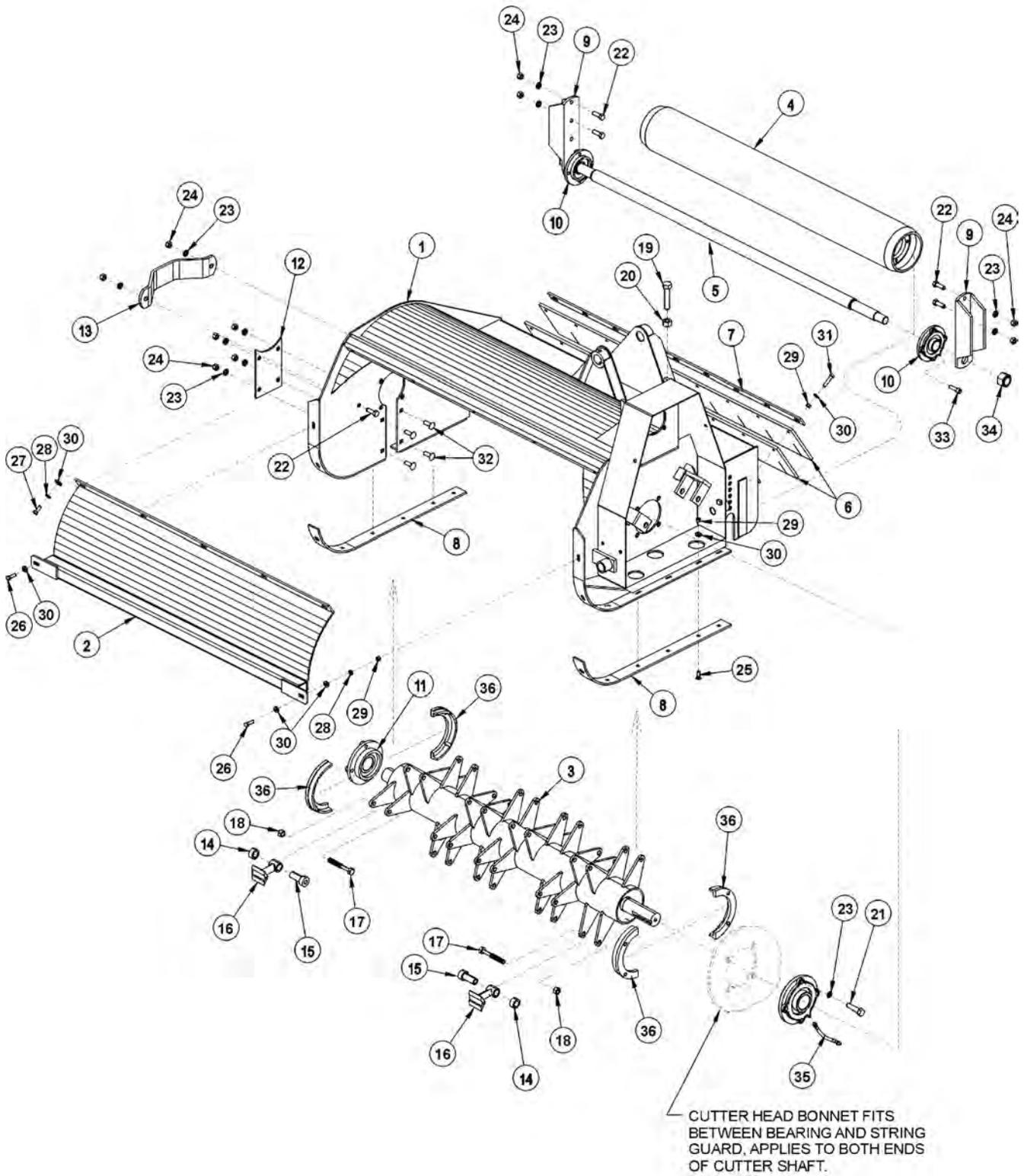

50IN FLAIL MOWER ASSY, PASS-THROUGH KNIVES

Continued...

ITEM	PART NO.	QTY.	DESCRIPTION
---	34172	1	FLAIL,BOOM,50,CPLT ASSY
1	TF3003F	1	CUTTER HEAD BONNET
2	TF3004	1	FRONT SHIELD
3	33717	1	TBF50,CUTTERSHAFT,PASS THRU KNIVES
4	TF3405	1	GROUND ROLLER
5	TF3406	1	GROUND ROLLER TIE ROD
6	TB1006A	2	DEFLECTOR FLAP
7	TB1008	1	FLAP RETAINING BAR
8	TF3001	2	SKID SHOE
9	TF3407	2	GROUND ROLLER ADJUSTMENT BRACKET
10	TF1022	2	FLANGE BEARING,1-3/8"
11	TF1018	2	FLANGE BEARING,2-3/16"
12	TF3007A	1	COVER PLATE
13	TF1040	1	CUTTER SHAFT GUARD
14	33858	24	SPACER,COLLAR
15	33857	24	SHOULDER,BUSHING
16	46399.01	24	KNIFE,FLAIL,FORGED
17	33854	24	CAPSCREW,5/8" X 4-1/2",NC
18	32674	24	HEX NUT,5/8",NC
19	21838	1	CAPSCREW,3/4" X 3-1/2",NC
20	21825	1	HEX NUT,5/8",NC
21	21732	8	CAPSCREW,1/2" X 1-3/4",NC
22	21731	6	CAPSCREW,1/2" X 1-1/2",NC
23	21990	18	LOCKWASHER,1/2"
24	21725	10	HEX NUT,1/2",NC
25	6T2270	12	PLOWBOLT,3/8" X 1",NC
26	21631	2	CAPSCREW,3/8" X 1-1/4",NC
27	21630	5	CAPSCREW,3/8" X 1",NC
28	21988	7	LOCKWASHER,3/8"
29	21625	23	HEX NUT,3/8",NC
30	22016	30	FLATWASHER,3/8"
31	21633	9	CAPSCREW,3/8" X 1-3/4",NC
32	6T7031D	4	PLOW BOLT,1/2" X 1-1/2",NC
33	6T2330	8	CAPSCREW,7/16" X 1-1/2",NC,SCKT HD
34	6T1023R	2	NYLOCK NUT,1-1/8",NF
35	TF1032	1	FLANGE BEARING GREASE HOSE
36	31204	2	STRING GUARD SET (2 PIECES PER SET)

COMMON BENGAL T4

63IN FLAIL DRIVE ASSEMBLY

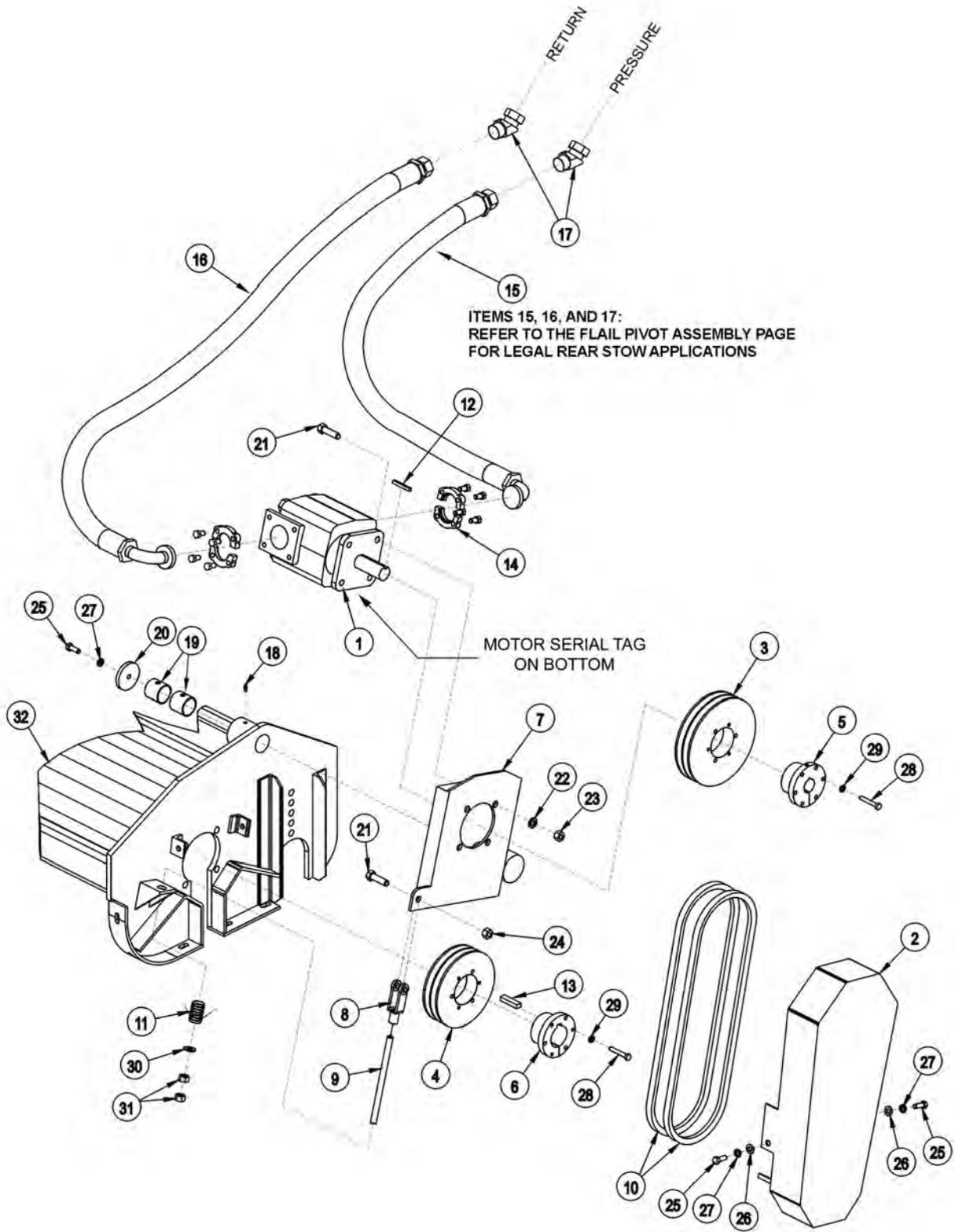

63IN FLAIL DRIVE ASSEMBLY

Continued...

ITEM	PART NO.	QTY.	DESCRIPTION
1	06504132	1	MOTOR (M350-1 3/4 GEAR)
2	28703B	1	BELT GUARD
3	TF3044	1	UPPER SHEAVE
4	TF3040	1	LOWER SHEAVE
5	TF3013	1	BUSHING
6	28723	1	BUSHING
7	28679B	1	MOTOR CHANNEL
8	PT3611A	1	CLEVIS
9	40496	1	THREADED ROD
10	28702	2	BELT
11	TF3620A	1	TENSIONER SPRING
12	28572	1	SQUARE KEY
13	26142A	1	SQUARE KEY
14	TF4852	2	FLANGE KIT
15	30308	1	HOSE,1 X 69 - PRESSURE
16	30309	1	HOSE,1 X 78 - RETURN
17	24724	2	SWIVEL FITTING
18	TF1033	1	GREASE ZERK
19	27580	2	BUSHING
20	28682	1	MOTOR CHANNEL WASHER
21	21732	5	CAPSCREW 1/2" X 1 3/4"
22	21990	4	LOCKWASHER 1/2"
23	21725	4	HEX NUT 1/2"
24	6T2418	1	STOVER NUT 1/2"
25	21630	3	CAPSCREW 3/8" X 1"
26	22016	2	FLATWASHER 3/8"
27	21988	3	LOCKWASHER 3/8"
28	21584	6	CAPSCREW 5/16" X 2"
29	21987	6	LOCKWASHER 5/16"
30	27938	1	FLATWASHER 1/2"
31	21700	2	HEX NUT 1/2" NF
32	-----	-	CUTTER HEAD *REFER TO MOWER ASSY

63IN FLAIL MOWER ASSEMBLY

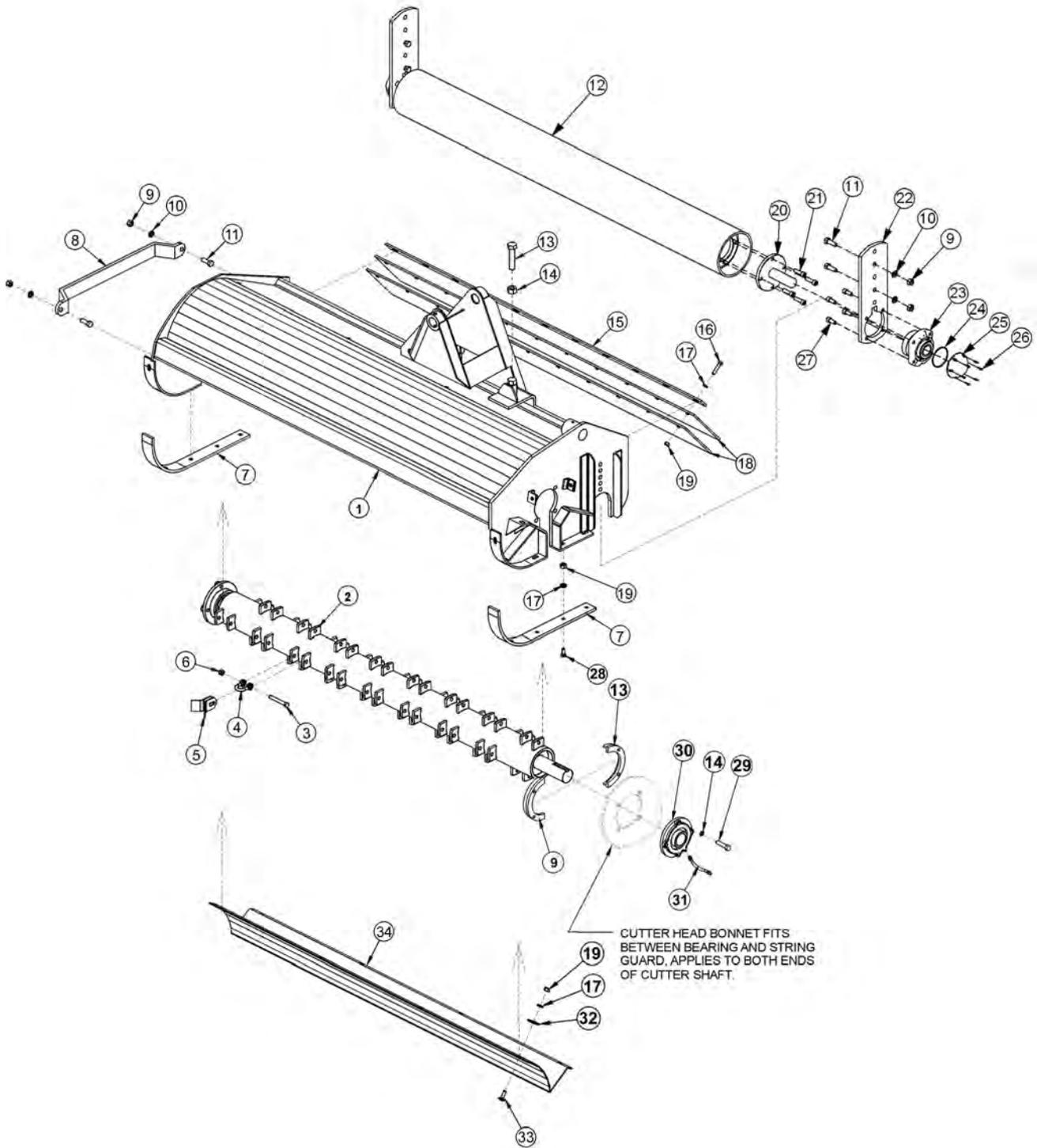

63IN FLAIL MOWER ASSEMBLY

Continued...

ITEM	PART NO.	QTY.	DESCRIPTION
-----	06200271	-	FLAIL,BOOM,63,GRASS,CPLT ASSY
1	28659H	1	CUTTER HEAD BONNET
2	28743	-	CUTTER SHAFT / KNIFE ASSY STANDARD GRASS
-----	28642C	1	CUTTER SHAFT,63,STD
3	34011	36	FLAIL KNIFE MOUNTING BOLT
4	TF1020	36	FLAIL KNIFE MOUNTING CLEVIS
5	33713	72	FLAIL KNIFE - STANDARD
6	21677	36	NYLOCK NUT
7	28086A	2	SKID SHOE
8	27975A	1	CUTTER SHAFT GUARD
9	21725	14	HEX NUT 1/2"
10	21990	14	LOCKWASHER 1/2"
11	21731	6	CAPSCREW 1/2" X 1 1/2"
12	06320240	1	GROUND ROLLER
13	33863	2	STRING GUARD,STD
14	06533006	8	FLATWASHER,1/2",SAE,L9
15	28700	1	FLAP RETAINING BAR
16	21633	11	CAPSCREW 3/8" X 1 3/4"
17	21988	28	LOCKWASHER 3/8"
18	28701	2	DEFLECTOR FLAP
19	21625	28	HEX NUT 3/8"
20	TF1045B	2	GROUND ROLLER STUB SHAFT
21	6T2330	8	CAPSCREW 7/16" X 1 1/2" SOCKET HEAD
22	28735	2	ADJUSTABLE ROLLER BRACKET
23	06520028	2	BEARING,FLANGE,1-3/8,GRNDRLLR
24	06520029	2	O-RING
25	06520027	2	CAP,BEARING,GROUNDROLLER
26	06530001	12	CAPSCREW,SKT HD,8-32 X 1/2,SS
27	6T2331	8	CAPSCREW 7/16" X 1" SOCKET HEAD
28	6T2270	10	PLOW BOLT 3/8" X 1 1/4"
29	06530217	8	CAPSCREW 1/2" X 2",L9
30	28683	2	FLANGE BEARING
31	TF1032	1	FLANGE BEARING GREASE HOSE
32	6T2615	7	FENDER WASHER 3/8"
33	6T2283	7	CARRIAGE BOLT 3/8" X 1"
34	28665A	1	BAFFLE (INSIDE UPPER REAR OF CUTTER HEAD)

BOOM FLAIL PIVOT ASSEMBLY

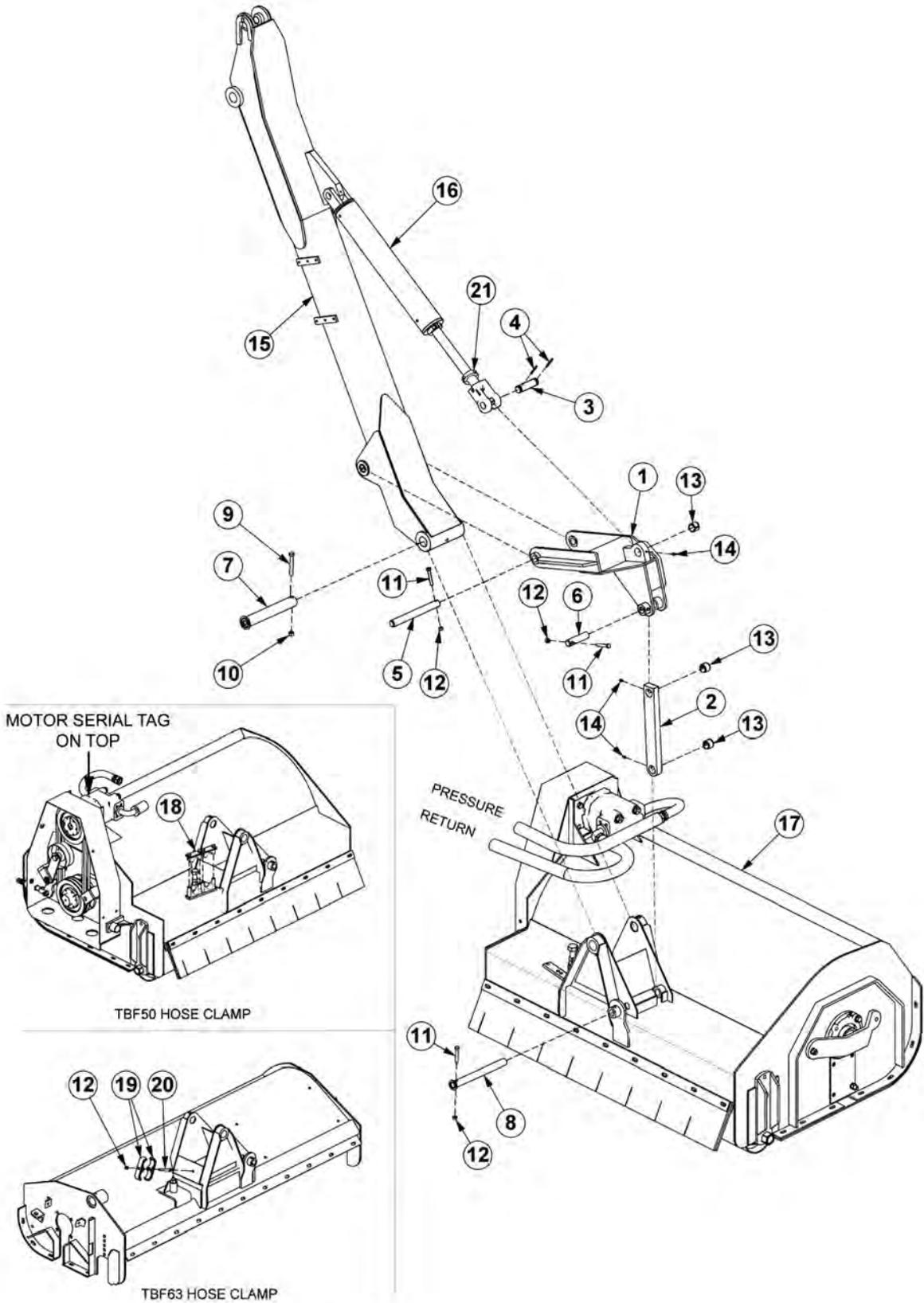

BOOM FLAIL PIVOT ASSEMBLY

Continued...

ITEM	PART NO.	QTY.	DESCRIPTION
1	TF3015	1	FLAIL PIVOT ASSY
2	TB1028	1	PIVOT ARM ASSY
3	TB1033	1	PIN CLEVIS
4	06537021	2	ROLL PIN
5	TF3097	1	PIN
6	TF3090	1	PIN
7	TB1024	1	PIN
8	TB1027	1	PIN
9	21688	1	CAPSCREW 7/16" X 3 1/4"
10	21677	1	NYLOCK NUT 7/16"
11	21635	3	CAPSCREW 3/8" X 2 1/4"
12	21627	4	NYLOCK NUT 3/8"
13	TB3010	3	BUSHING
14	6T3207	3	GREASE ZERK
15	-----	-	SECONDARY BOOM *REFER TO BOOM ARM ASSY
16	-----	-	CYLINDER - REFER TO BOOM ARM ASSY
17	-----	-	FLAIL MOWER HEAD *REFER TO FLAIL ASSY
18	31723	1	CLAMP KIT,TBF50 (USED ON 50" FLAIL)
19	TB3031	2	DOUBLE HOSE CLAMP (USED ON THE 63" FLAIL)
20	21638	1	CAPSCREW 3/8" X 3"
21	35312	2	SPLIT COLLAR

3IN X 13-7/8 IN WELDED CYLINDER BREAKDOWN

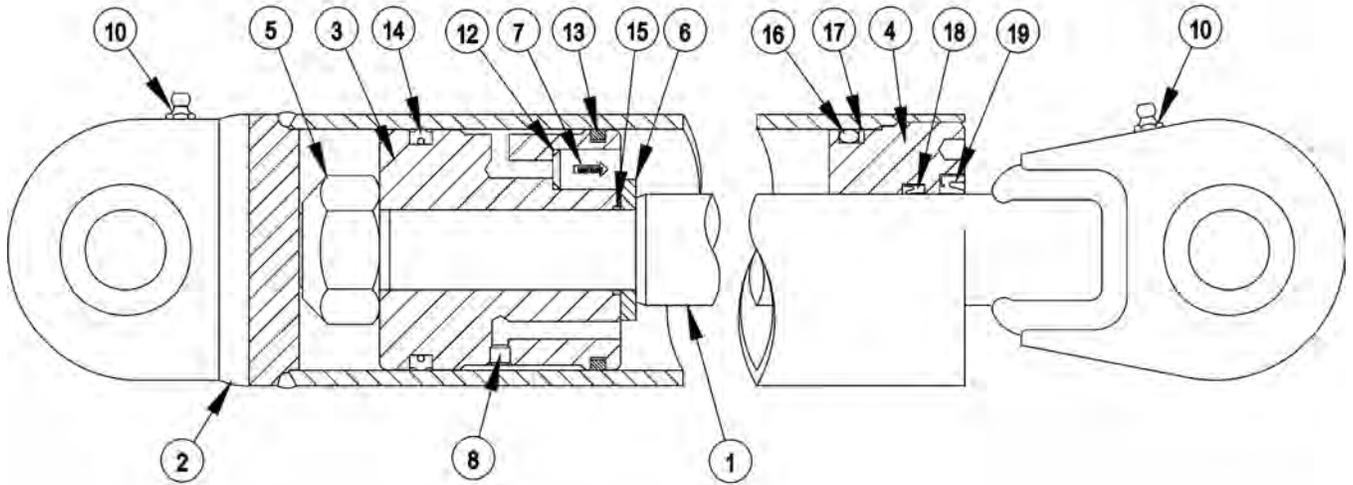

WARNING - MECHANICAL FASTENERS MUST BE TORQUED TO RECOMMENDED SPECIFICATIONS DURING REPAIR TO PREVENT PERSONAL INJURY OR EQUIPMENT DAMAGE.

ITEM	PART NO.	QTY.	DESCRIPTION
---	06501029	-	CYLINDER,WELDED,3" X 13.87"
1	06501630	1	PISTON ROD ASSY
2	06501648	1	BUTT & TUBE ASSY
3	06501649	1	PISTON
4	34574	1	GLAND
5	34575	1	LOCK NUT,1"-14 UNS (TORQUE TO 315 FT.LB.)
6	34576	1	SPACER
7	34577	1	CHECK VALVE,KEPNER
8	06501650	1	ORIFICE, ZERO LEAK, 0225
9	33761	1	SEAL KIT,PACKING (ITEMS 12 THRU 19)
10	-----	2	GREASE ZERK
12	-----	1	O - RING
13	-----	1	CAST IRON PISTON RING
14	-----	1	CROWN SEAL
15	-----	1	O - RING
16	-----	1	O - RING
17	-----	1	BACK - UP WASHER
18	-----	1	U - CUP
19	-----	1	WIPER
20	34334	-	SPHERICAL BEARING (NOT SHOWN)

3IN X 18IN WELDED CYLINDER BREAKDOWN

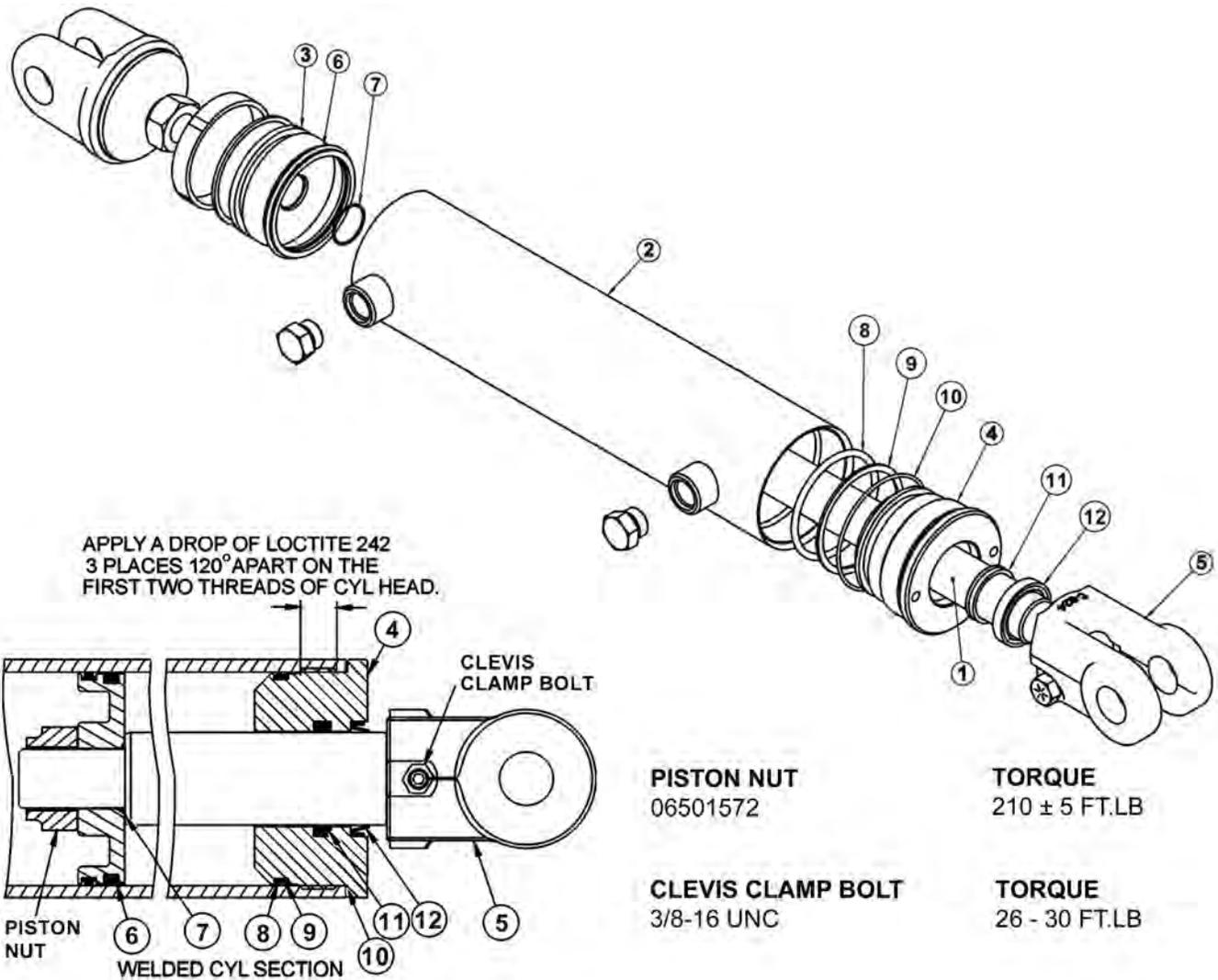

WARNING - MECHANICAL FASTENERS MUST BE TORQUED TO RECOMMENDED SPECIFICATIONS DURING REPAIR TO PREVENT PERSONAL INJURY OR EQUIPMENT DAMAGE.

ITEM	PART NO.	QTY.	DESCRIPTION
-----	06501023	-	HYDRAULIC CYLINDER COMPLETE
1	06501561	1	ROD
2	06501562	1	TUBE WELDMENT
3	06501552	1	PISTON
4	06501563	1	CYLINDER HEAD
5	06501554	1	CLEVIS
-----	06501564	-	SEAL REPAIR KIT (ITEMS 6 THROUGH 12)

3-1/2IN X 20IN WELDED CYLINDER BREAKDOWN

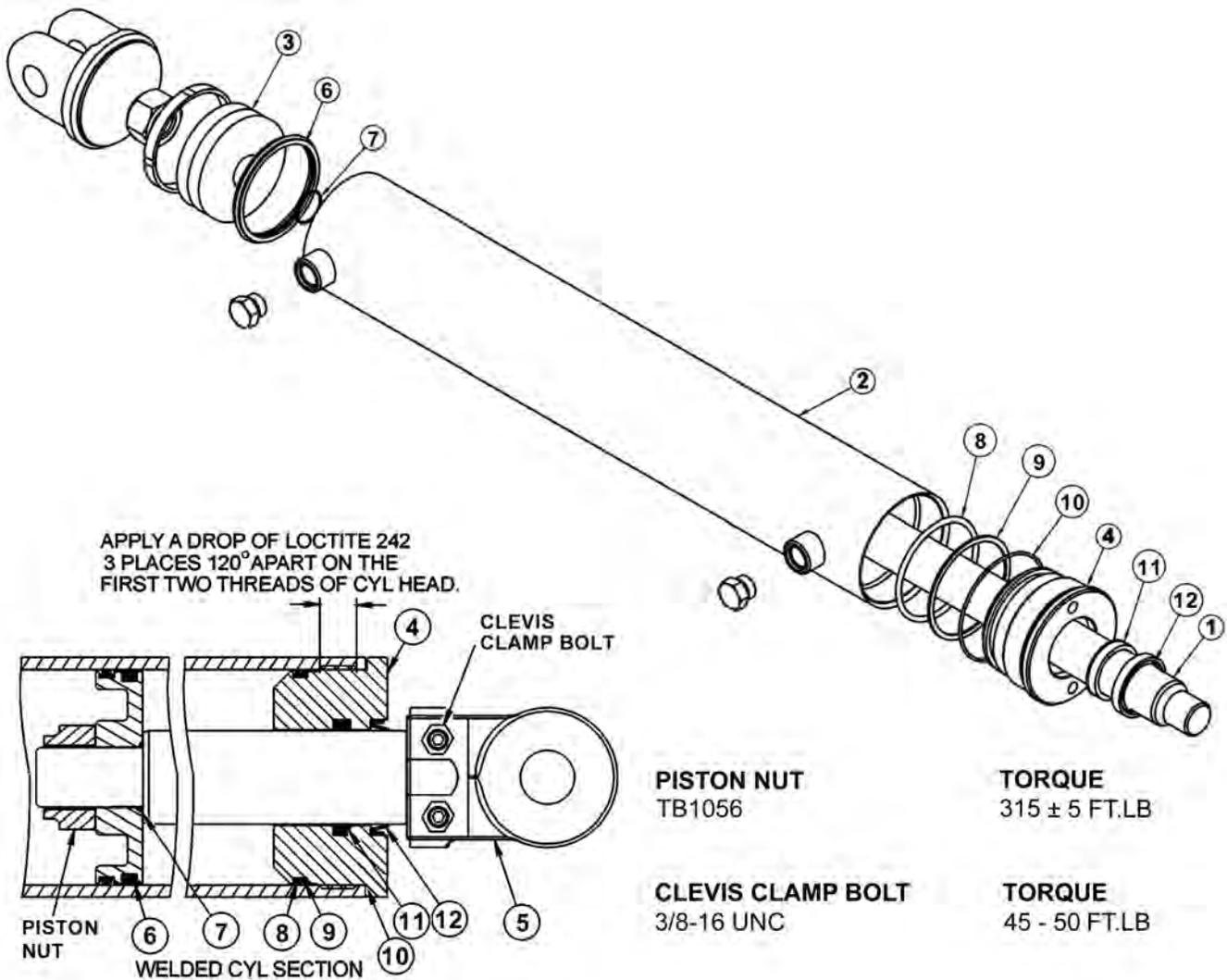

WARNING - MECHANICAL FASTENERS MUST BE TORQUED TO RECOMMENDED SPECIFICATIONS DURING REPAIR TO PREVENT PERSONAL INJURY OR EQUIPMENT DAMAGE.

ITEM	PART NO.	QTY.	DESCRIPTION
-----	06501024	-	HYDRAULIC CYLINDER COMPLETE
1	06501565	1	ROD
2	06501566	1	TUBE WELDMENT
3	06501567	1	PISTON
4	06501568	1	CYLINDER HEAD
5	TB3033	-	CLEVIS
-----	06501569	-	SEAL REPAIR KIT (ITEMS 6 THROUGH 12)

4IN X 20IN WELDED CYLINDER BREAKDOWN

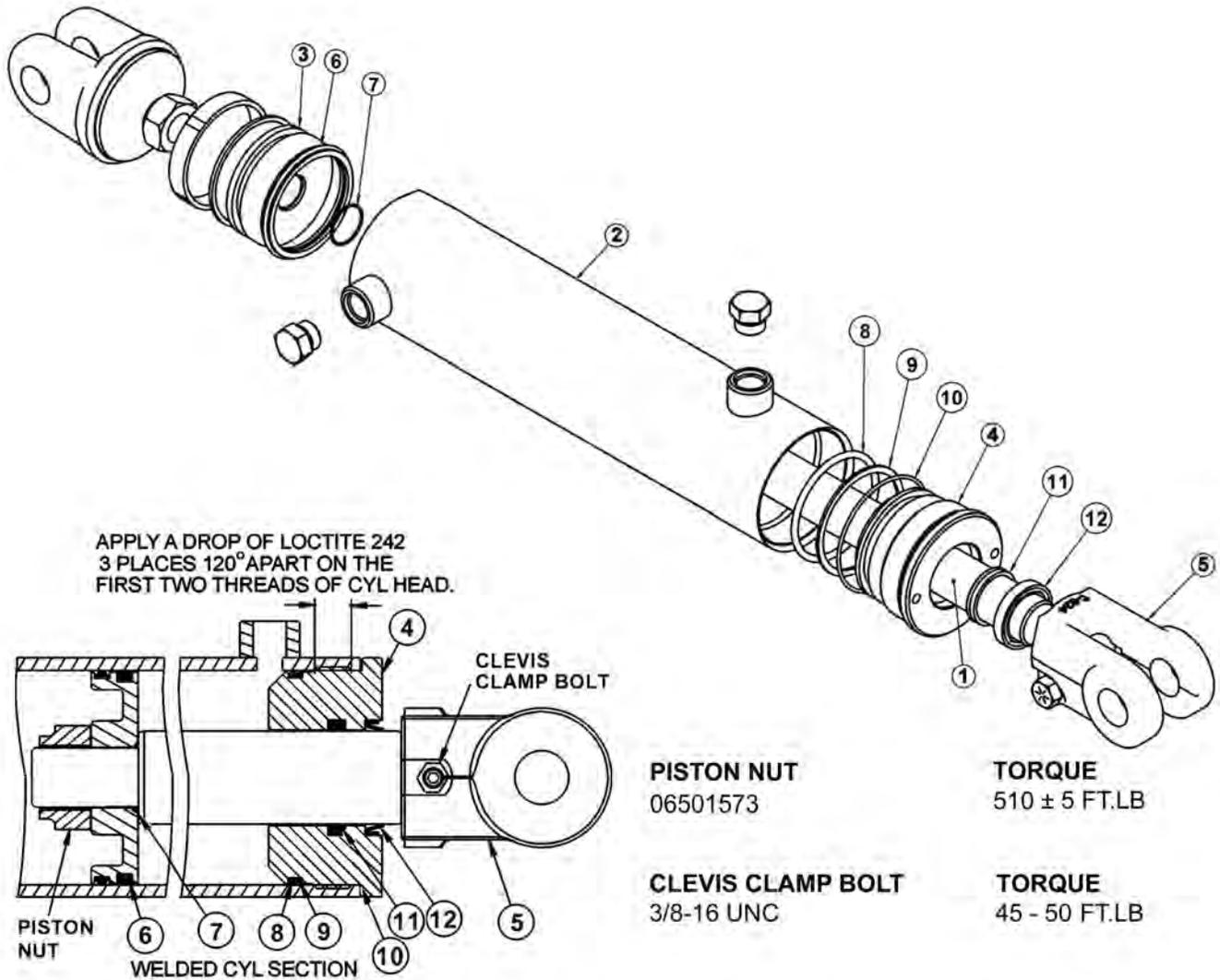

WARNING - MECHANICAL FASTENERS MUST BE TORQUED TO RECOMMENDED SPECIFICATIONS DURING REPAIR TO PREVENT PERSONAL INJURY OR EQUIPMENT DAMAGE.

ITEM	PART NO.	QTY.	DESCRIPTION
-----	06501022	-	HYDRAULIC CYLINDER COMPLETE
1	06501556	1	ROD
2	06501557	1	TUBE WELDMENT
3	06501558	1	PISTON
4	06501559	1	CYLINDER HEAD
5	6T0172	1	CLEVIS
5A	30172	-	CLEVIS (FOR EXTENDED BOOM)
-----	06501560	-	SEAL REPAIR KIT (ITEMS 6 THROUGH 12)

5IN X 20IN WELDED CYLINDER BREAKDOWN

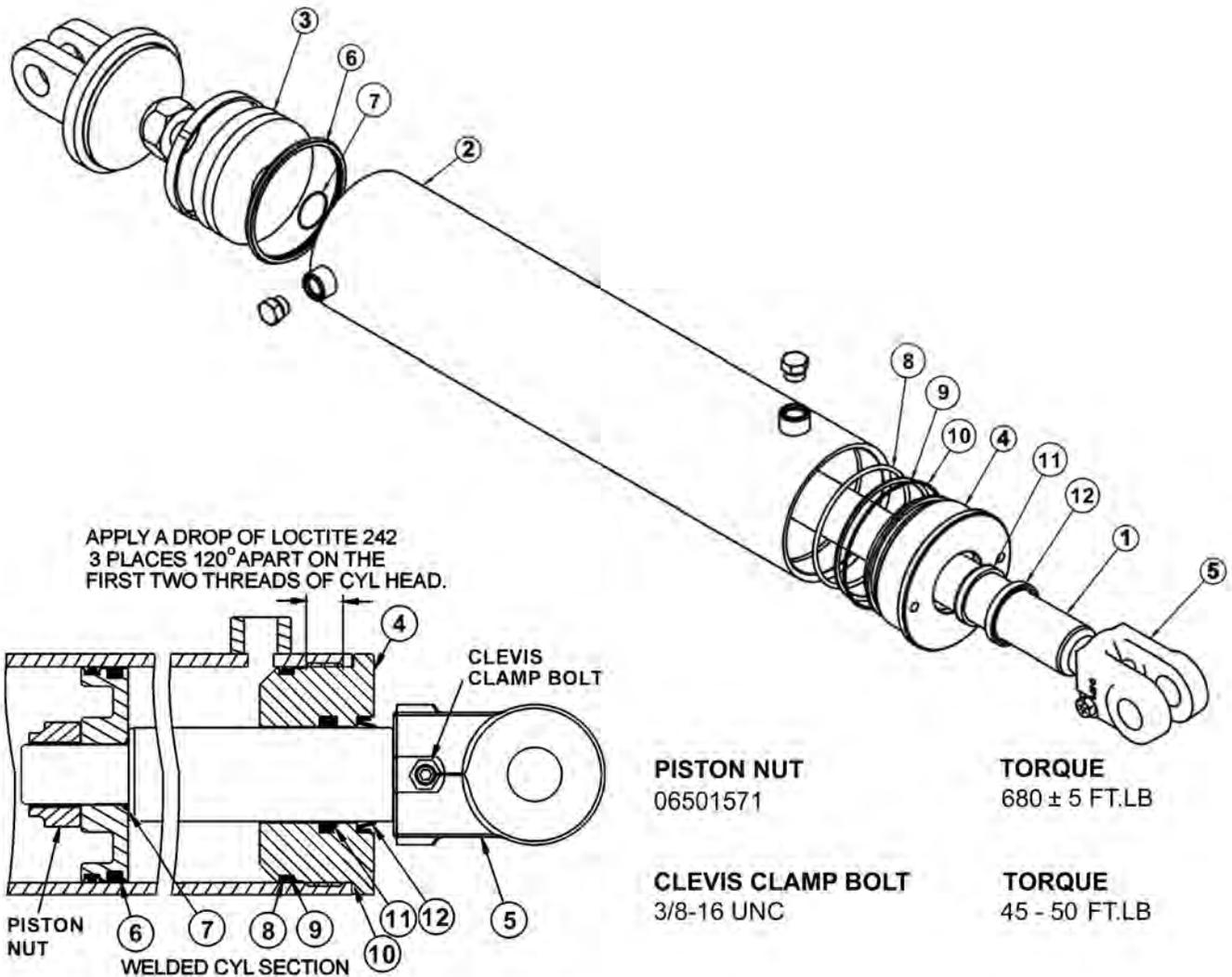

WARNING - MECHANICAL FASTENERS MUST BE TORQUED TO RECOMMENDED SPECIFICATIONS DURING REPAIR TO PREVENT PERSONAL INJURY OR EQUIPMENT DAMAGE.

ITEM	PART NO.	QTY.	DESCRIPTION
-----	06501020	-	HYDRAULIC CYLINDER COMPLETE
1	06501544	1	ROD
2	06501545	1	TUBE WELDMENT
3	06501546	1	PISTON
4	06501547	1	CYLINDER HEAD
5	06501548	1	CLEVIS
-----	06501549	-	SEAL REPAIR KIT (ITEMS 6 THROUGH 12)

NOTES

NOTES

5 SPOOL ELECTRONIC VALVE - OPEN STOW,3PS

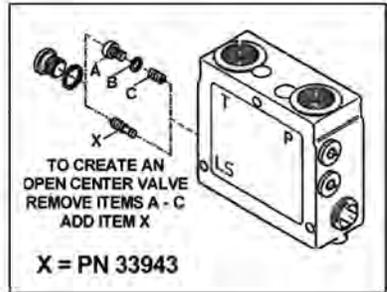
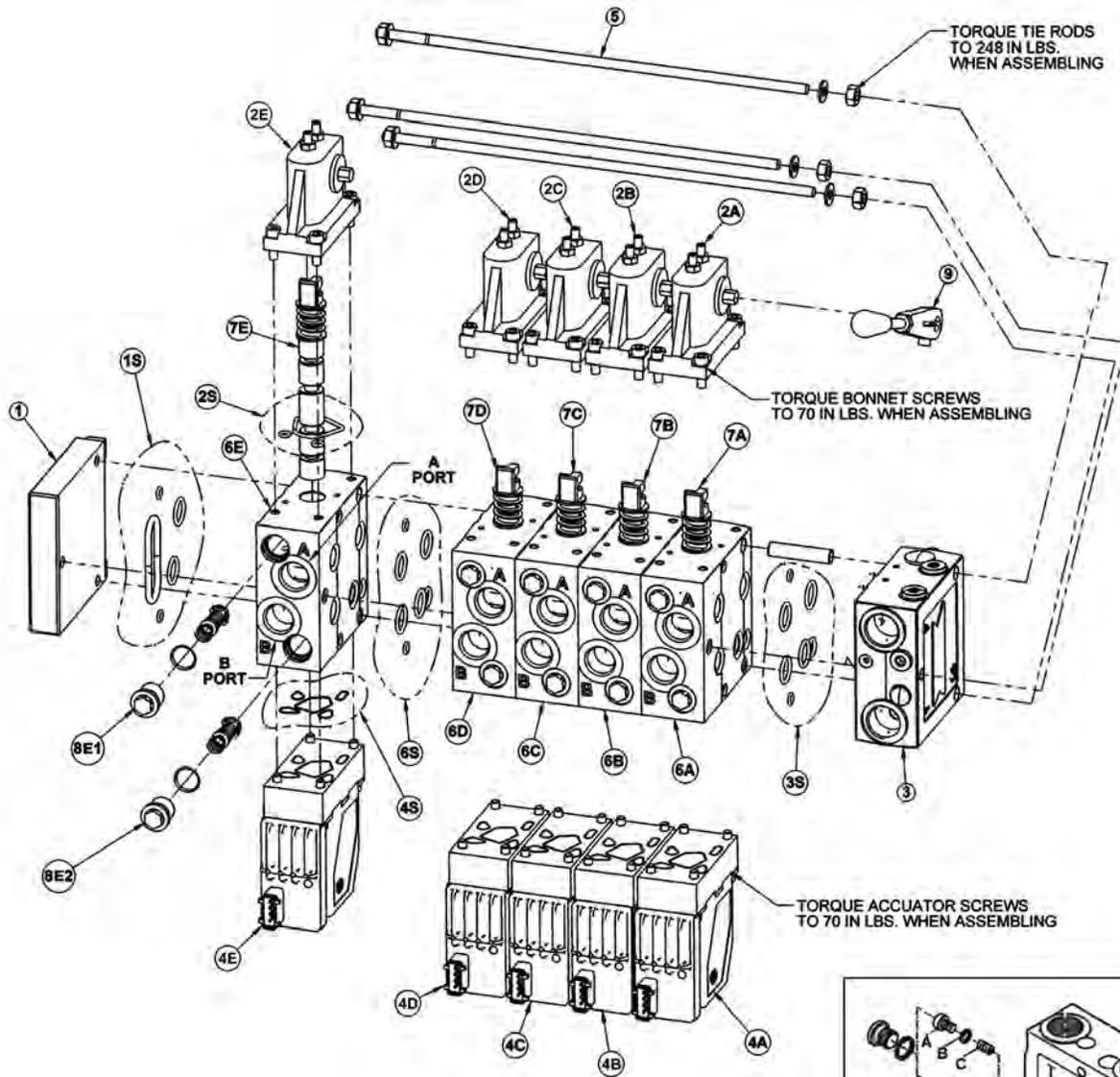

ITEM	PART NO.	QTY.	DESCRIPTION
----	06700224	-	VALVE, 5SP, OS
-----	06502097	-	VALVE, SUB-ASSEMBLY
1	06502074	1	END PLATE
1S	06505013	1	END PLATE SEAL KIT
2	-----	5	BONNET
2S	06505042	1	BONNET SEAL KIT

5 SPOOL ELECTRONIC VALVE - OPEN STOW,3PS

Continued...

ITEM	PART NO.	QTY.	DESCRIPTION
2A	42197	1	MAIN BOOM BONNET
2B	42197	1	SECONDARY BOOM BONNET
2C	42197	1	DECK ROLL BONNET
2D	42197	1	BOOM SWIVEL BONNET
2E	42197	1	DECK SHIELD BONNET
3	34308	1	INLET SECTION
3S	06505013	1	INLET SECTION SEAL KIT
4	-----	5	ELECTRONIC ACCUATOR
4A	06502101	1	MAIN BOOM ELECTRONIC ACCUATOR
4B	06502101	1	SECONDARY BOOM ELECTRONIC ACCUATOR
4C	06502100	1	DECK ROLL ELECTRONIC ACCUATOR
4D	06502101	1	BOOM SWIVEL ELECTRONIC ACCUATOR
4E	06502099	1	DECK SHIELD ELECTRONIC ACCUATOR
5	42202	1	TIE-BOLT KIT
6	-----	5	SECTION
6S	06505013	1	SECTION SEAL KIT
6A	42698	1	MAIN BOOM SECTION
6B	42698	1	SEC BOOM SECTION
6C	06502076	1	DECK ROLL SECTION
6D	42698	1	BOOM SWIVEL SECTION
6E	06502077	1	SHIELD SECTION
7	-----	5	SPOOL
7A	42697	1	MAIN BOOM SPOOL
7B	42697	1	SEC BOOM SPOOL
7C	4242106	1	DECK ROLL SPOOL
7D	06502073	1	BOOM SWIVEL SPOOL
7E	42201	1	DECK SHIELD SPOOL
8	-----	10	ANTI CAV/SHOCK RELIEF
8A1	06502084	1	MAIN BOOM A PORT RELIEF
8A2	06502081	1	MAIN BOOM B PORT RELIEF
8B1	42296	1	SEC BOOM A PORT RELIEF
8B2	06502082	1	SEC BOOM B PORT RELIEF
8C1	42295	1	DECK ROLL A PORT RELIEF
8C2	06502082	1	DECK ROLL B PORT RELIEF
8D1	06502070	1	BOOM SWIVEL A PORT RELIEF
8D2	06502083	1	BOOM SWIVEL B PORT RELIEF
8E1	06502081	1	DECK SHIELD A PORT RELIEF
8E2	06502081	1	DECK SHIELD B PORT RELIEF
9	33459	1	HANDLE

COMMON BENGAL T4

5 SPOOL ELECTRONIC VALVE - SIDE STOW

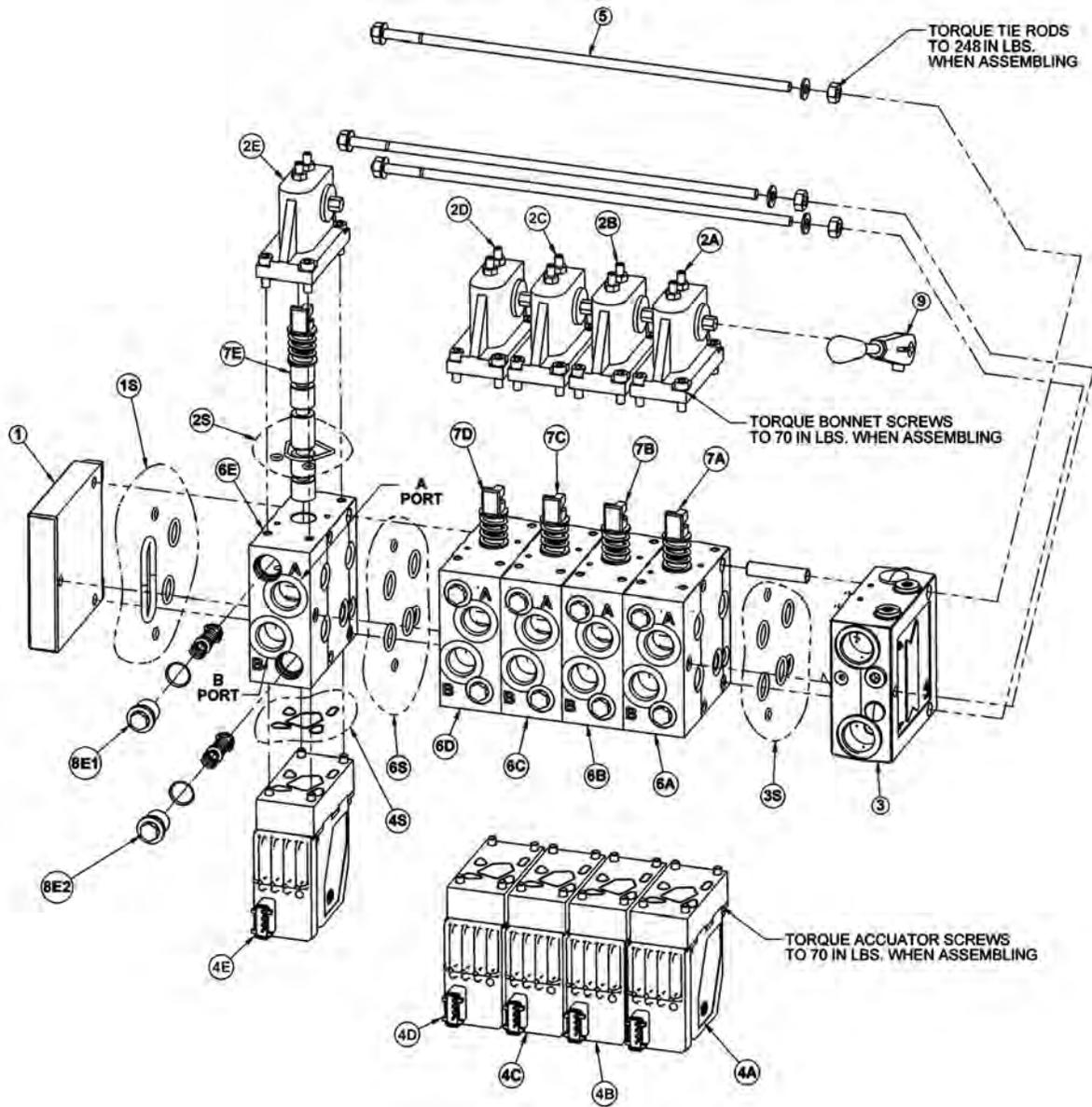

ITEM	PART NO.	QTY.	DESCRIPTION
-----	06502096	-	VLV,5SP,32PVG,SIDE STOW
1	06502074	1	END PLATE
1S	06505013	1	END PLATE SEAL KIT
2	-----	5	BONNET
2S	06505042	1	BONNET SEAL KIT
2A	42197	1	MAIN BOOM BONNET
2B	42197	1	SECONDARY BOOM BONNET
2C	42197	1	DECK ROLL BONNET
2D	42197	1	BOOM SWIVEL BONNET
2E	42197	1	DECK SHIELD BONNET

5 SPOOL ELECTRONIC VALVE - SIDE STOW

Continued...

ITEM	PART NO.	QTY.	DESCRIPTION
3	34308	1	INLET SECTION
3S	06505013	1	INLET SECTION SEAL KIT
4	-----	5	ELECTRONIC ACCUATOR
4A	06502101	1	MAIN BOOM ELECTRONIC ACCUATOR
4B	06502101	1	SECONDARY BOOM ELECTRONIC ACCUATOR
4C	06502100	1	DECK ROLL ELECTRONIC ACCUATOR
4D	06502101	1	BOOM SWIVEL ELECTRONIC ACCUATOR
4E	06502099	1	DECK SHIELD ELECTRONIC ACCUATOR
5	42202	1	TIE-BOLT KIT
6	-----	5	SECTION
6S	06505013	1	SECTION SEAL KIT
6A	42698	1	MAIN BOOM SECTION
6B	42698	1	SEC BOOM SECTION
6C	06502076	1	DECK ROLL SECTION
6D	42698	1	BOOM SWIVEL SECTION
6E	06502077	1	SHIELD SECTION
7	-----	5	SPOOL
7A	42697	1	MAIN BOOM SPOOL
7B	42697	1	SEC BOOM SPOOL
7C	4242106	1	DECK ROLL SPOOL
7D	06502073	1	BOOM SWIVEL SPOOL
7E	42201	1	DECK SHIELD SPOOL
8	-----	10	ANTI CAV/SHOCK RELIEF
8A1	42650	1	MAIN BOOM A PORT RELIEF
8A2	06502069	1	MAIN BOOM B PORT RELIEF
8B1	42650	1	SEC BOOM A PORT RELIEF
8B2	42295	1	SEC BOOM B PORT RELIEF
8C1	42296	1	DECK ROLL A PORT RELIEF
8C2	42295	1	DECK ROLL B PORT RELIEF
8D1	42295	1	BOOM SWIVEL A PORT RELIEF
8D2	42295	1	BOOM SWIVEL B PORT RELIEF
8E1	06502069	1	DECK SHIELD A PORT RELIEF
8E2	06502069	1	DECK SHIELD B PORT RELIEF
9	33459	1	HANDLE

FRONT HYDRAULIC PUMP

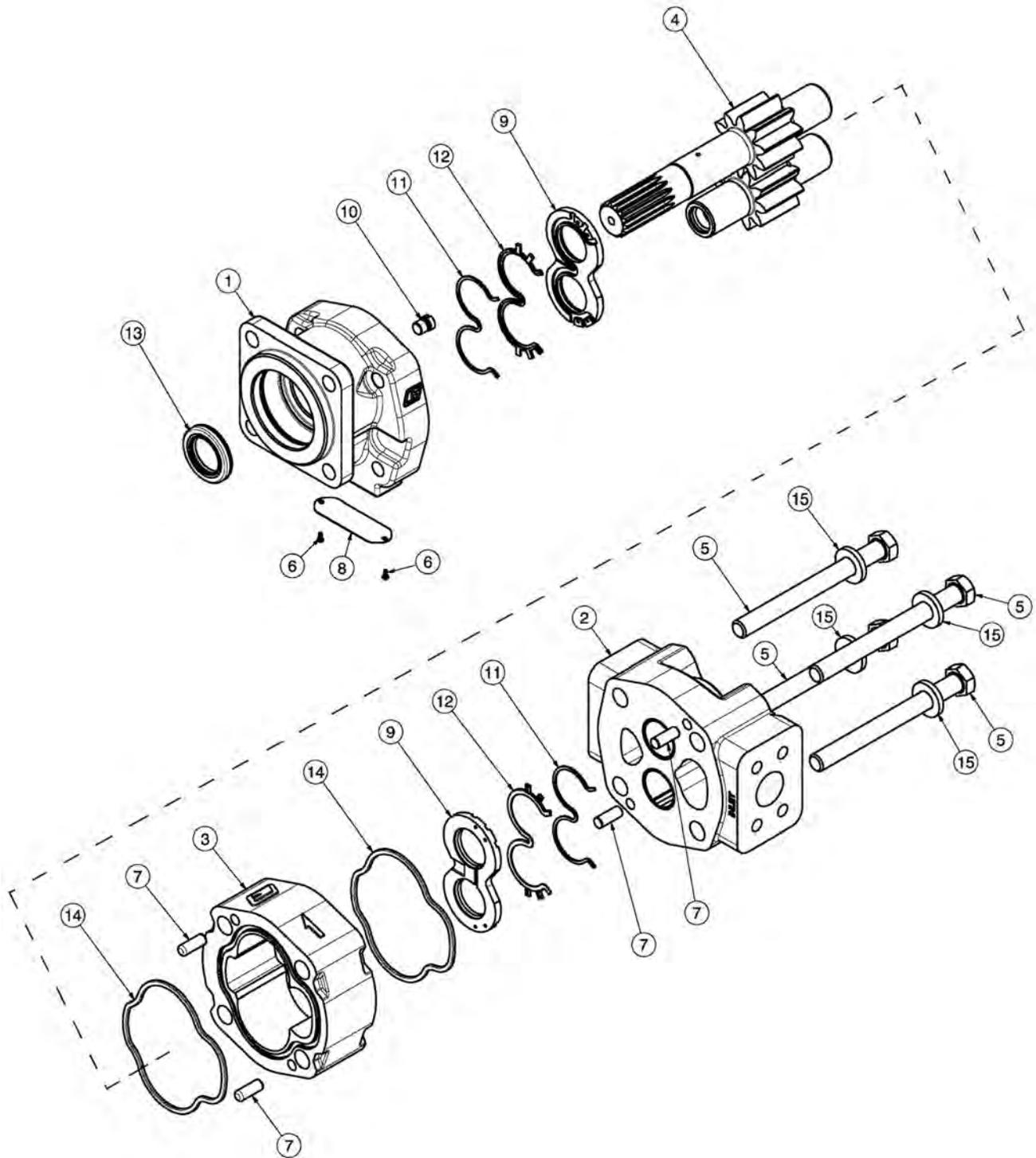

FRONT HYDRAULIC PUMP

Continued...

ITEM	PART NO.	QTY.	DESCRIPTION
---	23152	1	PUMP ASSEMBLY,1-3/4",COMPLETE
1	22766	1	SHAFT END COVER
2	22779	1	PORT END COVER
3	22774	1	GEAR HOUSING,1-3/4"
4	22771	1	GEAR SET
5	23824	4	CAPSCREW
6	06504078	2	SCREW,DRIVE
7	22773	4	DOWEL PINS
8	06504077	1	NAMEPLATE
9	22770	2	THRUST PLATE
10	22767	1	PLUG
11	06504075	2	SEAL,BK-UP
12	06504074	2	SEAL,CHAN
13	22765	1	SEAL,LIP
14	06504076	2	SEAL,SQ-R
15	02961917	4	WASHER
---	24150	1	SEAL KIT (INCLUDES 11, 12, 13 AND 14)

50IN AND 60IN ROTARY MOTOR BREAKDOWN

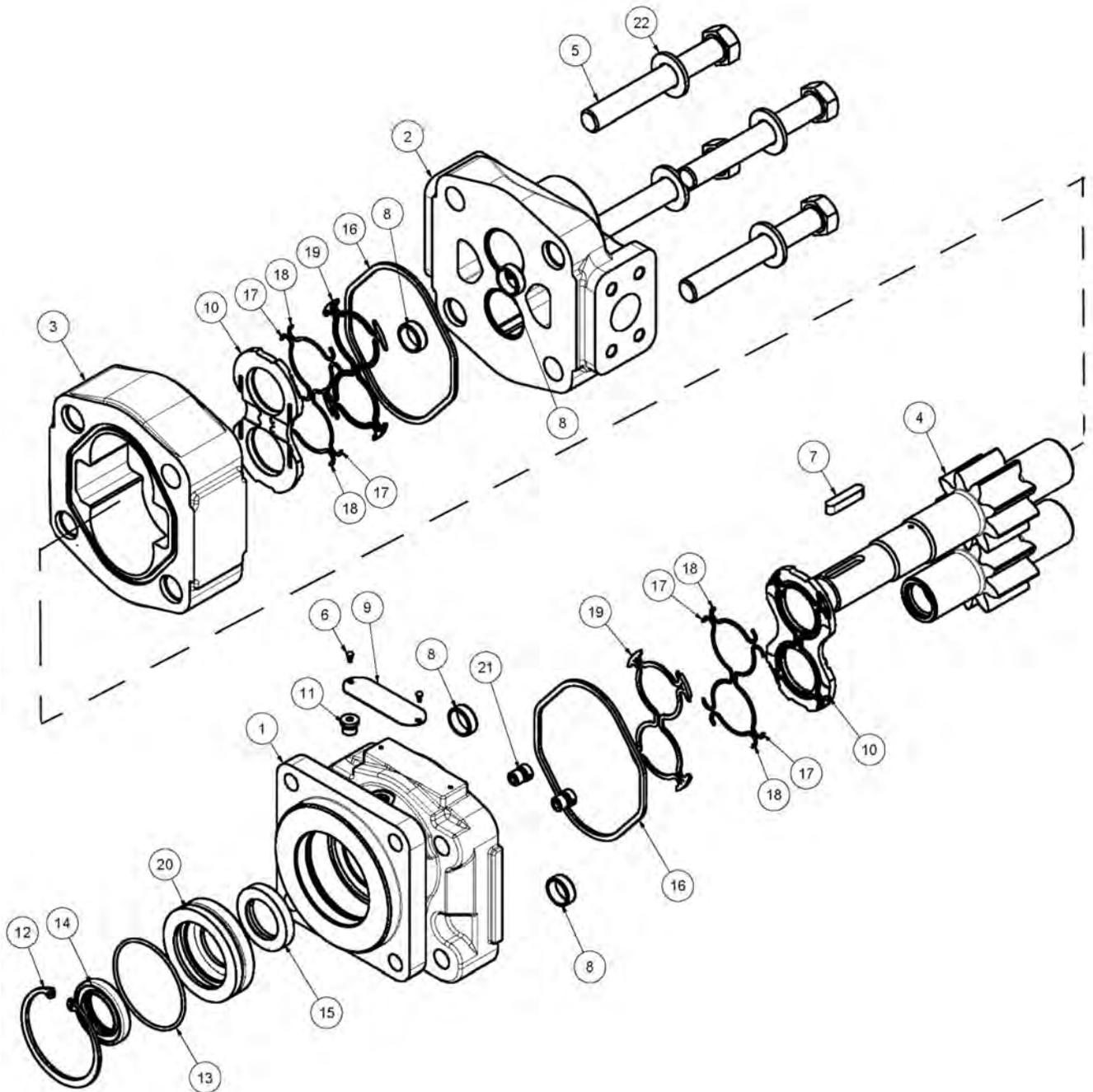

50IN AND 60IN ROTARY MOTOR BREAKDOWN

Continued...

ITEM	PART NO.	QTY.	DESCRIPTION
	06504011	-	MOTOR ASSEMBLY,TRB60
	06504012	-	MOTOR ASSEMBLY,TRB50
1	22790	1	HOUSING, SEC
2	06504088	1	HOUSING, PEC
3	06504062	1	HOUSING, GEAR,TRB60
-----	06504089	-	HOUSING, GEAR,TRB50
4	06504090	1	SET, GEAR SHAFT
5	06504104	4	CAP SCREW,TRB60
-----	06504091	-	CAP SCREW,TRB50
6	06504078	2	SCREW, DRIVE
7	06504092	1	KEY
8	06504093	4	PIN, DOWEL
9	06504094	1	NAME PLATE
10	06504095	2	THRPL
11	2961940	1	PLUG, ODT
12	2962200	1	RING, SNAP
13	06504096	1	O RING
14	6T5101	1	SEAL, LIP
15	06504097	1	SEAL, LIP
16	22797	2	SEAL, SQ-R
17	06504098	4	SEAL, SIDE CHAN
18	06504099	4	SEAL, END CHAN
19	06504100	2	SEAL, BK-UP
20	06504101	1	RTNR, SEAL
21	6T5809	2	CHECK ASS'Y
22	06504102	4	WASHER
-----	06504103	-	SEAL KIT

FLAIL MOTOR BREAKDOWN

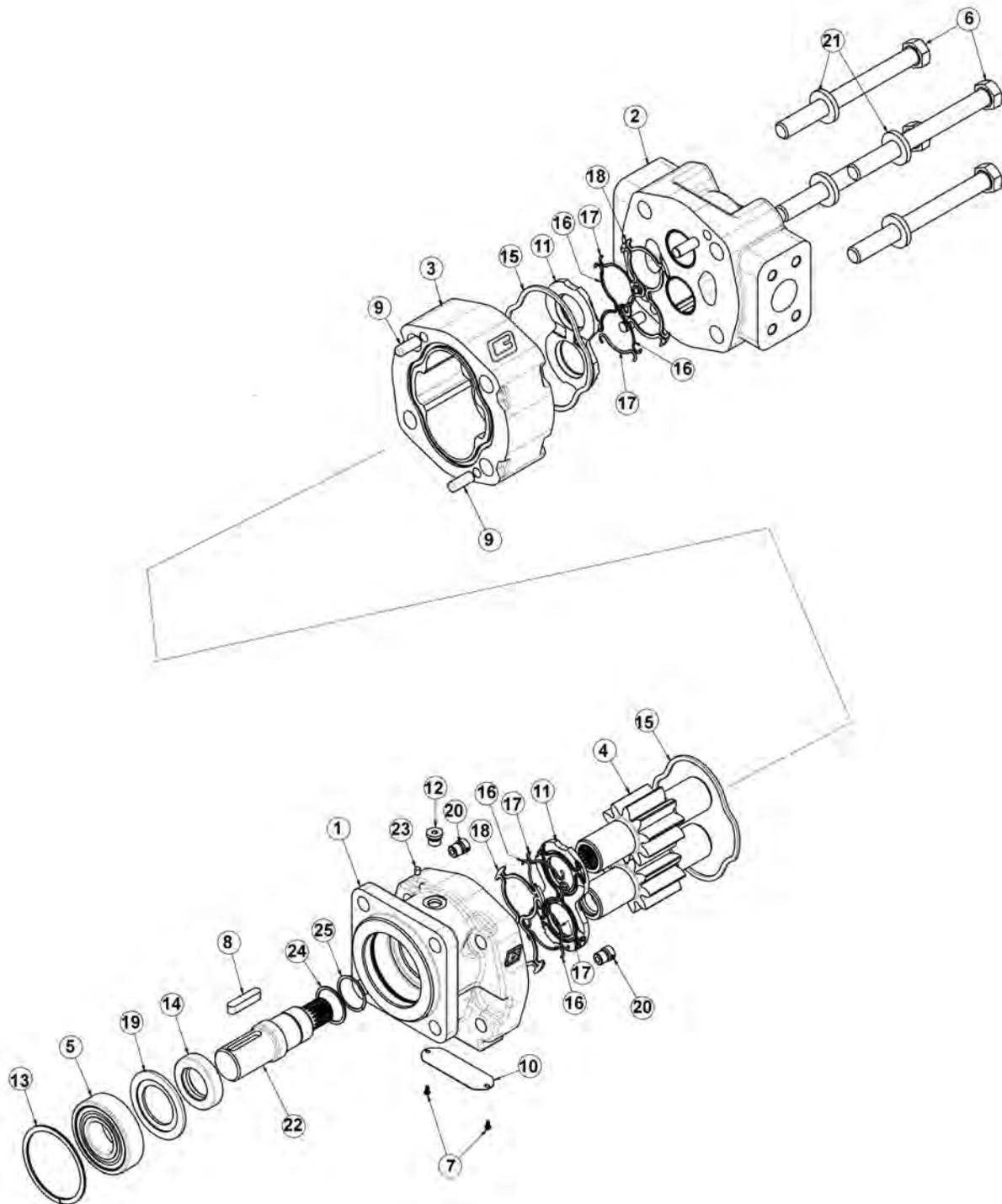

FLAIL MOTOR BREAKDOWN

Continued...

ITEM	PART NO.	QTY.	DESCRIPTION
*	06504132	-	MOTOR ASSEMBLY 350 - TBF50, TBF63
1	06504141	1	SHAFT END COVER
2	06504040	1	PORT END COVER
3	06504041	1	GEAR HOUSING
4	06504117	1	MATCHED GEAR SET
5	TF4402	1	BALL BEARING
6	06504043	4	CAP SCREW
7	06504044	2	SET SCREW
8	06504028	1	KEY
9	06504045	4	DOWEL PIN
10	*	1	NAMEPLATE
11	763759	1	THRUSTPLATE
12	2961940	1	PLUG, ODT (0.25)
13	TF4401	1	SNAP RING
14	06504142	1	LIP SEAL
15	TF4410	2	GASKET SEAL
16	06504046	4	SIDE SEAL
17	06504047	4	END SEAL
18	TF4407	2	BACK-UP SEAL
19	06504122	1	SEAL RETAINER
20	6T5809	2	CHECK ASSEMBLY
21	2961917	4	WASHER
22	06504140	1	SHAFT
23	06504139	1	BREATHER
24	06504121	1	SPACER, BRG
25	06504119	1	SNAP RING
*	06504116	-	SEAL KIT

RESERVOIR TANK FILTER ASSEMBLY

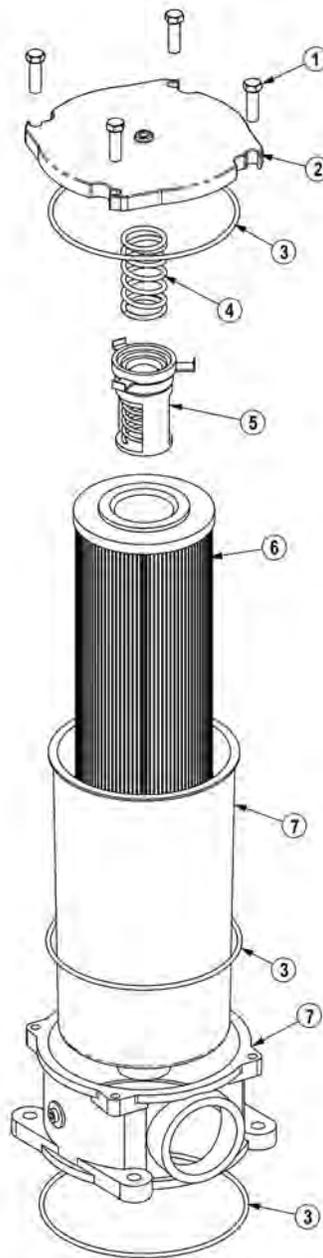

ITEM	PART NO.	QTY.	DESCRIPTION
-----	06505044	-	FILTER ASSY SAE 10 MICRON
1	28583	4	CAPSCREW,8MM X 25MM(1.25 PITCH)
2	06505045	1	COVER
3	06505046	1	SEAL KIT
4	06505047	1	SPRING
5	06505048	1	BYPASS
6	35259	1	FILTER,10 MIC,RETURN LINE
7	06505049	1	CAN/BODY

COMMON BENGAL T4

PUMP AND GRILL GUARD OPTIONS

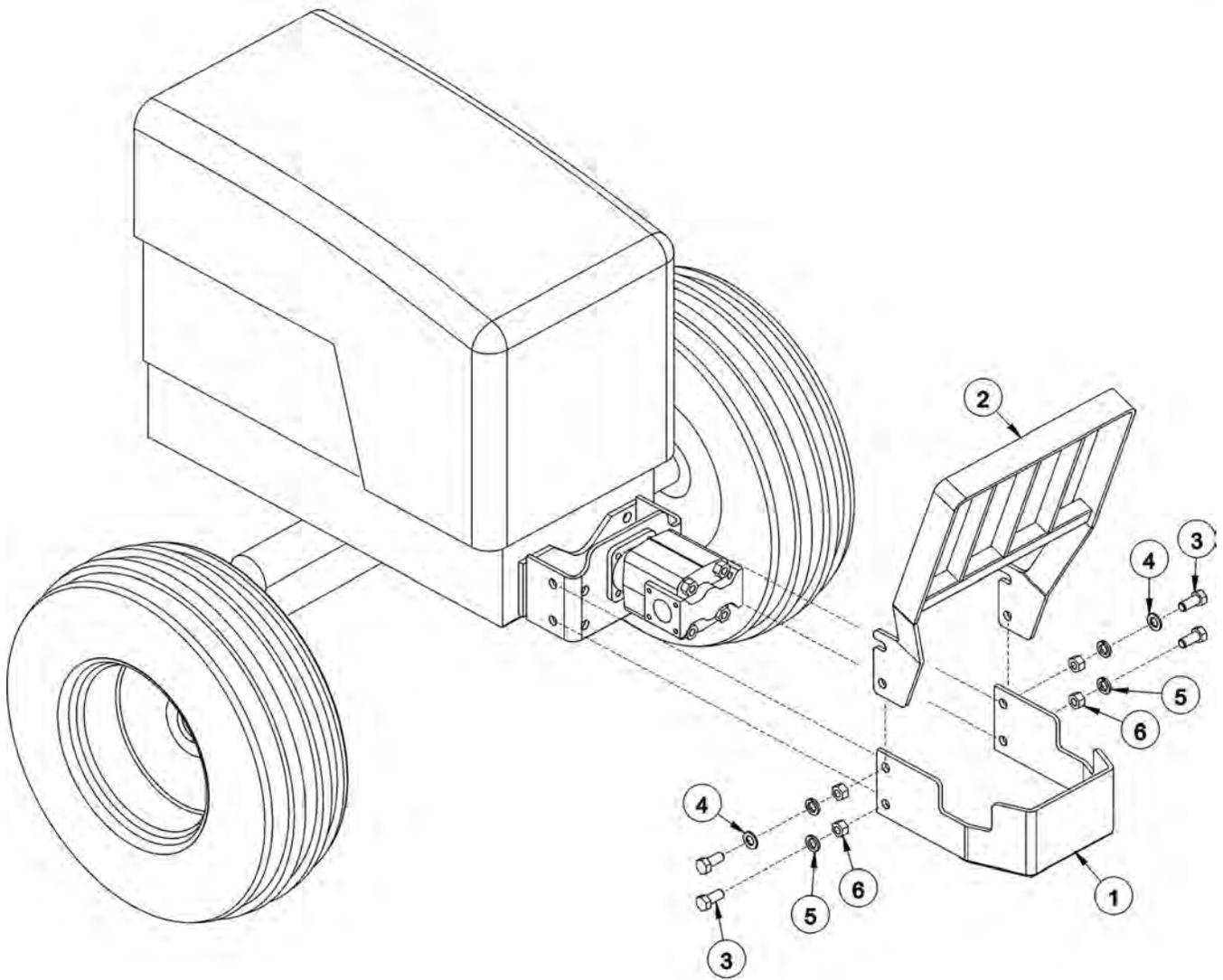

ITEM	PART NO.	QTY.	DESCRIPTION
1	32430	1	UNIVERSAL PUMP GUARD
2	32737	1	UNIVERSAL GRILL GUARD
3	21833	4	CAPSCREW,3/4" X 2-1/4",NC
4	22021	2	FLATWASHER,3/4"
5	21993	4	LOCKWASHER,3/4"
6	21825	4	HEX NUT,3/4",NC

BOOM TRAVEL LOCK

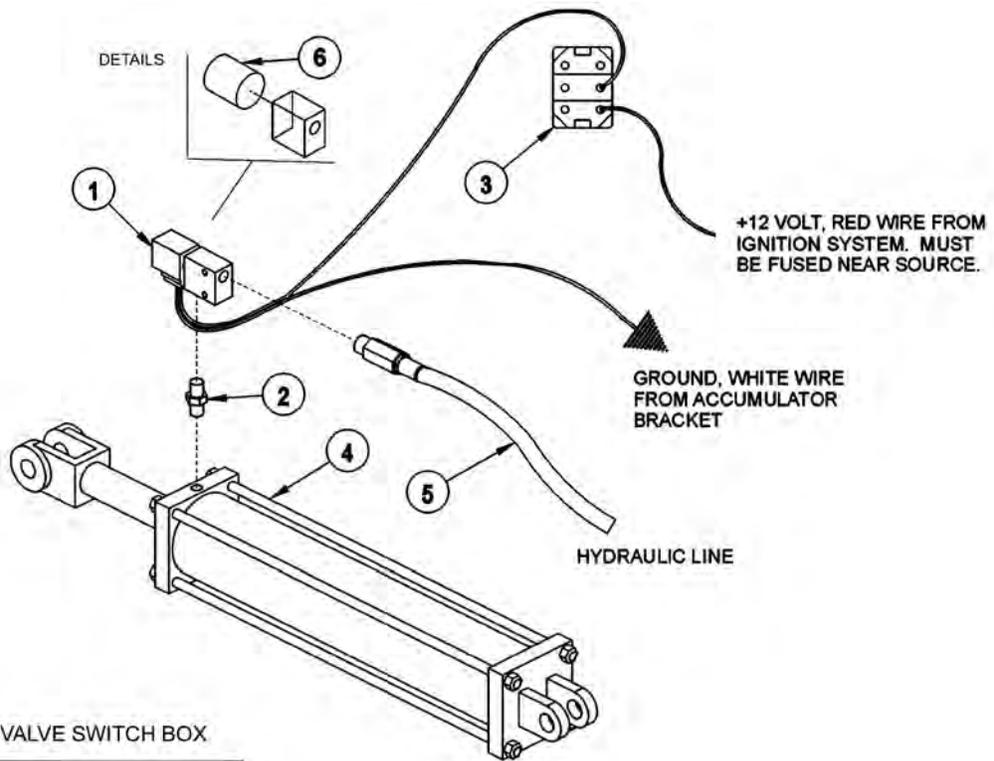

ELECTRONIC LIFT VALVE SWITCH BOX



TRAVEL LOCK SWITCH

MANUAL LIFT VALVE SWITCH BOX



TRAVEL LOCK SWITCH

ITEM	PART NO.	QTY.	DESCRIPTION
1	06510050	1	HYDRAULIC TRAVEL LOCK VALVE
2	31329	1	ADAPTER - STANDARD BOOM
-----	31611	1	ADAPTER - EXTENDED BOOM
3	34532	1	SWITCH,TRAVEL LOCK
4	-----	-	MAIN BOOM CYLINDER *REFER TO BOOM ASSY
5	-----	-	HOSE / FITTINGS *REFER TO BOOM HYD ASSY
6	06510092	1	COIL ,TRAVEL LOCK

MANUAL LIFT VALVE SWITCH BOX

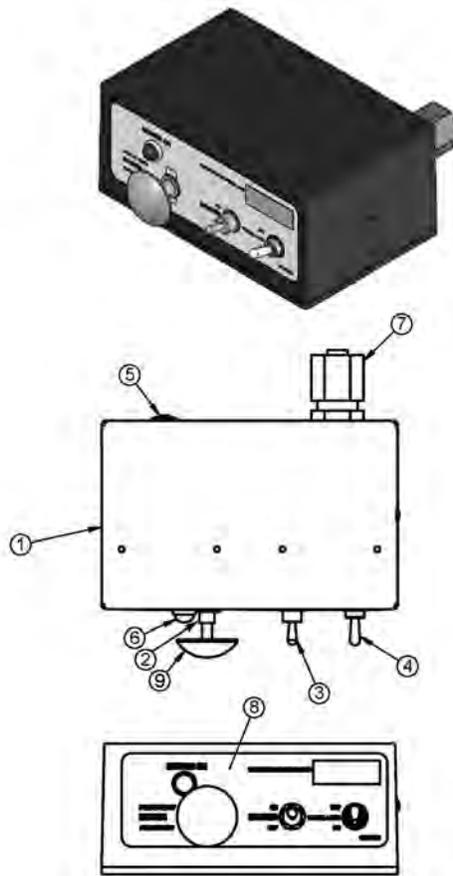

ITEM	PART NO.	QTY.	DESCRIPTION
1	06514012	1	SWBX,ALUM,BLK,06510100
2	35226	1	SWITCH,MOWER,COLEHERSEE
3	33811	1	SWITCH,MASTER/DECK FLOAT
4	34532	1	SWITCH,TRVL LCK
5	06514014	1	BREAKER,10A,SWBX
6	6T3923	1	INDICTATOR LIGHT,ON,RED
7	34540	1	STRAIN RELIEF,3/4,BLACK,NYLON
8	06550019	1	DECAL,SWTCHBX,BOOM,CG
9	02964063	1	KNOB,RED
10	35227	1	RELAY,DP,DT,12V,LY2F,35226

MANUAL LIFT VALVE SCHEMATIC

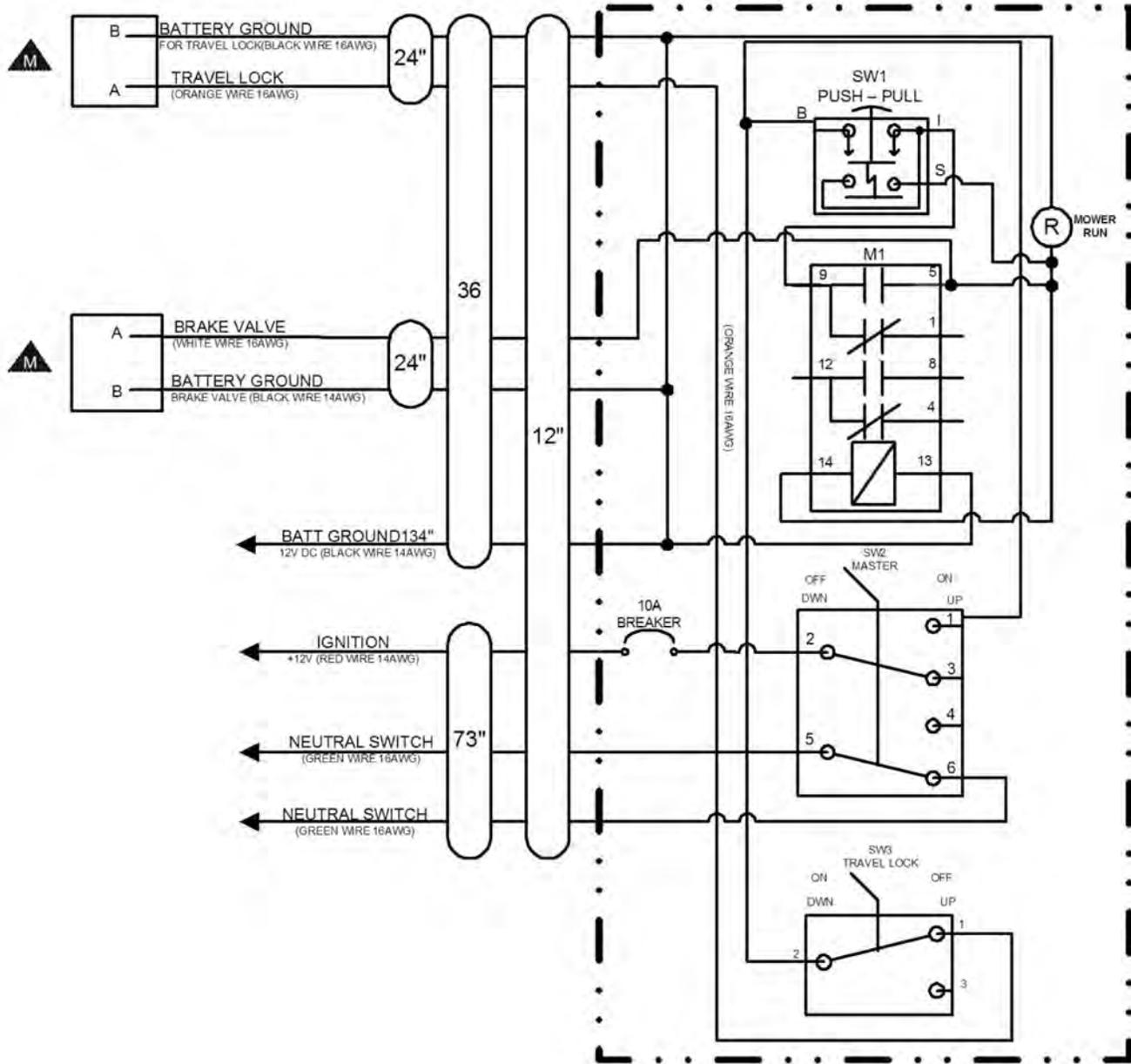

ELECTRONIC LIFT VALVE SWITCH BOX

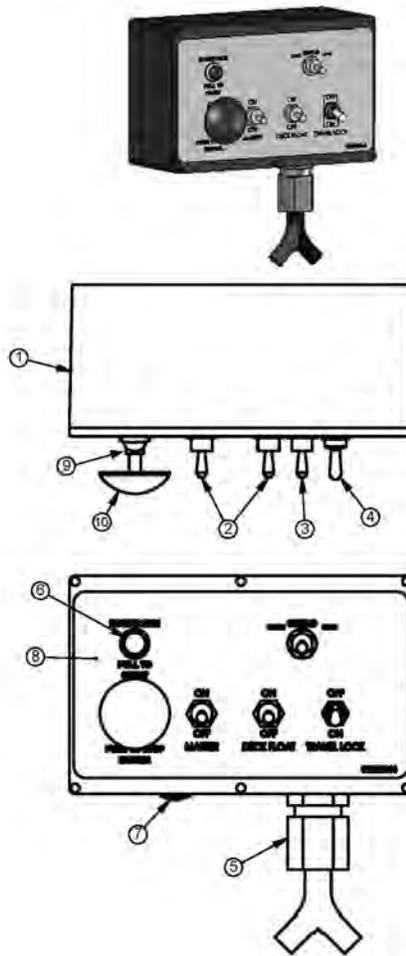

ITEM	PART NO.	QTY.	DESCRIPTION
1	06510196	1	SWBX,ASSY
2	33811	2	SWITCH,MASTER/DECK FLOAT
3	33813	1	SWITCH,SFTY SHIELD
4	34532	1	SWITCH,TRVL LCK
5	34540	1	STRAIN RELIEF,3/4",BLACK,NYLON
6	6T3923	1	INDICTATOR LIGHT,ON,RED
7	06514006	1	BREAKER,15A,SWBX
8	06550044	1	DECAL,SWBX,06510047
9	35226	1	SWITCH,MOWER,COLEHERSEE
10	02964063	1	KNOB,RED
11	35227	1	RELAY,DP,DT,12V,LY2F,35226

ELECTRONIC LIFT VALVE SCHEMATIC

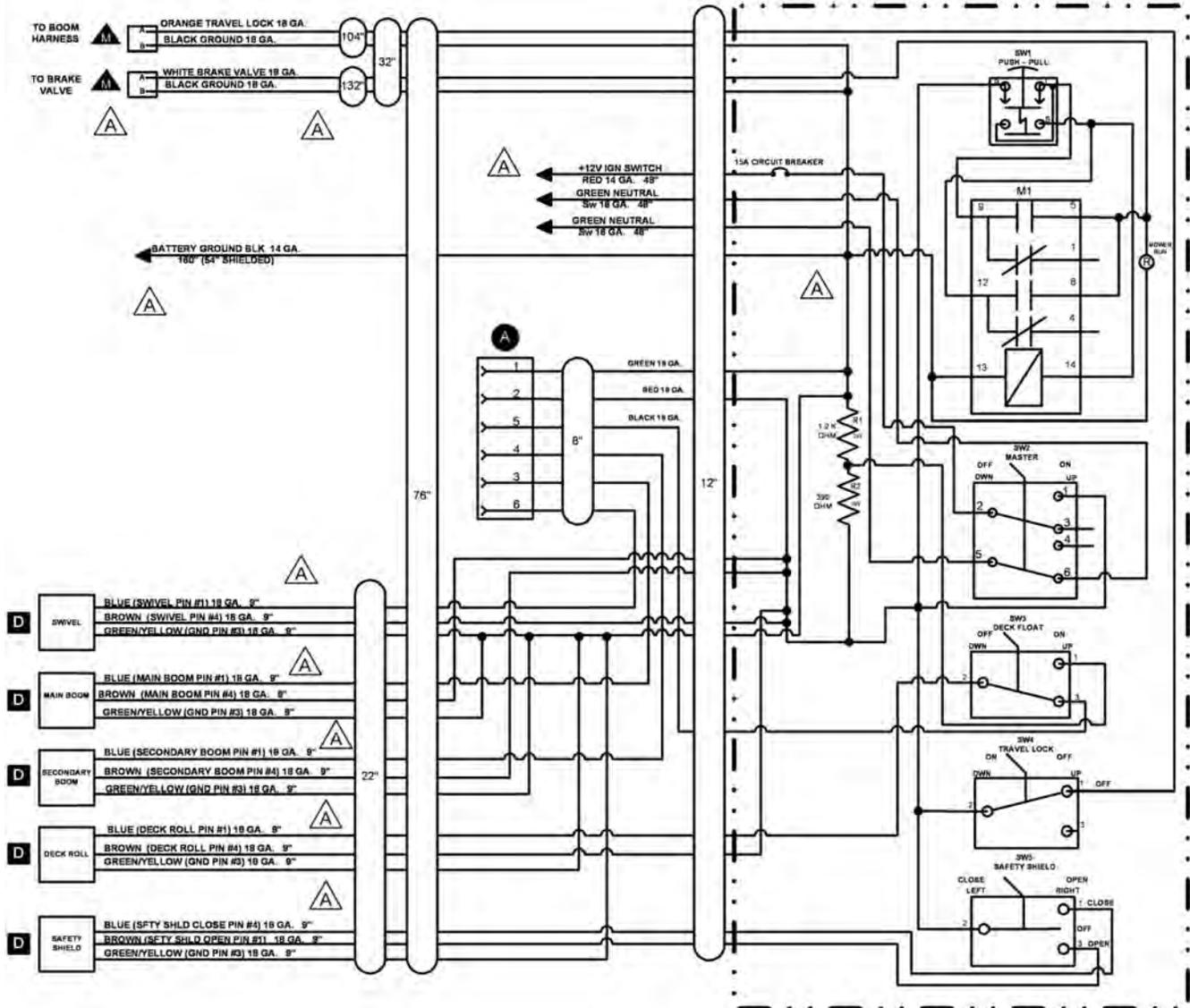

SOLENOID SWITCH BOX AND WIRING

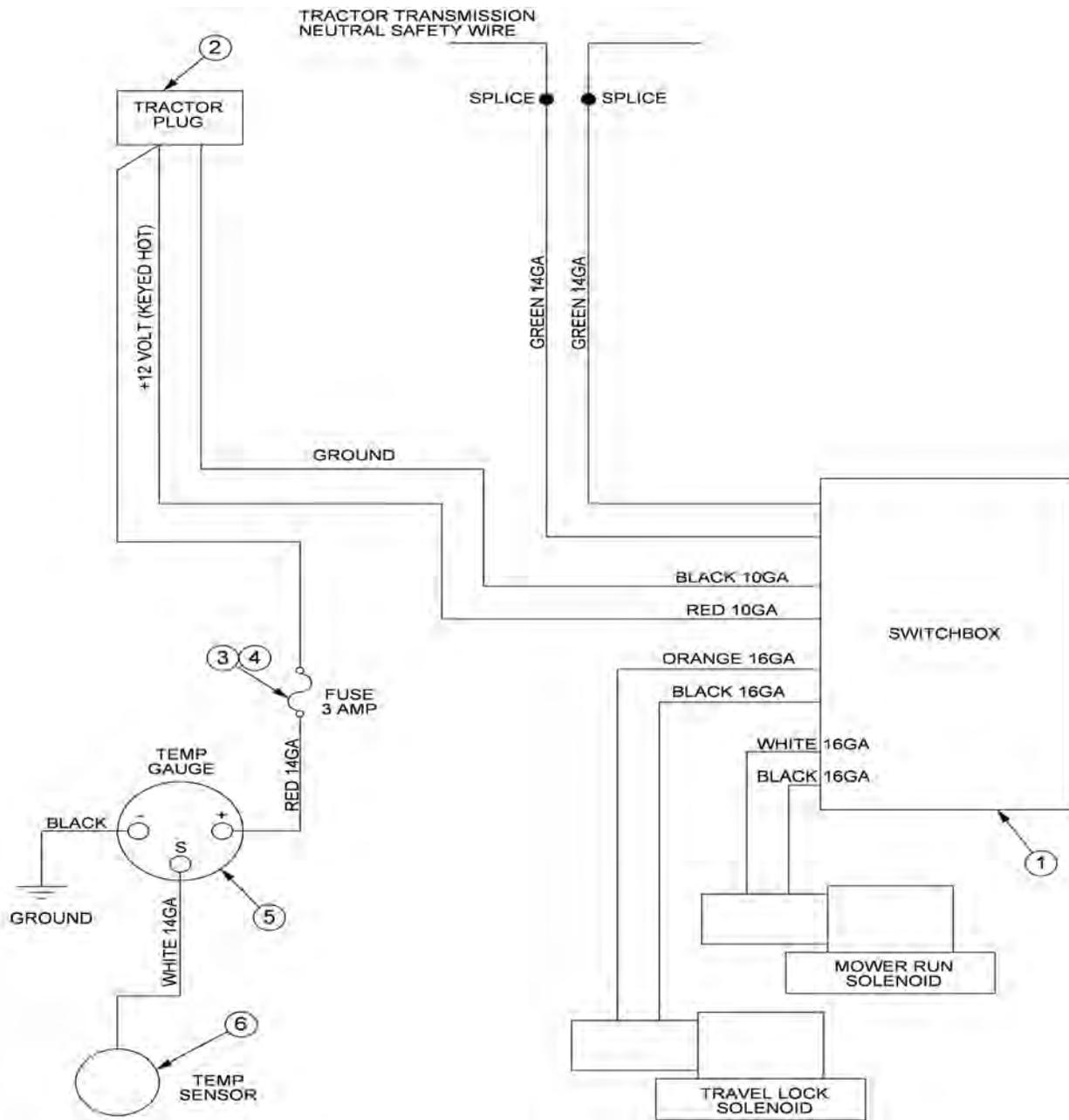

ITEM	PART NO.	QTY.	DESCRIPTION
1	-----	-	SWITCH BOX
2	RE37651	1	PLUG,AUX PWR
3	24204	-	FUSE HOLDER,IN-LINE (OPTION)
4	6T3965	-	FUSE,3AMP (OPTION)
5	6T3934	-	TEMPERATURE GAUGE (OPTION)
6	6T3931	-	TEMPERATURE SENSOR (OPTION)

BRAKE VALVE ASSEMBLY

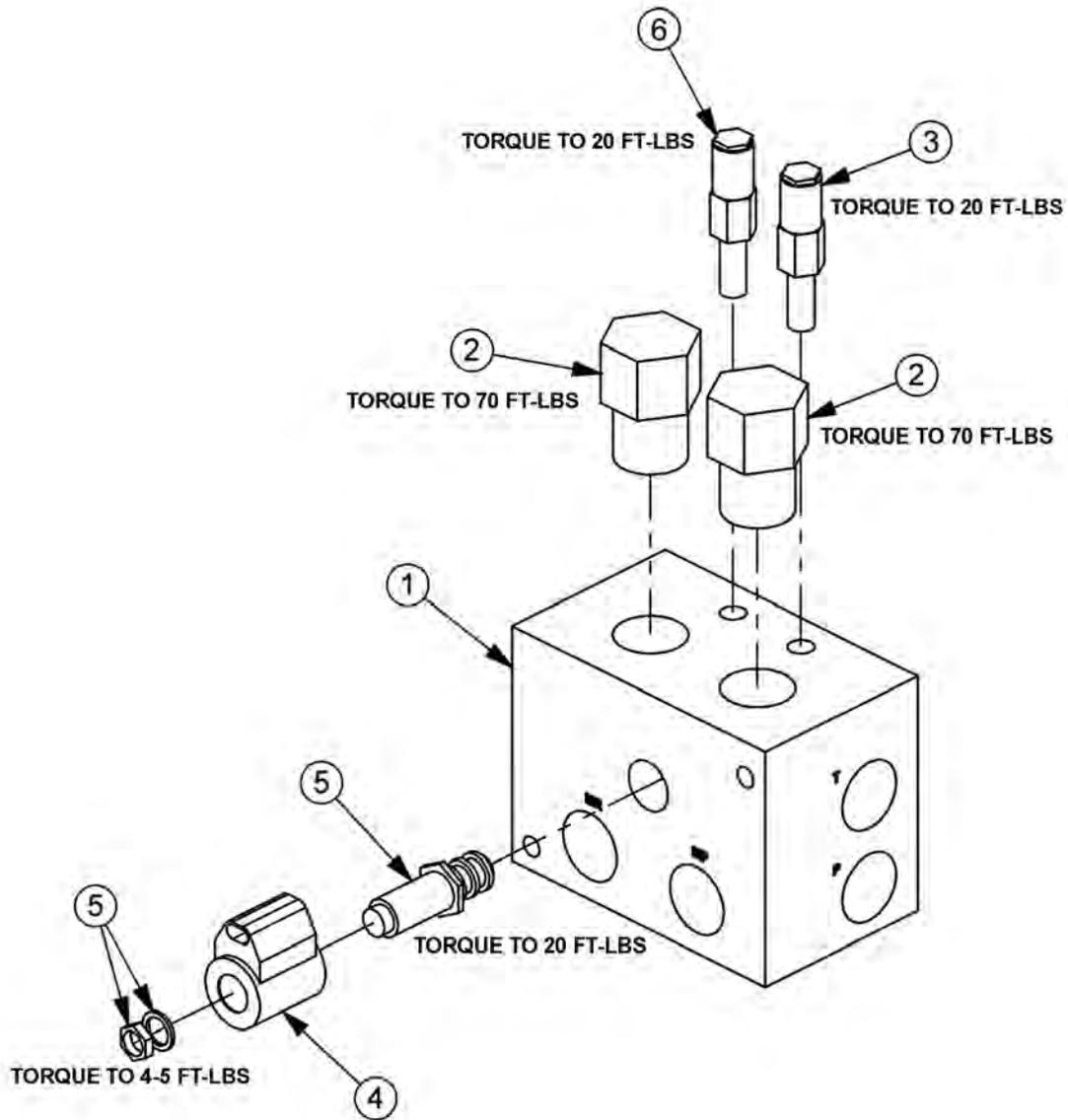

ITEM	PART NO.	QTY.	DESCRIPTION
---	06510083	1	BRAKE VALVE, ASSY
1	34092	1	BRAKE VALVE, BLANK
2	34094	2	LOGIC ELEMENT
3	34095	1	RELIEF VALVE, 3000 PSI
4	06510095	1	METRI PAK COIL
5	34093	1	CARTRIDGE, 2 POSITION, 3 WAY (WITH NUT & WASHER)
6	34091	1	RELIEF VALVE, 2600 PSI
---	34096	2	RELIEF SEAL KIT
----	34097	1	SOLENOID SEAL KIT
---	34098	2	ELEMENT SEAL KIT

BRAKE VALVE HYDRAULIC SCHEMATIC

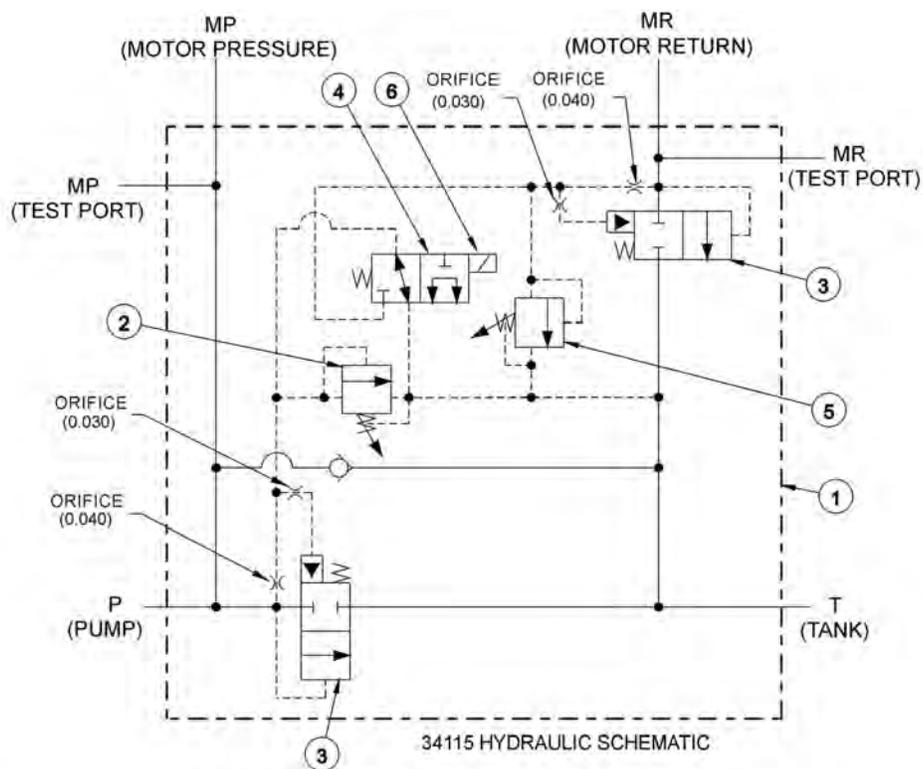

BRAKE VALVE TROUBLESHOOTING

FAILURE MODE:

- MOWER WILL NOT START - system pressure is low (engine not lugging).
- MOWER WILL NOT START - system pressure is high (engine lugging). "MR" port will be high pressure.
- MOWER WILL NOT ROTATE AT FULL SPEED - limited power.
- MOWER BLADE WILL NOT STOP - blade will not stop in proper time.

CHECK STEPS

- 1 thru 6
- 7
- 3 thru 5
- 7 thru 9

CORRECTIVE STEPS:

1. Check for voltage at solenoid (item 6), voltage must be between 10.2 volts and 13.8 volts.
2. Remove, inspect solenoid and cartridge (items 4, 6) for wear or contamination.
3. Remove, inspect logic elements near "P" port (item 3) for wear or contamination.
4. Remove, inspect 3000 psi relief valve (item 2) for wear or contamination.
5. Remove and inspect orifices near "P" port for contamination.
6. Remove "P" port hose and fitting, visually inspect for contamination, check ball for movement.
7. Remove and inspect orifices near "MR" port for contamination.
8. Remove, inspect 2600 psi relief valve (item 5) for wear of contamination.
9. Remove, inspect logic element near "MR" port (item 3) for wear or contamination.

ELECTRICAL TROUBLESHOOTING GUIDE

Joystick Electrical Troubleshooting guide

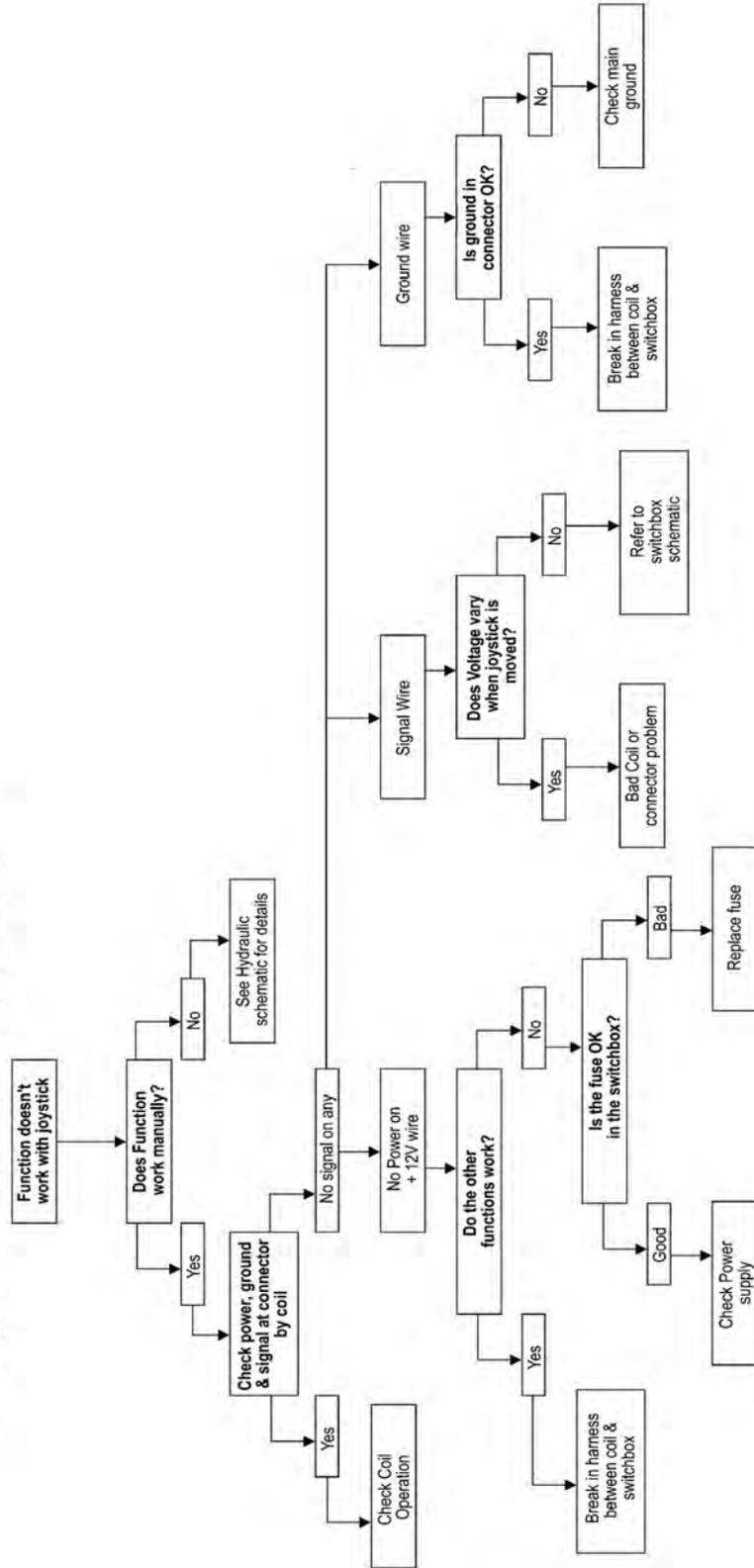

HYDRAULIC TROUBLESHOOTING GUIDE

Hydraulic Troubleshooting guide

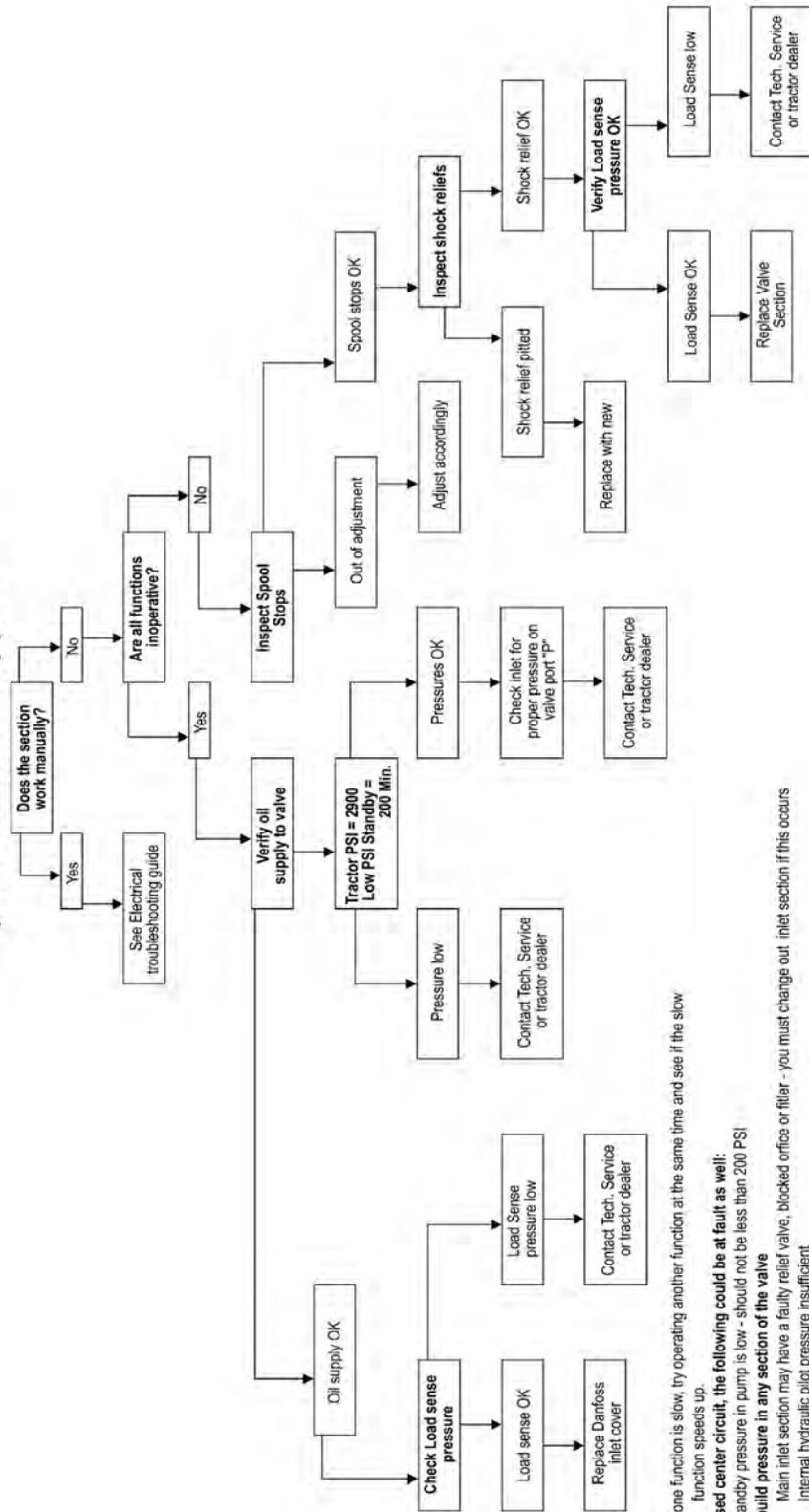

Notes: If one function is slow, try operating another function at the same time and see if the slow function speeds up.

On a closed center circuit, the following could be at fault as well:

Tractor standby pressure in pump is low - should not be less than 200 PSI

Cannot build pressure in any section of the valve

Main inlet section may have a faulty relief valve, blocked orifice or filter - you must change out inlet section if this occurs

Internal hydraulic pilot pressure insufficient

JOYSTICK TROUBLESHOOTING

Boom operation not responding to joystick movement.

Isolate hydraulic vs. electronic symptom.

Turn off electronic master switch (preventing electronic actuator on valve from attempting to hold spool in neutral position). With tractor engine running, operate the valve section with the manual handle. If function operates normally, continue with electronic inspection. If function does not operate normally, continue with hydraulic inspection.

Electronic inspection.

Connect a voltmeter to the cable connector of the valve section that is not operating. This will allow you to measure supply and signal voltage when the joystick is operated.

Main, Secondary, and Swivel Valves – signal voltage should be 50% of supply voltage with joystick in Neutral position, up to 75% of supply voltage in B direction, down to 25% of supply voltage in A direction. Signal voltage should change smoothly with lever movement.

Pin #1 – Signal Voltage, Pin #4 – Power Voltage, Pin #3 – Ground

Deck Roll Valve or Float Valve – signal voltage should be 50% of supply voltage with joystick in Neutral position, up to 65% of supply voltage in B direction, down to 35% of supply voltage in A direction. Signal voltage should change smoothly with lever movement. Signal voltage should be approximately 75% of supply voltage when float switch is operated.

Pin #1 – Signal Voltage, Pin #4 – Power Voltage, Pin #3 – Ground

Shield Valve or On/Off Valve – Voltage on pin #1 should be equal to supply voltage when switch is operated in A direction. Voltage on pin #4 should be equal to supply voltage when switch is operated in B direction.

Pin #1 – Signal Voltage (Shield Open), Pin #4 – Signal Voltage (Shield Close), Pin #3 – Ground

If none of the valve will operate with electrical signal, verify that there is oil pressure at the valve inlet. Electrical Valves must have pilot supply oil to move the spools.

Possible electronic problems.

Open circuit (broken wire, bad connection or loose connection in switchbox).

Shorted to positive, ground, or other.

Incorrect voltage signal from joystick.

Continued on next sheet

TROUBLESHOOTING - CONTINUED

Hydraulic inspection.

Install 3 pressure gauges, on the valve inlet (use M port, or tee into hose supplying oil from the pump to the inlet), on the workport that is not operating, and on the LS port.

With the spools in Neutral

Gear pump – P should be approximately 200 psi, LS = 0, workport – pressure on cylinder or function.

LS pump – P should equal pump standby pressure, LS = 0, workport – pressure on cylinder or function.

Pressure Comp pump – P should equal pump standby pressure, LS = 0, workport – pressure on cylinder or function.

Gear pump – P should be approximately 200 psi higher than LS, LS should equal workport, workport – pressure on cylinder or function.

LS pump – P should be LS + standby, LS should equal workport, workport – pressure on cylinder or function.

Pressure Comp pump – P should equal pump standby pressure, LS should equal workport, workport – pressure on cylinder or function.

Operate one spool, measure pressures with function at end of travel or stop

Gear pump – P should equal valve relief setting or workport shock valve setting. LS should equal workport. Workport should equal relief setting or workport shock valve setting.

LS pump – P should equal valve relief setting, pump max pressure setting, or workport shock valve setting. LS should equal workport. Workport should equal relief setting, pump max pressure setting, or workport shock valve setting.

Pressure Comp pump – P should equal pump standby pressure, LS should equal workport. Workport should equal pump standby pressure or workport shock valve setting.

Operate more than one spool.

Gear pump – P should be approximately 200 psi higher than LS. LS should equal highest workport pressure. Workport – pressure on cylinder or function.

LS pump – P should be LS + standby pressure. LS should equal highest workport pressure. Workport – pressure on cylinder or function.

Pressure Comp pump. P should equal pump standby pressure. LS should equal highest workport pressure. Workport – pressure on cylinder or function.

Possible hydraulic problems.

Cylinder leak.

LS signal leaking to tank before reaching pump LS port.

Hydraulic system or pump not supplying flow to valve.

WHEEL WEIGHT - BENGAL 18

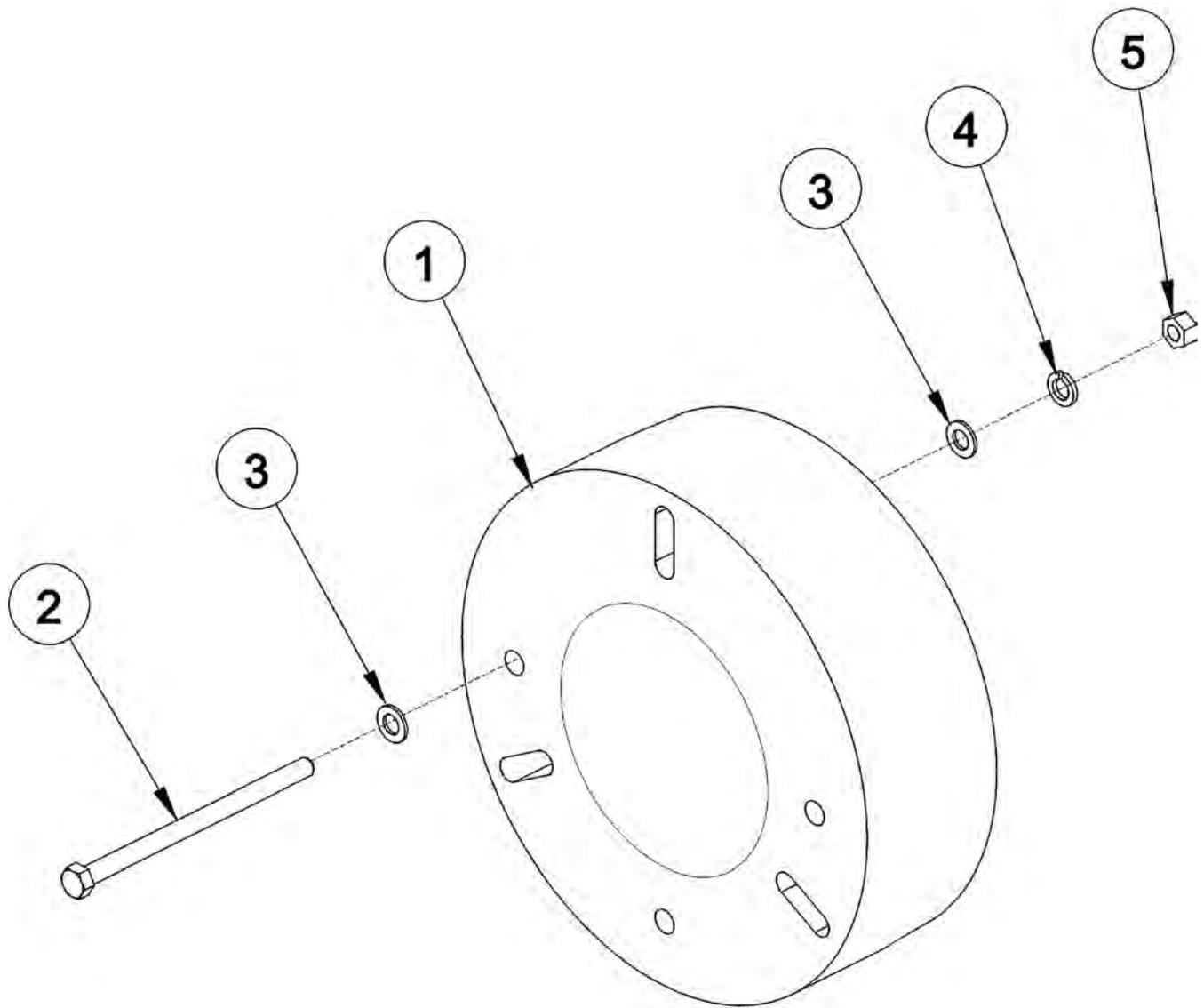

ITEM	PART NO.	QTY.	DESCRIPTION
1	30687	1	500# WHEEL WEIGHT
2	21956	4	CAPSCREW,3/4" X 13",NC
3	22021	8	FLATWASHER,3/4"
4	21993	4	LOCKWASHER,3/4"
5	21825	4	HEX NUT,3/4",NC

COMMON BENGAL T4

**WARRANTY
SECTION**

WARRANTY INFORMATION

Tiger Corporation, 3301 N. Louise, Sioux Falls, South Dakota, warrants to the original Retail Customer, the new Tiger equipment is free of defects in material and workmanship. Any part of equipment that in Tiger's judgement, show evidence of such defects will be repaired or replaced without charge, provided that the failure of part(s) shall have occurred within twelve (12) months from the date of delivery of said equipment to the Retail Customer. Expendable components such as knives, oil, chain sprockets, skid shoes, knife mounting disks and the like are excluded but not limited to this warranty.

The Retail Customer must pay the transportation cost to and from the Tiger Dealer's service shop for warranty service. Warranty service will be performed by the Tiger Dealer from whom the equipment was purchased, during service shop regularly scheduled days and hours of operation.

All Tiger obligation under this warranty shall be terminated if the equipment is modified or altered in ways not approved in writing by Tiger, if repair parts other than genuine Tiger repair parts have been used, or if the equipment has been subject to misuse, neglect, accident, improper maintenance or improper operation.

Tiger Corporation reserves the right to make improvements in design or changes in specification at any time without incurring any obligation to owners of equipment previously sold.

No agent or person has authority to alter, add to or waive the above warranties which are agreed to be in the only warranties, representations or promises, expressed or implied, as to the quality or performance of the products covered and which do not include any implied warranty of merchantability or fitness. In no event will Tiger be liable for incidental or consequential damages or injuries, including, but not limited to, loss of profits, rental or substitute equipment or other commercial loss.

**THERE ARE NO WARRANTIES WHICH EXTEND
BEYOND THOSE EXPRESSED HEREIN.**

It is the Purchasers obligation to sign the warranty registration form **AFTER** he / she has Read and Understands the Operation and Safety Instructions stated within this manual.

ONE LAST WORD

This manual cannot possibly cover all of the potentially hazardous situations you will encounter. By being familiar with the safety rules, operating and maintenance instructions in this manual you can help prevent accidents. The objective of this manual is to help make you a better operator. Remember, **SAFETY IS YOU!**



1012

Your safety and the safety of those around you depends on **YOU**. Common sense should play a large role in the operation of this machine.

Since we at Tiger Corporation are constantly striving to improve our products, we reserve the right to change specifications or design at any time.

TO THE OWNER / OPERATOR / DEALER



To keep your implement running efficiently and safely, read your manual thoroughly and follow these directions and the Safety Messages in this manual and on the machine. The table of contents clearly identifies each section where you can easily find the information you need.

The Occupational Safety and Health Act (OSHA 1928.51 subpart C) makes the following minimum requirements for tractor operators.

OWNER REQUIREMENTS:

1. Provide a Roll-Over-Protective Structure that meets the requirements of this Standard; and
2. Provide Seatbelts that meet the requirements of this Standard and SAE J3C; and
3. Ensure that each employee uses such Seatbelt while the tractor is moving; and
4. Ensure that each employee tightens the Seatbelt sufficiently to confine the employee to the protected area provided by the ROPS.

OPERATOR REQUIREMENTS:

1. Securely fasten seatbelt if the tractor has a ROPS.
2. Where possible, avoid operating the tractor near steep ditches, embankments, and holes.
3. Reduce speed when turning, crossing slopes, and on rough, slick, or muddy surfaces.
4. Stay off slopes too steep for safe operation.
5. Watch where you are going – especially at row ends, on roads, and around trees.
6. Do Not permit others to ride.
7. Operate the tractor smoothly – no jerky turns, starts, or stops.
8. Hitch only to the draw-bar and hitch points recommended by the tractor manufacturer.
9. When the tractor is stopped, set brakes securely and use park lock, if available



Printed in USA
© Tiger Corporation