

VEVOR[®]

TOUGH TOOLS, HALF PRICE

Technical Support and E-Warranty Certificate www.vevor.com/support

CAMP GRILL USER MANUAL

We continue to be committed to provide you tools with competitive price.

"Save Half", "Half Price" or any other similar expressions used by us only represents an estimate of savings you might benefit from buying certain tools with us compared to the major top brands and does not necessarily mean to cover all categories of tools offered by us. You are kindly reminded to verify carefully when you are placing an order with us if you are actually saving half in comparison with the top major brands.

VEVOR®

TOUGH TOOLS, HALF PRICE

CAMP GRILL

MODEL: JY-ZDKJ-02

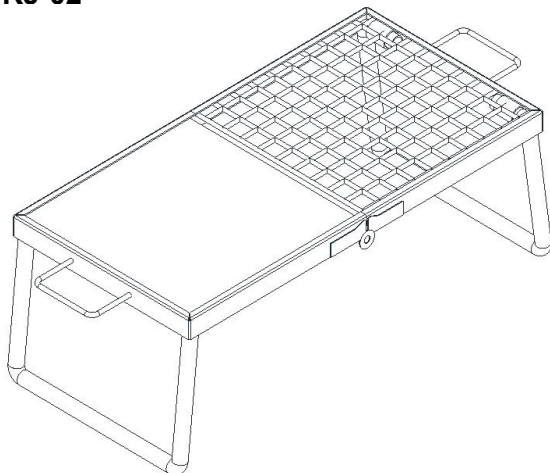

NEED HELP? CONTACT US!

Have product questions? Need technical support? Please feel free to contact us:

 CustomerService@vevor.com

This is the original instruction, please read all manual instructions carefully before operating. VEVOR reserves a clear interpretation of our user manual. The appearance of the product shall be subject to the product you received. Please forgive us that we won't inform you again if there are any technology or software updates on our product.

IMPORTANT SAFEGUARDS

Thank you for using this product. In order to make sure that you can operate the machine correctly, read this instruction carefully before operation and keep it properly for future reference. Please be sure to read the precautions and safety rules in this page to ensure your safe use.

This manual will outline safety warnings and precautions, operating, maintenance and cleaning. The warnings and instructions reviewed in this manual cannot cover all possible conditions and situations that may occur. Caution and common sense are not built into this product, since we believe that the uses will comply with these codes.

Please read ALL the instructions before using your machine.

1. **Do NOT** let children and minors get close to or touch the machine.
2. **Do NOT** touch the hot surface directly with your hands. Always operate with handle or knob.
3. **Do NOT** immerse the appliance in water or any other liquid.
4. Cool down the HOT parts before operation.
5. Using any accessories or attachments that are not provided or recommended by the manufacturer may cause injury.
6. KEEP IT OUT OF CHILDREN'S REACH.
7. Extreme caution must be taken when moving an appliance containing hot oil or other hot liquids.
8. Children shall not play with the machine alone. Cleaning and user maintenance shall not be made by children without supervision.
9. The barbeque must never be left unattended during operation or cleaning.

10. The barbeque should be located in an open area with good ventilation, away from trees and fences.

11. While every effort has been made in the manufacture of your barbeque to remove any sharp edge, you should handle all components with care in order to avoid accidental injury.

12. Keep fire extinguisher within safe and accessible distance and make sure those operating the barbeque are trained to use it.

13. Keep away from flammable material and fluids such as petroleum, alcohol, diesel fuel, kerosene and charcoal lighter fluid or vehicles while in use. Do not use these materials to light or relight also.

14. **DO NOT** use the barbeque in high wind.

15. **Do NOT** overload or use this barbeque to burn leaves, household waste, or paper.

16. **DO NOT** wear loose clothing, and ensure that long hair is tied back when around the barbeque when it is hot or in use.

17. **DO NOT** use this product as a furnace.

18. **DO NOT** cook before the charcoal has a coating of ash.

19. Ensure the product has a minimum of 2 meters overhead clearance and has a minimum of 2 m clearance from other surrounding items.

20. **NEVER** leave a burning fire unattended.



WARNING! This product rotisserie grill will become very hot, do not move it during operation.

WARNING! Keep children and pets away.

WARNING! In case of the danger of carbon monoxide poisoning, do not use the product rotisserie grill indoors.

WARNING! Do not use the barbecue in a confined and/or habitable space e.g. houses, tents, caravans, motor homes, boats.

WARNING! Remove all packaging materials and keep them for future use. Packaging materials are not a toy.

WARNING! Don't let children play with the packaging materials. If they swallow the packaging materials, they will suffocate!

WARNING! Keep children and pets away. Children must not operate or play near this barbecue.

WARNING! Failure to follow instructions could result in death, serious bodily injury and/or property loss.

WARNING! Do not extinguish with water as this may damage the barbecue.

ATTENTION! Always wear gloves when adjusting the grill, the handles of the grill can become very hot during the grilling process.

IMPORTANT! Do not pour water into the product while it is still hot.

ATTENTION AGAIN!

This article is intended for outdoor use. Do NOT use indoors!

Whilst every care is taken in the manufacture of this product, care must be taken during assembly in case sharp edges are present.

PRODUCT PARAMETERS

Model	Product Size/in	Equipped with storage bags
JY-ZDKJ-02	24×12	

Explosion Diagram

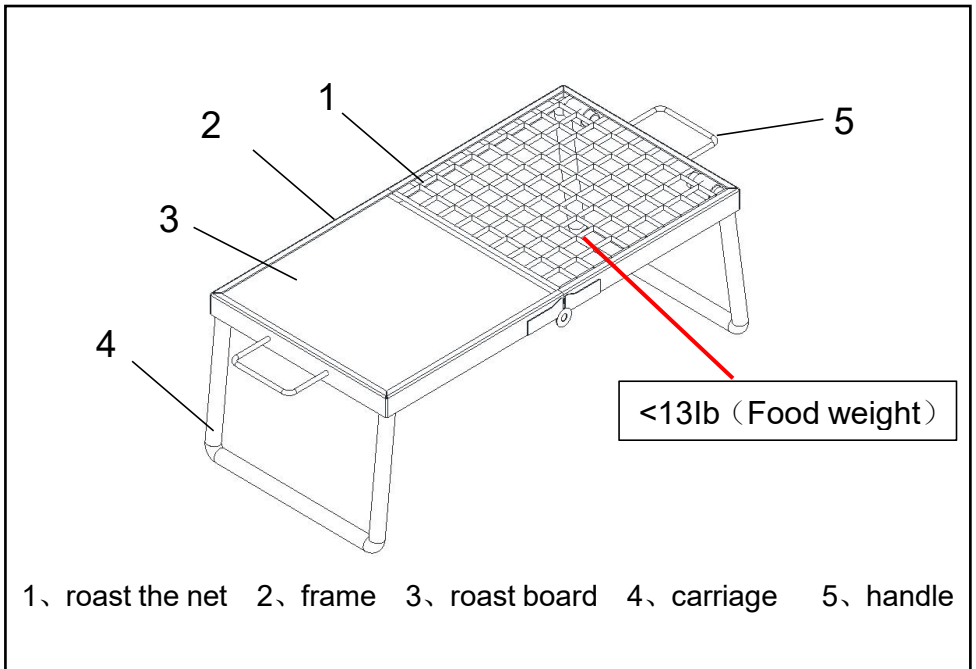

Cleaning

1. Allow the camp grill to become completely cold .
- 2.Can be cleaned using a dishcloth, warm water and a commercial detergent. Avoid using abrasive cleaners, and wire wool and brushes as these may scratch the surface.

VEVOR[®]

TOUGH TOOLS, HALF PRICE

Support and E-Warranty Certificate www.vevor.com/support