

# RONIN 2 User Manual

V1.2 2017.12

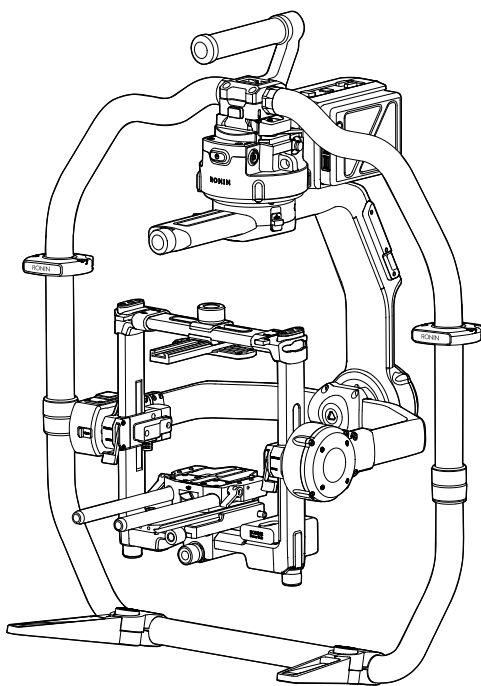

### **Searching for Keywords**

Search for keywords such as “battery” and “install” to find a topic. If you are using Adobe Acrobat Reader to read this document, press Ctrl+F on Windows or Command+F on Mac to begin a search.

### **Navigating to a Topic**

View a complete list of topics in the table of contents. Click on a topic to navigate to that section.

### **Printing this Document**

This document supports high resolution printing.

# Using this Manual

## Legend



Warning



Important



Hints and Tips



Reference

## Before You Begin

The following documents have been produced to help you safely operate and make full use of your RONIN™ 2:

Ronin 2 in the Box

Ronin 2 Quick Start Guide

Ronin 2 User Manual

Ronin 2 Intelligent Battery Safety Guidelines

Ronin 2 Disclaimer and Safety Guidelines

Check all of the included parts listed in the In the Box manual. Read this entire User Manual and watch the informational and tutorial videos on the product page of DJI's official website (<http://www.dji.com/ronin-2>). Read the Disclaimers and Safety Guidelines to understand your legal rights and responsibilities. If you have any questions or problems during the installation, maintenance or use of this product, please contact DJI or a DJI authorized dealer.

## Download the Ronin 2 App

Download and install the Ronin 2 App.

Search "Ronin 2" in the App Store or Google Play and then follow instructions for installation.



iOS 9.0 or above



Android 4.4 or above



Ronin 2 App

\* Ronin 2 app supports iOS 9.0 (or later) or Android 4.4 (or later).

## Download DJI Assistant 2

Download DJI Assistant 2 at <http://www.dji.com/ronin-2/info#downloads>

# Contents

<b>Using this Manual</b>	1
Legend	1
Before You Begin	1
Download the Ronin 2 App	1
Download DJI Assistant 2	1
<b>Introduction</b>	3
<b>Ronin 2 Diagram</b>	4
<b>Getting Started</b>	5
Assembling the Grip	5
Installing the Grip onto the Gimbal	6
Mounting the Camera	7
Extending the Roll Axis Arm	10
Cable and Accessory Guides	10
<b>Balancing</b>	12
Before Balancing	12
Step 1: Balancing the Vertical Tilt	12
Step 2: Balancing Depth for the Tilt Axis	13
Step 3: Balancing the Roll Axis	13
Step 4: Balancing the Pan Axis	14
<b>Intelligent Battery</b>	15
Charging the Intelligent Battery	16
Mounting the Intelligent Battery	19
Using the Intelligent Battery	20
<b>Gimbal Settings</b>	21
Built-in Touch Panel Settings	21
Ronin 2 App	29
<b>Remote Controller</b>	33
Remote Controller Diagram	33
Binding the Remote Controller	34
Charging	35
Calibrating the Control Joystick and Roll Knob	35
<b>Operation Modes</b>	36
3-Axis Mode	36
Pan Lock Mode	36
<b>Usage with a DJI A3 Flight Controller and Lightbridge</b>	36
<b>Maintenance</b>	36
<b>Specifications</b>	37



# Introduction

DJI Ronin 2 is a professional 3-axis handheld gimbal that is highly compatible with cable cams, drones, cranes, Steadicams, and more. Its customizable mounting modes such as Handheld, Car Mount, Aerial, and Tripod mode help the Ronin 2 work accurately in different shooting scenarios. Also, its new Pan Lock mode has been specially designed for work with Steadicams.

## Features Highlights

- Its carbon fiber structure makes the Ronin 2 lightweight, strong, and functional. Upgraded high-torque motors support payloads of 30 lbs.
- A new mechanical design makes camera mounting and balancing easier while optimizing accuracy. New axis locks improve usability, and its extendable roll axis allows the Ronin 2 to support more cameras.
- Angular vibration is within  $\pm 0.02^\circ$ , and the built-in GPS module improves the gimbal accuracy, making it extremely stable even while shooting at high speeds.
- Adjusting settings is easier with the built-in touch panel, and it also displays the Ronin 2's working status.
- A dual battery system and support for hot swapping allows for continuous operation when replacing batteries. With fully charged TB50 Intelligent Batteries, the Ronin 2 can power a camera and the whole system for 2.5 hours.
- Power and video signal are transmitted through the built-in slip ring. The Ronin 2 comes with several accessory ports and supports the DJI Focus system, lens hoods, wireless video downlinks, and monitors.
- Transmits signal at 2.4 GHz and 5.8 GHz to improve transmission stability.
- The brand new Ronin 2 app can adjust settings and also activate multiple intelligent features such as Track and CamAnchor.

## Ronin 2 Diagram

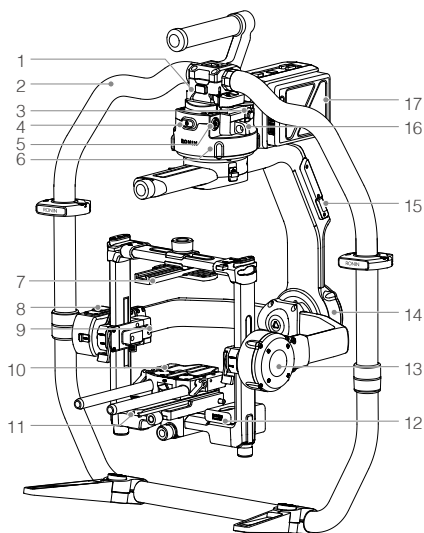

1. Gimbal Dovetail Mount
2. Ronin 2 Grip
3. SDI-Out Port
4. Power Button
5. 14.4 V Accessory Power Port
6. Pan Motor
7. Camera Top Cross Bar
8. Built-in GPS
9. SDI-in Port
10. 15 mm Rod and Focus Rod Mount
11. Camera Base Plate
12. Power Hub
13. Tilt Motor
14. Roll Motor
15. USB Type-C Port
16. Safety Hole
17. Battery Mount/Intelligent Batteries

18. Battery Mount Release Button
19. Secondary Power Button
20. Battery Eject Buttons
21. 14.4 V P-Tap Port
22. 22.8 V DC-out Port
23. Built-in Touch Panel
24. Built-in Antennas
25. D-Bus Port
26. 14.4 V Accessory Power Port
27. DC-in Port
28. 14.4 V Accessory Power Port

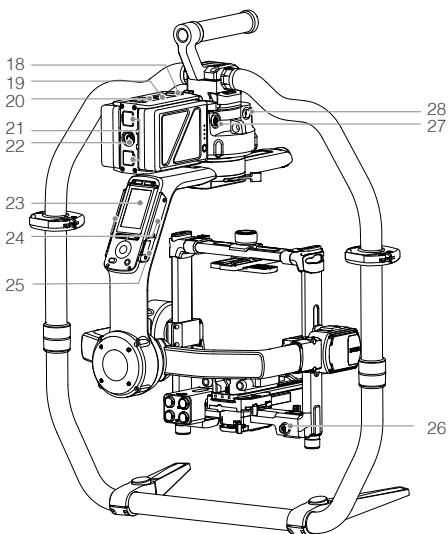

# Getting Started

## Assembling the Grip

Use the Grip to hold the Ronin 2 during setup or operation. Follow the steps below to assemble the Ronin 2 Grip.

1. Press the button ① on the Grip Feet and extend them outwards.
2. Attach the upper and lower parts of the Grip ② and then tighten them ③.

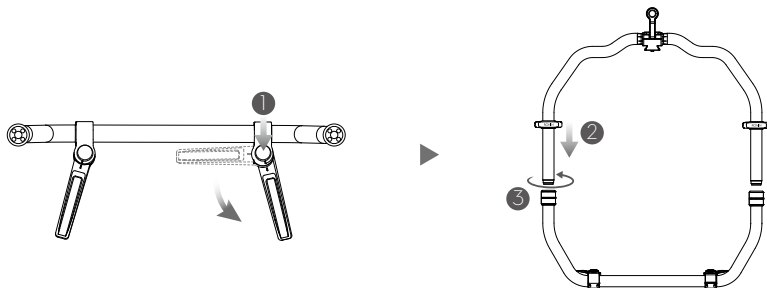

3. The hand stops on both sides are used to help users hold the Grip firmly. Adjust their positions according to your needs.

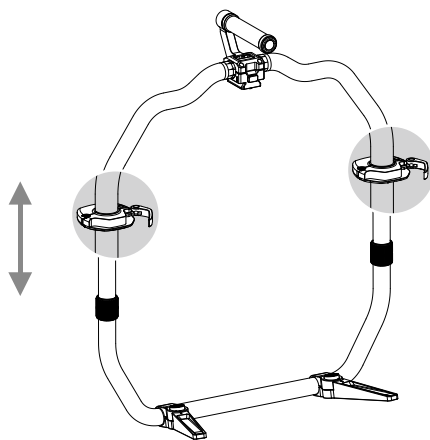

 When setting on a table, make sure the table is flat and level.

## Installing the Grip onto the Gimbal

1. The pan, tilt and roll axes are locked by default. Unlock the tilt and roll axes to adjust their positions as shown, then lock the tilt and roll axes again.

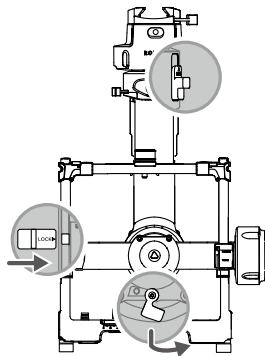

2. Toggle the lever ① to the unlocked position. Next, attach the gimbal to the Grip ② until the safety lock engages. Then lock the lever.

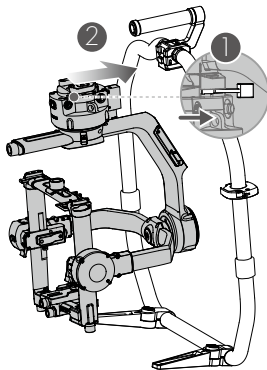

To remove the gimbal, toggle the lever to the unlocked position and press down the safety lock. Then slide the gimbal off the dovetail mount.

## Mounting the Camera

### Supported Cameras

ARRI ALEXA Mini	Canon C300 MKII	RED Raven
ARRI ALEXA XT	Canon C500	RED Dragon
Black Magic Ursa Mini	Panasonic Varicam LT	Sony FS5
Black Magic Ursa Mini Pro	RED Epic	Sony FS7
Canon C100	RED Epic-W	Sony F55
Canon C100 MKII	RED Scarlet	Sony F5
Canon C300	RED Weapon	

### Supported Lens

Canon	Fujinon	Cooke	Zeiss
CN-E Primes	ZK2.5x 14 T2.9	Mini S4/i Primes	Ultra Primes
CN-E 18-80	ZK4.7x 19 T2.9	S4/i Primes up to 135 mm	Master Primes
CN7x17 KAS	ZK3.5x 85 T2.9 -4.0	5/i Primes up to 100 mm	Master Anamorphic
CN-E 15.5-47	XK6x 20 T3.5	S7/i Primes up to 100 mm	Lightweight Zoom 21-100mm T2.9-3.9
CN-E 30-105 T2.8		Anamorphic/i lenses up to 135 mm (65 mm Macro excluded)	Cinema Zoom up to 70-200 T2.9
			Compact Primes

Angenieux	Leica	Sony	Schneider
Optimo Style Spherical 16-40, 30-76, 48-130	Summilux-C Primes	CineAlta Primes	Xenon FF-Primes
Optimo Spherical 15-40, 28-76, 45-120	Summicron-C Primes		
Optimo Anamorphic 30-72 A2S, 56-152 A2S			
Optimo DP 16-42, 30-80			
Type EZ Series			



Please note that not all camera and lens combinations will fit on the Ronin 2. For example, the ARRI ALEXA XT and XK6x 20 T3.5 is too long as a combination, so they cannot be used on Ronin 2 simultaneously.

## Camera Size Requirements

The maximum depth from the center of gravity on the camera base plate is 250 mm. The maximum height, measured from the top of the camera base plate, is 170 mm. The maximum width is 190 mm.

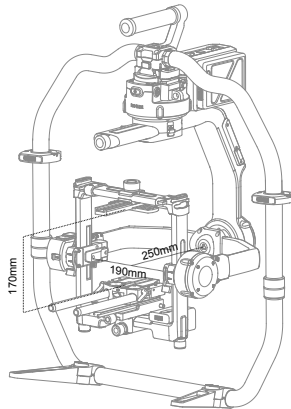

- Make sure the camera is powered off during installation.
  - It is recommended to use soft connection cables to avoid obstructing camera movement.
- 

## Mounting a Camera

1. Unlock the levers ① and remove the upper crossbar ②.

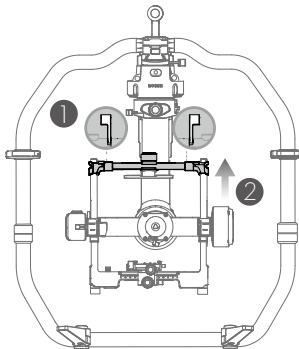

- Attach the Camera Top Cross Bar to the camera. Refer to the locations below to mount the Top Cross Bar to the ARRI ALEXA MINI (using M4-10 screws), RED EPIC (using 1/4" screws) and RED WEAPON 8K (using M4-10 screws) cameras.

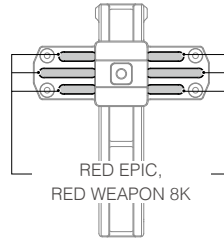
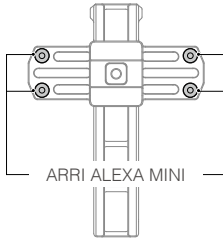

The Top Cross Bar can be installed in two directions. If the camera lens' center of gravity is forward, then mount the Top Cross Bar with the long part forward as shown.

- Attach the 15 mm Rod and the Focus Rod Mount to the camera.
- Choose the proper camera screws (type 3/8"-16 or 1/4"-20) and attach the Camera Base Plate to the camera.

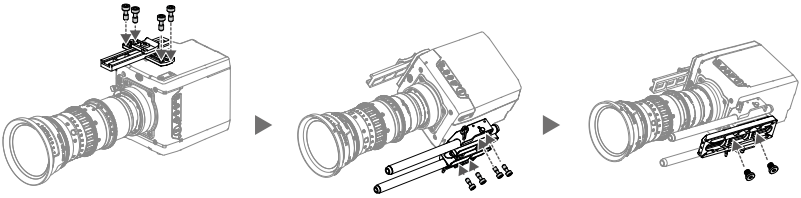

- Slide the camera into the mounting plate ① until the safety lock engages, then lock the lever ②.
- Attach the upper crossbar and tighten the securing knob ③ to the camera, then lock the levers ④.

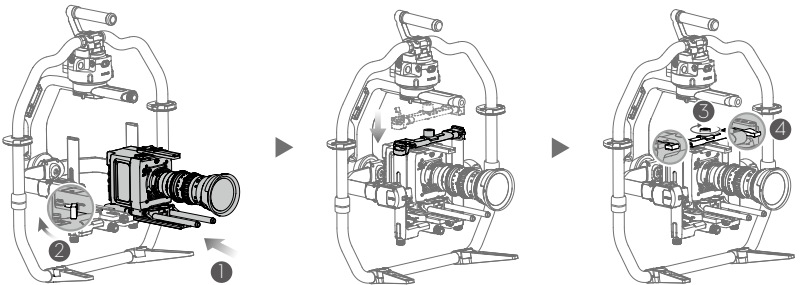

It is recommended to adjust the camera's center of gravity further back and down.

## Extending the Roll Axis Arm

The roll axis arm can be extended up to 5.5 cm if there isn't sufficient mounting space for a long camera.

Loosen the screws on both sides of the roll axis, and toggle the levers to their unlocked position. Next, pull out the arms on both sides simultaneously as needed. Make sure the measurement marks match up on both of the arms. Tighten the screws and toggle the levers.

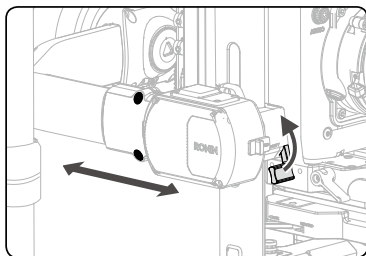

**⚠** The balance and performance of the gimbal may be reduced when the roll axis arms are extended. Make sure to push back the arms to their default position after use.

## Cable and Accessory Guides

Cables	Connector to Ronin 2	Connector to Device
ARRI Alexa Mini Power Cable	Push-Pull Connector 1B 4+2pin Male	Push-Pull Connector 2B 8pin Male
ARRI Alexa Mini Start/Stop Cable	Push-Pull Connector 1B 14pin Male	Push-Pull Connector 1B 7pin Male
RED Power Cable	Push-Pull Connector 1B 4+2pin Male	Push-Pull Connector 1B 4+2pin Female
RED RCP Control Cable*	Push-Pull Connector 1B 14pin Male	Push-Pull Connector 00B 4pin Male
Ronin 2 Power Cable	Push-Pull Connector 2B 10pin Single Slot Male	Push-Pull Connector 2B 10pin Dual Slot Male
2-pin Power Cable	Push-Pull Connector 1B 4+2pin Male	Push-Pull Connector 0B 2pin Male
DC Power Cable	Push-Pull Connector 1B 4+2pin Male	DC 5.5x2.1 Male
Triple P-TAP Breakout Box	Push-Pull Connector 1B 4+2pin Male	P-TAPx3
SDI IN Cable	BNC Male	BNC Male
SDI OUT Cable	BNC Male	BNC Male
USB Type-C Cable	USB Type-C	USB Type-A
UART to D-BUS Cable	DJI 4pin	3pin Servo Cable



The Top Mounting Block replaces the center handle on the Ronin 2 Grip. It has 1/4"-20 holes allowing third party handles and accessories to be attached.

The Universal Mount offers an attachment point for the gimbal allowing it to be mounted to various platforms such as a jib, vehicle mount, or cable cam.

---

 Do not use unauthorized accessories/cables as they may harm your Ronin 2 and void your warranty.

---

\* To control the RED camera, connect the RCP Control Cable to the CTRL Port of the camera. Go to Menu > Settings > Setup > Communication. Select the Serial tab and then choose REDLINK Command Protocol from the Serial Protocol drop-down menu. RED camera firmware V5.3.49 or above is required.

# Balancing

To obtain the best performance from the Ronin 2, proper balancing is essential. Accurate balance is critical for shots where the Ronin 2 will be subjected to fast motion or acceleration (running, biking, moving in cars, attached to aircraft, etc.). Proper balance will also offer longer battery runtimes. There are three axes that need to be accurately balanced prior to turning on the Ronin 2 and setting up the software.

## Before Balancing

1. Before balancing the camera, connect the SDI cable and the camera's power cable and install a Focus system.
2. The camera needs to be fully configured, with all accessories and cables connected, prior to installing and balancing the camera on the gimbal. If the camera has a lens cap, be sure to remove it prior to balancing.
3. Be sure that the Ronin 2's power and camera are turned off while balancing the camera.

## Step 1: Balancing the Vertical Tilt

1. Unlock the tilt axis. Rotate the tilt axis so that the camera lens is pointing up.
2. Push up on the side levers ① to their unlocked position. Then adjust the camera's balance by turning the adjustment knob ②. Make adjustments until the camera appears balanced without tilting up or down.
3. Tighten the levers ③.

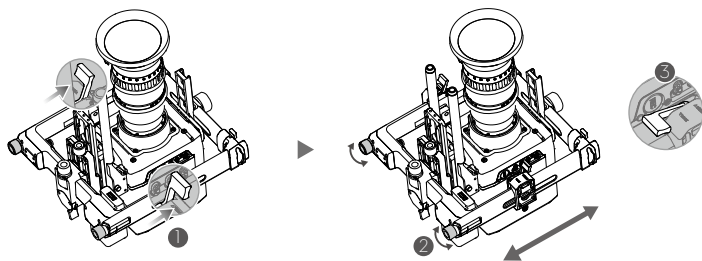

Ensure that the measurement marks match up on both of the vertical bars. If they do not match up, the assembly could possibly be skewed higher or lower on one side, which would cause the tilt motor to bind.

## Step 2: Balancing Depth for the Tilt Axis

1. Rotate the tilt axis so that the camera lens is pointing forward.
2. Toggle the lever ① to the unlocked position and then loosen the top securing knob ②.  
Adjust the camera's balance by turning the adjustment knob ③ until the camera remains still when rotating the tilt axis 45 degrees upwards or downwards.
3. Tighten the securing knob ④ and toggle the lever ⑤ to the locked position.
4. Lock the tilt axis.

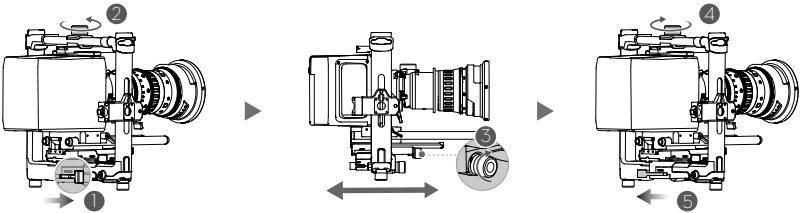

## Step 3: Balancing the Roll Axis

1. Unlock the roll axis.
2. Toggle the lever ① to the unlocked position, then loosen the top securing knob ②.  
Adjust the camera's position by turning the adjustment knob ③ until the camera remains still when rotating the tilt axis 45 degrees to the left or right.
3. Tighten the securing knob ④ and toggle the lever ⑤ to the locked position.
4. Lock the roll axis.

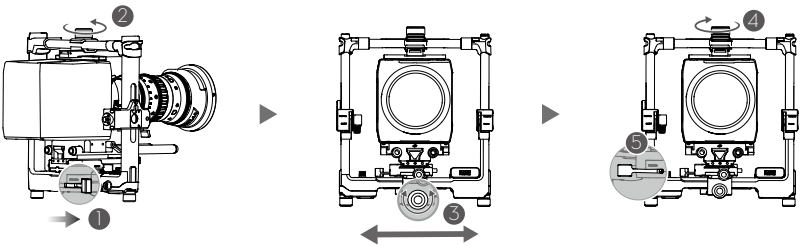

⚠ Recheck the tilt axis balance. Loosen the securing knob and adjust the camera's position if the tilt axis is not balanced.

## Step 4: Balancing the Pan Axis

Please note: It is recommended to mount the provided MotionBlock before balancing the pan axis when shooting in a high-speed situation for improved gimbal performance. Attach the MotionBlock to the pan axis and tighten the screws as shown.

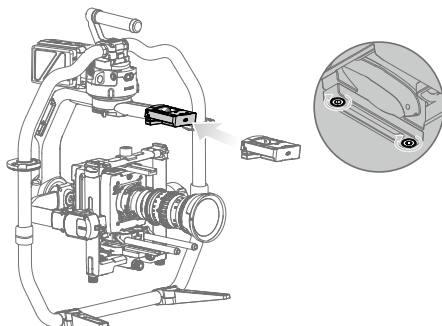

⚠ It is necessary to use the optional Counterweights if mounting a longer camera system and the MotionBlock cannot be mounted due to the pan axis balancing position. Visit the official DJI Online Store to learn more.

1. Unlock the pan axis. Lift up one side of the Grip.
2. Toggle the lever ① to the unlocked position, then adjust the camera's position by turning the adjustment knob ② until the camera remains still when rotating the pan axis 45 degrees while lifting up one side of the Grip.
3. Tighten the lever ③.

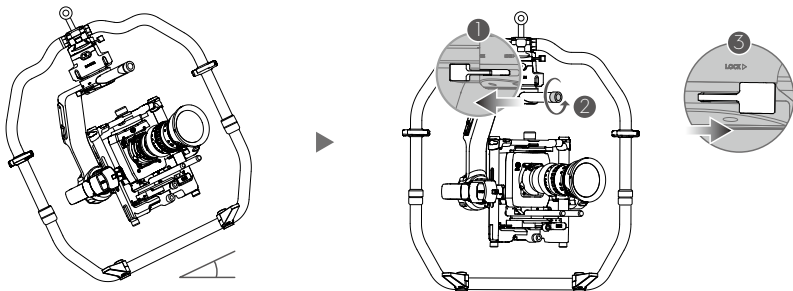

⚠ It is necessary to use the optional Counterweights if mounting a camera and the camera system cannot be moved back far enough for balancing.

# Intelligent Battery

The Ronin 2 comes with a hot-swappable dual battery system, allowing the gimbal work continuously without suspending shooting. The TB50 Intelligent Battery has a capacity of 4280 mAh, a voltage of 22.8 V, and a variety of power management functions. When the Intelligent Battery is fully charged, it can power the whole system, including the gimbal, camera, Focus system, and monitor for approximately 2.5 hours. When only powering the gimbal, the TB50 has a max runtime of eight hours.

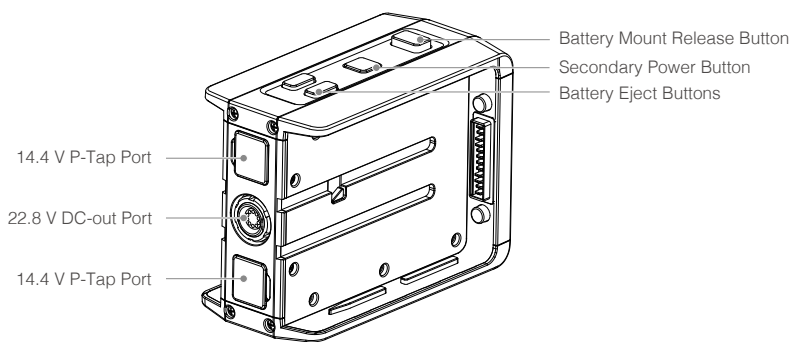

Dual TB50 Battery Mount

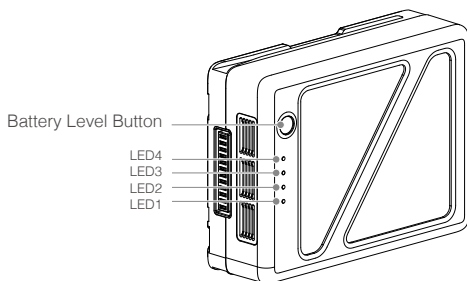

TB50 Intelligent Battery

## Intelligent Battery Functions

1. Battery Level Display: LEDs display the current battery level.
2. Auto-Discharging Function: The battery automatically discharges to below 70% of total power when it is idle for more than 10 days to prevent swelling. To exit idle state, press the Power Level button to check the battery level. It takes approximately three days to discharge the battery to 65%. It is normal to feel moderate heat emitting from the battery during the discharge process. Discharge thresholds can be set in the DJI

Assistant 2 app.

3. Balancing Function: Automatically balances the voltage of each battery cell when charging.
4. Overcharge Protection: Charging stops automatically when the battery is fully charged.
5. Temperature Protection: The battery will only charge when the temperature is between 5-45° C (41-113° F).
6. Overcurrent Protection: Battery stops charging when high amperage (> 10 A) is detected.
7. Over-Discharge Protection: To prevent serious damage to the battery, current output will be cut off when the battery cell is discharged to 2.8 V and not in use. To extend operating times, overcharging protection is disabled as batteries discharge during usage. In this instance, a battery voltage below 2 V may cause a safety hazard such as a fire when charged. To prevent this, the battery will not be able to charge if the voltage of a single battery cell is below 2 V. Avoid using any batteries matching this description. Always be alert to avoid over-discharging to prevent permanent battery damage.
8. Short Circuit Protection: Automatically cuts the power supply when a short circuit is detected.
9. Battery Cell Damage Protection: DJI Assistant 2 displays a warning message when detecting a damaged battery cell.
10. Sleep Mode: Sleep mode is entered to save power when the battery is not in use.
11. Communication: Battery voltage, capacity, current, and other relevant information is provided to the gimbal.
12. Pairing Batteries: Powered by two batteries (with battery cells connected in parallel), the Ronin 2 requires the two batteries to have similar properties, e.g., internal resistance. Pairing batteries in the beginning is recommended. Pairing can be done using DJI Assistant 2, which will also prompt when batteries that are not paired are in use. The Intelligent Battery Charging Hub will charge paired batteries simultaneously.
13. Heating: Batteries can work even in cold weather. Refer to "Using the Battery" section for details.



Read the user manual, disclaimer, and battery safety guidelines before use. Users take full responsibility for all operations and usage.

---

## Charging the Intelligent Battery

The Ronin 2 Quad Charging Hub is designed for use with the Ronin 2 Battery Charger. It charges up to four Intelligent Batteries simultaneously. The battery pair with more stored power will be charged first. If batteries are not paired, the Charging Hub will intelligently charge batteries in sequence according to battery power levels from high to low. Pairing can be carried out using DJI Assistant 2.

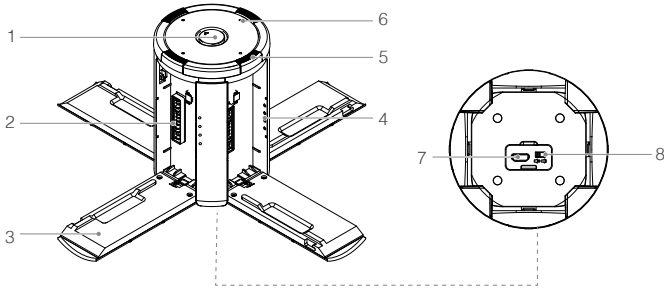

1. Power Port
2. Charging Port
3. Charging Port Cover
4. Battery Charging Level Indicators
5. Cover/Battery Release Button
6. Status LEDs
7. Firmware Update Port (Micro USB)
8. Speaker Switch

1. Connect the Battery Charger to a power outlet (100-240 V, 50/60 Hz), then uncover the rubber cover on the power port to connect the Charging Hub to the Battery Charger.

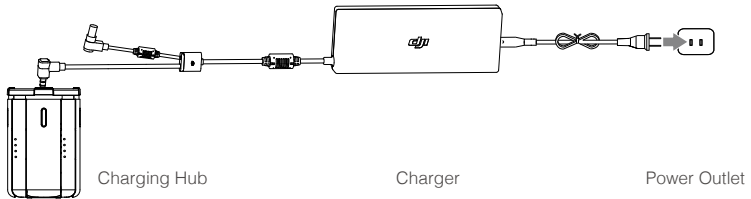



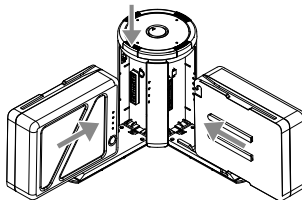



2. Press the Release button and open the corresponding charging port cover. Insert the Intelligent Battery into the charging port to begin charging.



















Refer to the "Status LED Descriptions" section for more information about Status LED blinking patterns. The Speaker will begin beeping when charging is complete. Refer to the "Speaker Beeping Descriptions" for more information about Speaker beeping patterns.

- ⚠ • Press the Release button to detach batteries after charging is complete.
- DO NOT leave metal terminals exposed to open air when not in use.

























## Status LED Descriptions

Status LED (Charging Hub)	Description	Description
 ..... Blinking Green	Charging	
 — Solid Green	Fully charged	
 ..... Blinking Red	Battery Charger Error. Retry with an official battery charger.	
 — Solid Red	Intelligent Battery error	
 ..... Blinking Yellow	Battery temperature too high/low.	
 — Solid Yellow	Ready to charge	
 ..... Alternating Green Blinks	Intelligent Battery not detected	

Battery Level Indicators while Charging (Battery)				
LED1	LED2	LED3	LED4	Battery Level
				0%~50%
				50%~75%
				75%~100%
				Fully Charged

## Charging Protection LED Display

The table below shows battery protection mechanisms and corresponding Status LED patterns.

Battery Level Indicators for Battery Protection					
LED1	LED2	LED3	LED4	Blinking Pattern	Battery Protection Item
				LED2 blinks twice per second	Over current detected
				LED2 blinks three times per second	Short circuit detected
				LED3 blinks twice per second	Over charge detected
				LED3 blinks three times per second	Over-voltage charger detected
				LED4 blinks twice per second	Charging temperature is too low (<0° C)
				LED4 blinks three times per second	Charging temperature is too high (>40° C)



After any of the above-mentioned protection issues are resolved, press the Battery Level button to turn off the Battery Level Indicator. Unplug the Intelligent Battery from the charger and plug it back in to resume charging. Note that you do not need to unplug and plug the charger in the event of a room temperature error. The charger will resume charging when the temperature falls within the normal range.

**⚠** DJI is not responsible for damage caused by third-party chargers.

## Speaker Beeping Descriptions

Toggle the Speaker switch to turn the warning sound on or off.

Descriptions	Beeping Pattern
Toggle the buzzer switch to turn it on	Quick beeping
Connect to the Battery Charger	Quick beeping
A battery pair is fully charged	Quick beeping
Four Intelligent Batteries are fully charged	Alternating two short and one long beeps, last for about 1 hour

## Mounting the Intelligent Battery

1. Insert the Intelligent Batteries into the Battery Mount until the battery's Eject buttons are engaged.
2. Attach the Battery Mount to the gimbal until the Release button is engaged.

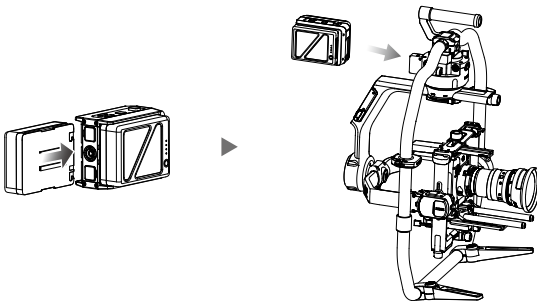

3. The Battery Mount can also be separated from the Ronin 2 during usage. Power the Ronin 2 by connecting the 22.8 V DC-Out Port on the Battery Mount to the Power Port of the gimbal using the provided Ronin 2 Power Cable.

- ⚠**
- An incorrectly installed battery may lead to (1) dropping during usage, (2) poor battery connection, or (3) unavailable battery information.
  - Be sure to press the Release button on top of the Charging Hub when removing the battery.

## Using the Intelligent Battery

### Check the Battery Level

Press the Battery Level button once to check the battery level.

### Powering ON/OFF

Press and hold the Power button on the gimbal or Battery Mount to turn on the Ronin 2. Make sure you unlock the pan, tilt, and roll axes before powering on the Ronin 2.

### Heating the Battery

**Manual Heating:** When the battery is powered off, press and hold the Power button for 3 seconds to initiate battery warm-up manually.

The battery will warm up if the temperature is below 15° C (59° F). As it warms, Status LED 1 & 2 and LED 3 & 4 will blink alternately. The battery will stop warming when it reaches 20° C (68° F). The temperature of the battery will remain between 15-20° C (59-68° F). When Status LED 1 and LED 4 blink alternately indicates a temperature above 15° C (59° F). This will last for approximately 30 minutes, then the Ronin 2 will power off automatically.

**Auto Heating:** Insert the batteries into the battery mount and power on. When the temperature of the battery is below 15° C (59° F), it will warm up automatically. Check the Status LEDs for the current power level.

### Low-Temperature Notice

1. The performance of the Intelligent Battery is significantly reduced at low temperatures (air temperatures below 5° C/41° F). Ensure that the battery is fully charged and the cell voltage is at 4.35 V before use.
2. In extremely cold weather, the battery temperature may not be high enough even after warming up. In these cases, insulate the battery as required.
3. To ensure optimum performance, keep the Intelligent Battery's core temperature above 20° C (68° F) when in use.

# Gimbal Settings

## Built-in Touch Panel Settings

After balancing and powering on the Ronin 2, you can adjust gimbal settings directly on the Built-in Touch Panel.

### Buttons Description

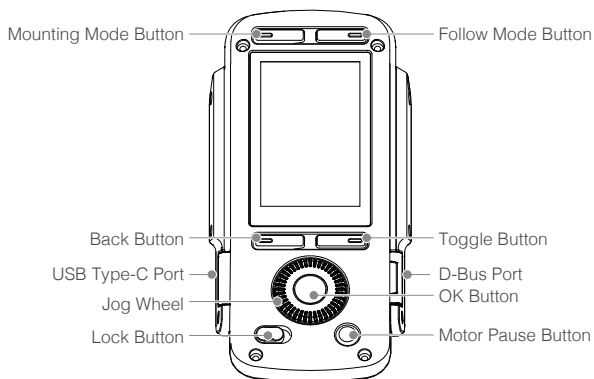

#### 1. Mounting Mode Button

Press the Mounting Mode button to select a mounting mode.

**Handheld:** Select Handheld mode when using the Ronin 2 handheld.

**Car Mount:** Select Car Mount mode when mounting the Ronin 2 on vehicle-mounted camera jibs. The Ronin 2 can remain stable for high-speed situations using the built-in GPS and offer increased holding strength.

**Aerial:** Select Aerial mode when mounting the Ronin 2 onto an aircraft and connected to a DJI A3 Flight Controller.

**Tripod Mode:** Select Tripod mode with static shots or when using a cable cam. Even for long periods of filming, the gimbal will not drift.

**⚠** If the Ronin 2 needs to be mounted on different mounting plates and switched between them, it is recommended to select the mounting modes listed below:

- Aerial, Car Mount and Handheld: select Aerial mode.
- Aerial and Handheld: select Aerial mode.
- Car Mount and Handheld: select Car Mount mode.

#### 2. Follow Mode Button

Press the Follow Mode button to select a Follow mode.

**Free Mode:** The Ronin 2 will stay in its current position, regardless of Grip movement.

**Follow Mode:** When Follow mode is enabled, the camera operator can “steer” the Ronin 2 on a selected axis. When the Grip is rotated left or right, the camera will smoothly follow the user’s input and stop at the appropriate angle. The SmoothTrack settings are applied in this mode, and the settings for the pan, roll, and tilt axes can be independently adjusted. SmoothTrack settings are affected when Follow mode is

enabled. It is not related to Free, Recenter, or FPV mode.

**FPV Mode:** The gimbal will synchronize with the movement of the Grip including roll to provide a first-person perspective experience.

**Recenter Mode:** The gimbal will reorient and reset the pan angle to the forward-facing direction.

**3. Back Button**

Press once to go back to the previous menu.

**4. Toggle Button**

Press once to toggle between the submenus.

**5. Jog Wheel**

Rotate to select options.

**6. OK Button**

Press once to confirm an option.

**7. Lock Button**

Toggle to lock the Touch Panel during usage to avoid unexpected operation.

**8. Motor Pause Button**

Press once to power off the motor without powering on the gimbal.

**9. D-Bus Port**

For connecting with Futaba and other third-party Futaba protocol remote controllers.

**10. USB Type-C Port**

Used to update the firmware via a USB connection.

**Top Bar Icon Description**

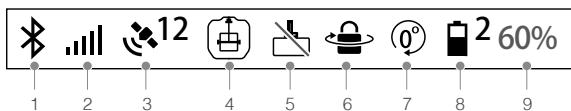

**1. Bluetooth Connection Status**

✶ : Indicates the Ronin 2 App is connected.

**2. Remote Controller Signal Strength**

▬▬▬ : Displays the remote controller signal strength.

**3. GPS Signal Strength**

📶<sup>12</sup> : Shows the current GPS signal strength.

**4. Mounting Mode**

👤 : Handheld Mode.

🚗 : Car Mount Mode.

🚁 : Aerial Mode.

📹 : Tripod Mode.

## 5. Motor Pause

 : Indicates the motor is powered off.

## 6. Pan Lock Mode

 : Indicates the gimbal is in Pan Lock Mode, and the pan motor is powered off.

## 7. Follow Mode

 : Free mode.

 : Follow mode.

 : FPV mode.

 : Recenter mode.

## 8. Working Battery number

 : Shows the number of batteries currently working. The Ronin 2 can operate with one or two batteries.

## 9. Battery Level

**60%** : Displays the current battery level.

# Basic Settings

## Motor Settings

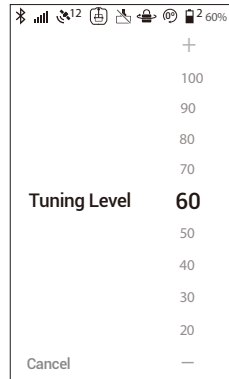
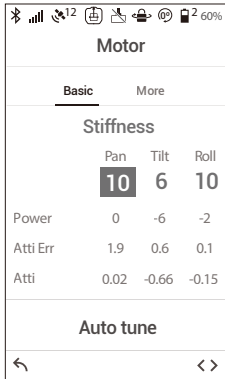

### 1. Basic Motor Settings

It is recommended to select Auto Tune to obtain automatic adjustment of each motor's settings.

**Auto Tune:** To begin the Auto Tune process, you need to select a Stiffness Grade. Stiffness value is determined by the gimbal system according to the payloads of the gimbal. 100% is the maximum stiffness value. For example, when the payload is 8 kg, 100% of the Stiffness value provided by Auto Tune is 50, so selecting the 60% means the Stiffness value is 30. It is recommended to select 60% for Handheld mode and 80% for Car Mount or Aerial mode.

Manual adjustment is required if gimbal performance is not ideal after auto tuning, or if anything causes Auto Tune to fail (if the payload includes too many accessories or the rotational inertia is too large). Reset the gimbal to default settings before trying to manually adjust settings.

**Stiffness:** Select the mounting mode prior to adjusting the Stiffness value. The motor stiffness adjustment allows you to fine-tune the amount of power that is applied by the motors as they react and balance the weight on each axis. Please make sure you leave an extra margin for this setting to ensure stability at all times. For example, if the Pan axis starts to shake at a stiffness of 40, then lower the value to 32. When shooting in Handheld mode, if the stiffness value set for the roll axis is 20, but the roll axis shaking affects the footage, that means the stiffness value is too low to provide optimal stability. Try increasing the stiffness value to 30.

**Strength:** It is recommended to leave this setting as default. The motor strength adjustment allows you to minimize Ronin 2's attitude error. This parameter affects how quickly the Ronin 2 will react to changes in orientation. If you see any unusual attitude errors (more than 1 in the readings), you may minimize it by increasing the corresponding motor's strength. However, increasing strength too much may also cause the Ronin 2 to over adjust its orientation and induce shakiness. When the Strength value is set to 10, and the pan axis cannot stop immediately after a fast rotation, try to decrease the value to 6.

**Filter:** This setting can ease high-frequency vibrations of the Ronin 2. When the Ronin 2 is vibrating at a high frequency, you may experience numbness while touching the gimbal motors of each axis. In such instances, it is recommended to lower the Filter settings.

**Control:** It is recommended to leave this setting as default. Control can guide the Ronin 2 to better handle low-frequency vibrations. If your Ronin 2 vibrates at a visible range, you can suppress it by increasing Control. When the vibration persists at low frequency, then decrease Control. Adjusting Control to optimal settings may take readjustment.

Payloads (kg)	Stiffness			Strength			Filter			Control		
	Pan	Tilt	Roll	Pan	Tilt	Roll	Pan	Tilt	Roll	Pan	Tilt	Roll
0	10	6	10	10	10	10	30	45	45	26	28	28
0-2 kg	25	20	20	10	10	10	30	45	45	26	28	28
2-4 kg	35	30	30	10	10	10	30	45	45	26	28	28
4-6 kg	40	40	35	10	10	10	30	40	40	26	28	28
6-8 kg	45	45	40	10	10	10	25	35	35	26	28	28
8-10 kg	50	50	40	10	10	10	25	35	35	26	28	28
10-12 kg	55	55	45	10	10	10	20	30	30	26	28	28
12-13.6 kg	60	55	45	10	10	10	20	25	25	26	28	28
Remarks	The values above are for reference. You can adjust the value within a value of 10 as needed.			It is recommended to use default settings.			The values above are for reference. You can adjust the value within a value of 10 as needed.			It is recommended to use default settings.		



It is recommended to use the remote controller to test the pan and tilt axis. Control the pan and tilt axis to all angles to see if shaking occurs. It is normal if the pan or tilt axis shakes one time and doesn't shake after that.

## 2. More Settings

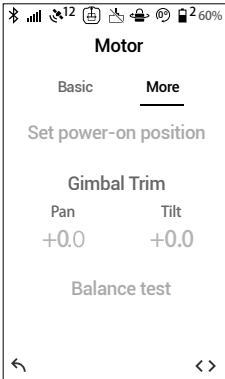

Set the Power-on Position: It is not necessary to set the power-on position if there is no special requirement. To set the power-on position, adjust the pan position as needed, and then press the OK button to confirm. The Ronin 2 will record this new position and the pan axis will stay at the recorded position when restarted.

Gimbal Trim: To fine-tune the pan or tilt axis. The default value is 0, which means the motor is at the center position and it is not necessary to change.

Balance Test: The pan, tilt, and roll axes will rotate automatically to check the balance status after selecting Balance Test. Ensure there is no obstruction of the gimbal before balance testing. Do not perform a Balance Test if the gimbal is set to Recenter mode.

## SmoothTrack Settings

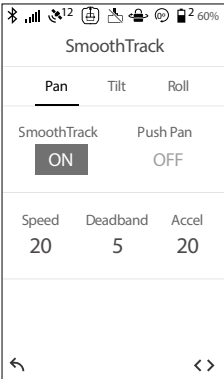

The settings for the pan, roll, and the tilt axes can be independently adjusted.

Push Pan (Push Tilt): Enable Push Pan or Push Tilt to allow the pan and tilt axes to be adjusted by hand when the Ronin 2 is turned on.

Speed: The speed will determine how fast the camera will travel while translating a pan, roll, or tilt movement.

Deadband will determine how much movement the gimbal will tolerate prior to translating the camera's pan, roll, and tilt.

Acceleration determines how closely the camera will follow the translated pan, tilt, and roll movement.

## Monitor

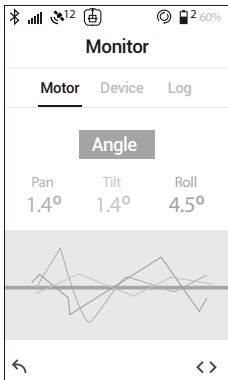

### 1. Motor

Displays the power, angle, and temperature of motors. If a particular motor axis indicates a power reading greater than 10, this often means the mechanical balance of the camera hasn't been properly adjusted. A properly balanced camera rig will display readings close to 0 power on each axis, but these values may vary.

### 2. Device

Displays the connection status with other devices, such as the remote controller, GPS, Flight Controller, DJI Focus, etc.

### 3. Log

Displays any abnormal status information of the gimbal.

## Remote Control Settings

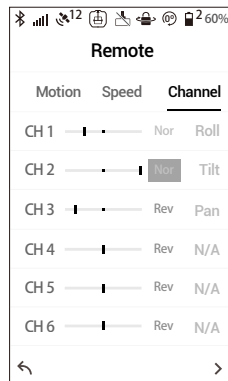
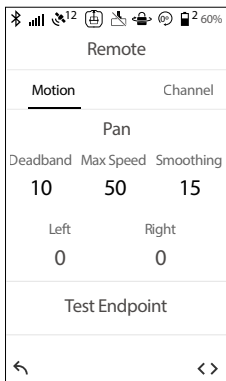

### 1. Motion

The remote controller can have independently adjusted pan, tilt, and roll deadband settings.

**Deadband:** When this value increases, more stick movement will be required to translate into actual movement of the gimbal.

**Max Speed:** Allows you to adjust the remote-controlled rotational speed.

**Smoothing:** When this value increases, and when control stick input is released it will be translated into smoother and slower movement. If smoothing is set to 0, the slowdown will be translated as an abrupt stop.



**Endpoint:** Limits the gimbal's rotation range by setting the endpoint during controller input.

**Test Endpoint:** Allows testing of the pan and tilt endpoints. Ensure the camera is unobstructed before tapping the test buttons.

 The default endpoint settings for pan axis are set to 180°, which means there is no endpoint for the pan axis, allowing it to rotate 360° continuously.

## 2. Channel

The channel indicator provides feedback during remote operator configuration. Pan, tilt, and roll can have channels reassigned. Each axis can also be reversed.

## System Settings

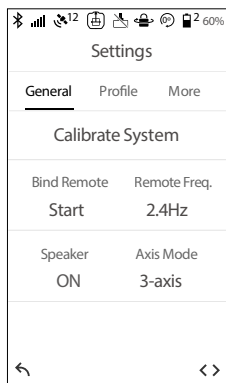

### 1. General

**Calibrate System:** Use only if you notice drift on any of the axes. To calibrate the system, place the Ronin 2 on the Grip and make sure it is completely steady. Be sure the camera can rotate 90° with the lens pointing straight down, without any interference from any wires. Select Calibrate System and let the process finish before picking up the Ronin 2.

**Bind Remote:** Select to bind with a remote controller.

**Remote Freq.:** The remote controller can work on both 2.4 GHz and 5.8 GHz Wi-Fi frequencies. Switch the operating frequency if serious interference is detected.

**Speaker:** A built-in speaker comes with the Ronin 2, and there will be sound alerts when powering the gimbal on or off or when an abnormal system status is detected. The speaker can be switched off via the built-in screen for quieter shooting scenarios.

**Axis Mode:** Choose between 3-Axis and Pan Lock mode.

### 2. Profile

The user can save the custom motor configurations or reset to default settings.

### 3. More

**Access Log File:** Internal storage is built into the Ronin 2 for recording data. If the gimbal is acting abnormally, contact DJI Support. If the provided solutions are not successful, DJI Support will request log files for further analysis. Access log files only when instructed by a DJI Support specialist.

**Password:** Displays the default Bluetooth password of your Ronin 2. The password can be changed.

**Joint Angle Calibration:** Joint Angle Calibration is needed if the gimbal cannot maintain its altitude, cannot recenter in Recenter mode, or the pan axis drifts in Tripod mode. To begin calibration, pause the motors, and then lock the pan, tilt, and roll axis. Then, select Joint Angle Calibration.

**Language:** Languages can be switched between English or Chinese.

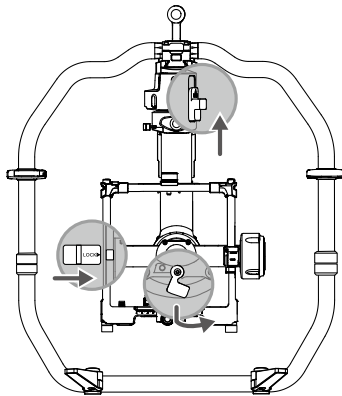

**About:** Displays the SN number and the firmware version of your Ronin 2.

#### Camera Page

Enter the Camera page to control camera recording and various other supported settings when a camera control cable is attached.

## Ronin 2 App

The Ronin 2 app allows you to adjust gimbal settings remotely. Also, new intelligent features have been added to the Create menu such as Track, CamAnchor, and more. Use the Ronin 2 app to activate the Ronin 2 for the very first time. An internet connection is required for product activation.

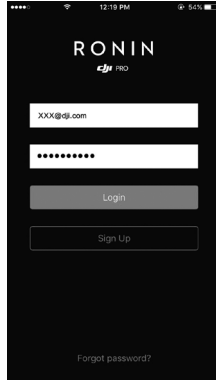

## Configuration

You can use the Default Settings or setup and save several custom settings profiles.

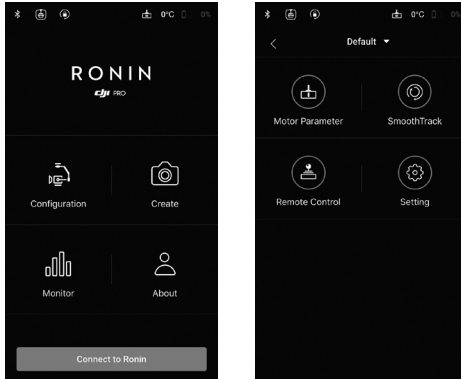

The options for Motor Settings, SmoothTrack, Remote Control, and General are the same as the Built-in Touch Panel. Refer to the section above to learn more, or tap the question mark icon to read basic guidelines.

## Create

The Create menu includes the Video, Track, and CamAnchor features.

- ⚠️ • Ensure the Ronin 2 is in Follow or Free mode when using Create features.
- It is recommended to mount the Ronin 2 onto a tripod when using Create features.

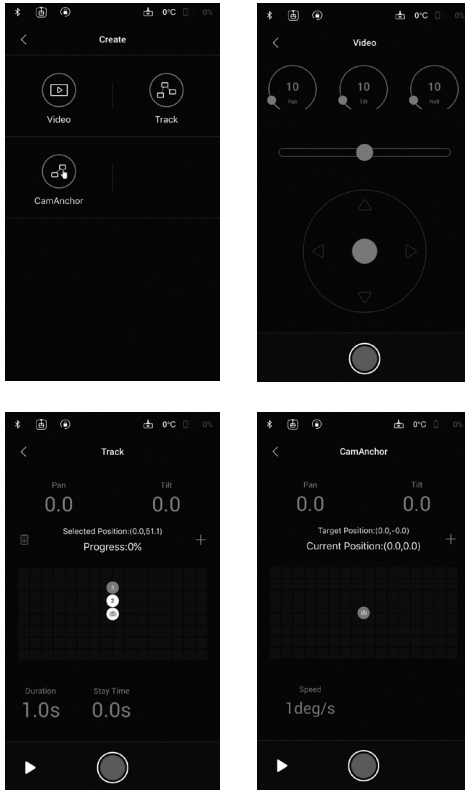

## Video

You can use the mobile device to control the camera for recording video.

⚙️ ⚙️ ⚙️ Speed Control Knobs: Turn the Speed Control Knobs to adjust the max speed of each axis.

🎛️ Roll Slider: Slide to control roll axis movement.

🕹️ Control Joystick: Slide the Joystick left or right to control pan axis movement, and slide the Joystick up or down to control tilt axis movement.

🔴 Record Button: Tap to start/stop recording.

## Track

Tap the screen to select several positions, and the camera will use the selected positions as a track to record video.

**1 2** Position Settings: Up to 10 individual positions can be selected. Tap **+** to add position and tap **🗑️** to delete.

**1.0s** **0.0s** Time Settings: Duration is how long the camera will take to move between two positions, and Stay Time is how long it will stay at the current position.

**▶** Preview Button: Tap Preview button to see if the position is proper.

**●** Record Button: Tap to start/stop recording.

## CamAnchor

In CamAnchor, you can control the camera move and record video between different target positions.

**📍** Target Position: Tap to select different target positions.

**Speed** **1deg/s** Speed: Determines the speed at which the camera will move between target positions.

**▶** Preview Button: Tap to see if the positions set are suitable.

**●** Record Button: Tap to start recording. Switch to the other target position, and the camera will move to that position at the set speed.

## Monitor

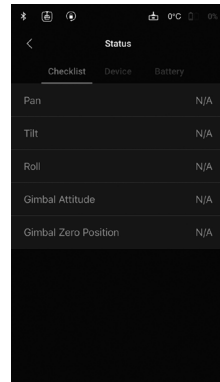
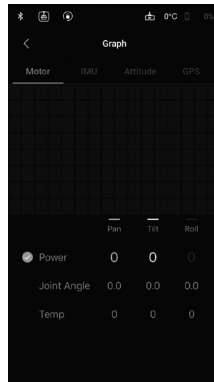
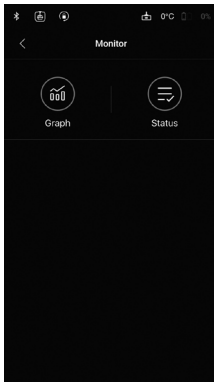

Displays the real-time status of the motors, IMU, attitude, GPS, connected devices, and batteries.

## About

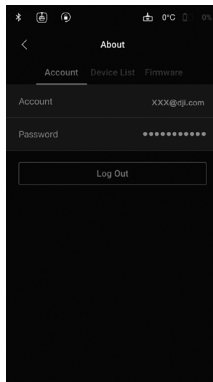

Displays your account information, firmware version, and more.

# Remote Controller

## Remote Controller Diagram

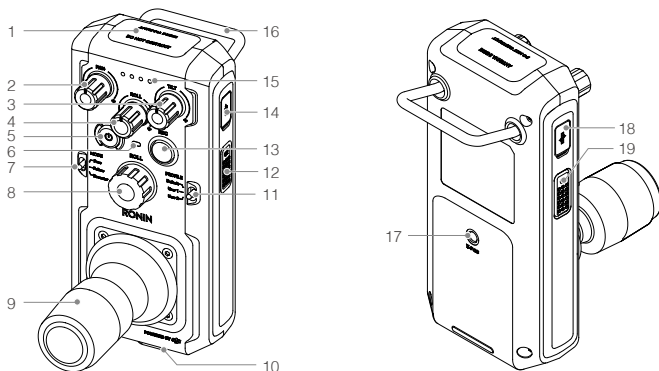

1. Built-in Antenna

Do not obstruct the antenna.

2. Pan Axis Speed Control Knob

Turn this Speed Control Knob to adjust the maximum speed of the pan axis.

3. Tilt Axis Speed Control Knob

Turn this Speed Control Knob to adjust the maximum speed of the tilt axis.

4. Roll Axis Speed Control Knob

Turn this Speed Control Knob to adjust the maximum speed of the roll axis.

5. Power Button

Press and hold the power button to turn on/off the remote controller.

6. Status LED

If the Status LED glows solid green, it is connected to the gimbal. If the status LED glows solid red, the remote controller is disconnected from the gimbal. Blinking red means the remote controller and gimbal are binding.

7. Mode Switch

Switches between the different follow modes: Free, Follow, and Recenter.

8. Roll Knob

Turn the knob to control roll axis movements (default settings can be changed).

9. Control Joystick

Push the Control Joystick up or down to control tilt axis movement. Push the Control Joystick left or right to control pan axis movement (default settings can also be changed).

10. Neck Strap Bracket
11. Profile Switch
  - Switch between various profiles.
12. C2 Button
13. Record Button
  - Press once to start/stop recording.
14. USB Type-C Port
  - For charging and updating firmware.
15. Battery Level Indicators
  - Displays the current battery level.
16. Handle
17. Accessory Mounting Hole
  - 1/4"-20 thread.
18. CAN Port
19. C1 Button

## Binding the Remote Controller

The remote controller is bound to the gimbal by default. If using a new remote controller, follow the steps below to begin binding.

1. Power on the gimbal and remote controller.
2. Enter the Settings page via the built-in touch panel and select "Bind Remote" Within 30 seconds, press C1, C2, and the Record Button simultaneously on the remote controller until you hear a continuous beep.
3. The status LED will glow solid green once a successful connection is established.

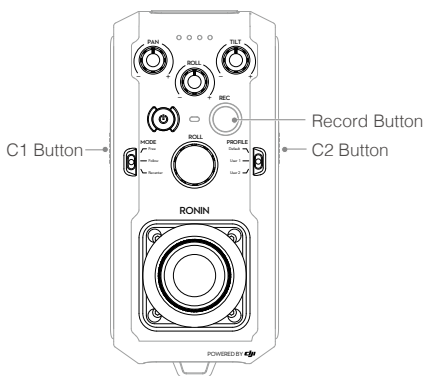
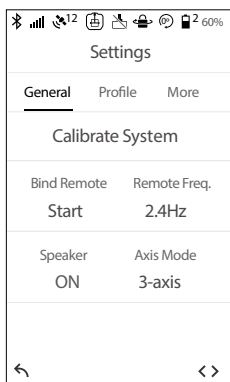

**⚠** When using the remote controller, ensure that the antenna is at least 20 cm away from any person or object to provide the best wireless connection.



## Charging

Charge the Remote Controller using a USB charger via the USB Type-C port. The remote controller has a maximum run time of 6 hours when fully charged.

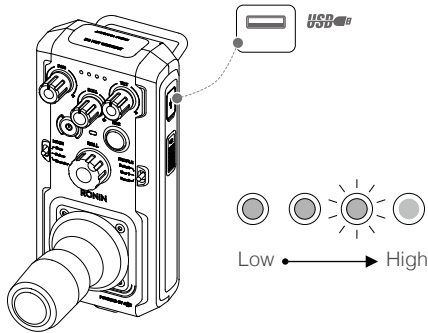

Charging Time: 2 hours (when charging at 2 A)

### Battery Level Indicators

The battery level indicators display the current battery level. The following is a description of the indicators.

○ : The LED is solidly lit      ☀ : The LED is blinking      ○ : The LED is off

LED1	LED2	LED3	LED4	Current Battery Level
○	○	○	○	75% to 100%
○	○	○	○	50% to 75%
○	○	○	○	25% to 50%
○	○	○	○	12.5% to 25%
☀	○	○	○	0% to 12.5%
○	○	○	○	<0%

## Calibrating the Control Joystick and Roll Knob

Only calibrate the Control Joystick and Roll knob if you notice control is not accurate (like if the pan axis is rotating without any input). Ensure the gimbal is powered off during calibration.

1. Press once on the C1+C2 buttons, and then press the C1 and C2 buttons simultaneously and hold them until the long beeping changes to a continuously short beeping, which indicates calibration has begun. Do not touch the Control Stick until calibration starts. Repeat step 1 if calibration fails to initiate.
2. Pull and push the control joystick and rotate the roll knob several times to the endpoints.
3. Press and hold the C1+C2 buttons again to exit calibration. The controller will beep if calibration is successful. If calibration fails and there is no beep emitted, repeat the steps above.

## Operation Modes

There are two operation modes for the Ronin 2: 3-Axis mode and Pan Lock mode.

### 3-Axis Mode

3-Axis mode is the standard, default mode. The Ronin 2 can be used in this mode without any adjustments.

### Pan Lock Mode

Pan Lock mode is specially designed for using the Ronin 2 with Steadicams. To use Pan Lock mode:

1. Select the Handheld Mounting mode.
2. Enter the Settings page via the built-in touch panel and select "Pan Lock," and then the pan motor will shut off.
3. Lock the pan axis. The Ronin 2 will now work in Pan Lock mode.
4. The pan axis cannot stabilize itself in Pan Lock mode, use a Steadicam stabilizer if needed.
5. The roll axis can rotate 360° in Pan Lock mode.
6. To properly use Pan Lock mode, the pan axis locking accessory should be installed. Please visit the official DJI Online Store for more details.

## Usage with a DJI A3 Flight Controller and Lightbridge

The Ronin 2 can be mounted to an aircraft with a DJI A3 Flight Controller and Lightbridge. Connect the Ronin 2's 14.4 V power/accessory port to the A3 Flight Controller, and connect the Ronin 2's CAN port to Lightbridge.

## Maintenance

The Ronin 2 is a precise machine, and its power/data ports are not waterproof. Be sure to protect them from dust and water during use. After use, it is recommended to wipe the Ronin 2 down with a soft dry cloth. Never spray any cleaning liquids onto the Ronin 2.

# Specifications

General	
Built-In Functions	<ul style="list-style-type: none"><li>• Operation Modes<ul style="list-style-type: none"><li>Underslung Mode</li><li>Upright Mode</li><li>Briefcase Mode</li><li>Handheld, Car Mount, Aerial, Tripod, &amp; Steadicam Mode</li></ul></li><li>• Built-in, independent IMU modules</li><li>• DJI Advanced 32-Bit ARM Processor</li><li>• DJI Specialized Gimbal Drive Motors with Encoders</li><li>• Dual Battery System</li><li>• Bluetooth Module</li><li>• D-Bus Receiver Supported</li><li>• 2.4 GHz/5.8 GHz Receiver</li><li>• Temperature Sensors</li><li>• Built-in Touch Panel</li><li>• Built-in GPS/GLONASS</li><li>• USB Type-C Connection</li><li>• Power and Video Signal through Slip Ring</li></ul>
Ingress Protection Rating	IP52*
Peripheral	
Camera Tray Dimensions	Maximum depth from the center of gravity on camera base plate: 250 mm Maximum height measured from top of the camera base plate: 190 mm Maximum width: 170 mm
Accessory Power Connections	14.4 V x 4 Camera Cage (Combined 8 A), 14.4V x 2 Pan Motor (Combined 4 A), 14.4 V x1 P-Tap (8 A)
Input Power	Intelligent Battery: 4280 mAh-22.8 V
Connections	2.4 GHz/5.8 GHz Remote Control; Bluetooth 4.0; USB Type-C
DJI Assistant 2 Requirements	Windows 7 or above; Mac OS X 10.11 or above
Ronin 2 App Requirements	iOS 9 or above; Android 4.4 or above

**Mechanical & Electrical Characteristics**

Working Current

- Static current:  $\approx 300$  mA (@22.8 V)
- Dynamic current:  $\approx 500$  mA (@22.8 V)
- Locked motor current: Max 15 A (@22.8 V)

Operating Temperature -4° F ~ 122° F (-20° C ~ 50° C)

Operating Frequency 2.4-2.4835 GHz; 5.725-5.850 GHz

Transmitter Power (EIRP) 2.4 GHz  
 FCC:  $\leq 25$  dBm; CE:  $\leq 20$  dBm; SRRC:  $\leq 20$  dBm  
 5.8 GHz  
 FCC:  $\leq 25$  dBm; CE:  $\leq 14$  dBm; SRRC:  $\leq 14$  dBm

Weight Including handle bar: 14 lb (6.3 kg)  
 Excluding handle bar: 11 lb (4.9 kg)

Dimensions Excluding handle bar : 350 mm (W) x 416 mm (D) x 530 mm (H)  
 Including handle bar : 630 mm (W) x 416 mm (D) x 720 mm (H)

**Working Performance**

Load Weight (Reference Value) 30 lbs (13.6 kg)

Angular Vibration Range  $\pm 0.02^\circ$

Maximum Controlled Rotation Speed  
 Pan axis: 400 °/s  
 Tilt axis: 360 °/s  
 Roll axis: 360 °/s

Mechanical Endpoint Range  
 Pan axis control: 360 ° continuous rotation  
 Tilt axis control:  $\pm 135^\circ$   
 Roll axis control:  $\pm 220^\circ$

Controlled Rotation Range  
 Pan axis control: 360 ° continuous rotation  
 Tilt axis control:  $\pm 135^\circ$   
 Roll axis control:  $\pm 30^\circ$

\* The Ronin 2's power/data ports are not waterproof. Be sure to protect them from harmful dust and water during use, otherwise damage may occur.

Contents are subject to change.

Download the latest version from  
<http://www.dji.com/product/ronin-2>

If you have any questions about this document, please contact DJI  
by sending a message to [DocSupport@dji.com](mailto:DocSupport@dji.com).

RONIN is a trademark of DJI OSMO. Copyright © 2017 DJI OSMO All Rights Reserved.