

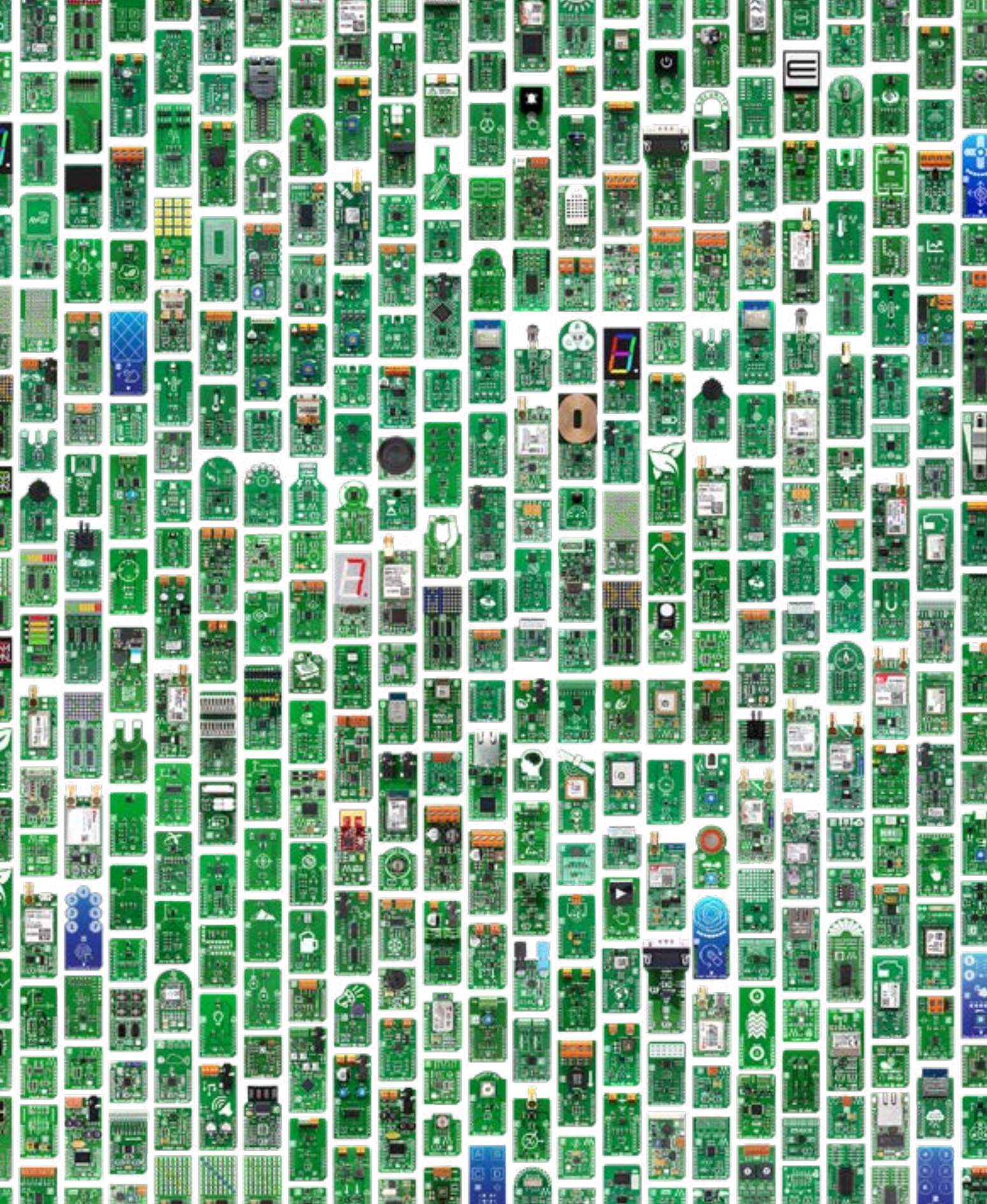

Click boards™

**THE BIGGEST ADD-ON BOARD
COLLECTION IN THE WORLD**

MIKROE
Time-saving embedded tools



mikroBUS™ standard

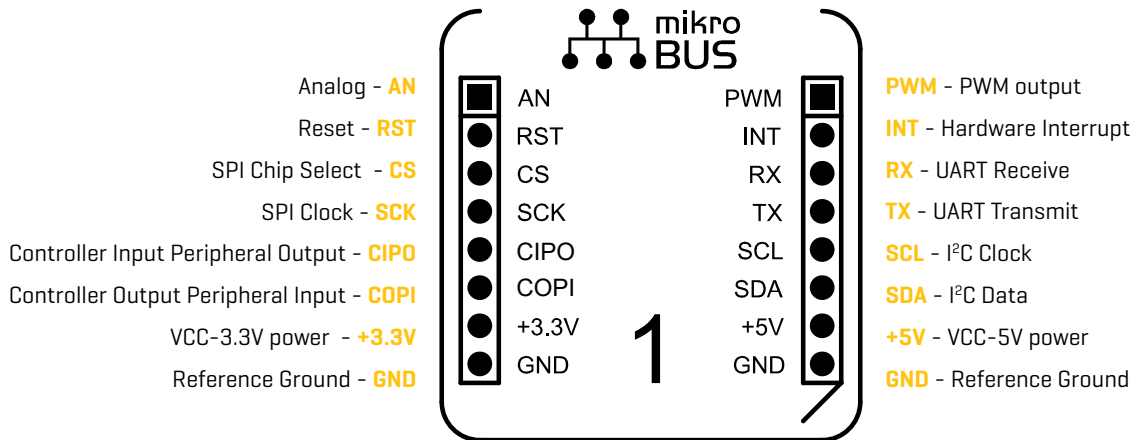

mikroBUS™ is an open standard that defines pinout and physical layout used for interfacing microcontroller & microprocessor with peripheral modules. It covers the widest range of add-on boards, saving months of development time, and delivering enormous design flexibility and scalability. Adding a mikroBUS™ socket to your design allows you to utilize the ever-expanding range of Click boards™. All the major silicon vendors have accepted the mikroBUS™ standard and added it to their development boards.



**Shape the future of
the embedded world
with our time-saving
development tools.**

MIKROE
Time-saving embedded tools

Table of contents

| | |
|---|-----|
| mikroBUS™ standard | 3 |
| The first Click board™ | 6 |
| New Click boards™ release per year | 8 |
| World's biggest add-on board collection – Click boards™ | 10 |
| Wireless connectivity | 11 |
| Sensors | 35 |
| Interface | 97 |
| Display & LED | 117 |
| HMI | 127 |
| Storage | 139 |
| Miscellaneous | 147 |
| Motor Control | 155 |
| Audio & Voice | 171 |
| Mixed Signal | 179 |
| Power Management | 195 |
| Clock & Timing | 211 |
| From one man's idea to a dominant add-on board standard | 218 |
| Growing with our partners | 220 |
| Clicking on all platforms | 222 |



All the information and images shown in this catalog are for illustration purposes only, and may not be the exact representation of the products. Actual products may vary due to products enhancement. MIKROE reserves the right to change product images and specifications at any time without notice.



st

GPS Click

It carries LEA-6S high-performance position engine from u-blox.

MSRP – \$49⁰⁰
MIKROE-1032

The first-ever mikroBUS™ compatible add-on board was made in 2011. With this board, we presented a new product line called Click boards™.



2024

209

2023

194

2022

183

2021

204

2020

206

2019

199

2018

165

2017

125

2016

81

2015

81

2014

33

2013

35

2012

25

New Click
boards™
release
per year

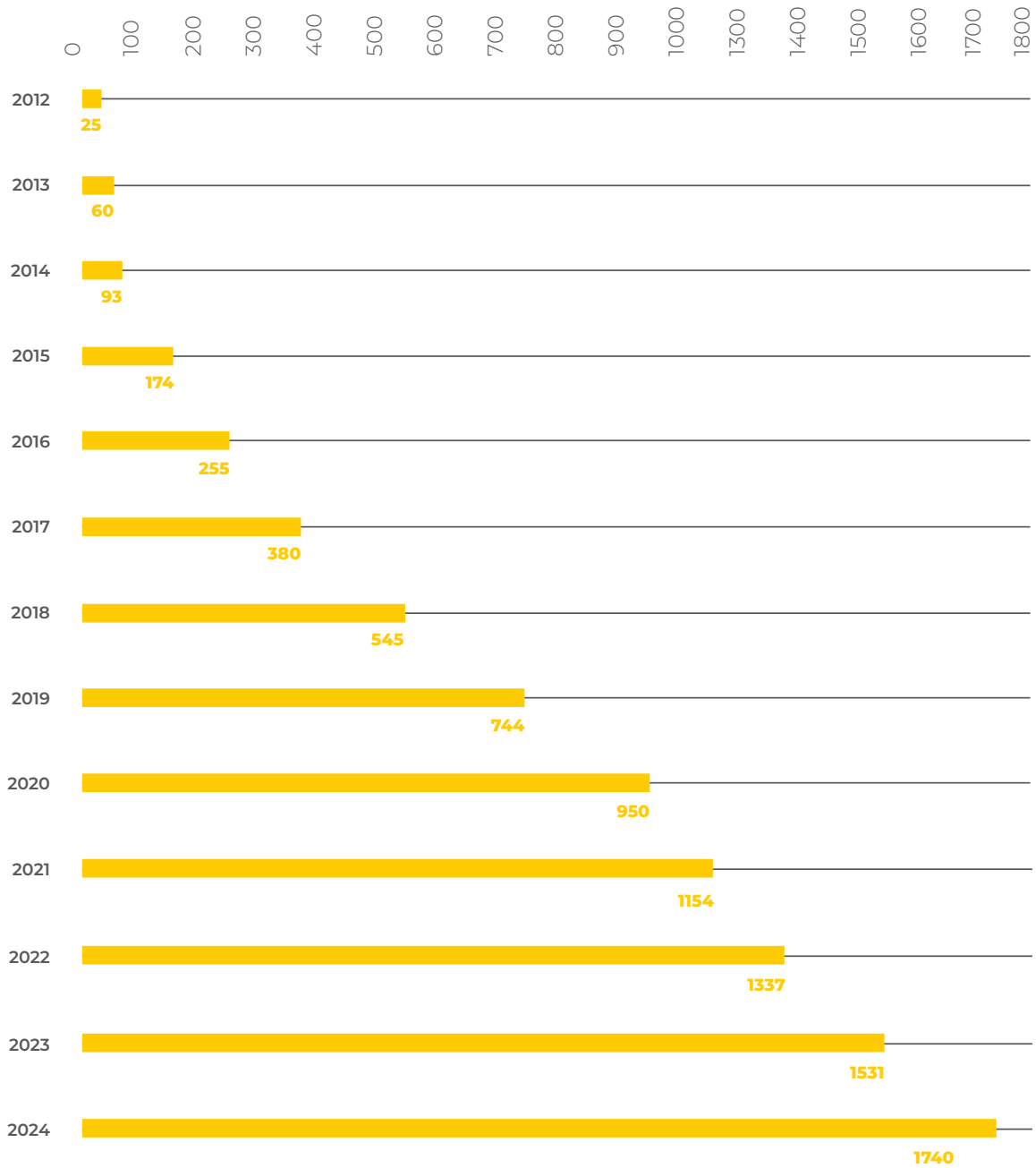

Number of Click boards™ at the end of the year

Click boards™

**The biggest
add-on board collection
in the world.**

WIRELESS CONNECTIVITY





3G Click (USA)

UG95 3G UMTS/HSPA module. With SIM card slot, Audio/Mic jack, micro USB port.

MSRP - \$89⁰⁰
MIKROE-2296



3G Click (EU/AUS)

UG95 3G UMTS/HSPA module. With SIM card slot, Audio/Mic jack, micro USB port.

MSRP - \$89⁰⁰
MIKROE-2226



3G SARA Click

With UMTS/HSPA cellular modem - the u-blox U201, from the SARA series.

MSRP - \$110⁰⁰
MIKROE-2244



4G LTE-E Click

With the LARA-R211 multi-mode cellular module from u-blox.

MSRP - \$130⁰⁰
MIKROE-2527



4G LTE-NA Click

It features the LARA-R204 multi-mode cellular module from u-blox.

MSRP - \$115⁰⁰
MIKROE-2535



BLE 2 Click

With RN4020 Bluetooth 4.1 module. Can be set up both as a client or a server.

MSRP - \$30⁰⁰
MIKROE-1715



BLE 3 Click

It features NI-NA-B1 Bluetooth 4.2 module from u-blox.

MSRP - \$39⁰⁰
MIKROE-2471



BLE P Click

With nRF8001 Bluetooth 4.0 peripheral device. Open source Android app available.

MSRP - \$25⁰⁰
MIKROE-1597



Bluetooth Click

It features the RN-41 low power, class 1 Bluetooth radio module.

MSRP - \$46⁰⁰
MIKROE-958



BT Audio Click

With RN52 Bluetooth audio module and on-board 3.5mm jacks for a mic and a speaker.

MSRP - \$49⁰⁰
MIKROE-2399





6LoWPAN C Click

TI's CC2520, 2.4GHz ZigBee®/IEEE 802.15.4 RF transceiver.

MSRP - \$26⁰⁰
MIKROE-2219



6LoWPAN T Click

TI's CC2520, 2.4GHz ZigBee®/IEEE 802.15. RF transceiver.

MSRP - \$26⁰⁰
MIKROE-2218



BEE Click

Microchip's MRF24J-40MA 2.4 GHz IEEE 802.15.4 radio transceiver module.

MSRP - \$36⁰⁰
MIKROE-987



GNSS Click

Quectel's L86 GNSS module with a patch antenna and an external antenna connector.

MSRP - \$46⁰⁰
MIKROE-1850



GNSS 2 Click

Quectel's L76 module and SMA antenna connector. GPS + GLONASS.

MSRP - \$39⁰⁰
MIKROE-1887



ccRF Click

With CC2500 low-power 2.4 GHz RF transceiver and PCB trace antenna.

MSRP - \$22⁰⁰
MIKROE-1435



ccRF 2 Click

With CC1120, high performance radio transceiver for ISM and SRD bands.

MSRP - \$36⁰⁰
MIKROE-1716



ccRF 3 Click

Carries the CC1120 high-performance RF transceiver for narrow-band systems from TI.

MSRP - \$36⁰⁰
MIKROE-2389



GSM Click

With quad-band GL865-QUAD GSM/ GPRS module, onboard antenna connector and SIM card socket.

MSRP - \$49⁰⁰
MIKROE-1298



GSM 2 Click

With Quectel's M95 FA quad-band GSM/GPRS module. 85.6 kbps GPRS data transfer.

MSRP - \$44⁰⁰
MIKROE-1375





GNSS 3 Click

Carries SIM33ELAGNSS module with an integrated antenna and an external antenna connector.

MSRP - \$39⁰⁰
MIKROE-1895



GNSS 4 Click

It features SAM-M8Q patch antenna module from u-blox.

MSRP - \$44⁰⁰
MIKROE-2045



GNSS 5 Click

It features NEO-M8N GNSS receiver module from u-blox.

MSRP - \$41⁰⁰
MIKROE-2670



GPS Click

It carries LEA-6S high-performance position engine from u-blox.

MSRP - \$49⁰⁰
MIKROE-1032



GPS 3 Click

With Quectel's L80, high-sensitivity GPS module with a patch antenna.

MSRP - \$44⁰⁰
MIKROE-1714



GSM 3 Click

With SIM800H quad-band GSM/GPRS module. 85.6 kbps GPRS data transfer.

MSRP - \$57⁰⁰
MIKROE-1720



GSM/GNSS Click

Quectel's MC60 quad-band GSM/GPRS/GNSS module. GPS/GNSS location tracking with GSM.

MSRP - \$79⁰⁰
MIKROE-2439



GSM/GNSS 2 Click

With SIM868 quad-band GSM/GPRS module. GPS/GNSS location tracking with GSM.

MSRP - \$69⁰⁰
MIKROE-2440



IQRF Click

With DCTR-76DA RF transceiver, operating in the 868/916 MHz frequency.

MSRP - \$43⁰⁰
MIKROE-2586



IQRF 2 Click

With DCTR-72DAT RF transceiver, operating in the 868/916 MHz frequency.

MSRP - \$49⁰⁰
MIKROE-2587





LR Click

With RN2483 LoRa Sub-GHz, 433/868 MHz European R&TTE Directive Assessed Radio Modem.

MSRP – \$39⁰⁰
MIKROE-4470



LR 2 Click

With RN2903 915 MHz Radio Modem compliant with regulations for use in the USA, CA, AU, NZ.

MSRP – \$50⁰⁰
MIKROE-4615



LR 3 Click

A LoRa technology-based SRD transceiver, operates at a sub-gigahertz frequency of 868MHz.

MSRP – \$45⁰⁰
MIKROE-4616



LR 4 Click

A LoRa RF technology based SRD transceiver, operates at a sub-GHz frequency of 868MHz.

MSRP – \$45⁰⁰
MIKROE-2934



LR 5 Click

SRD transceiver which operates at a sub-GHz frequency of 902-928 MHz SRD Band.

MSRP – \$53⁰⁰
MIKROE-4618



GSM-GPS Click

With SIM808, GSM/GPRS and GPS module. 2 antenna conn. SIM card slot, a micro USB conn.

MSRP – \$85⁰⁰
MIKROE-2382



nRF C Click

With nRF24L01P 2.4 GHz transceiver. Air data rates of 250 Kbps, 1 Mbps and 2 Mbps.

MSRP – \$19⁰⁰
MIKROE-1304



nRF S Click

With nRF24L01P 2.4 GHz transceiver. 250 Kbps, 1 Mbps and 2 Mbps air data rates.

MSRP – \$19⁰⁰
MIKROE-1836



nRF T Click

With nRF24L01P 2.4 GHz transceiver module. Air data rates of 250 Kbps, 1 Mbps and 2 Mbps.

MSRP – \$16⁰⁰
MIKROE-1305



RFid Click

With CR95HF 13.56 MHz contactless RFid transceiver, and trace antenna.

MSRP – \$29⁰⁰
MIKROE-1434



NFC Tag Click

With M24SR64 NFC/RFID tag IC with a dual interface and 8KB of high-reliability EEPROM built-in.

MSRP - \$12⁰⁰
MIKROE-1726



NFC Tag 2 Click

Carries NT3H1101 NTAG I2C energy harvesting NFC Forum Type 2 Tag from NXP.

MSRP - \$12⁰⁰
MIKROE-2462



tRF Click

With Telit's LE70-868 — a 868 MHz transceiver module with embedded stack.

MSRP - \$59⁰⁰
MIKROE-1535



LTE IoT 5 Click

Features the SARA-R510M8S cellular module from u-Blox.

MSRP - \$79⁰⁰
MIKROE-4325



LTE IoT 6 Click

The SARA-R412M, a cellular module for Low Power Wide Area solutions from u-Blox.

MSRP - \$79⁰⁰
MIKROE-4388



NFC Click

With near field communications controller PN7120 IC from NXP.

MSRP - \$34⁰⁰
MIKROE-2395



RN4678 Click

It carries RN4678 Bluetooth® 4.2 dual mode module from Microchip.

MSRP - \$38⁰⁰
MIKROE-2545



RN4870 Click

It carries RN4870 Bluetooth® 4.2 low energy module from Microchip.

MSRP - \$33⁰⁰
MIKROE-2543



RN4871 Click

It carries RN4871 Bluetooth® 4.2 low energy module from Microchip.

MSRP - \$33⁰⁰
MIKROE-2544



WiFi PLUS Click

With MRF24WB-OMA 2.4GHz, IEEE 802.11 module and MCW1001 controller.

MSRP - \$89⁰⁰
MIKROE-1135





WiFi 2 Click

With HLK-M30 module. Can be set up with either a static or dynamic IP address.

MSRP - \$29⁰⁰
MIKROE-1768



WiFi 3 Click

With ESP8266 module. TCP/IP stack. Supports Wi-Fi Direct (p2p). 6 GPIO pins.

MSRP - \$27⁰⁰
MIKROE-1769



WiFi 4 Click

With SPWF01SA standalone WiFi module. Built-in 2.45 GHz ISM band antenna.

MSRP - \$49⁰⁰
MIKROE-1913



WiFi 5 Click

With Gainspan's GS1500M 802.11b/g/n Low Power Wi-Fi module with a PCB trace antenna.

MSRP - \$29⁰⁰
MIKROE-2274



WiFi 6 Click

With WF121-A self-contained WiFi module. 2.4GHz band IEEE 802.11 b/g/n radio.

MSRP - \$69⁰⁰
MIKROE-2043



WiFly Click

With RN-131 embedded wireless LAN module. Qualified 2.4-GHz IEEE 802.11 b/g transceiver.

MSRP - \$74⁰⁰
MIKROE-1937



AnyNet 2G Click

WiFi module with integrated IPv4 TCP/IP stack and built-in network protocols.

MSRP - \$69⁰⁰
MIKROE-2747



AnyNet 3G-EA Click

A secure connection with the AWS over the air (OTA), by utilizing the Quectel UG95 3G module.

MSRP - \$121⁰⁰
MIKROE-2975



CC3100 Click

Carries low power, high security Wi-Fi CC3100 module. Support for 802.11n.

MSRP - \$49⁰⁰
MIKROE-2336



OOK RX Click

A wireless receiver that operates at the frequency of 433MHz (sub-GHz).

MSRP - \$19⁰⁰
MIKROE-2902



WiFi 7 Click

With ATWINC1510-MR210PB IEEE 802.11 b/g/n module, 20MHz solution.

MSRP - \$29⁰⁰
MIKROE-2046



WiFi ESP Click

With ESP-WROOM-02 module that integrates ESP8266EX. In AP WiFi and WiFi client mode.

MSRP - \$15⁰⁰
MIKROE-2542



MiWi Click

A subgigahertz radio transceiver which offers a reliable FSK or OOK communication solution.

MSRP - \$17⁰⁰
MIKROE-2924



MiWi 2 Click

A subgigahertz radio transceiver which offers a reliable FSK or OOK communication solution.

MSRP - \$24⁰⁰
MIKROE-2925



M-BUS RF Click

With ME70-169 RF wireless module. Unlicensed ISM frequency band 169.400-169.475 MHz.

MSRP - \$54⁰⁰
MIKROE-2048



OOK TX Click

A wireless transmitter that operates at the frequency of 433MHz [sub-GHz].

MSRP - \$19⁰⁰
MIKROE-2903



WiFi NINA Click

A standalone WiFi module, with the state-of-the-art NINA-W132 module from u-blox.

MSRP - \$45⁰⁰
MIKROE-2921



NB IoT Click

Allows LTE Cat NB1 connectivity by utilizing Quectel BC95-G

MSRP - \$59⁰⁰
MIKROE-3294



LTE IoT Click

Compact quad-band GSM solution, featuring the quad-band SARA-R410M-02B LTE/2G module.

MSRP - \$79⁰⁰
MIKROE-3072



LTE IoT 2 Click

Allows connection to the LTE networks, featuring Quectel BG96 LTE module.

MSRP - \$77⁰⁰
MIKROE-3144





SPIRIT Click

With SP1ML 868MHz ultra low-power RF module. Memory: 16 kB RAM and 128 kB Flash.

MSRP – \$39⁰⁰
MIKROE-2568



XBEE Click

Xbee® and Zig-bee-compliant XB-24CZ7PIS-004 module with a PCB antenna.

MSRP – \$70⁰⁰
MIKROE-1599



NANO GPS Click

With Nano Hornet, world's smallest GPS module with an integrated antenna.

MSRP – \$59⁰⁰
MIKROE-1912



GPS 4 Click

GPS 4 click carries the L70 compact GPS module from Quectel, with external antenna.

MSRP – \$34⁰⁰
MIKROE-2704



GSM 4 Click

Compact quad-band GSM solution, featuring the quad-band SARA-G350 module.

MSRP – \$57⁰⁰
MIKROE-2388



SigFox Click

Carries the SN10-11, a fully integrated Sigfox™ certified module by InnoComm.

MSRP – \$25⁰⁰
MIKROE-2534



SigFox 2 Click

Carries the SN10-12, a fully integrated Sigfox™ certified module by InnoComm.

MSRP – \$25⁰⁰
MIKROE-3039



SigFox 3 Click

Carries the SN10-13, a fully integrated Sigfox™ certified module by InnoComm.

MSRP – \$25⁰⁰
MIKROE-3163



EnOcean 4 Click

With ultra-low power TC-M515U transceiver gateway module which operates at 920MHz radio band.

MSRP – \$39⁰⁰
MIKROE-3637



DeviceDrive Click

The WRF01-M24A module uses the UART interface [with JSON command format].

MSRP – \$19⁰⁰
MIKROE-3663



EnOcean 3 Click

With ultra-low power TCM515 transceiver gateway module and operates at 868MHz radio band.

MSRP – \$39⁰⁰
MIKROE-3653



BLE 8 Click

With the ANNA-B112, an ultra-small, stand-alone Bluetooth low energy module.

MSRP – \$29⁰⁰
MIKROE-3674



WiFi 9 Click

With the PAN9420 a 2.4 GHz ISM band Wi-Fi embedded module.

MSRP – \$45⁰⁰
MIKROE-3666



WiFi 10 Click

Based on the SX-ULPAN-SB-2401, an integrated wireless LAN module.

MSRP – \$25⁰⁰
MIKROE-3432



LP WiFi Click

Based on the DA16200, an ultra-low power Wi-Fi module from Dialog Semiconductor.

MSRP – \$19⁰⁰
MIKROE-4836



Nano LR Click

The EMB-LR1276S, a sub-1GHz wireless module that supports the LoRaWANTM®.

MSRP – \$44⁰⁰
MIKROE-4514



G2C Click

A gateway Click board™ which provides a simple and reliable connection to the Click Cloud platform.

MSRP – \$19⁰⁰
MIKROE-3291



4G LTE-APJ Click

LTE Cat 1 / UMTS multimode cellular network solution, with the compact LARA-R2 series modem from u-blox.

MSRP – \$126⁰⁰
MIKROE-3351



4G LTE-AT&T Click

LTE Cat 1 / UMTS multimode cellular network solution, with the compact LARA-R2 series modem from u-blox.

MSRP – \$135⁰⁰
MIKROE-3350



GNSS 7 Click

It carries the NEO-M9N GNSS receiver module from u-blox.

MSRP – \$39⁰⁰
MIKROE-1887





GNSS ZOE Click

An evaluation board for ultra small ZOE-M8Q GNSS SIP receiver from u-blox.

MSRP - \$39⁰⁰
MIKROE-3660



NFC Tag 4 Click

NFC tag device, offering 16 Kbit of electrically erasable programmable memory (EEPROM).

MSRP - \$12⁰⁰
MIKROE-3659



SPIRIT 2 Click

With the SP1ML-915, an ultra-low power RF module, which operates at 915 MHz ISM band.

MSRP - \$49⁰⁰
MIKROE-3598



BLE 4 Click

It features the NINA-B312, an integrated wireless connectivity solution.

MSRP - \$37⁰⁰
MIKROE-3773



BLE 7 Click

Based on the BGX-13S22GA, a bluetooth low energy module from Silicon Labs.

MSRP - \$21⁰⁰
MIKROE-3872



G2C 3G Click

Allows connection to the feature-rich Click Cloud platform, over the 3.75G UMTS/HSPA network.

MSRP - \$69⁰⁰
MIKROE-3888



LTE Cat. 1-EU Click

Carries the ELS61 Cat 1 LTE connectivity module with 2G and 3G fall back.

MSRP - \$117⁰⁰
MIKROE-3757



LTE Cat. 1-US Click

Carries the ELS61 Cat 1 LTE connectivity module with 2G and 3G fall back.

MSRP - \$105⁰⁰
MIKROE-3885



BLE 5 Click

Based on the PA-N1760A, a Bluetooth 4.2 low energy module from Panasonic.

MSRP - \$26⁰⁰
MIKROE-4120



BT Audio 2 Click

Bluetooth audio stream add on board based on BM62 module from Microchip.

MSRP - \$45⁰⁰
MIKROE-4117





M-BUS RF 4 Click

With a Telit ME70-169 RF wireless module.

MSRP - \$41⁰⁰
MIKROE-3692



Thingstream Click

It is equipped with the SIM868, an 802.11b/g/n quad-band GPS/GLONASS/GSM module.

MSRP - \$45⁰⁰
MIKROE-3739



NFC Extend Click

Uses any shape and size external antenna, with 16 Kbit of EEPROM.

MSRP - \$6⁰⁰
MIKROE-3971



5G NB IoT Click

Based on Thales ENS22 NB-IoT Wireless Module that boosts highly efficient 5G conn. for the IoT.

MSRP - \$59⁰⁰
MIKROE-4034



BT-EZ Click

It features the CYBT-343026-01, module that supports BT 5.0 and BLE stack.

MSRP - \$25⁰⁰
MIKROE-4038



Nano GPS 2 Click

The smallest GPS module with an integrated patch antenna, the ORG1510-MK05 by OriginGPS.

MSRP - \$59⁰⁰
MIKROE-4150



BLE 6 Click

It's compliant with BT specifications v5.0 and BQE qualified.

MSRP - \$27⁰⁰
MIKROE-4170



UWB Click

The DWM1000 module based on Decawave's DW1000 Ultra-Wide-band [UWB] transceiver.

MSRP - \$69⁰⁰
MIKROE-4199



LTE IoT 3 Click

Features the EXS82-W, LTE-IoT Wireless Module from Thales.

MSRP - \$79⁰⁰
MIKROE-4118



ZigBee Click

Features the ETRX357, 2.4 GHz Zigbee Radio module from Silicon Labs.

MSRP - \$56⁰⁰
MIKROE-4277





Bluetooth 2 Click

With a WT41u, a long range class 1, Bluetooth® 2.1 + EDR module from Silicon Labs.

MSRP - \$107⁰⁰
MIKROE-4087



ISM TX Click

The MAX41460, a UHF sub-GHz ISM/SRD transmitter from Maxim Integrated.

MSRP - \$12⁰⁰
MIKROE-4242



RFID 2 Click

The ID-12LA-SA, an advanced low-cost RFID reader module with 38 different tags.

MSRP - \$109⁰⁰
MIKROE-4208



BT Click

The BT121, a dual-mode Bluetooth Smart Ready module from Silicon Labs.

MSRP - \$69⁰⁰
MIKROE-4384



NFC 2 Click

The PN7150, designed for contactless communication at 13.56 MHz from NXP.

MSRP - \$34⁰⁰
MIKROE-4309



ISM RX 2 Click

Features the Si4356, a standalone Sub-GHz RF receiver IC, from Silicon Labs.

MSRP - \$15⁰⁰
MIKROE-4230



GNSS RTK Click

The ZED-F9P, a multi-band GNSS module with integrated multi-band [RTK] technology from U-blox.

MSRP - \$229⁰⁰
MIKROE-4456



LTE IoT 9 Click

Features the EXS62-W, LTE-IoT Wireless Module from Thales.

MSRP - \$74⁰⁰
MIKROE-4465



ISM RX Click

Features the MAX1471, a low-power CMOS RF dual-channel receiver.

MSRP - \$69⁰⁰
MIKROE-4499



BLE TINY Click

Features the DA14531MOD, Smart-Bond TINY module.

MSRP - \$15⁰⁰
MIKROE-4582



NB IoT 5 Click

Based on the OT01-5, a narrow-band IoT universal wireless communication module from Notion.

MSRP – \$49⁰⁰
MIKROE-4472



NB IoT 2 Click

Based on the BC66-NA, a narrow-band IoT communication module from Quectel.

MSRP – \$45⁰⁰
MIKROE-4562



LR Click

Based on the RN2483, a long-range 433/868MHz RF transceiver module from Microchip.

MSRP – \$39⁰⁰
MIKROE-4470



BLE TX Click

Based on the AK1595, a Bluetooth 5.2 transmitter from AKM Semiconductor.

MSRP – \$9⁰⁰
MIKROE-4668



ISM Click

Based on the RFM75, a worldwide ISM frequency band GFSK transceiver from RF.

MSRP – \$15⁰⁰
MIKROE-4625



NTAG 5 Link Click

Based on the NTP5332, an NFC forum-compliant I2C bridge from NXP.

MSRP – \$12⁰⁰
MIKROE-4635



GPS 6 Click

Based on the A2200-A, a high-performance GPS module from Lantronix.

MSRP – \$55⁰⁰
MIKROE-5115



BLE 10 Click

Has the PAN1780-AT, a BLE 5 Module with Nordic's nRF52840 SoC from Panasonic.

MSRP – \$55⁰⁰
MIKROE-5135



GNSS MAX Click

Based on the MAX-M10S, a GNSS receiver for high-performance positioning from u-blox.

MSRP – \$45⁰⁰
MIKROE-4643

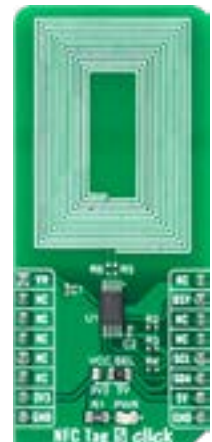

NFC Tag 5 Click

Based on the M24LR64E-R, energy harvesting NFC/RFID tag IC from STMicroelectronics.

MSRP – \$12⁰⁰
MIKROE-5230





WiFi 8 Click

Based on the ATWINC3400, an RF/Baseband/MAC network controller from Microchip.

MSRP - \$34⁰⁰
MIKROE-4704



LTE IoT 8 Click

Has the SKY66430-11, a multi-band SiP with 5G Massive LTE IoT connectivity from Skyworks.

MSRP - \$79⁰⁰
MIKROE-4493



IRNSS Click

Features the L89H, an acquiring and tracking IRNSS-enabled GNSS module from Quectel.

MSRP - \$35⁰⁰
MIKROE-4772



NB IoT 4 Click

Based on the C1-RM, an NB-IoT and IoT/2G wireless module from Cavli Wireless.

MSRP - \$55⁰⁰
MIKROE-4769



ISM RX 3 Click

Based on the MAX41470, a sub-GHz ISM RF receiver from Analog Devices.

MSRP - \$11⁰⁰
MIKROE-4828



GNSS 8 Click

Based on the LC79DA, a dual-band and multi-constellation GNSS module from Quectel.

MSRP - \$55⁰⁰
MIKROE-4673



NFC 4 Click

Based on the ST25R3916, a multi-purpose NFC transceiver from STMicroelectronics.

MSRP - \$21⁰⁰
MIKROE-4842



BLE 12 Click

Based on the BM832A, a BLE 0.5 module with Nordic's nRF52 SoC from Fanstel.

MSRP - \$22⁰⁰
MIKROE-4874



BT Audio 3 Click

Based on the BM83, a fully-certified Bluetooth 5.0 stereo audio module from Microchip.

MSRP - \$45⁰⁰
MIKROE-4947



GNSS 10 Click

Based on the NEO-M8J, a standard precision GNSS module built on the M8-GNSS engine from u-blox.

MSRP - \$57⁰⁰
MIKROE-5078



GPS 5 Click

Has the M20050-1, a GPS receiver with an integrated antenna and internal flash from Antenova.

MSRP - \$56⁰⁰
MIKROE-5298



XBee 2 Click

Based on the XB3-24ZBUM, an XBee® 3 ZigBee 3.0 transceiver module from Digi International.

MSRP - \$75⁰⁰
MIKROE-5302



XBee 3 Click

Based on the XB8X-DMUS-001, a Digi XBee® CE/RED certified RF module from Digi International.

MSRP - \$109⁰⁰
MIKROE-5299



GSM 5 Click

SARA-G450, a compact quad-band 2.5G GSM/GPRS module from u-blox.

MSRP - \$57⁰⁰
MIKROE-5124



LTE IoT 7 Click

Has the SARA-R422M8S, a multi-band LTE-M/NB-IoT/EGPRS multi-mode module from u-blox.

MSRP - \$85⁰⁰
MIKROE-5290



Wireless SUN Click

Has the BP35C5, a Wi-SUN FAN-compatible wireless module from Rohm Semiconductor.

MSRP - \$85⁰⁰
MIKROE-5338



4G LTE 2 Click-data

Has the LARA-R6001D, a data-only LTE Cat 1 module from u-blox.

MSRP - \$129⁰⁰
MIKROE-5236



4G LTE 2 Click-voice

Has the LARA-R6001, a data and voice LTE Cat 1 module from u-blox.

MSRP - \$139⁰⁰
MIKROE-5287



RTK Rover Click

Based on the LG69TAM-MD, a multi-constellation GNSS RTK rover module from Quectel.

MSRP - \$189⁰⁰
MIKROE-5440



RTK Base Click

Based on the LG-69TASMD, a multi-constellation GNSS RTK base module from Quectel.

MSRP - \$199⁰⁰
MIKROE-5442





GNSS RTK 2 Click

Features the ZED-F9R, a GNSS module with integrated RTK technology from u-blox.

MSRP - \$285⁰⁰
MIKROE-5430



LR IoT Click

This board features Semtech Corporation's LR1110.

MSRP - \$45⁰⁰
MIKROE-5447



LBAND RTK Click

Based on NEO-D9S-00B, satellite data receiver for L-band correction broadcast from u-blox.

MSRP - \$99⁰⁰
MIKROE-5411



GNSS 12 Click

With the CAM-M8C, a professional-grade GNSS module from u-blox.

MSRP - \$45⁰⁰
MIKROE-5527



NFC 3 Click

Carries the PN5180A0HN, high-performance full NFC Forum-compliant frontend from NXP.

MSRP - \$39⁰⁰
MIKROE-5538



GNSS 13 Click

With LG77LICMD, a global-region standard-precision GNSS module from Quectel.

MSRP - \$35⁰⁰
MIKROE-45580



IoT ExpressLink Click

Features the ESP32-C3-MINI-1-N4-A, WiFi and Bluetooth® module from Espressif.

MSRP - \$17⁰⁰
MIKROE-5800



ESP8684 Click

With ESP8684-MINI-1, a highly integrated WiFi, and a Bluetooth 5 module from Espressif.

MSRP - \$19⁰⁰
MIKROE-5803



NanoBeacon Click

Features the IN100, an ultra-low power Bluetooth 5.3 Beacon SoC from InPlay.

MSRP - \$11⁰⁰
MIKROE-5794



Nano GPS 3 Click

Features the ORG1511, a GPS/GNSS module with an integrated antenna from OriginGPS.

MSRP - \$49⁰⁰
MIKROE-5782



ANNA-B412 Click

Features the ANA-B412, a standalone Bluetooth 5.1 low-energy module from u-blox.

MSRP - \$29⁰⁰
MIKROE-5829



UWB 2 Click

Carries the DWM3000, an IEEE 802.15-z UWB transceiver module from Qorvo.

MSRP - \$46⁰⁰
MIKROE-5410



4G LTE 2 Click

Features the LTE Cat 1 module - LARA-R6001 from u-blox.

MSRP - \$139⁰⁰
MIKROE-5287



GNSS RTK 3 Click

Based on the LC29H, a dual-band, multi-constellation GNSS module from Quectel.

MSRP - \$85⁰⁰
MIKROE-5914



Wirepas Click

Features the WIRL-PRO2 Thetis-I, a radio module with Wirepas Mesh Protocol from Würth.

MSRP - \$55⁰⁰
MIKROE-5874



LTE IoT 11 Click

This board features the TX62-W, a global MTC module from Thales.

MSRP - \$69⁰⁰
MIKROE-5863



IoT ExpressLink 3 Click

Carries the NO-RA-W256WS, a standalone multi-radio module from u-blox.

MSRP - \$27⁰⁰
MIKROE-5891



GNSS 11 Click

Based on the EVA-M8M, a concurrent GNSS module from u-blox.

MSRP - \$45⁰⁰
MIKROE-5902



GNSS 6 Click

This board features the Teseo-LIV3FL, a tiny low-power GNSS module from STM.

MSRP - \$45⁰⁰
MIKROE-5638



IoT ExpressLink 2 Click

This board features the SARA-R510AWS, an LTE-M AWS IoT ExpressLink module from u-blox.

MSRP - \$109⁰⁰
MIKROE-5927





UWB 3 Click

Features the DWM3001, a fully integrated UWB transceiver module from Qorvo.

MSRP – \$69⁰⁰
MIKROE-5895



NeoMesh Click - 868MHz

Features the NC1000C-8, a wireless Mesh network module from NeoCortec.

MSRP – \$55⁰⁰
MIKROE-6006



NeoMesh Click - 915MHz

This board features the NC1000C-9, a wireless Mesh network module from NeoCortec.

MSRP – \$55⁰⁰
MIKROE-6007



NeoMesh 2 Click

Based on the NC2400, a wireless Mesh network module from NeoCortec.

MSRP – \$55⁰⁰
MIKROE-6008



LTE Cat.1 2 Click

Carries the ELS62-E, a single antenna LTE cat.1bis module from Thales.

MSRP – \$79⁰⁰
MIKROE-5906



LTE Cat.4 3 Click

Features LARA-L6004D-01B, an LTE Cat 4 module in the smallest form factor from u-blox.

MSRP – \$115⁰⁰
MIKROE-5991



NFC 6 Click

Based on the ST25R95, a near-field communication transceiver from STMicroelectronics.

MSRP – \$19⁰⁰
MIKROE-5935



GNSS 14 Click

Carries the MIA-M10Q, a standard precision GNSS module from u-blox.

MSRP – \$29⁰⁰
MIKROE-5995



GNSS 15 Click

Features the TESE0-VIC-3DA, an automotive GNSS dead-reckoning module from STM.

MSRP – \$49⁰⁰
MIKROE-5987



4G LTE&GNSS Click

Based on the LENA-R8, a multi-mode LTE Cat 1bis module from u-blox.

MSRP – \$135⁰⁰
MIKROE-5990



LR 9 Click

Features RA-08, a LoRaWAN module from Ai-Thinker Technology.

MSRP - \$30⁰⁰
MIKROE-6038



NFC 5 Click

Carries the ST25R3918, a multipurpose NFC transceiver from ST.

MSRP - \$29⁰⁰
MIKROE-6029



Mosaic Click

Features the Mosaic-X5, a compact GNSS receiver from Septentrio.

MSRP - \$650⁰⁰
MIKROE-6087



MICRF TX Click

Features the MICRF112, a high-performance RF transmitter IC from Microchip.

MSRP - \$18⁰⁰
MIKROE-6016



MICRF RX Click

Based on the MICRF220, an ASK/OOK 315MHz receiver from Microchip.

MSRP - \$18⁰⁰
MIKROE-5014



MICRF RX 2 Click

Carries the MICRF219A, an ASK/OOK 433MHz receiver with Auto-Poll and RSSI from Microchip.

MSRP - \$18⁰⁰
MIKROE-6015



M-BUS RF 2 Click

Based on the Metis-I (2605041183000), an 868MHz radio module from Würth.

MSRP - \$95⁰⁰
MIKROE-3303



GNSS 16 Click

Features the NEO-F10N-00B, a professional-grade L1/L5 dual-band GNSS receiver from u-blox.

MSRP - \$71⁰⁰
MIKROE-6129



LYRA 24P Click

Carries the LYRA 24P (453-00145R), a secure high-performance wireless module from Ezurio.

MSRP - \$35⁰⁰
MIKROE-6021



Thyone-I Click

Features the WIRL-PRO2 Thyone-I (2611011021000) module from Würth.

MSRP - \$59⁰⁰
MIKROE-6085





LTE Cat.1 3 Click - EU

This Click board is based on the EG91EXGA-128-SGNS, from Quectel.

MSRP - \$126⁰⁰
MIKROE-6152



LTE Cat.1 3 Click - NAM

Features the EG91EXGA-128-SGNS, from Quectel.

MSRP - \$145⁰⁰
MIKROE-6277



LTE Cat.1 3 Click - AUS

This board features the NC1000C-9, a wireless Mesh network module from NeoCortec.

MSRP - \$145⁰⁰
MIKROE-6278



GNSS 18 Click

Carries the SAM-M10Q, M10 standard precision GNSS module from u-blox.

MSRP - \$85⁰⁰
MIKROE-6127



BM78 Click

Features the BM78, a fully certified 2.4GHz BR/EDR/LE WiFi module from Microchip.

MSRP - \$47⁰⁰
MIKROE-6114



WIZF1360 Click

This board carries the WIZF1360, a WiFi module from WIZnet.

MSRP - \$25⁰⁰
MIKROE-6153



GNSS 17 Click

Features the M20071, an integrated full-function GNSS receiver module from Antenna.

MSRP - \$69⁰⁰
MIKROE-6176



UWB 4 Click

features the M20071, an integrated full-function GNSS receiver module from Antenna.

MSRP - \$85⁰⁰
MIKROE-6305



LTE Cat.4 Click - EU

Features the EG95EX-GA-128-SGNS, from Quectel.

MSRP - \$109⁰⁰
MIKROE-6256



LR 11 Click - 868MHz

Features the 453-00140R, an ultra-low power LoRaWAN module Ezurio.

MSRP - \$59⁰⁰
MIKROE-6316





LR 11 Click - 915MHz

Features the 453-00139R, an ultra-low power LoRaWAN module Ezurio.

MSRP - \$59⁰⁰
MIKROE-6333



B102C Click

Based on the B102C, a Bluetooth module from Amphenol.

MSRP - \$33⁰⁰
MIKROE-6088



LR 6 Click

Carries the Ra-01S, a LoRa™ wireless radio frequency module from Ai-Thinker.

MSRP - \$33⁰⁰
MIKROE-6112



WiFi NORA Click

Based on the NORA-W366-00B6-00B, a dual-band WiFi module with BLE from u-blox.

MSRP - \$55⁰⁰
MIKROE-6217



NINA-W152 Click

Based on the NINA-W152 multi-radio module from u-blox.

MSRP - \$49⁰⁰
MIKROE-6154



Calypso Click

Features the WIRL-WIFS Calypso WLAN module from Würth Elektronik.

MSRP - \$119⁰⁰
MIKROE-6274



M-BUS RF 3 Click

Based on the Metis-II an 868MHz radio module from Würth Elektronik.

MSRP - \$135⁰⁰
MIKROE-6084



GNSS MAX 2 Click

Carries the MAX-F10S, a professional-grade L1/L5 dual-band GNSS receiver from u-blox.

MSRP - \$65⁰⁰
MIKROE-6353



LTE IoT 12 Click

Features the BG95-M3 multi-mode data-only from Quectel.

MSRP - \$89⁰⁰
MIKROE-6311



CAN THE CLICK BOARDS™
GET EVEN BETTER?

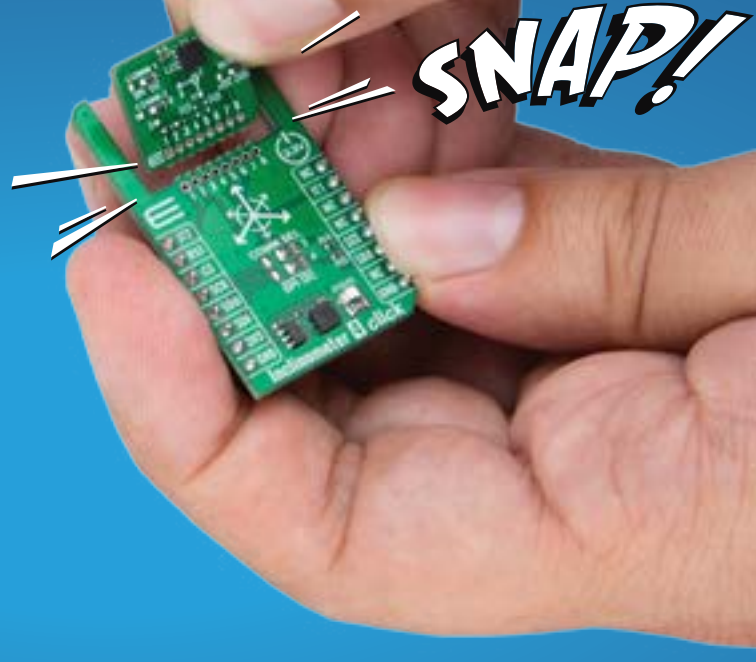

Click Snap

LOW-POWER,
SIZE REDUCTION AND
MORE **FLEXIBILITY**
FOR **FINAL PHASE PROTOTYPING**



Scan to learn more
about **Click Snap!**



DEVELOP PROJECT
ON A FULL SIZE BOARD



4x LESS
SPACE



SENSORS

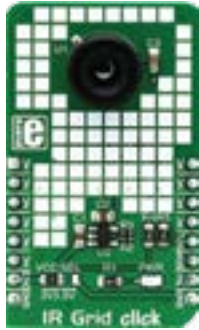

IR Grid Click

Equipped with the MLX90621BAD, a 16x4 IR array sensor, from Melexis.

MSRP - \$69⁰⁰
MIKROE-2622



Moisture Click

FDC2112 IC, a very precise 12bit capacitance to digital converter, from Texas Instruments.

MSRP - \$19⁰⁰
MIKROE-3084

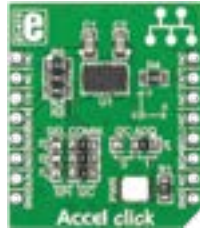

Accel Click

With ADXL345 3-axis accelerometer. 13-bit measurement, embedded FIFO technologies.

MSRP - \$19⁰⁰
MIKROE-1194



Accel 2 Click

LIS3DSH IC 3-axis accelerometer. Embedded FIFO buffer and 2 programmable state machines.

MSRP - \$19⁰⁰
MIKROE-1905



Accel 3 Click

H3LIS331DL 3-axis linear accelerometer. Dynamically selectable scales ±100g/±200g/±400g.

MSRP - \$21⁰⁰
MIKROE-2102



6DOF IMU 2 Click

With BMI160 low power IMU. For precise acceleration and gyroscopic measurement.

MSRP - \$24⁰⁰
MIKROE-2337



9DOF Click

LSM9DS1 inertial measurement module - 3D accelerometer, gyroscope and magnetometer.

MSRP - \$24⁰⁰
MIKROE-1941



Hydrogen Click

With MQ-8 sensor for hydrogen [H₂]. Sensor's detection range 100-10000ppm of H₂.

MSRP - \$15⁰⁰
MIKROE-1629



Angle 3 Click

With AK7451, a magnetic rotational angle sensor with 12-bit angle resolution.

MSRP - \$18⁰⁰
MIKROE-2755



Barometer Click

LPS25HB IC, piezoresistive absolute pressure sensor. Range 260-1260 hPa.

MSRP - \$15⁰⁰
MIKROE-1817





Opto Encoder Click

Uses the TCUT1600X01, a tall dome dual channel transmissive optical sensor from Vishay.

MSRP – \$9⁰⁰
MIKROE-2549



Ozone Click

Carries MiCS-2614, a compact MOS sensor for ozone [O3] detection.

MSRP – \$69⁰⁰
MIKROE-2355



LightRanger 8 Click

The VL53L3CX, a ToF ranging sensor with multi-target detection.

MSRP – \$12⁰⁰
MIKROE-4492



Diff Press Click

The MPXV7007DP, integrated monolithic differential pressure sensor from NXP .

MSRP – \$27⁰⁰
MIKROE-3332



GeoMagnetic Click

Measures the geomagnetic field in three perpendicular axes. The onboard sensor uses FlipCore from Bosch.

MSRP – \$15⁰⁰
MIKROE-2935



RTD Click

It is based on MAX31865 resistance to digital converter optimized for RTDs.

MSRP – \$19⁰⁰
MIKROE-2815



10DOF Click

With BN0055, a 9-axis absolute orientation sensor and BMP180, a digital pressure sensor.

MSRP – \$49⁰⁰
MIKROE-2073



3D Hall Click

With MLX90333 3-axis Hall sensor. Detects the position of any magnet in nearby space.

MSRP – \$25⁰⁰
MIKROE-1987



3D Motion Click

MM7150 9-axis sensor fusion motion module and SSC7150 motion coprocessor.

MSRP – \$59⁰⁰
MIKROE-1877



6DOF IMU Click

STM's LSM6DS33TR 6-axis IMU with 3-axis gyroscope and 3-axis accelerometer.

MSRP – \$49⁰⁰
MIKROE-1298





Air quality Click

MQ-135 sensor for detecting gases - ammonia, nitrogen oxides, benzene, smoke, CO2.

MSRP - \$16⁰⁰
MIKROE-1630



Air quality 2 Click

iQ-Core that measures VOC levels and provides CO2 equivalent and TVOC equivalent predictions.

MSRP - \$79⁰⁰
MIKROE-2529



Air quality 3 Click

Equipped with the CCS811, an ultra-low power digital gas sensor for monitoring the indoor air quality (IAQ).

MSRP - \$29⁰⁰
MIKROE-2953



Air quality 4 Click

An advanced air quality sensing device that combines multiple metal-oxide sensing elements on a chip.

MSRP - \$32⁰⁰
MIKROE-2896



Air quality 5 Click

MiCS-6814, a compact triple MOS sensor from SGX Sensortech, with 3 independent sensors.

MSRP - \$45⁰⁰
MIKROE-3056



Bi Hall Click

US2882 bipolar Hall-effect switch and a 74LVC1T45 single bit, dual supply transceiver.

MSRP - \$12⁰⁰
MIKROE-1646



CO Click

MQ-7 gas sensor with high sensitivity to carbon monoxide. Detection range 20ppm-2000ppm.

MSRP - \$16⁰⁰
MIKROE-1626



Color Click

With TCS3471 [RGBC] color light sensor and a RGB LED diode. Resolution up to 16-bits.

MSRP - \$15⁰⁰
MIKROE-1438



Color 2 Click

ISL29125 RGB color light sensor. 16-bit resolution data, measuring range 5.7 mlux-10,000 lux.

MSRP - \$16⁰⁰
MIKROE-1988



Color 3 Click

With TCS3771 color sensor and a narrow beam Infrared LED.

MSRP - \$17⁰⁰
MIKROE-2103





Compass Click

With LSM303DLHC ultra compact high performance e-compass module.

MSRP – \$25⁰⁰
MIKROE-1386



Compass 2 Click

With AK8963 3-axis elec. compass based on the Hall effect. 14-/16-bit selectable resolution.

MSRP – \$31⁰⁰
MIKROE-2264



Current Click

With INA196 current shunt monitor, MCP3201 12-bit ADC, MAX6106 voltage reference.

MSRP – \$35⁰⁰
MIKROE-1396



DHT22 Click

With DHT22 temp. and humidity measurement sensor. Hum. 0-100%, temp. -40 to +80° C.

MSRP – \$24⁰⁰
MIKROE-1798



Diff pressure Click

MPXV5010DP pressure sensor. Designed for comparing 2 pressure measurements.

MSRP – \$59⁰⁰
MIKROE-2387



EMG Click

Measures the electrical activity produced by the skeletal muscles.

MSRP – \$29⁰⁰
MIKROE-2621

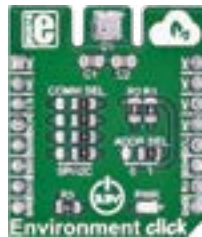

Environment Click

Measures temperature, relative humidity, pressure and Volatile Organic compounds gases.

MSRP – \$34⁰⁰
MIKROE-2467



Fever Click

Measures body temperature with MAX30205 sensor. Accuracy 0.1°C [37°C to 39°C].

MSRP – \$11⁰⁰
MIKROE-2554



FLAME Click

Used for fire detection. Carries PT334-6B silicon phototransistor sensitive only to infrared light.

MSRP – \$12⁰⁰
MIKROE-1820



Force Click

With Interlink Electronics' Force Sensing Resistors. Force sensitivity range 0.2N-20N.

MSRP – \$32⁰⁰
MIKROE-2065





Heart rate 3 Click

SFH7050 pulse oximetry and heart rate monitoring module, and AFE4404 IC for bio-sensing.

MSRP - \$39⁰⁰
MIKROE-2036



Heart rate 4 Click

Carrie the MAX30101 high-sensitivity pulse oximeter and heart-rate sensor.

MSRP - \$21⁰⁰
MIKROE-2510



Heart Rate 5 Click

Uses the top-of-the-class integrated BIOFY® SFH 7072 sensor from OSRAM.

MSRP - \$32⁰⁰
MIKROE-3012



Heart Rate 7 Click

The VEMD8080 photo-sensor. A high-speed PD element, with sensitivity in the visible light spectrum.

MSRP - \$23⁰⁰
MIKROE-2998



Illuminance Click

With TSL2561 light-to-digital converter. Two photodiodes: full-spectrum and infrared light.

MSRP - \$21⁰⁰
MIKROE-1688



IR Sense Click

With AK9750 quantum-type IR sensor. Detects the temperature of objects and people in motion.

MSRP - \$27⁰⁰
MIKROE-2677



IrThermo Click 3.3V

With MLX90614ESF-BAA IR thermometer module, factory calibrated in wide temp. range.

MSRP - \$29⁰⁰
MIKROE-1361



Proximity 2 Click

With MAX44000, an IC that integrates an ambient light and a proximity sensor. Range 0.03-65.535 lux.

MSRP - \$19⁰⁰
MIKROE-1818

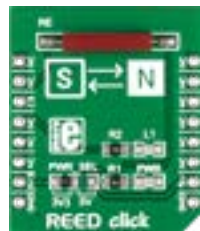

REED Click

With a standard reed switch. Used in mechanical systems as proximity sensors.

MSRP - \$7⁰⁰
MIKROE-1998



RF Meter Click

It's an RF power measurement device. Frequency span 1 MHz-8 GHz, over 60 dB range.

MSRP - \$44⁰⁰
MIKROE-2034





Earthquake Click

It carries D7S, the world's smallest high-precision seismic sensor from Omron.

MSRP - \$69⁰⁰
MIKROE-2561



ECG Click

It measures the electrical activity of a beating heart through electrodes taped to the skin.

MSRP - \$39⁰⁰
MIKROE-2455



ECG 2 Click

Tracks the patterns of your beating heart. It carries ADS1194 16-bit delta-sigma ADC.

MSRP - \$49⁰⁰
MIKROE-2507



HDC1000 Click

It's a humidity (and temperature) measurement Click carrying the HDC1000 sensor.

MSRP - \$19⁰⁰
MIKROE-1797

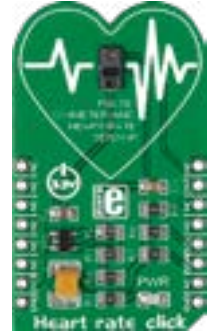

Heart rate Click

With Maxim's MAX30100 integrated pulse oximetry and heart-rate sensor.

MSRP - \$19⁰⁰
MIKROE-2000

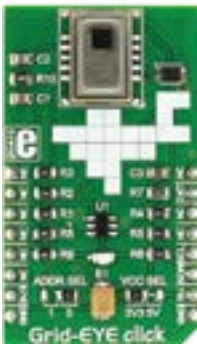

Grid-EYE Click

8x8 thermal array sensor-detector that carries AMG8853 infrared array sensor.

MSRP - \$100⁰⁰
MIKROE-2539



GYRO Click

L3GD20 3-axis digital gyroscope module - can measure angular rate and ambient temperature.

MSRP - \$25⁰⁰
MIKROE-1379



Hall current Click

High precision current sensor with TL4970-D050T4, a magnetic current sensor.

MSRP - \$34⁰⁰
MIKROE-1578

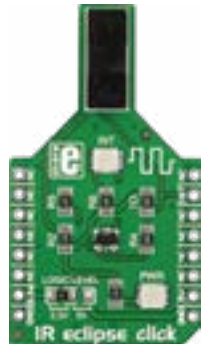

IR eclipse Click

With EE-SX198 photo interrupter sensor - detects anything that obstructs its beam.

MSRP - \$15⁰⁰
MIKROE-1711



IR reflect Click

Carries GP2S700HCP reflective photo interrupter and an onboard potentiometer.

MSRP - \$12⁰⁰
MIKROE-1882



LightHz Click

With TSL230BR converter for conversion of light intensity to frequency with no external components.

MSRP – \$17⁰⁰
MIKROE-990



LightRanger Click

It's a proximity sensor carrying VL6180X IC. Also works as an ambient light sensor.

MSRP – \$24⁰⁰
MIKROE-1897



LightRanger 2 Click

With VL53LOX IC, the world's smallest Time-of-Flight ranging and gesture detector sensor.

MSRP – \$24⁰⁰
MIKROE-2509



LIN HALL Click

Carries MLX90242 linear Hall sensor IC. Measures magnet's strength and distance.

MSRP – \$17⁰⁰
MIKROE-1648



Manometer 2 Click

With MS5525D-S0-SB001GS digital pressure sensor. 24-bit digital pressure and temp. value.

MSRP – \$45⁰⁰
MIKROE-2550



LSM6DSL Click

Measures linear and angular velocity with six degrees of freedom. Carries LSM6DSL module.

MSRP – \$15⁰⁰
MIKROE-2731



MAGNETO Click

Carries AS5048A contactless magnetic angle position sensor that relies on the Hall Effect.

MSRP – \$36⁰⁰
MIKROE-1886



MAGNETO 2 Click

Enables the design of non-contacting rotary position sensors with MLX90316 sensor IC.

MSRP – \$29⁰⁰
MIKROE-1938



Manometer Click

Carries a piezoresistive silicon pressure sensor with extremely high accuracy ($\pm 0.25\%FSS$ BFSL).

MSRP – \$115⁰⁰
MIKROE-2237



Barcode Click

The LV3296, a compact integrated barcode scanner from Rakinda company.

MSRP – \$199⁰⁰
MIKROE-2913



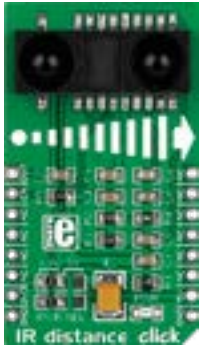

IR distance Click

With GP2Y0A60SZ0F distance measuring sensor. Measuring range 10-150 cm.

MSRP - \$25⁰⁰
MIKROE-1991



IrThermo Click 5V

With MLX90614ESF-AAA IR thermometer module, factory calibrated in wide temperature range.

MSRP - \$29⁰⁰
MIKROE-1362



IrThermo 2 Click

It is a non-contact temperature measurement solution, with an infrared thermopile sensor.

MSRP - \$20⁰⁰
MIKROE-1888



LDC1000 Click

With ind-to-digi. converter IC and a detachable inductive sensing.

MSRP - \$35⁰⁰
MIKROE-1583



Light Click

Used to measure ambient light intensity, with PD15-22CTR8 PIN photodiode.

MSRP - \$18⁰⁰
MIKROE-1424



Shake2Wake Click

With ADXL362 ultralow power, 3-axis MEMS accelerometer. Includes several activity detection modes.

MSRP - \$39⁰⁰
MIKROE-1942

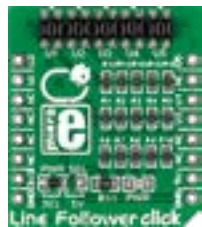

Line Follower Click

With five QRE1113 miniature reflective object sensors. Used for line following robots and cars.

MSRP - \$15⁰⁰
MIKROE-1999



LPG Click

With MQ-5 sensor for detecting liquefied petroleum gas leakage. Detection range 200-10000 ppm.

MSRP - \$15⁰⁰
MIKROE-1587

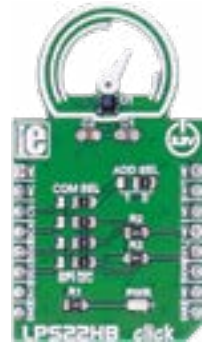

LPS22HB Click

Used as a digital barometer. It carries the LPS22HB MEMS nano pressure sensor.

MSRP - \$15⁰⁰
MIKROE-2665

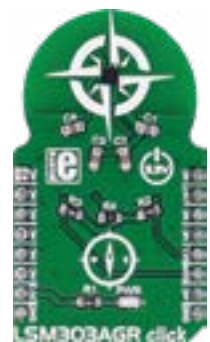

LSM303AGR Click

Measures acceleration and magnetic field characteristics. Carries LSM303AGR module.

MSRP - \$18⁰⁰
MIKROE-2684





Methane Click

With MQ-4 sensor for methane [CH4]. Detection range 200-10000ppm of CH4.

MSRP - \$15⁰⁰
MIKROE-1628



MOTION Click

It's a motion detector sensitive only to live bodies with PIR500B, a pyroelectric sensor.

MSRP - \$13⁰⁰
MIKROE-1589



MPU IMU Click

Carries MPU-6000 integrated 6-axis motion tracking device and a DMP [Digital Motion Processor].

MSRP - \$39⁰⁰
MIKROE-1577



Spectral Click

Uses the AS7261, an XYZ chromatic white color sensor + NIR with electronic shutter and smart interface.

MSRP - \$26⁰⁰
MIKROE-2972



Spectral 2 Click

Uses the AS7262, 6 channel visible spectral_ID device with electronic shutter and smart Interface.

MSRP - \$26⁰⁰
MIKROE-2973



MPU 9DOF Click

Carries the MPU-9150 system in package, the world's first 9-axis motion tracking device.

MSRP - \$31⁰⁰
MIKROE-1719



Ozone 2 Click

With MQ131 sensor for Ozone [O3]. Detection range 10-1000 ppm of O3.

MSRP - \$45⁰⁰
MIKROE-2767



Pollution Click

Detects organic gases - formaldehyde, benzene, alcohol, toluene, etc. Detection range 1x50ppm.

MSRP - \$49⁰⁰
MIKROE-2516



Pressure Click

With LPS331AP digital output pressure sensor. For pressure [260-1260 mbar] and temp. [-40°C to 80°C].

MSRP - \$25⁰⁰
MIKROE-1422



Pressure 2 Click

With MS5803, a high resolution MEMS pressure sensor. Range 0-14 bars, resolution up to 0.2 mbars.

MSRP - \$69⁰⁰
MIKROE-1880





Spectral 3 Click

Uses the AS7263, a 6 channel NIR Spectral_ID device with electronic shutter and smart Interface.

MSRP - \$26⁰⁰
MIKROE-2961



IR Sense 2 Click

Uses the AK9752, an ultra-small infrared sensor IC, with an I2C interface, from AKM.

MSRP - \$21⁰⁰
MIKROE-2966



SHT Click

Temperature and humidity sensor SHT3x-DIS. -0 to 100% RH, 40 to 125°C temp. range.

MSRP - \$26⁰⁰
MIKROE-2101

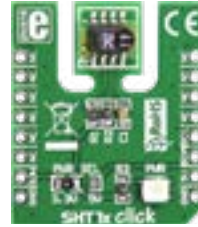

SHT1x Click

Digital humidity and temperature sensor SHT11. Not recommended for newer designs.

MSRP - \$13⁰⁰
MIKROE-949



Smoke Click

With MAX30105 optical sensor for smoke detection. Sensor's inherent resolution 0.0625°C.

MSRP - \$19⁰⁰
MIKROE-2560



Pressure 3 Click

With DPS310 digital barometric pressure sensor. Range 300-1200 hPa.

MSRP - \$20⁰⁰
MIKROE-2293



Proximity Click

With VCNL4010 proximity and ambient light sensor. Range up to 20cm, 16-bit resolution.

MSRP - \$17⁰⁰
MIKROE-1445



THERMO 4 Click

It carries digital temperature sensor and thermal watchdog. Range from -55 °C to +125 °C.

MSRP - \$9⁰⁰
MIKROE-2632



THERMO 5 Click

Measures temperature in default range of 0°C to 127°C and extended range of -64°C to 191°C.

MSRP - \$11⁰⁰
MIKROE-2571



Thermo 6 Click

Ambient temp. measurement device, based on the MAX31875 temp. sensor.

MSRP - \$9⁰⁰
MIKROE-2769





Stretch Click

Measures stretch forces with conductive rubber cord - 40-160 ohms per cm resistance.

MSRP - \$56⁰⁰
MIKROE-2064

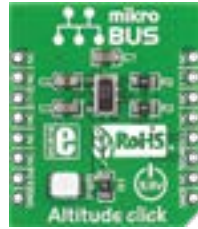

Altitude Click

MEMS pressure sensor MPL3115A2. Pressure/altitude (20-bit) and temp. (12-bit) data.

MSRP - \$14⁰⁰
MIKROE-1489



THERMO Click

With MAX31855K thermocouple-to-digital converter and PCC-SMP K-type thermocouple connector.

MSRP - \$29⁰⁰
MIKROE-1197

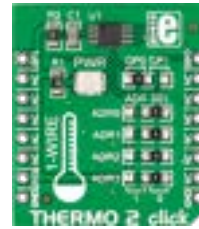

THERMO 2 Click

With DS1825, a digital thermometer IC with a unique 64-bit address. -10°C to 85°C, ±0.5°C accuracy.

MSRP - \$15⁰⁰
MIKROE-1840



Thermo 3 Click

With TMP102, a digital temp. sensor IC. Accurate within 0.5°C. Range from -25°C to 85°C.

MSRP - \$9⁰⁰
MIKROE-1885



THERMO K Click

It carries the MCP9600 IC. It can measure temperatures from -200 °C to +1372 °C.

MSRP - \$24⁰⁰
MIKROE-2501



HTU21D Click

Carries a relative humidity sensor with temperature output. Rel. hum. 0-100%, temp. -40 to +125° C.

MSRP - \$21⁰⁰
MIKROE-1687



ProxFusion Click

A multifunctional capacitive and Hall-effect sensor device. Carries the IQS624, a combined multi-sensor IC.

MSRP - \$9⁰⁰
MIKROE-2920



Hall Switch Click

Uses the AH1389, an ultra-sensitive dual output unipolar Hall Effect switch, from Diodes Incorporated.

MSRP - \$18⁰⁰
MIKROE-2985



Thermo 7 Click

Uses the MCP9800, a high accuracy temperature sensor IC with the 2-Wire interface, from Microchip.

MSRP - \$9⁰⁰
MIKROE-2979





Thermostat Click

It carries MAX7502 IC that can measure temp. from -25°C to +100°C. Accuracy ±1.5°C.

MSRP - \$19⁰⁰
MIKROE-2273

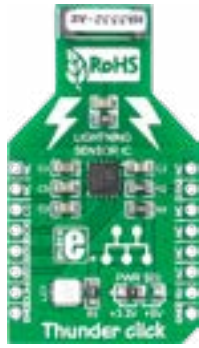

Thunder Click

Detects the presence and proximity of lightning activity with AS3935 lightning sensor.

MSRP - \$35⁰⁰
MIKROE-1444



Tilt Click

With RPL-1035, a 4-directional optical tilt sensor - left, right, backward, forward movement.

MSRP - \$12⁰⁰
MIKROE-1834



TILTnSHAKE Click

With MMA8491Q IC, a 3-axis digital accelerometer. Can function as a 45 ° tilt sensor.

MSRP - \$19⁰⁰
MIKROE-1853



UNI HALL Click

With US5881 unipolar Hall-effect switch sensitive to the North Pole magnetic fields.

MSRP - \$12⁰⁰
MIKROE-1647



Vibra sense Click

A micro shock vibration sensor with a digital output. For anti-tampering, anti-theft devices.

MSRP - \$18⁰⁰
MIKROE-1927



Water Detect Click

For detecting water and other electroconductive liquids. Carries Microchip's MCP606.

MSRP - \$9⁰⁰
MIKROE-2786



Weather Click

With BME280 integrated environmental unit. Detects humidity, pressure, and temperature.

MSRP - \$22⁰⁰
MIKROE-1978



Angle Click

Hall-effect angle sensing device used to measure the rotational angle of the magnetic field.

MSRP - \$16⁰⁰
MIKROE-2030



Thermo J Click

It is a temperature measurement Click board™, which uses a thermocouple type-J probe.

MSRP - \$24⁰⁰
MIKROE-2911

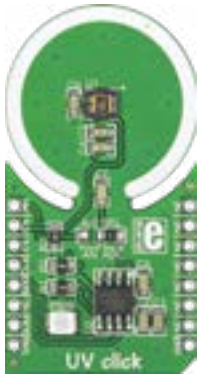

UV Click

With ML8511 IC that is sensitive to UVA and UVB rays. Outputs either analog or digital signals.

MSRP - \$24⁰⁰
MIKROE-1677

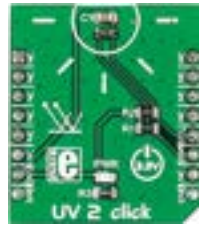

UV 2 Click

Carries VEML6075 UVA and UVB light sensor. With a photodiode, amplifiers, analog/digital circuits.

MSRP - \$19⁰⁰
MIKROE-2378



UV 3 Click

An advanced ultraviolet [UV] light sensor with VEML6070 UVA light sensor.

MSRP - \$9⁰⁰
MIKROE-2736



Proximity 5 Click

Features the VCN-L4035X01 J, a fully integrated proximity and ambient light sensor.

MSRP - \$15⁰⁰
MIKROE-2984

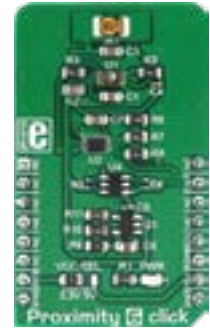

Proximity 6 Click

Uses the ADUX1020, a photometric sensor for gesture and proximity detection.

MSRP - \$29⁰⁰
MIKROE-3048



DHT22 2 Click

It is used for measuring the environmental temperature and relative humidity.

MSRP - \$22⁰⁰
MIKROE-2818



IrDA 3 Click

Intelligent IR transceiver device that sends and receives UART commands via the IR interface.

MSRP - \$26⁰⁰
MIKROE-2871



Microwave Click

It detects movement, thanks to the PD-V11 a 24GHz microwave motion sensor.

MSRP - \$25⁰⁰
MIKROE-2781



Proximity 3 Click

Intelligent proximity and light sensing device - high sensitivity long distance PS and ALS.

MSRP - \$17⁰⁰
MIKROE-2801



Alcohol Click

Detects alcohol in concentrations from 0.04 to 4mg/l with Q-3 Semi-conductor sensor.

MSRP - \$15⁰⁰
MIKROE-1586





Hall current 2 Click

A Hall effect linear current sensor with over-current fault output for less than 100 V Isolation App.

MSRP - \$18⁰⁰
MIKROE-2987



UV 4 Click

Equipped with the Si1133, a UV index and ambient light sensor with I2C Interface, from Silicon Labs.

MSRP - \$15⁰⁰
MIKROE-2989



Temp&Hum Click

With HTS221 temp. and relative humidity sensor. Measurement accuracy is $\pm 1^{\circ}\text{C}$ in 0-60 $^{\circ}\text{C}$ range.

MSRP - \$16⁰⁰
MIKROE-1971



Temp&Hum 2 Click

Uses the Si7034, a digital humidity and temperature sensor IC with I2C interface, from Silicon Labs.

MSRP - \$16⁰⁰
MIKROE-3085



Temp-Hum 3 Click

Uses the HDC2010, a Low Power Humidity and Temperature Digital Sensor from Texas Instruments.

MSRP - \$13⁰⁰
MIKROE-2937

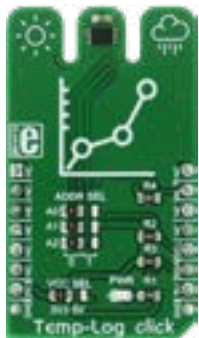

Temp-Log Click

A precise ambient temp. measurement device, with 8Kbit [1024 bytes] of EEPROM memory.

MSRP - \$15⁰⁰
MIKROE-2886



Temp-Log 2 Click

A precise ambient temp. measurement device, with the non-volatile [EEPROM] memory.

MSRP - \$15⁰⁰
MIKROE-3004

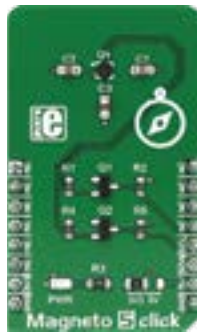

Magneto 5 Click

Features the MEMSIC MMC34160PJ, a 3-axis magnetic sensor IC.

MSRP - \$15⁰⁰
MIKROE-3050



Color 6 Click

Features the AS73211, an XYZ true color sensor from AMS.

MSRP - \$44⁰⁰
MIKROE-3061



Color 7 Click

Features the TCS3472 color light to digital converter with IR filter, from AMS.

MSRP - \$16⁰⁰
MIKROE-3062





Vacuum Click

With the monolithic vacuum sensor the MPXV6115V, it measures pressure values down to -115kPa.

MSRP - \$43⁰⁰
MIKROE-3195



Ambient 4 Click

Uses the BH1721FVC, a 16-bit digital light sensor with the I2C serial interface.

MSRP - \$16⁰⁰
MIKROE-3199



3D HALL 5 Click

Carries the IIS2MDC-TR, a low power 3D magnetic sensor.

MSRP - \$15⁰⁰
MIKROE-3197



Color 8 Click

Features the ROHM's BH1749NUC, an integrated color sensor IC.

MSRP - \$15⁰⁰
MIKROE-3213



Accel 7 Click

Features the KXTJ3-1057 14-bit tri-axis digital accelerometer from Kionix.

MSRP - \$13⁰⁰
MIKROE-3244



ECG 3 Click

Uses the MAX30003 IC, an ultra-low power, single channel, integrated biopotential AFE.

MSRP - \$45⁰⁰
MIKROE-3273



Gyro 2 Click

It is equipped with the FXAS21002C, a three-axis integrated angular rate gyroscope.

MSRP - \$18⁰⁰
MIKROE-3300



Heart rate 6 Click

With two green LEDs, driven by the BH1790GLC, a monolithic integrated sensor for heart rate monitoring.

MSRP - \$25⁰⁰
MIKROE-3215



IR Grid 3 Click

Equipped with the MLX90640-BAA, a 32x24 IR array sensor, from Melexis.

MSRP - \$87⁰⁰
MIKROE-3217



Ambient 2 Click

TI's OPT3001 ambient light sensor. Measures the visible part of the light spectrum.

MSRP - \$14⁰⁰
MIKROE-1903





Gaussmeter Click

The MLX90393, a micro-power magnetometer based on the proprietary Triaxis® technology.

MSRP – \$19⁰⁰
MIKROE-3099



Oximeter Click

The ADPD105, a highly configurable photometric front end (AFE) device from Analog Devices.

MSRP – \$39⁰⁰
MIKROE-3102



LightRanger 3 Click

Uses the Simblee™ enabled RFD77402 ToF sensor module from RF Digital.

MSRP – \$24⁰⁰
MIKROE-3103

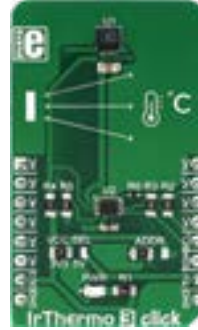

IrThermo 3 Click

Uses the MLX90632 FIR sensor from Melexis as the contactless temperature sensor.

MSRP – \$27⁰⁰
MIKROE-3121



CO 2 Click

With the SPEC amperometric, 3SP CO 1000 gas sensor which electrochemically reacts with the [CO].

MSRP – \$59⁰⁰
MIKROE-3196



Accel 5 Click

Features an ultra-low power triaxial accelerometer sensor, labeled as the BMA400.

MSRP – \$19⁰⁰
MIKROE-3149

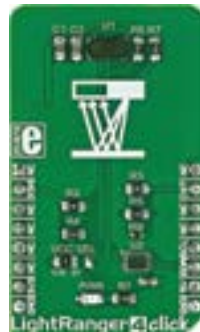

LightRanger 4 Click

Measures an accurate distance based on a ToF with VL53L1X rangefinder module.

MSRP – \$24⁰⁰
MIKROE-3176



Load cell Click

With the HX711, a 24bit analog to digital converter (ADC), for weight scale applications.

MSRP – \$12⁰⁰
MIKROE-3168

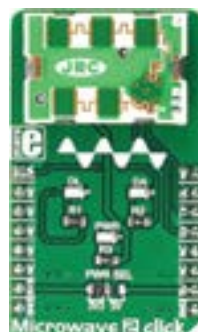

Microwave 2 Click

Detects movement by utilizing the NJR4265RF2C1, an intelligent 24GHz microwave motion sensor.

MSRP – \$55⁰⁰
MIKROE-3187



3D Hall 2 Click

Measures the magnetic field in three perpendicular axes. With the TLV493D-A1B6, a 3D magnetic sensor.

MSRP – \$15⁰⁰
MIKROE-3190



Alcohol 3 Click

Equipped with the MiCS-5524, a compact metal oxide [MOS] sensor.

MSRP – \$32⁰⁰
MIKROE-3318



Altitude 3 Click

Allows high-resolution barometric pressure measurement with the ICP-10100 sensor.

MSRP – \$15⁰⁰
MIKROE-3328

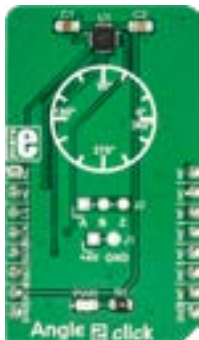

Angle 2 Click

A magnetic rotational sensor which relies on the ultra-fast MA700 angular sensor IC.

MSRP – \$16⁰⁰
MIKROE-2338



Alcohol 2 Click

The LMP91000, a high-precision integrated analog front-end IC [AFE].

MSRP – \$67⁰⁰
MIKROE-3097



NO2 Click

The 3SP-NO2-20 gas sensor from SPEC Sensors, which can sense NO2 concentration up to 20ppm.

MSRP – \$72⁰⁰
MIKROE-3098

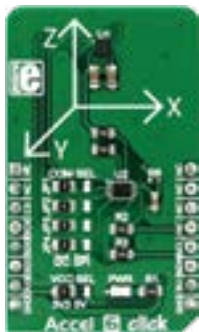

Accel 6 Click

The BMA280, a 14bit triaxial acceleration sensor with intelligent on-chip motion triggered interrupt controller.

MSRP – \$17⁰⁰
MIKROE-3075

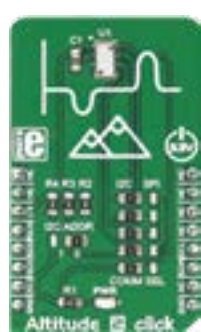

Altitude 2 Click

Uses the MS5607-Q2BA03, a barometric pressure sensor IC with the stainless steel cap.

MSRP – \$15⁰⁰
MIKROE-3030



Pressure 4 Click

Features the BMP280, a digital pressure sensor, from Bosch Sensortech.

MSRP – \$18⁰⁰
MIKROE-3020



NDIR CO2 Click

Uses the CDM7160 integrated sensor and measures an absolute CO2 concentration.

MSRP – \$149⁰⁰
MIKROE-3134



Hall Current 3 Click

Uses Hall effect to provide a precise and reliable measurement of reasonably high current.

MSRP – \$19⁰⁰
MIKROE-3116





Temp&Hum 10 Click

The BPS230, a relative humidity and temperature sensor with I²C Interface, by Bourns.

MSRP - \$16⁰⁰
MIKROE-3342



Temp&Hum 11 Click

The HDC1080, a low power humidity and temperature digital sensor from TI.

MSRP - \$13⁰⁰
MIKROE-3469



Temp&Hum 12 Click

The HDC2080, a Low Power Humidity and Temperature Digital Sensor from TI.

MSRP - \$21⁰⁰
MIKROE-3436



Temp&Hum 13 Click

The HTU21DF, a digital relative humidity sensor with temp. output from TE connectivity.

MSRP - \$12⁰⁰
MIKROE-3635



Pressure 6 Click

Allows readings in the range from 300hPa up to 1300hPa, with the BM1386GLV sensor.

MSRP - \$18⁰⁰
MIKROE-3216



LDC 1101 Click

With the LDC1101, the integrated, high-res, high-speed, inductance-to-digital converter.

MSRP - \$29⁰⁰
MIKROE-3240



Magnetic linear Click

Which utilizes the HMC1501, a magnetic field displacement sensor IC.

MSRP - \$18⁰⁰
MIKROE-3274



Magnetic rotary Click

Which utilizes the HMC1512, a magnetic field displacement sensor IC.

MSRP - \$24⁰⁰
MIKROE-3275

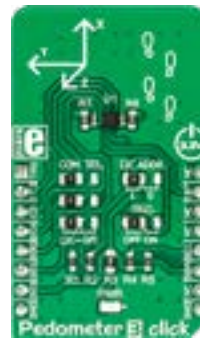

Pedometer 3 Click

Equipped with the KX126-1063, an advanced tri-axis acceleration sensor IC.

MSRP - \$13⁰⁰
MIKROE-3259



Hall Current 4 Click

Designed to measure relatively high current by the integrated ACS70331 sensor.

MSRP - \$18⁰⁰
MIKROE-3308



Angle 4 Click

With the AEAT-8800-Q24, an integrated 10 to 16-bit programmable angular magnetic encoder.

MSRP - \$26⁰⁰
MIKROE-3130



Thermo 15 Click

The NCT75, a high accuracy temp. sensor IC with the 2-Wire interface, from ON Semiconductor.

MSRP - \$9⁰⁰
MIKROE-3658



Thermo 16 Click

The TMP235, a high accuracy temperature sensor IC Texas Instruments.

MSRP - \$9⁰⁰
MIKROE-3662



Temp&Hum 5 Click

The HIH6130, a relative humidity and temp. sensor with I²C Interface, by Honeywell.

MSRP - \$28⁰⁰
MIKROE-3425

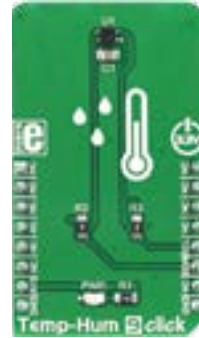

Temp&Hum 9 Click

The SHTC3, a relative humidity and temp. sensor with I²C Interface, by Sensirion.

MSRP - \$13⁰⁰
MIKROE-3331

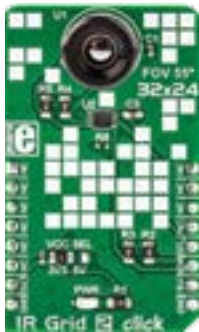

IR Grid 2 Click

It is equipped with the MLX90640, a 32x24 IR array sensor which contains 8 Kbit EEPROM.

MSRP - \$75⁰⁰
MIKROE-3194



MAGNETO 4 Click

The AS5311, a high resolution magnetic linear encoder by ams.

MSRP - \$30⁰⁰
MIKROE-3522



MAGNETO 7 Click

The BM1422AGMV, a 3-axis magnetic sensor IC from ROHM Semiconductor.

MSRP - \$17⁰⁰
MIKROE-3657



3D Hall 3 Click

The LIS2MDL, a low power 3D magnetic sensor, from STMicroelectronics.

MSRP - \$15⁰⁰
MIKROE-3310



3D Hall 7 Click

The AK09970N, a low power 3D magnetic sensor, from AsahiKASEI [AKM].

MSRP - \$17⁰⁰
MIKROE-3629



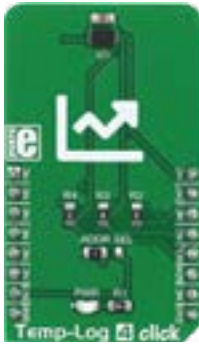

Temp-Log 4 Click

Featuring the SE97B IC, an accurate temperature sensor IC with integrated EEPROM.

MSRP - \$12⁰⁰
MIKROE-3329



Ultrasonic 2 Click

Equipped with the PGA460, a highly-integrated system-on-chip (SoC), based on SONAR principle.

MSRP - \$44⁰⁰
MIKROE-3302



Proximity 9 Click

The VCNL4040, a fully integrated proximity and ambient light sensor from Vishay Semiconductors.

MSRP - \$9⁰⁰
MIKROE-3465



Smart DOF Click

The BN0080, a System in Package (SiP) sensor produced by Hillcrest Labs.

MSRP - \$53⁰⁰
MIKROE-3457



6DOF IMU 4 Click

The ICM-20602, a 6-axis MEMS Motion-Tracking™ IC from TDK Invensense.

MSRP - \$22⁰⁰
MIKROE-3410



Thermo 11 Click

The TMP117, a high accuracy temp. sensor IC with the 2-Wire interface, from TI.

MSRP - \$12⁰⁰
MIKROE-3600



Color 5 Click

Features the P12347-01CT, a color and proximity sensor from Hamamatsu company.

MSRP - \$16⁰⁰
MIKROE-3107



Hall Current 6 Click

The ACS723(LLCTR-05AB-T), a high-accuracy, galvanically isolated current sensor IC, from Allegro Microsystems.

MSRP - \$23⁰⁰
MIKROE-3443



Temp-Log 5 Click

Equipped with the CAT34TS02 sensor from ON semiconductor.

MSRP - \$12⁰⁰
MIKROE-3442

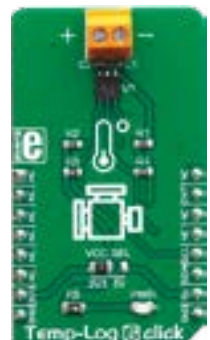

Temp-Log 6 Click

The MAX6642, a ±1°C, SMBus/I2C compatible local/remote temp. sensor by Maxim Integrated.

MSRP - \$14⁰⁰
MIKROE-3437



Temp&Hum 6 Click

With the ENS210 sensor. An ultra-accurate temperature and relative humidity sensor (RH).

MSRP - \$12⁰⁰
MIKROE-3270



Temp&Hum 7 Click

Equipped with the Si7021-A20, an accurate and reliable sensor IC.

MSRP - \$16⁰⁰
MIKROE-3272

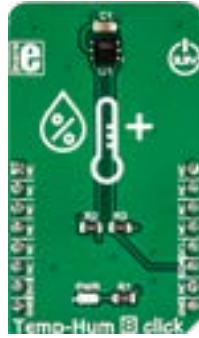

Temp&Hum 8 Click

Based on a sensor from the popular SHT family, designed to measure temperature and humidity.

MSRP - \$25⁰⁰
MIKROE-3263



Tilt 2 Click

Equipped with the RB-441-45, a 45° rolling ball sensor switch.

MSRP - \$13⁰⁰
MIKROE-3343



Temp-Log 3 Click

Featuring the MCP9843 IC, an accurate temperature sensor IC with integrated EEPROM.

MSRP - \$12⁰⁰
MIKROE-3326



Pressure 7 Click

Features an digital barometric pressure and temperature sensor labeled as MS5837.

MSRP - \$49⁰⁰
MIKROE-3246



Remote Temp Click

The EMC1833 from Microchip, a specifically designed IC, measuring remote temperature.

MSRP - \$15⁰⁰
MIKROE-3665



Gyro 3 Click

With the I3G4250, a three-axis digital gyroscope.

MSRP - \$25⁰⁰
MIKROE-3449



Gyro 4 Click

A two-axis MEMS gyroscope for optical image stabilization app. with the L20G20IS.

MSRP - \$15⁰⁰
MIKROE-3661



Gyro 5 Click

Equipped with the ITG-3701, a three-axis digital gyroscope.

MSRP - \$20⁰⁰
MIKROE-3669





Ambient 3 Click

The AS7225, a calibrated XYZ chromatic smart lighting director from ams AG.

MSRP - \$25⁰⁰
MIKROE-3686

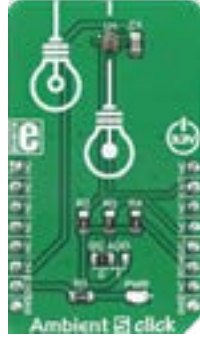

Ambient 5 Click

The VEML6030, a high accuracy ambient light sensor (ALS), from Vishay Semiconductors.

MSRP - \$11⁰⁰
MIKROE-3320



Ambient 6 Click

The ASS311, a high resolution magnetic linear encoder by ams.

MSRP - \$9⁰⁰
MIKROE-3444



Ambient 7 Click

The SFH 5701 A01, an accurate light-intensity sensor from Osram Opto Semiconductors.

MSRP - \$9⁰⁰
MIKROE-3601

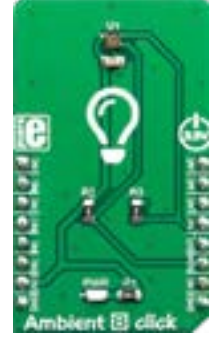

Ambient 8 Click

The LTR-329ALS-01, a high accuracy ambient light sensor (ALS) from LiteOn.

MSRP - \$9⁰⁰
MIKROE-3452



Pressure 5 Click

The BMP388, a digital pressure sensor, from Bosch Sensortech.

MSRP - \$14⁰⁰
MIKROE-3566



Pressure 8 Click

The MPRLS0025PA00001A, an accurate compensated pressure sensor, by Honeywell.

MSRP - \$21⁰⁰
MIKROE-3338



Pressure 9 Click

The DPS422, a digital barometric air pressure sensor, by Infineon.

MSRP - \$15⁰⁰
MIKROE-3441



Pressure 11 Click

The LPS33HW, digital output barometer IC in water-resistant package, from STMicroelectronics.

MSRP - \$24⁰⁰
MIKROE-3411



Pressure 12 Click

The ABP series gauge pressure sensor ABPLLNN600MGAA3, made by Honeywell.

MSRP - \$36⁰⁰
MIKROE-3466





6DOF IMU 8 Click

The ISM330DLC, a 3D accel. and 3D gyro. with digital output for industrial applications, by ST.

MSRP - \$21⁰⁰
MIKROE-3447



EEG Click

The INA114, a precision instrumentation amplifier (IA) by Burr Brown®, a division of TI.

MSRP - \$46⁰⁰
MIKROE-3359



ECG 4 Click

The BMD101, specialized bio-signal sensing System-on-Chip (SoC), from NeuroSky.

MSRP - \$35⁰⁰
MIKROE-3427



ECG 5 Click

The AD8232, an integrated heart rate monitoring front-end, by Analog Devices.

MSRP - \$35⁰⁰
MIKROE-3446



Hall current 5 Click

The ACS733(KLATR-AU), a Hall effect linear current sensor from Allegro Microsystems.

MSRP - \$18⁰⁰
MIKROE-3393



Thermostat 2 Click

The G6D series PCB power relay, from Omron.

MSRP - \$15⁰⁰
MIKROE-3415



Opto Encoder 2 Click

The AK09970N, a low power 3D magnetic sensor, from AsahiKASEI [AKM].

MSRP - \$26⁰⁰
MIKROE-3634



Barometer 2 Click

The LPS35HW, an absolute digital output barometer IC in water-resistant package.

MSRP - \$15⁰⁰
MIKROE-3603



Pedometer Click

Contains the STP201M module, made by NiceRF.

MSRP - \$16⁰⁰
MIKROE-3567



IR Sense 3 Click

The AK9754, an ultra-small infrared sensor IC, with an I2C interface, from AKM.

MSRP - \$21⁰⁰
MIKROE-3607





3D Hall 6 Click

With the MLX90380, a monolithic contactless sensor IC module.

MSRP - \$34⁰⁰
MIKROE-3310



6DOF IMU 7 Click

The ICM-20649, a high-performance, 6-axis MEMS MotionTracking™ IC from TDK InvenSense.

MSRP - \$23⁰⁰
MIKROE-3776



6DOF IMU 9 Click

The 6DOF IMU 9 click is based on the IAM-20680 is a 6-axis MotionTracking device for Automotive app.

MSRP - \$30⁰⁰
MIKROE-3827



6DOF IMU 11 Click

The KMX63 a tri-axis accelerometer, tri-axis magnetometer, and temp. sensor.

MSRP - \$28⁰⁰
MIKROE-3869



Accel 13 Click

The KMX63 a tri-axis accelerometer, tri-axis magnetometer, and temp. sensor.

MSRP - \$29⁰⁰
MIKROE-3742



Color 9 Click

The APDS-9250, an integrated color sensor IC, made by Broadcom.

MSRP - \$12⁰⁰
MIKROE-3690



GMR Angle Click

The TLI5012B E1000 is a 360° angle sensor and the analog multiplexer 74HCT4053.

MSRP - \$17⁰⁰
MIKROE-3815



Heart Rate 9 Click

With PIC16F1779 8-bit MCU and SFH 7060 heart rate and pulse oximetry monitoring sensor.

MSRP - \$19⁰⁰
MIKROE-3822



NO2 2 Click

With the MiCS-2714, a compact metal oxide [MOS] sensor.

MSRP - \$39⁰⁰
MIKROE-3700



Opto Encoder 3 Click

The TCUT1800X01 sensor is equipped with one infrared LED with the wavelength of 950nm.

MSRP - \$12⁰⁰
MIKROE-3710





Accel 8 Click

The MPU6050, a motion tracking sensor IC, from TDK Invensense.

MSRP – \$19⁰⁰
MIKROE-3341



Accel 11 Click

The BMA456, a digital triaxial acceleration sensor from Bosch Sensortech.

MSRP – \$17⁰⁰
MIKROE-3440



Accel 12 Click

The MC32216, a low-noise and low power 3-axis accelerometer, from mCube.

MSRP – \$9⁰⁰
MIKROE-3464



13DOF Click

The BME680 is a digital 4-in-1 sensor with gas, humidity, pressure and temp. measurement.

MSRP – \$48⁰⁰
MIKROE-3775



13DOF 2 Click

The BME680 is a digital 4-in-1 sensor with VOC, humidity, pressure and temp. measurement.

MSRP – \$42⁰⁰
MIKROE-3687



Presence Click

The TPiS 1S 1385, a device from CaliPile™ multi-function IR sensor series by Excelitas Technologies.

MSRP – \$35⁰⁰
MIKROE-3575

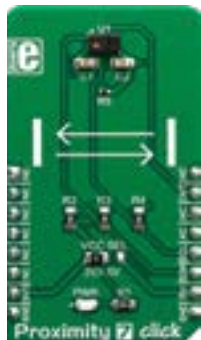

Proximity 7 Click

The ADPS9930, a digital ambient and proximity sensor, by Broadcom [Avago Technologies].

MSRP – \$14⁰⁰
MIKROE-3330



Proximity 8 Click

The VCNL36687S, a proximity sensor with VCSEL in a single package, from Vishay.

MSRP – \$13⁰⁰
MIKROE-3439



Hall Current 9 Click

The CQ3300, a high-speed response core-less current sensor using a Hall sensor.

MSRP – \$24⁰⁰
MIKROE-4466



AMR Current Click

The MCR1101-20-5 current sensor, which is an AMR based integrated current sensor.

MSRP – \$15⁰⁰
MIKROE-3812





Temp-Hum 4 Click

A smart environmental temp. and humidity sensor, uses HDC1010 sensor from Texas Instruments.

MSRP - \$13⁰⁰
MIKROE-2938



IR Click

Features TSOP38338 IR 38 kHz receiver module as well as QEE113 IR emitting diode.

MSRP - \$9⁵⁰
MIKROE-1377



IrDA2 Click

With TFDU4101 infrared transceiver module and MCP2120 infrared encoder/decoder.

MSRP - \$25⁰⁰
MIKROE-1195



IR Beacon Click

Functions as a beacon device with nine VSMB-2948SL high speed infrared emitting diodes.

MSRP - \$21⁰⁰
MIKROE-1939

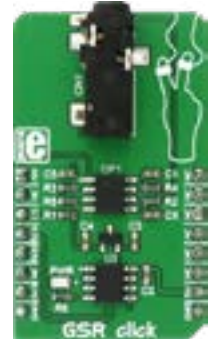

GSR Click

Galvanic skin response (GSR) measures the electrodermal activity (EDA) of the human body.

MSRP - \$24⁰⁰
MIKROE-2860



Heart Rate 8 Click

It is an optical biosensor Click board™, designed for heart-rate monitoring (HRM).

MSRP - \$35⁰⁰
MIKROE-3218



Thermo 8 Click

It features the MCP9808, a digital temp. sensor with ±0.5 °C max. accuracy, from Microchip.

MSRP - \$9⁰⁰
MIKROE-3290



6DOF IMU 10 Click

Features the KMX62-1031 a 6 Degrees-of-Freedom inertial sensor from Kionix.

MSRP - \$22⁰⁰
MIKROE-3934



Thermo 9 Click

Features the TSYS01, a digital temperature sensor from TE Connectivity.

MSRP - \$18⁰⁰
MIKROE-3983



Proximity 13 Click

Based on SI1153-AB09-GMR IC from Silicon Labs that can be used as a proximity, and gesture detector.

MSRP - \$13⁰⁰
MIKROE-3991





Ambient 3 Click

The IIS2DLPC, a high-performance ultra-low-power 3-axis accel. for industrial app.

MSRP - \$12⁰⁰
MIKROE-3742



Proximity 10 Click

The SI1143, a photometric sensor for the ambient light and proximity detection.

MSRP - \$23⁰⁰
MIKROE-3455



Proximity 11 Click

The RPR-0521RS, a digital ambient and proximity sensor, by ROHM Semiconductor.

MSRP - \$9⁰⁰
MIKROE-3689



Remote Temp Click

The EMC1833, a ±1°C, SMBus/I2C compatible local/remote temperature sensor.

MSRP - \$15⁰⁰
MIKROE-3685

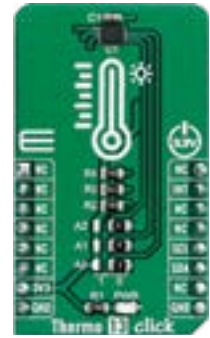

Thermo 13 Click

The BH1900NUX, a high accuracy temperature sensor IC with the 2-Wire interface.

MSRP - \$7⁰⁰
MIKROE-3688



PIR Click

The PL-N823-01 - a PL Pyroelectric Infrared Sensors from KEMET.

MSRP - \$18⁰⁰
MIKROE-3339



Thermostat 3 Click

The MAX31855, it's IC a thermocouple-to-digital converter with a built-in 14-bit ADC.

MSRP - \$36⁰⁰
MIKROE-3724

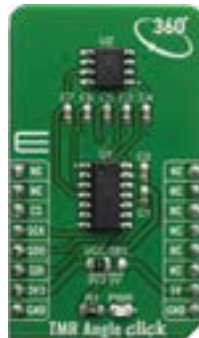

TMR Angle Click

The TLE5501 it's an angle sensors for any kind of angular position sensing.

MSRP - \$17⁰⁰
MIKROE-3769



CAMERA Click

Carries OV7670-VL2A, a low voltage CMOS image sensor.

MSRP - \$39⁰⁰
MIKROE-1816



Ambient Click

With MLX75305 IC, CMOS integrated optical sensor. Converts ambient light intensity into voltage.

MSRP - \$9⁰⁰
MIKROE-1890





Load Cell 2 Click

Features NAU7802 24-Bit Dual-Channel ADC For Bridge Sensors.

MSRP - \$9⁰⁰
MIKROE-4047

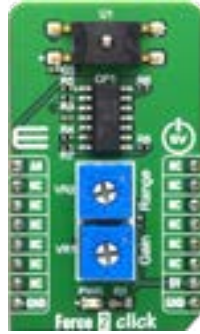

Force 2 Click

With the FSS015NGT Honeywell's FSS-SMT Series force sensor.

MSRP - \$159⁰⁰
MIKROE-4046



6DOF IMU 12 Click

The BMI270 IC, a low power inertial measurement unit, from Bosch Sensortec.

MSRP - \$22⁰⁰
MIKROE-4073



Motion 2 Click

Based on EKMC1607112, PIR motion sensor from Panasonic Corporation.

MSRP - \$29⁰⁰
MIKROE-4059



Motion 3 Click

Based on EKMC1606112, PIR motion sensor from Panasonic Corporation.

MSRP - \$31⁰⁰
MIKROE-4049



Compass 3 Click

The MMC5883MA, a complete 3-axis magnetic sensor with signal processing from MEMSIC.

MSRP - \$16⁰⁰
MIKROE-4063



ECG 6 Click

It features the MAX86150, a Reflective Heart Rate Monitor and Medical-Grade Pulse Oximeter.

MSRP - \$29⁰⁰
MIKROE-4061



6DOF IMU 3 Click

The FXOS8700CQ is a low-power 3-axis linear accelerometer, and 3-axis magnetometer.

MSRP - \$7⁰⁰
MIKROE-4086



Motion 4 Click

Features EKMC1603111, a PIR motion sensor from Panasonic Corporation.

MSRP - \$38⁰⁰
MIKROE-4078



6DOF IMU 5 Click

Features 7-Axis ICM-20789 chip from TDK.

MSRP - \$35⁰⁰
MIKROE-4089



Ambient 11 Click

With the VEML6035, a low power, high sensitivity, I2C ambient light sensor from Vishay Semiconductors.

MSRP - \$9⁰⁰
MIKROE-3990



Heater Click

Set and control exact PCB temp. with the TMP235 on board temp. sensor from Texas Instruments.

MSRP - \$16⁰⁰
MIKROE-3996



Thermo 17 Click

The TMP451-Q1, a high-accuracy, low-power remote temp. sensor monitor with a built-in local temp. sensor.

MSRP - \$9⁰⁰
MIKROE-3994



SHT AN Click

The SHT31-ARP, a high accuracy temperature and humidity sensor from Sensirion.

MSRP - \$16⁰⁰
MIKROE-3984



Color 10 Click

It's based on VEML3328, a RGB and IR light sensor from Vishay.

MSRP - \$7⁰⁰
MIKROE-3997



Index Counter Click

Features the TLE4966K, an integrated circuit double Hall-effect sensor.

MSRP - \$7⁰⁰
MIKROE-4005



Radiation Click

Feature the BG51 radiation sensor is based on an array of customized PIN diodes.

MSRP - \$149⁰⁰
MIKROE-4036



VCP Monitor Click

The NA260AIPWR, a digital-output, current, power, and voltage monitor with an I2C and SMBus™ interface.

MSRP - \$22⁰⁰
MIKROE-4039



Heart Rate 2 Click

The MAXM8616 - Single-Supply Integrated Optical Module for HR and SpO2 Measurement.

MSRP - \$23⁰⁰
MIKROE-4037



6DOF IMU 6 Click

The ICM-20689, a 6-axis Motion-tracking with a 3-axis gyroscope, a 3-axis accelerometer, and a DMP.

MSRP - \$15⁰⁰
MIKROE-4044





9DOF 3 Click

The BMX055, a 9-axis sensor for the detection of movements, rotations, and magnetic heading.

MSRP - \$16⁰⁰
MIKROE-4153



Light mix-sens Click

The TMD37253 IC, a proximity measurement, color sense (RGB+C+IR), and digital ALS device, from AMS.

MSRP - \$7⁰⁰
MIKROE-4148



Force 4 click

Based on HSFPA-R003A piezoresistive force sensor from Alpsalpine.

MSRP - \$36⁰⁰
MIKROE-4193

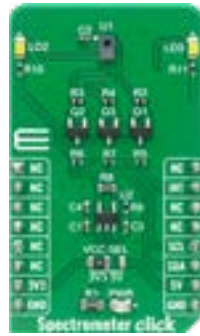

Spectrometer Click

Uses the AS7341 IC, 11-Channel Spectral Sensor Frontend from AMS-AG.

MSRP - \$24⁰⁰
MIKROE-4165

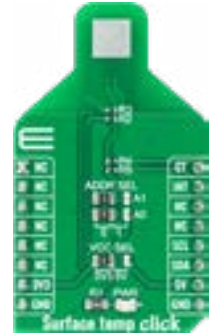

Surface temp Click

With the ADT7420 - an accurate 16-Bit Digital I2C temp. sensor from Analog Devices.

MSRP - \$26⁰⁰
MIKROE-4205



Ammonia Click

An Ammonia detection [NH3] sensor, based on the MQ-137 gas sensor.

MSRP - \$69⁰⁰
MIKROE-4151



Hydro Probe Click

Uses the MIC1557 and MCP3221 IC's. The capacitive soil moisture sensors.

MSRP - \$9⁰⁰
MIKROE-4131



Accel 14 Click

Uses the IIS3DWB IC, an ultra-wide bandwidth, low-noise, 3-axis digital vibration sensor.

MSRP - \$41⁰⁰
MIKROE-4185



Thermostat 4 Click

The TMP392, enables protection and detection of system thermal events from 30°C to 130°C.

MSRP - \$28⁰⁰
MIKROE-4194



Barometer 3 Click

Based on DPS368, a digital barometric air pressure sensor IC from Infineon.

MSRP - \$8⁰⁰
MIKROE-4190



TMR mix-sens Click

With three different Coto Technology RedRock™ TMR magnetic sensors.

MSRP – \$19⁰⁰
MIKROE-4106



Accel 10 Click

The LIS2DW12TR, a high-performance ultra-low-power 3-axis “femto” accelerometer.

MSRP – \$9⁰⁰
MIKROE-4112



Scanner Click

The TSL3301CL IC, 102 x 1 linear optical sensor array with onboard A/D conversion from AMS-AG.

MSRP – \$24⁰⁰
MIKROE-4108



9DOF 2 Click

Based on the ICM-20948, a high performance, 9-axis MotionTracking™ IC from TDK Invensense.

MSRP – \$20⁰⁰
MIKROE-4128



Altitude 4 Click

Uses the NPA-201 IC, an absolute pressure sensor with digital output for low-cost applications.

MSRP – \$12⁰⁰
MIKROE-4127



Thermo 14 Click

The STTS22H, a high accuracy temp. sensor IC with the 2-Wire interface, from STMicroelectronics.

MSRP – \$7⁰⁰
MIKROE-4132



UVB Click

Based on GU-VB-C31SM, a Digital UV Sensor from GENUV Technology.

MSRP – \$24⁰⁰
MIKROE-4145



UVC Click

The GUVU-T21GH UV sensor from GenUV, measures UVC spectrum in the range of 220nm up to 280nm.

MSRP – \$45⁰⁰
MIKROE-4144



Magneto 6 Click

Uses the TLI493D-A2B6 IC, low power 3 dimensional Hall effect sensor with I2C interface, from Infineon.

MSRP – \$12⁰⁰
MIKROE-4139



Pressure 10 Click

Uses the HSPPAD042A IC, a digital pressure sensor, from ALPS ELECTRIC.

MSRP – \$12⁰⁰
MIKROE-4142





Angle 5 Click

The MA302, a 12-bit digital contactless angle sensor with ABZ and UVW incremental outputs.

MSRP – \$18⁰⁰
MIKROE-4270



Compass 4 Click

Features AK09915, a complete 3-axis magnetic sensor with signal processing from AKM.

MSRP – \$12⁰⁰
MIKROE-4231



6DOF IMU 15 click

Features the ASM-330LHH, automotive 6-axis MEMS motion tracking device.

MSRP – \$31⁰⁰
MIKROE-4330



Thermo 19 Click

The MAX31825, a digital thermometer with 12-bit measurements.

MSRP – \$16⁰⁰
MIKROE-4295



XSENS MTi-3 Click

The MTi-3, a module outputting 3D orientation, 3D rate of turn, 3D accelerations, and 3D magnetic field.

MSRP – \$399⁰⁰
MIKROE-4192



Pressure 13 Click

The KP229E2701, a miniaturized analog absolute pressure sensor.

MSRP – \$18⁰⁰
MIKROE-4294



Force 5 Click

The FMAMSDXX025W-C2C3, a piezoresistive-based force sensor with a digital output.

MSRP – \$69⁰⁰
MIKROE-4305



Temp&Hum 14 Click

The SHT40, high-accuracy ultra-low-power 16-bit relative humidity and temperature sensor.

MSRP – \$15⁰⁰
MIKROE-4306



Thermo 20 Click

The TSYS03, a digital temp. sensor with precise digital output and low power consumption.

MSRP – \$7⁰⁰
MIKROE-4316



PHT Click

The MS8607, a digital combination sensor providing 3 environmental measurements.

MSRP – \$22⁰⁰
MIKROE-4348





Force 3 Click

Based on the FSR 400 series 34-00004 single zone Force Sensing Resistor IC from Interlink Electronics.

MSRP - \$25⁰⁰
MIKROE-4149



Magneto 8 Click

Features the AS5601, 12-bit programmable contactless encoder IC from AMS-AG.

MSRP - \$15⁰⁰
MIKROE-4204



6DOF IMU 14 Click

The ICM-42688-P, high precision 6-axis MEMS motion tracking device, from TDK InvenSense.

MSRP - \$15⁰⁰
MIKROE-4237



Ambient 9 Click

The APDS-9160-003, digital proximity, and ambient light sensing sensor from Broadcom Limited.

MSRP - \$15⁰⁰
MIKROE-4197



Oximeter 3 Click

Features the VCN-L4020C-GS08, a fully integrated high-resolution digital biosensor.

MSRP - \$15⁰⁰
MIKROE-4267



6DOF IMU 13 Click

The MC6470 with an accelerometer and magnetometer for a 6 DoF sensor solution.

MSRP - \$9⁰⁰
MIKROE-4228



Air quality 7 Click

The MiCS-VZ-89TE, an integrated sensor module for indoor air quality monitoring from Amphenol.

MSRP - \$41⁰⁰
MIKROE-4196



Surface temp 2 Click

Features the ADT7422, a 16-bit I2C temperature sensor from Analog Devices.

MSRP - \$16⁰⁰
MIKROE-4266



RTD 2 Click

The ADS1247, a highly integrated 24-bit data converters with a PGA.

MSRP - \$24⁰⁰
MIKROE-4282



Barcode 2 Click

The EM3080-W, a barcode decoder chip with superior performance, and low power consumption.

MSRP - \$139⁰⁰
MIKROE-4195





VCT Monitor Click

The LTC2990, a high-performance temperature, voltage, and current monitor.

MSRP – \$15⁰⁰
MIKROE-4353



Vibra Sense 2 Click

The LDTM-028K a vibration sensor, offering high sensitivity at low frequencies.

MSRP – \$26⁰⁰
MIKROE-4355



Compass 5 Click

The AK09918C, a 3-axis electronic compass with high sensitive Hall sensor technology.

MSRP – \$15⁰⁰
MIKROE-4366



RAQ Click

The ZMOD4450, a gas sensor module used to detect typical gases inside refrigeration applications.

MSRP – \$35⁰⁰
MIKROE-4385



pH Click

The pH EZ0™, offers the highest level of stability and accuracy from AtlasScientific.

MSRP – \$109⁰⁰
MIKROE-4297



Hall Current 7 Click

The ACS770, a Hall effect-based high precision linear current sensor with 100µV current conductor.

MSRP – \$36⁰⁰
MIKROE-4420



Temp Probe Click

The LTC2986, a high accuracy digital temperature measurement system.

MSRP – \$112⁰⁰
MIKROE-4301



Load Cell 4 Click

Features the ZSC31014, a CMOS integrated circuit for highly accurate amplification.

MSRP – \$20⁰⁰
MIKROE-4458



Oximeter 2 Click

The ADPD144RI, a PPG optical sensor for photoplethysmography detection of blood oxygenation.

MSRP – \$18⁰⁰
MIKROE-4292



Pressure 14 Click

The ABP2LANT060P-G2A3XX, a piezoresistive silicon pressure sensor.

MSRP – \$39⁰⁰
MIKROE-4424



Smoke 2 Click

The ADPD188BI module for smoke detection with optical dual-wave-length technology.

MSRP – \$45⁰⁰
MIKROE-4299



Environment 2 Click

The SHT40 and SGP40, a high-accuracy best-in-class SHT relative humidity, and a temp. sensor.

MSRP – \$19⁰⁰
MIKROE-4558



Temp&Hum 15 Click

The SHT40, high-accuracy ultra-low-power 16-bit relative humidity and temperature sensor.

MSRP – \$7⁰⁰
MIKROE-4496



Accel 15 Click

The BMA490L, a high-performance 16-bit digital triaxial longevity acceleration sensor.

MSRP – \$15⁰⁰
MIKROE-4501



ECG/GSR Click

The AS7030B, a vital sign sensor with PPG and Electrocardiogram [ECG] operations.

MSRP – \$27⁰⁰
MIKROE-4500



Load Cell 5 Click

The AD7780- pin-programmable, low power, 24-bit sigma-delta ADC from Analog Devices.

MSRP – \$21⁰⁰
MIKROE-4510



AMR Angle Click

Features the ADA4571, an AMR sensor with amplified cosine and sine output from ADI.

MSRP – \$32⁰⁰
MIKROE-4561



LightRanger 5 Click

Features the TMF8801, a dToF optical distance sensor with associated VCSEL from AMS.

MSRP – \$26⁰⁰
MIKROE-4592



3D Hall 8 Click

Features the TLI493D-W2BW, a low-power magnetic sensor from Infineon.

MSRP – \$11⁰⁰
MIKROE-4598



MR Angle Click

Features the KMZ60, a high precision sensor for magnetic angle measurement from NXP.

MSRP – \$19⁰⁰
MIKROE-4534





Ozone 3 Click

Features the 3SP-03-20, a electrochemical ozone sensor from SPEC Sensors.

MSRP – \$79⁰⁰
MIKROE-4654



Piezo Accel Click

Features the 820M1-0025, a piezoelectric accelerometer from TE Connectivity.

MSRP – \$109⁰⁰
MIKROE-4559



Hall Current 8 Click

25A version featuring the TL14971- A025T5, a high-precision coreless current sensor from Infineon.

MSRP – \$29⁰⁰
MIKROE-4632



Hall Current 8 Click

120A version features the TL14971- A120T5, a high-precision current sensor from Infineon.

MSRP – \$49⁰⁰
MIKROE-4508



Load Cell 3 Click

Features the PGA302, programmable signal-conditioner device from Texas Instruments.

MSRP – \$23⁰⁰
MIKROE-4297



Heart Rate 10 Click

Based on the MAX86916, an integrated optical sensor from Analog Devices.

MSRP – \$40⁰⁰
MIKROE-4724



Temp&Hum 16 Click

Features the WSEN-HIDS, a MEMS-based capacitive humidity sensor from Würth.

MSRP – \$15⁰⁰
MIKROE-4733



HVAC Click

Features the SCD41 carbon dioxide and connector for SPS30 PM sensor from Sensirion.

MSRP – \$69⁰⁰
MIKROE-4290



VAV Press Click

Carries the LMIS025B, a low differential pressure sensor from First Sensor.

MSRP – \$27⁰⁰
MIKROE-4667



Air Flow Click

Features the LHDULTRA M012UB3, an micro-flow differential pressure sensor from First Sensor.

MSRP – \$37⁰⁰
MIKROE-4677





Ultra-Low Press Click

Features the SM8436, mountable gage pressure sensor from Silicon Microstructure.

MSRP - \$27⁰⁰
MIKROE-4676



Temp&Hum 17 Click

Features the HS3001, a relative humidity and temperature sensor from Renesas.

MSRP - \$21⁰⁰
MIKROE-4702



Pressure 15 Click

Features the LPS27HHW, an piezoresistive pressure sensor from STMicroelectronics.

MSRP - \$32⁰⁰
MIKROE-4747



Proximity 14 Click

Features the VCNL36825T, a fully integrated close-range proximity sensor from Vishay.

MSRP - \$7⁰⁰
MIKROE-4744



Hall Current 10 Click

Features the ACHS-7194, a fully integrated Hall current sensor from Broadcom.

MSRP - \$31⁰⁰
MIKROE-4587



Color 13 Click

Based on the APDS-9999, RGB and proximity detector sensor in one module from Broadcom.

MSRP - \$14⁰⁰
MIKROE-4741



Inclinometer Click

Features the SCL3300, a high-performance inclinometer sensor component from Murata.

MSRP - \$85⁰⁰
MIKROE-4753



Hall Switch 2 Click

Carries the MHA100KN, a high-performance, low-power Hall-Effect sensor from MEMSIC.

MSRP - \$27⁰⁰
MIKROE-4788



Current 4 Click

Based on INA250, a bidirectional, zero-drift current-shunt monitor from Texas Instruments.

MSRP - \$15⁰⁰
MIKROE-4755



Proximity 12 Click

Carries TMD3719, an ambient, proximity, and flicker detection sensing IC from AMS-AG.

MSRP - \$22⁰⁰
MIKROE-3995





Pressure 16 Click

Features the WSENPADS, a high-precision MEMS pressure sensor from Wurth.

MSRP – \$16⁰⁰
MIKROE-4765



Ambient 12 Click

Based on the BH1620FVC, an analog current-output type ambient light sensor from Rohm.

MSRP – \$14⁰⁰
MIKROE-4781



6DOF IMU 17 Click

Features the IIM-42652, a 6-axis SmartIndustrial™ MotionTracking sensor from TDK.

MSRP – \$24⁰⁰
MIKROE-4785



Ambient 10 Click

Features the APDS-9006-020, analog-output ambient light photo-sensor from Broadcom.

MSRP – \$14⁰⁰
MIKROE-4777

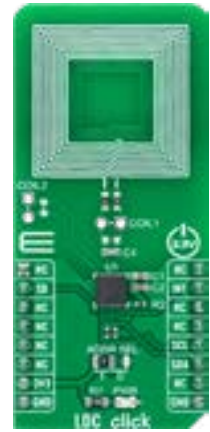

LDC Click

Based on the LDC1312-Q1, 12-bit inductance to digital converter from Texas Instruments.

MSRP – \$15⁰⁰
MIKROE-4784



Tilt 3 Click

Utilizes the DSBA1P, a non-contact switch with an embedded photo-interrupter from NKK.

MSRP – \$22⁰⁰
MIKROE-4779



Magnetometer 9 Click

Features the A1359, dual tracking output linear hall-effect sensor from Allegro.

MSRP – \$19⁰⁰
MIKROE-4778



Compass 6 Click

Based on the HSCDTD008A, a high-sensitivity geomagnetic sensor from ALPS.

MSRP – \$25⁰⁰
MIKROE-4796



Hall Current 11 Click

Features the TMCS110, a galvanically isolated Hall-effect current from Texas Instruments.

MSRP – \$30⁰⁰
MIKROE-4797



Color 14 Click

Features the APDS-9151, an integrated RGB and ambient light sensor from Broadcom.

MSRP – \$12⁰⁰
MIKROE-4793



LDC 2 Click

Features the LDC1041, inductance-to-digital converter from Texas Instruments.

MSRP – \$34⁰⁰
MIKROE-4783



Accel 18 Click

Based on MC3419, a digital output 3-axis accelerometer sensor from MEMSIC.

MSRP – \$7⁰⁰
MIKROE-4826



Proximity 15 Click

Uses the VL53L1, Time-of-Flight laser-ranging miniature sensor from ST.

MSRP – \$19⁰⁰
MIKROE-4822



Thermo 18 Click

Features the WSEN-TIDS, a high-precision digital temperature sensor from Würth.

MSRP – \$12⁰⁰
MIKROE-4829



Gyro 6 Click

Features the IAM-20380, a 3-axis and angular rate sensor (gyroscope) from TDK.

MSRP – \$27⁰⁰
MIKROE-4827



Hall Current 12 Click

Features the TMCS1100A4, a Hall-effect current sensor from Texas Instruments.

MSRP – \$38⁰⁰
MIKROE-4798



Accel 17 Click

Based on the MXC62320MP, a low-power dual-axis accelerometer from MEMSIC.

MSRP – \$25⁰⁰
MIKROE-4855



Barometer 4 Click

Features the ICP-10111, a high accuracy barometric and temperature sensor from TDK.

MSRP – \$12⁰⁰
MIKROE-4868



Magneto 10 Click

Is based on MLX90392, a +/-5mT range magnetometer for low-noise applications from Melexis.

MSRP – \$15⁰⁰
MIKROE-4866



Altitude 5 Click

Carries the KP236, an analog barometric air pressure sensor from Infineon.

MSRP – \$24⁰⁰
MIKROE-4875





Humidity Click

Features the HIH-5030, an analog output relative humidity sensor from Honeywell.

MSRP – \$25⁰⁰
MIKROE-4878



Accel 16 Click

Based on the ADXL363, a 3-axis and temperature sensor from Analog Devices.

MSRP – \$17⁰⁰
MIKROE-4876



Thermo 21 Click

Carries the ADT7301, a high-precision digital temperature sensor from Analog Devices.

MSRP – \$18⁰⁰
MIKROE-4879



Environment 3 Click

Features the BME688, a first gas sensor with Artificial Intelligence (AI) from Bosch Sensortec.

MSRP – \$24⁰⁰
MIKROE-4893

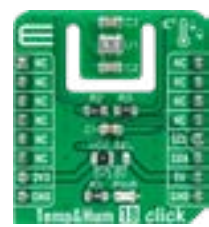

Temp&Hum 18 Click

Features the HS3003, a fully calibrated relative humidity and temperature sensor from Renesas.

MSRP – \$13⁰⁰
MIKROE-4892



Altitude 6 Click

Carries the MS5611-01BA, a high-resolution barometric pressure sensor from TE Connectivity.

MSRP – \$25⁰⁰
MIKROE-4903



Temp&Hum 20 Click

Features the CC2D23, a fully-calibrated relative humidity and temperature sensor from Amphenol.

MSRP – \$27⁰⁰
MIKROE-4907



Accel 20 Click

Based on KX134-1211, a digital output 3-axis accelerometer sensor from Rohm.

MSRP – \$33⁰⁰
MIKROE-4888



Air Quality 8 Click

Features the ZMOD4510, a fully calibrated digital air quality sensor from Renesas.

MSRP – \$19⁰⁰
MIKROE-4904



Ambient 16 Click

Features the BH1726NUC, a 16-bit digital-output ambient light sensor from Rohm.

MSRP – \$14⁰⁰
MIKROE-4933





Temp&Hum 19 Click

Is based on BPS240, a highly accurate relative humidity and temperature sensor from Bourns.

MSRP - \$18⁰⁰
MIKROE-4922



Load Cell 6 Click

Features the MAX11270, a high-performance 24-bit ADC from Analog Devices.

MSRP - \$52⁰⁰
MIKROE-4940

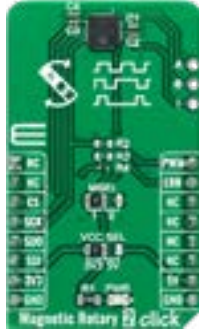

Magnetic Rotary 2 Click

Based on the AEAT-9922, an angular magnetic rotary sensor from Broadcom.

MSRP - \$58⁰⁰
MIKROE-4952



Barometer 5 Click

Features the MS5637-02BA03, a high accuracy low voltage barometric and temperature sensor

from TE
MSRP - \$12⁰⁰
MIKROE-4924



UVA Click

Based on the GUAU-C32SM, an ultraviolet light sensor from Genicom.

MSRP - \$24⁰⁰
MIKROE-4911



Current 5 Click

Features the INA381, a high-speed current-sense amplifier from Texas instruments.

MSRP - \$24⁰⁰
MIKROE-4953



Accel 19 Click

Based on the LIS2DTW12, an ultra-low-power high-performance three-axis accelerometer from ST.

MSRP - \$17⁰⁰
MIKROE-4949



3D Hall 9 Click

Carries the ALS31300, a 3D linear Hall-effect sensor with digital output from Allegro.

MSRP - \$14⁰⁰
MIKROE-4948



Barometer 7 Click

Carries the ALS31300, a 3D linear Hall-effect sensor with digital output from Allegro.

MSRP - \$23⁰⁰
MIKROE-4913



Smart Sens Click

Features the KP264XTMA1, a digital barometric air pressure sensor from Infineon.

MSRP - \$29⁰⁰
MIKROE-4926





Ambient 18 Click

Based on the BH1680FVC, an analog current-output ambient light sensor from Rohm.

MSRP – \$9⁰⁰
MIKROE-4943



Oximeter 5 Click

Features the MAX30102, pulse oximetry and heart-rate module from Analog Devices.

MSRP – \$37⁰⁰
MIKROE-4986



Ambient 15 Click

Carries the TSL2584T5V, a light-to-digital converter sensor from AMS-AG.

MSRP – \$12⁰⁰
MIKROE-4967



Pressure 17 Click

Features the BM1390GLV-Z, a high-precision piezoresistive pressure sensor from Rohm.

MSRP – \$24⁰⁰
MIKROE-4944



Barometer 6 Click

Features the 2SMPB-02E, a high-accuracy digital barometric air pressure sensor from Omron.

MSRP – \$12⁰⁰
MIKROE-4978



CO2 Click

Based on STC31, a miniature gas concentration CO2 sensor from Sensirion.

MSRP – \$79⁰⁰
MIKROE-4725



Angle 8 Click

Features the MA782GGU, a angle sensor with integrated wake-up angle detection from MPS.

MSRP – \$15⁰⁰
MIKROE-4971



Diff Press 2 Click

Boards contains SDP31, a small differential pressure sensor [500pa] from Sensirion.

MSRP – \$51⁰⁰
MIKROE-4894



Thermo 22 Click

Features the TMP75C, a high-precision digital temperature sensor from Texas Instruments.

MSRP – \$7⁰⁰
MIKROE-5068

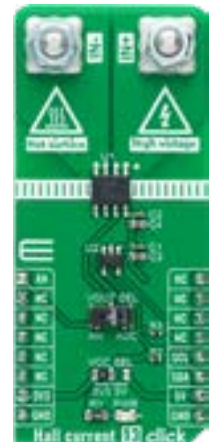

Hall Current 13 Click

Features the TMCS1107-Q1, galvanically isolated Hall-effect sensor from TI.

MSRP – \$38⁰⁰
MIKROE-5066



Current 6 Click

Features the MAX40080, a bi-directional current-sense amplifier from Analog Devices.

MSRP - \$32⁰⁰
MIKROE-4914



Magneto 11 Click

Based on the AS5510, a linear hall sensor with 10-bit resolution from ams AG.

MSRP - \$12⁰⁰
MIKROE-5067



RF Meter 3 Click

Features the LT5581, a monolithic precision RMS power detector from Analog Devices.

MSRP - \$24⁰⁰
MIKROE-4906



Current 7 Click

Based on the INA282, a high-accuracy current shunt monitor from Texas Instruments.

MSRP - \$26⁰⁰
MIKROE-4976



Magneto 12 Click

Carries the A31315, accurate and reliable magnetic position sensor from Allegro.

MSRP - \$18⁰⁰
MIKROE-4991



Air Quality 9 Click

Features the ENS160, a digital multi-gas sensor solution based on metal oxide from ScioSense.

MSRP - \$32⁰⁰
MIKROE-5060



Proximity 17 Click

Based on the TMD2635, a miniature proximity sensor module from ams AG.

MSRP - \$12⁰⁰
MIKROE-5084



IR 2 Click

Carries the TSMP58138, a sensor for receiving the modulated signal of IR diode from Vishay.

MSRP - \$7⁰⁰
MIKROE-5088



Ambient 17 Click

Features the TSL2572, a digital-output ambient light sensor from ams AG.

MSRP - \$7⁰⁰
MIKROE-5106

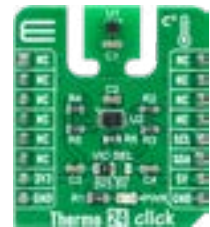

Thermo 24 Click

Features the STS40, a high-accuracy ultra-low-power temperature sensor from Sensirion.

MSRP - \$11⁰⁰
MIKROE-5110





Barometer 8 Click

Features the ILPS22QS, piezoresistive absolute pressure sensor from ST.

MSRP – \$15⁰⁰
MIKROE-5128



Thermo 23 Click

Based on the TMP144, a high-precision digital temperature sensor from TI.

MSRP – \$6⁰⁰
MIKROE-4979



Gyro 7 Click

Uses the ICG-1020S, a dual-axis MEMS angular rate sensor [gyroscope] from TDK.

MSRP – \$9⁰⁰
MIKROE-5145



Pressure 19 Click

Carries the MLX90817, a factory-calibrated absolute pressure sensor from Melexis.

MSRP – \$27⁰⁰
MIKROE-5089



3D Hall 10 Click

Based on the TMAG5170, a high-precision linear 3D Hall effect sensor from TI.

MSRP – \$9⁰⁰
MIKROE-5125



Color 15 Click

Based on the CLS-16D24, a low power color light sensor from Everlight Electronics.

MSRP – \$12⁰⁰
MIKROE-5121



Accel 22 Click

Based on the CLS-16D24, a low power color light sensor from Everlight Electronics.

MSRP – \$17⁰⁰
MIKROE-4896



Pressure 20 Click

Features the ADXL367, high-performance three-axis accelerometer from Analog Devices.

MSRP – \$12⁰⁰
MIKROE-5153



Inclinometer 2 Click

Features the IIS2ICLX, high accuracy, and resolution two-axis inclinometer from ST.

MSRP – \$79⁰⁰
MIKROE-5156



Radar Click

Features the MM5D91-00, a 60GHz mmWave presence sensor from Jorjin.

MSRP – \$89⁰⁰
MIKROE-5183



3D Hall 11 Click

Features the TMAG5273, a low-power linear 3D Hall-effect sensor from TI.

MSRP – \$6⁰⁰
MIKROE-5188



IR Gesture 2 Click

With the MAX25405, a gesture and proximity sensing system from Analog Devices.

MSRP – \$75⁰⁰
MIKROE-5146



Accel 4 Click

Features the FXLS8974CF, a 12-bit three-axis accelerometer from NXP.

MSRP – \$6⁰⁰
MIKROE-4780



Heart Rate 11 Click

Features the OB1203, a multi-channel light sensor and proximity sensor from Renesas.

MSRP – \$12⁰⁰
MIKROE-5170



Spectrometer 2 Click

Utilize the VD6283TX, a color sensor with advanced light flicker extraction from ST.

MSRP – \$17⁰⁰
MIKROE-5167



Hall Current 15 Click

Features the TMCS1101-Q1, a isolated Hall-effect current sensor from TI.

MSRP – \$21⁰⁰
MIKROE-5175



LightRanger 10 Click

Based on the VL53L4CX, a ToF optical distance sensor from ST.

MSRP – \$19⁰⁰
MIKROE-5206



Compass 7 Click

Features the MMC5633NJL, a monolithic complete 3-axis AMR magnetic sensor from MEMSIC.

MSRP – \$12⁰⁰
MIKROE-5190



Smart Sens 2 Click

Utilizes several environmental sensors [BHI260AP, BME688, BMP390, BMM150] from Bosch.

MSRP – \$49⁰⁰
MIKROE-5207



ECG 7 Click

Features the MCP6N16, a instrumentation amplifier with selectable gain from Microchip.

MSRP – \$25⁰⁰
MIKROE-5214





Magnetic Rotary Click

Features the AS5147U, an high-resolution rotary position sensor with full 360° range ams AG.

MSRP - \$26⁰⁰
MIKROE-5203



Angle 7 Click

Carries the AS5600, a Hall-based rotary magnetic position sensor from ams AG.

MSRP - \$15⁰⁰
MIKROE-5196



LDC Touch Click

Based on LDC3114-Q1, a four-channel inductance-to-digital converter from TI.

MSRP - \$19⁰⁰
MIKROE-5204



LightRanger 9 Click

Equipped with the TMF8828, a dToF [optical distance sensor] from ams AG.

MSRP - \$39⁰⁰
MIKROE-5237



Temp&Hum 21 Click

Features the HIH8130-021, a digital humidity and temperature sensor from Honeywell.

MSRP - \$27⁰⁰
MIKROE-5240



Ambient 19 Click

Features the APM-16D24-310, a ambient light and proximity sensor from Everlight.

MSRP - \$14⁷⁰
MIKROE-5245



Hall Current 14 Click

Carries the MCS1801, a Hall-effect-based isolated linear current sensor from MPS.

MSRP - \$27⁰⁰
MIKROE-5239



Magnetic Rotary 4 Click

Based on the AS5047D, high-resolution magnetic rotary position sensor from ams AG.

MSRP - \$21⁰⁰
MIKROE-5223



AMR Angle 2 Click

Equipped with the ADA4570, an integrated AMR angle sensor from Analog Devices.

MSRP - \$27⁰⁰
MIKROE-4981



Pressure 21 Click

Features the BMP581, an absolute barometric pressure sensor from Bosch.

MSRP - \$14⁰⁰
MIKROE-5274



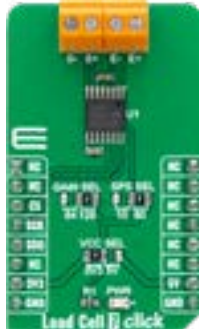

Load Cell 7 Click

Features the ADS1230, a 20-bit delta-sigma analog-to-digital converter from TI.

MSRP - \$25⁰⁰
MIKROE-5276



Angle 6 Click

Based on the MAQ470GQE, a 12-bit contactless angle sensor from MPS.

MSRP - \$17⁰⁰
MIKROE-5282

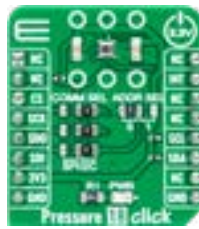

Pressure 18 Click

Equipped with the BMP384, a robust barometric pressure sensor from Bosch.

MSRP - \$17⁰⁰
MIKROE-5296



Temp&Hum 22 Click

Features the SHT41A, a relative humidity and temperature sensor from Sensirion.

MSRP - \$15⁰⁰
MIKROE-5310



Proximity 16 Click

Features the VL53L5CX, a Time-of-Flight multizone ranging sensor from ST.

MSRP - \$29⁰⁰
MIKROE-5286



Current 9 Click

Uses the CT415-HSN-830DR, XtremeSense® TMR current sensor from Crocus.

MSRP - \$29⁷⁰
MIKROE-5319



Accel 24 Click

Features the MXC6655XA, a 12-bit three-axis accelerometer from MEMSIC.

MSRP - \$9⁰⁰
MIKROE-5336



Proximity 18 Click

Carries the VCNL3036X01, a high-resolution proximity sensor from Vishay.

MSRP - \$15⁰⁰
MIKROE-5300



Temp&Hum 23 Click

Features the SHT45, a relative humidity and temperature sensor from Sensirion.

MSRP - \$17⁰⁰
MIKROE-5301



Thermo 25 Click

Based on the TMP127-Q1, a high-precision digital temperature sensor from TI.

MSRP - \$9⁰⁰
MIKROE-5335





Thermo 26 Click

Features the STS31-DIS, a high-accuracy digital temperature sensor from Sensirion.

MSRP - \$9⁰⁰
MIKROE-5384



Angle 10 Click

Based on the AS5070A, an angular position sensor with an analog output from ams AG.

MSRP - \$23⁰⁰
MIKROE-5387



Color 16 Click

Carries the AS7343, a 14-channel multi-purpose spectral sensor from ams AG.

MSRP - \$33⁰⁰
MIKROE-5421



Air Velocity Click

Features the FS3000-1005, a air velocity MEMS sensor from Renesas.

MSRP - \$59⁰⁰
MIKROE-5448



Ambient 20 Click

Features the BU27030NUC, a 16-bit digital-output ambient light sensor from Rohm.

MSRP - \$11⁰⁰
MIKROE-5469



Gyro 8 Click

Based on Murata's SCR2100-D08, a high-performance single-axis angular rate sensor.

MSRP - \$139⁰⁰
MIKROE-5471



Thermo 28 Click

Carries the ams AG's AS6221, a high-accuracy digital temperature sensor.

MSRP - \$11⁰⁰
MIKROE-5466



Thermo 27 Click

Features the TMP114, a high-accuracy digital temperature sensor from Texas Instruments.

MSRP - \$12⁰⁰
MIKROE-5509



Air Motion Click

With TDK InvenSense's ICM-40627, a 6-axis MEMS MotionTracking™ device.

MSRP - \$18⁰⁰
MIKROE-5524



Ambient 21 Click

Features ams AG's TSL2591, a very-high sensitivity light-to-digital converter.

MSRP - \$12⁰⁰
MIKROE-5529





Color 4 Click

Features the VEML6040, a 16-bit RGBW color sensor from Vishay.

MSRP - \$29⁰⁰
MIKROE-2220



Environment 4 Click

Based on the SHT41A-AD1B I2C and the SGP41, an MOx-based gas sensor, from Sensirion.

MSRP - \$55⁰⁰
MIKROE-5526



Accel 21 Click

Equipped with the MIS2DH, a high-performance three-axis accelerometer from STM.

MSRP - \$17⁰⁰
MIKROE-5530



Accel 30 Click

Features the MC3635, an integrated digital output 3-axis accelerometer from MEMSIC.

MSRP - \$12⁰⁰
MIKROE-5550

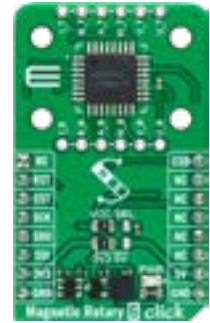

Magnetic Rotary 6 Click

Features the AS5247U, rotary position sensor for fast absolute angle measurement from ams AG.

MSRP - \$47⁰⁰
MIKROE-5585



Accel 25 Click

Uses the CT415-HSN-830DR, XtremeSense® TMR current sensor from Crocus.

MSRP - \$9⁰⁰
MIKROE-5602



6DOF IMU 18 Click

Features the ICM-42605, a high-performance 6-axis MotionTracking™ IMU from TDK.

MSRP - \$18⁰⁰
MIKROE-5591



Thermo 29 Click

Carries the TMP126, a SPI-configurable digital temperature sensor from TI.

MSRP - \$15⁰⁰
MIKROE-5586



Accel 27 Click

Features the ADXL373, a three-axis MEMS ±400g accelerometer from Analog Devices.

MSRP - \$43⁰⁰
MIKROE-5528



pH 2 Click

Based on the MCP607, a low-bias current Op Amp from Microchip.

MSRP - \$24⁰⁰
MIKROE-5596





Ambient 22 Click
Features the OPT3005, a single-chip lux meter from Texas Instruments.

MSRP - \$15⁰⁰
MIKROE-5647



Accel 29 Click
Based on the ADXL314, a three-axis $\pm 200g$ accelerometer from Analog Devices.

MSRP - \$27⁰⁰
MIKROE-5671



Temp&Hum 24 Click
Carries the HDC3021, humidity and temperature sensor Texas Instruments.

MSRP - \$12⁰⁰
MIKROE-5651



6DOF IMU 20 Click
Features the BMI323, a high-performance, low-power IMU from Bosch.

MSRP - \$17⁰⁰
MIKROE-5606



Barometer 10 Click
With the LPS28DFW, an ultra-compact piezoresistive absolute pressure sensor from STM.

MSRP - \$24⁰⁰
MIKROE-5601



Temp-Log 7 Click
Features the TMP1826, a 1-Wire[®] compatible digital output temperature sensor from TI.

MSRP - \$9⁰⁰
MIKROE-5598



Magnetic Rotary 5 Click
Based on the AS5134, a contactless magnetic rotary encoder from ams.

MSRP - \$25⁰⁰
MIKROE-5691



Ambient 23 Click
With the VEML3235SL, an advanced ambient light sensor from Vishay.

MSRP - \$11⁰⁰
MIKROE-5701



CO2 3 Click
Features XENSIV[™] PASCO2V01BUMA1, a highly accurate CO2 sensor from Infineon.

MSRP - \$129⁰⁰
MIKROE-5646



Color 12 Click
Carries the BU27006MUC-Z, a digital color sensor from Rohm.

MSRP - \$13⁰⁰
MIKROE-5724



MSRP - \$15⁰⁰
MIKROE-5586

MSRP - \$43⁰⁰
MIKROE-5528



Magna 13 Click

Features the MA736, a contactless digital angle sensor from Monolithic Power Systems.

MSRP - \$17⁰⁰
MIKROE-5643



Color 17 Click

Based on the OPT4048, a high-speed precision tristimulus XYZ color sensor from TI.

MSRP - \$18⁰⁰
MIKROE-5702



IrDA 4 Click

Carries the TFBS4650, an infrared transceiver from Vishay.

MSRP - \$26⁰⁰
MIKROE-5686



Smart DOF 2 Click

features the LSM6DSV16XTR, a high-performance 6-axis IMU from STM.

MSRP - \$29⁰⁰
MIKROE-5672

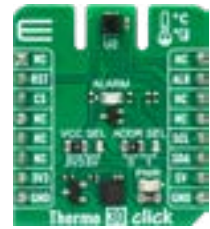

Thermo 30 Click

Features the STS32-DIS-10KS, certified digital temperature sensor from Sensirion.

MSRP - \$19⁰⁰
MIKROE-5736



Accel 28 Click

Features the LIS2HH12TR, high-performance three-axis accelerometer from STM.

MSRP - \$13⁰⁰
MIKROE-5737



Magna 14 Click

Carries the MA735, a contactless angle sensor with ABZ, and PWM output from MPS.

MSRP - \$17⁰⁰
MIKROE-5751



Thermo K 3 Click

Features the MAX6675, a cold-junction-compensated K-thermocouple-to-digital converter from ADI.

MSRP - \$45⁰⁰
MIKROE-5605



IR Gesture 3 Click

Based on the ADPD1080, a photometric front-end from Analog Devices.

MSRP - \$47⁰⁰
MIKROE-5742



Microwave 5 Click

With the PD-V10-G5, a miniature X-band microwave transceiver from Ningbo Pdlux.

MSRP - \$21⁰⁰
MIKROE-5772





Pressure 22 Click

Features the MS5839-02BA, an chlorine-resistant digital pressure and temperature sensor from TE.

MSRP - \$29⁰⁰
MIKROE-5774

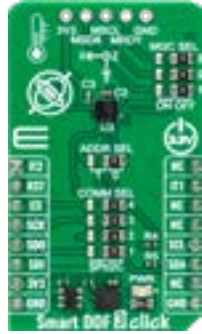

Smart DOF 3 Click

Based on the ISM3301S, an iNEMO inertial module from STM.

MSRP - \$37⁰⁰
MIKROE-5734



Diff Press 3 Click

Carries the WSEN-PDUS [2513130810401], a differential pressure sensor from Würth.

MSRP - \$95⁰⁰
MIKROE-5771



Hall Current 16 Click

Features the ACS37002, a 400kHz high-accuracy current sensor from Allegro Microsystems.

MSRP - \$39⁰⁰
MIKROE-5784



Angle 9 Click

With the AAS33001, a precision angle sensor with incremental and motor commutation outputs from Allegro.

MSRP - \$14⁰⁰
MIKROE-5576



Barometer 12 Click

Features the ICP-10125, barometric pressure and temperature sensor from TDK.

MSRP - \$19⁰⁰
MIKROE-5775



Microwave 4 Click

Features the PD-V12, a miniature high-frequency microwave transceiver from Ningbo Pdlux.

MSRP - \$21⁰⁰
MIKROE-5790



Ultrasonic 5 Click

Based on the TUSS4470, a transformer-drive ultrasonic sensor from TI.

MSRP - \$21⁰⁰
MIKROE-5790



Microwave 6 Click

Carries the PD-V10-G5, a miniature X-band microwave transceiver from Ningbo Pdlux.

MSRP - \$21⁰⁰
MIKROE-5790



LightRanger 7 Click

Features the AFBR-S50, a medium-range 3D multipixel Time-of-Flight [ToF] sensor from Broadcom.

MSRP - \$99⁰⁰
MIKROE-5841



Water Detect 2 Click

Features the OPB350L250, a tube liquid sensor from TT Electronics.

MSRP - \$35⁰⁰
MIKROE-5820



UV 5 Click

Based on the AS7331, a spectral UVA/B/C sensor from ams OSRAM.

MSRP - \$29⁰⁰
MIKROE-5535



Hall Current 17 Click

Features the ACS37010, a high-accuracy current sensor from Allegro MicroSystems.

MSRP - \$45⁰⁰
MIKROE-5845



Speed Radar Click

This board carries the K-LD2, a radar transceiver from RFbeam.

MSRP - \$89⁰⁰
MIKROE-5869

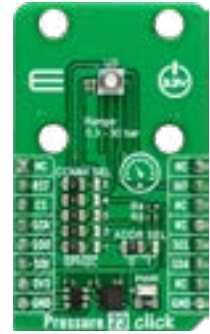

Pressure F2 Click

Based on the MS5849-30BA, chlorine-resistant absolute pressure sensor from TE Connectivity.

MSRP - \$29⁰⁰
MIKROE-5768

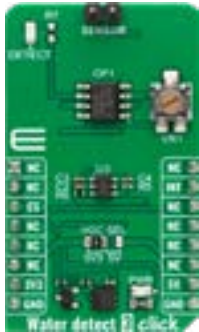

Water Detect 3 Click

Features the MCP606, a micropower CMOS operational amplifier from Microchip.

MSRP - \$19⁰⁰
MIKROE-5848

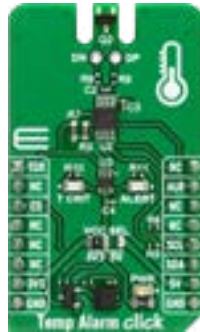

Temp Alarm Click

Carries the PTMP4718, a high-accuracy remote and local temperature sensor from TI.

MSRP - \$19⁰⁰
MIKROE-5872



Diff Press 4 Click

With the SM9336-BCE-S-250-000, a digital pressure and altimeter sensor module from TE.

MSRP - \$85⁰⁰
MIKROE-5868



PRESS Click

Features the ILPS28QSW, an absolute digital output barometer from STM.

MSRP - \$29⁰⁰
MIKROE-5862



LightRanger 11 Click

Based on the VL53L7CX, a time-of-flight 8x8 multizone ranging sensor from STM.

MSRP - \$25⁰⁰
MIKROE-5864





Color 11 Click

Features the TCS34083M, an ALS/color sensor from ams-OSRAM.

MSRP – \$15⁰⁰
MIKROE-5894

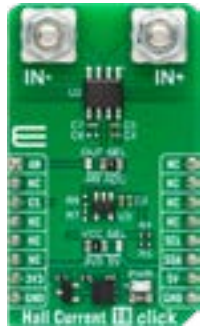

Hall Current 18 Click

Based on the MCS1806, an isolated Hall-effect current sensor from MPS.

MSRP – \$32⁰⁰
MIKROE-5832



Gyro 8 Click

Carries Murata's SCR2100-D08, a high-performance gyroscope.

MSRP – \$139⁰⁰
MIKROE-5471



Thunder EMU Click

Features circuits that generate an RF signal that mimics lightning strikes.

MSRP – \$19⁰⁰
MIKROE-5904



3D Hall 4 Click

This board features the SENM3Dx, a 3D Hall magnetic sensor from SENIS.

MSRP – \$45⁰⁰
MIKROE-5925



LIN Hall 2 Click

This board features the TMAG5253, a low-power linear Hall-effect sensor from TI.

MSRP – \$11⁰⁰
MIKROE-5932



Opto Encoder 4 Click

Carries the EE-SX4330, a transmissive photo-microsensor from OMRON.

MSRP – \$15⁰⁰
MIKROE-5979



6DOF IMU 16 Click

Features the ICM-42605, a 6-axis MotionTracking™ IMU from TDK InvenSense.

MSRP – \$19⁰⁰
MIKROE-6040



Speed Sense Click

Based the A17501, a dual output differential speed and direction sensor from Allegro.

MSRP – \$19⁰⁰
MIKROE-5977



IR Sense 4 Click

Carries the STHS34PF80, a low-power high-sensitivity infrared (IR) sensor from STM.

MSRP – \$18⁰⁰
MIKROE-5952



Accel&Pressure Click

Features the MPL3115A2, a precision pressure sensor with altimetry, both from NXP.

MSRP - \$15⁰⁰
MIKROE-6028



Hall Switch 3 Click

Based on the NMH1000, a Hall-effect magnetic switch from NXP.

MSRP - \$7⁰⁰
MIKROE-6017



Mag&Accel Click

Features NMH1000, a Hall-effect magnetic field sensor, and FXLS8974CF, accelerometer from NXP.

MSRP - \$15⁰⁰
MIKROE-6027



Barometer 13 Click

Carries the BMP585, a barometric pressure sensor from Bosch Sensortec.

MSRP - \$19⁰⁰
MIKROE-5921



EZO Carrier Click

With the EZO-DO™, an ISO 5814 compliant embedded dissolved oxygen circuit board from Atlas Scientific.

MSRP - \$135⁰⁰
MIKROE-6010



PCR Click

Features the XM125, the Entry+ PCR module from Acconeer.

MSRP - \$49⁰⁰
MIKROE-4636



EZO Carrier Click-RTD

Features the XM125, the Entry+ PCR module from Acconeer.

MSRP - \$119⁰⁰
MIKROE-6012



Barometer 9 Click

Features the ENS220, a barometric pressure and temperature sensor from ScioSense.

MSRP - \$18⁰⁰
MIKROE-6035



EZO Carrier Click-ORP

With EZO-ORP™, an ISO 11271 compliant embedded ORP circuit board from Atlas Scientific.

MSRP - \$129⁰⁰
MIKROE-6013



6DOF IMU 22 Click

Features the ICM-42670-P, a high-performance 6-axis MEMS MotionTracking IMU from TDK.

MSRP - \$18⁰⁰
MIKROE-6024





EZO Carrier Click-EC

With the EZO-EC™, an ISO 7888 compliant embedded ORP circuit board from Atlas Scientific.

MSRP – \$169⁰⁰
MIKROE-6011



Current Sens 2 Click

Features the HO 10-P, an AC/DC current transducer from LEM USA.

MSRP – \$32⁰⁰
MIKROE-6018



Hall Switch 3 Click

Based on the NMH1000, a Hall-effect magnetic switch from NXP.

MSRP – \$7⁰⁰
MIKROE-6017



Mag&Accel Click

Features NMH1000, a Hall-effect magnetic field switch, and FXLS8974CF, accelerometer from NXP.

MSRP – \$15⁰⁰
MIKROE-6027

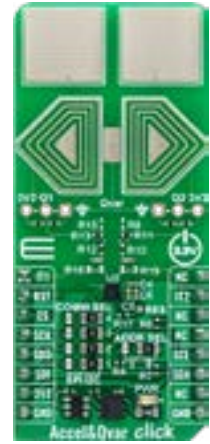

Accel&Qvar Click

Features the LIS2DUXS12, an ultralow-power accelerometer from STM.

MSRP – \$22⁰⁰
MIKROE-6025



Air Quality 11 Click

This board features the ENS161, a multi-gas sensor from ScioSense.

MSRP – \$32⁰⁰
MIKROE-6063



Opto Encoder 5 Click

Based on the OPB666N, a Photologic® slotted optical switch from TT Electronics.

MSRP – \$20⁰⁰
MIKROE-6056



IR Eclipse 2 Click

Carries the EE-SX1330, a transmissive photomicro-sensor with a phototransistor output from OMRON.

MSRP – \$14⁰⁰
MIKROE-6047



Light 2 Click

Features the ISL76682, a high-sensitivity, light-to-digital sensor with an I2C interface from Renesas.

MSRP – \$18⁰⁰
MIKROE-6022



Light 3 Click

Features the OPT4003-Q1, an automotive-grade digital ambient light sensor from TI.

MSRP – \$20⁰⁰
MIKROE-5994





Load Cell 8 Click

Features the ZSC31050, an advanced differential sensor signal conditioner from Renesas.

MSRP - \$35⁰⁰
MIKROE-6060

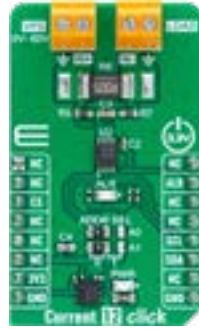

Current 12 Click

Based on the TSC1641, a 60V 16-bit power monitor with an I2C interface from ST.

MSRP - \$30⁰⁰
MIKROE-6065



PIR 2 Click

Carries the ZSLM323511, a dual-element balanced differential pyroelectric [PIR] sensor from Zilog.

MSRP - \$22⁰⁰
MIKROE-6052



Tilt 4 Click

Features the RB-231X2, a rolling ball tilt switch from C&K Switches.

MSRP - \$14⁰⁰
MIKROE-6026



IR Sense 5 Click

With the ZTP-148SRC1, a thermopile IR sensor from Amphenol.

MSRP - \$19⁰⁰
MIKROE-6093



Hall Current 19 Click

Features the CZ3AG2, a coreless current sensor from AKM Semiconductor.

MSRP - \$35⁰⁰
MIKROE-6097

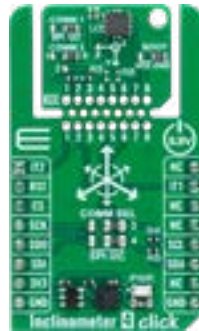

Inclinometer 4 Click

Based on the FX-LS8971CF, a 3-axis low-g MEMS accelerometer from NXP.

MSRP - \$11⁰⁰
MIKROE-6259



Compass 8 Click

Carries the AK09919, a 3-axis electronic compass IC from AKM Semiconductor.

MSRP - \$18⁰⁰
MIKROE-6099



Proximity 19 Click

With the RPR-0720, a digital optical proximity sensor from ROHM Semiconductor.

MSRP - \$14⁰⁰
MIKROE-6062

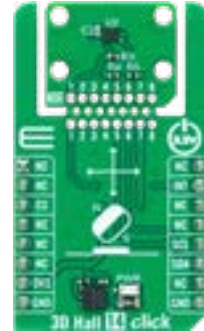

3D Hall 14 Click

Features the MLX90394, a 3-axis magnetometer from Melexis.

MSRP - \$14⁰⁰
MIKROE-6242





Temp&Hum 25 Click

With the SHT33-DIS-B2.5KS, humidity and temperature sensor from Sensirion.

MSRP - \$26⁰⁰
MIKROE-6241



Pressure 23 Click

Carries the MS5849-07BA, an ultra-compact, chlorine-resistant sensor from TE Connectivity.

MSRP - \$29⁰⁰
MIKROE-6207



6DOF IMU 23 Click

Features the IIM-20670, a high-performance 6-axis MotionTracking device from TDK.

MSRP - \$49⁰⁰
MIKROE-5999



Barcode 3 Click

Features the LV30, an advanced area image engine from Rakinda.

MSRP - \$149⁰⁰
MIKROE-6130

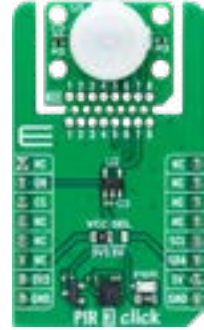

PIR 3 Click

Based on the ZDP323B1 sensor from Zilog [Littelfuse].

MSRP - \$29⁰⁰
MIKROE-6290



Current 11 Click

Features the ACS37600K, a programmable linear Hall-effect sensor IC from Allegro.

MSRP - \$29⁰⁰
MIKROE-6166

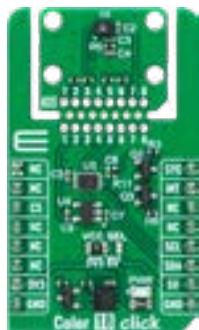

Color 18 Click

Based on the TCS3530, a true color ambient light sensor from ams OSRAM.

MSRP - \$37⁰⁰
MIKROE-6294



Grid-EYE 2 Click

Carries the AMG883543, an infrared array sensor from Panasonic.

MSRP - \$99⁰⁰
MIKROE-6208

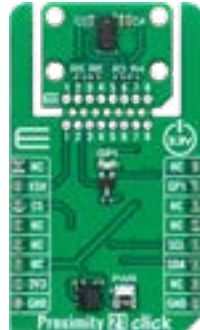

Proximity 21 Click

Features the VL53L4ED, a Time-of-Flight (ToF) proximity sensor from STMicroelectronics.

MSRP - \$21⁰⁰
MIKROE-6286

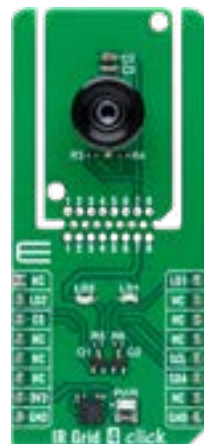

IR Grid 4 Click

Based on the MLX90641, a fully calibrated thermal IR array from Melexis.

MSRP - \$75⁰⁰
MIKROE-6306x



Power Monitor 2 Click

Features two INA219 12-bit I2C-output digital power monitors from TI.

MSRP - \$29⁰⁰
MIKROE-6202



IR Thermo 4 Click

Carries the TPI5 1T 1386 L5.5 H thermopile sensor from Excelitas.

MSRP - \$45⁰⁰
MIKROE-6135

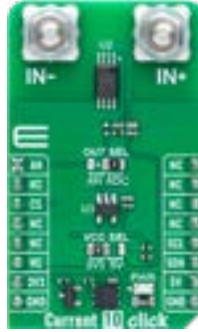

Current 10 Click

features the CT455, an XtremeSense™ TMR coreless current sensor from Allegro.

MSRP - \$29⁰⁰
MIKROE-6385



Inclinometer 3 Click

Based on the SCL3400-D01, a two-axis inclinometer sensor from Murata.

MSRP - \$139⁰⁰
MIKROE-6050



6DOF IMU 21 Click

Features the WSEN-ISDS [2536030320001] sensor from Würth Elektronik.

MSRP - \$35⁰⁰
MIKROE-6037



Ambient 14 Click

This board features the TMD2755, an advanced sensor from ams OSRAM

MSRP - \$14⁰⁰
MIKROE-6255



Smart DOF 5 Click

Features the ASM330LHHXG1, a high-accuracy 6-axis IMU from STMicroelectronics.

MSRP - \$49⁰⁰
MIKROE-6398



MY NAME IS **CLICK.**

SPEED RADAR CLICK.

With **ClickID** Click boards™ are now capable to **introduce** themselves!

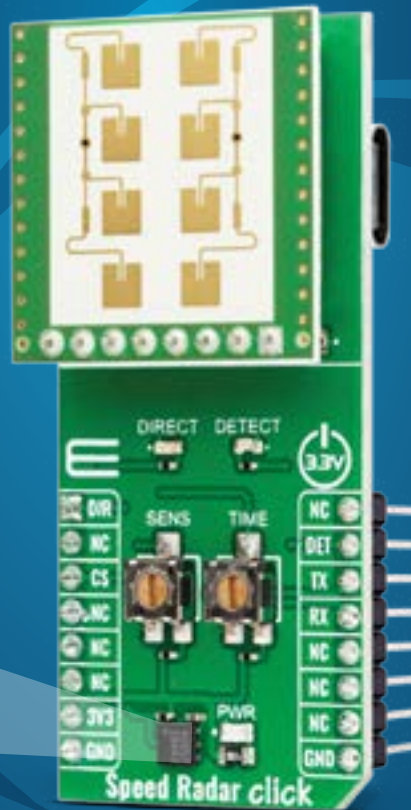

Scan to learn more
about **ClickID!**

INTERFACE





RS232 2 Click

The MAX3237E, a 3V to 5.5V multichannel RS232, 1 Mbit/s line driver/receiver from Texas Instruments.

MSRP - \$15⁰⁰
MIKROE-2897



1-Wire I2C Click

Converts I2C to 1-wire with DS28E17 1-Wire-to-I2C master bridge from Maxim Integrated.

MSRP - \$22⁰⁰
MIKROE-2750



4-20 mA R Click

Serves as a receiver in a 4-20mA current loop standard. Converts it into a voltage [0.4-2V].

MSRP - \$31⁰⁰
MIKROE-1387



4-20 mA T Click

Easy solution for adding 4-to-20mA industry standard communication protocol to your design.

MSRP - \$26⁰⁰
MIKROE-1296



ATA6563 Click

Microchip's ATA6563 high-speed CAN receiver for Classical CAN and CAN FD networks.

MSRP - \$20⁰⁰
MIKROE-2334



ATA663211 Click

LIN transceiver IC designed to handle low-speed data communication in applications.

MSRP - \$19⁰⁰
MIKROE-2335



CAN Isolator Click

Provides isolated CAN communication. Data rates of up to 1 Mbps. Carries a DB 9-pin male connector.

MSRP - \$39⁰⁰
MIKROE-2627



CAN SPI Click 3.3V

Adds CAN connectivity with SPI interface. Features SN65HVD230 CAN transceiver circuit.

MSRP - \$21⁰⁰
MIKROE-986



CAN SPI Click 5V

Adds CAN connectivity with SPI interface. With MCP2551 CAN transceiver circuit.

MSRP - \$21⁰⁰
MIKROE-988



DALI Click

Provides Digital Lighting Interface. With two optocouplers, push button, screw terminal.

MSRP - \$25⁰⁰
MIKROE-1297





ETH Click

With ENC28J60, a 28-pin, 10BASE-T stand-alone Ethernet controller with an on-board MAC & PHY.

MSRP - \$24⁰⁰
MIKROE-971



ETH WIZ Click

With W5500, a 48-pin, 10/100 BASE-TX stand-alone Ethernet controller. Standard RJ-45 connector.

MSRP - \$19⁰⁰
MIKROE-1718



EXPAND Click

Expands the number of input-output lines with Microchip's 16-bit I/O expander MCP23S17.

MSRP - \$12⁰⁰
MIKROE-951



Expand 2 Click

Expands the number of input-output lines with Microchip's 16-bit I/O expander MCP23017.

MSRP - \$12⁰⁰
MIKROE-1838

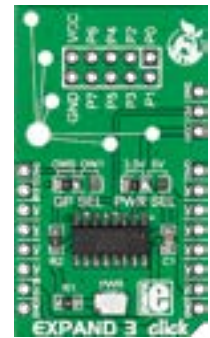

Expand 3 Click

With DS2408, an 8-channel programmable I/O expander from Maxim Integrated.

MSRP - \$19⁰⁰
MIKROE-1874



EXPAND 4 Click

Port expander for high power peripherals with TPC1C6A595 power logic 8-bit register.

MSRP - \$14⁰⁰
MIKROE-1910



BroadR-Reach Click

For realizing network in harsh environments that require reliable Ethernet-based open network.

MSRP - \$69⁰⁰
MIKROE-2796



USB UART 4 Click

USB to asynchronous serial data transfer interface. With FT232RL, USB-to-UART interface module.

MSRP - \$22⁰⁰
MIKROE-2810



RS232 Click

Adds RS232 connectivity with a standard RS232 DB9 port and a MAX3232 IC.

MSRP - \$15⁰⁰
MIKROE-1582



USB I2C Click

With MCP2221 USB-to-UART/I2C converter. Full-speed USB [12 Mb/s], I2C up to 400 kHz clock rates.

MSRP - \$13⁹⁰
MIKROE-1985



USB SPI Click

Microchip's MCP2210 USB-to-SPI protocol converter with GPIO as well as USB MINI B connector.

MSRP - \$13⁰⁰
MIKROE-1204



USB UART 2 Click

Provides USB isolation and carries the AD-UM4160BRWZ USB port isolator.

MSRP - \$39⁰⁰
MIKROE-2674



USB UART Click

Adds serial UART communication via USB cable. With FT232RL USB-to-UART interface module.

MSRP - \$22⁰⁰
MIKROE-1203



ATA663254 Click

It is a fully integrated LIN transceiver device with an integrated 5V LDO voltage regulator.

MSRP - \$16⁰⁰
MIKROE-2872



OBDII Click

Tap inside the car diagnostic systems! Features the STN1110 Multiprotocol OBD to UART Interface.

MSRP - \$9⁰⁰
MIKROE-2452



4D - display Click

Offers a mikroBUS™ interface for controlling 4D Systems gen4 Series Intelligent Display Modules.

MSRP - \$9⁰⁰
MIKROE-3044

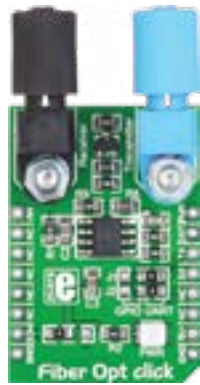

Fiber Opt Click

Adds fiber-optic communication with IF-D91 fiber-optic photodiode, IF-E97 fiber-optic LED diode.

MSRP - \$34⁰⁰
MIKROE-1940



FTDI Click

With FT2232H - dual high speed USB 2.0 to UART/I2C/SPI serial interface converter.

MSRP - \$29⁰⁰
MIKROE-1421



I2C 1-Wire Click

Performs bidirectional conversions between I2C masters and 1-Wire slave devices with DS2482-800.

MSRP - \$28⁰⁰
MIKROE-1892

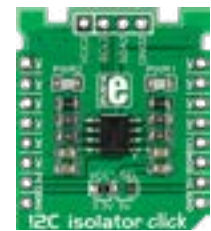

I2C Isolator Click

Ti's ISO1540, a low-power, bidirectional isolator compatible with I2C interfaces.

MSRP - \$18⁰⁰
MIKROE-1878





SPI Isolator Click
Carries ADuM4154 5kV digital isolator optimized for a serial peripheral interface (SPI).
MSRP - \$29⁰⁰
MIKROE-2583



I2C Isolator 2 Click
Provides I2C lines and power isolation for slave devices with ADM3260 dual I2C isolator.
MSRP - \$24⁰⁰
MIKROE-2609



MCP2517FD Click
With MCP2517FD CAN FD controller and ATA6563 high-speed CAN transceiver.
MSRP - \$25⁰⁰
MIKROE-2379



RS485 2 Click
Carries MAX3471 half-duplex transceiver for lithium battery-powered RS-485/RS-422 applications.
MSRP - \$18⁰⁰
MIKROE-2700

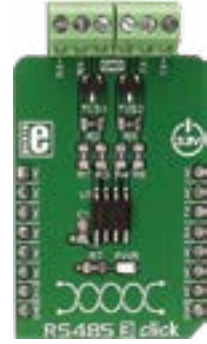

RS485 3 Click
The Click is intended to be used as UART to RS422/RS485 communication interface.
MSRP - \$20⁰⁰
MIKROE-2821



RS485 Click 3.3V
Carries SN-65HVD12 half-duplex, RS-485 transceiver from Texas Instruments.
MSRP - \$18⁰⁰
MIKROE-989



RS485 Click 5V
Carries the ADM485 differential line transceiver from Analog Devices.
MSRP - \$18⁰⁰
MIKROE-925



PS/2 Click
Adds keyboard and mouse connectivity. With a standard 6-pin Mini-DIN PS/2 connector.
MSRP - \$9⁰⁰
MIKROE-1576



PWM Click
For controlling 16 PWM outputs through a single I2C interface. With PCA9685PW IC.
MSRP - \$14⁰⁰
MIKROE-1898



PWM 2 Click
With the LT8500, a 48-Channel LED PWM generator with 12-Bit res. and 50MHz serial interface.
MSRP - \$27⁰⁰
MIKROE-3148



MCP2542 Click

Microchip's CAN FD Transceiver with Wake-Up Pattern. Compliant with CAN 2.0 and CAN FD.

MSRP - \$20⁰⁰

MIKROE-2299



RS485 Isolator Click

With ADM2682EBRIZ, a 5 kV RMS signal and power isolated RS-485 transceiver.

MSRP - \$49⁰⁰

MIKROE-2673



MCP25625 Click

With CAN controller with an integrated transceiver. High speed operation up to 1 Mb/s.

MSRP - \$24⁰⁰

MIKROE-2228



MCP2003B Click

It's a physical interface to automotive and industrial LIN systems with a bi-directional LIN transceiver.

MSRP - \$18⁰⁰

MIKROE-2227

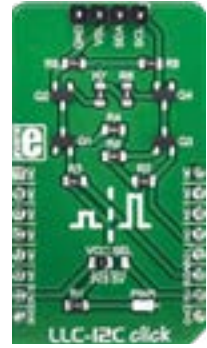

LLC-I2C Click

Used as the level converter for logic signals. It is perfectly suited for the bi-directional I2C communication.

MSRP - \$9⁰⁰

MIKROE-3276



LLC-SPI Click

Used as the level converter for logic signals. It is perfectly suited for SPI communication.

MSRP - \$9⁰⁰

MIKROE-3298



UART 1-Wire Click

Designed to convert standard UART or RS232 signals into 1-Wire® signals.

MSRP - \$22⁰⁰

MIKROE-3340



RS232 Isolator Click

Isolated dual transceiver Click - secure and easy UART to RS232 conversion, with galvanic isolation.

MSRP - \$56⁰⁰

MIKROE-2864



Skywire™ Click

Adapter Click, which hosts NibelLink/Skywire™ cellular modems (using stacking headers).

MSRP - \$19⁰⁰

MIKROE-2405

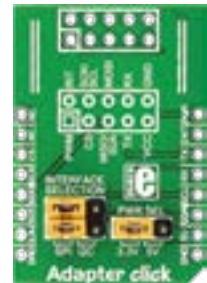

Adapter Click

Simplifies connection of the add-on boards with IDC10 headers to mikroBUS™ socket.

MSRP - \$6⁵⁰

MIKROE-1432





Riverti Click

An adapter for connecting Riverti TFT displays to a mikroBUS™ socket.

MSRP - \$9⁰⁰
MIKROE-2100



RiBUS Click

An adapter for connecting any Riverti TFT displays to a mikroBUS™ socket over the RiBUS connector.

MSRP - \$9⁰⁰
MIKROE-3642

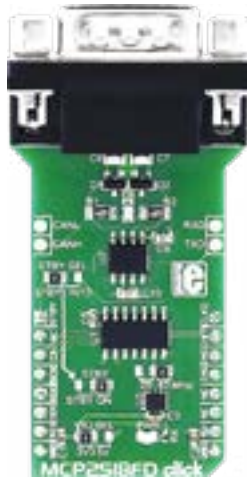

MCP2518D Click

The ATA6563, a high-speed CAN transceiver and the MCP2518FD, CAN FD controller both ICs by Microchip.

MSRP - \$25⁰⁰
MIKROE-3060



RS485 4 Click

The ADM2795E, a dual channel RS485 driver/receiver, with the ICoupler™ isolation technology, by Analog Devices.

MSRP - \$39⁰⁰
MIKROE-3395



UART I2C/SPI Click

The SC16IS740, 64 bytes of transmit and receive FIFOs, and IrDA SIR built-in support, from NXP.

MSRP - \$24⁰⁰
MIKROE-3349



Shuttle Click

The mikroBUS™ socket expansion board, which allows stacking up to four Click boards™.

MSRP - \$8⁰⁰
MIKROE-2880



iButton™ Click

Comes with Maxim's DS1990A, a serial number iButton™ device with a unique 64-bit serial number.

MSRP - \$35⁰⁰
MIKROE-3045



USB UART 3 Click

The CP2102N, a highly integrated USB to UART interface, from Silicon Labs.

MSRP - \$15⁰⁰
MIKROE-3063



DALI 2 Click

It is used for interfacing with the DALI network, and as a compliant with the DALI-2 physical layer requirements.

MSRP - \$25⁰⁰
MIKROE-2672



ATA6570 Click

Uses the ATA6570, a standalone high speed CAN transceiver IC from Microchip.

MSRP - \$23⁰⁰
MIKROE-2900



Dual LIN Click

It's a dual transceiver for LIN with the TLE-7268SKXUMA1 from Infineon.

MSRP - \$12⁰⁰
MIKROE-3870



eINK Click -WD

Click board adapter for connection of the e-paper displays to the MCU over SPI interface.

MSRP - \$7⁰⁰
MIKROE-3683



I2C to SPI Click

It's based around two SC18IS602B, an I2C-bus to SPI bridge from NXP.

MSRP - \$12⁰⁰
MIKROE-3743



LIN Click

It's the TLE7259-3GE, LIN transceiver with integrated wake-up and protection features.

MSRP - \$12⁰⁰
MIKROE-3816



M-Bus Master Click

It's the TLE7259-3GE, LIN transceiver with integrated wake-up and protection features.

MSRP - \$15⁰⁰
MIKROE-3880



Terminal Click

The stackable mikroBUS™ extension board that can be used for testing or com. surveillance.

MSRP - \$7⁰⁰
MIKROE-3745



Matrix RGB Click

Powered by a 32-bit FT900 MCU designed specifically for powering 16x32 RGB LED matrices.

MSRP - \$24⁰⁰
MIKROE-2239



UART MUX Click

It's the SN74LV4052A, a Dual 4-Channel Multiplexer and Demultiplexer.

MSRP - \$7⁰⁰
MIKROE-3878



RS232 SPI Click

It's a SPI to RS232 interface converter with two ICs - MAX3100 and MAX3232.

MSRP - \$29⁰⁰
MIKROE-3912



FT click

Features FT 6050 Free Topology Smart Transceiver from Dialog Semiconductor.

MSRP - \$39⁰⁰
MIKROE-3929





MCP2518FD Click

Features MCP2518FD, CAN FD controller and ATA6563 CAN transceiver.

MSRP - \$45⁰⁰
MIKROE-3060



I2C MUX Click

The TCA9546A, a quad bidirectional translating switch controlled via the I2C bus.

MSRP - \$7⁰⁰
MIKROE-4048



CAN FD Click

Features TLE9252V high speed CAN network transceiver from Infineon.

MSRP - \$21⁰⁰
MIKROE-3933



I2C MUX 2 Click

Uses the TCA9545A, a 4-channel, bidirectional translating I2C switch.

MSRP - \$7⁰⁰
MIKROE-4094



RS485 Isolator 2 Click

With the ADM2867E a 5.7 kV rms signal and power isolated full duplex RS-485 transceiver.

MSRP - \$35⁰⁰
MIKROE-3863



RS485 6 Click

With the THVD1329DT a half-duplex RS-485 communication with integrated surge protection.

MSRP - \$16⁰⁰
MIKROE-3993



CAN FD 3 Click

Features TLE9251V, a High-Speed CAN transceiver from Infineon.

MSRP - \$15⁰⁰
MIKROE-3992



Analog MUX Click

With the CD74HC4067, a high-speed CMOS logic 16-channel analog multiplexer/demultiplexer.

MSRP - \$7⁰⁰
MIKROE-4111



CAN FD 4 Click

Features the NC-V7344D10R2G, a Controller Area Network [CAN] transceiver.

MSRP - \$14⁰⁰
MIKROE-4107



XPRO-Adapter click

Xplained Pro boards have one or more dual row, 20-pin, 100mil female extension header.

MSRP - \$12⁰⁰
MIKROE-4123



DMX Click

With the ADM2862E - Power Isolated RS-485 Transceiver and PIC18F26K42 MCU.

MSRP - \$36⁰⁰
MIKROE-4130



Monarch Adapter Click

Connects a compatible Monarch Go LTE-M modems from Sequans to a development board or prototype device.

MSRP - \$16⁰⁰
MIKROE-4057



RS485 5 Click

Equipped with the MAX485, low-power, slew-rate-limited transceiver.

MSRP - \$16⁰⁰
MIKROE-4156



M-Bus Slave Click

Equipped with the TSS721A, a single chip transceiver.

MSRP - \$15⁰⁰
MIKROE-4137



RF Switch Click

Uses the MASWSS0115 IC, a GaAs PHEMT MMIC single-pole, double-throw (SPDT) switch.

MSRP - \$20⁰⁰
MIKROE-4168



EXPAND 5 Click

Uses the TCA6424A IC, low-voltage 24-bit I2C, and SMBus I/O expander.

MSRP - \$12⁰⁰
MIKROE-4186



I2C Extend Click

Based on the LTC4331, which is a point-to-point compatible I2C slave device extender.

MSRP - \$27⁰⁰
MIKROE-4207



SPI Extend Click

SPI Extend Click is based on LTC4332, a 2MHz point-to-point SPI bus extender.

MSRP - \$19⁰⁰
MIKROE-4184



Single Wire CAN Click

Based on the NCV7356D1R2G, a Single Wire CAN transceiver.

MSRP - \$9⁰⁰
MIKROE-4225



I2C MUX 4 Click

Based on the LTC4306, a 4-channel, 2-wire bus multiplexer with bus buffers.

MSRP - \$7⁰⁰
MIKROE-4240





EXPAND 6 Click

The CY8C9520A, 20-bit I/O expander with EEPROM, and 4 independently config. 8-bit PWM outputs.

MSRP - \$15⁰⁰
MIKROE-4243



I2C MUX 3 Click

The TCA9548APWR, a low voltage eight bidirectional translating switches with an active-low reset input.

MSRP - \$21⁰⁰
MIKROE-4262



EXPAND 7 Click

The CY8C9540A, 40-bit I/O expander with EEPROM, and 8 independently config. 8-bit PWM outputs.

MSRP - \$24⁰⁰
MIKROE-4244



8-pin I2C Click

A breakout board that simplifies the connection of MFI devices to the mikroBUS™ socket.

MSRP - \$7⁰⁰
MIKROE-4241



CAN FD 5 Click

Based on the UJA1162A, a 'self-supplied' high-speed [HS] CAN transceiver.

MSRP - \$21⁰⁰
MIKROE-4286



ISO 9141 Click

The L9637, a monolithic bus driver designed for serial comm. in automotive diagnostic applications.

MSRP - \$7⁰⁰
MIKROE-4331



CXPI Click

The BD41000AFJ-C, a transceiver for the Clock Extension Peripheral Interface [CXPI] communication.

MSRP - \$12⁰⁰
MIKROE-4336



I2C Extend 2 Click

The PCA9615, a Fast-Mode Plus [FM+] I2C bus buffer from NXP.

MSRP - \$17⁰⁰
MIKROE-4419



ATA6571 Click

A standalone high-speed CAN FD transceiver up to 5 Mbit/s from Microchip.

MSRP - \$23⁰⁰
MIKROE-4381



I2C MUX 5 Click

Based the LTC4306, a 4-channel, 2-wire bus multiplexer from Analog Devices.

MSRP - \$24⁰⁰
MIKROE-4453



SPI Isolator 2 Click

Features the ISO7741, a quad-channel digital isolator from Texas Instruments.

MSRP – \$12⁰⁰
MIKROE-4415



I2C Isolator 3 Click

CPC5902 - a dual optically isolated bi-directional logic-bus repeater.

MSRP – \$12⁰⁰
MIKROE-4467



Biarno Nova Click

Multi-protocol adapter, support for SPI I2C and UART interface, ideal for testing and validation.

MSRP – \$6⁵⁰
MIKROE-4439



ETH 3 Click

Uses the LAN9250, a fully-featured high-performance 10/100 Ethernet controller.

MSRP – \$39⁰⁰
MIKROE-2850



RS232 Isolator 2 Click

Uses the ICL3221, a 3.3V powered RS232 transmitter/receiver that provides ±15kV ESD protection.

MSRP – \$27⁰⁰
MIKROE-4536



UART MUX 2 Click

Features the MAX399, a precise CMOS analog multiplexer.

MSRP – \$36⁰⁰
MIKROE-4494



EtherCAT Click

2/3-Port EtherCAT® Slave Controller with Integrated Ethernet PHYs.

MSRP – \$37⁰⁰
MIKROE-2851



CAN FD 6 Click

Features the TCAN4550, CAN FD controller with integrated transceiver from Texas Instruments.

MSRP – \$21⁰⁰
MIKROE-4572



Expand 8 Click

Based on the MAX7317, 10-Port SPI-interfaced I/O expander from Analog Devices.

MSRP – \$18⁰⁰
MIKROE-4442

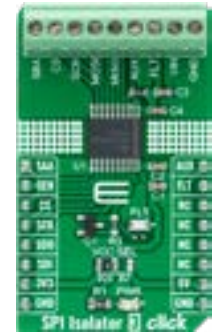

SPI Isolator 3 Click

Carries the ADuM341E, a quad-channel 5kVRMS digital isolator from Analog Devices.

MSRP – \$17⁰⁰
MIKROE-4651





CAN Bus Click

Based on the MAX13054, CAN transceiver with ±80V fault protection from Analog Devices.

MSRP – \$44⁰⁰
MIKROE-4640



I2C to CAN Click

Features the LT3960, transceiver that extends I2C bus up to 400kbps from Analog Devices.

MSRP – \$15⁰⁰
MIKROE-4644



Expand 10 Click

Features the PCAL6524, a 24-bit general-purpose I/O expander from NXP Semiconductors.

MSRP – \$15⁰⁰
MIKROE-4801



Expand 9 Click

Carries the SX1509QB, the world's lowest voltage level shifting GPIO expander from Semtech.

MSRP – \$23⁰⁰
MIKROE-4853



Turbidity Click

An adapter board with 1x3 pin 2.5mm connector suitable for connecting Turbidity sensors.

MSRP – \$6⁰⁰
MIKROE-4276



EXPAND 12 Click

Based on the MAX7300, a general-purpose I/O expander from Analog Devices.

MSRP – \$35⁰⁰
MIKROE-4889



EXPAND 13 Click

Carries the PI4I0-E5V96248, a 48-bit general-purpose I/O expander from Diodes.

MSRP – \$15⁰⁰
MIKROE-4887



Terminal 2 Click

Adapter Click board™ which can be used as a mikroBUS™ socket expansion board.

MSRP – \$12⁰⁰
MIKROE-4951



TFmini Click

Adapter board with 4pin 1.25mm connector suitable for connecting the TFmini LiDAR module.

MSRP – \$12⁰⁰
MIKROE-4974



I2C MUX 7 Click

Features the PI4MSD5V9547, an octal bidirectional multiplexer from TI.

MSRP – \$15⁰⁰
MIKROE-5069



USB to I2C 2 Click

Features the FT201X, a full-speed USB to I2C protocol slave IC from FTDI.

MSRP - \$15⁰⁰
MIKROE-5065



RS232 to I2C Click

With ZDU0110RFX, a bridge between a UART port and an I2C bus from Littelfuse.

MSRP - \$12⁰⁰
MIKROE-5056



SPI Isolator 6 Click

Carries the MAX22345, digital galvanic isolator from Analog Devices.

MSRP - \$29⁰⁰
MIKROE-5265



RS232 3 Click

Based on the SP3221E, a low-power RS232 transceiver from MaxLinear.

MSRP - \$15⁰⁰
MIKROE-5109

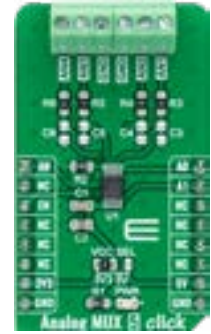

Analog MUX 5 Click

With the TMUX1308, a 8:1 single-ended CMOS MUX from Texas Instruments.

MSRP - \$12⁰⁰
MIKROE-5120



I2C MUX 6 Click

Features the PCA9518, an expandable five-channel bidirectional buffer from Texas Instruments.

MSRP - \$12⁰⁰
MIKROE-5168



Expand 14 Click

Equipped with the CAT9555, a CMOS device from ON Semiconductor.

MSRP - \$15⁰⁰
MIKROE-5241



MCP251863 Click

Carries the MCP251863, a CAN FD controller and transceiver in one package from Microchip.

MSRP - \$25⁰⁰
MIKROE-4955



Analog MUX 4 Click

Based on the TMUX1308, a CMOS MUX from Texas Instruments.

MSRP - \$11⁰⁰
MIKROE-4795



USB to I2C Click

Based on FT260, an interface device controller with USB 2.0 HID from FTDI.

MSRP - \$19⁰⁰
MIKROE-5312





I2C Isolator 4 Click

Features the MAX14937, I2C digital isolator from Analog Devices.

MSRP - \$12⁰⁰
MIKROE-4675



Smart Card 2 Click

Features Microchip's SEC1210, a low-power single-chip Smart Card controller.

MSRP - \$21⁰⁰
MIKROE-5492



Shutter Click

Carries the V0617A, a high-reliability phototransistor from Vishay.

MSRP - \$12⁰⁰
MIKROE-5493



UART to I2C Click

With the SC18IM704, a bridge between the UART host interface and a serial I2C bus from NXP.

MSRP - \$18⁰⁰
MIKROE-5508

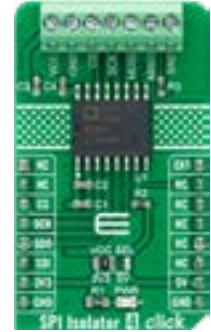

SPI Isolator 4 Click

Features the ADuM341E, a quad-channel 5kVRMS digital isolator from Analog Devices.

MSRP - \$12⁰⁰
MIKROE-4869



Expand 11 Click

Carries the TCA9536, a general-purpose remote I/O expansion from TI.

MSRP - \$15⁰⁰
MIKROE-5532



4-20mA T 2 Click

Features DAC161S997, a low-power 16-bit digital-to-analog converter [DAC] from TI.

MSRP - \$25⁰⁰
MIKROE-5540



USB UART 5 Click

Based on the CP2110, USB-to-UART bridge controller from Silicon Labs.

MSRP - \$18⁰⁰
MIKROE-5574



1-Wire Switch Click

Features the DS2413, a dual-channel programmable I/O 1-Wire switch from Analog Devices.

MSRP - \$13⁰⁰
MIKROE-5589



Two-Wire ETH Click

Features the LAN8651, a single-port Ethernet Controller with SPI from Microchip.

MSRP - \$42⁰⁰
MIKROE-5543





I2C Isolator 6 Click

Features the ADUM2250, a two-channel, 5kVRMS I2C digital isolator from Analog Devices.

MSRP - \$29⁰⁰
MIKROE-5603



RS485 Isolator 3 Click

With the ADM2763E, a 5.7kV RMS, signal-isolated RS-485 transceiver from Analog Devices.

MSRP - \$27⁰⁰
MIKROE-5597



Expand 15 Click

Carries the TCAL6416, a general-purpose I/O expansion from TI.

MSRP - \$15⁰⁰
MIKROE-5679



RS485 7 Click

Based on the THVD1424, a full duplex RS485 transceiver with a selectable data rate from TI.

MSRP - \$19⁰⁰
MIKROE-5659

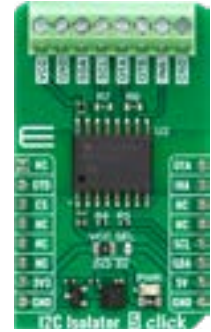

I2C Isolator 5 Click

Features ISO1644, a hot-swappable bidirectional I2C isolator from TI.

MSRP - \$21⁰⁰
MIKROE-5725



N-PLC Click

Based on the ultimate N-PLC transceiver, the SM2400, from Semtech.

MSRP - \$119⁰⁰
MIKROE-5677



UART MUX 4 Click

Carries the 74HC4066D, a quad single-pole, single-throw analog switch from Nexperia.

MSRP - \$9⁰⁰
MIKROE-5720



RS485 8 Click

With the THVD1426, an RS485 transceiver with auto-direction control from TI.

MSRP - \$15⁰⁰
MIKROE-5752



USB MUX Click

Features the TS3USB30E, a USB 2.0 1:2 multiplexer/multiplexer switch with a single enable from TI.

MSRP - \$15⁰⁰
MIKROE-5748



CAN Isolator 2 Click

Based on the ISO1042, an isolated CAN transceiver with a single enable from TI.

MSRP - \$19⁰⁰
MIKROE-4809





CAN Isolator 3 Click

Based on the MAX14882, an isolated CAN transceiver with from ADI.

MSRP - \$45⁰⁰
MIKROE-5785



RS Transceiver Click

With the XR34350, an RS-232/RS-422/RS-485 serial transceiver from MaxLinear.

MSRP - \$12⁰⁰
MIKROE-5746



USB UART ISO Click

Features the ISOUSB111, a full/low-speed isolated USB repeater from TI.

MSRP - \$45⁰⁰
MIKROE-5815



DIGI Isolator Click

Features two DCL540C01, high-speed, quad-channel digital isolators from Toshiba.

MSRP - \$15⁰⁰
MIKROE-5178



SPI Isolator 5 Click

Features the DC-L541A01, a high-speed quad-channel digital isolator from Toshiba.

MSRP - \$13⁰⁰
MIKROE-5179



SPI Isolator 8 Click

Carries the ISOW7743, a quad-channel digital isolator from TI.

MSRP - \$29⁰⁰
MIKROE-5873



CAN FD 7 Click

Based on the TCAN1462, an automotive fault-protected CAN FD transceiver from TI.

MSRP - \$24⁰⁰
MIKROE-5888



I2C Isolator 7 Click

Features the ADuM1252, an ultra-low power, bidirectional I2C isolator from ADI.

MSRP - \$25⁰⁰
MIKROE-5943



DIGI Isolator 2 Click

Carries the ISO1228, an eight-channel isolated digital input from TI.

MSRP - \$21⁰⁰
MIKROE-5981

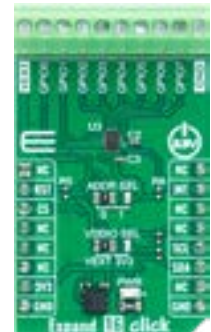

Expand 16 Click

With the FXL6408, a fully configurable 8-bit GPIO expander from ON Semi.

MSRP - \$15⁰⁰
MIKROE-5939



DIGI IN Click

Features the MAX22199, an octal industrial digital input from Analog Devices.

MSRP - \$32⁰⁰
MIKROE-6072



DIGI IN 2 Click

With the MAX22196, a high-performance octal industrial sink/source digital input IC from ADI.

MSRP - \$42⁰⁰
MIKROE-6049



I2C 1-Wire 2 Click

This board features the DS2485, an advanced 1-Wire master with memory from ADI.

MSRP - \$18⁰⁰
MIKROE-6058

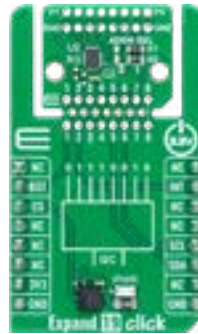

Expand 19 Click

With the TCAL9538, an 8-bit I2C-bus I/O expander from TI.

MSRP - \$13⁰⁰
MIKROE-6400



Expand 17 Click

Based on the TCAL6408, an 8-bit I/O expander from TI.

MSRP - \$15⁰⁰
MIKROE-6054



NECTO STUDIO

IDEAL CODING

ONE CODEBASE FOR ALL!

MULTI-LANGUAGE
MULTI-ARCHITECTURAL
CROSS-PLATFORM **IDE**

RUNS ON ALL PLATFORMS



Scan to learn more
about **NECTO Studio!**

GCC ARM mikroC ARM

MPLAB XC8 Compiler MPLAB XC32 Compiler

MikroC AVR GCC RISC-V mikroC PIC18

CLANG ARM mikroC PIC32 CLANG RISC-V

MikroC dsPIC MPLAB XC16 Compiler

mikroC



DISPLAY & LED



OLED B Click

With a 96 x 39px blue monochrome passive matrix OLED display and SSD1306 controller.

MSRP - \$24⁰⁰
MIKROE-1650



OLED C Click

With PSP27801 OLED display and SSD1351 OLED driver with controller. Various color support.

MSRP - \$37⁰⁰
MIKROE-1585



OLED W Click

Carries a 96x39px white monochrome passive matrix OLED display.

MSRP - \$24⁰⁰
MIKROE-1649



LCD mini Click

Displays 2x16 monochrome characters on an LMB162XFW LCD display.

MSRP - \$19⁰⁰
MIKROE-2453



OSD Click

With MAX7456 single-channel monochrome OSD module with integrated EEPROM memory.

MSRP - \$35⁰⁰
MIKROE-1366



Light Temp Click

The AL1782, a dual-channel PWM dimmable linear LED driver by Diodes Incorporated.

MSRP - \$17⁰⁰
MIKROE-3399

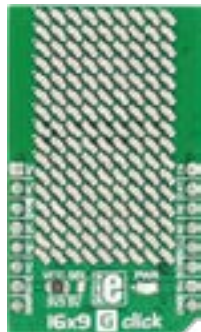

16x9 G Click

With a green 16x9 LED matrix and IS31FL3731 audio modulated matrix LED driver.

MSRP - \$34⁰⁰
MIKROE-2520

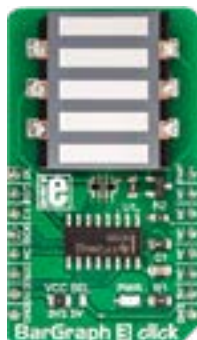

BarGraph 3 Click

Uses a single 74HC595 IC, a tri-state, serial-in, parallel-out, 8-bit shift-register with output latch.

MSRP - \$15⁰⁰
MIKROE-3264

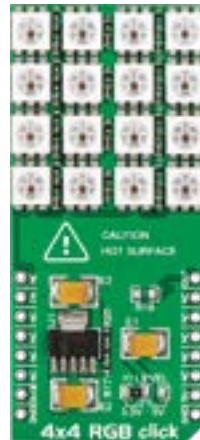

4X4 RGB Click

With a matrix of 16 WS2812 RGB LEDs a MCP1826 low dropout regulator.

MSRP - \$19⁰⁰
MIKROE-1881



7-SEG RGB Click

Carries a full color single 7 segment digit display. 16,581,375 color combinations.

MSRP - \$43⁰⁰
MIKROE-2734





7seg Click
 2-digit seven-seg display. With two 74HC595 8-bit serial-in, parallel-out shift registers.
 MSRP - \$10⁰⁰
 MIKROE-1201



7x10 B Click
 With a matrix of 70 blue LEDs driven by a pair of 8-bit serial-in, parallel-out shift registers.
 MSRP - \$15⁰⁰
 MIKROE-2789



7x10 G Click
 With a matrix of 70 green LEDs driven by a pair of 8-bit serial-in, parallel-out shift registers.
 MSRP - \$15⁰⁰
 MIKROE-2705



7x10 R Click
 With a matrix of 70 red LEDs driven by a pair of 8-bit serial-in, parallel-out shift registers.
 MSRP - \$15⁰⁰
 MIKROE-1993



7x10 Y Click
 With a matrix of 70 yellow LEDs driven by a pair of 8-bit serial-in, parallel-out shift registers.
 MSRP - \$15⁰⁰
 MIKROE-2790



16x12 G Click
 Carries a 16x12 LED display and the IS-31FL3733 matrix driver with 1/12 cycle rate.
 MSRP - \$30⁰⁰
 MIKROE-2758



8x8 B Click
 It features MAX7219 8-digit LED display driver module as well as 64 BLUE LEDs.
 MSRP - \$18⁰⁰
 MIKROE-1307

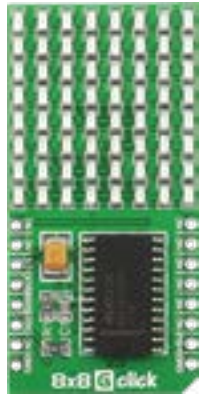

8x8 G Click
 It features MAX7219 8-digit LED display driver module as well as 64 GREEN LEDs.
 MSRP - \$21⁰⁰
 MIKROE-1306



8x8 R Click
 It features MAX7219 8-digit LED display driver module as well as 64 RED LEDs.
 MSRP - \$15⁰⁰
 MIKROE-1295



8x8 Y Click
 It features MAX7219 8-digit LED display driver module as well as 64 YELLOW LEDs.
 MSRP - \$15⁰⁰
 MIKROE-1294

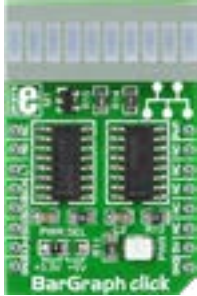

BarGraph Click

With 10-segment JSB-R102510Z light bar display and two 74HC595 8-bit shift registers.

MSRP – \$12⁰⁰
MIKROE-1423



BIG 7-SEG R Click

With SC10-21SR-WA seven-segment display and parallel-OUT shift register 74HC595.

MSRP – \$19⁰⁰
MIKROE-2269



eINK Click

With an adapter for connecting eINK displays, with a 24pin ribbon cable.

MSRP – \$59⁰⁰
MIKROE-2659



EVE Click

Brings visually stunning graphics even to 8-bit MCUs, with FT800Q graphics controller.

MSRP – \$39⁰⁰
MIKROE-1430



Matrix G Click

Matrix text display with two green 5x7 matrices and two MAX7219 8-bit LED display drivers.

MSRP – \$29⁰⁰
MIKROE-2246



LED Flash Click

Functions as a high power LED flash, and carries the CAT3224 flash LED driver.

MSRP – \$45⁰⁰
MIKROE-2479



LED Flash 2 Click

It is a powerful flash/ torch Click, featuring the MIC2870 from Microchip.

MSRP – \$19⁰⁰
MIKROE-2830



LED ring R Click

With a ring of 32 red LEDs driven by four 74HC595 serial-in, parallel-out shift registers.

MSRP – \$25⁰⁰
MIKROE-2153

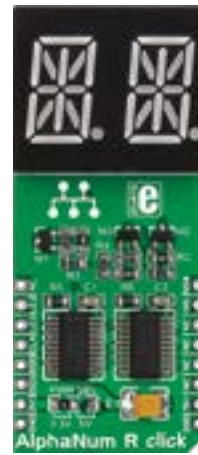

AlphaNum R Click

With a dual character red LED 14-segment display and two TLC5926 16-bit shift registers.

MSRP – \$15⁰⁰
MIKROE-1864

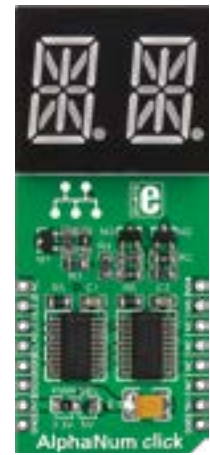

AlphaNum G Click

With a dual character green LED 14-segment display and two TLC5926 16-bit shift registers.

MSRP – \$15⁰⁰
MIKROE-1851





Matrix R Click

Matrix text display with two red 5x7 matrices and two MAX7219 8-bit LED display drivers.

MSRP - \$34⁰⁰
MIKROE-2245



4Dot-Matrix R Click

Displays 4 char. of 5x7 dot size. With SLO2016 module and MCP23017 I2C port expander.

MSRP - \$59⁰⁰
MIKROE-2706



UT-L 7-SEG R Click

With two SMD ultra-thin LED 7-SEG displays and MAX6969 constant-current LED driver.

MSRP - \$35⁰⁰
MIKROE-2034



UT-M 7-SEG R Click

Add a double 7 segment display to your next project. RED emitting color.

MSRP - \$34⁰⁰
MIKROE-2746



UT-S 7-SEG R Click

For displaying characters on two 7 segment displays. RED emitting color.

MSRP - \$27⁰⁰
MIKROE-2840



OLED Switch Click

With NKK Switch IS-C15ANP4 that combines a switch and a full color organic LED display.

MSRP - \$119⁰⁰
MIKROE-2449



BarGraph 2 Click

The 74HC595, 8-bit serial-in, parallel-out shift registers with output latches.

MSRP - \$19⁰⁰
MIKROE-3021



RGB Driver Click

The NCP5623B, a triple output RGB LED driver, controlled via the I2C interface, from ON Semiconductors.

MSRP - \$15⁰⁰
MIKROE-3078



LED-Driver 5 Click

The TPS54200, a synchronous buck converter designed to drive monochrome, color, and IR LED arrays by TI.

MSRP - \$15⁰⁰
MIKROE-3297



LED Driver 6 Click

The AL1781, a single-channel PWM dimmable linear LED driver by Diodes Incorporated.

MSRP - \$15⁰⁰
MIKROE-3400



LED Driver 7 Click

The AL1781, a single-channel PWM dimmable linear LED driver by Diodes Incorporated.

MSRP - \$23⁰⁰
MIKROE-3917



LCD Mono Click

The LS013B7DH03 LCD has an active-matrix memory liquid crystal display module with 128x128 panel.

MSRP - \$65⁰⁰
MIKROE-3789



MCP1664 Click

With 4 high-power white LEDs. Carries Microchip's MCP1664, a high-voltage step-up LED driver.

MSRP - \$26⁰⁰
MIKROE-2548



LED Driver Click

Carries MCP1662 high-voltage step-up voltage driver from Microchip.

MSRP - \$15⁰⁰
MIKROE-2676



LED Driver 2 Click

Carries the MCP1643 - LED constant current regulator, made by Microchip.

MSRP - \$15⁰⁰
MIKROE-2807

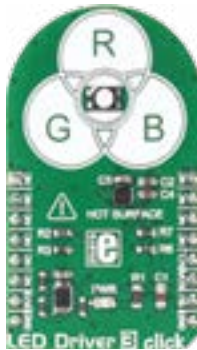

LED Driver 3 Click

The NCP5623B, a triple output RGB LED driver, controlled through the I2C protocol.

MSRP - \$15⁰⁰
MIKROE-2950



LED Driver 4 Click

The TPS61160A, a white LED driver with PWM brightness control.

MSRP - \$15⁰⁰
MIKROE-3037



10x10 RGB Click

A matrix of 100 "intelligent" RGB elements - WS2812 an intelligent control LED light source.

MSRP - \$42⁰⁰
MIKROE-4115



UVC Light Click

With ultraviolet LEDs with 275nm wavelength for measuring exact dose of UV radiation.

MSRP - \$39⁰⁰
MIKROE-4177



Dot Matrix R Click

Based on a four-digit dot matrix display module, labeled as HCMS-3906.

MSRP - \$72⁰⁰
MIKROE-4169





LED Driver 8 Click

The PCA9957, a daisy-chain SPI compatible 4-wire serial bus controlled 24-channel LED driver.

MSRP - \$12⁰⁰
MIKROE-4268



LED Driver 9 Click

Features the TLC59116, LED driver optimized for RGBA color mixing and backlight from Texas Instruments.

MSRP - \$15⁰⁰
MIKROE-4595



LED Driver 10 Click

Carries the TLC59283, LED driver with pre-charge FET from Texas Instruments.

MSRP - \$16⁰⁰
MIKROE-4787

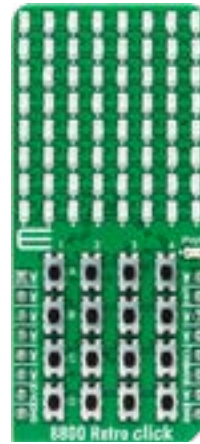

8800 Retro Click

Based on the AS1115, compact LED driver for 8x8 display screen from ASM-AG.

MSRP - \$23⁰⁰
MIKROE-4771



LED Driver 11 Click

The WLMDU9456001JT, a LED driver with the buck switching regulator and inductor from Würth.

MSRP - \$35⁰⁰
MIKROE-4757



BarGraph 4 Click

Based on the TLC59283, 16-channel constant-current sink LED driver from Texas Instruments.

MSRP - \$33⁰⁰
MIKROE-4782



LED Driver 13 Click

Carries the A80604-1, a 4-channel LED driver from Allegro Microsystems.

MSRP - \$25⁰⁰
MIKROE-4965



LED Driver 12 Click

Features the PCA9532, a I/O expander optimized for dimming LEDs from NXP Semiconductors.

MSRP - \$18⁰⁰
MIKROE-4977



LED Driver 14 Click

Features the BD18337EFV-M four-channel LED driver from Rohm Semiconductor.

MSRP - \$28⁰⁰
MIKROE-4996



LED Driver 16 Click

Features the PCA9745B, an SPI-configurable sixteen-channel constant current LED driver from NXP.

MSRP - \$18⁰⁰
MIKROE-5534



LED Driver 15 Click

With the MP3309C, a synchronous boost white LED driver from Monolithic Power Systems.

MSRP - \$15⁰⁰
MIKROE-5583



LED Driver 18 Click

Features the TLC5947, a 24-channel LED driver from Texas Instruments.

MSRP - \$26⁰⁰
MIKROE-5560



LED Ring 2 Click

Carries the three I2C-configurable LED matrix drivers, the LP5862 from TI.

MSRP - \$45⁰⁰
MIKROE-5634



LED Driver 17 Click

Based on the LTR3755, a highly efficient DC/DC controller from Analog Devices.

MSRP - \$35⁰⁰
MIKROE-5565

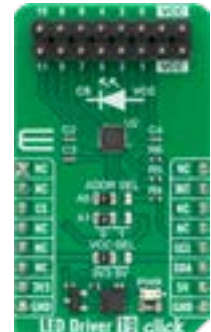

LED Driver 19 Click

Based on the LED1202, a 12-channel low quiescent current LED driver from STM.

MSRP - \$15⁰⁰
MIKROE-5639



4x4 RGB 2 Click

With the MP3309C, a synchronous boost white LED driver from Monolithic Power Systems.

MSRP - \$19⁰⁰
MIKROE-5661



UT-L 7-SEG B Click

Features two blue JSS-5611BUB-21s, ultra-thin single-digit numeric displays from Ningbo.

MSRP - \$35⁰⁰
MIKROE-5824



2x2 RGB Click

Carries the KTD2052A, a 12-channel RGB LED driver from Kinetic Technologies.

MSRP - \$12⁰⁰
MIKROE-5917



AlphaNum G 2 Click

Features the LTP-3862, a dual-digit 16-segment alphanumeric green display from Lite-ON.

MSRP - \$25⁰⁰
MIKROE-5903



LED Flash 3 Click

Based on the KTD2691, an inductor-less, single-flash LED driver from Kinetic Technologies.

MSRP - \$12⁰⁰
MIKROE-5922





UT-L 7-SEG B 2 Click

Carries the TLC5947, a constant-current sink LED driver from Texas Instruments.

MSRP - \$29⁰⁰
MIKROE-5912



7-SEG B Click

Features the LDT-M2804RI, a three-digit seven-segment display from Lumex.

MSRP - \$25⁰⁰
MIKROE-6005

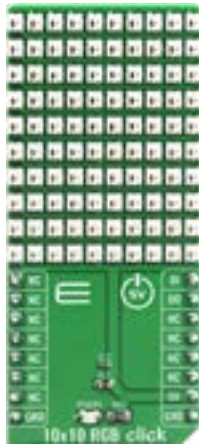

10x10 RGB Click

Features the IN-PC20TBT5R5G5B, an RGB LED with an advanced IC from Inolux.

MSRP - \$79⁰⁰
MIKROE-5976



1x4 RGB Click

Carries the LP5812, an advanced RGB LED driver from Texas Instruments.

MSRP - \$23⁰⁰
MIKROE-6240

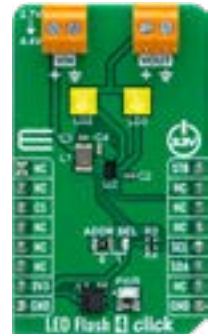

LED Flash 4 Click

Based on the AS1170, a high-current LED driver from ams OSRAM.

MSRP - \$19⁰⁰
MIKROE-6282

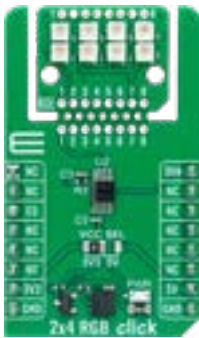

2x4 RGB Click

With an array of 2x4 RGB LEDs (WL-ICLED 1312121320437) from Würth Elektronik.

MSRP - \$25⁰⁰
MIKROE-6378



IPS Display Click

This board features the ER-TFT1.14-2, a 1.14" TFT LCD display from BuyDisplay.

MSRP - \$25⁰⁰
MIKROE-6077

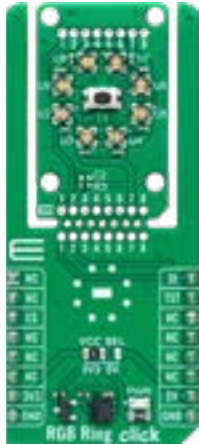

RGB Ring Click

Features eight RGB LEDs (WL-ICLED 1312020030000) from Würth Elektronik.

MSRP - \$17⁰⁰
MIKROE-6379

HUMAN MACHINE INTERFACE





Cap Extend 3 Click

With four capacitive sensor pads that can sense touch through a variety of different materials.

MSRP - \$16⁰⁰
MIKROE-2474



Cap Touch Click

A capacitive touch sensing button, integrated on a Click board™.

MSRP - \$16⁰⁰
MIKROE-2888



SwipeSwitch Click

The IQS266, a trackpad controller circuit, featuring ProxSense® and IQ Switch® technologies, from Azoteq.

MSRP - \$15⁰⁰
MIKROE-3202



CAP Wheel 2 Click

The IQS263B, ProxSense® IC, a 3-channel projected capacitive proximity and TC from Azoteq.

MSRP - \$15⁰⁰
MIKROE-3677



CAP Wheel Click

The IQS333, ProxSense® IC, a 9-channel projected capacitive proximity and TC from Azoteq.

MSRP - \$15⁰⁰
MIKROE-3203



Cap Touch 2 Click

A capacitive touch sensing button, which features the CAP1166.

MSRP - \$15⁰⁰
MIKROE-2964



TouchKey 2 Click

With 4 capacitive pads powered by Microchip's ATtiny817. Integrated touch QTouch® controller.

MSRP - \$16⁰⁰
MIKROE-2474



TouchKey 3 Click

Equipped with advanced capacitive sensors, based on the proprietary QTouch® technology.

MSRP - \$19⁰⁰
MIKROE-2405



SAML Touch Click

The ATSAML10, an ultra-low power 32-bit ARM® Cortex® MicroController Unit (MCU) from Microchip.

MSRP - \$15⁰⁰
MIKROE-3414



TouchKey 4 Click

A capacitive touch sensing button, with the advanced touch/proximity sensor IC.

MSRP - \$15⁰⁰
MIKROE-2965





TAMPER Click

Equipped with SDS001, a low profile side-actuated detect switch.

MSRP - \$9⁰⁰
MIKROE-2551



Button PLAY Click

It is equipped with the CTHS15CIC05ARROW, a capacitive touch sensor display.

MSRP - \$21⁰⁰
MIKROE-3327



Knob G Click

Combination of high-quality quadrature rotary encoder, and a LED ring of 24 individual green LEDs.

MSRP - \$17⁰⁰
MIKROE-3299



Slider Click

Features a mechanical slide action potentiometer.

MSRP - \$31⁰⁰
MIKROE-2702



TAMPER 2 Click

Levered D2HW-A221D switch. Outputs signal in both positions - pressed and released.

MSRP - \$15⁰⁰
MIKROE-2552

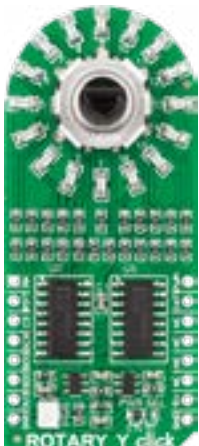

ROTARY Y Click

With a 15-pulse incremental rotary encoder with detents, surrounded by a ring of 16 yellow LEDs.

MSRP - \$12⁰⁰
MIKROE-1825

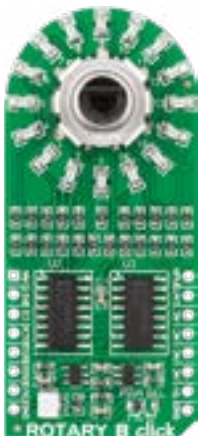

ROTARY B Click

With a 15-pulse incremental rotary encoder with detents, surrounded by a ring of 16 blue LEDs.

MSRP - \$12⁰⁰
MIKROE-1824

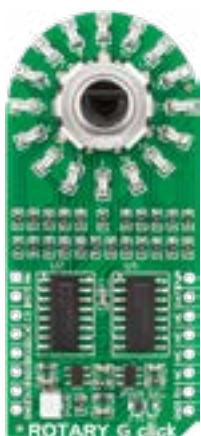

ROTARY G Click

With a 15-pulse incremental rotary encoder with detents, surrounded by a ring of 16 green LEDs.

MSRP - \$12⁰⁰
MIKROE-1822



ROTARY O Click

With a 15-pulse incremental rotary encoder with detents, surrounded by a ring of 16 orange LEDs.

MSRP - \$12⁰⁰
MIKROE-2380



ROTARY R Click

With a 15-pulse incremental rotary encoder with detents, surrounded by a ring of 16 red LEDs.

MSRP - \$12⁰⁰
MIKROE-1823



Joystick Click

A smart navigation key concept based on contactless, magnetic movement detection.

MSRP - \$22⁰⁰
MIKROE-1506



Keylock Click

Carries a processed sealed key lock mechanism that can be set in 3 different positions.

MSRP - \$43⁰⁰
MIKROE-2564



CapSense Click

Capacitive sensing module. Input - human body capacitance, output - the real time sensor information.

MSRP - \$16⁰⁰
MIKROE-1446



COUNTER Click

Counter Click carries an LS7366R 32-bit quadrature counter.

MSRP - \$25⁰⁰
MIKROE-1917



IR gesture Click

Enables contactless gesture recognition. With ambient light and proximity sensing capabilities.

MSRP - \$16⁰⁰
MIKROE-2086



2x2 Key Click

The Click has a 4 button keypad. It allows multiple key presses and has a debounce circuit.

MSRP - \$9⁰⁰
MIKROE-2152



4x4 Key Click

Carries a 16 button keypad. Allows for multiple key presses at the same time.

MSRP - \$11⁰⁰
MIKROE-1889



Button G Click

A single pushbutton - transparent, 6.8mm in diameter, with a green LED backlight.

MSRP - \$9⁰⁰
MIKROE-2040



Button R Click

A single pushbutton - transparent, 6.8mm in diameter, with a red LED backlight.

MSRP - \$9⁰⁰
MIKROE-1901



Cap Extend Click

With SX8633, capacitive button touch controller. 12 pins for connecting capacitive inputs.

MSRP - \$18⁰⁰
MIKROE-2238





Thumb wheel Click

With a 10-position rotary sprocket connected to a 1-Wire 8-Channel Addressable Switch.

MSRP - \$35⁰⁰
MIKROE-2366



TouchClamp Click

With NXP's MPR121 proximity capacitive touch sensor controller. 7 plated holes for clamps.

MSRP - \$9⁰⁰
MIKROE-2294



Thumbstick Click

A high precision input device with a dual axis, spring return and push-button enabled joystick.

MSRP - \$25⁰⁰
MIKROE-1627



Touchpad Click

Capacitive touch input device driven by Microchip's MTCH6102 controller.

MSRP - \$15⁰⁰
MIKROE-1995

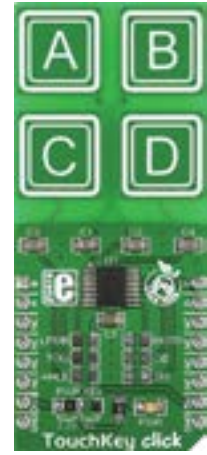

TouchKey Click

It has four capacitive input device powered by Microchip's TTP224, a touchpad detector IC.

MSRP - \$12⁰⁰
MIKROE-1906



Keylock 2 Click

Uses SK13AEG13 switch keylock from the company NKK Switches.

MSRP - \$35⁰⁰
MIKROE-3471



POT Click

The MCP1501, a precision voltage reference IC from Microchip.

MSRP - \$12⁰⁰
MIKROE-3402



ProxFusion[®] 2 Click

The IQS621, a multi-functional sensor with the ambient light [ALS] from Azoteq.

MSRP - \$9⁰⁰
MIKROE-3205

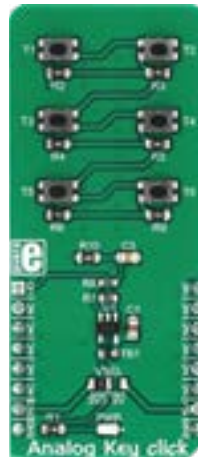

Analog Key Click

The KMR2 series KMR221 tactile buttons are high-quality SPST switches produced by CKSwitches.

MSRP - \$14⁰⁰
MIKROE-3409



Button Y Click

Designed with the high-quality, single-pole, single-throw [SPST] tactile switch labeled as 3006.2111.

MSRP - \$9⁰⁰
MIKROE-3262



Button ALARM Click

With the CTHS15CI-C05ALARM , a capacitive touch sensor display.

MSRP - \$21⁰⁰
MIKROE-3763



Button Power Click

With the CTH-S15CIC05ONOFF, a capacitive touch sensor display.

MSRP - \$19⁰⁰
MIKROE-3740



Cap Touch 5 Click

Features the CY-8CMBR3106S-LQXI CapSense® Express™ controller.

MSRP - \$15⁰⁰
MIKROE-3786



Joystick 2 Click

With a SKRHABE01, a 4-direction joystick switch with Center-push Function.

MSRP - \$15⁰⁰
MIKROE-3711



Power/Reset Click

IT's the QT1011, digital burst mode charge-transfer sensor - detects near proximity or touch.

MSRP - \$13⁰⁰
MIKROE-3771



Vibro Motor 2 Click

With the ERM motor. Uses the DMG3420U MOSFET to drive it.

MSRP - \$12⁰⁰
MIKROE-3713



HAPTIC Click

With DRV2605 Haptic Driver for ERM and LRA vibration motors. Over 100 haptic effects library.

MSRP - \$23⁰⁰
MIKROE-2025



Vibro Motor Click

Features a compact size Eccentric Rotating Mass [ERM] motor, labeled as C1026B002F.

MSRP - \$12⁰⁰
MIKROE-2826



Fingerprint Click

It carries the GTS-511E2 module, the thinnest optical touch fingerprint sensor in the world.

MSRP - \$55⁰⁰
MIKROE-1722



Slider 2 Click

Utilizes the PTA3043, a linear, high-grade, 10K potentiometer

MSRP - \$20⁰⁰
MIKROE-3301





POT 2 Click

The MCP1541, a precision voltage reference IC from Microchip is used to provide the voltage of 4.096V.

MSRP - \$12⁰⁰
MIKROE-3325



ProxFusion 3 Click

Features the IQS2692A, an 8-channel ProxFusion® capacitive touch and proximity controller.

MSRP - \$12⁰⁰
MIKROE-4469



Fingerprint 2 Click

The A-172-MRQ, a 2D capacitive fingerprint sensor capable of storing up to 24 different fingerprints.

MSRP - \$53⁰⁰
MIKROE-4119



Vibro Motor 3 Click

Features the G0832022D, a coin-sized linear resonant actuator [LRA].

MSRP - \$24⁰⁰
MIKROE-4356



HAPTIC 2 Click

The LC898302AXA, a motor driver dedicated to LRA and ERM applications.

MSRP - \$7⁰⁰
MIKROE-4452



TouchPad 3 Click

Features the MTCH6301, a turnkey capacitive touch controller from Microchip.

MSRP - \$11⁰⁰
MIKROE-4382



POT 3 Click

The MCP1501, a precision voltage reference IC from Microchip.

MSRP - \$32⁰⁰
MIKROE-3691



Touchpad 2 Click

Features the IQS525, a projected capacitive touch and proximity trackpad controller from Azoteq.

MSRP - \$9⁰⁰
MIKROE-4594



Touchpad 4 Click

This board features the IQS7211A, a tiny capacitive touch controller from Azoteq.

MSRP - \$11⁰⁰
MIKROE-4752



Vibro Motor 4 Click

Based on the VG1040003D, a coin-sized linear resonant actuator [LRA] from Vybionics.

MSRP - \$21⁰⁰
MIKROE-4825



CapSense 2 Click

Carries the CAP1114, a multi-channel capacitive touch sensor from Microchip.

MSRP - \$18⁰⁰
MIKROE-4982



Haptic 3 Click

Features the DA7282, LRA and ERM haptic driver from Dialog Semiconductor.

MSRP - \$15⁰⁰
MIKROE-5087



Touchpad 5 Click

Based on the IQS550, a projected capacitive touch and proximity trackpad controller from Azoteq.

MSRP - \$11⁰⁰
MIKROE-5199



Joystick 3 Click

Features 2765, a high-quality mini 2-axis analog output thumbstick from Adafruit Industries.

MSRP - \$15⁰⁰
MIKROE-5378

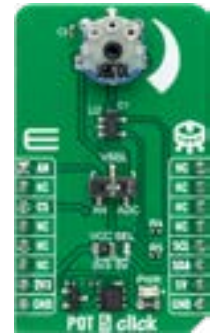

POT 5 Click

Carries the PDB081-P10-103B1, 8mm micro rotary 10k potentiometer from Bourns.

MSRP - \$18⁰⁰
MIKROE-5445



POT 4 Click

Features the PRS11R-425F-S103B1, a 11mm rotary 10k potentiometer from Bourns.

MSRP - \$19⁰⁰
MIKROE-5454



Cap Touch 6 Click

Carries the IQS227D, a capacitive controller with an internal voltage regulator from Azoteq.

MSRP - \$15⁰⁰
MIKROE-5517



HOD CAP Click

This board features the AS8579, a capacitive sensor from ams OSRAM.

MSRP - \$35⁰⁰
MIKROE-5719



Rotary W 2 Click

Based on the TLC5925, a low-power 16-channel constant-current LED sink driver from TI.

MSRP - \$19⁰⁰
MIKROE-5892

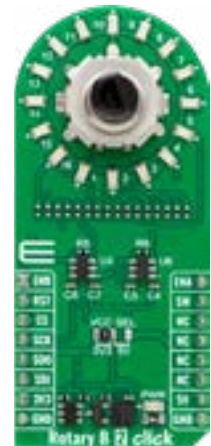

Rotary B 2 Click

Features the TLC5925, a low-power 16-channel constant-current LED sink driver from TI.

MSRP - \$19⁰⁰
MIKROE-5974





Rotary O 2 Click

Features the TLC5925, a low-power 16-channel constant-current LED sink driver from TI.

MSRP - \$19⁰⁰
MIKROE-5892



CDC Click

Carries the PCA004, a capacitance-to-digital converter [CDC] from ScioSense.

MSRP - \$25⁰⁰
MIKROE-5985



Rotary R 2 Click

Based on the TLC5925, a low-power 16-channel constant-current LED sink driver from TI.

MSRP - \$19⁰⁰
MIKROE-5975



Fingerprint 3 Click

Secure your projects with a biometric all-in-one fingerprint sensor.

MSRP - \$6⁰⁰
MIKROE-4265



Fingerprint 4 Click

Based on the FPC BM-Lite module [100018754] from Fingerprints.

MSRP - \$73⁰⁰
MIKROE-5465



ProxFusion Click

Carries the IQS624, a combined multi-sensor IC from Azoteq.

MSRP - \$9⁰⁰
MIKROE-2920



CAP Slider Click

With the IQS333, ProxSense® IC, a 9-channel capacitive proximity and touch controller from Azoteq.

MSRP - \$15⁰⁰
MIKROE-3204



Haptic 4 Click

Carries the DA7280, a haptic driver designed to drive LRA and ERM actuators from Renesas.

MSRP - \$14⁰⁰
MIKROE-6045



Rotary RGB Click

With 16 individual RGB LEDs from Worldsemi and EC12D1564402 encoder from ALPS.

MSRP - \$28⁰⁰
MIKROE-6067

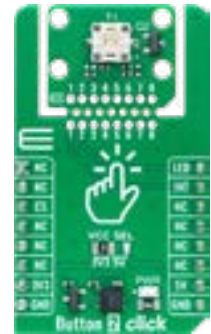

Button 2 Click

Features the TL3215AF160BQ, a TL3215 series of tactile switches from E-Switch.

MSRP - \$18⁰⁰
MIKROE-6275

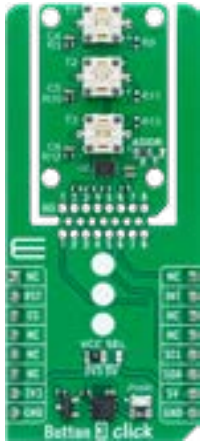

Button 3 Click

Features three TL3215 series tactile switches from E-Switch.

MSRP - \$25⁰⁰
MIKROE-6276

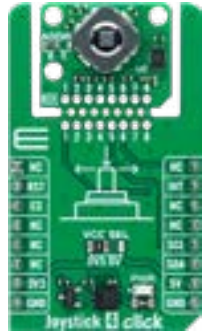

Joystick 4 Click

With the 2434804-1, a 5-position tactile switch from the ALCOSWITCH series by TE Connectivity.

MSRP - \$12⁰⁰
MIKROE-6279



Cap Touch 4 Click

Based on the IQS211B, a single-channel capacitive controller from Azoteq.

MSRP - \$12⁰⁰
MIKROE-6399



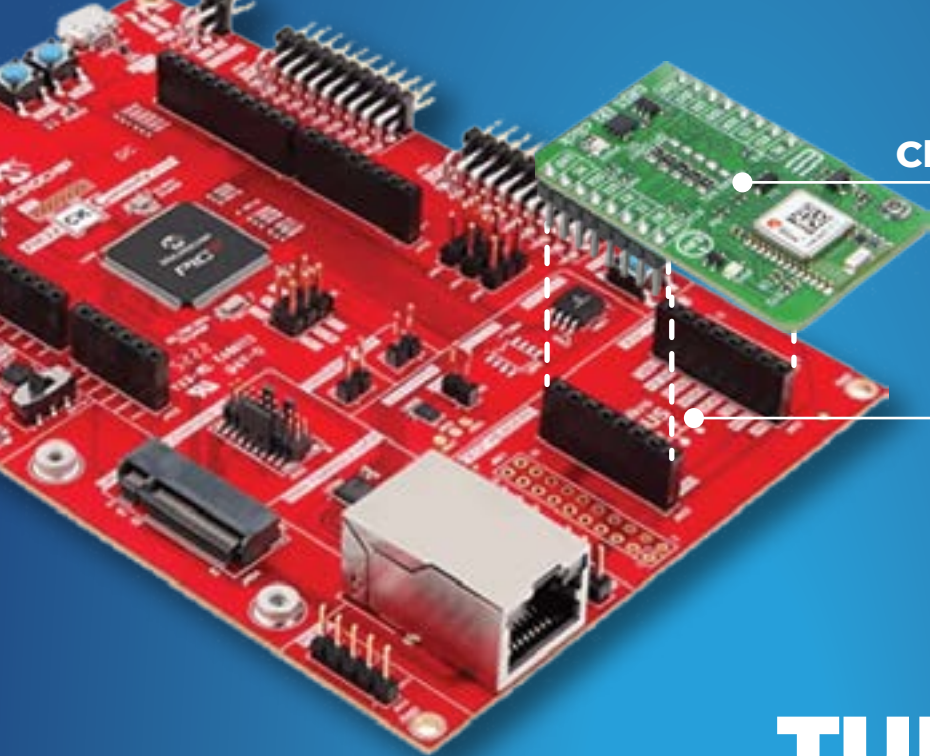

1700+
Click boards™

mikroBUS™
socket

TURN YOUR BOARD INTO A DEV TOOL

100+ COMPANIES ADOPTED
the mikroBUS™ standard



Scan to learn more
about mikroBUS™!

mikroBUS™ is an **open standard**. Just refer to the PDF document outlining the mikroBUS™ standard specification and join over **100+ companies** who have embraced mikroBUS™. Once integrated, your dev board will be featured on the EmbeddedWiki platform, with **1M+ embedded projects**. This exposure means more than just visibility — it means your dev. board will be featured in thousands of embedded projects. And with access to thousands of Click boards™, the dev. board users can develop thousands of different projects. Don't miss out on expanding your market footprint — add mikroBUS™ to your board **today**.

STORAGE



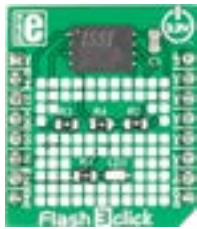

Flash 3 Click

With ISSI's IS25LP128 IC with 128 Mbit capacity. 50MHz at Normal, 133MHz at Fast Read speeds.

MSRP - \$12⁰⁰
MIKROE-2374



Flash 4 Click

Carries the S25FL512S, a 512 Mbit SPI Flash memory module.

MSRP - \$34⁰⁰
MIKROE-3191

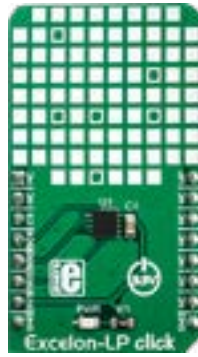

Excelon-LP Click

Equipped with the CY-15B108Q, a serial ferro-electric (FRAM) module with 8 Mbit density.

MSRP - \$33⁰⁰
MIKROE-3104



MAC Address Click

A unique node address. Carries 24AA025E64 2Kb Serial EEPROM with EUI-64™ node identity.

MSRP - \$9⁰⁰
MIKROE-2733



microSD Click

With a microSD card slot for microSD cards used as a mass storage media for portable devices.

MSRP - \$16⁰⁰
MIKROE-924



FRAM 2 Click

With CY15B104Q 4-Mbit [512K x 8] serial F-RAM from Cypress. 100 trillion [10¹⁴] read/writes.

MSRP - \$19⁰⁰
MIKROE-2768



EEPROM Click

With 24C08WP - a highly reliable, high performance CMOS technology serial 8K EEPROM.

MSRP - \$8⁰⁰
MIKROE-1200



EEPROM 2 Click

With M95M02-DR DIP-8 socket EEPROM chip with 256 KB of memory from STMicroelectronics.

MSRP - \$18⁰⁰
MIKROE-1909



EEPROM 3 Click

With AT24CM02 DIP-8 socket EEPROM chip with 256 KB of memory from Microchip.

MSRP - \$14⁰⁰
MIKROE-1989



EERAM 3.3V Click

With 47L16 EERAM, a 16Kbit SRAM with EEPROM Backup from Microchip.

MSRP - \$14⁰⁰
MIKROE-2728





EERAM 5V Click

With 47C16 EERAM, a 16Kbit SRAM with EEPROM Backup from Microchip.

MSRP – \$14⁰⁰
MIKROE-2729



Flash Click

With EN25Q80B - 8Mb serial Flash memory module. Clock frequency up to 75MHz.

MSRP – \$10⁰⁰
MIKROE-1199



Flash 2 Click

It carries Microchip's SST26VF064B flash-memory module with 64 Mbits capacity.

MSRP – \$12⁰⁰
MIKROE-2267



MRAM Click

Uses the MR25H256, a 256 kilobits serial SPI MRAM memory module from Everspin company.

MSRP – \$18⁰⁰
MIKROE-2914



Dual EE Click

Contains 2 EEPROM ICs onboard - the AT24CM02, an I2C serial EEPROM.

MSRP – \$18⁰⁰
MIKROE-3762



Flash 5 Click

Based on the W25N01GVZEIG/IT (1G-bit) Serial SLC NAND Flash Memory.

MSRP – \$9⁰⁰
MIKROE-3760



FRAM 3 Click

Uses the MB94R330, which is an FRAM [Ferroelectric Random Access Memory].

MSRP – \$9⁰⁰
MIKROE-3817



Semper Flash Click

Memory module based on the S25HS512T a 512 Mbit SPI Flash memory module, from Cypress.

MSRP – \$25⁰⁰
MIKROE-3823



SRAM Click

Provides 1 Mbit of additional SRAM memory, via Microchip's 23LC1024.

MSRP – \$15⁰⁰
MIKROE-1902



SQI FLASH Click

Based on the SST-26VF064B, a 64 Mbit Serial Quad I/O flash device from Microchip.

MSRP – \$13⁹⁰
MIKROE-2626





EEPROM 4 Click

An EEPROM memory medium with the capacity of 256KB.

MSRP – \$15⁰⁰
MIKROE-2536



ReRAM Click

Resistive Random Access Memory module which contains the cell array with 4 Mbits of data.

MSRP – \$18⁰⁰
MIKROE-3641



FRAM Click

256K [32,768 words x 8 bits] of Ferroelectric Random Access Memory with MB85RS256A module.

MSRP – \$15⁰⁰
MIKROE-1486



Semper Flash 2 Click

The S25HL512T, a 512 Mbit SPI/QSPI Flash memory module, from Cypress.

MSRP – \$25⁰⁰
MIKROE-4028



Flash 6 Click

The W25Q128JV array is organized into 65,536 programmable pages of 256-bytes each.

MSRP – \$7⁰⁰
MIKROE-4067



EERAM 2 Click

A static RAM [SRAM] memory Click board™ with hidden EEPROM backup.

MSRP – \$20⁰⁰
MIKROE-4129



SRAM 2 Click

Based on ANV32A62A SRAM memory from Anvo-Systems Dresden.

MSRP – \$15⁰⁰
MIKROE-4178



MRAM 2 Click

Features the MR10Q010, 1Mb Quad Output High-Speed Serial SPI MRAM memory.

MSRP – \$25⁰⁰
MIKROE-4232



SRAM 3 Click

The ANV32AA1WDK66, a 1Mb serial SRAM with a non-volatile SONOS storage element.

MSRP – \$27⁰⁰
MIKROE-4293



EEPROM 6 Click

The DS28EC20, a 20480-bit EEPROM organized as 80 memory pages of 256 bits each.

MSRP – \$9⁰⁰
MIKROE-4296





Flash 7 Click

With the GD25LQ16C, a high-performance 16Mbit SPI NOR Flash Memory solution.

MSRP - \$9⁰⁰
MIKROE-4440



nvSRAM Click

The CY14B101J, a 1-Mbit nvSRAM organized as 128K words of 8 bits each.

MSRP - \$30⁰⁰
MIKROE-4441



nvSRAM 2 Click

the CY14B101Q, a 1Mbit nvSRAM organized as 128K words of 8 bits each.

MSRP - \$29⁰⁰
MIKROE-4423



nvSRAM 3 Click

Features the CY14B101I, a 1-Mbit nvSRAM organized as 128K words of 8 bits each.

MSRP - \$33⁰⁰
MIKROE-4497



nvSRAM 4 Click

The CY14B101PA, a 1-Mbit nvSRAM with a fully-featured real-time clock.

MSRP - \$35⁰⁰
MIKROE-4482



EEPROM 7 Click

The 25CSM04, a 4-Mbit SPI Serial EEPROM with a 128-bit serial number and write protection mode.

MSRP - \$12⁰⁰
MIKROE-4421



EEPROM 5 Click

Features the M95M04, the 4Mbit electrically erasable programmable memory.

MSRP - \$9⁰⁰
MIKROE-4422



SWI EEPROM Click

The AT21CS01, a single-wire serial EEPROM with a, factory-programmed 64-bit serial number.

MSRP - \$7⁰⁰
MIKROE-4521



SRAM 4 Click

Equipped with the CY14B512Q, a 512Kbit nonvolatile SRAM from Infineon.

MSRP - \$29⁰⁰
MIKROE-4835



FRAM 6 Click

Features the CY-15B102Q, a 2Mbit nonvolatile memory from Infineon.

MSRP - \$51⁰⁰
MIKROE-4831





EERAM 3 Click

Based on the 48L256, a serial EERAM with SRAM memory core, from Microchip.

MSRP - \$17⁰⁰
MIKROE-4854



ReRAM 2 Click

Features the MB85AS8MT, an 8Mbit of ReRAM nonvolatile memory chip from Fujitsu.

MSRP - \$22⁰⁰
MIKROE-4895



Flash 9 Click

Based on the W25Q02JV, a serial Flash memory solution from Winbond.

MSRP - \$60⁰⁰
MIKROE-4987



FRAM 5 Click

Carries the FM24V10, a 1Mbit nonvolatile memory from Infineon.

MSRP - \$39⁰⁰
MIKROE-5119



EEPROM 8 Click

Features the CAV24C512, a 512-Kb electrically erasable/program memory from ON Semiconductor.

MSRP - \$9⁰⁰
MIKROE-5073



MRAM 3 Click

Features the AS3001204, 1Mb SPI MRAM memory from Avalanche.

MSRP - \$19⁰⁰
MIKROE-5191



Excelon-Ultra Click

Based on the CY15B116QSN, 16-Mbit nonvolatile memory from Infineon.

MSRP - \$69⁰⁰
MIKROE-4698

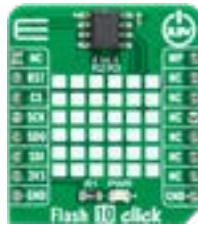

Flash 10 Click

Carries the AT25FF321A, 32Mbit serial Flash memory from Dialog.

MSRP - \$6⁰⁰
MIKROE-5289



Flash 8 Click

Carries the GD5F2GQ5UEY1GR, a 2Gb high-density nonvolatile memory from GigaDevice.

MSRP - \$17⁰⁰
MIKROE-5293



DRAM Click

Equipped with the APS6404L-3SQR, a 64Mb PSRAM memory from AP Memory.

MSRP - \$9⁰⁰
MIKROE-5337





EEPROM 9 Click

Features the M95P32-I, the 32Mbit electrically erasable programmable memory from Microchip.

MSRP - \$12⁰⁰
MIKROE-5681



Flash 11 Click

Carries the AT25SF321B, a 32-Mbit SPI serial Flash memory from Dialog.

MSRP - \$9⁰⁰
MIKROE-5740



EEPROM 10 Click

Based on the N24C32, a 32Kb I2C CMOS Serial EEPROM from ON Semiconductor.

MSRP - \$7⁵⁰
MIKROE-5735



MRAM 4 Click

Features the EM064LX, an industrial STT-MRAM persistent memory from Everspin.

MSRP - \$119⁰⁰
MIKROE-5838



EEPROM 11 Click

Carries the S-34C04AB, an EEPROM for DIMM serial presence detection from ABLIC.

MSRP - \$7⁵⁰
MIKROE-5889



EEPROM 12 Click

Features the M24256E, an EEPROM memory from STMicroelectronics.

MSRP - \$7⁵⁰
MIKROE-5893



EEPROM 13 Click

Based on the M24M01E, an EEPROM memory from from STM.

MSRP - \$9⁰⁰
MIKROE-5885



Flash 12 Click

Features the AT25EU0041A, a 4Mbit serial flash memory from Renesas.

MSRP - \$11⁰⁰
MIKROE-6036



MISCELLANEOUS





Secure Click

With ATECC508A cryptographic coprocessor with secure hardware-based key storage.

MSRP - \$9⁰⁰
MIKROE-2522

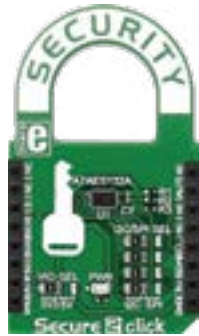

Secure 2 Click

Microchip's ATAES132A, a cryptographic coprocessor with secure hardware-based key storage.

MSRP - \$9⁰⁰
MIKROE-2760

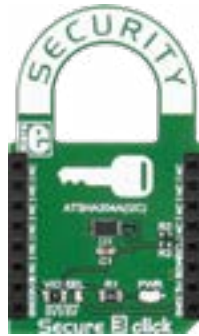

Secure 3 Click

Microchip's ATSHA204A, a cryptographic coprocessor with secure hardware-based key storage.

MSRP - \$9⁰⁰
MIKROE-2761



Secure 4 Click

Includes the ATECC608A, a secure CryptoAuthentication™ device from Microchip.

MSRP - \$9⁰⁰
MIKROE-2829



Secure 5 Click

The ATECC508A integrates ECDH [Elliptic Curve Diffie Hellman] security protocol.

MSRP - \$13⁰⁰
MIKROE-3774



Secure 6 Click

The ATSHA204A implements a complete asymmetric key cryptographic signature solution.

MSRP - \$7⁰⁰
MIKROE-3699



Secure 7 Click

The ATECC608A integrates ECDH [Elliptic Curve Diffie Hellman] security protocol.

MSRP - \$7⁰⁰
MIKROE-3915



RELAY Click

With two G6D1AA-SI-5DC power PCB relay modules. Controls up to 5A, 250V AC/30V DC loads.

MSRP - \$18⁰⁰
MIKROE-1370



Relay 2 Click

Carries two LCA717 single-pole, OptoMOS® solid state relays.

MSRP - \$26⁰⁰
MIKROE-1899



PROTO Click

10x11 prototyping area and additional power pads for creating custom electronics or Click boards™.

MSRP - \$4⁵⁰
MIKROE-1507





FLICKER Click

TI's NA556 dual precision timer and Omron's G6D-ASI power PCB relay. ON/OFF 0.1-6 sec.

MSRP - \$19⁰⁰
MIKROE-2481



Signal Relay Click

It carries four ultra-small GV5-1 PCB relays from Omron. For ON/OFF control.

MSRP - \$29⁰⁰
MIKROE-2154



UNIQUE ID Click

With DS2401 enhanced silicon serial number IC. Provides a unique registration number.

MSRP - \$9⁰⁰
MIKROE-1819

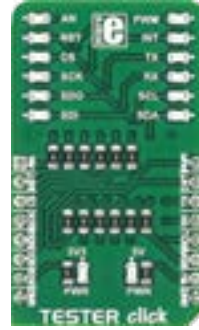

TESTER Click

An ideal solution for testing and diagnostics of the mikroBUS™ socket pin states.

MSRP - \$6⁰⁰
MIKROE-3083



Opto 2 Click

Uses four TLP2770, 20-Mbps low-power optocouplers, from Toshiba.

MSRP - \$25⁰⁰
MIKROE-3015



Opto 3 Click

Two pairs of normally opened, high-quality solid-state relays labeled as TLP241A.

MSRP - \$21⁰⁰
MIKROE-3319



Secure SOIC Click

It's an universal socket that supports any Microchip security SOIC IC device.

MSRP - \$48⁰⁰
MIKROE-3788



Secure UDFN Click

The 08QN50L43020 is an universal socket that supports basically any 8-pin UDFN device.

MSRP - \$79⁰⁰
MIKROE-3746



Relay 3 Click

It features two SRD-05VDC-SL-C small-size relays, from Songle Relays.

MSRP - \$18⁰⁰
MIKROE-3357



Opto 4 Click

The LTV-817S, an optocoupler with a high isolation voltage, by LITEON.

MSRP - \$16⁰⁰
MIKROE-3337



Opto Click

It features two V02630 dual channel, high speed optocoupler modules.

MSRP - \$21⁰⁰
MIKROE-1196



Thermostat 2 Click

Configures mikro-BUS™ signals into pull-up or pull-down states.

MSRP - \$15⁰⁰
MIKROE-5539



Opto 5 Click

Features the FOD4216, a random phase snubberless Triac driver.

MSRP - \$15⁰⁰
MIKROE-4476



RNG Click

The NC7S14M5X inverter, and the ADS1115 - 16BIT sigma-delta ADC.

MSRP - \$27⁰⁰
MIKROE-4090



Trust M Click

It's based on SLS 32AIA010 OPTIGA™ Trust M1 high-end security controller.

MSRP - \$8⁰⁰
MIKROE-4236



SolidSwitch Click

Features the TPS22918, four single-channel load switches from Texas Instruments.

MSRP - \$35⁰⁰
MIKROE-4569



Plug&Trust Click

Equipped with the SE050C, ready-to-use IoT secure element IC from NXP.

MSRP - \$15⁰⁰
MIKROE-4656



SolidSwitch 3 Click

Features the BD8LB600FS-C, an automotive channel switch from Rohm.

MSRP - \$21⁰⁰
MIKROE-5079



Secure 8 Click

Features the ATECC608B, a member of the Microchip CryptoAuthentication™ family.

MSRP - \$8⁰⁰
MIKROE-5154



SE051Plug&Trust Click

Based on the SE051C2, an updatable extension of the EdgeLock® SE050 from NXP.

MSRP - \$15⁰⁰
MIKROE-5392





A5000 Plug&Trust Click

Carries the EdgeLock® A5000, a Secure Authenticator from NXP.

MSRP – \$12⁰⁰
MIKROE-5391



Relay 4 Click

Features the J1031C-3VDC, SPDT signal relay from CIT Relay and Switch.

MSRP – \$15⁰⁰
MIKROE-5539



Relay 5 Click

Carries three J1031C-3VDC.15S SPDT signal relays from NXP.

MSRP – \$19⁰⁰
MIKROE-5675



Zero-Cross Click

This board features circuitry that provides Zero Crossing Detection [ZCD].

MSRP – \$18⁰⁰
MIKROE-5760



Timer Relay Click

This board features the NE555, a precision timer from Diodes Incorporated.

MSRP – \$24⁰⁰
MIKROE-5562



Opto 7 Click

Based on two ISOM8710, high-speed single-channel opto-emulators from TI.

MSRP – \$15⁰⁰
MIKROE-5923



IPD Click-TPD2017

Carries TPD2017FN, an 8-channel low-side switch with MOSFET outputs from Toshiba.

MSRP – \$17⁰⁰
MIKROE-6075



IPD Click-TPD2015

Features TPD2015FN, an 8-channel high-side switch with MOSFET outputs from Toshiba.

MSRP – \$17⁰⁰
MIKROE-6074



EasyPull Click

Configures mikro-BUS™ signals into pull-up or pull-down states.

MSRP – \$9⁰⁰
MIKROE-6053

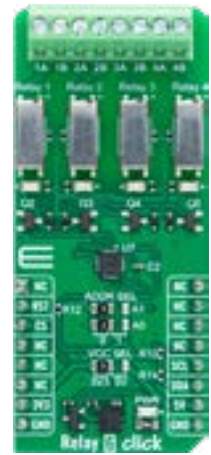

Relay 6 Click

Features four 9913-05-20TRs, a reed relay from Coto Technology.

MSRP – \$96⁰⁰
MIKROE-6001





Relay 7 Click

This board features four CRR05-1As, a CRR series reed relay from Standex.

MSRP - \$84⁰⁰
MIKROE-6000



SolidSwitch 6 Click

With the VNF1048F, a high-side switch controller with intelligent e-fuse protection from ST.

MSRP - \$29⁰⁰
MIKROE-6089



MOTOR CONTROL





Brushless 6 Click

Designed to drive a three-phase sensorless, brushless motor. With ATmega8A from Microchip.

MSRP - \$27⁰⁰
MIKROE-2847



Fan 3 Click

Perfect solution for speed control. It can operate in seven discrete speed steps.

MSRP - \$17⁹⁰
MIKROE-2841



DC Motor 8 Click

The MIC4605, 85V half-bridge MOSFET driver with adaptive dead time and shoot-through protection.

MSRP - \$18⁰⁰
MIKROE-2893



Stepper 7 Click

MTS62C19A Dual Full-Bridge Motor Driver, MCP23S08 8bit I/O Expander with Serial Interface.

MSRP - \$17⁰⁰
MIKROE-2912



Brushless 4 Click

The MCP8063, a 3 phase brushless sinusoidal sensorless motor driver, from Microchip.

MSRP - \$19⁰⁰
MIKROE-3019



H-Bridge Click

Uses the MC34933, a dual H-bridge driver, from NXP.

MSRP - \$16⁰⁰
MIKROE-3031



H-Bridge 2 Click

Uses the MPC17510, an H-Bridge DC motor driver, with up to 15V and 1.2A, from NXP.

MSRP - \$18⁰⁰
MIKROE-3000



Brushless 5 Click

Uses the A4941, a three-phase sensorless fan driver IC, made by Allegro MicroSystems LLC.

MSRP - \$19⁰⁰
MIKROE-3032



Stepper 5 Click

Uses the TM2208, a highly integrated bipolar step motor power driver, with the UART interface.

MSRP - \$17⁰⁰
MIKROE-2624



Driver Click

The DRV777, an integrated motor and relay driver from Texas Instruments.

MSRP - \$13⁰⁰
MIKROE-3109





Servo Click

A 16-channel PWM servo driver with the voltage sensing circuitry.

MSRP – \$33⁰⁰
MIKROE-3133



FAN 4 Click

A two-wire fan driver. Utilizes the LTC1695, an I2C fan speed controller.

MSRP – \$15⁰⁰
MIKROE-3200



DC MOTOR 7 Click

Advanced PWM chopper-type integrated DC motor driver, labeled as TB67H400AFTG.

MSRP – \$19⁰⁰
MIKROE-3289



DC MOTOR 9 Click

The DR8871, a brushed DC motor driver, with internal current sensing, by Texas Instruments.

MSRP – \$24⁰⁰
MIKROE-3416



DC MOTOR 11 Click

The DRV8830, a Low-Voltage Motor Driver With Serial Interface, by Texas Instruments.

MSRP – \$15⁰⁰
MIKROE-3649



Brushless Click

Toshiba's TB6575F-NG IC for driving 3-phase full-wave Brushless DC motors.

MSRP – \$39⁰⁰
MIKROE-2441



Brushless 2 Click

It carries TI's DRV10964 BLDC motor controller with an integrated output stage.

MSRP – \$26⁰⁰
MIKROE-2754



Brushless 3 Click

With TI's DRV10983 three-phase sensorless motor driver with integrated power MOSFETs.

MSRP – \$19⁰⁰
MIKROE-2766



DC MOTOR Click

With TI's DRV8833RT-YH-Bridge motor driver and TI's 74HC4053 multiplexer.

MSRP – \$18⁰⁰
MIKROE-1526



DC MOTOR 2 Click

With Toshiba's TB6593F-NG driver IC for direct current motors. Motors' supply voltage 2.5V-13V.

MSRP – \$17⁰⁰
MIKROE-2699





DC MOTOR 3 Click

With Toshiba's TB-6549FG full-bridge driver for direct current motors. Up to 3.5A with 30V.

MSRP - \$19⁰⁰
MIKROE-2047



DC MOTOR 4 Click

With MAX14870 motor driver from Maxim Integrated. Motors' voltage supply 4.5V-36V.

MSRP - \$15⁰⁰
MIKROE-2221



DC MOTOR 5 Click

With TI's DRV8701 brushed DC motor full-bridge gate driver. Operating voltage supply 5.9V-45V.

MSRP - \$17⁰⁰
MIKROE-2699



FAN Click

With EMC2301 controller for powering and regulating the operation of 5V four-wire fans.

MSRP - \$9⁰⁰
MIKROE-2004



Fan 2 Click

With MAX31760 precision fan-speed controller. Can control two fans at the same time.

MSRP - \$12⁰⁰
MIKROE-2708



PWM driver Click

Silicon Labs' Si8711CC one-channel isolator for controlling DC motors with loads up to 10A.

MSRP - \$19⁰⁰
MIKROE-2272



STEPPER Click

With A3967SLBT microstepping motor driver with a built-in translator. Max. output drive 30V, ±500 mA.

MSRP - \$18⁰⁰
MIKROE-1528



STEPPER 2 Click

With A4988 microstepping motor driver. Required external power supply minimum 7V.

MSRP - \$19⁰⁰
MIKROE-1926



STEPPER 3 Click

With TI's ULN2003 High-Current Darlington transistor array. For precise motor control.

MSRP - \$19⁰⁰
MIKROE-2035



STEPPER 4 Click

With TB67S269FTG two-phase bipolar stepping motor driver from Toshiba.

MSRP - \$19⁰⁰
MIKROE-2748





Stepper 6 Click

The DRV8886, a highly integrated bipolar step motor driver with current sensing, from TI.

MSRP – \$23⁰⁰
MIKROE-3214



DC MOTOR 10 Click

The TLE 6208-6 G, a Hex-Half-Bridge-Driver made for auto. and industrial motion control app.

MSRP – \$23⁰⁰
MIKROE-3879



Fan 6 Click

The EMC2103 includes an RPM based Fan Speed Control Algorithm.

MSRP – \$24⁰⁰
MIKROE-3867



Silent Step Click

The TMC5130 - the universal high voltage controller/driver for 2-phase bipolar stepper motor.

MSRP – \$24⁰⁰
MIKROE-3714



Stepper 13 Click

The step motor driver IC is the MP6500, a dual full-bridge motor driver.

MSRP – \$15⁰⁰
MIKROE-3736



STSPIN220 Click

The STSPIN220, a low voltage stepper motor driver by STMicroelectronics.

MSRP – \$17⁰⁰
MIKROE-3545



STSPIN250 Click

The STSPIN250, a brushed DC motor driver with the current limiting and current sensing.

MSRP – \$14⁰⁰
MIKROE-3543



STSPIN820 Click

The STSPIN820, an advanced stepper motor driver produced by STMicroelectronics.

MSRP – \$17⁰⁰
MIKROE-3544



STSPIN233 Click

The step motor driver IC is the MP6500, a dual full-bridge motor driver.

MSRP – \$17⁰⁰
MIKROE-3546



Driver Click

The TMC2660, a highly integrated bipolar step motor power driver, from the Trinamic company.

MSRP – \$27⁰⁰
MIKROE-3676



H-Bridge 3 Click

The TLE9201SG, an H-Bridge DC motor driver, with up to 28V and 6A, from Infineon.

MSRP - \$42⁰⁰
MIKROE-3613

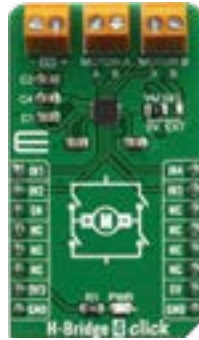

H-Bridge 4 Click

Contains the AP1010AEN, which is a two channel H-Bridge motor driver.

MSRP - \$15⁰⁰
MIKROE-3787



H-Bridge 5 Click

Contains the MP6515GF-Z, a H-bridge motor driver from MPS.

MSRP - \$15⁰⁰
MIKROE-3854



Silent Step 3 Click

Uses the TMC2660, a highly integrated bipolar step motor power driver.

MSRP - \$27⁰⁰
MIKROE-3676



DC Motor 14 Click

The TB67H450FNG, a PWM chopper-type brushed DC motor driver.

MSRP - \$14⁰⁰
MIKROE-3982



DC Motor 6 Click

The TB67H451FNG, a PWM chopper-type brushed DC motor driver.

MSRP - \$12⁰⁰
MIKROE-4114



Stepper 8 Click

Based on TC78H-670FTG a clock-in and serial controlled Bipolar Stepping Motor Driver.

MSRP - \$15⁰⁰
MIKROE-4157



H-Bridge 7 Click

Uses the DRV8876N IC, N-channel H-bridge motor driver.

MSRP - \$43⁰⁰
MIKROE-4143



Stepper 10 Click

Uses the TB67S128FTG a two-phase bipolar stepper motor driver.

MSRP - \$37⁰⁰
MIKROE-4138



Stepper 14 Click

Features the DRV8847PWPR, a step motor driver with bipolar step motor controle.

MSRP - \$21⁰⁰
MIKROE-4125





Brushless 7 Click

Based on TC78B-009FTG IC which is a three-phase BLDC motor controller.

MSRP – \$25⁰⁰
MIKROE-4182

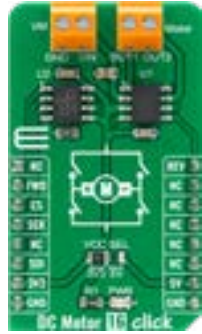

DC Motor 16 Click

The ZXBM5210 a high-performance single phase reversible DC motor drive with speed control.

MSRP – \$9⁰⁰
MIKROE-4333



DC Motor 15 Click

Features the DRV8874, an integrated motor driver with N-channel H-bridge.

MSRP – \$15⁰⁰
MIKROE-4334



Driver 2 Click

Features the IR2104S, a high voltage, high-speed power MOSFET and IGBT driver.

MSRP – \$15⁰⁰
MIKROE-4352



H-Bridge 6 Click

Features the VN-HD7008AY, an H-bridge motor driver for automotive DC motor.

MSRP – \$29⁰⁰
MIKROE-4289



Brushless 12 Click

Features the L6235, DMOS fully integrated 3-phase motor driver.

MSRP – \$29⁰⁰
MIKROE-4357



DC Motor 17 Click

Features the TC78H-660FTG, a dual H Bridge driver for one or two brushed motors.

MSRP – \$12⁰⁰
MIKROE-4454



Brushless 8 Click

The TC78B042FTG, a sine-wave PWM drive three-phase full-wave brushless motor controller.

MSRP – \$29⁰⁰
MIKROE-4275



Brushless 9 Click

The TC78B027FTG, a 1-Hall sine-wave PWM controller for three-phase brushless DC motors.

MSRP – \$19⁰⁰
MIKROE-4387



Stepper 15 Click

Has the DRV8889A, a current sense stepper driver with stall detection from Texas Instruments.

MSRP – \$29⁰⁰
MIKROE-4639



Stepper 18 Click

Features the DRV8426, a PWM microstepping stepper motor driver from Texas Instruments.

MSRP - \$24⁰⁰
MIKROE-4689

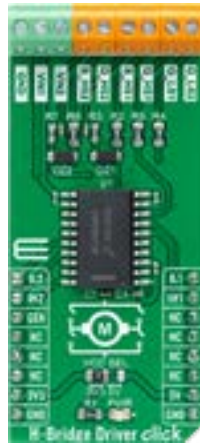

H-Bridge Driver Click

Features the DRV8426, a PWM microstepping stepper motor driver from Texas Instruments.

MSRP - \$28⁰⁰
MIKROE-4696



Stepper 16 Click

Has the NCV70517, a microstepping stepper motor driver from ON Semiconductor.

MSRP - \$21⁰⁰
MIKROE-4751



Brushless 14 Click

Has the TB67B001FTG, a three-phase PWM chopper driver for sensorless BLDC from Toshiba.

MSRP - \$32⁰⁰
MIKROE-4648



Brushless 16 Click

Features the LB11685AV, a three-phase full-wave current-linear-drive motor driver from ON Semi.

MSRP - \$15⁰⁰
MIKROE-4742



Stepper 11 Click

Features the TB9120AFTG, a bipolar stepping motor driver with a clock input interface from Toshiba.

MSRP - \$39⁰⁰
MIKROE-4578



DC Motor 18 Click

Features the TB9051FTG, a PWM type H-Bridge DC brushed motor driver from Toshiba.

MSRP - \$15⁰⁰
MIKROE-4786



H-Bridge 8 Click

Based on the MP6519, a monolithic step-down current-source driver from MPS.

MSRP - \$15⁰⁰
MIKROE-4775



Stepper 17 Click

Has the TB67S539FTG, a PWM-chopper bipolar stepping motor driver from Toshiba.

MSRP - \$25⁰⁰
MIKROE-4547



H-Bridge 9 Click

Has the L99UDL01, a PWM-configurable multiple H-bridge driver from STMicroelectronics.

MSRP - \$36⁰⁰
MIKROE-4821





Fan 8 Click

Based on the MAX6615, a compliant fan-speed controller from Analog Devices.

MSRP - \$27⁰⁰
MIKROE-4824



DC Motor 19 Click

Has the TC78H653FTG, a dual H-bridge driver for DC brushed or stepper motor from Toshiba.

MSRP - \$12⁰⁰
MIKROE-4883

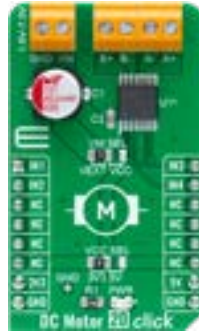

DC Motor 20 Click

Features the TC78H653FTG, a dual H-bridge driver for DC/stepping motors from Toshiba.

MSRP - \$9⁰⁰
MIKROE-4884



DC Motor 21 Click

Based on the A3910, a dual half-bridge motor driver from Allegro Microsystems.

MSRP - \$6⁰⁰
MIKROE-4877



Brushless 15 Click

Has the TB9061AFNG, a sensorless controller for a 3-phase full-wave BLDC motor from Toshiba.

MSRP - \$32⁰⁰
MIKROE-4885



H-Bridge Driver 2 Click

Has the NCV7535, a monolithic SPI-controlled H-bridge gate driver from ON Semiconductor.

MSRP - \$28⁰⁰
MIKROE-4931



Brushless 21 Click

Based on the AMT49400, a 3-phase BLDC controller with integrated MOSFETs from Allegro Microsystems.

MSRP - \$15⁰⁰
MIKROE-5055



Brushless 22 Click

Has the MTD6508, a 3-phase sinusoidal sensorless BLDC fan motor driver from Microchip.

MSRP - \$9⁰⁰
MIKROE-4995



H-Bridge 10 Click

Based on the MP6523, a triple half-bridge motor driver from MPS.

MSRP - \$18⁰⁰
MIKROE-5108



Multi Stepper Click

Features the TB62261, a CLOCK-in controlled bipolar stepping motor driver from Toshiba.

MSRP - \$26⁰⁰
MIKROE-5040





Multi Stepper Click

Features the TB62262, a CLOCK-in controlled bipolar stepping motor driver from Toshiba.

MSRP - \$26⁰⁰
MIKROE-5037



Multi Stepper Click

Features the TB62269, a CLOCK-in controlled bipolar stepping motor driver from Toshiba.

MSRP - \$26⁰⁰
MIKROE-5039



Multi Stepper Click

Features the TB67S101 a CLOCK-in controlled bipolar stepping motor driver from Toshiba.

MSRP - \$26⁰⁰
MIKROE-5044



Multi Stepper Click

Features the TB67S102 a CLOCK-in controlled bipolar stepping motor driver from Toshiba.

MSRP - \$26⁰⁰
MIKROE-5043



Multi Stepper Click

Features the TB67S109 a CLOCK-in controlled bipolar stepping motor driver from Toshiba.

MSRP - \$27⁰⁰
MIKROE-5052



Multi Stepper Click

Features the TB67S209, a CLOCK-in controlled bipolar stepping motor driver from Toshiba.

MSRP - \$26⁰⁰
MIKROE-5042



Multi Stepper Click

Features the TB67S261, a CLOCK-in controlled bipolar stepping motor driver from Toshiba.

MSRP - \$26⁰⁰
MIKROE-5051



Multi Stepper Click

Features the TB67S269, a CLOCK-in controlled bipolar stepping motor driver from Toshiba.

MSRP - \$19⁰⁰
MIKROE-5045



Brushless 23 Click

Has the TC78B011FTG, a 3-phase PWM chopper predriver for sensorless BLDC motor from Toshiba.

MSRP - \$25⁰⁰
MIKROE-5100



Brushless 17 Click

Features the L6229Q, a DMOS driver for a three-phase brushless DC motor from STMicroelectronics.

MSRP - \$19⁰⁰
MIKROE-5000





DC Motor 22 Click

Uses the TMC7300, a low voltage driver optimized for DC motor control from Analog Devices.

MSRP - \$24⁰⁰
MIKROE-5189



Brushless 20 Click

Features the DRV8313, a fully integrated three-phase BLDC motor driver from Texas Instruments.

MSRP - \$19⁰⁰
MIKROE-5294



Stepper 12 Click

Has the TB67S549FTG, a PWM chopper 2-phase bipolar stepping motor driver from Toshiba.

MSRP - \$23⁰⁰
MIKROE-5303



DC Motor 12 Click

Has the TB9054FTG, PWM-type dual-channel brushed DC motor driver from Toshiba.

MSRP - \$23⁰⁰
MIKROE-5374

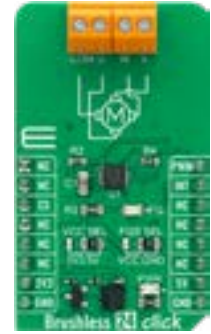

Brushless 24 Click

Features the DRV10866, a 3-phase sensorless motor driver from Texas Instruments.

MSRP - \$15⁰⁰
MIKROE-5478



Fan 5 Click

features Microchip's TC654, a PWM mode fan speed controller with FanSense™ technology.

MSRP - \$25⁰⁰
MIKROE-5507



DC Motor 24 Click

Carries the L9958, an SPI-controlled H-bridge from STMicroelectronics.

MSRP - \$39⁰⁰
MIKROE-5537



H-Bridge 11 Click

With the MAX22200, an octal serial-controlled solenoid and motor driver from Analog Devices.

MSRP - \$29⁰⁰
MIKROE-5636



DC Motor 25 Click

Has the A3908, a low-voltage bidirectional DC motor driver from Allegro Microsystems.

MSRP - \$15⁰⁰
MIKROE-5523



DC Motor 26 Click

Features the TB9053FTG, a PWM-type, dual-channel, H-bridge, brushed DC motor driver from Toshiba.

MSRP - \$35⁰⁰
MIKROE-5655



DC Motor 23 Click

Carries the MCT8316A, sensorless trapezoidal control integrated FET BLDC driver from TI.

MSRP - \$29⁰⁰
MIKROE-5644



Brushless 25 Click

Features the DRV8825, a stepper motor controller integral circuit from Texas Instruments.

MSRP - \$35⁰⁰
MIKROE-5678



H-Bridge 12 Click

Based on the DRV8823, a 4-bridge serial interface motor driver from Texas Instruments.

MSRP - \$49⁰⁰
MIKROE-5690



DC Motor 13 Click

Features the TB67H481FNG, H-bridge, brushed DC motor driver from Toshiba.

MSRP - \$23⁰⁰
MIKROE-5101



Brushless 26 Click

With the TB67H480FNG, a dual-channel, H-bridge, brushed DC motor driver from Toshiba.

MSRP - \$19⁰⁰
MIKROE-5476



Fan 9 Click

Features the TB67S581F-NG, a two-phase bipolar stepping motor driver from Toshiba.

MSRP - \$25⁰⁰
MIKROE-5263



Stepper 20 Click

With the TB67S580F-NG, a two-phase bipolar stepping motor driver from Toshiba.

MSRP - \$26⁰⁰
MIKROE-5477



H-Bridge 13 Click

Carries the DRV8411A, a dual H-bridge motor driver with current regulations from TI.

MSRP - \$21⁰⁰
MIKROE-5795



DC Motor 27 Click

With the DRV8143, an automotive half-bridge driver from TI.

MSRP - \$21⁰⁰
MIKROE-5806



Brushless 26 Click

Based on the DRV8317H, a three-phase PWM motor driver from TI.

MSRP - \$19⁰⁰
MIKROE-5843





Brushless 11 Click

Features the A4931, a 3-phase brushless DC motor pre-driver from Allegro Microsystems.

MSRP - \$25⁰⁰
MIKROE-5865



Brushless 13 Click

With the STSPIN830, a compact and versatile 3-phase and 3-sense motor driver from STM.

MSRP - \$24⁰⁰
MIKROE-5886



Brushless 27 Click

Features the TMC6300, a power driver for BLDC/ PMSM motors from Analog Devices.

MSRP - \$19⁰⁰
MIKROE-5910



H-Bridge 14 Click

Based on the DRV8873, an automotive H-Bridge motor driver from Texas Instruments.

MSRP - \$23⁰⁰
MIKROE-5916



DC Motor 29 Click

Carries the DRV8245P, an automotive H-Bridge drive from Texas Instruments.

MSRP - \$35⁰⁰
MIKROE-5905



H-Bridge 15 Click

Features the DRV8834, a dual-bridge stepper or DC motor driver from Texas Instruments.

MSRP - \$35⁰⁰
MIKROE-5913



H-Bridge 16 Click

Carries the DRV8262, a dual H-Bridge motor driver from Texas Instruments.

MSRP - \$29⁰⁰
MIKROE-5926



Silent Step 2 Click

Features the TMC2130, a high-performance two-phase stepper motor driver from ADI.

MSRP - \$35⁰⁰
MIKROE-5934



Silent Step 4 Click

This board features the TMC2240, a smart integrated stepper driver from ADI.

MSRP - \$29⁰⁰
MIKROE-5980



Stepper 19 Click

This board features the DRV8424, a stepper motor driver from Texas Instruments.

MSRP - \$23⁰⁰
MIKROE-6034



Brushless 10 Click

This board features the TC78B016FTG, a 3-phase sine-wave PWM driver from Toshiba.

MSRP – \$49⁰⁰
MIKROE-6136



Cooler Click

Features the DRV8213, a brushless DC motor driver from TI.

MSRP – \$53⁰⁰
MIKROE-6068



Stepper 23 Click

With the TB67S569FTG, a BiCD constant-current 2-phase bipolar stepping motor driver IC from Toshiba.

MSRP – \$35⁰⁰
MIKROE-6253



Fan 9 Click

Carries the A5932, a sensorless fan controller from Allegro Microsystems

MSRP – \$30⁰⁰
MIKROE-6103



Stepper 24 Click

Based on the TB67S589FTG, a 2-phase bipolar stepping motor driver IC from Toshiba.

MSRP – \$45⁰⁰
MIKROE-6254



Brushless 30 Click

This board features the TB9083FTG, a gate-driver IC from Toshiba.

MSRP – \$89⁰⁰
MIKROE-6337



Stepper 22 Click

Features the DRV8711, a bipolar stepper motor gate driver from TI.

MSRP – \$35⁰⁰
MIKROE-6206



Brushless 31 Click

Carries the TB6605FTG, a three-phase full sine-wave brushless motor controller from Toshiba.

MSRP – \$49⁰⁰
MIKROE-6348





EMBEDDEDWIKI

Find more than
1M READY-FOR-USE
EMBEDDED
PROJECTS

on the world's **largest**
embedded project platform



Scan the code and
get access!

AUDIO & VOICE





SpeakUp Click

A speech recognition Click. Can recognize over 200 different voice commands.

MSRP - \$39⁰⁰
MIKROE-1534



SpeakUp 2 Click

A speech recognition Click. Set it up to recognize up to 100 commands.

MSRP - \$34⁰⁰
MIKROE-2375



Audio Amp 4 Click

With the LM4860, an audio amplifier IC capable of delivering up to 1W of continuous power to an 8ohm load.

MSRP - \$17⁰⁰
MIKROE-3271



AudioMUX Click

Two-band digitally controlled high-quality audio processor with BASS ALC feat. and a 4-channel input selector.

MSRP - \$49⁰⁰
MIKROE-3344



Audio Amp 5 Click

The TPA3138D2, an inductorless stereo class-D amplifier, from Texas Instruments.

MSRP - \$17⁰⁰
MIKROE-3401



Audio Amp 6 Click

The TPA3138D2, a stereo class-D audio amplifier, from Texas Instruments.

MSRP - \$14⁰⁰
MIKROE-3448



MIC 2 Click

The MCP6022, a dual, rail-to-rail, low noise operational amplifier from Microchip.

MSRP - \$15⁰⁰
MIKROE-3445



Rec&Play Click

The ISD3900, a multi-message record and playback device with ChipCorder® technology, by Nuvoton.

MSRP - \$45⁰⁰
MIKROE-3345



2x20W Amp Click

Carries MAX9744 stereo class D audio power amplifier from Maxim Integrated.

MSRP - \$30⁰⁰
MIKROE-2779



2x5W AMP Click

Functions as an amplifier. With TDA7491LP 2x5-watt dual BTL class-D audio amplifier.

MSRP - \$19⁰⁰
MIKROE-2477





Audio Amp Click

A mono audio amplifier. With TI's LM48100Q-Q1 Boomer™ Mono, 1.3W Audio Power Amplifier IC.

MSRP – \$14⁰⁰
MIKROE-2368



BUZZ Click

Features a piezo speaker capable of emitting audio signals. Resonant frequency 3.8 kHz.

MSRP – \$9⁰⁰
MIKROE-945



BUZZ 2 Click

With CMT-8540S-SMT magnetic buzzer transducer. The buzzer's resonant frequency is 4 kHz.

MSRP – \$12⁰⁰
MIKROE-2720



StereoAmp Click

With 2 TI's LM48100Q-Q1 Boomer™ single supply, mono, bridge-tied load amplifier ICs.

MSRP – \$24⁰⁰
MIKROE-2454



TextToSpeech Click

With S1V30120 speech synthesis IC powered by the Fonix DEctalk® v5 speech synthesis engine.

MSRP – \$46⁰⁰
MIKROE-2253



GainAMP 2 Click

A 6-channel programmable gain amplifier. Amplifies up to 32x, in eight discrete steps.

MSRP – \$15⁰⁰
MIKROE-2859



RadioStation Click

With the Si4713-B30, the best in class integrated FM broadcast stereo transmitter.

MSRP – \$25⁰⁰
MIKROE-2822



Noise Click

With noise detecting circuitry. Enables you to set a noise detection threshold.

MSRP – \$29⁰⁰
MIKROE-2371



FM Click

Features Si4703 IC and functions as a FM radio tuner. Supports worldwide FM band [76-108 MHz].

MSRP – \$29⁰⁰
MIKROE-1431



GainAMP Click

Carries LTC®6912 channel, low noise, digitally programmable gain amplifier [PGA].

MSRP – \$21⁰⁰
MIKROE-2555





Mic Click

With SPQ0410HR5H-B surface mount silicon microphone with max. RF protection.

MSRP - \$9⁰⁰
MIKROE-2563



MP3 Click

With a stereo MP3 decoder VS1053. Multiple formats (MP3, MP1, MP2, MPEG4, etc.).

MSRP - \$21⁹⁰
MIKROE-946



2x30W Amp Click

The TPA3128, 2x30-W class-D amplifier with low idle power dissipation, from TI.

MSRP - \$30⁰⁰
MIKROE-3010



Audio Amp 2 Click

The TDA7491, a 20W dual BTL class-D audio amplifier IC, from STMicroelectronics.

MSRP - \$21⁰⁰
MIKROE-3077



EVC Click

The PT2258, a six-channel electronic volume controller IC, by Princeton Technology Corp.

MSRP - \$17⁰⁰
MIKROE-3358



AM/FM Click

Based on the Si4731 IC - digital CMOS AM/FM radio receiver from Silicon Labs.

MSRP - \$49⁰⁰
MIKROE-3800



Audio Amp 3 Click

Based on the Si4731 IC - digital CMOS AM/FM radio receiver from Silicon Labs.

MSRP - \$45⁰⁰
MIKROE-3901



Audio Xover Click

An analog active crossover solution for two-way loudspeakers with MCP6H012.

MSRP - \$18⁰⁰
MIKROE-4104



MIC 3 Click

Features the SSM2167-1RMZ-R7, a Microphone Preamplifier.

MSRP - \$15⁰⁰
MIKROE-4136



MP3 2 Click

Based on KT403A, a hardware audio MP3/WAV decoder and DSP, with on-board microSD card slot.

MSRP - \$17⁰⁰
MIKROE-4159





DTMF Generator Click

Features the HT9200A, a dual-tone multi-frequency decoder.

MSRP - \$26⁰⁰
MIKROE-4298



BUZZ 3 Click

The PAM8904, a piezo-sounder driver with a Multi-Mode charge pump boost converter.

MSRP - \$9⁰⁰
MIKROE-4390



Volume Click

Based on the CS3310, a complete stereo digital volume control.

MSRP - \$48⁰⁰
MIKROE-4450



DSP Click

Based on the V1000, a complete multi-effects audio DSP from Coolaudio.

MSRP - \$53⁰⁰
MIKROE-4431



Volume V2 Click

The NJU72341, a 2-channel I2C configurable electronic volume IC with external mute control.

MSRP - \$15⁰⁰
MIKROE-4560



DTMF Decoder Click

Features the MT8870D, a complete DTMF receiver integrating the band-split filter.

MSRP - \$24⁰⁰
MIKROE-4579



Speaker Click

Features the MAX9717, a 1.4W mono BTL architecture audio power amplifier from Maxim Integrated.

MSRP - \$31⁰⁰
MIKROE-4662



Headphone AMP Click

Carries the LM4811, Boomer® audio power amplifier with digital volume control from Texas Instruments.

MSRP - \$15⁰⁰
MIKROE-4766



GainAMP 3 Click

Based on the ADA4254, a programmable gain instrumentation amplifier from Analog Devices.

MSRP - \$25⁰⁰
MIKROE-4800



VU Meter Click

Features the LM3914 dot/bar display driver and 10 segment bargraph display from TI.

MSRP - \$35⁰⁰
MIKROE-5111



Smart Mic Click

Based on the IA611, an "Always-On" voice-wake acoustic processor from Knowles Electronics.

MSRP - \$19⁰⁰
MIKROE-4158



AudioAmp 8 Click

Features the MA12070, a super-efficient audio power amplifier from Infineon Technologies.

MSRP - \$35⁰⁰
MIKROE-4812



SpeakUp 3 Click

Carries the VC-02, a low-cost pure offline speech recognition module from Ai-Thinker Technology.

MSRP - \$17⁰⁰
MIKROE-5420



AudioAmp 11 Click

Features the NAU8224, a high-performance stereo Class-D audio amplifier from Nuvoton.

MSRP - \$19⁰⁰
MIKROE-5584



Audio DAC Click

Carries the PCM5142, a 32-bit 384kHz audio stereo DAC with the DIR9001 digital audio receiver from TI.

MSRP - \$49⁰⁰
MIKROE-5587



AudioAMP 9 Click

Features the PAM8124, a 10W efficient, Class-D audio power amplifier from Diodes.

MSRP - \$21⁰⁰
MIKROE-5595



Headphone AMP 3 Click

With the Si4732, a broadcast AM/FM/SE/LW/RDS radio receiver from Skyworks.

MSRP - \$29⁰⁰
MIKROE-5721



AM/FM 2 Click

Carries the VC-02, a low-cost pure offline speech recognition module from Ai-Thinker Technology.

MSRP - \$24⁰⁰
MIKROE-5793



AudioAmp 12 Click

Based on the TS-2007FC, a filter-free class-D audio amplifier from STM.

MSRP - \$29⁰⁰
MIKROE-5796



Headphone AMP 2 Click

With the MAX9723, a stereo DirectDrive headphone amplifier with BassMax, volume control, and I2C from ADI.

MSRP - \$18⁰⁰
MIKROE-5577





Piezo Driver Click

Features the PAM8906, a piezo sounder driver with self-excitation mode from Diodes Inc.

MSRP - \$12⁰⁰
MIKROE-5896



DTMF Click

Based on the CMX865A, a DTMF Codec/FSK Combo multi-standard modem from CML Micro.

MSRP - \$69⁰⁰
MIKROE-6170



Buzzer Click

Features the CPT-7502-65-SMT-TR, a piezoelectric buzzer transducer from Same Sky.

MSRP - \$12⁰⁰
MIKROE-6370



Rec&Play 2 Click

Based on the ISD1616B, a single-message voice record and playback IC from Nuvoton.

MSRP - \$45⁰⁰
MIKROE-6167



MIXED
SIGNAL





PIXI™ Click

Features proprietary PIXI™ technology. Configurable 20-channel mixed-signal data converter.

MSRP - \$29⁰⁰
MIKROE-2817



Multimeter Click

Has different ICs: amplifiers, NE555 timer, BCD decoder, frequency to voltage converter, and an A/D converter (ADC).

MSRP - \$39⁰⁰
MIKROE-3116



LEM Click

Measures AC and DC current (up to 200 KHz). With LTS 6-NP current transducer.

MSRP - \$59⁰⁰
MIKROE-2553



PAC1934 Click

Carries PAC1934 four channel DC power/frequency monitor from Microchip.

MSRP - \$29⁰⁰
MIKROE-2735



V to Hz Click

The TC9400, a voltage-to-frequency and frequency-to-voltage converter from Microchip.

MSRP - \$27⁰⁰
MIKROE-2889



Hz to V Click

The TC9400, a voltage-to-frequency and frequency-to-voltage converter from Microchip.

MSRP - \$27⁰⁰
MIKROE-2890



PAC1921 Click

The PAC1921, a high side power/current monitor from Microchip.

MSRP - \$17⁰⁰
MIKROE-2910



DIGI POT 3 Click

The AD5321, a 1024-position (10bit) digital potentiometer with a non-volatile memory (EEMEM).

MSRP - \$21⁰⁰
MIKROE-3016



ADC 6 Click

With the AD7124-8, an 8 channel, low noise, low power, 24bit sigma-delta ADC.

MSRP - \$29⁰⁰
MIKROE-2932



ADC 7 Click

The LTC2500-32. It is a 32-bit oversampling ADC with a configurable digital filter, from Analog Devices.

MSRP - \$99⁰⁰
MIKROE-3115





AC Current Click

Measure alternating currents up to 30A. MCP3201 ADC converter and MCP607 CMOS Op Amp.

MSRP - \$14⁰⁰
MIKROE-2523



ADAC Click

It's an 8-channel 12-bit ADC, DAC and GPIO. With AD5593R configurable ADC/DAC.

MSRP - \$14⁰⁰
MIKROE-2523



ADC Click

With Microchip's MCP3204 12-bit Analog-to-Digital converter.

MSRP - \$26⁰⁰
MIKROE-2690



Hz to V 2 Click

With the VFC32KU, a voltage-to-frequency and frequency-to-voltage converter.

MSRP - \$42⁰⁰
MIKROE-3126



V to Hz 2 Click

With the VFC32KU, a voltage-to-frequency and frequency-to-voltage converter.

MSRP - \$42⁰⁰
MIKROE-3131



Ammeter Click

With circuitry for measuring electric current (AC and DC). 0.1A-1A measurement range.

MSRP - \$24⁰⁰
MIKROE-2377



C Meter Click

Circuitry for measuring the value of capacitors. Based on NE-555 timer/square-wave generator.

MSRP - \$9⁰⁰
MIKROE-2376



Comparator Click

Carries LM2903 IC, has two independent precision voltage comparators. 2 mV offset voltage.

MSRP - \$12⁰⁰
MIKROE-1915



DAC Click

Includes a 12-bit Digital-to-Analog Converter MCP4921 from Microchip.

MSRP - \$18⁰⁰
MIKROE-950



DAC 2 Click

Carries LTC2601CDD, a 16-bit digital-to-analog converter from Linear Technology.

MSRP - \$19⁰⁰
MIKROE-1918



DAC 3 Click

Carries Micro-chip's MCP4726 IC, a 12-bit digital-to-analog converter.

MSRP - \$18⁰⁰
MIKROE-2038



ADC 2 Click

With MCP3551/3, a 22-bit ADC with automatic internal offset and gain calibration.

MSRP - \$24⁰⁰
MIKROE-1893



ADC 3 Click

With Micro-chip's MCP3428 16-bit multichannel analog-to-digital converter.

MSRP - \$22⁰⁰
MIKROE-1894



ADC 4 Click

An advanced analog to digital multichannel converter. It can work in 16bit or 24bit mode.

MSRP - \$65⁰⁰
MIKROE-2879



ADC 5 Click

With a low power, single channel 12-bit CMOS analog to digital converter.

MSRP - \$18⁰⁰
MIKROE-2846



DIGI POT Click

Carries MCP416 single-channel 8-bit resolution [256 wiper steps] digital potentiometer.

MSRP - \$16⁰⁰
MIKROE-923



DIGI POT 2 Click

Carries a single channel digital potentiometer TPL0501 with 256 wiper positions.

MSRP - \$16⁰⁰
MIKROE-2332



DIGI POT 4 Click

A digitally controlled dual potentiometer, with the resistance of 10KΩ.

MSRP - \$21⁰⁰
MIKROE-2873



R Meter Click

With circuitry for measuring the value of resistors. A wide range of resistors [0-1 Mega Ohm].

MSRP - \$27⁰⁰
MIKROE-2396



Voltmeter Click

For measuring voltage in an external electric circuit. Measures direct current [from 0 to 24V].

MSRP - \$24⁰⁰
MIKROE-2436





DIGI POT 5 Click

A digitally controlled quad potentiometer, with the resistance of 10KΩ.

MSRP – \$16⁰⁰
MIKROE-2863



PWR Meter Click

Uses the MCP39F511A, a very sophisticated monitoring IC from Microchip, with 16-bit processing core.

MSRP – \$42⁰⁰
MIKROE-3169



PWR Meter 2 Click

Measuring and monitoring voltage up to 24V and current up to 5A. It carries the MCP3910 module.

MSRP – \$19⁰⁰
MIKROE-3150



RMS to DC Click

With the LTC1968, converter IC, which outputs an analog voltage depending on the RMS value of the input signal.

MSRP – \$35⁰⁰
MIKROE-3311

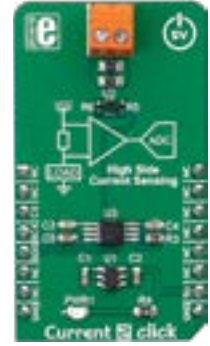

Current 2 Click

Equipped with an integrated transimpedance amplifying circuit.

MSRP – \$17⁰⁰
MIKROE-3292



MUX Click

Equipped with the MUX508, a precise analog multiplexing IC.

MSRP – \$17⁰⁰
MIKROE-3247



MUX 2 Click

The MUX508, a modern CMOS analog multiplexing integrated circuit.

MSRP – \$17⁰⁰
MIKROE-3245



MUX 3 Click

Based around the TMUX1208 module, a 5-V Bidirectional 8:1, 1-Channel Multiplexer.

MSRP – \$7⁰⁰
MIKROE-3916

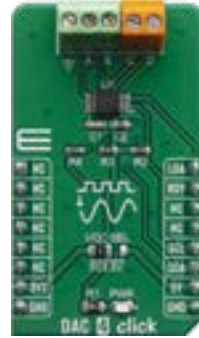

DAC 4 Click

The MCP4728, a quad, 12-bit voltage output Digital-to-Analog Converter [DAC] with [EEPROM].

MSRP – \$12⁰⁰
MIKROE-3707



DAC 5 Click

It's an advanced 10-bit eight-channel digital to analog converter [DAC] with DAC53608.

MSRP – \$15⁰⁰
MIKROE-3712



DAC 7 Click

It's an advanced 12-bit, four-channel digital to analog converter (DAC) with AD5624R.

MSRP - \$26⁰⁰
MIKROE-3886



DAC 8 Click

The DAC8554IPWR, a 16-bit QUAD channel voltage-output digital to analog converter.

MSRP - \$35⁰⁰
MIKROE-4229



DigiVref Click

With the MCP1541 it is a perfect solution to be used in various A/D conversion applications.

MSRP - \$15⁰⁰
MIKROE-3334



Waveform Click

The AD9833, a low-power, programmable waveform generator.

MSRP - \$47⁰⁰
MIKROE-3309



Waveform 2 Click

Features the AD9834, a 75 MHz low power DDS device.

MSRP - \$45⁰⁰
MIKROE-4346



L meter click

Features the LM311D, a high-speed voltage comparator.

MSRP - \$9⁰⁰
MIKROE-3505



AD-SWIO Click

The AD74412R a quad-channel software configurable input/output solution.

MSRP - \$49⁰⁰
MIKROE-4081



AD-SWIO 2 Click

With a 16-bit ADC converter, and 13-bit DAC converter integrated into the AD74413R.

MSRP - \$56⁰⁰
MIKROE-3861



AN To PWM click

Uses OPA365 series op-amps, and the TLV3201 comparators from TI.

MSRP - \$12⁰⁰
MIKROE-4060



AN to PWM 2 Click

Features the LTC6992CS6, a silicon oscillator from Analog Devices.

MSRP - \$24⁰⁰
MIKROE-4221





ISO ADC Click

The AMC1204BDWR, Iso- lated Delta-Sigma Mod- ulator for Current-Shunt Measurement.

MSRP – \$15⁰⁰
MIKROE-4088



ISO ADC 2 Click

Features the AD7091R, successive-approx- imation analog-to-digi- tal converter [ADC].

MSRP – \$45⁰⁰
MIKROE-4166



ISO ADC 3 Click

Features the AMC1100, a precision isolation amplifier.

MSRP – \$15⁰⁰
MIKROE-4383



ADC 8 Click

The ADS1115 a high precision, low-power, 16-bit analog-to-digi- tal converter [ADC].

MSRP – \$21⁰⁰
MIKROE-3394



ADC 9 Click

Based on MCP3564 a 24-bit Delta-Sigma Analog-to-Digital Converter.

MSRP – \$17⁰⁰
MIKROE-4105



ADC 10 Click

Features the AD- S122U04, a 24-bit precision $\Sigma\Delta$ ADC converter.

MSRP – \$27⁰⁰
MIKROE-4488



ADC 12 Click

The ADS7828, a low-power 12-bit data acquisition device.

MSRP – \$27⁰⁰
MIKROE-4376



DIGI POT 6 Click

Features the MCP41HV51, 8-bit dual power rails digital potentiometer.

MSRP – \$14⁰⁰
MIKROE-4110



VCP monitor 2 Click

Uses the INA3221-Q1, a three-channel, high- side current and bus voltage monitor.

MSRP – \$23⁰⁰
MIKROE-4126



VCP Monitor 3 Click

Features the LTC2947 a high precision power and energy monitor.

MSRP – \$17⁰⁰
MIKROE-4222



Wheatstone Click

With the MAX4208 – an ultra-low offset/ drift, precision instrumentation amplifier.

MSRP – \$15⁰⁰
MIKROE-4124



DAC 6 Click

The DAC104S085, 10-bit, micro-power, a quad digital-to-analog converter.

MSRP – \$15⁰⁰
MIKROE-4206



DAC 9 Click

Features the DAC80501, a 16-bit voltage-output digital-to-analog converter.

MSRP – \$15⁰⁰
MIKROE-4332



DIGI POT 7 Click

Features the AD5175, a single-channel 1024-position digital rheostat.

MSRP – \$12⁰⁰
MIKROE-4414



Current 3 Click

Features the EMC1702, a combination of the high-side current sensing device.

MSRP – \$15⁰⁰
MIKROE-4203



Analog MUX 2 Click

Features the ADG728, a low voltage, CMOS 8-channel analog matrix switch.

MSRP – \$18⁰⁰
MIKROE-4468



Waveform 3 Click

Uses the AD9837, a fully integrated direct digital synthesis [DDS] device.

MSRP – \$25⁰⁰
MIKROE-4432



DAQ 3 Click

Uses the ADAQ4003, a fast and precise system-in-package DAQ signal chain solution.

MSRP – \$79⁰⁰
MIKROE-4486



Analog MUX 3 Click

Uses the ADG738, a CMOS analog matrix switch with a serially-controlled SPI interface.

MSRP – \$12⁰⁰
MIKROE-4580



ADC 11 Click

Features the LTC1864, a 16-bit 250ksp/s analog-to-digital converter from Analog Devices.

MSRP – \$33⁰⁰
MIKROE-4593





DIGI POT 8 Click

Carries the AD5206, 6-channel digitally controlled potentiometer from Analog Devices.

MSRP – \$21⁰⁰
MIKROE-4596



PAC1954 Click

Features the PAC1954, a four-channel DC power/energy monitor from Microchip.

MSRP – \$24⁰⁰
MIKROE-4291



PAC1944 Click

Based on the PAC1944, a multi-channel DC power/energy monitor from Microchip.

MSRP – \$19⁰⁰
MIKROE-4478



DAC 10 Click

Equipped the DAC53401, a 10-bit voltage-output smart DAC from TI.

MSRP – \$11⁰⁰
MIKROE-4732



ADC 13 Click

With the ADS1262, programmable analog-to-digital converter from Texas Instruments.

MSRP – \$51⁰⁰
MIKROE-4743



MUX 4 Click

With the 74HC4851, 8-channel analog multiplexer/demultiplexer from Nexperia.

MSRP – \$7⁰⁰
MIKROE-4754



ISO ADC 5 Click

Based on the MAX22530, galvanically isolated 4-channel AD converter from Analog Devices.

MSRP – \$27⁰⁰
MIKROE-4758



VCP Monitor 4 Click

Features the INA239, digital power monitor for current-sensing applications from TI.

MSRP – \$21⁰⁰
MIKROE-4763



DAC 11 Click

Features the DAC128S085, a OCTAL 12-bit analog output DAC from TI.

MSRP – \$47⁰⁰
MIKROE-4767



DAQ Click

Features the ADAQ7768-1, a 24-bit precision DAQ µModule system from Analog Devices.

MSRP – \$75⁰⁰
MIKROE-4495



PAC1720 Click

Features the PAC1720, a bi-directional current sensing monitor from Microchip.

MSRP - \$15⁰⁰
MIKROE-4905



ADC 15 Click

Based on the ADS131M02, analog-to-digital converter from Texas Instruments.

MSRP - \$26⁰⁰
MIKROE-4890



Serializer Click

Carries the MAX31910, an industrial eight-channel digital input serializer from ADI.

MSRP - \$42⁰⁰
MIKROE-4925



ADC 17 Click

Features the MAX11645, a low-power two-channel 12-bit ADC converter from Analog Devices.

MSRP - \$15⁰⁰
MIKROE-4966



ADC 16 Click

With the ADS7142-Q1, a low-power two-channel 12-bit ADC converter from Texas Instruments.

MSRP - \$33⁰⁰
MIKROE-4937



DAC 12 Click

Carries the DAC60508, a general-purpose octal 12-bit DAC from Texas Instruments.

MSRP - \$42⁰⁰
MIKROE-5097

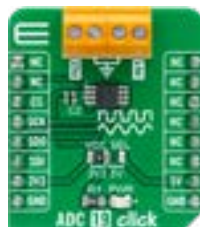

ADC 19 Click

Features the ADC122S101, a two-channel CMOS 12-bit ADC converter from TI.

MSRP - \$13⁰⁰
MIKROE-4997



DIGI POT 9 Click

Based on the AD5235, a dual-channel, digital potentiometer from Analog Devices.

MSRP - \$36⁰⁰
MIKROE-4727



ADC 18 Click

Carries the MAX22005, an twelve-channel 24-bit analog-to-digital converter from ADI.

MSRP - \$35⁰⁰
MIKROE-5132



ADAC 3 Click

With the PCF8591, an 8-bit A/D and D/A converter device from NXP.

MSRP - \$24⁰⁰
MIKROE-5198





V to Hz 3 Click

Features the AD7740, an synchronous voltage-to-frequency converter from Analog Devices.

MSRP - \$21⁰⁰
MIKROE-5250



DIGI POT 11 Click

Carries the MAX5387, a double pack digital potentiometer from Analog Devices.

MSRP - \$22⁰⁰
MIKROE-4318



DAC 13 Click

With the AD3541R, a 16-bit accuracy single channel DAC converter from Analog Devices.

MSRP - \$109⁰⁰
MIKROE-5412



ADAC 2 Click

Features the MAX22000, a 24-bit ADC, an 18-bit DAC, and AFE from Analog Devices.

MSRP - \$115⁰⁰
MIKROE-5475



MUX 9 Click

Features the ADG1438, a CMOS 8-channel analog matrix switch from Analog Devices.

MSRP - \$29⁰⁰
MIKROE-5500



ADC 20 Click

Features the TLA2518, an SPI-configurable eight-channel 12-bit SAR ADC from TI.

MSRP - \$21⁰⁰
MIKROE-5424



PWR Meter 3 Click

Features the ACS37800, an I2C-configurable power monitoring solution from Allegro.

MSRP - \$45⁰⁰
MIKROE-5510



DAC 14 Click

Carries the DAC53202, a programmable voltage/current-output DAC from TI.

MSRP - \$24⁰⁰
MIKROE-5525



ADC 21 Click

With the ADC1283, a CMOS 12-bit analog-to-digital converter from STM.

MSRP - \$17⁰⁰
MIKROE-5531



HW Monitor Click

Features the LM96080, hardware monitor from Texas Instruments.

MSRP - \$25⁰⁰
MIKROE-5684



HW Monitor 2 Click

Features the LM96080, an I2C-configurable system hardware monitor from TI.

MSRP - \$21⁰⁰
MIKROE-5684



DIGI POT 12 Click

With the AD5142A, a dual-channel, 256-position nonvolatile digital potentiometer from ADI.

MSRP - \$21⁰⁰
MIKROE-5656



DIGI POT 13 Click

Carries the MAX5419, a 256-tap non-volatile digital potentiometer from ADI.

MSRP - \$19⁰⁰
MIKROE-5683



ADC 22 Click

Features the ADS8665, a high-speed single-supply SAR ADC data acquisition system from TI.

MSRP - \$19⁰⁰
MIKROE-5640



DAC 15 Click

Features the DAC80502, a dual 16-bit 1-LSB INL voltage-output DAC from TI.

MSRP - \$27⁰⁰
MIKROE-5825



RMS to DC 2 Click

Carries the AD8436, a low-cost, low-power, true RMS-to-DC converter from ADI.

MSRP - \$45⁰⁰
MIKROE-5821



DIGI POT 14 Click

Features the TPL0102, a dual-channel digital potentiometer with non-volatile memory from TI.

MSRP - \$25⁰⁰
MIKROE-5814



ADC 23 Click

With the ADS127L11, 24-bit delta-sigma analog-to-digital converter from TI.

MSRP - \$49⁰⁰
MIKROE-5861



ADC 14 Click

Features the MAX1108A, a low-power serial ADC from ADI.

MSRP - \$25⁰⁰
MIKROE-5880



AD-SWIO 3 Click

Features the AD74115H, software-configurable input and output with HART mode from ADI.

MSRP - \$109⁰⁰
MIKROE-5946





EZO Carrier Click-pH

Based on the EZQ™ pH, a pH measurement interface circuit board from Atlas Scientific.

MSRP – \$129⁰⁰
MIKROE-6009



ISO ADC 6 Click

Features the AD7124-8, an 8-channel, low noise, low power, 24-bit, sigma-delta ADC from ADI.

MSRP – \$45⁰⁰
MIKROE-5901



Hall Current 8 Click

Features the TLI4971-A025T5, a high-precision coreless current sensor from Infineon

MSRP – \$29⁰⁰
MIKROE-4632



Hall Current 8 Click

Features the TLI4971-A120T5, a high-precision coreless current sensor from Infineon

MSRP – \$49⁰⁰
MIKROE-4508

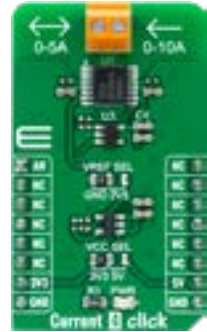

Current 4 Click

Features the INA250, a bidirectional, zero-drift current-shunt monitor from TI.

MSRP – \$15⁰⁰
MIKROE-4755



DIGI POT 11 Click

Features a double pack of the MAX5387, digital potentiometer from Analog Devices.

MSRP – \$22⁰⁰
MIKROE-5318

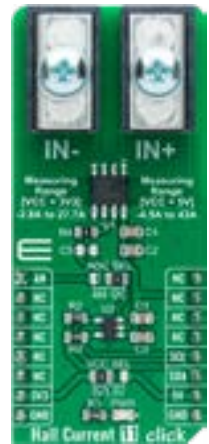

Hall Current 11 Click

Based on the TMC-S1108A2U, a galvanically isolated Hall-effect current sensor from TI.

MSRP – \$30⁰⁰
MIKROE-4797



Hall Current 12 Click

Features the TMC-S1100A4, a galvanically isolated Hall-effect current sensor from TI.

MSRP – \$38⁰⁰
MIKROE-4798



Current 5 Click

With the INA381, a high-speed current-sense amplifier with an integrated Hall-effect current comparator from TI.

MSRP – \$24⁰⁰
MIKROE-4953



Hall Current 13 Click

Based on the TMCS1107-Q1, a galvanically isolated Hall-effect current sensor from TI.

MSRP – \$38⁰⁰
MIKROE-5066



Current 6 Click

Features the MAX40080, a fast-response bi-directional current-sense amplifier from ADI.

MSRP - \$32⁰⁰
MIKROE-4914



Hall Current 15 Click

With the TMCS1101-Q1, a galvanically isolated Hall-effect current sensor from TI.

MSRP - \$21⁰⁰
MIKROE-5175

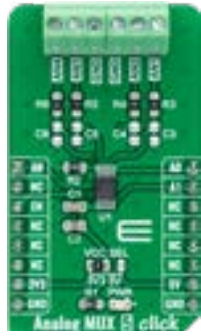

Analog MUX 5 Click

Carries the MAX4634, a fast, low-voltage four-channel CMOS analog multiplexer from ADI.

MSRP - \$12⁰⁰
MIKROE-5120

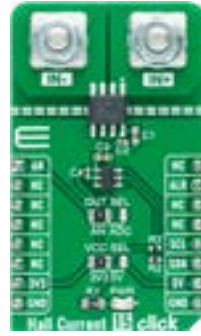

Hall Current 15 Click

Based on the TMCS1101-Q1, a galvanically isolated Hall-effect current from TI.

MSRP - \$21⁰⁰
MIKROE-5175

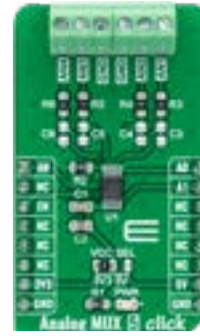

Analog MUX 5 Click

Features the MAX4634, a fast, low-voltage four-channel CMOS analog multiplexer from ADI.

MSRP - \$12⁰⁰
MIKROE-5120

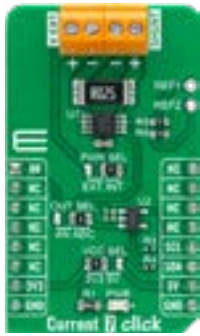

Current 7 Click

Features the INA282, high-accuracy current shunt monitor from Texas Instruments.

MSRP - \$26⁰⁰
MIKROE-4976



Hall Current 14 Click

features the MCS1801, a fully integrated Hall-effect-based isolated linear current sensor from MPS.

MSRP - \$27⁰⁰
MIKROE-5239

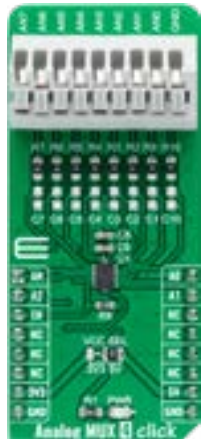

Analog MUX 4 Click

Based on the TMUX1308, a general-purpose 8:1 single-ended CMOS multiplexer [MUX] from TI.

MSRP - \$11⁰⁰
MIKROE-4795



Current 9 Click

With the CT415-HSN-830DR, XtremeSense[®] TMR current sensor from Allegro.

MSRP - \$29⁰⁰
MIKROE-5319



MUX 5 Click

features the MAX14661, a serially controlled, dual-channel analog multiplexer from ADI.

MSRP - \$27⁰⁰
MIKROE-5423





ADC 24 Click

Features the AD7490, a 12-bit, 16-channel successive approximation ADC from ADI.

MSRP – \$42⁰⁰
MIKROE-6039



DAC 16 Click

Carries the DAC63204-Q1, an automotive-qualified 12-bit DAC from TI.

MSRP – \$45⁰⁰
MIKROE-6209



VCP Monitor 6 Click

Features the INA780A, a digital power monitor with EZShunt™ technology from TI.

MSRP – \$28⁰⁰
MIKROE-6101



PWR Meter 3 Click

Features the ACS37800KMAC-TR-030B3-I2C, from Allegro.

MSRP – \$54⁰⁰
MIKROE-6257



DAC 17 Click

Carries the DAC63204-Q1, an automotive-qualified 12-bit DAC from TI.

MSRP – \$40⁰⁰
MIKROE-6059



CDC Click

Features the PCAP04, a capacitance-to-digital converter [CDC] from ScioSense.

MSRP – \$30⁰⁰
MIKROE-5985



ISO ADC 6 Click

With the AD7124-8, an 8-channel, low noise, low power, 24-bit, sigma-delta ADC from ADI.

MSRP – \$54⁰⁰
MIKROE-6901



AD-SWIO 3 Click

Carries the AD74115H, input and output with HART mode from ADI.

MSRP – \$28⁰⁰
MIKROE-6101

POWER MANAGEMENT





BATT-MAN Click

The LTC3586, a high-efficiency power manager with boost, buck-boost, and dual buck converters.

MSRP – \$27⁰⁰
MIKROE-2901



MCP73213 Click

Carries MCP73213 dual-cell Li-Ion/Li-Polymer battery charge management controller.

MSRP – \$18⁰⁰
MIKROE-2575



MIC23099 Click

Carries MIC23099 single AA/AAA cell step-down/step-up regulator with battery monitoring.

MSRP – \$29⁰⁰
MIKROE-2765



MIC24045 Click

Carries MIC24045 5A synchronous step-down regulator. Input range 4.5V-19V.

MSRP – \$13⁰⁰
MIKROE-2574



VREG Click

Digitally controlled DC voltage regulator. Based on the well-known LM317 circuit.

MSRP – \$24⁰⁰
MIKROE-2443



Charger 2 Click

The STBC08, an 800 mA standalone linear Li-Ion battery charger with thermal regulation.

MSRP – \$17⁰⁰
MIKROE-3049



MCP16331 INV Click

Works in an inverting configuration, provides a negative output voltage in respect to the GND.

MSRP – \$22⁰⁰
MIKROE-2917



Step Down 2 Click

The L6986HTR is a step-down monolithic switching regulator able to deliver up to 2 A DC.

MSRP – \$15⁰⁰
MIKROE-3895



Step Up Click

The MCP1665, a 500 kHz, compact, high-efficiency, fixed-frequency, nonsynchronous step-up DC-DC.

MSRP – \$19⁰⁰
MIKROE-3709



Peltier Click

With the SPV1050, an ultralow power energy harvester and battery charger.

MSRP – \$24⁰⁰
MIKROE-3814





MIC24055 Click

Equipped with the MIC24055, high-efficiency buck regulator from Microchip.

MSRP - \$29⁰⁰
MIKROE-2835



Qi Receiver Click

Utilizes the principles of the inductive coupling for the purpose of wireless power transfer.

MSRP - \$18⁰⁰
MIKROE-2799



Solar energy Click

Uses TI's BQ25570 - a nano-power high-efficiency boost charger and buck converter device.

MSRP - \$27⁰⁰
MIKROE-2814

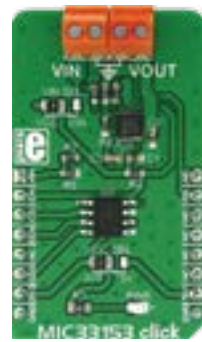

MIC33153 Click

A DC-DC adjustable step-down [buck] converter.

MSRP - \$21⁰⁰
MIKROE-2887



VREG 2 Click

Uses the LM2596, a 3A, step down voltage regulator working at 150 kHz, from Texas Instruments.

MSRP - \$21⁰⁰
MIKROE-3055



Buck-Boost 2 Click

The LTC3115-2, a 40V, 2A synchronous buck-boost DC/DC converter from Linear Technology.

MSRP - \$27⁰⁰
MIKROE-2963



Buck-Boost Click

Features LTC3129-1, a buck-boost DC/DC conversion integrated circuit.

MSRP - \$20⁰⁰
MIKROE-2806

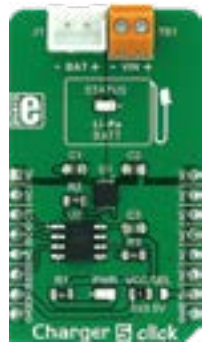

Charger 5 Click

Designed to charge Lithium-Ion and Lithium-Polymer batteries.

MSRP - \$16⁰⁰
MIKROE-2848



MCP16331 Click

Functions as a non-inverting buck-boost voltage regulator.

MSRP - \$22⁰⁰
MIKROE-2782

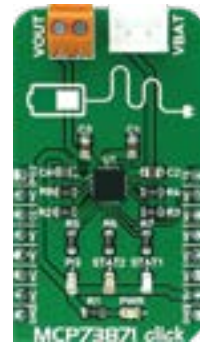

MCP73871 Click

Integrated solution for system power delivery and Li-Po/Li-Ion battery charge management.

MSRP - \$16⁰⁰
MIKROE-2858





Boost Click

Carries Microchip's MIC2606, a 2MHz, PWM DC/DC boost switching regulator.

MSRP - \$21⁰⁰
MIKROE-2780



BOOST 2 Click

A DC-DC step-up regulator that has a fixed 5V output.

MSRP - \$15⁰⁰
MIKROE-2894



Boost 4 Click

Carries TI's TPS61230A, a high efficiency fully integrated synchronous boost converter.

MSRP - \$17⁰⁰
MIKROE-2757



Nano Power 2 Click

The MAX40000AUT12+, a nanoPower comparator with built-in reference.

MSRP - \$11⁰⁰
MIKROE-3036



Smart Buck Click

The MIC2230, a dual synchronous step-down DC/DC regulator.

MSRP - \$29⁰⁰
MIKROE-3113



BUCK 7 Click

The MAX17504, a high efficiency, synchronous step-down DC-DC converter with internal compensation.

MSRP - \$27⁰⁰
MIKROE-3094



Buck 8 Click

Uses the MAX17536, a high-efficiency, synchronous step-down DC-DC converter.

MSRP - \$26⁰⁰
MIKROE-2997



Buck-Boost 3 Click

The ISL85403, a 2.5A regulator with the integrated high-side MOSFET and a low-side driver.

MSRP - \$27⁰⁰
MIKROE-3277



Charger Click

Carries a battery charger controller and a battery charge monitor, along with a battery connector.

MSRP - \$22⁰⁰
MIKROE-2033



Charger 8 Click

The MAX8903B and the MAX17201, both ICs from Maxim Integrated.

MSRP - \$24⁰⁰
MIKROE-3348





Buck 9 Click

The MP9943, a synchronous step-down converter, from Monolithic Power Systems [MPS].

MSRP - \$21⁰⁰
MIKROE-3057



Buck 10 Click

The MPM3632C, a 18V 3A ultra-low profile DC-to-DC power module by Monolithic Power Systems [MPS].

MSRP - \$15⁰⁰
MIKROE-3569



Buck 11 Click

The LMR36015, a synchronous step-down converter, from Texas Instruments.

MSRP - \$21⁰⁰
MIKROE-3438



Buck 12 Click

The MPQ8632, a synchronous step-down converter, from Monolithic Power [MPS].

MSRP - \$21⁰⁰
MIKROE-3438



Buck 13 Click

The MPM3530, a 55V 3A ultra-low profile DC-to-DC power module by Monolithic Power Systems [MPS].

MSRP - \$21⁰⁰
MIKROE-3438



Charger 9 Click

The MAX1757, a stand-alone, switch-mode Li+ battery charger, from Maxim Integrated.

MSRP - \$24⁰⁰
MIKROE-3568



BUCK Click

Buck switching regulator. A wide input voltage range of up to 40V. Steps it down to 3.3V or 5V.

MSRP - \$28⁰⁰
MIKROE-1592



Buck 2 Click

A powerful step down DC-DC switching regulator. Input voltage range 4.5V-19V.

MSRP - \$16⁰⁰
MIKROE-2858



Buck 3 Click

Uses the TPS568215, a 4.5V to 17V Input, 8A synchronous step-down SWIFT™ converter.

MSRP - \$22⁰⁰
MIKROE-2971



Boost 6 Click

The BQ25887 fully integrated 2-cell Li-ion batt. charger IC ideal for portable app. with cell balancing.

MSRP - \$15⁰⁰
MIKROE-3813



BUCK 5 Click

The MAX17506, a high efficiency, synchronous step-down DC/DC converter with internal compensation.

MSRP - \$29⁰⁰
MIKROE-3100



BUCK 6 Click

Uses the MAX17572, a step down [buck] DC-DC converter from Maxim Integrated.

MSRP - \$18⁰⁰
MIKROE-2957

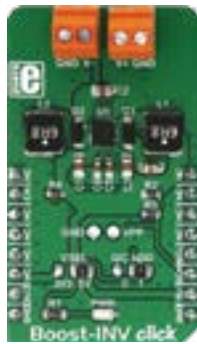

Boost-INV Click

The LTC3582, programmable boost and inverting DC/DC converter with OTP memory.

MSRP - \$21⁰⁰
MIKROE-3124



Boost-INV 2 Click

The TPS65131, a positive and negative output DC/DC Converter, from Texas Instruments.

MSRP - \$29⁰⁰
MIKROE-3123



UPS Click

The LTC3225, a 150mA supercapacitor charger from Analog Devices.

MSRP - \$25⁰⁰
MIKROE-3001



Nano Power Click

The MAX17222 - a nanoPower synchronous boost converter with True Shutdown™ technology.

MSRP - \$11⁰⁰
MIKROE-3035



Balancer 3 Click

The BQ29200, Voltage Protection with Automatic Cell Balance for 2-Series Cell Li-Ion Batt.

MSRP - \$12⁰⁰
MIKROE-3737



Balancer 5 Click

The BQ25887 fully integrated 2-cell Li-ion battery charger IC ideal for portable app. with cell balancing.

MSRP - \$15⁰⁰
MIKROE-3853



BATT-MON Click

The STC3115, a high-precision batt. gas gauge IC with alarm output for handheld app.

MSRP - \$13⁰⁰
MIKROE-3741



BUCK 14 Click

Based around the BMR4613001/001 - a PoL regulator from Flex.

MSRP - \$32⁰⁰
MIKROE-3947





Charger 11 Click

The MCP73123 - Lithium Iron Phosphate (LiFePO4) batt. charge management controller.

MSRP - \$17⁰⁰
MIKROE-3650

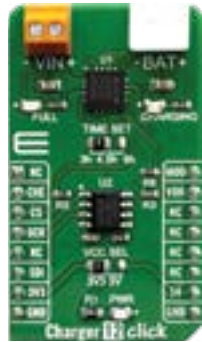

Charger 12 Click

The MAX1501 - linear battery charger with thermal regulation for portable applications.

MSRP - \$15⁰⁰
MIKROE-3744

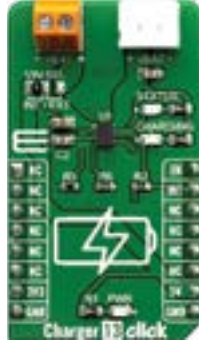

Charger 13 Click

It's a single lithium-ion (Li+) cell batt. charger based on the RT-9532GQW.

MSRP - \$15⁰⁰
MIKROE-3748



Single Cell Click

The MCP16251 synchronous boost reg. with true load disconnect and MCP1811A LDO linear reg.

MSRP - \$9⁰⁰
MIKROE-3844



3xBuck Click

It relies on the TPS65263, a triple synchronous step-down converter.

MSRP - \$35⁰⁰
MIKROE-3201



Balancer 2 Click

The MCP3202, Dual Channel 12-Bit A/D Converter with SPI Serial Interface.

MSRP - \$15⁰⁰
MIKROE-4058



PowerBank Click

Uses MP2632B a highly integrated 3A Lu-ion and Li-polymer battery charger.

MSRP - \$19⁰⁰
MIKROE-4082



PowerBank 2 Click

Equipped with the RT9480, highly integrated and easy to use power solution.

MSRP - \$19⁰⁰
MIKROE-4116



Power MUX Click

Uses the TPS2115AP-WR IC, auto-switching power multiplexer.

MSRP - \$11⁰⁰
MIKROE-4109

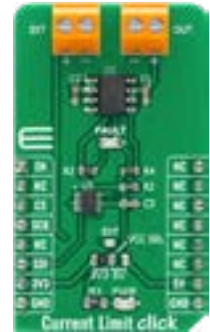

Current Limit Click

Features the MAX890L, a low-resistance power switch.

MSRP - \$15⁰⁰
MIKROE-4271



Boost 3 Click

The TPS61391, a 700-kHz pulse-width modulating (PWM) Step-Up converter.

MSRP - \$15⁰⁰
MIKROE-4287



USB-C Source Click

The STUSB4700, an independent USB power delivery controller.

MSRP - \$25⁰⁰
MIKROE-4329



USB-C Sink Click

Features the STUSB4700, an independent USB power delivery controller.

MSRP - \$25⁰⁰
MIKROE-4328



Buck & Boost Click

The MIC7401, a highly-integrated power-management IC with five synchronous buck regulators.

MSRP - \$69⁰⁰
MIKROE-4354



eFuse 2 Click

The TPS259631, a highly integrated circuit protection and power management solution.

MSRP - \$21⁰⁰
MIKROE-4335



Qi RX Click

The PIC16F15313, a 8-bit MCU that makes a flexible, alternative to the wireless charging solutions.

MSRP - \$33⁰⁰
MIKROE-4345



Charger 3 Click

Features the TP4056, a complete constant-current/constant-voltage linear charger.

MSRP - \$12⁰⁰
MIKROE-4449



UPS 3 Click

The LTC3110, a bidirectional buck-boost DC/DC regulator/charger combination.

MSRP - \$29⁰⁰
MIKROE-4479

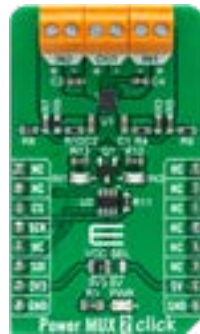

Power MUX 2 Click

The TPS2120, a dual-input single-output power multiplexer with an automatic switchover.

MSRP - \$15⁰⁰
MIKROE-4575



Charger 6 Click

Uses the BQ25601, a fast-charging solution for single-cell Li-Ion and Li-polymer battery.

MSRP - \$12⁰⁰
MIKROE-4576





eFuse 3 Click

Based on the NIS6150, a self-protected resettable electronic fuse from ON Semiconductor.

MSRP - \$21⁰⁰
MIKROE-4630



eFuse Click

Has the STPW12, a programmable electronic power breaker from STMicroelectronics.

MSRP - \$15⁰⁰
MIKROE-4726



Charger 16 Click

Features the LT1571, a PWM battery charger with constant I/U control from Analog Devices.

MSRP - \$26⁰⁰
MIKROE-4768



Power Monitor Click

Uses the INA228, a high-precision power/energy/charge monitor from Texas Instruments.

MSRP - \$21⁰⁰
MIKROE-4810

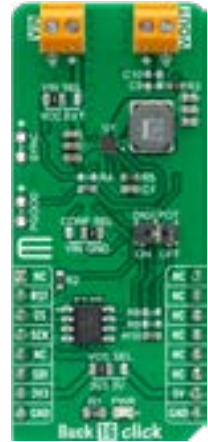

Buck 16 Click

Based on the TPS62912, a current mode synchronous buck converter from Texas Instruments.

MSRP - \$23⁰⁰
MIKROE-4846



PROFET 2 Click-3A

Has the BTS7080-2EP, a dual-channel smart high-side power switch for 3A loads from Infineon.

MSRP - \$17⁰⁰
MIKROE-4818



PROFET 2 Click-7.5A

Has the BTS7080-2EP, a dual-channel smart high-side power switch for 7.5A loads from Infineon.

MSRP - \$17⁰⁰
MIKROE-4819



PROFET Click-10A

Uses the BTS7008-1EPA, a single-channel high-side power switch for 10A loads from Infineon.

MSRP - \$17⁰⁰
MIKROE-4817



PROFET Click-15A

Uses the BTS7008-1EPA, a single-channel high-side power switch for 15A loads from Infineon.

MSRP - \$17⁰⁰
MIKROE-4701



BATT-MAN 3 Click

Features the ADP5350, an advanced battery management PMIC from Analog Devices.

MSRP - \$35⁰⁰
MIKROE-4909



Current Limit 6 Click

Based on the MAX17608, a current-limiting IC with protection features from Analog Devices.

MSRP - \$24⁰⁰
MIKROE-4915



BATT-MAN 2 Click

Has the MAX77654, a battery charging and power supply solution IC from Analog Devices.

MSRP - \$27⁰⁰
MIKROE-4837



Current Limit 7 Click

Features the MAX14575A, an adjustable current-limit switch from Analog Devices.

MSRP - \$44⁰⁰
MIKROE-4972



Charger 18 Click

Has the LTC3553, a power management and battery charger IC from Analog Devices.

MSRP - \$28⁰⁰
MIKROE-4990

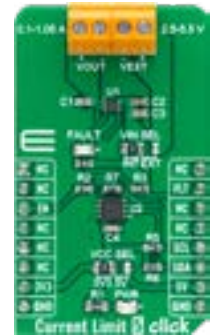

Current Limit 5 Click

Based on the MIC2099, a current-limiter with adjustable overcurrent protection from Microchip.

MSRP - \$12⁰⁰
MIKROE-4999



BATT-MON 3 Click

Has the BQ35100, a battery fuel gauge and end-of-service monitor from Texas Instruments.

MSRP - \$33⁰⁰
MIKROE-5098



BATT-MON 4 Click

Uses the LTC3337, a primary battery state of health monitor from Analog Devices.

MSRP - \$12⁰⁰
MIKROE-5092

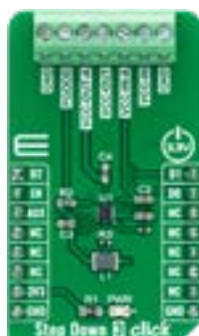

Step Down 3 Click

Features the ST1PS03, a synchronous step-down converter from STMicroelectronics.

MSRP - \$29⁰⁰
MIKROE-5169



Balancer 4 Click

Has the MP2672A, a boost charger with cell balance for 2-cell Li-Ion from MPS.

MSRP - \$15⁰⁰
MIKROE-5271



SolidSwitch 2 Click

Based on the L9026, a multi-channel relay driver from STMicroelectronics.

MSRP - \$12⁰⁰
MIKROE-5313





BATT-MON 2 Click

Has the MAX17262, a 1-cell fuel gauge IC with ModelGauge m5 EZ algorithm from ADI.

MSRP - \$11⁰⁰
MIKROE-5019

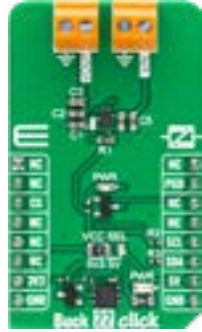

Buck 22 Click

Based on the TPS62869, a synchronous step-down converter from Texas Instruments.

MSRP - \$18⁰⁰
MIKROE-5446



Buck 19 Click

Features the STPD01, a programmable synchronous buck converter from STM.

MSRP - \$24⁰⁰
MIKROE-5451



Boost 8 Click

Carries the LT1945, a dual micropower DC/DC converter from Analog Devices.

MSRP - \$21⁰⁰
MIKROE-5468



eFuse 4 Click

Based on the TPS25940, an eFuse power switch with reverse current blocking from TI.

MSRP - \$29⁰⁰
MIKROE-5501



Buck 20 Click

With the MP2316, a high-efficiency, synchronous, step-down switch-mode converter from MPS.

MSRP - \$45⁰⁰
MIKROE-5533



Buck 23 Click

Features the MAX20010C, a high-efficiency, synchronous, step-down converter from ADI.

MSRP - \$29⁰⁰
MIKROE-5536



Charger 23 Click

Carries the ISL78693, a single-cell Li-ion or Li-polymer battery charger from Renesas.

MSRP - \$18⁰⁰
MIKROE-5573



Boost 7 Click

Features the BD8316GWL, a dual DC/DC converter from Rohm.

MSRP - \$13⁰⁰
MIKROE-5575



eFuse 5 Click

Based on the TPS16530, positive 58V, 4.5A eFuse with a 31m Ω integrated FET from TI.

MSRP - \$29⁰⁰
MIKROE-5599

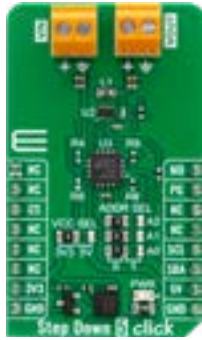

Step Down 5 Click

Features the TPS628510, a synchronous step-down DC/DC converter from TI.

MSRP – \$15⁰⁰
MIKROE-5572



USB-C Power Click

Uses the TPS25750S, a highly integrated USB Type-C and Power Delivery [PD] controller from TI.

MSRP – \$15⁰⁰
MIKROE-5682



LDO Click

Features the TPS7A83A, a low-noise, low-dropout linear regulator [LDO] from TI.

MSRP – \$29⁰⁰
MIKROE-5645



Smart Buck 3 Click

Features the TPS62366A, a processor supply with I2C compatible interface and a remote sense from TI.

MSRP – \$29⁰⁰
MIKROE-5741



Solar Energy 2 Click

With the EM8500, a power management controller with an energy harvesting interface from EM.

MSRP – \$25⁰⁰
MIKROE-5594



Boost-INV 3 Click

This board features the TPS65132, a dual-output power supply from TI.

MSRP – \$15⁰⁰
MIKROE-5755

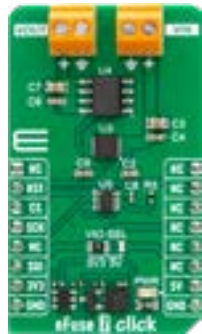

eFuse 7 Click

With the LS12052BD33, an eFuse with over-voltage protection and blocking FET control from Littelfuse.

MSRP – \$15⁰⁰
MIKROE-5738



Smart Buck 4 Click

Features the LTS3562, a quad synchronous step-down DC-DC regulator from ADI.

MSRP – \$27⁰⁰
MIKROE-5750



Step Down 7 Click

Carries the MAX17624, a synchronous step-down converter with integrated MOSFETs from ADI.

MSRP – \$15⁰⁰
MIKROE-5754



Charger 17 Click

Based on the RT9471, a 3A single-cell switching battery charger from Richtek.

MSRP – \$15⁰⁰
MIKROE-5823





Step Down 6 Click

Based on the MPM54304, a quad-output power module from MPS.

MSRP - \$29⁰⁰
MIKROE-5776



USB-C Sink 2 Click

With the AP33772, a high-performance USB PD sink controller from Diodes Inc.

MSRP - \$15⁰⁰
MIKROE-5792



Nano Power 3 Click

Carries the RPL-3.0-R, a buck converter with an integrated inductor from Recom Power.

MSRP - \$29⁰⁰
MIKROE-5783



USB-C Sink 3 Click

Features the AP33771, a high-performance USB PD sink controller from Diodes Inc.

MSRP - \$25⁰⁰
MIKROE-5791

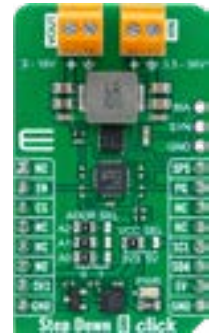

Step Down 8 Click

Carries the MAX25232, a mini buck converter from Analog Devices.

MSRP - \$19⁰⁰
MIKROE-5813



Charger 25 Click

Features the BQ25792, a buck-boost battery charger from Texas Instruments.

MSRP - \$25⁰⁰
MIKROE-5839



Step Down 9 Click

Carries the MAX20406, synchronous silent switcher buck converter from ADI.

MSRP - \$29⁰⁰
MIKROE-5844



Charger 23 Click

Based on the MAX1811, a USB-powered Li+ charger from Analog Devices.

MSRP - \$21⁰⁰
MIKROE-5882



Step Down 10 Click

Features the TPSM63610, buck DC/DC power module with enhanced HotRod™ from TI.

MSRP - \$59⁰⁰
MIKROE-5875



Charger 19 Click

Based on the nPM1100, an integrated power management IC from Nordic.

MSRP - \$19⁰⁰
MIKROE-5899



Smart Buck 2 Click

Features the TPS62363, a 3A processor supply with remote sense from TI.

MSRP - \$17⁰⁰
MIKROE-5871



Current Limit 9 Click

Features the NPS4053, a load switch with a precision adjustable current limit from Nexperia.

MSRP - \$24⁰⁰
MIKROE-5937



Current Limit 10 Click

Carries the HS2950P, a load protection HotSwitch from Semtech.

MSRP - \$29⁰⁰
MIKROE-5938



Step Down 11 Click

This board features the TPSM82913, a low-noise and low-ripple buck power module from TI.

MSRP - \$45⁰⁰
MIKROE-5936



Charger 27 Click

Features the MP2639B, a Li-Ion or Li-Polymer switching charger from MPS.

MSRP - \$23⁰⁰
MIKROE-5960



Buck-Boost 4 Click

Features the TPS55289, a buck-boost converter from Texas Instruments.

MSRP - \$35⁰⁰
MIKROE-5871



BATT Boost Click

Carries the NBM5100A, a coin-cell battery life booster with adaptive power down DC/DC converter from Nexperia.

MSRP - \$27⁰⁰
MIKROE-5947



Buck 15 Click

Features the TPS62903, a synchronous step-down DC/DC converter from Texas Instruments.

MSRP - \$23⁰⁰
MIKROE-6044



Step Up 2 Click

Based on the TPS61299, a synchronous boost converter from Texas Instruments.

MSRP - \$35⁰⁰
MIKROE-6076



Boost 11 Click

Features the XCL105B331H2-G, a synchronous step-up DC/DC converter from TOREX.

MSRP - \$18⁰⁰
MIKROE-6061





Battery Source Click

Features the TPS81256, a high-efficiency step-up converter from Texas Instruments.

MSRP - \$30⁰⁰
MIKROE-6090



Solar Energy 3 Click

With the NEH2000BY, an energy-harvesting PMIC from Nexperia.

MSRP - \$25⁰⁰
MIKROE-6057



PMIC Click

Carries the nPM1300, an advanced PMIC from Nordic Semiconductor.

MSRP - \$29⁰⁰
MIKROE-6201

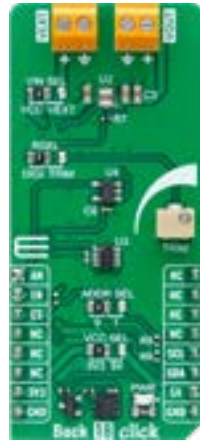

Buck 18 Click

Based on the MAXM38643, an ultra-low-IQ nanoPower buck module from ADI.

MSRP - \$39⁰⁰
MIKROE-6071



BATT Boost 2 Click

Carries the NBM7100A, a coin-cell battery-life booster from Nexperia.

MSRP - \$29⁰⁰
MIKROE-6098



USB-C Sink 4 Click

Features the CYPD3178, a USB Type-C power sink controller from Infineon.

MSRP - \$19⁰⁰
MIKROE-6174

CLOCK & TIMING





RTC 4 Click

Carries DS2417, a real time clock/calendar with a 1-Wire MicroLAN interface. 16.3 kbits per second.

MSRP - \$21⁰⁰
MIKROE-1891



RTC 5 Click

Carries Microchip's MCP79510 real-time clock/calendar.

MSRP - \$21⁰⁰
MIKROE-1990



PLL Click

The ICS501, a LOCO™ PLL clock multiplier, from Integrated Device Technology.

MSRP - \$15⁰⁰
MIKROE-2993



Clock Gen 2 Click

The DS1087LU-266, a 3.3V spread-spectrum EconOscillator, from Maxim Integrated.

MSRP - \$17⁰⁰
MIKROE-3076



RTC 8 Click

The RV-3028-C7, an extreme low power RTC module from Micro Crystal Switzerland.

MSRP - \$17⁰⁰
MIKROE-3076



RTC 6 Click

Carries MCP79410 real-time clock/calendar IC. 64 bytes of battery-backed SRAM.

MSRP - \$21⁰⁰
MIKROE-2063



TIMER Click

With DS1682 total elapsed time recorder from Maxim Integrated. ETC used with the ALARM pin.

MSRP - \$18⁰⁰
MIKROE-2333



PULSE Click

A pulse generator with precise frequency control. Features NE555 precision timer.

MSRP - \$25⁰⁰
MIKROE-2032



RTC 2 Click

With DS1307 serial real-time clock. It's a full binary-coded decimal [BCD] clock/calendar.

MSRP - \$21⁰⁰
MIKROE-948



RTC 3 Click

Carries BQ32000, a real time clock with an integrated trickle charge circuit for automatic switchover.

MSRP - \$21⁰⁰
MIKROE-1839





One Shot Click

The LTC6993-2, a monostable multivibrator known as a “one-shot” pulse generator.

MSRP – \$19⁰⁰
MIKROE-3877



RTC 7 Click

The MAX31341B, a low-current RTC with I2C interface and power management.

MSRP – \$17⁰⁰
MIKROE-2976



RTC 10 Click

The DS3231M, a low-cost, extremely accurate, I2C real-time clock [RTC].

MSRP – \$17⁰⁰
MIKROE-2976



Clock Gen Click

Features the Si5351A, an I2C configurable clock generator.

MSRP – \$15⁰⁰
MIKROE-4113

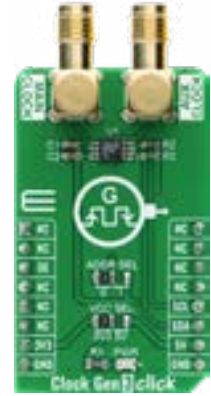

Clock Gen 3 Click

Uses the LTC6904 IC, 1kHz to 68MHz Serial Port Programmable Oscillator.

MSRP – \$17⁰⁰
MIKROE-4171



Clock Gen 4 Click

The CS2200-CP, an analog PLL architecture comprised of a Delta-Sigma fractional-N frequency synthesizer.

MSRP – \$19⁰⁰
MIKROE-4300



Clock Gen 5 Click

Features the LTC6903, a low-power self-contained digital frequency source.

MSRP – \$15⁰⁰
MIKROE-4413



RTC 9 Click

Features the M41T82, a real-time clock [RTC] with battery switchover

MSRP – \$12⁰⁰
MIKROE-4121



RTC 11 Click

The AB0815, an ultra-low-power coupled with a highly sophisticated feature set.

MSRP – \$7⁰⁰
MIKROE-4288



Watchdog Click

Features the TPS3430, a stand-alone watchdog timer.

MSRP – \$7⁰⁰
MIKROE-4416



RTC Click

It features the PCF8583 serial real-time clock (RTC).

MSRP - \$21⁰⁰
MIKROE-947



RTC 12 Click

Based on the ISL1221, a low-power RTC with battery-backed SRAM from Renesas.

MSRP - \$23⁰⁰
MIKROE-4697



TDC Click

Carries the TDC7200, a time-to-digital converter from Texas Instruments.

MSRP - \$15⁰⁰
MIKROE-4770



RTC 14 Click

Based on the ISL1221, a low-power RTC with battery-backed SRAM and event detection from Renesas.

MSRP - \$19⁰⁰
MIKROE-4799



RTC 13 Click

Features the PCF2123, clock/calendar optimized for low power operations from NXP Semiconductors.

MSRP - \$15⁰⁰
MIKROE-4794



Waveform 4 Click

Features the AD9106, a quad-channel, 12-bit, 180MSPS waveform generator from Analog Devices.

MSRP - \$115⁰⁰
MIKROE-4908



RTC 16 Click

Carries the BU9873, a CMOS real-time clock from Rohm Semiconductors.

MSRP - \$13⁰⁰
MIKROE-5083



RTC 17 Click

Features the RV5C387A, a CMOS real-time clock from Nisshinbo Micro Devices Inc.

MSRP - \$12⁰⁰
MIKROE-5129



RTC 18 Click

Based on RV-3032-C7, real-time clock module from Micro Crystal AG.

MSRP - \$13⁰⁰
MIKROE-5192



Clock Gen 6 Click

Features the MIC1557, an IttyBitty CMOS RC oscillator from Microchip Technology.

MSRP - \$12⁰⁰
MIKROE-4973





RTC 19 Click

features the MAX31334, an I2C-configurable real-time clock with an integrated power switch from ADI.

MSRP - \$21⁰⁰
MIKROE-5426



TDC 2 Click

Features ScioSense's AS6500, a four-channel time-to-digital converter [TDC].

MSRP - \$83⁰⁰
MIKROE-5570



RTC 21 Click

Based on the PT7C4311, a real-time clock module from Diodes.

MSRP - \$15⁰⁰
MIKROE-5541



RTC 20 Click

Carries the AB0805, a real-time clock with a highly sophisticated feature set from Abracon.

MSRP - \$15⁰⁰
MIKROE-5600



How BIG is 1 000 000 exactly?

1♥ = 1 EW project

Blue whale - the largest animal on Earth, weights 200t (200 000kg).
If 1kg is 1 EmbeddedWiki project, the EmbeddedWiki platform would be the size of 5 BLUE WHALES!



YEARS TO GO

28

1' = 1 EW project

The average project reading time on EmbeddedWiki is 15 minutes.
If you were to start reading projects now, continuously without interruption, it would take you 28 years to read every project on the platform.

449ft The Great Pyramid of Giza

358ft (tower of ONE MILLION dollars)

316ft Big Ben

305ft Statue of Liberty



\$1 = 1 EW project

If one project on EmbeddedWiki represents one paper dollar in a stack of a million dollars, that stack would be 358 feet high! Just above the Statue of Liberty in New York, and Big Ben in London!



Scan the code and get access!

From one man's idea to a dominant add-on board standard

The entire company works towards a shared vision – to save time of our fellow engineers. Click boards™ product line constitutes a key component of the future we have envisioned.

Development boards are substantially similar: they integrate a microcontroller, power supply, tact switches, LEDs, pins. The features that differentiate development boards are the peripherals such as UART, 7-seg digits, RTC, Relay, ADC, EPROM, and the like. Different projects, however, require that a different peripheral be used each time. If peripherals on a single board could be changed, its functionality would improve significantly.



Presented with the problem, I started looking for a solution: how to change peripherals easily and what to add to a board to be able to do so.

I remember the very moment when I hit upon the idea of the mikroBUS™ standard - the very first drawing of it I made in the sand and later on a piece of paper. In fact, my family was on holiday in a hotel - Hillside -Su - in Antalya (Turkey), and the hotel played a key role in the story of mikroBUS™ standard: there was a play area for children and an even better one - in the shade and roomy - for babies and for my papers and data-sheet. Amid the papers and babies, as I was keeping an eye on my five-year-old daughter Lena, mikroBUS™ standard came to life.

The name was chosen by one of my colleagues a long time ago: 'click' is what you hear when you place the Click board™ onto the development board. 'It just Clicks' is a marketing message we wish to convey.

The shape and end-dimension of the Click board™ posed a great challenge. Now that we have made more than thousand Click boards™, it is easy to notice that all WiFi, LTE, BLE, GSM, GPS modules, OLED screen, and 7-seg digits fit Click boards™ perfectly, and that the size is right. However, dimension check requires that the components and modules

classification on a single Click board™ be reviewed and several hundred datasheets be opened. I take pride in our solution: this part of the Click boards™ story looks like a simple task; however, without it, there would be a great decrease in the number of Click boards™ created.

Back at work, I called a meeting and presented my idea: I spoke about the pins I chose and why I chose those very pins; I explained what the overarching goal was and provided other relevant information. It was in that meeting that we revised the statement and increased the functionality of the mikroBUS™ standard by adding a few more pins, so that there was a total of 16 pins - 8 in each row. We now know that this is by far the smallest number of the pins one can use and which account for most chips, modules, and other components you could place on Click board™.

1700 Click boards™ is a huge milestone since not a single company in our industry has that number of peripheral boards.. We made history in reaching that number. More importantly, the mikroBUS™ standard has proven to be very usable: if you can design thousands of different Click boards™ on one standard and create another thousand and then another thousand, that means that the standard is quite exceptional.



Nebojsa Matic,
CEO

Growing with our partners



| | | | | |
|---|---|--|--|---|
|  248 boards |  214 boards |  183 boards |  107 boards |  49 boards |
|  48 boards |  48 boards |  45 boards |  41 boards |  21 boards |
|  26 boards |  26 boards |  24 boards |  23 boards |  23 boards |
|  22 boards |  22 boards |  22 boards |  21 boards |  21 boards |
|  19 boards |  18 boards |  16 boards |  15 boards |  13 boards |
|  12 boards |  12 boards |  12 boards |  10 boards |  10 boards |
|  9 boards |  9 boards |  9 boards |  8 boards |  8 boards |
|  8 boards |  7 boards |  7 boards |  6 boards |  6 boards |
|  5 boards |  5 boards |  5 boards |  5 boards |  4 boards |
|  4 boards |  4 boards |  4 boards |  4 boards |  4 boards |
|  4 boards |  4 boards |  4 boards |  4 boards |  3 boards |

SHARP

3 boards



3 boards



3 boards



2 boards



2 boards



2 boards



1 board



1 board



1 board



1 board



1 board



1 board



3 boards



3 boards



3 boards



2 boards



2 boards



2 boards



1 board



1 board



1 board



1 board



1 board



1 board

winbond

3 boards



3 boards



3 boards



2 boards



2 boards



2 boards



1 board



1 board



1 board



1 board



1 board



1 board

neo.cortec

3 boards



3 boards



3 boards



2 boards



2 boards



2 boards



1 board



1 board



1 board



1 board



1 board



1 board

RICHTEK
your power partner.

3 boards



3 boards



3 boards



2 boards



2 boards



2 boards



1 board



1 board



1 board



1 board



1 board



1 board

Clicking on all platforms

Use Click boards™ with your favorite development platform.
A range of Shields bring Click connectivity to:

- **Arduino**
- **BeagleBone Black**
- **Raspberry Pi**
- **Freedom**
- **Feather**
- **Discovery and more...**

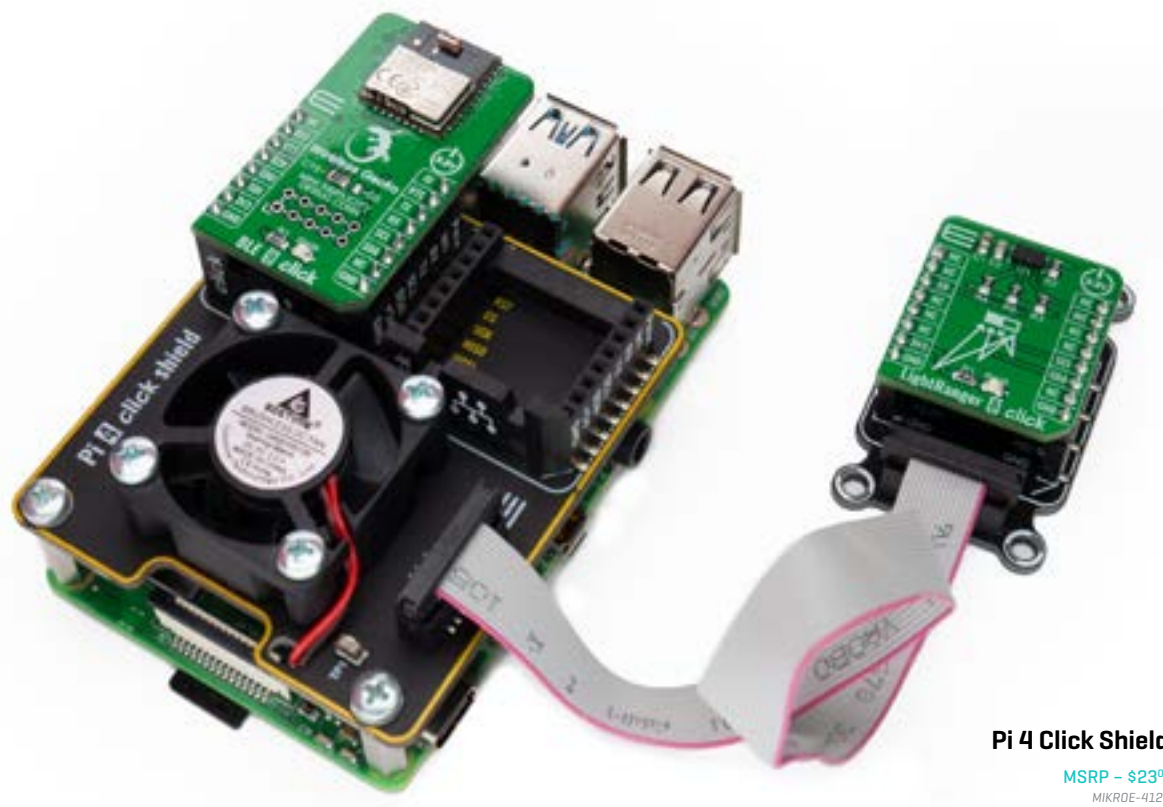

Pi 4 Click Shield

MSRP - \$23⁰⁰
MIKROE-4122

Arduino Nano Click Shield

MSRP – \$29⁰⁰

MIKROE-4443



Scan QR Code
to see them all.



mikroBUS cape

MSRP – \$8⁰⁰

MIKROE-1857



NEW
Click board™
yet to come

NEW
Click board™
yet to come

Even though it was printed recently, the booklet you are holding is probably already outdated. That's because we release new Click boards™ daily.

To learn more about Click boards™, visit: www.mikroe.com/click-boards and for the most current list of Click boards™, visit: www.mikroe.com/click

NEW
Click board™
yet to come

NEW
Click board™
yet to come

MIKROE
Time-saving embedded tools



Aleksandar Mitrovic

Head of Click Team and
Product Marketing Manager

Aleksandar is in charge of our Click board™ product line, and the Click team. He started his career at MIKROE through internship and later technical support, making his way up to his current position.

This accomplishment requested huge dedication to the work, to the customers and products, all of which he demonstrated during the years of employment at MIKROE. As someone who is taking care of hundreds existing and countless future Click boards™, he will be your main contact regardless if you are silicon vendor interested in **Chips4Clicks program** or a regular customer interested in sharing ideas about a new Click board™.



Scan QR
Code for
contact info.

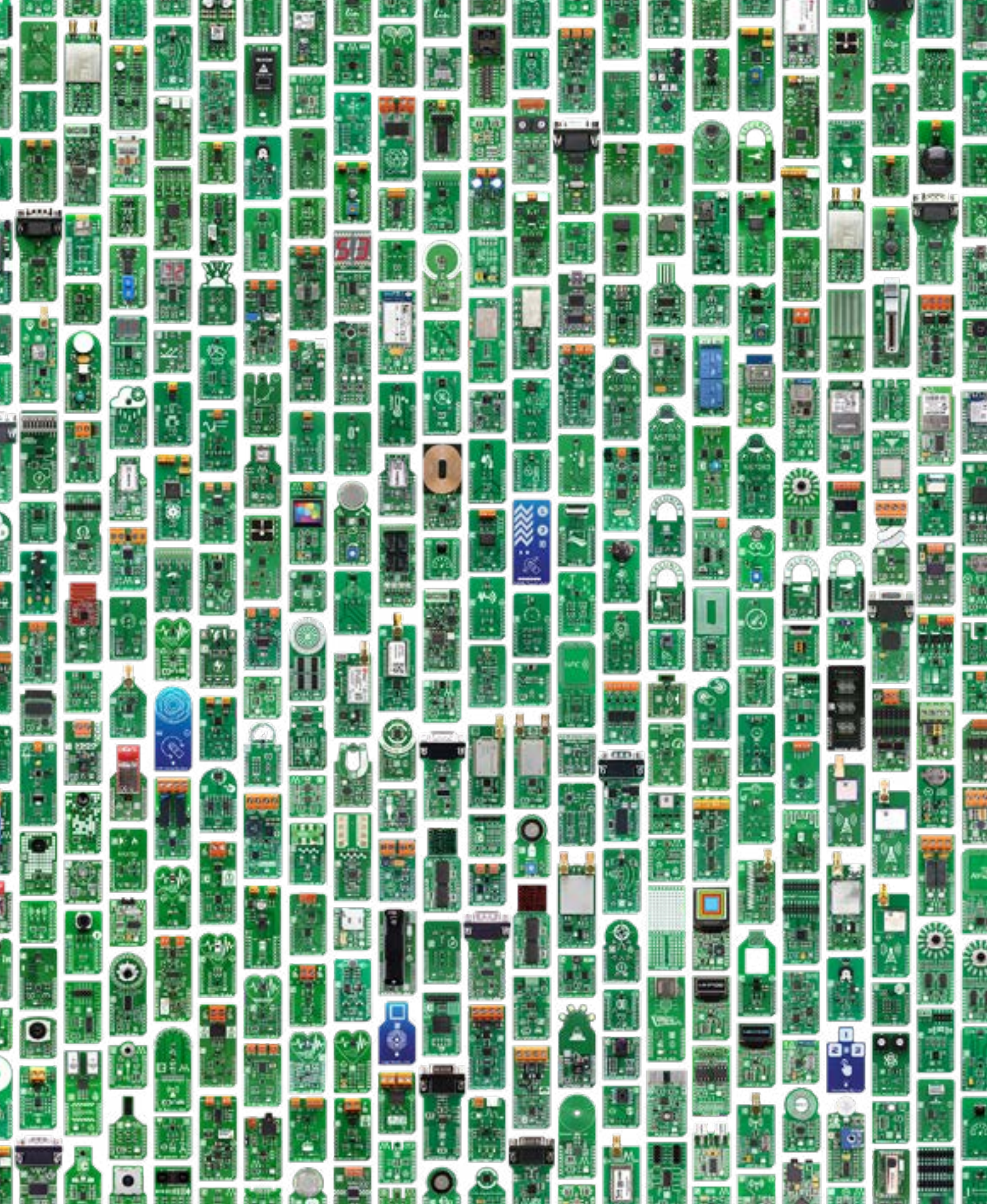

1700+ Edition
Designed by MIKROE
www.mikroe.com