

**Elegance in iron**  
since 2008

**THE FINEST STEEL DOORS AND WINDOWS  
COMMERCIAL/RESIDENTIAL**

# Elegance in iron

since 2008

WHO WE ARE ..... 02-03

CLASSIC SERIES ..... 04-11

SLIM STEEL SERIES ..... 12-18

THERMAL BREAK STEEL SERIES ..... 19-25

CONTACT US ..... 26

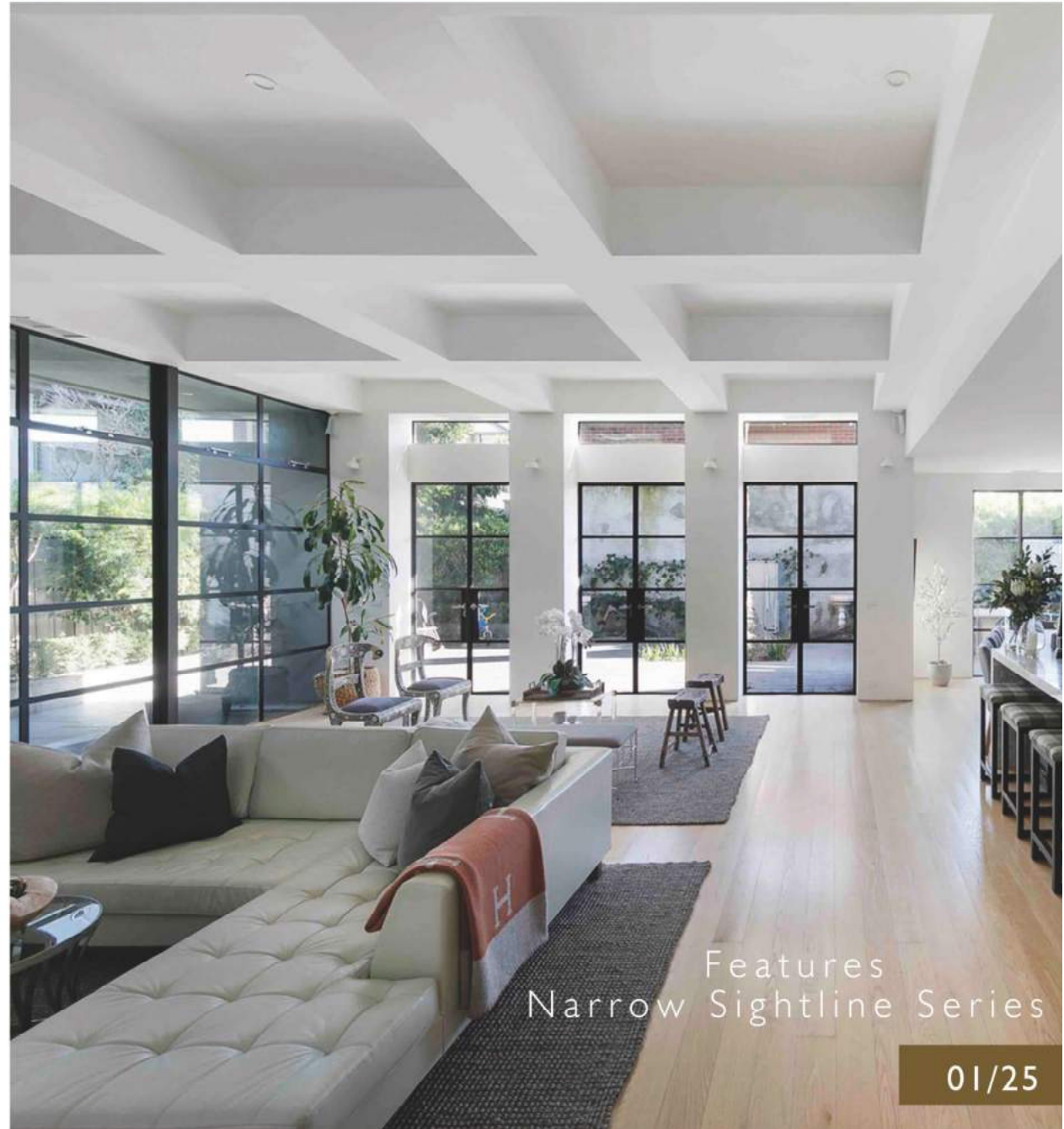

Features  
Narrow Sightline Series

Elegance in iron is the leading manufacturer of iron doors for more than 10 years, and has been crafting artistically designed steel doors, windows since 2008



We have been fabricating finest steel doors and windows for projects across Australia, USA and Japan.

With incomparable technique and remarkably strong profiles ,we fabricates custom steel doors, windows in beauty, elegance, and durability. Our narrow sightlines of steel doors and windows are widely used in commercial, residential, replacement, industrial, and historical applications.

We look forward to working with you who require custom fabricated designs, bringing high performance and structural excellence together with reliability, versatility, beauty and durability.

# FEATURES

- Narrow sightlines for increased light and views ;
- Remarkable strong profiles ;
- Versatility in designs for the freedom to create ;
- Qualified hardware ;
- Dual compression weather stripping ;
- True divided and simulated divided lites ;
- Fluorocarbon paint coating ;
- Custom colors ;
- Thermally broken systems for high energy performance as option ;
- Sustainable.



# CLASSICAL SERIES — SWING DOORS



# CLASSICAL SERIES—SWING DOORS



# CLASSIC SERIES — FOLDING & SLIDING DOORS



# CLASSIC SERIES — PIVOT & BARN DOORS





# CLASSIC SERIES — DOORS & WALLS

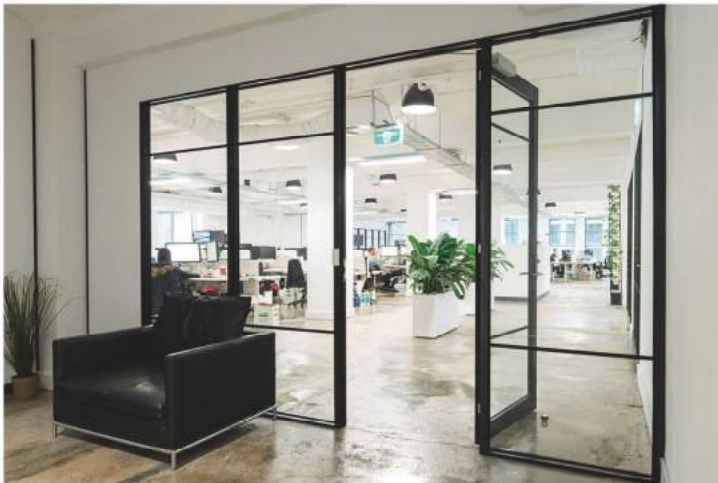
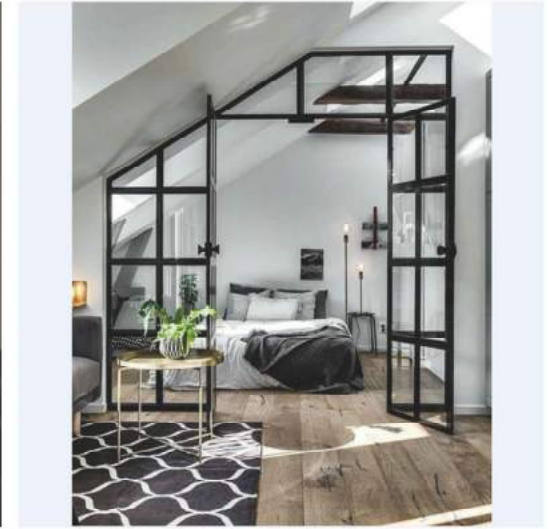

# CLASSIC SERIES

Classic Series of doors and windows  
Gives the houses a look of beauty and elegance

## THE FEATURES OF CLASSIC SERIES:

- PU foam-filled jamb, stile and rail;
- Versatility in designs for the freedom to create;
- Heavy-duty welded steel hinges;
- Double paned, low -E and tempered glass;
- True divided lite and simulated divided lite as option;
- Wet glazing/dry glazing as option;
- Sloped integrated steel threshold;
- Kerfed sweeps and weather strip;
- Predrilled for door and window hardware;
- Thermally broken is optional.

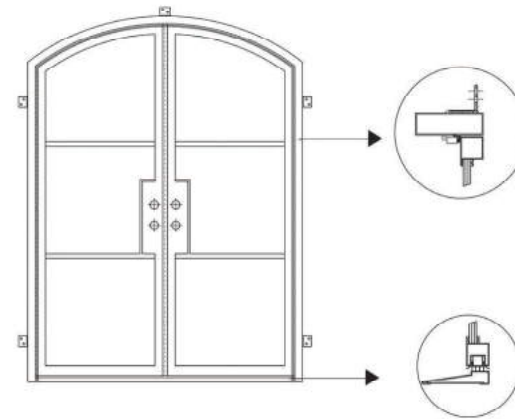

# AVAILABLE STYLES

## Classic Series Doors

Swing



Sliding



Bifold



Pivot



## Classic Series Windows

Casment



Twin Casment



Fixed

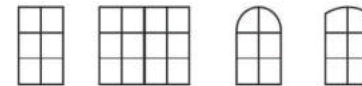

Awning



# GLAZING OPTIONS

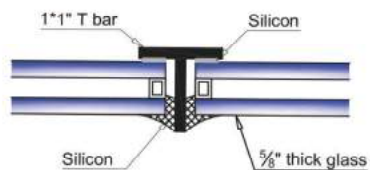

TDL

TDL

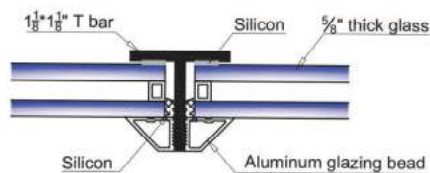

TDL

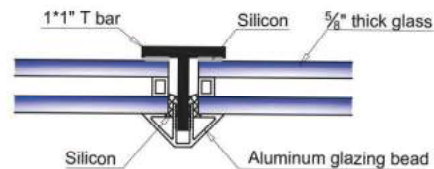

TDL

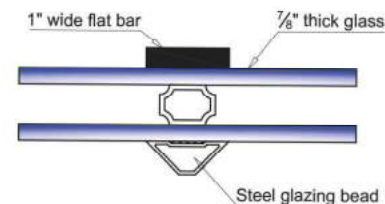

SDL

# ACCESSORIES



ELEGANT WINDOW LATCH



FRICTION WINDOW STAY



CONCEALED FLOOR CLOSER



CLASSIC HINGE



BARN DOOR ROLLER



SLIDING DOOR ROLLER



WINDOW STAY

# SLIM STEEL SERIES—SWING DOORS



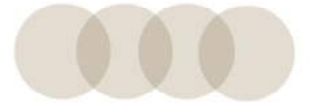

# SLIM STEEL SERIES

Slim Steel Series of doors and windows



# SLIM STEEL SERIES—DOORS& WALLS

Slim Steel Series is made from strong material, which brings your houses or shops with durability, elegance and reliability.





Slim Steel Series enable you to enjoy the light and views outside the houses or shops, it has optional escape and rescue possibilities, because of the transparency and openness of steel structures.



# SLIM STEEL SERIES

## THE FEATURES OF SLIM STEEL SERIES :

- Narrow sightlines;
- Versatility in Designs for the freedom to create;
- Fully welded;
- weather stripping;
- Galvanized;
- Custom made color available;
- Insulated, Low E, tempered glass.

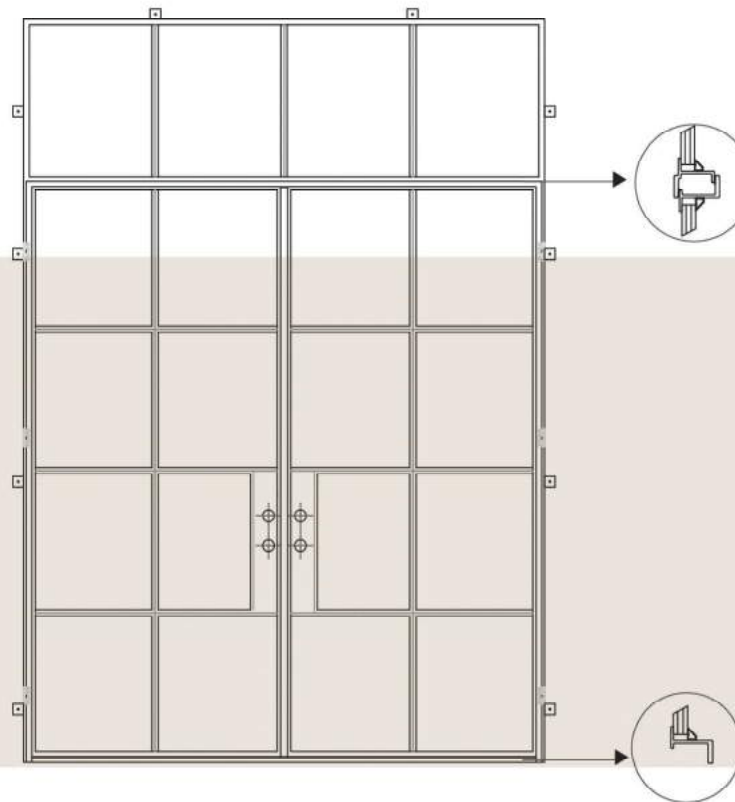

# AVAILABLE STYLES

## Slim Steel Doors

Swing



## Slim Steel Windows

Casment



Twin  
Casment



Fixed

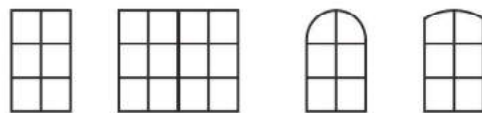

Awning

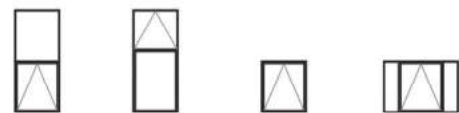

# GLAZING OPTION

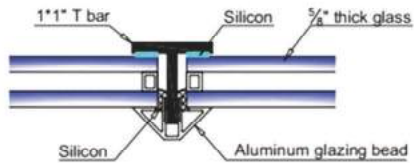

TDL

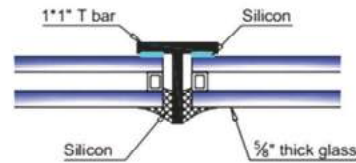

TDL

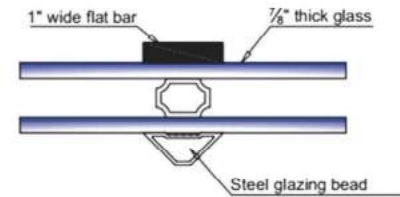

SDL

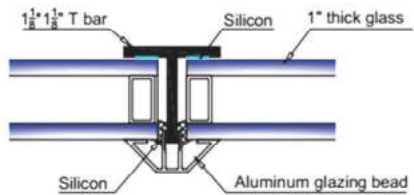

TDL

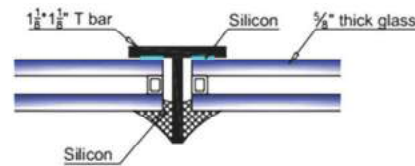

TDL

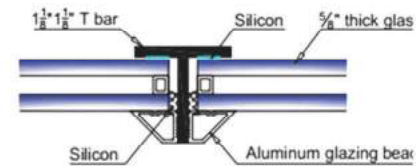

TDL

# ACCESSORIES



WINDOW OPERATOR



ELEGANT WINDOW LATCH



FRICTION WINDOW STAY



CLASSIC HINGE



BUTT HINGE



BACKSET



MODERN LOCKSET FOR NARROW



CLASSIC LOCK 2



THERMAL BREAK STEEL SERIES

19/25





# THERMAL BREAK STEEL SERIES

As energy costs continue to rise, thermal performance is getting more and more important. It's important to maintain the architect's aesthetic vision, the structural integrity and the beauty and elegance of the windows and doors.



# THERMAL BREAK STEEL SERIES FEATURES

- Energy efficient;
- Dual compression weather stripping;
- Glazing stop options;
- True divided and simulated divided lites;
- Fluorocarbon paint coating;
- Custom made color;
- Thermal break systems for high energy;
- Sustainability;
- Durability.

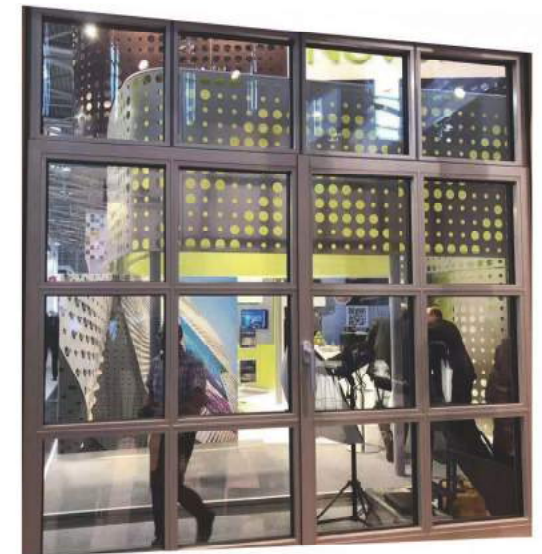
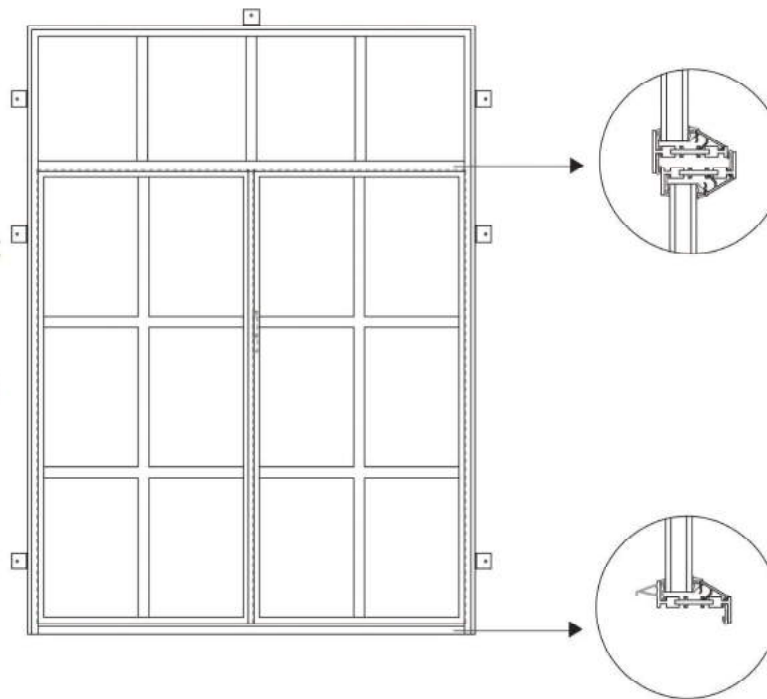



# AVAILABLE STYLES

## Thermal Break Steel Doors

Swing



## Thermal Break Steel Windows

Casment



Twin Casment



Fixed

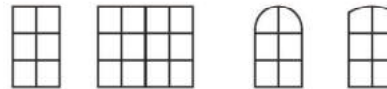

Awning

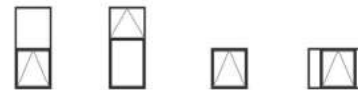

Hopper



# GLAZING OPITON

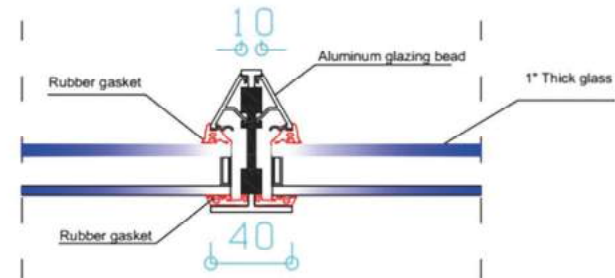
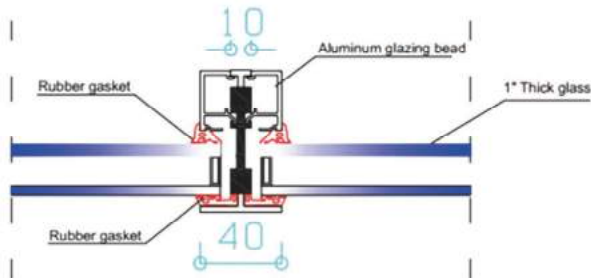

# ACCESSORIES



WINDOW STAY



WINDOW OPERATOR



ELEGANT WINDOW LATCH



FRICTION WINDOW STAY



MODERN LOCKSET FOR NARROW BACKSET



DOOR LATCH

Elegance in iron  
since 2008

# ARCHITECTURAL STEEL DOORS&WINDOWS

F E A T U R E S   N A R R O W   S I G H T L I N E   S E R I E S

[www.eleganceiniron.com.au](http://www.eleganceiniron.com.au)

Elegance in iron  
Add: 1367 Malvern Rd, Malvern  
Phone: 03 9824 8456  
Mob: 0450 010 101  
Email: [info@eleganceiniron.com.au](mailto:info@eleganceiniron.com.au)