

40 YEARS



FANIMATION®  
SHOWROOM COLLECTION



FANIMATION®  
SHOWROOM COLLECTION



From our humble beginnings in the family garage of our visionary founder, Tom Frampton, to the forefront of the ceiling fan industry, our 40-year journey has been nothing short of extraordinary.

As a family-owned company, our legacy is deeply rooted in a commitment to quality, innovation, and timeless design. Our fans are not just products; they are a testament to four decades of passion and expertise. Each blade, every curve, and the advanced features like LED lighting with CCT Select and WiFi fanSync voice controls are meticulously crafted to ensure an unparalleled customer experience.

Inside these pages, you'll discover more than just ceiling fans; you'll uncover a legacy of comfort and style. We invite you to explore the Fanimation difference – where tradition meets cutting-edge technology, and where every fan tells a story of quality that stands the test of time.

Thank you for being an essential part of our journey. Here's to 40 years of cooling your spaces with innovation and elegance.

# MOTORS

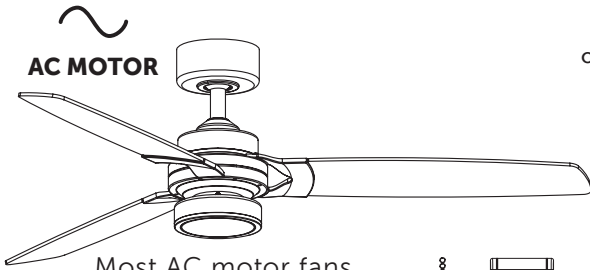

**AC MOTOR**

Most AC motor fans are pull chain operated or include our TR500 or TR800 remote control & receiver



optional hardwired wall controls



2-wire fan-only  
WC1WH

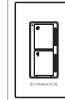

3-wire fan + light  
WC2WH

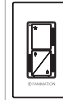

3-wire fan + uplight/downlight  
WC3WH

optional remote wall controls



2-wire fan-only  
WR500WH



2-wire fan + light  
WR501WH



2-wire fan + uplight/downlight  
WR502WH

**Easily upgrade our AC fans to WiFi fanSync! See details on facing page.**

voice and smart device control



fanSync WiFi Smart Receiver  
WFR50



fanSync WiFi Smart Receiver  
WFR55 (Kwartet only)

**DC MOTOR**

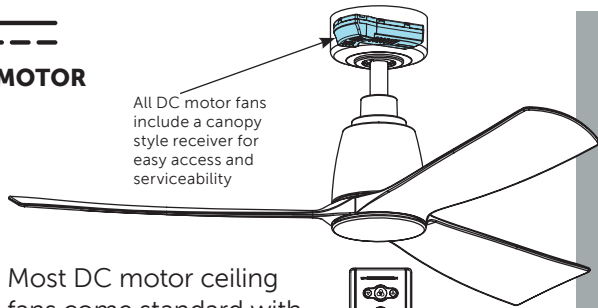

All DC motor fans include a canopy style receiver for easy access and serviceability

Most DC motor ceiling fans come standard with our TR305 remote, WiFi fanSync (facing page) and CCT Select (below).

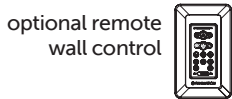

optional remote wall control

2-wire fan + light  
TW306

## REMOTE CONTROL BUTTON FUNCTIONS

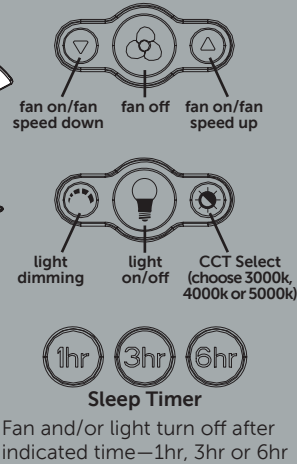

- Home Away** — Light turns on and off at random intervals to simulate someone at home while away.
- Fresh Air** — Fan speed modulates to simulate a natural breeze.
- Safe Exit** — Light turns on and remains on for one minute before turning off to provide safe, lit exit.
- Reverse** — Changes direction of rotation. Snowflake pushes air up and sun pushes air down.

# LIGHTING

**LED BOARDS or LAMPS**—All integrated light kits, light kit accessories and accessory fitters utilize LED technology and meet ENERGY STAR 4.0 and CEC TITLE 24 specifications.

## CCT SELECT

How do you like your light—warm, white or cool? Now you can choose! Featured on our DC fans and Kwartet, CCT Select allows you to choose the correlated color temperature (CCT) of your fan's light kit—3,000K, 4,000K or 5,000K.



Press and release button to cycle through color correlated temperatures: 3,000K/4,000K/5,000K

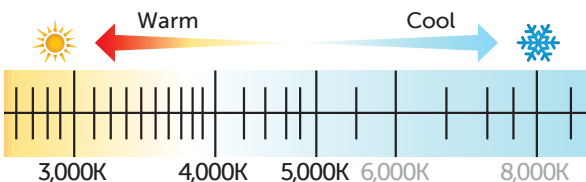

## PULL-TO-DIM

PC/DC L and LK179 accessory light kit feature Pull-to-Dim technology.

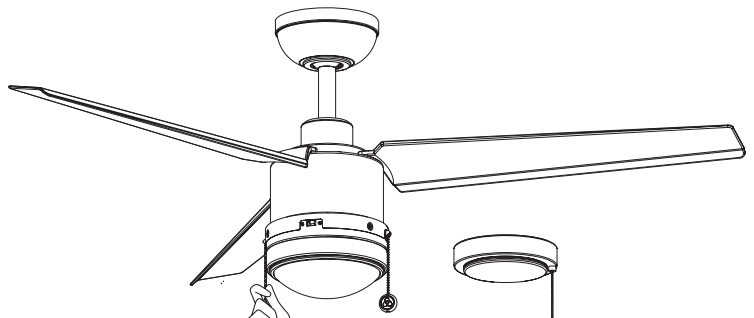

- 1st pull → light on
- 2nd pull → begins dimming
- 3rd pull → stops dimming
- 4th pull → light off

# KWIKWIRE—EASY CONNECTION



Fanimation's new for 2024 DC motor fans—Brawn, Klear and Pendry—are equipped with the KwikWire feature, which makes wiring of the fan's receiver unit quicker and easier by replacing five wire-nut connections with two simple connectors!

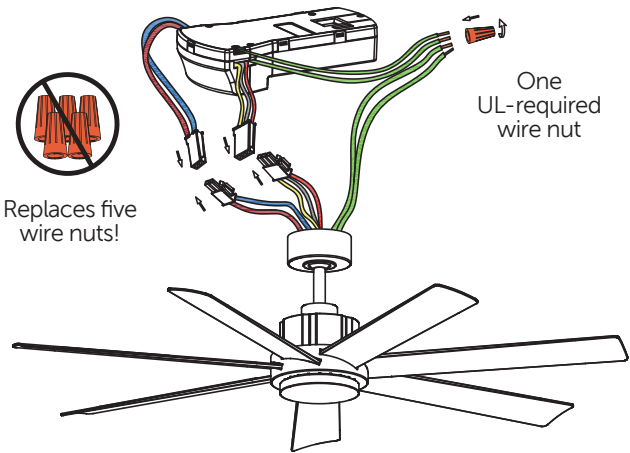

# WIFI FANSYNC—VOICE & SMART CONTROLS



**CONTROL YOUR CEILING FAN WITH YOUR SMART DEVICES & PERSONAL VOICE ASSISTANTS!**

WFR50



WFR55 Kwartet only



DC WiFi\*



- fanSync WiFi® receiver
- AC fan—3 fan speeds
- Fan and downlight control
- Timer, safe exit and favorites list via smart device

- fanSync WiFi® receiver
- AC fan—3 fan speeds
- Fan and downlight control
- Timer, safe exit and favorites list via smart device

- fanSync WiFi® receiver
- DC fan—variable fan speeds
- Fan and downlight control
- Included with DC ceiling fans

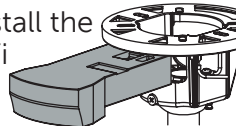
- 1 Wire and install the fanSync WiFi receiver into your ceiling fan's hanger bracket/canopy. 
- 2 Download the fanSync Wifi app in the Google Play or App Store and follow the simple setup instructions.

**Hey Google**

Turn bedroom fan on.

**Hey Google**

Turn bedroom light on.



**Alexa**

Turn living room fan on.

**Alexa**

Turn living room light on.



**INTEGRATES WITH:**



**+ OTHERS**

Devices other than Amazon Echo and Google Home connect via the IFTTT app.

# LOCATION

Where you will install your fan is the first step in selecting the right fan for your space.

- Dry, indoor location: Choose from any of our fans—dry, damp or wet rated.
- Outdoor covered or high-humidity indoor location: Choose from our damp or wet rated fans.
- Outdoor location with likely direct contact with water: Choose from our wet rated fans.



= Dry location rated



= Damp location rated



= Wet location rated

# AIRFLOW

The ceiling fan airflow testing results provided herein are conducted in accordance with the US Department of Energy's testing standards and under specific controlled environmental conditions—highlighted below. Actual airflow performance may vary based on the installation location and environmental factors. The testing standards are designed to offer a standardized basis for comparison, but individual installations may differ significantly.

Factors such as room size/shape, indoor or outdoor installation, ceiling height, presence of obstacles, and ambient temperature can influence the actual airflow experienced in a particular setting. Users are advised to consider these variables when interpreting and applying the airflow data provided.

## DOE AIRFLOW TEST PROCEDURE

The ceiling fan is mounted directly to the ceiling using the fan's included downrod. Hugger fans are flush-mounted. A sensor arm gauges airflow from various points along the length of the blade.

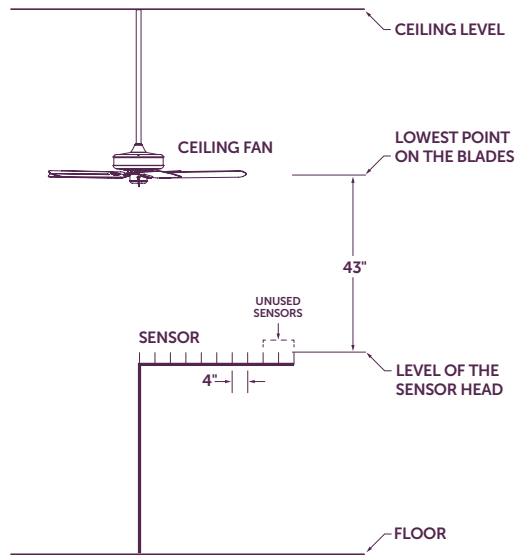

Additionally, packaging highlights the average-speed airflow, which, of course, is lower than the high-speed CFM numbers previously listed. We have chosen to include high-speed values in this catalog, along with the average-speed values required on the Energy Guide label.

Energy Guide—catalog

ENERGY GUIDE				
	<b>TOTAL AIR VOLUME</b>	<b>ENERGY USE</b>	<b>ESTIMATED YEARLY ENERGY COST</b>	<b>AIRFLOW EFFICIENCY</b>
<b>AVERAGE SPEED</b>	<b>4,873 CFM</b>	<b>22 Watts</b>	<b>\$6</b>	<b>217 CFM/Watts</b>

Energy Guide label —packaging









# SUPPORT

Need more assistance? We're here to help! 888-567-2055 or fanimation.com





















# TABLE OF CONTENTS

Aire Deluxe™—Light .....	18	Spitfire™ AC 60.....	86
Aire Deluxe™—No Light .....	16	Spitfire™ AC 60 Flush .....	88
Amped™ .....	14	Spitfire™ DC 64.....	92
Arden™ .....	192	Spitfire™ DC 64 Flush .....	94
Barlow™ .....	34	Spitfire™ DC 72.....	96
Brawn™ .....	38	Spitfire™ DC 72 Flush .....	98
Celano v2™ .....	24	Spitfire™ DC 84.....	100
Doren™ .....	26	Spitfire™ DC 84 Flush .....	102
Edgewood® 44 .....	180	Spitfire™ DC 96.....	104
Edgewood® 52 .....	182	Spitfire™ DC 96 Flush.....	106
Edgewood® 62 .....	184	Stellar™ Custom 56.....	166
Edgewood® 72.....	186	Stellar™ Custom 64.....	168
Gleam™.....	46	Stellar™ Custom 72.....	170
GlideAire™.....	74	Stellar™ Custom 84.....	172
Henry™ .....	48	Stellar™ Custom 96.....	174
Hugh™ 44 .....	56	TriAire™ Custom 44 .....	138
Hugh™ 52.....	58	TriAire™ Custom 48 .....	140
Klear™ .....	36	TriAire™ Custom 52.....	142
Klinch™ 44 .....	52	TriAire™ Custom 56 .....	144
Klinch™ 52.....	54	TriAire™ Custom 60 .....	146
Kute5™ 52 .....	68	TriAire™ Custom 64 .....	148
Kute5™ 52 Flush.....	70	TriAire™ Custom 72.....	150
Kute™ 44 .....	60	TriAire™ Custom 84 .....	152
Kute™ 44 Flush.....	62	Windpointe® .....	188
Kute™ 52.....	64	Wrap™ Custom 44.....	118
Kute™ 52 Flush .....	66	Wrap™ Custom 48.....	120
Kwad™ 44 .....	20	Wrap™ Custom 52.....	122
Kwad™ 52.....	22	Wrap™ Custom 56 .....	124
Kwartet™ .....	50	Wrap™ Custom 60.....	126
Levon™ AC.....	28	Wrap™ Custom 64.....	128
Levon™ Custom 52.....	110	Wrap™ Custom 72.....	130
Levon™ Custom 64 .....	112	Wrap™ Custom 84.....	132
Levon™ Custom 72.....	114	Xeno™ Damp .....	76
Obvi™ .....	12	Xeno™ Wet.....	78
Odyn™ Custom 56.....	156	Lighting Info.....	3
Odyn™ Custom 64 .....	158	Motor Info.....	3
Odyn™ Custom 72.....	160	KwikWire.....	4
Odyn™ 84 .....	162	WiFi FanSync—Voice & Smart Control Info .....	4
Paget™ .....	32	Airflow Info.....	5
PC/DC™—Light.....	178	Location Info .....	5
PC/DC™—No Light.....	176	Controls .....	193
Pendry™ 56 .....	40	Downrods.....	195
Pendry™ 72.....	42	Low-Profile LED Light Kit.....	196
Pyramid™ .....	44	Close-to- & Sloped-Ceiling Kits .....	196
SculptAire™.....	72	Finish Swatches.....	197
Spitfire™ AC 48.....	82	Antique Fan Museum.....	199
Spitfire™ AC 48 Flush .....	84	Index.....	201

# INDOOR FANS

 AIRE DELUXE 52—LIGHT P.18	 AIRE DELUXE 52—NO LIGHT P.16	 AMPED P.14	 CELANO v2 P.24
 DOREN P.26	 KWAD 44 P.20	 KWAD 52 P.22	 LEVON AC P.28
 OBVI P.12			

# INDOOR/OUTDOOR FANS

 BARLOW P.34	 BRAUN P.38	 EDGEWOOD 44 P.180	 EDGEWOOD 52 P.182
 EDGEWOOD 60 P.184	 EDGEWOOD 72 P.186	 GLEAM P.46	 GLIDEAIRE P.74
 HENRY P.48	 HUGH 44 P.56	 HUGH 52 P.58	 KLEAR P.36
 KLINCH 44 P.52	 KLINCH 52 P.54	 KUTE 44 P.60	 KUTE 44 FLUSH P.62
 KUTE 52 P.64	 KUTE 52 FLUSH P.66	 KUTE5 52 P.68	 KUTE5 52 FLUSH P.70



# INDOOR/OUTDOOR FANS

 KWARTET p.50	 LEVON DC CUSTOM p.108	 ODYN CUSTOM p.154	 ODYN 84 p.162
 PAGET p.32	 PC/DC—LIGHT p.178	 PC/DC—NO LIGHT p.176	 PENDRY 56 p.40
 PENDRY 72 p.42	 PYRAMID p.44	 SCULPTAIRE p.72	 SPITFIRE AC CUSTOM p.80
 SPITFIRE DC CUSTOM p.90	 STELLAR CUSTOM p.164	 TRIAIRE CUSTOM p.134	 WINDPOINTE p.188
 WRAP CUSTOM p.116	 XENO DAMP p.76	 XENO WET p.78	

## PORTABLE



## ACCESSORIES







INDOOR FANS



<p><b>HANGING DIMENSIONS</b> with 6" downrod (included)</p> <p>5.83" diameter varying blade pitch 14.91" 19.80" blade sweep: 22" 26.43" Net weight: 21.16 lbs.</p>	<p><b>CONTROL TYPE</b></p> <p>TR205D handheld remote included</p>
--	---

<p><b>MOTOR TYPE &amp; SIZE</b></p> <p><b>DC 153 x 12</b> (LIMITED LIFETIME WARRANTY)</p> <p>Reverse switch on remote</p>	<p><b>FAN SPEEDS</b> variable</p> <p><b>HIGH-SPEED RPM</b> 386</p> <p><b>*HIGH-SPEED CFM</b> 1,426 CFM</p>	<p><b>LOCATION RATING</b></p> <div style="display: flex; justify-content: space-around;"> <div style="text-align: center;">  dry </div> <div style="text-align: center;">  damp </div> <div style="text-align: center;">  wet </div> </div>
---	--	---

<p><b>LIGHTING</b> (light kit included)</p> <p>(4) 6W Center Band LED (included) (6) 4W Arm LED (included)</p>	<p><b>LIGHTING SPECS</b></p> <p>lumens: arms—2,580 band—1,370 CCT: 3,000k CRI: 90</p>	<p><b>MOUNTING TYPE</b></p> <div style="display: flex; justify-content: space-around;"> <div style="text-align: center;">  downrod 6" included </div> <div style="text-align: center;">  sloped up to 19° included </div> <div style="text-align: center;">  flush sold separately </div> </div>
--	---	--

**SCAN EACH QR CODE FOR FULL IMAGE**

ENERGY GUIDE					CERTIFICATION
AVERAGE SPEED	TOTAL AIR VOLUME	ENERGY USE	ESTIMATED YEARLY ENERGY COST	AIRFLOW EFFICIENCY	
	1,177 CFM	19 Watts	\$5	62 CFM/Watts	

DC MOTOR

DRY

Fan: FP3050\*\*  
included:

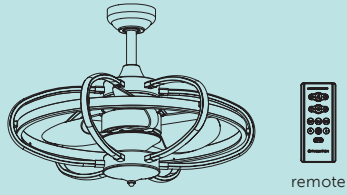

\*\* replace with available finish code below

### optional accessories (sold separately)

mounting



Close-To-Ceiling  
Kit  
CCK8002\*\*



Sloped Ceiling Kit  
(up to 42°)  
SCK1-52



Longer  
Downrods  
page 195

controls



2-wire  
Wall Remote  
TW206D

### FP3050\*\* motor & blade finish combinations



black + clear



brushed nickel + clear

view larger swatches on page 197



OBVI™

# AMPED™

## HANGING DIMENSIONS

with 4.5" downrod (included)

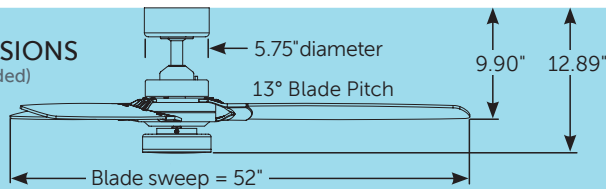

Net weight: 14.55 lbs.

## CONTROL TYPE



TR500 handheld remote included

## MOTOR TYPE & SIZE

**AC 172 x 15**  
(LIMITED LIFETIME WARRANTY)

Reverse switch on fan

## FAN SPEEDS

3

## HIGH-SPEED RPM

193

## \*HIGH-SPEED CFM

5,335 CFM

## LOCATION RATING



dry



damp



wet



## LIGHTING

(light kit included)

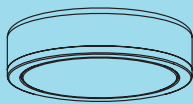

18W LED with opal frosted glass

## LIGHTING SPECS

18W integrated LED

lumens: 1,500  
CCT: 3,000k  
CRI: 90

## MOUNTING TYPE



downrod  
4.5" included



sloped  
up to 27" included



flush



SCAN EACH QR CODE FOR FULL IMAGE

## ENERGY GUIDE

## CERTIFICATION

AVERAGE SPEED

TOTAL AIR VOLUME  
3,612 CFM

ENERGY USE  
46 Watts

ESTIMATED YEARLY ENERGY COST  
\$13

AIRFLOW EFFICIENCY  
79 CFM/Watts



**AC MOTOR** **DRY**

Fan: FP7634\*\*  
included:

remote

\*\* replace with available finish code below

**optional accessories**  
(sold separately)

mounting	<b>Sloped Ceiling Ball</b> (up to 42°) SCB1-52	<b>Longer Downrods</b> page 195
controls	<b>3-wire Fan + Light Wall Control</b> WR501WH	<b>3-wire Fan + Light Wall Control</b> WC2WH
	<b>WiFi Smart Receiver</b> WFR50	

**FP7634\*\* motor & blade finish combinations**

<b>BL</b> black + black	<b>MW</b> matte white + matte white
<b>BLBS</b> black + brushed satin brass blade arms & light kit with black blades	<b>MWBS</b> matte white + brushed satin brass blade arms & light kit with matte white blades
<b>BN</b> brushed nickel + brushed nickel	

view larger swatches on page 197



**AMPED™**

# AIRE DELUXE™ 52 NL

## HANGING DIMENSIONS with 4.5" downrod (included)

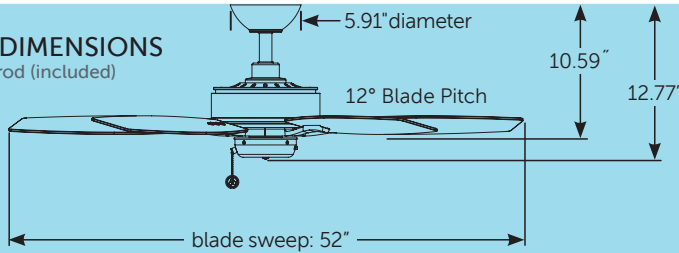

Net weight: 15.36 lbs.

## CONTROL TYPE



Pullchain

## MOTOR TYPE & SIZE

**AC 153 x 15**  
(LIMITED LIFETIME WARRANTY)

Reverse switch on fan

## FAN SPEEDS

3

## HIGH-SPEED RPM

158

## \*HIGH-SPEED CFM

4,908 CFM

## LOCATION RATING



dry



damp



wet



SCAN EACH QR CODE FOR FULL IMAGE

## MOUNTING TYPE



downrod

4.5" included



sloped

up to 19" included



flush

sold separately



## ENERGY GUIDE

AVERAGE SPEED	TOTAL AIR VOLUME	ENERGY USE	ESTIMATED YEARLY ENERGY COST	AIRFLOW EFFICIENCY
	3,496 CFM	34 Watts	\$10	102 CFM/Watts

## CERTIFICATION



FANIMATION.COM

\*Airflow testing is conducted in accordance with the US Department of Energy's testing standards and under specific controlled environmental conditions. Actual airflow performance may vary based on the installation location and environmental factors.



AC MOTOR





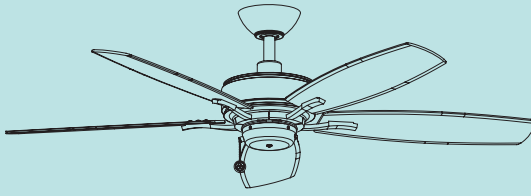

DRY

Fan: FP6284\*\*  
included:

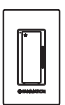

\*\* replace with available finish code below

optional accessories  
(sold separately)

mounting	 <b>Close-To-Ceiling Kit</b> CCK8002**	 <b>Sloped Ceiling Kit</b> (up to 42°) SCK1-52	 <b>Longer Downrods</b> page 195
controls	 <b>2-wire Fan-only Wall Control</b> WC1WH	 <b>2-wire Fan-only Wall Remote</b> WR500WH	
	 <b>Fan + Light Remote &amp; Receiver</b> CR500	 <b>WiFi Smart Receiver</b> WFR50	

FP6284\*\* motor & blade finish combinations

 <b>BN</b> brushed nickel + reversible cherry/dark walnut	 <b>GR</b> matte greige + weathered wood
 <b>DZ</b> dark bronze + reversible cherry/dark walnut	 <b>MW</b> matte white + matte white

view larger swatches on page 197



AIRE DELUXE™ 52 NO LIGHT

# AIRE DELUXE™ 52

**HANGING DIMENSIONS**  
with 4.5" downrod (included)

5.91" diameter  
12° Blade Pitch  
10.59"  
17.36"  
blade sweep: 52"

Net weight: 17.26 lbs.

**CONTROL TYPE**

Fan and light pullchains

**MOTOR TYPE & SIZE**

**AC 153 x 15**  
(LIMITED LIFETIME WARRANTY)

Reverse switch on fan

**FAN SPEEDS**

**3**

**HIGH-SPEED RPM**

**158**

**\*HIGH-SPEED CFM**

**4,842 CFM**

**LOCATION RATING**

dry

✓

damp

✗

wet

✗

**LIGHTING**  
(light kit included)

(2) 9W E26 LED with white frosted glass

**LIGHTING SPECS**

**lumens: 1,620**  
**CCT: 2,700k**  
**CRI: 90**

**MOUNTING TYPE**

downrod  
4.5" included

✓

sloped  
up to 19" included

✓

flush  
sold separately

✓



ENERGY GUIDE				
AVERAGE SPEED	TOTAL AIR VOLUME	ENERGY USE	ESTIMATED YEARLY ENERGY COST	AIRFLOW EFFICIENCY
	3,476 CFM	34 Watts	\$10	102 CFM/Watts

**CERTIFICATION**

AC MOTOR

DRY

Fan: FP6285B\*\*  
included:

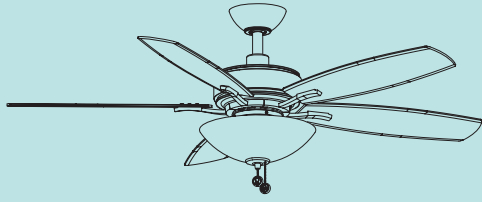

\*\* replace with available finish code below

optional accessories  
(sold separately)

mounting



Close-To-Ceiling Kit  
CCK8002\*\*



Sloped Ceiling Kit  
(up to 42°)  
SCK1-52



Longer Downrods  
page 195

controls

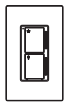

3-wire Fan + Light  
Wall Control  
WC2WH

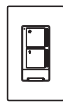

2-wire Fan + Light  
Wall Remote  
WR501WH



Fan + Light  
Remote &  
Receiver  
CR500



WiFi Smart  
Receiver  
WFR50

FP6285B\*\* motor & blade finish combinations



brushed nickel + reversible  
cherry/dark walnut



matte greige + weathered  
wood



dark bronze + reversible  
cherry/dark walnut



matte white + matte white

view larger swatches on page 197



AIRE DELUXE™ 52

# KWAD™ 44

**HANGING DIMENSIONS**  
with 4.5" downrod (included)

Net weight: 14.77 lbs.

**CONTROL TYPE**

TR500 handheld remote included

**MOTOR TYPE & SIZE**

**AC 153 x 13**  
(LIMITED LIFETIME WARRANTY)

Reverse switch on fan

**FAN SPEEDS**

**3**

**HIGH-SPEED RPM**

**195**

**\*HIGH-SPEED CFM**

**3,533 CFM**

**LOCATION RATING**

dry

✓

damp

✗

wet

✗

**LIGHTING**  
(light kit included)

18W LED with opal frosted glass

**LIGHTING SPECS**

**18W integrated LED**

**lumens: 1,500**  
**CCT: 3,000k**  
**CRI: 90**

**MOUNTING TYPE**

downrod  
4.5" included

✓

sloped  
up to 27° included

✓

flush  
sold separately

✓



SCAN EACH QR CODE FOR FULL IMAGE

ENERGY GUIDE					CERTIFICATION
AVERAGE SPEED	TOTAL AIR VOLUME	ENERGY USE	ESTIMATED YEARLY ENERGY COST	AIRFLOW EFFICIENCY	
	2,579 CFM	29 Watts	\$8	88 CFM/Watts	

FANIMATION.COM

\*Airflow testing is conducted in accordance with the US Department of Energy's testing standards and under specific controlled environmental conditions. Actual airflow performance may vary based on the installation location and environmental factors.

**AC MOTOR**



Fan: FP7644\*\*  
included:

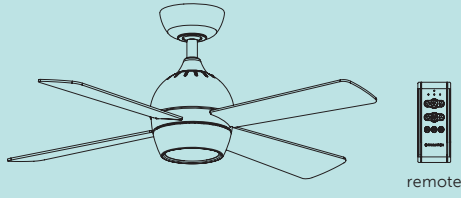

\*\* replace with available finish code below

**optional accessories**  
(sold separately)

mounting	<b>Close-To-Ceiling Kit</b> CCK8002**	<b>Sloped Ceiling Ball (up to 42°)</b> SCB1-52	<b>Longer Downrods</b> page 195
controls	<b>3-wire Fan + Light Wall Control</b> WC2WH	<b>2-wire Fan + Light Wall Remote</b> WR501WH	
	<b>WiFi Smart Receiver</b> WFR50		

**FP7644\*\* motor & blade finish combinations**

<b>BL</b> black + black	<b>DZ</b> dark bronze + reversible cherry/dark walnut
<b>BN</b> brushed nickel + reversible brushed nickel/black	<b>GR</b> matte greige + weathered wood
<b>BS</b> brushed satin brass + matte white	<b>MW</b> matte white + matte white

view larger swatches on page 197



**KWAD™ 44**

# KWAD™ 52

**HANGING DIMENSIONS**  
with 4.5" downrod (included)

Net weight: 16.31lbs.

**CONTROL TYPE**

TR500 handheld remote included

**MOTOR TYPE & SIZE**

**AC 153 x 18**  
(LIMITED LIFETIME WARRANTY)

Reverse switch on fan

**FAN SPEEDS**

**3**

**HIGH-SPEED RPM**

**170**

**\*HIGH-SPEED CFM**

**4,738 CFM**

**LOCATION RATING**

dry

✓

damp

✗

wet

✗

**LIGHTING**  
(light kit included)

18W LED with opal frosted glass

**LIGHTING SPECS**

**18W integrated LED**

**lumens: 1,500**  
**CCT: 3,000k**  
**CRI: 90**

**MOUNTING TYPE**

downrod  
4.5" included

✓

sloped  
up to 27° included

✓

flush  
sold separately

✓



SCAN EACH QR CODE FOR FULL IMAGE

ENERGY GUIDE					CERTIFICATION
AVERAGE SPEED	TOTAL AIR VOLUME	ENERGY USE	ESTIMATED YEARLY ENERGY COST	AIRFLOW EFFICIENCY	
	3,533 CFM	37 Watts	\$10	96 CFM/Watts	

\*Airflow testing is conducted in accordance with the US Department of Energy's testing standards and under specific controlled environmental conditions. Actual airflow performance may vary based on the installation location and environmental factors.

**AC MOTOR** **DRY**



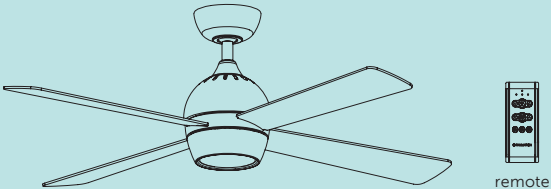



Fan: FP7652\*\*  
included:







remote

\*\* replace with available finish code below

**optional accessories**  
(sold separately)

mounting	 <b>Close-To-Ceiling Kit</b> CCK8002**	 <b>Sloped Ceiling Ball (up to 42°)</b> SCB1-52	 <b>Longer Downrods</b> page 195
controls	 <b>3-wire Fan + Light Wall Control</b> WC2WH	 <b>2-wire Fan + Light Wall Remote</b> WR501WH	
	 <b>WiFi Smart Receiver</b> WFR50		

**FP7652\*\* motor & blade finish combinations**

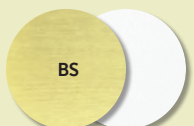
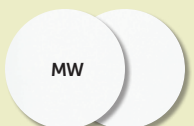
 <b>BL</b> black + black	 <b>DZ</b> dark bronze + reversible cherry/dark walnut
 <b>BN</b> brushed nickel + reversible brushed nickel/black	 <b>GR</b> matte greige + weathered wood
 <b>BS</b> brushed satin brass + matte white	 <b>MW</b> matte white + matte white

view larger swatches on page 197



# CELANO V2™

## HANGING DIMENSIONS with 4.5" downrod (included)

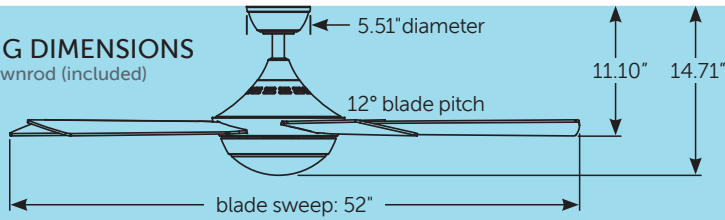

Net weight: 17.86 lbs.

## CONTROL TYPE



TR500 handheld remote included

## MOTOR TYPE & SIZE

**AC 172 x 17**  
(LIMITED LIFETIME WARRANTY)

Reverse switch on fan

## FAN SPEEDS

**3**

## HIGH-SPEED RPM

**171**

## \*HIGH-SPEED CFM

**5,192 CFM**

## LOCATION RATING



dry



damp



wet



## LIGHTING

(light kit included)

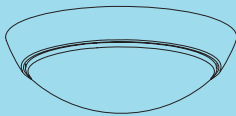

18W LED with opal frosted glass

## LIGHTING SPECS

**18W integrated LED**

**lumens: 1,500**  
**CCT: 3,000k**  
**CRI: 90**

## MOUNTING TYPE



**downrod**  
4.5" included



**sloped**  
up to 19° included



**flush**  
sold separately



SCAN EACH QR CODE FOR FULL IMAGE

## ENERGY GUIDE

AVERAGE SPEED	TOTAL AIR VOLUME	ENERGY USE	ESTIMATED YEARLY ENERGY COST	AIRFLOW EFFICIENCY
	<b>3,402 CFM</b>	<b>38 Watts</b>	<b>\$11</b>	<b>90 CFM/Watts</b>

## CERTIFICATION





AC MOTOR





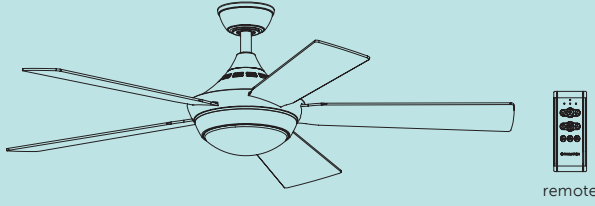

DRY

Fan: FP8062B\*\*  
included:



\*\* replace with available finish code below

optional accessories  
(sold separately)

mounting	 Close-To-Ceiling Kit CCK8002**	 Sloped Ceiling Kit (up to 42°) SCK1-52	 Longer Downrods page 195
controls	 3-wire Fan + Light Wall Control WC2WH	 2-wire Fan + Light Wall Remote WR501WH	
	 WiFi Smart Receiver WFR50		

FP8062B\*\* motor & blade finish combinations



BN  
brushed nickel + reversible  
cherry/dark walnut



DZ  
dark bronze + reversible  
cherry/dark walnut



MW  
matte white + matte white

view larger swatches on page 197



# DOREN™

**HANGING DIMENSIONS**  
with 4.5" downrod (included)

6.52" diameter  
13° blade pitch  
blade sweep: 52"  
12.53"  
13.65"

Net weight: 19.84 lbs.

**CONTROL TYPE**

TR500 handheld remote included

**MOTOR TYPE & SIZE**

**AC 172 x 20**  
(LIMITED LIFETIME WARRANTY)

Reverse switch on fan

**FAN SPEEDS**

**3**

**HIGH-SPEED RPM**

**163**

**\*HIGH-SPEED CFM**

**5,198 CFM**

**LOCATION RATING**

dry  damp  wet

**LIGHTING**  
(light kit included)

17W LED with opal frosted glass

**LIGHTING SPECS**

**17W integrated LED**

**lumens: 1,350**  
**CCT: 3,000k**  
**CRI: 90**

**MOUNTING TYPE**

downrod 4.5" included  sloped up to 27° included  flush sold separately

**SCAN EACH QR CODE FOR FULL IMAGE**

ENERGY GUIDE				
<b>AVERAGE SPEED</b>	<b>TOTAL AIR VOLUME</b>	<b>ENERGY USE</b>	<b>ESTIMATED YEARLY ENERGY COST</b>	<b>AIRFLOW EFFICIENCY</b>
	3,774 CFM	39 Watts	\$11	97 CFM/Watts

**CERTIFICATION**

**AC MOTOR** **DRY**



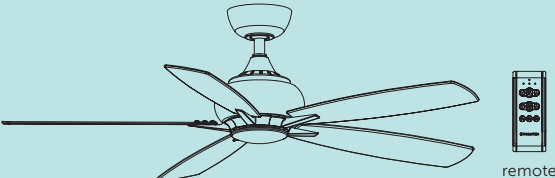



Fan: FP8533\*\*  
included:







remote

\*\* replace with available finish code below

**optional accessories**  
(sold separately)

mounting		<b>Close-To-Ceiling Kit</b> CCK8002**		<b>Sloped Ceiling Ball (up to 42°)</b> SCB1-52		<b>Longer Downrods</b> page 195
controls		<b>3-wire Fan + Light Wall Control</b> WC2WH		<b>2-wire Fan + Light Wall Remote</b> WR501WH		
		<b>WiFi Smart Receiver</b> WFR50				

**FP8533\*\* motor & blade finish combinations**

 <b>BL</b> black + black	 <b>GR</b> matte greige + weathered wood
 <b>BN</b> brushed nickel + reversible brushed nickel/black	 <b>PN</b> polished nickel + black
 <b>DZ</b> dark bronze + reversible cherry/dark walnut	

view larger swatches on page 197



# LEVON™ AC

**HANGING DIMENSIONS**  
with 6" downrod (included)

5.75" diameter  
14° blade pitch  
blade sweep: 63"  
\*12.0"  
\*14.5"

Net weight: 23.8 lbs.

**CONTROL TYPE**

pull chain

**MOTOR TYPE & SIZE**

**AC 188 x 25**  
(LIMITED LIFETIME WARRANTY)

Reverse switch on fan

**FAN SPEEDS**

3

**HIGH-SPEED RPM**

105

**\*HIGH-SPEED CFM**

5,878 CFM

**LOCATION RATING**

dry damp wet

**SCAN EACH QR CODE FOR FULL IMAGE**

**MOUNTING TYPE**

downrod sloped flush

6" included up to 27" included sold separately

ENERGY GUIDE				
AVERAGE SPEED	TOTAL AIR VOLUME	ENERGY USE	ESTIMATED YEARLY ENERGY COST	AIRFLOW EFFICIENCY
	4,273 CFM	42 Watts	\$12	102 CFM/Watts

**CERTIFICATION**

FANIMATION.COM

\*Airflow testing is conducted in accordance with the US Department of Energy's testing standards and under specific controlled environmental conditions. Actual airflow performance may vary based on the installation location and environmental factors.

AC MOTOR





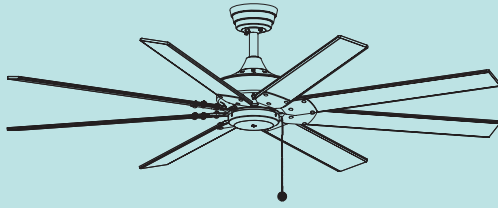



DRY

Fan: FP7910\*\*  
included:



\*\* replace with available finish codes below

**optional accessories**  
(sold separately)

light kit		<b>Low-profile Light Kit</b> LK179**		
mounting		<b>Close-To-Ceiling Kit</b> CCK8002**		<b>Sloped Ceiling Ball (up to 42°)</b> SCB1-52
				<b>Longer Downrods</b> page 195
controls		<b>2-wire Fan-only Wall Control</b> WC1WH		<b>3-wire Fan + Light Wall Control</b> WC2WH
		<b>2-wire Fan-only Wall Remote</b> WR500WH		<b>2-wire Fan + Light Wall Remote</b> WR501WH
		<b>WiFi Smart Receiver</b> WFR50		



FP7910\*\* motor & blade finish combinations



BL

black + black



DZ

dark bronze + reversible  
cherry/dark walnut



MW

matte white + matte white

view larger swatches on page 197





INDOOR/OUTDOOR FANS

# PAGET™

<p><b>HANGING DIMENSIONS</b> with 6" downrod (included)</p> <p>6.50" diameter 13° blade pitch 9.70" 16.29" blade sweep: 52"</p> <p>Net weight: 13.45 lbs.</p>		<p><b>CONTROL TYPE</b></p> <p>TR500 handheld remote included</p>			
<p><b>MOTOR TYPE &amp; SIZE</b></p> <p><b>AC 153 x 17</b> (LIMITED LIFETIME WARRANTY)</p> <p>Reverse switch on fan</p>	<p><b>FAN SPEEDS</b></p> <p><b>3</b></p>		<p><b>LOCATION RATING</b></p>		
	<p><b>HIGH-SPEED RPM</b></p> <p><b>160</b></p>		<p>dry</p> <p><input checked="" type="checkbox"/></p>	<p>damp</p> <p><input checked="" type="checkbox"/></p>	<p>wet</p> <p><input type="checkbox"/></p>
	<p><b>HIGH-SPEED CFM</b></p> <p><b>5,429 CFM</b></p>				
<p><b>LIGHTING</b> (light kit included)</p> <p>18W LED with opal frosted glass</p>		<p><b>LIGHTING SPECS</b></p> <p><b>18W integrated LED</b></p> <p>lumens: 1,700 CCT: 3,000k CRI: 90</p>		<p><b>MOUNTING TYPE</b></p>	
		<p>downrod 6" included</p> <p><input checked="" type="checkbox"/></p>	<p>sloped up to 27" included</p> <p><input checked="" type="checkbox"/></p>	<p>flush</p> <p><input type="checkbox"/></p>	



<b>ENERGY GUIDE</b>					<b>CERTIFICATION</b>
<b>AVERAGE SPEED</b>	<b>TOTAL AIR VOLUME</b>	<b>ENERGY USE</b>	<b>ESTIMATED YEARLY ENERGY COST</b>	<b>AIRFLOW EFFICIENCY</b>	
	4,014 CFM	36 Watts	\$10	110 CFM/Watts	



**AC MOTOR** **DRY** **DAMP**

Fan: FP6837\*\*  
included:

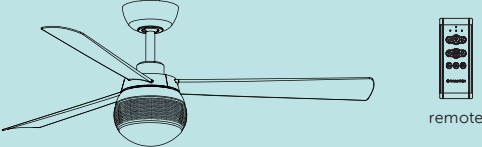





remote



**optional accessories**

(sold separately)

mounting	 <b>Sloped Ceiling Ball (up to 42°)</b> SCB1-52	 <b>Longer Downrods</b> page 195
controls	 <b>3-wire Fan + Light Wall Control</b> WC2WH	 <b>2-wire Fan + Light Wall Remote</b> WR501WH
	 <b>WiFi Smart Receiver</b> WFR50	

**FP6837\*\* motor & blade finish combinations**



brushed satin brass + matte white

view larger swatches on page 197

# BARLOW™

## HANGING DIMENSIONS

with 6" downrod (included)

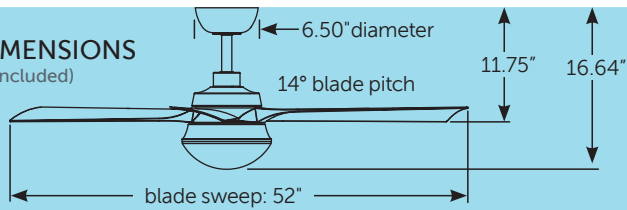

Net weight: 18.13 lbs.

## CONTROL TYPE



TR500 handheld remote included

## MOTOR TYPE & SIZE

**AC 153 x 20**  
(LIMITED LIFETIME WARRANTY)

Reverse switch on fan

## FAN SPEEDS

**3**

## HIGH-SPEED RPM

**141**

## \*HIGH-SPEED CFM

**5,476 CFM**

## LOCATION RATING



dry



damp



wet



## LIGHTING

(light kit included)

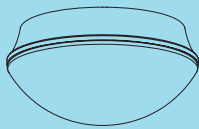

24W LED with opal frosted glass

## LIGHTING SPECS

**24W integrated LED**

**lumens: 2,000**  
**CCT: 3,000k**  
**CRI: 90**

## MOUNTING TYPE



downrod  
6" included



sloped  
up to 27° included



flush  
sold separately



SCAN EACH QR CODE FOR FULL IMAGE

## ENERGY GUIDE

## CERTIFICATION

AVERAGE SPEED

TOTAL AIR VOLUME

**3,951 CFM**

ENERGY USE

**38 Watts**

ESTIMATED YEARLY ENERGY COST

**\$11**

AIRFLOW EFFICIENCY

**105 CFM/Watts**



**AC MOTOR** **DRY** **DAMP**

Fan: FP6807\*\*  
included:

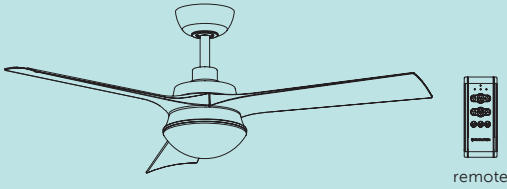







remote

\*\* replace with available finish code below

**optional accessories**

(sold separately)

mounting		<b>Close-To-Ceiling Kit</b> CCK8002**		<b>Sloped Ceiling Ball (up to 42°)</b> SCB1-52		<b>Longer Downrods</b> page 195
controls		<b>3-wire Fan + Light Wall Control</b> WC2WH		<b>2-wire Fan + Light Wall Remote</b> WR501WH		
		<b>WiFi Smart Receiver</b> WFR50				

**FP6807\*\* motor & blade finish combinations**

 <b>AGP</b> antique graphite + light oak	 <b>BSBL</b> brushed satin brass + black
 <b>BL</b> black + black	 <b>BSMW</b> brushed satin brass + matte white

view larger swatches on page 197

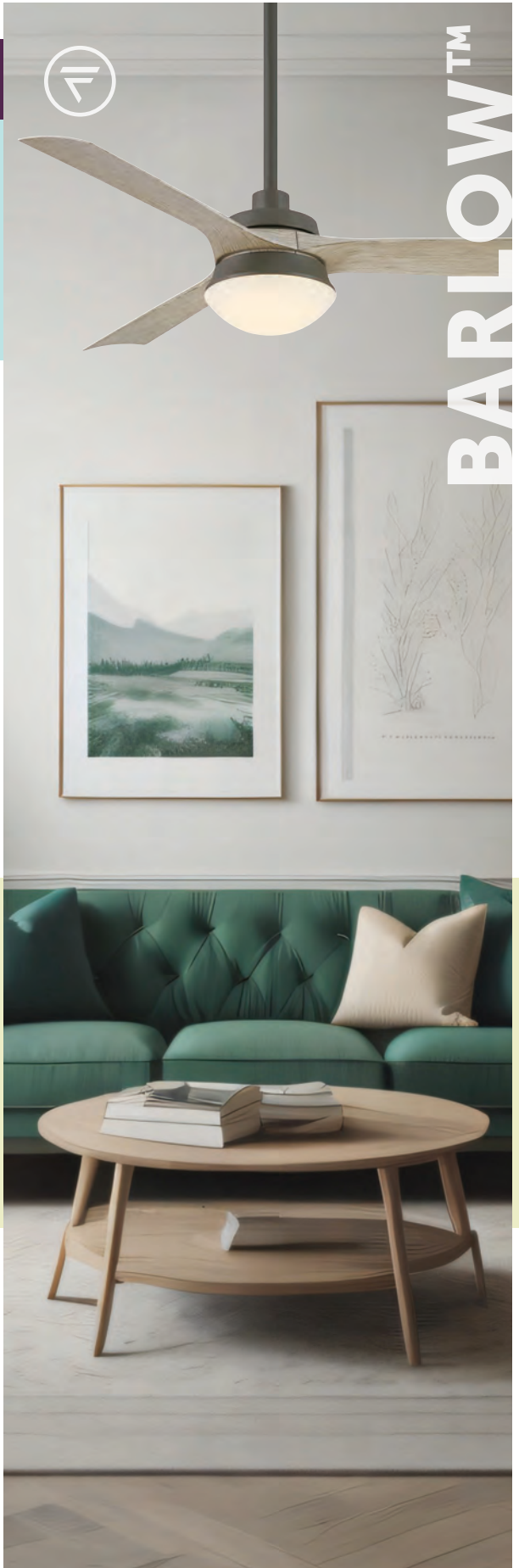

**BARLOW™**

# KLEAR™

**HANGING DIMENSIONS**  
with 4.5" downrod (included)

5.75" diameter  
14° blade pitch  
10.78"  
14.81" cap  
15.03" light  
blade sweep: 56"

Net weight: 16.98 lbs.

**KWIKWIRE**

**CONTROL TYPE**

+ **fanSync** by FANIMATION

TR305 handheld remote included

<p><b>MOTOR TYPE &amp; SIZE</b></p> <p><b>DC 100 x 30</b> (LIMITED LIFETIME WARRANTY)</p> <p>Reverse switch on remote</p>	<p><b>FAN SPEEDS</b></p> <p><b>variable</b></p> <hr/> <p><b>HIGH-SPEED RPM</b></p> <p><b>161</b></p> <hr/> <p><b>*HIGH-SPEED CFM</b></p> <p><b>6,878 CFM</b></p>	<p><b>LOCATION RATING</b></p> <div style="display: flex; justify-content: space-around;"> <div style="text-align: center;"> <p>dry</p> <p>✓</p> </div> <div style="text-align: center;"> <p>damp</p> <p>✓</p> </div> <div style="text-align: center;"> <p>wet</p> <p>✗</p> </div> </div>
---	--	--

<p><b>LIGHTING</b> (light kit and cap included)</p> <p>24W LED with opal frosted glass</p>	<p><b>LIGHTING SPECS</b></p> <p><b>24W integrated LED with CCT Select</b></p> <p><b>lumens: 2,000</b></p> <p><b>CCT: 3000k/4000k/5000k</b></p> <p><b>CRI: 90</b></p>	<p><b>MOUNTING TYPE</b></p> <div style="display: flex; justify-content: space-around;"> <div style="text-align: center;"> <p>downrod 4.5" included</p> <p>✓</p> </div> <div style="text-align: center;"> <p>sloped up to 27° included</p> <p>✓</p> </div> <div style="text-align: center;"> <p>flush sold separately</p> <p>✓</p> </div> </div>
--	--	---

**SCAN EACH QR CODE FOR FULL IMAGE**

ENERGY GUIDE					CERTIFICATION
AVERAGE SPEED	TOTAL AIR VOLUME <b>4,312 CFM</b>	ENERGY USE <b>19 Watts</b>	ESTIMATED YEARLY ENERGY COST <b>\$5</b>	AIRFLOW EFFICIENCY <b>228 CFM/Watts</b>	

**DC MOTOR** **DRY** **DAMP**

Fan: FPD6858\*\*  
included:

remote



**KLEAR™**

**optional accessories**  
(sold separately)

- mounting**  
**Close-To-Ceiling Kit**  
CCK8002\*\*
- Sloped Ceiling Ball**  
(up to 42°)  
SCB1-52
- Longer Downrods**  
page 195
- controls**  
**2-wire Fan-only Wall Control**  
TW306

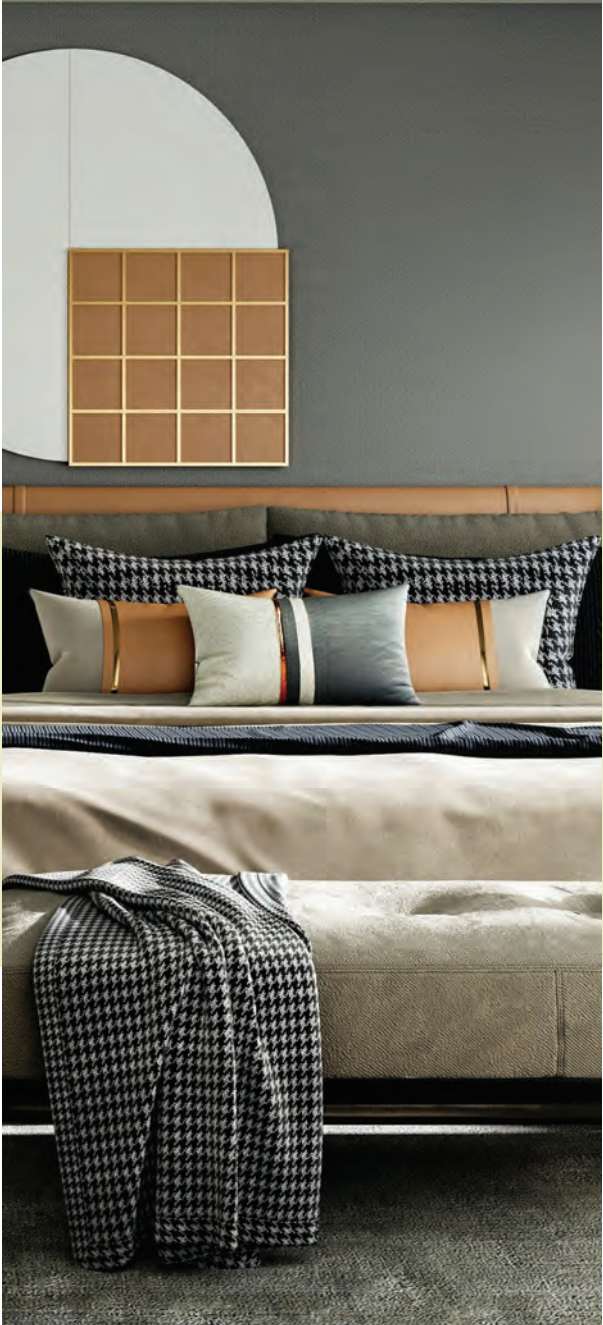

**FPD6858\*\* motor & blade finish combinations**

<p><b>BL</b></p> <p>black + black</p>	<p><b>BSMW</b></p> <p>brushed satin brass + matte white</p>
<p><b>BSBL</b></p> <p>brushed satin brass + black</p>	<p><b>MW</b></p> <p>matte white + matte white</p>

view larger swatches on page 197

# BRAWN™

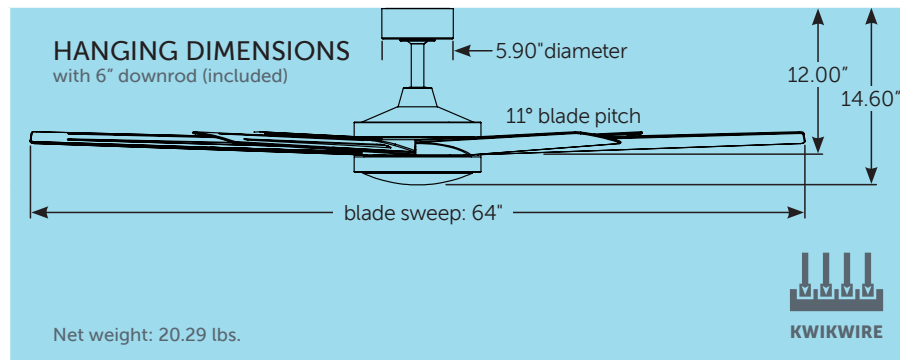

**CONTROL TYPE**

TR305 handheld remote included

**MOTOR TYPE & SIZE**

**DC 126 x 12**  
(LIMITED LIFETIME WARRANTY)

Reverse switch on remote

**FAN SPEEDS**  
variable

**HIGH-SPEED RPM**  
136

**\*HIGH-SPEED CFM**  
7,443 CFM

**LOCATION RATING**

dry  damp  wet

**LIGHTING**  
(light kit included)

30W LED with opal frosted glass

**LIGHTING SPECS**

**30W integrated LED with CCT Select**

lumens: 2,700  
CCT: 3000k/4000k/5000k  
CRI: 90

**MOUNTING TYPE**

downrod 6" included  sloped up to 27° included  flush sold separately



SCAN EACH QR CODE FOR FULL IMAGE

ENERGY GUIDE				
AVERAGE SPEED	TOTAL AIR VOLUME	ENERGY USE	ESTIMATED YEARLY ENERGY COST	AIRFLOW EFFICIENCY
	4,693 CFM	22 Watts	\$6	214 CFM/Watts

**CERTIFICATION**

\*Airflow testing is conducted in accordance with the US Department of Energy's testing standards and under specific controlled environmental conditions. Actual airflow performance may vary based on the installation location and environmental factors.

**DC MOTOR** **DRY** **DAMP**

Fan: FPD6605\*\*  
included:

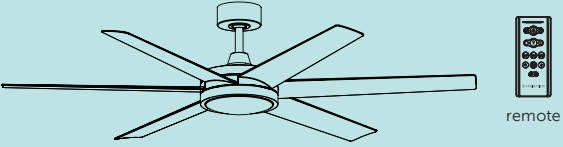



remote

**optional accessories**  
(sold separately)

mounting  **Close-To-Ceiling Kit**  
CCK8002\*\*

 **Sloped Ceiling Ball**  
(up to 42°)  
SCB1-52

 **Longer Downrods**  
page 195

controls  **2-wire Fan-only Wall Control**  
TW306

**FPD6605\*\* motor & blade finish combinations**

 **AGP**  
antique graphite + light oak

 **BL**  
black + black

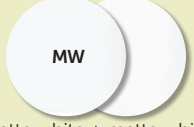
 **MW**  
matte white + matte white

view larger swatches on page 197

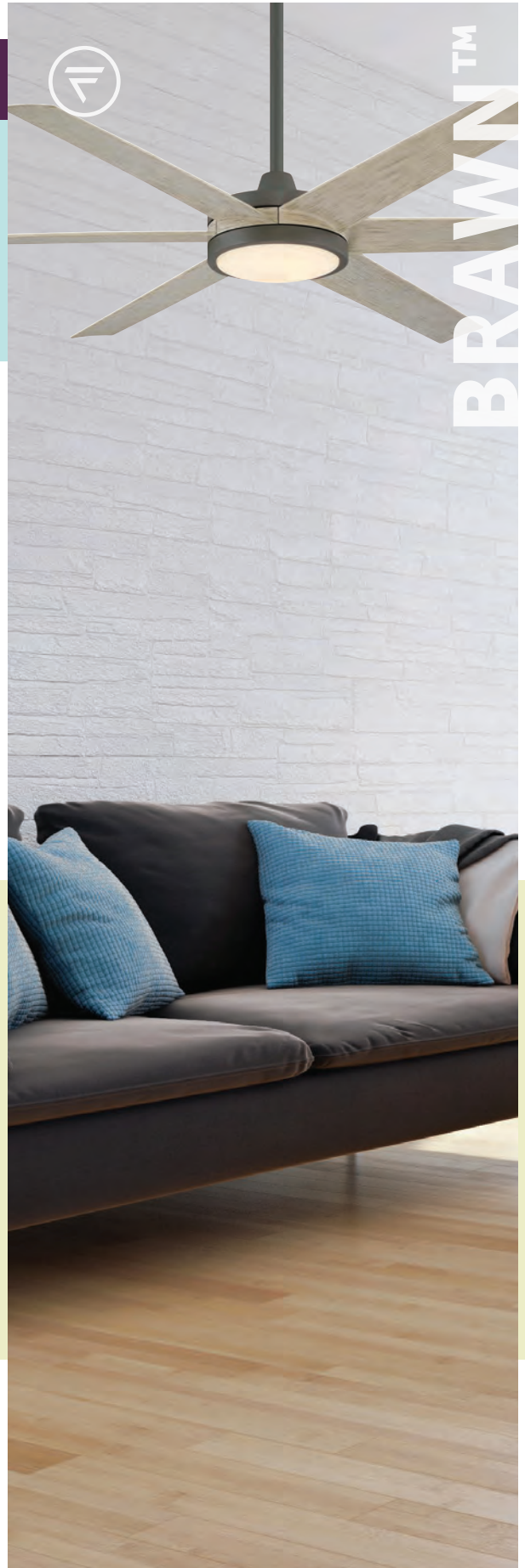

# PENDRY™ 56

**HANGING DIMENSIONS**  
with 6" downrod (included)

Net weight: 20.29 lbs.

**CONTROL TYPE**

TR305 handheld remote included

**KWIKWIRE**

**MOTOR TYPE & SIZE**

**DC 126 x 12**  
(LIMITED LIFETIME WARRANTY)

Reverse switch on remote

**FAN SPEEDS**  
variable

**HIGH-SPEED RPM**  
137

**\*HIGH-SPEED CFM**  
6,847 CFM

**LOCATION RATING**

dry

damp

wet

BLW & MWW

**LIGHTING—LK6865**  
(sold separately)

24W LED with opal frosted glass

**LIGHTING SPECS—LK6865**  
(sold separately)

**24W integrated LED**

lumens: 2,000  
CCT: 3000k/4000k/5000k  
CRI: 90

**MOUNTING TYPE**

downrod  
6" included

sloped  
up to 27° included

flush  
sold separately

**SCAN EACH QR CODE FOR FULL IMAGE**

ENERGY GUIDE				
AVERAGE SPEED	TOTAL AIR VOLUME 4,278 CFM	ENERGY USE 22 Watts	ESTIMATED YEARLY ENERGY COST \$6	AIRFLOW EFFICIENCY 196 CFM/Watts

**CERTIFICATION**





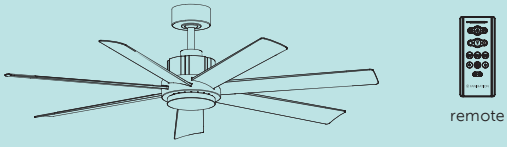

**DC MOTOR** **DRY** **DAMP**

Fan: FPD6865\*\*\*  
included:



**optional accessories**  
(sold separately)

- light kit**  

**LED Light Kit**  
 LK6865
- mounting**  

**Close-To-Ceiling Kit**  
 CCK8002\*\*
- 
**Sloped Ceiling Ball (up to 42°)**  
 SCB1-52
- 
**Longer Downrods**  
 page 195
- controls**  

**2-wire Fan-only Wall Control**  
 TW306

**ordering example**

FPD6865BLBN  
(black motor with brushed  
nickel accent and black blades)  
+  
LK6865  
(Pendry light kit)



**FPD6865\*\*\* motor & blade finish combinations**

 <p><b>BLW</b> black + black</p>	 <p><b>BSMW</b> brushed satin brass + matte white</p>
 <p><b>BLBN</b> black &amp; brushed nickel + black</p>	 <p><b>MWW</b> matte white + matte white</p>

view larger swatches on page 197

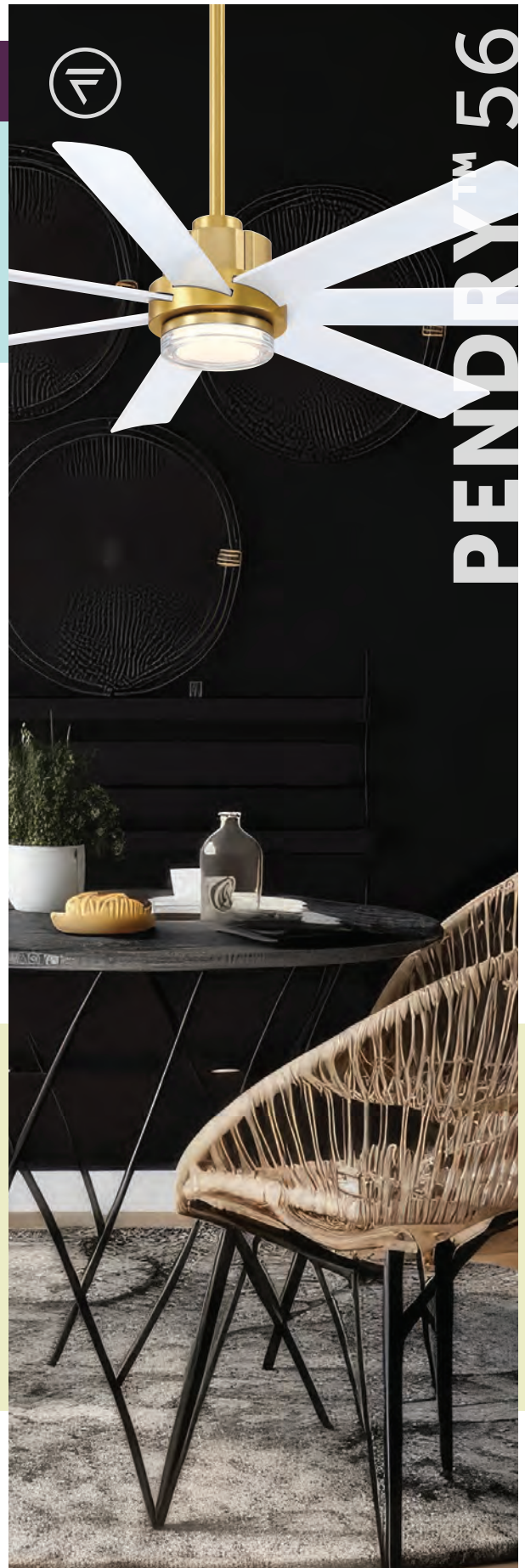

# PENDRY™ 72

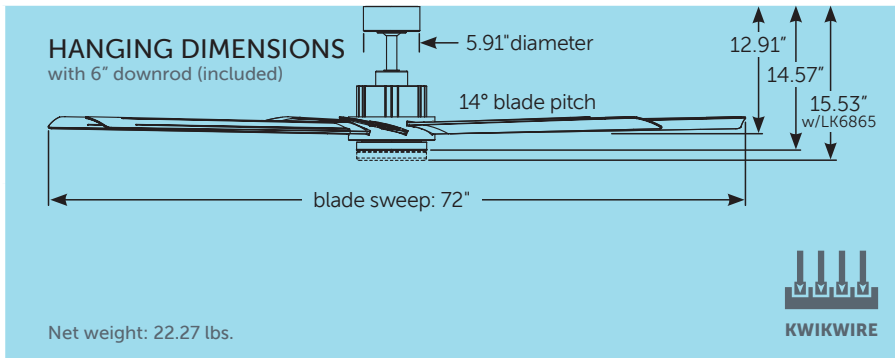

**CONTROL TYPE**

wifi + fanSync by FANIMATION

TR305 handheld remote included

**MOTOR TYPE & SIZE**

**DC 126 x 20**  
(LIMITED LIFETIME WARRANTY)

Reverse switch on remote

**FAN SPEEDS**  
variable

**HIGH-SPEED RPM**  
93

**\*HIGH-SPEED CFM**  
8,755 CFM

**LOCATION RATING**

dry damp wet

✓ ✓ !

BLW & MWW

**LIGHTING—LK6865**  
(sold separately)

24W LED with opal frosted glass

**LIGHTING SPECS—LK6865**  
(sold separately)

**24W integrated LED**

lumens: 2,000  
CCT: 3000k/4000k/5000k  
CRI: 90

**MOUNTING TYPE**

downrod sloped flush  
6" included up to 27" included sold separately

✓ ✓ ✓

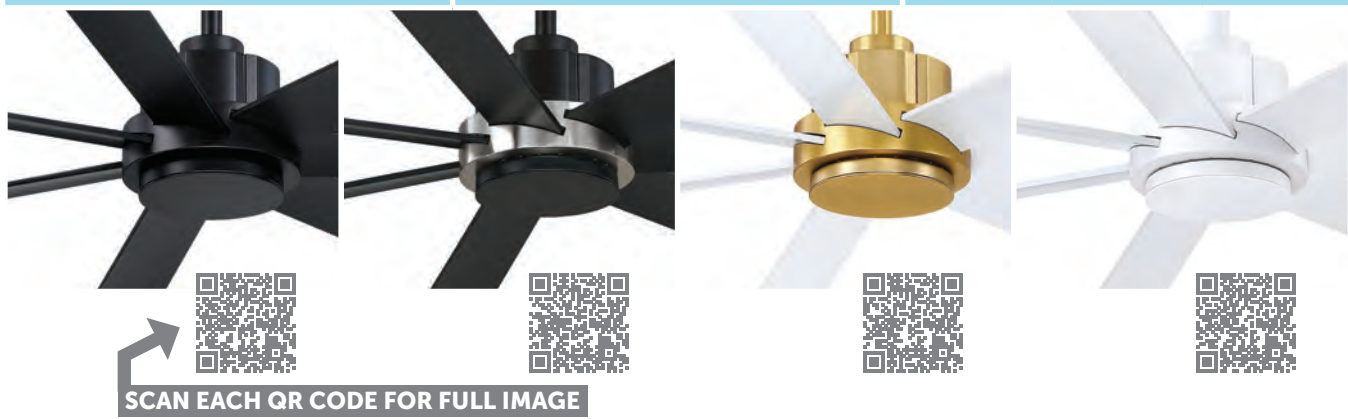

ENERGY GUIDE				
<b>AVERAGE SPEED</b>	<b>TOTAL AIR VOLUME</b>	<b>ENERGY USE</b>	<b>ESTIMATED YEARLY ENERGY COST</b>	<b>AIRFLOW EFFICIENCY</b>
	5,867 CFM	21 Watts	\$6	279 CFM/Watts

**CERTIFICATION**

**DC MOTOR** **DRY** **DAMP**

Fan: FPD6872\*\*\*  
included:

remote

**optional accessories**  
(sold separately)

- light kit**  
**LED Light Kit**  
 LK6865
- mounting**  
**Close-To-Ceiling Kit**  
 CCK8002\*\*
- Sloped Ceiling Ball**  
 (up to 42°)  
 SCB1-52
- Longer Downrods**  
 page 195
- controls**  
**2-wire Fan-only Wall Control**  
 TW306

**ordering example**

FPD6872BSMW  
(brushed satin brass motor  
with matte white blade)  
+  
LK6865  
(Pendry light kit)



**FPD6872\*\*\* motor & blade finish combinations**

<p><b>BLW</b> black + black</p>	<p><b>BSMW</b> brushed satin brass + matte white</p>
<p><b>BLBN</b> black &amp; brushed nickel + black</p>	<p><b>MWW</b> matte white + matte white</p>

view larger swatches on page 197



# PYRAMID™

### HANGING DIMENSIONS

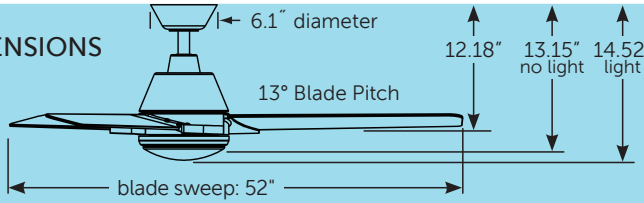

Net weight: 17.40 lbs.

### CONTROL TYPE



TR500 handheld remote included

### MOTOR TYPE & SIZE

**AC 153 x 20**  
(LIMITED LIFETIME WARRANTY)

Reverse switch on fan

### FAN SPEEDS

**3**



### HIGH-SPEED RPM



**186**



### \*HIGH-SPEED CFM

**4,827 CFM**

### LOCATION RATING

  
**dry**  

  
**damp**  

  
**wet**  

### LIGHTING

(light kit and cap included)





18W LED with opal frosted glass



### LIGHTING SPECS



**18W integrated LED**

**lumens: 1,500**  
**CCT: 3,000k**  
**CRI: 90**

### MOUNTING TYPE

  
**downrod**  
4.5" included  

  
**sloped**  
up to 19° included  

  
**flush**  
sold separately  



SCAN EACH QR CODE FOR FULL IMAGE

ENERGY GUIDE					CERTIFICATION
AVERAGE SPEED	TOTAL AIR VOLUME	ENERGY USE	ESTIMATED YEARLY ENERGY COST	AIRFLOW EFFICIENCY	
	<b>3,466 CFM</b>	<b>38 Watts</b>	<b>\$11</b>	<b>90 CFM/Watts</b>	

FANIMATION.COM \*Airflow testing is conducted in accordance with the US Department of Energy's testing standards and under specific controlled environmental conditions. Actual airflow performance may vary based on the installation location and environmental factors.

**AC MOTOR** **DRY** **DAMP**

Fan: FP8406\*\*  
included:

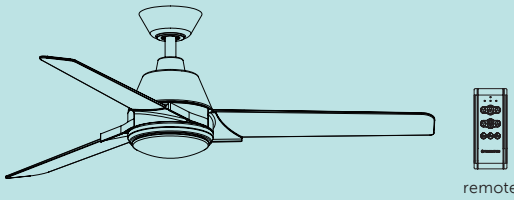







remote

\*\* replace with available finish code below

**optional accessories**

(sold separately)

mounting	 <p><b>Sloped Ceiling Kit</b> (up to 42°) SCK1-52</p>	 <p><b>Longer Downrods</b> page 195</p>
controls	 <p><b>2-wire Fan-only Wall Control</b> WC1WH</p>	 <p><b>3-wire Fan + Light Wall Control</b> WC2WH</p>
	 <p><b>2-wire Fan-only Wall Remote</b> WR500WH</p>	 <p><b>2-wire Fan + Light Wall Remote</b> WR501WH</p>
	 <p><b>WiFi Smart Receiver</b> WFR50</p>	

**FP8406\*\* motor & blade finish combinations**



**BL**  
black + black

---



**BN**  
brushed nickel + silver

---



**MW**  
matte white + matte white

view larger swatches on page 197



# GLEAM™

**HANGING DIMENSIONS**  
with 4.5" downrod (included)

Net weight: 20.90 lbs.

**CONTROL TYPE**

TR500 handheld remote included

<p><b>MOTOR TYPE &amp; SIZE</b></p> <p><b>AC 82 x 30</b> <small>(LIMITED LIFETIME WARRANTY)</small></p> <p>Reverse switch on fan</p>	<p><b>FAN SPEEDS</b></p> <p><b>3</b></p> <hr/> <p><b>HIGH-SPEED RPM</b></p> <p><b>563</b></p> <hr/> <p><b>*HIGH-SPEED CFM</b></p> <p><b>1,531 CFM</b></p>	<p><b>LOCATION RATING</b></p> <div style="display: flex; justify-content: space-around;"> <div style="text-align: center;"> <p>dry</p> <p><input checked="" type="checkbox"/></p> </div> <div style="text-align: center;"> <p>damp</p> <p><input checked="" type="checkbox"/></p> </div> <div style="text-align: center;"> <p>wet</p> <p><input type="checkbox"/></p> </div> </div>
--	---	---

<p><b>LIGHTING</b> <small>(light kit included)</small></p> <p>20W LED</p>	<p><b>LIGHTING SPECS</b></p> <p><b>20W integrated LED</b></p> <p><b>lumens: 2,200</b> <b>CCT: 3,000k</b> <b>CRI: 90</b></p>	<p><b>MOUNTING TYPE</b></p> <div style="display: flex; justify-content: space-around;"> <div style="text-align: center;"> <p>downrod <small>4.5" included</small></p> <p><input checked="" type="checkbox"/></p> </div> <div style="text-align: center;"> <p>sloped <small>up to 20° included</small></p> <p><input checked="" type="checkbox"/></p> </div> <div style="text-align: center;"> <p>flush <small>sold separately</small></p> <p><input checked="" type="checkbox"/></p> </div> </div>
---	---	--



**SCAN EACH QR CODE FOR FULL IMAGE**

ENERGY GUIDE					CERTIFICATION
AVERAGE SPEED	TOTAL AIR VOLUME <b>1,206 CFM</b>	ENERGY USE <b>33 Watts</b>	ESTIMATED YEARLY ENERGY COST <b>\$9</b>	AIRFLOW EFFICIENCY <b>36 CFM/Watts</b>	

**AC MOTOR** **DRY** **DAMP**



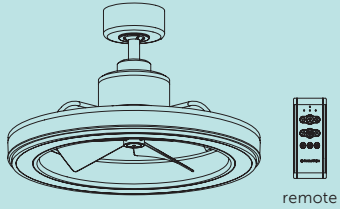



Fan: FP8404\*\*  
included:



remote

\*\* replace with available finish code below

**optional accessories**  
(sold separately)

mounting		<b>Close-To-Ceiling Kit</b> CCK8002**		<b>Sloped Ceiling Ball</b> (up to 42°) SCB1-52		<b>Longer Downrods</b> page 195
controls		<b>3-wire Fan + Light Wall Control</b> WC2WH		<b>2-wire Fan + Light Wall Remote</b> WR501WH		
		<b>WiFi Smart Receiver</b> WFR50				

**FP3050\*\* motor & blade finish combinations**

**BL**  
black + black











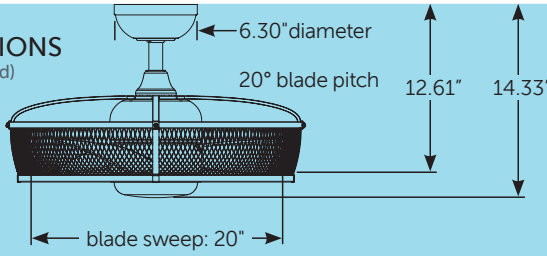



---

**BN**  
brushed nickel + brushed nickel

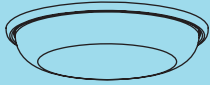
view larger swatches on page 197



# HENRY™

<p><b>HANGING DIMENSIONS</b> with 4.5" downrod (included)</p>  <p>Net weight: 15.88 lbs.</p>		<p><b>CONTROL TYPE</b></p>  <p>TR500 handheld remote included</p>	
<p><b>MOTOR TYPE &amp; SIZE</b></p> <p><b>AC 153 x 15</b> (LIMITED LIFETIME WARRANTY)</p> <p>Reverse switch on fan</p>	<p><b>FAN SPEEDS</b></p> <p><b>3</b></p>		<p><b>LOCATION RATING</b></p> <div style="display: flex; justify-content: space-around;"> <div style="text-align: center;">  dry </div> <div style="text-align: center;">  damp </div> <div style="text-align: center;">  wet </div> </div>
	<p><b>HIGH-SPEED RPM</b></p> <p><b>343</b></p>		
	<p><b>*HIGH-SPEED CFM</b></p> <p><b>1,282 CFM</b></p>		
<p><b>LIGHTING</b> (light kit included)</p>  <p>18W LED with opal frosted glass</p>	<p><b>LIGHTING SPECS</b></p> <p><b>18W integrated LED</b></p> <p>lumens: 1,500 CCT: 3,000k CRI: 90</p>		<p><b>MOUNTING TYPE</b></p> <div style="display: flex; justify-content: space-around;"> <div style="text-align: center;">  downrod 4.5" included </div> <div style="text-align: center;">  sloped up to 27° included </div> <div style="text-align: center;">  flush sold separately </div> </div>



SCAN QR CODE FOR FULL IMAGE

<b>ENERGY GUIDE</b>					<b>CERTIFICATION</b>
<b>AVERAGE SPEED</b>	<b>TOTAL AIR VOLUME</b>	<b>ENERGY USE</b>	<b>ESTIMATED YEARLY ENERGY COST</b>	<b>AIRFLOW EFFICIENCY</b>	
	1,105 CFM	11 Watts	\$3	104 CFM/Watts	



**AC MOTOR** **DRY** **DAMP**

Fan: FP8519BL  
included:

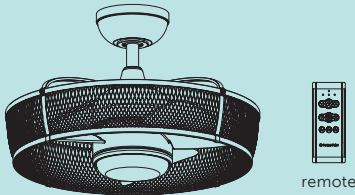

remote

**optional accessories**

(sold separately)

mounting



**Close-To-Ceiling Kit**  
CCK8002\*\*



**Sloped Ceiling Ball**  
(up to 42°)  
SCB1-52



**Longer Downrods**  
page 195

FP8519BL motor & blade finish combinations



black + black

view larger swatches on page 197



# KWARTET™

### HANGING DIMENSIONS

7.09" diameter  
12.5° Blade Pitch  
8.60" 10.48" cap 11.52" light  
blade sweep: 52"

Net weight: 17.18 lbs.

### CONTROL TYPE

TR800 handheld remote included

<h3>MOTOR TYPE &amp; SIZE</h3> <p><b>AC 153 x 20</b> <small>(LIMITED LIFETIME WARRANTY)</small></p> <p>Reverse switch on fan</p>	<h3>FAN SPEEDS</h3> <p><b>3</b></p> <hr/> <h3>HIGH-SPEED RPM</h3> <p><b>158</b></p> <hr/> <h3>*HIGH-SPEED CFM</h3> <p><b>4,498 CFM</b></p>	<h3>LOCATION RATING</h3> <div style="display: flex; justify-content: space-around;"> <div style="text-align: center;"> <p>dry</p> <p><input checked="" type="checkbox"/></p> </div> <div style="text-align: center;"> <p>damp</p> <p><input checked="" type="checkbox"/></p> </div> <div style="text-align: center;"> <p>wet</p> <p><input type="checkbox"/></p> </div> </div>
--	--	--

<h3>LIGHTING</h3> <p><small>(light kit and cap included)</small></p> <p>18W LED with opal frosted glass</p>	<h3>LIGHTING SPECS</h3> <p><b>18W integrated LED with CCT Select</b></p> <p>lumens: 1,600 CCT: 3000k/4000k/5000k CRI: 90</p>	<h3>MOUNTING TYPE</h3> <div style="display: flex; justify-content: space-around;"> <div style="text-align: center;"> <p>downrod</p> <p><input type="checkbox"/></p> </div> <div style="text-align: center;"> <p>sloped</p> <p><input type="checkbox"/></p> </div> <div style="text-align: center;"> <p>flush</p> <p><input checked="" type="checkbox"/></p> </div> </div>
---	--	---

SCAN EACH QR CODE FOR FULL IMAGE

ENERGY GUIDE					CERTIFICATION
AVERAGE SPEED	TOTAL AIR VOLUME <b>3,340 CFM</b>	ENERGY USE <b>37 Watts</b>	ESTIMATED YEARLY ENERGY COST <b>\$10</b>	AIRFLOW EFFICIENCY <b>91 CFM/Watts</b>	

\*Airflow testing is conducted in accordance with the US Department of Energy's testing standards and under specific controlled environmental conditions. Actual airflow performance may vary based on the installation location and environmental factors.

**AC MOTOR** ☀️ **DRY**    ☁️ **DAMP**

Fan: FPS8553\*\*  
included:

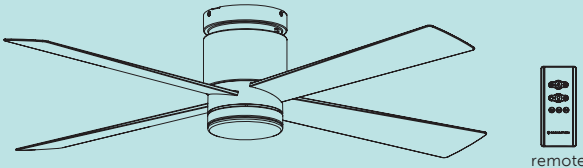



remote

\*\* replace with available finish code below

**optional accessories**

(sold separately)

controls		<b>2-wire Fan + Light CCT Select Wall Remote WT503WH</b>		<b>3-wire Fan + Light CCT Select Wall Control WC4WH</b>
		<b>WiFi Smart Receiver WFR55</b>		

**FPS8553\*\* motor & blade finish combinations**

 <b>BL</b> black + black	 <b>GR</b> matte greige + weathered wood
 <b>BN</b> brushed nickel + brushed nickel	 <b>MW</b> matte white + matte white
 <b>BS</b> brushed satin brass + matte white	

view larger swatches on page 197



# KLINCH™ 44

**HANGING DIMENSIONS**

8.49" diameter  
15° Blade Pitch  
blade sweep: 44"  
8.85" cap  
10.21" light  
10.85"

Net weight: 16.32 lbs.

**CONTROL TYPE**

TR500 handheld remote included

**MOTOR TYPE & SIZE**

**AC 153 x 15**  
(LIMITED LIFETIME WARRANTY)

Reverse switch on fan

**FAN SPEEDS**

**3**

**HIGH-SPEED RPM**

**166**

**\*HIGH-SPEED CFM**

**4,054 CFM**

**LOCATION RATING**

dry damp wet

✓ ✓ ✗

**LIGHTING**  
(light kit and cap included)

18W LED with opal frosted glass

**LIGHTING SPECS**

**18W integrated LED**

lumens: 1,600  
CCT: 3,000k  
CRI: 90

**MOUNTING TYPE**

downrod sloped flush

✗ ✗ ✓

SCAN EACH QR CODE FOR FULL IMAGE

ENERGY GUIDE				
AVERAGE SPEED	TOTAL AIR VOLUME	ENERGY USE	ESTIMATED YEARLY ENERGY COST	AIRFLOW EFFICIENCY
	2,904 CFM	31 Watts	\$9	93 CFM/Watts

**CERTIFICATION**

\*Airflow testing is conducted in accordance with the US Department of Energy's testing standards and under specific controlled environmental conditions. Actual airflow performance may vary based on the installation location and environmental factors.

**AC MOTOR** **DRY** **DAMP**



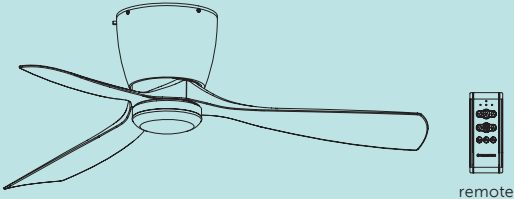

Fan: FPS7681\*\*  
included:



remote

\*\* replace with available finish code below

**optional accessories**  
(sold separately)

controls		<b>2-wire Fan-only Wall Control WC1WH</b>		<b>3-wire Fan + Light Wall Control WC2WH</b>
		<b>2-wire Fan-only Wall Remote WR500WH</b>		<b>2-wire Fan + Light Wall Remote WR501WH</b>
		<b>WiFi Smart Receiver WFR50</b>		

FPS7681\*\* motor & blade finish combinations

**BL**  
black + black

---

**BN**  
brushed nickel + brushed nickel

---

**MW**  
matte white + matte white

[view larger swatches on page 197](#)

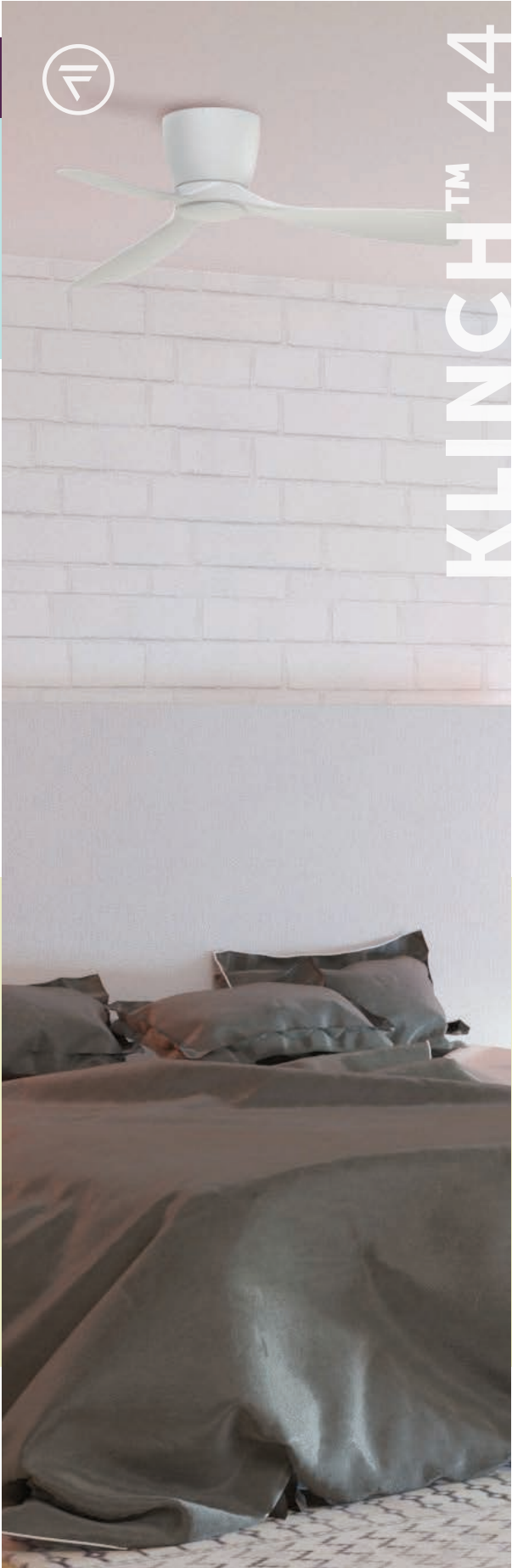

**KLINCER™ 44**

# KLINCH™ 52

## HANGING DIMENSIONS

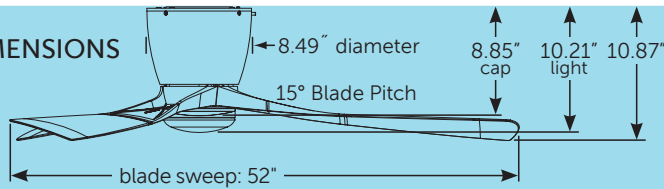

Net weight: 19.00 lbs.

## CONTROL TYPE



TR500 handheld remote included

## MOTOR TYPE & SIZE

**AC 172 x 17**  
(LIMITED LIFETIME WARRANTY)

Reverse switch on fan

## FAN SPEEDS

3

HIGH-SPEED RPM  
**166**

\*HIGH-SPEED CFM  
**5,429 CFM**

## LOCATION RATING



dry



damp



wet



## LIGHTING

(light kit and cap included)

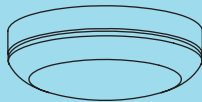

18W LED with opal frosted glass

## LIGHTING SPECS

**18W integrated LED**

lumens: 1,600  
CCT: 3,000k  
CRI: 90

## MOUNTING TYPE



downrod



sloped



flush



SCAN EACH QR CODE FOR FULL IMAGE

## ENERGY GUIDE

## CERTIFICATION

AVERAGE SPEED

TOTAL AIR VOLUME  
**3,744 CFM**

ENERGY USE  
**37 Watts**

ESTIMATED YEARLY ENERGY COST  
**\$10**

AIRFLOW EFFICIENCY  
**102 CFM/Watts**



FANIMATION.COM

\*Airflow testing is conducted in accordance with the US Department of Energy's testing standards and under specific controlled environmental conditions. Actual airflow performance may vary based on the installation location and environmental factors.

**AC MOTOR** **DRY** **DAMP**

Fan: FPS7679\*\*  
included:

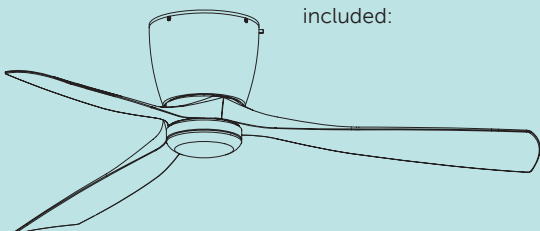





remote:



\*\* replace with available finish code below

**optional accessories**  
(sold separately)

controls		<b>2-wire Fan-only Wall Control WC1WH</b>		<b>3-wire Fan + Light Wall Control WC2WH</b>
		<b>2-wire Fan-only Wall Remote WR500WH</b>		<b>2-wire Fan + Light Wall Remote WR501WH</b>
		<b>WiFi Smart Receiver WFR50</b>		

FPS7679\*\* motor & blade finish combinations



view larger swatches on page 197

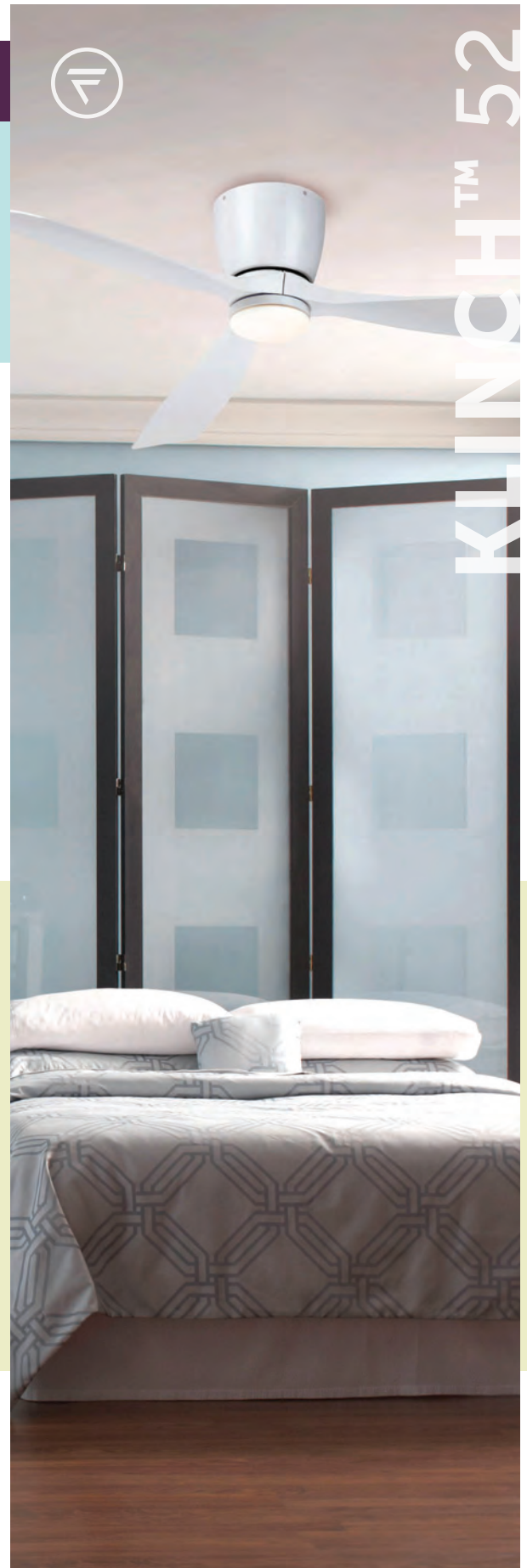

# HUGH™ 44

## HANGING DIMENSIONS

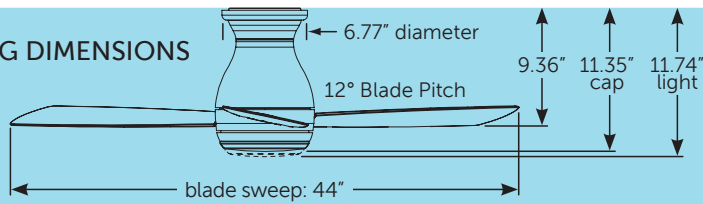

Net weight: 13.89 lbs.

## CONTROL TYPE



TR500 handheld remote included

## MOTOR TYPE & SIZE

**AC 153 x 12**  
(LIMITED LIFETIME WARRANTY)

Reverse switch on fan

## FAN SPEEDS

3

## HIGH-SPEED RPM

199

## \*HIGH-SPEED CFM

3,785 CFM

## LOCATION RATING



dry



damp



wet



## LIGHTING

(light kit and cap included)

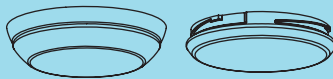

18W LED with opal frosted glass

## LIGHTING SPECS

18W integrated LED

lumens: 1,500  
CCT: 3,000k  
CRI: 90

## MOUNTING TYPE



downrod



sloped



flush



SCAN EACH QR CODE FOR FULL IMAGE

## ENERGY GUIDE

## CERTIFICATION

AVERAGE SPEED

TOTAL AIR VOLUME

2,653 CFM

ENERGY USE

34 Watts

ESTIMATED YEARLY ENERGY COST

\$9

AIRFLOW EFFICIENCY

79 CFM/Watts









**AC MOTOR**      **DRY**      **DAMP**      **WET**

Fan: **FPS8332B\*\*\***  
included:

remote

\*\* replace with available finish code below

**optional accessories**  
(sold separately)

controls		<b>2-wire Fan-only Wall Control WC1WH</b>		<b>3-wire Fan + Light Wall Control WC2WH</b>
		<b>2-wire Fan-only Wall Remote WR500WH</b>		<b>2-wire Fan + Light Wall Remote WR501WH</b>
		<b>WiFi Smart Receiver WFR50</b>		

**FPS8332B\*\*\* motor & blade finish combinations**

	
<b>BLW</b> black + black	<b>GRW</b> matte greige + matte greige
	
<b>BNW</b> brushed nickel + brushed nickel	<b>MWW</b> matte white + matte white
	
<b>DZW</b> dark bronze + dark bronze	

view larger swatches on page 197



# HUGH™ 52

## HANGING DIMENSIONS

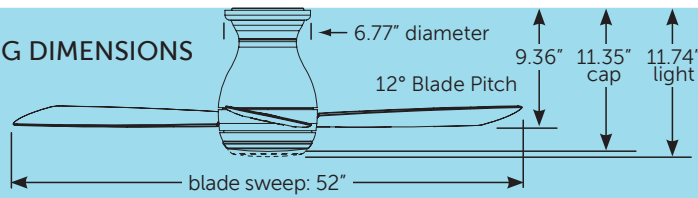

Net weight: 16.53 lbs.

## CONTROL TYPE



TR500 handheld remote included

## MOTOR TYPE & SIZE

**AC 153 x 20**  
(LIMITED LIFETIME WARRANTY)

Reverse switch on fan

## FAN SPEEDS

3

## HIGH-SPEED RPM

171

## \*HIGH-SPEED CFM

5,104 CFM

## LOCATION RATING



dry



damp



wet



## LIGHTING

(light kit and cap included)

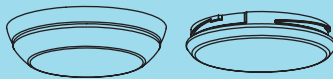

18W LED with opal frosted glass

## LIGHTING SPECS

18W integrated LED

lumens: 1,500  
CCT: 3,000k  
CRI: 90

## MOUNTING TYPE



downrod



sloped



flush



SCAN EACH QR CODE FOR FULL IMAGE

## ENERGY GUIDE

## CERTIFICATION

AVERAGE SPEED

TOTAL AIR VOLUME  
3,392 CFM

ENERGY USE  
35 Watts

ESTIMATED YEARLY ENERGY COST  
\$10

AIRFLOW EFFICIENCY  
98 CFM/Watts







**AC MOTOR**      **DRY**      **DAMP**      **WET**

Fan: **FPS8355B\*\*\***  
included:

remote

\*\* replace with available finish code below

**optional accessories**  
(sold separately)

controls	
	<b>2-wire Fan-only Wall Control</b> WC1WH
	<b>3-wire Fan + Light Wall Control</b> WC2WH
	<b>2-wire Fan-only Wall Remote</b> WR500WH
	<b>2-wire Fan + Light Wall Remote</b> WR501WH
	<b>WiFi Smart Receiver</b> WFR50

**FPS8355B\*\*\* motor & blade finish combinations**

	
<b>BL</b> black + black	<b>GR</b> matte greige + matte greige
	
<b>BN</b> brushed nickel + brushed nickel	<b>MW</b> matte white + matte white
	
<b>DZ</b> dark bronze + dark bronze	

view larger swatches on page 197



# KUTE™ 44

**HANGING DIMENSIONS**  
with 4.5" downrod (included)

Net weight: 11.80 lbs.

**CONTROL TYPE**

TR305 handheld remote included

<p><b>MOTOR TYPE &amp; SIZE</b></p> <p><b>DC 100 x 30</b> <small>(LIMITED LIFETIME WARRANTY)</small></p> <p>Reverse switch on remote</p>	<p><b>FAN SPEEDS</b></p> <p><b>variable</b></p> <hr/> <p>HIGH-SPEED RPM</p> <p><b>213</b></p> <hr/> <p>*HIGH-SPEED CFM</p> <p><b>5,490 CFM</b></p>	<p><b>LOCATION RATING</b></p> <div style="display: flex; justify-content: space-around;"> <div style="text-align: center;"> <p>dry</p> <p><input checked="" type="checkbox"/></p> </div> <div style="text-align: center;"> <p>damp</p> <p><input checked="" type="checkbox"/></p> </div> <div style="text-align: center;"> <p>wet</p> <p><input type="checkbox"/></p> </div> </div>
--	--	---

<p><b>LIGHTING—LK8534**</b> <small>(sold separately)</small></p> <p>16W LED with opal frosted glass and CCT Select</p>	<p><b>LIGHTING SPECS—LK8534**</b> <small>(sold separately)</small></p> <p><b>16W integrated LED with CCT Select</b></p> <p>lumens: 1,500</p> <p>CCT: 3000k/4000k/5000k</p> <p>CRI: 90</p>	<p><b>MOUNTING TYPE</b></p> <div style="display: flex; justify-content: space-around;"> <div style="text-align: center;"> <p>downrod 4.5" included</p> <p><input checked="" type="checkbox"/></p> </div> <div style="text-align: center;"> <p>sloped up to 27° included</p> <p><input checked="" type="checkbox"/></p> </div> <div style="text-align: center;"> <p>flush sold separately</p> <p><input checked="" type="checkbox"/></p> </div> </div>
--	---	---



<p><b>ENERGY GUIDE</b></p>					<p><b>CERTIFICATION</b></p>
AVERAGE SPEED	TOTAL AIR VOLUME <b>3,729 CFM</b>	ENERGY USE <b>17 Watts</b>	ESTIMATED YEARLY ENERGY COST <b>\$5</b>	AIRFLOW EFFICIENCY <b>216 CFM/Watts</b>	

**DC MOTOR** **DRY** **DAMP**

Fan: FPD8547\*\*  
included:

remote

\*\* replace with available finish code below

**optional accessories**  
(sold separately)

- lighting **LED Light Kit**  
LK8534\*\*
- mounting **Close-To-Ceiling Kit**  
CCK8534\*\*
- Sloped Ceiling Ball**  
(up to 42°)  
SCB1-52
- Longer Downrods**  
page 195
- controls **2-wire Wall Remote**  
TW306

**ordering example**

FPD8547BSBL  
(brushed satin brass motor  
with black blades)  
+  
LK8534BS  
(brushed satin brass light kit)



**FPD8547\*\* motor & blade finish combinations**

 <b>BL</b> black + black	 <b>BSBL</b> brushed satin brass + black	 <b>GR</b> matte greige + weathered wood
 <b>BN</b> brushed nickel + brushed nickel	 <b>DZ</b> dark bronze + dark walnut	 <b>MW</b> matte white + matte white
 <b>BS</b> brushed satin brass + matte white		

view larger swatches on page 197



**KUTE™ 44**

# KUTE™ 44 FLUSH

**HANGING DIMENSIONS**  
with CCK8534\*\* (sold separately)

7.85" diameter  
16° blade pitch  
9.86"  
10.32" cap  
11.00" light  
blade sweep: 44"

Net weight: 11.23 lbs.

**CONTROL TYPE**

wifi + fanSync by FANIMATION

TR305 handheld remote included

**MOTOR TYPE & SIZE**

**DC 100 x 30**  
(LIMITED LIFETIME WARRANTY)

Reverse switch on remote

**FAN SPEEDS**  
variable

**HIGH-SPEED RPM**  
206

**\*HIGH-SPEED CFM**  
5,145 CFM

**LOCATION RATING**

dry damp wet

✓ ✓ ✗

**LIGHTING—LK8534\*\***  
(sold separately)

16W LED with opal frosted glass and CCT Select

**LIGHTING SPECS—LK8534\*\***  
(sold separately)

**16W integrated LED with CCT Select**  
lumens: 1,500  
CCT: 3000k/4000k/5000k  
CRI: 90

**MOUNTING TYPE**

downrod sloped flush  
sold separately

✗ ✗ ✓



SCAN EACH QR CODE FOR FULL IMAGE

ENERGY GUIDE				
AVERAGE SPEED	TOTAL AIR VOLUME	ENERGY USE	ESTIMATED YEARLY ENERGY COST	AIRFLOW EFFICIENCY
	2,861 CFM	21 Watts	\$6	137 CFM/Watts

**CERTIFICATION**

**DC MOTOR** **DRY** **DAMP**

**required**  
(sold separately)

Fan  
FPD8547\*\*  
Includes remote: +

Close-To-Ceiling Kit  
CCK8534\*\*  
(sold separately)

\*\* replace with available finish code below

**optional accessories**  
(sold separately)

lighting **LED Light Kit**  
LK8534\*\*

controls **2-wire**  
**Wall Remote**  
TW306

**ordering example**

FPD8547BL  
(black motor with black blades)  
+  
CCK8534BL  
(black Kute™ close-to-ceiling kit)



**FPD8547\*\* motor & blade finish combinations**

<p><b>BL</b></p> <p>black + black</p>	<p><b>BSBL</b></p> <p>brushed satin brass + black</p>	<p><b>GR</b></p> <p>matte greige + weathered wood</p>
<p><b>BN</b></p> <p>brushed nickel + brushed nickel</p>	<p><b>DZ</b></p> <p>dark bronze + dark walnut</p>	<p><b>MW</b></p> <p>matte white + matte white</p>
<p><b>BS</b></p> <p>brushed satin brass + matte white</p>		

view larger swatches on page 197



KUTE™ 44 FLUSH

KUTE™ 44 FLUSH

KUTE™ 44 FLUSH

KUTE™ 44 FLUSH

# KUTE™ 52

**HANGING DIMENSIONS**  
with 4.5" downrod (included)

5.75" diameter  
16° blade pitch  
blade sweep: 52"  
12.58"  
13.10" cap  
13.78" light

Net weight: 12.30 lbs.

**CONTROL TYPE**

TR305 handheld remote included

<p><b>MOTOR TYPE &amp; SIZE</b></p> <p><b>DC 100 x 30</b> <small>(LIMITED LIFETIME WARRANTY)</small></p> <p>Reverse switch on remote</p>	<p><b>FAN SPEEDS</b></p> <p><b>variable</b></p> <hr/> <p>HIGH-SPEED RPM</p> <p><b>171</b></p> <hr/> <p>*HIGH-SPEED CFM</p> <p><b>6,701 CFM</b></p>	<p><b>LOCATION RATING</b></p> <div style="display: flex; justify-content: space-around;"> <div style="text-align: center;">  dry <input checked="" type="checkbox"/></div> <div style="text-align: center;">  damp <input checked="" type="checkbox"/></div> <div style="text-align: center;">  wet <input type="checkbox"/></div> </div>
--	--	---

<p><b>LIGHTING—LK8534**</b> <small>(sold separately)</small></p> <p>16W LED with opal frosted glass and CCT Select</p>	<p><b>LIGHTING SPECS—LK8534**</b> <small>(sold separately)</small></p> <p><b>16W integrated LED with CCT Select</b></p> <p>lumens: 1,500 CCT: 3000k/4000k/5000k CRI: 90</p>	<p><b>MOUNTING TYPE</b></p> <div style="display: flex; justify-content: space-around;"> <div style="text-align: center;">  downrod 4.5" included <input checked="" type="checkbox"/></div> <div style="text-align: center;">  sloped up to 27" included <input checked="" type="checkbox"/></div> <div style="text-align: center;">  flush sold separately <input checked="" type="checkbox"/></div> </div>
--	---	---



**SCAN EACH QR CODE FOR FULL IMAGE**

<p><b>ENERGY GUIDE</b></p>					<p><b>CERTIFICATION</b></p>
AVERAGE SPEED	TOTAL AIR VOLUME <b>4,873 CFM</b>	ENERGY USE <b>22 Watts</b>	ESTIMATED YEARLY ENERGY COST <b>\$6</b>	AIRFLOW EFFICIENCY <b>217 CFM/Watts</b>	

\*Airflow testing is conducted in accordance with the US Department of Energy's testing standards and under specific controlled environmental conditions. Actual airflow performance may vary based on the installation location and environmental factors.



**DC MOTOR** **DRY** **DAMP**

Fan: FPD8534\*\*  
included:

remote

\*\* replace with available finish code below

**optional accessories**  
(sold separately)

- lighting **LED Light Kit**  
LK8534\*\*
- mounting **Close-To-Ceiling Kit**  
CCK8534\*\*
- Sloped Ceiling Ball**  
(up to 42°)  
SCB1-52
- Longer Downrods**  
page 195
- controls **2-wire Wall Remote**  
TW306

**ordering example**

FPD8534GR  
(matte greige motor  
with weathered wood blades)  
+  
LK8534GR  
(matte greige light kit)



**FPD8534\*\* motor & blade finish combinations**

<p><b>BL</b> black + black</p>	<p><b>BSBL</b> brushed satin brass + black</p>	<p><b>GR</b> matte greige + weathered wood</p>
<p><b>BN</b> brushed nickel + brushed nickel</p>	<p><b>DZ</b> dark bronze + dark walnut</p>	<p><b>MW</b> matte white + matte white</p>
<p><b>BS</b> brushed satin brass + matte white</p>		

view larger swatches on page 197



# KUTE™ 52 FLUSH

**HANGING DIMENSIONS**  
with CCK8534\*\* (sold separately)

7.85" diameter  
16° blade pitch  
blade sweep: 52"  
9.80" cap  
10.32" cap  
11.00" light

Net weight: 11.73 lbs.

**CONTROL TYPE**

TR305 handheld remote included

**MOTOR TYPE & SIZE**

**DC 100 x 30**  
(LIMITED LIFETIME WARRANTY)

Reverse switch on remote

**FAN SPEEDS**  
variable

**HIGH-SPEED RPM**  
169

**\*HIGH-SPEED CFM**  
6,122 CFM

**LOCATION RATING**

dry ✓ damp ✓ wet ✗

**LIGHTING—LK8534\*\***  
(sold separately)

16W LED with opal frosted glass and CCT Select

**LIGHTING SPECS—LK8534\*\***  
(sold separately)

**16W integrated LED with CCT Select**  
lumens: 1,500  
CCT: 3000k/4000k/5000k  
CRI: 90

**MOUNTING TYPE**

downrod ✗ sloped ✗ flush ✓  
flush sold separately



SCAN EACH QR CODE FOR FULL IMAGE

ENERGY GUIDE				
AVERAGE SPEED	TOTAL AIR VOLUME	ENERGY USE	ESTIMATED YEARLY ENERGY COST	AIRFLOW EFFICIENCY
	3,670 CFM	23 Watts	\$7	158 CFM/Watts

**CERTIFICATION**

\*Airflow testing is conducted in accordance with the US Department of Energy's testing standards and under specific controlled environmental conditions. Actual airflow performance may vary based on the installation location and environmental factors.

**DC MOTOR** **DRY** **DAMP**

**required**  
(sold separately)

**Fan**  
FPD8534\*\*  
Includes remote: +

**Close-To-Ceiling Kit**  
CCK8534\*\*  
(sold separately)

\*\* replace with available finish code below

**optional accessories**  
(sold separately)

**lighting** **LED Light Kit**  
LK8534\*\*

**controls** **2-wire Wall Remote**  
TW306

**ordering example**

FPD8534DZ  
(dark bronze finish motor  
with dark walnut finish blades)  
+  
CCK8534DZ  
(dark bronze finish  
close-to-ceiling kit)



**FPD8534\*\* motor & blade finish combinations**

<p><b>BL</b></p> <p>black + black</p>	<p><b>BSBL</b></p> <p>brushed satin brass + black</p>	<p><b>GR</b></p> <p>matte greige + weathered wood</p>
<p><b>BN</b></p> <p>brushed nickel + brushed nickel</p>	<p><b>DZ</b></p> <p>dark bronze + dark walnut</p>	<p><b>MW</b></p> <p>matte white + matte white</p>
<p><b>BS</b></p> <p>brushed satin brass + matte white</p>		

view larger swatches on page 197



KUTE™ 52 FLUSH

# KUTE5™ 52

## HANGING DIMENSIONS

with 4.5" downrod (included)

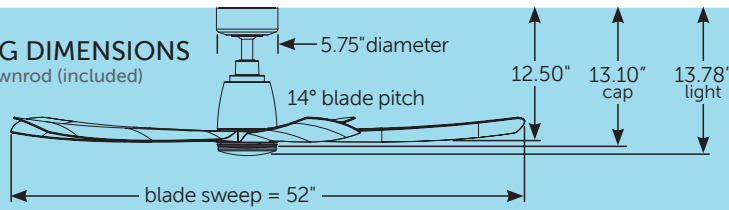

Net weight: 12.30 lbs.

## CONTROL TYPE



TR305 handheld remote included

## MOTOR TYPE & SIZE

**DC 100 x 30**  
(LIMITED LIFETIME WARRANTY)

Reverse switch on remote

## FAN SPEEDS

variable

HIGH-SPEED RPM  
**158**

\*HIGH-SPEED CFM  
**6,719 CFM**

## LOCATION RATING



dry



damp



wet



## LIGHTING—LK8534\*\*

(sold separately)

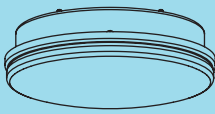

16W LED with opal frosted glass and CCT Select

## LIGHTING SPECS—LK8534\*\*

(sold separately)

**16W integrated LED with CCT Select**  
lumens: 1,500  
CCT: 3000k/4000k/5000k  
CRI: 90

## MOUNTING TYPE



downrod  
4.5" included



sloped  
up to 27° included



flush  
sold separately



SCAN EACH QR CODE FOR FULL IMAGE

## ENERGY GUIDE

## CERTIFICATION

AVERAGE SPEED

TOTAL AIR VOLUME

4,257 CFM

ENERGY USE

23 Watts

ESTIMATED YEARLY ENERGY COST

\$6

AIRFLOW EFFICIENCY

184 CFM/Watts



**DC MOTOR** **DRY** **DAMP**

Fan: FPD5534\*\*  
included:

remote

\*\* replace with available finish code below

**optional accessories**  
(sold separately)

- lighting **LED Light Kit**  
LK8534\*\*
- mounting **Sloped Ceiling Ball**  
(up to 42°)  
SCB1-52
- controls **2-wire Wall Remote**  
TW306
- Longer Downrods**  
page 195

**ordering example**

FPD5534DZ  
(dark bronze motor  
with dark walnut blades)  
+  
LK8534DZ  
(dark bronze light kit)



**FPD5534\*\* motor & blade finish combinations**

<p><b>BL</b> black + black</p>	<p><b>BSBL</b> brushed satin brass + black</p>	<p><b>GR</b> matte greige + weathered wood</p>
<p><b>BN</b> brushed nickel + brushed nickel</p>	<p><b>DZ</b> dark bronze + dark walnut</p>	<p><b>MW</b> matte white + matte white</p>
<p><b>BS</b> brushed satin brass + matte white</p>		

view larger swatches on page 197



# KUTE5™ 52 FLUSH

**HANGING DIMENSIONS**  
with CCK8534\*\* (sold separately)

7.85" diameter  
14° blade pitch  
52" sweep  
9.72" cap  
10.32" cap  
11.00" light

Net weight: 11.12 lbs.

**CONTROL TYPE**

WiFi + fanSync by FANIMATION

TR305 handheld remote included

**MOTOR TYPE & SIZE**

DC 100 x 30  
(LIMITED LIFETIME WARRANTY)

Reverse switch on remote

**FAN SPEEDS**  
variable

HIGH-SPEED RPM  
156

\*HIGH-SPEED CFM  
6,224 CFM

**LOCATION RATING**

dry  damp  wet

**LIGHTING—LK8534\*\***  
(sold separately)

16W LED with opal frosted glass and CCT Select

**LIGHTING SPECS—LK8534\*\***  
(sold separately)

16W integrated LED with CCT Select  
lumens: 1,500  
CCT: 3000k/4000k/5000k  
CRI: 90

**MOUNTING TYPE**

downrod  sloped  flush  sold separately



SCAN EACH QR CODE FOR FULL IMAGE

ENERGY GUIDE				
AVERAGE SPEED	TOTAL AIR VOLUME	ENERGY USE	ESTIMATED YEARLY ENERGY COST	AIRFLOW EFFICIENCY
	3,786 CFM	23 Watts	\$6	164 CFM/Watts

**CERTIFICATION**

**DC MOTOR** **DRY** **DAMP**

**required**  
(sold separately)

**Fan**  
FPD5534\*\*  
Includes remote:

**Close-To-Ceiling Kit**  
CCK8534\*\*  
(sold separately)

\*\* replace with available finish code below

**optional accessories**  
(sold separately)

**lighting** **LED Light Kit**  
LK8534\*\*

**controls** **2-wire Wall Remote**  
TW306

**ordering example**

FPD5534MW  
(matte white motor  
with matte white blades)  
+  
CCK8534MW  
(matte white close-to-ceiling kit)  
+  
LK8534MW  
(matte white LED light kit)



**motor & blade finish combinations**

<p><b>BL</b></p> <p>black + black</p>	<p><b>BSBL</b></p> <p>brushed satin brass + black</p>	<p><b>GR</b></p> <p>matte greige + weathered wood</p>
<p><b>BN</b></p> <p>brushed nickel + brushed nickel</p>	<p><b>DZ</b></p> <p>dark bronze + dark walnut</p>	<p><b>MW</b></p> <p>matte white + matte white</p>
<p><b>BS</b></p> <p>brushed satin brass + matte white</p>		

view larger swatches on page 197



KUTE5™ 52 FLUSH

# SCULPTAIRE™

## HANGING DIMENSIONS with 4.5" downrod (included)

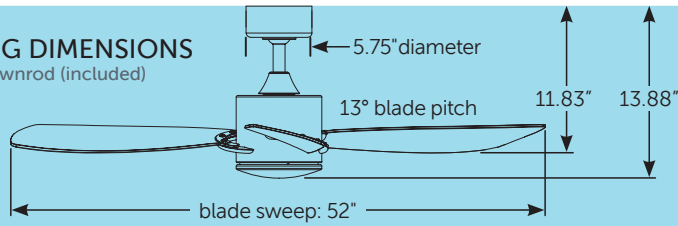

Net weight: 18.11 lbs.

## CONTROL TYPE



TR500 handheld remote included

## MOTOR TYPE & SIZE

**AC 153 x 20**  
(LIMITED LIFETIME WARRANTY)

Reverse switch on fan

## FAN SPEEDS

3

HIGH-SPEED RPM  
**130**

\*HIGH-SPEED CFM  
**4,663 CFM**

## LOCATION RATING



BL & MW only

## LIGHTING

(light kit and cap included)

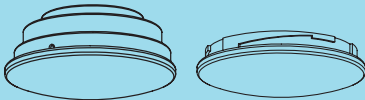

18W LED with opal frosted glass

## LIGHTING SPECS

**18W integrated LED**

lumens: 1,500  
CCT: 3,000k  
CRI: 90

## MOUNTING TYPE



downrod  
4.5" included



sloped  
up to 27° included



flush  
sold separately



SCAN EACH QR CODE FOR FULL IMAGE

## ENERGY GUIDE

## CERTIFICATION

AVERAGE SPEED

TOTAL AIR VOLUME  
**3,868 CFM**

ENERGY USE  
**38 Watts**

ESTIMATED YEARLY ENERGY COST  
**\$11**

AIRFLOW EFFICIENCY  
**101 CFM/Watts**





AC MOTOR





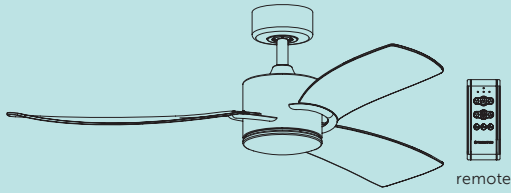



Fan: FP8511\*\*  
included:



\*\* replace with available finish code below

### optional accessories (sold separately)

mounting	 Close-To-Ceiling Kit CCK8002**	 Sloped Ceiling Ball (up to 42°) SCB1-52	 Longer Downrods page 195
controls	 3-wire Fan + Light Wall Control WC2WH	 2-wire Fan + Light Wall Remote WR501WH	
	 WiFi Smart Receiver WFR50		

### FP8511\*\* motor & blade finish combinations

 BL black + clear	 CH chrome + clear
 BS brushed satin brass + clear	 MW matte white + clear

view larger swatches on page 197



SCULPTAIRE™

# GLIDEAIRE™

<p><b>HANGING DIMENSIONS</b> with 4.5" downrod (included)</p> <p>Net weight: 13.3 lbs.</p>		<p><b>CONTROL TYPE</b></p> <p>TR205D handheld remote included</p>													
<p><b>MOTOR TYPE &amp; SIZE</b></p> <p><b>DC 158 x 15</b> (LIMITED LIFETIME WARRANTY)</p> <p>Reverse switch on remote</p>	<p><b>FAN SPEEDS</b> variable</p>		<p><b>LOCATION RATING</b></p> <p>dry <input checked="" type="checkbox"/> damp <input checked="" type="checkbox"/> wet <input checked="" type="checkbox"/></p>												
	<p>HIGH-SPEED RPM <b>173</b></p>														
	<p>*HIGH-SPEED CFM <b>5,538 CFM</b></p>														
<p><b>MOUNTING TYPE</b></p> <p>downrod 4.5" included <input checked="" type="checkbox"/> sloped up to 19" included <input checked="" type="checkbox"/> flush <input checked="" type="checkbox"/></p>		<p>SCAN EACH QR CODE FOR FULL IMAGE</p>													
		<p><b>ENERGY GUIDE</b></p> <table border="1"> <thead> <tr> <th>AVERAGE SPEED</th> <th>TOTAL AIR VOLUME</th> <th>ENERGY USE</th> <th>ESTIMATED YEARLY ENERGY COST</th> <th>AIRFLOW EFFICIENCY</th> </tr> </thead> <tbody> <tr> <td></td> <td>3,746 CFM</td> <td>17 Watts</td> <td>\$5</td> <td>218 CFM/Watts</td> </tr> </tbody> </table>		AVERAGE SPEED	TOTAL AIR VOLUME	ENERGY USE	ESTIMATED YEARLY ENERGY COST	AIRFLOW EFFICIENCY		3,746 CFM	17 Watts	\$5	218 CFM/Watts	<p><b>CERTIFICATION</b></p>	
AVERAGE SPEED	TOTAL AIR VOLUME	ENERGY USE	ESTIMATED YEARLY ENERGY COST	AIRFLOW EFFICIENCY											
	3,746 CFM	17 Watts	\$5	218 CFM/Watts											

FANIMATION.COM

\*Airflow testing is conducted in accordance with the US Department of Energy's testing standards and under specific controlled environmental conditions. Actual airflow performance may vary based on the installation location and environmental factors.

**DC MOTOR** **DRY** **DAMP**

Fan: FPD8520\*\*  
included:

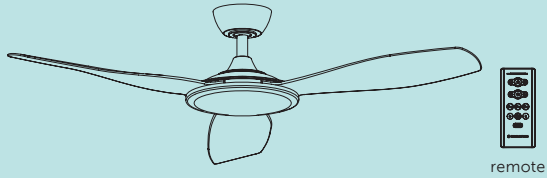



remote

\*\* replace with available finish code below

**optional accessories**  
(sold separately)

mounting  **Close-To-Ceiling Kit**  
CCK8002\*\*

 **Sloped Ceiling Kit**  
(up to 42°)  
SCK1-52

 **Longer Downrods**  
page 195

controls  **2-wire Wall Remote**  
TW206D

**FPD8520\*\* motor & blade finish combinations**

**BL**  
black + black

---

**BNBL**  
brushed nickel + black

---

**BNBN**  
brushed nickel + brushed nickel

view larger swatches on page 197



**GLIDEAIRE™**

# XENO™

<p><b>HANGING DIMENSIONS</b> with 4.5" downrod (included)</p> <p>Net weight: 25.66 lbs.</p>		<p><b>CONTROL TYPE</b></p> <p>TR500 handheld remote included</p>	
<p><b>MOTOR TYPE &amp; SIZE</b></p> <p><b>AC 188 x 25</b> (LIMITED LIFETIME WARRANTY)</p> <p>Reverse switch on fan</p>	<p><b>FAN SPEEDS</b></p> <p><b>3</b></p>		<p><b>LOCATION RATING</b></p> <p>dry <input checked="" type="checkbox"/> damp <input checked="" type="checkbox"/> wet <input checked="" type="checkbox"/></p>
	<p><b>HIGH-SPEED RPM</b></p> <p><b>197</b></p>		
	<p><b>*HIGH-SPEED CFM</b></p> <p><b>6,605 CFM</b></p>		
<p><b>LIGHTING</b> (light kit and cap included)</p> <p>18W LED with opal frosted glass</p>		<p><b>LIGHTING SPECS</b></p> <p><b>18W integrated LED</b></p> <p>lumens: 1,500 CCT: 3,000k CRI: 90</p>	
		<p><b>MOUNTING TYPE</b></p> <p>downrod 4.5" included <input checked="" type="checkbox"/> sloped up to 27° included <input checked="" type="checkbox"/> flush sold separately <input checked="" type="checkbox"/></p>	



SCAN QR CODE FOR FULL IMAGE

<b>ENERGY GUIDE</b>					<b>CERTIFICATION</b>
<b>AVERAGE SPEED</b>	<b>TOTAL AIR VOLUME</b>	<b>ENERGY USE</b>	<b>ESTIMATED YEARLY ENERGY COST</b>	<b>AIRFLOW EFFICIENCY</b>	
	4,654 CFM	44 Watts	\$12	106 CFM/Watts	







**AC MOTOR** **DRY** **DAMP**

Fan: FP6728BBN  
included:

remote

**optional accessories**

(sold separately)

mounting	 <b>Close-To-Ceiling Kit</b> CCK8002**	 <b>Sloped Ceiling Ball (up to 42°)</b> SCB1-52	 <b>Longer Downrods</b> page 195
controls	 <b>3-wire Fan + Light Wall Control</b> WC2WH	 <b>2-wire Fan + Light Wall Remote</b> WR501WH	
	 <b>WiFi Smart Receiver</b> WFR50		

**FP6728BBN motor & blade finish combinations**

**BN**

brushed nickel + brushed nickel

view larger swatches on page 197



# XENO™ WET

**HANGING DIMENSIONS**  
with 4.5" downrod (included)

6.58" diameter  
14° blade pitch  
10.24"  
14.54"  
blade sweep: 56"

Net weight: 23.81 lbs.

**CONTROL TYPE**

TR500 handheld remote included

**MOTOR TYPE & SIZE**

**AC 188 x 25**  
(LIMITED LIFETIME WARRANTY)

Reverse switch on fan

**FAN SPEEDS**

**3**

**HIGH-SPEED RPM**

**161**

**\*HIGH-SPEED CFM**

**6,379 CFM**

**LOCATION RATING**

dry

damp

wet

**LIGHTING**  
(light kit and cap included)

18W LED with opal frosted glass

**LIGHTING SPECS**

**18W integrated LED**

**lumens: 1,500**  
**CCT: 3,000k**  
**CRI: 90**

**MOUNTING TYPE**

downrod  
4.5" included

sloped  
up to 27° included

flush  
sold separately

**SCAN EACH QR CODE FOR FULL IMAGE**

ENERGY GUIDE				
AVERAGE SPEED	TOTAL AIR VOLUME	ENERGY USE	ESTIMATED YEARLY ENERGY COST	AIRFLOW EFFICIENCY
	4,280 CFM	33 Watts	\$9	129 CFM/Watts

**CERTIFICATION**

**AC MOTOR**      **DRY**      **DAMP**      **WET**

Fan: FP6729B\*\*\*  
included:

remote

**optional accessories**

(sold separately)

mounting	<b>Close-To-Ceiling Kit</b> CCK8002**	<b>Sloped Ceiling Kit</b> (up to 42°) SCB1-52	<b>Longer Downrods</b> page 195
controls	<b>3-wire Fan + Light Wall Control</b> WC2WH	<b>2-wire Fan + Light Wall Remote</b> WR501WH	
	<b>WiFi Smart Receiver</b> WFR50		

**FP6729B\*\*\* motor & blade finish combinations**

<b>BLW</b> black + black	<b>MWW</b> matte white + matte white
<b>DZW</b> dark bronze + dark bronze	<b>SLW</b> silver + silver

view larger swatches on page 197





48-INCH



60-INCH





SPITFIRE™ AC CUSTOM

# SPITFIRE™ 48

**HANGING DIMENSIONS**  
with 4.5" downrod (included)

7.09" diameter  
21° blade pitch  
blade sweep: 48"  
12.00"  
13.71"

Net weight: 18.88 lbs.

**CONTROL TYPE**

TR500 handheld remote included

<p><b>MOTOR TYPE &amp; SIZE</b></p> <p><b>AC 188 x 25</b> <small>(LIMITED LIFETIME WARRANTY)</small></p> <p>Reverse switch on fan</p>	<p><b>FAN SPEEDS</b></p> <p><b>3</b></p> <hr/> <p><b>HIGH-SPEED RPM</b></p> <p><b>183</b></p> <hr/> <p><b>*HIGH-SPEED CFM</b></p> <p><b>5,176 CFM</b></p>	<p><b>LOCATION RATING</b></p> <div style="display: flex; justify-content: space-around;"> <div style="text-align: center;">  dry </div> <div style="text-align: center;">  damp </div> <div style="text-align: center;">  wet </div> </div>
---	---	---

<p><b>LIGHTING—LK6721B**</b> <small>(sold separately)</small></p> <p><b>18W LED</b> fresnel &amp; frosted PC lenses included</p>	<p><b>LIGHTING SPECS—LK6721B**</b> <small>(sold separately)</small></p> <p><b>18W integrated LED</b></p> <p><b>lumens: 1,500</b> <b>CCT: 3,000k</b> <b>CRI: 90</b></p>	<p><b>MOUNTING TYPE</b></p> <div style="display: flex; justify-content: space-around;"> <div style="text-align: center;">  downrod 4.5" included </div> <div style="text-align: center;">  sloped up to 19° included </div> <div style="text-align: center;">  flush sold separately </div> </div>
--	--	--



ENERGY GUIDE					CERTIFICATION
AVERAGE SPEED	TOTAL AIR VOLUME	ENERGY USE	ESTIMATED YEARLY ENERGY COST	AIRFLOW EFFICIENCY	
	3,435 CFM	41 Watts	\$11	84 CFM/Watts	

\*Airflow testing is conducted in accordance with the US Department of Energy's testing standards and under specific controlled environmental conditions. Actual airflow performance may vary based on the installation location and environmental factors.

# MIX & MATCH FAN MOTOR, BLADES & LIGHT KIT SOLD SEPARATELY

**AC MOTOR** **DRY** **DAMP**

**required**  
(sold separately)

**Motor**  
MA6721B\*\*  
Includes remote: +

**Blade Set**  
B6720-48\*\*

\*\* replace with available finish codes below

## optional accessories

(sold separately)

light kit		<b>LED Light Kit</b> LK6721B**	
mounting		<b>Close-To-Ceiling Kit</b> CCK6721**	
controls		<b>2-wire Fan-only Wall Control</b> WC1WH	
		<b>2-wire Fan-only Wall Remote</b> WR500WH	
		<b>3-wire Fan + Light Wall Control</b> WC2WH	
		<b>2-wire Fan + Light Wall Remote</b> WR501WH	
		<b>WiFi Smart Receiver</b> WFR50	

## ordering example

MA6721BBS  
(brushed satin brass motor)  
+  
B6720-48BL  
(black blade set)  
+  
LK6721BBS  
(brushed satin brass light kit)

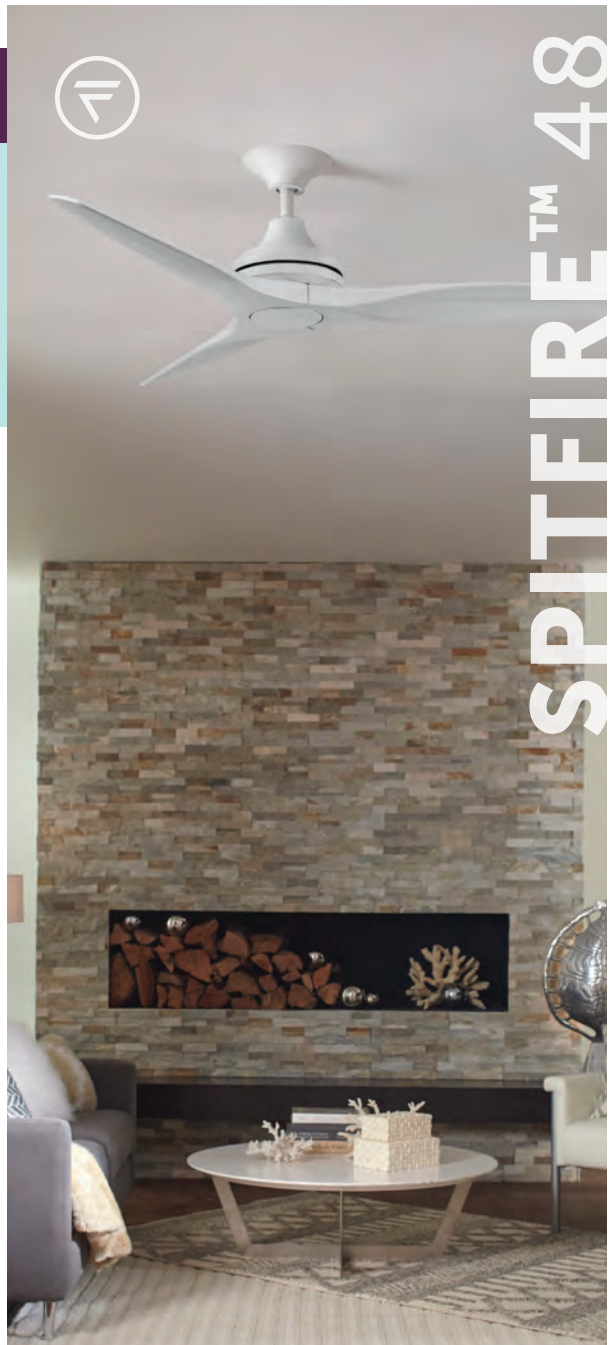

SPITFIRE™ 48

### motor, light kit & close-to-ceiling kit finishes

<b>AGP</b> antique graphite	<b>BS</b> brushed satin brass	<b>GZ</b> galvanized
<b>BL</b> black	<b>DZ</b> dark bronze	<b>MW</b> matte white
<b>BN</b> brushed nickel	<b>GR</b> matte greige	

### blade finishes

<b>BL</b> black	<b>LO</b> <small>NEW</small> light oak	<b>WE</b> weathered wood
<b>BN</b> brushed nickel	<b>MW</b> matte white	<b>WK</b> whiskey wood
<b>DWA</b> dark walnut	<b>N</b> natural	<b>WW</b> white washed

view larger swatches on page 197

# SPITFIRE™ FLUSH 48

**HANGING DIMENSIONS**  
with CCK6721 (sold separately)

7.85" diameter  
21° blade pitch  
9.50"  
11.21"  
blade sweep: 48"

Net weight: 20.60 lbs.

**CONTROL TYPE**

TR500 handheld remote included

<p><b>MOTOR TYPE &amp; SIZE</b></p> <p><b>AC 188 x 25</b> <small>(LIMITED LIFETIME WARRANTY)</small></p> <p>Reverse switch on fan</p>	<p><b>FAN SPEEDS</b></p> <p><b>3</b></p> <hr/> <p><b>HIGH-SPEED RPM</b></p> <p><b>201</b></p> <hr/> <p><b>*HIGH-SPEED CFM</b></p> <p><b>4,995 CFM</b></p>	<p><b>LOCATION RATING</b></p> <div style="display: flex; justify-content: space-around;"> <div style="text-align: center;"> <p>dry</p> <p><input checked="" type="checkbox"/></p> </div> <div style="text-align: center;"> <p>damp</p> <p><input checked="" type="checkbox"/></p> </div> <div style="text-align: center;"> <p>wet</p> <p><input type="checkbox"/></p> </div> </div>
---	---	---

<p><b>LIGHTING—LK6721B**</b> <small>(sold separately)</small></p> <p><b>18W LED</b> fresnel &amp; frosted PC lenses included</p>	<p><b>LIGHTING SPECS—LK6721B**</b> <small>(sold separately)</small></p> <p><b>18W integrated LED</b></p> <p><b>lumens: 1,500</b> <b>CCT: 3,000k</b> <b>CRI: 90</b></p>	<p><b>MOUNTING TYPE</b></p> <div style="display: flex; justify-content: space-around;"> <div style="text-align: center;"> <p>downrod</p> <p><input type="checkbox"/></p> </div> <div style="text-align: center;"> <p>sloped</p> <p><input type="checkbox"/></p> </div> <div style="text-align: center;"> <p>flush <small>sold separately</small></p> <p><input checked="" type="checkbox"/></p> </div> </div>
--	--	---

**SCAN EACH QR CODE FOR FULL IMAGE**

ENERGY GUIDE					CERTIFICATION
AVERAGE SPEED	TOTAL AIR VOLUME <b>3,330 CFM</b>	ENERGY USE <b>44 Watts</b>	ESTIMATED YEARLY ENERGY COST <b>\$12</b>	AIRFLOW EFFICIENCY <b>75 CFM/Watts</b>	

FANIMATION.COM

\*Airflow testing is conducted in accordance with the US Department of Energy's testing standards and under specific controlled environmental conditions. Actual airflow performance may vary based on the installation location and environmental factors.

# MIX & MATCH FAN MOTOR, BLADES & LIGHT KIT SOLD SEPARATELY

**AC MOTOR** **DRY** **DAMP**

**required**  
(sold separately)

**Motor**  
MA6721B\*\*  
Includes remote:

**Close-To-Ceiling Kit**  
CCK6721\*\*

**Blade Set**  
B6720-48\*\*

\*\* replace with available finish codes below

## optional accessories

(sold separately)

**light kit** **LED Light Kit**  
LK6721B\*\*

**mounting** **Close-To-Ceiling Kit**  
CCK6721\*\*

**controls**

	<b>2-wire Fan-only Wall Control</b> WC1WH		<b>3-wire Fan + Light Wall Control</b> WC2WH
	<b>2-wire Fan-only Wall Remote</b> WR500WH		<b>2-wire Fan + Light Wall Remote</b> WR501WH
	<b>WiFi Smart Receiver</b> WFR50		

## ordering example

MA6721BDZ  
(dark bronze motor)  
+  
B6720-48N  
(natural blade set)  
+  
CCK6721DZ  
(dark bronze close-to-ceiling kit)



SPITFIRE™ 48 FLUSH

### motor, light kit & close-to-ceiling kit finishes

<b>AGP</b> antique graphite	<b>BS</b> brushed satin brass	<b>GZ</b> galvanized
<b>BL</b> black	<b>DZ</b> dark bronze	<b>MW</b> matte white
<b>BN</b> brushed nickel	<b>GR</b> matte greige	

### blade finishes

<b>BL</b> black	<b>LO</b> <small>NEW</small> light oak	<b>WE</b> weathered wood
<b>BN</b> brushed nickel	<b>MW</b> matte white	<b>WK</b> whiskey wood
<b>DWA</b> dark walnut	<b>N</b> natural	<b>WW</b> white washed

view larger swatches on page 197

# SPITFIRE™ 60

<p><b>HANGING DIMENSIONS</b> with 4.5" downrod (included)</p> <p>7.09" diameter 21° blade pitch blade sweep: 60" 12.00" 13.71"</p> <p>Net weight: 19.20 lbs.</p>		<p><b>CONTROL TYPE</b></p> <p>TR500 handheld remote included</p>	
<p><b>MOTOR TYPE &amp; SIZE</b></p> <p><b>AC 188 x 25</b> (LIMITED LIFETIME WARRANTY)</p> <p>Reverse switch on fan</p>	<p><b>FAN SPEEDS</b></p> <p><b>3</b></p>		<p><b>LOCATION RATING</b></p> <p>dry  damp  wet </p> <p> </p>
	<p><b>HIGH-SPEED RPM</b></p> <p><b>114</b></p>		
	<p><b>*HIGH-SPEED CFM</b></p> <p><b>5,227 CFM</b></p>		
<p><b>LIGHTING—LK6721B**</b> (sold separately)</p> <p><b>18W LED</b> fresnel &amp; frosted PC lenses included</p>	<p><b>LIGHTING SPECS—LK6721B**</b> (sold separately)</p> <p><b>18W integrated LED</b></p> <p><b>lumens: 1,500</b> <b>CCT: 3,000k</b> <b>CRI: 90</b></p>		<p><b>MOUNTING TYPE</b></p> <p>downrod  sloped  flush </p> <p>4.5" included up to 19" included sold separately</p> <p> </p>



SCAN EACH QR CODE FOR FULL IMAGE

ENERGY GUIDE					CERTIFICATION
AVERAGE SPEED	TOTAL AIR VOLUME	ENERGY USE	ESTIMATED YEARLY ENERGY COST	AIRFLOW EFFICIENCY	
	3,776 CFM	41 Watts	\$12	92 CFM/Watts	

\*Airflow testing is conducted in accordance with the US Department of Energy's testing standards and under specific controlled environmental conditions. Actual airflow performance may vary based on the installation location and environmental factors.

# MIX & MATCH FAN MOTOR, BLADES & LIGHT KIT SOLD SEPARATELY

**AC MOTOR** **DRY** **DAMP**

**required**  
(sold separately)

**Motor**  
MA6721B\*\*  
Includes remote: +

**Blade Set**  
B6720\*\*

\*\* replace with available finish codes below

## optional accessories

(sold separately)

<b>light kit</b>		<b>LED Light Kit</b> LK6721B**	
<b>mounting</b>		<b>Close-To-Ceiling Kit</b> CCK6721**	 <b>Longer Downrods</b> page 195
		<b>Sloped Ceiling Kit (up to 42°)</b> SCK1-52	
<b>controls</b>		<b>2-wire Fan-only Wall Control</b> WC1WH	
		<b>2-wire Fan-only Wall Remote</b> WR500WH	
		<b>WiFi Smart Receiver</b> WFR50	

## ordering example

MA6721BGR  
(matte greige motor)  
+  
B6720WE  
(weathered wood blade set)  
+  
LK6721BGR  
(matte greige light kit)



SPLITFIRE™ 60

### motor, light kit & close-to-ceiling kit finishes

 AGP antique graphite	 BS brushed satin brass	 GZ galvanized
 BL black	 DZ dark bronze	 MW matte white
 BN brushed nickel	 GR matte greige	

### blade finishes

 BL black	 LO light oak	 WE weathered wood
 BN brushed nickel	 MW matte white	 WK whiskey wood
 DWA dark walnut	 N natural	 WW white washed

view larger swatches on page 197

# SPITFIRE™ FLUSH 60

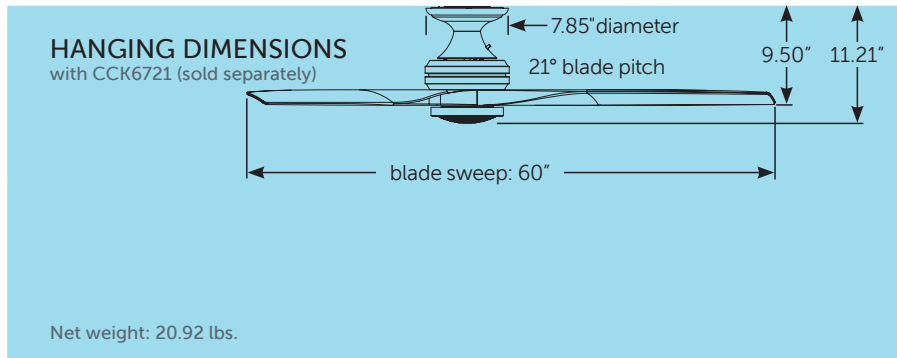

**CONTROL TYPE**

TR500 handheld remote included

**MOTOR TYPE & SIZE**

**AC 188 x 25**  
(LIMITED LIFETIME WARRANTY)

Reverse switch on fan

**FAN SPEEDS**

**3**

**HIGH-SPEED RPM**

**128**

**\*HIGH-SPEED CFM**

**4,006 CFM**

**LOCATION RATING**

dry  damp  wet

**LIGHTING—LK6721B\*\***  
(sold separately)

**18W LED**  
fresnel & frosted PC lenses included

**LIGHTING SPECS—LK6721B\*\***  
(sold separately)

**18W integrated LED**

**lumens: 1,500**  
**CCT: 3,000k**  
**CRI: 90**

**MOUNTING TYPE**

downrod  sloped  flush   
flush sold separately



ENERGY GUIDE				
AVERAGE SPEED	TOTAL AIR VOLUME	ENERGY USE	ESTIMATED YEARLY ENERGY COST	AIRFLOW EFFICIENCY
	2,657 CFM	44 Watts	\$12	60 CFM/Watts

**CERTIFICATION**

FANIMATION.COM

\*Airflow testing is conducted in accordance with the US Department of Energy's testing standards and under specific controlled environmental conditions. Actual airflow performance may vary based on the installation location and environmental factors.



# MIX & MATCH FAN MOTOR, BLADES & LIGHT KIT SOLD SEPARATELY

~
AC MOTOR

**DRY**

**DAMP**

**required**  
(sold separately)

**Motor**  
MA6721B\*\*  
Includes remote:

+

**Close-To-Ceiling Kit**  
CCK6721\*\*

+

**Blade Set**  
B6720\*\*

\*\* replace with available finish codes below

## optional accessories (sold separately)

light kit		<b>LED Light Kit</b> LK6721B**
mounting		<b>Close-To-Ceiling Kit</b> CCK6721**
controls		<b>2-wire Fan-only Wall Control</b> WC1WH
		<b>3-wire Fan + Light Wall Control</b> WC2WH
		<b>2-wire Fan-only Wall Remote</b> WR500WH
		<b>2-wire Fan + Light Wall Remote</b> WR501WH
		<b>WiFi Smart Receiver</b> WFR50

## ordering example

MA6721BGZ  
(galvanized motor)  
+  
B6720WK  
(whiskey wood blade set)  
+  
CCK6721GZ  
(galvanized close-to-ceiling kit)



SPITFIRE™ 60 FLUSH

### motor, light kit & close-to-ceiling kit finishes

 antique graphite	 brushed satin brass	 galvanized
 black	 dark bronze	 matte white
 brushed nickel	 matte greige	

### blade finishes

 black	 light oak	 weathered wood
 brushed nickel	 matte white	 whiskey wood
 dark walnut	 natural	 white washed

view larger swatches on page 197



64-INCH



72-INCH



84-INCH

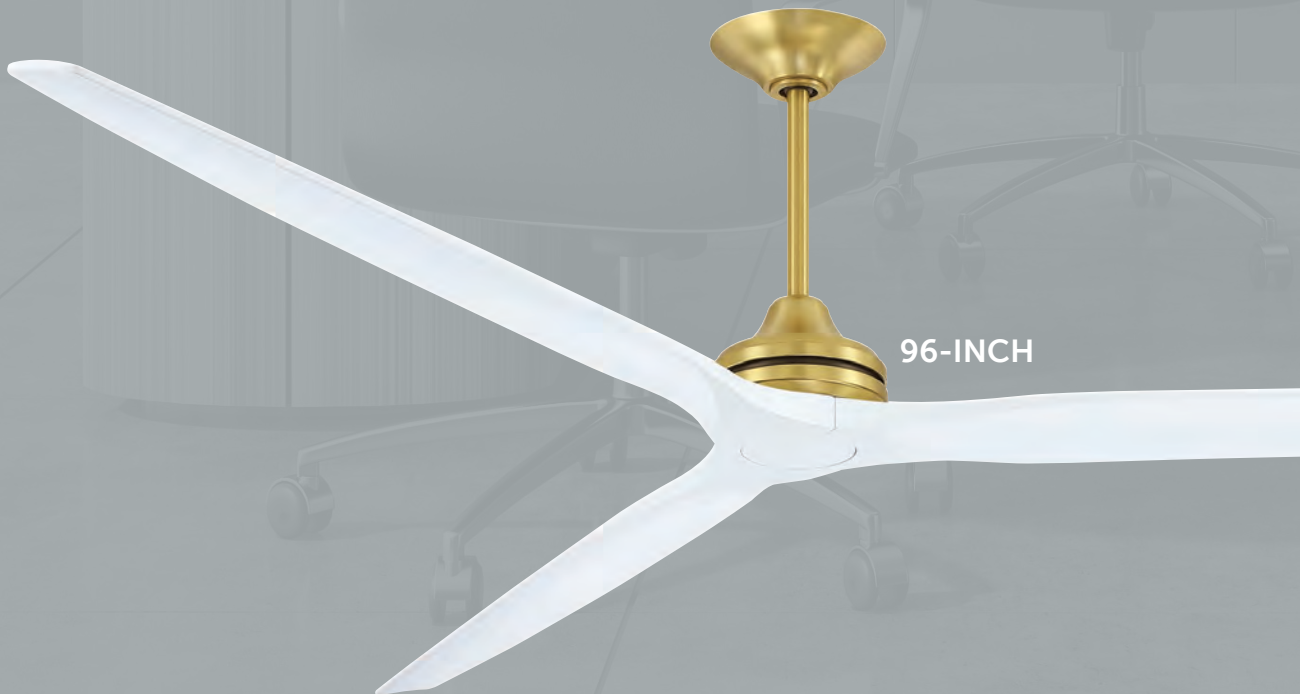

96-INCH



SPIRITFIRE™ DC CUSTOM

# SPITFIRE™ DC 64

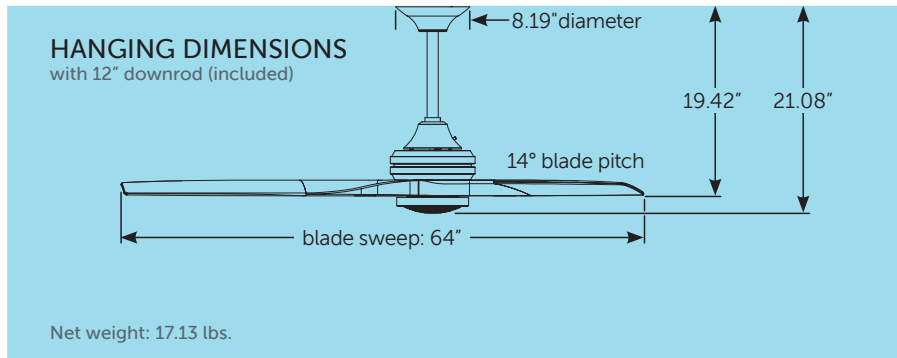

**CONTROL TYPE**

TR305 handheld remote included

**MOTOR TYPE & SIZE**

**DC 153 x 25FS**  
(LIMITED LIFETIME WARRANTY)

Reverse switch on remote

**FAN SPEEDS**  
variable

**HIGH-SPEED RPM**  
163

**\*HIGH-SPEED CFM**  
9,076 CFM

**LOCATION RATING**

dry  damp  wet

**LIGHTING—LK6721BDC\*\***  
(sold separately)

18W LED  
fresnel & frosted PC lenses included

**LIGHTING SPECS—LK6721BDC\*\***  
(sold separately)

**18W integrated LED with CCT Select**  
lumens: 1,600  
CCT: 3000k/4000k/5000k  
CRI: 90

**MOUNTING TYPE**

downrod 12" included  sloped up to 20° included  flush sold separately

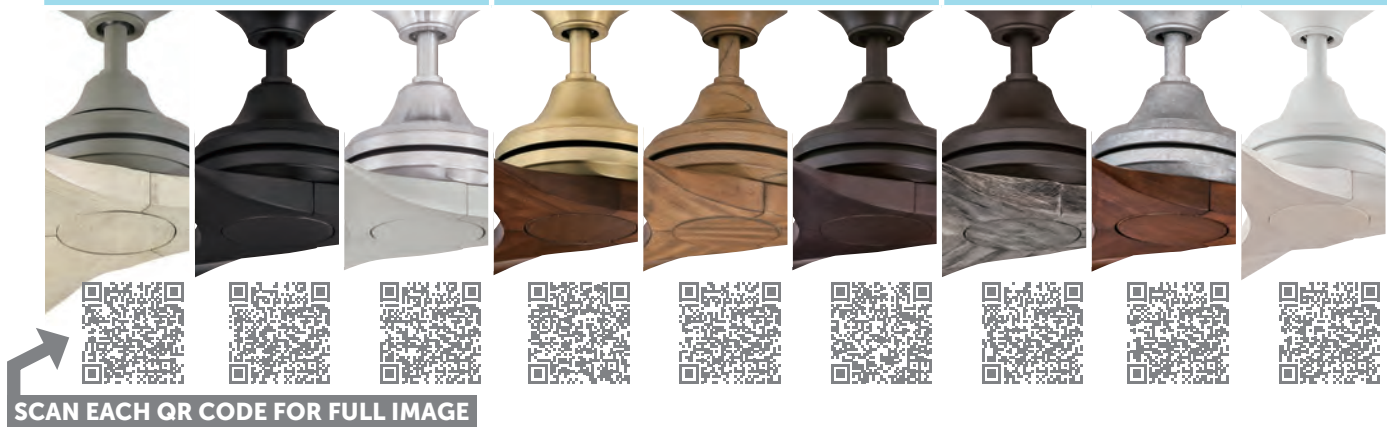

ENERGY GUIDE				
AVERAGE SPEED	TOTAL AIR VOLUME	ENERGY USE	ESTIMATED YEARLY ENERGY COST	AIRFLOW EFFICIENCY
	5,858 CFM	19 Watts	\$5	311 CFM/Watts

**CERTIFICATION**

\*Airflow testing is conducted in accordance with the US Department of Energy's testing standards and under specific controlled environmental conditions. Actual airflow performance may vary based on the installation location and environmental factors.

# MIX & MATCH FAN MOTOR, BLADES & LIGHT KIT SOLD SEPARATELY

DC MOTOR
DRY
DAMP

**required**  
(sold separately)



**Motor**  
MAD6721\*\*  
Includes remote:







+



**Blade Set**  
B6720-64\*\*

\*\* replace with available finish codes below

## optional accessories (sold separately)

- light kit  **LED Light Kit**  
LK6721BDC\*\*
- mounting  **Close-To-Ceiling Kit**  
CCK6721\*\*
  **Sloped Ceiling Ball**  
(up to 42°)  
SCB1-52
 **Longer Downrods**  
page 195
- controls  **2-wire Fan-only Wall Control**  
TW306

## ordering example

MAD6721GR  
(matte greige motor)  
+  
B6720-64WE  
(weathered wood blade set)  
+  
LK6721BDCGR  
(matte greige light kit)



### motor, light kit & close-to-ceiling kit finishes

 <p><b>AGP</b> antique graphite</p>	<p><b>NEW</b></p>  <p><b>BS</b> brushed satin brass</p>	 <p><b>GR</b> matte greige</p>
 <p><b>BL</b> black</p>	 <p><b>DF</b> driftwood</p>	 <p><b>GZ</b> galvanized</p>
 <p><b>BN</b> brushed nickel</p>	 <p><b>DZ</b> dark bronze</p>	 <p><b>MW</b> matte white</p>

### blade finishes

 <p><b>BL</b> black</p>	 <p><b>DWA</b> dark walnut</p>	 <p><b>N</b> natural</p>	 <p><b>WW</b> white washed</p>
 <p><b>BN</b> brushed nickel</p>	<p><b>NEW</b></p>  <p><b>LO</b> light oak</p>	 <p><b>WE</b> weathered wood</p>	
 <p><b>DF</b> driftwood</p>	 <p><b>MW</b> matte white</p>	 <p><b>WK</b> whiskey wood</p>	

view larger swatches on page 197

# SPITFIRE™ DC 64 FLUSH

## HANGING DIMENSIONS with CCK6721 (sold separately)

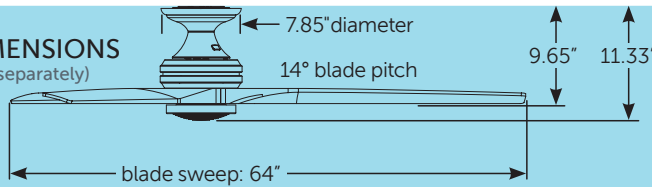

Net weight: 20.15 lbs.

## CONTROL TYPE



TR305 handheld remote included

## MOTOR TYPE & SIZE

**DC 153 x 25FS**  
(LIMITED LIFETIME WARRANTY)

Reverse switch on remote

## FAN SPEEDS variable

HIGH-SPEED RPM  
**159**

\*HIGH-SPEED CFM  
**7,302 CFM**

## LOCATION RATING



dry



damp



wet



## LIGHTING—LK6721BDC\*\* (sold separately)

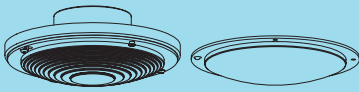

**18W LED**  
fresnel & frosted PC lenses included

## LIGHTING SPECS—LK6721BDC\*\* (sold separately)

**18W integrated LED  
with CCT Select**  
lumens: 1,600  
CCT: 3000k/4000k/5000k  
CRI: 90

## MOUNTING TYPE



downrod



sloped



**flush**  
sold separately



SCAN EACH QR CODE FOR FULL IMAGE

## ENERGY GUIDE

## CERTIFICATION

AVERAGE SPEED

TOTAL AIR VOLUME  
**4,324 CFM**

ENERGY USE  
**20 Watts**

ESTIMATED YEARLY ENERGY COST  
**\$6**

AIRFLOW EFFICIENCY  
**215 CFM/Watts**



FANIMATION.COM

\*Airflow testing is conducted in accordance with the US Department of Energy's testing standards and under specific controlled environmental conditions. Actual airflow performance may vary based on the installation location and environmental factors.

# MIX & MATCH FAN MOTOR, BLADES & LIGHT KIT SOLD SEPARATELY

---
☀
☂

**DC MOTOR** **DRY** **DAMP**

**required**  
(sold separately)



**Motor**  
MAD6721\*\*

Includes remote:



+

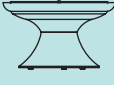

**Close-To-Ceiling Kit**  
CCK6721\*\*

+



**Blade Set**  
B6720-64\*\*

\*\* replace with available finish codes below

## optional accessories

(sold separately)

light kit  **LED Light Kit**  
LK6721BDC\*\*

controls  **2-wire Fan-only Wall Control**  
TW306

## ordering example

MAD6721BL  
(black motor)  
+  
B6720-64BL  
(black blade set)  
+  
LK6721BDCBL  
(black light kit)  
+  
CCK6721BL  
(black close-to-ceiling kit)



SPITFIRE™ DC 64 FLUSH

### motor, light kit & close-to-ceiling kit finishes

 <b>AGP</b> <small>antique graphite</small>	 <b>BS</b> <small>brushed satin brass</small>	 <b>GR</b> <small>matte greige</small>
 <b>BL</b> <small>black</small>	 <b>DF</b> <small>driftwood</small>	 <b>GZ</b> <small>galvanized</small>
 <b>BN</b> <small>brushed nickel</small>	 <b>DZ</b> <small>dark bronze</small>	 <b>MW</b> <small>matte white</small>

### blade finishes

 <b>BL</b> <small>black</small>	 <b>DWA</b> <small>dark walnut</small>	 <b>N</b> <small>natural</small>	 <b>WW</b> <small>white washed</small>
 <b>BN</b> <small>brushed nickel</small>	 <b>LO</b> <small>light oak</small>	 <b>WE</b> <small>weathered wood</small>	
 <b>DF</b> <small>driftwood</small>	 <b>MW</b> <small>matte white</small>	 <b>WK</b> <small>whiskey wood</small>	

view larger swatches on page 197

# SPITFIRE™ DC 72

**HANGING DIMENSIONS**  
with 12" downrod (included)

8.19" diameter  
19.42"  
21.08"  
14° blade pitch  
blade sweep: 72"

Net weight: 17.49 lbs.

**CONTROL TYPE**

TR305 handheld remote included

**MOTOR TYPE & SIZE**

**DC 153 x 25FS**  
(LIMITED LIFETIME WARRANTY)

Reverse switch on remote

**FAN SPEEDS**  
variable

**HIGH-SPEED RPM**  
135

**\*HIGH-SPEED CFM**  
10,988 CFM

**LOCATION RATING**

dry  damp  wet

**LIGHTING—LK6721BDC\*\***  
(sold separately)

18W LED  
fresnel & frosted PC lenses included

**LIGHTING SPECS—LK6721BDC\*\***  
(sold separately)

**18W integrated LED with CCT Select**  
lumens: 1,600  
CCT: 3000k/4000k/5000k  
CRI: 90

**MOUNTING TYPE**

downrod 12" included  sloped up to 20" included  flush sold separately

**SCAN EACH QR CODE FOR FULL IMAGE**

ENERGY GUIDE				
AVERAGE SPEED	TOTAL AIR VOLUME	ENERGY USE	ESTIMATED YEARLY ENERGY COST	AIRFLOW EFFICIENCY
	7,007 CFM	21 Watts	\$6	336 CFM/Watts

**CERTIFICATION**

\*Airflow testing is conducted in accordance with the US Department of Energy's testing standards and under specific controlled environmental conditions. Actual airflow performance may vary based on the installation location and environmental factors.



# MIX & MATCH FAN MOTOR, BLADES & LIGHT KIT SOLD SEPARATELY

≡ **DC MOTOR**
☀️ **DRY**
☁️ **DAMP**

**required**  
(sold separately)



**Motor**  
MAD6721\*\*  
Includes remote:



+



**Blade Set**  
B6720-72\*\*

\*\* replace with available finish codes below

## optional accessories (sold separately)

**light kit**



**LED Light Kit**  
LK6721BDC\*\*

**mounting**



**Close-To-Ceiling Kit**  
CCK6721\*\*



**Sloped Ceiling Ball**  
(up to 42°)  
SCB1-52



**Longer Downrods**  
page 195

**controls**



**2-wire Fan-only Wall Control**  
TW306

## ordering example

MAD6721MW  
(matte white motor)  
+  
B6720-72WW  
(white washed blade set)  
+  
LK6721BDCMW  
(matte white light kit)



### motor, light kit & close-to-ceiling kit finishes

 <b>AGP</b> antique graphite	 <b>BS</b> brushed satin brass	 <b>GR</b> matte greige
 <b>BL</b> black	 <b>DF</b> driftwood	 <b>GZ</b> galvanized
 <b>BN</b> brushed nickel	 <b>DZ</b> dark bronze	 <b>MW</b> matte white

### blade finishes

 <b>BL</b> black	 <b>DWA</b> dark walnut	 <b>N</b> natural	 <b>WW</b> white washed
 <b>BN</b> brushed nickel	 <b>LO</b> light oak	 <b>WE</b> weathered wood	
 <b>DF</b> driftwood	 <b>MW</b> matte white	 <b>WK</b> whiskey wood	

view larger swatches on page 197

# SPITFIRE™ DC 72 FLUSH

## HANGING DIMENSIONS with CCK6721 (sold separately)

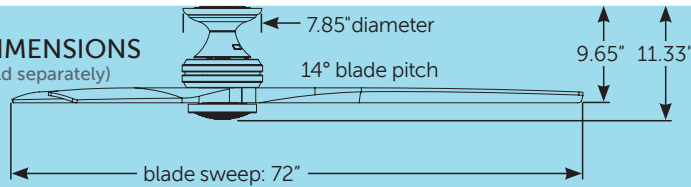

Net weight: 20.51 lbs.

## CONTROL TYPE



TR305 handheld remote included

## MOTOR TYPE & SIZE

**DC 153 x 25FS**  
(LIMITED LIFETIME WARRANTY)

Reverse switch on remote

## FAN SPEEDS variable

HIGH-SPEED RPM  
**135**

\*HIGH-SPEED CFM  
**8,522 CFM**

## LOCATION RATING



dry



damp



wet



## LIGHTING—LK6721BDC\*\* (sold separately)

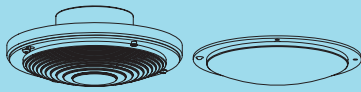

**18W LED**  
fresnel & frosted PC lenses included

## LIGHTING SPECS—LK6721BDC\*\* (sold separately)

**18W integrated LED  
with CCT Select**  
lumens: 1,600  
CCT: 3000k/4000k/5000k  
CRI: 90

## MOUNTING TYPE



downrod



sloped



**flush**  
sold separately



SCAN EACH QR CODE FOR FULL IMAGE

## ENERGY GUIDE

AVERAGE SPEED	TOTAL AIR VOLUME	ENERGY USE	ESTIMATED YEARLY ENERGY COST	AIRFLOW EFFICIENCY
	5,200 CFM	24 Watts	\$7	220 CFM/Watts

## CERTIFICATION



FANIMATION.COM

\*Airflow testing is conducted in accordance with the US Department of Energy's testing standards and under specific controlled environmental conditions. Actual airflow performance may vary based on the installation location and environmental factors.

# MIX & MATCH FAN MOTOR, BLADES & LIGHT KIT SOLD SEPARATELY

≡
☀
☂

**DC MOTOR** **DRY** **DAMP**

**required**  
(sold separately)



**Motor**  
MAD6721\*\*

Includes remote:



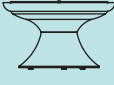

**Close-To-Ceiling Kit**  
CCK6721\*\*



**Blade Set**  
B6720-72\*\*

\*\* replace with available finish codes below

## optional accessories

(sold separately)

light kit  **LED Light Kit**  
LK6721BDC\*\*

controls  **2-wire Fan-only Wall Control**  
TW306

## ordering example

MAD6721GZ  
(galvanized motor)  
+  
B6720-72BL  
(black blade set)  
+  
CCK6721GZ  
(galvanized close-to-ceiling kit)



SPITFIRE™ DC72 FLUSH

### motor, light kit & close-to-ceiling kit finishes

 <b>AGP</b> antique graphite	 <b>BS</b> brushed satin brass	 <b>GR</b> matte greige
 <b>BL</b> black	 <b>DF</b> driftwood	 <b>GZ</b> galvanized
 <b>BN</b> brushed nickel	 <b>DZ</b> dark bronze	 <b>MW</b> matte white

### blade finishes

 <b>BL</b> black	 <b>DWA</b> dark walnut	 <b>N</b> natural	 <b>WW</b> white washed
 <b>BN</b> brushed nickel	 <b>LO</b> light oak	 <b>WE</b> weathered wood	
 <b>DF</b> driftwood	 <b>MW</b> matte white	 <b>WK</b> whiskey wood	

view larger swatches on page 197

# SPITFIRE™ DC 84

**HANGING DIMENSIONS**  
with 12" downrod (included)

8.19" diameter  
19.42"  
21.08"  
14° blade pitch  
blade sweep: 84"

Net weight: 18.17 lbs.

**CONTROL TYPE**

TR305 handheld remote included

**MOTOR TYPE & SIZE**

**DC 153 x 25FS**  
(LIMITED LIFETIME WARRANTY)

Reverse switch on remote

**FAN SPEEDS**  
variable

**HIGH-SPEED RPM**  
112

**\*HIGH-SPEED CFM**  
12,900 CFM

**LOCATION RATING**

dry damp wet

**LIGHTING—LK6721BDC\*\***  
(sold separately)

18W LED  
fresnel & frosted PC lenses included

**LIGHTING SPECS—LK6721BDC\*\***  
(sold separately)

**18W integrated LED**  
with CCT Select

lumens: 1,600  
CCT: 3000k/4000k/5000k  
CRI: 90

**MOUNTING TYPE**

downrod sloped flush  
12" included up to 20" included sold separately

**SCAN EACH QR CODE FOR FULL IMAGE**

ENERGY GUIDE				
AVERAGE SPEED	TOTAL AIR VOLUME	ENERGY USE	ESTIMATED YEARLY ENERGY COST	AIRFLOW EFFICIENCY
	7,429 CFM	20 Watts	\$6	376 CFM/Watts

**CERTIFICATION**

MIX & MATCH FAN MOTOR, BLADES & LIGHT KIT SOLD SEPARATELY

**DC MOTOR** **DRY** **DAMP**

**required**  
(sold separately)

**Motor**  
MAD6721\*\*  
Includes remote:

**Blade Set**  
B6720-84\*\*

\*\* replace with available finish codes below

**optional accessories**  
(sold separately)

**light kit** **LED Light Kit**  
LK6721BDC\*\*

**mounting** **Close-To-Ceiling Kit**  
CCK6721\*\*

**Sloped Ceiling Ball (up to 42°)**  
SCB1-52

**Longer Downrods**  
page 195

**controls** **2-wire Fan-only Wall Control**  
TW306

**ordering example**

MAD6721BL  
(black motor)  
+  
B6720-84BL  
(black blade set)  
+  
LK6721BDCBS  
(brushed satin brass light kit)



SPITFIRE™ DC 84

**motor, light kit & close-to-ceiling kit finishes**

<b>NEW</b> AGP antique graphite	BS brushed satin brass	GR matte greige
BL black	DF driftwood	GZ galvanized
BN brushed nickel	DZ dark bronze	MW matte white

**blade finishes**

BL black	DWA dark walnut	N natural	WW white washed
BN brushed nickel	<b>NEW</b> LO light oak	WE weathered wood	
DF driftwood	MW matte white	WK whiskey wood	

view larger swatches on page 197

# SPITFIRE™ DC 84 FLUSH

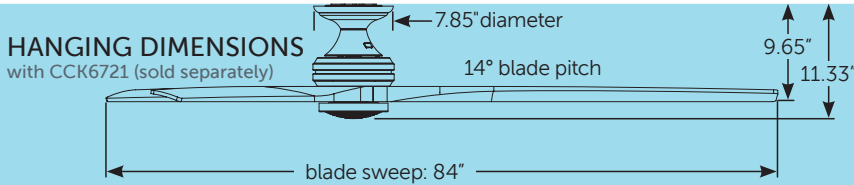

Net weight: 21.19 lbs.

## CONTROL TYPE



TR305 handheld remote included

## MOTOR TYPE & SIZE

**DC 153 x 25FS**  
(LIMITED LIFETIME WARRANTY)

Reverse switch on remote

## FAN SPEEDS

variable

HIGH-SPEED RPM  
**100**

\*HIGH-SPEED CFM  
**2,732 CFM**

## LOCATION RATING



dry



damp



wet



## LIGHTING—LK6721BDC\*\*

(sold separately)

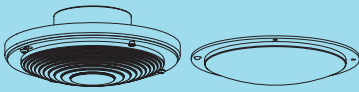

**18W LED**  
fresnel & frosted PC lenses included

## LIGHTING SPECS—LK6721BDC\*\*

(sold separately)

**18W integrated LED**  
with CCT Select

lumens: 1,600

CCT: 3000k/4000k/5000k

CRI: 90

## MOUNTING TYPE



downrod



sloped



**flush**  
sold separately



SCAN EACH QR CODE FOR FULL IMAGE

## ENERGY GUIDE

## CERTIFICATION

AVERAGE SPEED

TOTAL AIR VOLUME  
**2,847 CFM**

ENERGY USE  
**24 Watts**

ESTIMATED YEARLY ENERGY COST  
**\$6**

AIRFLOW EFFICIENCY  
**122 CFM/Watts**



FANIMATION.COM

\*Airflow testing is conducted in accordance with the US Department of Energy's testing standards and under specific controlled environmental conditions. Actual airflow performance may vary based on the installation location and environmental factors.

# MIX & MATCH FAN MOTOR, BLADES & LIGHT KIT SOLD SEPARATELY

**DC MOTOR** **DRY** **DAMP**

**required**  
(sold separately)

**Motor**  
MAD6721\*\*  
Includes remote:

**Close-To-Ceiling Kit**  
CCK6721\*\*

**Blade Set**  
B6720-84\*\*

\*\* replace with available finish codes below

## optional accessories

(sold separately)

light kit **LED Light Kit**  
LK6721BDC\*\*

controls **2-wire Fan-only Wall Control**  
TW306



## ordering example

MAD6721DF  
(driftwood motor)  
+  
B6720-84DF  
(driftwood blade set)  
+  
CCK6721DF  
(driftwood close-to-ceiling kit)



### motor, light kit & close-to-ceiling kit finishes

<b>AGP</b> antique graphite	<b>BS</b> brushed satin brass	<b>GR</b> matte greige
<b>BL</b> black	<b>DF</b> driftwood	<b>GZ</b> galvanized
<b>BN</b> brushed nickel	<b>DZ</b> dark bronze	<b>MW</b> matte white

### blade finishes

<b>BL</b> black	<b>DWA</b> dark walnut	<b>N</b> natural	<b>WW</b> white washed
<b>BN</b> brushed nickel	<b>LO</b> light oak	<b>WE</b> weathered wood	
<b>DF</b> driftwood	<b>MW</b> matte white	<b>WK</b> whiskey wood	

view larger swatches on page 197

# SPITFIRE™ DC 96

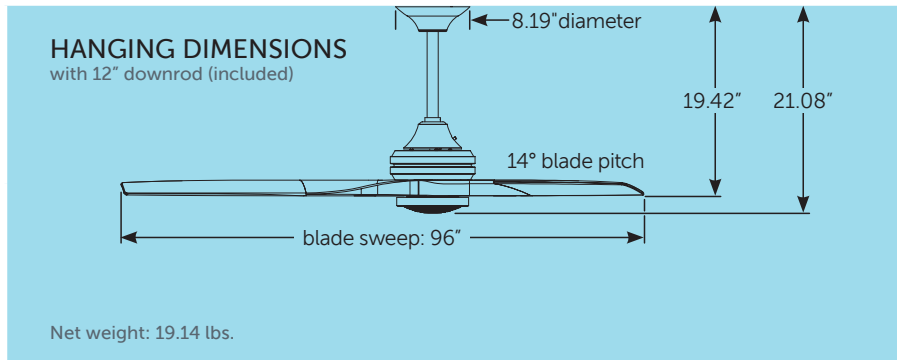

**CONTROL TYPE**

TR305 handheld remote included

**MOTOR TYPE & SIZE**

**DC 153 x 25FS**  
(LIMITED LIFETIME WARRANTY)

Reverse switch on remote

**FAN SPEEDS**  
variable

**HIGH-SPEED RPM**  
83

**\*HIGH-SPEED CFM**  
12,410 CFM

**LOCATION RATING**

dry damp wet

✓ ✓ ✗

**LIGHTING—LK6721BDC\*\***  
(sold separately)

18W LED  
fresnel & frosted PC lenses included

**LIGHTING SPECS—LK6721BDC\*\***  
(sold separately)

**18W integrated LED**  
with CCT Select

lumens: 1,600  
CCT: 3000k/4000k/5000k  
CRI: 90

**MOUNTING TYPE**

downrod sloped flush  
4.5" included up to 20" included sold separately

✓ ✓ ✓



ENERGY GUIDE				
AVERAGE SPEED	TOTAL AIR VOLUME	ENERGY USE	ESTIMATED YEARLY ENERGY COST	AIRFLOW EFFICIENCY
	8,515 CFM	24 Watts	\$7	361 CFM/Watts

**CERTIFICATION**



# MIX & MATCH FAN MOTOR, BLADES & LIGHT KIT SOLD SEPARATELY

**DC MOTOR** **DRY** **DAMP**

**required**  
(sold separately)

**Motor**  
MAD6721\*\*  
Includes remote:

**Blade Set**  
B6720-96\*\*

\*\* replace with available finish codes below

## optional accessories

(sold separately)

**light kit** **LED Light Kit**  
LK6721BDC\*\*

**mounting** **Close-To-Ceiling Kit**  
CCK6721\*\* | **Sloped Ceiling Ball (up to 42°)**  
SCB1-52 | **Longer Downrods**  
page 195

**controls** **2-wire Fan-only Wall Control**  
TW306

## ordering example

MAD6721BS  
(brushed satin brass motor)  
+  
B6720-96MW  
(matte white blade set)



SPITFIRE™ DC 96

### motor, light kit & close-to-ceiling kit finishes

<b>AGP</b> antique graphite	<b>BS</b> brushed satin brass	<b>GR</b> matte greige
<b>BL</b> black	<b>DF</b> driftwood	<b>GZ</b> galvanized
<b>BN</b> brushed nickel	<b>DZ</b> dark bronze	<b>MW</b> matte white

### blade finishes

<b>BL</b> black	<b>DWA</b> dark walnut	<b>N</b> natural	<b>WW</b> white washed
<b>BN</b> brushed nickel	<b>LO</b> light oak	<b>WE</b> weathered wood	
<b>DF</b> driftwood	<b>MW</b> matte white	<b>WK</b> whiskey wood	

view larger swatches on page 197

# SPITFIRE™ DC 96 FLUSH

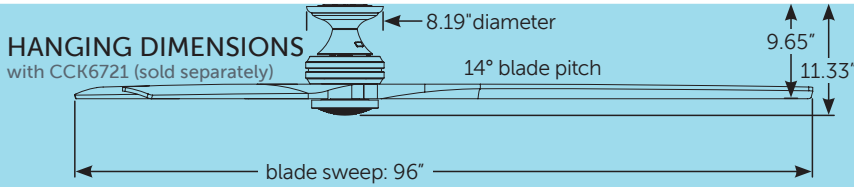

Net weight: 22.16 lbs.

## CONTROL TYPE



TR305 handheld remote included

## MOTOR TYPE & SIZE

**DC 153 x 25FS**  
(LIMITED LIFETIME WARRANTY)

Reverse switch on remote

## FAN SPEEDS

variable

HIGH-SPEED RPM  
**83**

\*HIGH-SPEED CFM  
**2,686 CFM**

## LOCATION RATING



dry



damp



wet



## LIGHTING—LK6721BDC\*\*

(sold separately)

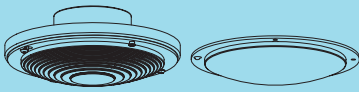

**18W LED**  
fresnel & frosted PC lenses included

## LIGHTING SPECS—LK6721BDC\*\*

(sold separately)

**18W integrated LED**  
with CCT Select  
lumens: 1,600  
CCT: 3000k/4000k/5000k  
CRI: 90

## MOUNTING TYPE



downrod



sloped



**flush**  
sold separately



SCAN EACH QR CODE FOR FULL IMAGE

## ENERGY GUIDE

AVERAGE SPEED	TOTAL AIR VOLUME	ENERGY USE	ESTIMATED YEARLY ENERGY COST	AIRFLOW EFFICIENCY
	1,806 CFM	23 Watts	\$7	77 CFM/Watts

## CERTIFICATION



FANIMATION.COM

\*Airflow testing is conducted in accordance with the US Department of Energy's testing standards and under specific controlled environmental conditions. Actual airflow performance may vary based on the installation location and environmental factors.

# MIX & MATCH FAN MOTOR, BLADES & LIGHT KIT SOLD SEPARATELY

DC MOTOR
DRY
DAMP

**required**  
(sold separately)



**Motor**  
MAD6721\*\*

Includes remote:



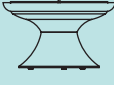

**Close-To-Ceiling Kit**  
CCK6721\*\*



**Blade Set**  
B6720-96\*\*

\*\* replace with available finish code below

## optional accessories (sold separately)

light kit  **LED Light Kit**  
LK6721BDC\*\*

controls  **2-wire Fan-only Wall Control**  
TW306

## ordering example

MAD6721DZ  
(dark bronze motor)  
+  
B6720-96N  
(natural blade set)  
+  
CCK6721DZ  
(dark bronze close-to-ceiling kit)



### motor, light kit & close-to-ceiling kit finishes

 <p><b>AGP</b> antique graphite</p>	<p><b>NEW</b></p>  <p><b>BS</b> brushed satin brass</p>	 <p><b>GR</b> matte greige</p>
 <p><b>BL</b> black</p>	 <p><b>DF</b> driftwood</p>	 <p><b>GZ</b> galvanized</p>
 <p><b>BN</b> brushed nickel</p>	 <p><b>DZ</b> dark bronze</p>	 <p><b>MW</b> matte white</p>

### blade finishes

 <p><b>BL</b> black</p>	 <p><b>DWA</b> dark walnut</p>	 <p><b>N</b> natural</p>	 <p><b>WW</b> white washed</p>
 <p><b>BN</b> brushed nickel</p>	<p><b>NEW</b></p>  <p><b>LO</b> light oak</p>	 <p><b>WE</b> weathered wood</p>	
 <p><b>DF</b> driftwood</p>	 <p><b>MW</b> matte white</p>	 <p><b>WK</b> whiskey wood</p>	

view larger swatches on page 197



52-INCH



64-INCH



72-INCH



LEVON™ DCCUSTOM

# LEVON™ CUSTOM 52

**HANGING DIMENSIONS**  
with 6" downrod (included)

5.75" diameter  
14° blade pitch  
14.55" 15.73" 16.45"  
blade sweep: 52"

Net weight: 26.89 lbs.

**CONTROL TYPE**

TR305 handheld remote included

**MOTOR TYPE & SIZE**

**DC135**  
(LIMITED LIFETIME WARRANTY)

Reverse switch on remote

**FAN SPEEDS**  
variable

HIGH-SPEED RPM  
**170**

\*HIGH-SPEED CFM  
**6,416 CFM**

**LOCATION RATING**

dry damp wet

✓ ✓ ✗

**LIGHTING—LK7912B\*\***  
(sold separately)

18W LED with opal frosted glass

**LIGHTING SPECS—LK7912B\*\***  
(sold separately)

**18W integrated LED**  
with CCT Select

lumens: 1,600  
CCT: 3000k/4000k/5000k  
CRI: 90

**MOUNTING TYPE**

downrod sloped flush  
6" included up to 27" included sold separately

✓ ✓ ✓



SCAN EACH QR CODE FOR FULL IMAGE

ENERGY GUIDE				
	<b>TOTAL AIR VOLUME</b>	<b>ENERGY USE</b>	<b>ESTIMATED YEARLY ENERGY COST</b>	<b>AIRFLOW EFFICIENCY</b>
AVERAGE SPEED	4,389 CFM	21 Watts	\$6	209 CFM/Watts

**CERTIFICATION**

\*Airflow testing is conducted in accordance with the US Department of Energy's testing standards and under specific controlled environmental conditions. Actual airflow performance may vary based on the installation location and environmental factors.

# MIX & MATCH FAN

MOTOR, BLADES & LIGHT KIT SOLD SEPARATELY

---
☀
☂

**DC MOTOR**

**DRY**

**DAMP**

**required**  
(sold separately)

+

+

**Motor**  
MAD7912B\*\*

Includes remote:

**Blade Set**

Buttonwood: B7914\*\*  
or  
Composite: BPW7914\*\*

\*\* replace with available finish codes below

## optional accessories

(sold separately)

light kit

**LED Light Kit**  
LK7912B\*\*

mounting

**Close-To-Ceiling Kit**  
CCK8002\*\*

**Sloped Ceiling Ball**  
(up to 42°)  
SCB1-52

**Longer Downrods**  
page 195

controls

**2-wire Fan-only Wall Control**  
TW306

## ordering example

MAD7912BGZ  
(galvanized motor)  
+  
BPW7914N  
(natural blade set)  
+  
LK7912BGZ  
(galvanized light kit)



LEVON™ CUSTOM 52

### motor & light kit finishes

 BL black	 BN brushed nickel
 DZ dark bronze	 GR matte greige
 GZ galvanized	 MW matte white

### B7914\*\* blade finish options

 BN brushed nickel
 CYWA cherry/walnut reversible

### BPW7914\*\* composite blade finish options

 BL black	 BN brushed nickel	 CY cherry
 DWA dark walnut	 MW matte white	 N natural
 WE weathered wood	 WP washed pine	 WW white washed

view larger swatches on page 197

# LEVON™ CUSTOM 64

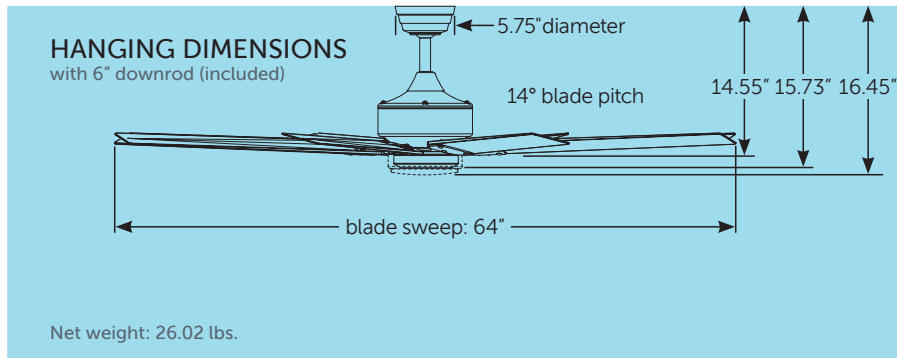

**CONTROL TYPE**

wifi + fanSync by FANIMATION

TR305 handheld remote included

**MOTOR TYPE & SIZE**

**DC135**  
(LIMITED LIFETIME WARRANTY)

Reverse switch on remote

**FAN SPEEDS**  
variable

**HIGH-SPEED RPM**  
119

**\*HIGH-SPEED CFM**  
7,880 CFM

**LOCATION RATING**

dry  damp  wet

**LIGHTING—LK7912B\*\***  
(sold separately)

18W LED with opal frosted glass

**LIGHTING SPECS—LK7912B\*\***  
(sold separately)

**18W integrated LED with CCT Select**  
lumens: 1,600  
CCT: 3000k/4000k/5000k  
CRI: 90

**MOUNTING TYPE**

downrod 6" included  sloped up to 27" included  flush sold separately



SCAN EACH QR CODE FOR FULL IMAGE

ENERGY GUIDE				
	<b>TOTAL AIR VOLUME</b>	<b>ENERGY USE</b>	<b>ESTIMATED YEARLY ENERGY COST</b>	<b>AIRFLOW EFFICIENCY</b>
<b>AVERAGE SPEED</b>	5,521 CFM	21 Watts	\$6	269 CFM/Watts

**CERTIFICATION**

\*Airflow testing is conducted in accordance with the US Department of Energy's testing standards and under specific controlled environmental conditions. Actual airflow performance may vary based on the installation location and environmental factors.



# MIX & MATCH FAN MOTOR, BLADES & LIGHT KIT SOLD SEPARATELY

≡
☀
☂

**DC MOTOR** **DRY** **DAMP**

**required**  
(sold separately)

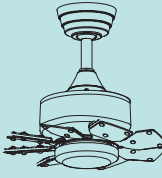

**Motor**  
MAD7912B\*\*

Includes remote:



+







**Blade Set**  
Buttonwood:  
B7912\*\*  
or  
Composite:  
BPW7912\*\*

\*\* replace with available finish codes below

## optional accessories

(sold separately)

<p>light kit</p> 	<p><b>LED Light Kit</b> LK7912B**</p>				
<p>mounting</p> 	<p><b>Close-To-Ceiling Kit</b> CCK8002**</p>		<p><b>Sloped Ceiling Ball</b> (up to 42°) SCB1-52</p>		<p><b>Longer Downrods</b> page 195</p>
<p>controls</p> 	<p><b>2-wire Fan-only Wall Control</b> TW306</p>				

## ordering example



MAD7912BBL  
(black motor)  
+  
BPW7912BL  
(black blade set)  
+  
LK7912BBL  
(black light kit)



### motor & light kit finishes

 BL black	 BN brushed nickel
 DZ dark bronze	 GR matte greige
 GZ galvanized	 MW matte white

### B7912\*\* blade finish options

 BN brushed nickel
 CYWA cherry/walnut reversible

### BPW7912\*\* composite blade finish options

 BL black	 BN brushed nickel	 CY cherry
 DWA dark walnut	 MW matte white	 N natural
 WE weathered wood	 WP washed pine	 WW white washed

view larger swatches on page 197

# LEVON™ CUSTOM 72

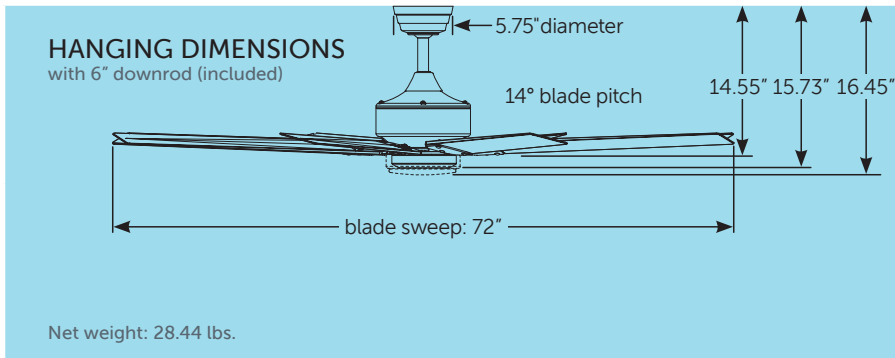

**CONTROL TYPE**

wifi + fanSync by Fanimation

TR305 handheld remote included

**MOTOR TYPE & SIZE**

**DC135**  
(LIMITED LIFETIME WARRANTY)

Reverse switch on remote

**FAN SPEEDS**  
variable

HIGH-SPEED RPM  
**95**

\*HIGH-SPEED CFM  
**8,091 CFM**

**LOCATION RATING**

dry damp wet

✓ ✓ ✗

**LIGHTING—LK7912B\*\***  
(sold separately)

18W LED with opal frosted glass

**LIGHTING SPECS—LK7912B\*\***  
(sold separately)

**18W integrated LED**  
with CCT Select

lumens: 1,600  
CCT: 3000k/4000k/5000k  
CRI: 90

**MOUNTING TYPE**

downrod sloped flush  
6" included up to 27" included sold separately

✓ ✓ ✓



SCAN EACH QR CODE FOR FULL IMAGE

ENERGY GUIDE				
	<b>TOTAL AIR VOLUME</b>	<b>ENERGY USE</b>	<b>ESTIMATED YEARLY ENERGY COST</b>	<b>AIRFLOW EFFICIENCY</b>
AVERAGE SPEED	6,040 CFM	22 Watts	\$6	272 CFM/Watts

**CERTIFICATION**

\*Airflow testing is conducted in accordance with the US Department of Energy's testing standards and under specific controlled environmental conditions. Actual airflow performance may vary based on the installation location and environmental factors.

# MIX & MATCH FAN MOTOR, BLADES & LIGHT KIT SOLD SEPARATELY

DC MOTOR
DRY DAMP

required  
(sold separately)



**Motor**  
MAD7912B\*\*

Includes remote:



+



**Blade Set**  
Buttonwood:  
B7913\*\*  
or  
Composite:  
BPW7913\*\*

\*\* replace with available finish codes below

## optional accessories (sold separately)

- light kit

**LED Light Kit**  
LK7912B\*\*
- mounting



**Close-To-Ceiling Kit**  
CCK8002\*\*



**Sloped Ceiling Ball (up to 42°)**  
SCB1-52



**Longer Downrods**  
page 195
- controls



**2-wire Fan-only Wall Control**  
TW306

## ordering example

MAD7912BGR  
(matte greige motor)  
+  
BPW7913WE  
(weathered wood blade set)  
+  
LK7912BGR  
(matte greige light kit)



### motor & light kit finishes

<b>BL</b> black	<b>BN</b> brushed nickel
<b>DZ</b> dark bronze	<b>GR</b> matte greige
<b>GZ</b> galvanized	<b>MW</b> matte white

### B7913\*\* blade finish options

<b>BN</b> brushed nickel
<b>CYWA</b> cherry/walnut reversible

### BPW7913\*\* composite blade finish options

<b>BL</b> black	<b>BN</b> brushed nickel	<b>CY</b> cherry
<b>DWA</b> dark walnut	<b>MW</b> matte white	<b>N</b> natural
<b>WE</b> weathered wood	<b>WP</b> washed pine	<b>WW</b> white washed

view larger swatches on page 197



44-INCH



48-INCH



52-INCH



56-INCH



60-INCH



64-INCH



72-INCH



84-INCH



WRAP™ CUSTOM

# WRAP™ CUSTOM 44

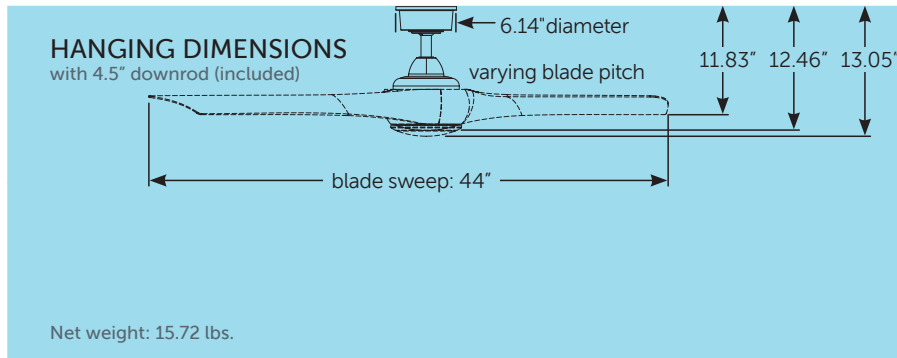

**CONTROL TYPE**

+ fanSync<sup>®</sup> by Fanimation

TR305 handheld remote included

**MOTOR TYPE & SIZE**

**DC 158 x 22**  
(LIMITED LIFETIME WARRANTY)

Reverse switch on remote

**FAN SPEEDS**  
variable

**HIGH-SPEED RPM**  
203

**\*HIGH-SPEED CFM**  
5,320 CFM

**LOCATION RATING**

dry damp wet

✓ ✓ ✗

**LIGHTING—LK8530\*\***  
(sold separately)

18W LED with opal frosted glass

**LIGHTING SPECS—LK8530\*\***  
(sold separately)

**18W integrated LED**  
with CCT Select

lumens: 1,600  
CCT: 3000k/4000k/5000k  
CRI: 90

**MOUNTING TYPE**

downrod sloped flush  
4.5" included up to 27" included sold separately

✓ ✓ ✓



SCAN EACH QR CODE FOR FULL IMAGE

ENERGY GUIDE				
	<b>TOTAL AIR VOLUME</b>	<b>ENERGY USE</b>	<b>ESTIMATED YEARLY ENERGY COST</b>	<b>AIRFLOW EFFICIENCY</b>
<b>AVERAGE SPEED</b>	3,530 CFM	20 Watts	\$6	178 CFM/Watts

**CERTIFICATION**

FANIMATION.COM

\*Airflow testing is conducted in accordance with the US Department of Energy's testing standards and under specific controlled environmental conditions. Actual airflow performance may vary based on the installation location and environmental factors.

MIX & MATCH FAN MOTOR, BLADES & LIGHT KIT SOLD SEPARATELY

**DC MOTOR** **DRY** **DAMP**

**required**  
(sold separately)

**Motor**  
MAD8530\*\*  
Includes remote:

**Blade Set**  
BPW8530-44\*\*

\*\* replace with available finish codes below

**optional accessories**  
(sold separately)

**light kit** **LED Light Kit** LK8530\*\*

**mounting** **Close-To-Ceiling Kit** CCK8002\*\* | **Sloped Ceiling Ball (up to 42°)** SCB1-52 | **Longer Downrods** page 195

**controls** **2-wire Fan-only Wall Control** TW306

**ordering example**

MAD8530BS  
(brushed satin brass motor)  
+  
BPW8530-44BL  
(black blade set)  
+  
LK8530BS  
(brushed satin brass light kit)



WRAP™ CUSTOM 44

**motor & light kit finishes**

<b>BL</b> black	<b>BN</b> brushed nickel	<b>BS</b> brushed satin brass
<b>DZ</b> dark bronze	<b>GR</b> matte greige	<b>MW</b> matte white

**blade finishes**

<b>BL</b> black	<b>BN</b> brushed nickel	<b>DWA</b> dark walnut
<b>MW</b> matte white	<b>N</b> natural	<b>WE</b> weathered wood
<b>WW</b> white washed		

view larger swatches on page 197

# WRAP™ CUSTOM 48

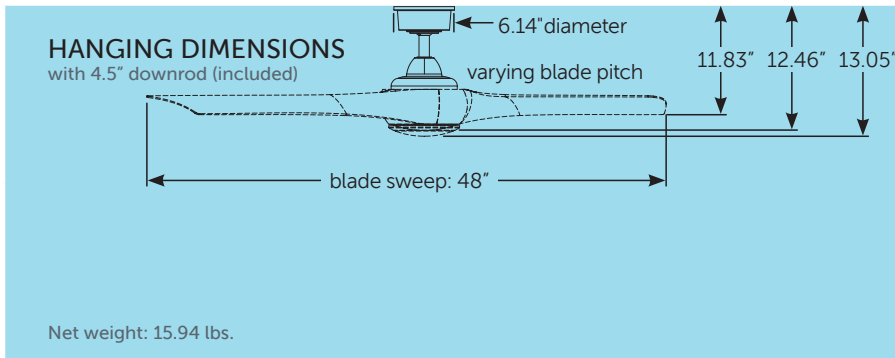

**CONTROL TYPE**

wifi + fanSync by FANIMATION

TR305 handheld remote included

**MOTOR TYPE & SIZE**

**DC 158 x 22**  
(LIMITED LIFETIME WARRANTY)

Reverse switch on remote

**FAN SPEEDS**  
variable

**HIGH-SPEED RPM**  
184

**\*HIGH-SPEED CFM**  
6,090 CFM

**LOCATION RATING**

dry damp wet

✓ ✓ ✗

**LIGHTING—LK8530\*\***  
(sold separately)

18W LED with opal frosted glass

**LIGHTING SPECS—LK8530\*\***  
(sold separately)

**18W integrated LED with CCT Select**  
lumens: 1,600  
CCT: 3000k/4000k/5000k  
CRI: 90

**MOUNTING TYPE**

downrod sloped flush  
4.5" included up to 27" included sold separately

✓ ✓ ✓



SCAN EACH QR CODE FOR FULL IMAGE

ENERGY GUIDE				
	<b>TOTAL AIR VOLUME</b>	<b>ENERGY USE</b>	<b>ESTIMATED YEARLY ENERGY COST</b>	<b>AIRFLOW EFFICIENCY</b>
<b>AVERAGE SPEED</b>	4,120 CFM	21 Watts	\$6	192 CFM/Watts

**CERTIFICATION**

FANIMATION.COM

\*Airflow testing is conducted in accordance with the US Department of Energy's testing standards and under specific controlled environmental conditions. Actual airflow performance may vary based on the installation location and environmental factors.



# MIX & MATCH FAN MOTOR, BLADES & LIGHT KIT SOLD SEPARATELY

≡
☀
☂

**DC MOTOR** **DRY** **DAMP**

**required**  
(sold separately)

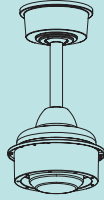

**Motor**  
MAD8530\*\*  
Includes remote:



+







**Blade Set**  
BPW8530-48\*\*

\*\* replace with available finish codes below

## optional accessories

(sold separately)

<p>light kit</p> 	<p><b>LED Light Kit</b> LK8530**</p>		
<p>mounting</p> 	<p><b>Close-To-Ceiling Kit</b> CCK8002**</p>		<p><b>Sloped Ceiling Ball</b> (up to 42°) SCB1-52</p>
<p>controls</p> 	<p><b>2-wire Fan-only Wall Control</b> TW306</p>		<p><b>Longer Downrods</b> page 195</p>

## ordering example

MAD8530BS  
(brushed satin brass motor)  
+  
BPW8530-48DWA  
(dark walnut blade set)



### motor & light kit finishes

<b>BL</b>	<b>BN</b>	<b>BS</b>
black	brushed nickel	brushed satin brass
<b>DZ</b>	<b>GR</b>	<b>MW</b>
dark bronze	matte greige	matte white

### blade finishes

<b>BL</b>	<b>BN</b>	<b>DWA</b>
black	brushed nickel	dark walnut
<b>MW</b>	<b>N</b>	<b>WE</b>
matte white	natural	weathered wood
<b>WW</b>		
white washed		

view larger swatches on page 197

# WRAP™ CUSTOM 52

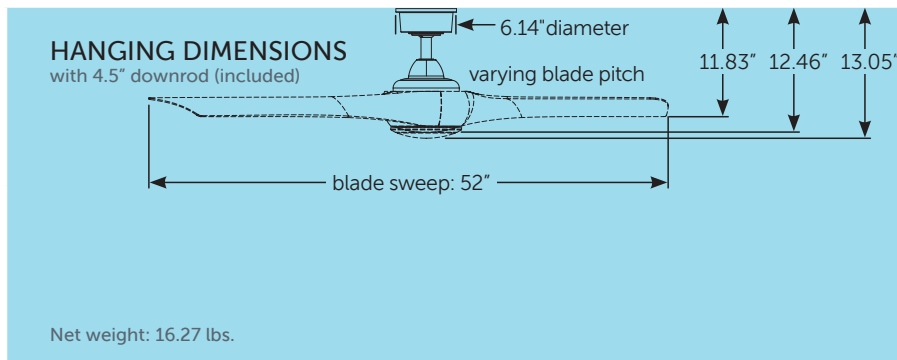

**CONTROL TYPE**

wifi + fanSync by FANIMATION

TR305 handheld remote included

**MOTOR TYPE & SIZE**

**DC 158 x 22**  
(LIMITED LIFETIME WARRANTY)

Reverse switch on remote

**FAN SPEEDS**  
variable

HIGH-SPEED RPM  
**165**

\*HIGH-SPEED CFM  
**6,279 CFM**

**LOCATION RATING**

dry damp wet

✓ ✓ ✗

**LIGHTING—LK8530\*\***  
(sold separately)

18W LED with opal frosted glass

**LIGHTING SPECS—LK8530\*\***  
(sold separately)

**18W integrated LED**  
with CCT Select

lumens: 1,600  
CCT: 3000k/4000k/5000k  
CRI: 90

**MOUNTING TYPE**

downrod sloped flush  
4.5" included up to 27" included sold separately

✓ ✓ ✓



SCAN EACH QR CODE FOR FULL IMAGE

ENERGY GUIDE				
AVERAGE SPEED	TOTAL AIR VOLUME	ENERGY USE	ESTIMATED YEARLY ENERGY COST	AIRFLOW EFFICIENCY
	4,411 CFM	21 Watts	\$6	214 CFM/Watts

**CERTIFICATION**

FANIMATION.COM

\*Airflow testing is conducted in accordance with the US Department of Energy's testing standards and under specific controlled environmental conditions. Actual airflow performance may vary based on the installation location and environmental factors.

# MIX & MATCH FAN

MOTOR, BLADES & LIGHT KIT  
SOLD SEPARATELY

**DC MOTOR** **DRY** **DAMP**

**required**  
(sold separately)

**Motor**  
MAD8530\*\*  
Includes remote:

**Blade Set**  
BPW8530-52\*\*

\*\* replace with available finish codes below

## optional accessories

(sold separately)

**light kit** **LED Light Kit**  
LK8530\*\*

**mounting** **Close-To-Ceiling Kit**  
CCK8002\*\* | **Sloped Ceiling Ball (up to 42°)**  
SCB1-52 | **Longer Downrods**  
page 195

**controls** **2-wire Fan-only Wall Control**  
TW306

## ordering example

MAD8530BS  
(brushed satin brass motor)  
+  
BPW8530-52N  
(natural blade set)  
+  
LK8530BS  
(brushed satin brass light kit)



### motor & light kit finishes

<b>BL</b> black	<b>BN</b> brushed nickel	<b>BS</b> brushed satin brass
<b>DZ</b> dark bronze	<b>GR</b> matte greige	<b>MW</b> matte white

### blade finishes

<b>BL</b> black	<b>BN</b> brushed nickel	<b>DWA</b> dark walnut
<b>MW</b> matte white	<b>N</b> natural	<b>WE</b> weathered wood
<b>WW</b> white washed		

view larger swatches on page 197

# WRAP™ CUSTOM 56

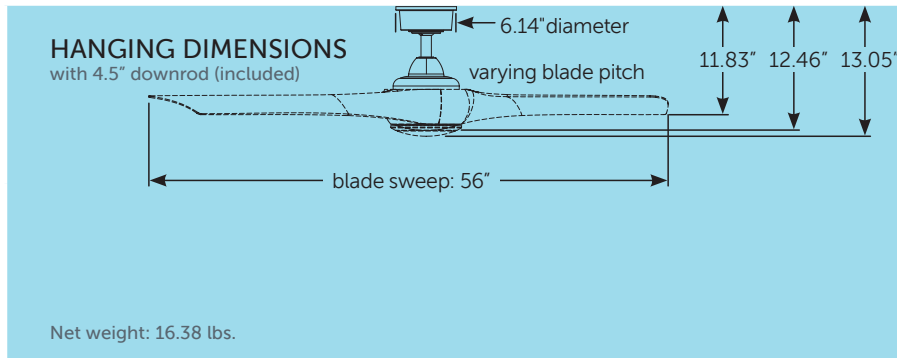

**CONTROL TYPE**

wifi + fanSync by FANIMATION

TR305 handheld remote included

**MOTOR TYPE & SIZE**

**DC 158 x 22**  
(LIMITED LIFETIME WARRANTY)

Reverse switch on remote

**FAN SPEEDS**  
variable

**HIGH-SPEED RPM**  
143

**\*HIGH-SPEED CFM**  
6,814 CFM

**LOCATION RATING**

dry damp wet

✓ ✓ ✗

**LIGHTING—LK8530\*\***  
(sold separately)

18W LED with opal frosted glass

**LIGHTING SPECS—LK8530\*\***  
(sold separately)

**18W integrated LED with CCT Select**

lumens: 1,600  
CCT: 3000k/4000k/5000k  
CRI: 90

**MOUNTING TYPE**

downrod sloped flush  
4.5" included up to 27" included sold separately

✓ ✓ ✓



SCAN EACH QR CODE FOR FULL IMAGE

ENERGY GUIDE				
AVERAGE SPEED	TOTAL AIR VOLUME	ENERGY USE	ESTIMATED YEARLY ENERGY COST	AIRFLOW EFFICIENCY
	5,011 CFM	23 Watts	\$7	215 CFM/Watts

**CERTIFICATION**

FANIMATION.COM

\*Airflow testing is conducted in accordance with the US Department of Energy's testing standards and under specific controlled environmental conditions. Actual airflow performance may vary based on the installation location and environmental factors.

MIX & MATCH FAN MOTOR, BLADES & LIGHT KIT SOLD SEPARATELY

**DC MOTOR** **DRY** **DAMP**

**required**  
(sold separately)

**Motor**  
MAD8530\*\*  
Includes remote:

**Blade Set**  
BPW8530-56\*\*

\*\* replace with available finish codes below

**optional accessories**  
(sold separately)

**light kit** **LED Light Kit** LK8530\*\*

**mounting** **Close-To-Ceiling Kit** CCK8002\*\* | **Sloped Ceiling Ball (up to 42°)** SCB1-52 | **Longer Downrods** page 195

**controls** **2-wire Fan-only Wall Control** TW306

**ordering example**

MAD8530BL  
(black motor)  
+  
BPW8530-56BL  
(black blade set)  
+  
LK8530BS  
(brushed satin brass light kit)



**motor & light kit finishes**

<b>BL</b> black	<b>BN</b> brushed nickel	<b>BS</b> brushed satin brass
<b>DZ</b> dark bronze	<b>GR</b> matte greige	<b>MW</b> matte white

**blade finishes**

<b>BL</b> black	<b>BN</b> brushed nickel	<b>DWA</b> dark walnut
<b>MW</b> matte white	<b>N</b> natural	<b>WE</b> weathered wood
<b>WW</b> white washed		

view larger swatches on page 197

# WRAP™ CUSTOM 60

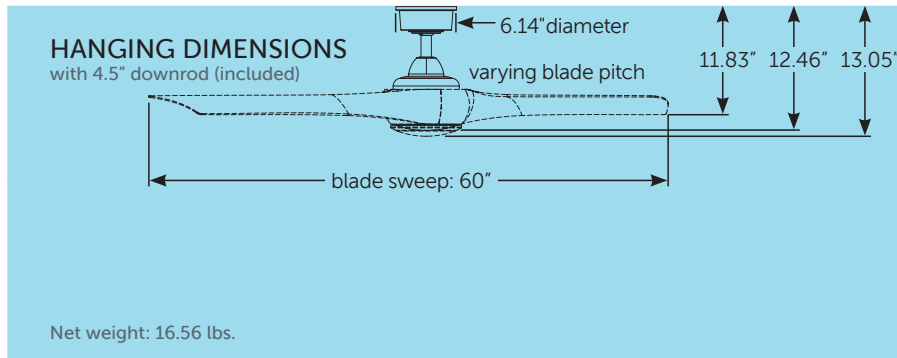

**CONTROL TYPE**

TR305 handheld remote included

**MOTOR TYPE & SIZE**

**DC 158 x 22**  
(LIMITED LIFETIME WARRANTY)

Reverse switch on remote

**FAN SPEEDS**  
variable

**HIGH-SPEED RPM**  
138

**\*HIGH-SPEED CFM**  
7,141 CFM

**LOCATION RATING**

dry damp wet

✓ ✓ ✗

**LIGHTING—LK8530\*\***  
(sold separately)

18W LED with opal frosted glass

**LIGHTING SPECS—LK8530\*\***  
(sold separately)

**18W integrated LED**  
with CCT Select

lumens: 1,600  
CCT: 3000k/4000k/5000k  
CRI: 90

**MOUNTING TYPE**

downrod sloped flush  
4.5" included up to 27" included sold separately

✓ ✓ ✓



SCAN EACH QR CODE FOR FULL IMAGE

ENERGY GUIDE				
	<b>TOTAL AIR VOLUME</b>	<b>ENERGY USE</b>	<b>ESTIMATED YEARLY ENERGY COST</b>	<b>AIRFLOW EFFICIENCY</b>
<b>AVERAGE SPEED</b>	5,114 CFM	24 Watts	\$7	211 CFM/Watts

**CERTIFICATION**

FANIMATION.COM

\*Airflow testing is conducted in accordance with the US Department of Energy's testing standards and under specific controlled environmental conditions. Actual airflow performance may vary based on the installation location and environmental factors.

# MIX & MATCH FAN MOTOR, BLADES & LIGHT KIT SOLD SEPARATELY

≡
☀
☂

**DC MOTOR**      **DRY**      **DAMP**

**required**  
(sold separately)

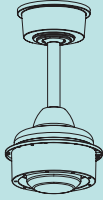

**Motor**  
MAD8530\*\*

Includes remote:



+





**Blade Set**  
BPW8530-60\*\*

\*\* replace with available finish codes below

## optional accessories

(sold separately)

- light kit

**LED Light Kit**  
LK8530\*\*
- mounting



**Close-To-Ceiling Kit**  
CCK8002\*\*



**Sloped Ceiling Ball**  
(up to 42°)  
SCB1-52



**Longer Downrods**  
page 195
- controls



**2-wire Fan-only Wall Control**  
TW306

## ordering example

MAD8530BL  
(black motor)  
+  
BPW8530-60BL  
(black blade set)  
+  
LK8530BS  
(brushed satin brass light kit)



WRAP™ CUSTOM 60

### motor & light kit finishes

 BL black	 BN brushed nickel	 BS brushed satin brass
 DZ dark bronze	 GR matte greige	 MW matte white

### blade finishes

 BL black	 BN brushed nickel	 DWA dark walnut
 MW matte white	 N natural	 WE weathered wood
 WW white washed		

view larger swatches on page 197

# WRAP™ CUSTOM 64

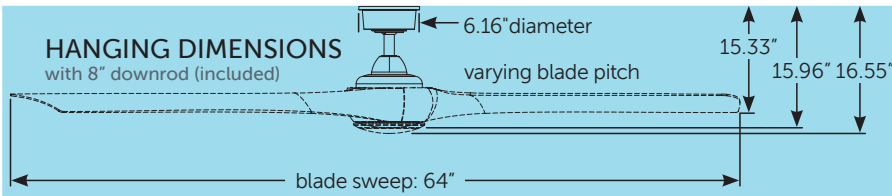

Net weight: 18.06 lbs.

## CONTROL TYPE



TR305 handheld remote included

## MOTOR TYPE & SIZE

**DC 153 x 25FS**  
(LIMITED LIFETIME WARRANTY)

Reverse switch on remote

## FAN SPEEDS

variable

HIGH-SPEED RPM  
**124**

\*HIGH-SPEED CFM  
**8,887 CFM**

## LOCATION RATING



dry



damp



wet



**LIGHTING—LK8530\*\***  
(sold separately)

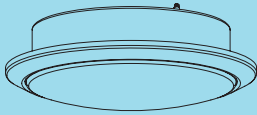

18W LED with opal frosted glass

**LIGHTING SPECS—LK8530\*\***  
(sold separately)

**18W integrated LED**  
with CCT Select  
lumens: 1,600  
CCT: 3000k/4000k/5000k  
CRI: 90

## MOUNTING TYPE



downrod  
8" included



sloped  
up to 27° included



flush  
sold separately



SCAN EACH QR CODE FOR FULL IMAGE



## ENERGY GUIDE

## CERTIFICATION

AVERAGE  
SPEED

TOTAL AIR  
VOLUME

6,448 CFM

ENERGY  
USE

21 Watts

ESTIMATED YEARLY  
ENERGY COST

\$6

AIRFLOW  
EFFICIENCY

307 CFM/Watts



FANIMATION.COM

\*Airflow testing is conducted in accordance with the US Department of Energy's testing standards and under specific controlled environmental conditions. Actual airflow performance may vary based on the installation location and environmental factors.



# MIX & MATCH FAN MOTOR, BLADES & LIGHT KIT SOLD SEPARATELY

≡
☀
☂

**DC MOTOR** **DRY** **DAMP**

**required**  
(sold separately)

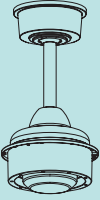

**Motor**  
MAD8531\*\*

Includes remote:



+







**Blade Set**  
BPW8531-64\*\*

\*\* replace with available finish codes below

## optional accessories

(sold separately)

light kit		<p><b>LED Light Kit</b> LK8530**</p>
mounting		<p><b>Close-To-Ceiling Kit</b> CCK8002**</p>
		<p><b>Sloped Ceiling Ball</b> (up to 42°) SCB1-52</p>
		<p><b>Longer Downrods</b> page 195</p>
controls		<p><b>2-wire Fan-only Wall Control</b> TW306</p>

## ordering example

MAD8531BS  
(brushed satin brass motor)  
+  
BPW8531-64DWA  
(dark walnut blade set)



WRAP™ CUSTOM 64

### motor & light kit finishes

 BL black	 BN brushed nickel	 BS brushed satin brass
 DZ dark bronze	 GR matte greige	 MW matte white

### blade finishes

 BL black	 BN brushed nickel	 DWA dark walnut
 MW matte white	 N natural	 WE weathered wood
 WW white washed		

view larger swatches on page 197

# WRAP™ CUSTOM 72

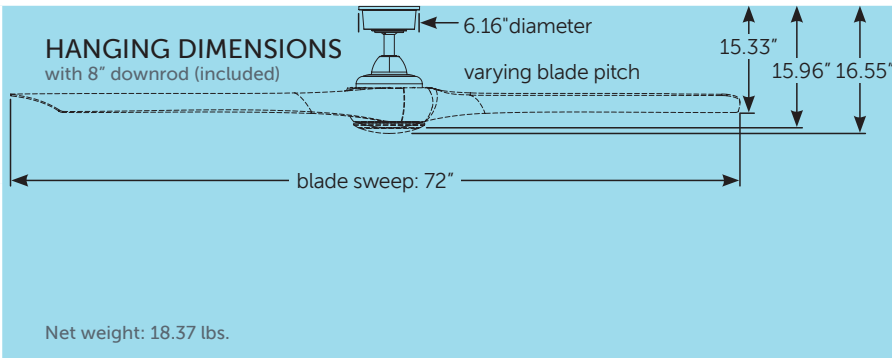

**CONTROL TYPE**

wifi + fanSync by FANIMATION

TR305 handheld remote included

**MOTOR TYPE & SIZE**

**DC 153 x 25FS**  
(LIMITED LIFETIME WARRANTY)

Reverse switch on remote

**FAN SPEEDS**  
variable

HIGH-SPEED RPM  
**107**

\*HIGH-SPEED CFM  
**10,846 CFM**

**LOCATION RATING**

dry damp wet

✓ ✓ ✗

**LIGHTING—LK8530\*\***  
(sold separately)

18W LED with opal frosted glass

**LIGHTING SPECS—LK8530\*\***  
(sold separately)

**18W integrated LED with CCT Select**

lumens: 1,600

CCT: 3000k/4000k/5000k

CRI: 90

**MOUNTING TYPE**

downrod sloped flush

8" included up to 27" included sold separately

✓ ✓ ✓



SCAN EACH QR CODE FOR FULL IMAGE

ENERGY GUIDE				
	<b>TOTAL AIR VOLUME</b>	<b>ENERGY USE</b>	<b>ESTIMATED YEARLY ENERGY COST</b>	<b>AIRFLOW EFFICIENCY</b>
<b>AVERAGE SPEED</b>	7,685 CFM	21 Watts	\$6	372 CFM/Watts

**CERTIFICATION**

FANIMATION.COM

\*Airflow testing is conducted in accordance with the US Department of Energy's testing standards and under specific controlled environmental conditions. Actual airflow performance may vary based on the installation location and environmental factors.

# MIX & MATCH FAN

MOTOR, BLADES & LIGHT KIT  
SOLD SEPARATELY

**DC MOTOR** **DRY** **DAMP**

**required**  
(sold separately)

**Motor**  
MAD8531\*\*  
Includes remote:

**Blade Set**  
BPW8531-72\*\*

\*\* replace with available finish codes below

## optional accessories

(sold separately)

**light kit** **LED Light Kit** LK8530\*\*

**mounting** **Close-To-Ceiling Kit** CCK8002\*\* | **Sloped Ceiling Ball (up to 42°)** SCB1-52 | **Longer Downrods** page 195

**controls** **2-wire Fan-only Wall Control** TW306

## ordering example

MAD8531BS  
(brushed satin brass motor)  
+  
BPW8531-72N  
(natural blade set)  
+  
LK8530BS  
(brushed satin brass light kit)



### motor & light kit finishes

<b>BL</b> black	<b>BN</b> brushed nickel	<b>BS</b> brushed satin brass
<b>DZ</b> dark bronze	<b>GR</b> matte greige	<b>MW</b> matte white

### blade finishes

<b>BL</b> black	<b>BN</b> brushed nickel	<b>DWA</b> dark walnut
<b>MW</b> matte white	<b>N</b> natural	<b>WE</b> weathered wood
<b>WW</b> white washed		

view larger swatches on page 197

# WRAP™ CUSTOM 84

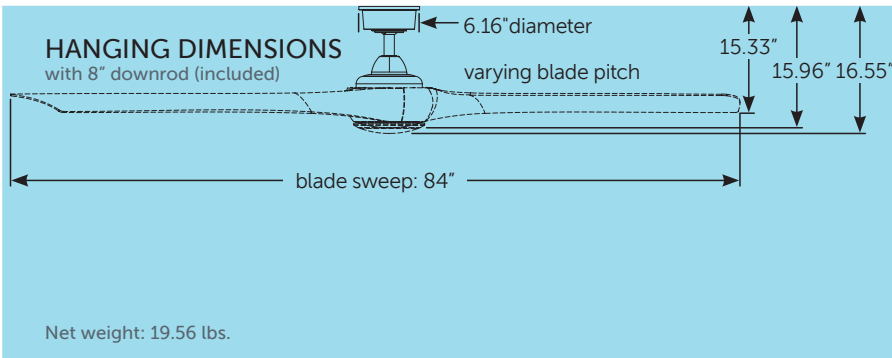

**CONTROL TYPE**

TR305 handheld remote included

**MOTOR TYPE & SIZE**

**DC 153 x 25FS**  
(LIMITED LIFETIME WARRANTY)

Reverse switch on remote

**FAN SPEEDS**  
variable

**HIGH-SPEED RPM**  
81

**\*HIGH-SPEED CFM**  
11,206 CFM

**LOCATION RATING**

dry  damp  wet

**LIGHTING—LK8530\*\***  
(sold separately)

18W LED with opal frosted glass

**LIGHTING SPECS—LK8530\*\***  
(sold separately)

**18W integrated LED with CCT Select**  
lumens: 1,600  
CCT: 3000k/4000k/5000k  
CRI: 90

**MOUNTING TYPE**

downrod  sloped  flush   
8" included up to 27" included sold separately



SCAN EACH QR CODE FOR FULL IMAGE

ENERGY GUIDE				
AVERAGE SPEED	TOTAL AIR VOLUME	ENERGY USE	ESTIMATED YEARLY ENERGY COST	AIRFLOW EFFICIENCY
	8,762 CFM	21 Watts	\$6	420 CFM/Watts

**CERTIFICATION**

FANIMATION.COM

\*Airflow testing is conducted in accordance with the US Department of Energy's testing standards and under specific controlled environmental conditions. Actual airflow performance may vary based on the installation location and environmental factors.

# MIX & MATCH FAN MOTOR, BLADES & LIGHT KIT SOLD SEPARATELY

DC MOTOR
DRY
DAMP

**required**  
(sold separately)

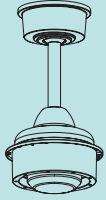

**Motor**  
MAD8531\*\*

Includes remote:



+







**Blade Set**  
BPW8531-84\*\*

\*\* replace with available finish codes below

## optional accessories

(sold separately)

<p>light kit</p> 	<p><b>LED Light Kit</b> LK8530**</p>		
<p>mounting</p> 	<p><b>Close-To-Ceiling Kit</b> CCK8002**</p>		<p><b>Sloped Ceiling Ball</b> (up to 42°) SCB1-52</p>
<p>controls</p> 	<p><b>2-wire Fan-only Wall Control</b> TW306</p>		<p><b>Longer Downrods</b> page 195</p>

## ordering example

MAD8531BL  
(black motor)  
+  
BPW8531-84BL  
(black blade set)  
+  
LK8530BS  
(brush satin brass light kit)



WRAP™ CUSTOM 84

### motor & light kit finishes

 BL black	 BN brushed nickel	 BS brushed satin brass
 DZ dark bronze	 GR matte greige	 MW matte white

### blade finishes

 BL black	 BN brushed nickel	 DWA dark walnut
 MW matte white	 N natural	 WE weathered wood
 WW white washed		

view larger swatches on page 197



44-INCH



48-INCH



52-INCH



56-INCH



60-INCH

TRIAIRE™ CUSTOM



64-INCH

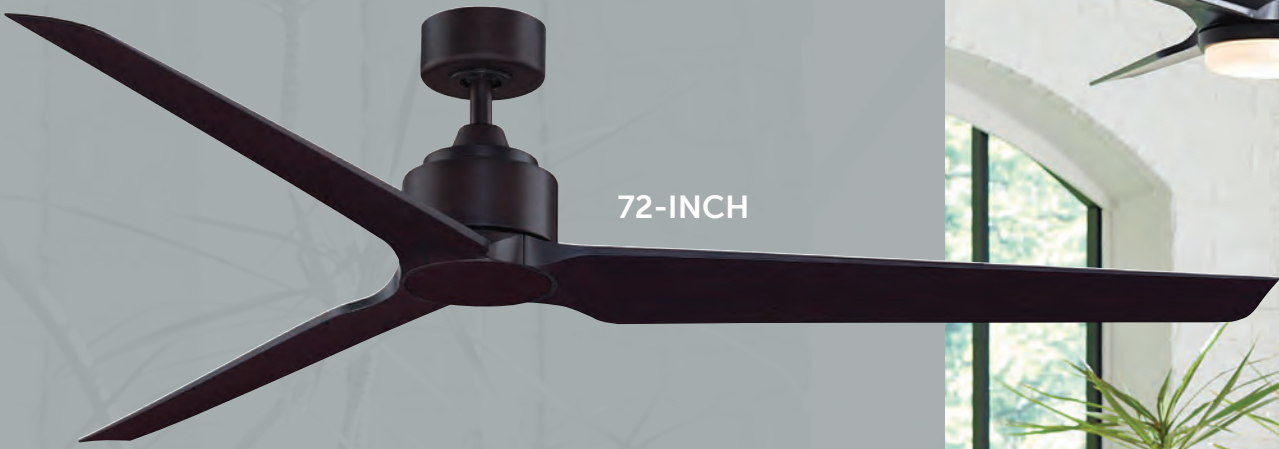

72-INCH



84-INCH





WET RATED

MAD8514\*\*M/MAD8515\*\*M

MAD8514\*\*W/MAD8515\*\*W

Stainless 316

Stainless 304

Composite

Galvanized & painted steel

Composite

Galvanized & painted steel

Composite

Galvanized & painted steel

Composite

Galvanized & painted steel

Composite

Composite

Stainless 316 & Composite

Galvanized & painted steel

Glass

Glass

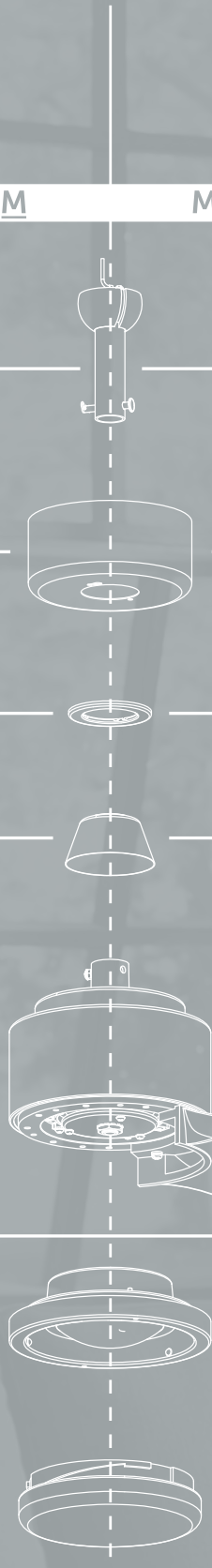





TRIPLE™ CUSTOM—MARINE GRADE



# TRIARE™ CUSTOM 44—WET LOCATION & MARINE GRADE

**HANGING DIMENSIONS**  
with 4.5" downrod (included)

5.75" diameter  
14° blade pitch  
blade sweep: 44"  
12.42"  
12.92"  
14.62"

Net weight: 15.85 lbs.

**CONTROL TYPE**

+ **fanSync** by Fanimation

TR305 handheld remote included

OPTIONAL

FINISHES

**MOTOR TYPE & SIZE**

**DC 158 x 22**  
(LIMITED LIFETIME WARRANTY)

Reverse switch on remote

**FAN SPEEDS**  
variable

HIGH-SPEED RPM  
**268**

\*HIGH-SPEED CFM  
**5,103 CFM**

**LOCATION RATING**

dry

damp

wet

**LIGHTING—LK8514\*\*W (WET) & LK8514\*\*M (MARINE)**  
(sold separately)

18W LED with opal frosted glass

**LIGHTING SPECS**  
LK8514\*\*M & LK8514\*\*W  
(sold separately)

**18W integrated LED with CCT Select**

lumens: 1,600  
CCT: 3000k/4000k/5000k  
CRI: 90

**MOUNTING TYPE**

downrod  
4.5" included

sloped  
up to 27° included

flush  
sold separately



SCAN EACH QR CODE FOR FULL IMAGE

ENERGY GUIDE					CERTIFICATION
AVERAGE SPEED	TOTAL AIR VOLUME	ENERGY USE	ESTIMATED YEARLY ENERGY COST	AIRFLOW EFFICIENCY	
	2,975 CFM	12 Watts	\$3	256	

# MIX & MATCH FAN MOTOR, BLADES & LIGHT KIT SOLD SEPARATELY

**DC MOTOR** **DRY** **DAMP** **WET**

**required**  
(sold separately)

**Motor**  
MAD8514\*\*M (MARINE GRADE)  
MAD8514\*\*W (WET LOCATION)

Includes remote: + 

**Blade Set**  
BPW8514-44\*\*W



\*\* replace with available finish codes below

## optional accessories

(sold separately)



**LED Light Kit**  
LK8514\*\*M (MARINE GRADE)  
LK8514\*\*W (WET LOCATION)



## ordering example

MAD8514MWM  
(matte white motor)  
+  
BPW8514-44MWW  
(matte white blade set)  
+  
LK8514MWM  
(matte white light kit)



TRIAIRE™ CUSTOM 44

### motor & light kit finishes

 BLM black (marine grade)	 BLW black	 DZW dark bronze
 GRW matte greige	 MWM matte white (marine grade)	 MWW matte white
	 SLW silver	

### blade finishes

 BLW black	 DWAU dark walnut	 MWW matte white
 SLW silver	 WEW weathered wood	

view larger swatches on page 197

# TRIARE™ CUSTOM 48—WET LOCATION & MARINE GRADE

**HANGING DIMENSIONS**  
with 4.5" downrod (included)

Net weight: 16.10 lbs.

**CONTROL TYPE**

TR305 handheld remote included

OPTIONAL

FINISHES

**MOTOR TYPE & SIZE**

**DC 158 x 22**  
(LIMITED LIFETIME WARRANTY)

Reverse switch on remote

**FAN SPEEDS**  
variable

HIGH-SPEED RPM  
**216**

\*HIGH-SPEED CFM  
**5,297 CFM**

**LOCATION RATING**

dry

damp

wet

**LIGHTING—LK8514\*\*W (WET) & LK8514\*\*M (MARINE)**  
(sold separately)

18W LED with opal frosted glass

**LIGHTING SPECS**  
LK8514\*\*M & LK8514\*\*W  
(sold separately)

**18W integrated LED with CCT Select**

lumens: 1,600  
CCT: 3000k/4000k/5000k  
CRI: 90

**MOUNTING TYPE**

downrod  
4.5" included

sloped  
up to 27" included

flush  
sold separately



SCAN EACH QR CODE FOR FULL IMAGE

ENERGY GUIDE				
AVERAGE SPEED	TOTAL AIR VOLUME	ENERGY USE	ESTIMATED YEARLY ENERGY COST	AIRFLOW EFFICIENCY
	3,412 CFM	13 Watts	\$4	259



**CERTIFICATION**

# MIX & MATCH FAN MOTOR, BLADES & LIGHT KIT SOLD SEPARATELY

**DC MOTOR**      **DRY**      **DAMP**      **WET**

**required**  
(sold separately)

**Motor**  
MAD8514\*\*M (MARINE GRADE)  
MAD8514\*\*W (WET LOCATION)

Includes remote:  + 



**Blade Set**  
BPW8514-48\*\*W

\*\*M or \*\*W replace with available finish codes below

## optional accessories

(sold separately)

**light kit**  **LED Light Kit**  
LK8514\*\*M

**mounting**  **Close-To-Ceiling Kit**  
CCK8002\*\* (not marine grade)       **Sloped Ceiling Ball (up to 42°)**  
SCB1-52       **Longer Downrods**  
page 195

**controls**  **2-wire Fan-only Wall Control**  
TW306

## ordering example

MAD8514BLM  
(black motor)  
+  
BPW8514-48BLW  
(black blade set)  
+  
LK8514BLM  
(black light kit)



TRIPIRE™ CUSTOM 48

### motor & light kit finishes

 BLM black (marine grade)	 BLW black	 DZW dark bronze
 GRW matte greige	 MWM matte white (marine grade)	 MWW matte white
	 SLW silver	

### blade finishes

 BLW black	 DWAU dark walnut	 MWW matte white
 SLW silver	 WEW weathered wood	

view larger swatches on page 197

# TRIARE™ CUSTOM 52 – WET LOCATION & MARINE GRADE

**HANGING DIMENSIONS**  
with 4.5" downrod (included)

5.75" diameter  
14° blade pitch  
blade sweep: 52"  
12.42"  
12.92"  
14.62"

**CONTROL TYPE**

TR305 handheld remote included

Net weight: 16.36 lbs.

**MARINE  
GRADE**

**MOTOR TYPE & SIZE**

**DC 158 x 22**  
(LIMITED LIFETIME WARRANTY)

Reverse switch on remote

**FAN SPEEDS**  
variable

**HIGH-SPEED RPM**  
205

**\*HIGH-SPEED CFM**  
6,100 CFM

**LOCATION RATING**

dry

damp

wet

**LIGHTING—LK8514\*\*W (WET) & LK8514\*\*M (MARINE)**  
(sold separately)

18W LED with opal frosted glass

**LIGHTING SPECS**  
LK8514\*\*M & LK8514\*\*W  
(sold separately)

**18W integrated LED with CCT Select**  
lumens: 1,600  
CCT: 3000k/4000k/5000k  
CRI: 90

**MOUNTING TYPE**

downrod  
4.5" included

sloped  
up to 27" included

flush  
sold separately



SCAN EACH QR CODE FOR FULL IMAGE



ENERGY GUIDE					CERTIFICATION
AVERAGE SPEED	TOTAL AIR VOLUME	ENERGY USE	ESTIMATED YEARLY ENERGY COST	AIRFLOW EFFICIENCY	
	3,696 CFM	12 Watts	\$3	299	

# MIX & MATCH FAN MOTOR, BLADES & LIGHT KIT SOLD SEPARATELY

**DC MOTOR**      **DRY**      **DAMP**      **WET**

**required**  
(sold separately)

**Motor**  
MAD8514\*\*M (MARINE GRADE)  
MAD8514\*\*W (WET LOCATION)

Includes remote:  + 



**Blade Set**  
BPW8514-52\*\*W

\*\*M or \*\*W replace with available finish codes below

## optional accessories

(sold separately)

**light kit**  **LED Light Kit**  
LK8514\*\*M

**mounting**  **Close-To-Ceiling Kit**  
CCK8002\*\* (not marine grade)       **Sloped Ceiling Ball (up to 42°)**  
SCB1-52       **Longer Downrods**  
page 195

**controls**  **2-wire Fan-only Wall Control**  
TW306

## ordering example

MAD8514MWM  
(matte white motor)  
+  
BPW8514-52MWW  
(matte white blade set)  
+  
LK8514MWM  
(matte white light kit)



### motor & light kit finishes

 BLM black (marine grade)	 BLW black	 DZW dark bronze
 GRW matte greige	 MWM matte white (marine grade)	 MWW matte white
	 SLW silver	

### blade finishes

 BLW black	 DWAU dark walnut	 MWW matte white
 SLW silver	 WEW weathered wood	

view larger swatches on page 197

# TRIARE™ CUSTOM 56—WET LOCATION & MARINE GRADE

**HANGING DIMENSIONS**  
with 4.5" downrod (included)

5.75" diameter  
14° blade pitch  
blade sweep: 56"  
12.42"  
12.92"  
14.62"

**CONTROL TYPE**

TR305 handheld remote included

Net weight: 16.95 lbs.

**MARINE  
GRADE**

**MOTOR TYPE & SIZE**

**DC 158 x 22**  
(LIMITED LIFETIME WARRANTY)

Reverse switch on remote

**FAN SPEEDS**  
variable

**HIGH-SPEED RPM**  
184

**\*HIGH-SPEED CFM**  
6,775 CFM

**LOCATION RATING**

dry

damp

wet

**LIGHTING—LK8514\*\*W (WET) & LK8514\*\*M (MARINE)**  
(sold separately)

18W LED with opal frosted glass

**LIGHTING SPECS**  
LK8514\*\*M & LK8514\*\*W  
(sold separately)

**18W integrated LED with CCT Select**

lumens: 1,600  
CCT: 3000k/4000k/5000k  
CRI: 90

**MOUNTING TYPE**

downrod  
4.5" included

sloped  
up to 27° included

flush  
sold separately



SCAN EACH QR CODE FOR FULL IMAGE

ENERGY GUIDE					CERTIFICATION
AVERAGE SPEED	TOTAL AIR VOLUME	ENERGY USE	ESTIMATED YEARLY ENERGY COST	AIRFLOW EFFICIENCY	
	4,252 CFM	14 Watts	\$4	294	

\*Airflow testing is conducted in accordance with the US Department of Energy's testing standards and under specific controlled environmental conditions. Actual airflow performance may vary based on the installation location and environmental factors.





# MIX & MATCH FAN MOTOR, BLADES & LIGHT KIT SOLD SEPARATELY

**DC MOTOR**      **DRY**      **DAMP**      **WET**

**required**  
(sold separately)

**Motor**  
MAD8514\*\*M (MARINE GRADE)  
MAD8514\*\*W (WET LOCATION)

Includes remote:  + 



**Blade Set**  
BPW8514-56\*\*W

\*\*M or \*\*W replace with available finish codes below

## optional accessories

(sold separately)

**light kit**  **LED Light Kit**  
LK8514\*\*M

**mounting**  **Close-To-Ceiling Kit**  
CCK8002\*\* (not marine grade)       **Sloped Ceiling Ball (up to 42°)**  
SCB1-52       **Longer Downrods**  
page 195

**controls**  **2-wire Fan-only Wall Control**  
TW306

## ordering example

MAD8514BLM  
(black motor)  
+  
BPW8514-56BLW  
(black blade set)  
+  
LK8514BLM  
(black light kit)



### motor & light kit finishes

 BLM black (marine grade)	 BLW black	 DZW dark bronze
 GRW matte greige	 MWM matte white (marine grade)	 MWW matte white
 SLW silver		

### blade finishes

 BLW black	 DWAU dark walnut	 MWW matte white
 SLW silver	 WEW weathered wood	

view larger swatches on page 197

# TRIARE™ CUSTOM 60—WET LOCATION & MARINE GRADE

**HANGING DIMENSIONS**  
with 4.5" downrod (included)

Net weight: 17.26 lbs.

**CONTROL TYPE**

+ **fanSync** by FANIMATION

TR305 handheld remote included

**MOTOR TYPE & SIZE**

**DC 158 x 22**  
(LIMITED LIFETIME WARRANTY)

Reverse switch on remote

**FAN SPEEDS**  
variable

**HIGH-SPEED RPM**  
161

**\*HIGH-SPEED CFM**  
6,765 CFM

**LOCATION RATING**

dry

damp

wet

**LIGHTING—LK8514\*\*W (WET) & LK8514\*\*M (MARINE)**  
(sold separately)

18W LED with opal frosted glass

**LIGHTING SPECS**  
LK8514\*\*M & LK8514\*\*W  
(sold separately)

**18W integrated LED with CCT Select**

lumens: 1,600  
CCT: 3000k/4000k/5000k  
CRI: 90

**MOUNTING TYPE**

downrod  
4.5" included

sloped  
up to 27° included

flush  
sold separately



SCAN EACH QR CODE FOR FULL IMAGE

ENERGY GUIDE					CERTIFICATION
AVERAGE SPEED	TOTAL AIR VOLUME	ENERGY USE	ESTIMATED YEARLY ENERGY COST	AIRFLOW EFFICIENCY	
	4,860 CFM	20 Watts	\$6	247	

# MIX & MATCH FAN MOTOR, BLADES & LIGHT KIT SOLD SEPARATELY



**DC MOTOR**



**DRY**



**DAMP**



**WET**

**required**  
(sold separately)



**Motor**  
MAD8514\*\*M (MARINE GRADE)  
MAD8514\*\*W (WET LOCATION)

Includes remote: +





**Blade Set**  
BPW8514-60\*\*W

\*\*M or \*\*W replace with available finish codes below

## optional accessories (sold separately)

light kit



**LED Light Kit**  
LK8514\*\*M

mounting



**Close-To-Ceiling Kit**  
CCK8002\*\*  
(not marine grade)



**Sloped Ceiling Ball**  
(up to 42°)  
SCB1-52



**Longer Downrods**  
page 195

controls



**2-wire Fan-only Wall Control**  
TW306

## ordering example

MAD8514BLM  
(black motor)  
+  
BPW8514-60BLW  
(black blade set)



TRIAIRE™ CUSTOM 60

### motor & light kit finishes

 BLM black (marine grade)	 BLW black	 DZW dark bronze
 GRW matte greige	 MWM matte white (marine grade)	 MWW matte white
 SLW silver		

### blade finishes

 BLW black	 DWAU dark walnut	 MWW matte white
 SLW silver	 WEW weathered wood	

view larger swatches on page 197

# TRIARE™ CUSTOM 64—WET LOCATION & MARINE GRADE

**HANGING DIMENSIONS**  
with 8" downrod (included)

5.75" diameter  
14° blade pitch  
blade sweep: 64"  
15.92" 16.42" 18.12"

Net weight: 18.88 lbs.

**CONTROL TYPE**

WiFi + fanSync by Fanimation

TR305 handheld remote included

<p><b>MOTOR TYPE &amp; SIZE</b></p> <p><b>DC 153 x 25FS</b> <small>(LIMITED LIFETIME WARRANTY)</small></p> <p>Reverse switch on remote</p>	<p><b>FAN SPEEDS</b></p> <p><b>variable</b></p> <hr/> <p>HIGH-SPEED RPM</p> <p><b>140</b></p> <hr/> <p>*HIGH-SPEED CFM</p> <p><b>7,435 CFM</b></p>	<p><b>LOCATION RATING</b></p> <div style="display: flex; justify-content: space-around;"> <div style="text-align: center;">  dry <input checked="" type="checkbox"/></div> <div style="text-align: center;">  damp <input checked="" type="checkbox"/></div> <div style="text-align: center;">  wet <input checked="" type="checkbox"/></div> </div>
--	--	--

<p><b>LIGHTING—LK8514**W (WET) &amp; LK8514**M (MARINE)</b> <small>(sold separately)</small></p> <p>18W LED with opal frosted glass</p>	<p><b>LIGHTING SPECS</b> LK8514**M &amp; LK8514**W <small>(sold separately)</small></p> <p><b>18W integrated LED with CCT Select</b></p> <p>lumens: 1,600 CCT: 3000k/4000k/5000k CRI: 90</p>	<p><b>MOUNTING TYPE</b></p> <div style="display: flex; justify-content: space-around;"> <div style="text-align: center;">  downrod 8" included <input checked="" type="checkbox"/></div> <div style="text-align: center;">  sloped up to 27" included <input checked="" type="checkbox"/></div> <div style="text-align: center;">  flush sold separately <input checked="" type="checkbox"/></div> </div>
---	--	---

SCAN EACH QR CODE FOR FULL IMAGE

ENERGY GUIDE					CERTIFICATION
AVERAGE SPEED	TOTAL AIR VOLUME 5,680 CFM	ENERGY USE 17 Watts	ESTIMATED YEARLY ENERGY COST \$5	AIRFLOW EFFICIENCY 328	



FANIMATION.COM \*Airflow testing is conducted in accordance with the US Department of Energy's testing standards and under specific controlled environmental conditions. Actual airflow performance may vary based on the installation location and environmental factors.

# MIX & MATCH FAN MOTOR, BLADES & LIGHT KIT SOLD SEPARATELY

**DC MOTOR** **DRY** **DAMP** **WET**

**required**  
(sold separately)

**Motor**  
MAD8515\*\*M (MARINE GRADE)  
MAD8515\*\*W (WET LOCATION)

Includes remote:  + 



**Blade Set**  
BPW8515-64\*\*W

\*\*M or \*\*W replace with available finish codes below

## optional accessories

(sold separately)

**light kit**  **LED Light Kit**  
LK8514\*\*M

**mounting**  **Close-To-Ceiling Kit**  
CCK8002\*\* (not marine grade) |  **Sloped Ceiling Ball (up to 42°)**  
SCB1-52 |  **Longer Downrods**  
page 195

**controls**  **2-wire Fan-only Wall Control**  
TW306

## ordering example

MAD8515MWM  
(matte white motor)  
+  
BPW8515-64MWW  
(matte white blade set)  
+  
LK8514MWM  
(matte white light kit)



TRIAIRE™ CUSTOM 64

### motor & light kit finishes

 BLM black (marine grade)	 BLW black	 DZW dark bronze
 GRW matte greige	 MWM matte white (marine grade)	 MWW matte white
	 SLW silver	

### blade finishes

 BLW black	 DWAU dark walnut	 MWW matte white
 SLW silver	 WEW weathered wood	

view larger swatches on page 197

# TRIARE™ CUSTOM 72—WET LOCATION & MARINE GRADE

**HANGING DIMENSIONS**  
with 8" downrod (included)

Net weight: 19.68 lbs.

**CONTROL TYPE**

+ **fanSync**  
by FANIMATION

TR305 handheld remote included

**MOTOR TYPE & SIZE**

**DC 153 x 25FS**  
(LIMITED LIFETIME WARRANTY)

Reverse switch on remote

**FAN SPEEDS**  
variable

HIGH-SPEED RPM  
**124**

\*HIGH-SPEED CFM  
**8,666 CFM**

**LOCATION RATING**

dry

damp

wet

**LIGHTING—LK8514\*\*W (WET) & LK8514\*\*M (MARINE)**  
(sold separately)

18W LED with opal frosted glass

**LIGHTING SPECS**  
LK8514\*\*M & LK8514\*\*W  
(sold separately)

**18W integrated LED with CCT Select**

lumens: 1,600  
CCT: 3000k/4000k/5000k  
CRI: 90

**MOUNTING TYPE**

downrod  
8" included

sloped  
up to 27" included

flush  
sold separately



SCAN EACH QR CODE FOR FULL IMAGE



ENERGY GUIDE					CERTIFICATION
AVERAGE SPEED	TOTAL AIR VOLUME	ENERGY USE	ESTIMATED YEARLY ENERGY COST	AIRFLOW EFFICIENCY	
	6,722 CFM	20 Watts	\$6	328	

# MIX & MATCH FAN MOTOR, BLADES & LIGHT KIT SOLD SEPARATELY

**DC MOTOR**      **DRY**      **DAMP**      **WET**

**required**  
(sold separately)

**Motor**  
MAD8515\*\*M (MARINE GRADE)  
MAD8515\*\*W (WET LOCATION)

Includes remote:  + 



**Blade Set**  
BPW8515-72\*\*W

\*\*M or \*\*W replace with available finish codes below

## optional accessories

(sold separately)

**light kit**  **LED Light Kit**  
LK8514\*\*M

**mounting**  **Close-To-Ceiling Kit**  
CCK8002\*\* (not marine grade)       **Sloped Ceiling Ball**  
(up to 42°)  
SCB1-52       **Longer Downrods**  
page 195

**controls**  **2-wire Fan-only Wall Control**  
TW306

## ordering example

MAD8515BLM  
(black motor)  
+  
BPW8515-72BLW  
(black blade set)



### motor & light kit finishes

 BLM black (marine grade)	 BLW black	 DZW dark bronze
 GRW matte greige	 MWM matte white (marine grade)	 MWW matte white
 SLW silver		

### blade finishes

 BLW black	 DWAU dark walnut	 MWW matte white
 SLW silver	 WEW weathered wood	

view larger swatches on page 197

# TRIARE™ CUSTOM 84—WET LOCATION & MARINE GRADE

**HANGING DIMENSIONS**  
with 8" downrod (included)

5.75" diameter  
14° blade pitch  
blade sweep: 84"  
15.92" 16.42" 18.12"

**MARINE GRADE**

Net weight: 20.26 lbs.

**CONTROL TYPE**

WiFi + fanSync by Fanimation

TR305 handheld remote included

<p><b>MOTOR TYPE &amp; SIZE</b></p> <p><b>DC 153 x 25FS</b> (LIMITED LIFETIME WARRANTY)</p> <p>Reverse switch on remote</p>	<p><b>FAN SPEEDS</b></p> <p><b>variable</b></p> <hr/> <p>HIGH-SPEED RPM</p> <p><b>100</b></p> <hr/> <p>*HIGH-SPEED CFM</p> <p><b>10,387 CFM</b></p>	<p><b>LOCATION RATING</b></p> <div style="display: flex; justify-content: space-around;"> <div style="text-align: center;">  dry <input checked="" type="checkbox"/> </div> <div style="text-align: center;">  damp <input checked="" type="checkbox"/> </div> <div style="text-align: center;">  wet <input checked="" type="checkbox"/> </div> </div>
---	---	---

<p><b>LIGHTING—LK8514**W (WET) &amp; LK8514**M (MARINE)</b> (sold separately)</p> <p>18W LED with opal frosted glass</p>	<p><b>LIGHTING SPECS</b> LK8514**M &amp; LK8514**W (sold separately)</p> <p><b>18W integrated LED with CCT Select</b></p> <p>lumens: 1,600</p> <p>CCT: 3000k/4000k/5000k</p> <p>CRI: 90</p>	<p><b>MOUNTING TYPE</b></p> <div style="display: flex; justify-content: space-around;"> <div style="text-align: center;">  downrod 8" included <input checked="" type="checkbox"/> </div> <div style="text-align: center;">  sloped up to 27" included <input checked="" type="checkbox"/> </div> <div style="text-align: center;">  flush sold separately <input checked="" type="checkbox"/> </div> </div>
--	---	--



SCAN EACH QR CODE FOR FULL IMAGE

	<p><b>ENERGY GUIDE</b></p>	<p><b>CERTIFICATION</b></p>		
<p>AVERAGE SPEED</p>	<p>TOTAL AIR VOLUME</p> <p><b>7,827 CFM</b></p>	<p>ENERGY USE</p> <p><b>21 Watts</b></p>	<p>ESTIMATED YEARLY ENERGY COST</p> <p><b>\$6</b></p>	<p>AIRFLOW EFFICIENCY</p> <p><b>378</b></p>



# MIX & MATCH FAN MOTOR, BLADES & LIGHT KIT SOLD SEPARATELY



**DC MOTOR**



**DRY**



**DAMP**



**WET**

**required**  
(sold separately)



**Motor**  
MAD8515\*\*M (MARINE GRADE)  
MAD8515\*\*W (WET LOCATION)

Includes remote: +





**Blade Set**  
BPW8515-84\*\*W

\*\*M or \*\*W replace with available finish codes below

## optional accessories (sold separately)

**light kit**



**LED Light Kit**  
LK8514\*\*M

**mounting**



**Close-To-Ceiling Kit**  
CCK8002\*\*  
(not marine grade)

**mounting**



**Sloped Ceiling Ball**  
(up to 42°)  
SCB1-52

**mounting**



**Longer Downrods**  
page 195

**controls**



**2-wire Fan-only Wall Control**  
TW306

## ordering example

MAD8515MWM  
(matte white motor)  
+  
BPW8515-84MWW  
(matte white blade set)  
+  
LK8514MWM  
(matte white light kit)



TRIARE™ CUSTOM 84

### motor & light kit finishes

 BLM black (marine grade)	 BLW black	 DZW dark bronze
 GRW matte greige	 MWM matte white (marine grade)	 MWW matte white
 SLW silver		

### blade finishes

 BLW black	 DWA dark walnut	 MWW matte white
 SLW silver	 WEW weathered wood	

view larger swatches on page 197





ODYN™ CUSTOM

# ODYN™ CUSTOM 56

## HANGING DIMENSIONS with 12" downrod (included)

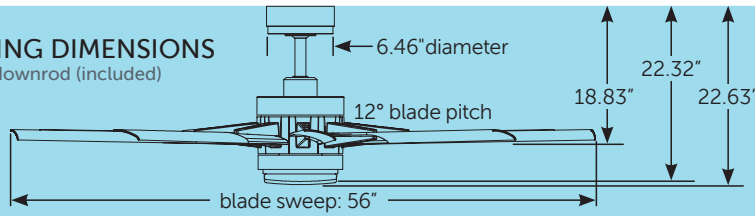

Net weight: 30.72 lbs.

## CONTROL TYPE



TR305 handheld remote included

## MOTOR TYPE & SIZE

**DC 135**

(LIMITED LIFETIME WARRANTY)

Reverse switch on remote

## FAN SPEEDS

variable

HIGH-SPEED RPM

**126**

\*HIGH-SPEED CFM

**7,587 CFM**

## LOCATION RATING



dry



damp



wet



## LIGHTING

(light kit with cap included)

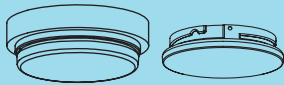

18W LED with opal frosted glass

## LIGHTING SPECS

**18W integrated LED  
with CCT Select**  
lumens: **1,600**  
CCT: 3000k/4000k/5000k  
CRI: 90

## MOUNTING TYPE



downrod  
12" included



sloped  
up to 27" included



flush  
sold separately



SCAN EACH QR CODE FOR FULL IMAGE



## ENERGY GUIDE

## CERTIFICATION

AVERAGE  
SPEED

TOTAL AIR  
VOLUME  
**5,627 CFM**

ENERGY  
USE  
**21 Watts**

ESTIMATED YEARLY  
ENERGY COST  
**\$6**

AIRFLOW  
EFFICIENCY  
**269**



FANIMATION.COM

\*Airflow testing is conducted in accordance with the US Department of Energy's testing standards and under specific controlled environmental conditions. Actual airflow performance may vary based on the installation location and environmental factors.

# MIX & MATCH FAN MOTOR, BLADES & LIGHT KIT SOLD SEPARATELY

**DC MOTOR** **DRY** **DAMP** **WET**

**required**  
(sold separately)

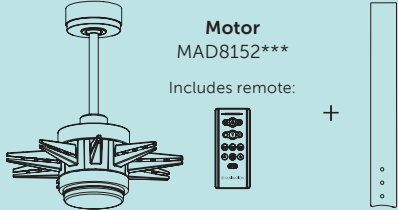

**Motor**  
MAD8152\*\*\*  
Includes remote:

**Blade Set**  
BPW8152-56\*\*\*

\*\*\* replace with available finish codes below

## optional accessories

(sold separately)

**mounting**

- Close-To-Ceiling Kit**  
CCK8002\*\*
- Sloped Ceiling Ball (up to 42°)**  
SCB1-52
- Longer Downrods**  
page 195

**controls**

- 2-wire Fan-only Wall Control**  
TW306

## ordering example

MAD8152BLW  
(black motor)  
+  
BPW8152-56DWA  
(dark walnut blade set)



ODYN™ CUSTOM 56

### motor & light kit finishes

<b>BLW</b> black	<b>BNW</b> brushed nickel	<b>DZW</b> dark bronze
<b>GRW</b> matte greige	<b>MWW</b> matte white	

### blade finishes

<b>BLW</b> black	<b>BNW</b> brushed nickel	<b>DWA</b> dark walnut
<b>MWW</b> matte white	<b>WEW</b> weathered wood	

view larger swatches on page 197

# ODYN™ CUSTOM 64

**HANGING DIMENSIONS**  
with 12" downrod (included)

6.46" diameter  
12° blade pitch  
blade sweep: 64"  
18.83"  
22.32"  
22.63"

Net weight: 31.60 lbs.

**CONTROL TYPE**

wifi + fanSync by FANIMATION

TR305 handheld remote included

<p><b>MOTOR TYPE &amp; SIZE</b></p> <p><b>DC 135</b> <small>(LIMITED LIFETIME WARRANTY)</small></p> <p>Reverse switch on remote</p>	<p><b>FAN SPEEDS</b></p> <p><b>variable</b></p> <hr/> <p>HIGH-SPEED RPM</p> <p><b>99</b></p> <hr/> <p>*HIGH-SPEED CFM</p> <p><b>8,415 CFM</b></p>	<p><b>LOCATION RATING</b></p> <div style="display: flex; justify-content: space-around;"> <div style="text-align: center;">  dry <input checked="" type="checkbox"/></div> <div style="text-align: center;">  damp <input checked="" type="checkbox"/></div> <div style="text-align: center;">  wet <input checked="" type="checkbox"/></div> </div>
---	---	--

<p><b>LIGHTING</b> <small>(light kit with cap included)</small></p> <p>18W LED with opal frosted glass</p>	<p><b>LIGHTING SPECS</b></p> <p><b>18W integrated LED with CCT Select</b></p> <p>lumens: 1,600 CCT: 3000k/4000k/5000k CRI: 90</p>	<p><b>MOUNTING TYPE</b></p> <div style="display: flex; justify-content: space-around;"> <div style="text-align: center;">  downrod 12" included <input checked="" type="checkbox"/></div> <div style="text-align: center;">  sloped up to 27" included <input checked="" type="checkbox"/></div> <div style="text-align: center;">  flush sold separately <input checked="" type="checkbox"/></div> </div>
--	---	--



	<b>ENERGY GUIDE</b>				<b>CERTIFICATION</b>
<b>AVERAGE SPEED</b>	<b>TOTAL AIR VOLUME</b>	<b>ENERGY USE</b>	<b>ESTIMATED YEARLY ENERGY COST</b>	<b>AIRFLOW EFFICIENCY</b>	
15	4,934 CFM	22 Watts	\$6	227	

FANIMATION.COM

\*Airflow testing is conducted in accordance with the US Department of Energy's testing standards and under specific controlled environmental conditions. Actual airflow performance may vary based on the installation location and environmental factors.

# MIX & MATCH FAN

**DC MOTOR**      **DRY**      **DAMP**      **WET**

**required**  
(sold separately)

**Motor**  
MAD8152\*\*\*  
Includes remote:

**Blade Set**  
BPW8152-64\*\*\*

\*\*\* replace with available finish codes below

## optional accessories

(sold separately)

**mounting**

**Close-To-Ceiling Kit**  
CCK8002\*\*

**Sloped Ceiling Ball (up to 42°)**  
SCB1-52

**Longer Downrods**  
page 195

**controls**

**2-wire Fan-only Wall Control**  
TW306

## ordering example

MAD8152DZW  
(dark bronze motor)  
+  
BPW8152-64WEW  
(weathered wood blade set)



ODYN™ CUSTOM 64

### motor & light kit finishes

<b>BLW</b> black	<b>BNW</b> brushed nickel	<b>DZW</b> dark bronze
<b>GRW</b> matte greige	<b>MWW</b> matte white	

### blade finishes

<b>BLW</b> black	<b>BNW</b> brushed nickel	<b>DWAW</b> dark walnut
<b>MWW</b> matte white	<b>WEW</b> weathered wood	

view larger swatches on page 197

# ODYN™ CUSTOM 72

**HANGING DIMENSIONS**  
with 12" downrod (included)

6.46" diameter  
12° blade pitch  
blade sweep: 72"  
18.83"  
22.32"  
22.63"

Net weight: 32.50 lbs.

**CONTROL TYPE**

+ **fanSync** by Fanimation

TR305 handheld remote included

<p><b>MOTOR TYPE &amp; SIZE</b></p> <p><b>DC 135</b> (LIMITED LIFETIME WARRANTY)</p> <p>Reverse switch on remote</p>	<p><b>FAN SPEEDS</b></p> <p><b>variable</b></p> <p>HIGH-SPEED RPM <b>79</b></p> <p>*HIGH-SPEED CFM <b>9,193 CFM</b></p>	<p><b>LOCATION RATING</b></p> <div style="display: flex; justify-content: space-around;"> <div style="text-align: center;">  dry <input checked="" type="checkbox"/></div> <div style="text-align: center;">  damp <input checked="" type="checkbox"/></div> <div style="text-align: center;">  wet <input checked="" type="checkbox"/></div> </div>
--	---	--

<p><b>LIGHTING</b> (light kit with cap included)</p> <p>18W LED with opal frosted glass</p>	<p><b>LIGHTING SPECS</b></p> <p><b>18W integrated LED with CCT Select</b></p> <p>lumens: 1,600 CCT: 3000k/4000k/5000k CRI: 90</p>	<p><b>MOUNTING TYPE</b></p> <div style="display: flex; justify-content: space-around;"> <div style="text-align: center;">  downrod 12" included <input checked="" type="checkbox"/></div> <div style="text-align: center;">  sloped up to 27" included <input checked="" type="checkbox"/></div> <div style="text-align: center;">  flush sold separately <input checked="" type="checkbox"/></div> </div>
---	---	--



<p><b>ENERGY GUIDE</b></p>					<p><b>CERTIFICATION</b></p>
<p>AVERAGE SPEED</p>	<p>TOTAL AIR VOLUME</p> <p><b>6,471 CFM</b></p>	<p>ENERGY USE</p> <p><b>20 Watts</b></p>	<p>ESTIMATED YEARLY ENERGY COST</p> <p><b>\$6</b></p>	<p>AIRFLOW EFFICIENCY</p> <p><b>326</b></p>	



# MIX & MATCH FAN

**DC MOTOR** **DRY** **DAMP** **WET**

**required**  
(sold separately)

**Motor**  
MAD8152\*\*\*  
Includes remote:

**Blade Set**  
BPW8152-72\*\*\*

\*\*\* replace with available finish code below

## optional accessories

(sold separately)

**mounting**

- Close-To-Ceiling Kit**  
CCK8002\*\*
- Sloped Ceiling Ball**  
(up to 42°)  
SCB1-52
- Longer Downrods**  
page 195

**controls**

- 2-wire Fan-only Wall Control**  
TW306

## ordering example

MAD8152MWW  
(matte white motor)  
+  
BPW8152-72MWW  
(matte white blade set)

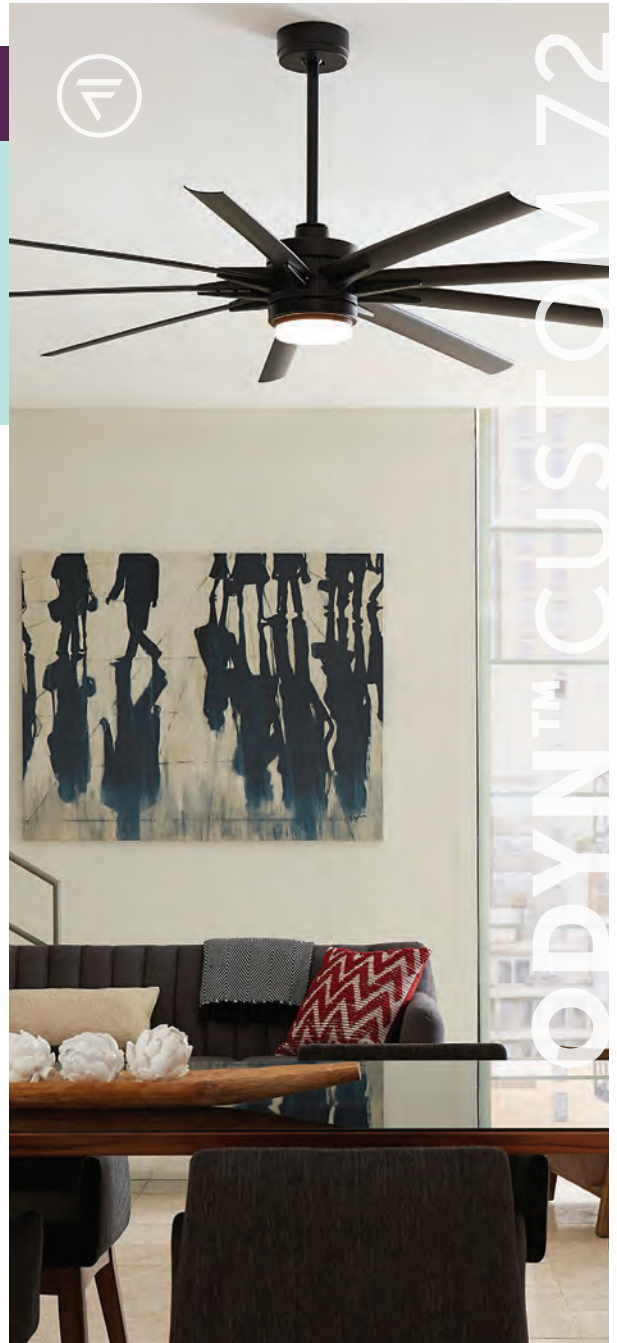

### motor & light kit finishes

<b>BLW</b> black	<b>BNW</b> brushed nickel	<b>DZW</b> dark bronze
<b>GRW</b> matte greige	<b>MWW</b> matte white	

### blade finishes

<b>BLW</b> black	<b>BNW</b> brushed nickel	<b>DWAW</b> dark walnut
<b>MWW</b> matte white	<b>WEW</b> weathered wood	

view larger swatches on page 197

# ODYN™ 84

## HANGING DIMENSIONS with 12" downrod (included)

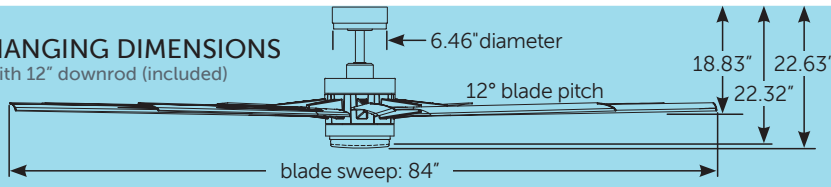

Net weight: 33.74 lbs.

## CONTROL TYPE



TR305 handheld remote included

## MOTOR TYPE & SIZE

**DC135L**

(LIMITED LIFETIME WARRANTY)

Reverse switch on remote

## FAN SPEEDS

variable

HIGH-SPEED RPM

70

\*HIGH-SPEED CFM

11,363 CFM

## LOCATION RATING



dry



damp



wet



## LIGHTING

(light kit with cap included)

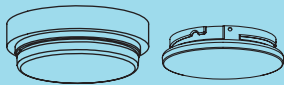

18W LED with opal frosted glass

## LIGHTING SPECS

18W integrated LED  
with CCT Select  
lumens: 1,600  
CCT: 3000k/4000k/5000k  
CRI: 90

## MOUNTING TYPE



downrod  
12" included



sloped  
up to 27°  
included



flush  
sold separately



SCAN EACH QR CODE FOR FULL IMAGE



## ENERGY GUIDE

## CERTIFICATION

AVERAGE SPEED	TOTAL AIR VOLUME 7,949 CFM	ENERGY USE 23 Watts	ESTIMATED YEARLY ENERGY COST \$7	AIRFLOW EFFICIENCY 339 CFM/Watts
---------------	-------------------------------	------------------------	-------------------------------------	-------------------------------------



\*Airflow testing is conducted in accordance with the US Department of Energy's testing standards and under specific controlled environmental conditions. Actual airflow performance may vary based on the installation location and environmental factors.

**DC MOTOR**
**DRY**
**DAMP**
**WET**

Fan: FPD8159\*\*\*  
included:

remote:

\*\*\* replace with available finish code below

**optional accessories**  
(sold separately)

**mounting**
**Close-To-Ceiling Kit**  
CCK8002\*\*
 **Sloped Ceiling Ball**  
(up to 42°)  
SCB1-52
 **Longer Downrods**  
page 195

**controls**
**2-wire Fan-only Wall Control**  
TW306

**FPD8159\*\*\* motor & blade finish combinations**

<p><b>BLW</b> black + black</p>	<p><b>DZW</b> dark bronze + dark walnut</p>
<p><b>BNWBL</b> brushed nickel + black</p>	<p><b>GRW</b> matte greige + weathered wood</p>
<p><b>BNWBN</b> brushed nickel + brushed nickel</p>	<p><b>MWW</b> matte white + matte white</p>

view larger swatches on page 197





STELLAR™ CUSTOM



# STELLAR™ CUSTOM 56

**HANGING DIMENSIONS**  
with 12" downrod (included)

6.30" diameter  
12.6° blade pitch  
blade sweep: 56"  
18.61"  
20.61"

Net weight: 28.51 lbs.

**CONTROL TYPE**

TR305 handheld remote included

**MOTOR TYPE & SIZE**

**DC 153 x 25FS**  
(LIMITED LIFETIME WARRANTY)

Reverse switch on remote

**FAN SPEEDS**  
variable

HIGH-SPEED RPM  
**129**

\*HIGH-SPEED CFM  
**8,042 CFM**

**LOCATION RATING**

dry damp wet

✓ ✓ ✓

**LIGHTING**  
(light kit with cap included)

18W LED with opal frosted glass

**LIGHTING SPECS**

**18W integrated LED with CCT Select**

lumens: 1,600  
CCT: 3000k/4000k/5000k  
CRI: 90

**MOUNTING TYPE**

downrod sloped flush  
12" included up to 27" included sold separately

✓ ✓ ✓

SCAN EACH QR CODE FOR FULL IMAGE

ENERGY GUIDE				
AVERAGE SPEED	TOTAL AIR VOLUME	ENERGY USE	ESTIMATED YEARLY ENERGY COST	AIRFLOW EFFICIENCY
	6,023 CFM	23 Watts	\$7	257

**CERTIFICATION**

\*Airflow testing is conducted in accordance with the US Department of Energy's testing standards and under specific controlled environmental conditions. Actual airflow performance may vary based on the installation location and environmental factors.

MIX & MATCH FAN MOTOR, BLADES & LIGHT KIT SOLD SEPARATELY

**DC MOTOR** **DRY** **DAMP** **WET**

**required**  
(sold separately)

**Motor**  
MAD7997\*\*\*  
Includes remote:

**Blade Set**  
B7997-56\*\*\*

\*\*\* replace with available finish codes below

**optional accessories**  
(sold separately)

**mounting**

- Close-To-Ceiling Kit**  
CCK8002\*\*
- Sloped Ceiling Ball**  
(up to 42°)  
SCB1-52
- Longer Downrods**  
page 195

**controls**

- 2-wire Fan-only Wall Control**  
TW306

**ordering example**

MAD7997SLW  
(silver motor)  
+  
B7997-56BLW  
(black blade set)



**motor & light kit finishes**



black



silver

**blade finishes**



black



silver

view larger swatches on page 197



# STELLAR™ CUSTOM 64

**HANGING DIMENSIONS**  
with 12" downrod (included)

6.30" diameter  
12.6° blade pitch  
blade sweep: 64"  
18.61"  
20.61"

Net weight: 30.25 lbs.

**CONTROL TYPE**

+ **fanSync**  
by FANIMATION

TR305 handheld remote included

<p><b>MOTOR TYPE &amp; SIZE</b></p> <p><b>DC 153 x 25FS</b> <small>(LIMITED LIFETIME WARRANTY)</small></p> <p>Reverse switch on remote</p>	<p><b>FAN SPEEDS</b></p> <p><b>variable</b></p> <hr/> <p>HIGH-SPEED RPM</p> <p><b>108</b></p> <hr/> <p>*HIGH-SPEED CFM</p> <p><b>9,277 CFM</b></p>	<p><b>LOCATION RATING</b></p> <div style="display: flex; justify-content: space-around;"> <div style="text-align: center;">  dry <input checked="" type="checkbox"/></div> <div style="text-align: center;">  damp <input checked="" type="checkbox"/></div> <div style="text-align: center;">  wet <input checked="" type="checkbox"/></div> </div>
--	--	--

<p><b>LIGHTING</b></p> <p>18W LED with opal frosted glass</p>	<p><b>LIGHTING SPECS</b></p> <p><b>18W integrated LED</b> with CCT Select</p> <p>lumens: 1,600 CCT: 3000k/4000k/5000k CRI: 90</p>	<p><b>MOUNTING TYPE</b></p> <div style="display: flex; justify-content: space-around;"> <div style="text-align: center;">  downrod 12" included <input checked="" type="checkbox"/></div> <div style="text-align: center;">  sloped up to 27" included <input checked="" type="checkbox"/></div> <div style="text-align: center;">  flush sold separately <input checked="" type="checkbox"/></div> </div>
---	---	--

**SCAN EACH QR CODE FOR FULL IMAGE**

ENERGY GUIDE					CERTIFICATION
AVERAGE SPEED	TOTAL AIR VOLUME <b>7,081 CFM</b>	ENERGY USE <b>23 Watts</b>	ESTIMATED YEARLY ENERGY COST <b>\$6</b>	AIRFLOW EFFICIENCY <b>306</b>	

FANIMATION.COM

\*Airflow testing is conducted in accordance with the US Department of Energy's testing standards and under specific controlled environmental conditions. Actual airflow performance may vary based on the installation location and environmental factors.



# MIX & MATCH FAN MOTOR, BLADES & LIGHT KIT SOLD SEPARATELY

**DC MOTOR**      **DRY**      **DAMP**      **WET**

**required**  
(sold separately)

**Motor**  
MAD7997\*\*\*

Includes remote:  +

**Blade Set**  
B7997-64\*\*\*

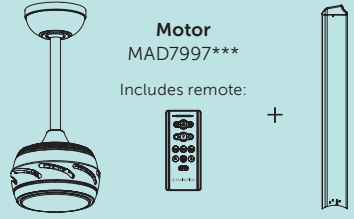

\*\*\* replace with available finish codes below

## optional accessories

(sold separately)

**mounting**

 **Close-To-Ceiling Kit**  
CCK8002\*\*

 **Sloped Ceiling Ball (up to 42°)**  
SCB1-52

 **Longer Downrods**  
page 195

**controls**

 **2-wire Fan-only Wall Control**  
TW306

## ordering example

MAD7997BLW  
(black motor)  
+  
B7997-64BLW  
(black blade set)  
+  
DR1SS-24BLW  
(black 24" downrod)



### motor & light kit finishes

 **BLW**  
black

 **SLW**  
silver

### blade finishes

 **BLW**  
black

 **SLW**  
silver

view larger swatches on page 197



STEELHARVEST CUSTOM 64

# STELLAR™ CUSTOM 72

**HANGING DIMENSIONS**  
with 12" downrod (included)

6.30" diameter  
12.6° blade pitch  
blade sweep: 72"  
18.61"  
20.61"

Net weight: 31.86 lbs.

**CONTROL TYPE**

TR305 handheld remote included

**MOTOR TYPE & SIZE**

**DC 153 x 25FS**  
(LIMITED LIFETIME WARRANTY)

Reverse switch on remote

**FAN SPEEDS**  
variable

HIGH-SPEED RPM  
**91**

\*HIGH-SPEED CFM  
**9,978 CFM**

**LOCATION RATING**

dry damp wet

**LIGHTING**

18W LED with opal frosted glass

**LIGHTING SPECS**

**18W integrated LED with CCT Select**  
lumens: 1,600  
CCT: 3000k/4000k/5000k  
CRI: 90

**MOUNTING TYPE**

downrod sloped flush  
12" included up to 27" included sold separately

**SCAN EACH QR CODE FOR FULL IMAGE**

ENERGY GUIDE				
AVERAGE SPEED	TOTAL AIR VOLUME	ENERGY USE	ESTIMATED YEARLY ENERGY COST	AIRFLOW EFFICIENCY
	8,503 CFM	24 Watts	\$7	355

**CERTIFICATION**

\*Airflow testing is conducted in accordance with the US Department of Energy's testing standards and under specific controlled environmental conditions. Actual airflow performance may vary based on the installation location and environmental factors.

MIX & MATCH FAN MOTOR, BLADES & LIGHT KIT SOLD SEPARATELY

**DC MOTOR** **DRY** **DAMP** **WET**

**required**  
(sold separately)

**Motor**  
MAD7997\*\*\*  
Includes remote: +

**Blade Set**  
B7997-72\*\*\*

\*\*\* replace with available finish codes below

**optional accessories**  
(sold separately)

**mounting**

**Close-To-Ceiling Kit**  
CCK8002\*\*

**Sloped Ceiling Ball (up to 42")**  
SCB1-52

**Longer Downrods**  
page 195

**controls**

**2-wire Fan-only Wall Control**  
TW306

**ordering example**

MAD7997SLW  
(silver motor)  
+  
B7997-72SLW  
(silver blade set)  
+  
DR1SS-24SLW  
(silver 24" downrod)



**motor & light kit finishes**



black



silver

**blade finishes**



black



silver

view larger swatches on page 197



STELLAR™ CUSTOM 72

# STELLAR™ CUSTOM 84

**HANGING DIMENSIONS**  
with 12" downrod (included)

6.30" diameter

12.6° blade pitch

blade sweep: 84"

18.61" 20.61"

Net weight: 32.92 lbs.

**CONTROL TYPE**

wifi + fanSync by FANIMATION

TR305 handheld remote included

<p><b>MOTOR TYPE &amp; SIZE</b></p> <p><b>DC 153 x 25FS</b> <small>(LIMITED LIFETIME WARRANTY)</small></p> <p>Reverse switch on remote</p>	<p><b>FAN SPEEDS</b></p> <p><b>variable</b></p> <hr/> <p>HIGH-SPEED RPM</p> <p><b>71</b></p> <hr/> <p>*HIGH-SPEED CFM</p> <p><b>11,092 CFM</b></p>	<p><b>LOCATION RATING</b></p> <div style="display: flex; justify-content: space-around;"> <div style="text-align: center;"> <p>dry</p> <p><input checked="" type="checkbox"/></p> </div> <div style="text-align: center;"> <p>damp</p> <p><input checked="" type="checkbox"/></p> </div> <div style="text-align: center;"> <p>wet</p> <p><input checked="" type="checkbox"/></p> </div> </div>
--	--	--

<p><b>LIGHTING</b></p> <p>18W LED with opal frosted glass</p>	<p><b>LIGHTING SPECS</b></p> <p><b>18W integrated LED with CCT Select</b></p> <p>lumens: 1,600</p> <p>CCT: 3000k/4000k/5000k</p> <p>CRI: 90</p>	<p><b>MOUNTING TYPE</b></p> <div style="display: flex; justify-content: space-around;"> <div style="text-align: center;"> <p>downrod 12" included</p> <p><input checked="" type="checkbox"/></p> </div> <div style="text-align: center;"> <p>sloped up to 27° included</p> <p><input checked="" type="checkbox"/></p> </div> <div style="text-align: center;"> <p>flush sold separately</p> <p><input checked="" type="checkbox"/></p> </div> </div>
---	---	--

**SCAN EACH QR CODE FOR FULL IMAGE**

ENERGY GUIDE					CERTIFICATION
AVERAGE SPEED	TOTAL AIR VOLUME	ENERGY USE	ESTIMATED YEARLY ENERGY COST	AIRFLOW EFFICIENCY	
	10,015 CFM	22 Watts	\$6	465	

FANIMATION.COM

\*Airflow testing is conducted in accordance with the US Department of Energy's testing standards and under specific controlled environmental conditions. Actual airflow performance may vary based on the installation location and environmental factors.

MIX & MATCH FAN MOTOR, BLADES & LIGHT KIT SOLD SEPARATELY

**DC MOTOR** **DRY** **DAMP** **WET**

**required**  
(sold separately)

**Motor**  
MAD7997\*\*\*  
Includes remote:  +

**Blade Set**  
B7993-84\*\*\*

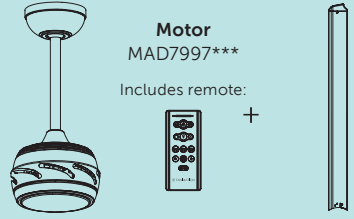

\*\*\* replace with available finish codes below

**optional accessories**  
(sold separately)

**mounting**  **Close-To-Ceiling Kit**  
CCK8002\*\*

 **Sloped Ceiling Ball (up to 42°)**  
SCB1-52

 **Longer Downrods**  
page 195

**controls**  **2-wire Fan-only Wall Control**  
TW306

**ordering example**

MAD7997BLW  
(black motor)  
+  
B7993-84SLW  
(silver blade set)  
+  
DR1SS-24BLW  
(black 24" downrod)





**motor & light kit finishes**

 **BLW**  
black

 **SLW**  
silver

**blade finishes**

 **BLW**  
black

 **SLW**  
silver

view larger swatches on page 197



STELLAR™ CUSTOM 84

# STELLAR™ CUSTOM 96

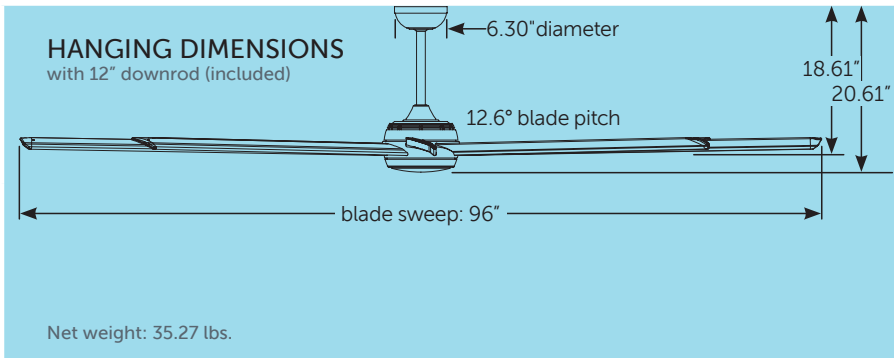

**CONTROL TYPE**

wifi + fanSync by FANIMATION

TR305 handheld remote included

**MOTOR TYPE & SIZE**

**DC 153 x 25NFB**  
(LIMITED LIFETIME WARRANTY)

Reverse switch on remote

**FAN SPEEDS**  
variable

HIGH-SPEED RPM  
**60**

\*HIGH-SPEED CFM  
**12,965 CFM**

**LOCATION RATING**

dry damp wet

✓ ✓ ✓

**LIGHTING**

18W LED with opal frosted glass

**LIGHTING SPECS**

**18W integrated LED with CCT Select**

lumens: 1,600  
CCT: 3000k/4000k/5000k  
CRI: 90

**MOUNTING TYPE**

downrod sloped flush  
12" included up to 27" included sold separately

✓ ✓ ✓



ENERGY GUIDE				
AVERAGE SPEED	TOTAL AIR VOLUME	ENERGY USE	ESTIMATED YEARLY ENERGY COST	AIRFLOW EFFICIENCY
	9,770 CFM	23 Watts	\$7	418

**CERTIFICATION**

\*Airflow testing is conducted in accordance with the US Department of Energy's testing standards and under specific controlled environmental conditions. Actual airflow performance may vary based on the installation location and environmental factors.

MIX & MATCH FAN MOTOR, BLADES & LIGHT KIT SOLD SEPARATELY

**DC MOTOR**      **DRY**      **DAMP**      **WET**

**required**  
(sold separately)

**Motor**  
MAD7998\*\*\*  
Includes remote:

**Blade Set**  
7998-96\*\*\*

\*\*\* replace with available finish codes below

**optional accessories**  
(sold separately)

**mounting**

**Close-To-Ceiling Kit**  
CCK8002\*\*

**Sloped Ceiling Ball**  
(up to 42°)  
SCB1-52

**Longer Downrods**  
page 195

**controls**

**2-wire Fan-only Wall Control**  
TW306

**ordering example**

MAD7998BLW  
(black motor)  
+  
B7998-96BLW  
(black blade set)  
+  
DR1SS-24BLW  
(black 24" downrod)



**motor & light kit finishes**

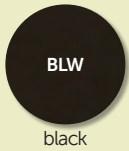

**blade finishes**

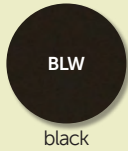

view larger swatches on page 197



STEFAN™ CUSTOM 96

# PC/DC NL™

<p><b>HANGING DIMENSIONS</b> with 6" downrod (included)</p> <p>Net weight: 13.23 lbs.</p>		<p><b>CONTROL TYPE</b></p> <p>pull chain</p>													
<p><b>MOTOR TYPE &amp; SIZE</b></p> <p><b>DC 100 x 30</b> (LIMITED LIFETIME WARRANTY)</p> <p>Reverse switch on fan</p>	<p><b>FAN SPEEDS</b></p> <p><b>3</b></p>		<p><b>LOCATION RATING</b></p> <p>dry damp wet</p> <p><input checked="" type="checkbox"/> <input checked="" type="checkbox"/> <input checked="" type="checkbox"/></p>												
	<p><b>HIGH-SPEED RPM</b></p> <p><b>171</b></p>														
	<p><b>*HIGH-SPEED CFM</b></p> <p><b>5,664 CFM</b></p>														
<p><b>SCAN EACH QR CODE FOR FULL IMAGE</b></p>			<p><b>MOUNTING TYPE</b></p> <p>downrod sloped flush</p> <p>6" included up to 27" included sold separately</p> <p><input checked="" type="checkbox"/> <input checked="" type="checkbox"/> <input checked="" type="checkbox"/></p>												
<p><b>ENERGY GUIDE</b></p> <table border="1"> <thead> <tr> <th>AVERAGE SPEED</th> <th>TOTAL AIR VOLUME</th> <th>ENERGY USE</th> <th>ESTIMATED YEARLY ENERGY COST</th> <th>AIRFLOW EFFICIENCY</th> </tr> </thead> <tbody> <tr> <td></td> <td>3,813 CFM</td> <td>19 Watts</td> <td>\$5</td> <td>202 CFM/Watts</td> </tr> </tbody> </table>					AVERAGE SPEED	TOTAL AIR VOLUME	ENERGY USE	ESTIMATED YEARLY ENERGY COST	AIRFLOW EFFICIENCY		3,813 CFM	19 Watts	\$5	202 CFM/Watts	<p><b>CERTIFICATION</b></p>
AVERAGE SPEED	TOTAL AIR VOLUME	ENERGY USE	ESTIMATED YEARLY ENERGY COST	AIRFLOW EFFICIENCY											
	3,813 CFM	19 Watts	\$5	202 CFM/Watts											

FANIMATION.COM

\*Airflow testing is conducted in accordance with the US Department of Energy's testing standards and under specific controlled environmental conditions. Actual airflow performance may vary based on the installation location and environmental factors.



**DC MOTOR**      **DRY**      **DAMP**      **WET**

Fan: FPD7617\*\*  
included:

\*\*\* replace with available finish codes below

**optional accessories**

(sold separately)

mounting



**Close-To-Ceiling Kit**  
CCK8002\*\*



**Sloped Ceiling Ball (up to 42°)**  
SCB1-52



**Longer Downrods**  
page 195



PC/DC™ NO LIGHT

**FPD7617\*\* motor & blade finish combinations**

**BLW**  
black + black

---

**MWW**  
matte white + matte white

---

**SLW**  
silver + silver

view larger swatches on page 197

# PC/DC L™

**HANGING DIMENSIONS**  
with 6" downrod (included)

Net weight: 15.06 lbs.

**CONTROL TYPE**

pull chain

**MOTOR TYPE & SIZE**

**DC 100 x 30**  
(LIMITED LIFETIME WARRANTY)

Reverse switch on fan

**FAN SPEEDS**

**3**

---

**HIGH-SPEED RPM**

**168**

---

**\*HIGH-SPEED CFM**

**5,874 CFM**

**LOCATION RATING**

dry

damp

wet

**LIGHTING**  
(light kit included)

18W LED with opal frosted glass

**LIGHTING SPECS**

**18W integrated LED**

lumens: 1500  
CCT: 3,000k  
CRI: 90

**MOUNTING TYPE**

downrod  
6" included

sloped  
up to 27° included





flush  
sold separately

**SCAN EACH QR CODE FOR FULL IMAGE**

ENERGY GUIDE				
AVERAGE SPEED	TOTAL AIR VOLUME <b>3,649 CFM</b>	ENERGY USE <b>19 Watts</b>	ESTIMATED YEARLY ENERGY COST <b>\$5</b>	AIRFLOW EFFICIENCY <b>188 CFM/Watts</b>

**CERTIFICATION**

\*Airflow testing is conducted in accordance with the US Department of Energy's testing standards and under specific controlled environmental conditions. Actual airflow performance may vary based on the installation location and environmental factors.

 **DC MOTOR**
 **DRY**
 **DAMP**
 **WET**

Fan: FPD7619\*\*  
included:

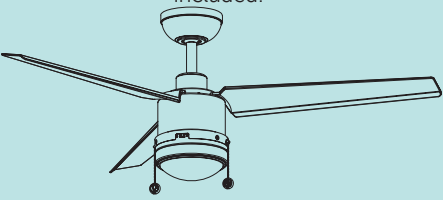

\*\*\* replace with available finish codes below

**optional accessories**  
(sold separately)

mounting



**Close-To-Ceiling Kit**  
CCK8002\*\*

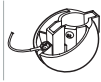

**Sloped Ceiling Ball (up to 42°)**  
SCB1-52



**Longer Downrods**  
page 195

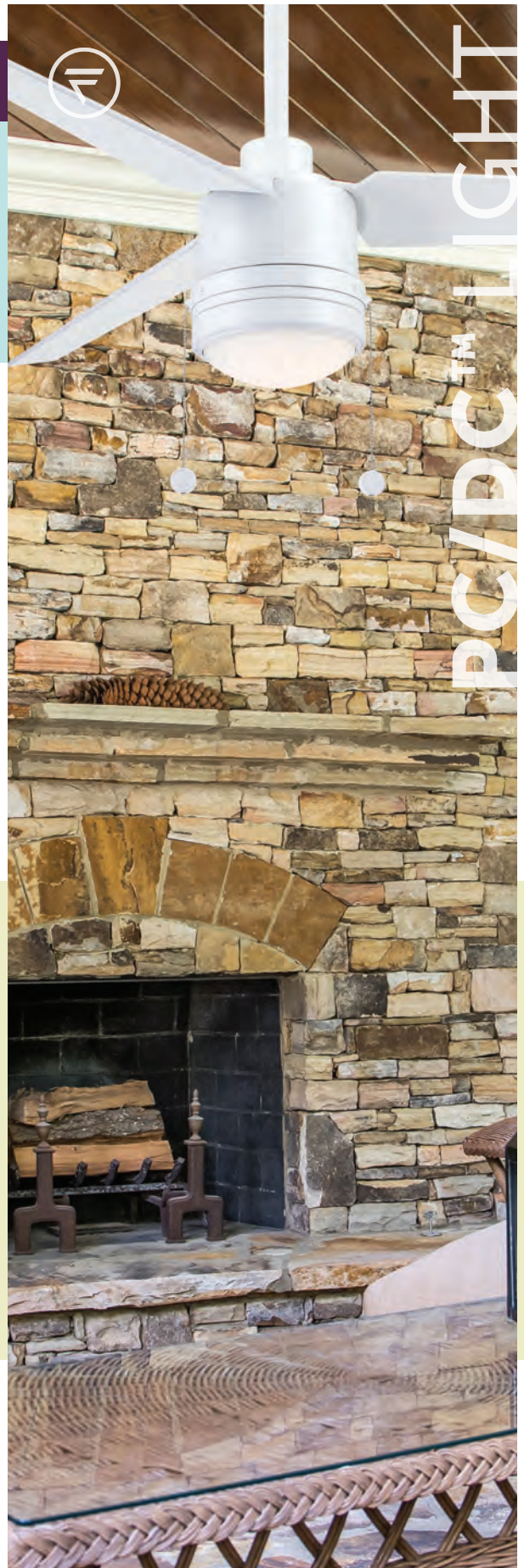

DC MOTOR LIGHT

FPD7619\*\* motor & blade finish combinations



**BLW**

black + black



**MWW**

matte white + matte white



**SLW**

silver + silver

view larger swatches on page 197

# EDGEWOOD® 44

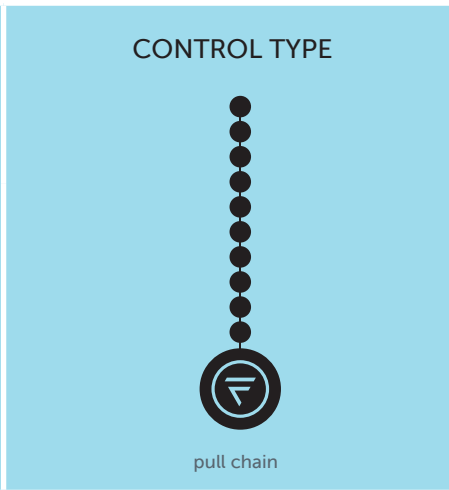
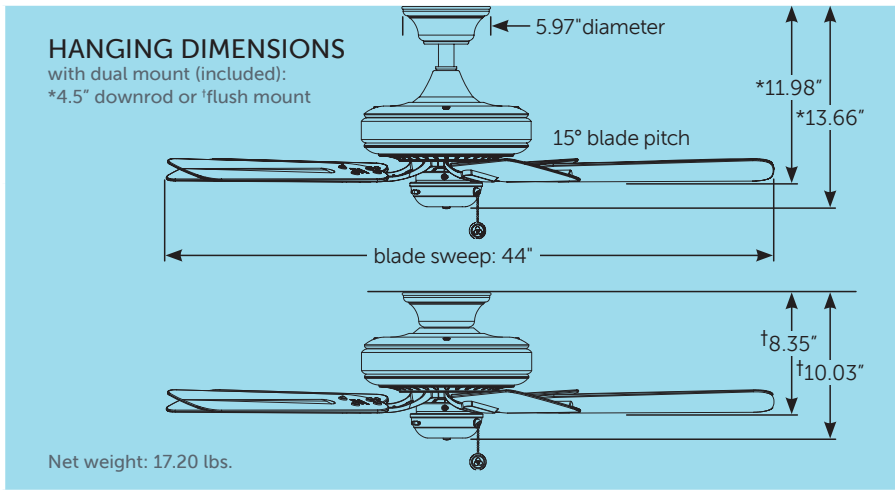

**MOTOR TYPE & SIZE**

**AC 153 x 18**  
(LIMITED LIFETIME WARRANTY)

Reverse switch on fan

**FAN SPEEDS**

3

**HIGH-SPEED RPM**

204

**\*HIGH-SPEED CFM**

4,426 CFM

**LOCATION RATING**

dry damp wet

✓ ✓ ✓



SCAN EACH QR CODE FOR FULL IMAGE

**MOUNTING TYPE**

downrod sloped flush

4.5" included up to 17" included included

✓ ✓ ✓

**ENERGY GUIDE**

AVERAGE SPEED	TOTAL AIR VOLUME	ENERGY USE	ESTIMATED YEARLY ENERGY COST	AIRFLOW EFFICIENCY
	3,165 CFM	37 Watts	\$10	85 CFM/Watts

**CERTIFICATION**





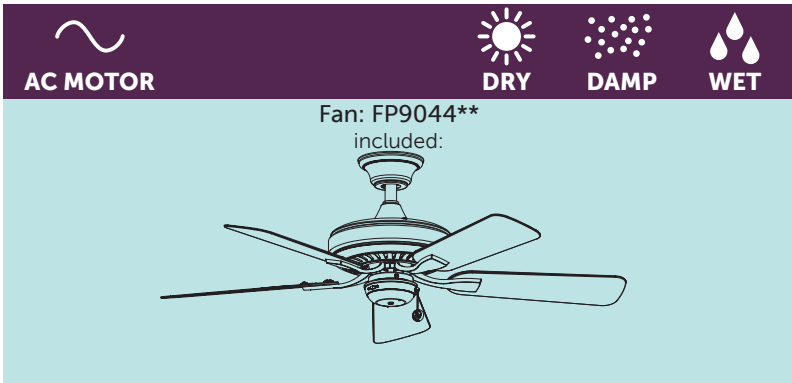



FANIMATION.COM

\*Airflow testing is conducted in accordance with the US Department of Energy's testing standards and under specific controlled environmental conditions. Actual airflow performance may vary based on the installation location and environmental factors.



\*\*\* replace with available finish codes below

**optional accessories**  
(sold separately)

light kit	 <b>Low-profile Light Kit</b> LK179**	
mounting	 <b>Sloped Ceiling Kit (up to 42°)</b> SCK1-52	 <b>Longer Downrods</b> page 195
controls	 <b>2-wire Fan-only Wall Control</b> WC1WH	 <b>3-wire Fan + Light Wall Control</b> WC2WH
	 <b>2-wire Fan-only Wall Remote</b> WR500WH	 <b>2-wire Fan + Light Wall Remote</b> WR501WH
	 <b>Fan + Light Remote &amp; Receiver</b> CR500	 <b>WiFi Smart Receiver</b> WFR50

**FP9044\*\* motor & blade finish combinations**

 <b>BLW</b> black + black	 <b>DZW</b> dark bronze + dark walnut
 <b>BNW</b> brushed nickel + dark walnut	 <b>MWW</b> matte white + matte white

view larger swatches on page 197



EDGEWOOD® 44

# EDGEWOOD® 52

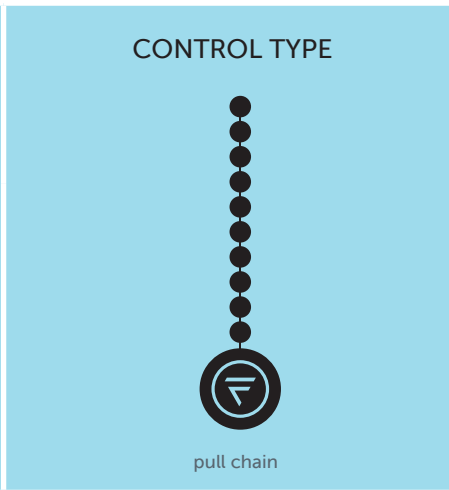
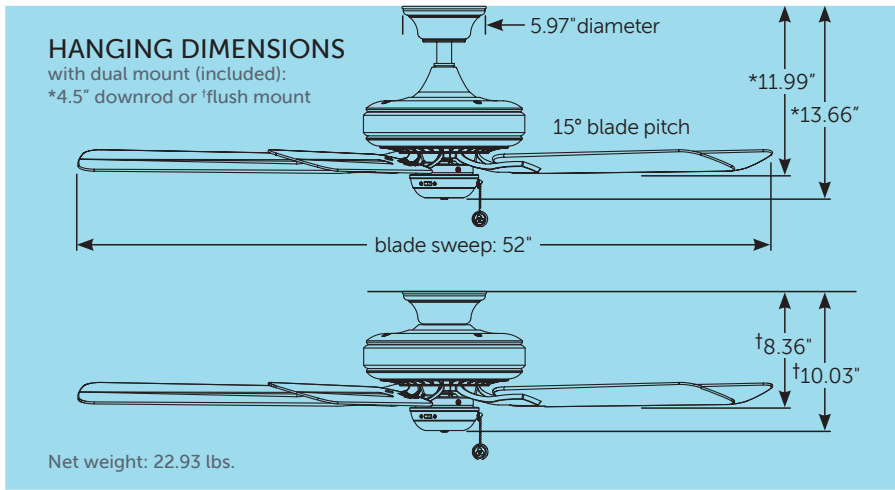

**MOTOR TYPE & SIZE**

**AC 188 x 22**  
(LIMITED LIFETIME WARRANTY)

Reverse switch on fan

**FAN SPEEDS**

**3**

**HIGH-SPEED RPM**

**172**

**\*HIGH-SPEED CFM**

**6,107 CFM**

**LOCATION RATING**

dry

damp

wet



**MOUNTING TYPE**

downrod  
4.5" included

sloped  
up to 17" included

flush  
included

**ENERGY GUIDE**

AVERAGE SPEED	TOTAL AIR VOLUME	ENERGY USE	ESTIMATED YEARLY ENERGY COST	AIRFLOW EFFICIENCY
	4,326 CFM	45 Watts	\$13	95 CFM/Watts

**CERTIFICATION**





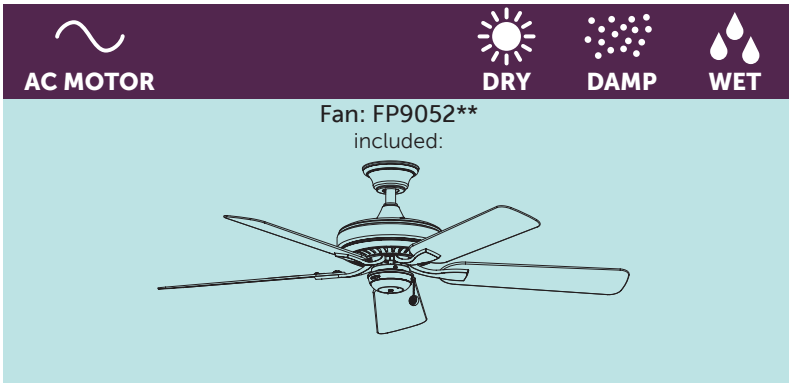



FANIMATION.COM

\*Airflow testing is conducted in accordance with the US Department of Energy's testing standards and under specific controlled environmental conditions. Actual airflow performance may vary based on the installation location and environmental factors.



\*\*\* replace with available finish codes below

**optional accessories**  
(sold separately)

light kit		<b>Low-profile Light Kit</b> LK179**	
mounting		<b>Sloped Ceiling Kit (up to 42°)</b> SCK1-52	
			<b>Longer Downrods</b> page 195
controls		<b>2-wire Fan-only Wall Control</b> WC1WH	
		<b>2-wire Fan-only Wall Remote</b> WR500WH	
		<b>Fan + Light Remote &amp; Receiver</b> CR500	
			<b>3-wire Fan + Light Wall Control</b> WC2WH
			<b>2-wire Fan + Light Wall Remote</b> WR501WH
			<b>WiFi Smart Receiver</b> WFR50



EDGEWOOD® 52"

FP9052\*\* motor & blade finish combinations

	
black + black	dark bronze + dark walnut
	
brushed nickel + dark walnut	matte white + matte white

view larger swatches on page 197

# EDGEWOOD® 60

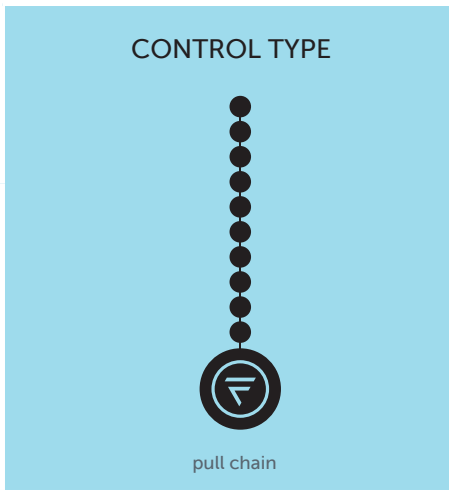
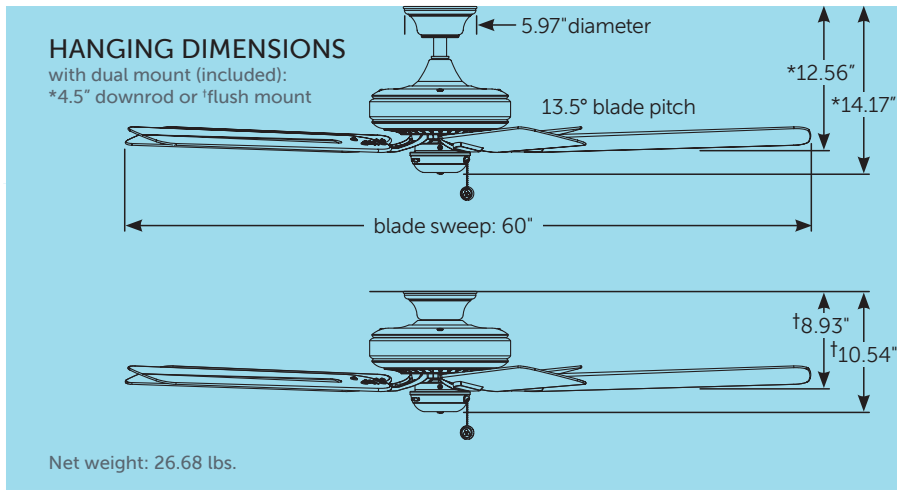

**MOTOR TYPE & SIZE**

**AC 188 x 25**  
(LIMITED LIFETIME WARRANTY)

Reverse switch on fan

**FAN SPEEDS**

**3**

**HIGH-SPEED RPM**

**135**

**\*HIGH-SPEED CFM**

**6,450 CFM**

**LOCATION RATING**

dry damp wet

✓ ✓ ✓



**MOUNTING TYPE**

downrod sloped flush  
4.5" included up to 17" included included

✓ ✓ ✓

**ENERGY GUIDE**

AVERAGE SPEED	TOTAL AIR VOLUME	ENERGY USE	ESTIMATED YEARLY ENERGY COST	AIRFLOW EFFICIENCY
	4,907 CFM	50 Watts	\$14	98 CFM/Watts

**CERTIFICATION**







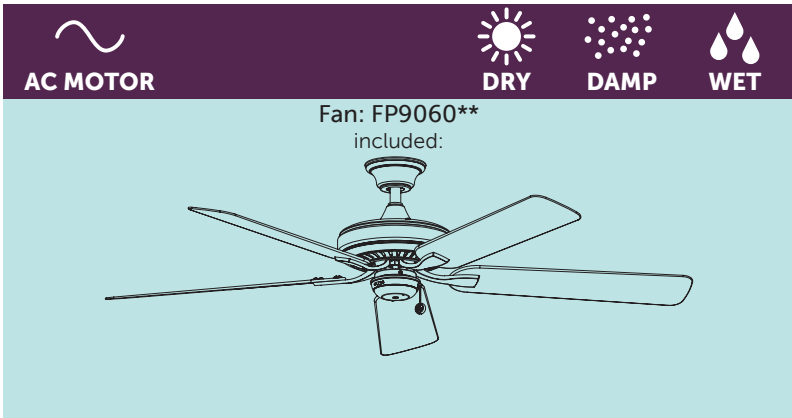

FANIMATION.COM

\*Airflow testing is conducted in accordance with the US Department of Energy's testing standards and under specific controlled environmental conditions. Actual airflow performance may vary based on the installation location and environmental factors.





**optional accessories**  
(sold separately)

light kit	 <b>Low-profile Light Kit</b> LK179**	
mounting	 <b>Sloped Ceiling Kit (up to 42°)</b> SCK1-52	 <b>Longer Downrods</b> page 195
controls	 <b>2-wire Fan-only Wall Control</b> WC1WH	 <b>3-wire Fan + Light Wall Control</b> WC2WH
	 <b>2-wire Fan-only Wall Remote</b> WR500WH	 <b>2-wire Fan + Light Wall Remote</b> WR501WH
	 <b>Fan + Light Remote &amp; Receiver</b> CR500	 <b>WiFi Smart Receiver</b> WFR50



**FP9060\*\* motor & blade finish combinations**

 <b>BLW</b> black + black	 <b>DZW</b> dark bronze + dark walnut
 <b>BNW</b> brushed nickel + dark walnut	 <b>MWW</b> matte white + matte white

view larger swatches on page 197

# EDGEWOOD® 72

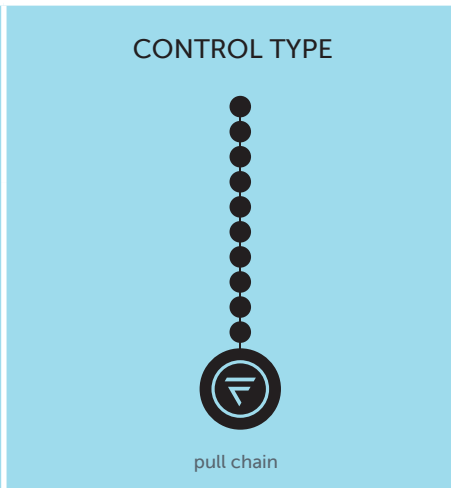
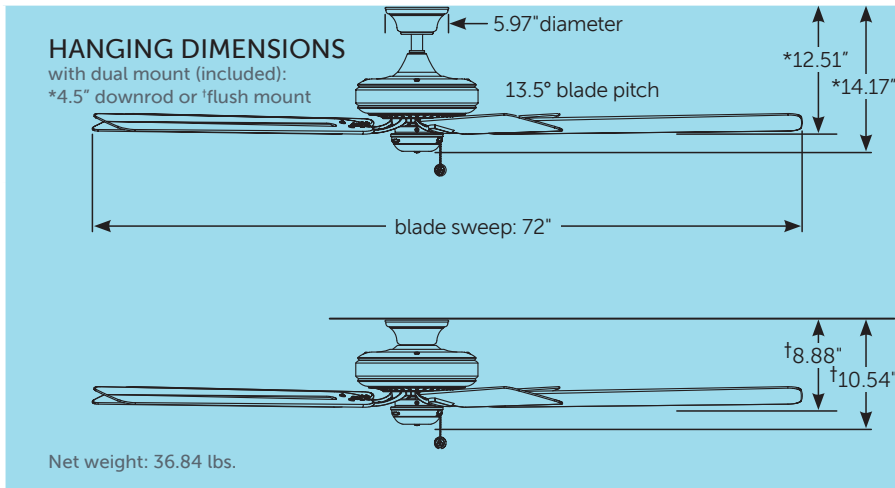

**MOTOR TYPE & SIZE**

**AC 212 x 35**  
(LIMITED LIFETIME WARRANTY)

Reverse switch on fan

**FAN SPEEDS**

3

**HIGH-SPEED RPM**

98

**\*HIGH-SPEED CFM**

7,671 CFM

**LOCATION RATING**

dry damp wet

✓ ✓ ✓



SCAN EACH QR CODE FOR FULL IMAGE

**MOUNTING TYPE**

downrod sloped flush  
4.5" included up to 17" included included

✓ ✓ ✓

**ENERGY GUIDE**

AVERAGE SPEED	TOTAL AIR VOLUME	ENERGY USE	ESTIMATED YEARLY ENERGY COST	AIRFLOW EFFICIENCY
	5,460 CFM	58 Watts	\$16	94 CFM/Watts

**CERTIFICATION**





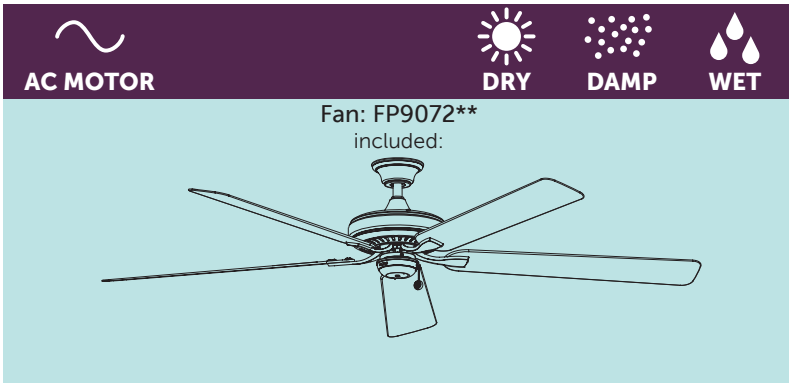



FANIMATION.COM

\*Airflow testing is conducted in accordance with the US Department of Energy's testing standards and under specific controlled environmental conditions. Actual airflow performance may vary based on the installation location and environmental factors.



\*\*\* replace with available finish codes below

**optional accessories**  
(sold separately)

light kit	 <b>Low-profile Light Kit</b> LK179**	
mounting	 <b>Sloped Ceiling Kit (up to 42°)</b> SCK1-52	 <b>Longer Downrods</b> page 195
controls	 <b>2-wire Fan-only Wall Control</b> WC1WH	 <b>3-wire Fan + Light Wall Control</b> WC2WH
	 <b>2-wire Fan-only Wall Remote</b> WR500WH	 <b>2-wire Fan + Light Wall Remote</b> WR501WH
	 <b>Fan + Light Remote &amp; Receiver</b> CR500	 <b>WiFi Smart Receiver</b> WFR50

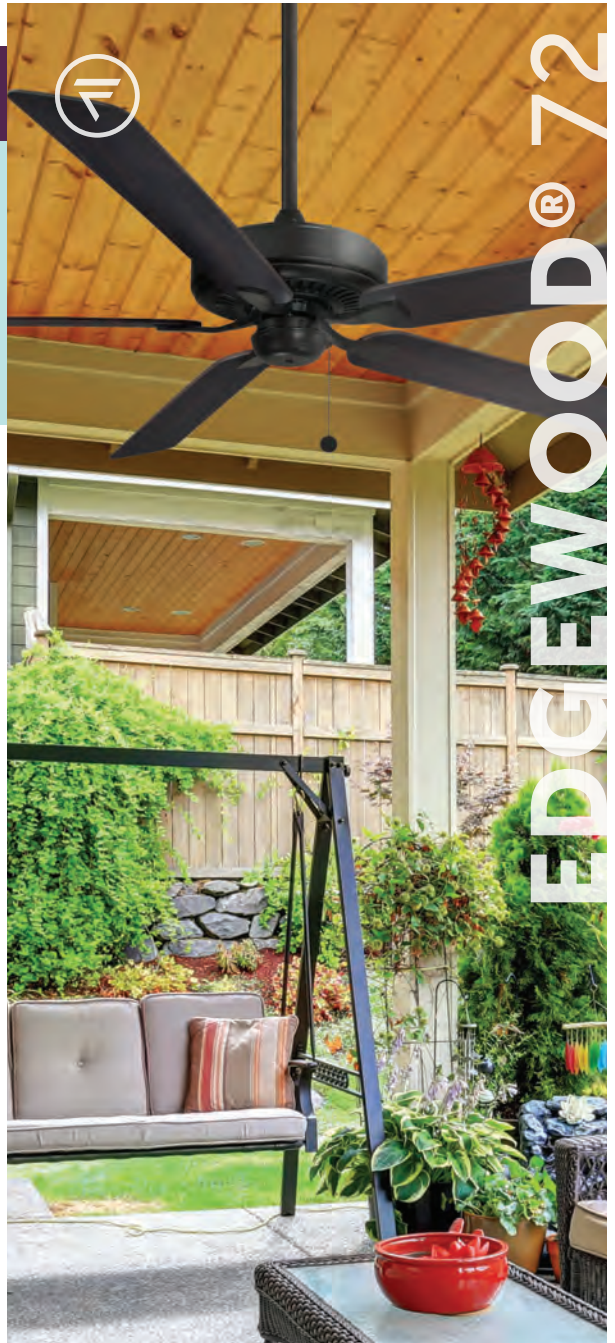

EDGEWOOD® 72"

FP9072\*\* motor & blade finish combinations

 <b>BLW</b> black + black	 <b>DZW</b> dark bronze + dark walnut
 <b>BNW</b> brushed nickel + dark walnut	 <b>MWW</b> matte white + matte white

view larger swatches on page 197

# WINDPOINTE®

**HANGING DIMENSIONS**  
with 6" downrod (included)

5.75" diameter  
18° blade pitch  
52" sweep  
\*14.0"  
\*14.5"

Net weight: 25.66 lbs. (AB)  
29.87 lbs. (OBP4)  
25.41 lbs. (RS)

**CONTROL TYPE**

pull chain

**MOTOR TYPE & SIZE**

**AC 188 x 25**  
(LIMITED LIFETIME WARRANTY)

Reverse switch on fan

**FAN SPEEDS**

**3**

**HIGH-SPEED RPM**  
(with ISP1 blades)

**80**

**\*HIGH-SPEED CFM**  
(with ISP1 blades)

**2,769 CFM**

**LOCATION RATING**

dry      damp      wet

RS only

**MOUNTING TYPE**

**downrod**  
6" included

**sloped**  
up to 27" included

**flush**  
sold separately

SCAN EACH QR CODE FOR FULL IMAGE

ENERGY GUIDE				
AVERAGE SPEED	TOTAL AIR VOLUME	ENERGY USE	ESTIMATED YEARLY ENERGY COST	AIRFLOW EFFICIENCY
	4,654 CFM	44 Watts	\$12	106 CFM/Watts

**CERTIFICATION**

FANIMATION.COM







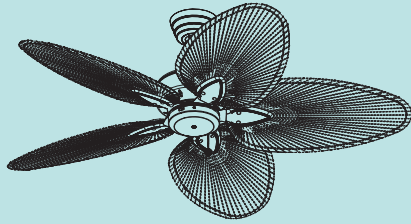



\*Airflow testing is conducted in accordance with the US Department of Energy's testing standards and under specific controlled environmental conditions. Actual airflow performance may vary based on the installation location and environmental factors.

AC MOTOR ☀️ DRY 💧 DAMP

Fan: FP7500\*\*  
included:



**optional accessories**  
(sold separately)

light kit	 <b>Low-profile Light Kit</b> LK179**		
mounting	 <b>Close-To-Ceiling Kit</b> CCK8002**	 <b>Sloped Ceiling Ball (up to 42°)</b> SCB1-52	 <b>Longer Downrods</b> page 195
controls	 <b>2-wire Fan-only Wall Control</b> WC1WH	 <b>3-wire Fan + Light Wall Control</b> WC2WH	
	 <b>2-wire Fan-only Wall Remote</b> WR500WH	 <b>2-wire Fan + Light Wall Remote</b> WR501WH	
	 <b>Fan + Light Remote &amp; Receiver</b> CR500	 <b>WiFi Smart Receiver</b> WFR50	

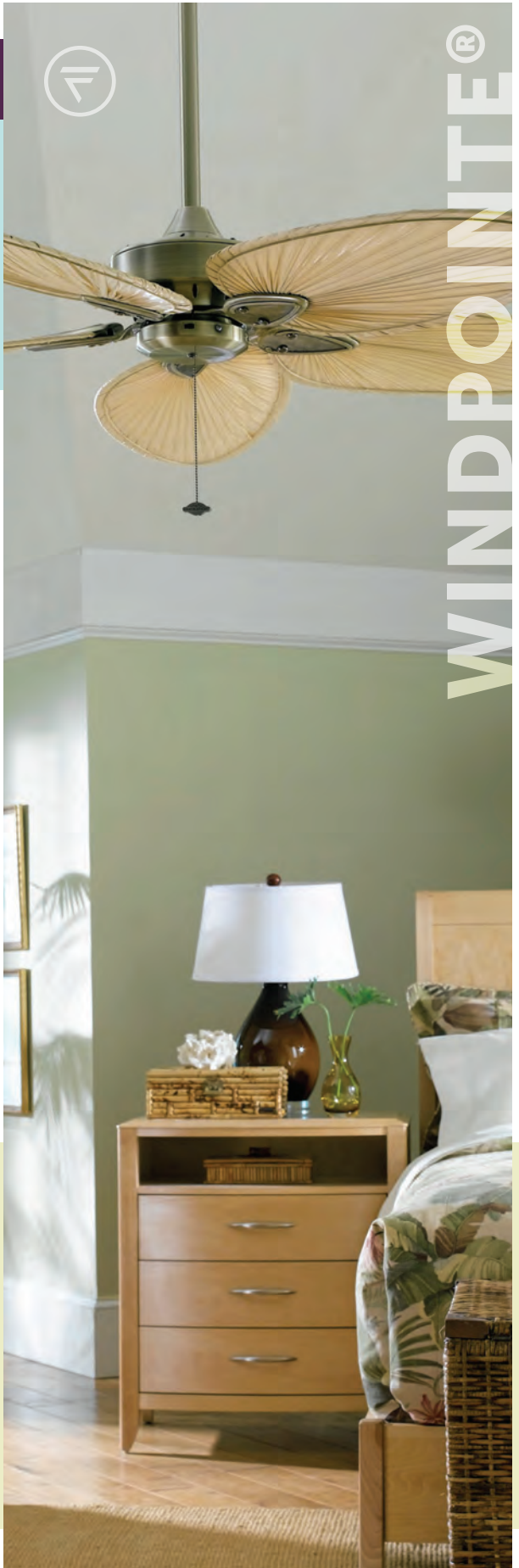

WINDPOINT®

FP7500\*\* motor & blade finish combinations



view larger swatches on page 197



PORTABLE



# ARDEN™

<p><b>DIMENSIONS</b></p> <p>Net weight: 13.1 lbs.</p>		<p><b>CONTROL TYPE</b></p> <p>rotary knob</p>
<p><b>MOTOR TYPE &amp; SIZE</b></p> <p><b>AC 82 x 25</b> (LIMITED LIFETIME WARRANTY)</p> <p>Reverse switch on fan</p>	<p><b>FAN SPEEDS</b></p> <p><b>3</b></p> <p><b>HIGH-SPEED RPM</b></p> <p><b>1,541</b></p> <p><b>*HIGH-SPEED CFM</b></p> <p><b>1,322</b></p>	<p><b>LOCATION RATING</b></p> <p>dry <input checked="" type="checkbox"/> damp <input type="checkbox"/> wet <input type="checkbox"/></p>
<p><b>POWER CORD</b></p> <p><b>8-FOOT</b></p>		
<p><b>CERTIFICATION</b></p>		

FANIMATION.COM



SCAN EACH QR CODE FOR FULL IMAGE



AC MOTOR

DRY

Fan: FP8014\*\*  
included:

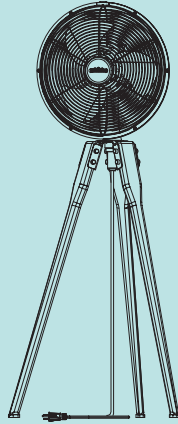

\*\* replace with available finish codes below

### FP8014\*\* motor & leg finish combinations



oil-rubbed bronze + walnut



satin nickel + walnut

view larger swatches on page 197



ARDEN™



# CONTROLS

## AC MOTOR

UL LISTED

Optional

**Do not store or mount remote controls outdoors**

WH—White  
LA—Light Almond



**WFR50**  
• WiFi® connectivity  
• Fan and downlight  
• Receiver unit  
• AC motors only

**WFR55**  
• WiFi® connectivity  
• Fan and downlight  
• Receiver unit  
• AC motors only  
• CCT Select control

**CR500**  
• Non-reversing fan and light remote  
• Receiver unit and hand-held transmitter  
• 5 dipswitches for 32 code settings  
• 3 fan speeds  
• Downlight control

**CRL4WH**  
• Non-reversing fan and light remote  
• Learn-mode canopy receiver unit for easy set up and 65,000 code settings included  
• 3 fan speeds  
• 1.25 amps max. fan load  
• Infinite light levels up to 190 watts  
• Dimmer on/off switch for use with CFL bulbs (dimmer must be turned off)  
• May be used with CWRL4\*\*

**CWRL4WH & CWRL4LA**  
• Non-reversing fan and light control  
• 2-wire installation  
• 3 fan speeds  
• 1.0 amps max. fan load  
• Learn-mode canopy receiver unit with 65,000 code settings included  
• Infinite light levels up to 190 watts  
• May be used with CRL4WH

	WFR50	WFR55	CR500	CRL4WH	CWRL4WH & CWRL4LA
Aire Deluxe™ 52	○		○	○	○
Amped™	○			○	○
Barlow™	○			○	○
Celano v2™	○			○	○
Doren™	○				
Edgewood® —All	○		○	○	○
Gleam™	○			○	○
Henry™					
Hugh™—All	○			○	○
Klinch™—All	○				
Kwad™—All	○			○	○
Kwartet™		○			
Levon™ AC	○		○	○	○
Paget™	○			○	○
Pyramid™	○				
SculptAir™	○			○	○
Spitfire™ AC—All	○			○	
Windpointe®	○		○	○	○
Xeno™ —All	○			○	○



## CONTROL YOUR CEILING FAN WITH YOUR SMART DEVICES & PERSONAL VOICE ASSISTANTS!

WFR50



WFR55 Kwartet only



DC WiFi\*



- fanSync WiFi® receiver
- AC fan—3 fan speeds
- Fan and downlight control
- Timer, safe exit and favorites list via smart device

- fanSync WiFi® receiver
- AC fan—3 fan speeds
- Fan and downlight control
- Timer, safe exit and favorites list via smart device

- fanSync WiFi® receiver
- DC fan—variable fan speeds
- Fan and downlight control
- Included with DC ceiling fans

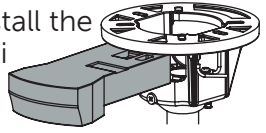
- 1 Wire and install the fanSync WiFi receiver into your ceiling fan's hanger bracket/canopy. 
- 2 Download the fanSync Wifi app in the Google Play or App Store and follow the simple setup instructions.

### INTEGRATES WITH:



Devices other than Amazon Echo and Google Home connect via the IFTTT app.

# CONTROLS



- CW5WH & CW5LA**
- Fan-only two fan slide control
  - 2-wire installation
  - 3 fan speeds
  - 5 amps max. fan load



- CW7WH**
- Fan-only five fan slide control
  - 2-wire installation
  - 3 fan speeds
  - 5 amps max. fan load



- WC1WH**
- Fan only control
  - Control on/off rocker switch
  - 3 fan speeds
  - 2-wire hardwire installation



- WC2WH**
- Fan and light control
  - Control on/off rocker switch
  - 3 fan speeds
  - Dimming
  - 3-wire hardwire installation



- WC4WH**
- Fan and light control
  - CCT Select control
  - Control on/off rocker switch
  - 3 fan speeds
  - Dimming
  - 3-wire installation
  - **For use with Kwartet only**



- WR500WH**
- Fan only control
  - Control on/off rocker switch
  - 3 fan speeds
  - Receiver included
  - 5 dip switch
  - 2-wire installation



- WR501WH**
- Fan and light control
  - Control on/off rocker switch
  - 3 fan speeds
  - Receiver included
  - 5 dip switch
  - 2-wire installation



- WT503WH**
- Fan and light control
  - CCT Select control
  - Control on/off rocker switch
  - 3 fan speeds
  - Transmitter only
  - 5 dip switch
  - 2-wire installation
  - **For use with Kwartet only**

	○	○	○	○		○	○	
				○			○	
				○			○	
		○		○			○	
	○	○	○	○		○	○	
				○			○	
			○	○		○	○	
			○	○		○	○	
					○			○
	○	○	○	○		○	○	
			○	○		○	○	
	○	○	○	○		○	○	
	○	○	○	○		○	○	
			○	○		○	○	

## DC MOTOR

- Wall controls include matching face plate
- **UL LISTED**

○ Optional

**Do not store or mount wall controls outdoors**



**TW206D**

- DC reversible fan and light control
- Mounts over switch plate
- 2-wire installation
- Variable fan speeds
- Downlight control
- For use with fans that include TR205D remote only



**TW306**

- DC reversible fan and light control with CCT Select
- Mounts over switch plate
- 2-wire installation
- Variable fan speeds
- Downlight control
- For use with fans that include TR305 remote only

Brawn™		○
GlideAire™	○	
Klear™		○
Kute™—All		○
Levon™ Custom—All		○
Obvi™	○	
Odyn™ Custom		○
Odyn™ 84		○
PC/DC—All		
Pendry™—All		○
Spitfire™ DC—All		○
Stellar™—All		○
TriAire™—All		○
Wrap™—All		○

# DOWNRODS & EXTENSION POLES

## DOWNRODS

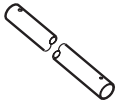

- Order according to length
- Use finish code to complete the part number—larger swatches on page 197
- See bottom of page for suggested lengths

## DOWNROD COUPLERS



- Joins two downrods together for extended lengths
  - When ordering, use finish code for steel downrods shown below to complete the part number.
- DR1-CP\*\* 1" diameter downrod coupler

### STEEL

- DR1-12\*\* 12" downrod
- DR1-18\*\* 18" downrod
- DR1-24\*\* 24" downrod
- DR1-36\*\* 36" downrod
- DR1-48\*\* 48" downrod
- DR1-60\*\* 60" downrod
- DR1-72\*\* 72" downrod



### TRUE STAINLESS STEEL

Wet location rated.  
Resistant to rust and corrosion.

- DR1SS-12\*\*\* 12" wet downrod
- DR1SS-18\*\*\* 18" wet downrod
- DR1SS-24\*\*\* 24" wet downrod
- DR1SS-36\*\*\* 36" wet downrod
- DR1SS-48\*\*\* 48" wet downrod
- DR1SS-60\*\*\* 60" wet downrod
- DR1SS-72\*\*\* 72" wet downrod



## CHOOSING YOUR DOWNROD

Recommended downrod length is based on ceiling height.  
Ideal distance from floor to fan blades is 7 to 9 feet.

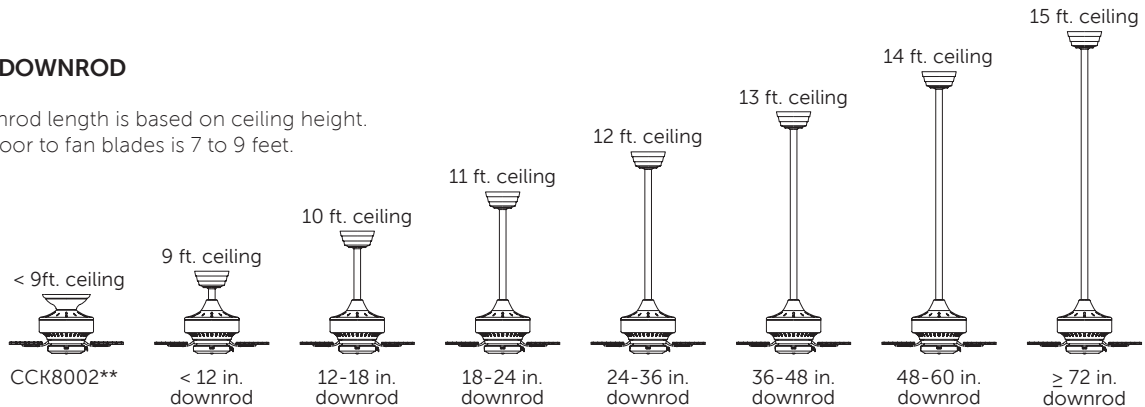

For sloped-ceiling applications.

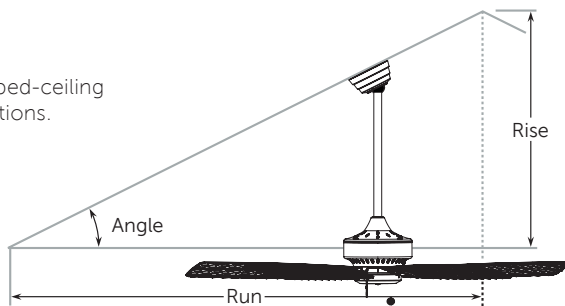

Pitch (Rise/Run)	Angle	Minimum Downrod
1/12	4.8°	Standard
2/12	9.5°	6"
3/12	14.0°	12"
4/12	18.4°	12"
5/12	22.6°	18"
6/12	26.5°	18"
7/12	30.3°	24"
8/12	33.7°	24"
> 8/12	> 33.7°	> 36"

Ideal distance from floor to fan blades is 7 to 9 feet.

For lengths greater than 72 in., join two downrods with DR1-CP\*\* coupler

# LOW-PROFILE LED LIGHT KIT ACCESSORY

## LK179 LIGHT KIT



- For use with Aire Deluxe™, Edgewood™, Levon™ AC, and Windpointe™
- 18W dimmable LED included
- Lumens (initial): 1,500
- Color Temp: 3,000
- CRI: 90
- White frosted lens included

**UL LISTED**

### DRY RATED

LK179AB antique brass

### WET RATED

LK179BLW antique brass wet  
LK179DZW dark bronze wet  
LK179MWW matte white wet  
LK179OBW oil-rubbed bronze wet

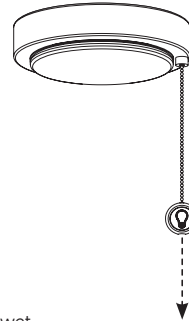

### Pull to Dim

- First pull = On
- Second pull = Begins dimming
- Third pull = Stops dimming
- Fourth pull = Off

## CLOSE-TO- & SLOPED-CEILING KITS

### CLOSE-TO-CEILING KIT



- Replaces hanger bracket/downrod assembly to move your fan closer to the ceiling, creating more head room
- Intended for use with low ceilings.
- Please see individual fan pages for compatibility
- Tall and short kits both included.
- Tall dimensions: 5.13" (H) x 8" (DIA.)
- Short dimensions: 2.67" (H) x 8" (DIA.)
- For 4.5" included downrod fans: Subtract 3.74" for short close to ceiling kit and 1.28" for tall close to ceiling kit
- For 6" included downrod fans: Subtract 5.24" for short close to ceiling kit and 2.78" for tall close to ceiling kit

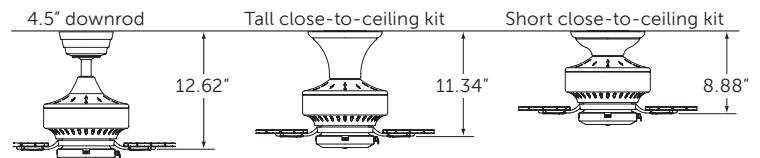

### STANDARD

CCK8002AB	antique brass	CCK8002GZ	galvanized
CCK8002BL	black	CCK8002MW	matte white
CCK8002BN	brushed nickel	CCK8002OB	oil-rubbed bronze
CCK8002CH	chrome	CCK8002PN	polished nickel
CCK8002DZ	dark bronze		

### WET RATED

CCK8002ABW	antique brass wet	CCK8002GRW	matte greige wet
CCK8002BLW	black wet	CCK8002MWW	matte white wet
CCK8002BNW	brushed nickel wet	CCK8002OBW	oil-rubbed bronze wet
CCK8002BSW	brushed satin brass wet	CCK8002SLW	silver wet
CCK8002DZW	dark bronze wet		

### SPITFIRE™ ONLY

CCK6721BL	black	CCK6721DZ	dark bronze
CCK6721BN	brushed nickel	CCK6721GR	matte greige
CCK6721BS	brushed satin brass	CCK6721GZ	galvanized
CCK6721DF	driftwood	CCK6721MW	matte white

### KUTE™/KUTE5™ ONLY

CCK8534BL	black	CCK8534DZ	dark bronze
CCK8534BN	brushed nickel	CCK8534GR	matte greige
CCK8534BS	brushed satin brass	CCK8534MW	matte white

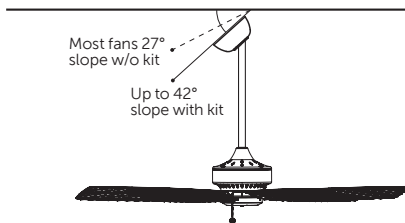

Most fans 27° slope w/o kit  
Up to 42° slope with kit

### SLOPED-CEILING KIT



- Includes hanger bracket, hanger ball, ceiling canopy, canopy screw cover and mounting hardware
- See spec section of individual fan pages for compatibility with your fan.
- Allows for ceiling slope up to 42°
- For use with any length downrod

### STANDARD

SCK1-52BL	black
SCK1-52BN	brushed nickel
SCK1-52BS	brushed satin brass
SCK1-52CH	chrome
SCK1-52DF	driftwood
SCK1-52DZ	dark bronze
SCK1-52GR	matte greige
SCK1-52GZ	galvanized
SCK1-52MW	matte white
SCK1-52OB	oil-rubbed bronze
SCK1-52PN	polished nickel

### WET RATED

SCK1-52BLW	black wet
SCK1-52DZW	dark bronze wet
SCK1-52GRW	matte greige wet
SCK1-52MWW	matte white wet
SCK1-52SLW	silver wet

### SLOPED-CEILING BALL KIT



- Includes black hanger ball only
- See spec section of individual fan pages for compatibility with your fan.
- Hanger ball works with current Fanimation canopy and hanger bracket.
- Allows for ceiling slope up to 42°.
- For use with any length downrod

SCB1-52 For use with 1" dia. downrods

# MOTOR, DOWNROD & LIGHT KIT FINISH SWATCHES

DUE TO THE NATURE OF MATERIALS; FINISHES COLOR, TEXTURE AND SHADING MAY VARY



**AB**—ANTIQU BRASS



**AGP**—ANTIQU GRAPHITE



**BL**—BLACK  
**BLW**—BLACK WET  
**BLM**—BLACK MARINE GRADE



**BN**—BRUSHED NICKEL  
**SSBNW**—STAINLESS STEEL  
BRUSHED NICKEL



**BNW**—BRUSHED NICKEL WET



**BS**—BRUSHED SATIN BRASS  
**BSW**—BRUSHED SATIN BRASS WET



**DF**—DRIFTWOOD  
**DFW**—DRIFTWOOD WET



**DZ**—DARK BRONZE  
**DZW**—DARK BRONZE WET



**GR**—MATTE GREIGE  
**GRW**—MATTE GREIGE WET



**GZ**—GALVANIZED  
**GZW**—GALVANIZED WET



**MW**—MATTE WHITE  
**MWW**—MATTE WHITE WET  
**MWM**—MATTE WHITE MARINE  
GRADE



**OB**—OIL-RUBBED BRONZE  
**OB**—OIL-RUBBED BRONZE  
WET



**PN**—POLISHED NICKEL

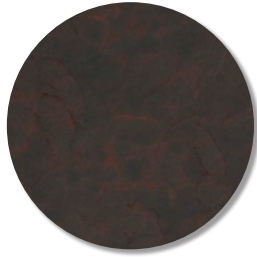

**RS**—RUST



**SL**—SILVER  
**SLW**—SILVER WET



**SN**—SATIN NICKEL

# BLADE SWATCHES

DUE TO THE NATURE OF MATERIALS; FINISHES COLOR, TEXTURE AND SHADING MAY VARY



**A**—ANTIQUE WOVEN BAMBOO



**BL**—BLACK



**BN**—BRUSHED NICKEL



**CY**—CHERRY



**DC**—DARK CHERRY



**DF**—DRIFTWOOD



**DWA**—DARK WALNUT



**DZ**—DARK BRONZE



**GR**—MATTE GREIGE



**MW**—MATTE WHITE



**LO**—LIGHT OAK



**N**—NATURAL



**P**—NATURAL PALM



**SL**—SILVER



**WA**—WALNUT



**WE**—WEATHERED WOOD



**WK**—WHISKEY WOOD



**WP**—WASHED PINE



**WW**—WHITE WASHED

# ANTIQUE FAN COLLECTORS ASSOCIATION

## ANTIQUE FAN MUSEUM



### PASSION, HERITAGE & PRESERVATION

Led by our Founder and Chairman, Tom Frampton, Fanimation is dedicated to preserving the history of fans and the fan industry. For years, Tom has been an avid antique fan collector and member of the Antique Fan Collectors Association (AFCA). The AFCA membership has operated a museum since 1997, displaying fans on loan by the membership; this museum was in Wichita, Kansas up until 2008, when the need to relocate the museum arose. Answering the call to preserve viewing of the one-of-a-kind collection, Fanimation made the offer to house the museum at its facility in Zionsville. The move and set-up took nearly a year and the museum saw its reopening July 23, 2009. Since that time, the museum has grown and continues to grow, housing over two thousand antique fans on two floors. Tom's own unique collection of fans is a part of the museum collection along with over 500 antique advertising style hand fans and other fan memorabilia.







## LOCATION

10983 Bennett Parkway  
Zionsville, IN 46077



## HOURS

Monday thru Friday 10 am - 4 pm  
Or call for an appointment, 317-733-4113



## MUSEUM HIGHLIGHTS

- The AFCA museum contains more than 2,000 antique ceiling, desk and hand fans with over 140 manufacturers represented
- The oldest electric desk fan in the museum dates from the early 1890's
- The oldest non-electric fans (steam, belt & pulley or water powered) date from the early 1880's.
- It is the only antique fan museum open to the public in the world
- The AFCA has approximately 850 members worldwide
- The museum contains some of the earliest battery-powered fans, water-powered fans, wind-up fans, electric hand-held fans, ceiling fans, wall fans, desk fans, pedestal fans, rail-car fans and fans that don't even look like fans.
- The museum contains hundreds of hand-held fans that feature advertising from manufactures, retailers, politicians and movie stars.



# INDEX

<b>FANS</b>	<b>PAGE</b>	<b>LIGHT KITS</b>	<b>PAGE</b>	<b>CONTROLS</b>	<b>PAGE</b>
FP3050**	12	LK179**	196	CW5LA	194
FP6284**	16	LK6721B**	81-88	CW5WH	194
FP6285B**	18	LK6721BDC**	91-106	CW7WH	194
FP6728BBN	76	LK7912B**	109-114	CWRL4LA	193
FP6729B***	78	LK8514***	137-152	CWRL4WH	193
FP6807**	34	LK8530**	117-132	TW206D	194
FP6837**	32	LK8534**	59-70	TW306	194
FP7500**	188			WC1WH	194
FP7634**	14	<b>BLADE SETS</b>	<b>PAGE</b>	WC2WH	194
FP7644**	20	B6720**	86, 88	WC4WH	50, 194
FP7652**	22	B6720-48**	82, 84	WFR50	3, 4, 193
FP7910**	28	B6720-64**	92, 94	WFR55	3, 4, 50, 193
FP8014**	192	B6720-72**	96, 98	WR500WH	194
FP8062B**	24	B6720-84**	100, 102	WR501WH	194
FP8404**	46	B6720-96BLW	104, 106	WT503WH	50, 194
FP8406**	44	B7912**	112		
FP8511**	72	B7913**	114	<b>ACCESSORIES</b>	<b>PAGE</b>
FP8519BL	48	B7914**	110	CCK6721**	82-88, 92-106, 196
FP8533**	26	B7993-84***	172	CCK8002**	196
FP9044***	180	B7997-56***	166	CCK8534**	52-62, 196
FP9052***	182	B7997-64***	168	DR1-12**	195
FP9060***	184	B7997-72***	170	DR1-18**	195
FP9072***	186	B7998-96***	174	DR1-24**	195
FPD5534**	68-70	BPW7912**	112	DR1-36**	195
FPD6605**	38	BPW7913**	114	DR1-48**	195
FPD6858**	36	BPW7914**	110	DR1-60**	195
FPD6865***	40	BPW8152-56***	156	DR1-72**	195
FPD6872***	42	BPW8152-64***	158	DR1-CP**	195
FPD7617***	176	BPW8152-72***	160	DR1SS-12***	195
FPD7619***	178	BPW8514-44***	138	DR1SS-12SSBNW	195
FPD8159***	162	BPW8514-48***	140	DR1SS-18***	195
FPD8520**	74	BPW8514-52***	142	DR1SS-18SSBNW	195
FPD8534**	64-66	BPW8514-56***	144	DR1SS-24***	195
FPD8547**	60-62	BPW8514-60***	146	DR1SS-24SSBNW	195
FPS7679**	54	BPW8515-64***	148	DR1SS-36***	195
FPS7681**	52	BPW8515-72***	150	DR1SS-36SSBNW	195
FPS8332B***	56	BPW8515-84***	152	DR1SS-48***	195
FPS8355B***	58	BPW8530-44**	118	DR1SS-48SSBNW	195
FPS8553**	50	BPW8530-48**	120	DR1SS-60***	195
MA6721B**	82-88	BPW8530-52**	122	DR1SS-60SSBNW	195
MAD6721**	92-106	BPW8530-56**	124	DR1SS-72***	195
MAD7912B**	110-114	BPW8530-60**	126	DR1SS-72SSBNW	195
MAD7997***	166-172	BPW8531-64**	128	SCB1-52	196
MAD7998***	174	BPW8531-72**	130	SCK1-52**	196
MAD8152***	156-160	BPW8531-84**	132		
MAD8514***	138-146			<b>CONTROLS</b>	<b>PAGE</b>
MAD8515***	148-152			CR500	193
MAD8530**	118-126			CRL4WH	193
MAD8531**	128-132				

40 YEARS



**FANIMATION**<sup>®</sup>  
C E I L I N G F A N S

10983 Bennett Parkway  
Zionsville, IN 46077

888 567 2055 (toll-free)  
317 733 4113  
317 733 4162 (fax)

**FANIMATION.COM**

