



ROLLING MOTORS ELECTRIC AND PNEUMATIC

- Pipe Beveling Machines
- Pipe Cutting Machines
- Grinding Machines
- Pipe Stands and Clamps
- Pipe Purging
- Plate Bevelers
- Heat Exchanger, Boiler & Bundle
- Plus so much more.....





GBC INDUSTRIAL TOOLS LTD ARE THE 'PIPE EQUIPMENT SPECIALISTS' FOR THE SUPPLY OF PIPEWORK EQUIPMENT AND TOOLS.

Over the past 30 years our parent company GBC Industrial Tools Spa, has established itself as one of the worlds leading manufacturers of portable pipework machinery, due to its consistent high level of quality, both in product and service. We are pleased to be part of that team.

GBC has established an extensive distribution network to industries across the world. These industries include:

- Petrochemical
- Offshore
- Power Generation
- Heat Exchange Manufacture/ Repair
- Boiler Industry
- Ship Building and Repair
- Nuclear
- General Fabrication
- Site Services



GBC Industrial Tools offer a comprehensive range of on-site machining services, please check with our office for your specific requirements.



Registered address: 7 Drakes Drive, Crendon Business Park Long Crendon, HP18 9FE

Registered in England & Wales. Registration no. 08966210
VAT no. 190019919

Rolling Motors

ELECTRIC TUBE EXPANSION SYSTEMS

“WATTAGE” BASED TORQUE CONTROLLERS

Why a “Wattage” Based Torque Controller is Right and a “Current” Based Torque Controller is Wrong.

A) Tube expansion can best be done by expanding tubes at a set torque value. Torque is nothing but a rotary force acting on the tubes. For a given drive, the 'RPM' being constant, torque becomes proportional to the drive power.

Hence, if the drive power is controlled for tube expansion, the results will be excellent. All tubes will be expanded equally. Supply voltage fluctuations which are very common, do not affect the performance of a wattage based controller as the controller will trip at a set wattage irrespective of the supply voltage.

B) In case of a current based tube expansion torque controller, the drive current can become proportional to the torque if & only if the supply voltage is absolutely constant. This is never the case. Practically, the supply voltages vary as much as 20% to 25%. This directly affects the expansion results as the drive trips at a set current. That means for a 20% higher supply voltage, the tubes will be effectively expanded by 20% more torque than the required one. Hence tubes will be over-expanded. For supply voltages less than normal, tubes will be under expanded proportionately.

Since, the supply voltages fluctuate quite often, the expansion results of current based controllers will be unpredictable. They will have no consistency.

It is our experience that a seasoned operator will more consistently expand tubes with just a drive than if he is to use a current based Torque Controller. Of course if he were to use a Wattage based torque controller, he would achieve near perfect tube expansions all the time.

POWERMASTER is the only company in the world to offer you a choice of 2 Wattage based Torque Controllers.



PR-2000 - BUILT IN PRINTER



PR-2000 - EXTERNAL PRINTER

1. **PR-2000 Series**, with microprocessor control, built in printer and computer connectivity to download and study expansion values. Ability to generate 10 report formats for quality control of expanded joints. Operates with a remote control.



2. **TCW Series**, which is a less expensive alternate to the above but has features like a 'slow start' for the drives, automatic recognition of connected drives and automatic setting of max trip values for each drive.

Rolling Motors

PR-2000 TORQUE CONTROLLER



FEATURES :

- 1) Microcontroller base, PC compatible Electronic Torque Controller uses the latest "State of the art" technology.
- 2) Setting of torque on a digital display in pure numbers.
- 3) Fully automatic operation.
- 4) Adjustable reverse and pause times.
- 5) Smooth start enables connection of any make of drive to the controller, improves brush life and enables re-expansion of tubes.
- 6) The auto-repeat feature with programmed acceleration allows you to estimate the exact expansion time.
- 7) Manual reverse operation provided.
- 8) Easy to set up and use, no special skill required .
- 9) Number keys are provided - enable direct entry of required parameter value.
The Torque Controller data can be transferred to PC through a separate connector which has been provided on the remote handset.
The data of torque values of expansions can be stored on a disc through the PC. This data can be further processed and analysed for quality checks through the PC.
- 10) Plugin type PCB's - Easy for servicing.
- 11) Rugged and reliable design.
- 12) Built -in printer or external printer-both options available. Print out possible of trip setting plus minimum, maximum and average of trips. Upto 950 expansions can be stored in memory.
- 13) Statistical print outs of under/over expanded tubes with specific tube numbers makes quality control of expanded tubes easier and faster.
- 14) Initial slow speed up of drive programmed in the controller, increases life of drives.
- 15) Key pad provided on a remote hand set gives following advantages.
 - A) Change of set values by authorised person only.
 - B) Set values are tamper proof.
 - C) Data stored in controller memory can be loaded to PC for further processing via the hand set. Controller need not be taken to the PC.
- 16) Line Voltage can be easily seen on controller display.
- 17) On connecting a drive, controller automatically sets the maximum trip wattage and indicates drive model.
- 18) Drive's reverse speed can be fixed at slow or fast.
- 19) 16 character 2 line alpha numeric LCD display guides the operator.
- 20) Display of adjusted reverse and pause times. Real time clock enables automatic printing of date & time of starting of job.

Microprocessor used	:	89C55WD (8 bit)
Clock Frequency	:	12 Mhz
Programme Memory	:	built in
Data Storage Memory (E2PROM)	:	1 K
Real Power Measurement upto	:	2 KW
Voltage, Current sampling rate	:	50 times/sec.
No. of values that can be stored	:	950
Printer	:	Inbuilt / External

Model No.	Voltage Single Phase 50/60 Hz	Weight (kg)	
		With Printer	Without Printer
PR-2000-110	110 V	19.0	9.0
PR-2000-230	230 V	19.0	9.0

Note : Refer to Pg. 23 & 24 for Drive Units, Voltage Stabilizers for use with PR-2000 torque controllers.

All PR-2000 torque controllers are supplied with operation manuals.

Rolling Motors

TCW TORQUE CONTROLLER

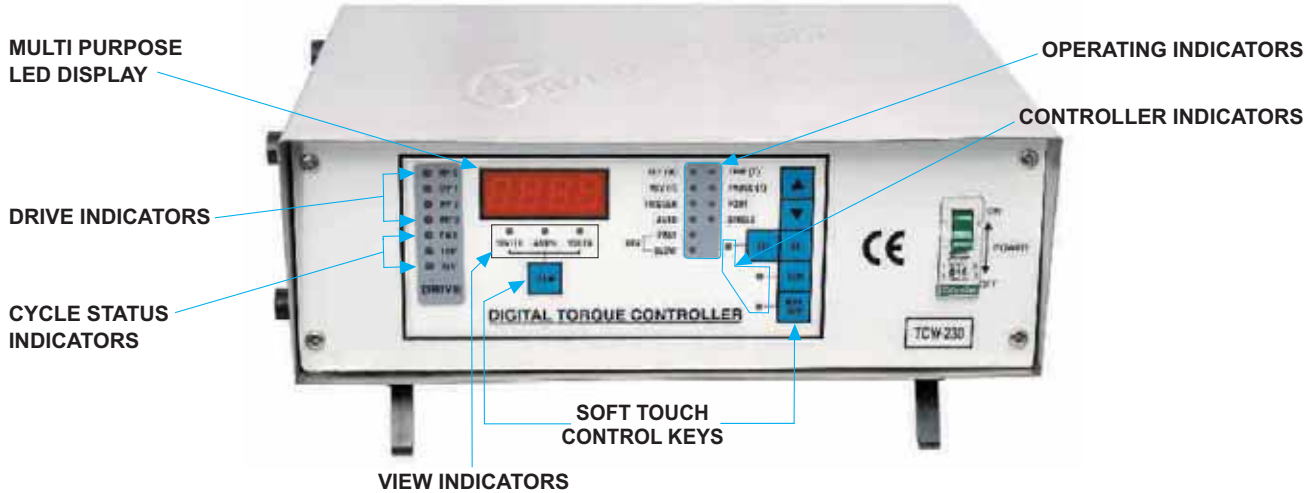

FEATURES :

- 1) Fully Solid State Design - no moving parts - no wear and tear of parts - no noise - consequently long life.
- 2) Uses one main circuit board for easy maintenance.
- 3) Uses the latest micro-controller chip for control functions.
- 4) Accurately calibrated digital torque settings with a resolution of 1 watt makes torque settings accurate and can be easily reproduced for identical results.
- 5) Soft start has been provided for all drives. This feature reduces starting currents in the drive. As a result, life of carbon brushes & drive increases.
- 6) Connected drive is automatically recognised & indicated by means of LED on the torque controller.
- 7) Torque setting arranged in four different ranges to suit four different drives. Appropriate wattage range is automatically selected for the connected drive, hence drives can not be abused or overused.
- 8) Actual drive wattage (torque) is displayed. Set wattage (torque), drive current and line voltage can be seen by press of a button.
- 9) Trip time adjustable from (0.1 sec to 10 secs.)
- 10) Adjustable reverse time from (1 sec to 100 secs.)
- 11) Pause time (time interval between cycles) adjustable from (1 sec to 100 secs.)
- 12) Manual reverse by push button, in case of emergency.
- 13) Drive Speed adjustable in reverse rotation.
- 14) Hand (trigger) mode or foot switch mode, both are available.
- 15) Expansions can be carried out either in single cycle mode or auto repeat mode.
- 16) LED indicators provided for forward, reverse & trip conditions of drive.
- 17) MCB has been provided to protect the controller and drives against over current by short circuits.
- 18) Plug in type of PCBs reduce down time to minimum during trouble shooting.
- 19) All the spares inside the panel viz : PCBs, Transformers, CT, Relays DPM etc. can be replaced by use of only a screw driver.
- 20) Superior SCR technology has been incorporated rather than triacs. SCRS have much better voltage, current & dv/dt ratings than triacs. This leads to greater reliability & the power circuit becomes almost failsafe.
- 21) Powermaster has over 1000 TCW Torque Controllers in active use worldwide since its inception in year 2000.

Microprocessor used	:	89C55WD (8 bit)
Clock Frequency	:	12 Mhz
Programme Memory	:	built in
Real Power Measurement upto	:	2 KW
Voltage, Current sampling rate	:	50 times/sec.

Model No.	Voltage Single Phase 50/60 Hz	Weight (kg)
TCW-110	110 V	7.5
TCW-230	230 V	7.5

Note : Refer to Pg. 23 & 24 for Drive Units, Voltage Stabilizers for use with TCW torque controllers.

All TCW torque controllers are supplied with operation manuals.

Rolling Motors

ELECTRIC DRIVES FOR USE WITH TORQUE CONTROLLERS



MPB - 0



MPB - 1



MPG - 2



MPG - 3



FEATURES:

- 1) Heavy Duty German motors form the heart of these drives.
- 2) Continuous cycle operation vs. Intermittent cycle operation of drives from other manufactures.
- 3) High torque to weight ratio.

SPECIFICATIONS

Supply Voltage Single Phase 50/60 Hz	Drive Model	Speed I / II	No Load R.P.M.	Expansion Range				Drive Weight Kgs.
				Steel Tube O.D.		Copper Tube O.D.		
				inch	mm	inch	mm	
230 V	MPB - 0N	I	2200	1/4" - 3/8"	6 - 10	1/4" - 1/2"	6 - 12	2
	MPB - 1N	I	1000	3/8" - 5/8"	10 - 16	3/8" - 3/4"	13 - 20	2.5
		II	1900	5/16" - 3/8"	8 - 13	5/16" - 1/2"	8 - 13	
	MPG - 2N	I	480	5/8" - 1.3/4"	16 - 45	5/8" - 2"	16 - 50	7.5
		II	1080	5/8" - 1.1/4"	16 - 32	5/8" - 1.1/2"	16 - 38	
	MPG - 3N	I	130	1" - 3"	25 - 76	1" - 4"	25 - 102	8.5
II		430	1" - 2"	25 - 50	1" - 3"	25 - 76		
110 V	MPB - 0L	I	2200	1/4" - 3/8"	6 - 10	1/4" - 1/2"	6 - 12	2
	MPB - 1L	I	1000	3/8" - 5/8"	10 - 16	3/8" - 3/4"	13 - 20	2.5
		II	1900	5/16" - 3/8"	8 - 13	5/16" - 1/2"	8 - 13	
	MPG - 2L	I	480	5/8" - 1.3/4"	16 - 45	5/8" - 2"	16 - 50	7.5
		II	1080	5/8" - 1.1/4"	16 - 32	5/8" - 1.1/2"	16 - 38	
	MPG - 3L	I	130	1" - 3"	25 - 76	1" - 4"	25 - 102	8.5
II		430	1" - 2"	25 - 50	1" - 3"	25 - 76		

Rolling Motors

VOLTAGE STABILIZERS / TRANSFORMERS



FOR USE WITH TORQUE CONTROLLERS

FEATURES:

- Digital display of output voltage.
- Used in on site application and areas which are prone to high voltage fluctuations.

Model No.	Input Voltage (V)	Output Voltage (V)
VS1BB	160 - 260	103 - 118
VS2BB	160 - 260	215 - 245

ACCESSORIES FOR ELECTRIC TUBE EXPANSION SYSTEM



TROLLEY

Features :

- Heavy Duty Sheet Metal Construction.
- Conveniently houses all tools needed for expanding tubes.

Model	Description
FS-1	Set of 3 Foot Switches
TCW	Torque Controller
TR-1	Collapsible Trolley - Stainless Steel
SWF-5	Spring Balancer
SB-1	Swivel Bracket
MP	Electric Drive
TS	Telescopic Shaft

Rolling Motors

TELESCOPIC SHAFTS

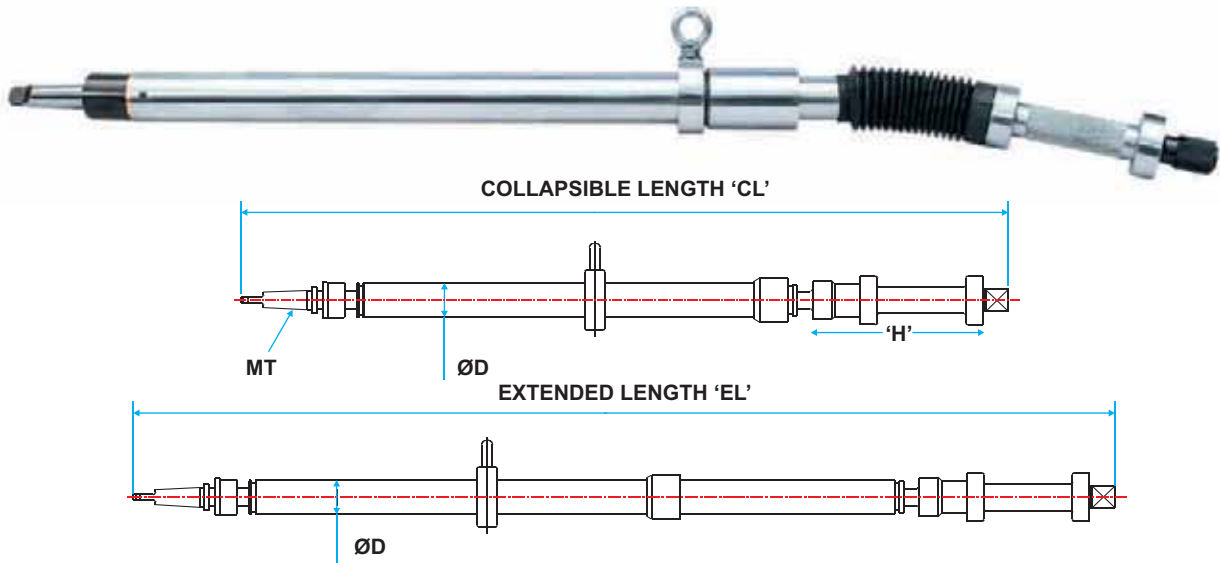

FEATURES:

- Used to free the operator from handling drives.
- Sturdy construction absorbs all torque during tube expansion.

Model Number	MT Shank	CL mm	EL mm	Handle Length 'H' mm	D mm	For Use with Drive Model	Weight kg	Supplied with Quick Change Chucks and Adaptors of Following Sizes
TS-1 E	2 MT	850	1250	200	38.0	MP-2	2.75	3/8", 1/2", 3/4"
TS-2 E	3 MT	1000	1505	225	38.0	MP-3	5.75	1/2", 3/4", 1"
TS-3 E	3 MT	1000	1400	250	51.0	MP-3	9.20	1/2", 3/4", 1"

QUICK CHANGE CHUCKS AND ADAPTORS

FEATURES:

- For use directly with Rolling Motors - electric, hydraulic and pneumatic.
- For use with Telescopic Shafts.
- Any combination possible for use with any manufacturers equipment.
- Specify square size and thread type (if applicable) on either end of quick change chuck / adaptor when ordering.

QUICK CHANGE CHUCK



Specify Square Size
(to couple to expander mandrel square)

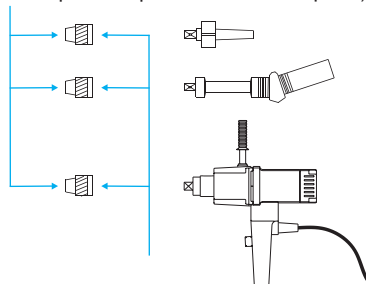

Specify Square or thread size
(to couple to rolling motor / telescopic shaft)

ADAPTOR



Specify Square Size
(to couple to expander mandrel square)

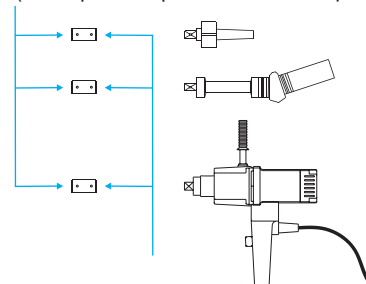

Specify Square or thread size
(to couple to rolling motor / telescopic shaft)

Rolling Motors

HYDRAULIC THRUST EXPANSION SYSTEM

USING IN LINE ROLL TUBE EXPANDERS

FEATURES :

- Specially designed to expand stainless steel thick walled and exotic harder tubes, where conventional expanders would fail.
- Can expand tubes in a deep channel using stepping extension.
- Quality leak proof joint in 3 to 5 seconds.
- Precise control of advancing force.
- Constant RPM even under load condition ensures equal pressure to the rolls for tight fit, leak proof joint between tube and tube sheet.
- Internal cylindricity of expanded tubes.
- Durable heavy-duty construction ensures long reliable life.
- Reduction of tube stretching & internal stresses.
- Simple operation saves time & reduces operator fatigue.
- Large oil tank and external filter for better cooling effect and easy filter replacement.
- Automatic lubrication system increases tool life and reduces consumable cost.
- Continuous programmed cycle-microprocessor controlled.



PUMP SPECIFICATION

- Power Requirement : 415v, 3 Phase
- Electric motor : 5 HP
- Reservoir Capacity : 138 liters (32 gallons)
- Weight : 450 kg (990 lbs)
- Height : 1000 mm (39") over reservoir
2630 mm (103") over suspension system
- Base : 1220 mm x 630 mm (48" x 25")
- Maximum Working Pressure : 100 bar

DRIVE SPECIFICATION

- Tube range 1/2" to 2" O.D. up to 5.1/2" thick tube sheets.
- Special expanders also available .
- No load RPM - 780.
- Control voltage - 24 volts DC.
- Thrust stroke - 65 mm.

NOTE : Optional stepping space for rolling thicker tube sheets without removing expander from the tube.

Extension for expanding of tubes in deep channels is available.

Ask for catalog number HTTE/038/1 for expanders available.

System is supplied with operation manual showing detailed features and accessories.

Rolling Motors

HYDRAULIC TUBE EXPANSION SYSTEMS (HYDEX)

FEATURES:

- 1) Drive communicates with the pump via 9v DC remote control. This ensures safety and eliminates the need of electrical cord between pump and drive that other manufacturers provide.
- 2) Silent during use. In comparison electric and pneumatic tube expansion systems are noisy.
- 3) Compact, therefore easy to use inside boiler drums.
- 4) Compatibility - Same powerpack for all the 4 drives to expand 5/8" o.d to 4" o.d tube.
- 5) Very High Torque Developed - can expand large diameter, thick wall tubes in thick tube sheets easily.
- 6) Long life + low maintenance.
- 7) Boiler erections get completed in record time.
- 8) Can be use for long working hours because drive is unaffected by heat.
- 9) Dual drive powerpack is available to connect 2 drives to a single powerpack to cut down tube expansion time cycle by a further 50%.
- 10) Microprocessor controls on the pump automate the expansion cycle. Trip, pause and reverse times for the drive are adjustable. No need for repeated manual STOP/START of the drive during the expansion cycle - completely automatic.
- 11) Drive speed remains constant during the expansion cycle unlike electric or pneumatic drives.

The hydraulic pump supplied with hydraulic drive incorporates the latest state of the art technology resulting in a subcompact pump developing 100 bar pressure. The system is mounted on four wheels for on site manoeuvrability.

Expansion of tubes is regulated by adjusting pressure setting on pump. Once required amount of wall thinning is achieved the drive trips automatically.

Powermaster offers you an unparalleled choice of three different pumps based on your application and budget.



HYDRAULIC PUMP HEP-500

	Hydraulic Pump Models		
	HEP-300	HEP-500	HEP-1000 TWIN HEAD
Oil Tank Capacity (Litres)	30	45	138
Hydraulic Oil	SAE VG 68	SAE VG 68	SAE VG 68
Maximum Working Pressure (bar)	100	100	100
Net Weight (kgs)	80	100	220
Overall Dimensions (mm)	610 x 270 x 985	820 x 320 x 985	1775 x 550 x 1200
Electric Motor	3 hp. Single phase	5 hp. 3 phase	10 hp. 3 phase
Voltage	230 v / 110 v	415 v	415 v
Standard Hose Size (Length)	1/2" (10 mtrs.)	1/2" (10 mtrs.)	1/2" (10 mtrs.)

Rolling Motors

ACCESSORIES FOR HYDRAULIC TUBE EXPANSION SYSTEMS

ACCESSORIES FOR HYDRAULIC EXPANSION SYSTEMS



HYDRAULIC DRIVES

Tube Expansion Range				Drive		Drive No Load Speed (RPM)	Drive Weight Kgs.
Steel Tube O.D.		Copper Tube O.D.		Model No.	Square Socket inch	With HEP-300/500/1000	
mm	inch	mm	inch				
15 - 25	5/8 - 1	25 - 38	1-1.1/2	HED-3	3/8	620/954/800	9.6
19 - 38	3/4 - 1.1/2	32 - 64	1.1/4-2.1/2	HED-4	3/8 & 1/2	350/480/400	9.7
38 - 76	1.1/2 - 3	50 - 102	2-4	HED-5	1/2 & 3/4	62/84/70	11.0
50 - 102	2 - 4	-	-	HED-6	3/4 & 1	40/62/54	11.5

Note : Drive supplied with FORWARD, STOP, REVERSE, AUTO BUTTONS, QUICK RELEASE COUPLINGS, SOCKETS and REACTION BAR. Powerpack includes 2 hoses each of length 10 meters. If required longer hoses can be supplied.

HYDRAULIC HOSE



Model No.	Hydraulic Hose (Qty. x Size x Length) (Mtrs.)
HE/HS/1210/2	2 x 1/2" x 10
HE/HS/5815/2	2 x 5/8" x 15
HE/HS/5820/2	2 x 5/8" x 20
HE/HS/1210/4	4 x 1/2" x 10
HE/HS/5815/4	4 x 5/8" x 15
HE/HS/5820/4	4 x 5/8" x 20

SUPPLY CABLE



Model No.	Supply Cable Length (Mtrs.)
HE/SC/15	15
HE/SC/20	20
HE/SC/25	25

HYDRAULIC DR...



Model No.	Square Size
HE/DS/38	3/8"
HE/DS/12	1/2"
HE/DS/34	3/4"
HE/DS/1	1"

Rolling Motors

ACCESSORIES FOR HYDRAULIC EXPANSION SYSTEMS

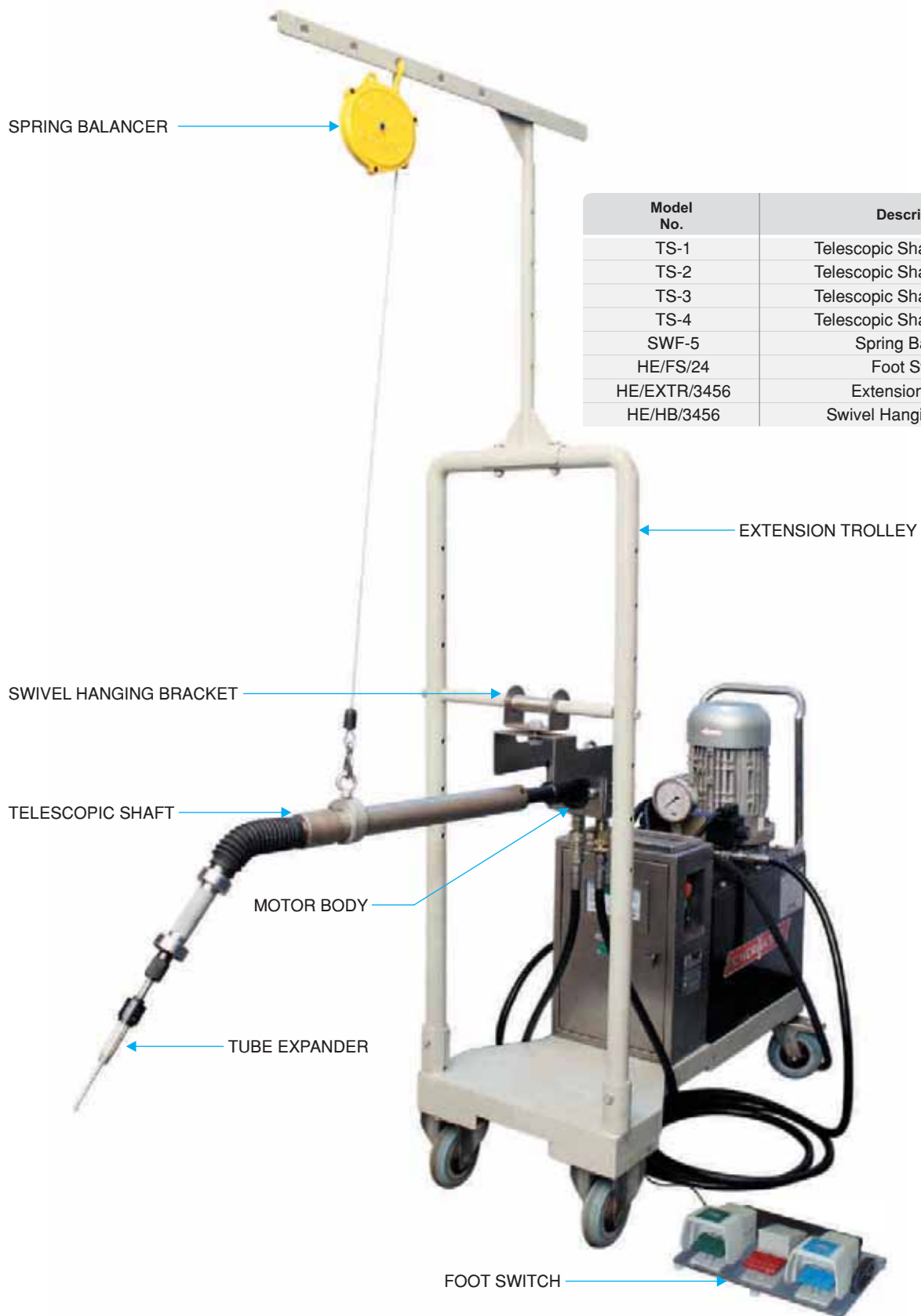

Model No.	Description
TS-1	Telescopic Shaft for HED-3
TS-2	Telescopic Shaft for HED-4
TS-3	Telescopic Shaft for HED-5
TS-4	Telescopic Shaft for HED-6
SWF-5	Spring Balancer
HE/FS/24	Foot Switch
HE/EXTR/3456	Extension Trolley
HE/HB/3456	Swivel Hanging Bracket

SPRING BALANCER

EXTENSION TROLLEY

SWIVEL HANGING BRACKET

TELESCOPIC SHAFT

MOTOR BODY

TUBE EXPANDER

FOOT SWITCH

Rolling Motors

PNEUMATIC ROLLING DRIVES



Pneumatic Rolling Drives are specifically designed to ensure uniform tube to tube sheet expansions, there by ensuring exact rolling of tubes.

FEATURES:

- Light weight aluminum body.
- Ergonomically correct push/pull throttle.
- Automatically stops tube expansion at defined setting.
- Precision control measures torque output.

Model Number	Free Speed rpm	Min Torque Nm	Max Torque Nm	Tube Capacity inch	Air Consumption l/min	Weight kg
720-550	550	0.226	8.47	1/2	480	1.20
850-1250	1250	1.58	12.20	3/4	1700	4.80
850-600	600	2.49	21.81	1	1700	4.80
850-400	400	5.00	36.00	1.1/4	1700	4.80

RIGHT ANGLE ROLLING DRIVES



Right Angle Rolling Drives are specifically designed for expanding boiler tubes in steam, mud drums, fire tube & related boiler equipment.

FEATURES:

- Unique head design consisting of fully enclosed bearing for long & trouble free life.
- Both models equipped with roll throttle as standard. Lever throttle optional.
- Easy adjustable torque.
- Angle head can be setup in numerous positions.
- 360 degree adjustable air exhaust.

Model Number	Free Speed rpm	Min Torque Nm	Max Torque Nm	Tube Capacity inch	Square Drive inch	Weight kg
P72-RT-190	190	95	190	2.5	5/8	5.80
P72-RT-90	90	200	410	4	3/4	6.70

GBC Rental

GBC Rental

We are the leading supplier of rental pipework fabrication equipment and we have an unrivalled range and quantity of equipment available off the shelf; from pipe bevelling and cutting to tube pulling and expanding, including:

- Pipe and Plate Beveling Machines
- Pipe Cutting Machines
- Pipe Clamps and Stands
- Bundle Pullers
- Tube Expanding Machines
- Rolling Motors for Tube Expanders
- Tube Pulling Machines
- Reciprocating Saws
- Orbital Pipe Saws
- Flange Facing Machines

You can hire these...

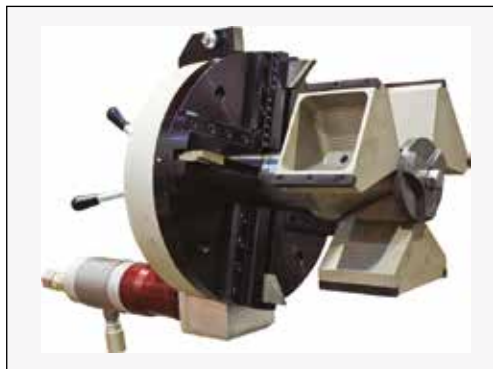
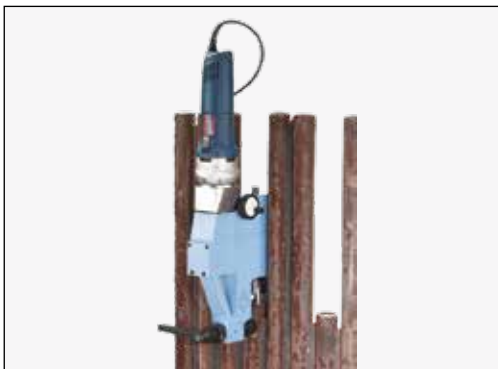

...plus so much more!



- **PEDIGREE - 35+ Years Experience**
- **QUALITY - ISO 9001 Since 1996**
- **PERFORMANCE - Guaranteed**