

↑
指3本
丸い指先

あな
ライン体

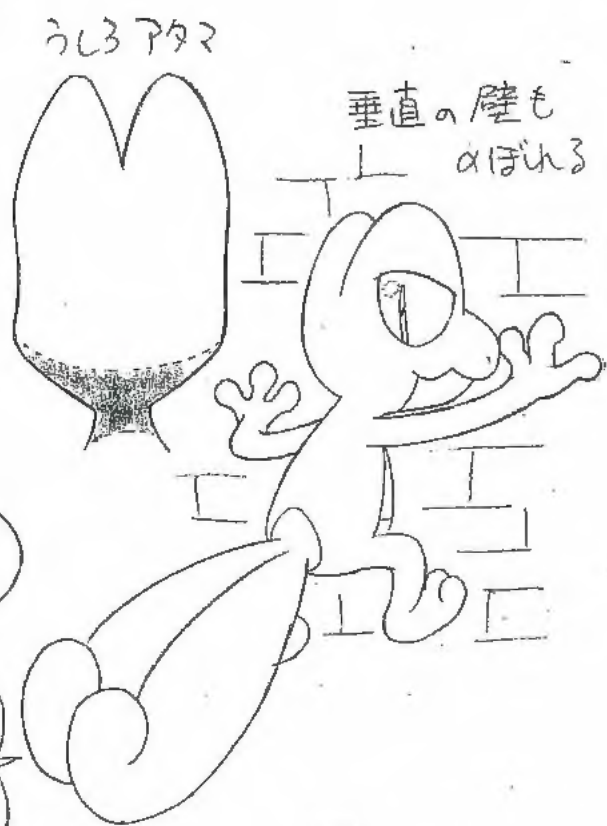

Hi色下P



うしろアタマ

垂直の壁も
αぼゆる

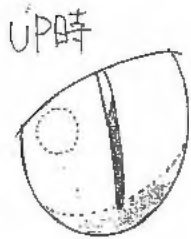

UP時



暗い所では瞳太くなる



しほ°2房
苔状の
質感



動きによる
のびるディフォルメ

スパイダーマン?

←くらつく



キバなし
舌はのびない



キモII

2002. 4. 27.

決定稿
2002. 05. 07



- クール
- マイペース
- プライドが高い
- 仲間とは常に
- キョリを置くタイプ

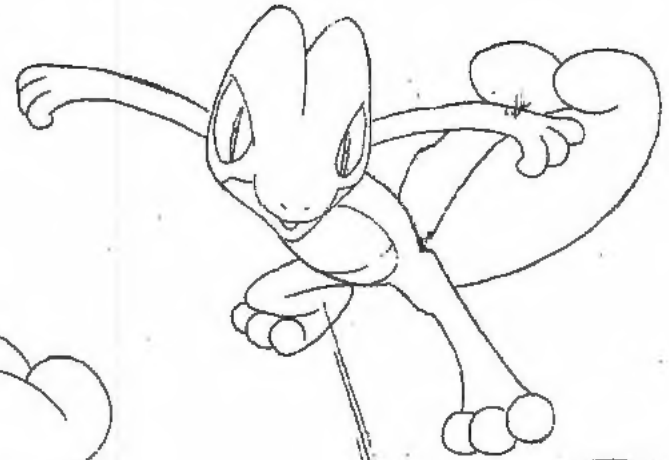

木の枝をくわえては
木の枝の先端
まわりから
調達

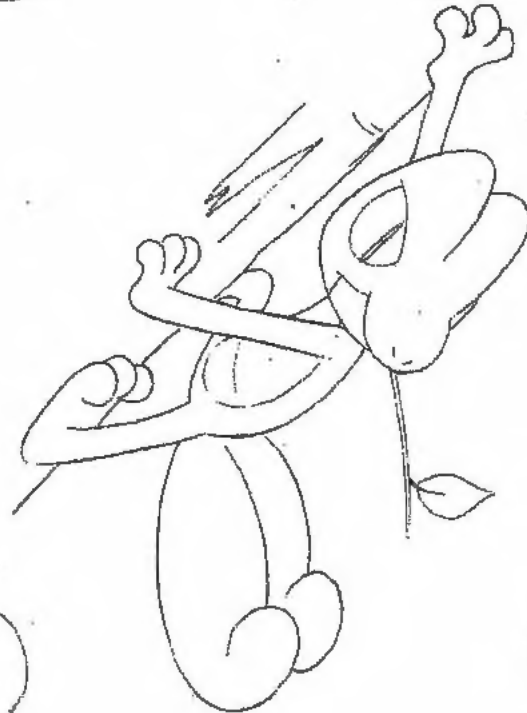

木の枝を
坂の矢のように
撃つ、下りする。

アサヒ

アサヒのフクロ

2002.8.20

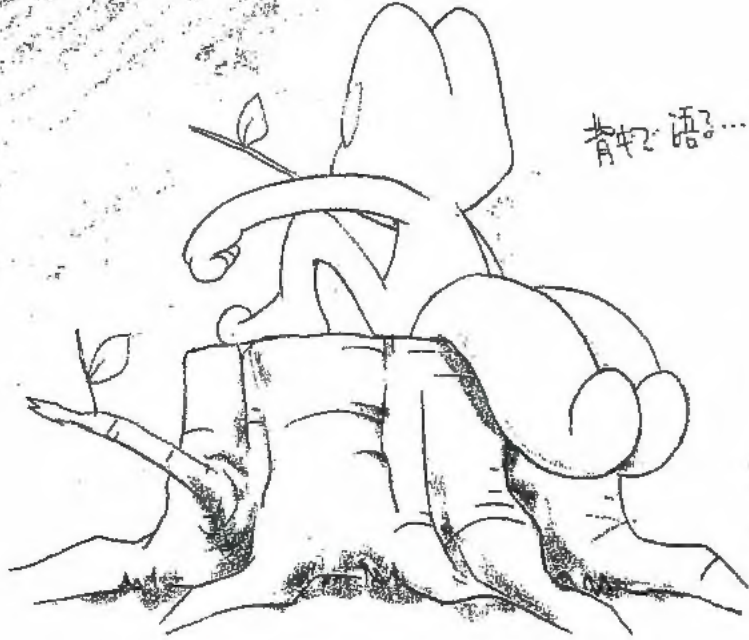

青物語...?

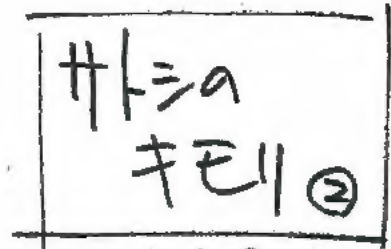

2002.8.20.

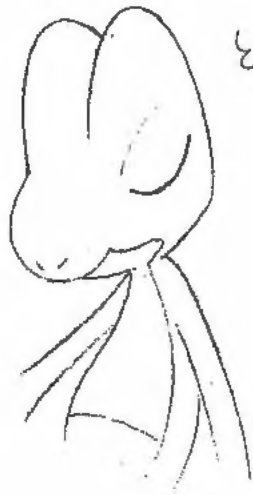
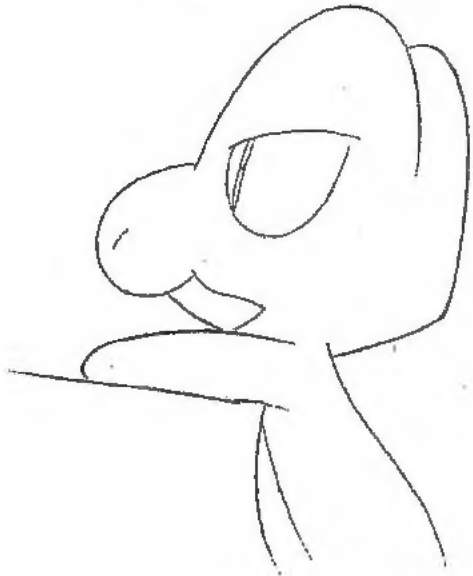
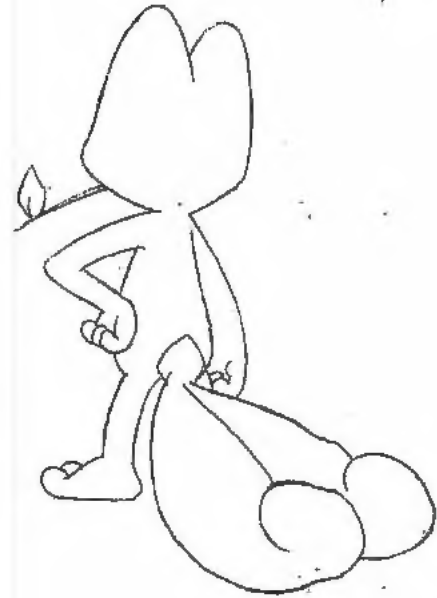

クビ



カゲリキ

断面

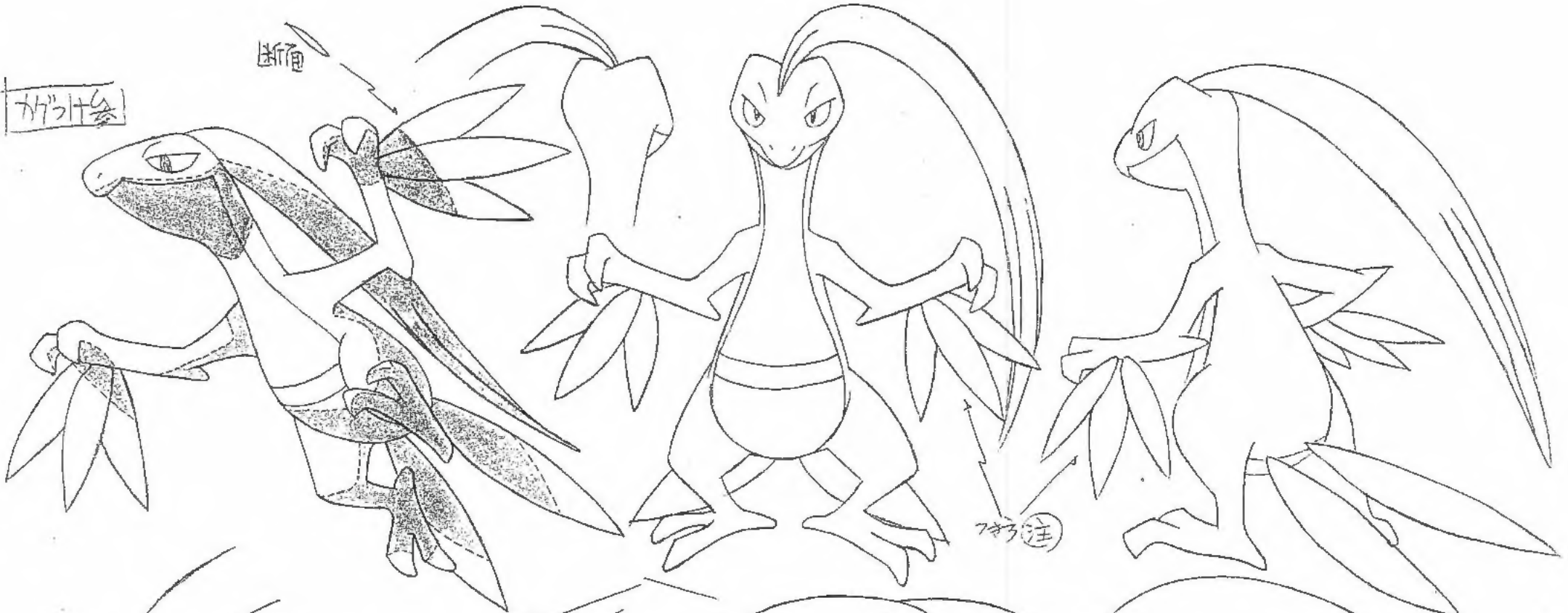

注意



目の印

断面



歯なし

シユアトル

決定稿

肩の骨

腕の断面

約90°

断面

しほ
刈分竹
(実線)

断面は丸い

4: 実線

爪の4実線

下顎

目の裏

このラインは
背中の(種)の下で
途切れる

足の裏

決定稿

白キバはなし

ジュカイン

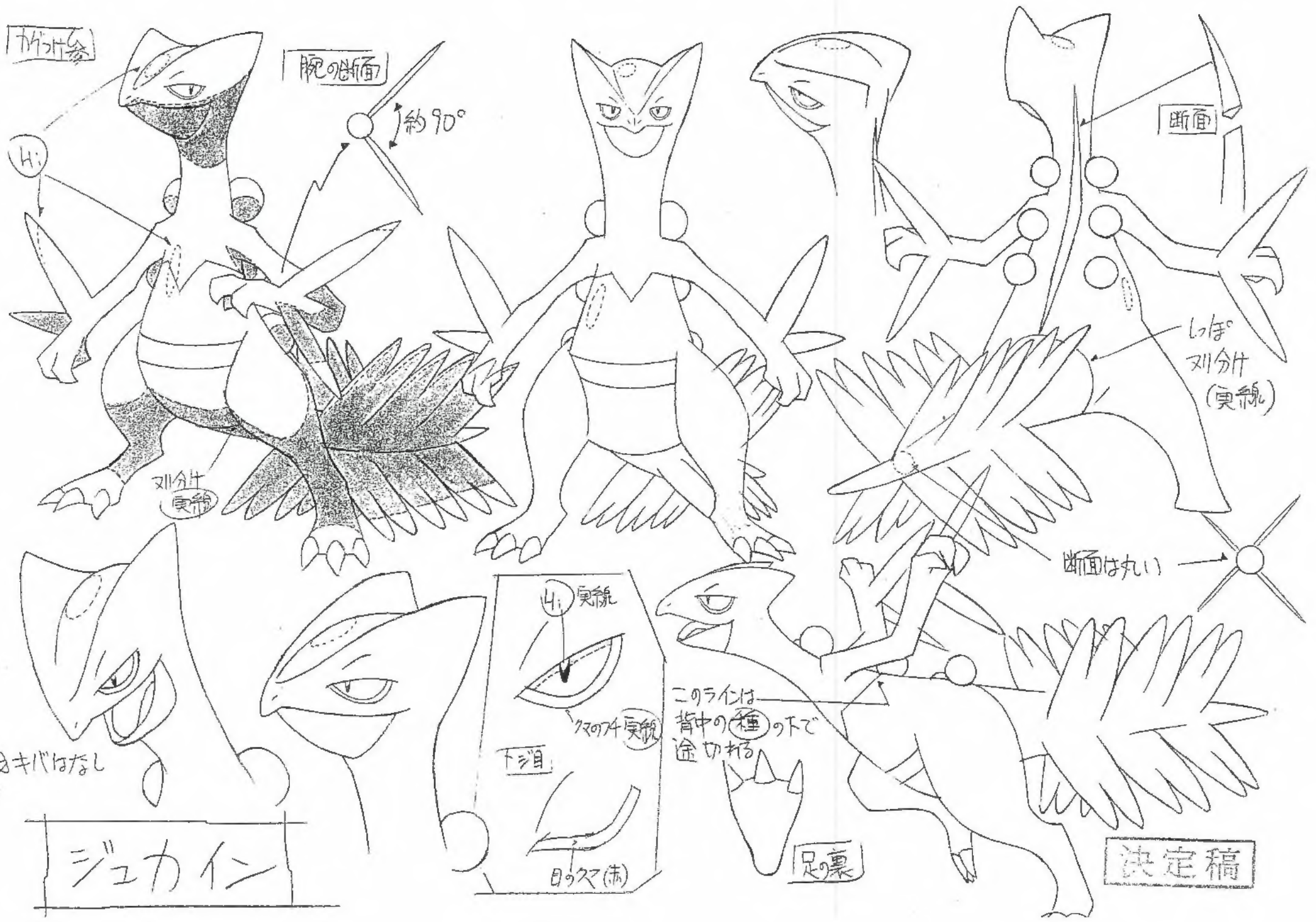

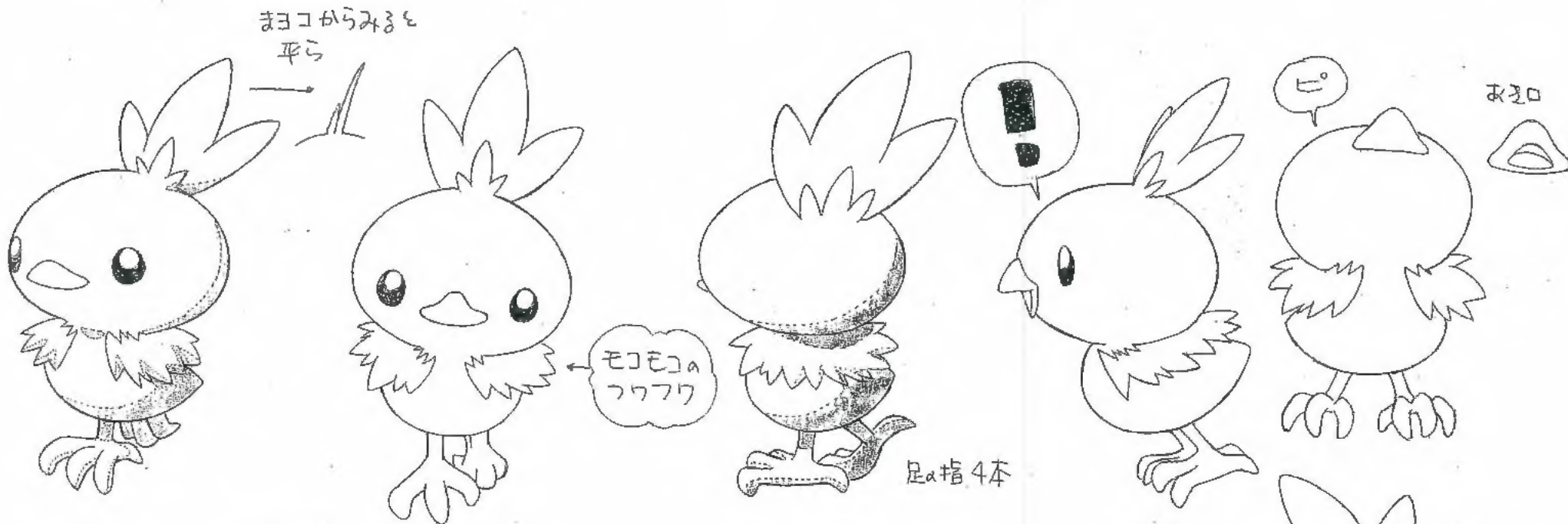

◎ 飛べない
飛び出した程度。
✕ ーゆう
はがたまは
しやせ

↑UP時
*目を
まけたら長
一息だけ"

おくらさ
↑
足はこたえてお
思、て下さい



✕ 肉じ口の時にこれし
✕

アキマ
決定稿

2002.5.2.
5.30

腕の断面

(H)

パツリ目

☆基本はツリ目です

困り

カケハシ

1/2x
曲がっても
このくらひ

(H) 更線

目の印

トサカ
厚みおれせん

破線
参考で
はス始め

アキロ

ワカシャモ

決定稿

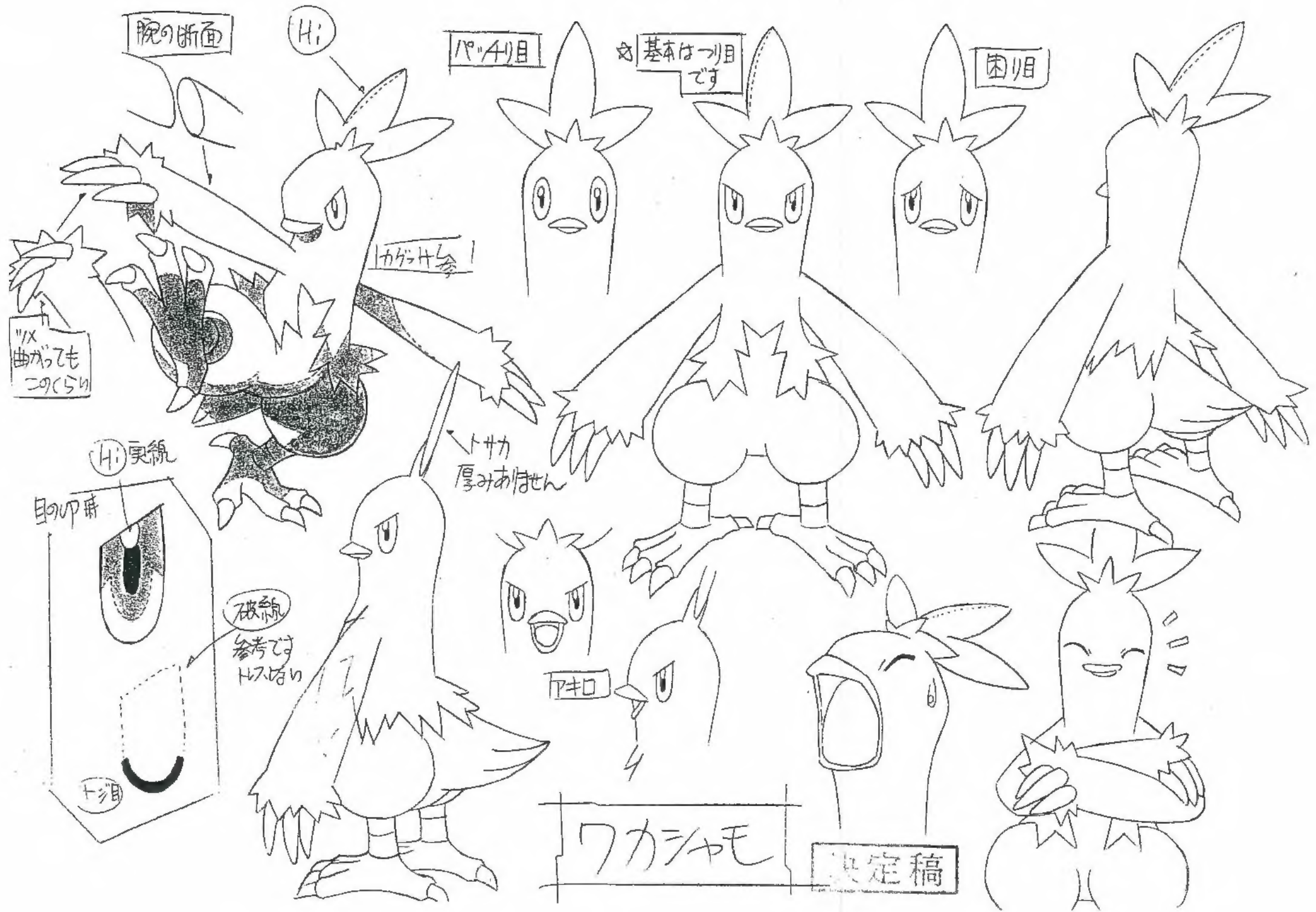

190cm

トサカ 断面
9面
△カマボコ型

キバなし
キカキカ
4つ

78
78
25

H1
髪は板状

怒り攻撃時のみ
ウレオ

ウレオ

*ニヤウレオ
羽色が赤み、
イメージ

バシャーモ

決定稿

2002. 6. 8

2002. 06. 10

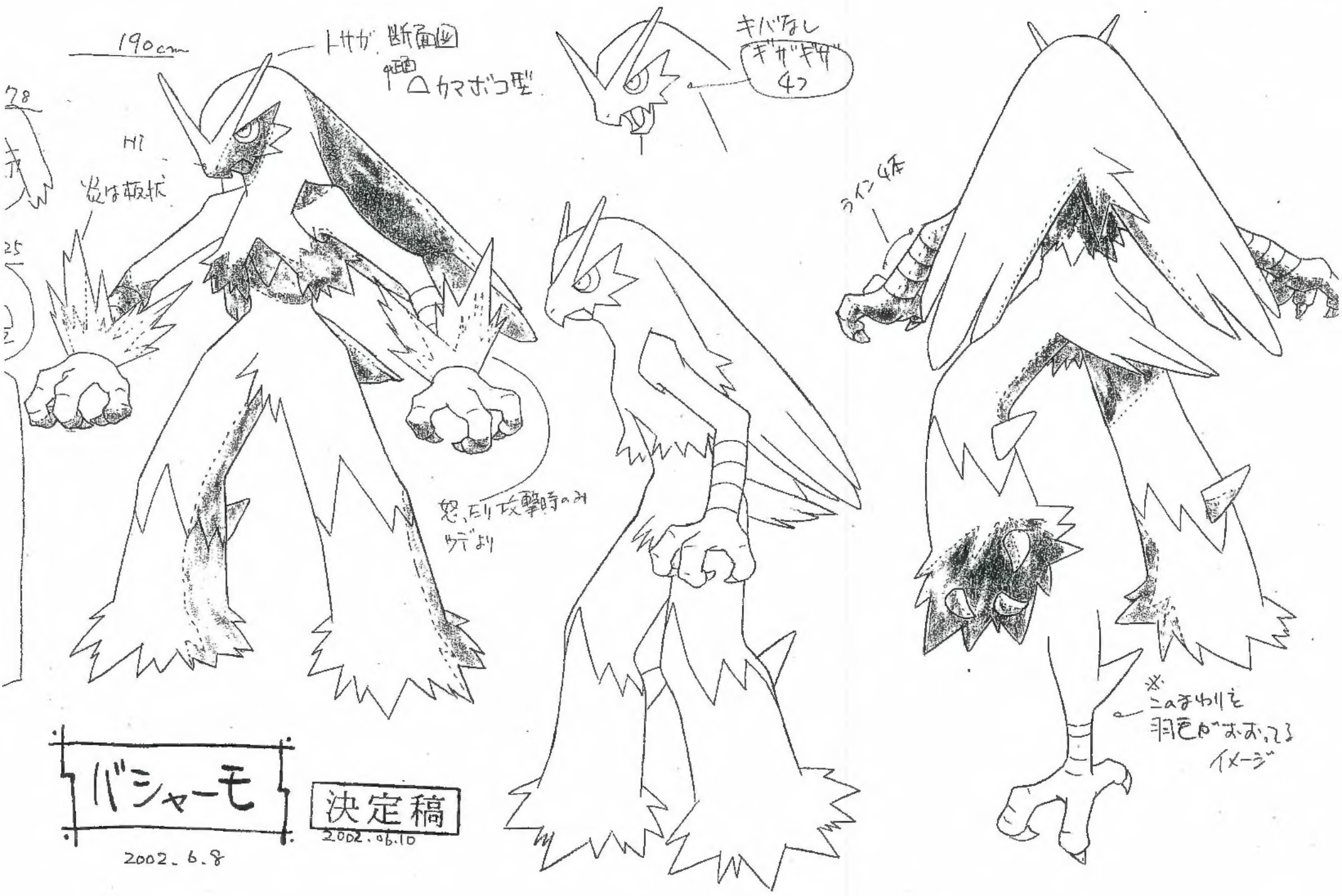

逆立つ羽根

この上は
上がる

少く
雨

感情が高い時
自然と逆立ち

① 川が
深
川が
急

動きは、2-11-17
フーリ

特徴はローマの
ようなポーズは
しません。

横
この上は
雨がる

上がる
羽

アトリス

決定稿

2002.06.19

バシャーモ

②

2002.6.13.

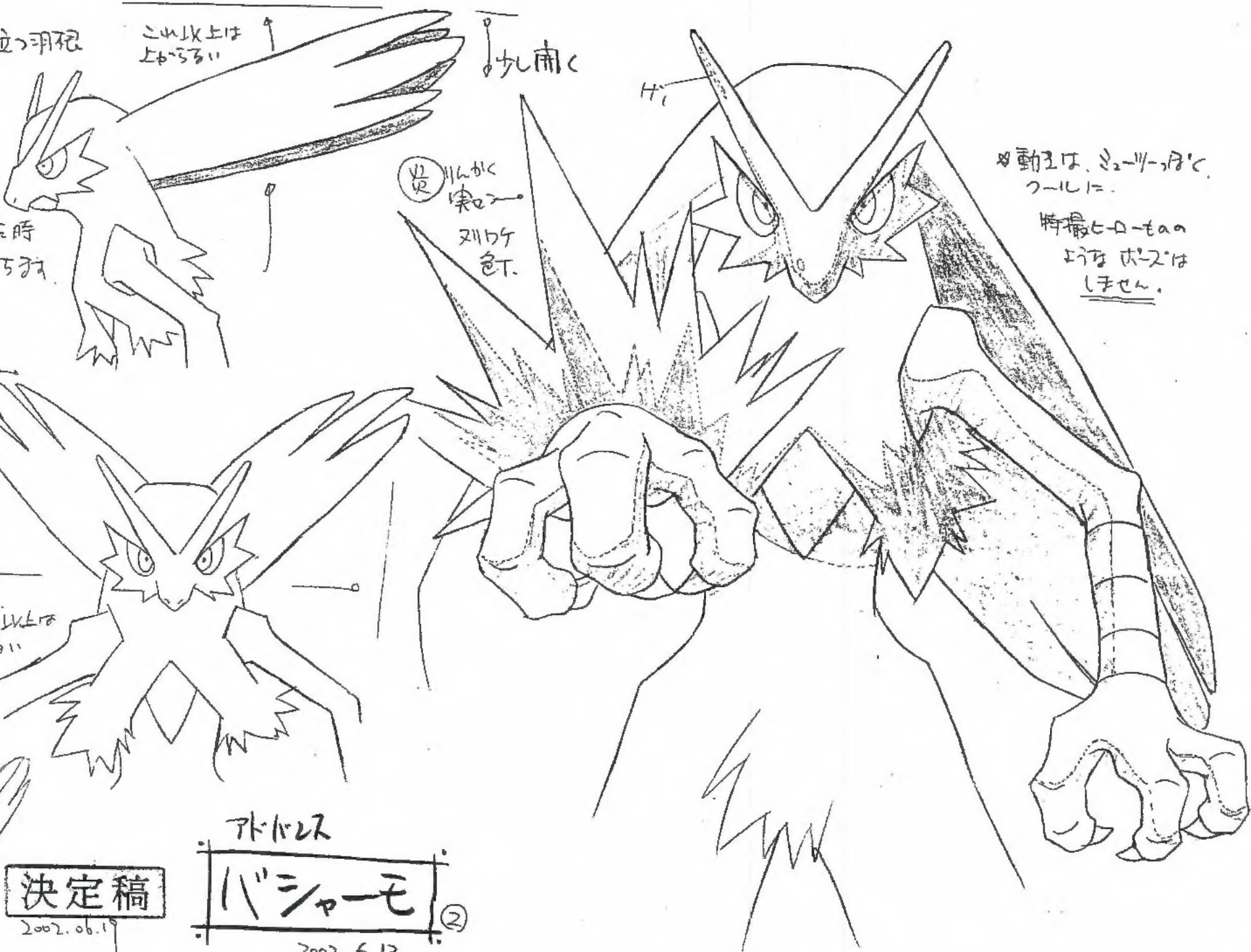
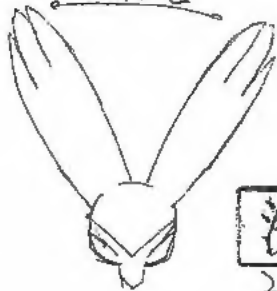



水陸両性.



歩て、走りは
尻系で

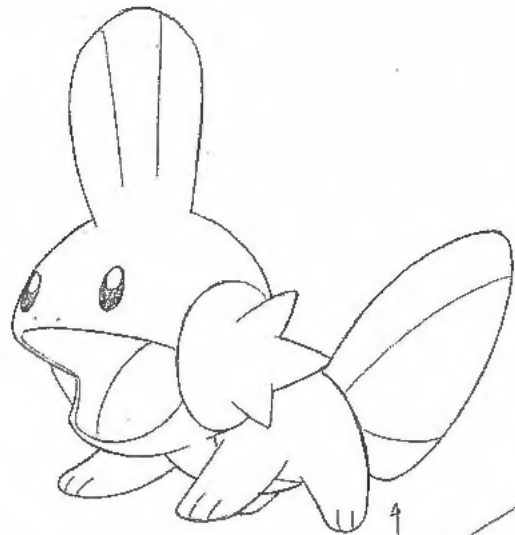
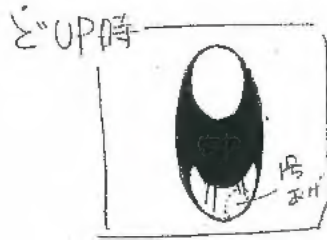
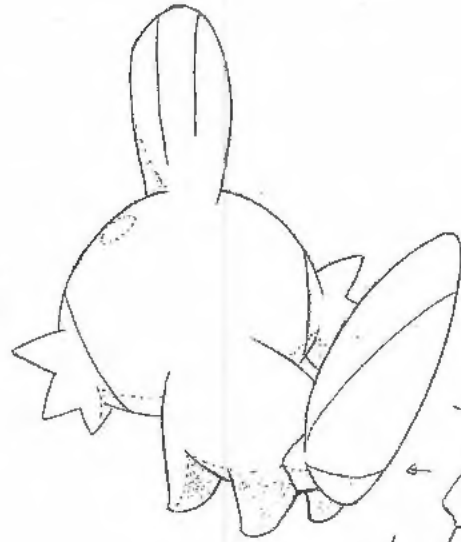

オチカのアリケは
しほ(ヒ)おこっただけ



足のゆわ
何もなし

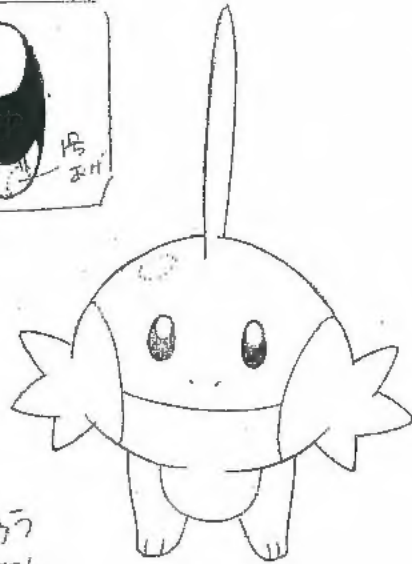

水中では尾ビレを
使って泳ぐ

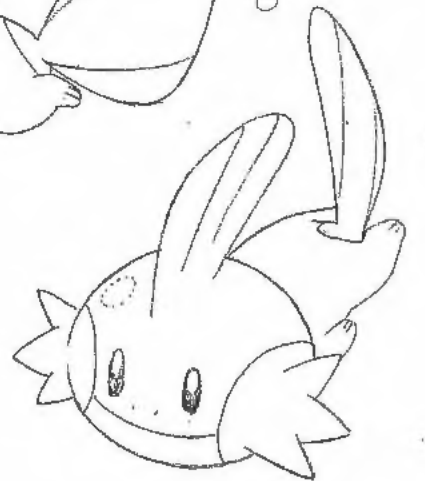

決定稿

2002.05.04

ミズゴロウ

2002.5.2

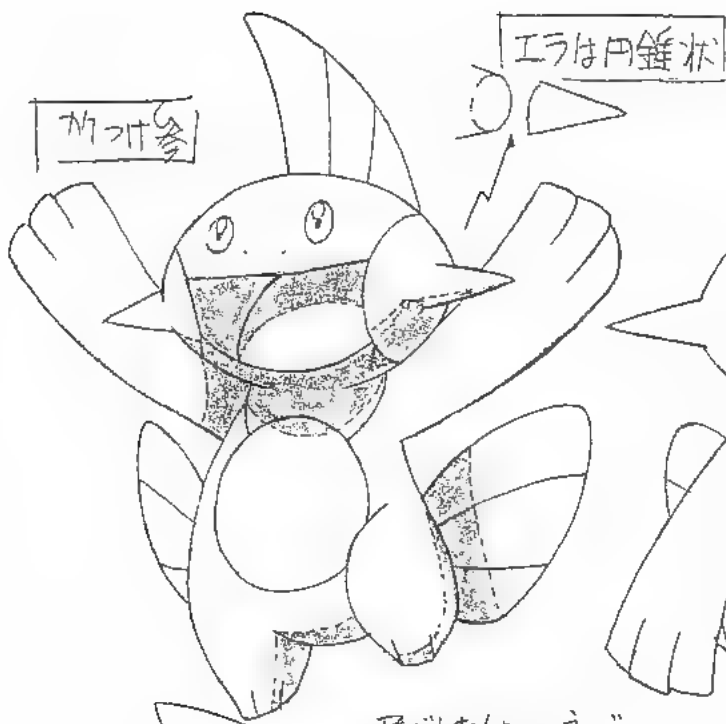

アゴは円錐状

アゴの舌

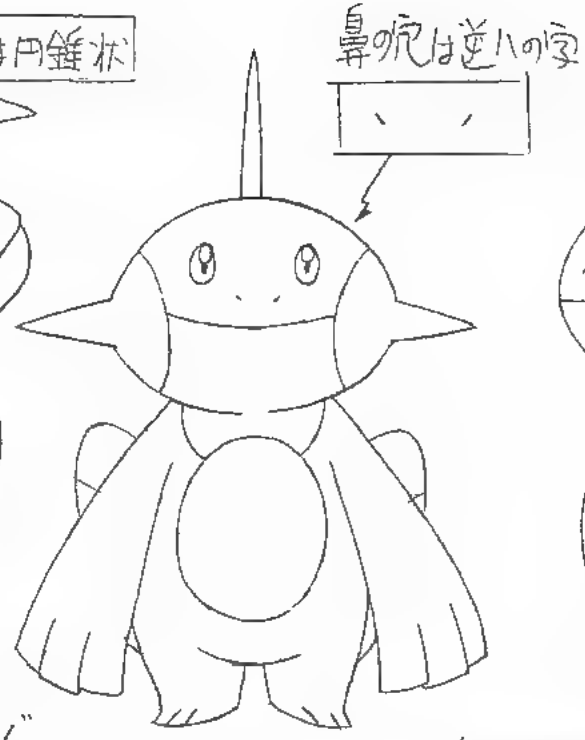

鼻の穴は逆ハの字

、

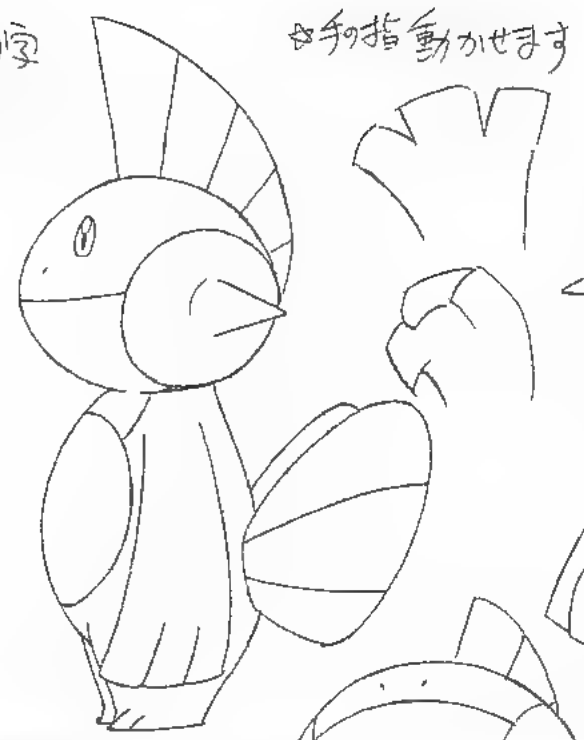

手の指動かせる

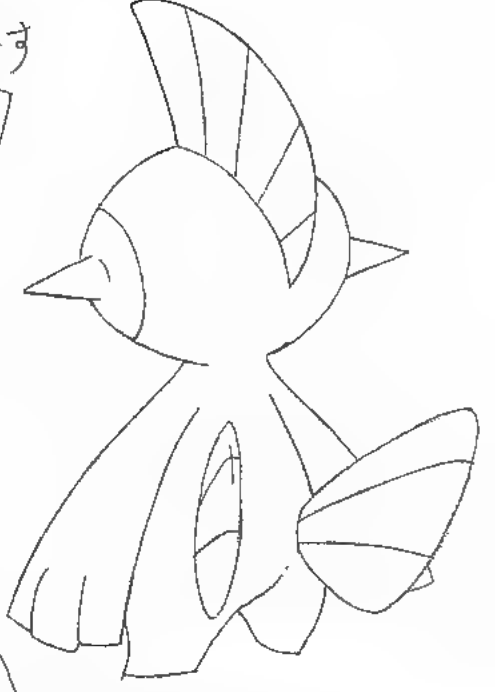

尾ビレを使って泳ぐ

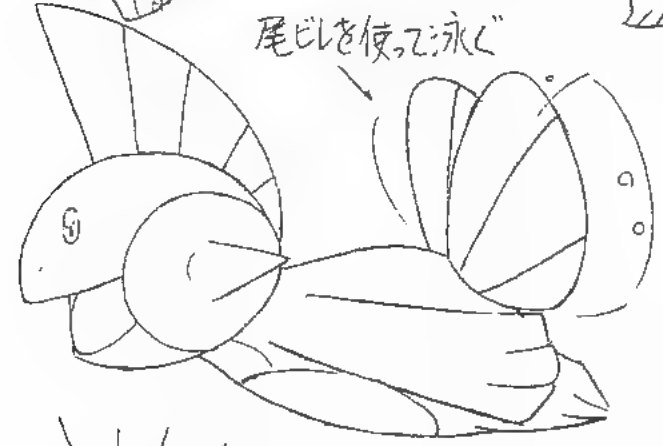

目の印時

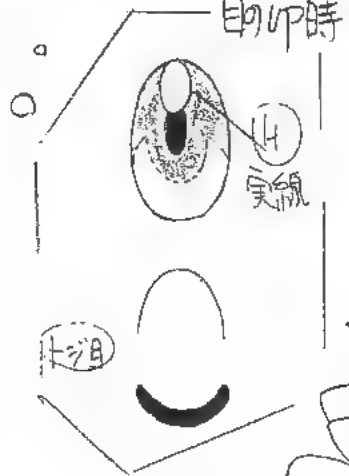

口周りと見えてせんがアゴの下に2つ分けられ(実線)

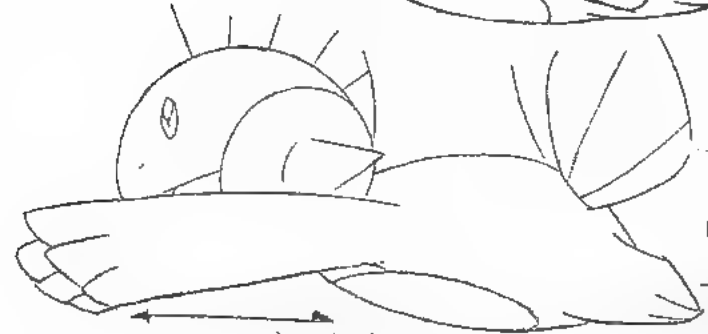
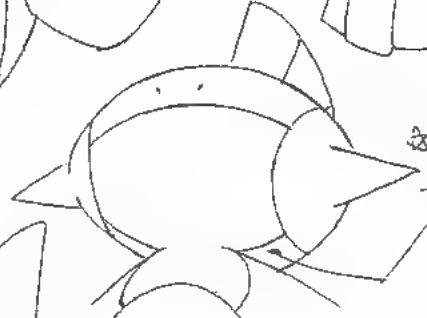

たまに手で水をかき出す

ヌマクロー

決定版

2002.11.25 OK

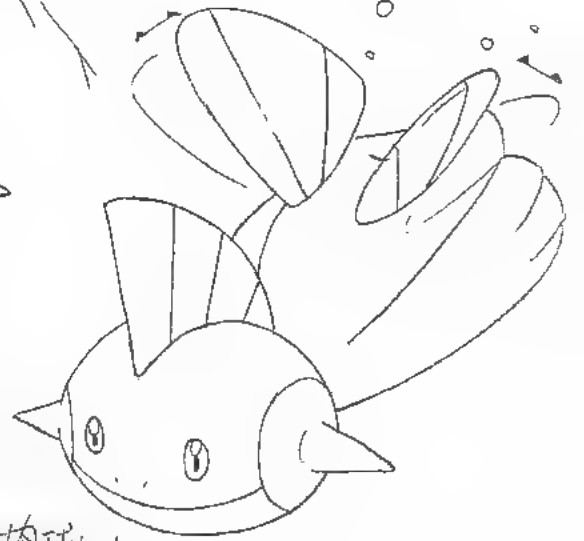
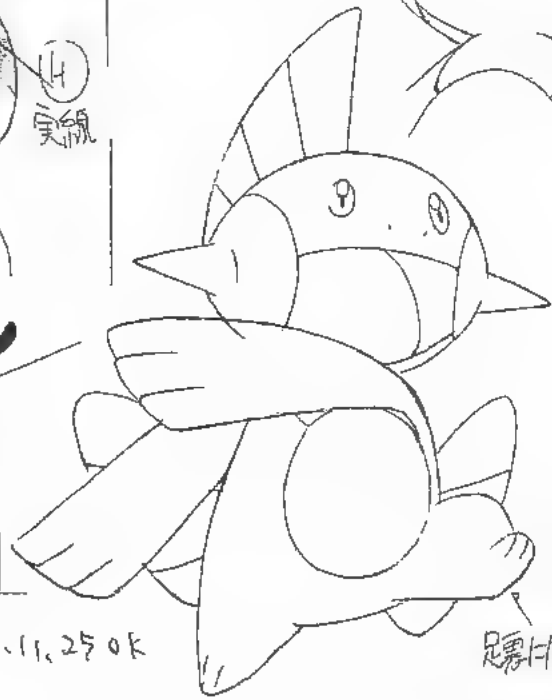

尻肉球はなし

カウハク

H.

H.

基本的に中腰ポーズです

前の口を開けると少下がる

ラインは2本

☆尾ビシのラインは6本

H.

目のOP

トシ目

マダはヒの色

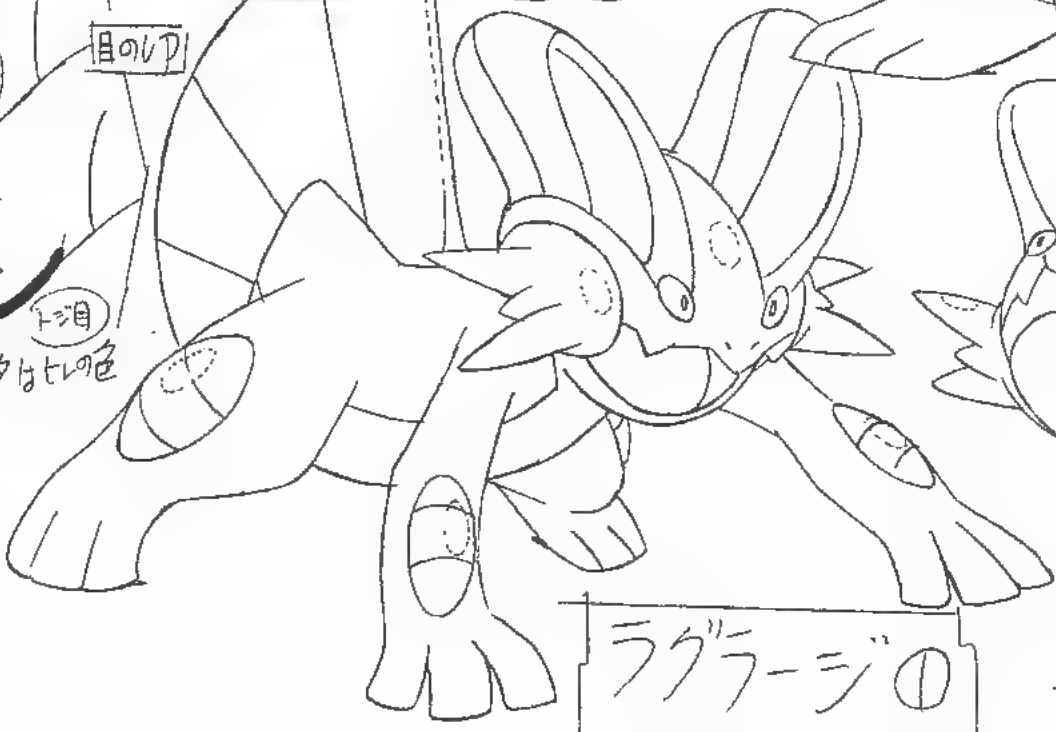
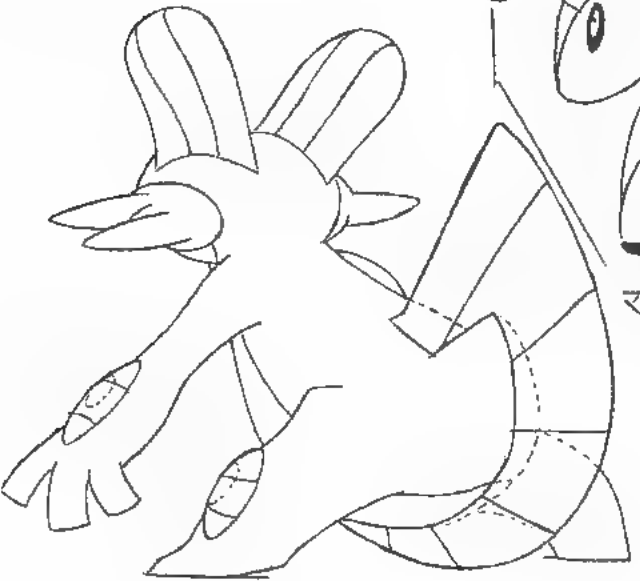

ラグラージ①

決定稿

2002.11.25 OK

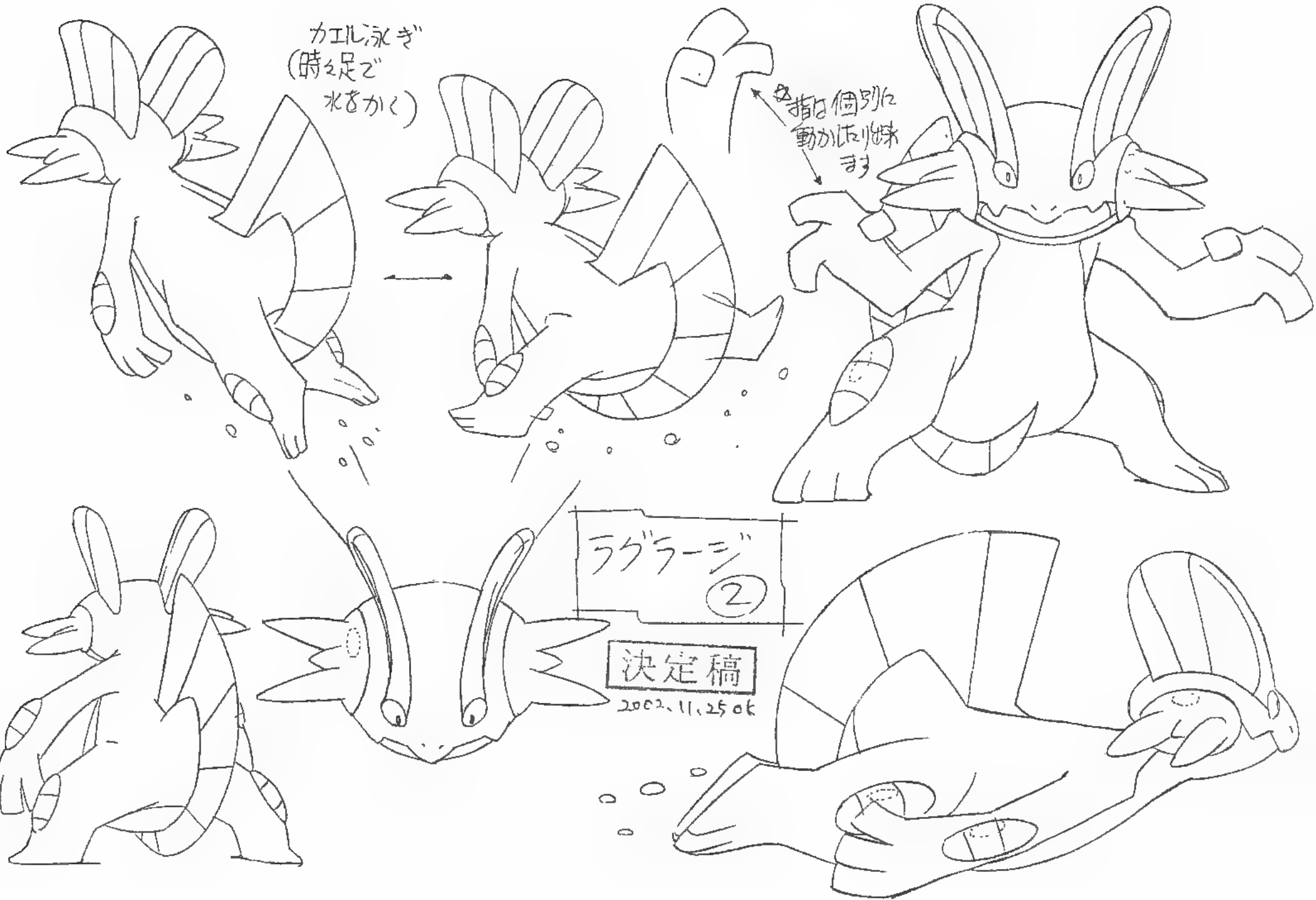

カエル泳ぎ
(時々足で
水をかく)

指は個別に
動かす仕様
あり

ラグラージ
②

決定稿

2002.11.25 ok



いぼアタリ

Hi

前足、お中の山か
！一番大きい



足aツx 3本
肉球あり



上下の前キバ4本、
下アゴの奥キバ2本
それ以外キバの数は

アタリ



グロエナ ①

決定稿

2002. 8. 19
03. 2 6 (23)

2002. 8. 21 OK.
2003. 2. 6 改定



※動きは犬で
※しっぽフリワケ



715E+②

2002. 8. 19
03. 2. 6 (改)

決定稿

2002. 8. 19 OK
2003. 2. 6 改正

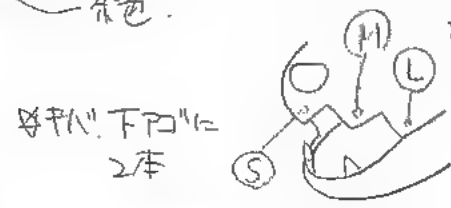
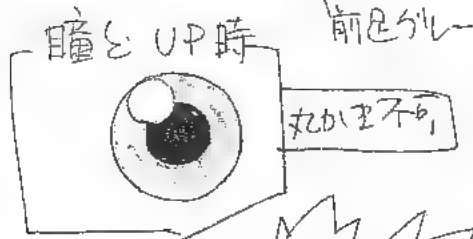
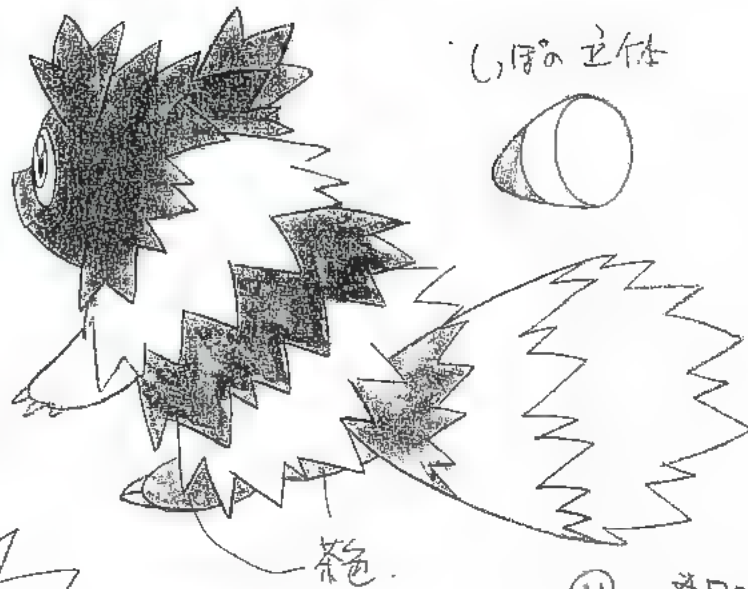

※口のギザギザの大きさは中心が一番小さく外側が一番大きい

アヒルズ
ジグザグマ

2002. 6. 26

決定稿

2002. 07. 01

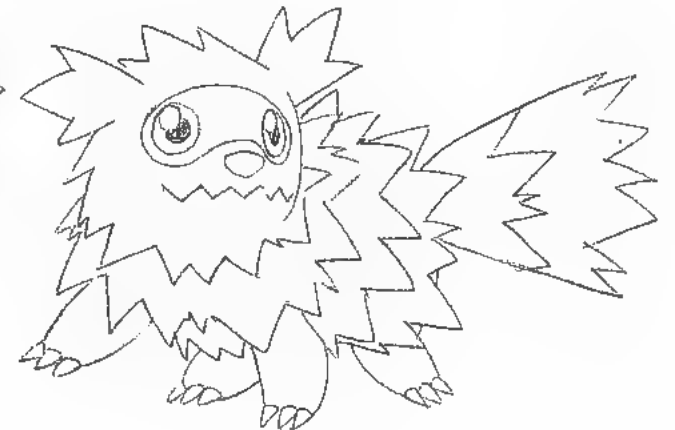

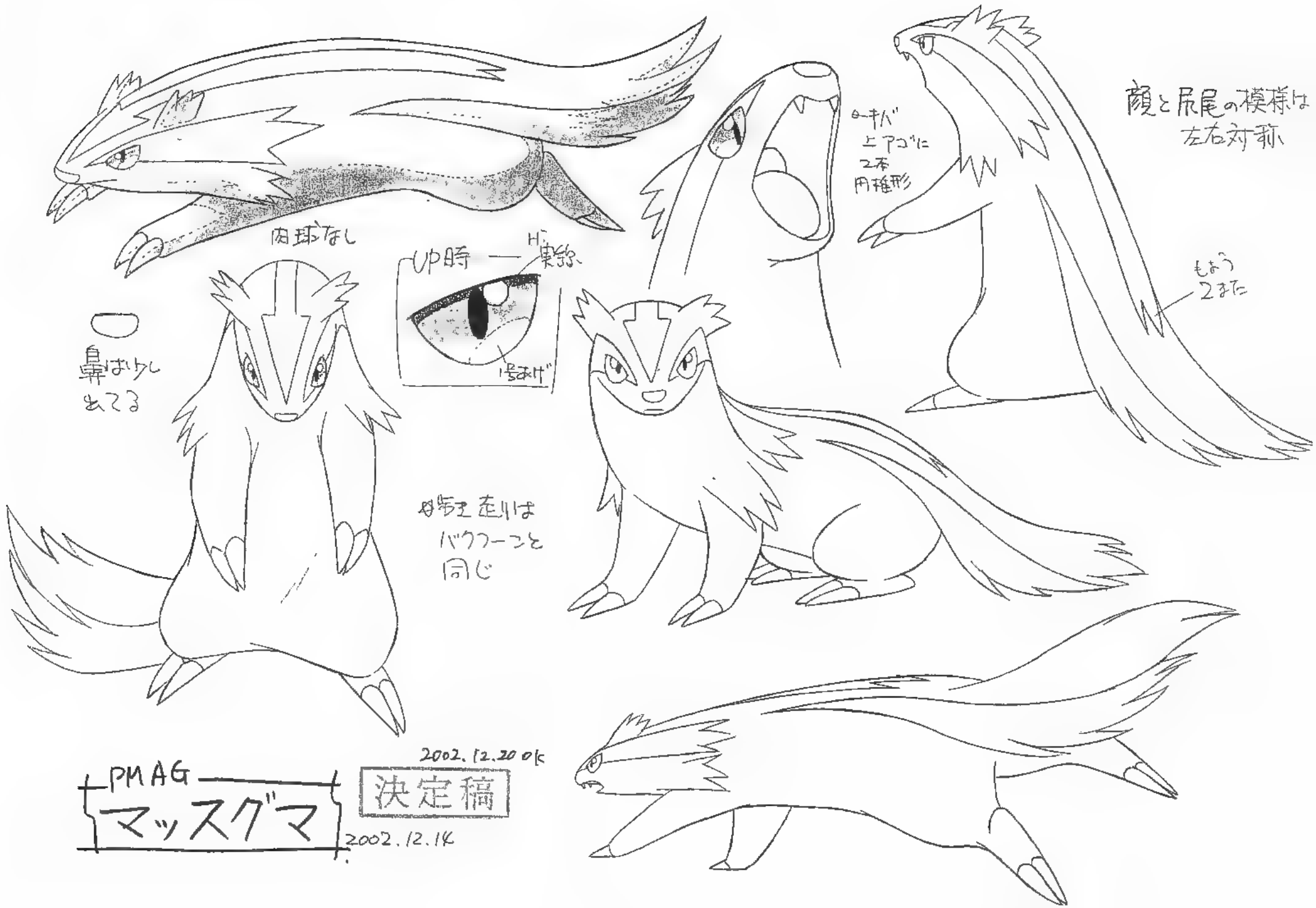

顔と尻尾の模様は
左右対称

4.18"
上アコヒ
2本
円錐形

もよう
2本

内球なし

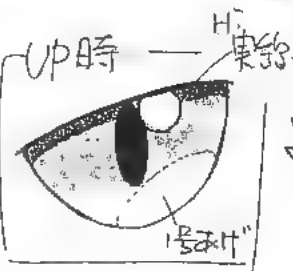

鼻は少し
出てる

母歯を引は
バクーンと
同じ

PMAG
マッスグマ

決定稿

2002.12.14

2002.12.20 OK

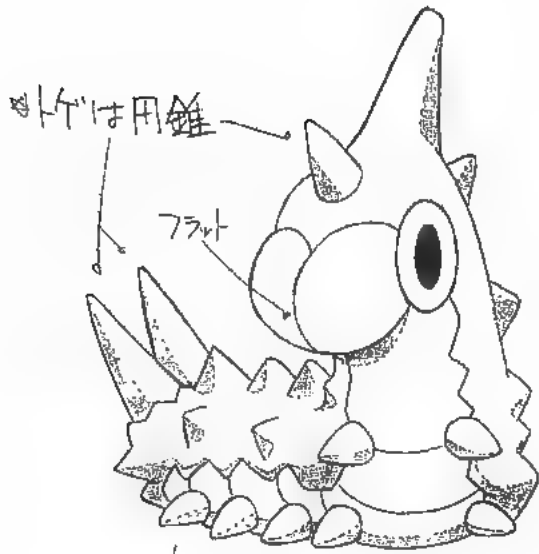

トゲは用錐

フラット

足は左右5本ずつ
丸い円錐

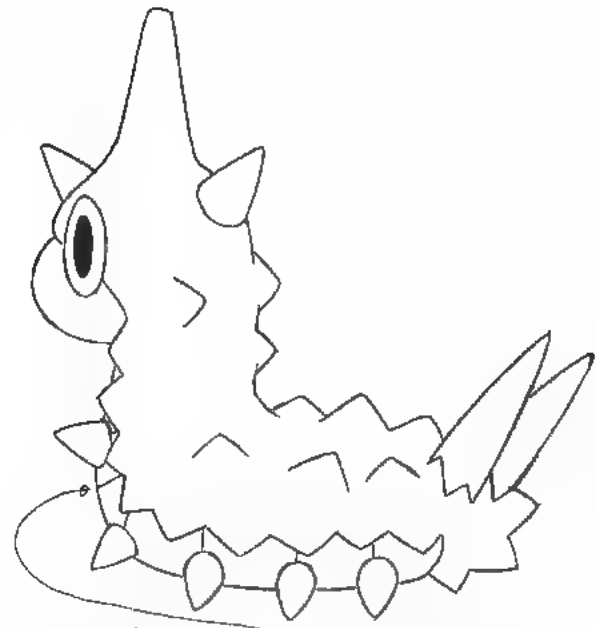

お腹のライン
足の所に5本+1本で計6本

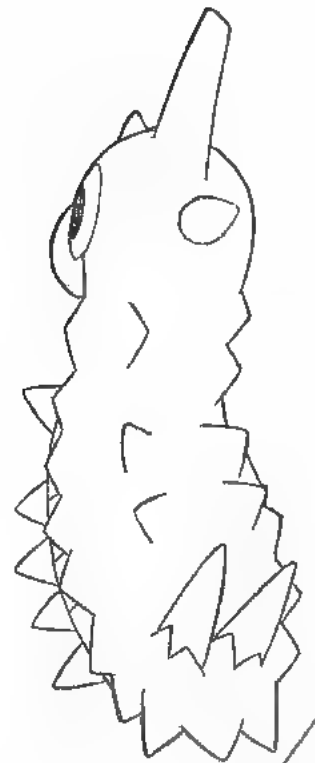

決定稿

2002.10.21 OK
2003.01.24 改正

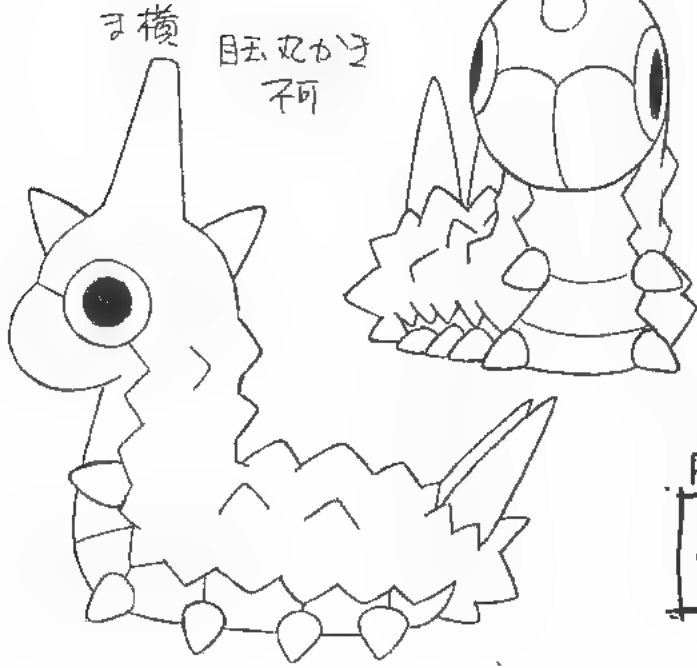

マ横

目玉丸かき
不可



あなが

PMAG
ケムツリ

2002.10.1
2003.1.24 修

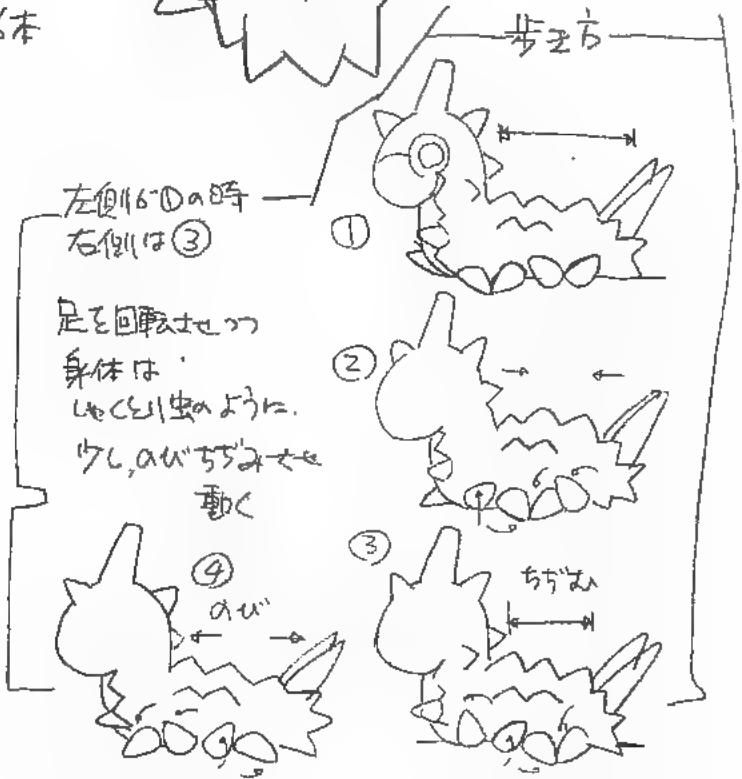

歩き方

左側160の時
右側は3

足を回転させたの
身体は
ヤシロ虫のように
ウレ、ウレ、ウレと
動く

①

②

③

④

ちぢみ



目の上ギギギ
3>

目は体より一段
へこんだ



正画

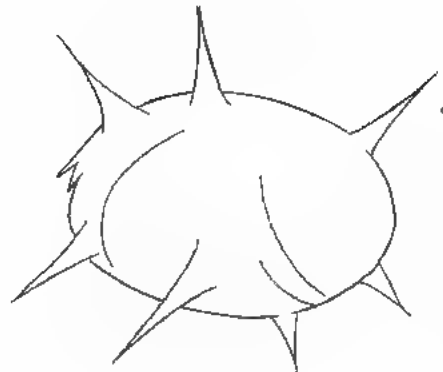

← 体は個定不対称の系
7~8本出ている
系の長土、位置は個体差
あり。

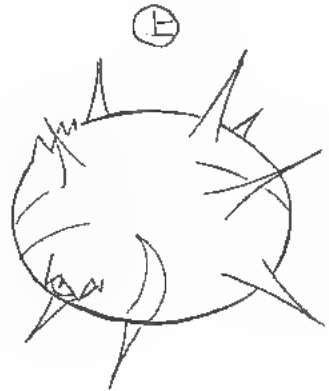

PMAG.

カラサリス

2002.10.1

決定稿

2002.10.21 OK

アゲハの顔と足

アゲハの足と羽

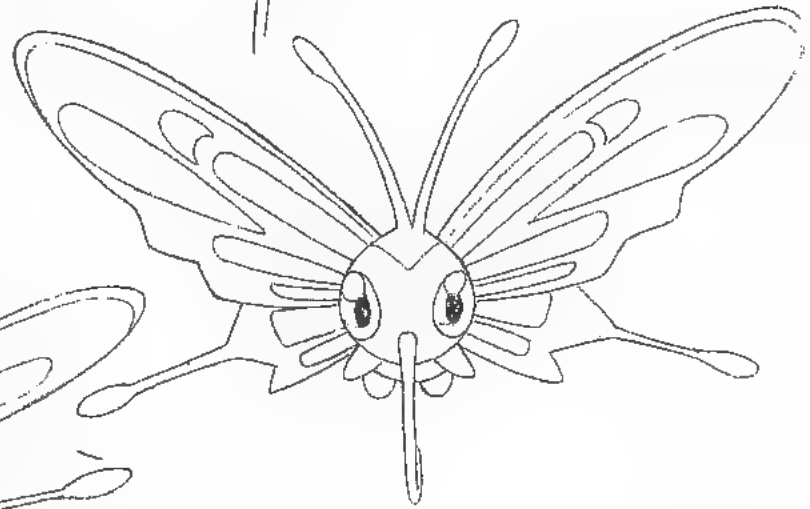
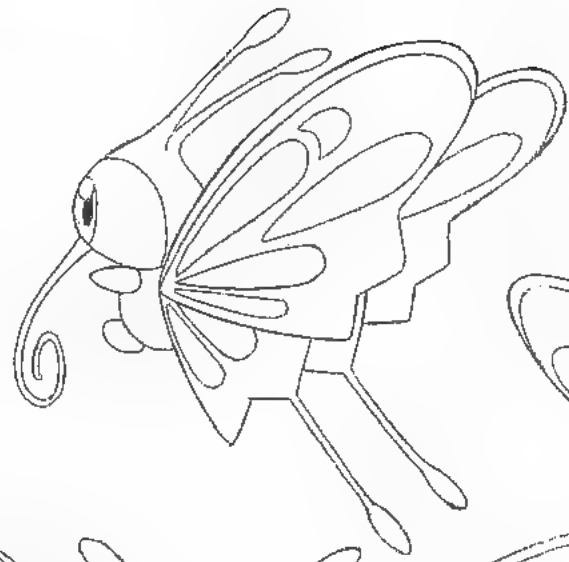

アゲハの足

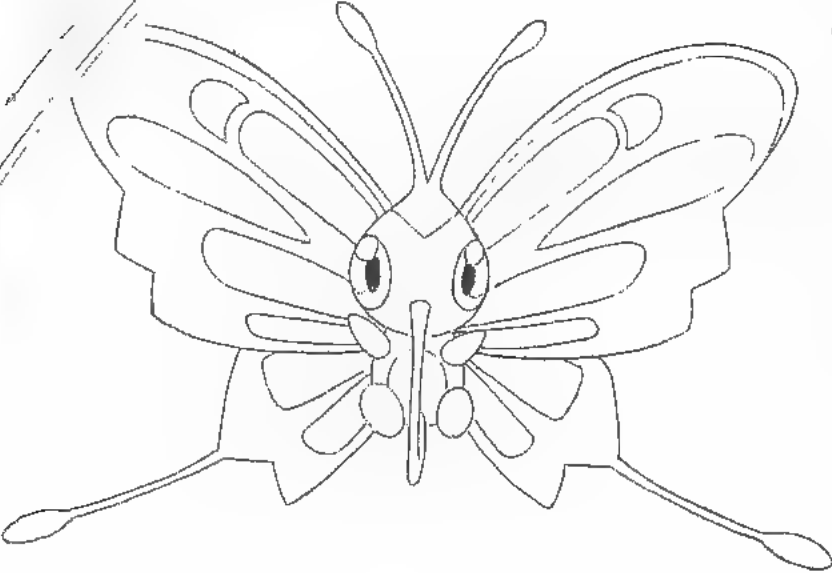
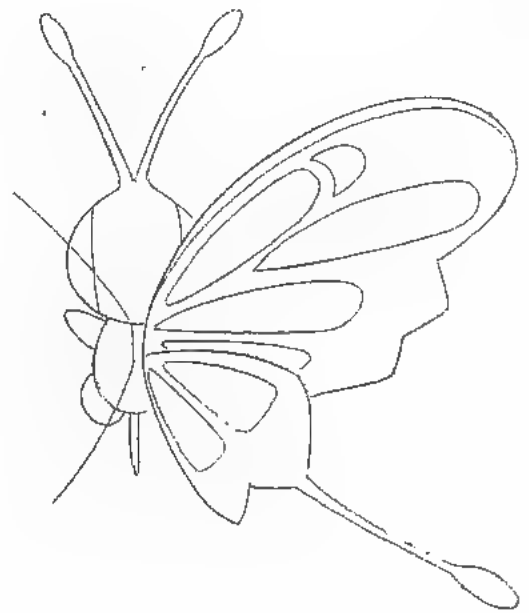
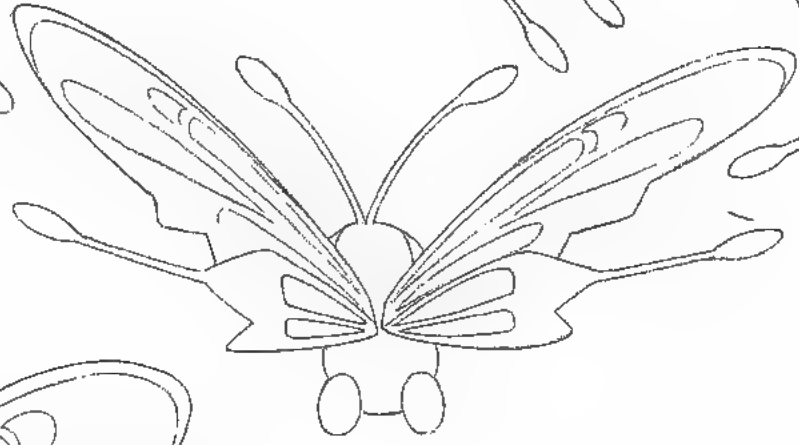
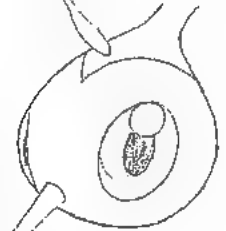

PMAG
アゲハント

2002.10.1.

決定稿

2002.10.21 OK

アザハルト追加事項

基本はマダカし。目14はほせんが

※ 特別な場合のみ
使用して下さい

(演出指示のある場合のみ)

1-21L時



怒ったとき

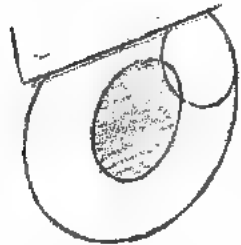

やられたとき
(困ったとき)



戦闘不能

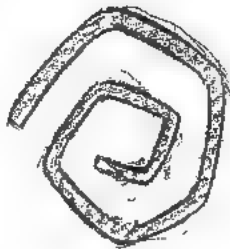

※ 常に目とかは
見えてしまうので
これは使用しないで
下さい。
あざはる時にも
使いません。

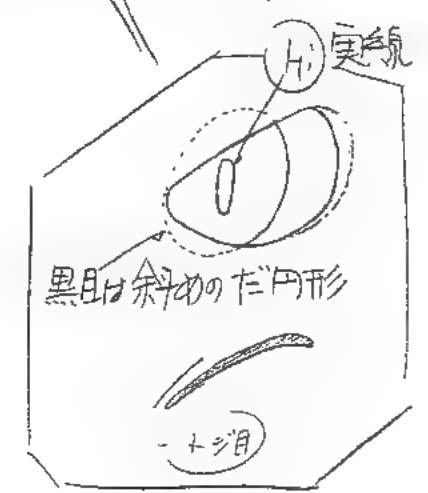
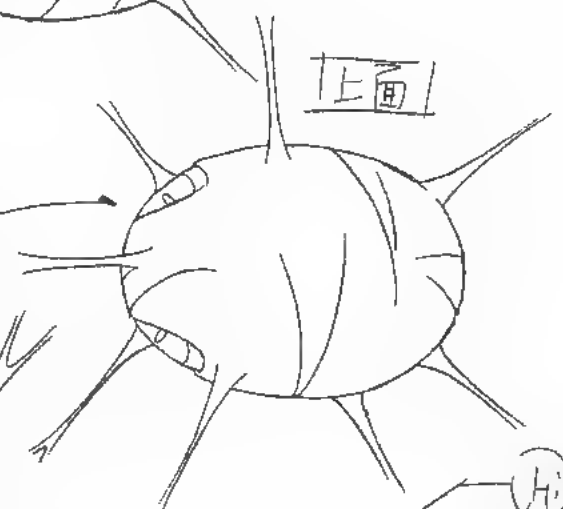
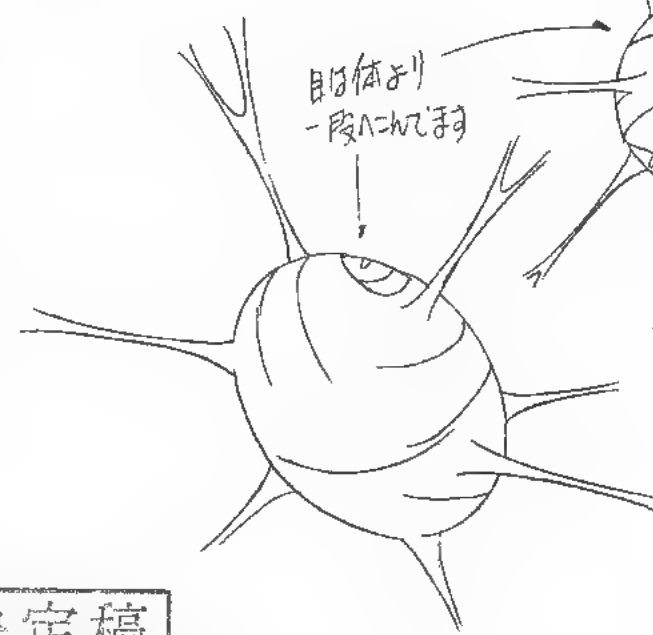
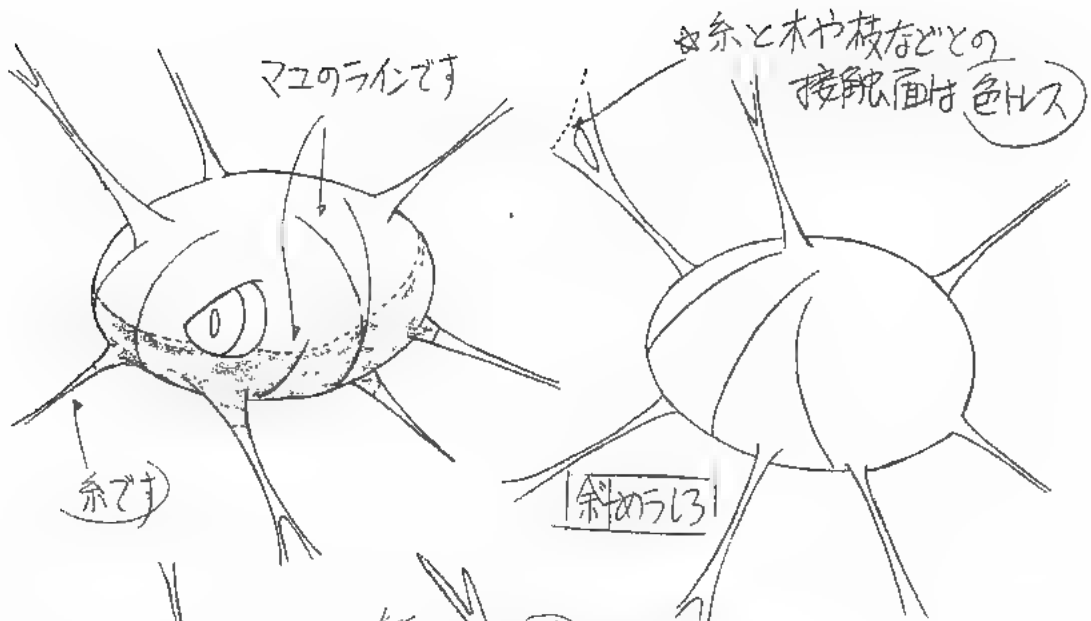

マユルド

決定稿
2002.11.9 of

トゲツル

トコロ

目と口

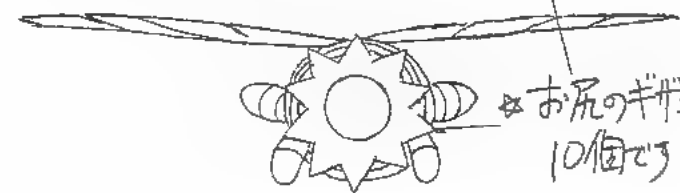
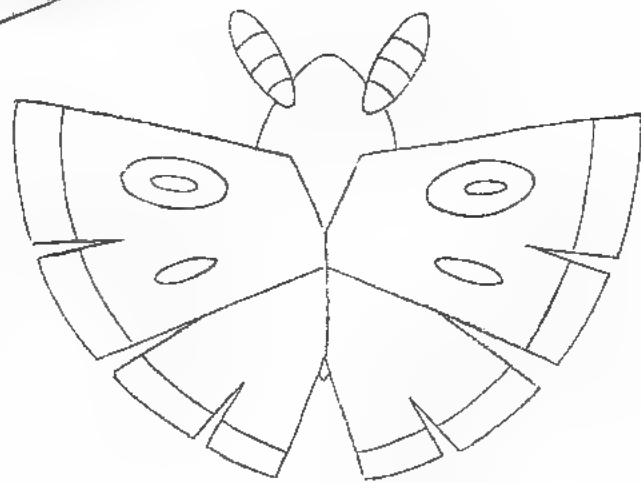
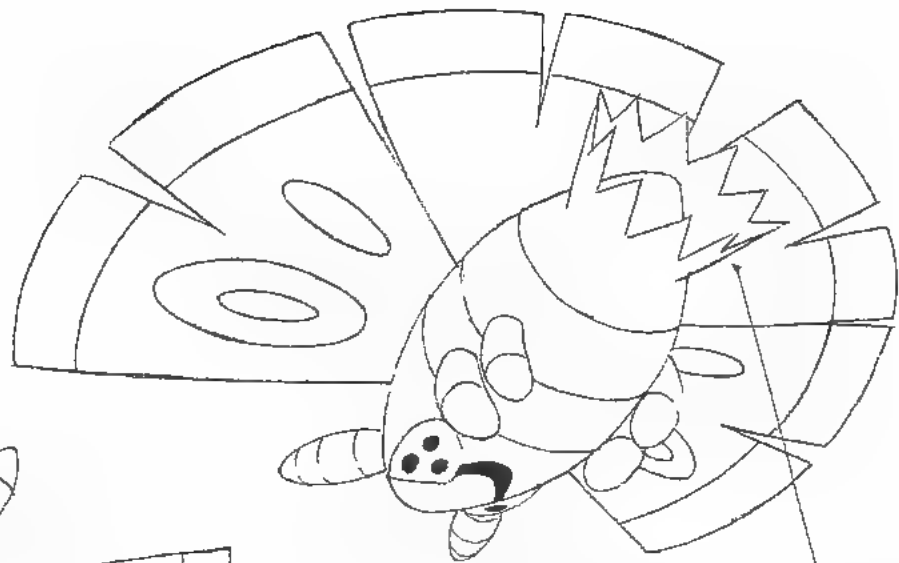
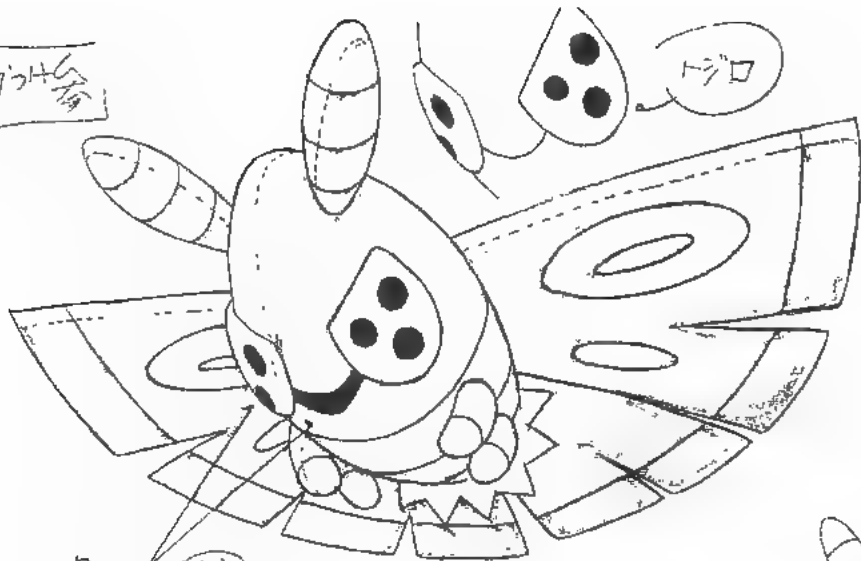

お尻のギガギサは10個です

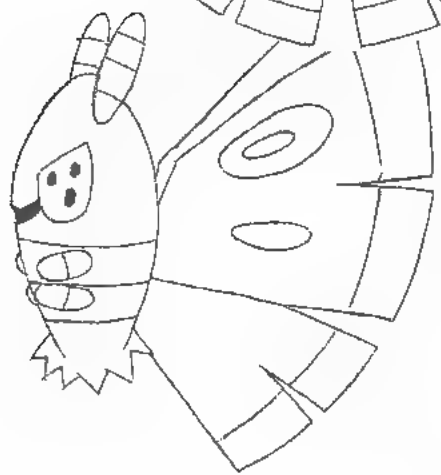
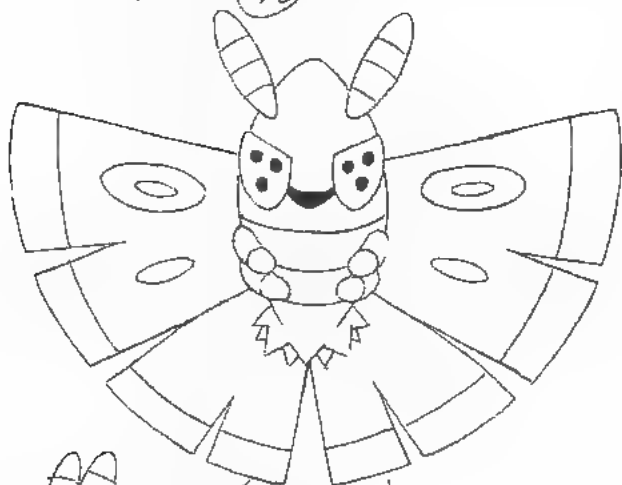

ドクケイル

決定稿
2002.11.9 OF



飛んでいる時は常に羽バタキにまち(バタフリと同じ)

シンボリ...



葉は部分のみ、単独で動くことほありせし

センターに溝がある

折

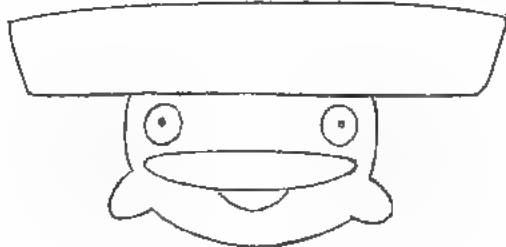
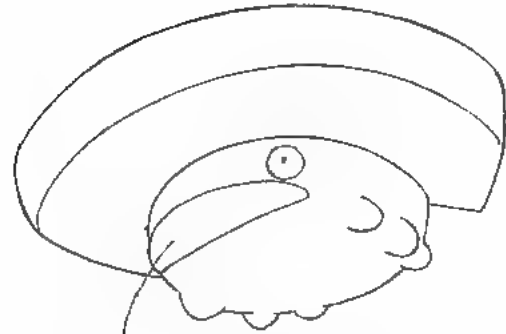
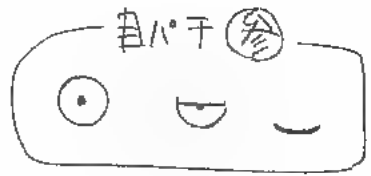
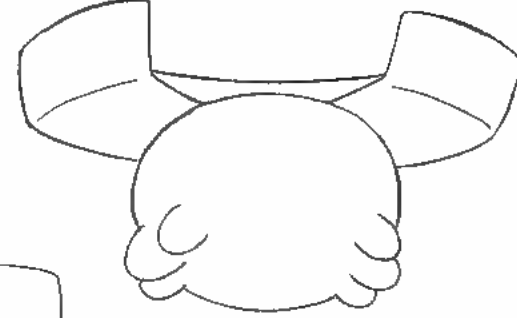
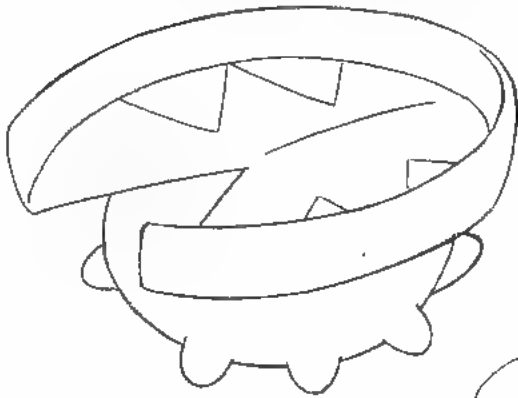

この部分は上唇のようなもの

キバなし

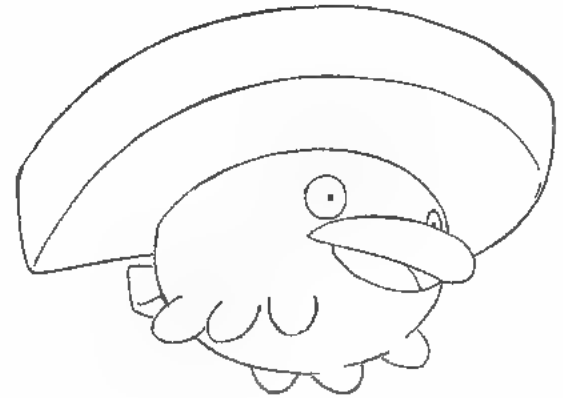
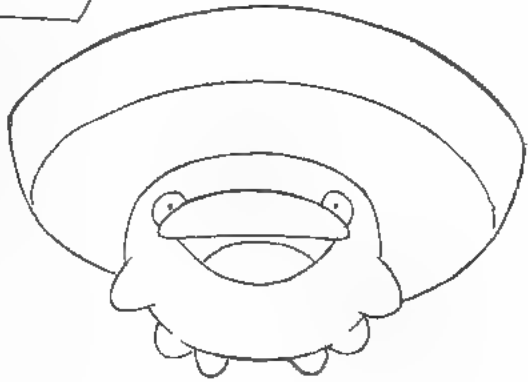

ハスボー

決定稿

2002. 8. 19 OK

2002. 7. 15.



フラット

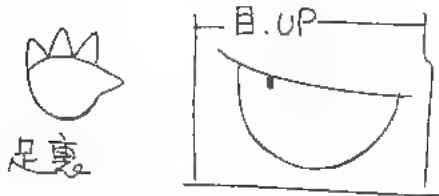
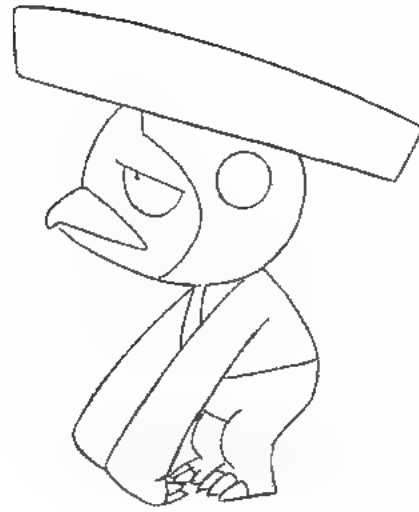
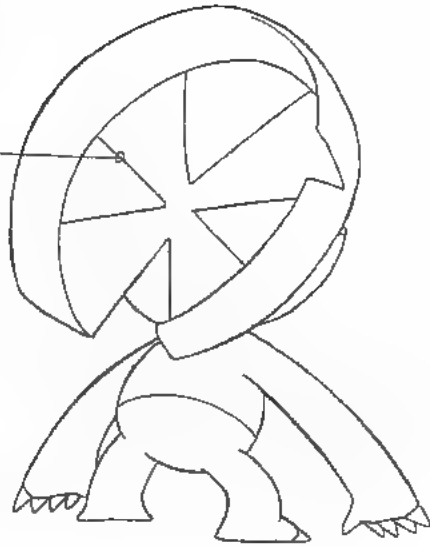

足裏

目UP

この切れ目は個体差で
左側とみずみちいる

くろはしは質感は
硬め



とこ目



くろはしは
たけ色

PMAG

ハズブロ

2002.12.07.

決定稿

2002.12.13 OK

カクッパ

模様どろ



☆センターに
ギザギザの谷が
来ます

足裏に肉球(フット)あり



Hiなし

普通の目

目のOP

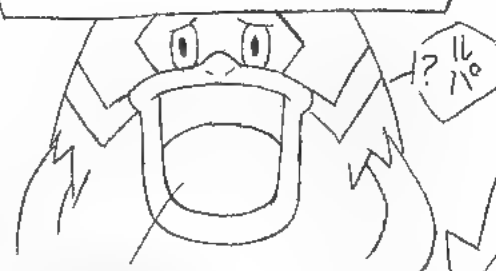

☆歯なし



決定稿

2002.11.02 OK

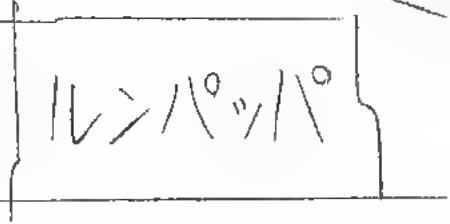

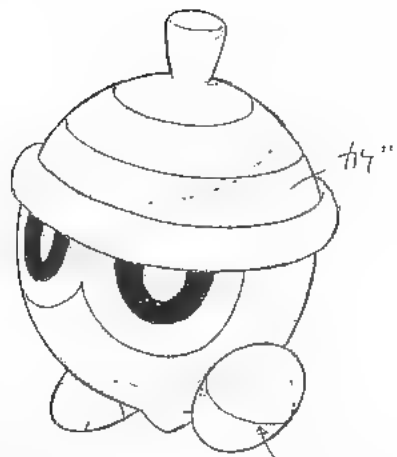

目は少し
縦長、E'田

ラインは
足の真中

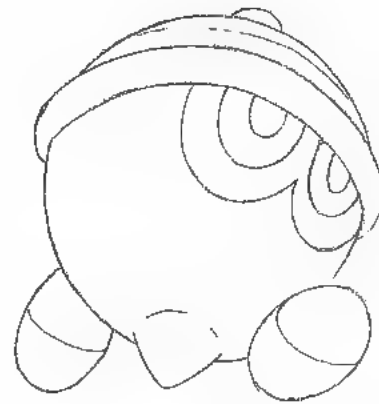
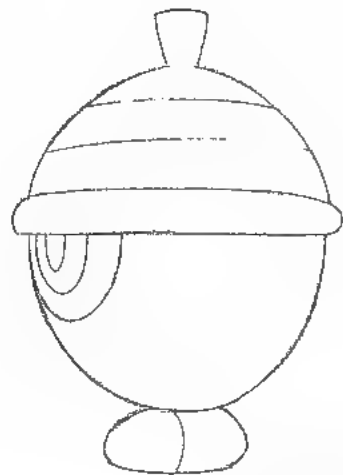
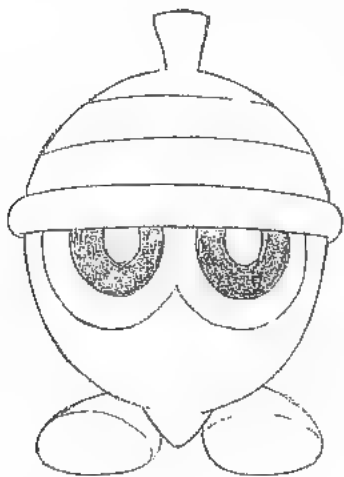
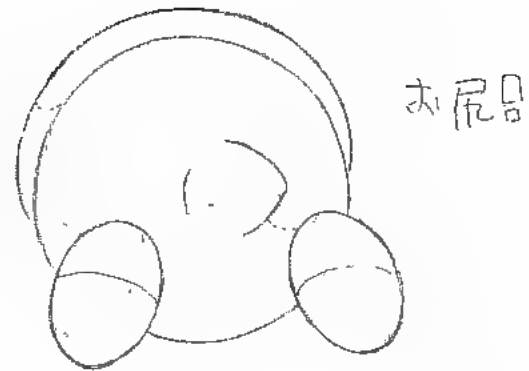

タネボー

2002.7.15

決定稿

2002.08.19

目の動き

目はふたつ動かない。ニコ笑たりはしない



鼻は円すい形、先は丸っこい

キバなし

胸には黒い点が
2つ

手はミトン

ちび忍者のイメージ

おたまの葉、はは
どちらかに
流す

決定稿
2002.12.13 OK

PMAG
コノハナ

2002.12.06.

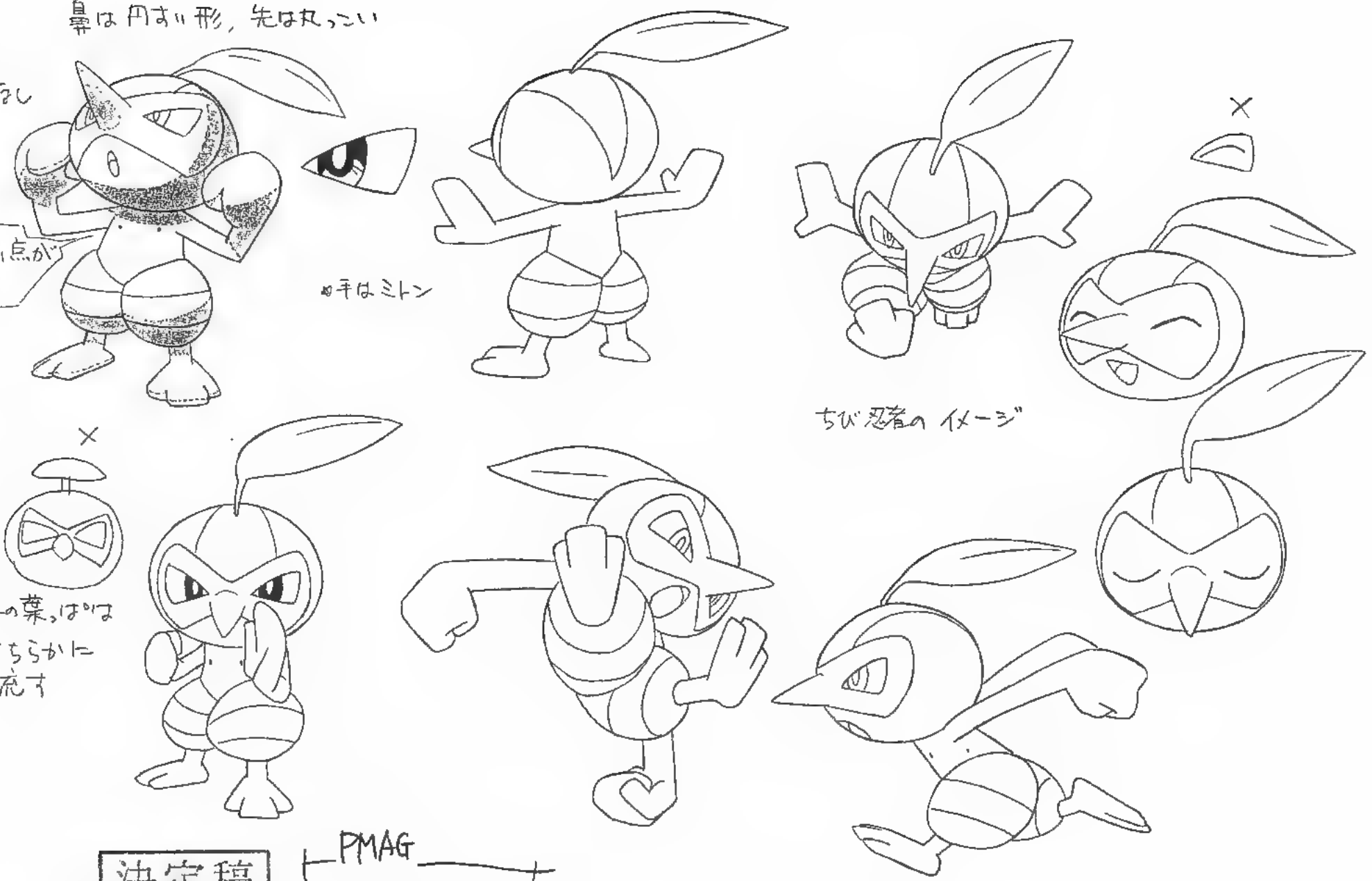

歯をくいは、2113状態が基本。
完全に肉になることも出る！

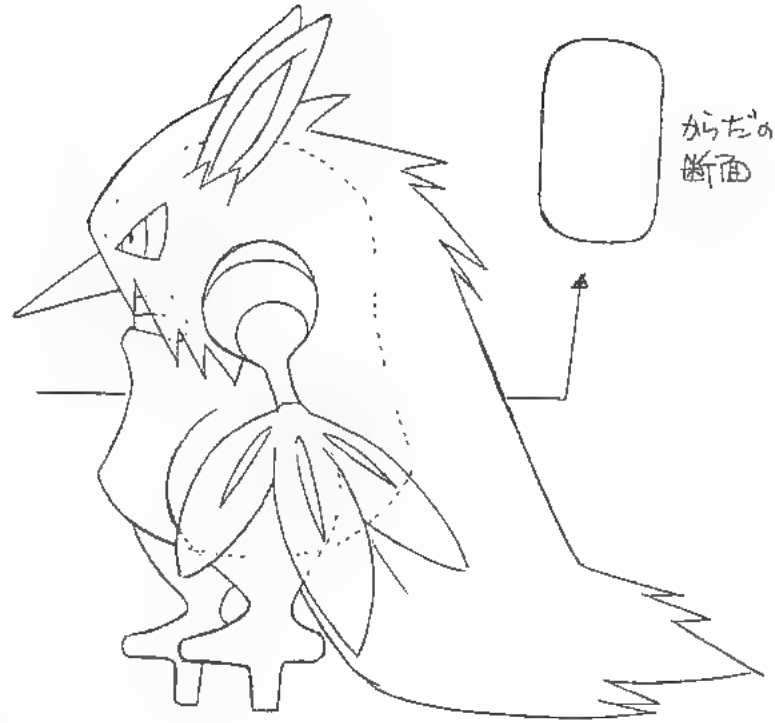
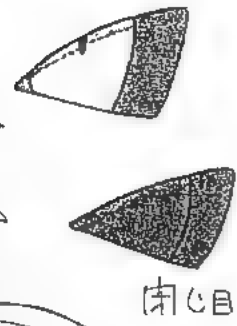

歯は細かく分かれ
いる!!



PMAG
ダーテーク
決定稿
2002.12.07. 2002.12.13 OK

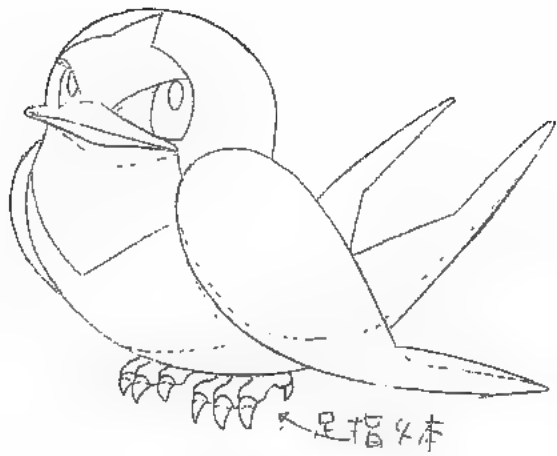

足指4本

瞳UP時

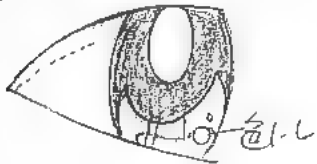

尾羽花はフラット



♀正面がオは
はるかに
遅ける
(1.5)

決定稿

2002.06.27

アバズ

スバメ

2002.6.20
6.27

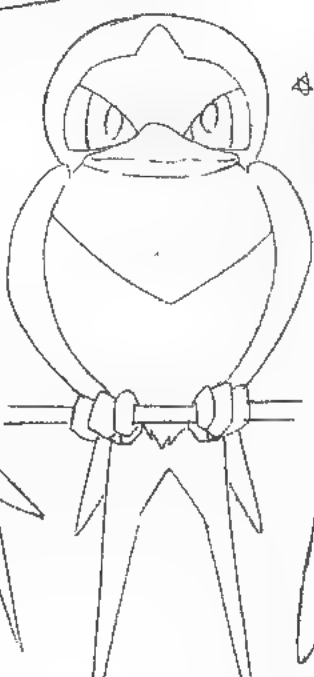

枝はビレ
ゆり時は
尾.下がり



まがいの延長(おかけがはなし)
鼻の穴はなし。



とじ目

カゲキ

またその上のラインは
ゆりや平ら

鷹のトビの
動き

←木の上では
尾羽根上がる

正面がたま
なるべく避けて
下り

まがいの
厚はなし

まがいの
まがいの?

地面にいる時は
尾羽根上がる

PMAG

オオスバメ

2002.12.07.

決定稿

2002.12.13 01C

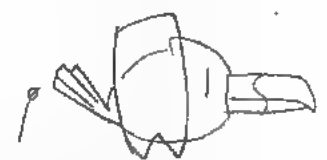
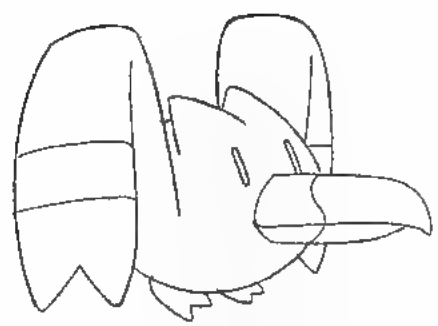
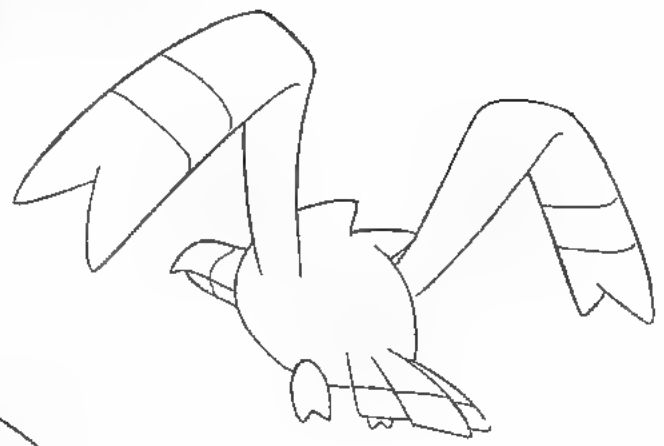
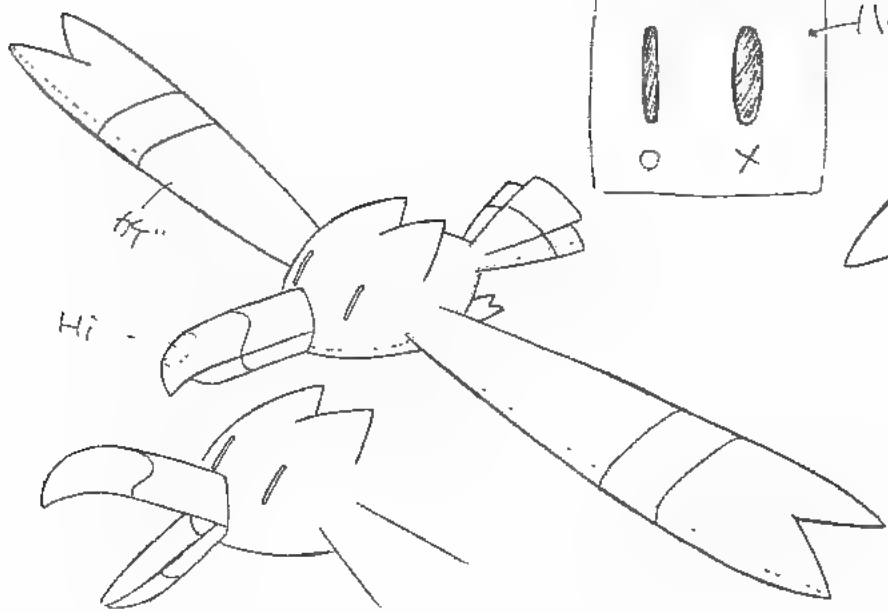
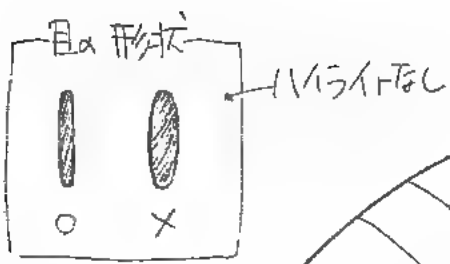

地面に止るといった時、
尾は上へ

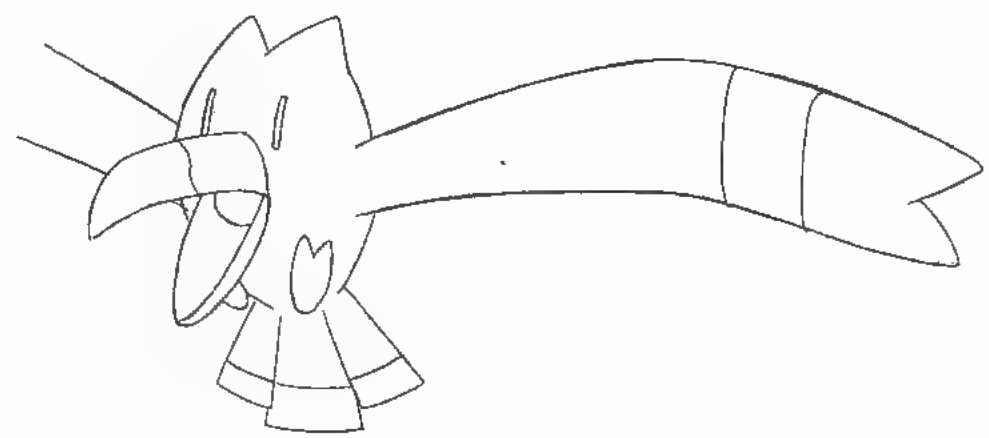
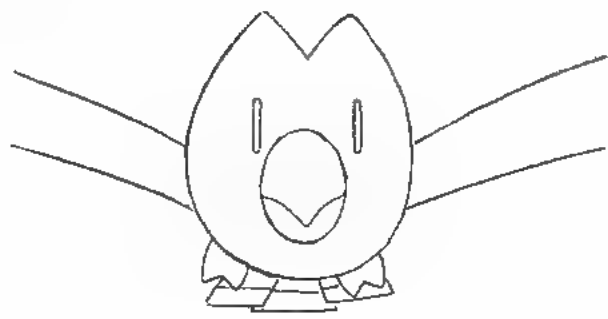
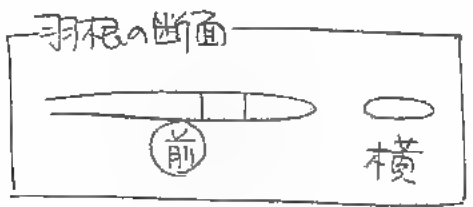

決定稿

キヤモX

舌はあぶりが通常
みえな



ココは
フラット

このあたりまで
くちはしの丸み(有)

鼻の穴ラインが入る

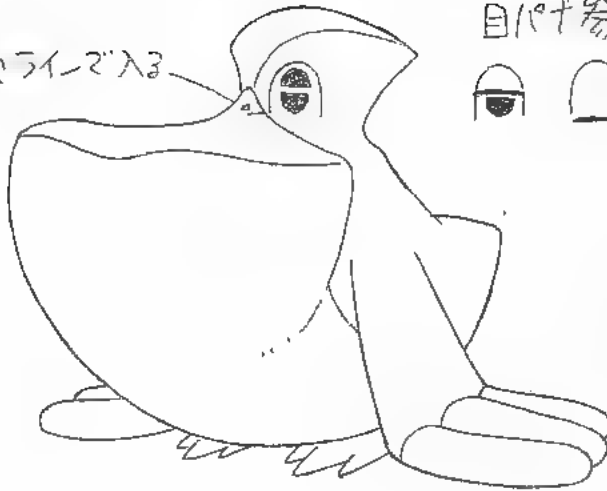

目バツ参考

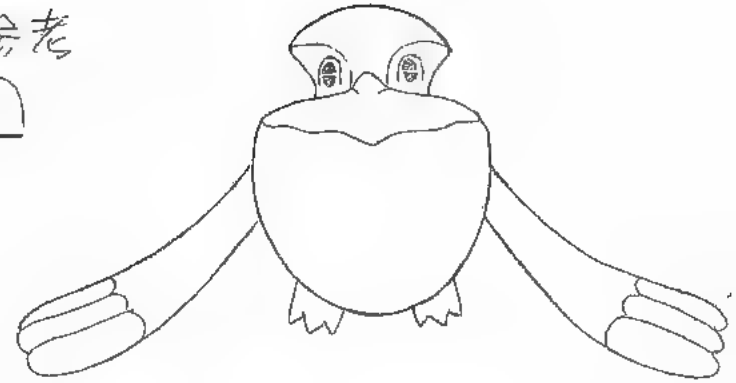

目にバツ「かーが」
場合参考



羽根 断面図

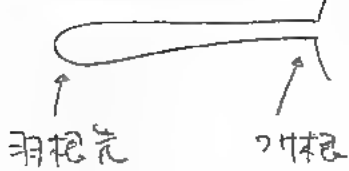

羽根先

羽根

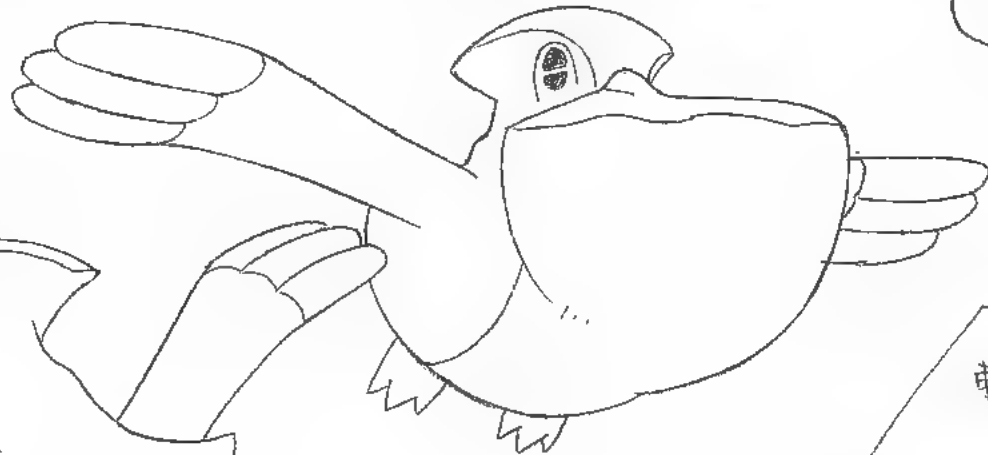
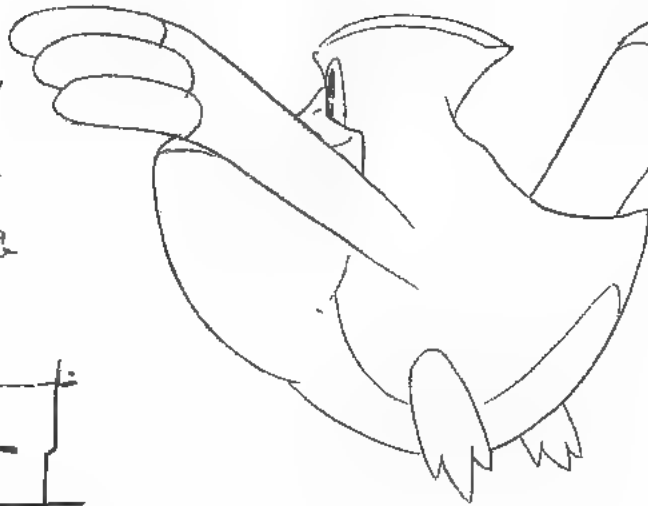

輸送中イメージ

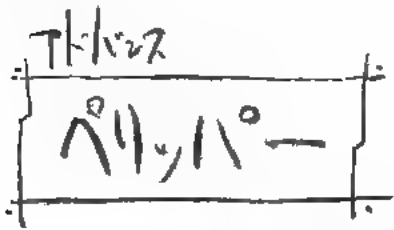

2002.6.20

決定稿

2002.06.21

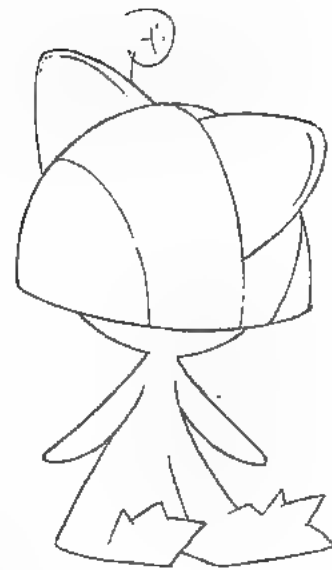
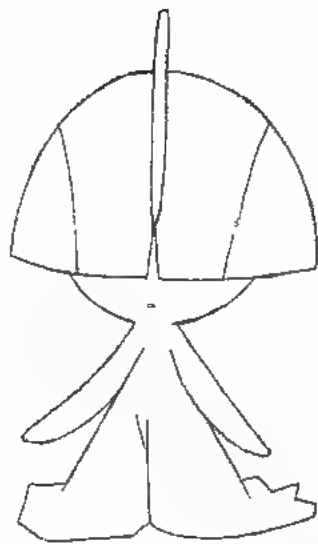
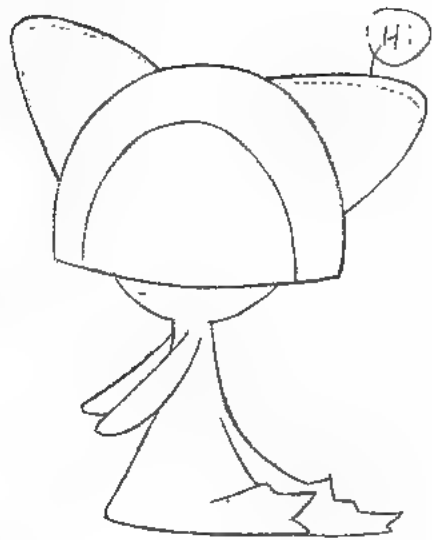
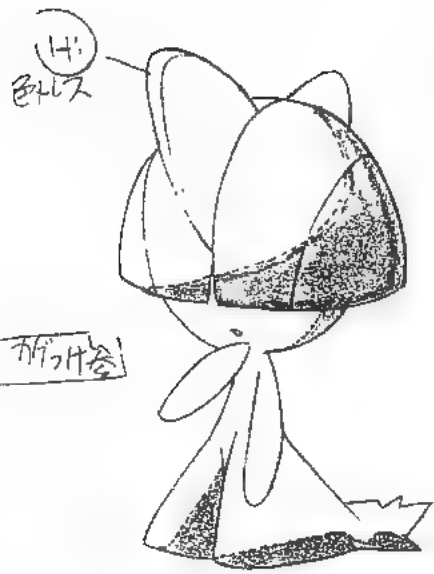

決定稿
2002.11.9 OK

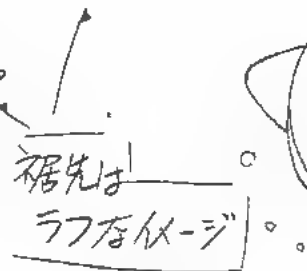
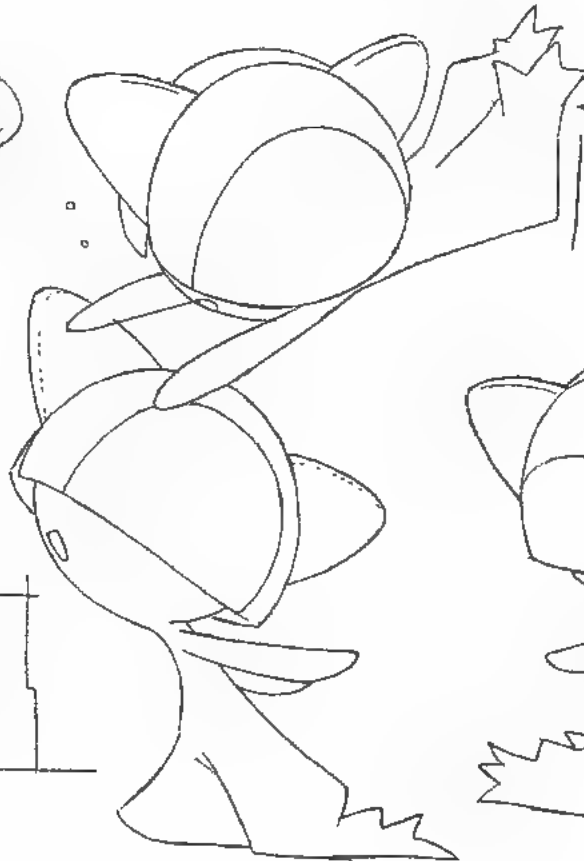
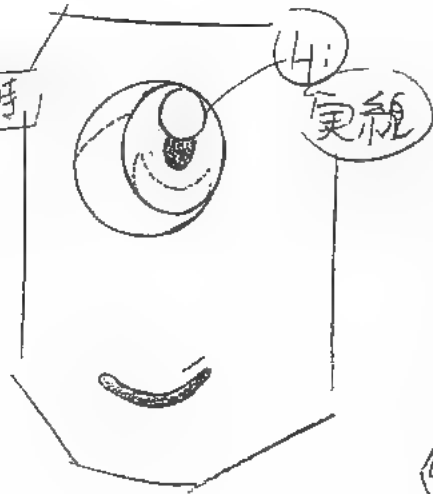

※このくらいのアングルでないと
目は見えません

ラルトス



裾を引きずり歩く

カワハク参!

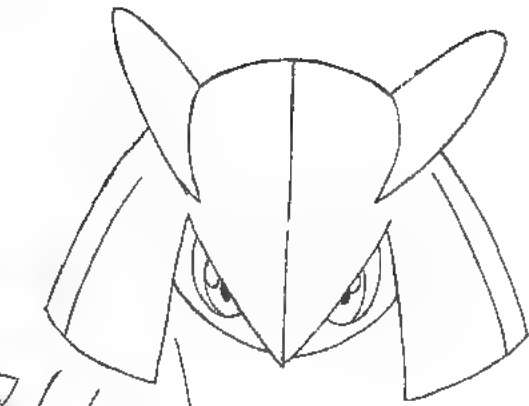
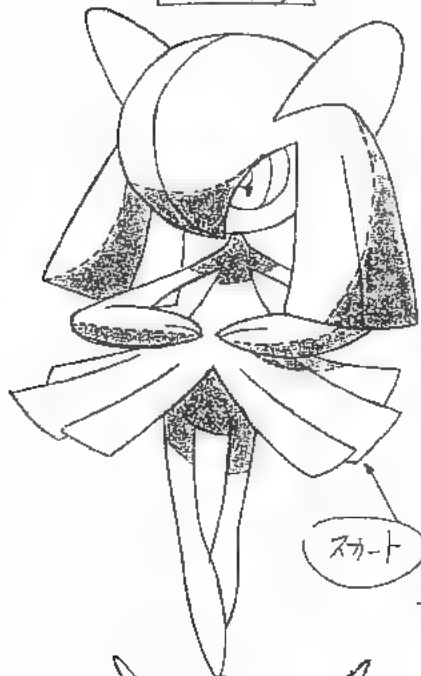

スカート
おんかが一番長い

手の断面は
だ円

断面

先へ向かって
薄くなる

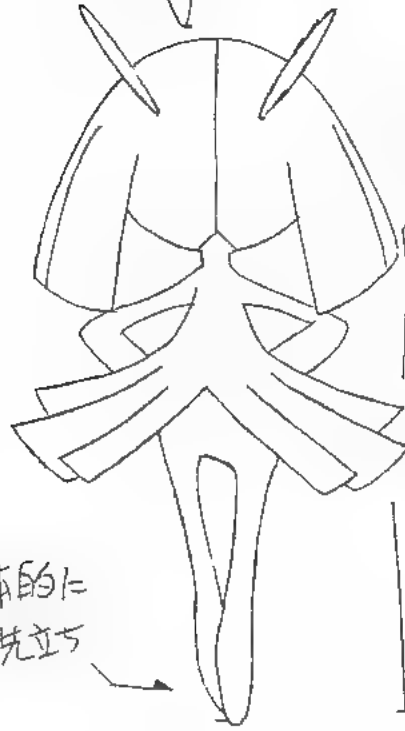

目のUP時

H: 実線

前髪のラインが
ヒマブタの
ラインと
異なる

ヒジ目



基本的に
おん先立ち

決定稿

キルリア

前のどはり
尖ってます

後ろの
どはり
丸っこい

スカートの内側
色塗ります

前髪のファンが
上マブタの
ライン
になる

目のOP時

サナイトの

影の挿入

おん中の指
太り

後ろ側の
スカートは
後ろに向かって
長く伸びる

足はほとんど
見えません

足は細く
つま先立ち

前

上から見た足のワキ姿

裾の創面から
ますぐ出る

決定稿

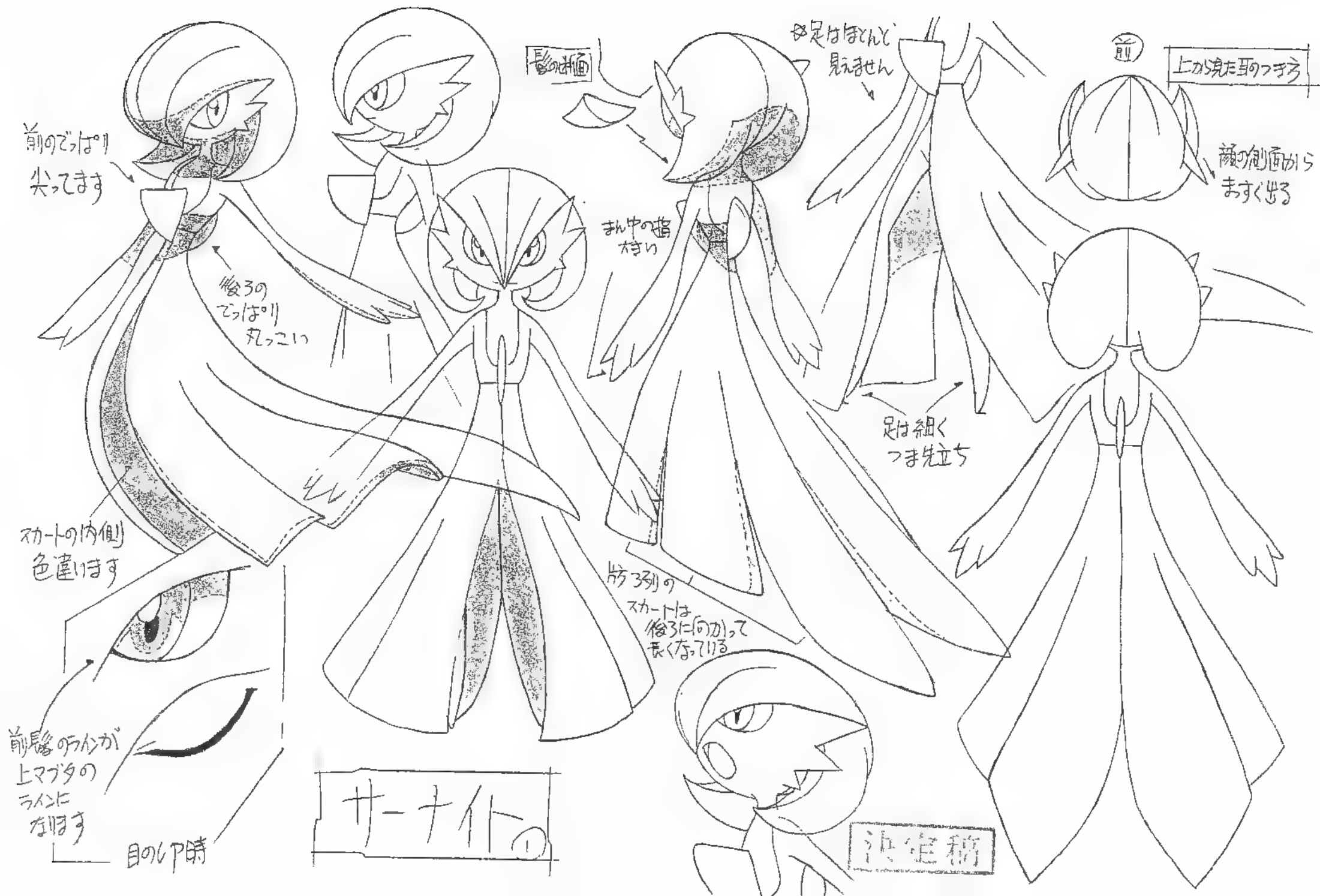



☆手握てモエの(5)

サ-タイト②	決定..
--------	------

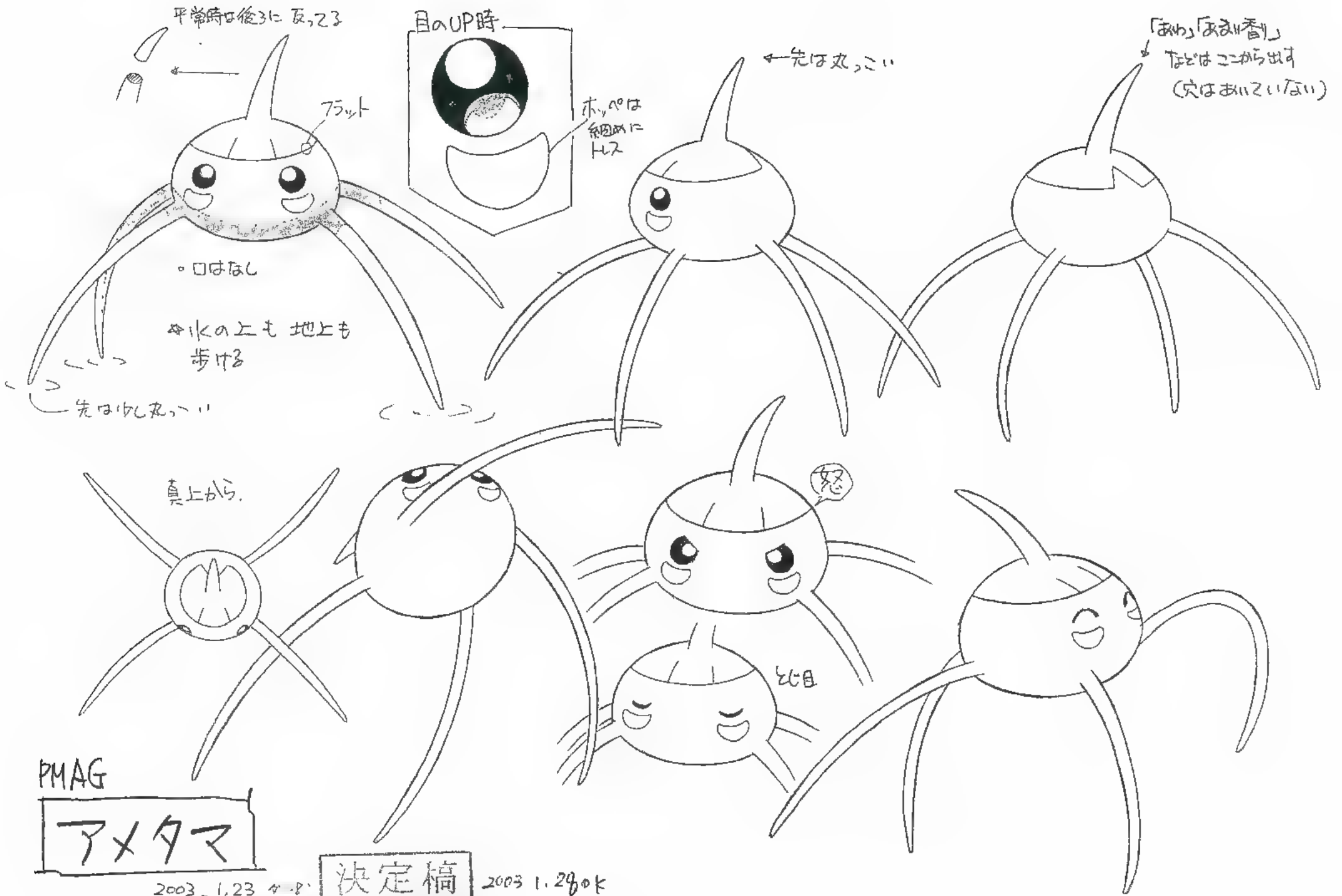

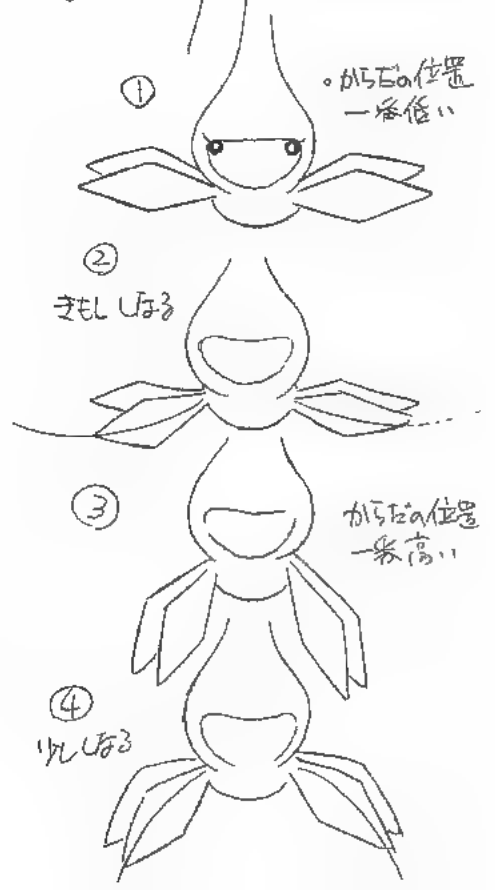
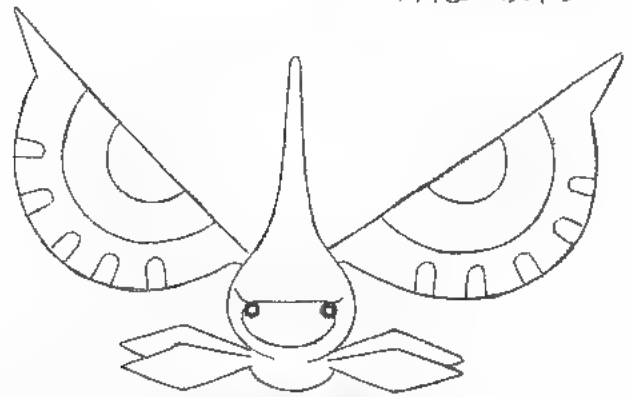
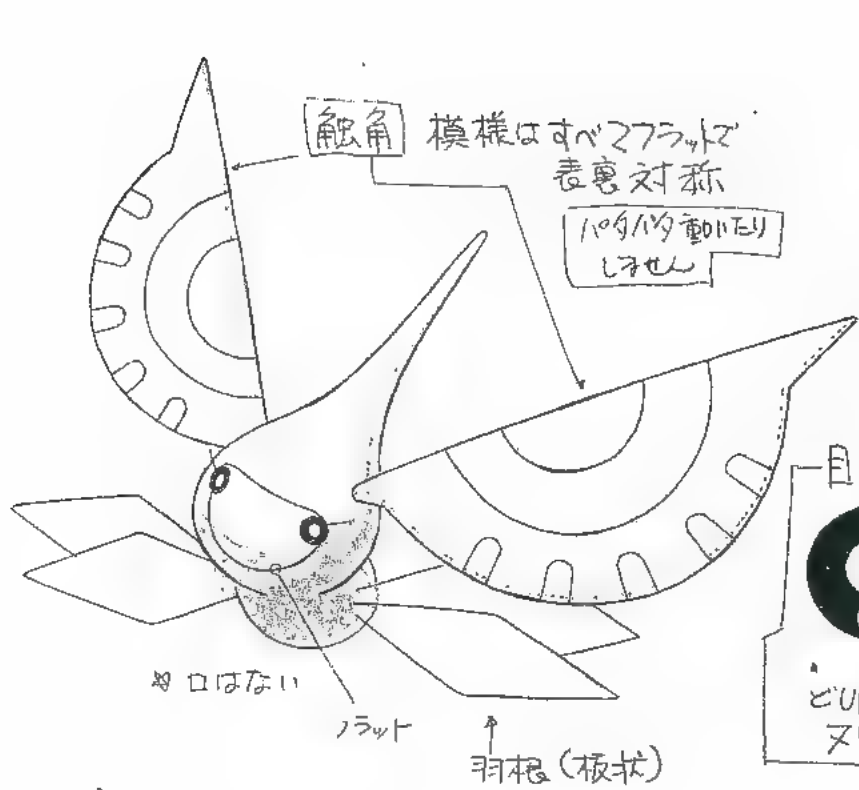

PMAG 決定稿 2003.1.28付

アメモース

2003.1.23.

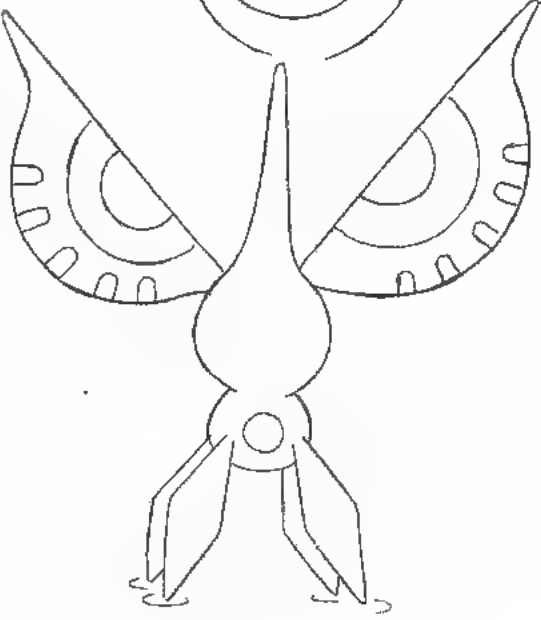

H.急下.P



← 頭a突起 5つ



← ヒタ 12枚

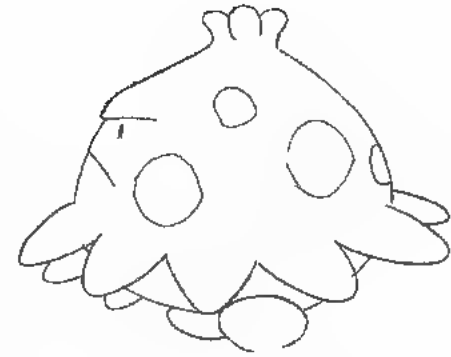

↑ 3つ

前



上唇はハの字
下唇はEの字
が下.



突起5つ.

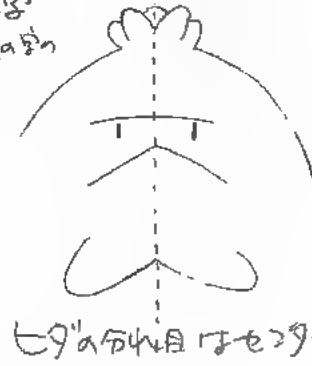

ヒタの分岐目はセツ一.

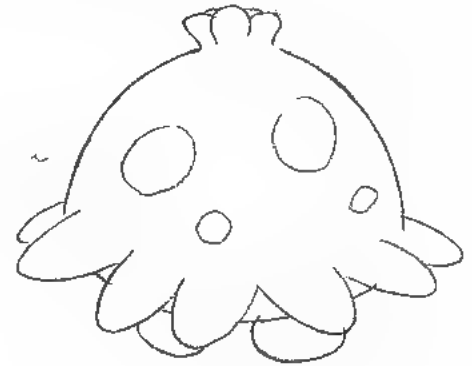

身体aヒタは自分の意志で
動かす.

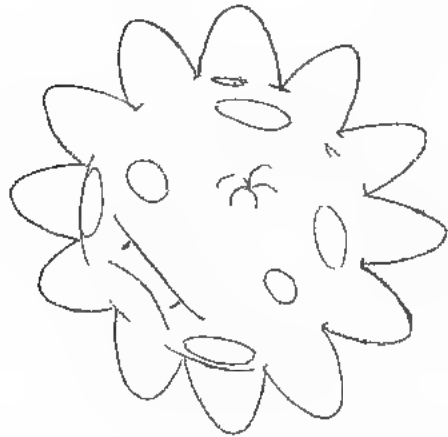

アキコ
キ/ココ

2002.6.26.

決定稿

2002.07.01



この穴からしゅん粉が出てくる

この穴からしゅん粉が出てくる

この穴からしゅん粉が出てくる

首のヒゲ全部で6枚

手の断面

足の断面

丸が2枚

手

足

この穴からしゅん粉が出てくる

とじ目

笑い口

PMAG
キ/ガッサ

2002.12.06.

決定稿 2002.12.19 of

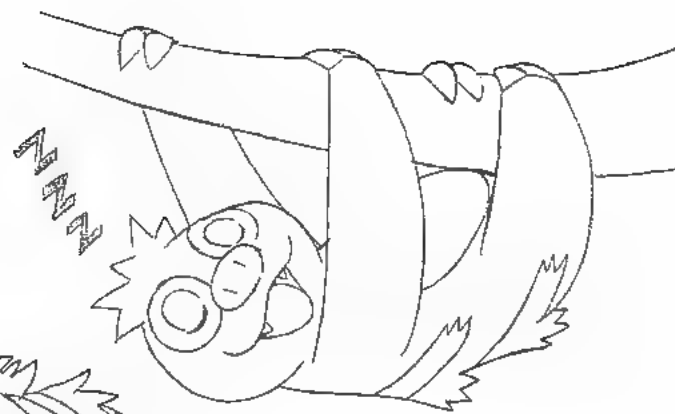
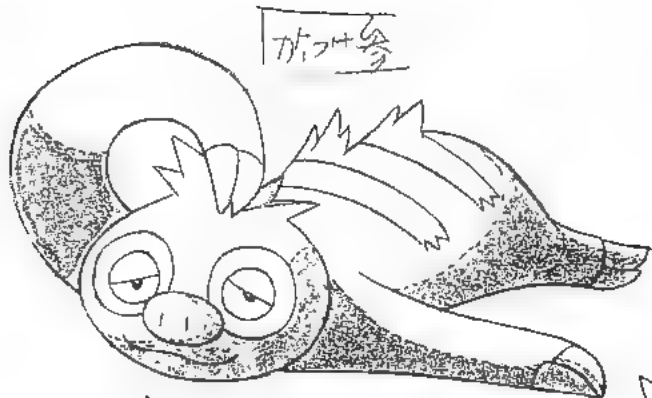

上アゴにキバ 2つ



歩く時は四つ足で
のろのろ歩く

手の平、足の裏に
肉球あり



尻とお腹
又に分け



背中=2つの
クセ毛

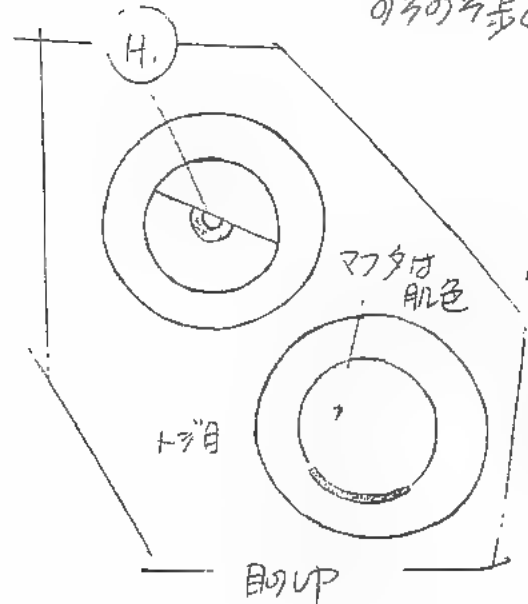
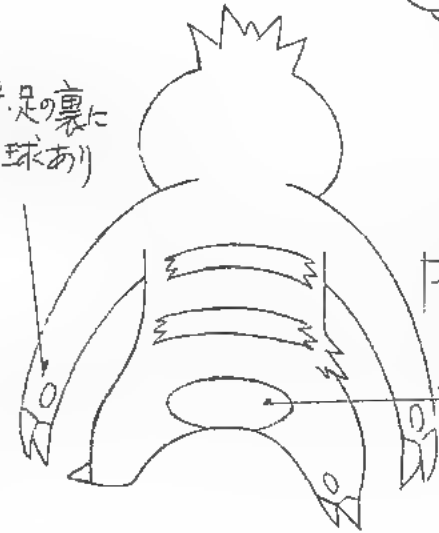

決定稿 2002.11.9 ok

十マケロ



立つとこんな
感じ
(ほとんど立つ
ことは
ありません)

後頭部
少しは、???

肉球はまん丸
手に対し
フラット

100

足のうら

目のUP時

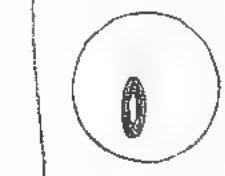

耳、正面から見た
少し細い

決定稿

2002. 8. 19 OK
10. 17 確認

用心D. 上のキバが出る

ヤルキモ10

2002. 8. 9.
10. 17. 確認し

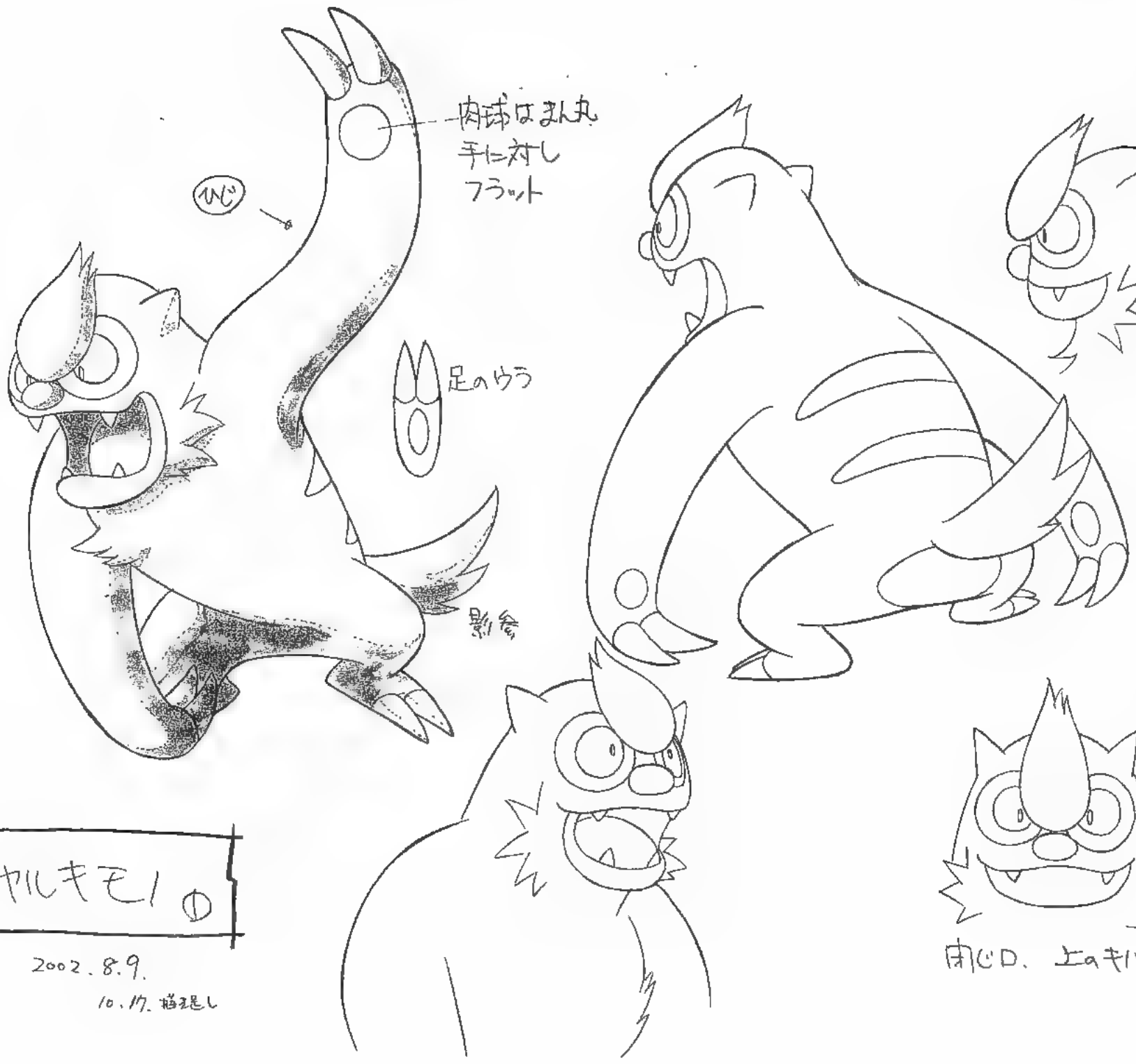

ヤルキモ1②

2002. 8. 9
8. 21 修正

決定稿

2002. 8. 21 OK



手と前足のおと
便へ。
歩いた
走った時。

ゴリラ系

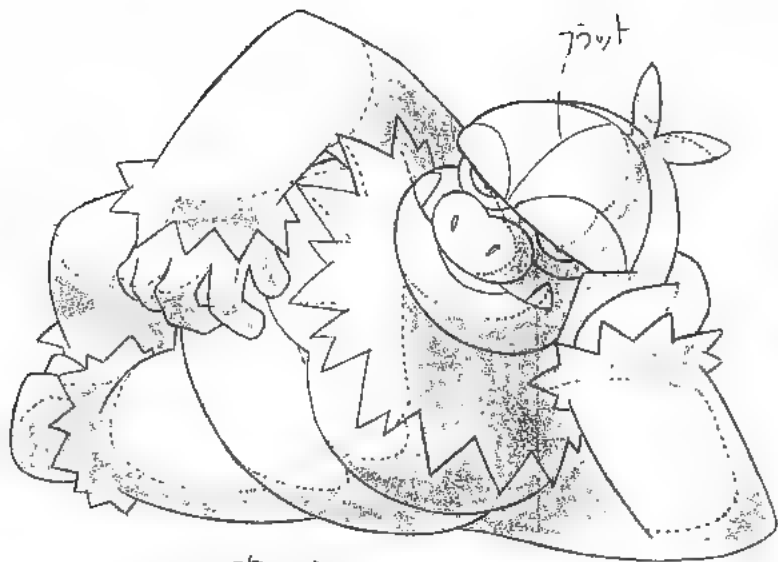

お腹は毛がたしい



瞳は黒の点
Hiは丸



足は丸



ミソナで
ツメや肉球は
丸

PMAG
ケツキング

2002.11.20

決定稿

2002.11.25 ok

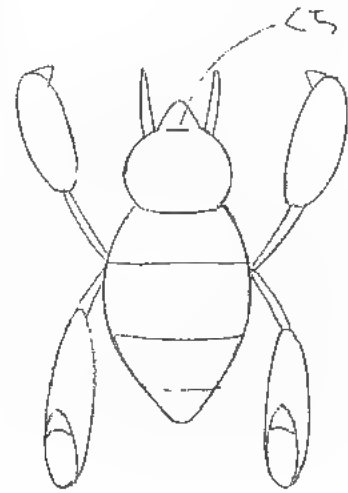
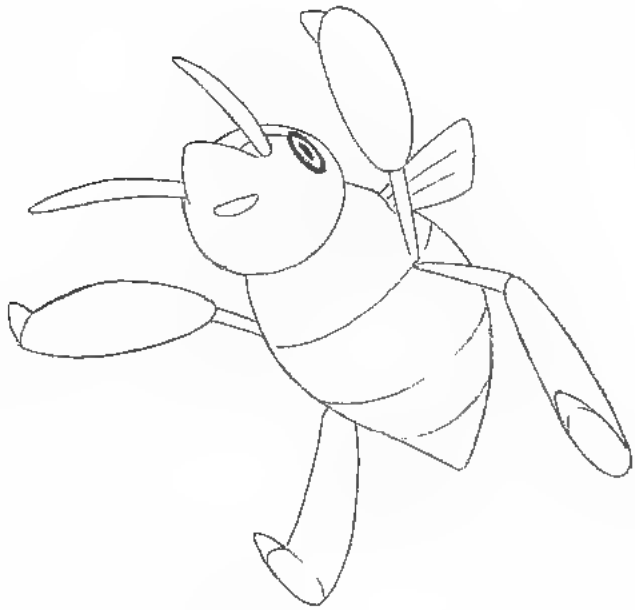
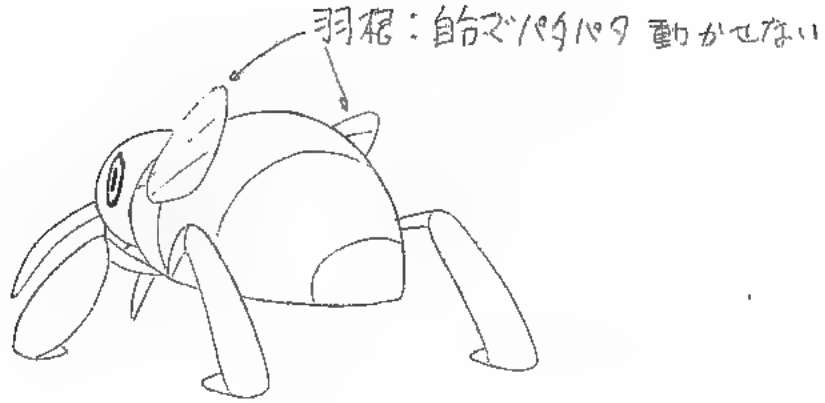
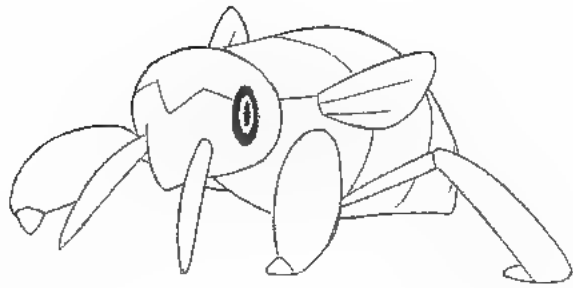

ツクニ

決定稿

2002.08.19

2002.7.24

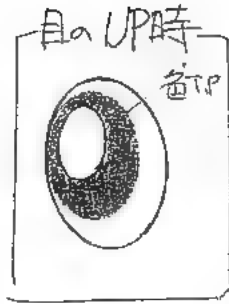
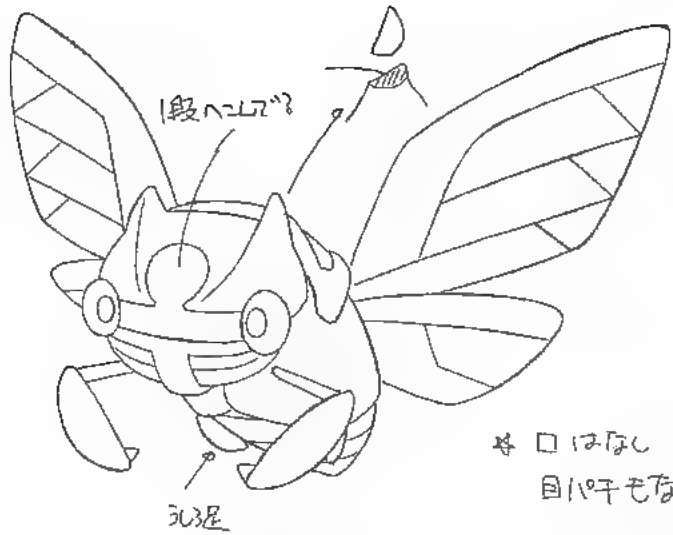

*口はなし
目ハキモなし.

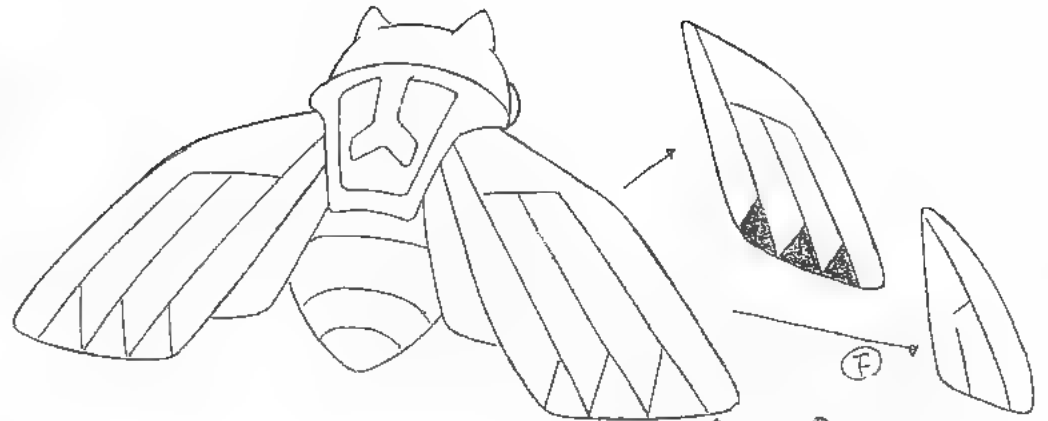

飛行時 羽根 リンカク 臭線

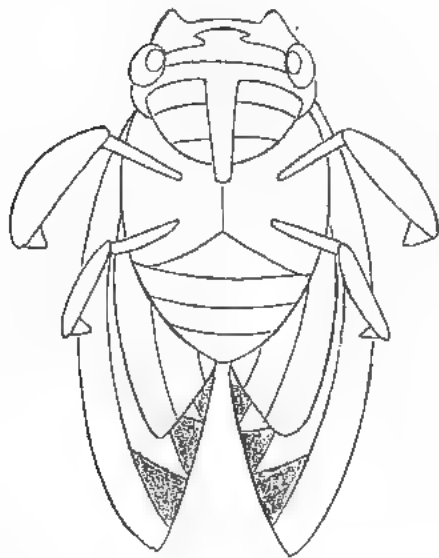

飛んでいる時
うしろ足は
モテル

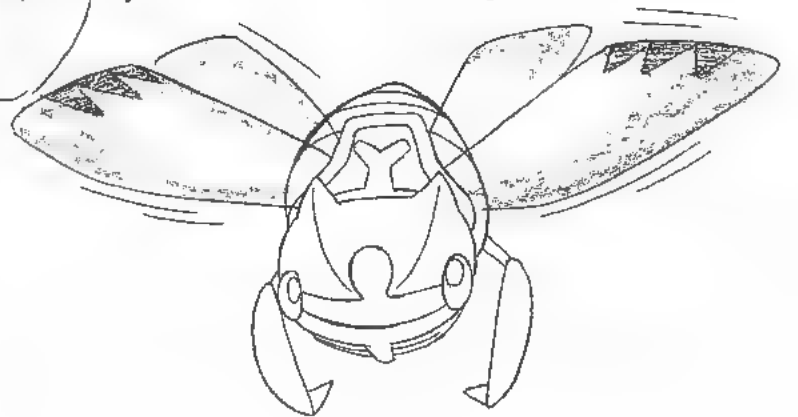
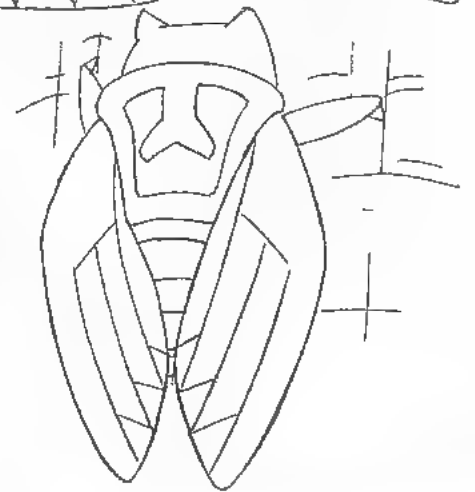
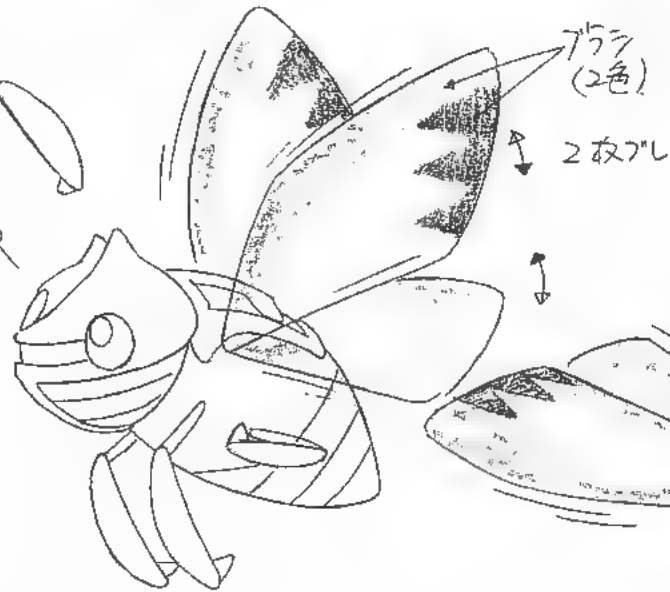

PMAG

ティカニン

2003.1.24.

2003.01.30 OK

決定稿

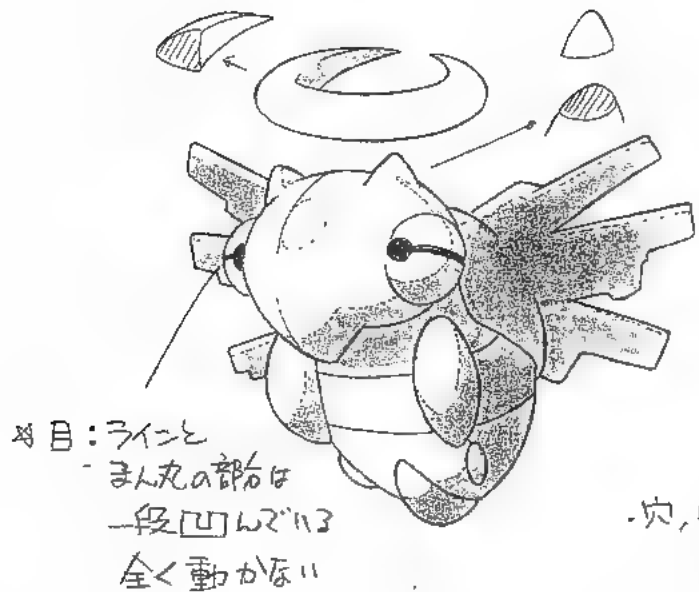

※目:ラインと
 -まん丸の部分は
 一段凹んでる
 全く動かさない

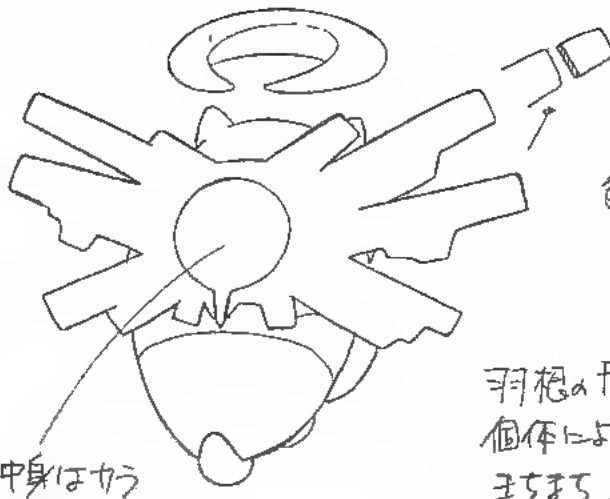

-穴, 中身はカラ

H
 色T.P

羽根の形は
 個体によって
 まちまち.



※、手首、羽根等は動かさない。

正にセミの抜け殻のイメージ。

※ 浮んで移動。

PMAG.

ヌケニン

2003.1.24.



2003.01.30 作

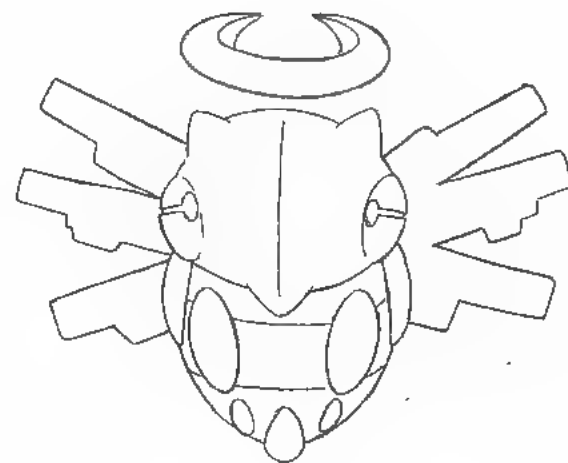
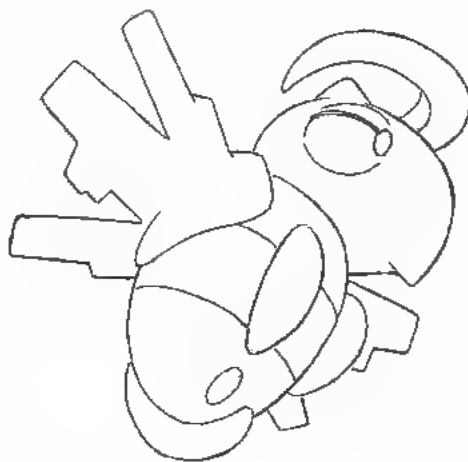

かたがけ



耳の穴
印刷形

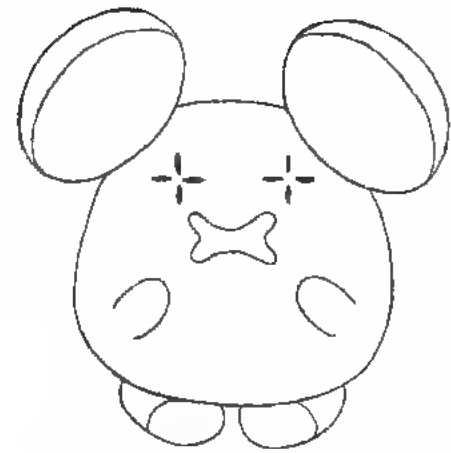

☆耳は垂直に立たせせん。立ててもこのくらい



尻尾の
穴です

☆足はいつも内股ぎみ

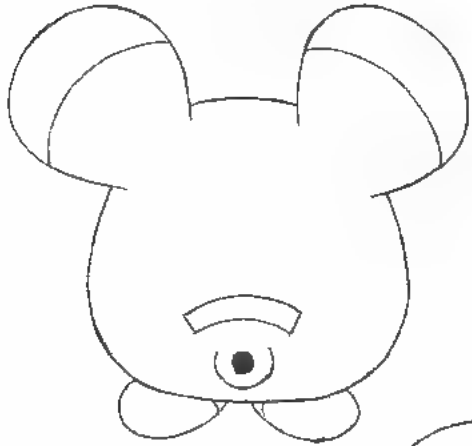

聴かざくと泣きかむ



目のUP

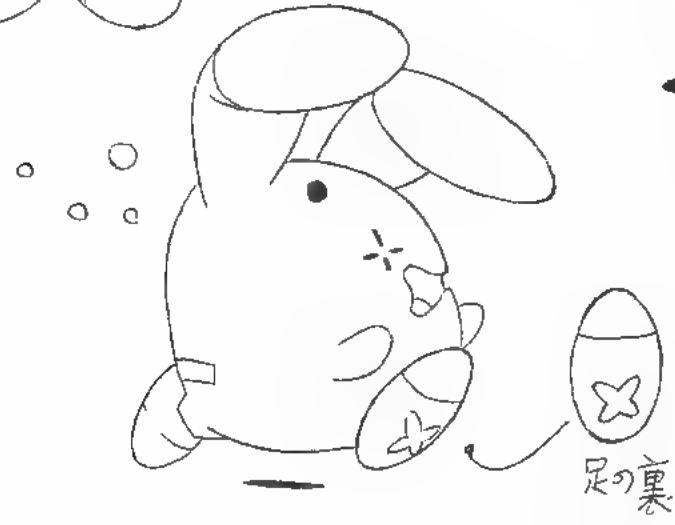

足の裏

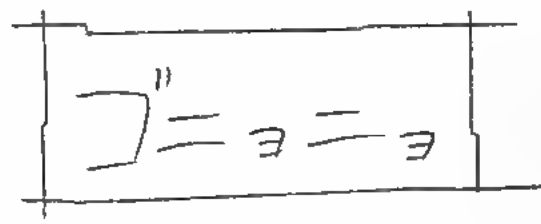

決定稿
2002.11.9 OK

カゲツサ

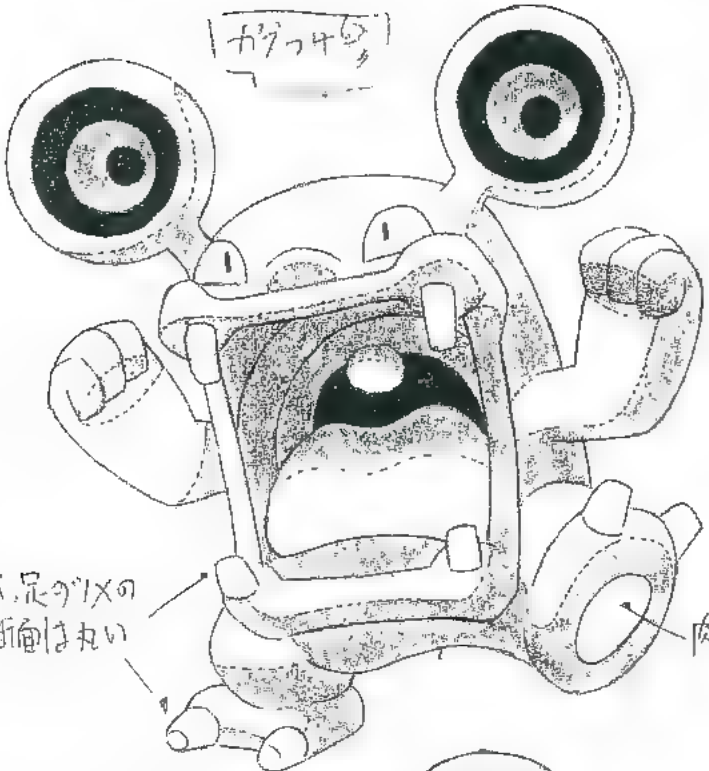

キバ、足ツノの
断面は丸い

肉球

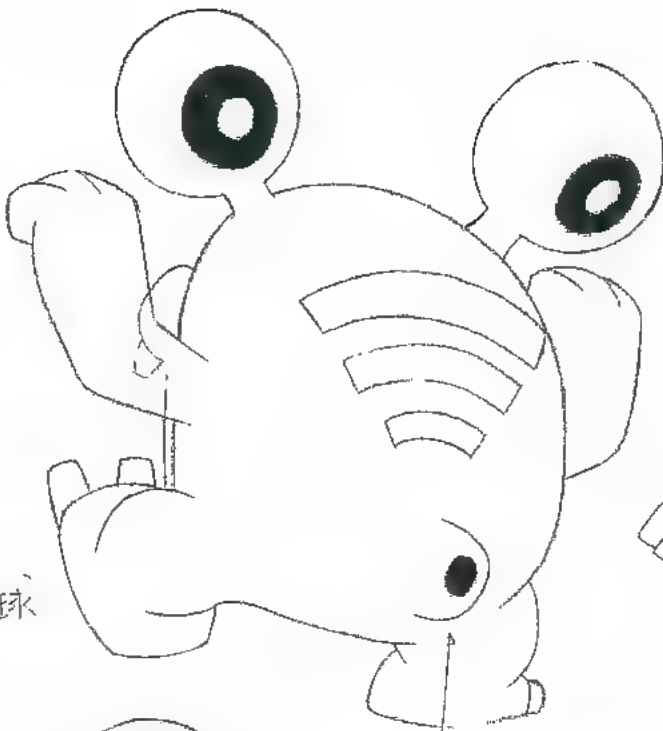

口閉じると

縮む



目の位置はなし



下目

口の形
は



伸びる

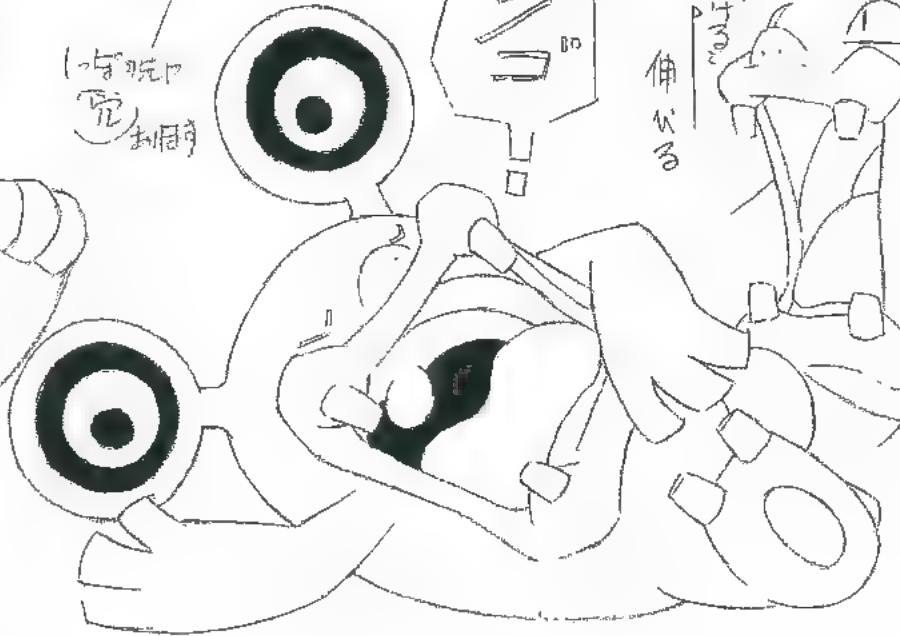
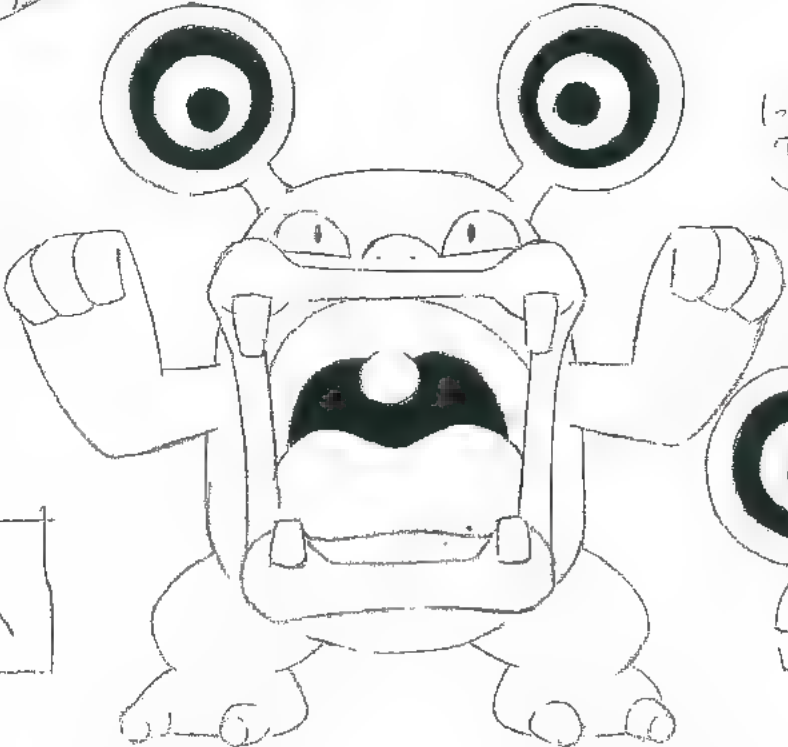

ドゴーム

決定稿

2002.11.02.or

おしりの形は激しく動いても
基本的に変わらない



バックオング②

決定稿

2003.01.15 OK

UP時(H)あり

断面 尻はあはせん

トジロ

舌は

目のUP(H)

かき

足の裏

アキロ

歯の形状

かき

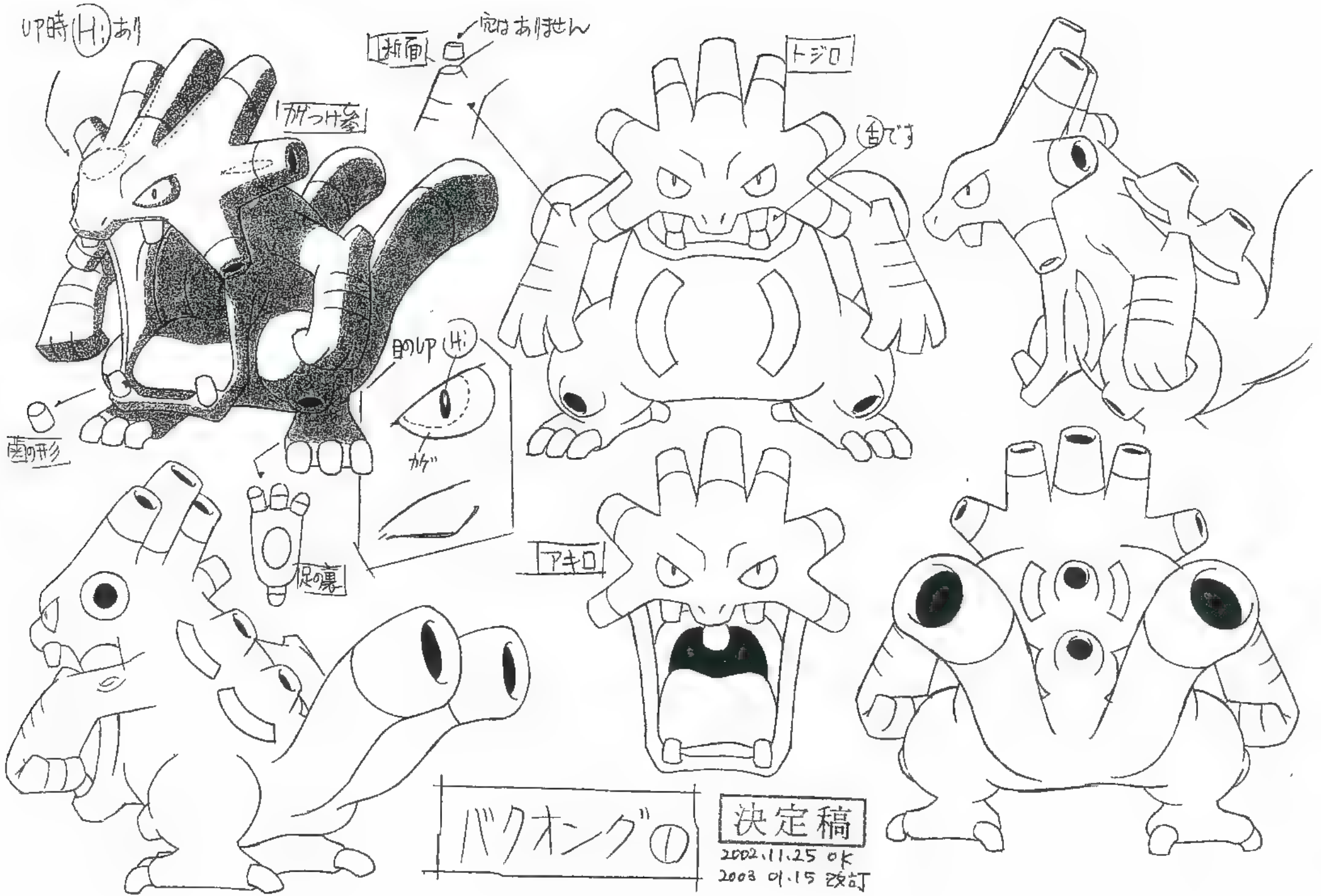

バクオング①

決定稿

2002.11.25 OK
2003 01.15 改訂

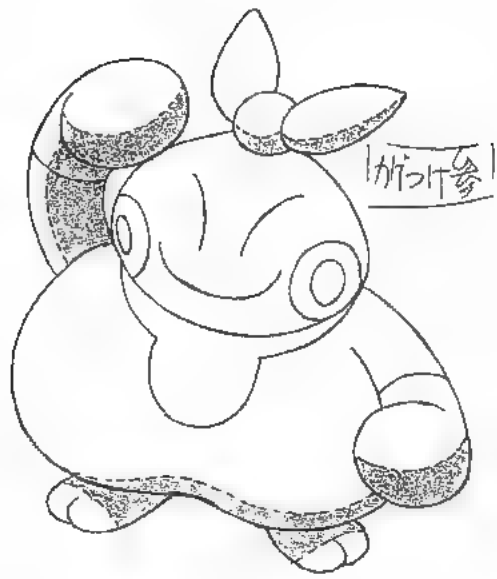

かたつけ

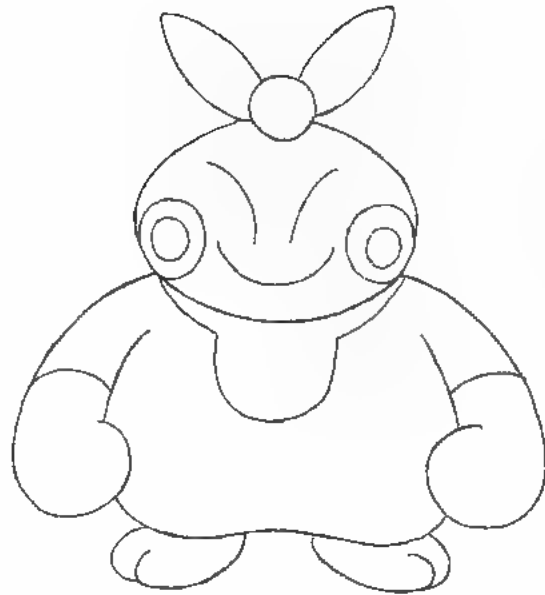
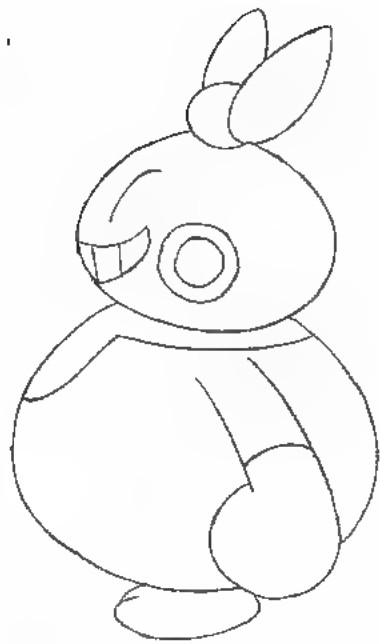

断面は花円形

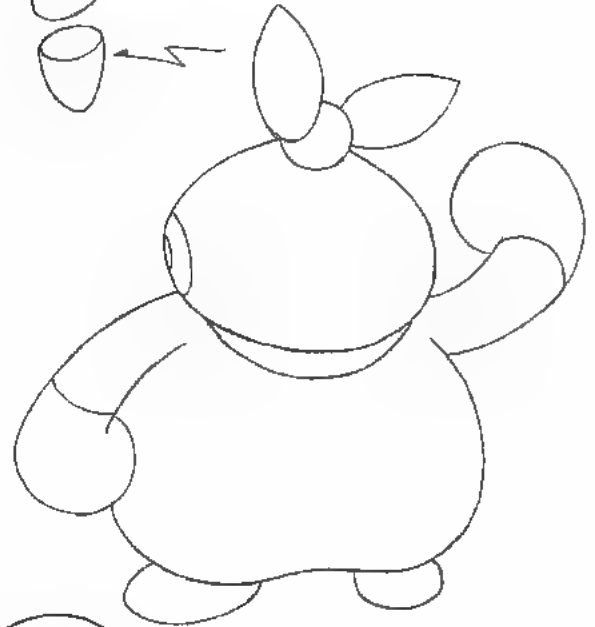

ムーブ

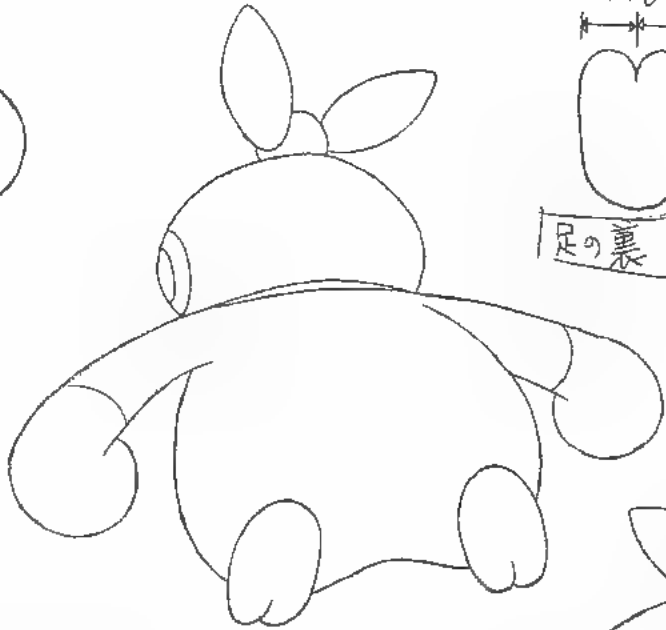

同じくさし



足の裏

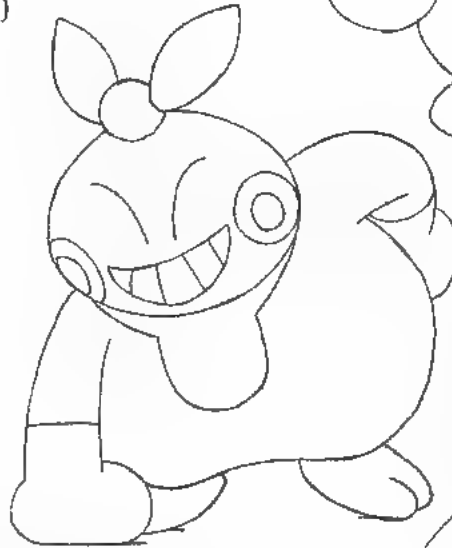

ムーブ...

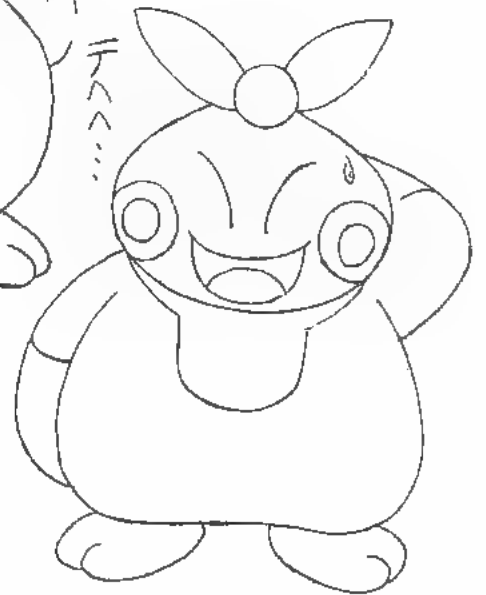

定稿

マクィタ

カワトコ

☆指は平べったい
(薄っぺらではない)

☆口はあきせん

取穴 (BL)

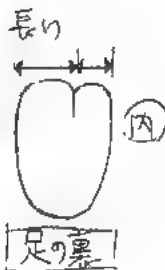
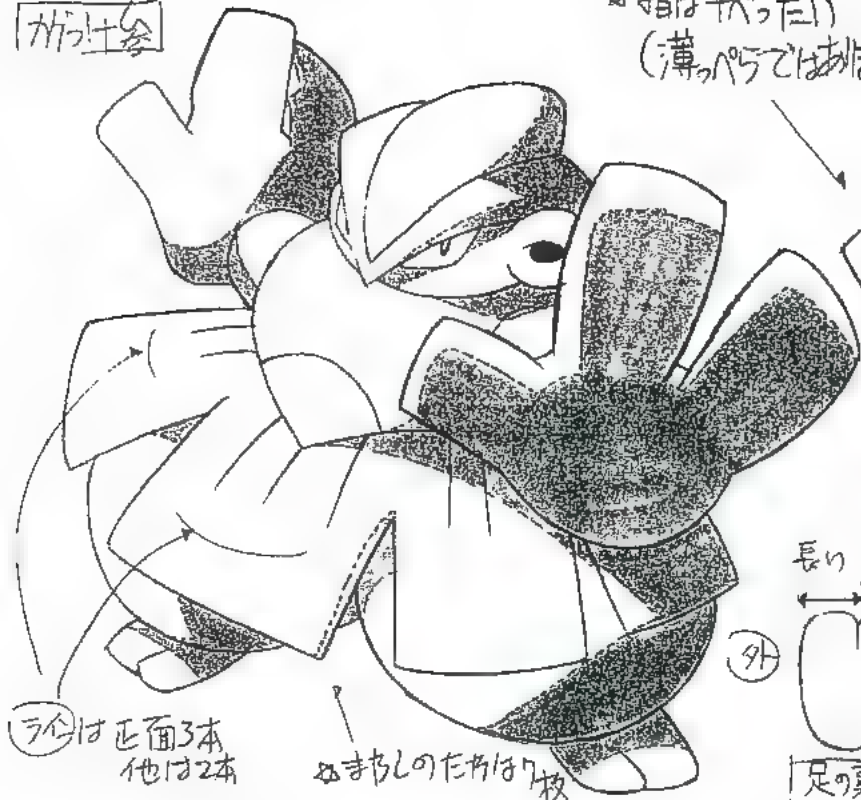

ラシは正面3本
他は2本

※まじりのたけは7枚

外 内

後ろ側

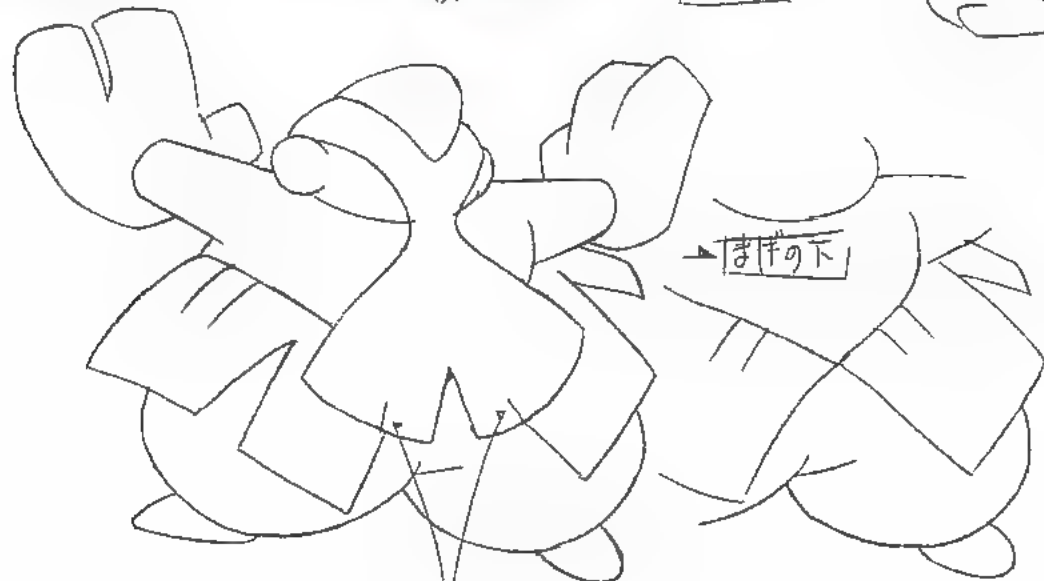

※ライン1本あり

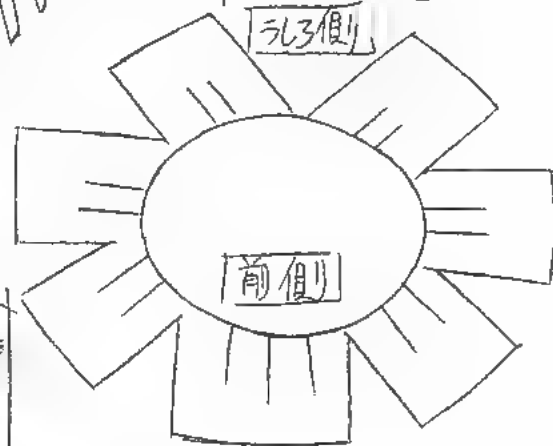
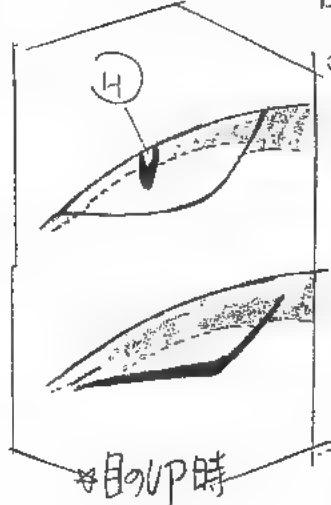

前側

ハリヤマ①
決定稿

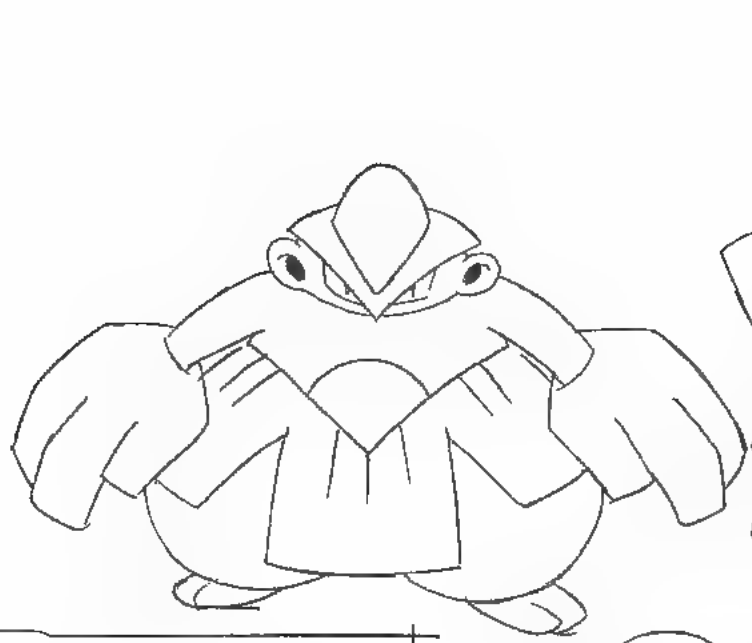

ハリヤマ②

決定稿



(H)

↑高上げ 柄.

☆カゲはついでUP時
ポイント的に

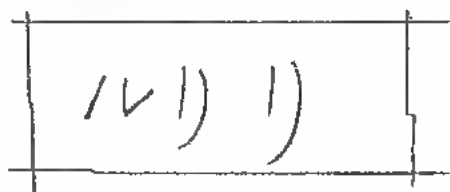
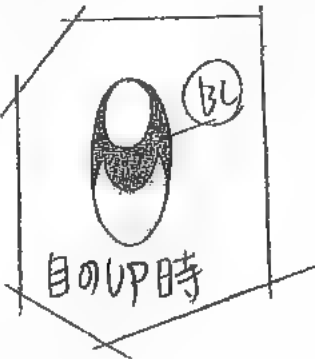
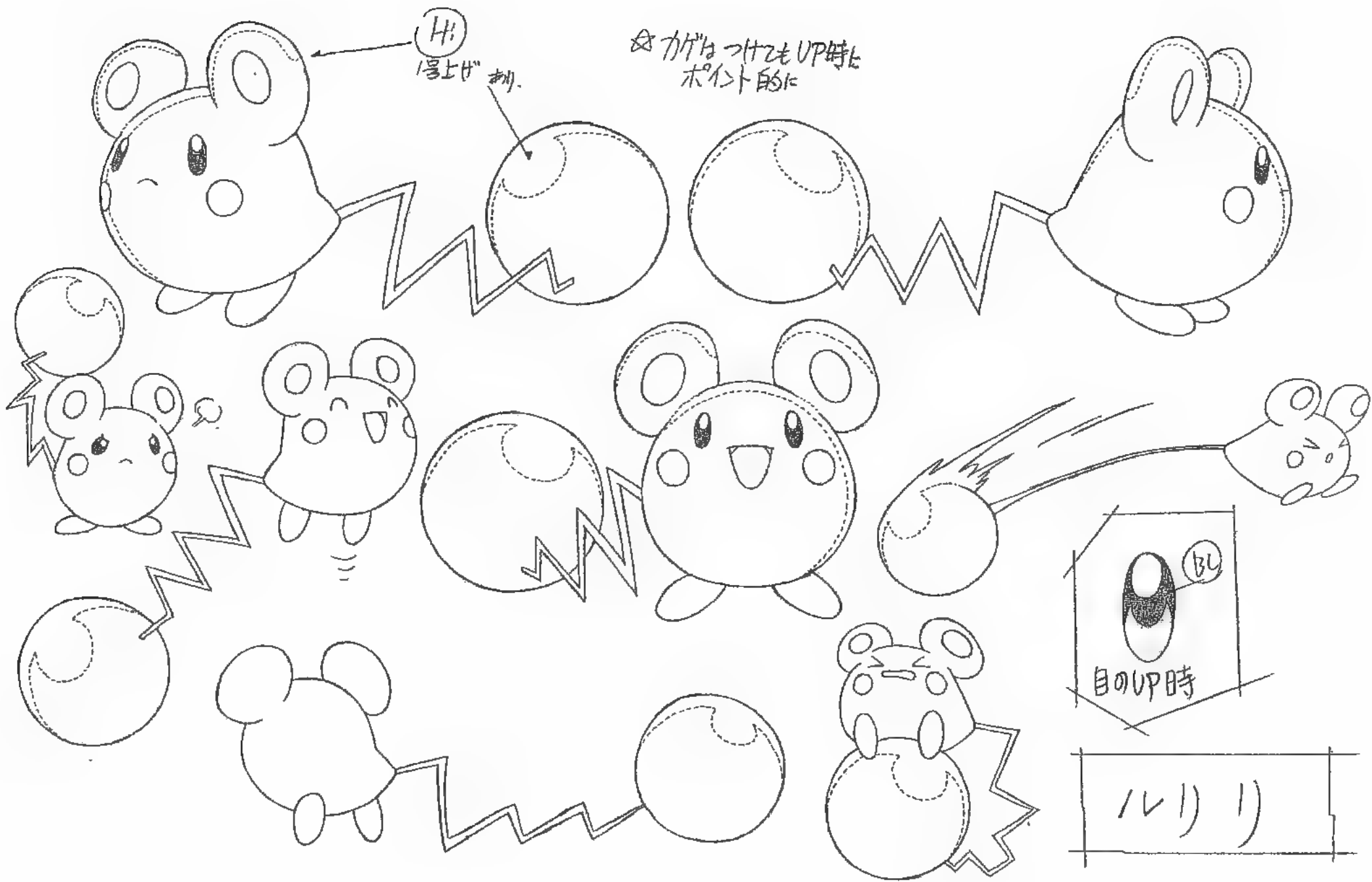

カクシカク

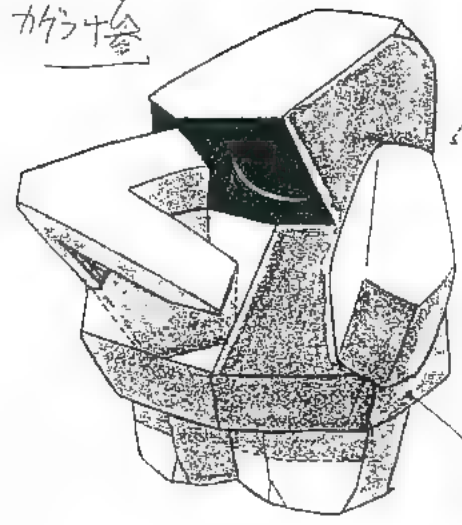

手の先端

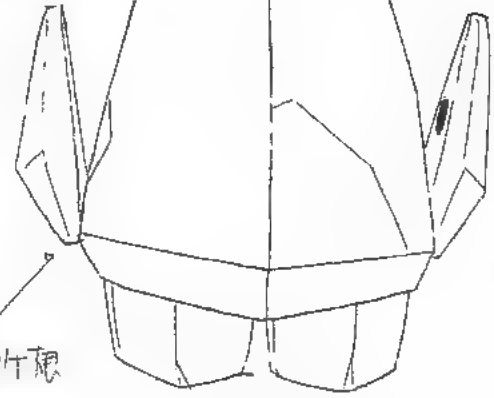

手の根

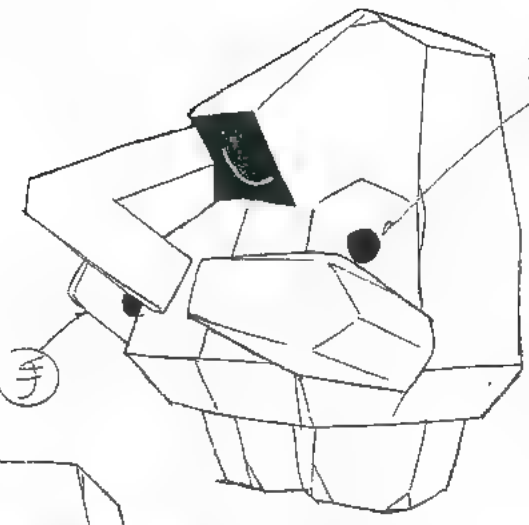

耳の穴

寂時前後動大きい

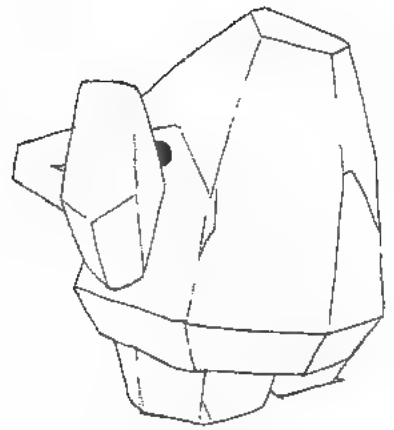
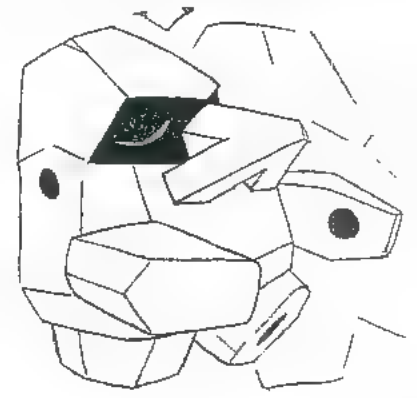

目の色は人のライン

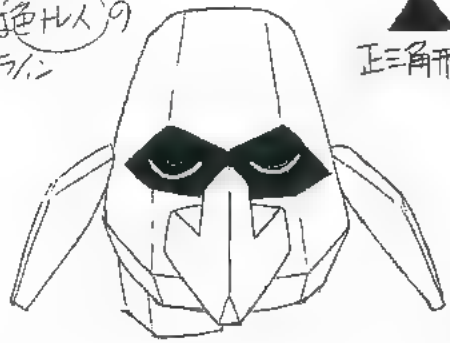

鼻の穴は正三角形

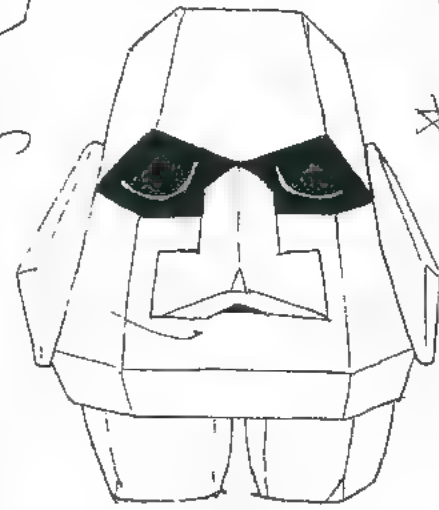

女口はあはせん

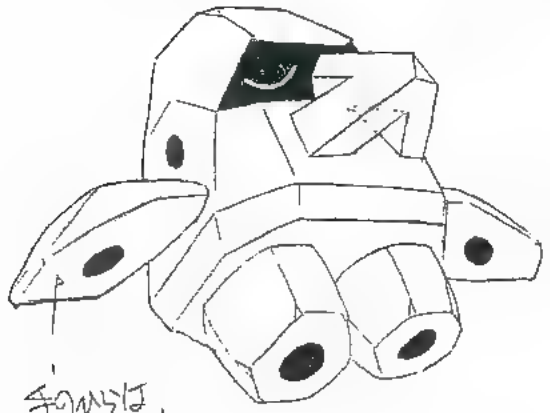
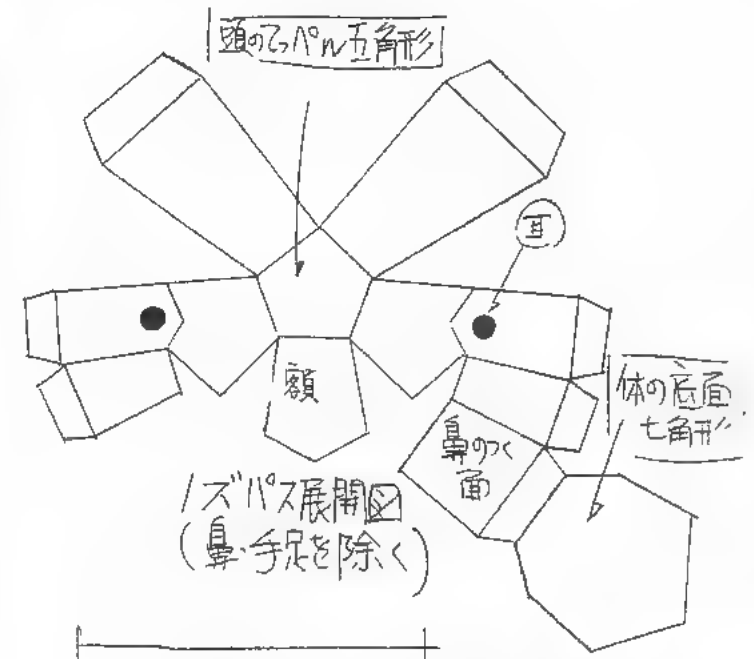

手の爪はフラット



後 足は七角形

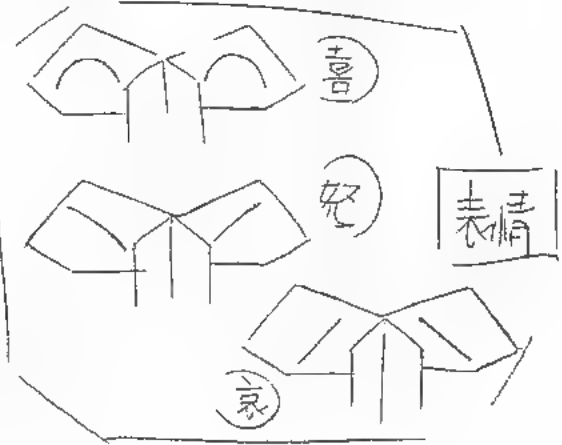

1/3パス

決定稿

2002.11.9 OK

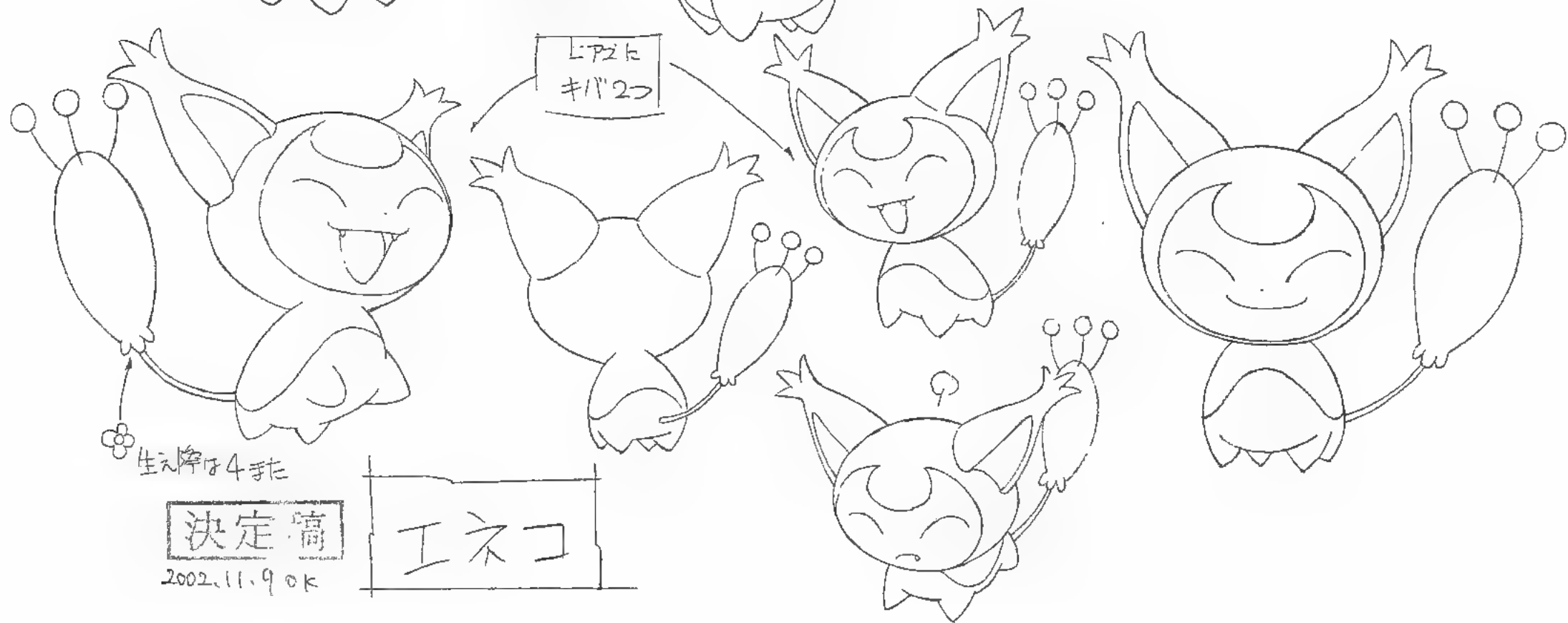
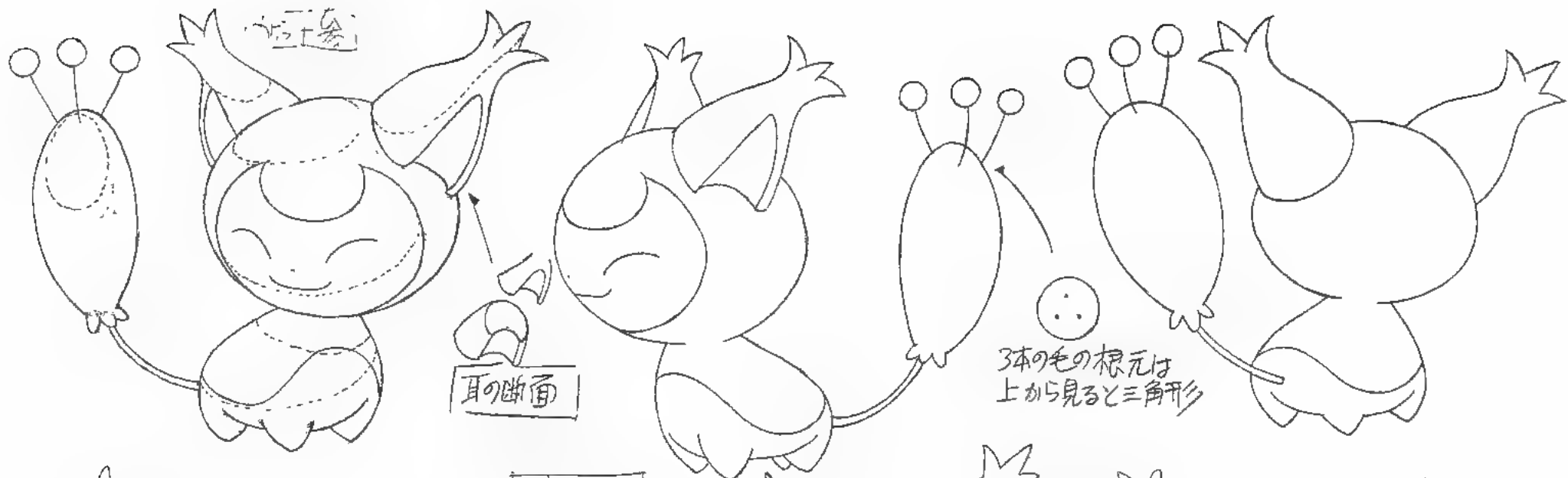

決定稿

2002.11.9 OK

エネコ

耳の断面

ハゲボシ

耳の中
BL

目のリブ



足は指・肉球なし

尾の先は
4つくらいに
分かれる

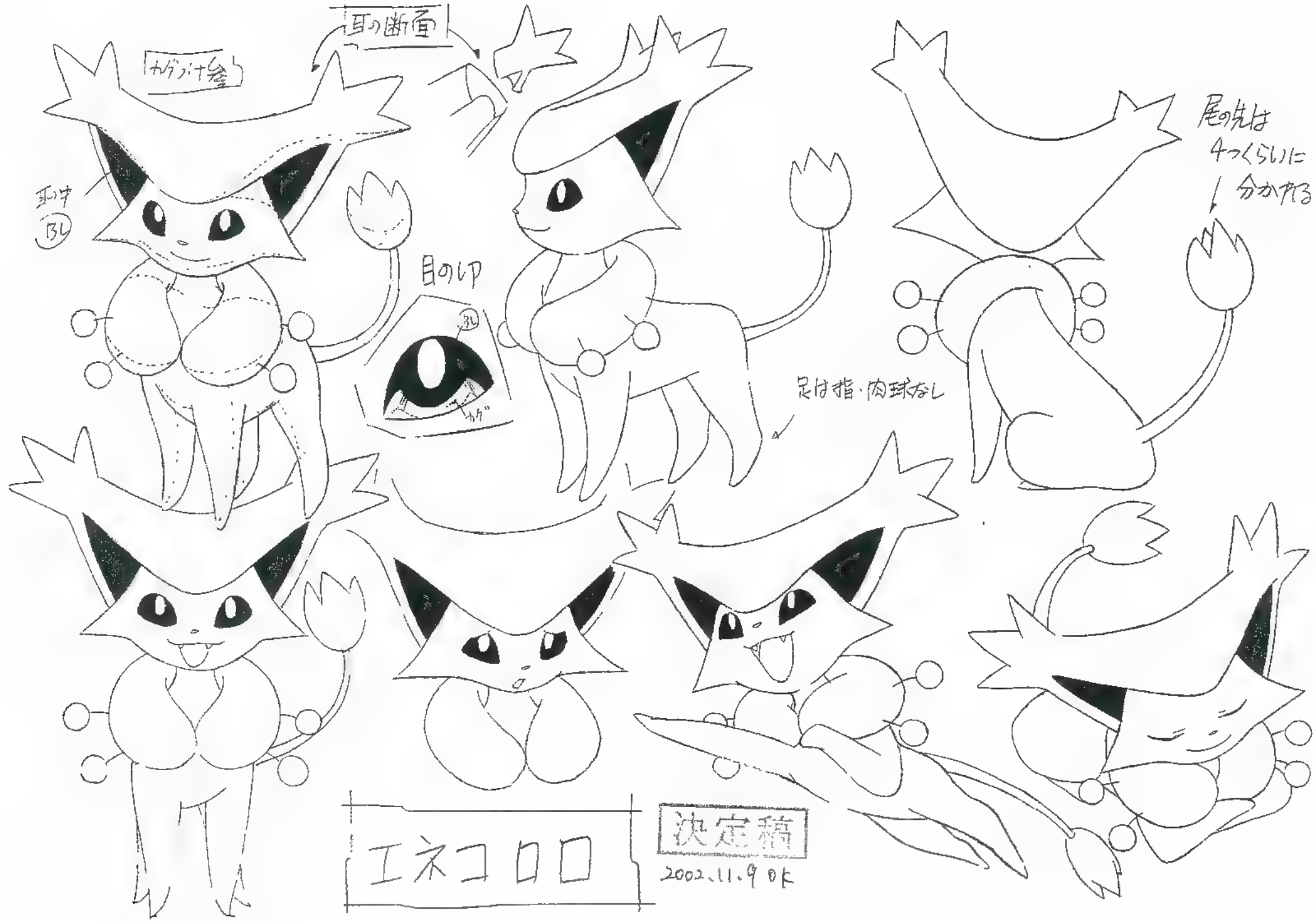

エネコロロ

決定稿

2002.11.9 OK



口は取るか
中心にいると
見えない

ギガ
ギガ
3つ

指3本



背中
に
鉱物(原石)
形、大きさなどは
個体差がある



頭のカット面取りは
シロウト

前

3/3

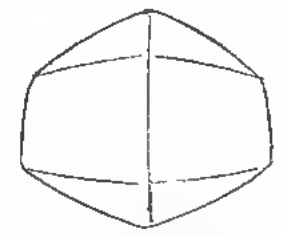
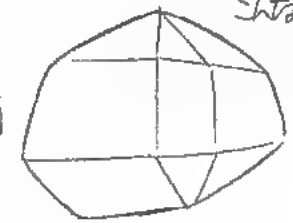

正面

歯はノギリ状
噛み合わせ
ピッタリ

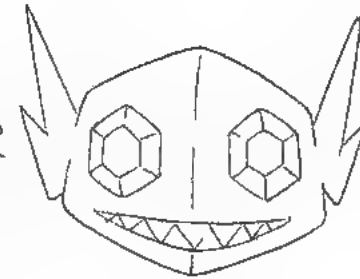

ヤミラミ

2002.8.20

決定稿

2002.08.21 OK



断面

キバは上アゴ6本
下アゴ4本
計10本です

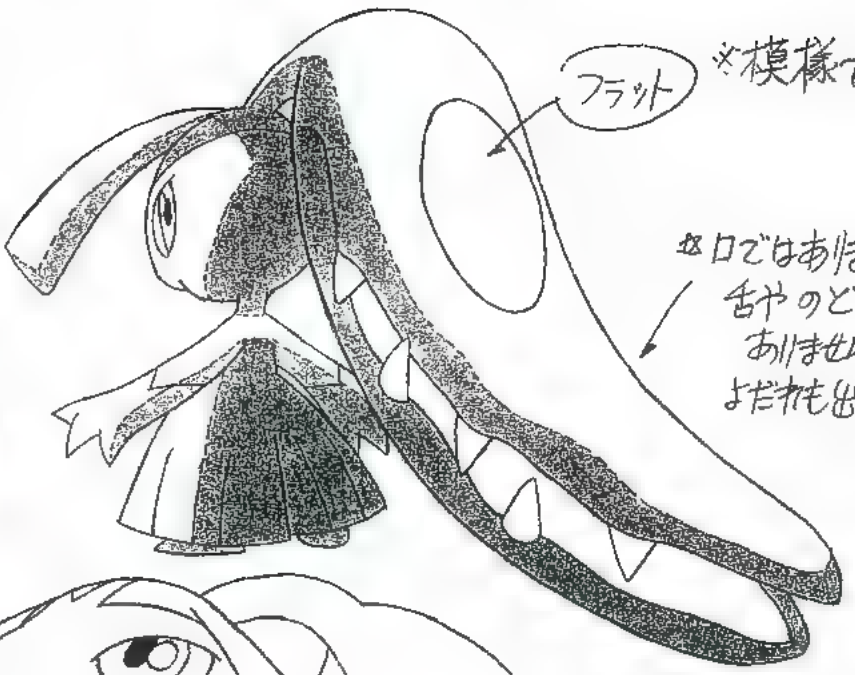

フラット ※模様なし

口ではあてませんので
舌やのどの穴も
あてません
よだれも出ません

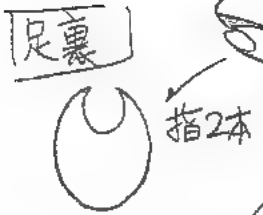

足裏

指2本

指は真中が
少し長い

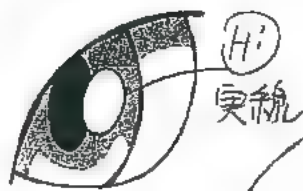
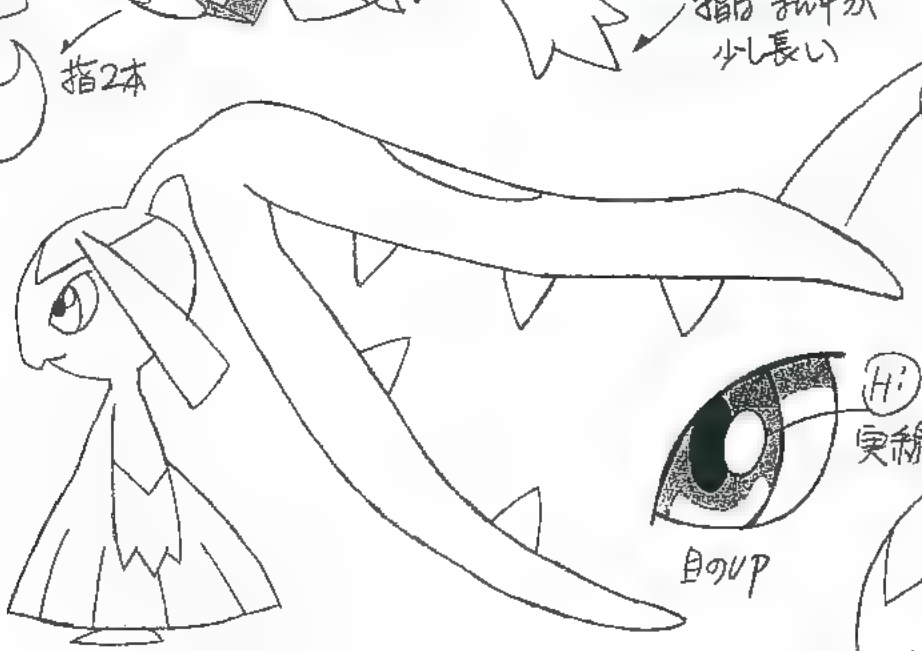

目のUP

(H)実線



頭のキバは
通常うしろ向きで
使います。
反動で
こらえり動か
こもあつた

24-1

決定稿

2003.02.19 OK

裾裏はフラットなだ円

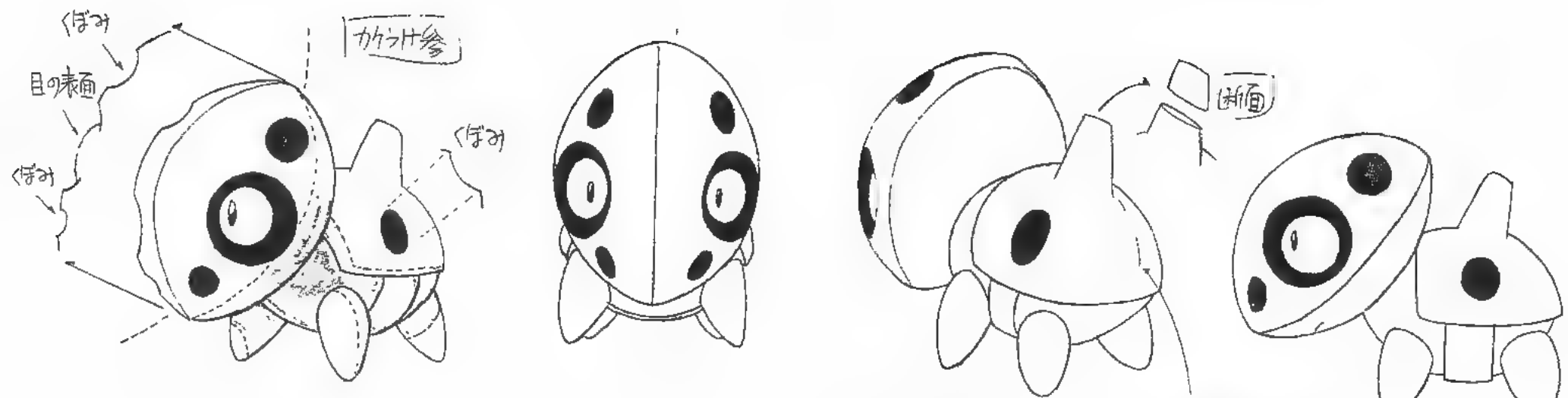

うしろ

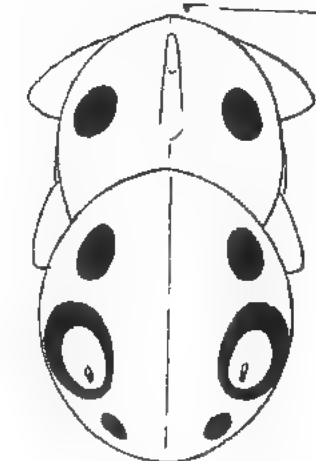
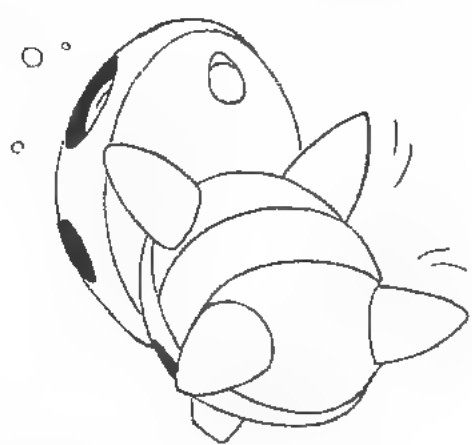
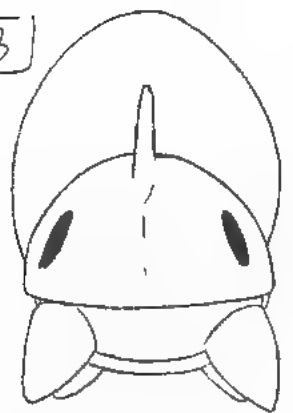

甲羅のセンターは
少し角張る

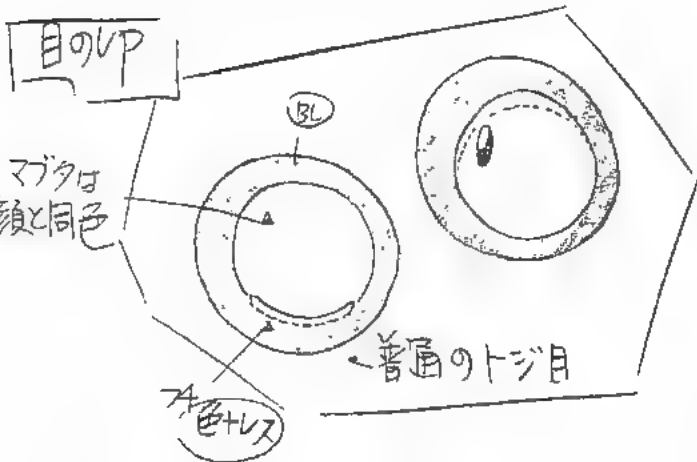
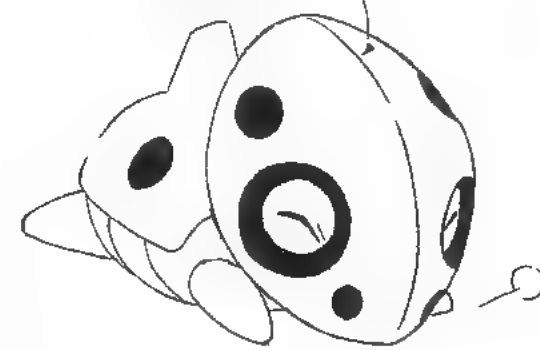

決定稿

2002.11.9ok

エコドラ

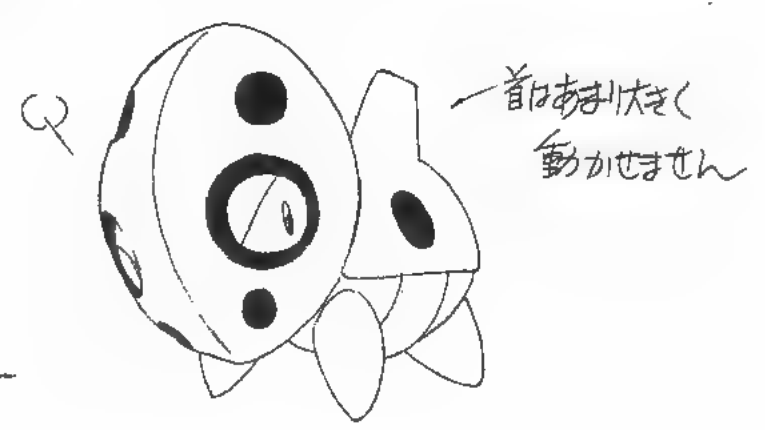

カゲツキ

尻の断面

背ビレの断面

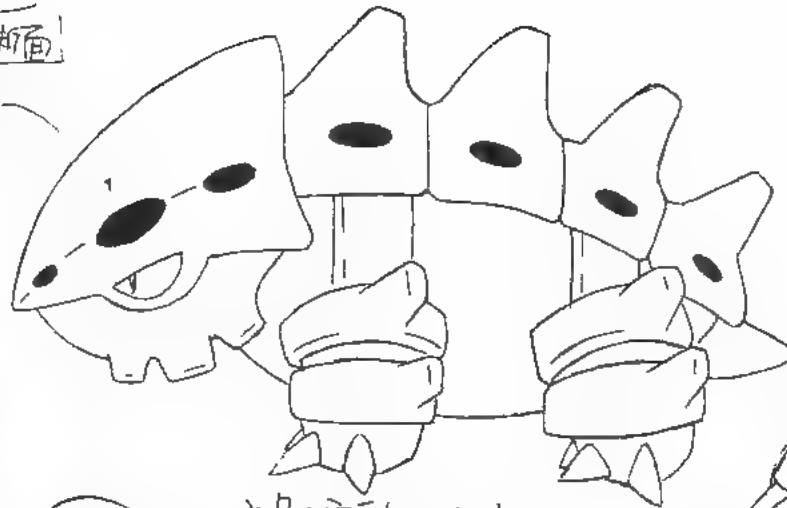
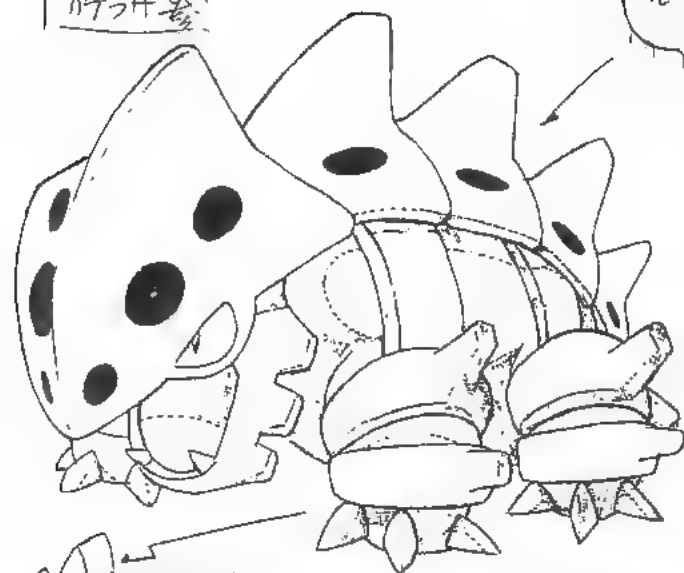

M.Xの断面

☆体は2本の
出っ張った
ライン

☆足のウラはフラット
"Xは3本

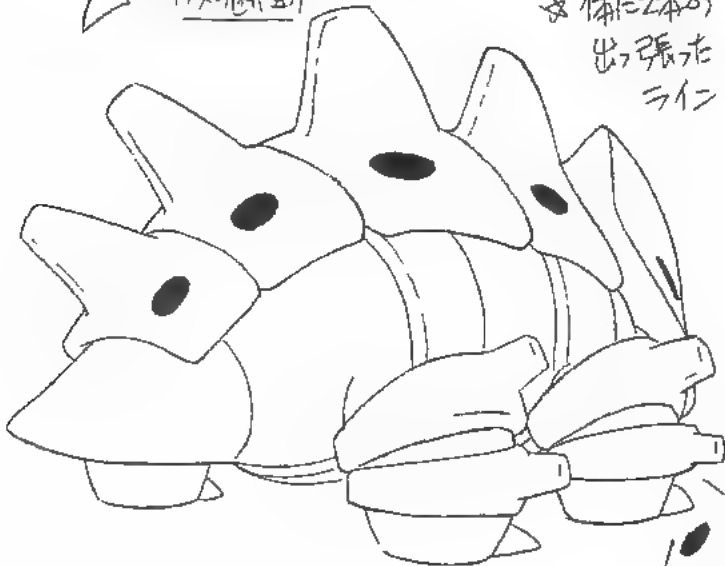
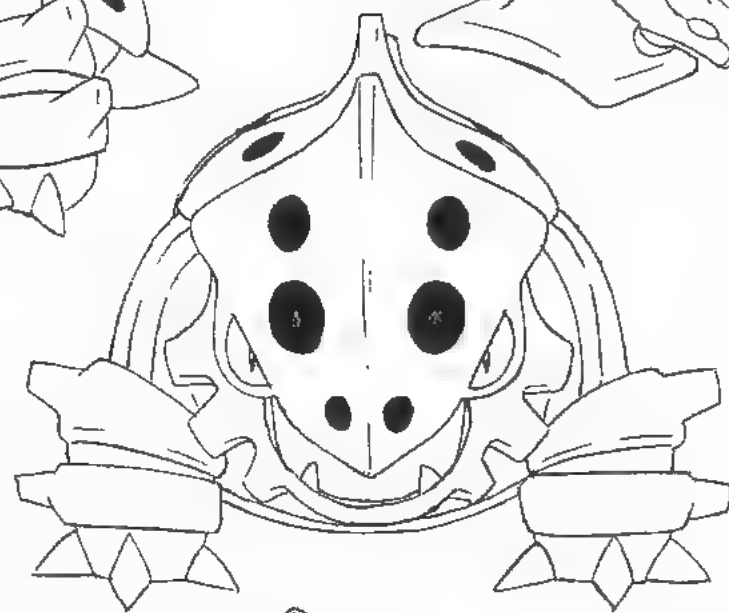
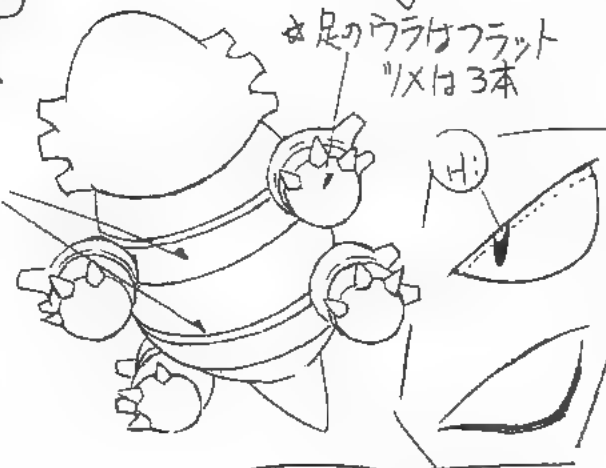

キバは
下アゴに
2本

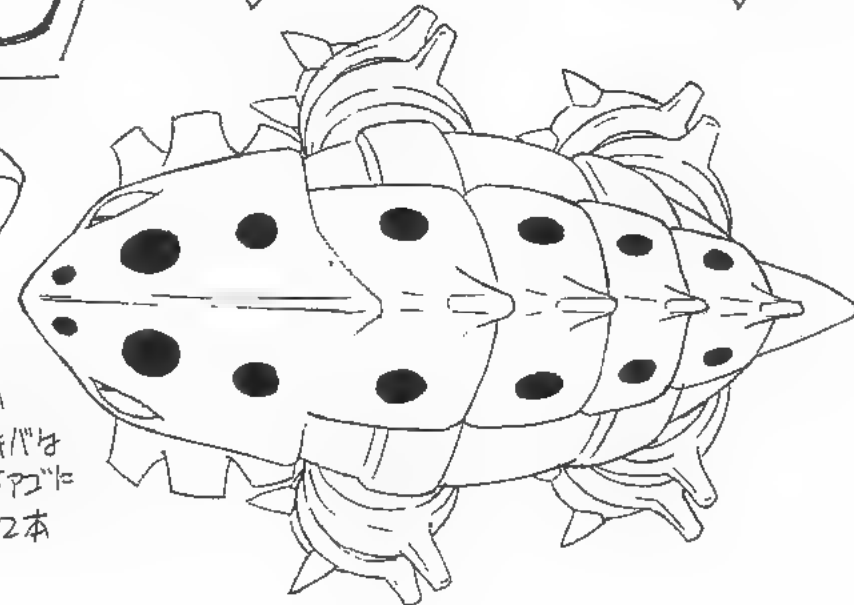

ゴドラ

決定稿

2002.11.9 OK

757+6

足の裏はアリソト

4

目9UP時



ボスゴドラ

決定稿

2002.11.9 OK

歯は基本的に
見えない



断面

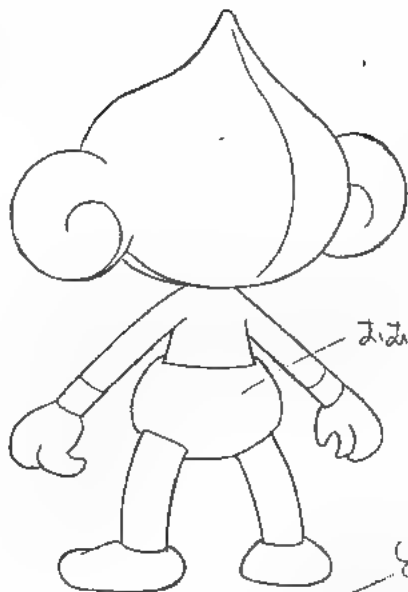
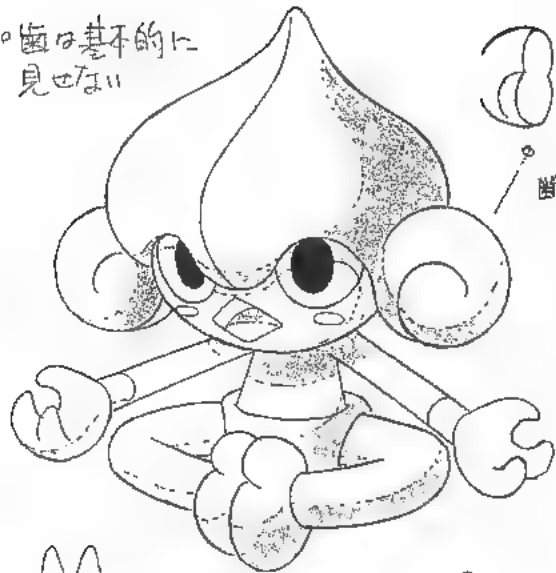

みみっほい

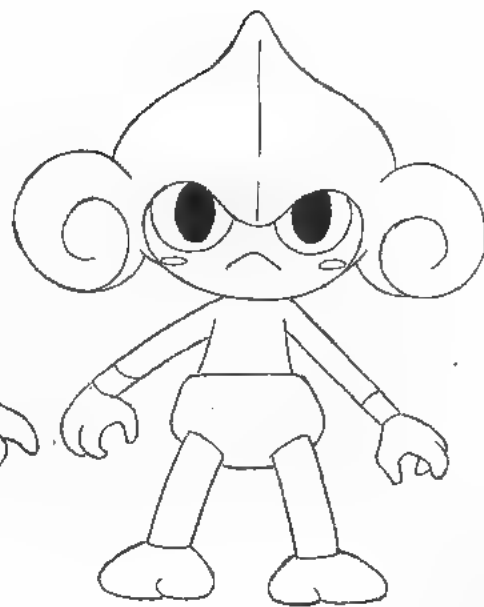

足ら



とび



NG

笑いサオは
目のみで表現



指先
細い



怒

PMAG
アサナン

決定稿

2003.1.17.

2003.01.22 ok



もろは
フラット

目はまん丸
瞳はUP時に
黒

↑
上腕細い

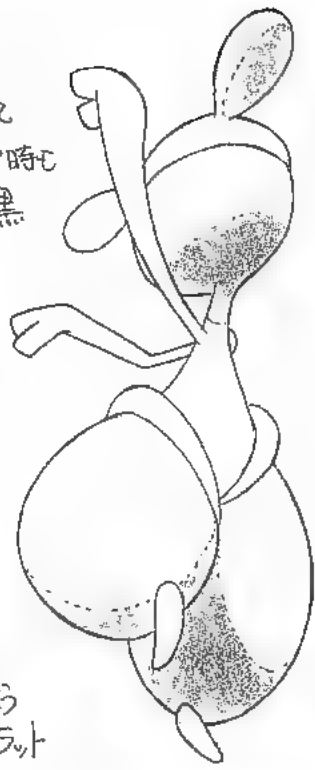

もろ
フラット

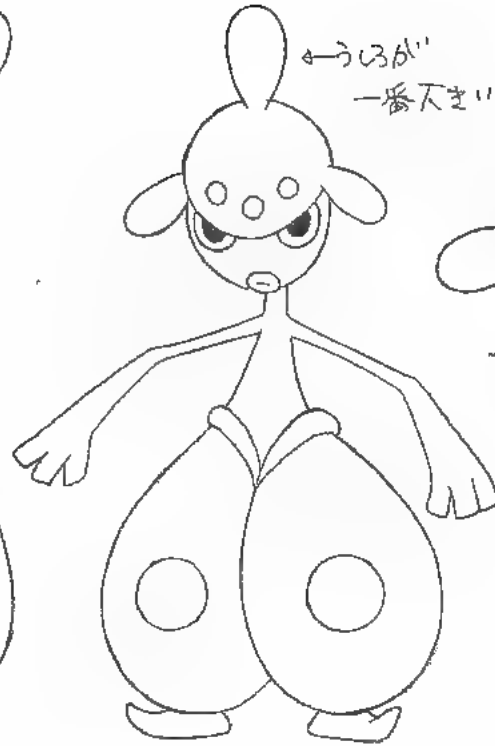

←うしろが
一番大きい



怒



つま先少し上がる

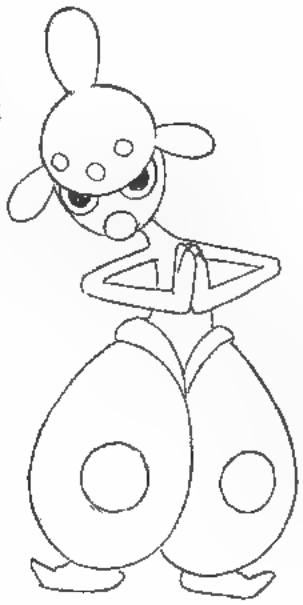

笑い目

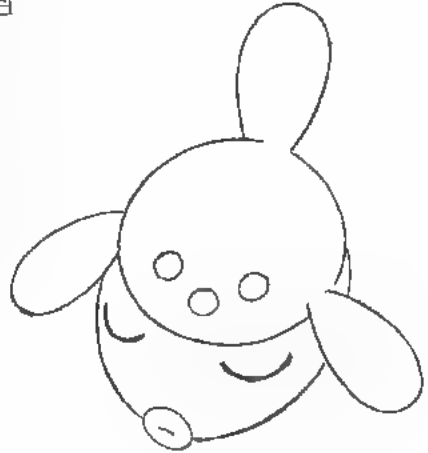

PMAG 決定稿

フェーレン

2008.1.28 OK

2008.1.23

カクシキ

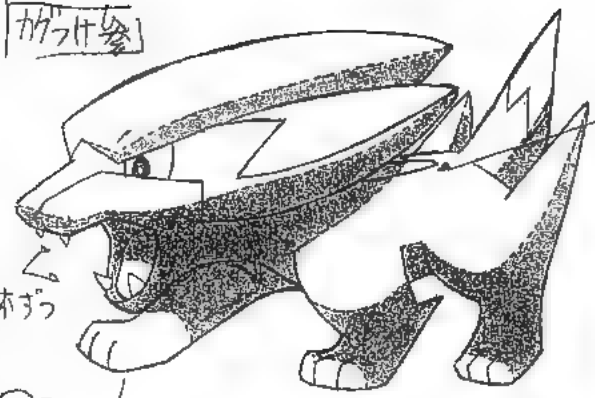

キハ
上下2本ずつ

背中に細長い模様おぼす

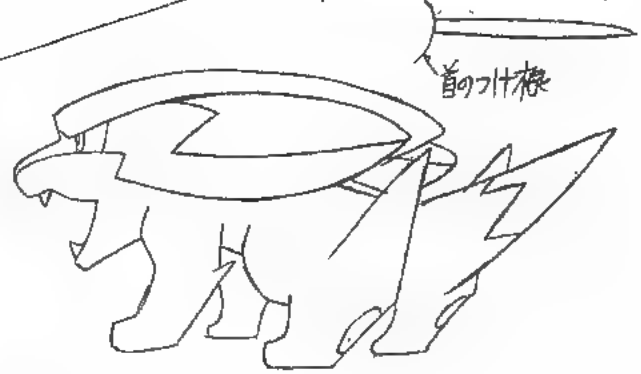

首のツケ線

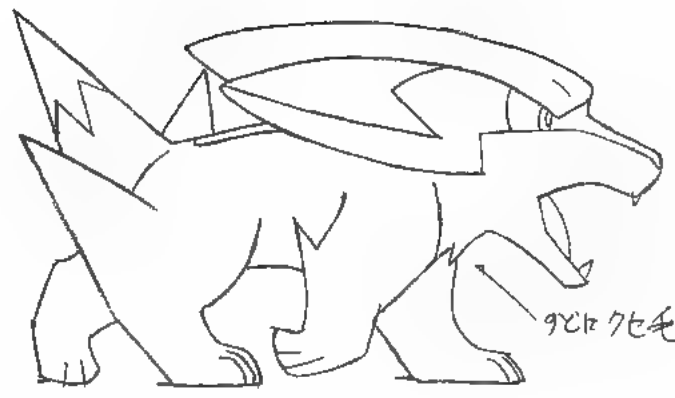

90%の毛/7割



前足の肉球
(フラット)

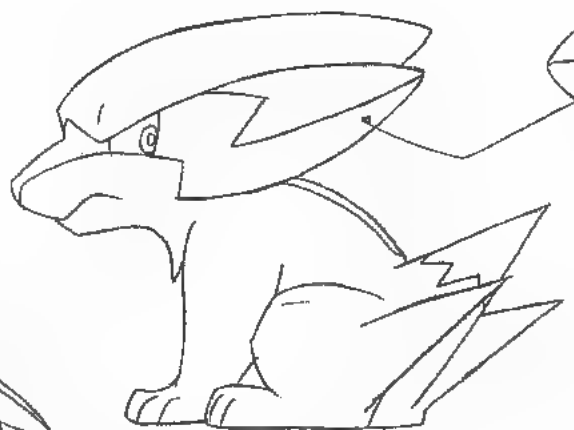
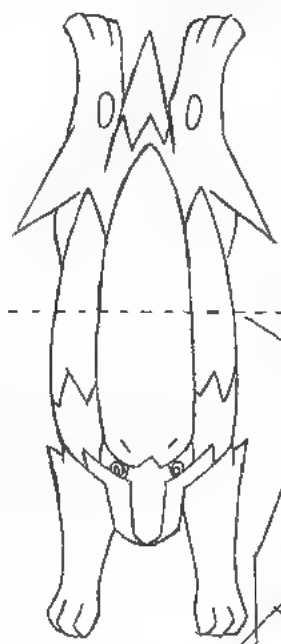

うしろから見ると



断面

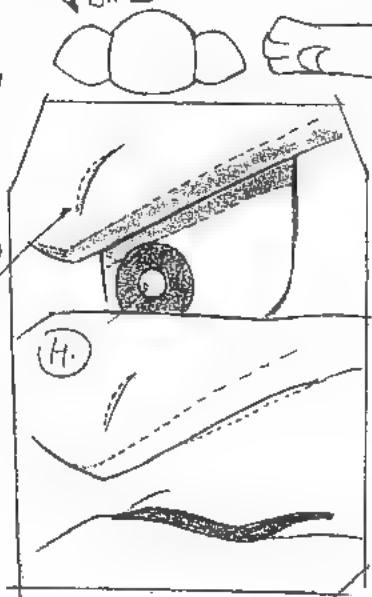

眉間のツギ

うしろ足の肉球
(丸)



ラクライ

決定稿

2002.11.25 OK
2002.11.30 改定

トゲ状

ヒキバは上下
2本ずつ

しほの断面

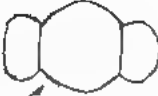

断面

トゲ

前から2番目が
一番大きい

首の前
山2つ

首のうしろ
山2つ

Yの断面



目=H/乱

+シ目

目のUP時

前後の足裏に
肉球あり

ライボルト

決定稿

2002.11.25 OK



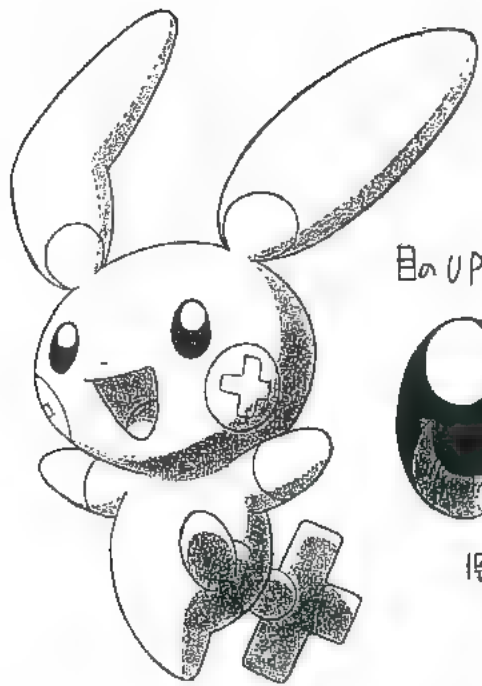

目のUP



尻尾



鼻は円

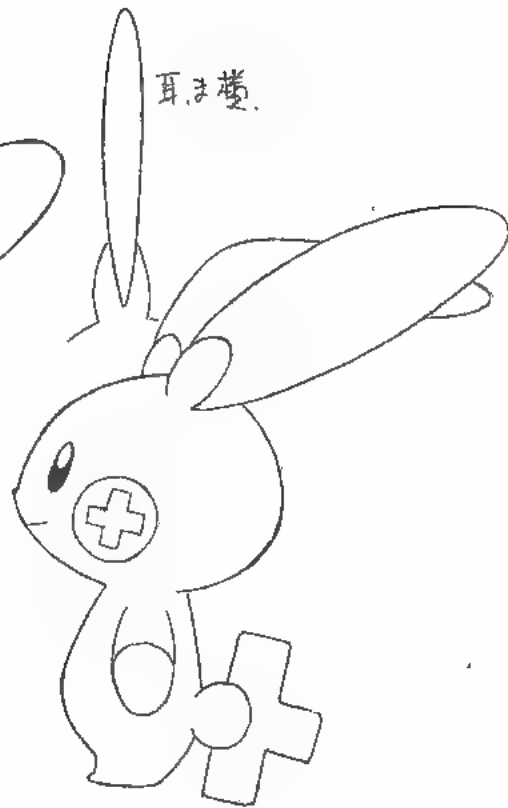

耳は葉

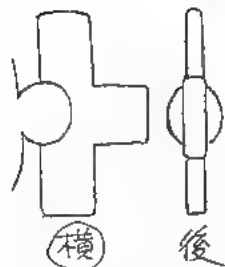

マインも
厚みなどは同じ

※プラスルとマイナンの形状は、
ホッパと尻尾以外は同じ。

PMAG

プラスル & マイナン

2003.1.16.

決定稿

2003.01.21 OF



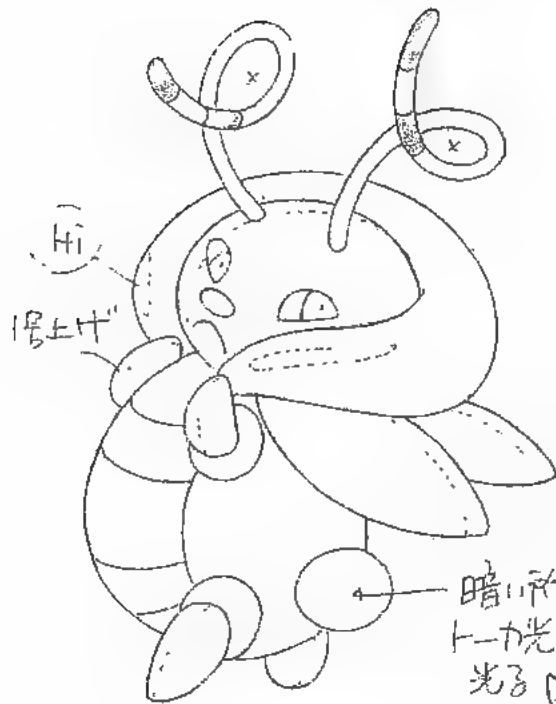

(H)
目上げ

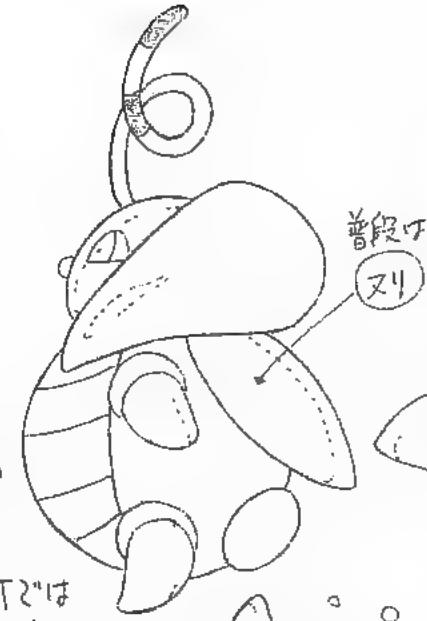

普通の
アリ

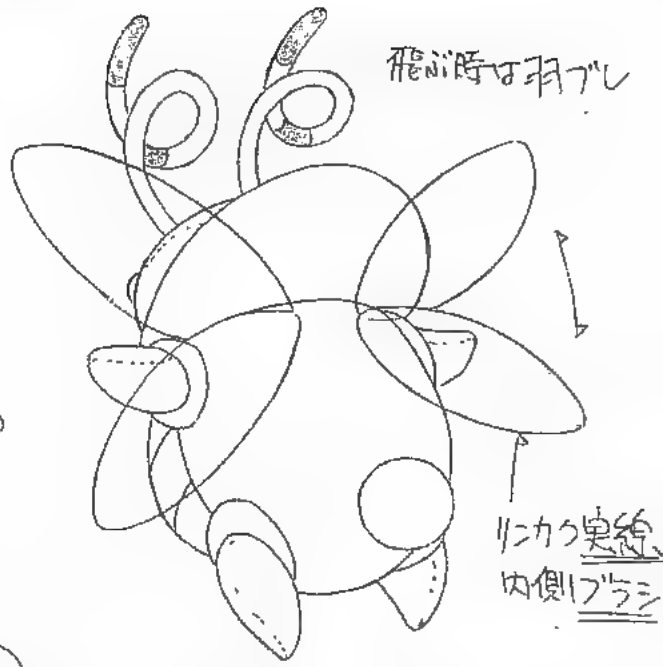
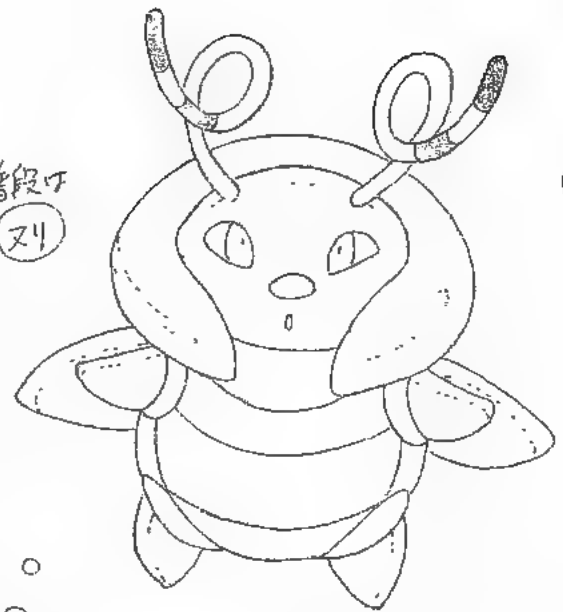

飛ぶ時は羽がレ

リノカク奥線
内側ブラシ

暗い所では
トカ光る
光る



転ぶと体がなが起き上がらない

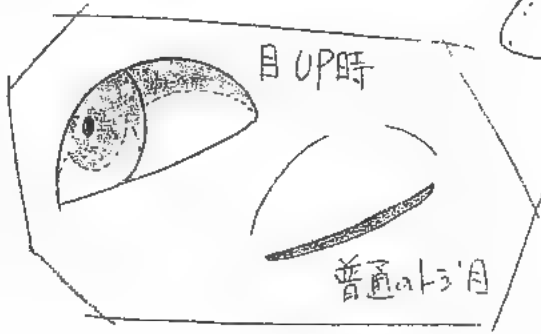
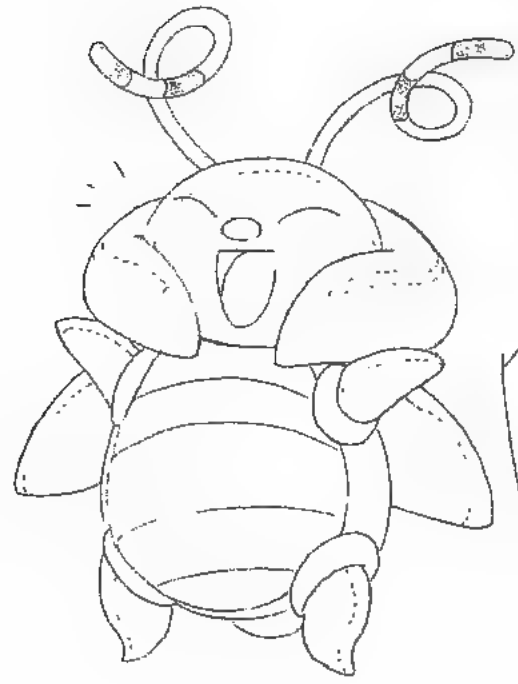

目UP時

普通の月

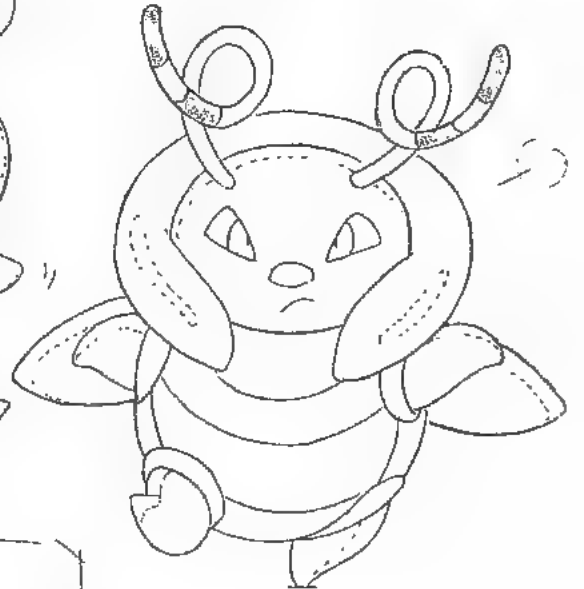
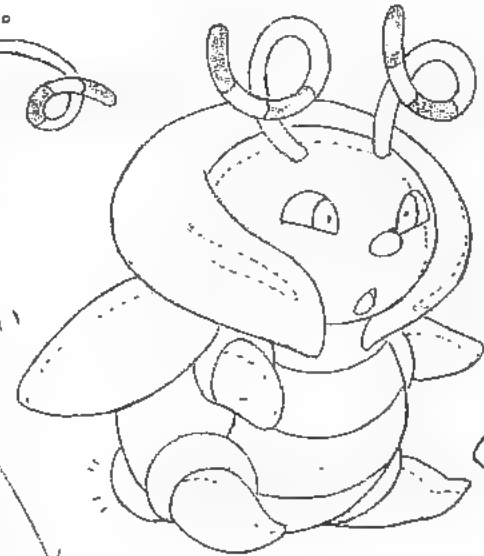

ハルビ

2001.10.25



目UP時

ゆし厚みあり

とこ目 赤色から色

※あひの毛はうらた 光らない

※羽根 増設は21

飛行時
ニカク奥線
内側ブラシ

※歯はなし

目Hi 色T.P

※両方あり

PMAG
イリス-ゼ

2002.12.20.

決定稿 2003 1.6 OK

4.

※花びらは左右色違い
(赤と青以外もあり)

さすがは固い質感

かたけき

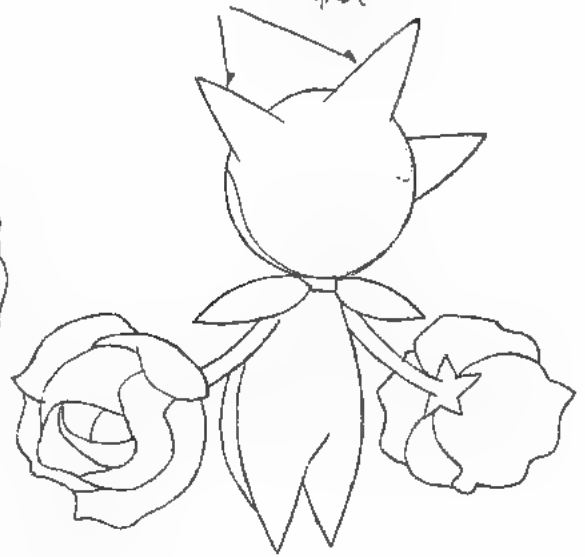

かたけき5枚
★

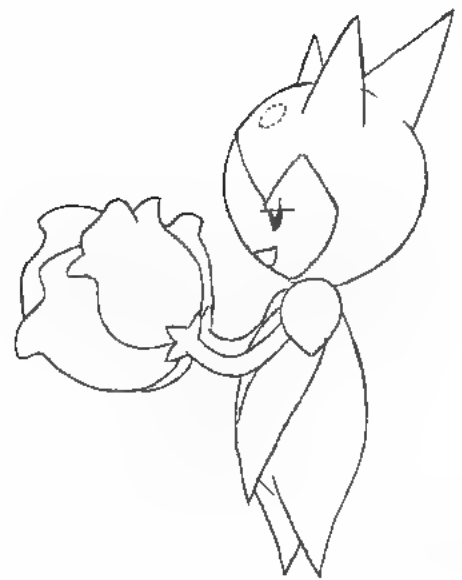

ま毛は2本

H.

※白眼は
あはせん

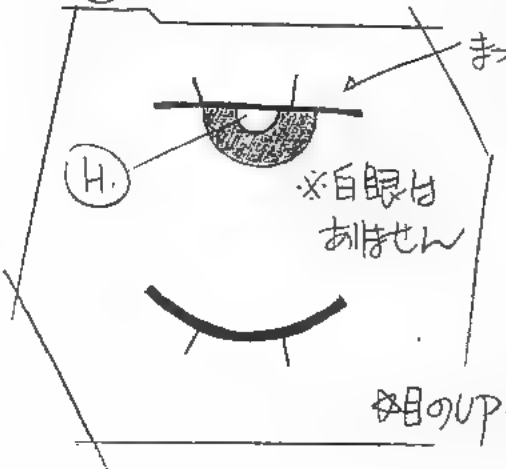

目のUP時

ロゼリア

決定稿

2002.11.25 OK

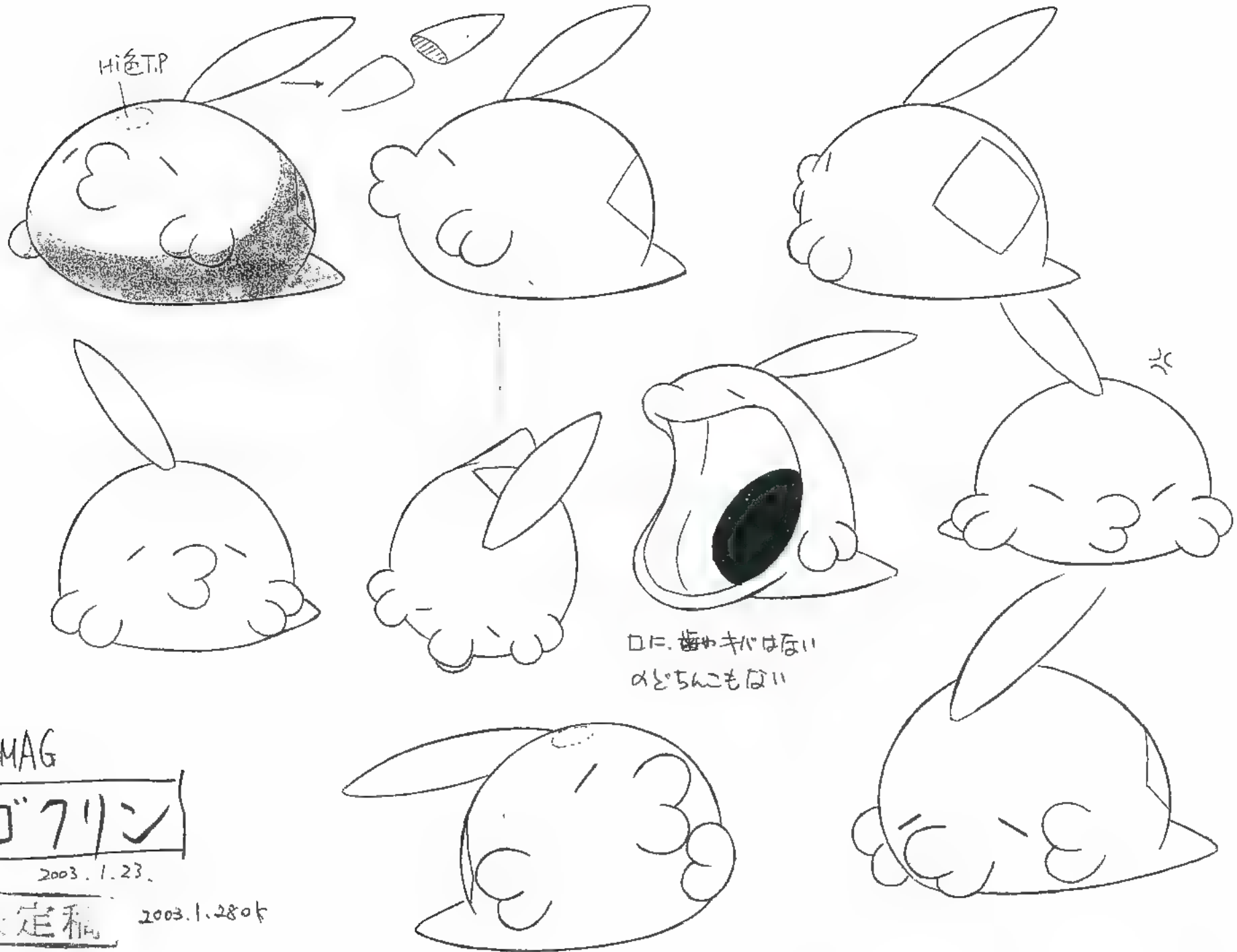

Hi&T.P

口は、歯やキバはない
 みとちゃんにもない

PMAG

ゴクリン

2003.1.23.

決定稿

2003.1.28ok



・目はまん丸で
少し大きめに
Hi色T.P



まうは
全部で
5つ

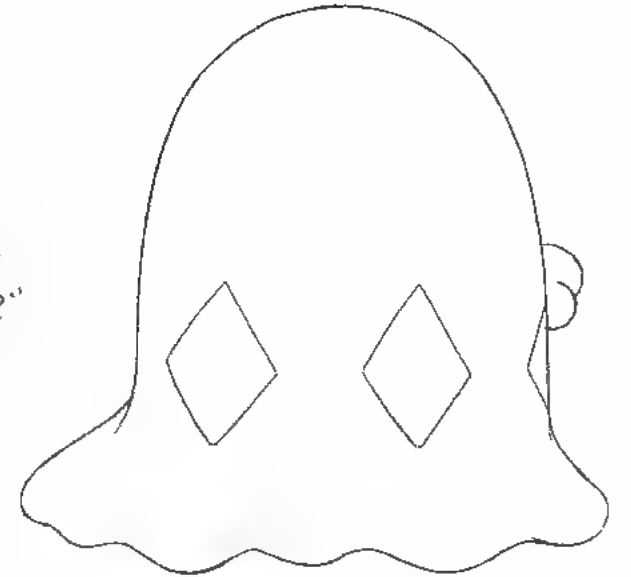

瞳 Hi
色T.P
色トス
2021/7/9
目の色UP時
α21.

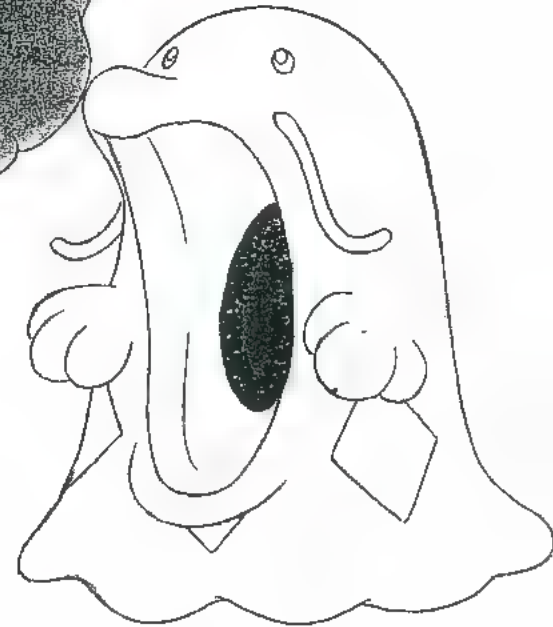
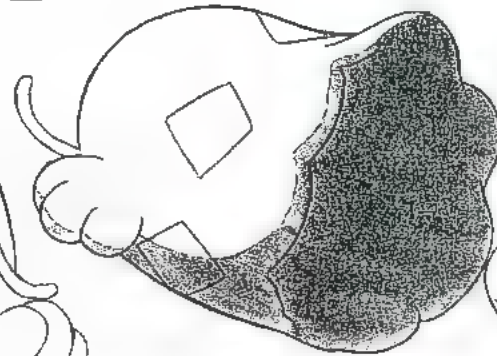

PMAG
1マ101-6
2003. 1.24.

決定稿
2003. 01. 30 ok
07. 08 改正

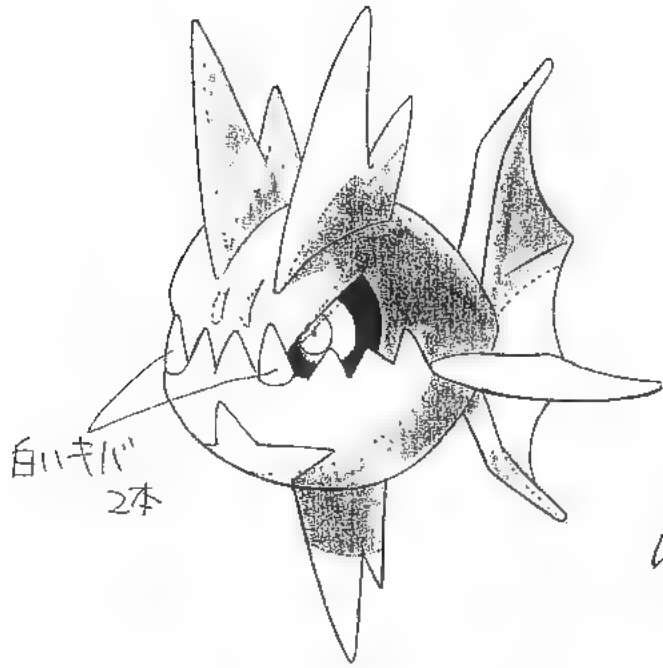

キバニア

2002.8.19.

決定稿

2002.08.21

目のまわりの
黒い部分は
からむより一段
凹む。

上キバ3本 →



キハ"上計ク本

※キハ"は上下&E
之本1組

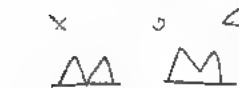

⑤前歯は3本



下のキハ"
計4本

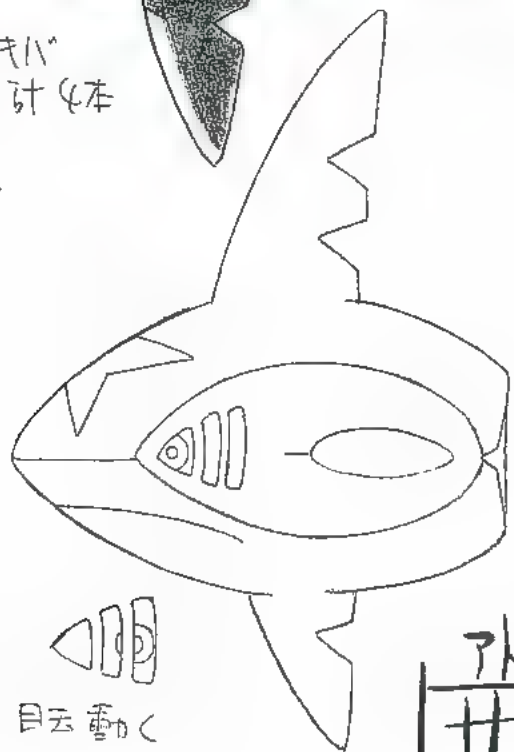

目云動く

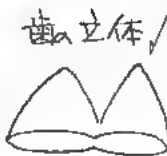

先は
少し丸有.

フット

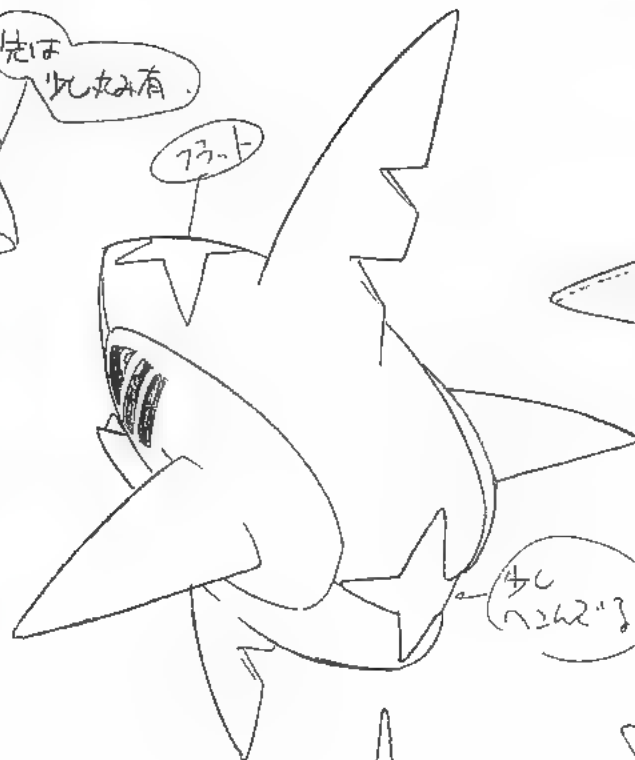

40
の262"3

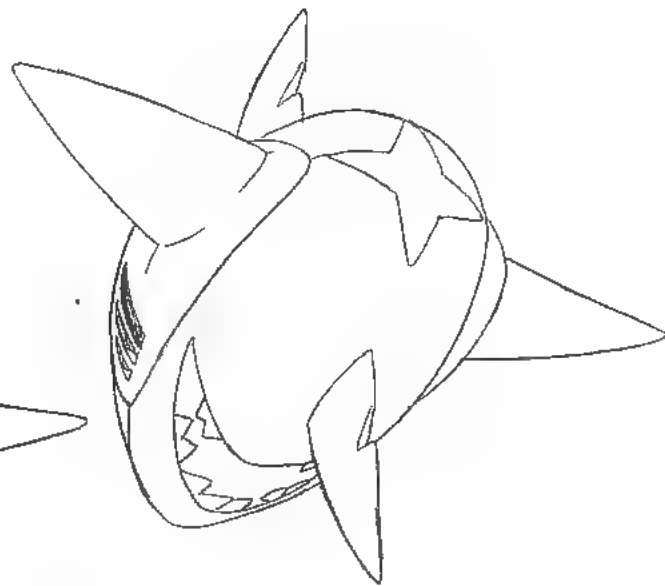
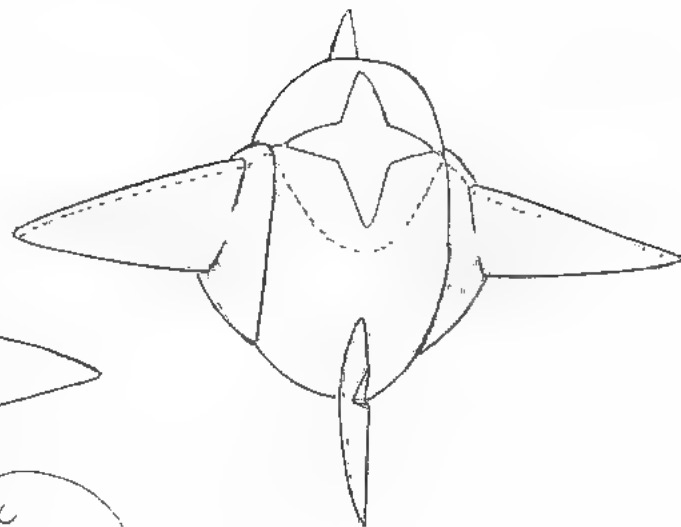

アドバンス
サメハダ

2002. 6. 20.

決定稿

2002. 6. 21 OK

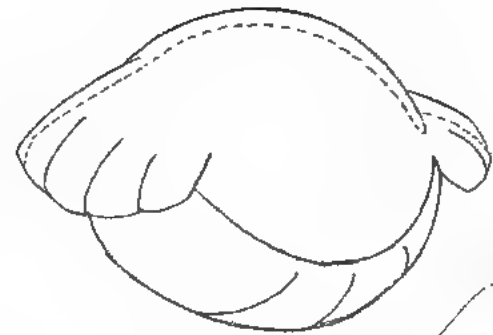
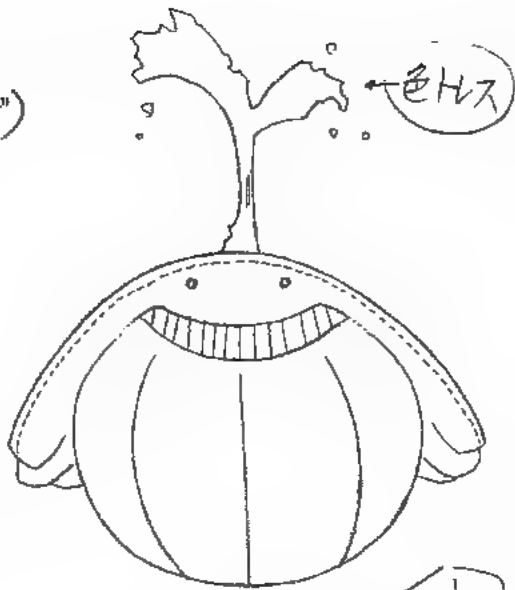
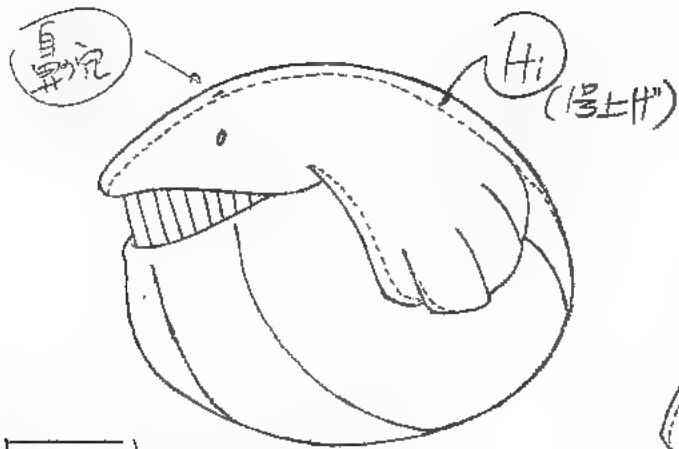

アキロ

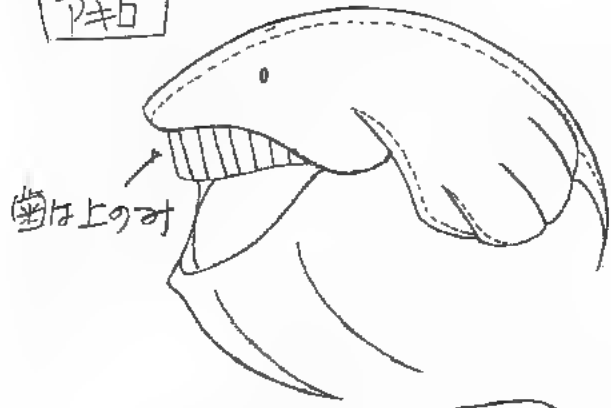

鼻(潮吹き)の穴です

ホエ
?

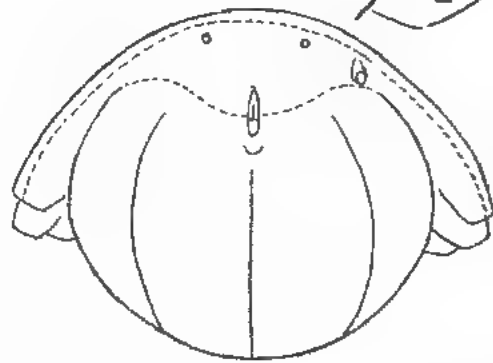

※基本的に目は閉じたまわ

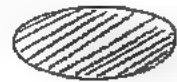
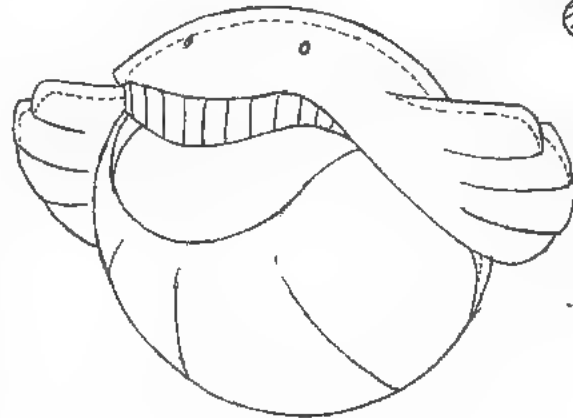
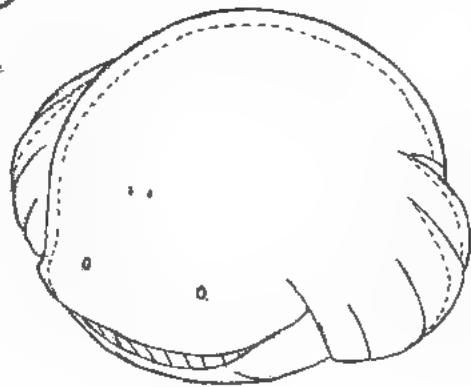
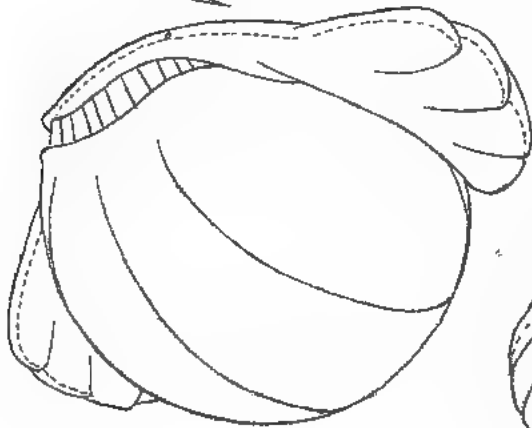
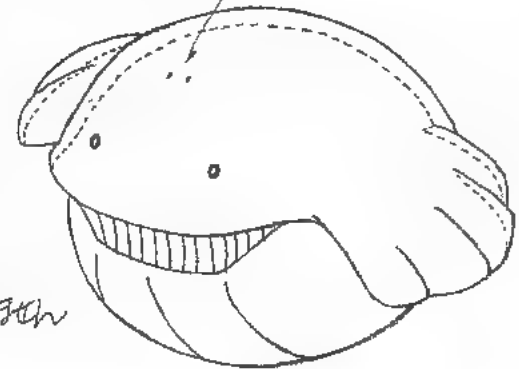

ホエルコ

(改)

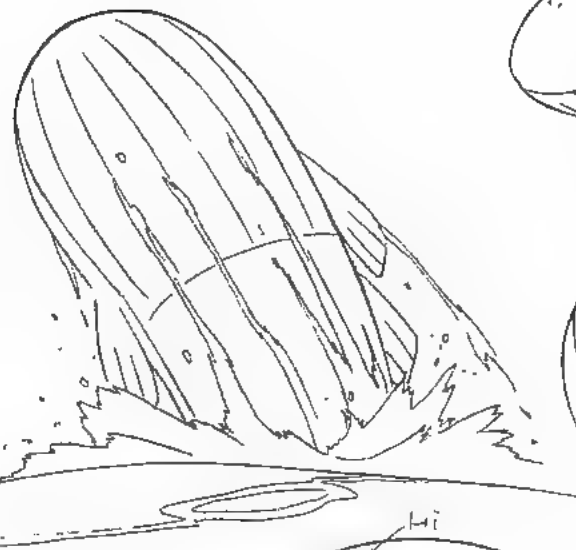
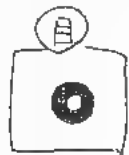
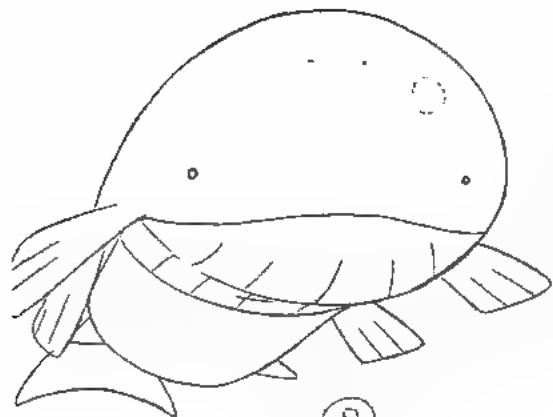

鼻の穴

もろは、前から後ろに行くほど目が小さくなる。

"ヒゲ"は上アゴのみ。
質感は歯ほど硬くはない

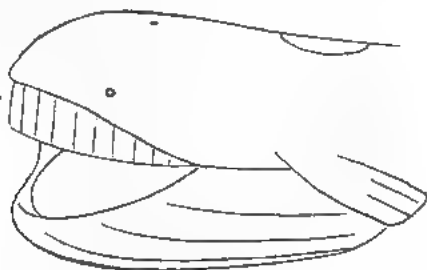

フラット

ヒ

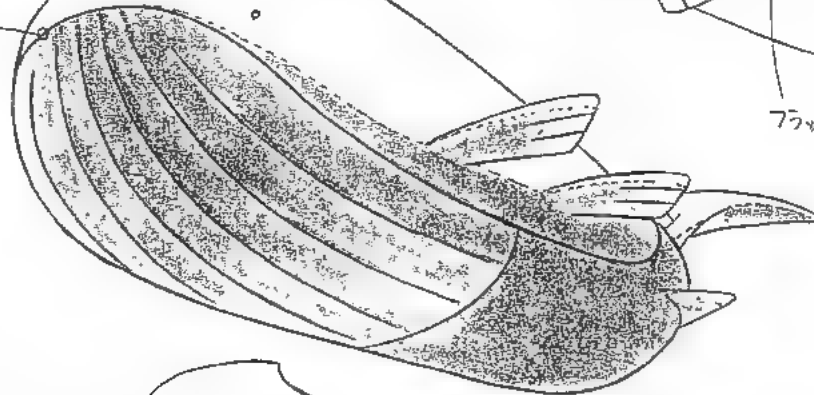

フラット

コペパン体型。

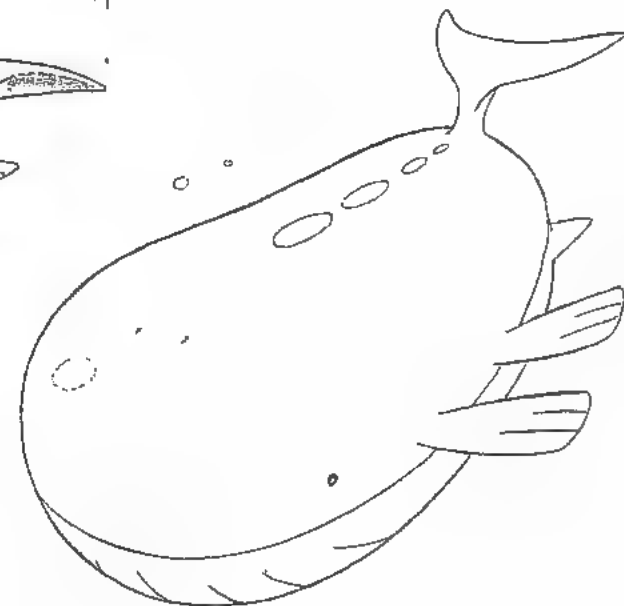
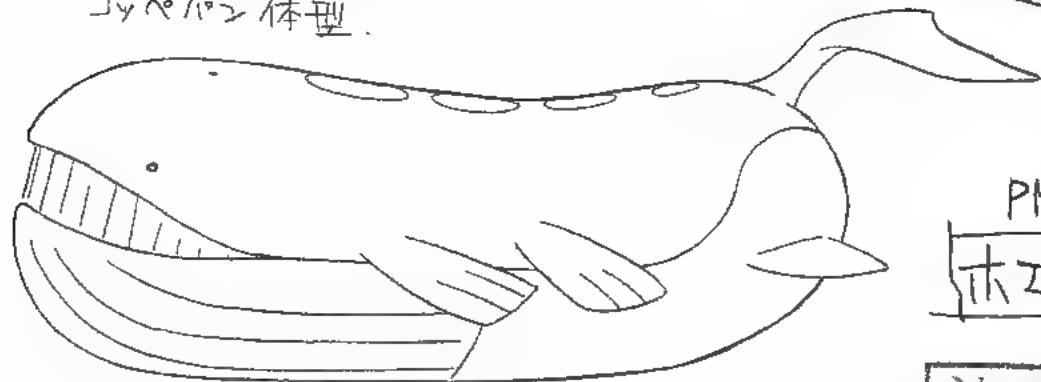

PMAG

木エルオ

2002.12.07

決定稿

2002.12.13 05

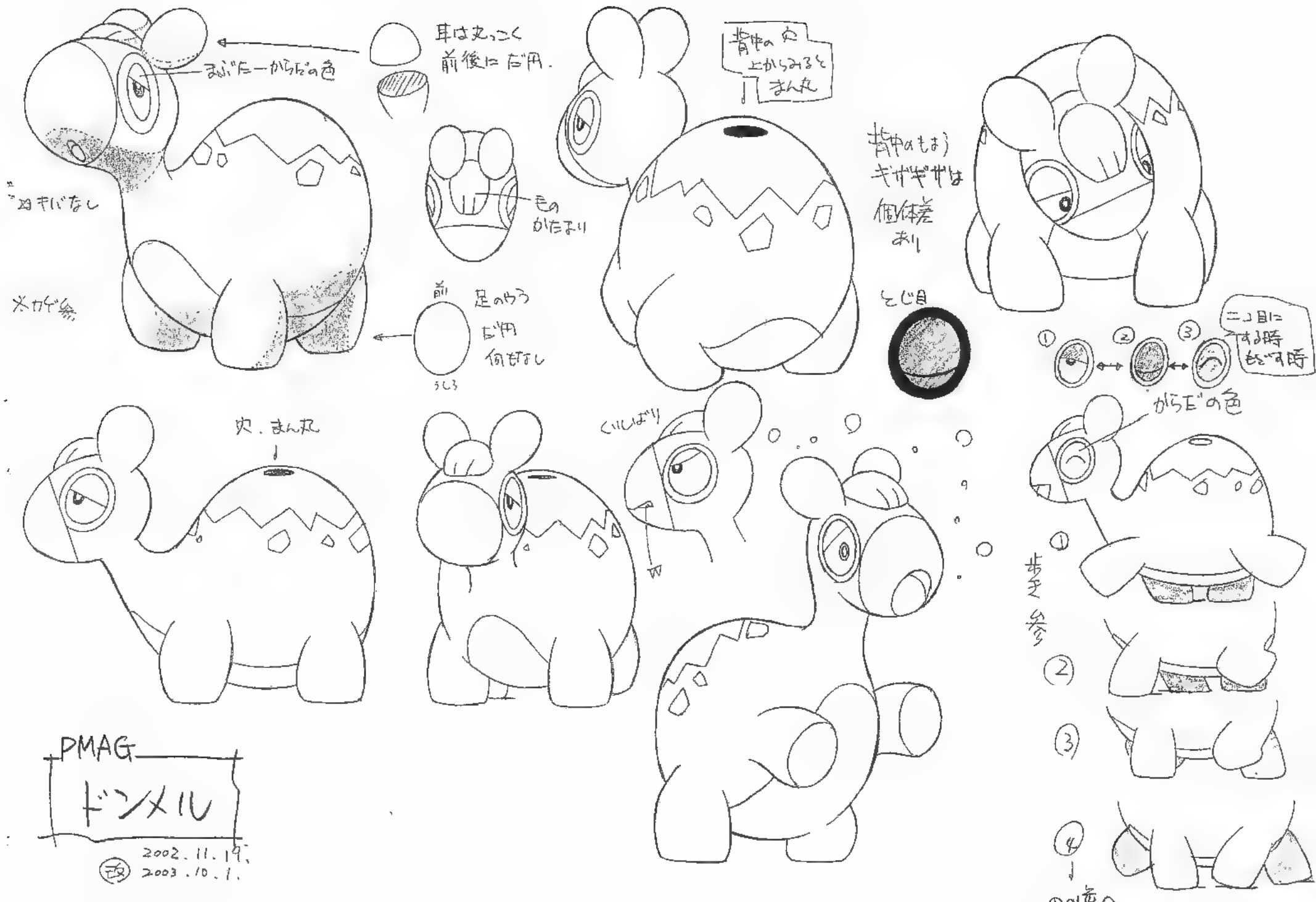

※キバなし
※が糸

背中の丸
上からみると
まん丸

背中の丸
ギザギザは
個体差
あり

とじ目

二目には
目がある時
とある時

穴・まん丸

くちばり

からEの色

背中の丸

④
↓
man丸

PMAG
ドンキル

2002.11.19.
2003.10.1.

断面図

コアを上げると

内はほほま丸
外周は多角形
角数は
個体差有

まいたしー
あっぽた



PMAG
ハクータ

決定稿

2002.11.20

2002.11.25 OK

2003.01.22 改正



まいた(目)は丸く出ていてこの状態で目が開いていて(夕ヶと同じ)

夕ヶ色下.P

鼻の穴は子丸

断面

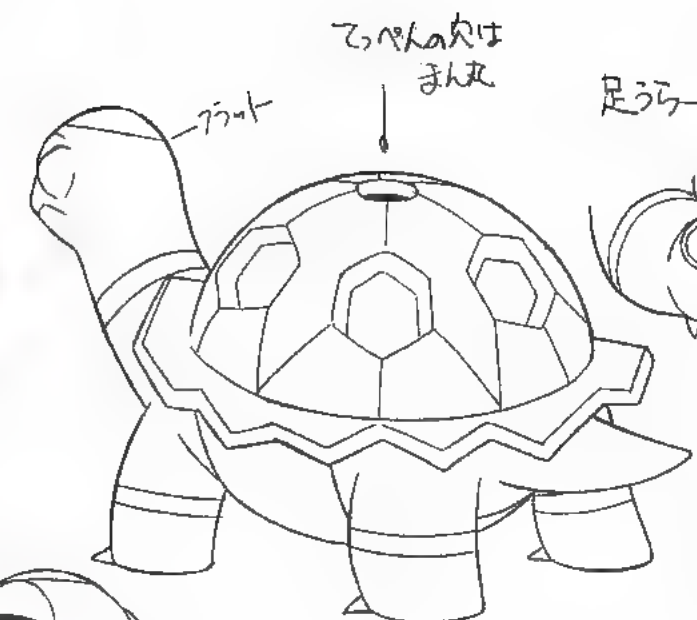

乙ペカは子丸

足子丸

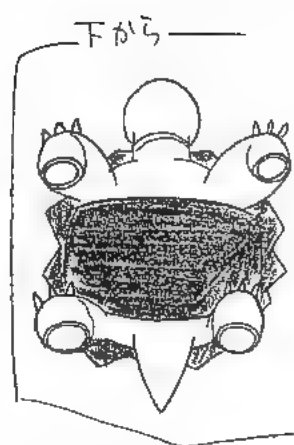

下から

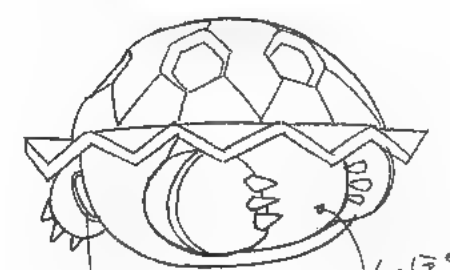
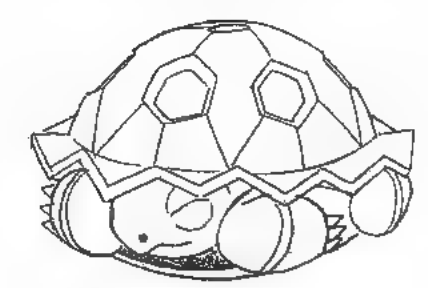
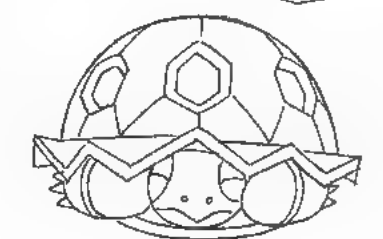

夕ヶは子丸

歯なし

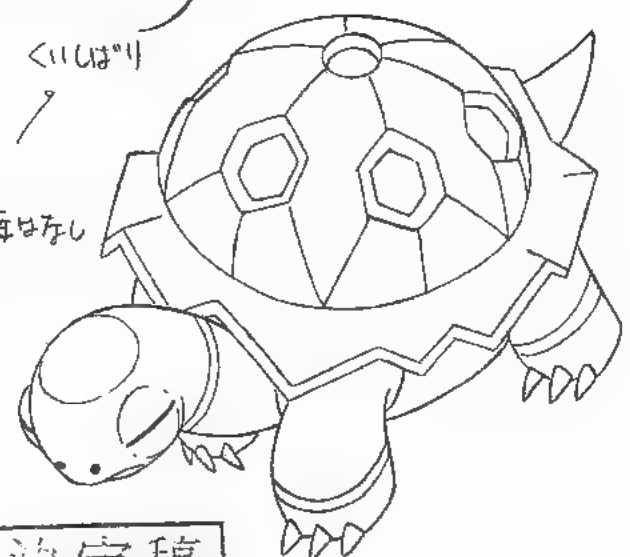

PMAG

コ-97

2002.11.26

決定稿

2002.12.10 OK

子丸の歯

子丸の歯



Hi色TP
←真珠
乗せている右“け”
くっついているわけじゃない

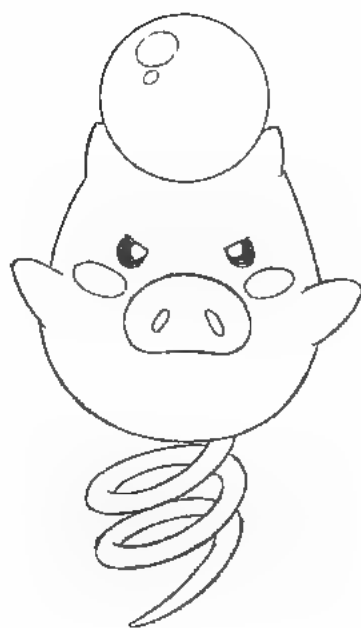
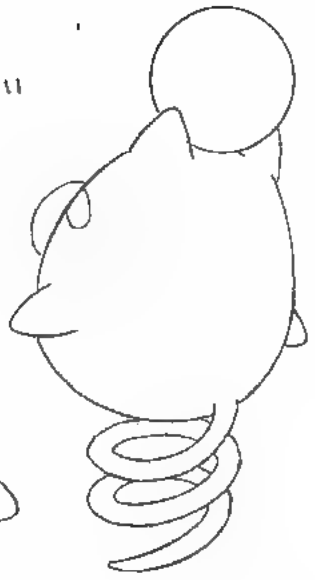

目UP時



丸っこい

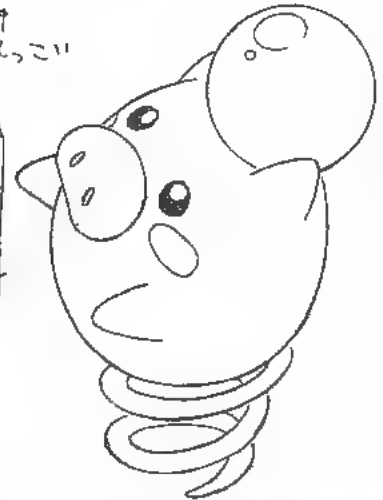

口はなし

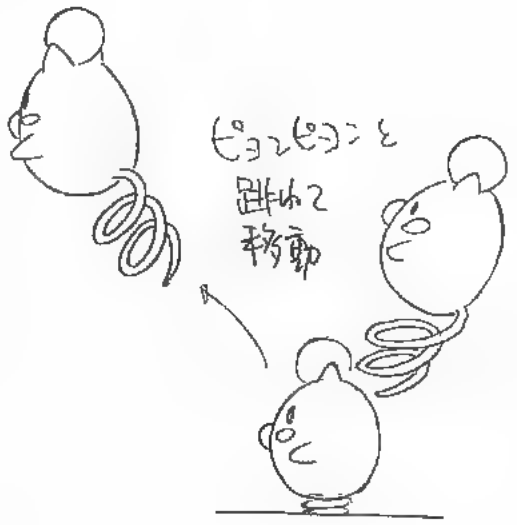

ピョッピョッと
跳び移る

PHAG

バネブー

2003.1.24.

決定稿

2003.01.30 OK

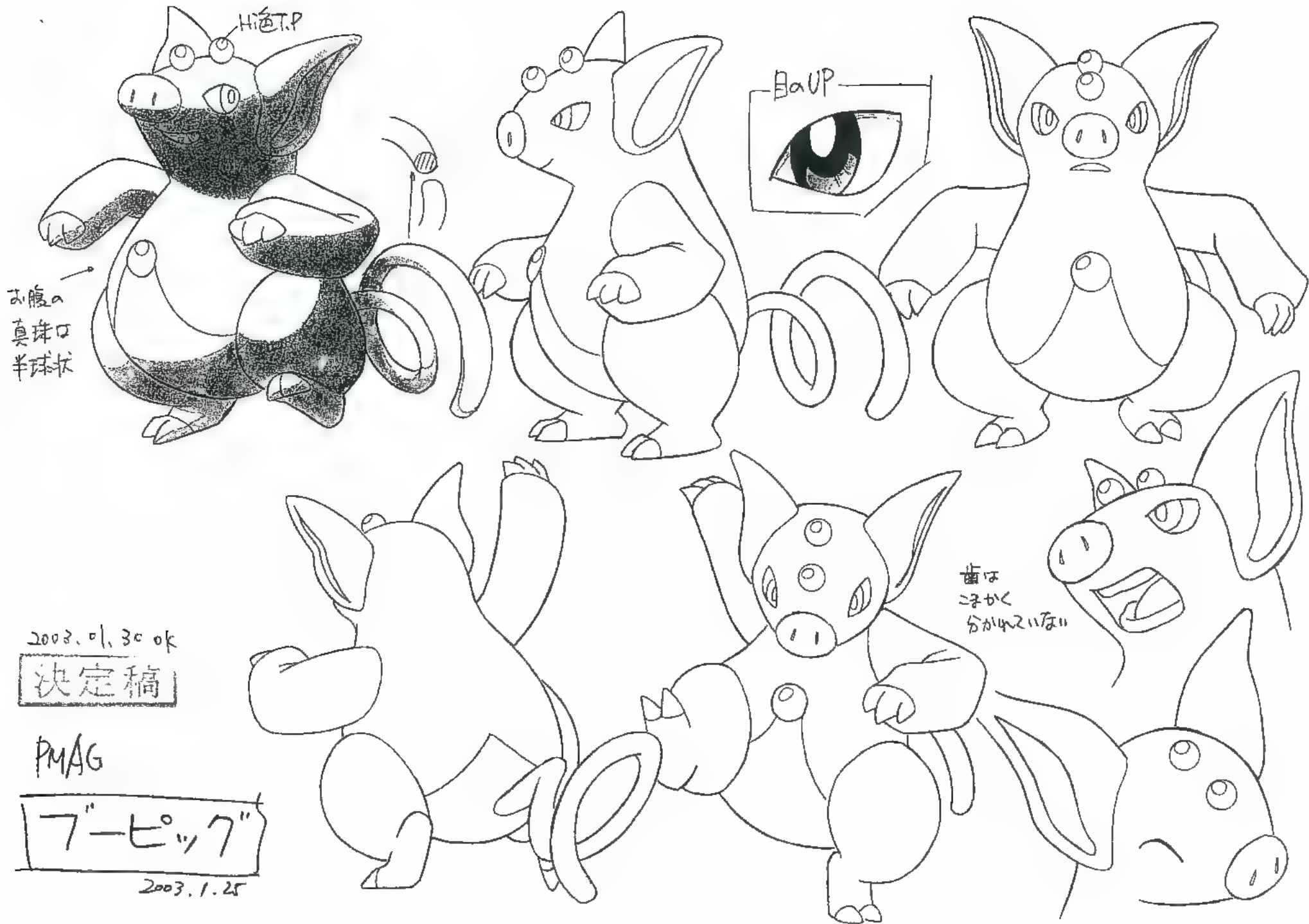

HiE.T.P

目UP

お腹の
真珠口
半球状

歯は
こかく
分かんないな

2003.01.30 OK

決定稿

PMAG

7"ーピッ7"

2003.1.25



パチお
色T.P

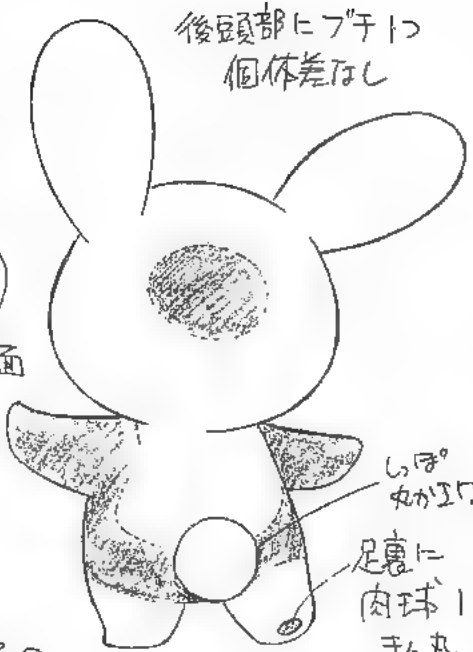

後頭部にパチ1つ
個体差なし

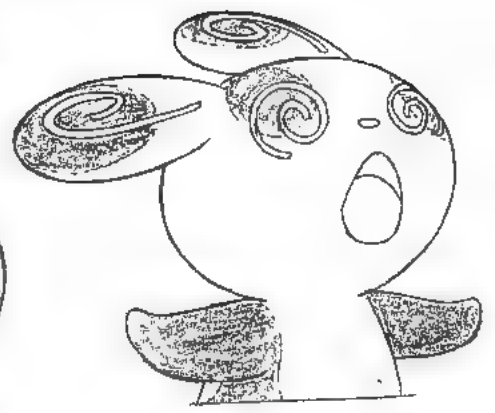
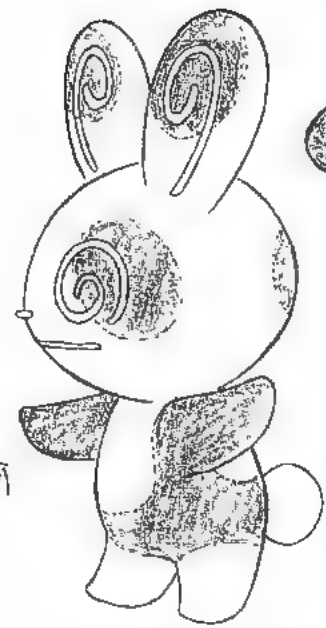

しほ
丸かまぼこ
足裏に
肉球1こ
まん丸



笑い顔?

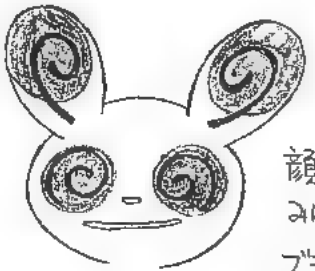
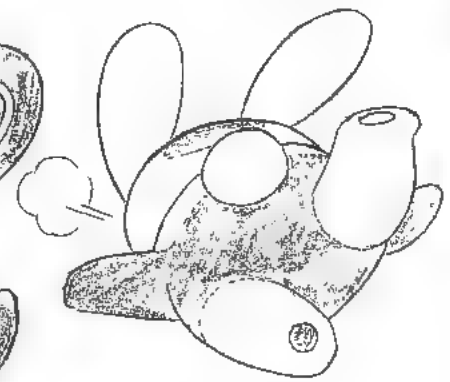

顔のパチ模様は
みんな位置が違う

パチの形は
基本的に丸型
首から下の模様と
後頭部は個体差なし



PMAG

パチー11

2003.1.16.

決定稿

2003.01.22日

Hi色T.P

上アゴ
少し
出ている

とこが口
のつら

目

首

基本
3K #TS.

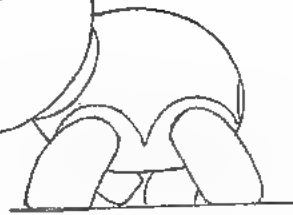
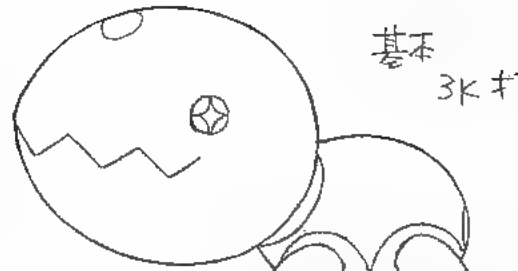
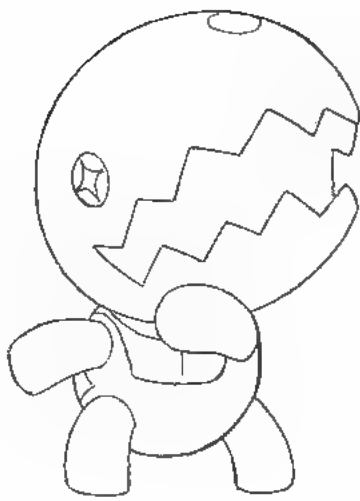
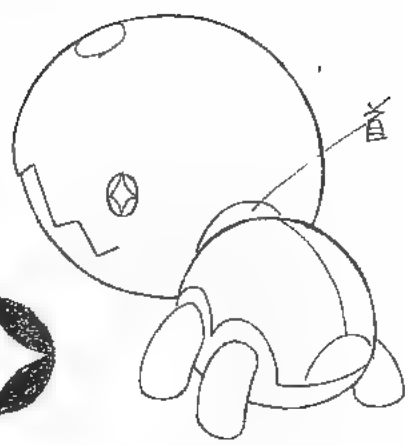

中4の
歩

★がら石のまわり 4K #TS

自由ゆい石が
丸く出ている

★口のギザギザは
上アゴ6つ
下 5つ

基本的にトロい。

アライゴク

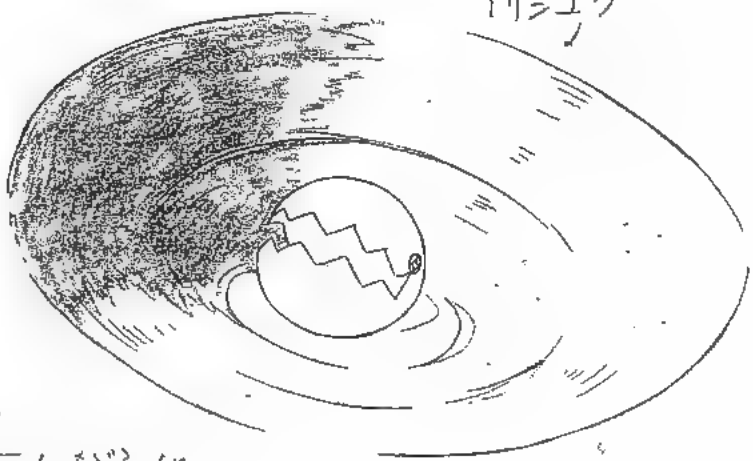
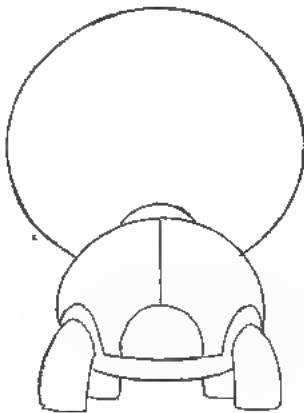
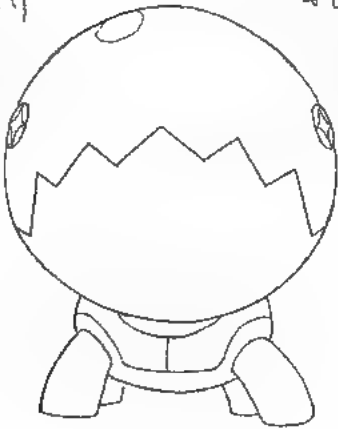

アタマが重い
ひっくり返ると元にもどるのか
大変。

PMAG

チャクラー

2003.1.28.

決定稿

2003.01.30 付

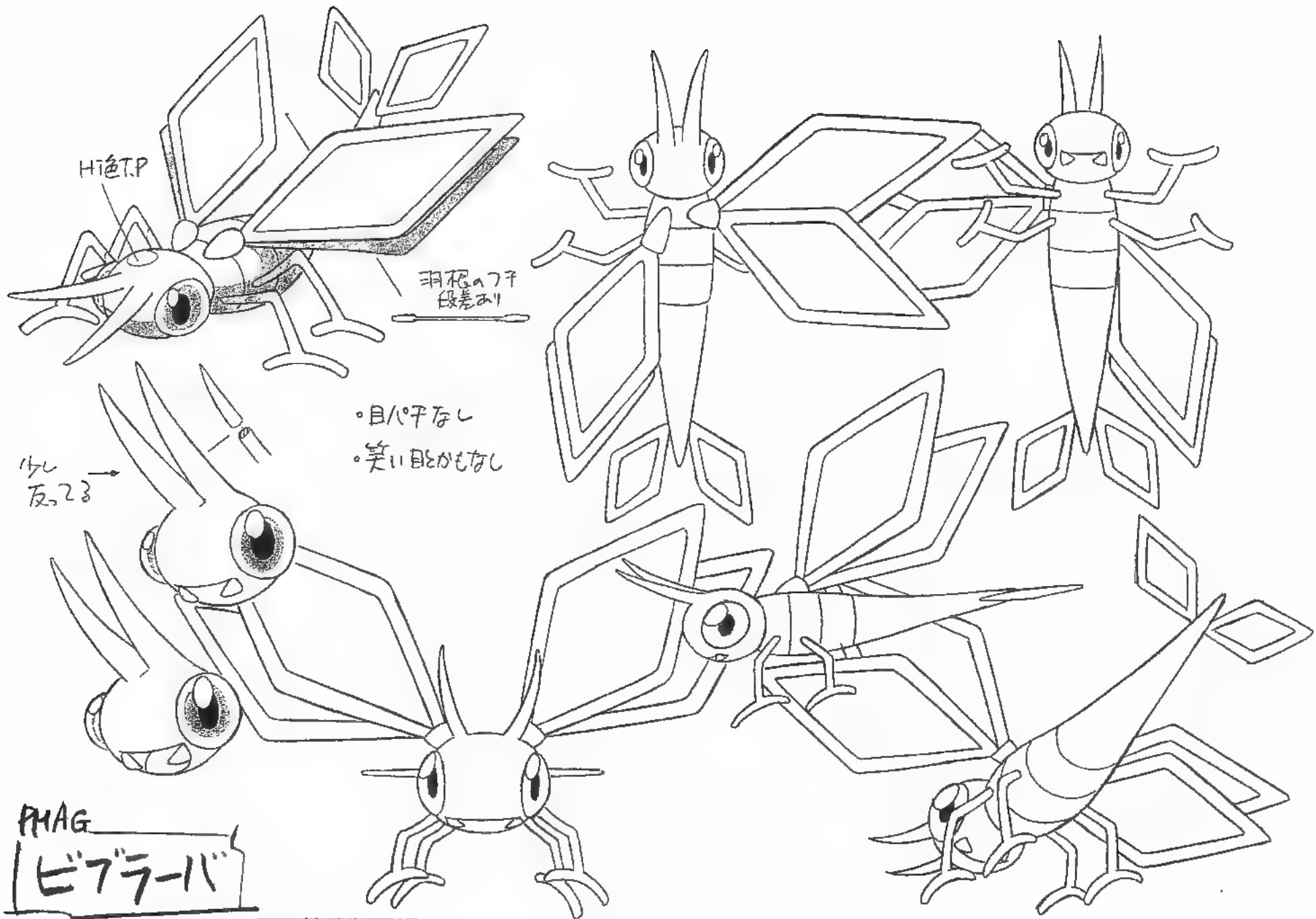

H1色.P

羽根の7千
段差あり

- 目ハ平なし
- 笑い目とかもなし

4L
反23

PMAG
ビブラーバ

2003.1.26.

決定稿 2003.02.03 OK

「フライゴニ」

④ 色トス

② 断面

フが段高い

③ 注
ライン入り

♀顔のラインあり

♀上は半球状
パーツが乗る

断面はだ円形

尻尾の模様4つ

腹側

背側

④

③

目のUP時

決定稿

2002.11.25 of

横位置になる
感じ

♀キバは上アゴに2本

足裏は表と同じ

フライゴニ ①

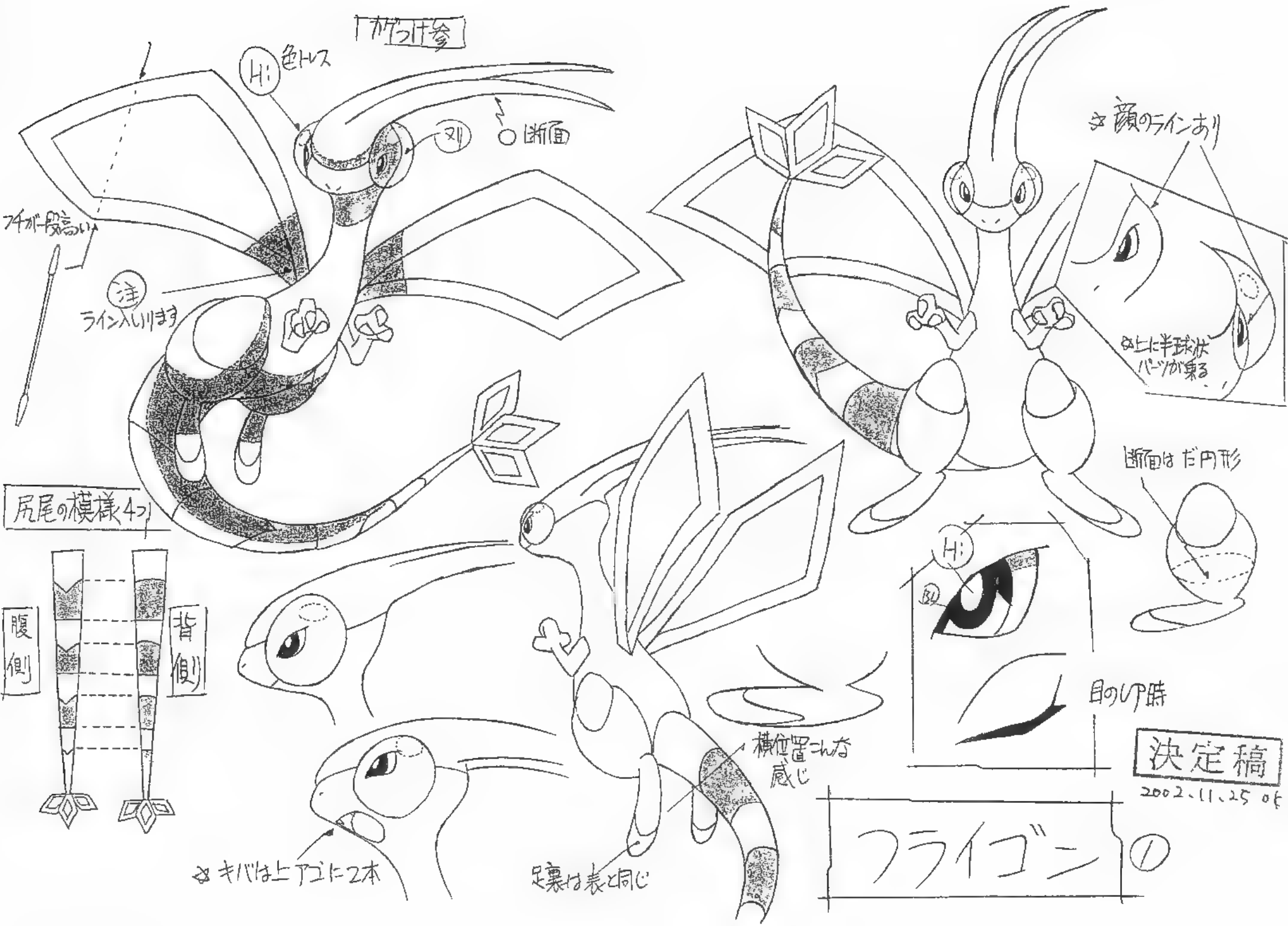



☆羽バタキは
 11ガードンのように
 時々大きく
 羽バタキするパターンで

☆半球状パーツの
 奥のラインは
 忘れず
 (11アリア
 考えたい)

決定稿

フライゴン ② 2002.11.25 of



☆分析

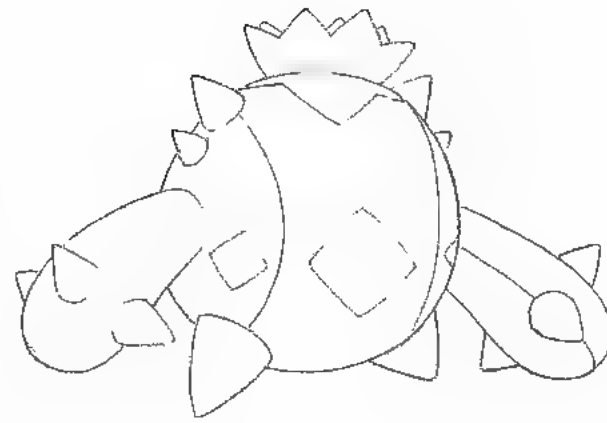

目の黒い部分の
色は黒い
色は黒い



・目はまん丸
ハイライトあり



・瞳の色は
まっ黒にしたい
真ん中の線の色はトランス

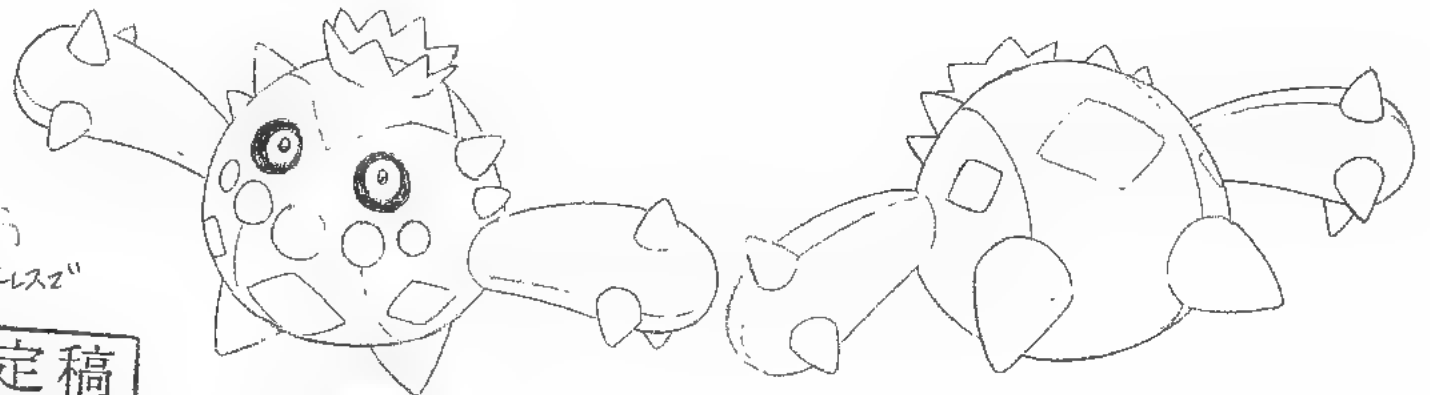

サボネ

決定稿

2002.08.21
2003.02.20 改正

2002. 8. 19

・口は平常時は、丸いおまんこ丸いおまんこ
表情による変化する
舌やギバはない

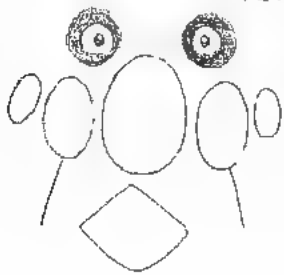

上から見た花



前

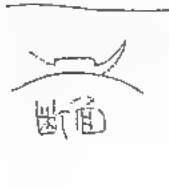

断面



上から見た花の下の模様

笑いかた

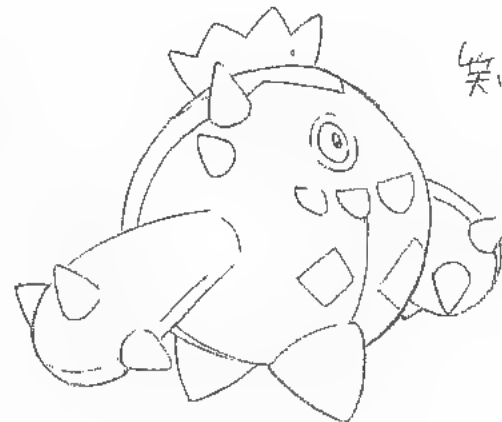

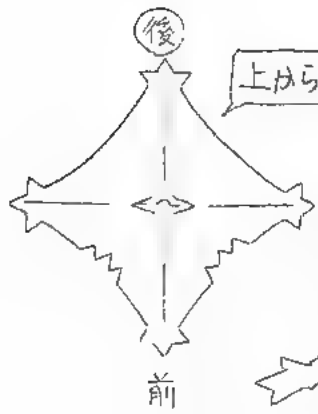

上から見ると頭

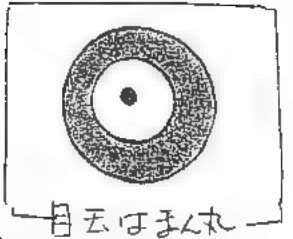

目玉はまん丸

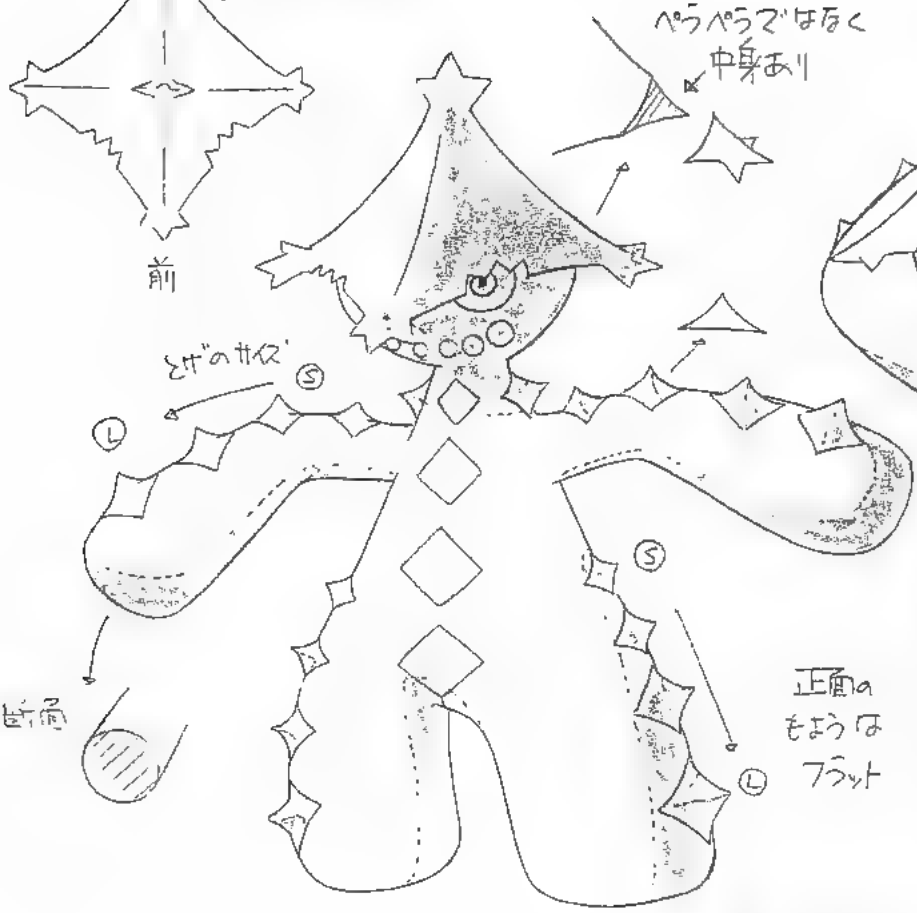

ぱらぱらアはるく
中身あり

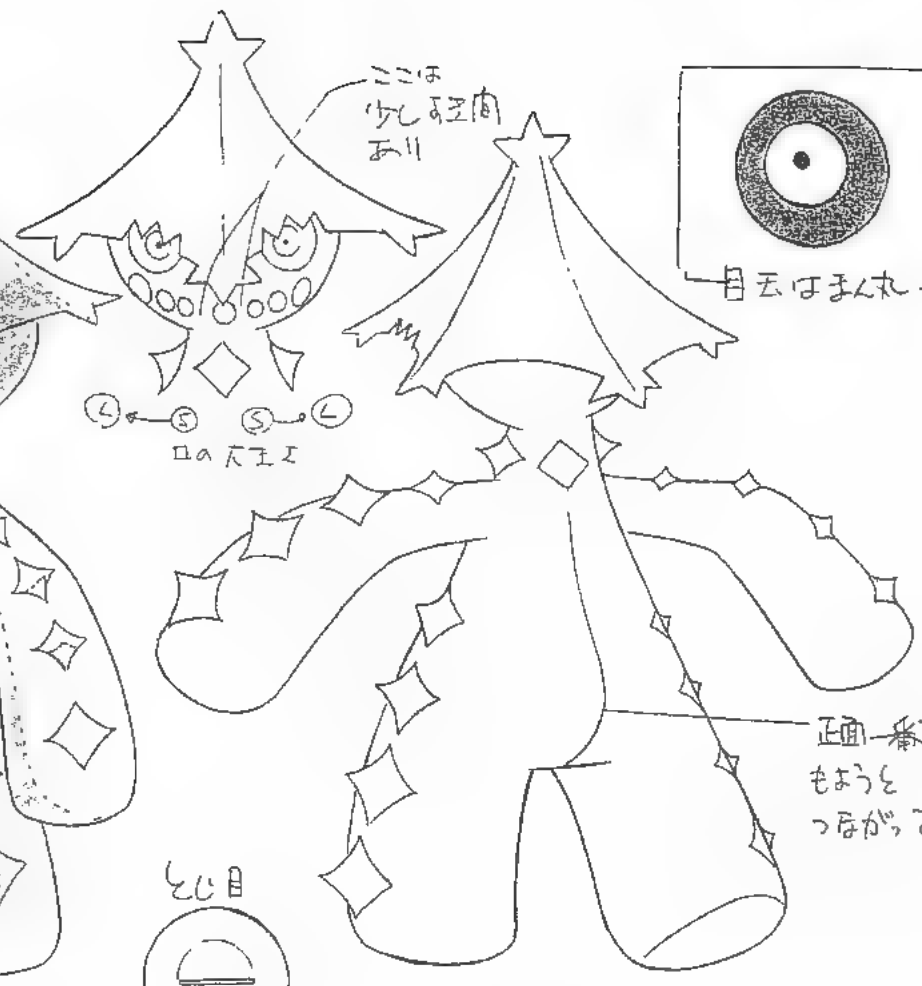

ここは
少し軽肉
あり

と目

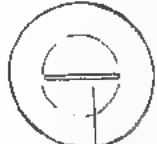

色T.P

断面

正面の
まほうは
フット

正面一番下の
まほうと
つながっている

怒った時の目



笑いカオ

サボ字性
同じ

PMAG

ノクダス

2003.1.7

決定

2003.01.15 of

目は丸く出ていて、
周りの黒い部分と口は
凹んでいる

目は気持ちよく
少し出ている

UP時

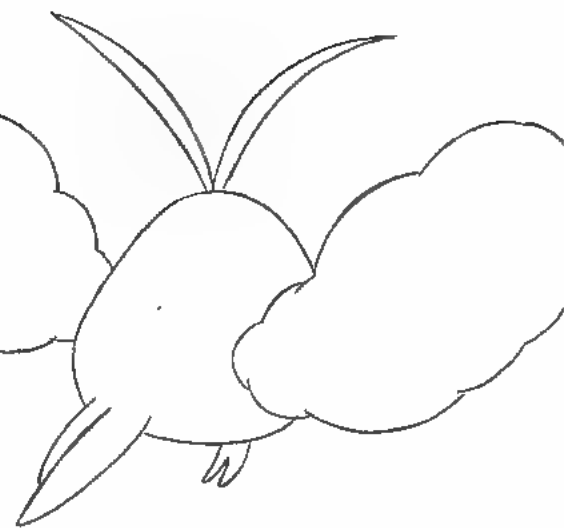
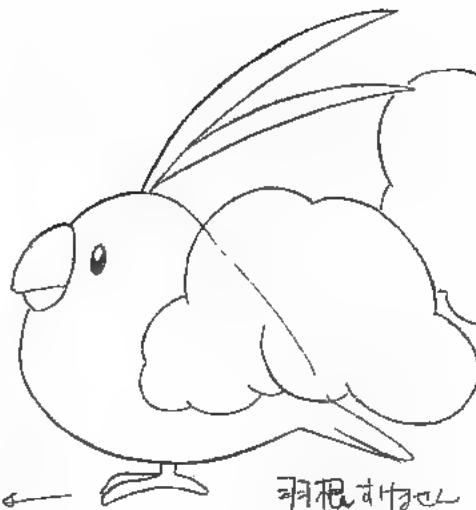
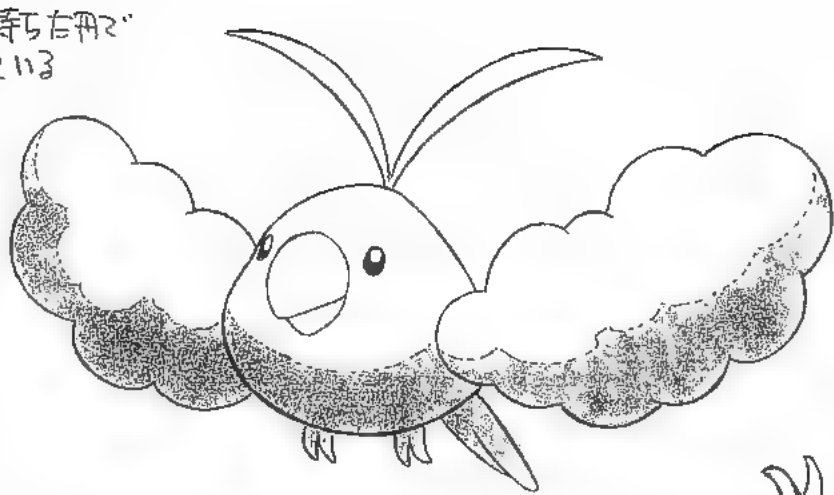

羽根の付け
念のため



顔の
別紙

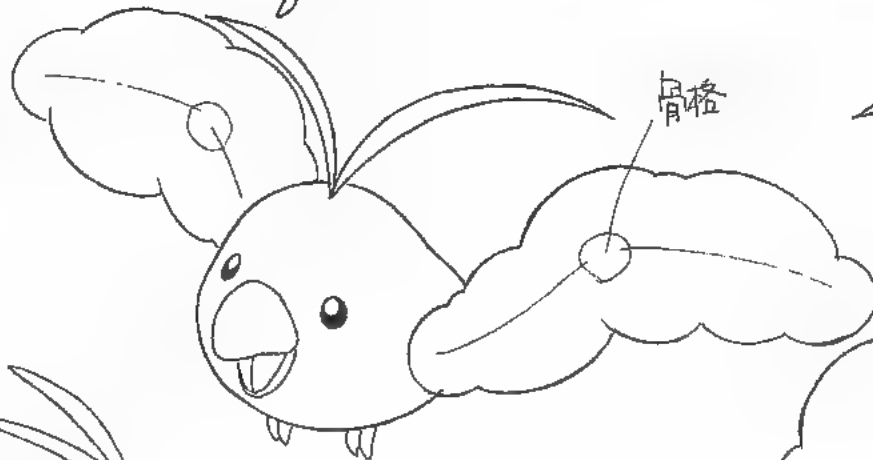

骨格



PMAG

フィルット

2003.1.26.

決定稿

2003.02.03 OK

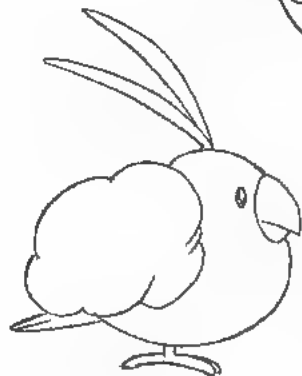

心づいて羽根を貼った
ε=3.

決心稿

2002.11.25 ok

十羽のけい

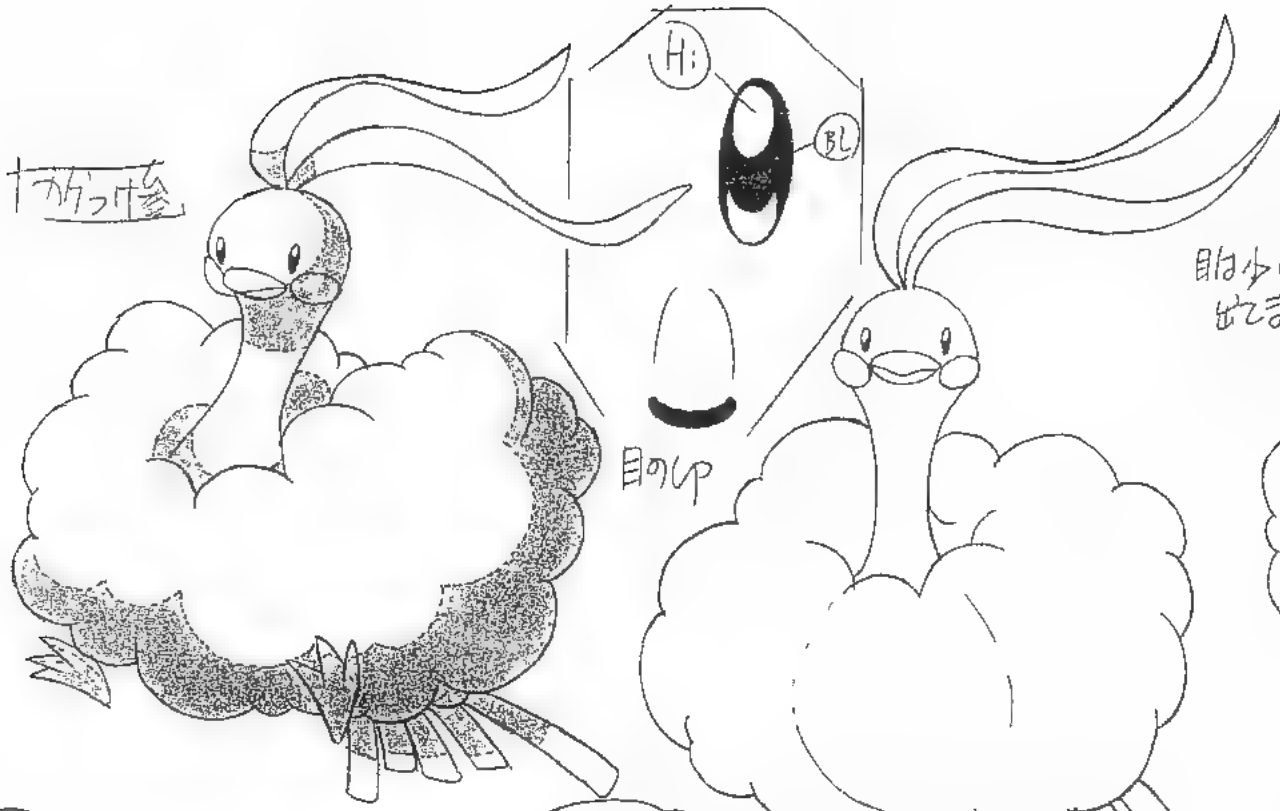

目は少し
出します

綿状の羽

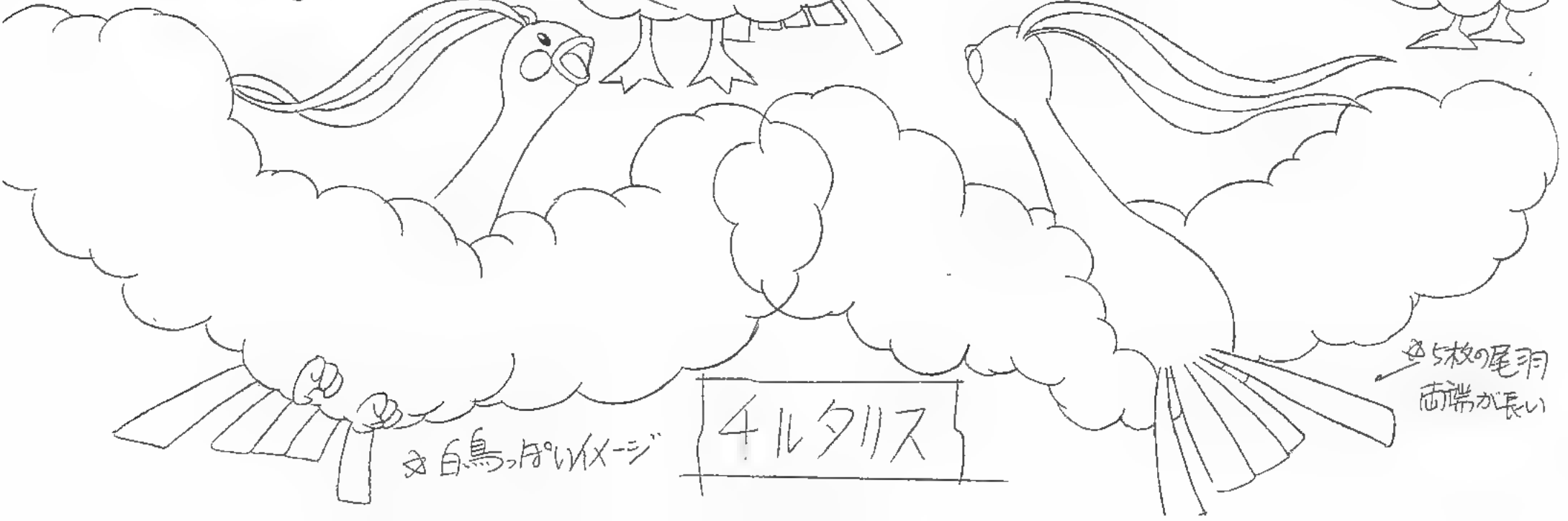

白鳥のイメージ

5枚の尾羽
両端が長い

決定稿

2002.11.25 06



耳先は
2裂

断面

肩の毛

肉球

11 X
2本

親指

尻尾の
先端は
3つに分かれます

肩の毛

真中が一番長い

肉球

足の裏に付く肉球

目の74のライン
太い

目のUP時

ザンダース ①

通常は四つ足です

決定稿

2002.11.25 OK

※四つ足バージョン

ザングース

(2)

※前足の先は毛(丸) 後ろ足の先はツメ(尖)

※四つ足の時はツメ
右EWでます

※キバは
上下2本ずつ



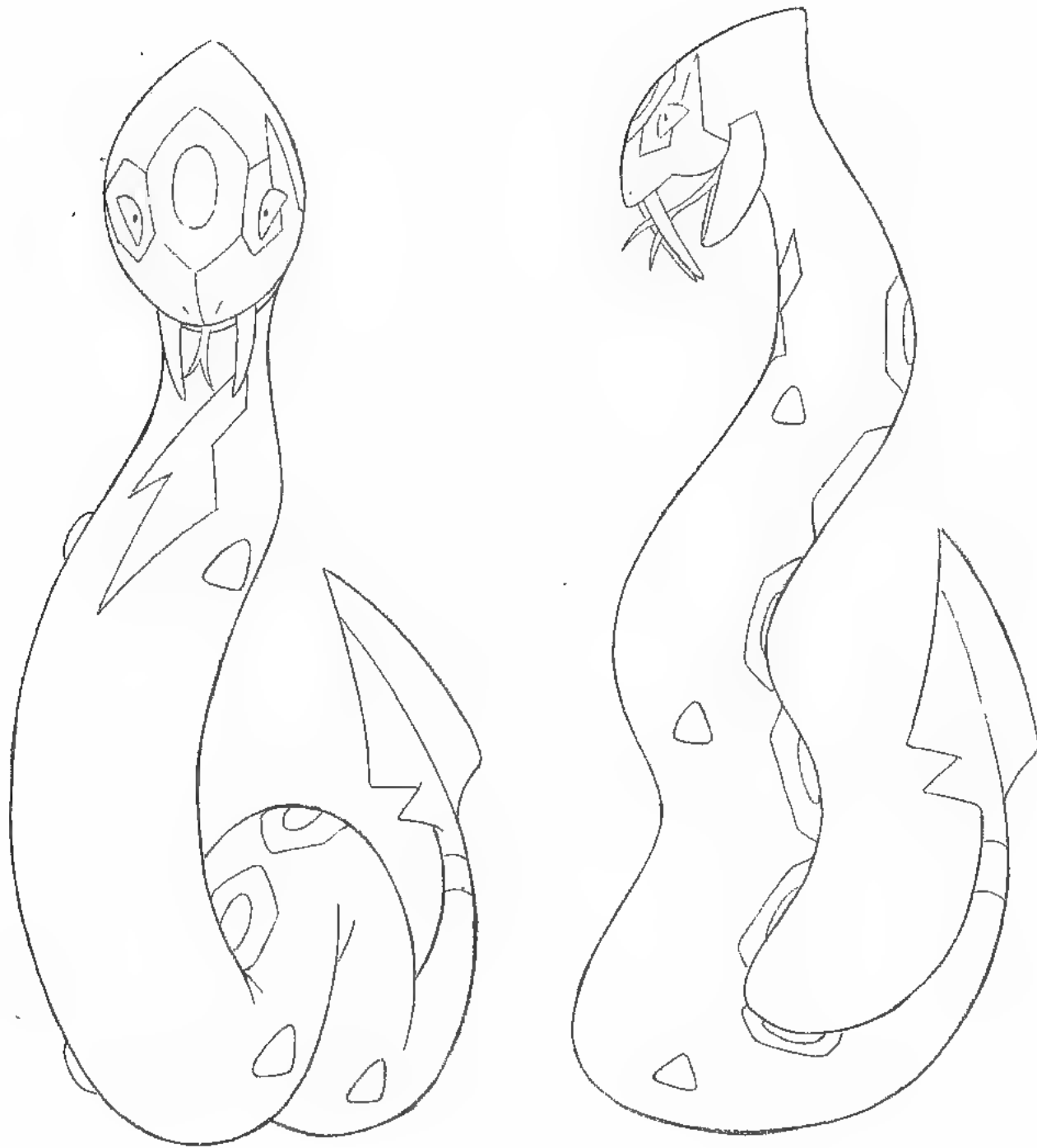

ハブネーク②
鎌首も石がたどこ

2002.8.20

決定稿

2002.08.21

ハブネク 大口おけ作時の
口の中の処理

2003. 1. 22.

決定稿

2003. 01. 22 OK



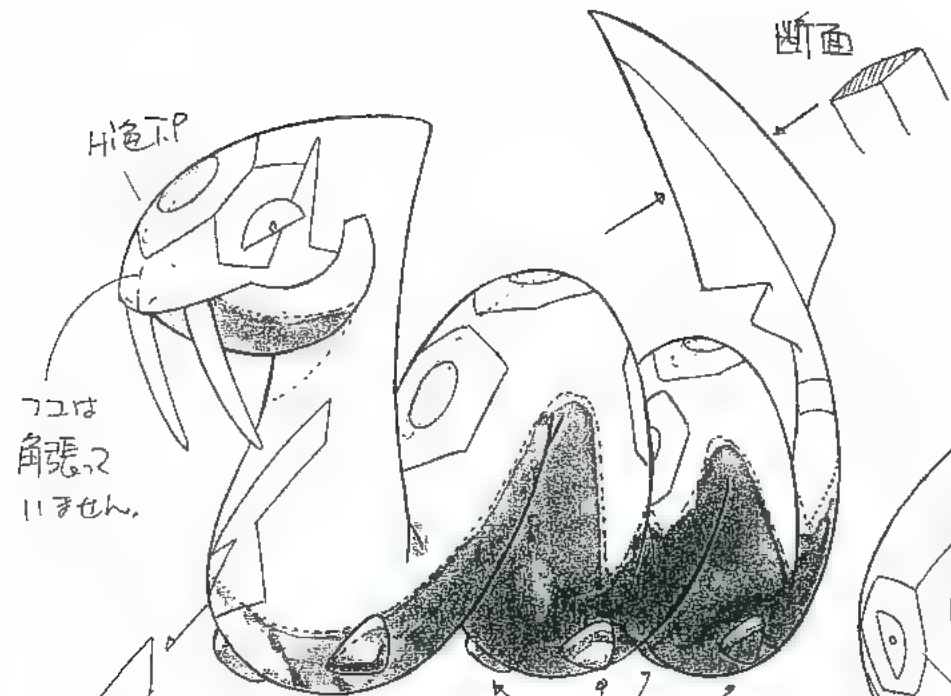

Hi色.P

フコは
角張る
11センチ

キバの先は
丸い

下アゴキバなし

少しお張る
計6つ



アバ、たい
丸みあり
プレート状

舌はこの舌より
伸びることはない

X

ニヤウモの舌は
ありません

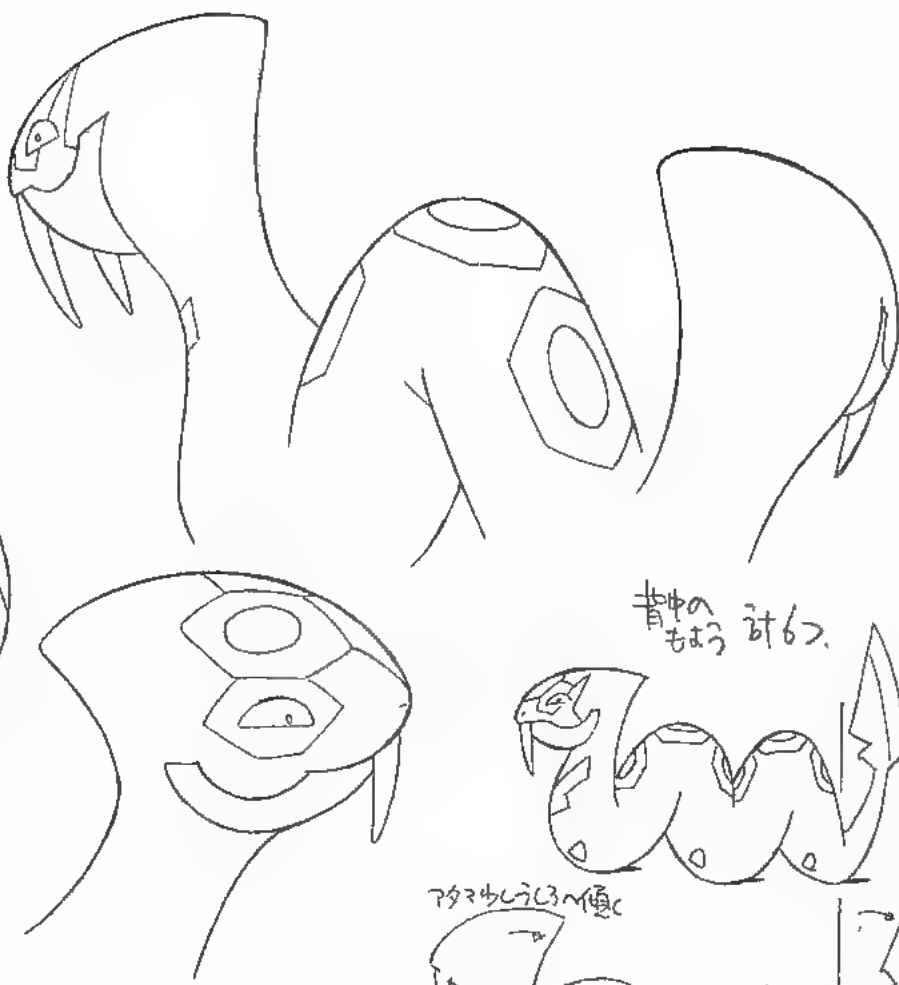
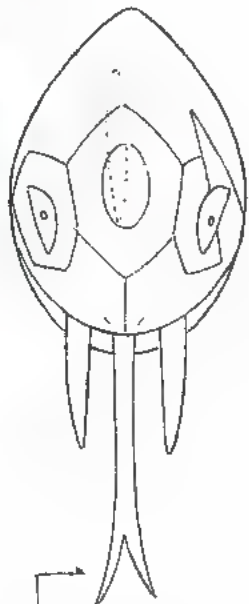

背中の
もろ計6つ

アバウシシノ腹

ココ基点に
連る

前の山はまた
まわりがわるい

アバウシ前

舌の先はココ基点にする

決定稿

117"ネーク①

2002. 8. 21

2003. 2. 07

4. 04

改正

2002. 8. 20

03. 4. 09.

改



UP時のみナゲ
 ほぼ黒なので
 小穴はナゲなし
 でOK??

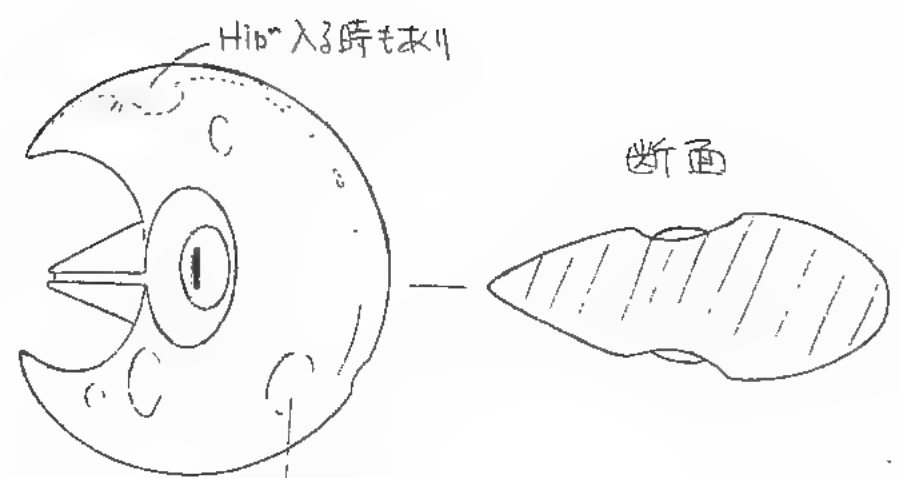

体の模様
 すべて丸で 左右対称
 片面に4つ、計8つ。
 表面は少し凹んでる

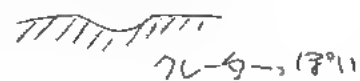

ま横

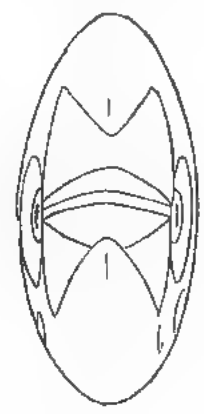
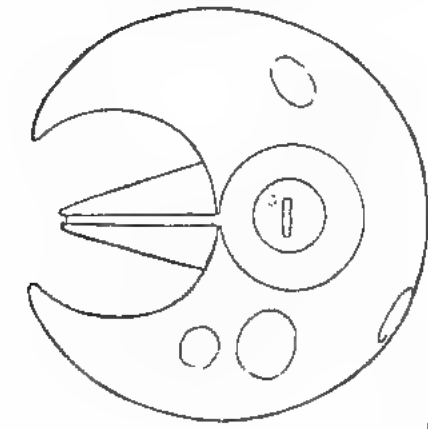

正面



真上

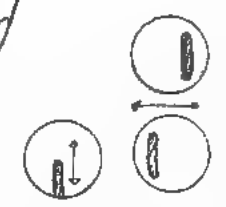

目云
 ハイライトあり
 動は可

決定稿

2002.11.25 OK

PMAG
 ルナトーン

2002.11.19.

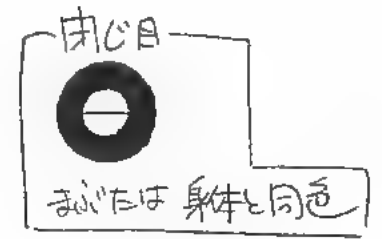

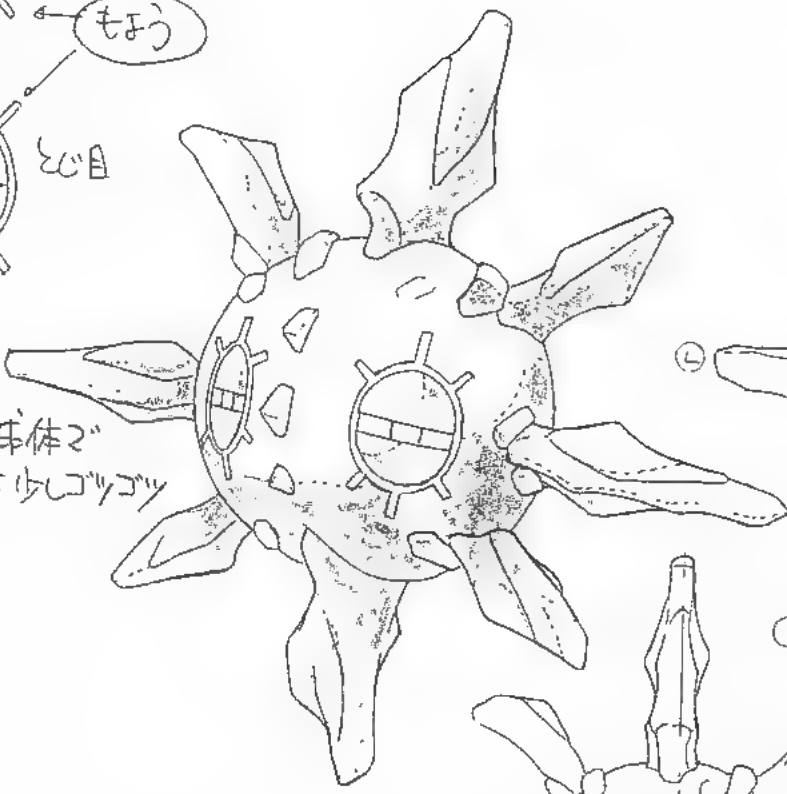
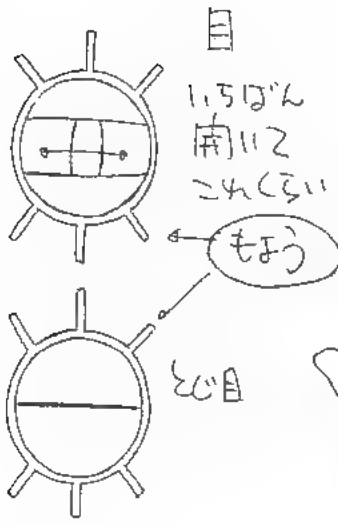

体は球体2"
表面は少シゴツゴツ

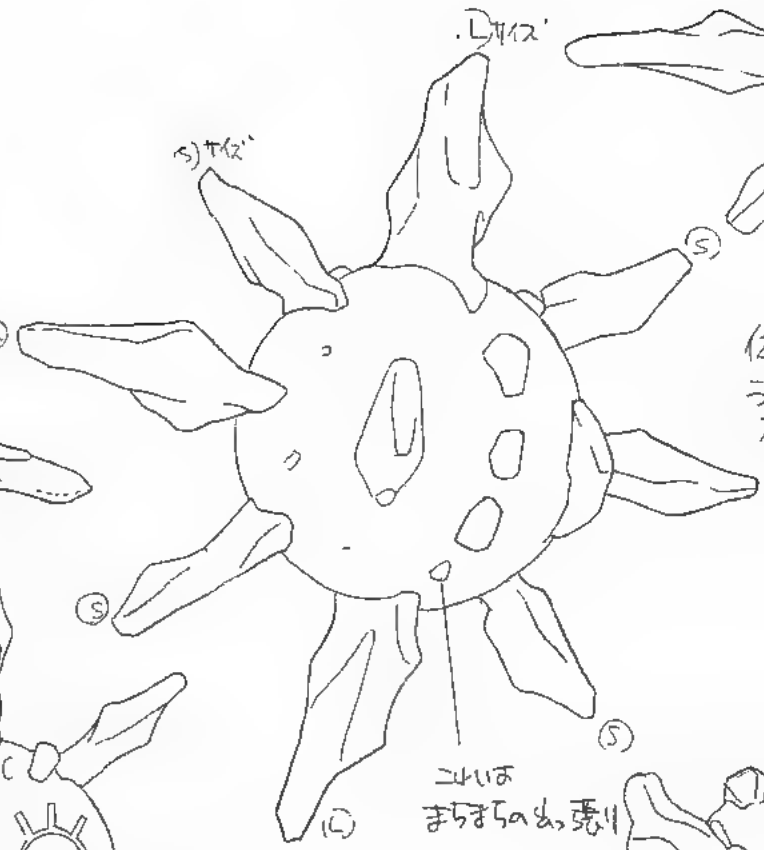

真上

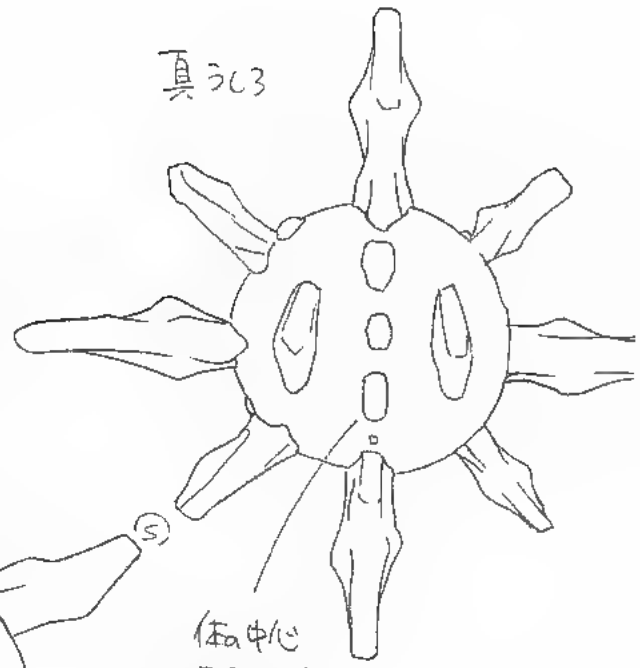

体中心
ライン上に
石3つ

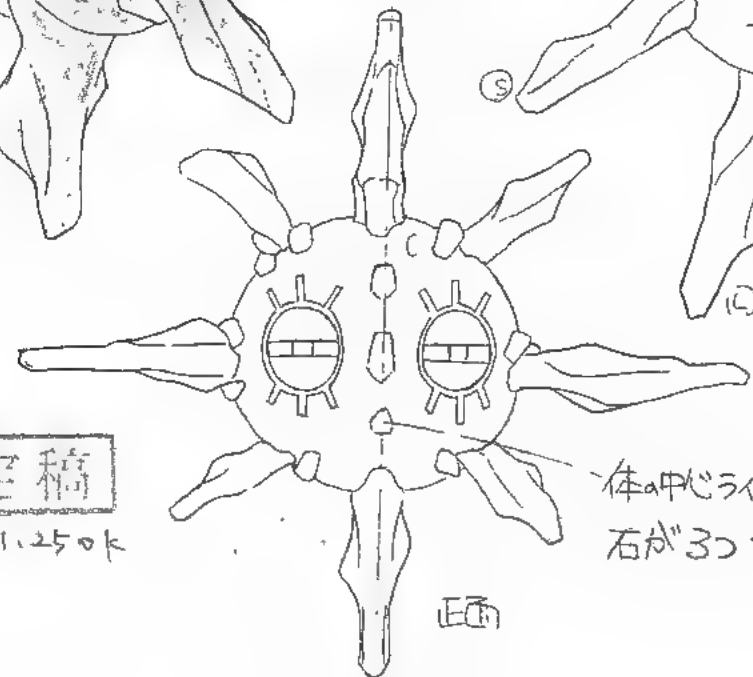

体中心ライン上に
石が3つついて

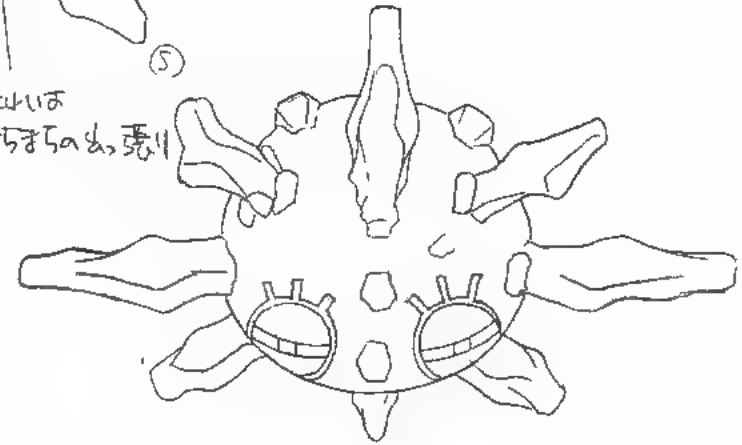

PMAG
ソルロック

2002.11.19.

決定稿

2002.11.25ok

正画

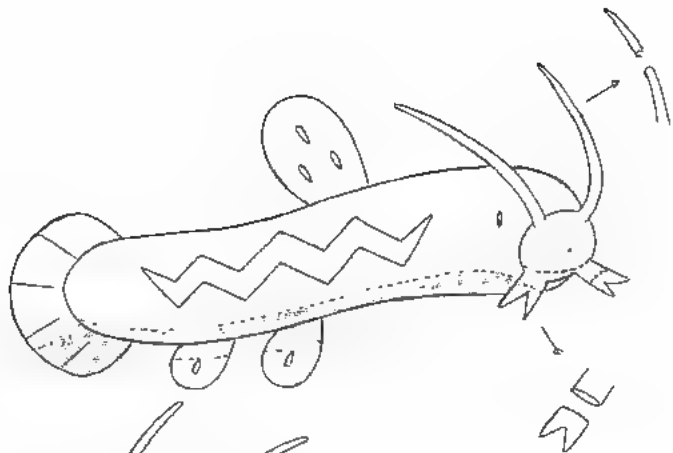

先は丸っこい

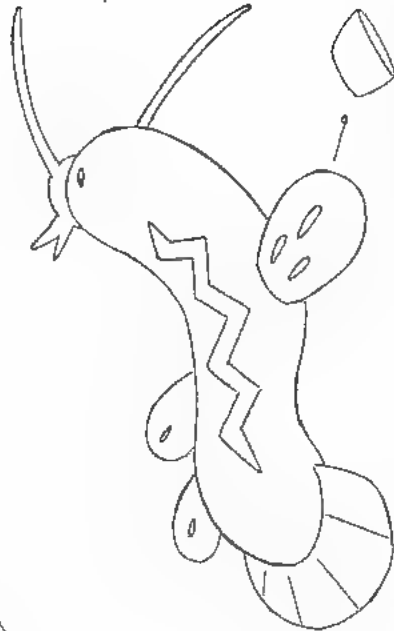

目のUP

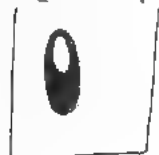

あはほ口

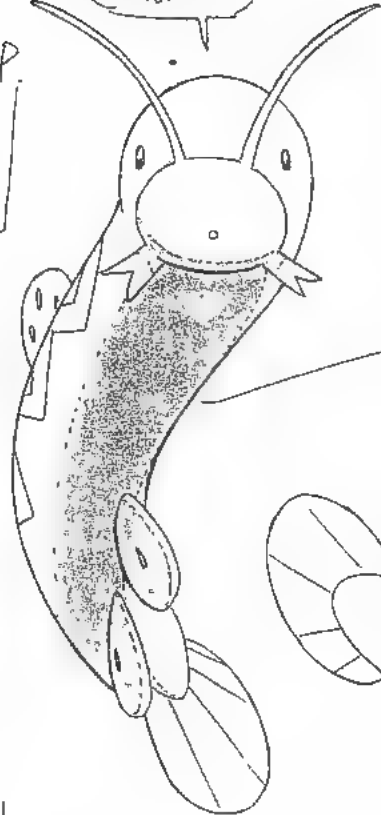

胴体の断面は丸

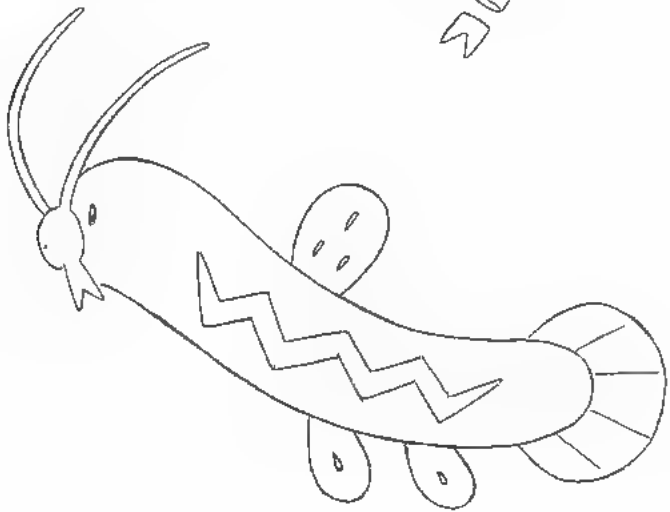

びっくり

一瞬だけこんな目



PMAG

ドジョウ

2003.1.7.

決定稿

2003 01.15ok

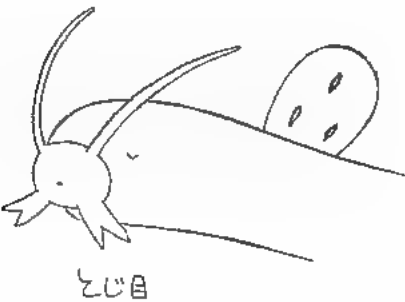

とび目

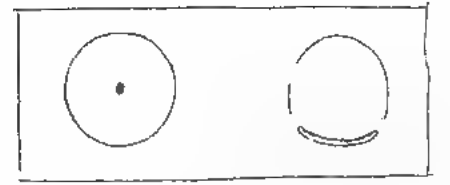
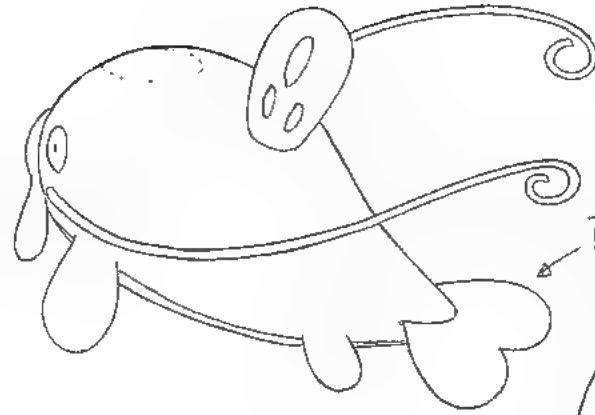
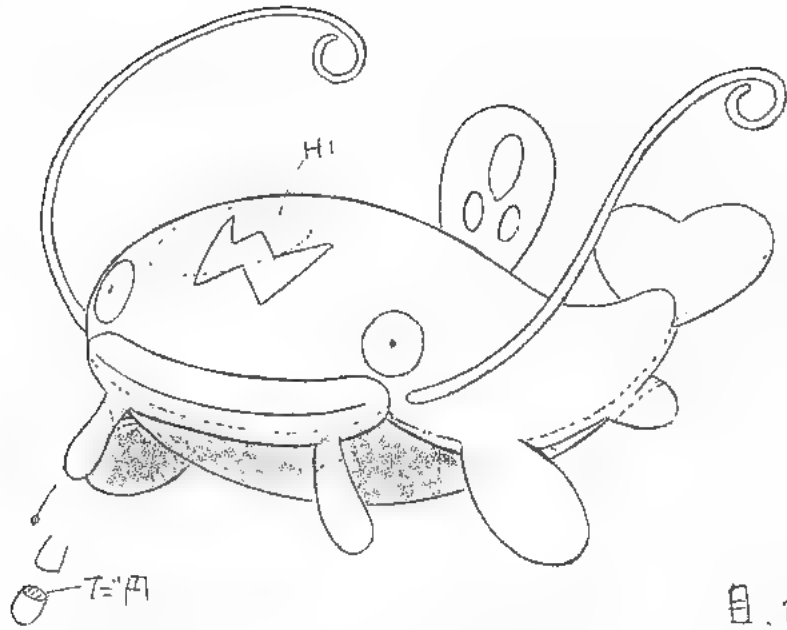

目、少し石目さみ

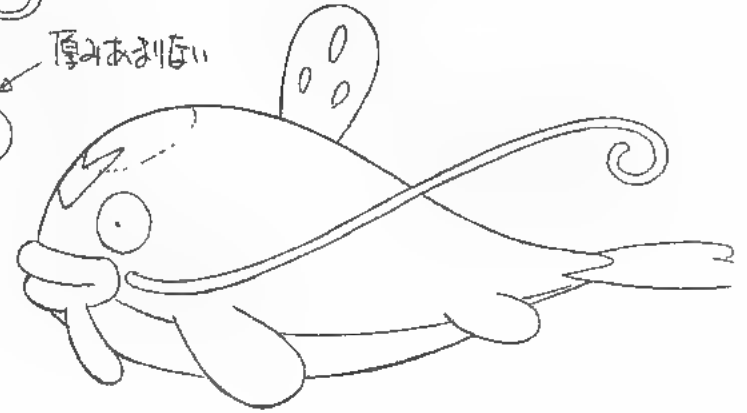

目、びみょーに
出てる

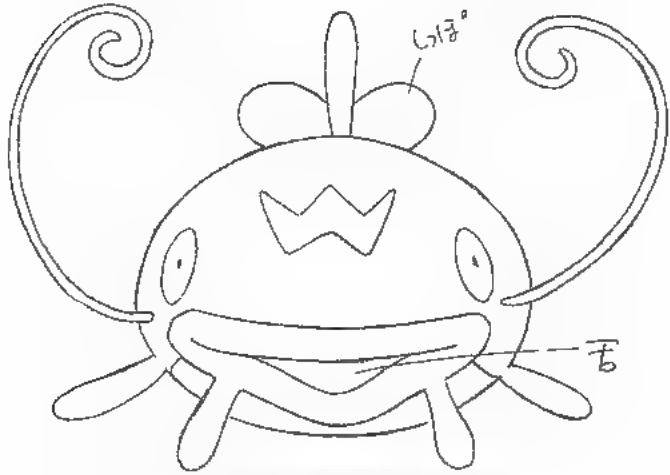
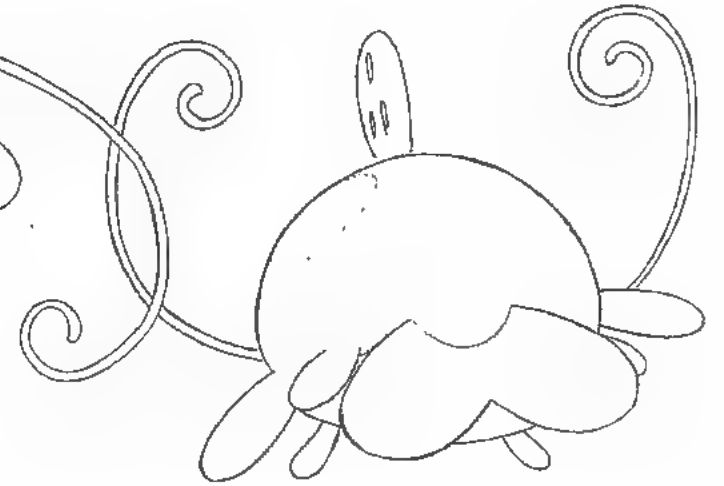
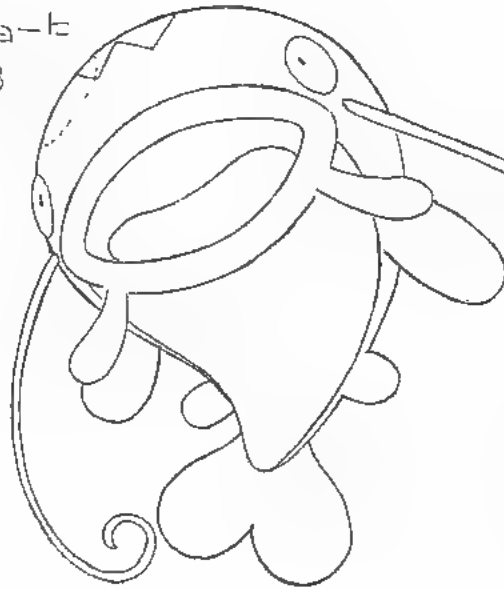

← PHAG →
ナマズン

決定稿

2003.01.22 ok

2003.1.8

☆ホコト白ヒ

「カゲオチ参」

(H) 2/3



3/27の断面

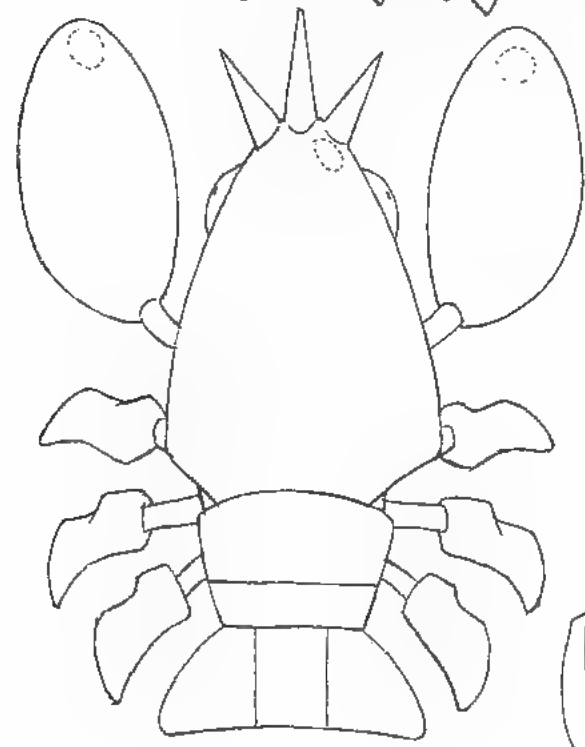

アキロ

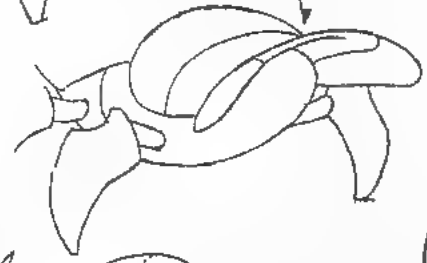
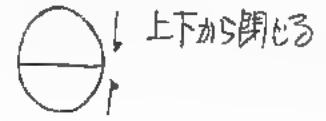

☆お籠のラレは4本

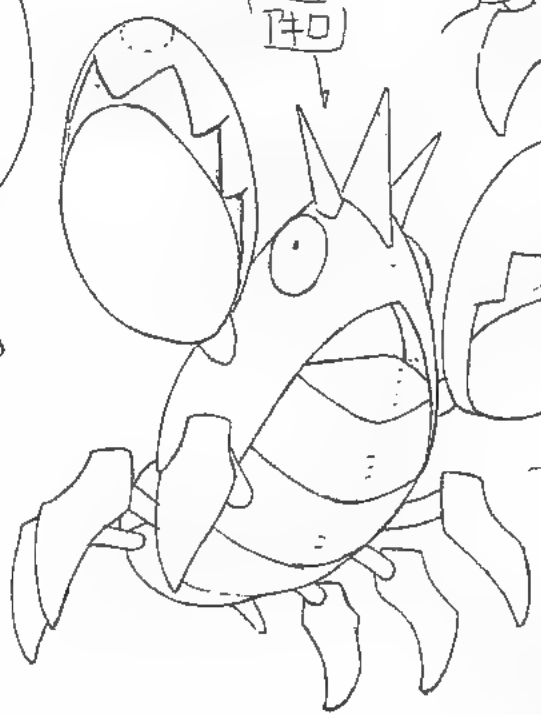

アキロ

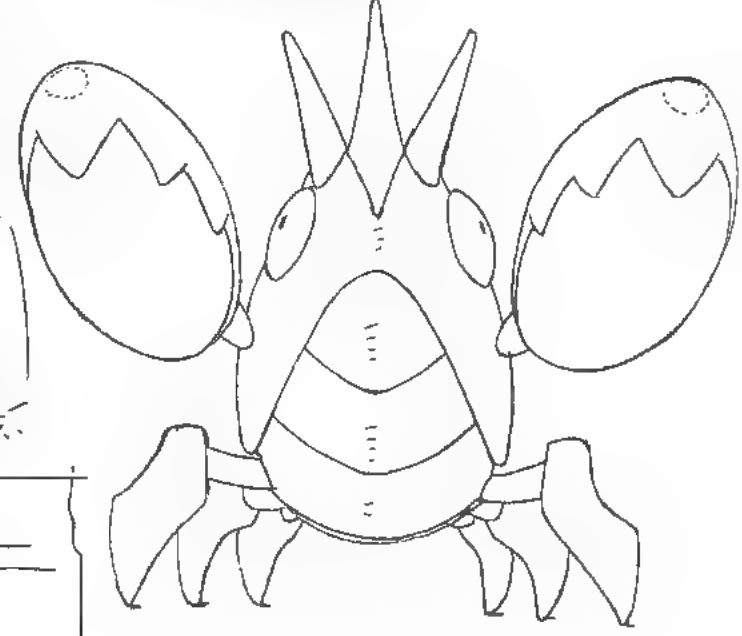

エイガニ

決定稿 2002.11.9 OK

△ハート

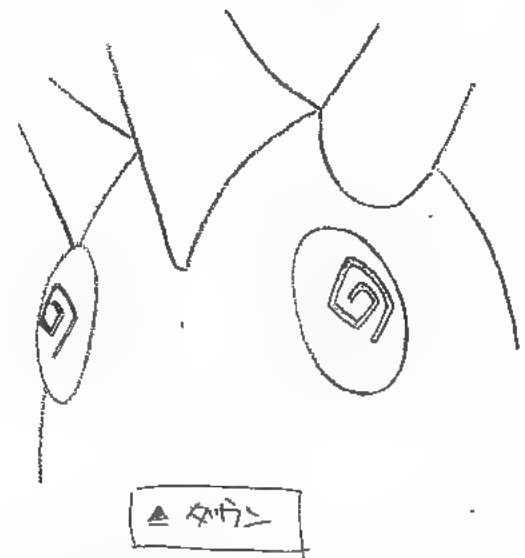
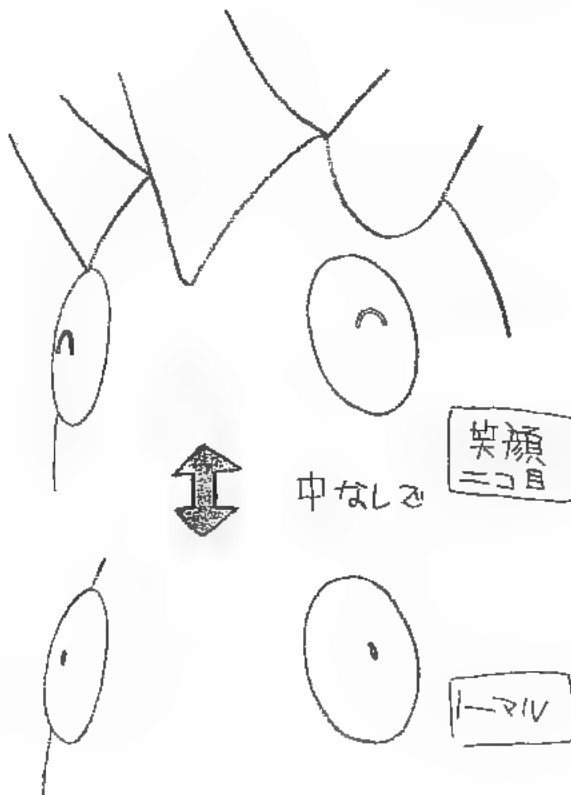
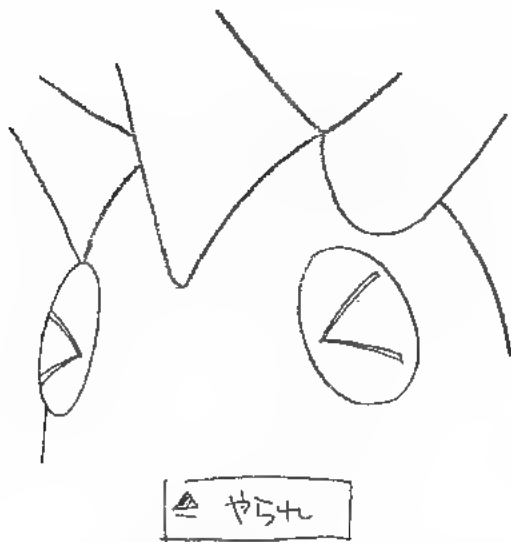

決定稿

2003.02.28 OK
03.10 2次

PMAG
ハート=表情

★ 基本的に「ハート」の口は「ハート」
お/殺しエウ。
・ 話のけり時など、必要に
応じて有りはして下さい。

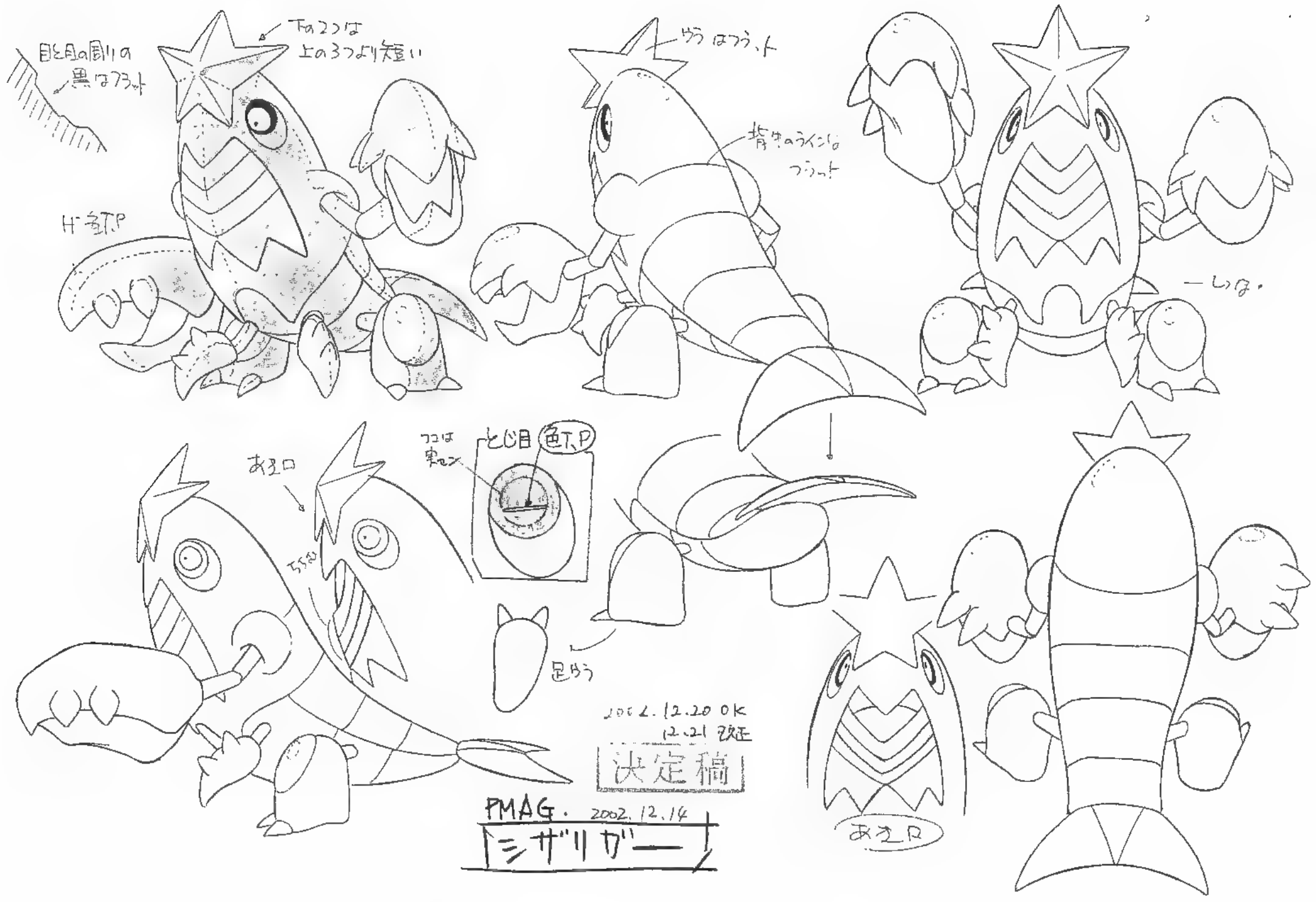

目と目の間の黒は73+

上の3つより短い

ウツは73+

指の幅は73+

H 73+

— 73+

あま

550

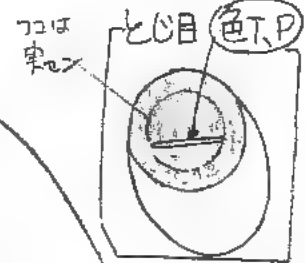

73+

足

2002.12.20 OK
12.21 修正

決定稿

PMAG. 2002.12.14

シガリガ

あま



お口はなし

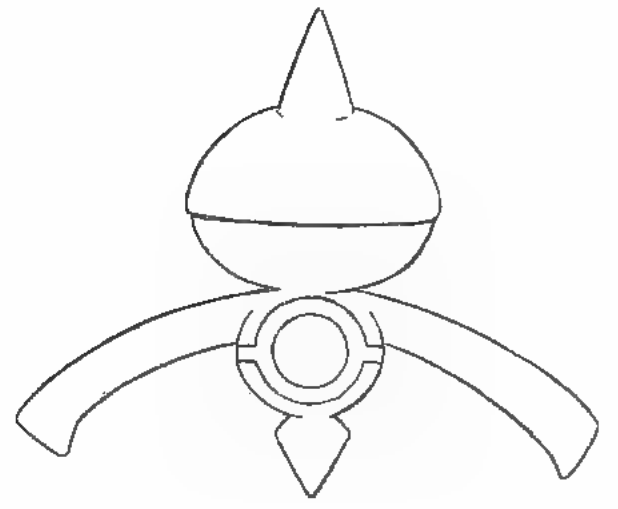
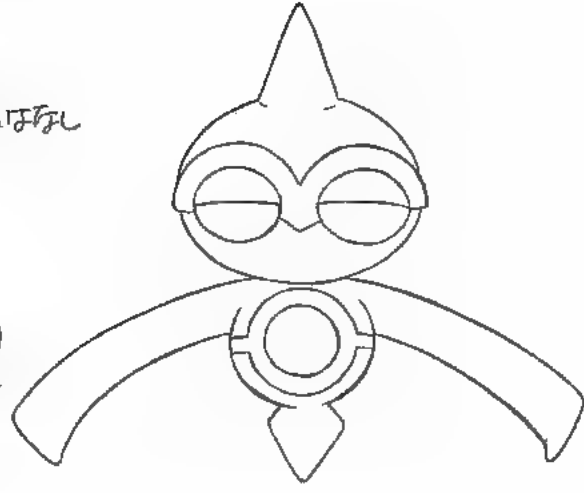

おなかのまようはフラット

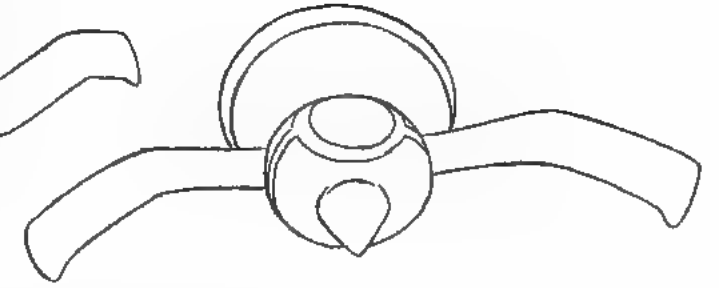
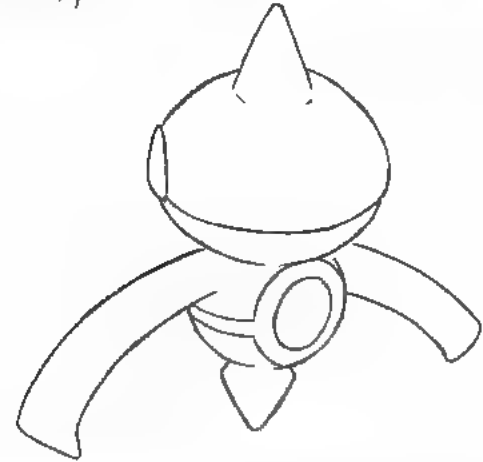

PMAG

決定稿

ヤジロン

2003.01.30 of

2003.1.25.

くまぐる回転したから総動
 かんじとてかたはり、浮くはせきる

溝うへ

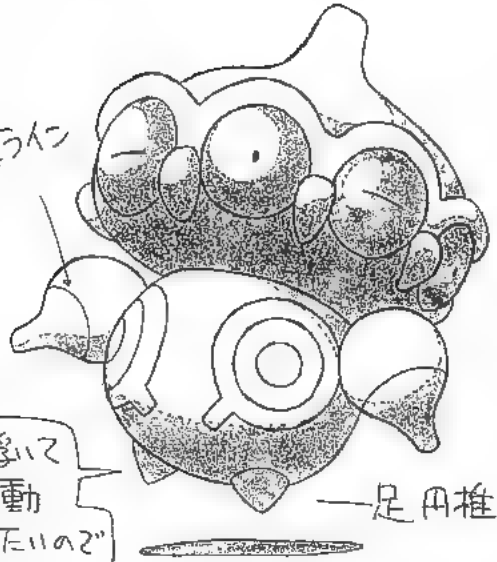

足円椎

宙に浮いて
移動
体が重たいので
素早くない

通常正面中心の目の両側は
閉じている。

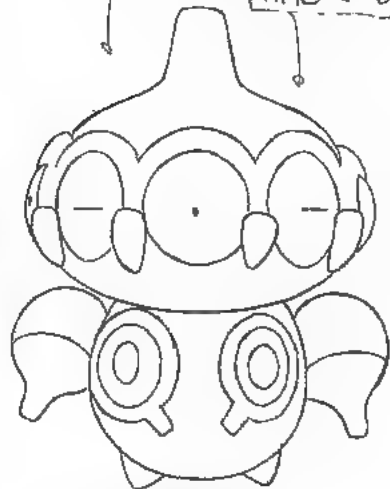

正面

※下だし、横を見ている時などは
見ている方向の正面に
あたる目の両側が
閉じます

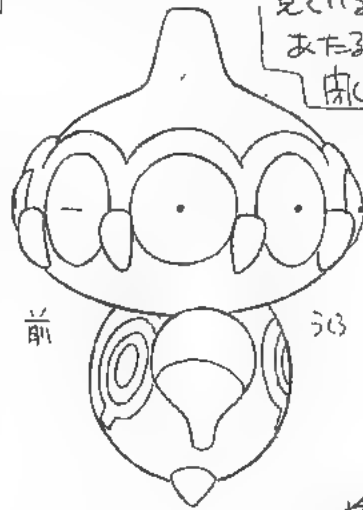

横

※目とB.L
Hはなし

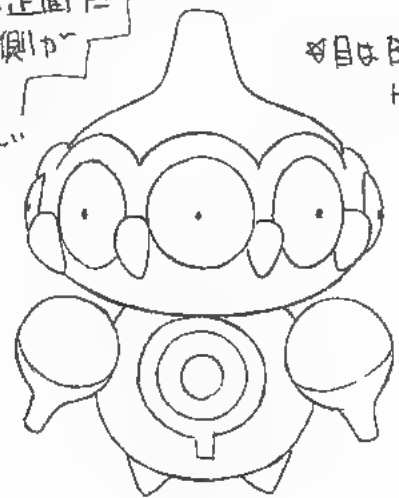

後

※首はまわりません

※どの目も開閉する

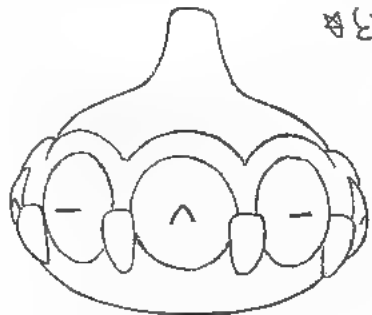

笑い目
(正面の両側は閉じてる)

※2"
体から離れて
遠隔操作
出来る

先から光線
出る

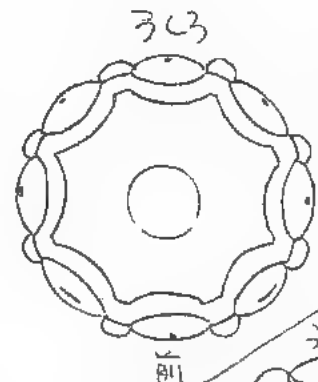

上面図

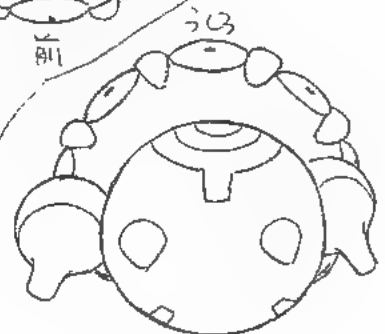

下から

PMAG
ネドール

2003.1.8

決定稿

2003.01.21 OK

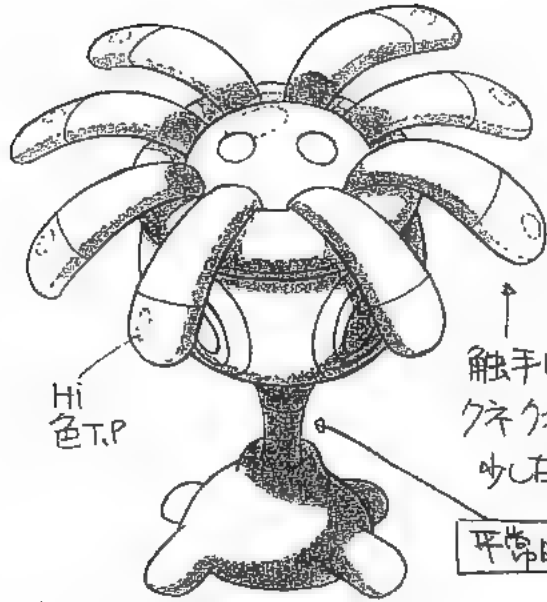

Hi色T.P

触手は8本
クネクネ動き
少しだけ伸びる

平常時の首の長さ

足: 4本 + しっぽ 1本
歩くことはできない

岩などにしがみつくことはできる

正面

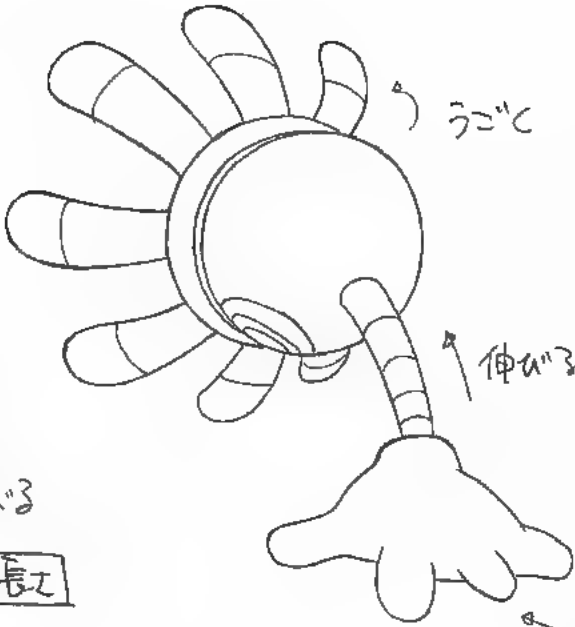
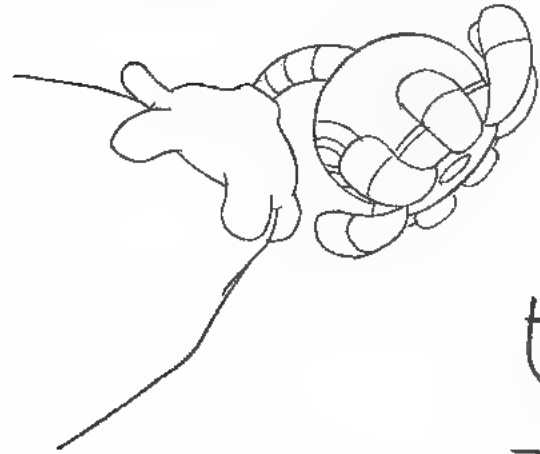
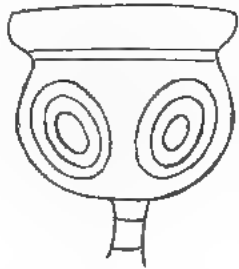

うごくと

伸びる

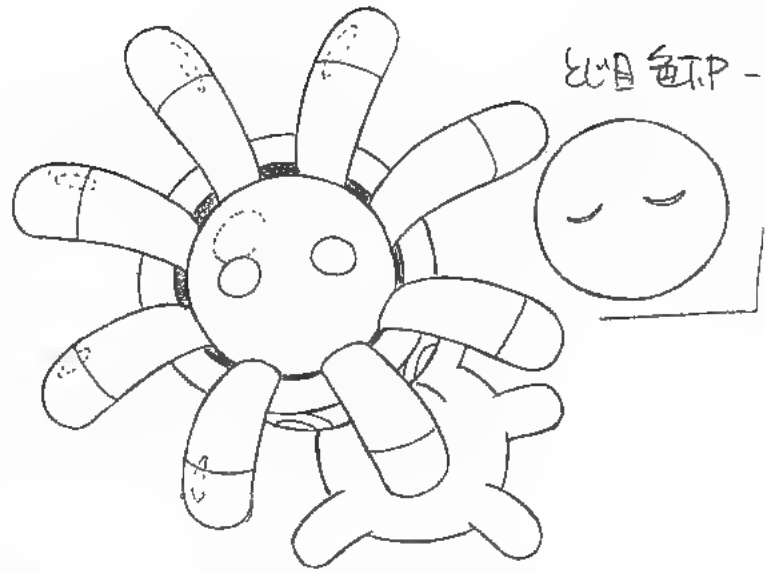

ヒ色T.P -

しっぽは足列
のしっぽ

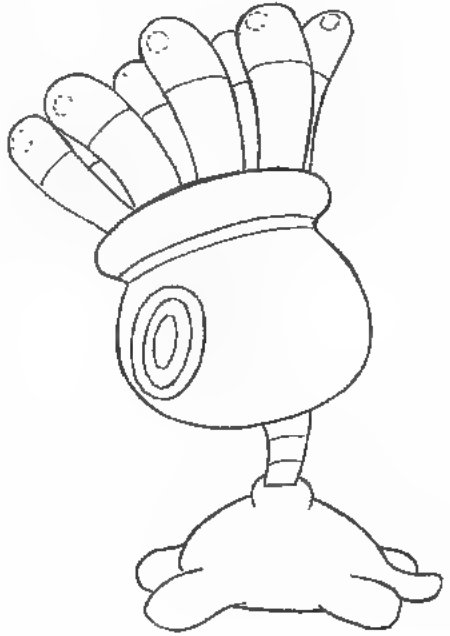
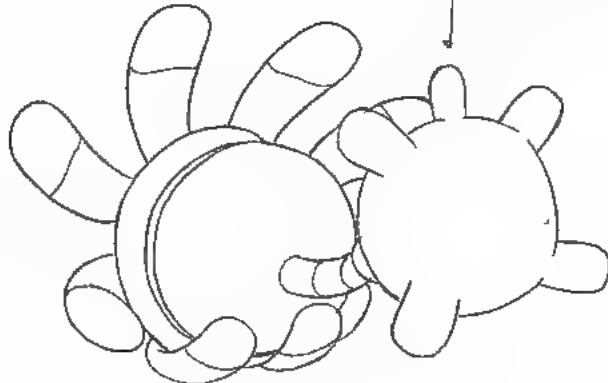

PHAG
リリーラ

2002.12.25.

決定稿

2003.01.14 OK

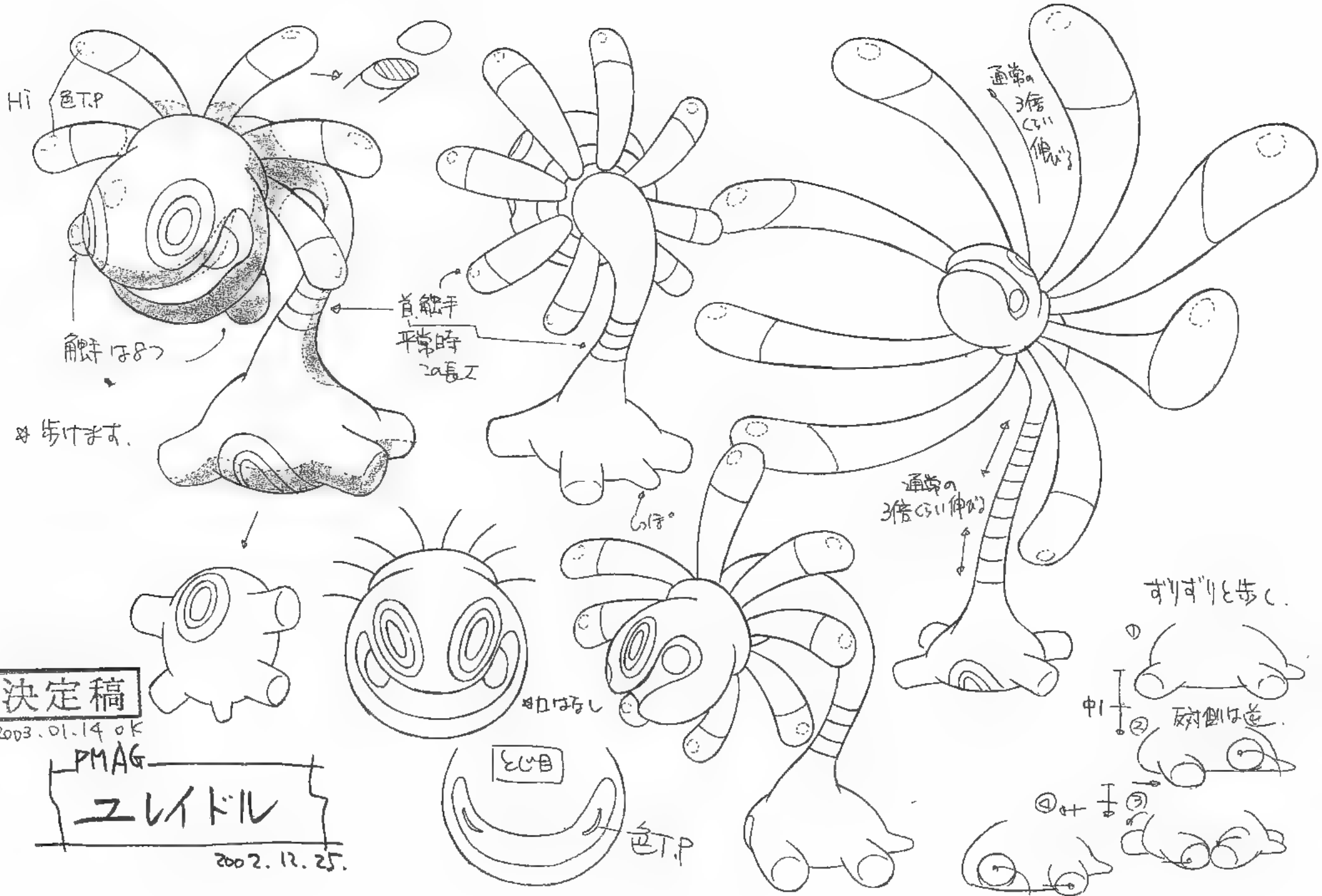

決定稿

2003.01.14 OK

PMAG

ユレイドル

2002.12.25

①②③

色T.P

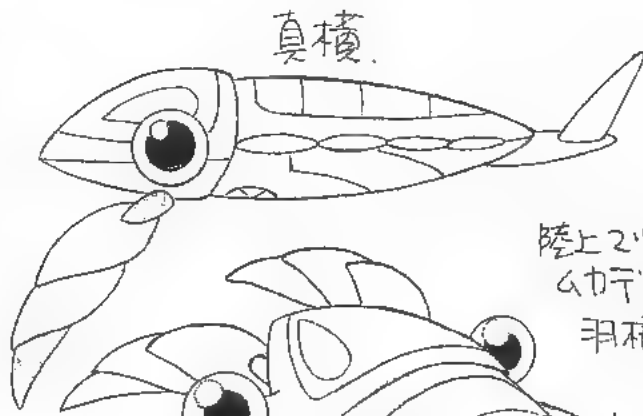
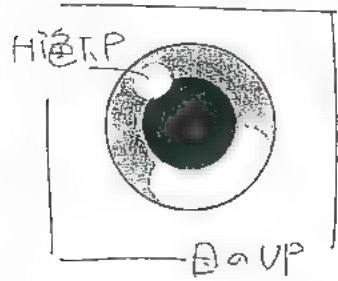
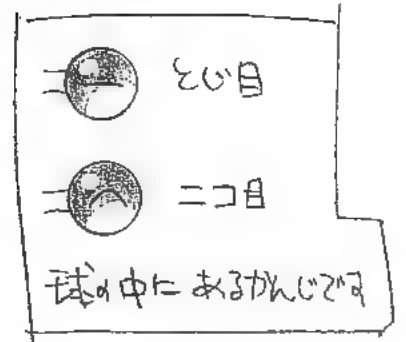
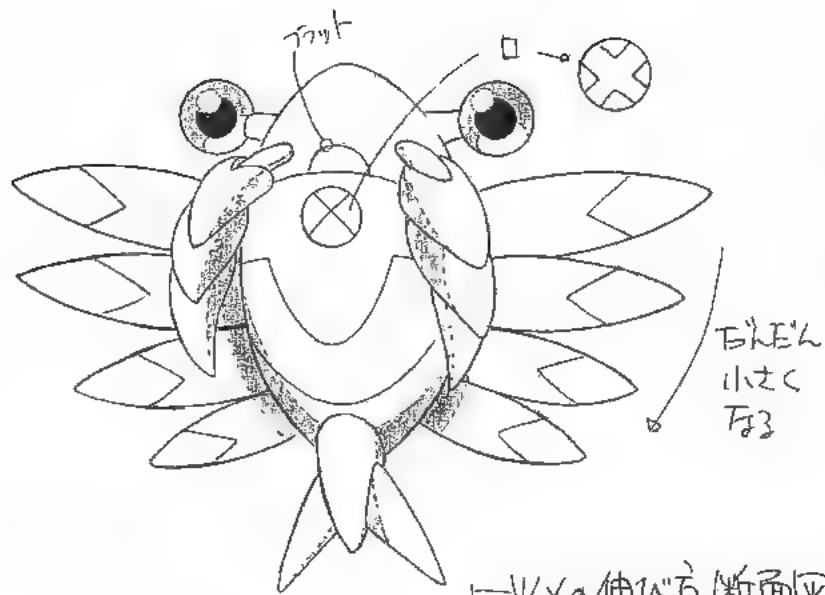
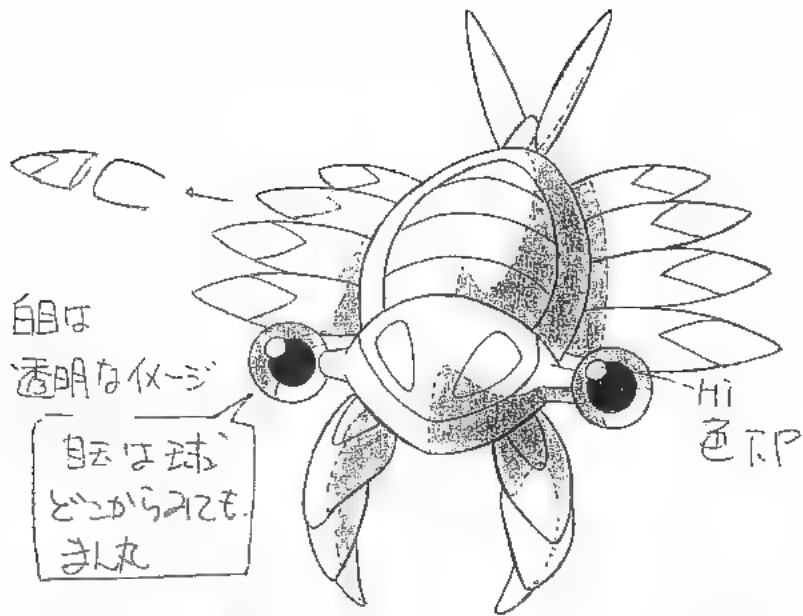

陸上では
ムカデのふた
羽根を動かして
移動

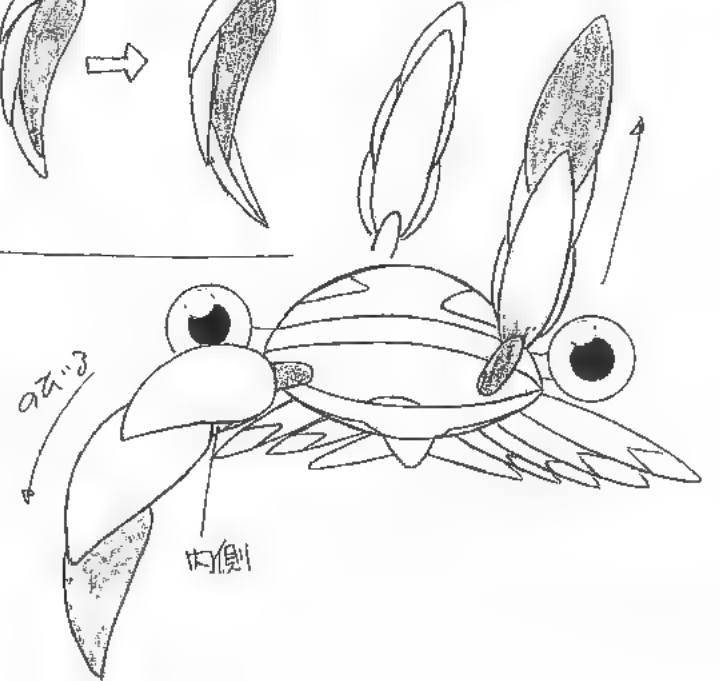
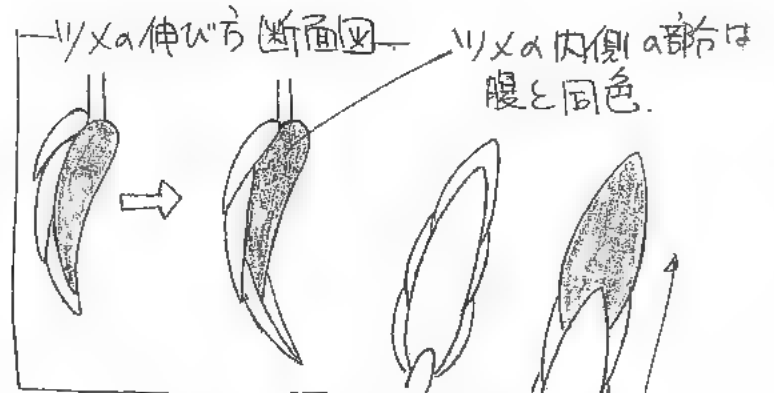

PMAG

アノリス

2002.12.26.

決定稿

2003.01.15 ok.



キハ
上ゴコは
3本のみ

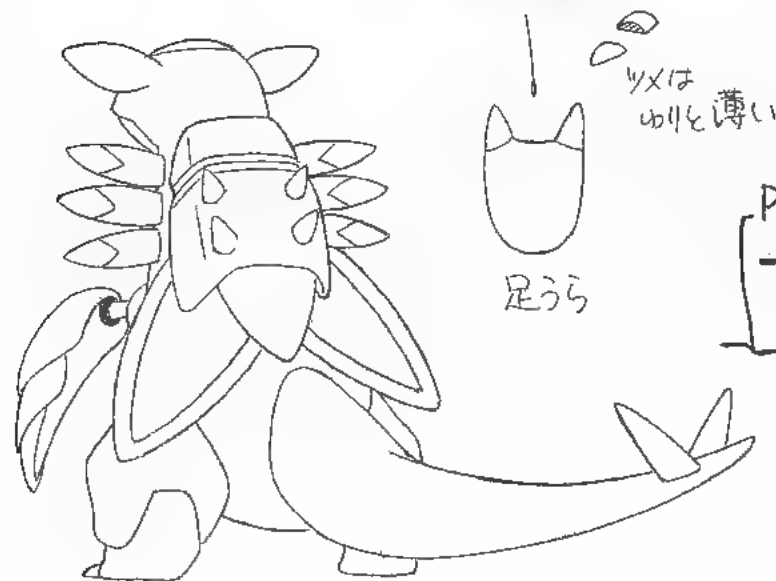

PMAG
アーマルド

2002.12.26

決定稿

2003.01.15ok

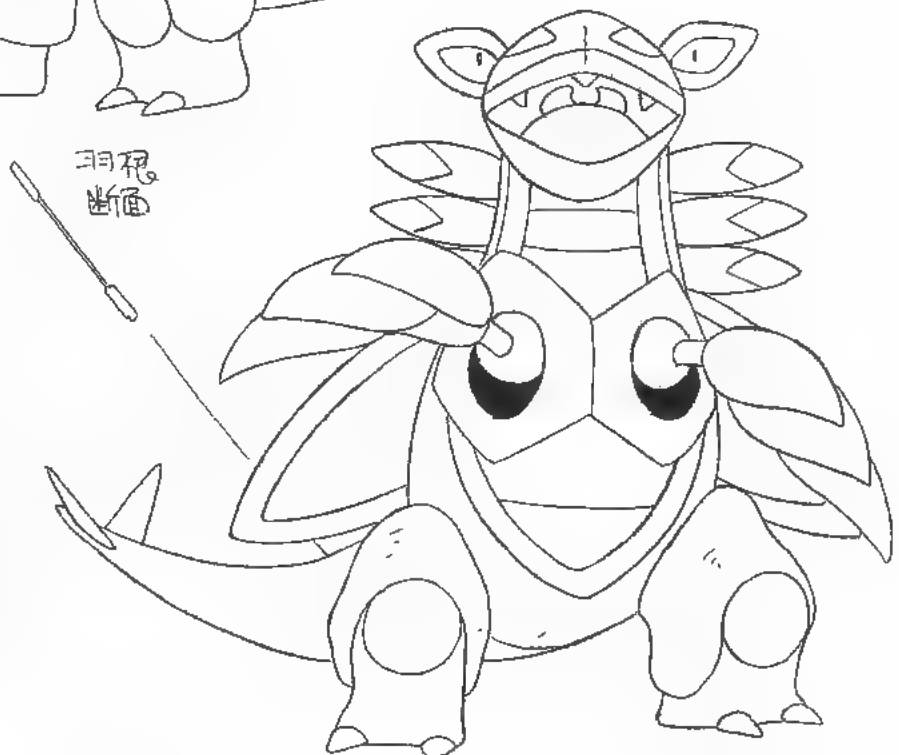

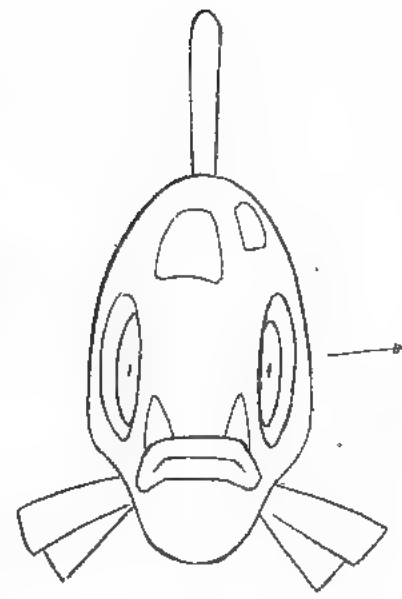
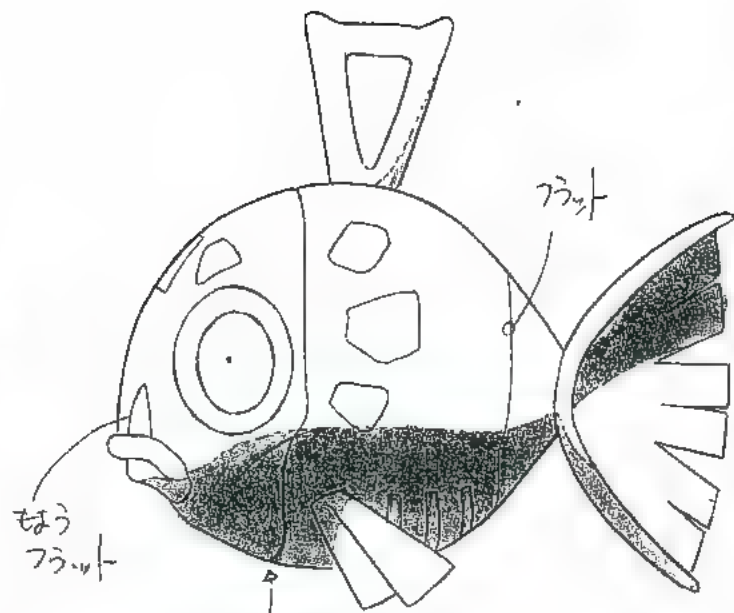
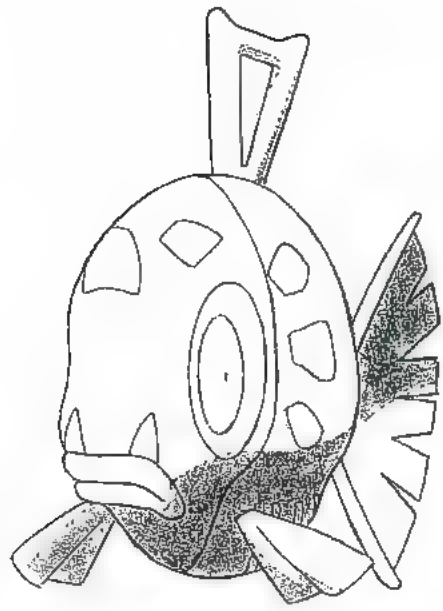

瞳は黒い円
ハイライトあり

首のラインは
少しだけ溝がある

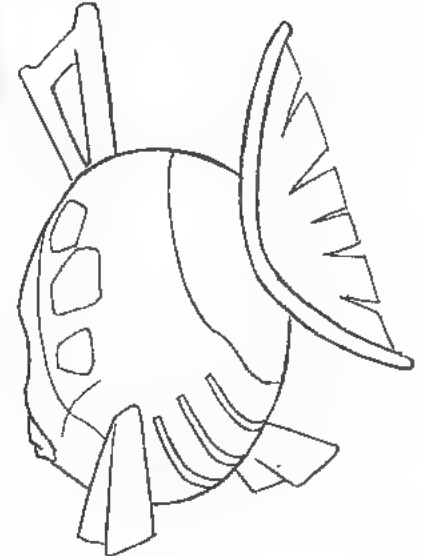
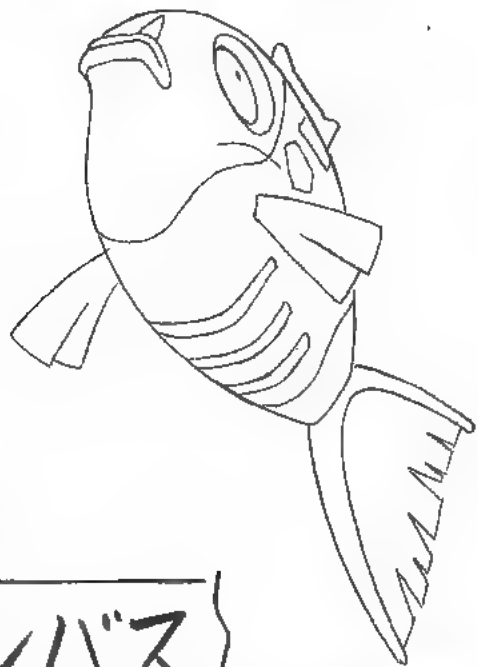

PMAG

ヒンバス

2007.1.19.

決定稿

2003.01.22 of

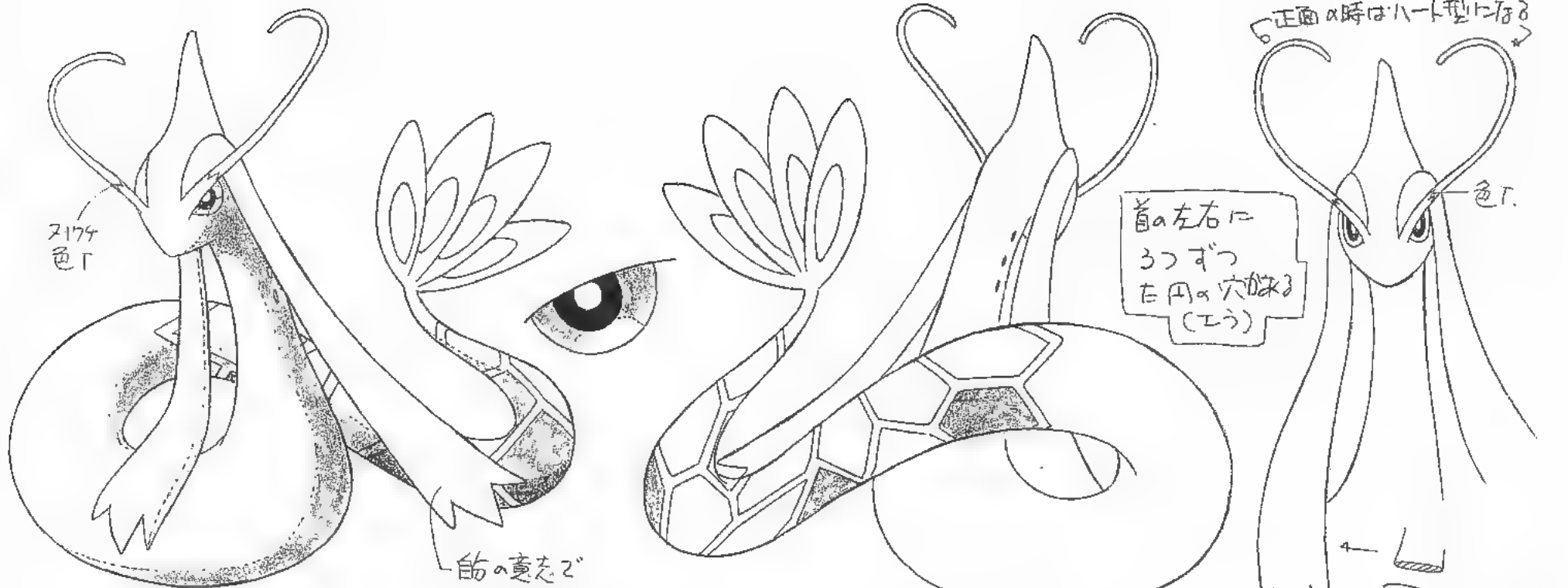

2174
色T

正面の時はハート型になる

首の左右に
3つずつ
右円穴がある
(エウ)

色T

筋の意を
動かすことは出来ない

五中が
いじり
たい

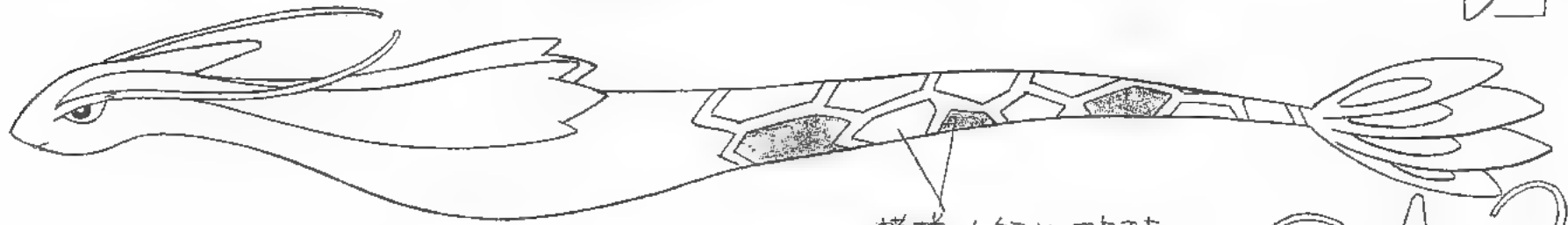

模様のカケはまじまじ
色は3ヶ所が赤色。
カケ内統一にしたい

とび目

PMAG
ミロカス

決定稿
2003.01.150F

この笑目はNG

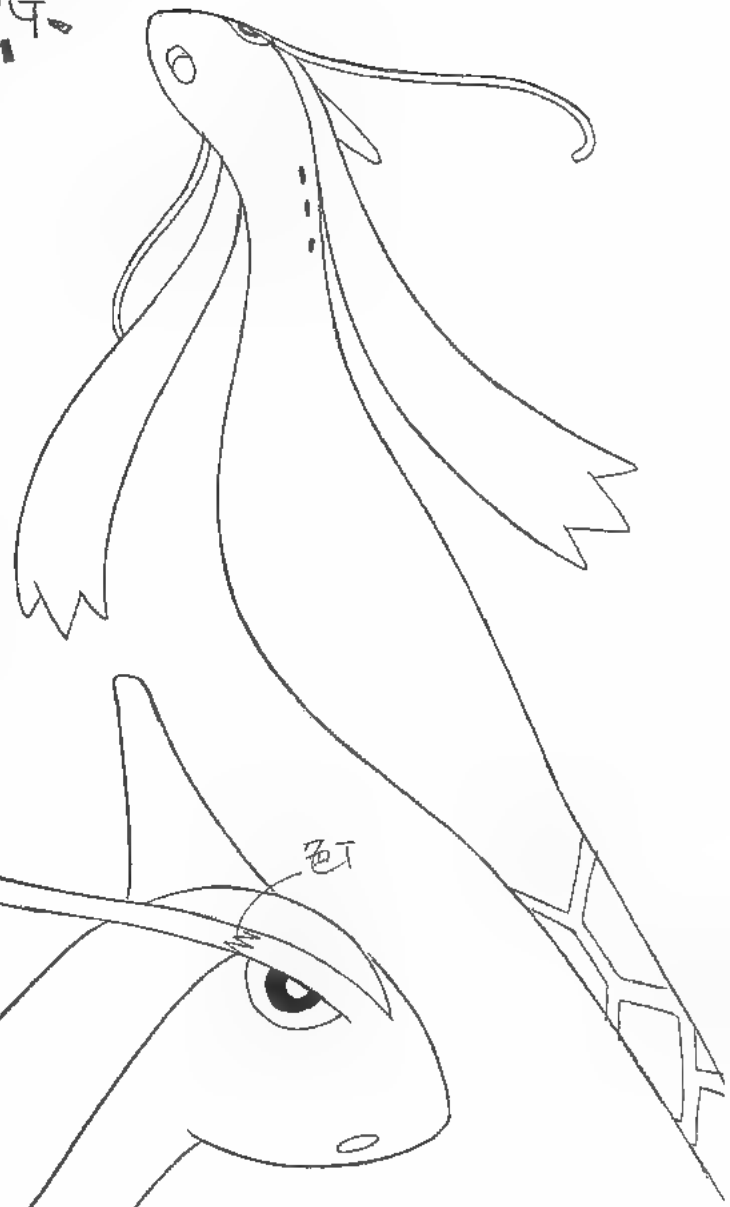
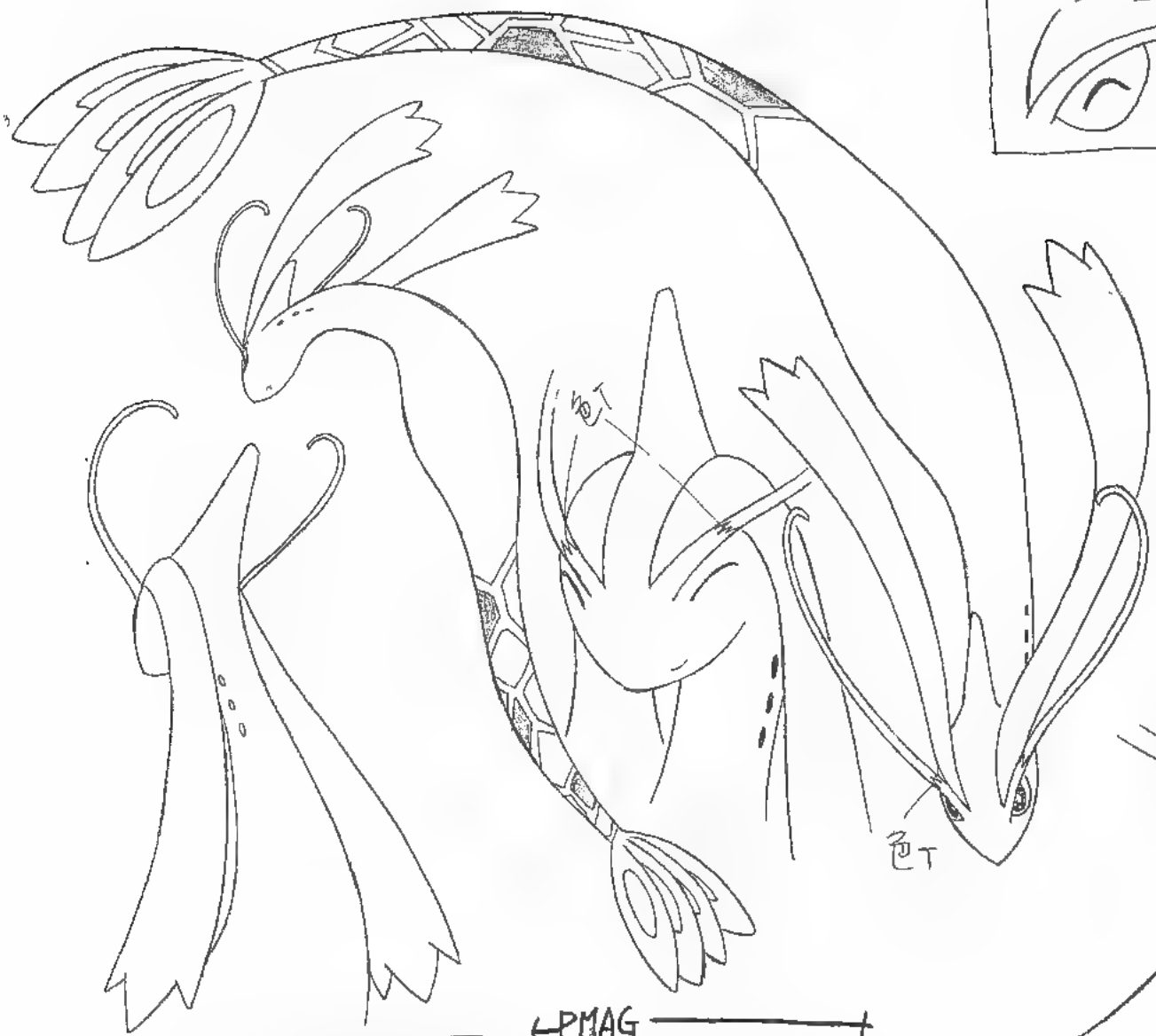

決定稿

2003.01.15OK

PMAG
ニロカロス②

2003.1.8

丸が支不可.

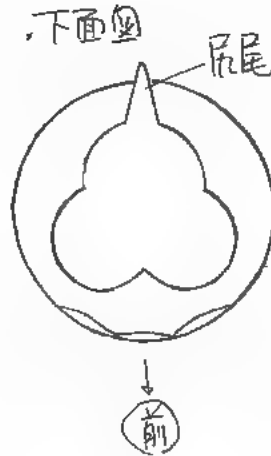
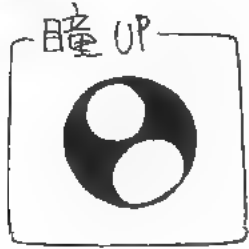
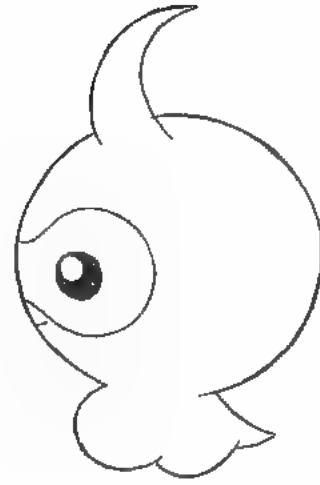
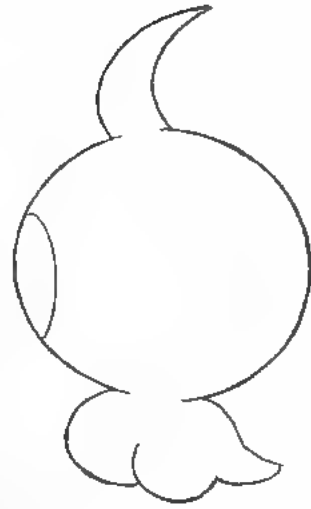

←宙に浮かび移動



PMAG
ポワルン (1-210)
2009.1.25

決定稿
2009.01.30 OK



Hi色T.P

頭の周りは半透明の
イメージ
又IIの処理です

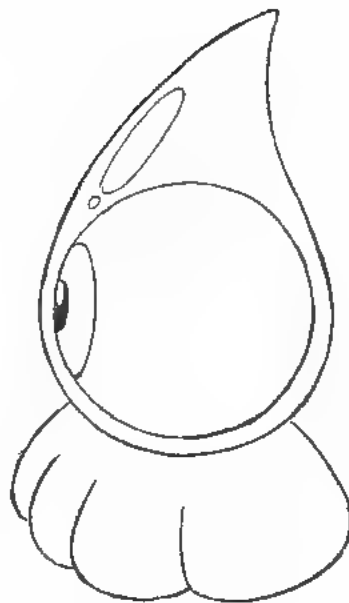

表情等は
ノミルと同じ

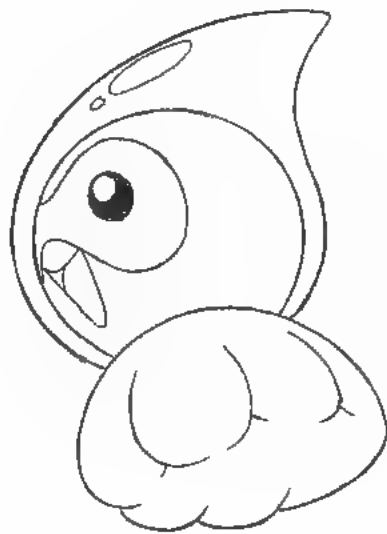

下図

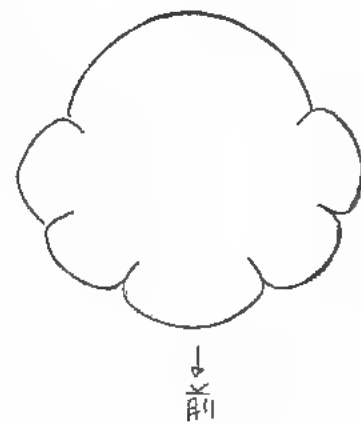

PMAG

ポワルン(水)

2003.1.25

決定稿 2003.01.30 OK

丸型不可

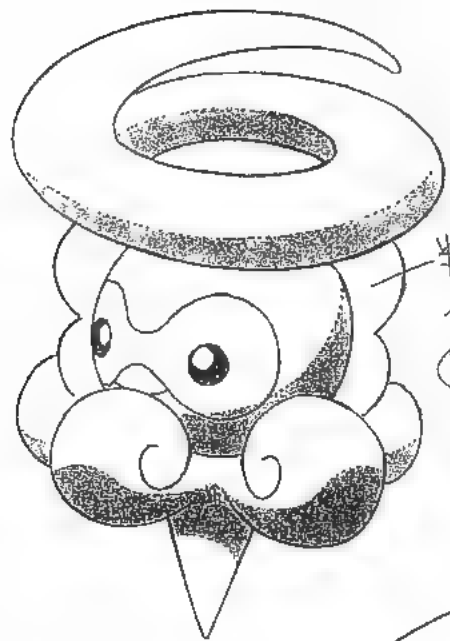

半透明の
仮→"
又11

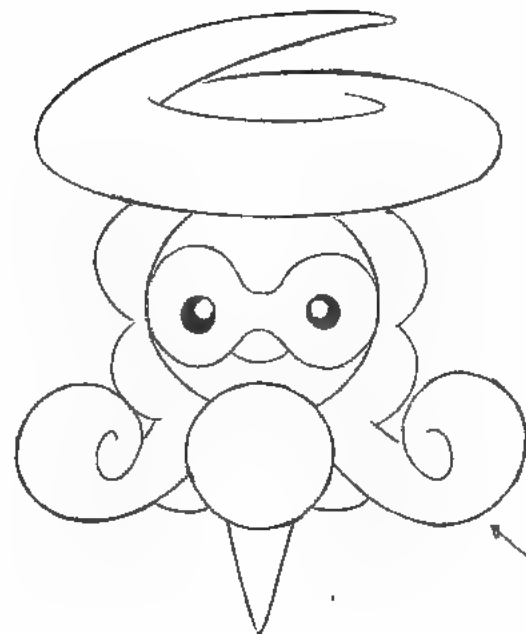
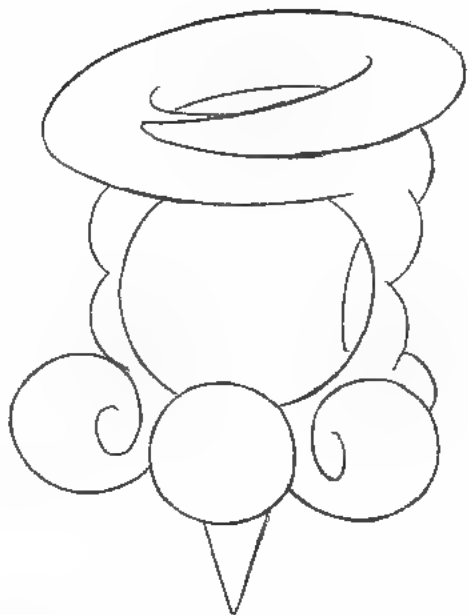

体の周りに
カハシエ(10-11)
50

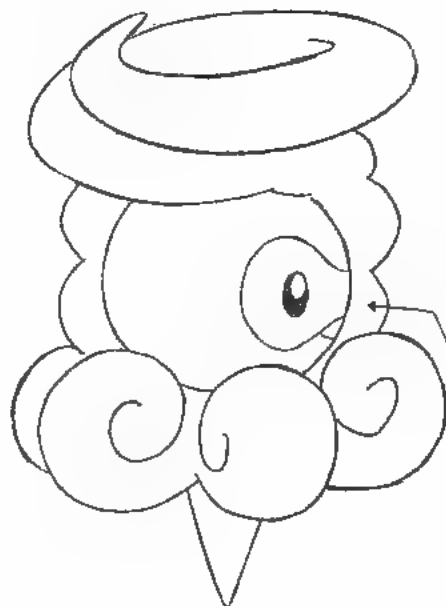

ココ
ココ

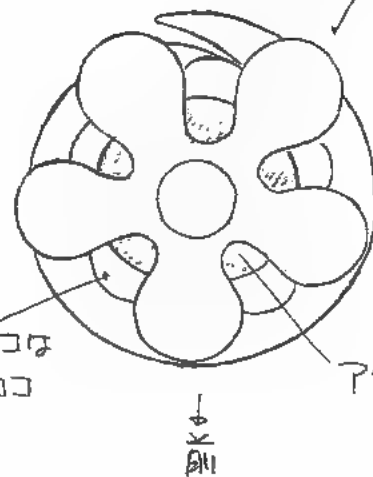

下面図

アタリ

PMAG

ポクリン(米)

2003.1.25

決定稿

2003.01.30 04

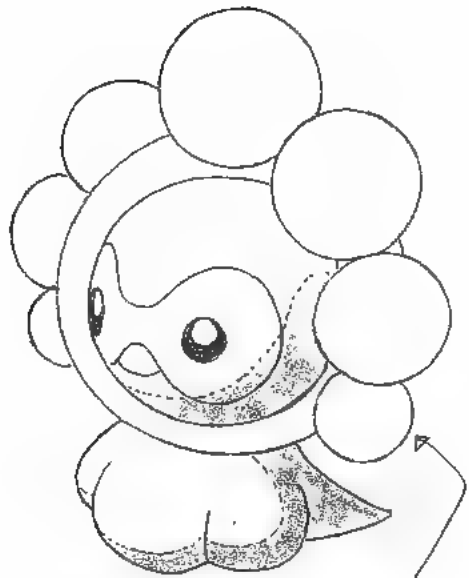

※ 外周の球体は
丸がエ OKで"バカ"
他は不可で"バ"

外周の球体はエ

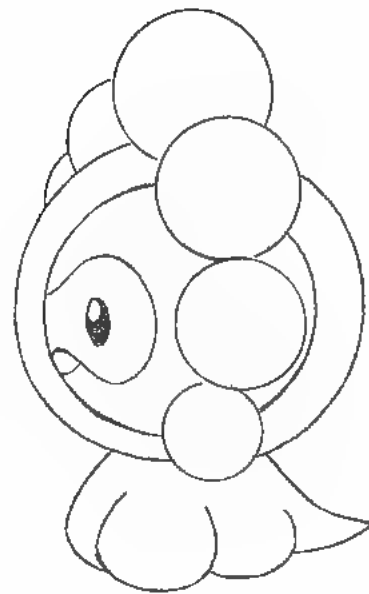
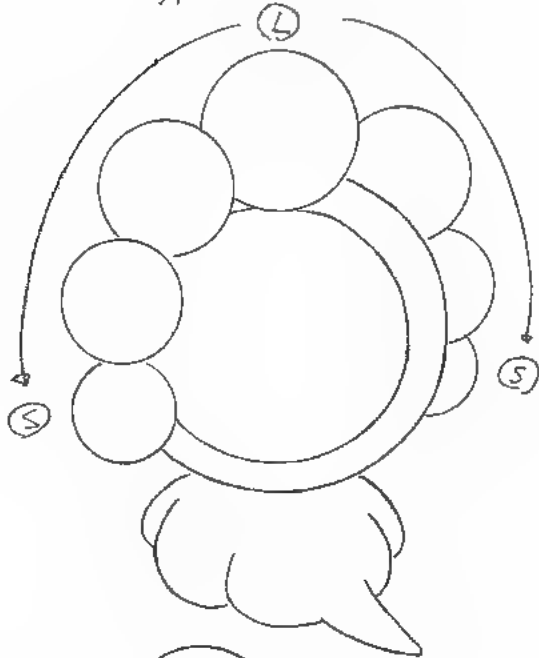

・下面図

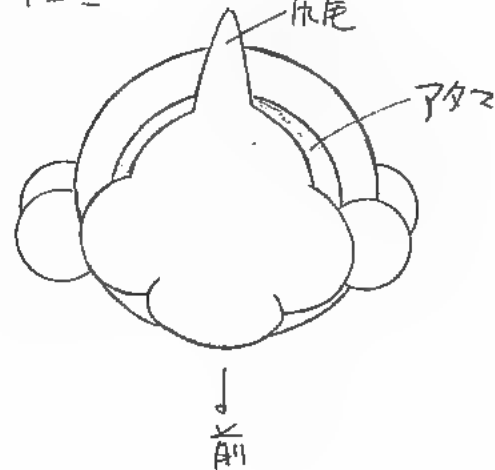

PMAG
ポワルン (炭)

2003.1.25

決定稿 2003.02.03 OK

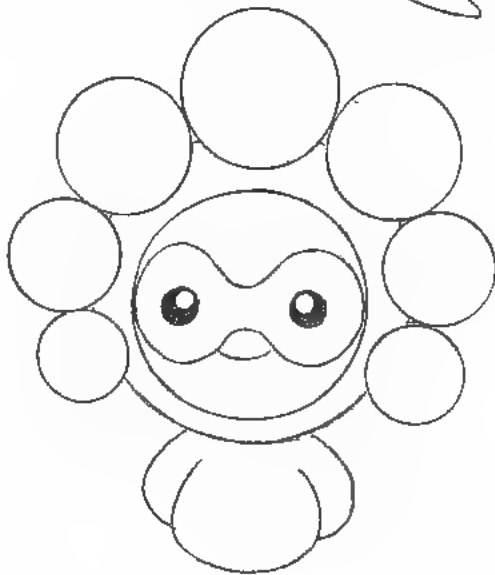

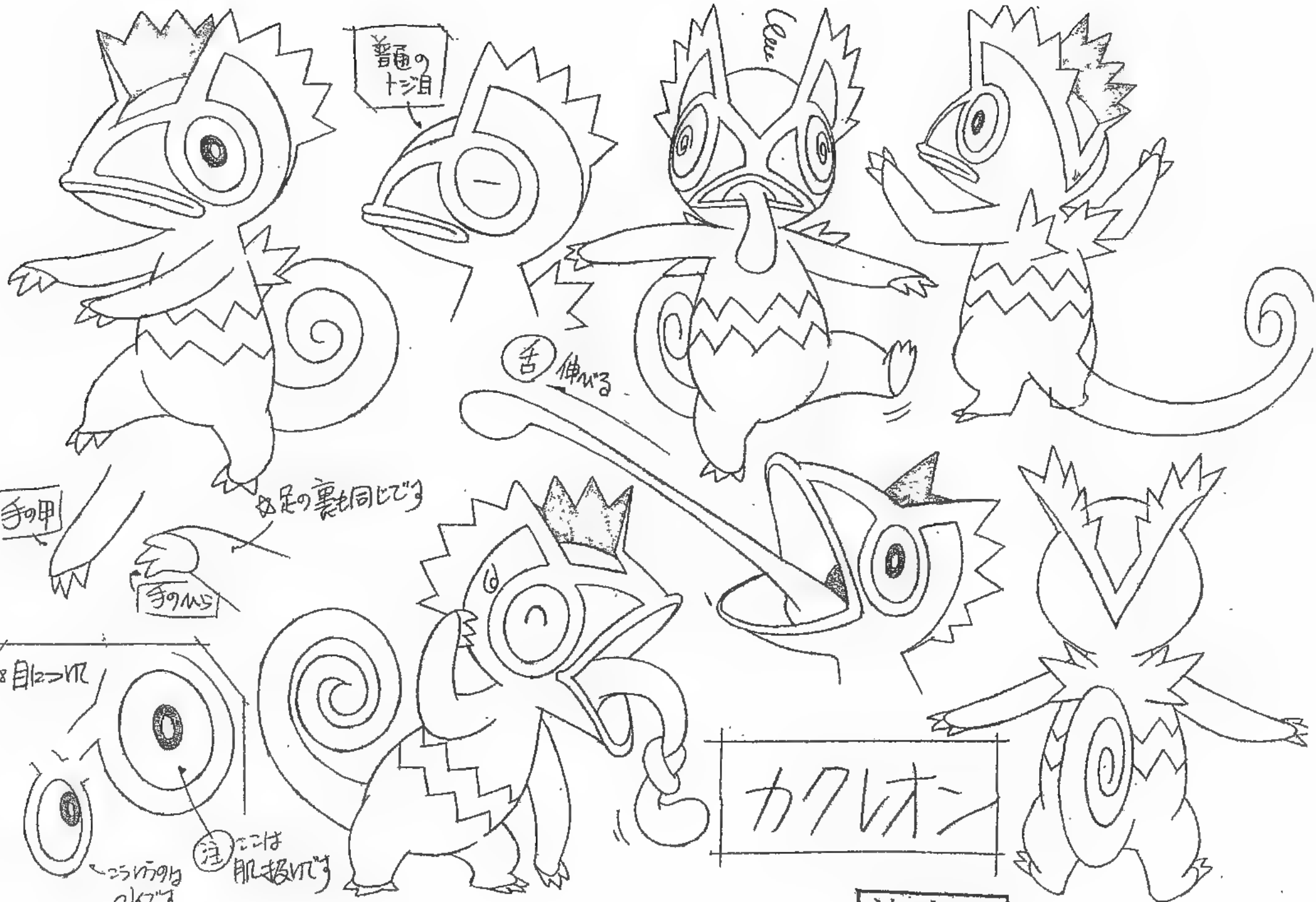

普通の
トジ目

舌
伸める

手の甲

手の裏

足の裏も同じです

目はV型

注
これは
肌扱いです

さしめが
okです

カクボ

決定稿



PMAG
カゲボウズ

2003 1.26

決定稿

2003.02.07 OK

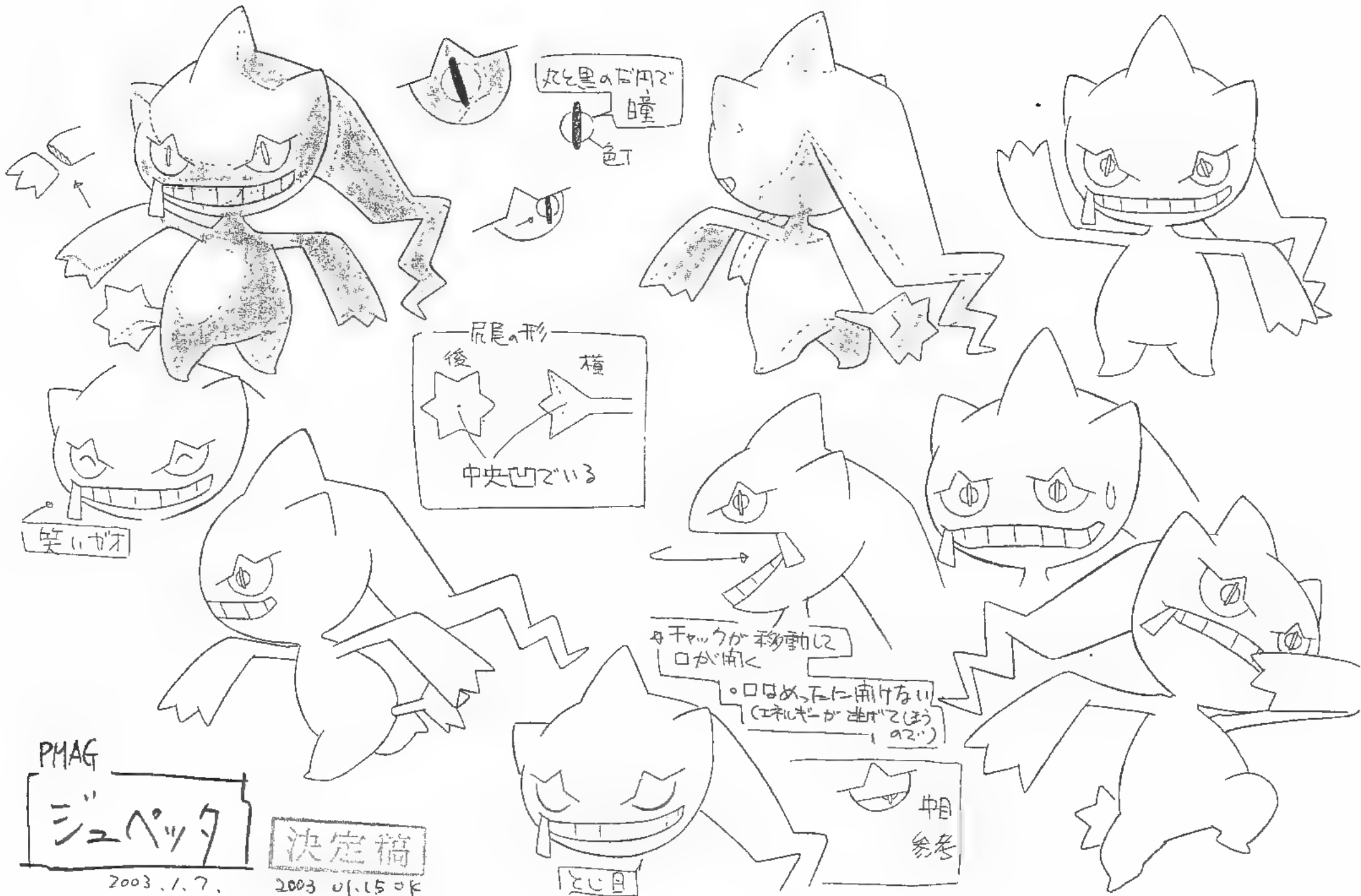

UP時 Hi (骨あけの311).

色トス

目玉は1コ
自由にする.



色トス
奥セン

⑧のみT光ス-112
たがせま

か付可参

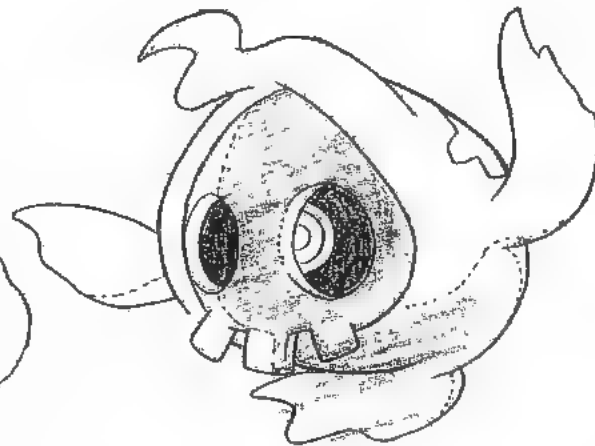
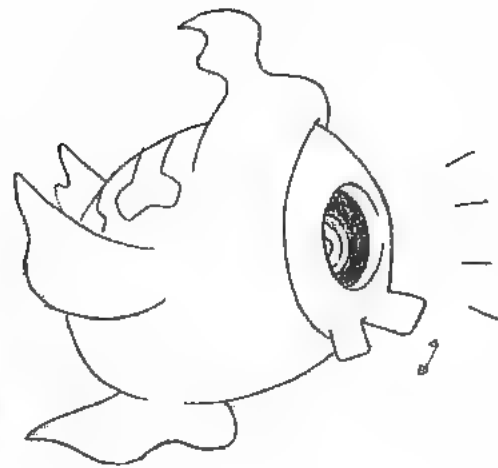
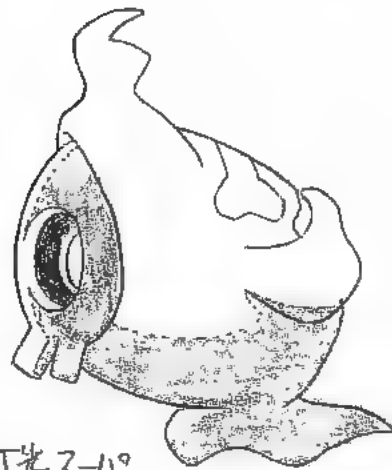

ヨマケル 2001.11/6.

ナゲルム

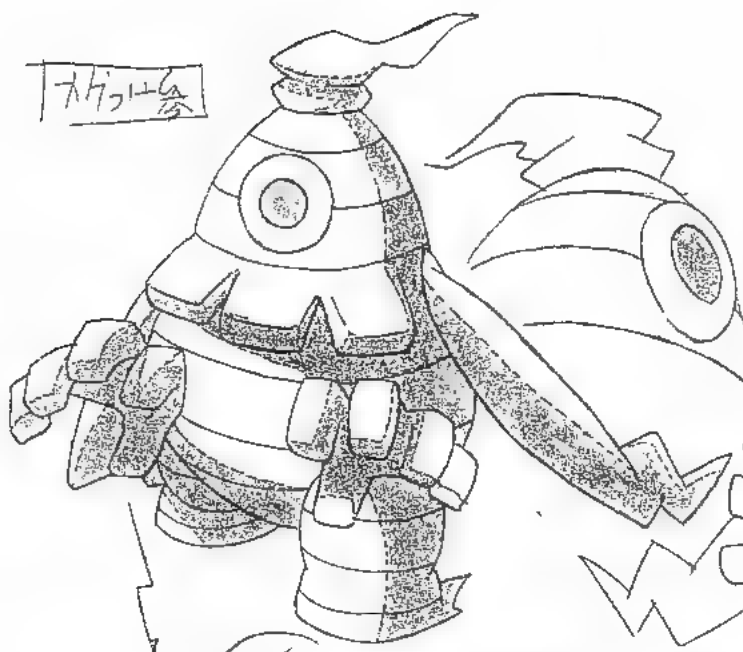

11/11/02 後部 = 2/1/01
+ 1/1/01

このラインは
目のセンターを通る

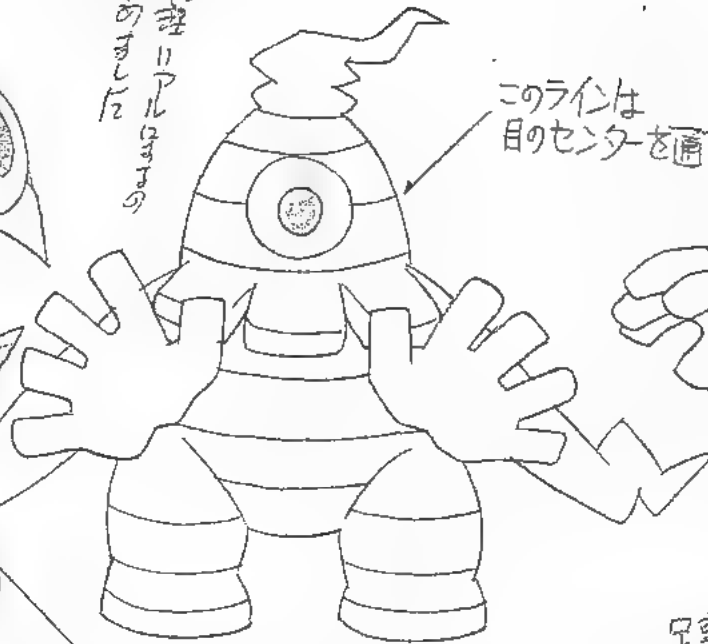

ライン
頭3本

胴3本

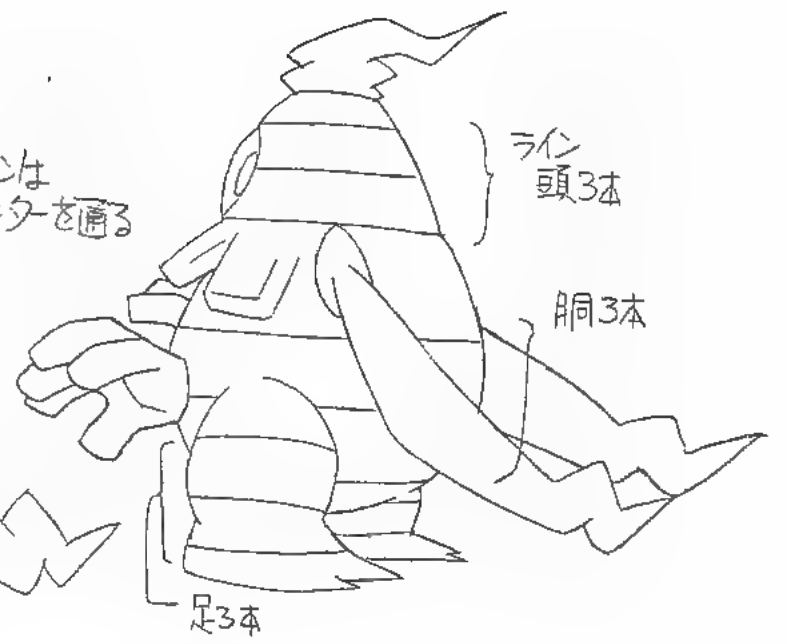

足3本

指の断面

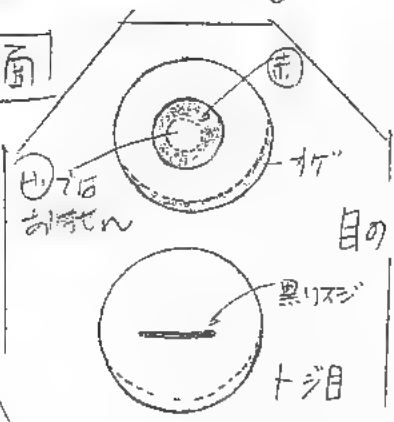

目のUP時

黒いスジ
+ 須

足裏の模様



自在に
動かす



サマヨール



決定稿

2002.11.28 OK

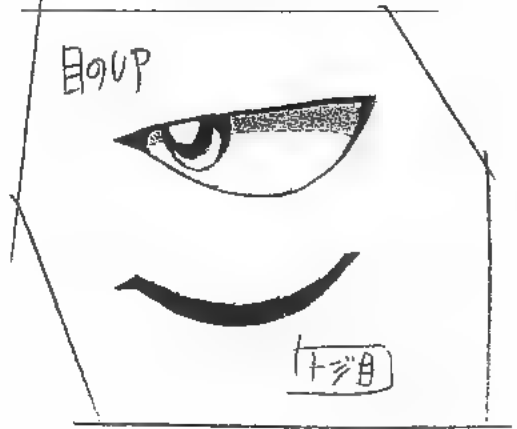
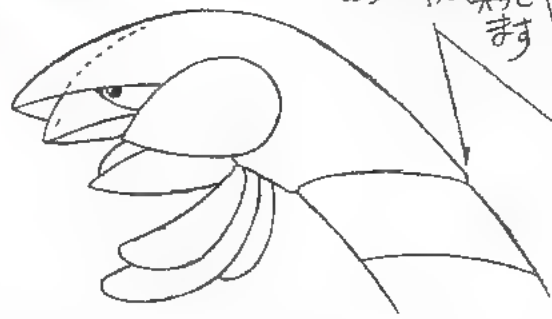
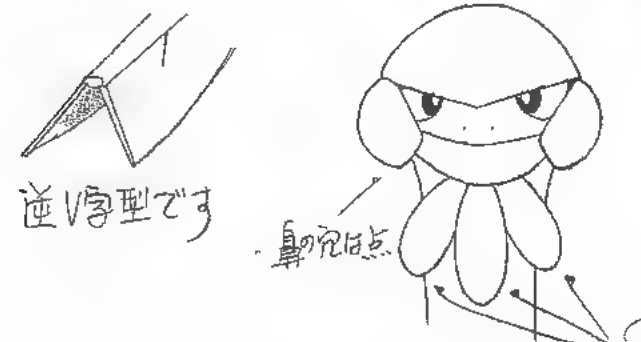
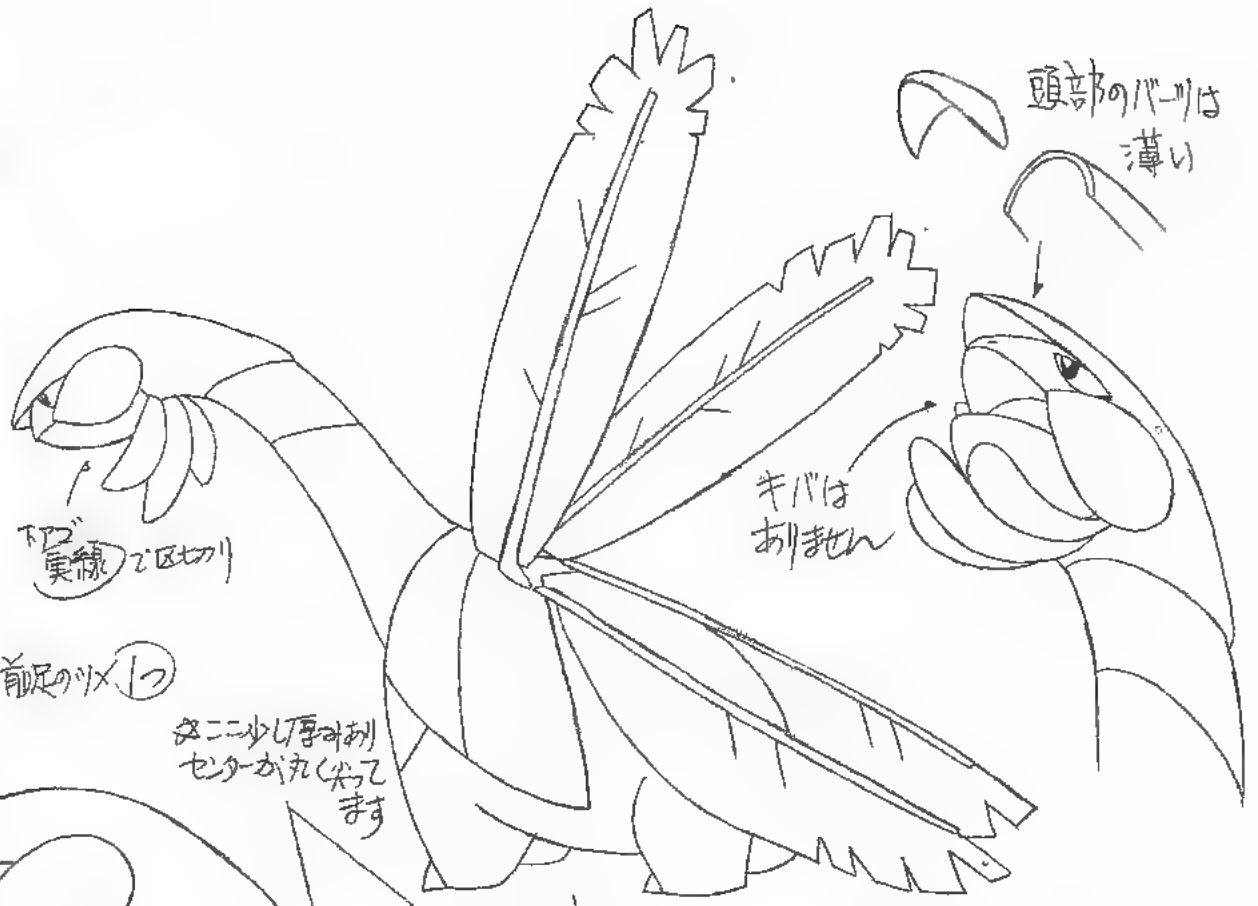

トロピウス ① 決定稿
 2003.02.19 OK

頭部
 上面

♀ 飛ぶ時は上の2枚で
羽バタキ

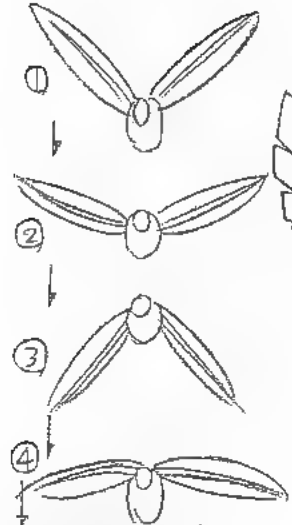

①× | 羽バタキ |
通常の状態で飛んでて
時々羽バタキします

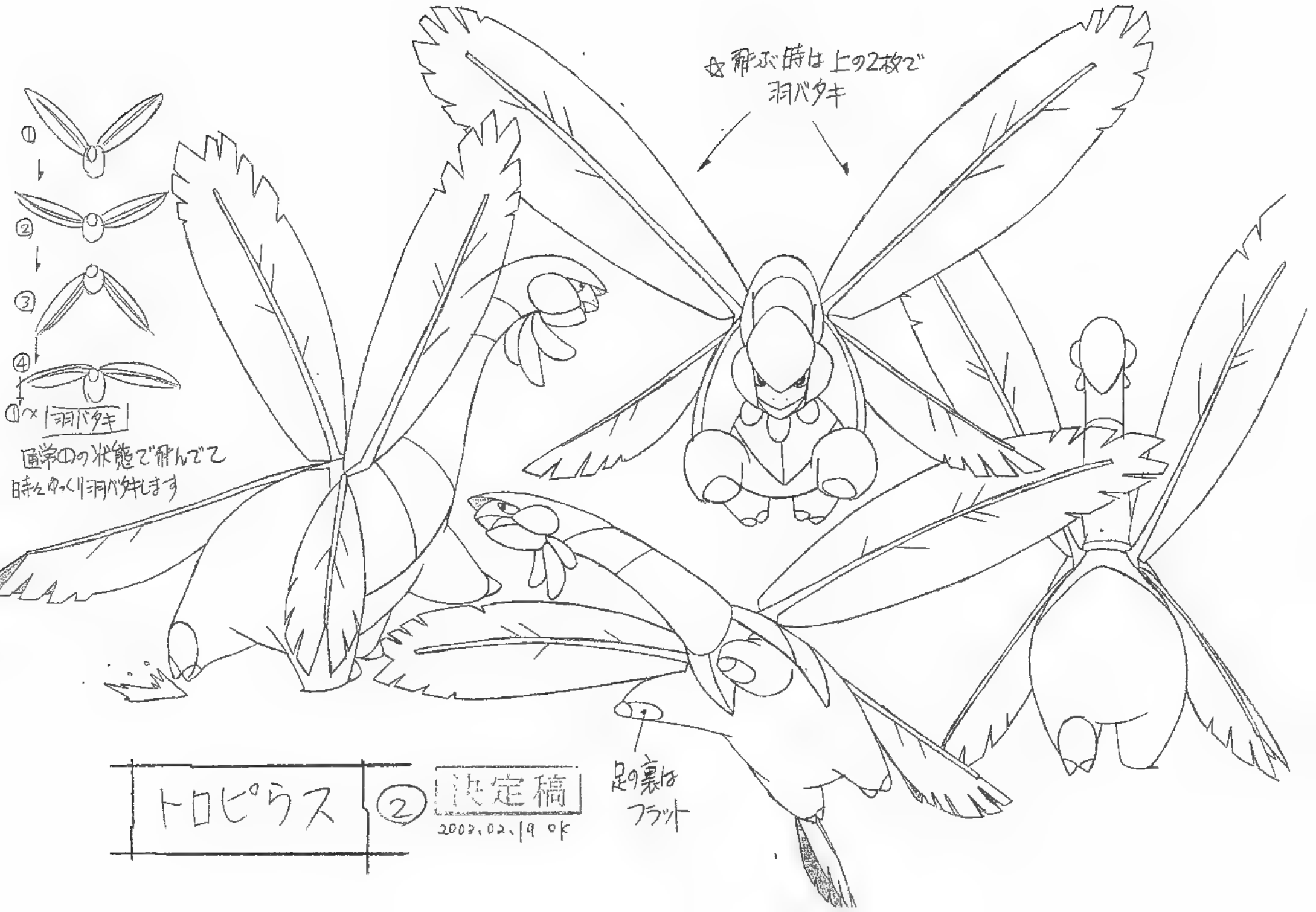

足の裏は
フラット

トロピラス

②

決定稿

2007.02.19 OK

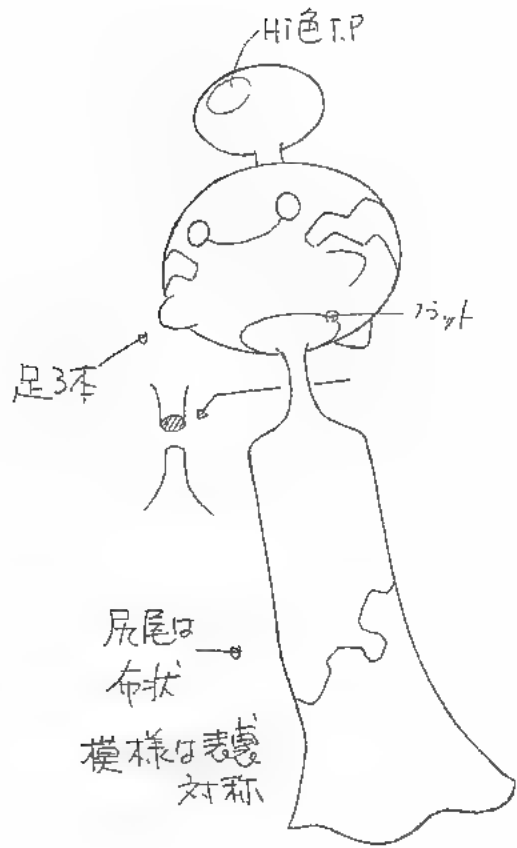

頭の上は丸のこいが
吸盤のようになっている
木の枝などにぶら下がることが出来る
(形は変わらない)

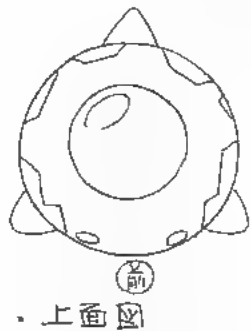

・上面図

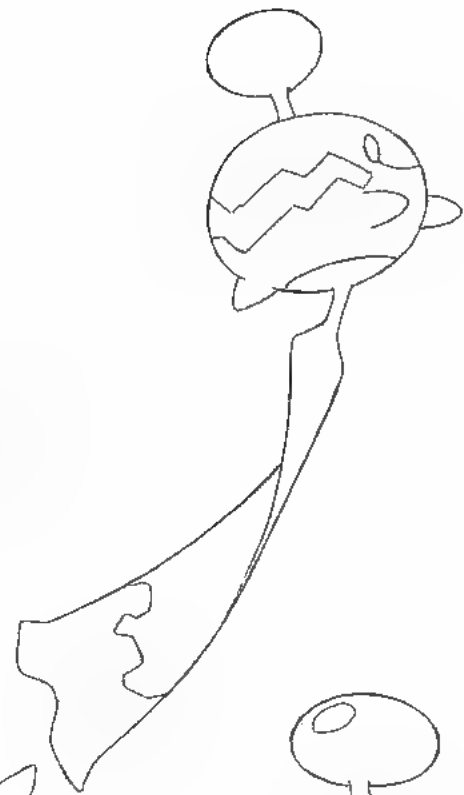
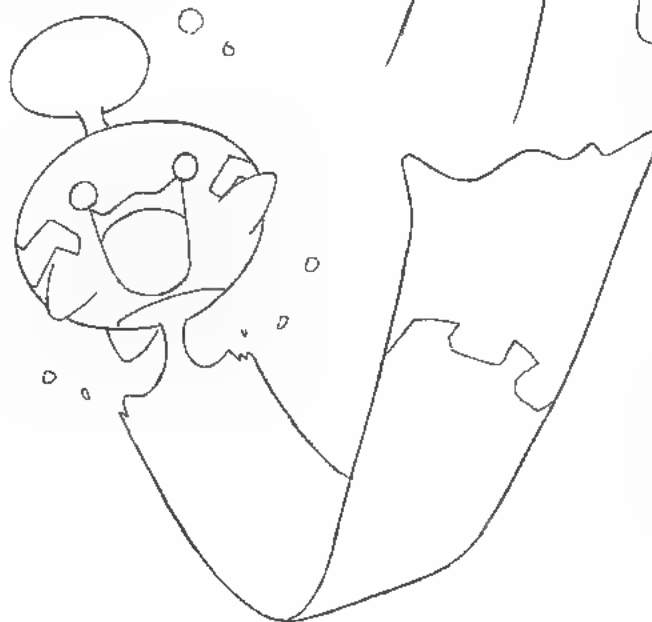
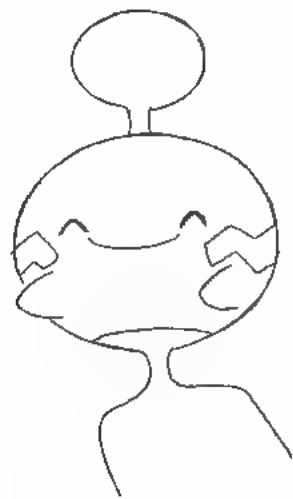

↑
尻尾は自分の意志で動かし
物を持つことが出来る。

PMAG

クリーン

2003.1.24

決定稿

2003.01.30 OK



鏡状
硬質

目UP時

妖艶な
ホーミーのイジ

足の肉球らし

鼻は
人間と同じ

中央のツバカ
少しズレい

PMAG
アブソル ①

2002. 10. 24.

決定稿

2002. 11. 1 OK



ライオンと野良猫
の中間種

PMAG
アブソル ③
 2002.10.24.

決定稿
 2002.11.10k



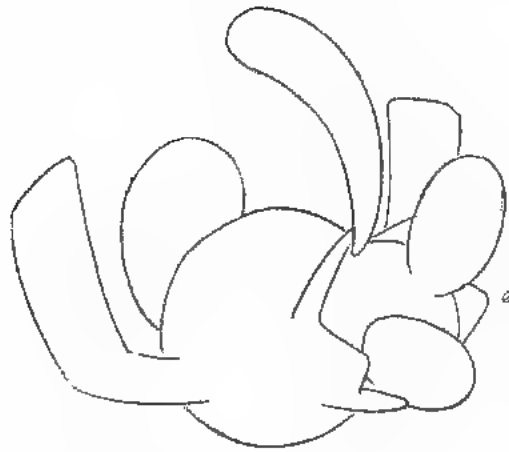
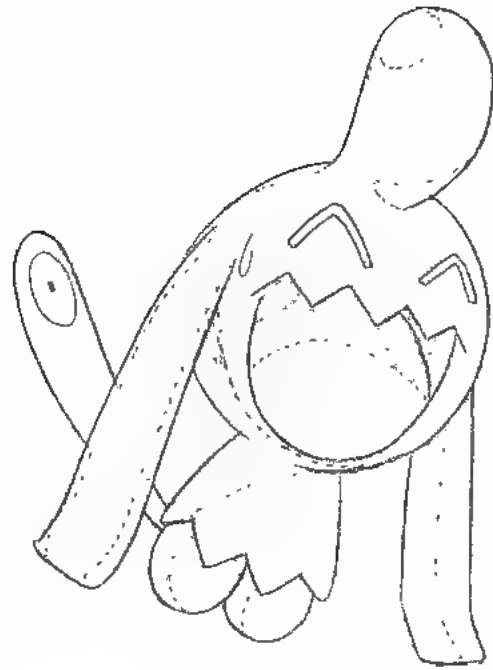

丸み
厚み
おしり



1-71②

2001.11.7.

UP時
(4)時



歩き方はトゲ(ピー) タイフ
ピキ(ピー) タイフ



取らうとかが
手です。

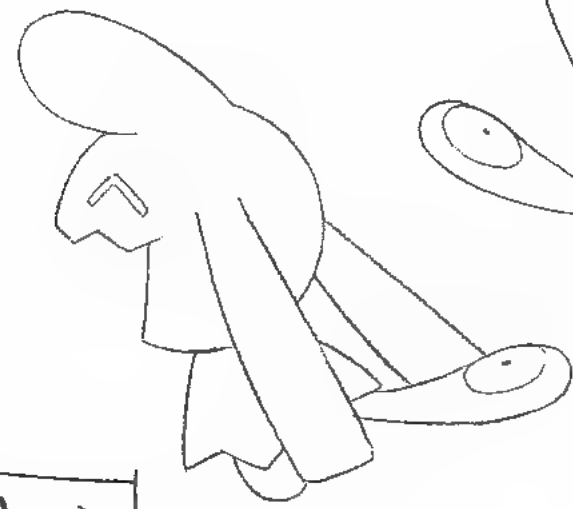

ソーナ) ①

2001.11.2.

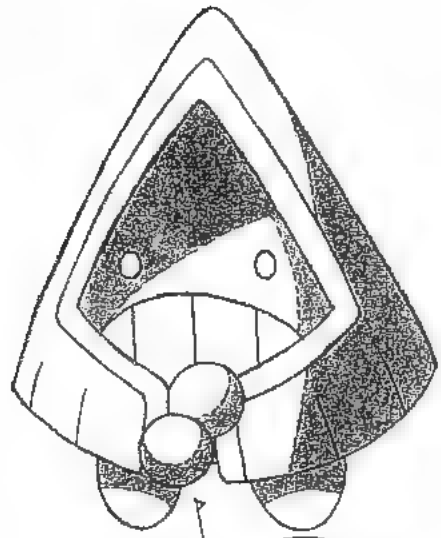

手は球体

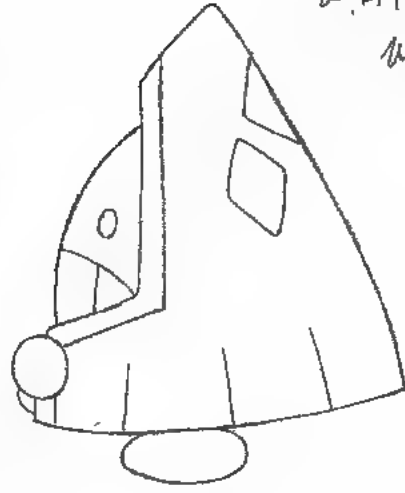

☆背中=3つの
山形の模様

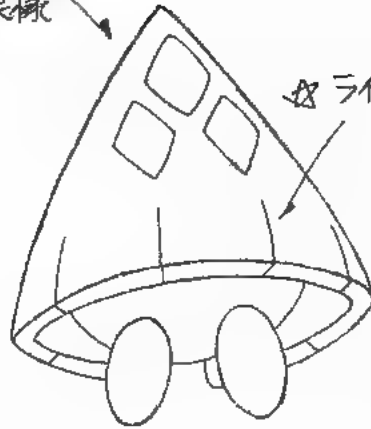

☆ライン6つ

これは"NG"

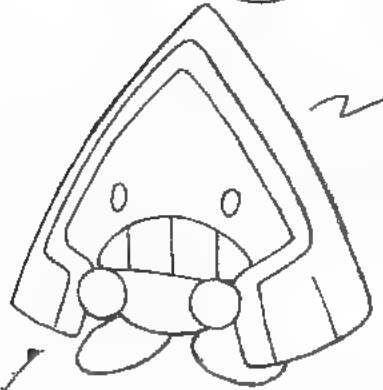
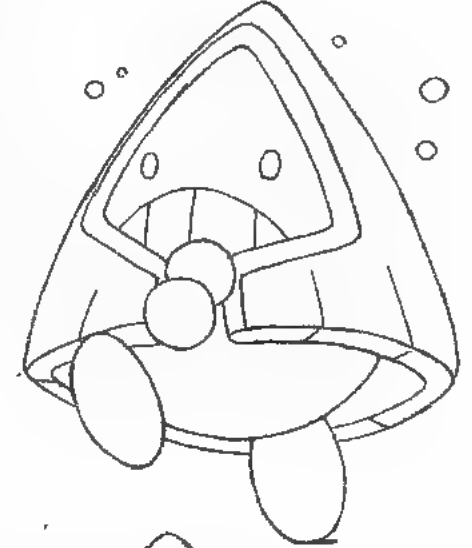

笠は手で開閉
開閉できる

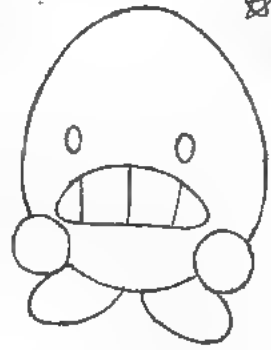

☆本体は夕ゴ型
(本体と笠は
分離しません)

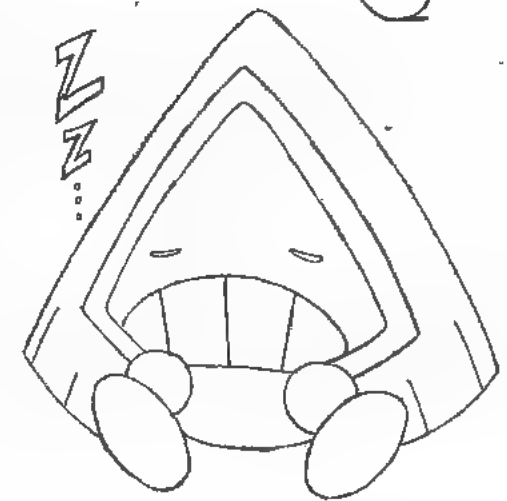

目(H)は
つきせん

☆歯は4枚、口は開きません

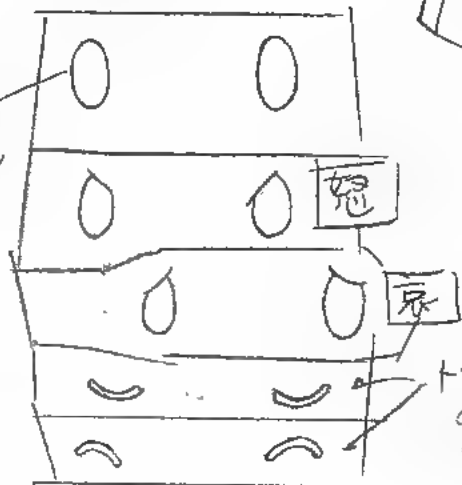

ト羽、三口目
色ハ

ユキワラシ

決定稿

2003.02.19 OK

ヌリワケ



とこ組

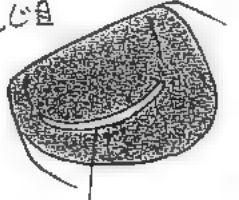

色下P

目玉



舌あり

※質感は白い部分氷
黒い部分岩



PMAG

オニゴーリ

2003.1.6

決定稿

2003 01.15 OK

※口は南肉するが
肉心りと噛み合わせの
ラインはみぞ厚くする

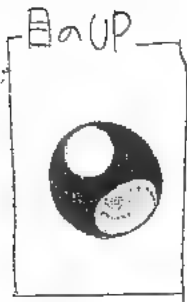

目のUP



穴の部分
凹んでる



やはり左右対照

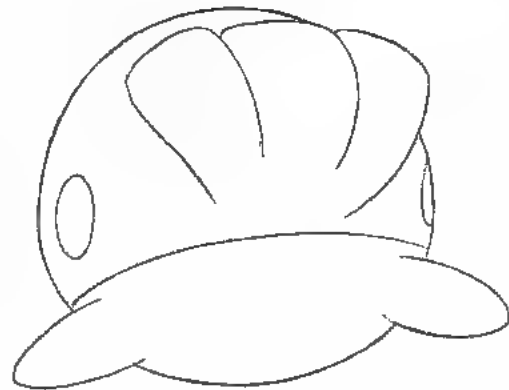
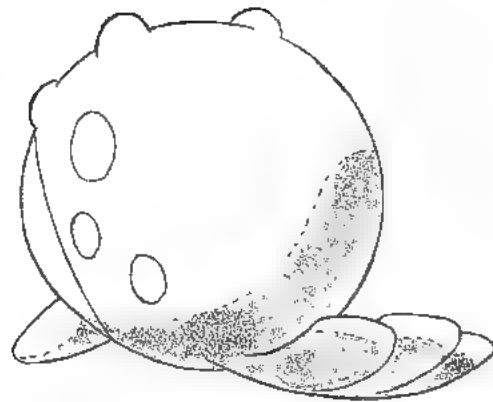

喜ぶ時平気な顔

2003.01.15ok

決定稿

PMAG
タマザラシ

2003.1.8



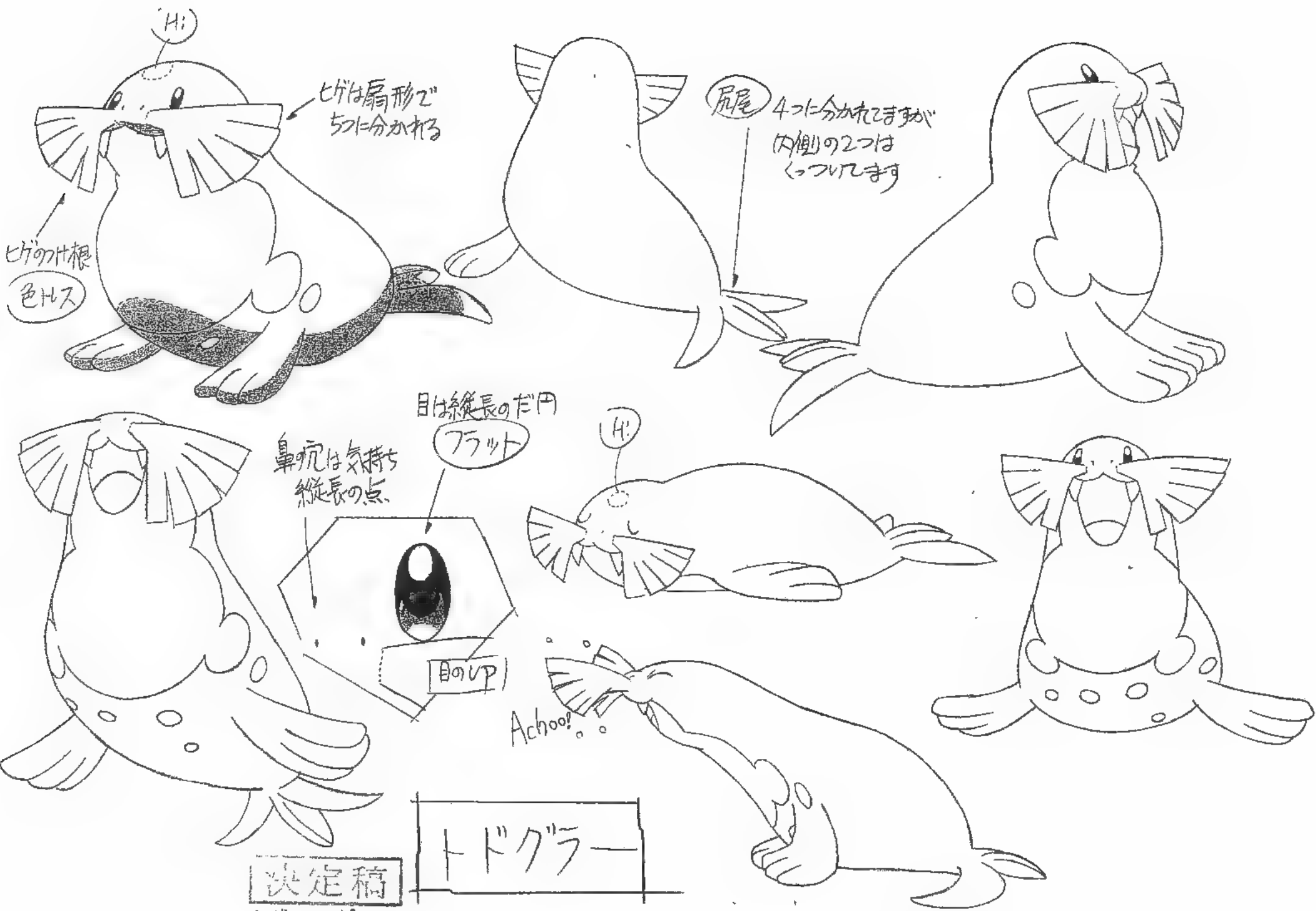

決定稿

2007.02.19 OK

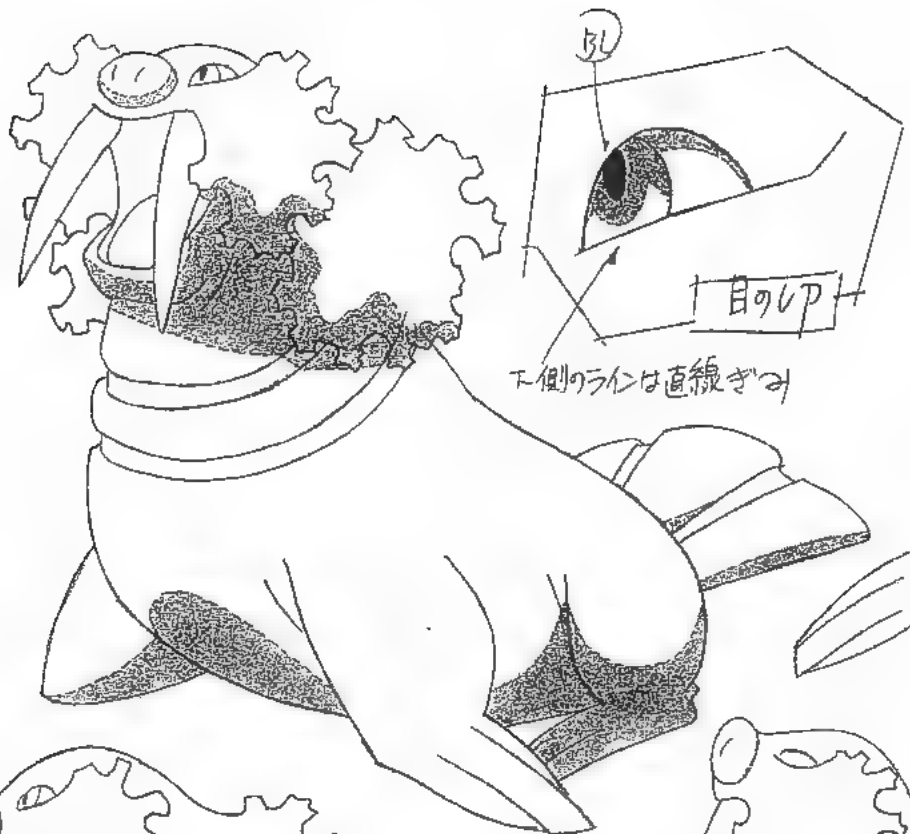

目のレリ
下側のラインは直線のみ



手足の指3本
人間のように
開くには
あわせん

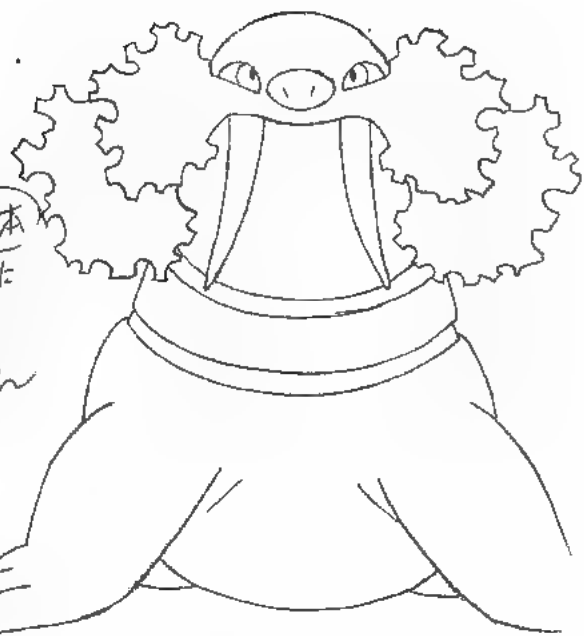

決定稿
2003.02.19 OK



溝は2本 表裏対称

トドゼルカ

殻の段差は5つ(上下とも)

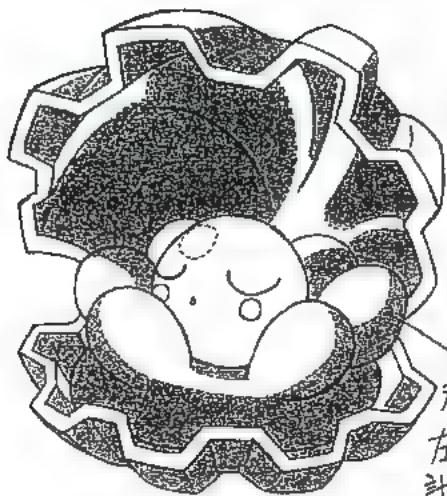

丸い出っ張り
左右3つずつ
計6つ
やわらかい

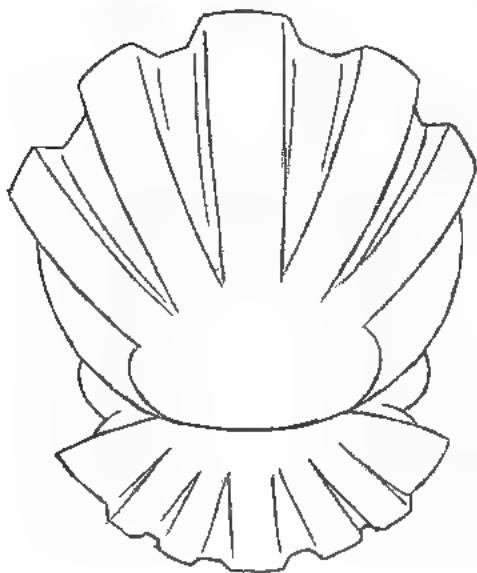
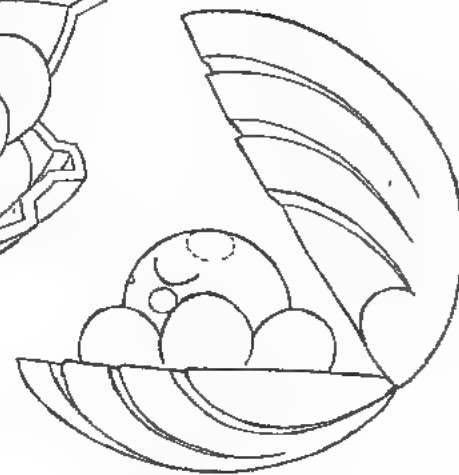
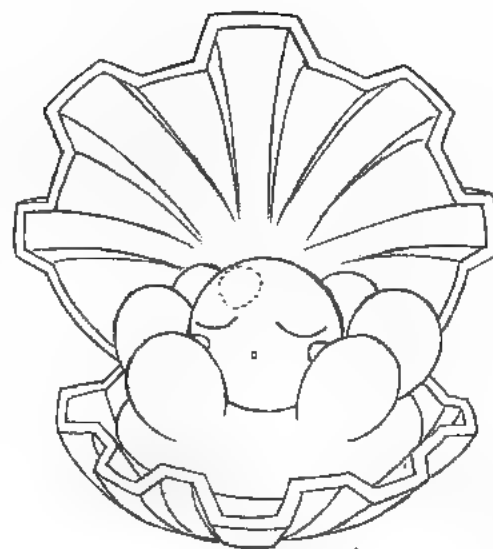
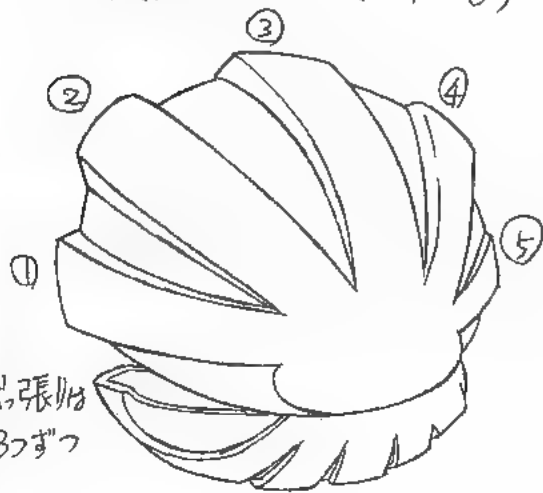

殻の形 上下で
違いますが

目はラインです
開きません

(H)色は

ほっぺ(更線)

※顔は体から
取ることはあつせん

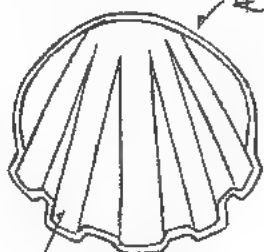

下面



上面

下側の殻は上側より
殻の厚み分小さい

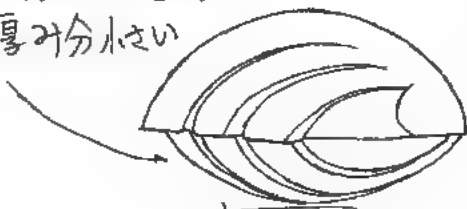

側面

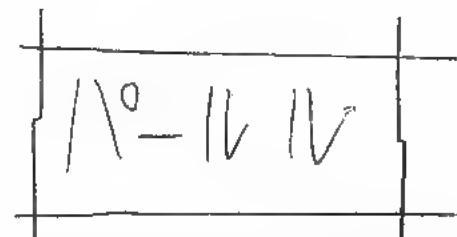

決定稿

2003
02月
03日

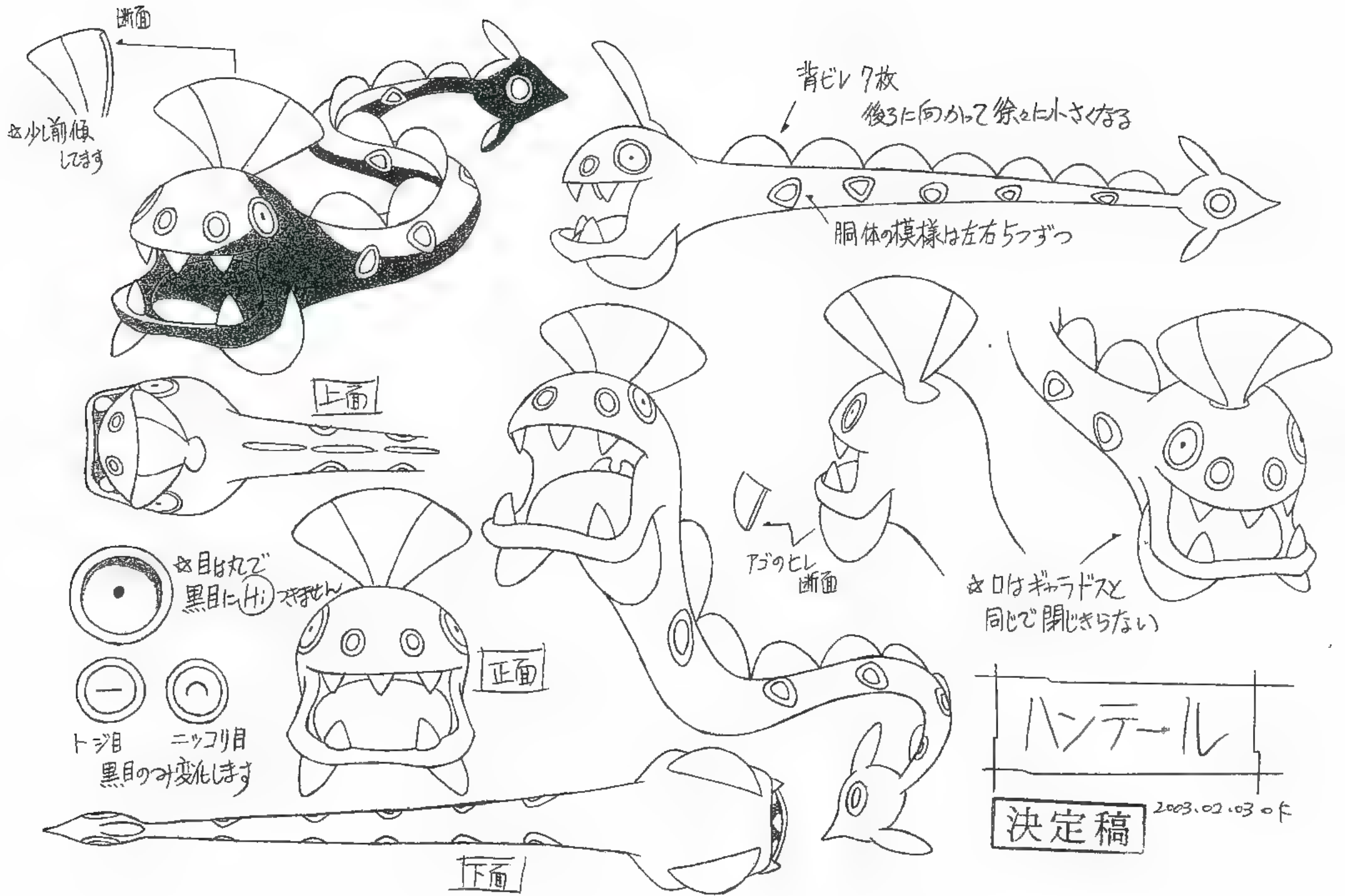

断面

☆少し前傾
しています

背ビレ7枚
後3に向けて徐々に小さくなる

胴体の模様は左右ちがう

上面

正面

アゴのヒレ
断面

☆口はギョラドスと
同じで閉じきらない

☆目は丸で
黒目にヒビが入ると

トジ目 ニッコリ目
黒目のみ変化します

下面

ハンテール

決定稿 2003.02.03 of

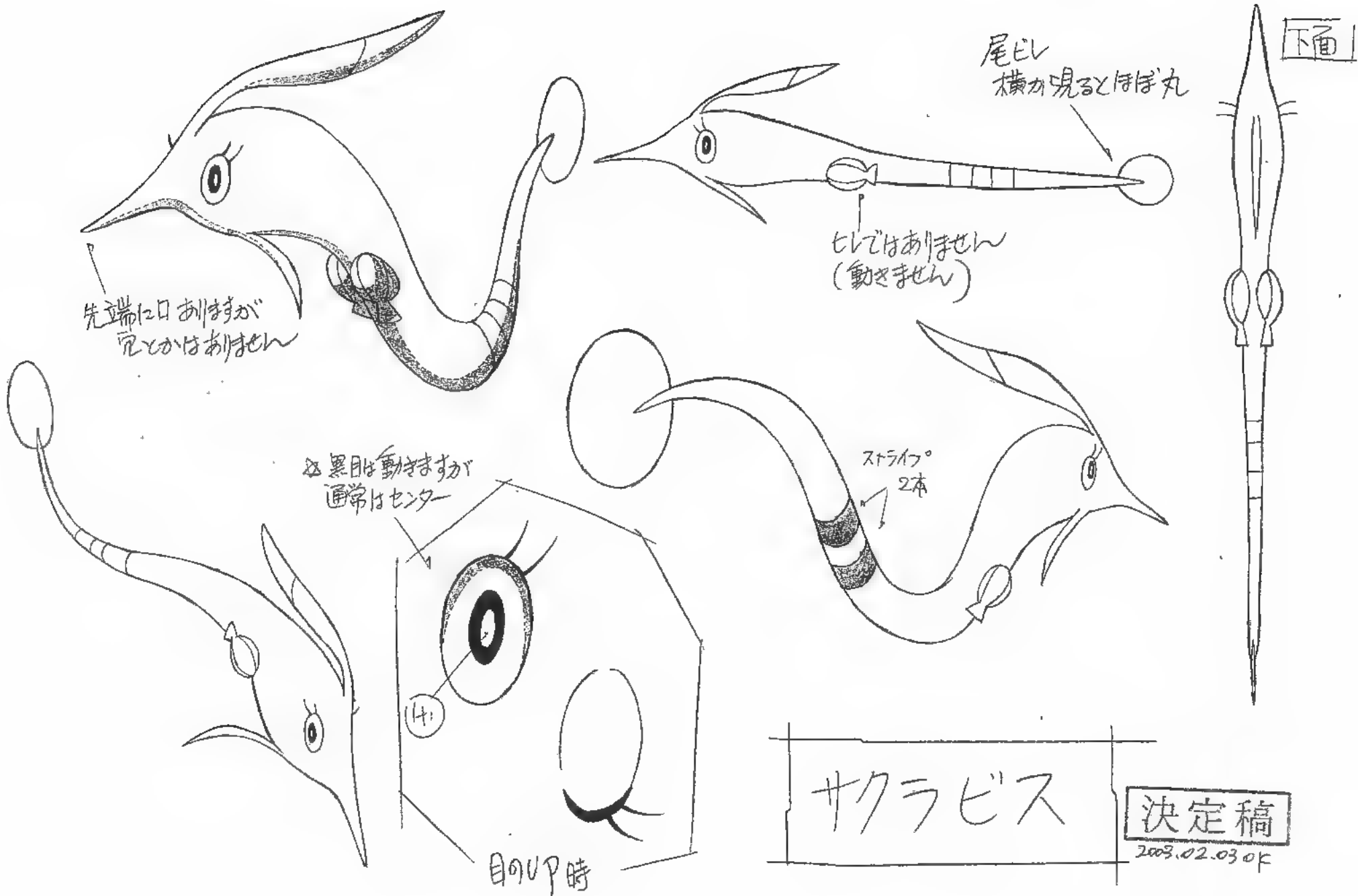

サクラビス

決定稿

2003.02.03 OK

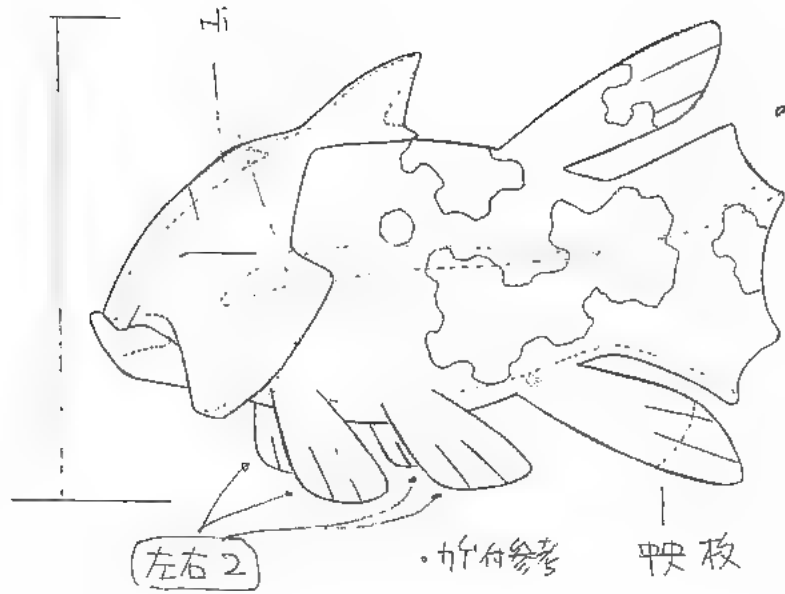

体の模様は
左右対称

基本の動きは遅い
の、尾を動かす

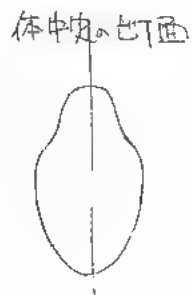
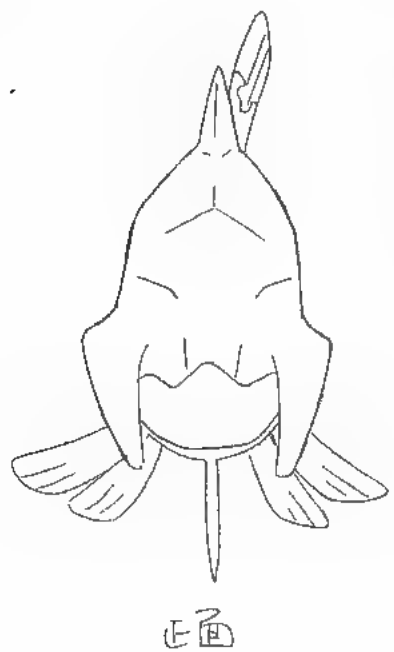
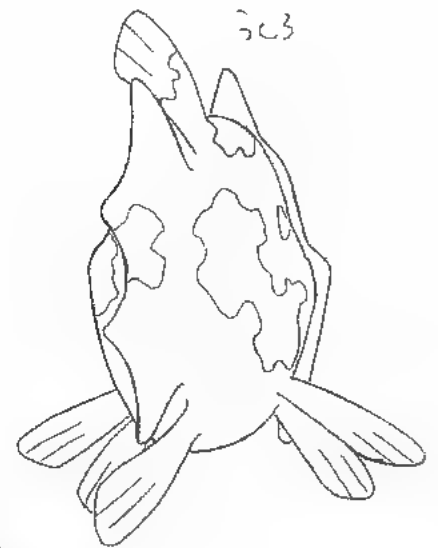

PMAG
ゾーランス

2002.9.21

決定稿

2002.10.04 OK

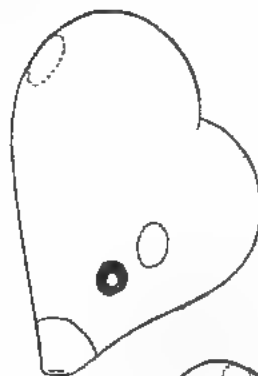
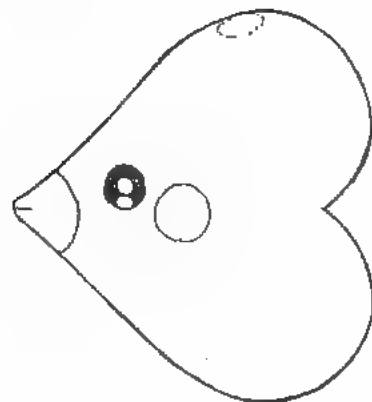
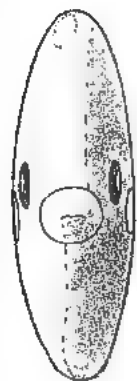
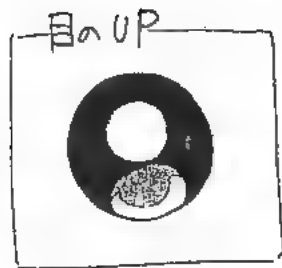
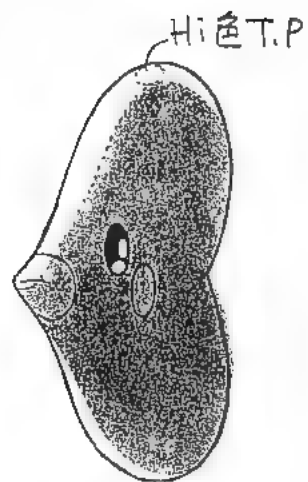

3L3



←PMAG
ラブカス

決定稿

2003.1.8

2003.01.22 OK

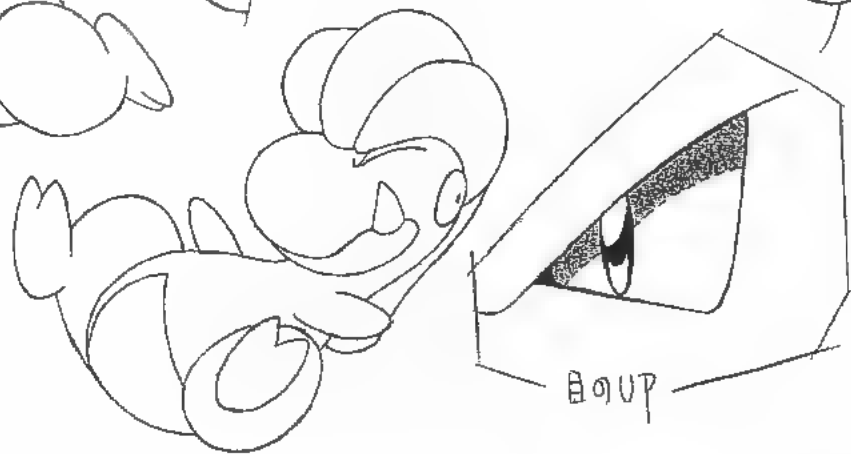
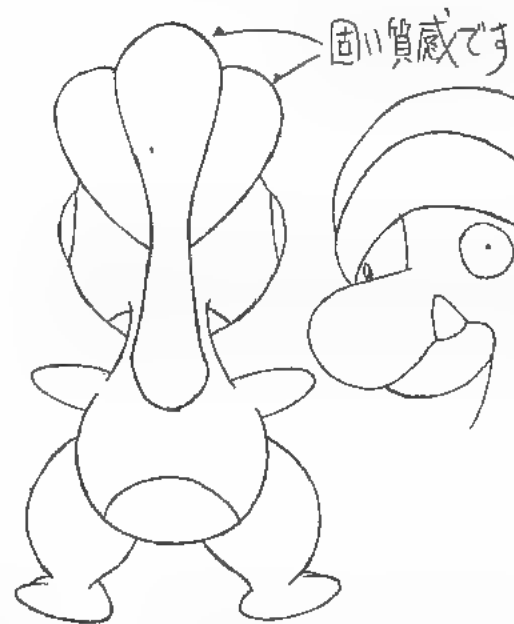
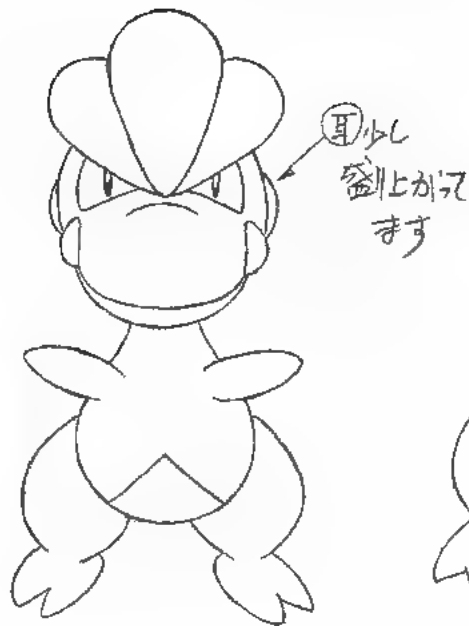

タツベイ	2003.02-03 OK
	決定稿

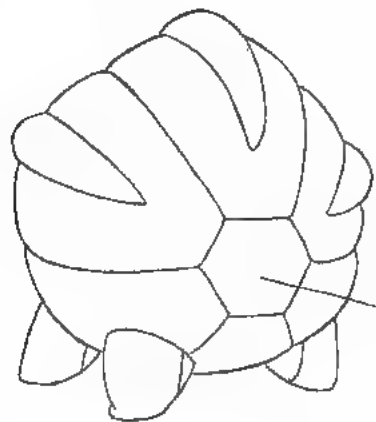
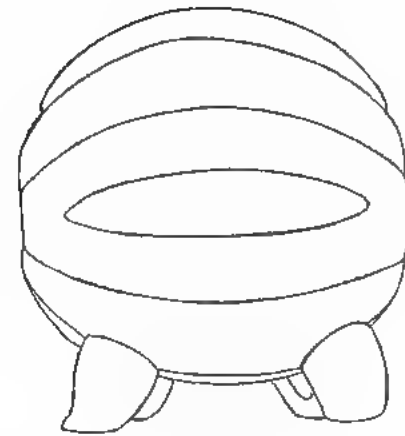
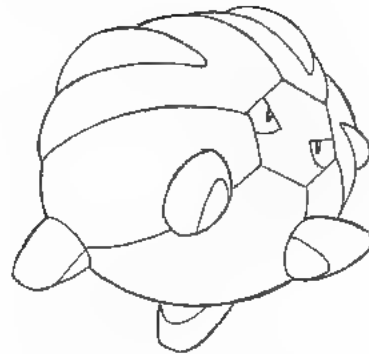
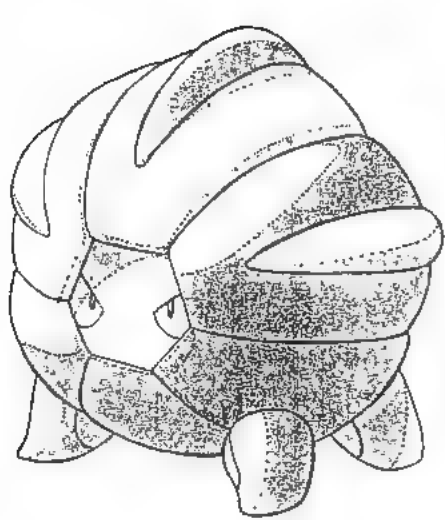

うしろ

1段へこんでます。
カオと同じかんじ

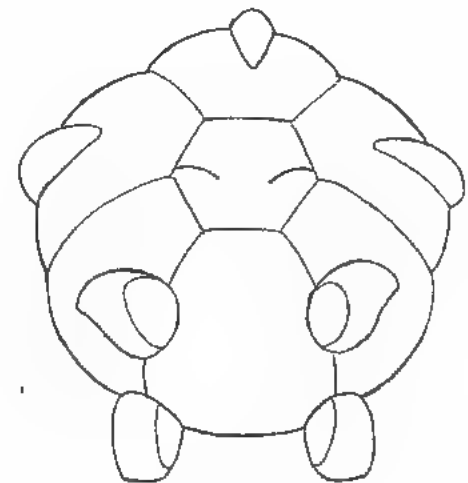

PMAG

コモルー

2002.11.26.

決定稿

2002.12.10 OK

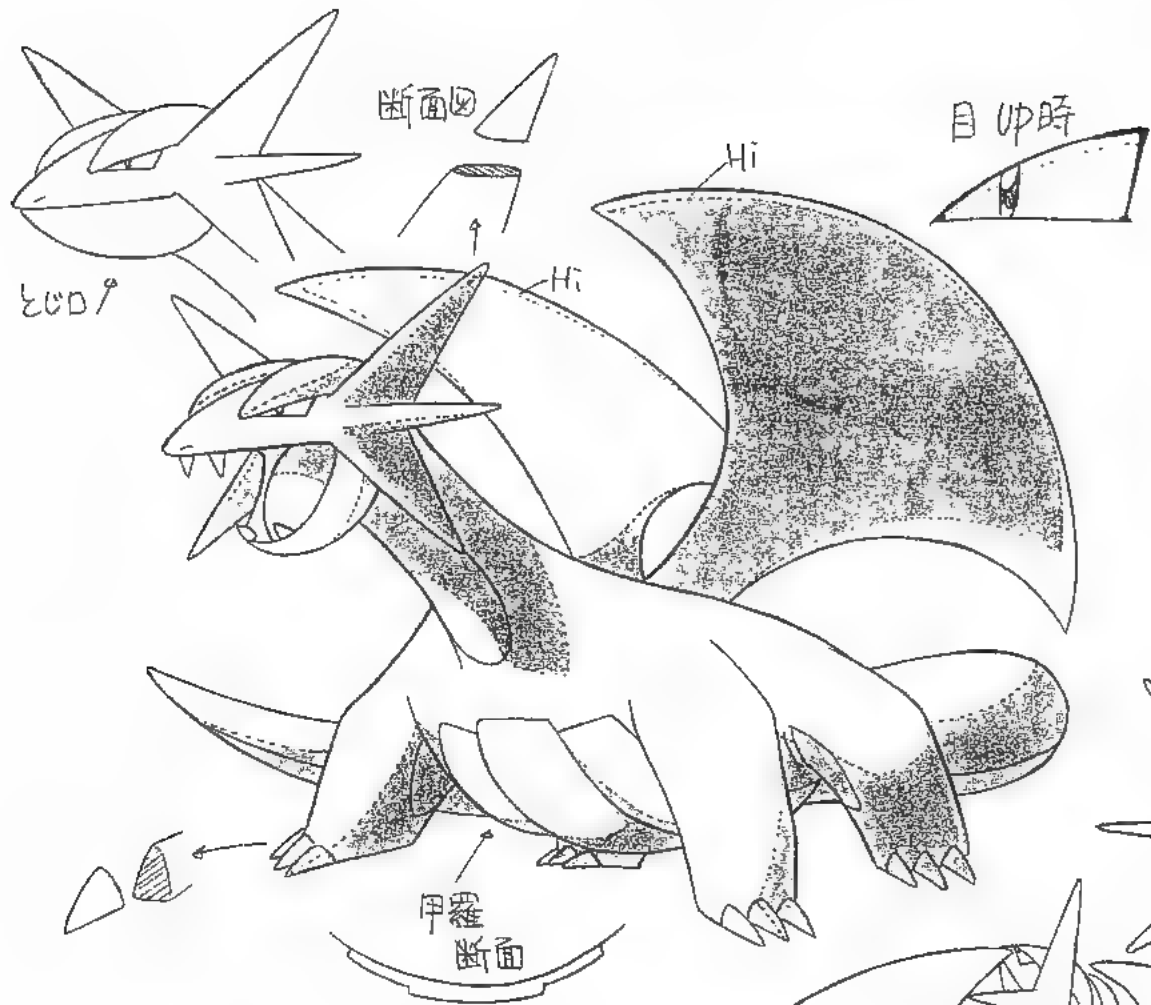

○背中は
わりと平ら。

PMAG

ボーマンタ

決定稿

2002.11.26.

2002.12.10 OK

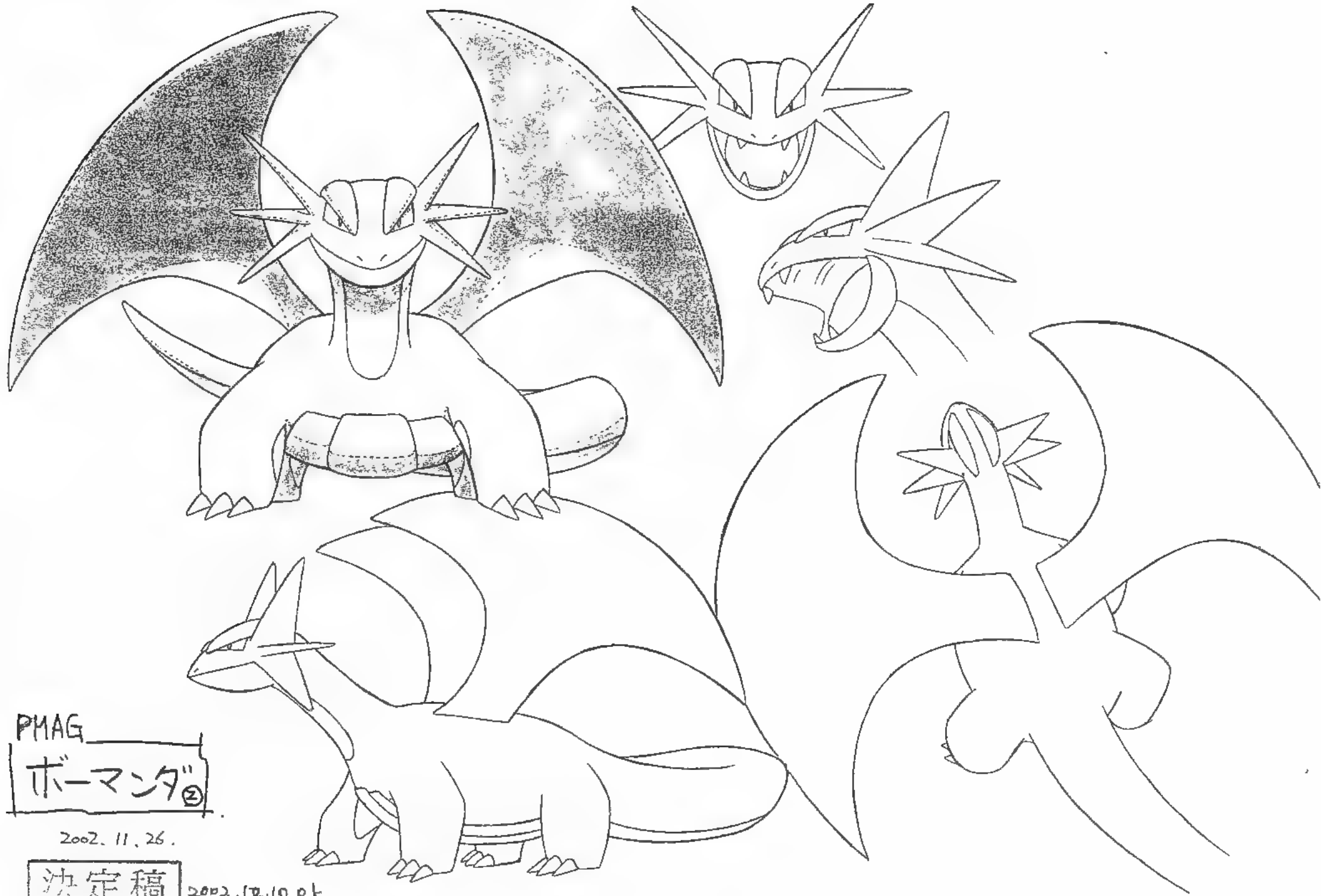

PMAG

ボーマンTM

2002. 11. 26.

決定稿

2002. (12.10) OK

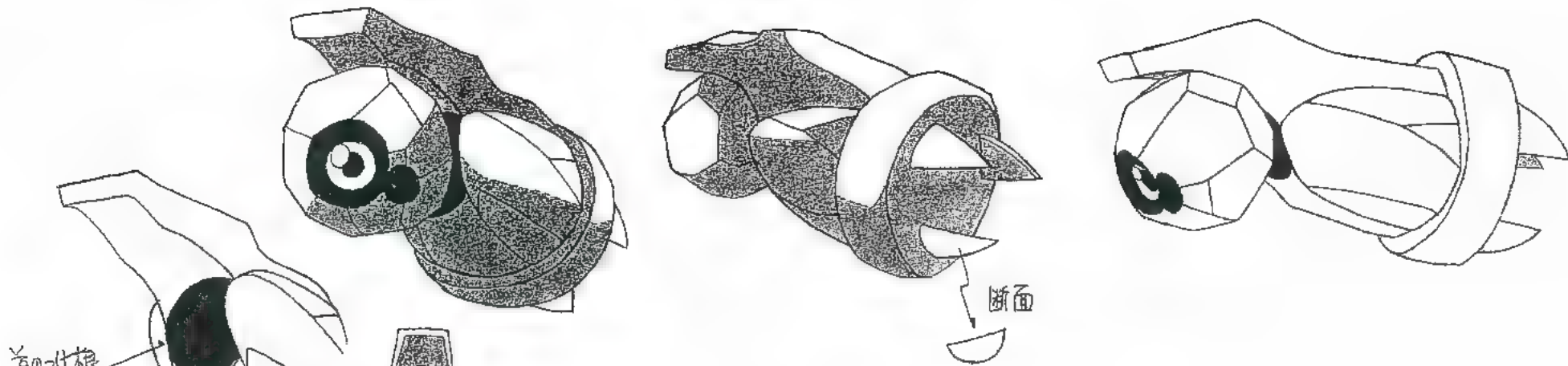

首の付け根
(BL)

断面



首は上下左右に
動きます

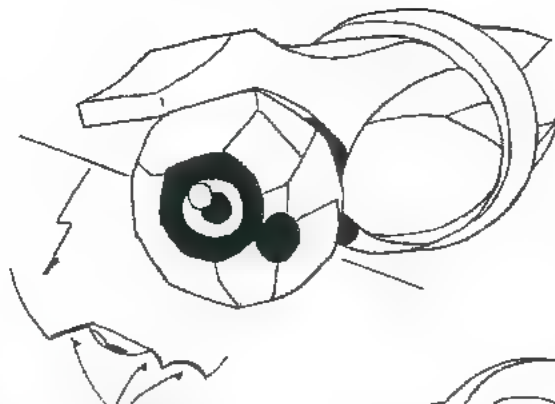

黒い部分が
凹んでいます

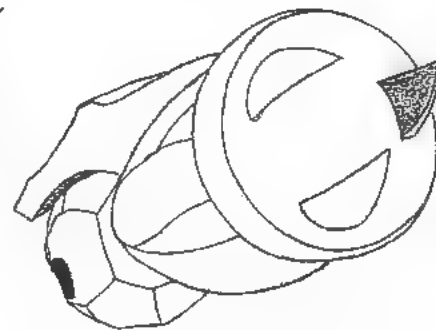
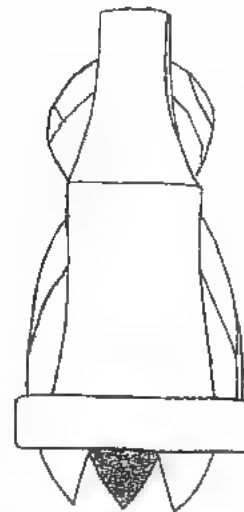
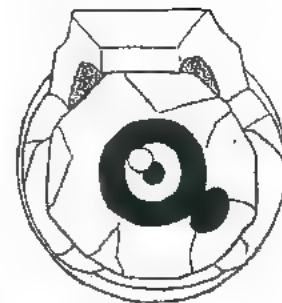

目は大きい丸の中だけで
動きます

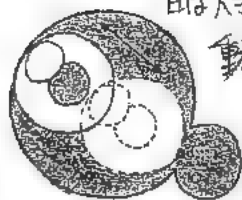

☆右の3つの目は
色が入らず

トジ目

ニッコリ目

グルグル目
(回転はしません)

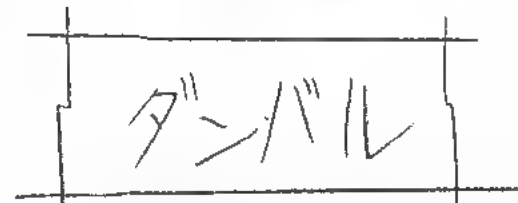

決定稿

2003.02.03 OK
02.17 改正

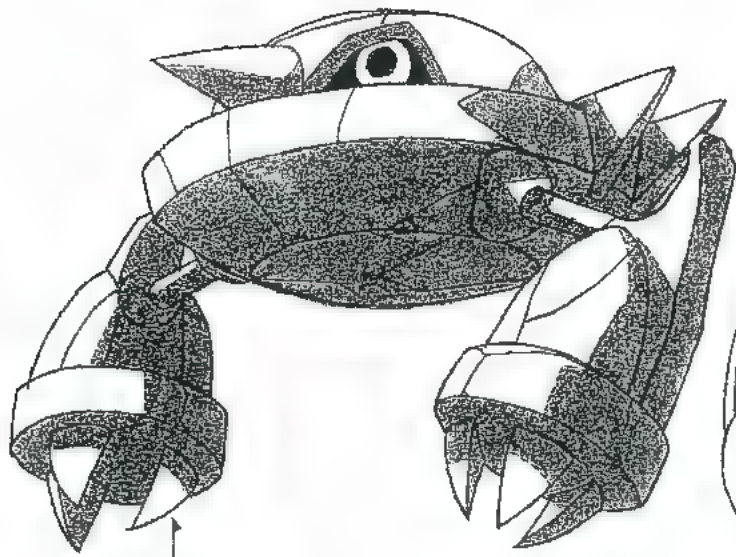

ツノの断面



ツノ
開閉はす

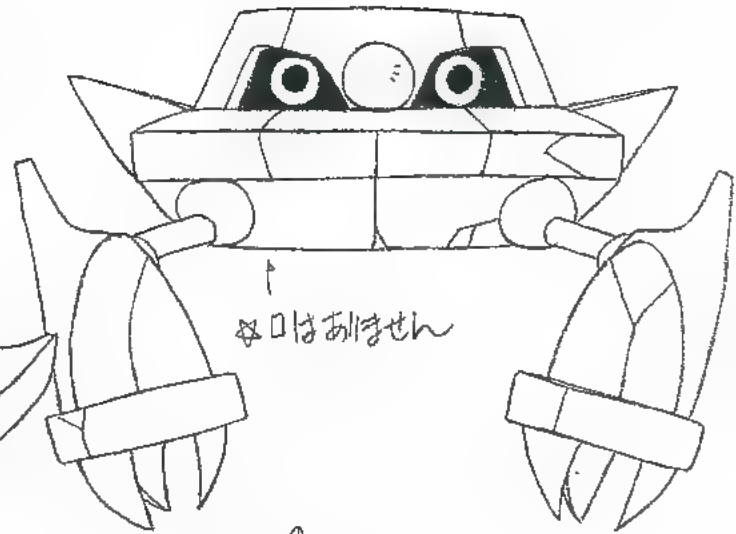

※口はあきせん

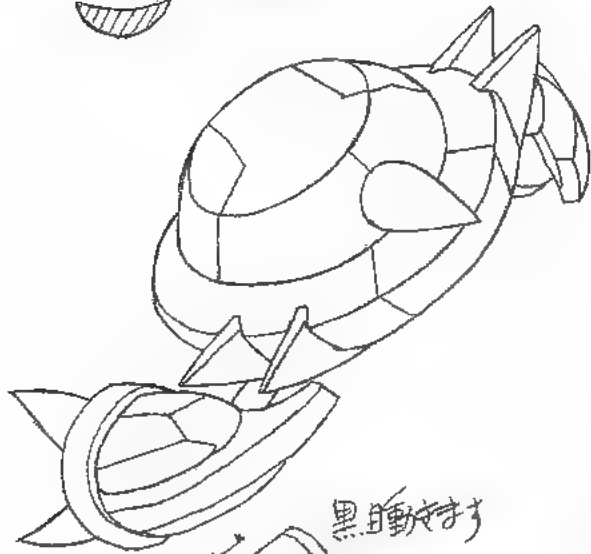

黒睡袋はす

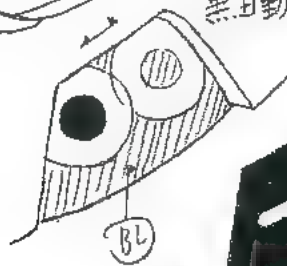

BL



ト涙色はす

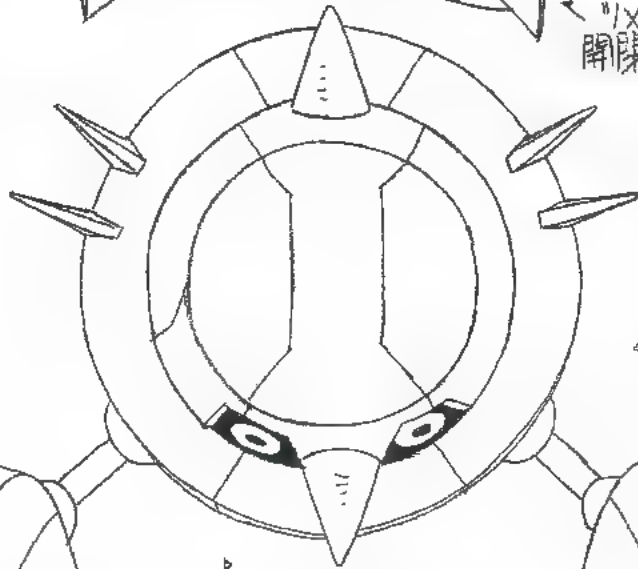

宙に浮かび移動
地面に降下時の
お腹を着く

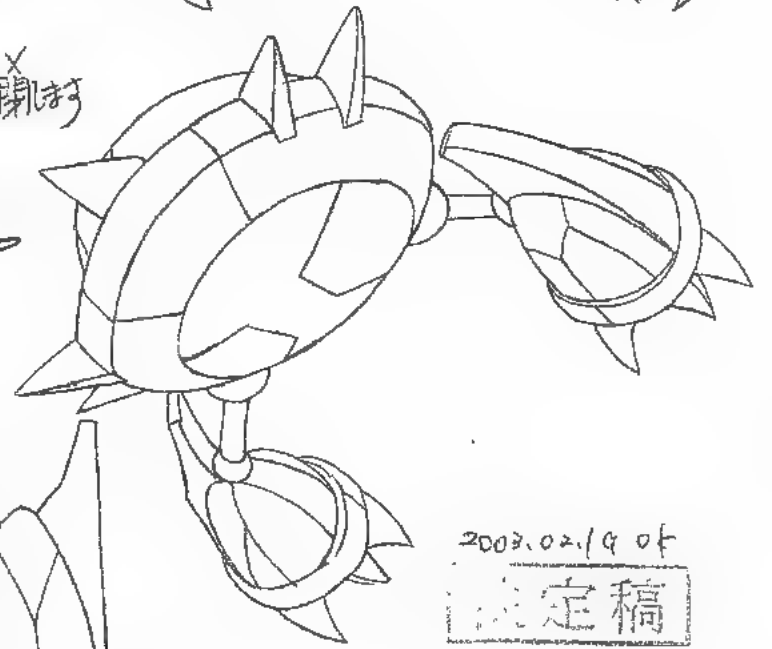

2003.02.19 付

決定稿

Xターク

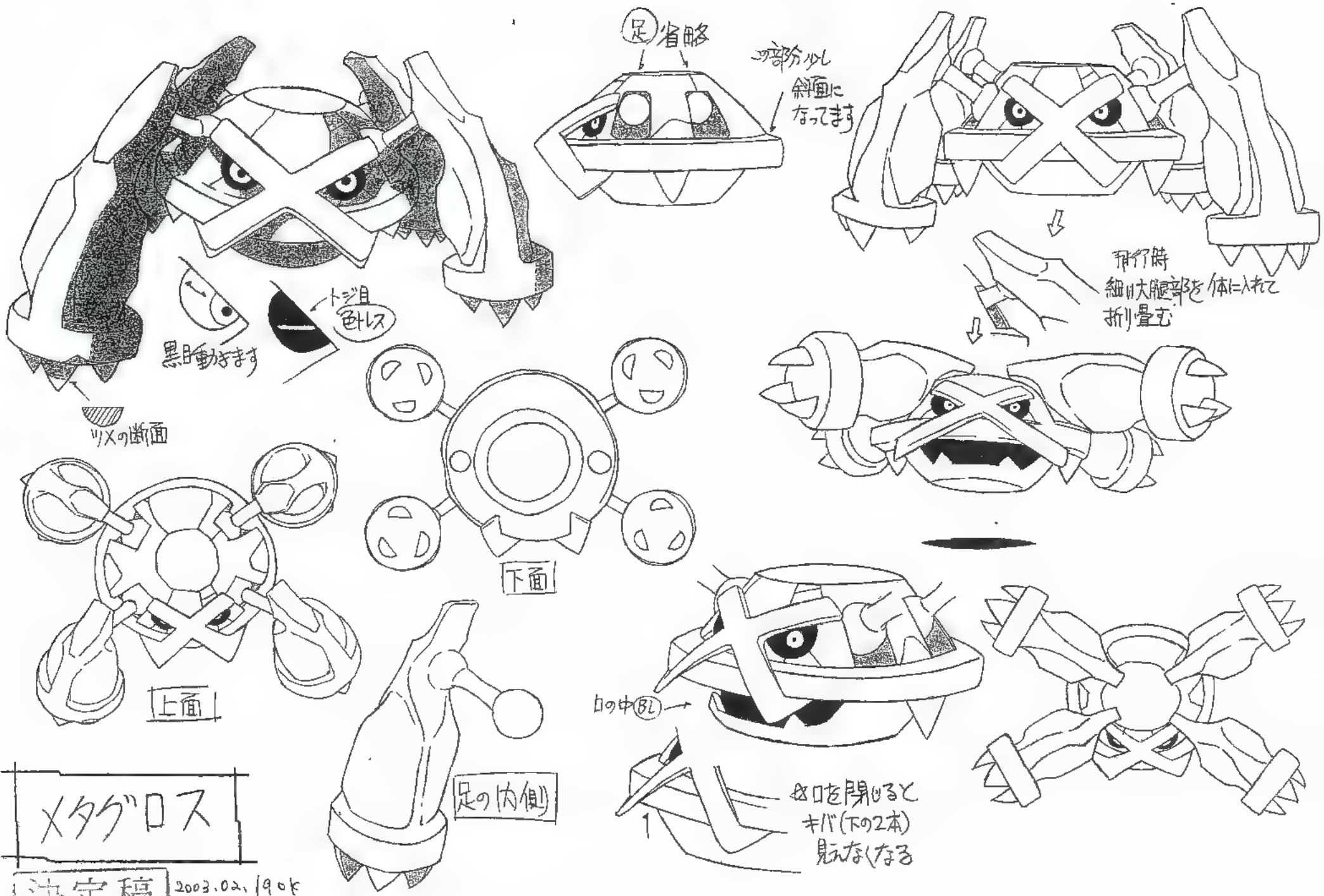

メタクロス

決定稿 2003.02.19 OK

目は7つ. 閉じない
 両肩色落ち

母体の表面のゴツゴツの
 細部の形は
 おろそかに
 アバウト
 OK.

身体の色落ちの部分は
 ・左胸
 ・右腰
 ・左右の肘
 の3ヶ所

この3ヶ所
 色落ち

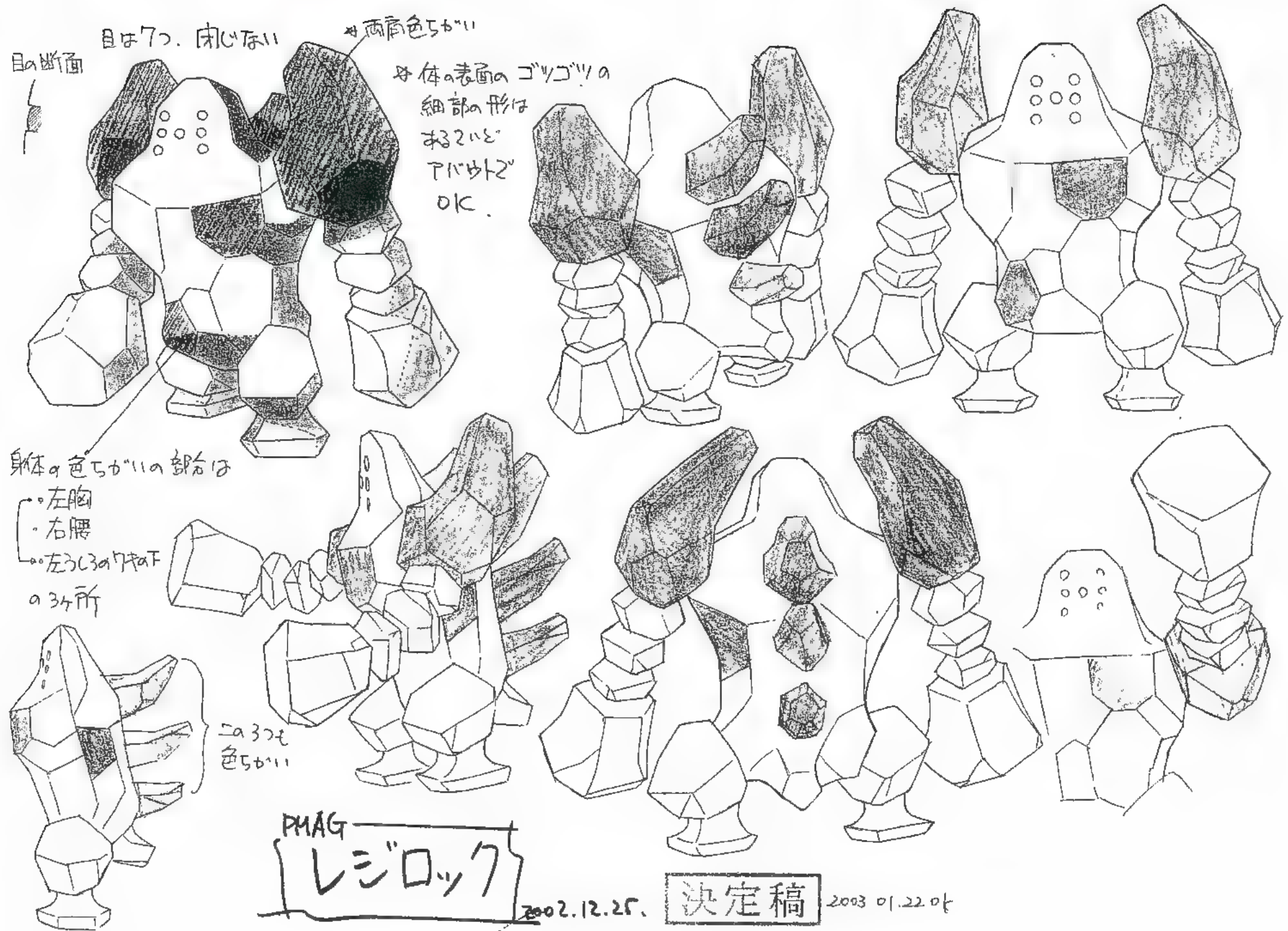

PMAG
レジロック

2002.12.25.

決定稿

2003 01.22.04

3色で立体を表現

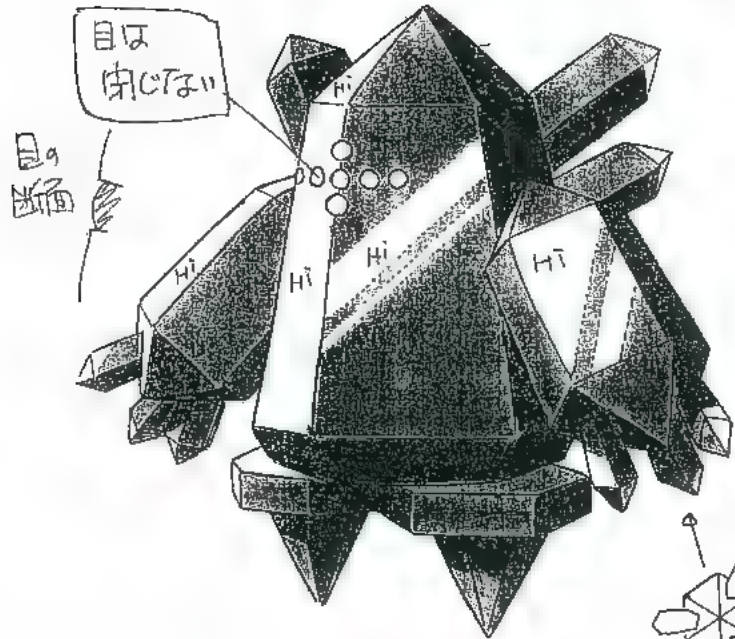

六角錐の先が
肩関節です

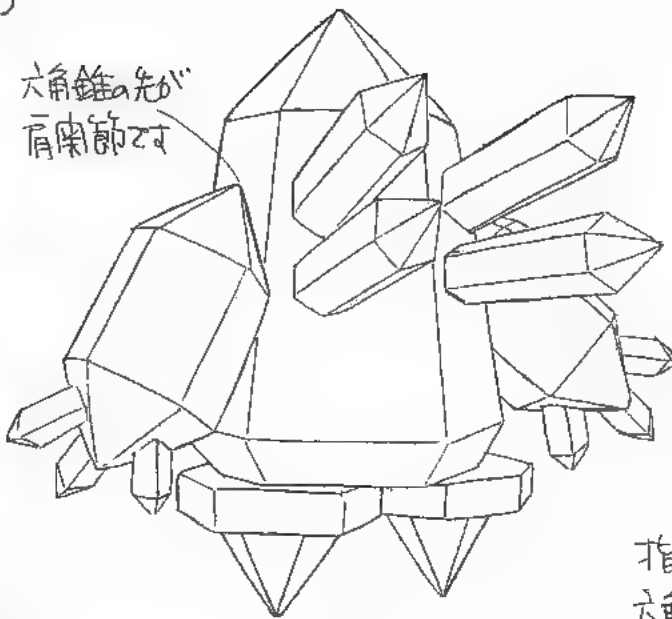

指は可動
六角柱+六角錐

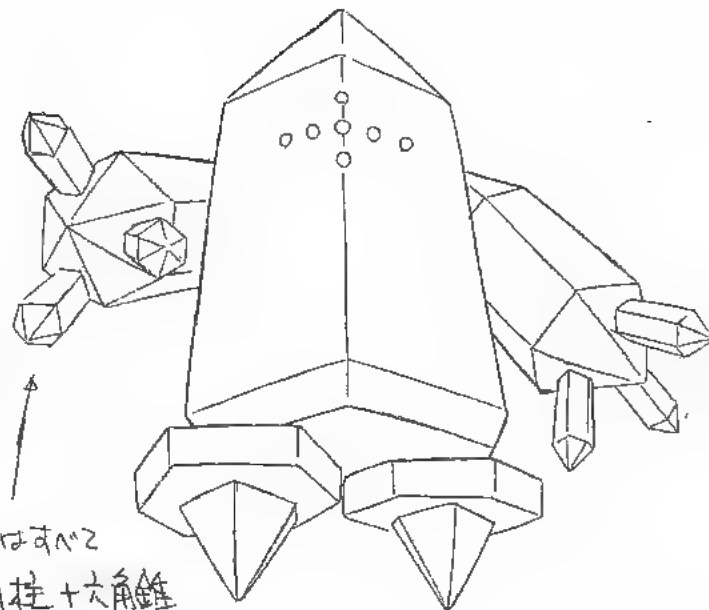

↑
4x4位置

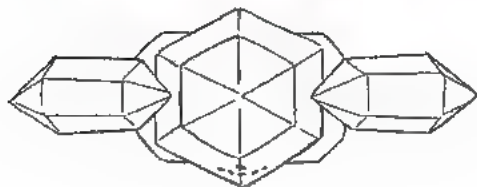

・ 上から

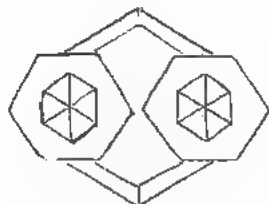

・ 下から

PMAG

レジアイス

2002. 12. 26

決定稿

2003. 01. 15 OK

手の動かし時は
滑るように
動く
足はほとんど
動かし

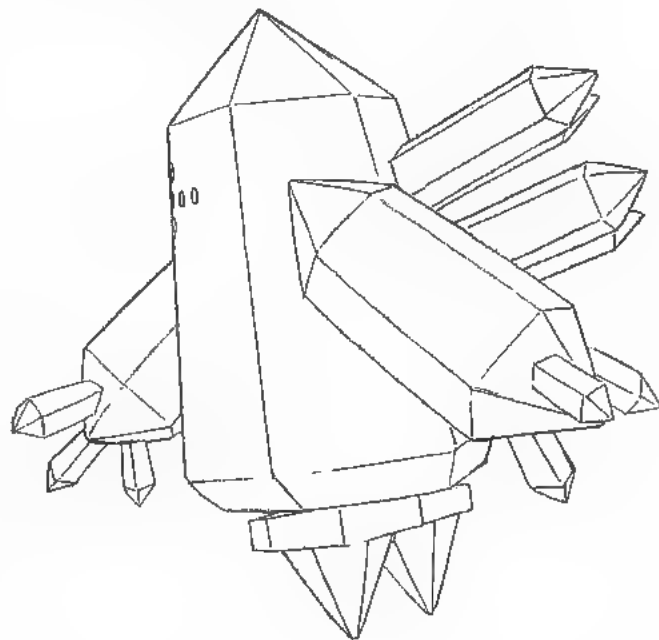

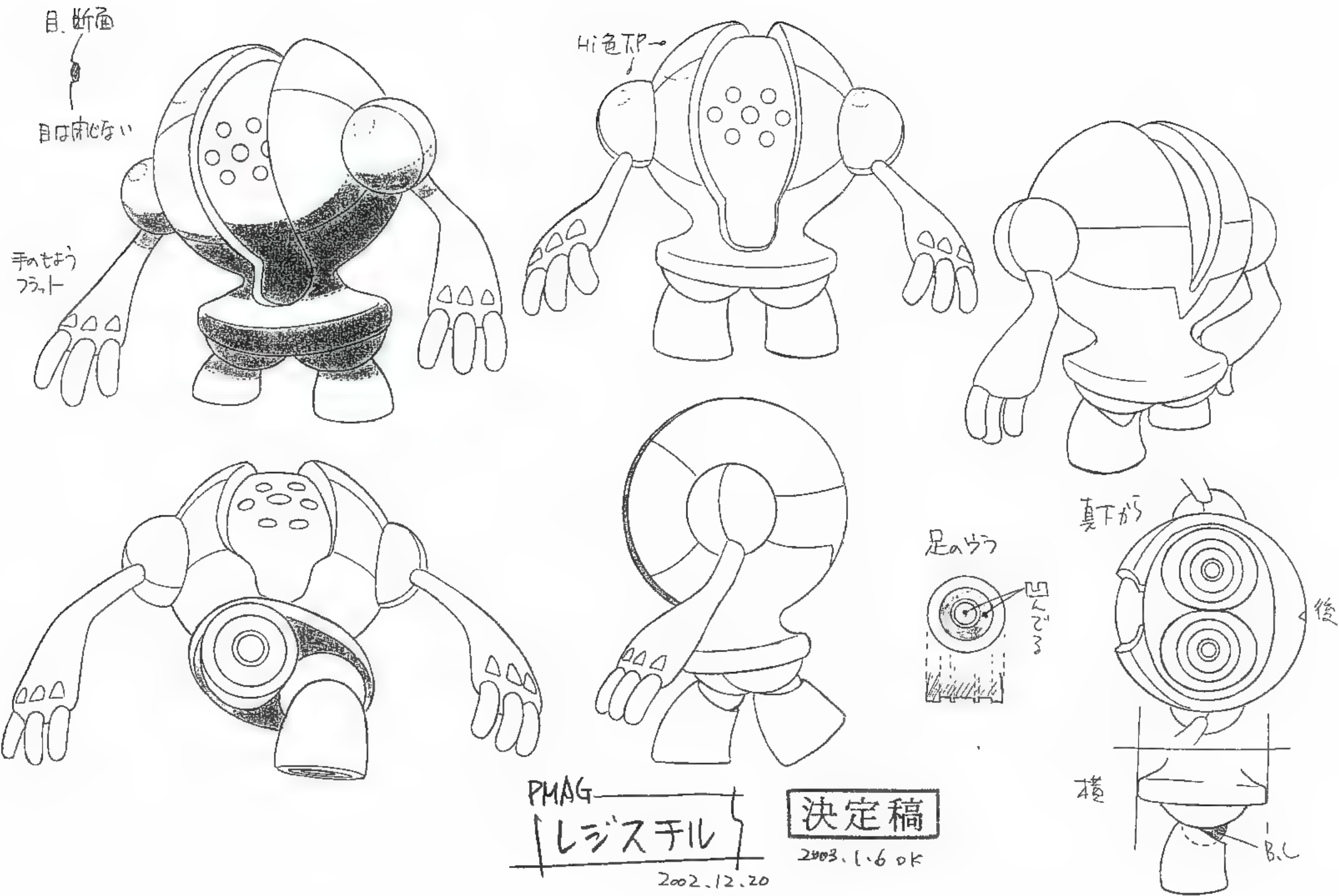

PMAG
レジスチル
2002.12.20

決定稿
2003.1.6 OK

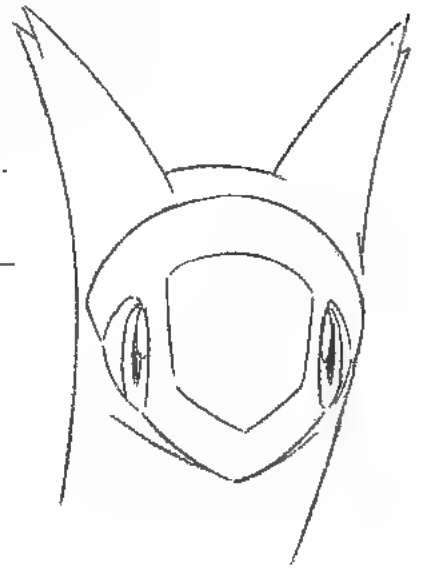
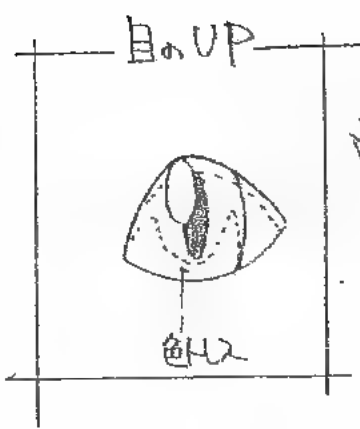
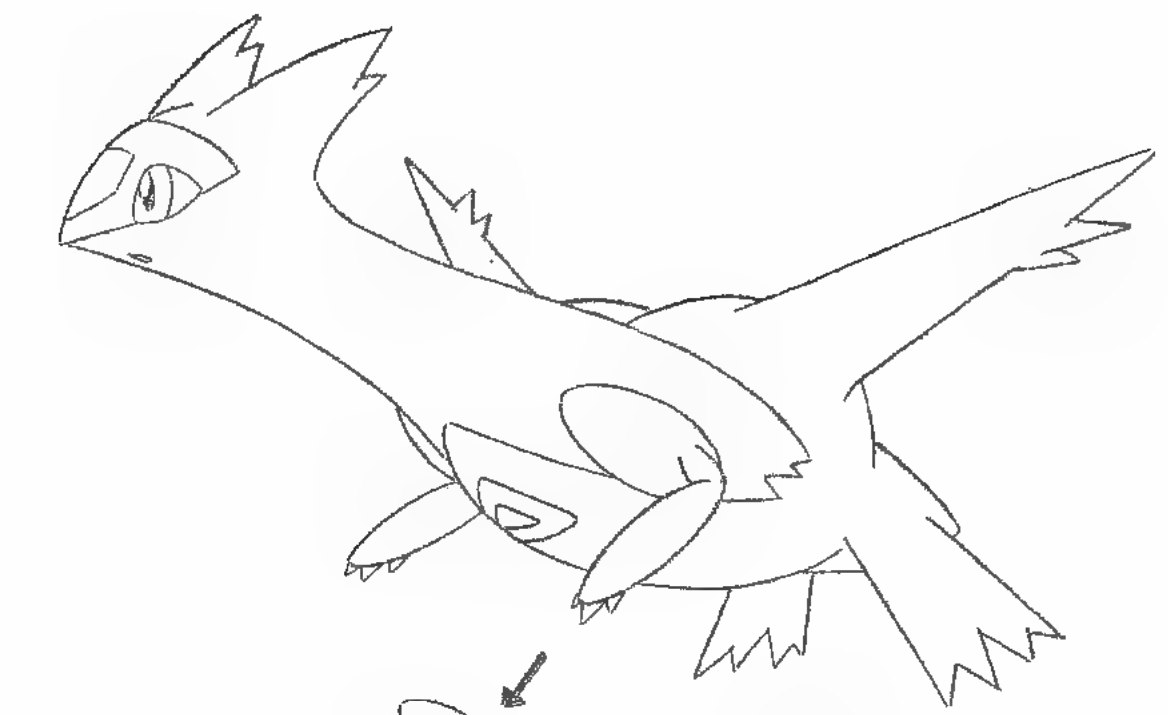

• ウデを反して高速飛行

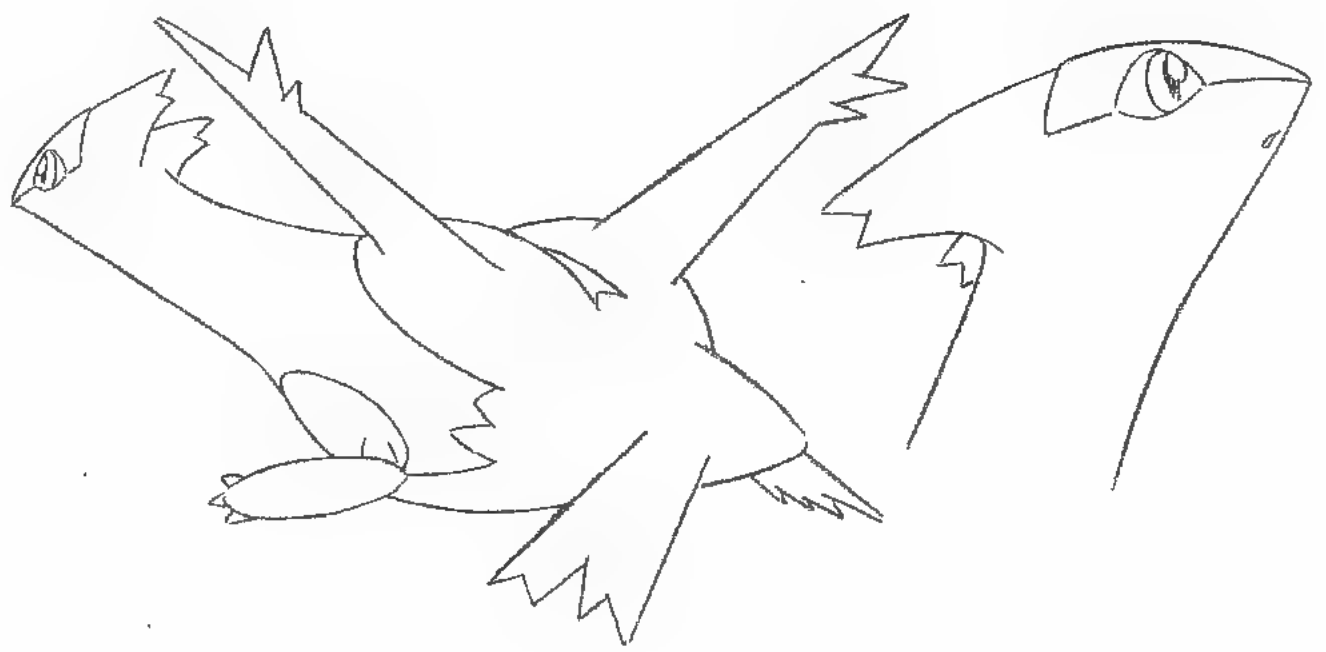

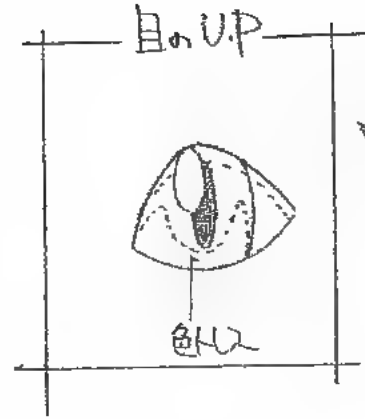
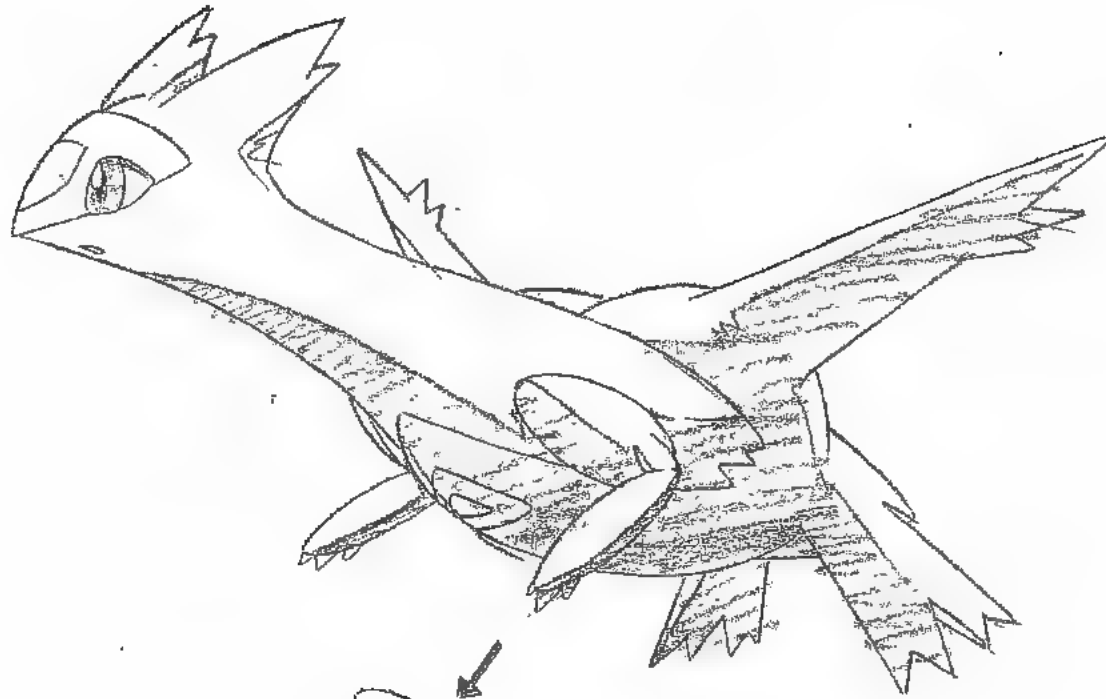

ウツカバと高速飛行

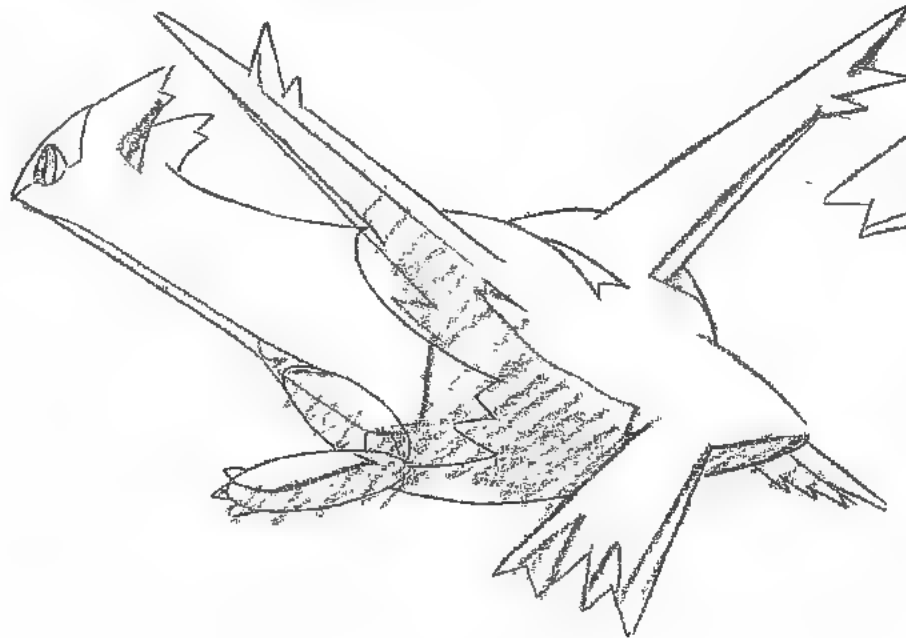

ラティス①
影付

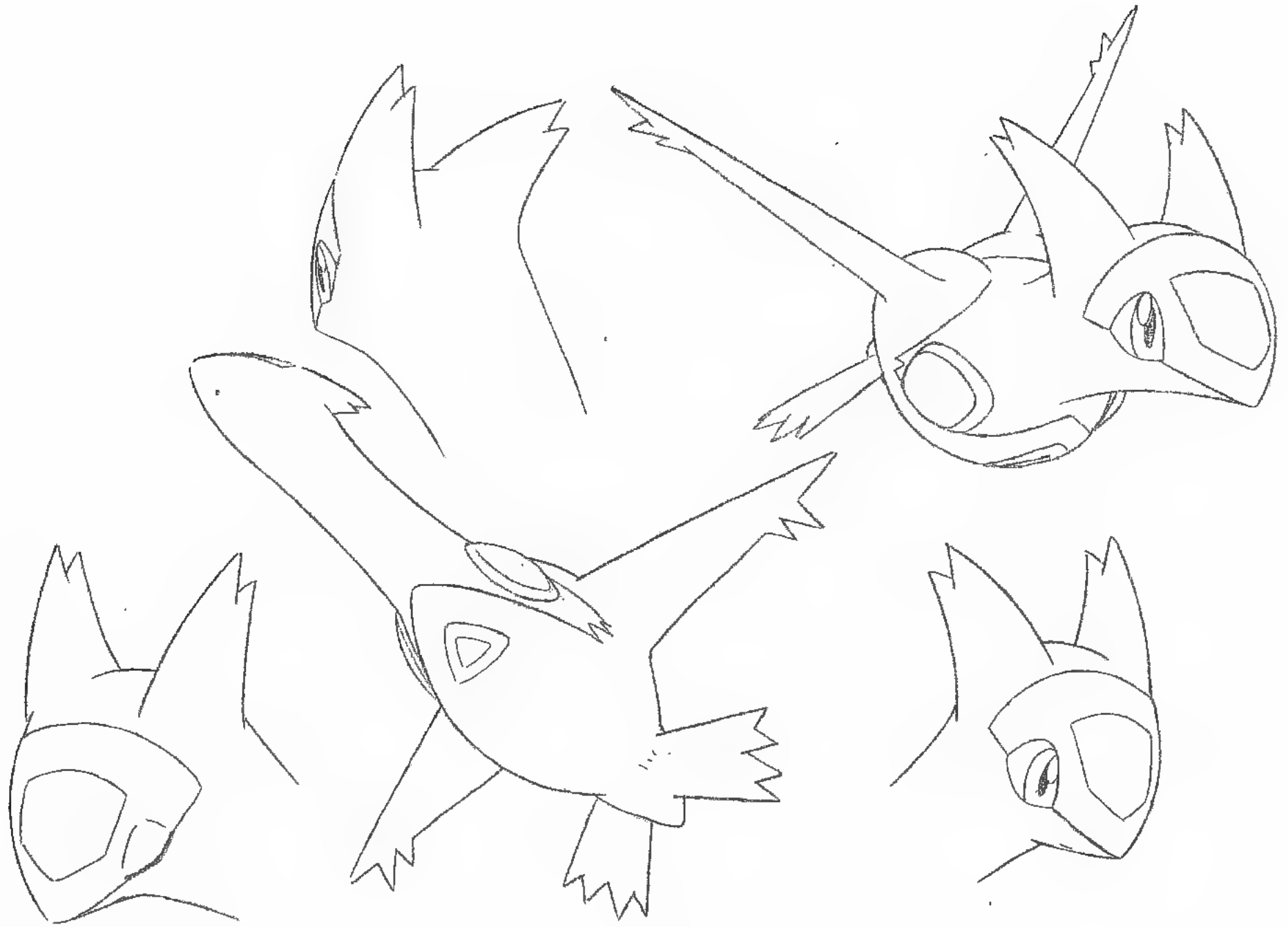

ラティアス ③

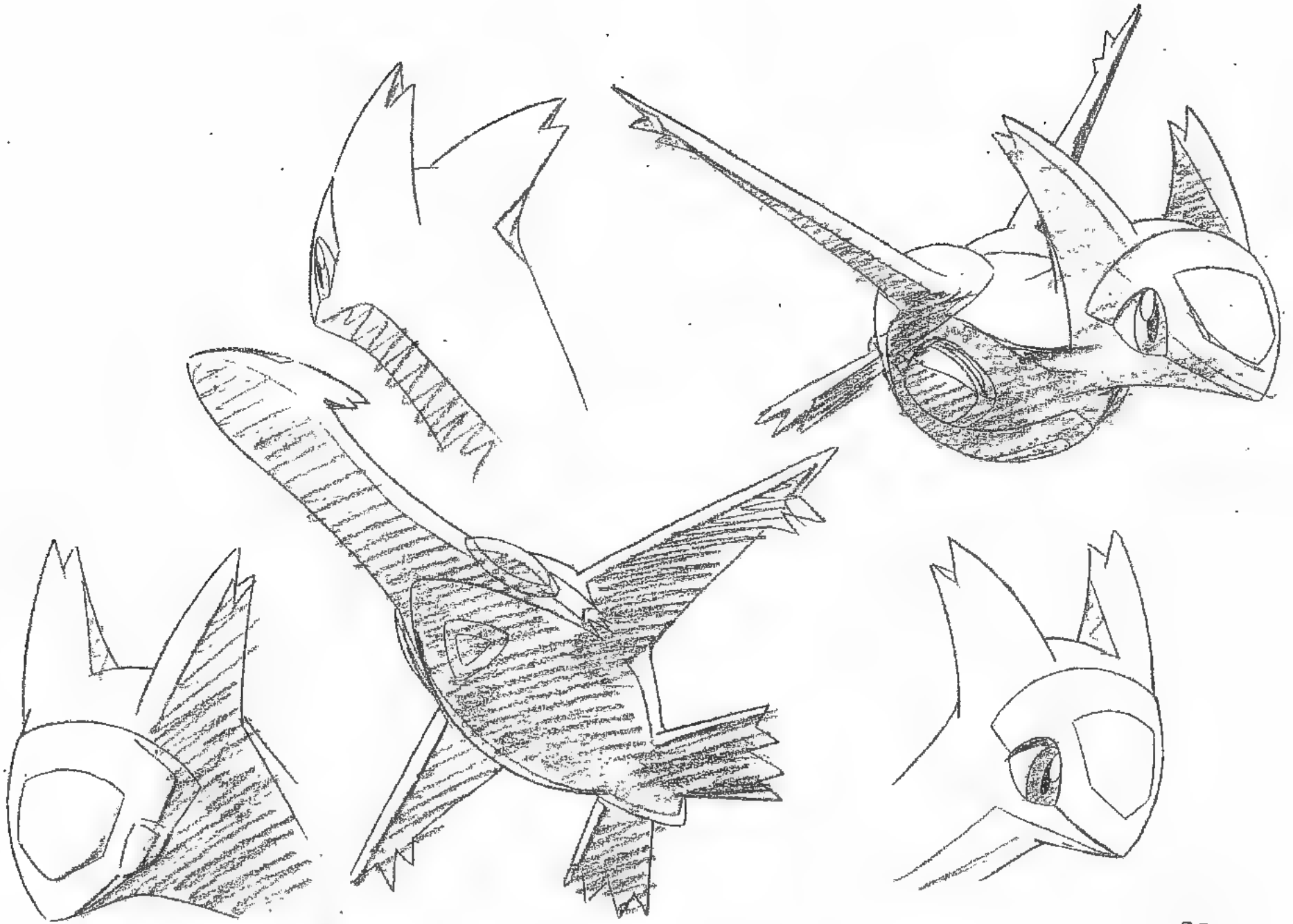

ラティス②
影付

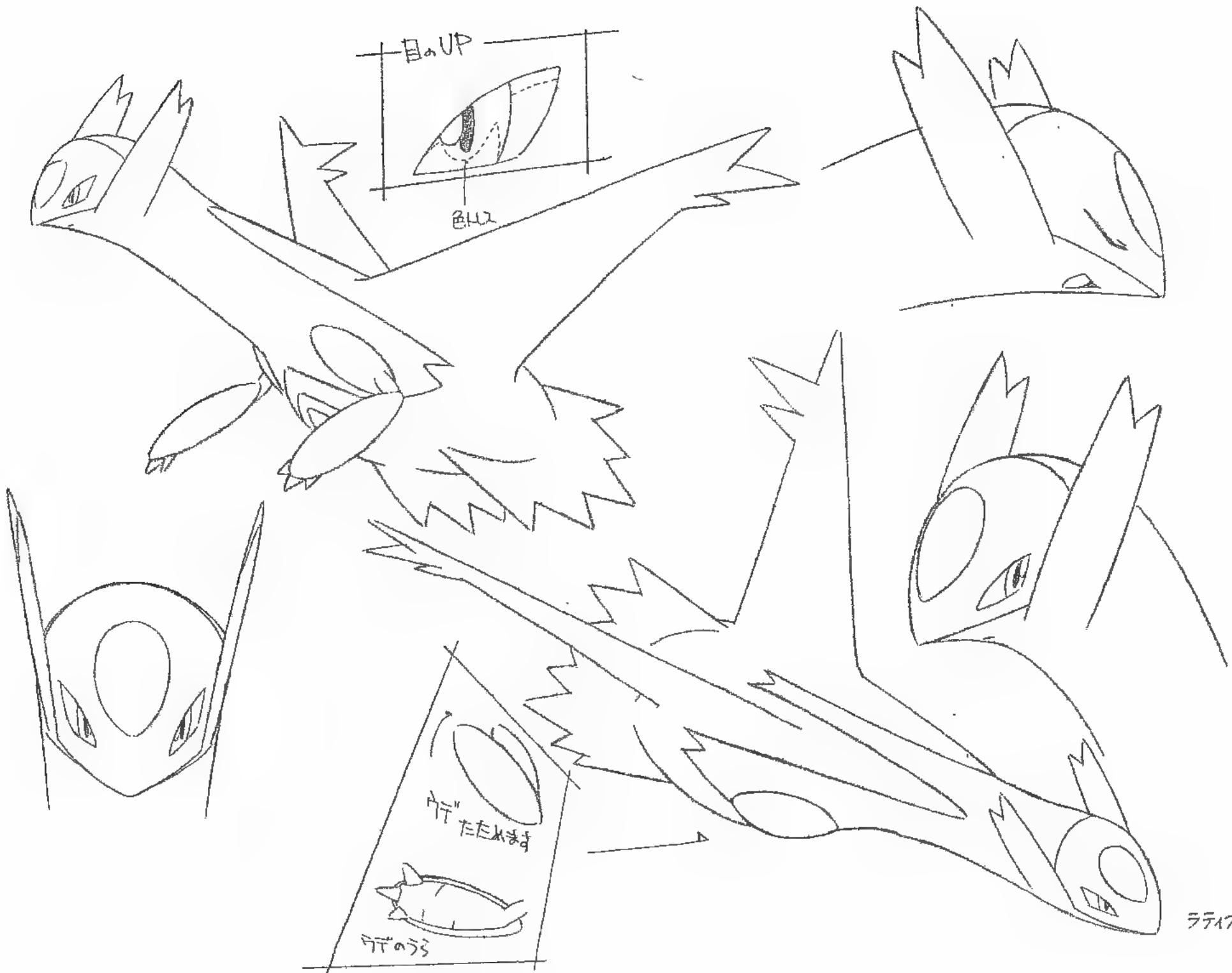

目UP
色UP

色UP

アト
アトのうろ

アトのうろ

ラティオス①

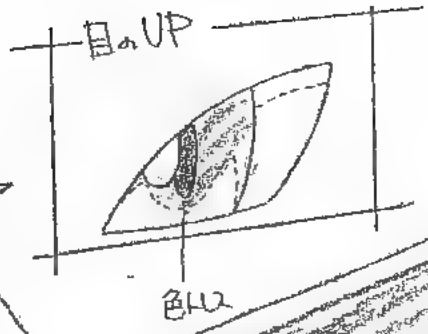
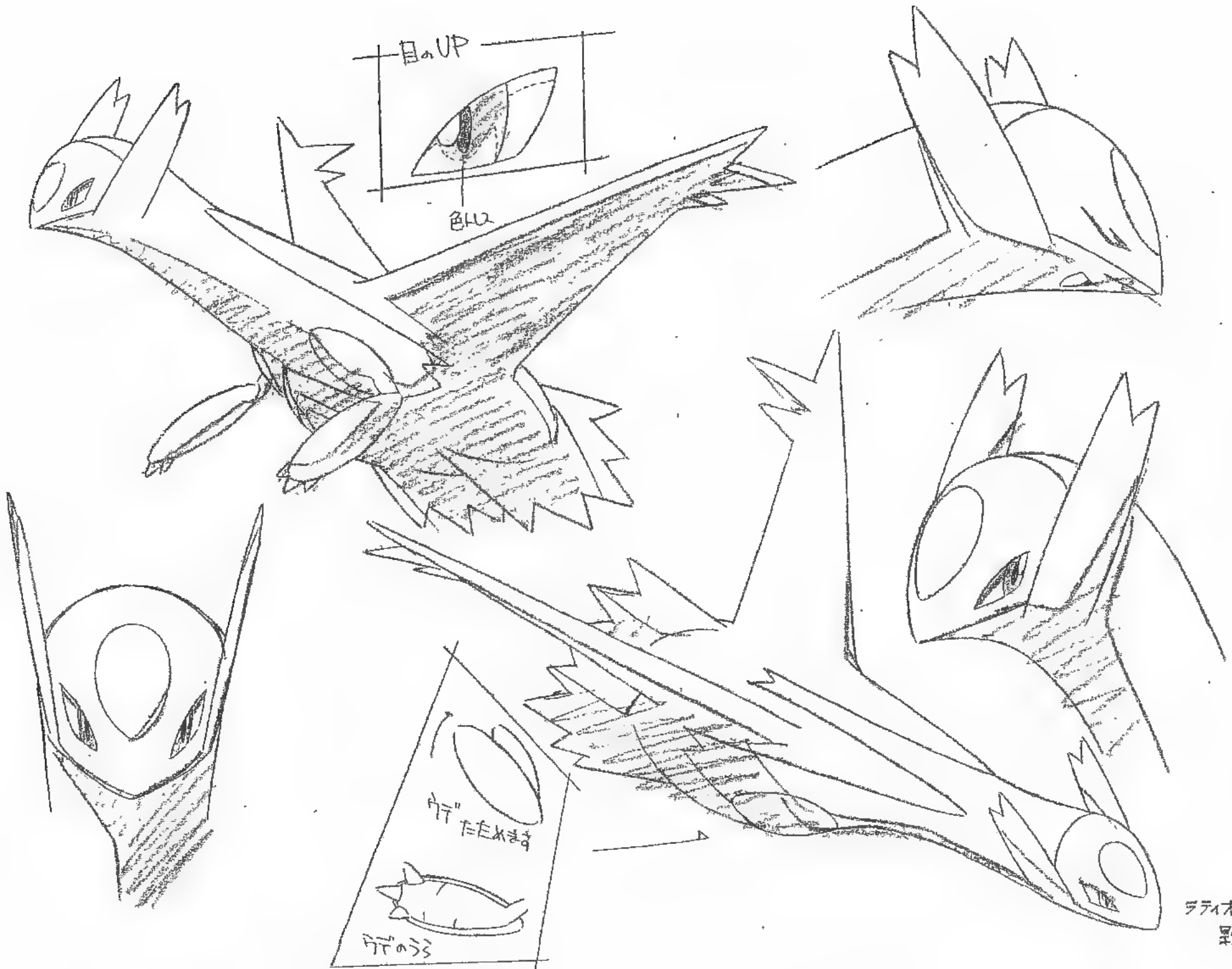

ラティオス①
影付

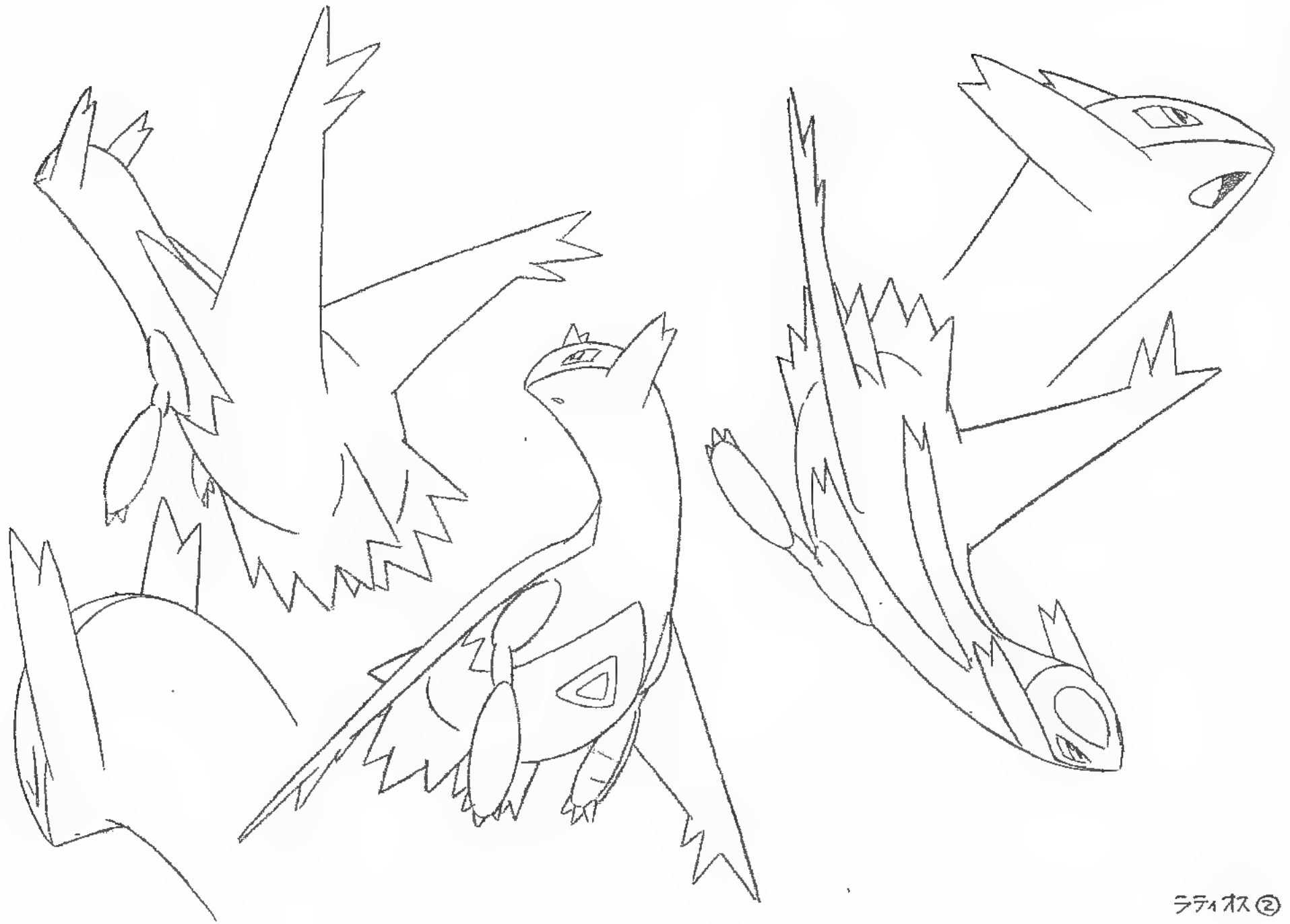

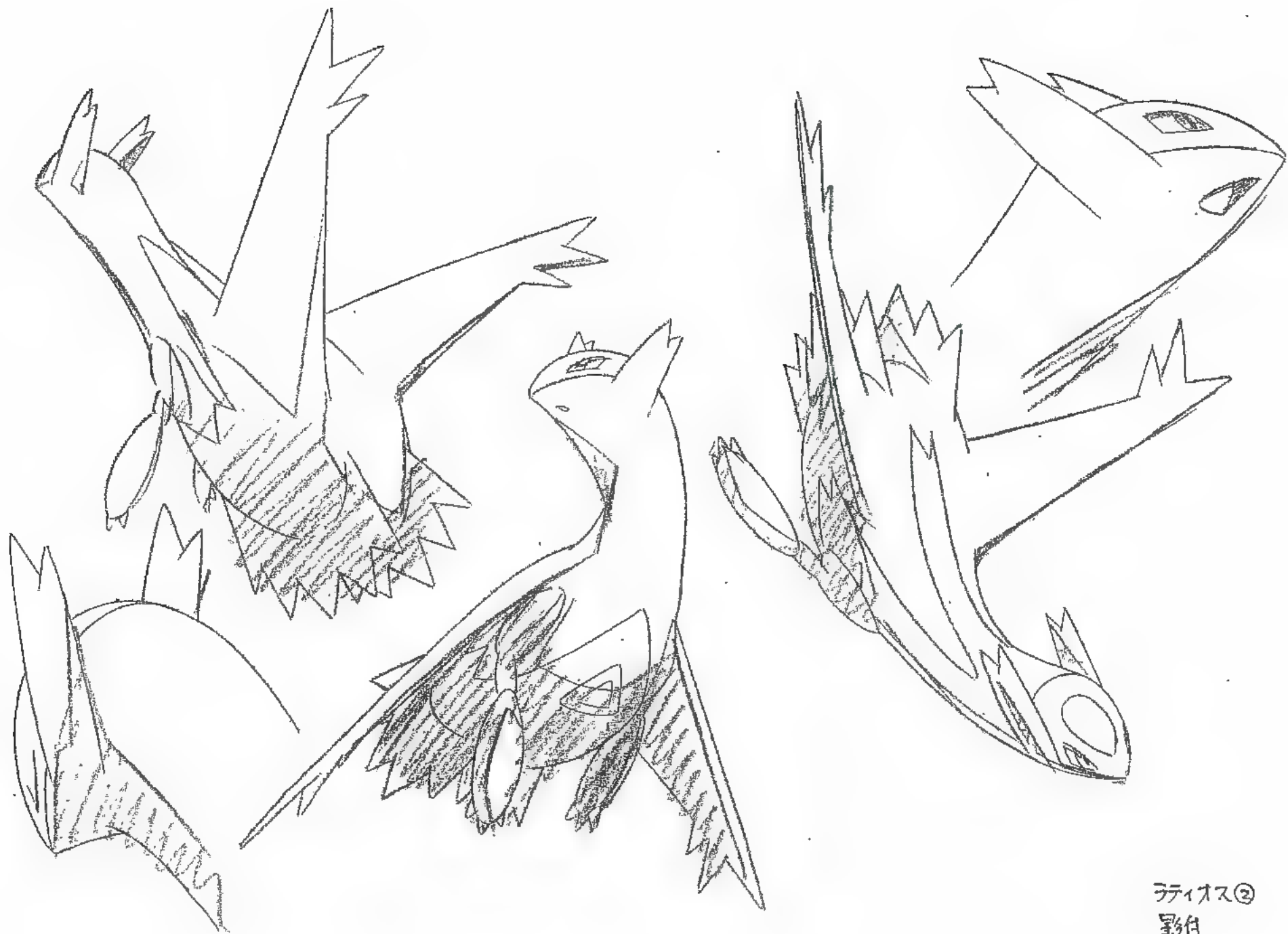

ラティオス②
影付

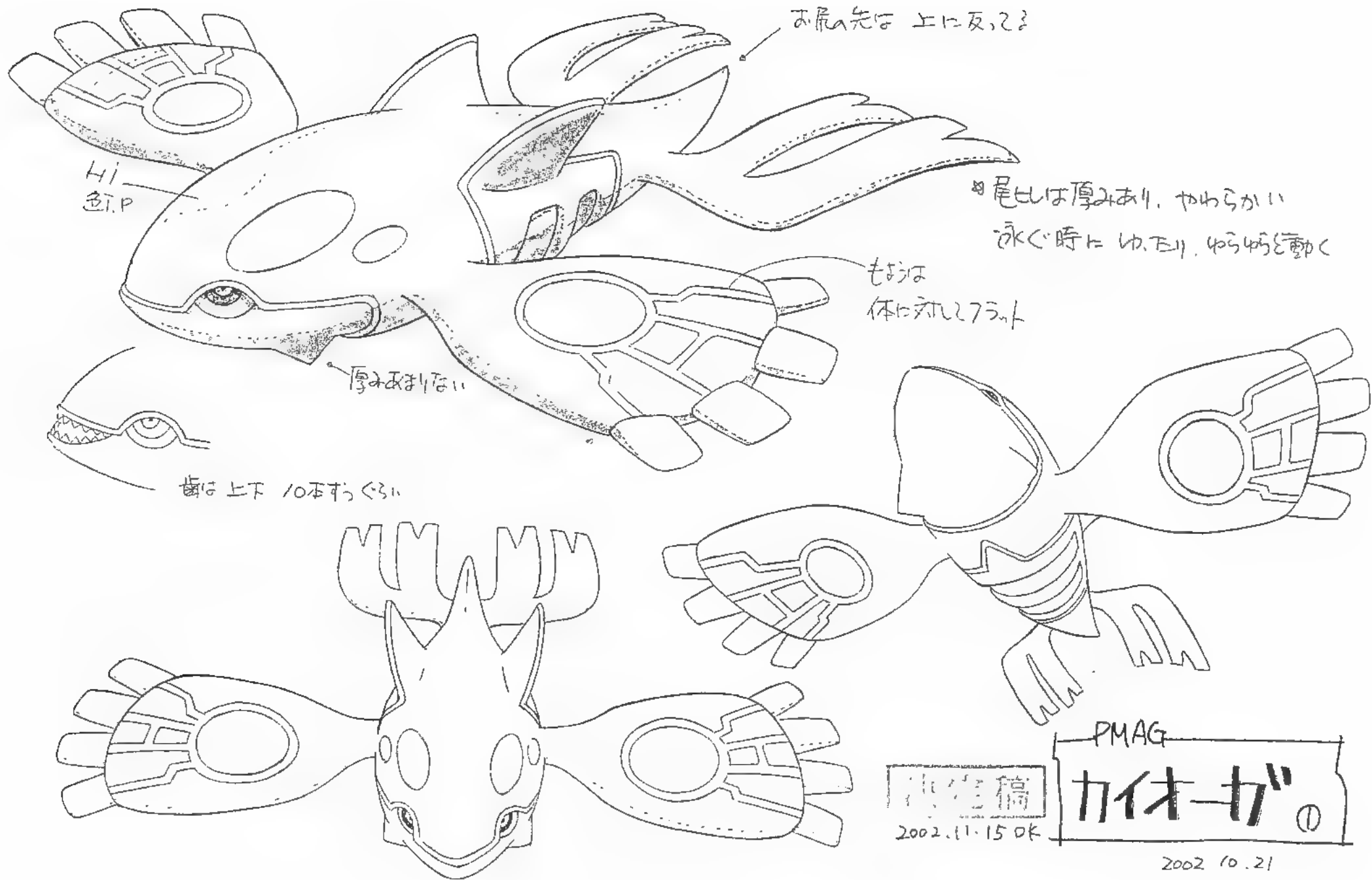

お尻の先は上に反る?

HI
色I.P

尾は厚みあり、やわらかい
泳ぐ時はゆ、尾、ゆらゆら動く

毛は
体に対して短

厚みあり

歯は上下 10本ずつ

決定稿
2002.11.15 OK

PMAG
カイオ-ガ ①

2002 10.21

※動きはシャキ.

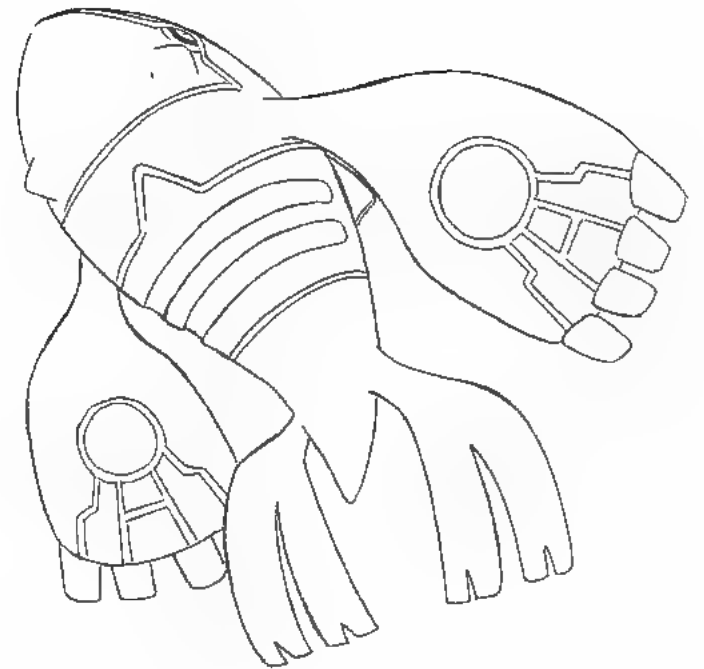
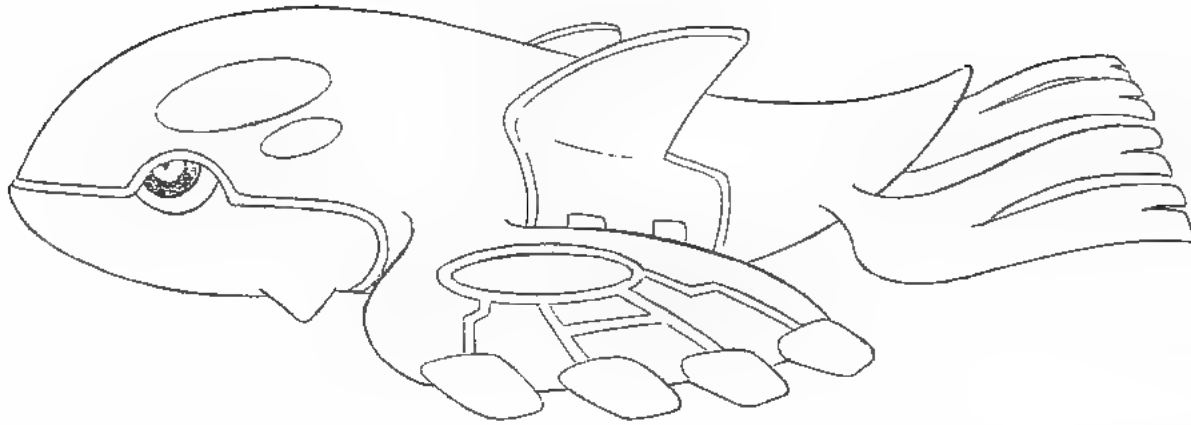

決定稿

2002.11.15 OK

PMAG

カイキガ^②

2002.10.21.

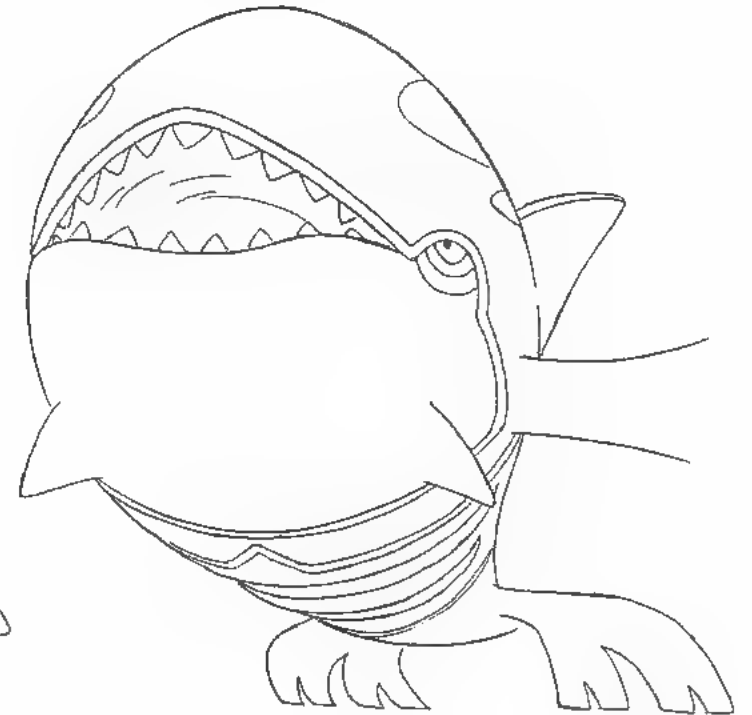
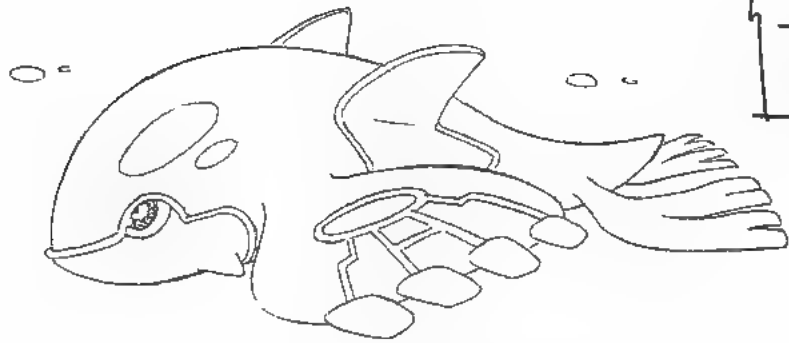

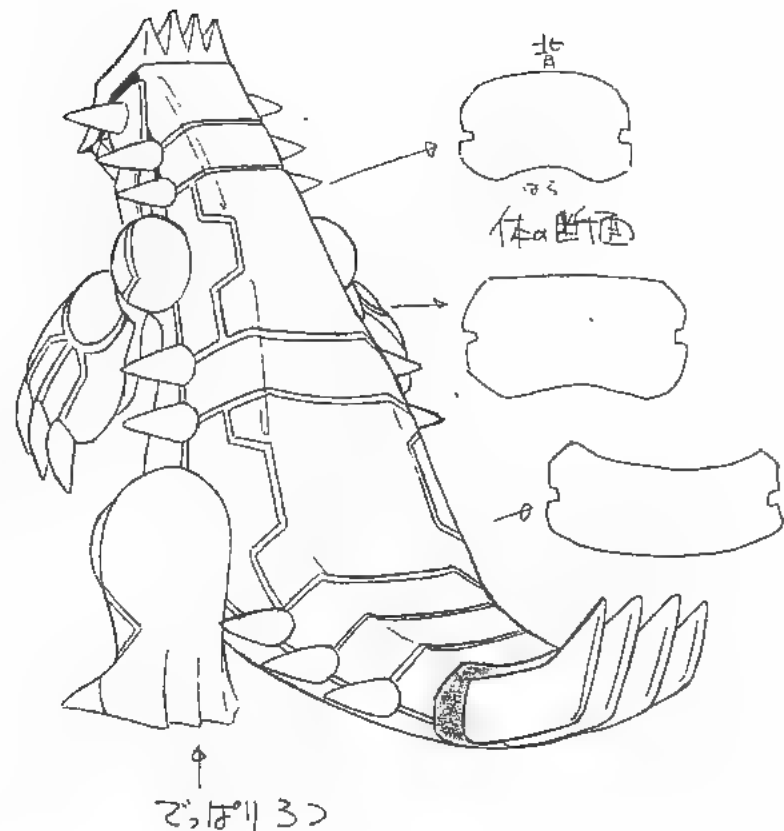
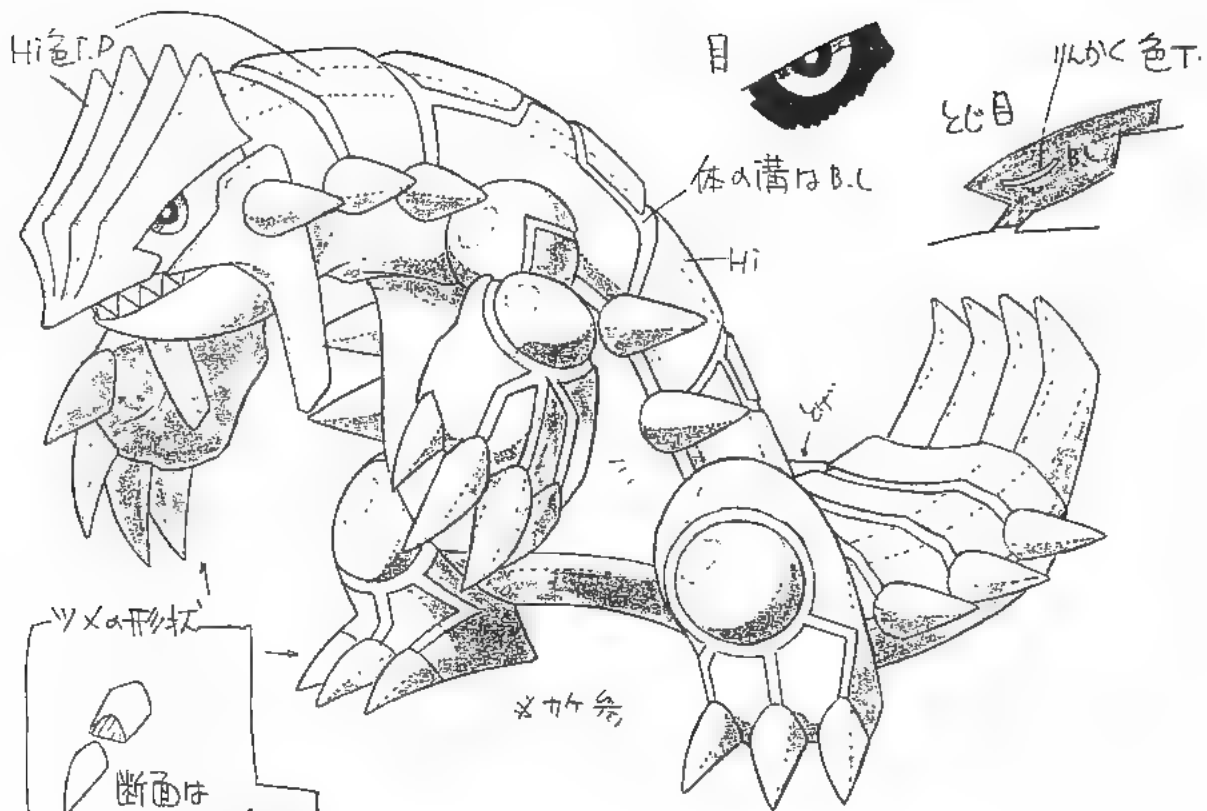

※歯の噛み合わせは
ピタリ

PMAG.
グランドン①

2002.10.19
11.28

決定稿
2002.12.13 OK

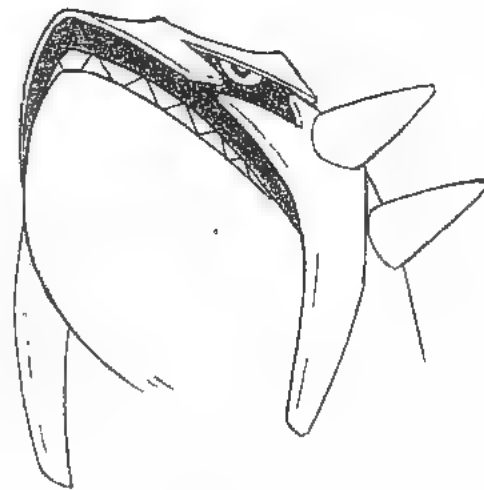

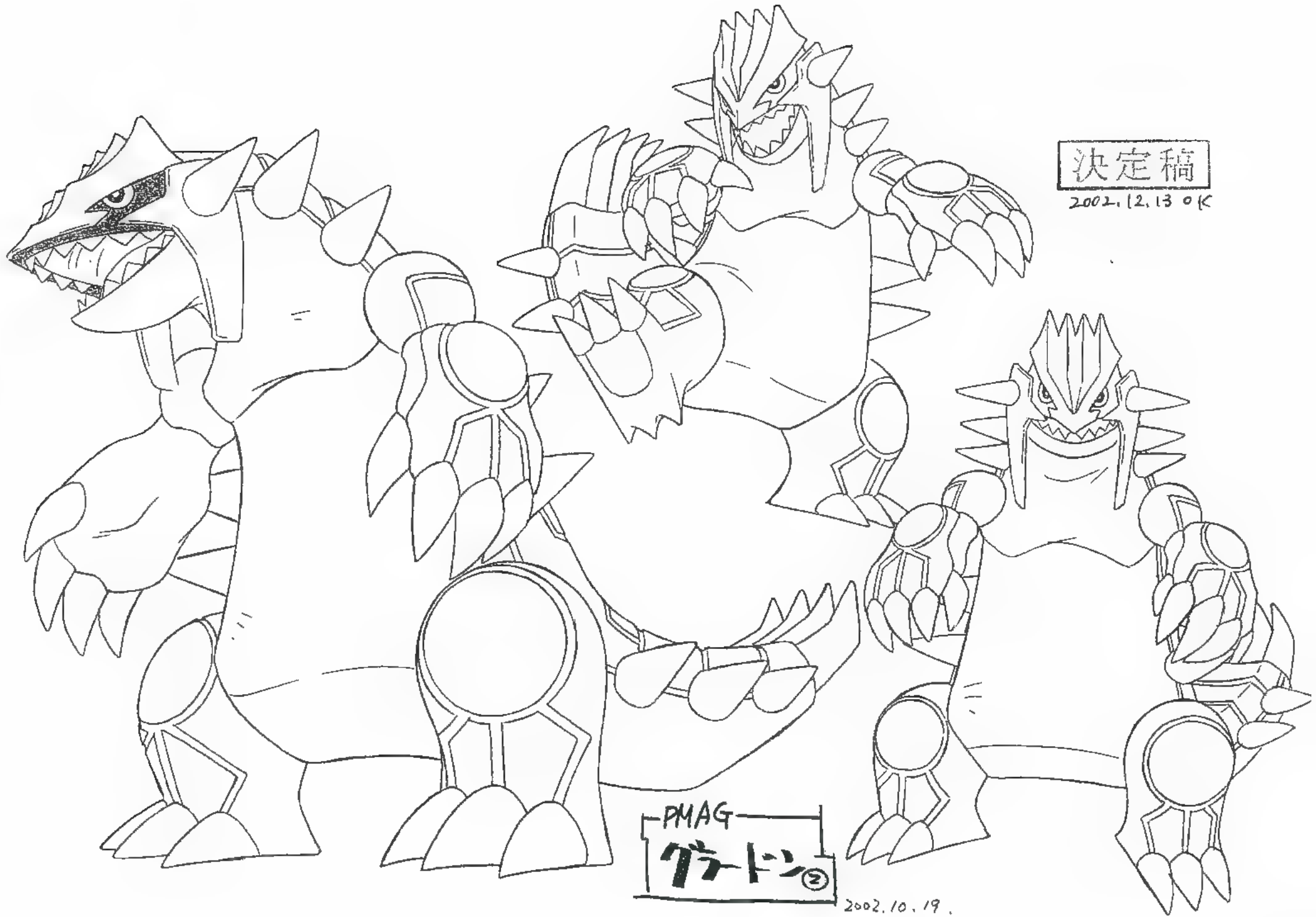

決定稿

2002.12.13 OK

PMAG
ゲドン②

2002.10.19.

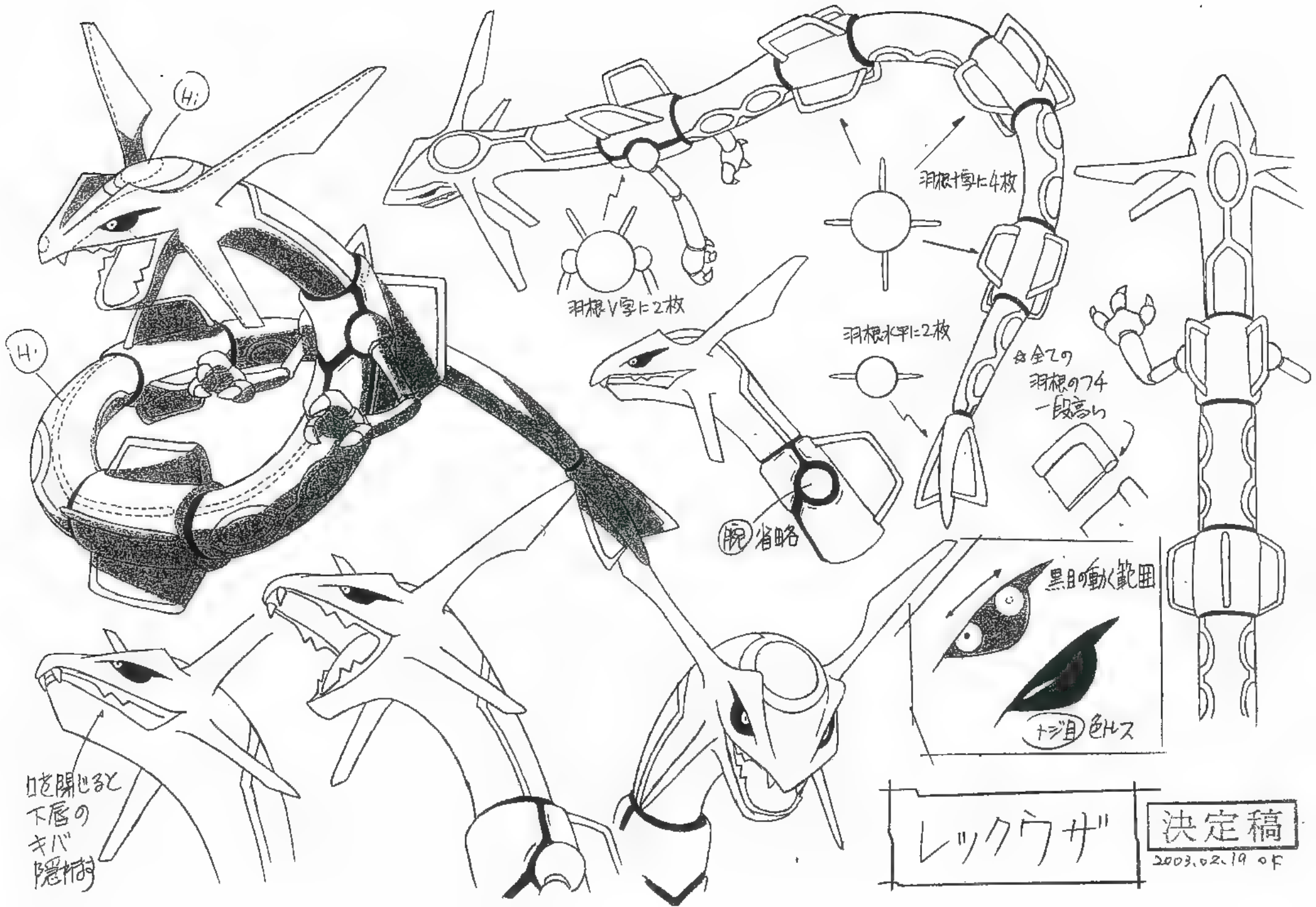

H.

H.

羽根V字に2枚

羽根十字に4枚

羽根水平に2枚

腕省略

全2の羽根の74一段高の

黒目の動く範囲

ナジ目色ハズ

口を開けると下層のキバ隠れ

レックウザ

決定稿

2003.02.19 of

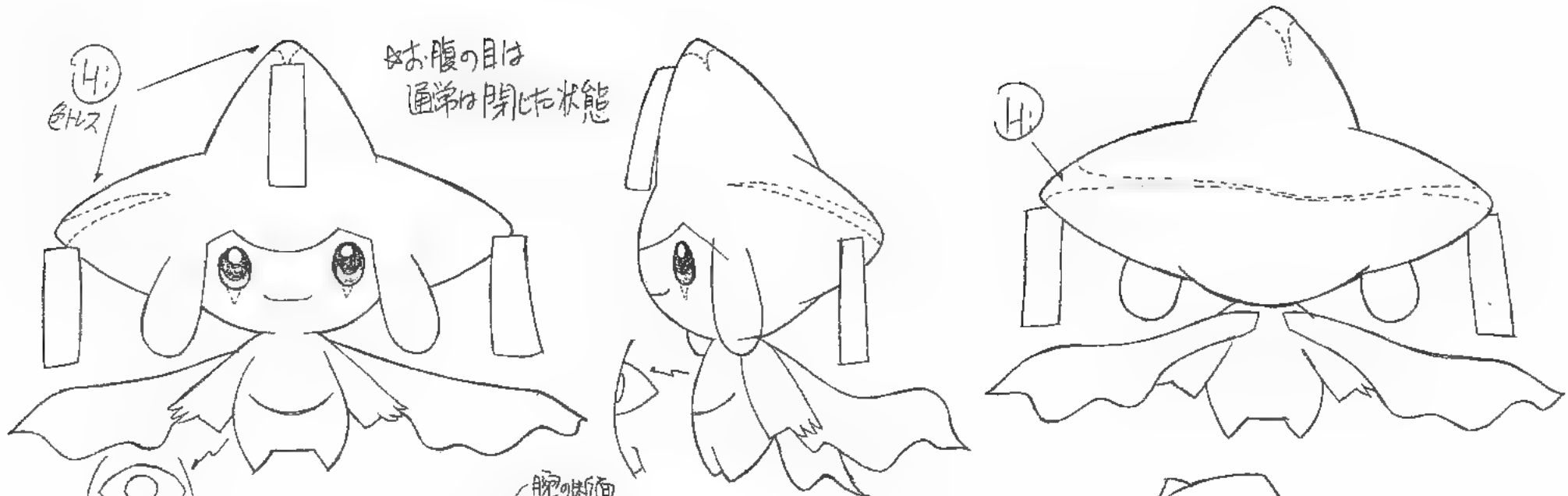

お腹の目は
通常は閉じた状態

④
色ハズ

④



④
色ハズ

模様です
色ハズ又

③

目の印時



腕の断面

膝3本

腕の下は
ヒラヒラ



眠る時は背中のヒラヒラで
体を包む(縦目も消える)

決定稿
2003.01.15 OK

飛ぶ時は
ヒラヒラが広く

シラ-4

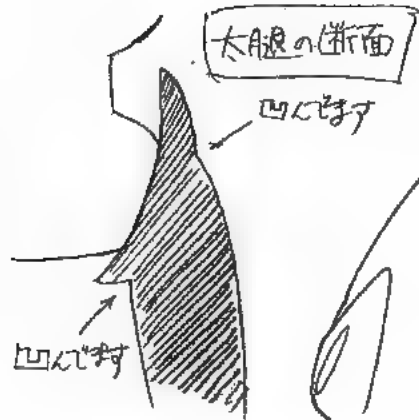

* 顔の形はムシカブトと同じです 目玉の処理合わせをお願いします

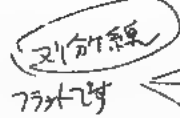

* 背中の3つの橋内模様は他の形態同様に穴を空けます



* 背中の溝に2本の線を入れます

テオキス A
(アタラシキ)

03.12.12.3 その①

胸の凹みの上には溝を2本入れよう (アタラシキ時2本線)

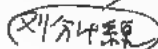

フラットです

03.12.14 テオキス "A" (アタラシキ) ①

「
 テキサスノールの
 胸のラインについて
 」

* ノールタイプの胸の水晶体周りのラインは、
 正面時、正中線にラインが二重の様
 になります

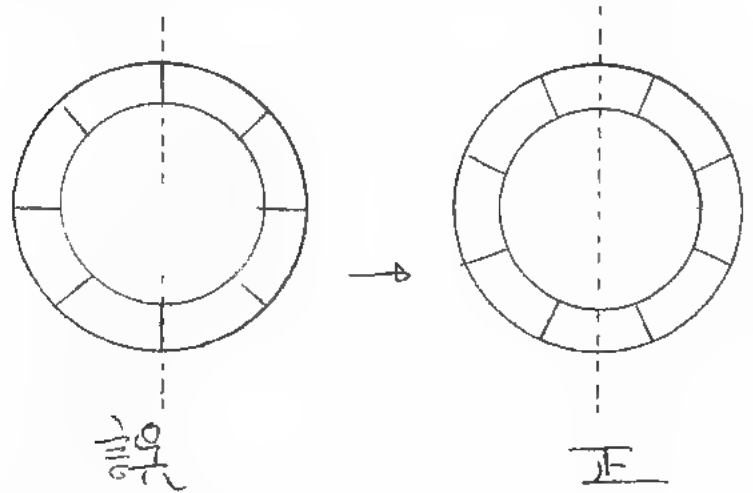

* 又、ラインは水晶体と
 外側の線にのりて
 下し
 (持ち手が無いので
 申しあげません)

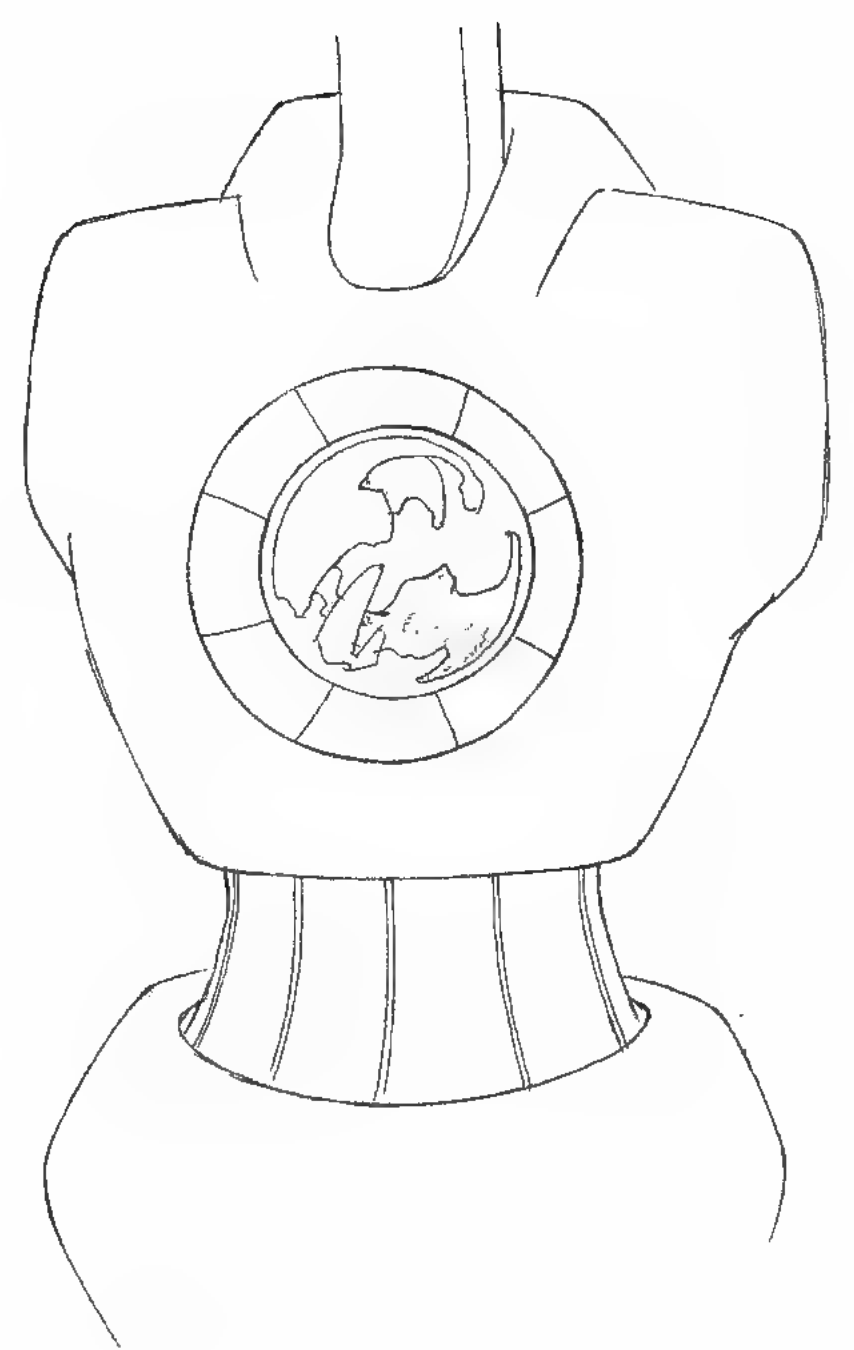
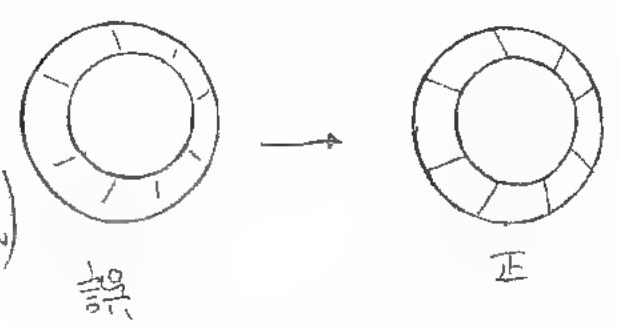

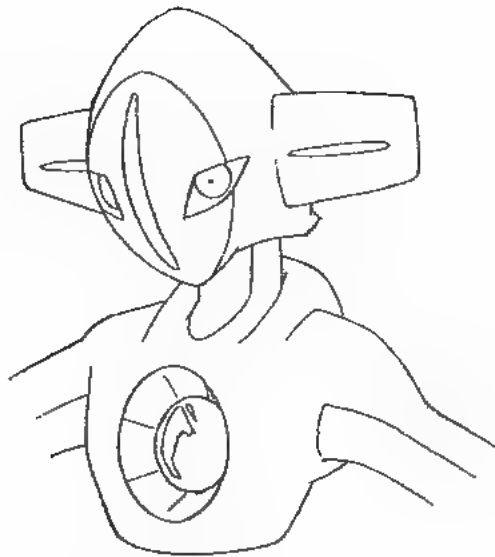

D29"時

1/3外のみ着て

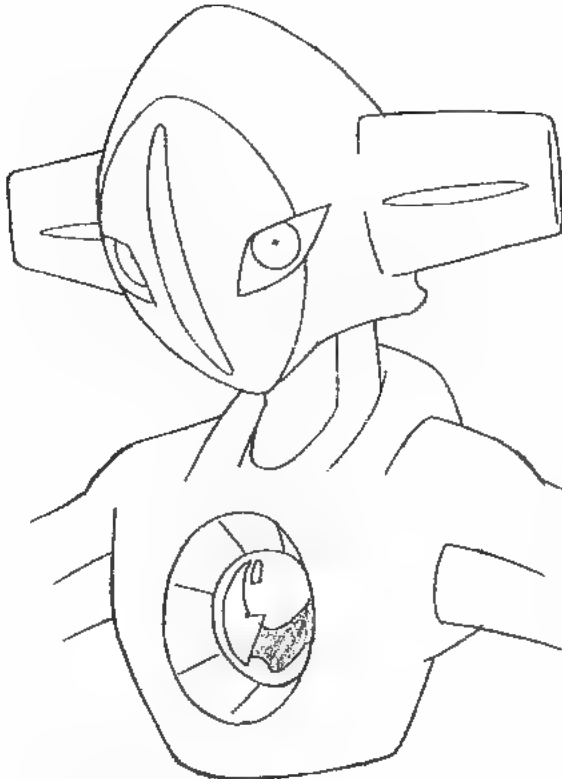

サイズに合わせて
描き込みを省略



1/3外
2/3

多少
1/3

P77"時

テオキス
胸の水晶体体入処理

1-マル
テオキスの腹部に2/3

1-マル、P77、テオキス共通

* 1-マルP77の
腹部の2/3
P77"時
2本線2"
(P77フィルムに合わせて)

not. of. (20

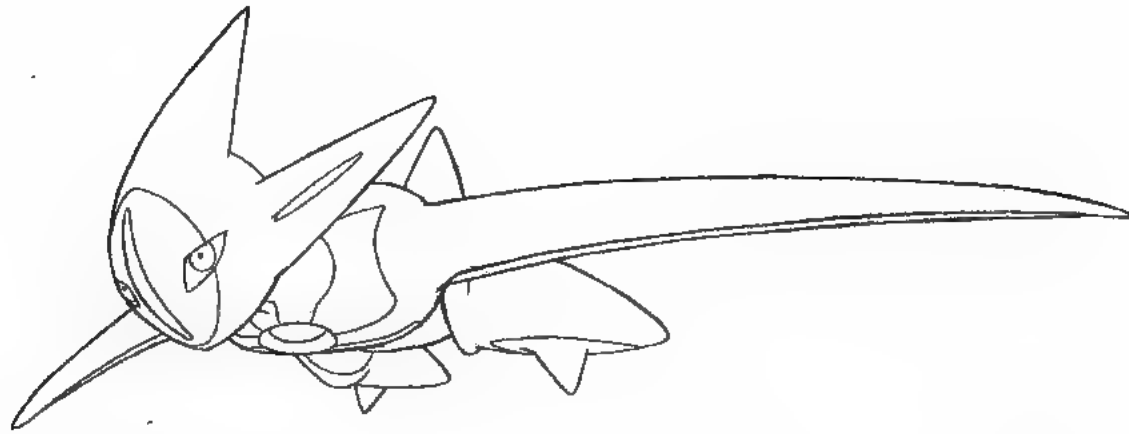

千オキシス (A)
(P9・77・1111)
M.H. 03. (2-3) 30②

飛行マ-ト

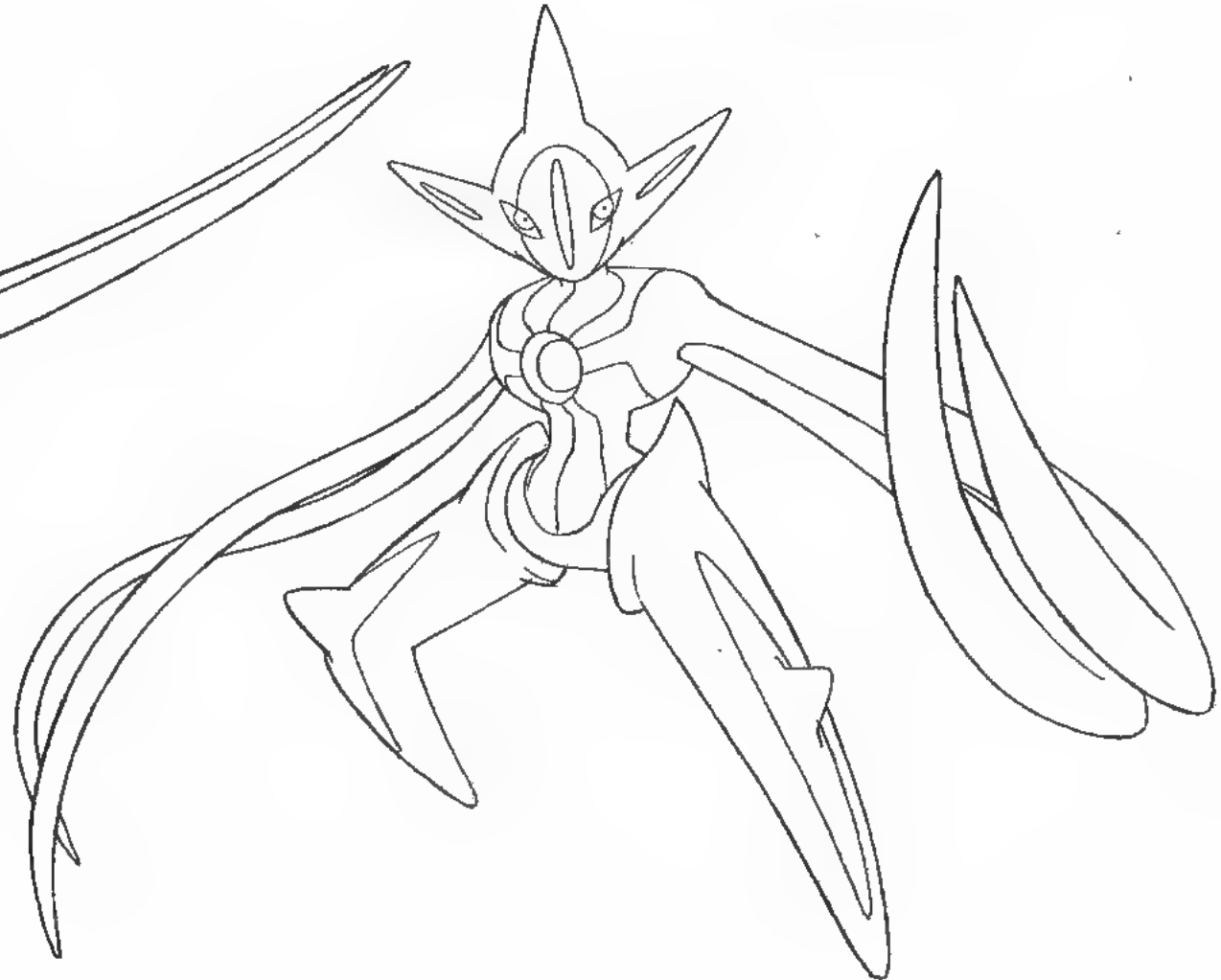
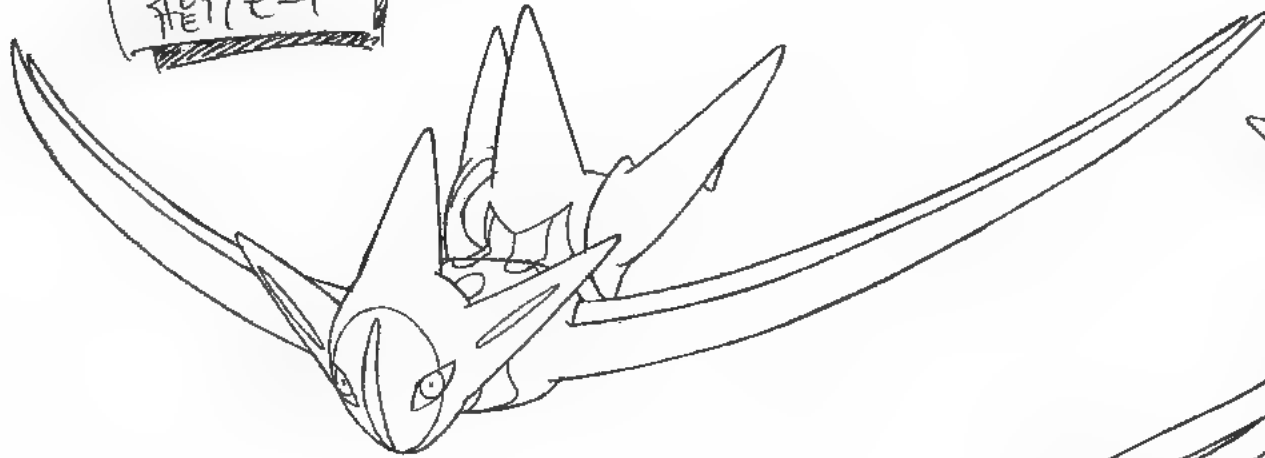

03.12.4. 千オキシス "A" (P9・77) (2)

* 顔の形はノリスアキスと
同じです。目玉アキス等
処理合わせ不願します

* 4本の触手、もとバラバラに(原案が)
重かす事して望みます。

* 背中の丸はケシ
窪みます
(ノリスアキスと
同様)

* 膝のラインは溝付
アキス時 2本線に
不願します

アキス①
(ディレン7机)
2004.03.16.29

* 大腿の付け根
内側は平アキス
(ノリスアキスと
同様)



(断面)

* 膝の上下の
ラインは溝付
(アキス時 2本線)

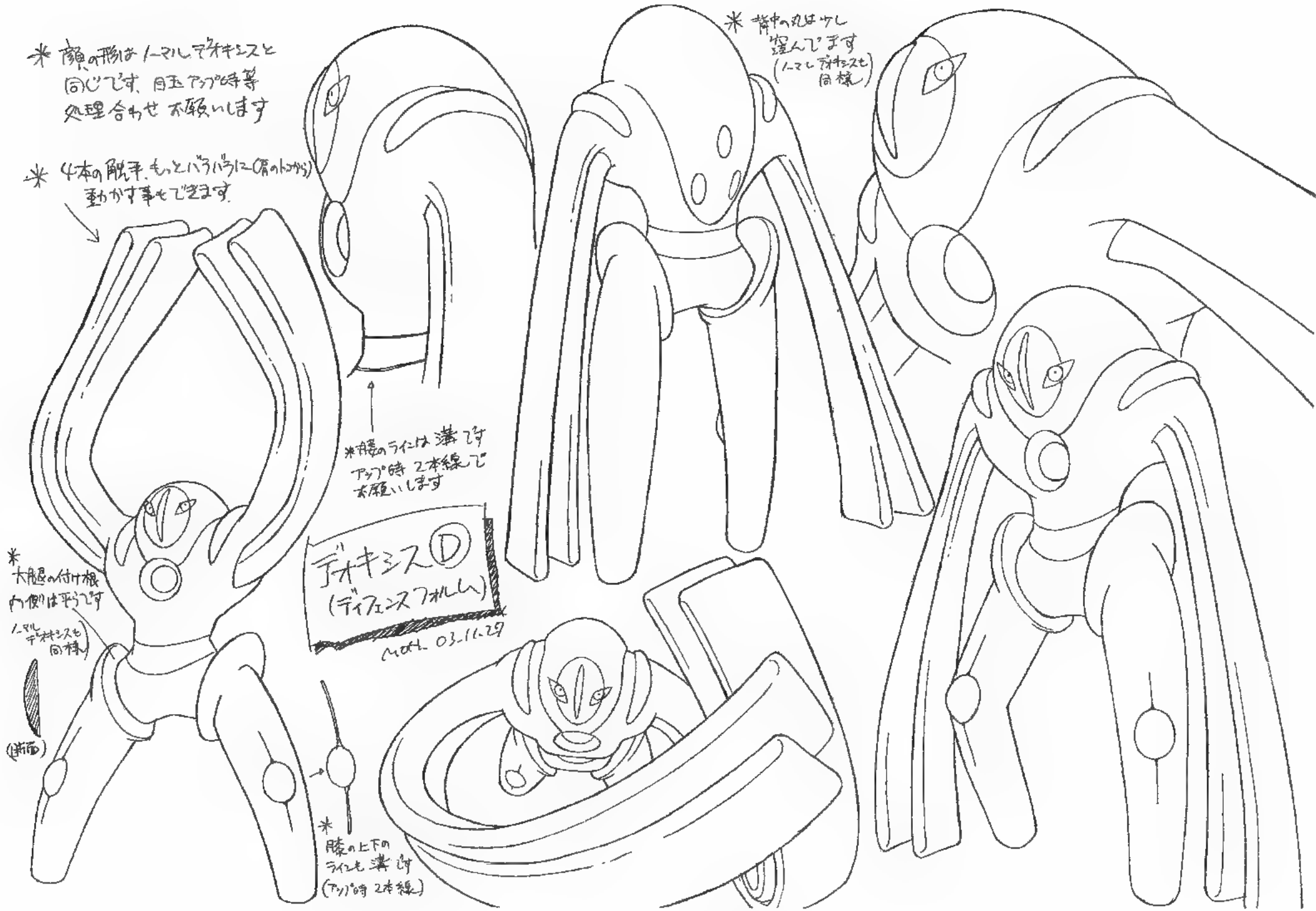

テオキニス
N(1-214)

309①
改(03.11.8)

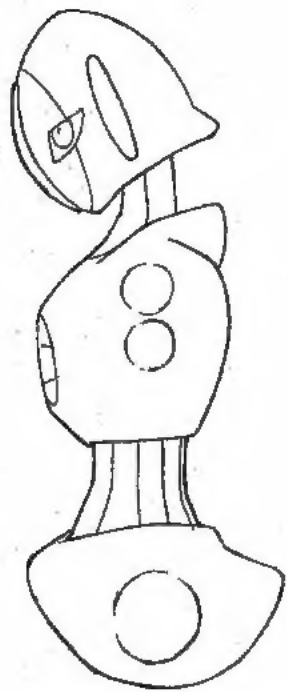

Mod. 03.10.21



胸の断面

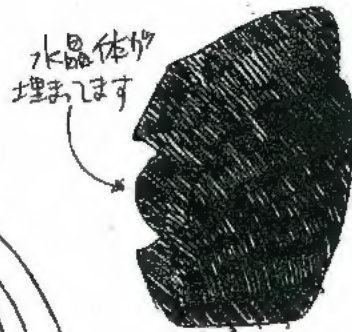

触手は先端以外は
ほぼ同じ太さで

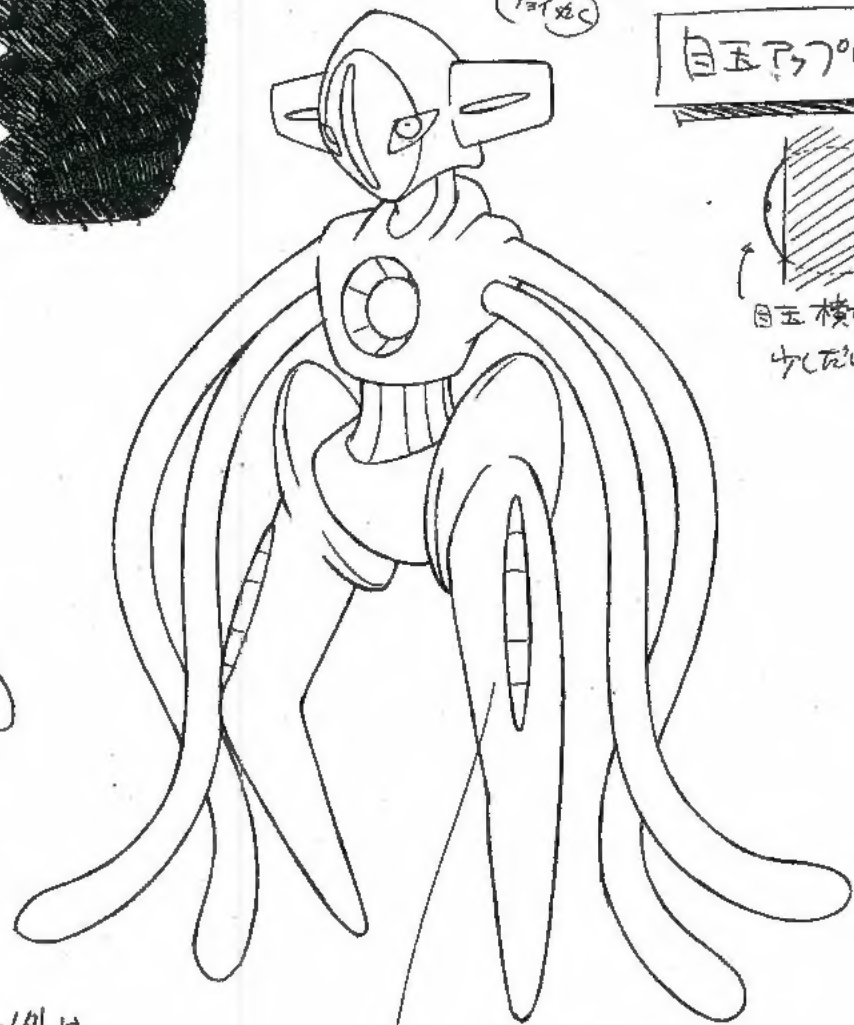

この部分、73外で少し
出し出します

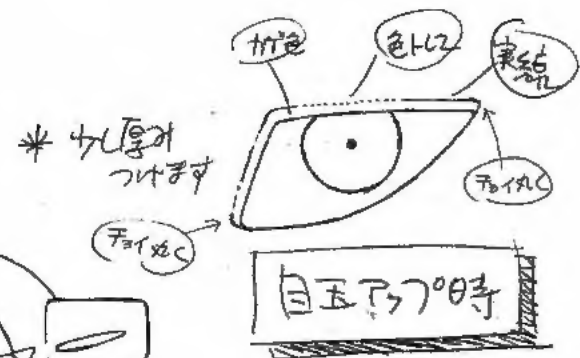

* 少し厚み
つけます

ファイバ

自玉73°時

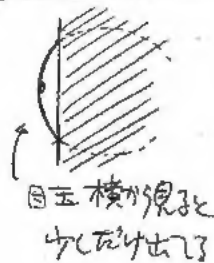

目玉横の線が
少しだけ出た

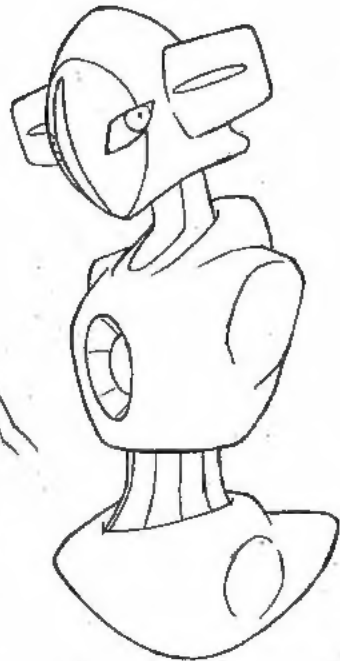
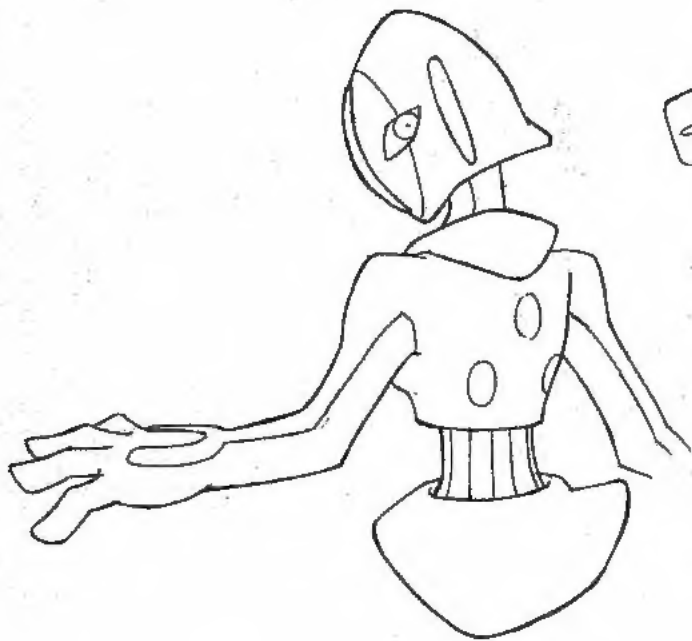

デキニス
N(ノーマル)

その②

改(03.11.8)

フラットで

腕の手から
肘から
腕にモーター?

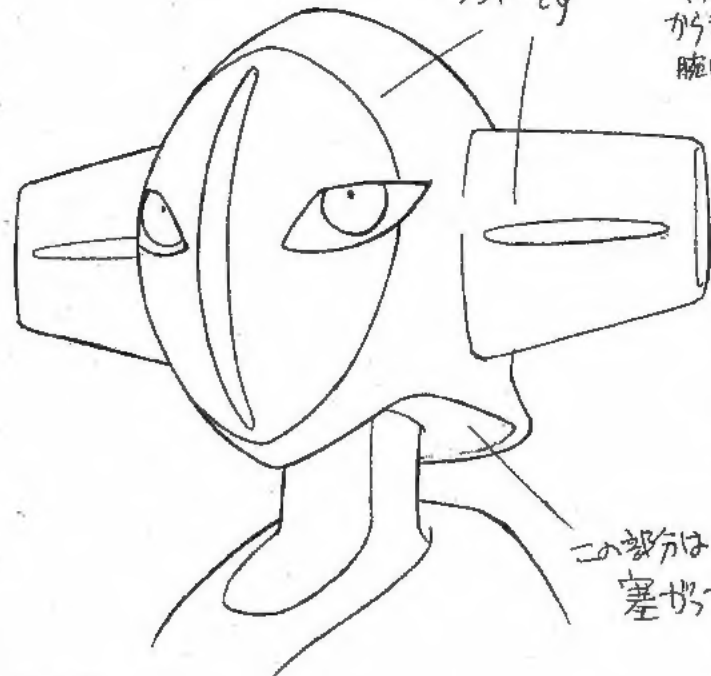

この部分は中空でよく
塞がっています

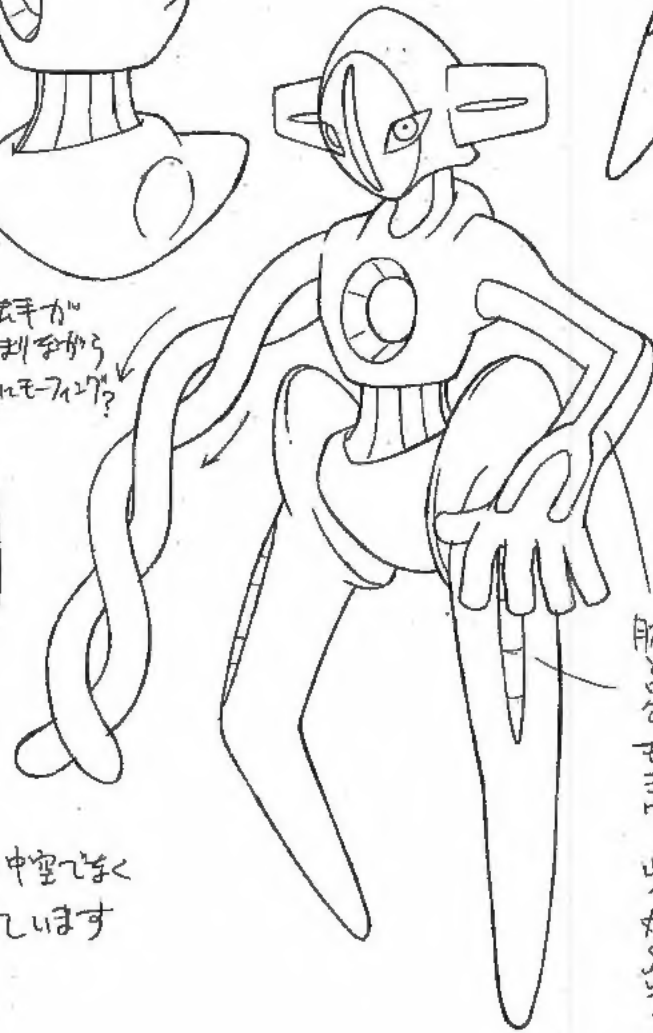

腕のモーターは
肘から腕に
モーター

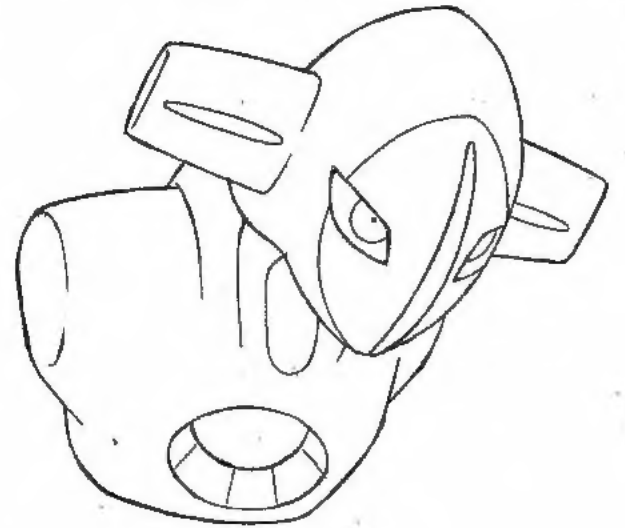

MOH. 03.10.21

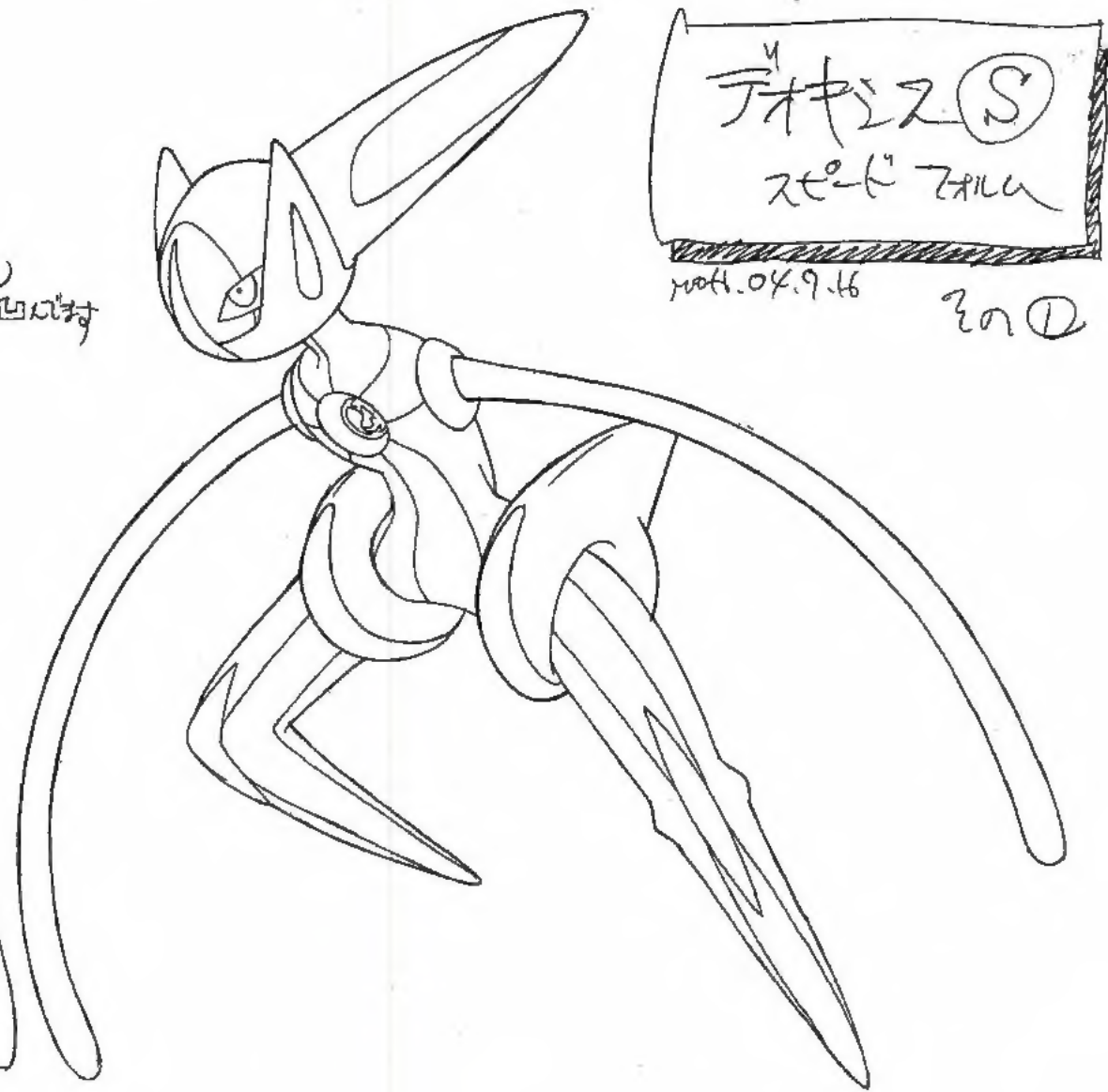
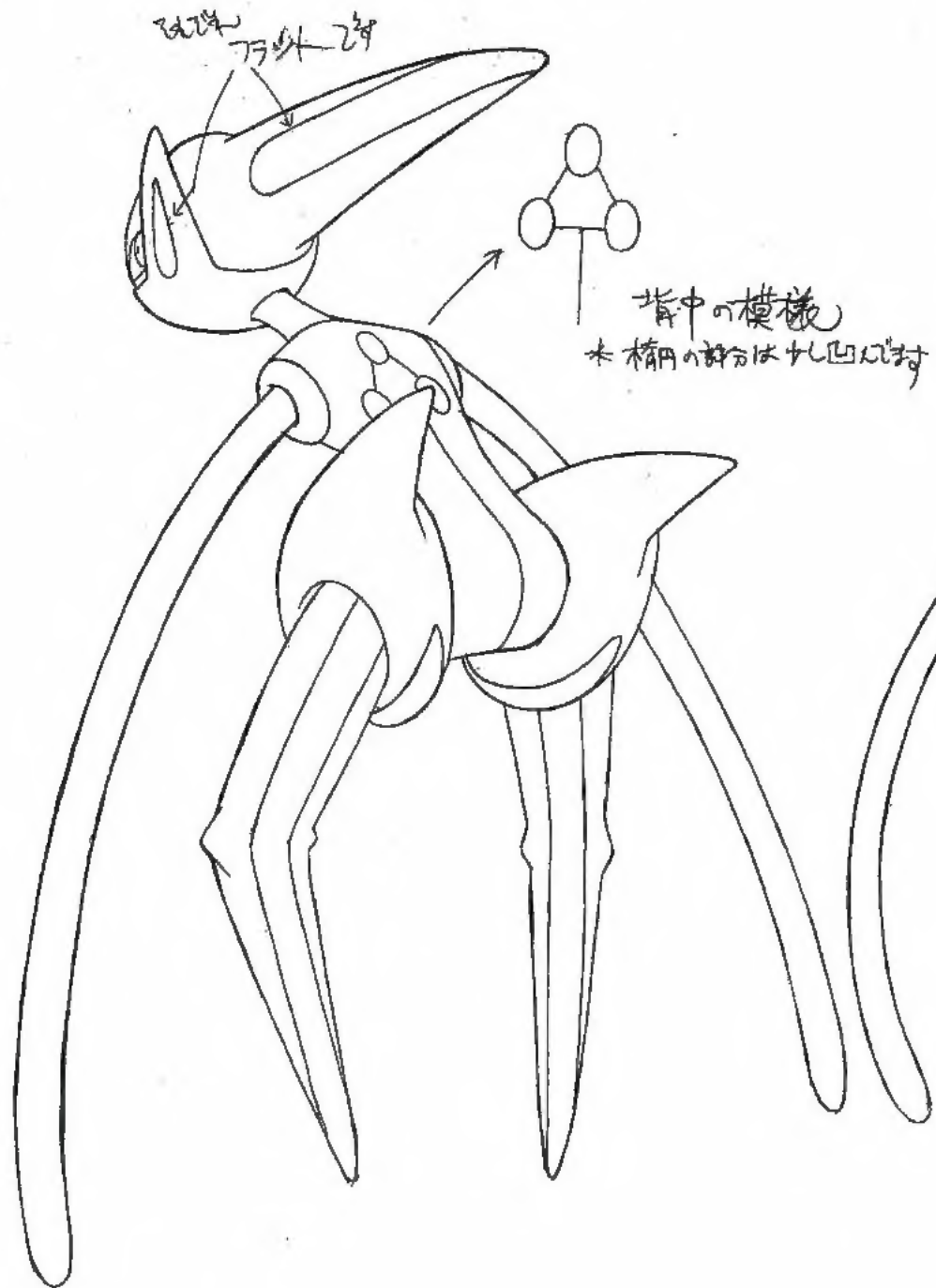

テオキス (S)
ステッドアム

1004.04.9.16

その①

アキス (S)
スピードフォルム
2011.04.16

その (2)

目と胸の水晶体の
処理等は
スピードフォルムに
準じます

足の内側に
ラインを引ます

* 胸の部分は
足の付け根にラインを引
ます。
(アキスに準じます)

