

## KUKA Control Panel (KCP)

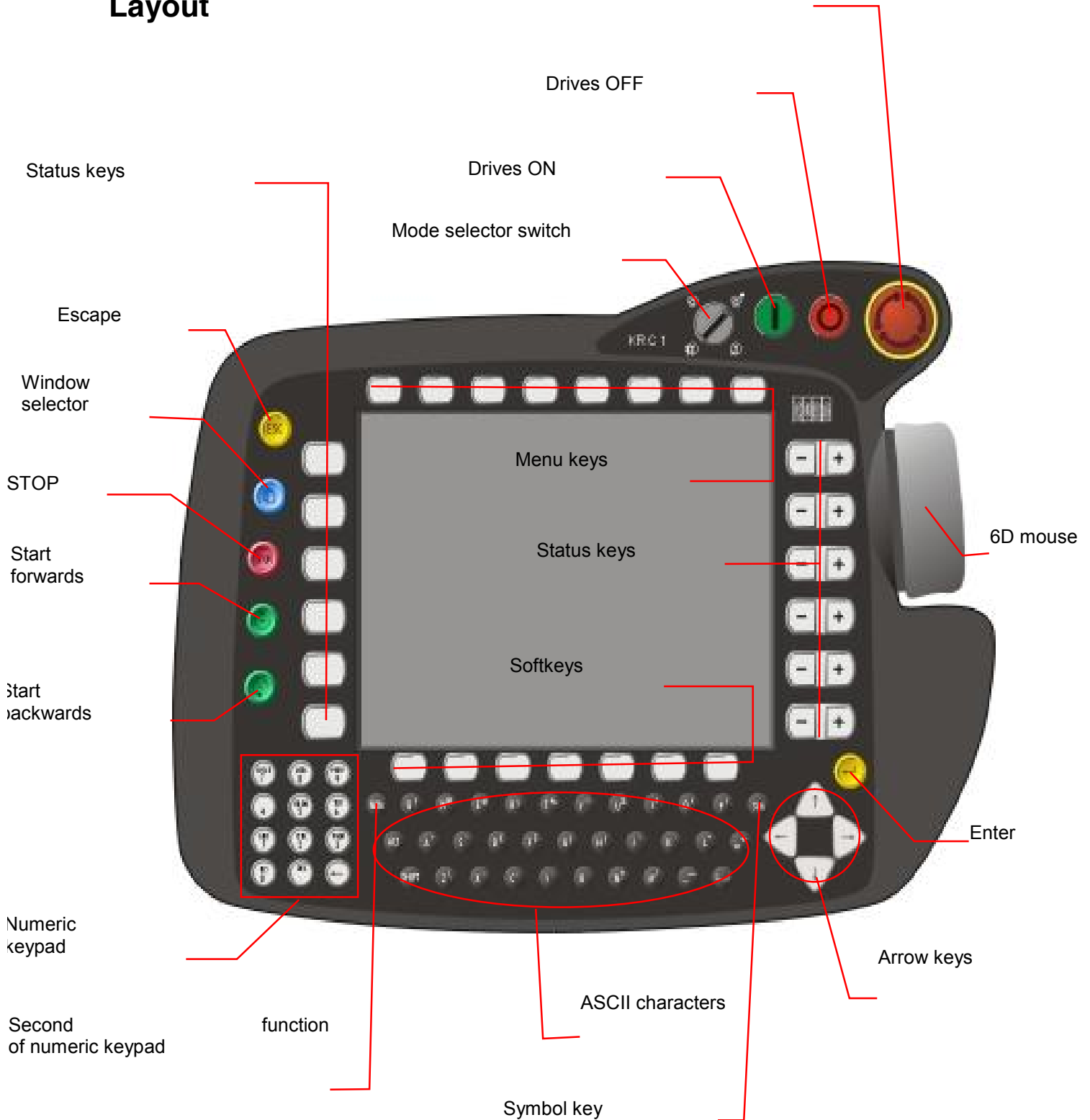





The KUKA control panel is the interface to the robot controller and to the robot. This document gives an schematic overview of the buttons and symbols. Do note however that this document does not replace the KUKA documentation. This document is valid for most KR C1 and all KR C2 robot controllers.

### Layout

EMERGENCY STOP



## Important function keys

-  An action that has been started can be aborted at any time using the **ESC key**.
-  It is possible to toggle between the program, status and message windows using the **window selection key**. The active window is indicated by a blue background.
-  Pressing the **Stop key** stops a program that is running in automatic mode.
-  Pressing the **Program start forwards key** starts a program that has been selected.
-  If the **Program start backwards key** is pressed, the motion blocks are executed step by step towards the beginning of the program.
-  The **Enter key** is used, for example, to complete commands or to confirm entries in forms, etc.

The **menu keys** (a) are used to open menus in the menu bar. Navigation is accomplished with the aid of the arrow keys.

The **status keys** (b) are used for selecting operating options, switching individual functions and setting values.

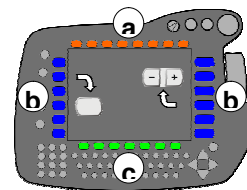

The functions of the **softkeys** (c) are dynamically adapted to the current requirements, i.e. the assignment of the softkey bar is altered.

Mode selector switch

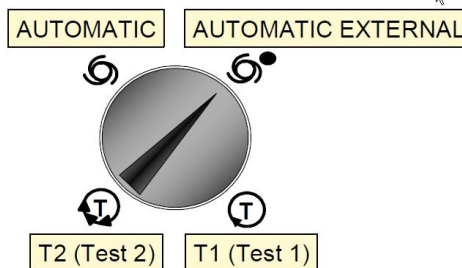

### Mode selector switch



Mode selector switch	T1	T2	AUTOMATIC	AUTOMATIC EXTERNAL
Jogging using keys or Space Mouse 	250 mm/s Enabling switch (dead man function)	250 mm/s Enabling switch (dead man function)	Jogging not active	Jogging not active
Program execution 	250 mm/s Enabling switch (dead man function) START key pressed	Prog. velocity Enabling switch (dead man function) START key pressed	Prog. velocity Drives ON START key --> PULSE	Prog. velocity Drives ON external External start

## Jog mode and program execution

**Jogging using the status keys**

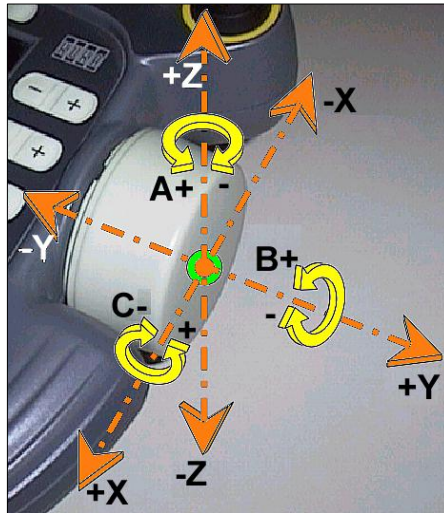

**Jogging using the 6D mouse**



**Program mode:**  
Jogging deactivated



**GO mode:** Program execution is continued as long as the “Program start forwards” key remains pressed.



**Single Step mode:** For each motion command, the “Program start forwards” key must be released and pressed again.



**Backward move:** Appears automatically when the “Program start backwards” key is pressed.



**Program velocity in % (POV):**  
Motion velocity of the robot during program execution.  
 T1: max. 250 mm/s; T2: max. process velocity



**Jog velocity in % (HOV):**  
Motion velocity of the robot during jogging using the jog keys or 6D mouse.  
 T1 & T2: max. 250 mm/s

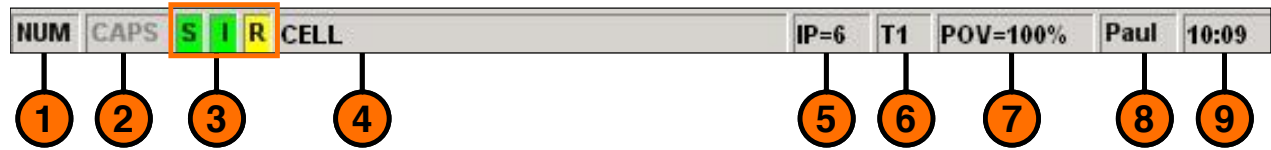

## Status bar





1 – Numeric keypad

2 – Upper / lower-case letters





3 – Status Submit-Interpreter:

-  Submit interpreter deselected
-  Submit interpreter stopped
-  Submit interpreter running

Status Drives:

-  Drives not ready
-  Drives ready (600 ms)

Status Program:

-  No program is selected
-  The block pointer is situated on the first line of the selected program
-  A program has been selected and is currently being executed
-  The selected and started program has been stopped
-  The block pointer is situated on the last line of the selected program

4 – Selected program

5 – Current block number

6 – Current operating mode:

- T1 Test 1: max. 250 mm/s
- T2 Test 2: process velocity
- AUT Automatic
- EXT Automatic external

7 – Current override:

- HOV Hand override (hand jogging velocity)
- POV Program override (program velocity)

8 – Robot name

9 – Time

## Coordinate systems

### Axis-specific jogging:

**Each axis can be moved individually in a positive or negative direction.**



Area of application: Rough method for addressing points. Only way of moving an unmastered robot. Moving away from a software limit switch.

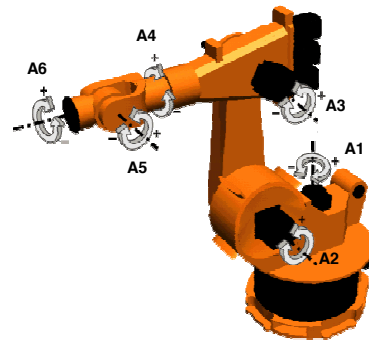

### WORLD – Coordinate system



Fixed coordinate system whose origin is located at the base of the robot.  
Area of application: Motion of the robot to any point in space using the keyboard or 6D mouse. Tool and BASE calibration.

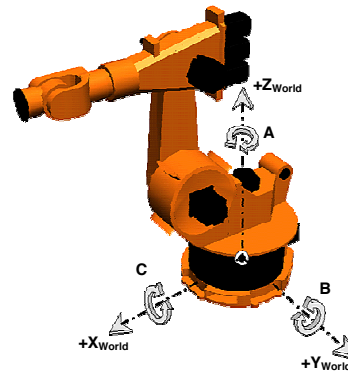

### TOOL – Coordinate system



Coordinate system whose origin is located in the robot tool.  
Area of application: Motion with the tool along a straight line if the orientation of the tool is inclined. Spot welding on the work piece. Gripper functions on the work piece. Motion of a work piece under an external TCP.

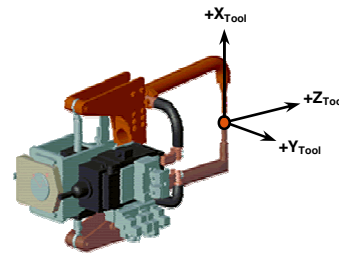

### BASE – Coordinate system



Coordinate system whose origin is located in the work piece.  
Area of application: Motion of work piece with defined BASE. "Mouse" jogging of work piece if the positive X axis of the BASE coordinate system is pointing towards the programmer.

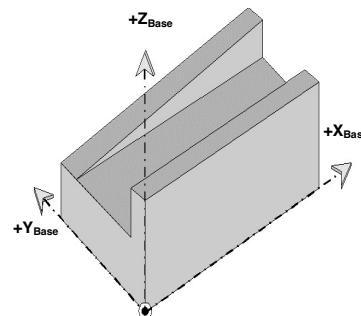

## Setting the mouse position

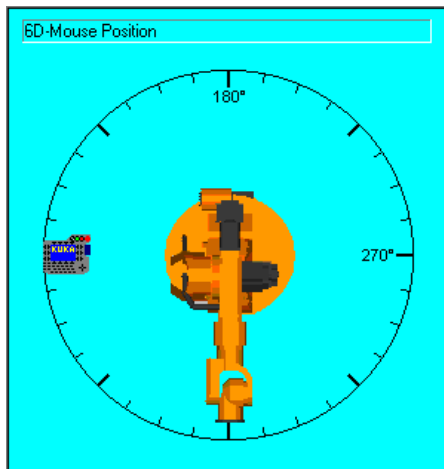

The menu item:

- Configure
- Jogging
- Mouse position

is used by the operator to communicate his position to the controller.

When switching to "Automatic" mode, the mouse position is automatically reset to 0 degrees!



## Setting the mouse configuration

The menu item:

- Configure
- Jogging
- Mouse configuration

is used by the operator to limit the degrees of freedom (a) and to switch the Dominant mode (b) on or off.

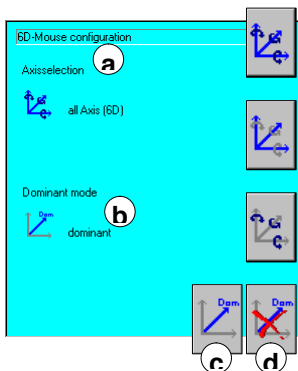

- Axis-spec.:** all axes 1 to 6
- Cartesian:** all directions X,Y,Z and all angles A,B,C
- Axis-spec.:** only main axes 1 to 3
- Cartesian:** only directions X,Y,Z
- Axis-spec.:** only wrist axes 4 to 6
- Cartesian:** only angles A,B,C

Dominant mode on (c)  
 Dominant mode off (d)

# Everything for your HMI running



Touch.Keypad.Display

✉ sales@vicpas.com

☎ +86-15876525394

