



Electricity Grids and Secure Energy Transitions

Enhancing the foundations of resilient,
sustainable and affordable power systems

International
Energy Agency



INTERNATIONAL ENERGY AGENCY

The IEA examines the full spectrum of energy issues including oil, gas and coal supply and demand, renewable energy technologies, electricity markets, energy efficiency, access to energy, demand side management and much more. Through its work, the IEA advocates policies that will enhance the reliability, affordability and sustainability of energy in its 31 member countries, 13 association countries and beyond.

This publication and any map included herein are without prejudice to the status of or sovereignty over any territory, to the delimitation of international frontiers and boundaries and to the name of any territory, city or area.

Revised version, November 2023
Information notice found at:
www.iea.org/corrections

Source: IEA,
International Energy Agency
Website: www.iea.org

IEA member countries:

Australia
Austria
Belgium
Canada
Czech Republic
Denmark
Estonia
Finland
France
Germany
Greece
Hungary
Ireland
Italy
Japan
Korea
Lithuania
Luxembourg
Mexico
Netherlands
New Zealand
Norway
Poland
Portugal
Slovak Republic
Spain
Sweden
Switzerland
Republic of Türkiye
United Kingdom
United States

The European Commission also participates in the work of the IEA

IEA association countries:

Argentina
Brazil
China
Egypt
India
Indonesia
Kenya
Morocco
Senegal
Singapore
South Africa
Thailand
Ukraine



Abstract

Grids have been the backbone of electricity systems for more than a century, underpinning economic activity by bringing power to homes, industry and services. As clean energy transitions advance, the role of electricity will be more prominent, making grids even more important for society and economies. Electrification and renewables deployment are both picking up pace, but without adequate grids to connect the new electricity supply with the demand, there is a risk that clean energy transitions will stall.

This report offers a global stocktake of the world's electricity grids as they stand today, taking a detailed look at grid infrastructure, connection queues, the cost of outages, grid congestion, generation curtailment, and timelines for grid development. We find that there are already signs today that grids are becoming a bottleneck to clean energy transitions and analyse the risks we face if grid development and reform do not advance fast enough.

We find that delayed action means prolonging reliance on fossil fuels, resulting in an increase in emissions and costs to society. An unprecedented level of attention from policy makers and business leaders is needed to ensure grids support clean energy transitions and maintain electricity security. The report concludes with key recommendations for policy makers, highlighting the necessary actions in areas including investment, regulation and planning.

Acknowledgements, contributors and credits

This study was prepared by the Renewable Integration and Secure Electricity (RISE) Unit in the Directorate of Energy Markets and Security (EMS) in co-operation with other directorates and offices of the International Energy Agency (IEA). The study was designed and directed by Pablo Hevia-Koch, Head of RISE. Main authors are Pablo Hevia-Koch, Brent Wanner, Head of Power Sector Unit, and Rena Kuwahata, Energy Analyst Power System Transformation.

The electricity grid modelling team for this report was led by Brent Wanner and additional analysis was led by Rena Kuwahata. Zoe Hungerford was also part of the core team and contributed across the report. Key contributions were from Eren Çam (outages), Javier Jorquera Copier (congestion management and outages), Trevor Criswell (connection queues), Michael Drtil (transmission and permitting), Stavroula Evangelopoulou (supply chain), Eric Fabozzi (modelling), Enrique Gutierrez (regulation), Bruno Idini (employment), Laura Mari Martinez (curtailment), Alessio Pastore (regulation and distribution), and Alana Rawlins Bilbao (investment).

Other contributions from across the agency were from:

Heymi Bahar (connection queues and curtailment), Daniel Crow, Minna Genser (cyber security), Julia Guyon (electricity demand and electric vehicles), Katsuki Ishimaki (cyber security), John Moloney (outages), Yu Nagatomi (planning and investment policies), Camille Paillard (public acceptance and permitting), Uwe Remme (supply chains) and Daniel Wetzel (employment).

Matthieu Coget, Jinpyung Kim, Hyejeong Lee, Jae Sun Lee, Jeremy Tessier, Lukas Trippe, and Zhiyu Yang provided essential support.

Justin French-Brooks carried editorial responsibility.

Other key contributors from across the IEA were: Rita Madeira, Jinsun Lim, Astha Gupta, Brendan Reidenbach, and Vida Rozite.

Valuable comments and feedback were provided by other senior management and numerous other colleagues within the IEA. In particular, Keisuke Sadamori, Laura Cozzi and Tim Gould.

Thanks go to the IEA's Communications and Digital Office for their help in producing the report and website materials, particularly to Jethro Mullen, and

Oliver Joy, Poeli Bojorquez, Astrid Dumond, Grace Gordon, Isabelle Nonain-Semelin, Lucile Wall and Clara Vallois, provided essential support to the production process.

IEA's Office of the Legal Counsel, Office of Management and Administration and Energy Data Centre provided assistance throughout the preparation of the report.

Valuable input to the analysis was provided by: David Wilkinson (independent consultant).

The work could not have been achieved without the support and co-operation provided by many government bodies, organisations and companies worldwide, notably: Enel Grids; Hitachi Energy; Iberdrola; ACER; Cigre; EDF; ENTSO-E; EU DSO Entity; European Commission; GE Vernova; KEEI; Ministério de Minas e Energia Brazil; Ministry of Economy, Trade and Industry, Japan; Ministry of Energy of Kenya; OCCTO; State Grid Energy Research Institute; US Department of Energy.

Thanks also go to the IEA Electricity Security Advisory Board.

Peer reviewers

Many senior government officials and international experts provided input and reviewed preliminary drafts of the report. Their comments and suggestions were of great value. They include:

David Felipe Acosta Correa	Asociación de Distribuidoras de Energía eléctrica Latinoamericanas (ADELAT)
Keigo Akimoto	The Research Institute of Innovative Technology for the Earth
Mirlan Aldayarov	The World Bank
Murad Alomari	National Electric Power Company
Catarina Augusto	SolarPower Europe
Pankaj Batra	Integrated Research and Action for Development
Ahmed Barakat	EgyptERA
Harmeet Bawa	Hitachi Energy
Edith Bayer	Oregon Department of Energy
Pierre Bornard	BSDE Associates
Samir Chandra Saxena	Grid Controller of India

Xavier Chen	Beijing Energy Club
Naomi Chevillard	SolarEurope
Andrei Covatariu	United Nations Digitalisation Task Force
Juan David Molina Castro	Colombia Intelligente
Carlo Degli Esposti	TERADEC
Marcello del Brenna	Prysmian Group
Fernando Dominguez	EU DSO Entity
Zhongming Du	Electric Power Planning & Engineering Institute
Marek Duk	Polskie Sieci Elektroenergetyczne (PSE)
Frederic Dunon	Elia
Pablo González Gascón y Marín	Iberdrola
Edwin Haesen	ENTSO-E
Melis Isikli	Eurelectric
Gerald Kaendler	Amprion
James Kappel	Ministry of Energy and Natural Resources of Canada
Sarah Keay-Bright	National Grid ESO
Vasiliki Klonari	Wind Europe
Jan Kostevc	Agency for the Cooperation of Energy Regulators (ACER)
Ashok Kumar Rajput	Central Electricity Authority
Patricia Labra	Red Eléctrica de España
Francisco Laverón	Iberdrola
Marina Lombardi	Enel Grids
Stephen Lorimer	Centre for Net Zero
Qiuyang Ma	State Grid Research Institute
Matthew Magill	National Grid ESO
Yasuo Matsuura	Kansai Transmission and Distribution
Christoph Maurer	Consentec
Victoria Mollard	Australian Energy Market Commission

Albert Moser	RWTH Aachen
Mirela Mustafic	Svenska Kraftnet
Manabu Nabeshima	The Electricity and Gas Market Surveillance Commission
S R Narasimhan	Grid Controller of India
Bruce Nordman	Lawrence Berkeley National Laboratory
Kaname Ogawa	Ministry of Economy, Trade and Industry Japan
Mika Ohbayashi	Japan Renewable Energy Institute
Hiroshi Okamoto	TEPCO Power Grid
Juan Carlos Olmedo	Coordinador Eléctrico Nacional
Barbara O'Neill	National Renewable Energy Laboratory
Eli Pack	Australian Energy Market Operator
Robert Pan	BC Hydro
Kristen Panerali	World Economic Forum
Zsuzsanna Pato	Regulatory Assistance Project
Michelle Patron	Microsoft
Alan Pears	RMIT University
Zubin Postwalla	GE Vernova Grid Solutions
Julia Reinaud	Breakthrough Energy
Magnus Röstellund	NKT Group
Louise Rullaud	Eurelectric
Gerhard Salge	Hitachi Energy
Ignacio Santelices	Adelat
Raphael Sauter	European Commission
Marcus Stewart	Department for Business, Energy and Industrial Strategy
Reena Suri	India Smart Grid Forum
Marcio Szechtman	CIGRE
Thais Texeira	Empresa de Pesquisa Energética
Alberto Toril	Breakthrough Energy

Nikos Tsafos	Office of the Prime Minister, Hellenic Republic
Andreas Ulbrig	RWTH Aachen
Nuki Utama	ASEAN Centre for Energy
Jan Van Roost	Coreso
Peter Vermaat	EU DSO Entity
Stéphane Verret	Hydro Quebec
Aisma Vītiņa	Ørsted
Viviana Vitto	Enel Grids
Karin Wadsack	Global Power System Transformation
Volker Wendt	Europacable
Matthew Wittenstein	United Nations Economic and Social Commission for Asia and the Pacific (ESCAP)
Hyeok-Jun Yoon	Korea Power Exchange
Audrey Zibelman	Zibelman Energy Advisors
Christian Zinglensen	Agency for the Cooperation of Energy Regulators (ACER)

Executive summary

Modern, smart and expanded grids are essential for successful energy transitions

The backbone of today's electricity systems, grids are set to become increasingly important as clean energy transitions progress, but they currently receive too little attention. Grids have been delivering power to households, businesses and industry for over 100 years. Clean energy transitions are now driving the transformation of our energy systems and expanding the role of electricity across economies. As a result, countries' transitions to net zero emissions need to be underpinned by bigger, stronger and smarter grids.

To achieve countries' national energy and climate goals, the world's electricity use needs to grow 20% faster in the next decade than it did in the previous one. Electricity demand needs to grow even more rapidly in a global pathway to net zero emissions by 2050, which is consistent with limiting the rise in global temperatures to 1.5 °C. Expanded grids are critical to enable such levels of growth as the world deploys more electric vehicles, installs more electric heating and cooling systems, and scales up hydrogen production using electrolysis.

Reaching national goals also means adding or refurbishing a total of over 80 million kilometres of grids by 2040, the equivalent of the entire existing global grid. Grids are essential to decarbonise electricity supply and effectively integrate renewables. In a scenario in which countries' national energy and climate goals are met on time and in full, wind and solar PV account for over 80% of the total increase in global power capacity in the next two decades, compared with less than 40% over the past two decades. In the International Energy Agency's (IEA) Net Zero Emissions by 2050 Scenario, wind and solar account for almost 90% of the increase. The acceleration of renewable energy deployment calls for modernising distribution grids and establishing new transmission corridors to connect renewable resources – such as solar PV projects in the desert and offshore wind turbines out at sea – that are far from demand centres like cities and industrial areas.

Modern and digital grids are vital to safeguard electricity security during clean energy transitions. As the shares of variable renewables such as solar PV and wind increase, power systems need to become more flexible to accommodate the changes in output. In a scenario consistent with meeting national climate goals, the need for system flexibility doubles between 2022 and 2030. Grids need to both operate in new ways and leverage the benefits of distributed resources,

such as rooftop solar, and all sources of flexibility. This includes deploying grid-enhancing technologies and unlocking the potential of demand response and energy storage through digitalisation.

Grids risk becoming the weak link of clean energy transitions

At least 3 000 gigawatts (GW) of renewable power projects, of which 1 500 GW are in advanced stages, are waiting in grid connection queues – equivalent to five times the amount of solar PV and wind capacity added in 2022. This shows grids are becoming a bottleneck for transitions to net zero emissions. The number of projects awaiting connection worldwide is likely to be even higher, as data on such queues is accessible for countries accounting for half of global wind and solar PV capacity. While investment in renewables has been increasing rapidly – nearly doubling since 2010 – global investment in grids has barely changed, remaining static at around USD 300 billion per year.

Delays in grid investment and reform would substantially increase global carbon dioxide (CO₂) emissions, slowing energy transitions and putting the 1.5 °C goal out of reach. For this report, we developed the Grid Delay Case to explore the impacts of more limited investment, modernisation, digitalisation and operational changes than are envisioned in the IEA's climate-focused scenarios. The Grid Delay Case shows transitions stalling, with slower uptake of renewables and higher fossil fuel use. Cumulative CO₂ emissions from the power sector to 2050 would be 58 gigatonnes higher in the Grid Delay Case than in a scenario aligned with national climate targets. This is equivalent to the total global power sector CO₂ emissions from the past four years. It would also mean that the global long-term temperature rise would go well above 1.5 °C, with a 40% chance of it exceeding 2 °C.

At a time of fragile natural gas markets and concerns about gas supply security, failing to build out grids increases countries' reliance on gas. In the Grid Delay Case, global gas imports are over 80 billion cubic metres (bcm) a year higher after 2030 than in a scenario aligned with national climate targets – and coal imports nearly 50 million tonnes higher. Delayed grid development also increases the risk that economically damaging outages would multiply. Today, such outages already cost around USD 100 billion a year, or 0.1% of global GDP.

Action today can secure grids for the future

Regulation needs to be reviewed and updated to support not only deploying new grids but also improving the use of assets. Grid regulation needs to incentivise grids to keep pace with the rapid changes in electricity demand and supply. This requires addressing administrative barriers, rewarding high

performance and reliability, and spurring innovation. Regulatory risk assessments also need to improve to enable accelerated buildout and efficient use of infrastructure.

Planning for transmission and distribution grids needs to be further aligned and integrated with broad long-term planning processes by governments.

New grid infrastructure often takes five to 15 years to plan, permit and complete, compared with one to five years for new renewables projects and less than two years for new EV charging infrastructure. Grid plans need to integrate inputs from long-term energy transition plans across sectors, anticipating and enabling the growth of distributed resources, connecting resource-rich regions including offshore wind, and reflecting links with other sectors including transport, buildings and industry, and fuels such as hydrogen. Robust stakeholder and public engagement is key to inform scenario development. The public needs to be aware and informed about the link between grids and successful energy transitions.

To meet national climate targets, grid investment needs to nearly double by 2030 to over USD 600 billion per year after over a decade of stagnation at the global level, with emphasis on digitalising and modernising distribution grids. Concerningly, emerging and developing economies, excluding China, have seen a decline in grid investment in recent years, despite robust electricity demand growth and energy access needs. Advanced economies have seen steady growth in grid investment, but the pace needs to step up to enable rapid clean energy transitions. Investment continues to rise in all regions beyond 2030.

Building out grids requires secure supply chains and a skilled workforce.

Governments can support the expansion of supply chains by creating firm and transparent project pipelines and by standardising procurement and technical installations. They also need to build in future flexibility by ensuring interoperability of all the different elements of the system. There is also a significant need for skilled professionals across the entire supply chain, as well as at operators and regulatory institutions. It will be essential to build out a pipeline of talent, ensure digital skills are integrated into power industry curricula and manage the impacts of the energy transition and increased automation on workers through reskilling and on-the-job training.

The most important barriers to grid development differ by region. The financial health of utilities is a central challenge in some countries, including India, Indonesia and Korea, while access to finance and high cost of capital are key barriers in many emerging market and developing economies, particularly in Sub-Saharan Africa. Financial barriers can be addressed by improving the way grid companies are remunerated, driving targeted grid funding and increasing cost transparency. For other jurisdictions, such as Europe, the United States, Chile and Japan, the strongest barriers relate to public acceptance of new projects and the need for regulatory reform. Here, policy makers can speed up progress on grids by enhancing planning, ensuring regulatory risk assessments allow for anticipatory investments and streamlining administrative processes.

Introduction

Clean energy transitions are gaining momentum globally. The number of country-level net zero targets has exploded in the last five years, with more than 90 announced to date. Many of these are now reflected in policy documents and in some cases enacted into law. The global energy crisis is set to accelerate clean energy transitions despite the turmoil it has created in the sector, as governments respond with stronger policies to improve energy security using clean sources. The power sector is at the forefront of these transitions, both in policy ambition and progress. Renewables deployment set new records in 2022 and is set to do so again in 2023. Electrification is picking up pace, with heat pump installations growing rapidly and electric car markets increasing exponentially.

Grids are essential to modern life, but energy transitions are at risk without vital upgrades

All of these developments are enabled by power grids, which sit at the heart of electricity sector security, affordability and decarbonisation. Yet, grids have so far not captured the level of public attention that they warrant – and need. Grids are above all essential for bringing power to industry, citizens and services. To do this in the context of secure and affordable transitions they must host and connect new power generation sources and efficient and flexible devices, as well as adapt to changing patterns of population. Lack of grid development – expansion and strengthening, digitalisation, modernisation and more effective utilisation – presents risks to electricity security while both limiting the pace and increasing the cost of clean transitions. This is not only a problem for the future, but one we are seeing already, where long lead times for grid projects delay necessary upgrades and grid connection acts as a bottleneck for renewables deployment in many places. Grids are also a key provider of flexibility for the power system, facilitating the integration of variable renewable energy and distributed energy resources, as well as being key to the regional integration of power systems.

Today's policy context and grid expansion plans show that grids will need to continue growing and being strengthened to meet growing demand, with electrification intensifying GDP-driven growth in emerging economies and driving new growth in advanced economies. At the same time, clean energy transitions coupled with new technology will transform the grids we have now. Microgrids and storage will complement, but not replace, grid development. Digitalisation and more distributed resources create an opportunity for smarter and more resilient grids, while requiring them to operate more flexibly and be protected from cybersecurity threats. Technological change calls for updates to institutions and

regulation to ensure that remuneration structures reward the investments that will deliver efficient, modern grids. New technologies and practices, such as increased battery storage and the development of microgrids, can act as alternatives to traditional infrastructure buildout in some cases, but we need new poles and wires too. Policy makers need to ensure that planning and investment bring the best solutions forward in diverse situations, accounting for complex criteria that balance cost, acceptability and sustainability.

It is time for policy makers to create the frameworks for grid transformation

With this special report, we aim to put an urgently needed spotlight on power grids. While grids in many local and technical situations require specific solutions, we can nonetheless identify key themes that hold true across many contexts. The role of grids in energy transitions is just as foundational as that of solar panels, wind turbines and electric vehicles. Policy makers need to create the frameworks that will enable grids to be transformed, modernised and expanded. The private sector will need to innovate and invest. The wider public should be made aware of the need for this critical infrastructure and be enabled to help find the balance between cost and impact on society and the environment.

The report starts with a stocktake of grids as they stand, to understand their current status and pace of change in recent years. We then look at where we need to go to achieve the climate targets for 2050 and what would happen if grid development falls short. Finally we distil a set of recommendations for policy makers to identify actions they can take to ensure grids enable, rather than impede, energy transitions across different power industry and economic contexts.

Our analysis is based on the Announced Pledges Scenario (APS) from the World Energy Outlook 2022 modelling, and a special Grid Delay Case. The APS shows the pathway corresponding with announced ambitions and targets, including all national announcements as of September 2022. This scenario provides a benchmark for the grid development that would be needed to meet today's climate pledges on time. The Grid Delay Case is a variation of the APS that was developed for this report to explore the potential impacts of failing to deliver grid infrastructure in a timely manner. In this case, slower development of grid infrastructure delays the deployment of solar PV and wind power in all regions, keeping global solar PV capacity additions 10% below the APS level in 2030 and almost 20% below it in 2050. Wind capacity additions are held more than 15% below the APS in both 2030 and 2050. This results in higher outputs from other technologies, including fossil fuels, and higher emissions as a consequence. Comparing these scenarios allows us to highlight the need to accelerate grid development now and the potential risks if grids do not keep pace with energy transitions.

The report is structured in four chapters as follows:

In **Chapter 1 (State of play)** we give an overview of grids today, including a brief introduction to grid infrastructure and its current status, and describing recent rates of grid deployment, supply chains and the implications of digitalisation. We then look at the links between grid development and clean energy transitions, showing how electrification will place additional demands on the grid while at the same time higher dependence on electricity raises the importance of reliable, secure supply. We provide analysis of current connection queues, grid congestion and losses, and grid permitting and construction times, illustrating how grids are already becoming a barrier to electricity sector transformation. Finally we look at current remuneration structures for grids and reforms that can support efficient grid investment, including the modernisation and deployment of new technologies.

In **Chapter 2 (Regulation and policy)** we describe current trends in power grid planning and the necessary evolution, currently underway in many places, to adapt planning to the needs of energy transitions. We identify promising policy-driven initiatives targeting accelerated grid development, which can act as useful examples for policy makers, including those that are boosting investment, lowering regulatory barriers and fostering societal support.

In **Chapter 3 (Identifying the gap)** we look at the key drivers for grid development in energy transitions, including electrification, integrating distributed energy resources, resilience to climate risk and the need to keep improving electricity access. We analyse the implications of these drivers in terms of the need to increase investment and the deployment of infrastructure in the coming years. We then present the Grid Delay Case and quantify the potential impacts of reduced grid development on renewables deployment and the ability to meet decarbonisation targets.

In **Chapter 4 (Policy recommendations)** we present policy approaches to support timely grid deployment across six key areas – planning, investment, grid enhancement, supply chains, data streamlining, transparency and digitalisation, and developing capable institutions and skilled workforces. While each country context is specific, we identify recommendations that address common challenges across many countries and highlight aspects of particular relevance to emerging or advanced economies.

Chapter 1: State of play

Power grids are major pieces of infrastructure with many components and a high degree of technical complexity. Understanding the current state of grid development is not a simple task, particularly due to data availability challenges relating both to the basic infrastructure and the technologies used in its operation and management. Nonetheless, to identify where grids need to go in the coming years and the current priorities for action, we need an understanding of the current state of play.

In this chapter we attempt the first global stocktake of power grids. It includes comprehensive data collection on the quantity and age of existing infrastructure, and the technologies used. We also quantify recent investment trends, analyse the status of supply chains and give an overview of progress in interconnection and the role of digitalisation. To better understand shifts already taking place in power grids, we also look at the impacts of electrification and decarbonisation at the grid level, and the role of grids in electricity security. We then analyse deployment times for grids to better understand the speed at which new infrastructure can currently be deployed in different regions. Finally, we look at jobs related to the grids sector and how they are evolving.

The total length of electricity grid infrastructure has grown steadily over the last 50 years, concentrated in distribution networks. The rapid growth of variable renewables and distributed resources is creating new challenges for grids and requiring them to be more flexible. In advanced economies we see increasing investment, but also very long lead times for transmission grid projects, signalling challenges to the realisation of planned development. In emerging market and developing economies (EMDEs), significant strides have been made in increasing electricity access, but investment has been falling off in recent years while demand continues to grow, driven by economic and population growth. Supply chains for grids are already showing some tightness, which could pose risks to grid development in the coming years. We see grids playing a central role in electricity security, and at the same time increasing signs of grid congestion and bottlenecks in connecting renewable projects in many places. In short, we find evidence of multiple challenges that will need to be addressed to deliver the grids of the future.

Overview of electricity grids today

Grid length has almost doubled over the past 30 years, driven by expansion of distribution networks

Over the past five decades the electricity grid has experienced continuous growth, at a rate of about 1 million km per year. The majority of this expansion has occurred in distribution grids, which account for about 93% of the total length. They are essential as they form the last mile to the majority of customers, and they need to expand to bring electricity access to more people and to meet demand growth. Transmission lines constitute the remaining 7% of the grid's total length.

Global historical grid length, 1971-2021

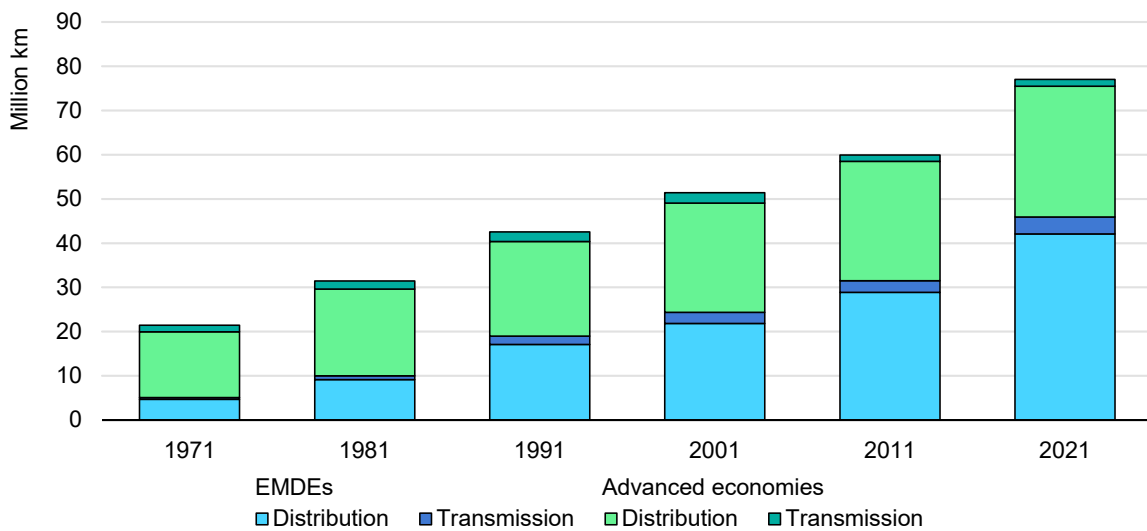

IEA. All rights reserved.

Note: Line route length of grids.

Sources: IEA analysis based on [Global Transmission](#) and [NRG Expert](#).

In 2021, there were almost 80 million km of overhead power lines and underground cables worldwide, of varying voltage levels, which equate to roughly a hundred trips to the moon and back.

Grids are differentiated according to their voltage levels. Low-voltage lines supply electricity to residential and commercial users, while medium-voltage lines serve villages and small and medium-sized industrial sites; both levels connect distributed electricity generation. Collectively, these lines form the distribution grid.

The high-voltage grid connects utility-size generation, distribution grids and large industrial consumers, and, along with extra-high-voltage and ultra-high-voltage (UHV) lines that transport electricity over longer distances, they form the transmission grid.

Most electricity grids carry alternating current (AC), historically generated by rotating generators in thermal and hydroelectric power plants. Renewable energy sources such as solar PV and wind systems, as well as batteries and fuel cells, connect to the power grid through power electronic converters.

One of the main reasons for the proliferation of AC in grid systems is the ease of changing voltage level using power transformers. This enables the transformation of electricity to higher voltages for efficient long-distance transmission, minimising losses, and its transformation to lower voltages for regional or local distribution grids catering to industrial, commercial and residential needs.

However, numerous situations arise where DC (direct current) proves to be more sensible and holds specific advantages. For instance, DC can be preferable in scenarios involving subsea cables connecting multiple wind farms or markets, cross-border interconnectors and long-distance power transmission from large hydropower facilities to large demand centres, allowing minimal losses, supporting grid stability and offering black-start capabilities.

Key technology components of electricity grids

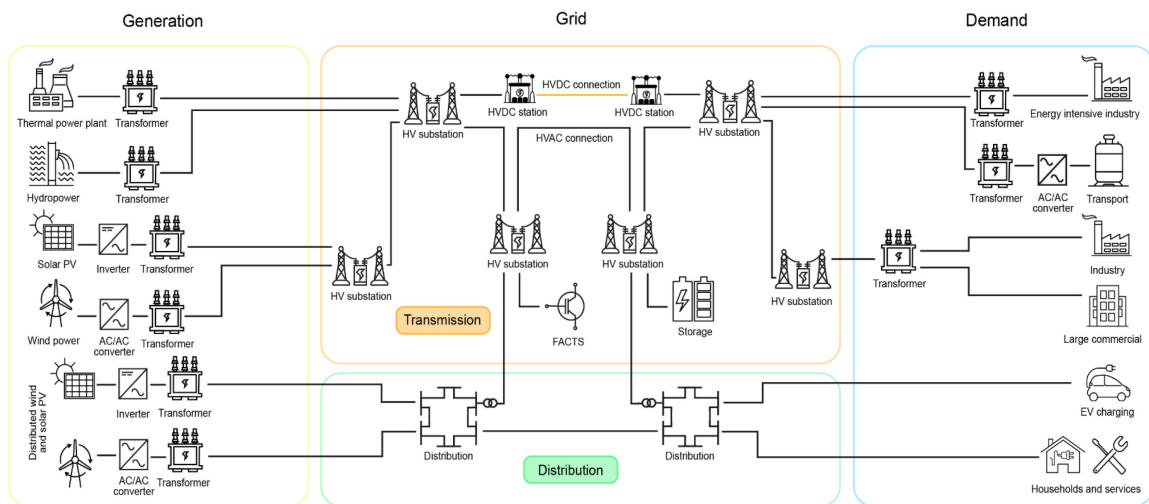

IEA. CC BY 4.0.

Notes: FACTS = flexible alternating current transmission system; HVAC = high-voltage alternating current; HVDC = high-voltage direct current.

Since the early 2000s electricity grids worldwide have experienced significant development and transformation. Besides coping with the increasing demand for

electricity, the drivers for change include renewable energy integration, implementation of digital and smart grid technologies, grid modernisation, enhanced grid resilience and security, the electrification of transport, the decentralisation of generation, the increase in distributed energy resources and the integration of energy storage.

Distribution grids

Most grid expansion has been seen at the distribution level in EMDEs. These grids have grown by over 40% in the past decade and have almost doubled over the last 25 years, playing a central role in granting electricity access to many people for the first time. One of the main advances in electricity access is the widespread acknowledgement of three reliable approaches to connecting households and industry to a dependable electricity supply: grid extension, mini-grids, and standalone systems. These three methods have found their way into the national policies and strategies of numerous countries. Among them, grid extension, where feasible, is typically the most cost-effective option for achieving electricity access for households. Significant efforts have been made at the distribution level to connect new customers in EMDEs, resulting in an increase in the share of their population with electricity access of around 12 percentage points in the past decade.

The expansion of the distribution grid in EMDEs has resulted in impressive examples of raising electricity access. For example, nearly 100% of the populations of India and Indonesia have electricity access, even though the access rate was less than 45% and 55%, respectively, only 20 years ago.

In India, the [Saubhagya programme](#) played a crucial role in connecting millions of households to the grid, effectively reducing the country's overall electricity deficit and enhancing the quality of life for numerous citizens. Similarly, the People's Republic of China (hereafter "China") pursued several [electrification programmes](#) including State Grid Corporation's 2006 programme, providing electricity to 1.9 million households and 7.5 million people by 2015, and China Southern Power Grid's programme reaching 2.3 million people by 2012. By the end of 2015, nearly the [entire Chinese population](#) of 1.4 billion people had access to electricity.

In total, approximately 15 million km of distribution lines have been constructed in the past decade, with EMDEs accounting for almost 12.5 million km. India alone contributed more than 3.5 million km, while China added nearly 2.2 million km, representing approximately 30% of these countries' distribution grids. Brazil added 1.7 million km, an increase of 53% boosted by the "[Luz Para Todos](#)" (Light for All) programme, which played a vital role in extending electricity to rural households, schools and healthcare centres.

Since electricity access is already close to 100% in advanced economies, they experienced a modest rise of more than 9% over the past ten years. The United States added around 925 000 km of new distribution lines, while the countries of the European Union added around 715 000 km. Japan's grid only experienced a 3% increase, equivalent to less than 40 000 km.

Transmission grids

In the past ten years, EMDEs have constructed around 1.17 million km of new transmission lines. The primary reason for the expansion of transmission grids in these regions is the growing demand for electricity, which is further accelerated by expanding access to electricity. Several countries have established ambitious targets for renewable energy integration, leading to renewable power generation in locations distant from major load centres. The variability of this generation, coupled with the need for energy security, has prompted the construction of additional transmission lines to bolster the grid and in many cases the establishment of interconnections with neighbouring countries.

Electricity transmission and distribution lengths by age and country/region, 2021

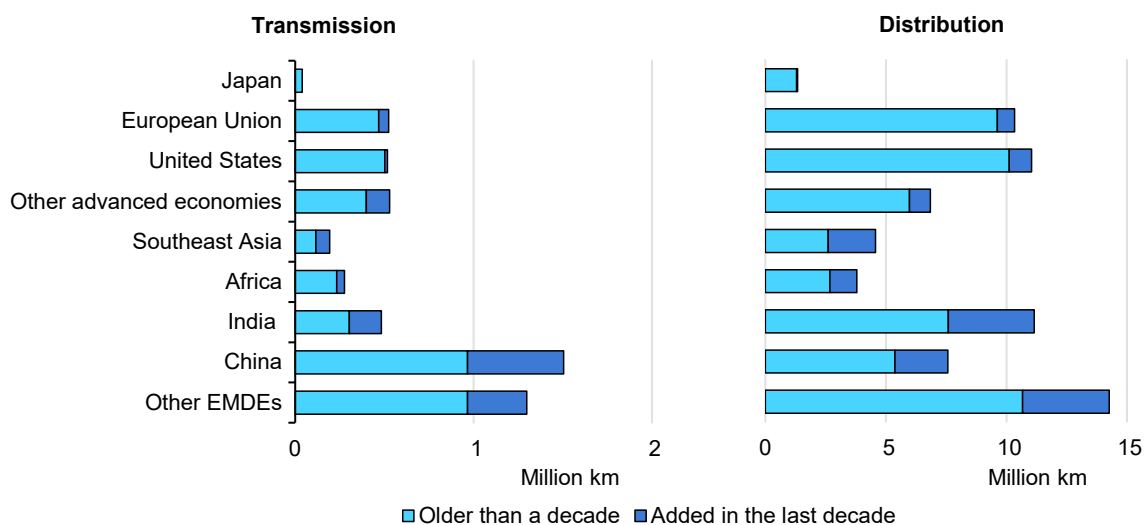

IEA. All rights reserved.

Sources: IEA analysis based on [Global Transmission](#).

China alone accounts for over one-third of the world’s transmission grid expansion in the past decade, having constructed over half a million km of transmission lines connecting, among other places, the eastern load centres to the renewable energy-rich northern and western provinces via UHV lines. Noteworthy projects in China include the ±800 kV Wudongde-Kunliulong UHV Multiterminal Flexible DC Demonstration Project and the Zhudong-Wannan ±1 100 kV UHV DC Transmission Project. In addition to China, India and Brazil have also made significant progress in expanding their grids. India has added nearly 180 000 km

of transmission lines over the past decade, an increase of around 60%. Similarly, Brazil has expanded its transmission system by over 92 000 km during the same period, growing by more than 50%.

In contrast, advanced economies have witnessed comparatively modest growth of 9% in their transmission grids. This is related to higher population densities in countries like Japan and Korea, but also in part due to rural-urban migration (leading to higher urban densities, and thus to higher urban need for grids and less need to expand grids into rural areas). The European Union experienced an increase of 12% in its transmission grid, while the United States saw a 3% expansion. Certain countries, such as Japan, even observed a slight decrease in the total length of their transmission lines. This might happen when old parallel lines are replaced by a single line with higher capacity. In advanced economies a significant amount of uprating occurs, which involves the replacement of existing lines with stronger or higher-voltage lines. This strategy is adopted to mitigate the challenges associated with lengthy permitting processes.

Direct current transmission

High-voltage direct current (HVDC) point-to-point transmission, which involves fewer power losses as well as other technical advantages, is becoming more common, mainly for long distances but also over medium and short distances.

The technology was first commercially used in the 1950s employing mercury-arc valves, but after the 1970s the introduction of high-power semiconductors led to the use of thyristors in HVDC converter stations, which makes smaller HVDC systems more economical. The latest generation using insulated gate bipolar transistors forming voltage source converters (VSC) offers several further benefits over line commutated converters (LCC), such as independent and flexible control of active and reactive power within the system. They also offer flexible AC voltage control, system stabilisation capabilities during grid faults, the ability to connect asynchronous grids and the ability to black-start grids, allowing the restoration of a part of the grid without relying on the external transmission grid in the event of a total or partial shutdown.

Most HVDC links today operate at voltages ranging from 300 kV to 800 kV, although there are projects, such as one in China, operating at 1 100 kV with a transmission capacity of up to 12 GW. HVDC systems are not only efficient for onshore power transmission, but also enable the connection of offshore wind farms, particularly in remote locations where underwater AC cabling is not economically or technically feasible. At present, HVDC transmission losses across 1 000 km are around 3% compared with typically more than 7% using AC lines.

The global length of HVDC lines has almost tripled since 2010, surpassing 100 000 km by the end of 2021, with a total transmission capacity exceeding

350 GW. However, this represents only 2% of the total transmission length. The growth in HVDC lines is primarily driven by long-distance overhead lines in China and Brazil, as well as underground and submarine cables in Europe. China accounted for almost 50% of total HVDC line length in 2021, while Europe had around 10%.

Global HVDC transmission line lengths by country/region

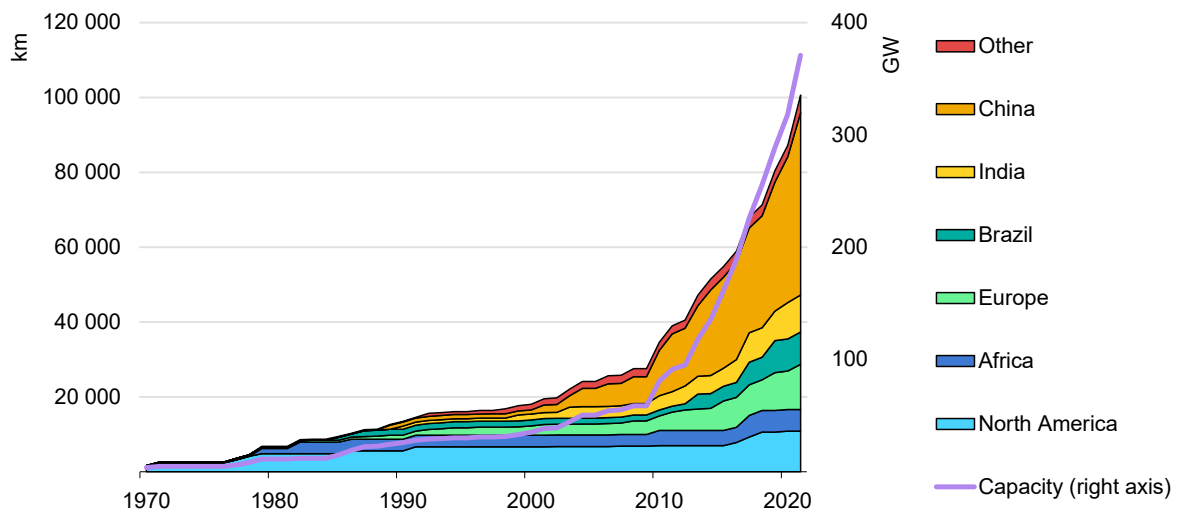

IEA. CC BY 4.0.

Notes: Data are for year end. "Capacity" refers to global HVDC transmission capacity, but excludes the capacity of HVDC back-to-back systems, which are used to link two AC grids.

Sources: IEA analysis based on [RTE International](#) (2022).

In 1992 the [first multiterminal HVDC system](#) began operation in Canada, featuring three stations. These systems enable the simultaneous transfer of power between three or more terminals, offering increased flexibility in integrating various power sources, including renewable energy generation. They facilitate efficient power transfer between regions with diverse generation and demand patterns, fostering seamless energy exchange across different areas.

Grid investment growth in the past decade has occurred mainly in advanced economies and China

Global spending on power grid infrastructure has remained relatively stable for more than a decade, hovering at around USD 300 billion per year. The majority of these investments are concentrated in advanced economies and China, underpinned by the need to support greater electrification efforts and address grid balancing requirements in power systems that are becoming increasingly reliant on renewable energy sources. Most growth in grid spending is occurring in advanced economies and is focused on grid upgrade and replacement rather than expansion.

Despite the lower average during the 2020-2022 period, China has witnessed growth in grid investment since 2021, coinciding with the unveiling of its 14th Five-Year Plan. Notably, in 2022 the State Grid Corporation of China budgeted a record USD 75 billion for 2023. It has a particular focus on UHV projects, especially in transmission, with over USD 22 billion worth of initiatives in the second half of 2022 and the start of 2023.

In advanced economies, grid investment has grown at around 5% on average over the past five years. The main focus is on enhancing the reliability of its grids and upgrading outdated grid infrastructure, leading to substantial capital spending in this area. In 2022 the United States invested approximately USD 90 billion, signifying a 7% increase compared with 2021. Europe’s spending grew at a similar rate, reaching USD 65 billion.

Annual average capital spending on electricity grids by region, 2014-2022

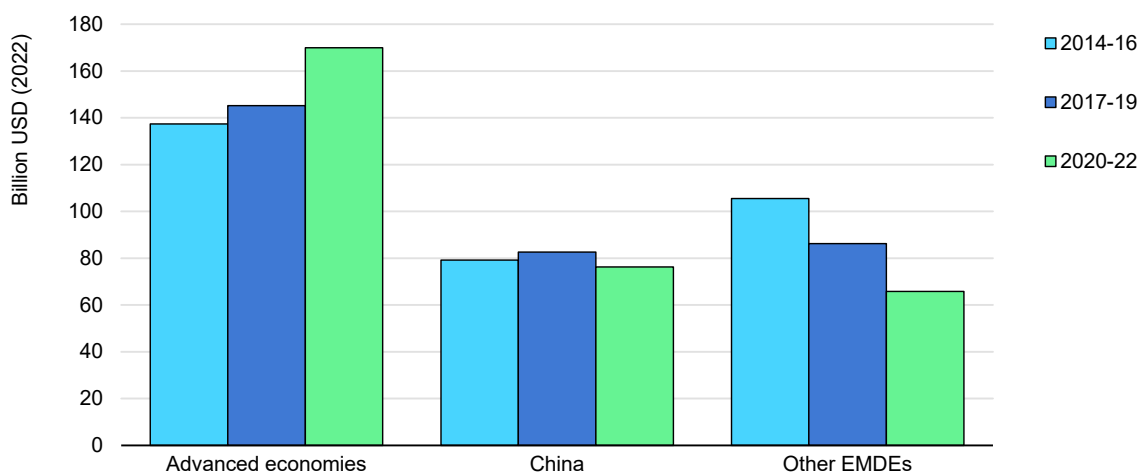

IEA. CC BY 4.0.

Source: IEA (2023), [World Energy Investment](#).

The pace of investment in EMDEs excluding China has slowed in the last five years, declining on average by 7% per year. The main drivers for investment have been electricity access and demand growth, and the investment slowdown is particularly concerning in light of continued demand growth and the need to continue improving reliability in many regions. Nonetheless, countries like India and regions such as Southeast Asia have made impressive strides in connecting people to the grid. A significant proportion of grid investments in EMDEs heavily rely on government funding, often through state-owned enterprises (SOEs), which dominate the utility sector. There are some exceptions, such as Brazil, where there is a much higher involvement of the private sector due to public-private partnership programmes and concession policies. In Africa, despite efforts to enhance electricity access, factors such as insufficient financial resources, regulatory barriers and, in some countries, political instability have hindered investment in electricity grids.

Electricity grid supply chains

The supply chain for grid infrastructure is showing tightness

Global supply chains of all kinds have faced various barriers and bottlenecks in recent years. The Covid-19 pandemic and the Russian Federation's (hereafter "Russia") invasion of Ukraine critically disrupted global energy and technology supply chains. Soaring prices for energy and materials, and shortages of critical minerals, semiconductors and other components, pose potential roadblocks for the energy transition.

Grid technology supply chains were severely affected. Taking just one example, power transformers of 50 MVA size had typical procurement times of 11 months prior to the pandemic, but purchasers can currently face a wait of over 18 months as manufacturers are struggling to cope with labour and material shortages.

Constructing a transmission line is a complex task, requiring a variety of different components and technologies (e.g. cables, lines, transformers, substations and control systems). Different materials are needed to manufacture these technologies and components. Copper and aluminium are the principal materials for the manufacture of cables and lines. Because of its good electrical conductivity, copper was for a long time the preferred choice, although it is three times heavier and much more expensive than aluminium. Aluminium has approximately 60% of the conductivity of copper, which means that much thicker wires are required for the same capacity. As the conductivity-to-weight ratio of aluminium is superior to copper, aluminium is usually preferred for overhead power lines and is increasingly also used for underground and subsea transmission cables, while copper is mostly used for underground and subsea cables.

The material needs for transmission and distribution lines depend on their voltage level. Transmission capacity is the product of current and voltage: if the voltage is increased with the same current, transmission capacity increases. Current determines the thickness requirement of the conductor as well as the losses. The higher the current, the greater the conductor's thickness and the higher the losses. Voltage determines how much insulation is needed – either air for an overhead line or insulating material such as cross-linked polyethylene (VPE, XLPE, PE-X or XPE), polyvinyl chloride (PVC), cross-linked ethylene-propylene polymer (EPR) and silicone rubber in the case of a cable. The higher the voltage, the higher the need for insulation. The amount of conductor material and electricity losses can therefore be reduced by increasing the transmission voltage.

An overhead AC transmission line requires around 11 kilogrammes of aluminium per megawatt and per kilometre (kg/MW/km), compared with 65 kg/MW/km for an

overhead distribution line operating at a much lower voltage. Wood, steel and concrete are used for the pylons in the distribution grid, while steel is used for transmission towers to support the overhead conductors. Underground cables require 101 kg/MW/km of copper for transmission and 438 kg/MW/km for distribution. An HVDC line requires much less metal than an AC line – around 5 kg/MW/km of aluminium for an overhead HVDC line and 29 kg/MW/km of copper for an underground cable. Reactive power makes a big difference in the material needs of AC lines compared with HVDC lines of the same capacity. A significant portion of the power capacity of an AC line is used by reactive power (MVar), which does not produce useful work. This is not the case for an HVDC line, which is entirely used for active power transmission (MW). In addition, HVDC systems usually operate at higher voltages, which further reduces the material needs relative to AC for the same transmission capacity.

There are several manufacturers of HVAC and HVDC cables and overhead lines, with factories around the world. The factories are often located close to demand centres to reduce the cost and time associated with transporting cables. The top industry players in the high-voltage cable and line market are located in Europe (Südkabel in Germany, Nexans in France, NKT in Denmark, Prysmian in Italy, Hellenic in Greece and Tele-Fonika/JDR in Poland/United Kingdom), the United States (General Cable, Belden and Okonite), in China (NBO and ZTT), in Japan (Sumitomo Electric Industries), in Korea (LS Cable) and in the Middle East (Dubai Cable Company Pvt Ltd). There are manufacturers in Africa, India and Australia with lower manufacturing capacity (e.g. Cullin Africa, Bhuwal Insulation Cable and Znergy Cable).

Typical material composition of overhead lines and cables and their supporting infrastructure by weight, 2021

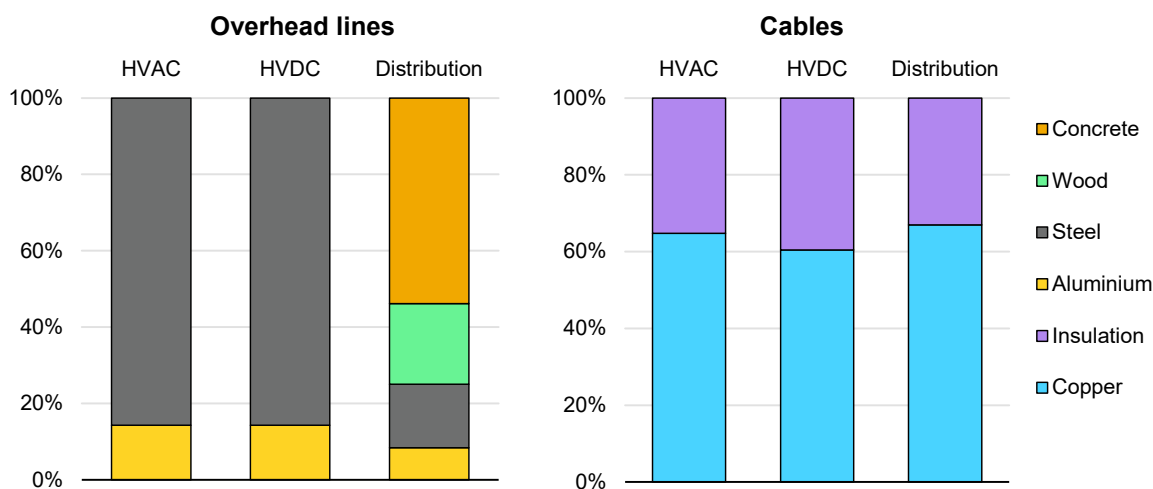

IEA. CC BY 4.0.

Notes: For most power cables, the conductor will be either aluminium or copper. The figure shows information for copper cables due to lack of data on aluminium cable material intensities.

Besides manufacturing, the process of constructing new transmission lines can also be affected by bottlenecks. Subsea cables, for example, require cable-laying vessels. The 45 cable-laying vessels in operation worldwide can lay a total of 4 200-7 000 km of cable per year (depending on the type of project). Depending on the future deployment of offshore wind and subsea interconnectors, additional vessels could be needed, which, if their construction is not planned well ahead, could create a shortage and delay projects.

Power transformers are a further key component of power systems. Almost half of the material (by weight) required for their manufacture is steel, of which more than 60% is grain-oriented electrical steel (GOES) with specific magnetic properties and high permeability, while the remainder is construction steel. GOES is a key material for manufacturing transformers, power generators and EV charging stations. The transformer segment currently accounts for the largest share. GOES is available in various quality levels, with high permeability varieties allowing the transformer to be smaller, requiring less oil for insulation and reducing electrical losses. Minimum efficiency standards for transformers, such as the Energy Efficiency Program for Certain Commercial and Industrial Equipment in the United States, and the [Ecodesign Directive](#) in the European Union, are pushing the use of higher-quality GOES, although European manufacturers have warned recently of shortages.

Typical material composition of transformers by weight and value, 2021

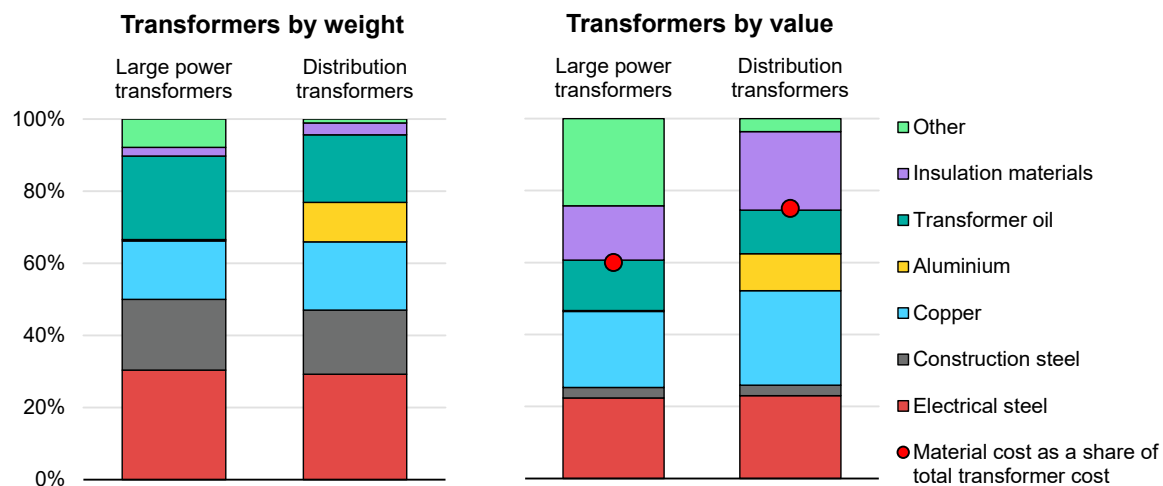

IEA. CC BY 4.0.

Sources: IEA analysis and environmental product declaration reports from manufacturers.

The cost of GOES used in the transformer core represents more than 20% of the transformer’s total cost. The price of GOES is almost 2.5 times higher than that of construction steel, and it does not follow the same price trends. Other materials needed for the manufacture of transformers include copper, aluminium,

transformer oil for insulation, insulation material, pressboard, paper, plastics, porcelain and rubber. Aluminium is mainly used in low-voltage distribution transformers, while mineral oil is used in all types of transformers to insulate and cool the transformer windings (copper coils) and core.

Transformer manufacturing varies according to the size of the transformer. The production of medium-voltage and distribution transformers (building of the core, production of the windings and the oil tank, assembly of the core and windings and final assembly of the transformer and testing) is not overly technologically demanding. Their production is spread over a large number of companies across the world. The production of large power transformers is concentrated in a few companies since special facilities are required (i.e. drying ovens for windings, high power testing laboratories, etc.). More than the 40% of the global market is accounted for by Hitachi Energy (Switzerland), Siemens Energy (Germany), Mitsubishi Electric and Toshiba (Japan), General Electric and Westinghouse (United States), Hyundai Heavy Industries (Korea), Chint and China XD Electric (China) and Compton Greaves (India).

The availability of GOES has a significant impact on transformer production. In 2020 the global manufacturing capacity of GOES stood at around 3.8 Mt and was concentrated in a few countries: China, Japan, France, Germany, India, Poland, the Czech Republic, Russia, Brazil, Korea and the United States. China is the largest market, with estimated annual domestic consumption of [1.33 Mt in 2020, followed by the European Union at 0.23 Mt and the United States at 0.15 Mt](#). The transformer industry has been facing shortages of GOES, which led to price increases of 70% in 2022 compared with 2020. The sanctions on material exports from Russia, which accounted for almost 10% of global GOES production capacity in 2020, is an important factor. The ongoing electrification of the transport sector is a further contributor, since GOES is used in EV charging stations. Growing demand for non-oriented electrical steel (NOES) for making EV motors is another contributing factor, as it has led some steel producers to switch part of their production away from GOES.

Semiconductors represent a further area facing supply shortages. The market for semiconductors has been volatile for the last two years, and it is expected that the supply chain challenges in the industry may continue until early 2024. High-power semiconductors are a central component of HVDC converter valves, used in HVDC converter stations. HVDC converter stations include a series of other components, such as insulated-gate bipolar transistors, capacitors, switches/breakers, resistors, inductors, power transformers, DC filters, control systems and measuring instruments. Many materials are required in the supply chains of the components of the HVDC stations, including silicon, steel, aluminium, copper, nickel, polymer and zinc. The expected increase in demand for HVDC equipment over the next ten years might put supply chains under

additional pressure, potentially amplified by a lack of experienced personnel in manufacturing and also areas such as engineering, construction and project management. The leading producer of converter stations is Hitachi Energy (formerly ABB) in Switzerland, followed by Siemens (Germany), General Electric (United States), Mitsubishi Electric (Japan), NR Electric and C-EPRI Electric Power Engineering (China) and Bharat Heavy Electricals Limited (India).

Another development affecting supply chains is the move towards greater sustainability for power grid components. Several jurisdictions are considering phasing out the use of certain materials such as lead and SF₆ in grid equipment, which have limited alternatives. Avoiding supply bottlenecks for grid components will require the development of alternative replacement technologies and the scale-up of their supply chains.

Electricity grid trends: Ageing, interconnection and digitalisation

Grids are ageing, posing safety and reliability risks

The age of electricity grids varies by country, influenced by factors such as historical development, investment and ongoing modernisation efforts. The lifespan of grid equipment also varies depending on specific components, overloading and capacity issues, environmental factors, maintenance practices and technological advancements. Electricity grids are expensive assets that are often in service much longer than the equipment they connect.

Typical design lifetimes for high-voltage equipment, solar PV, wind and EV charging stations

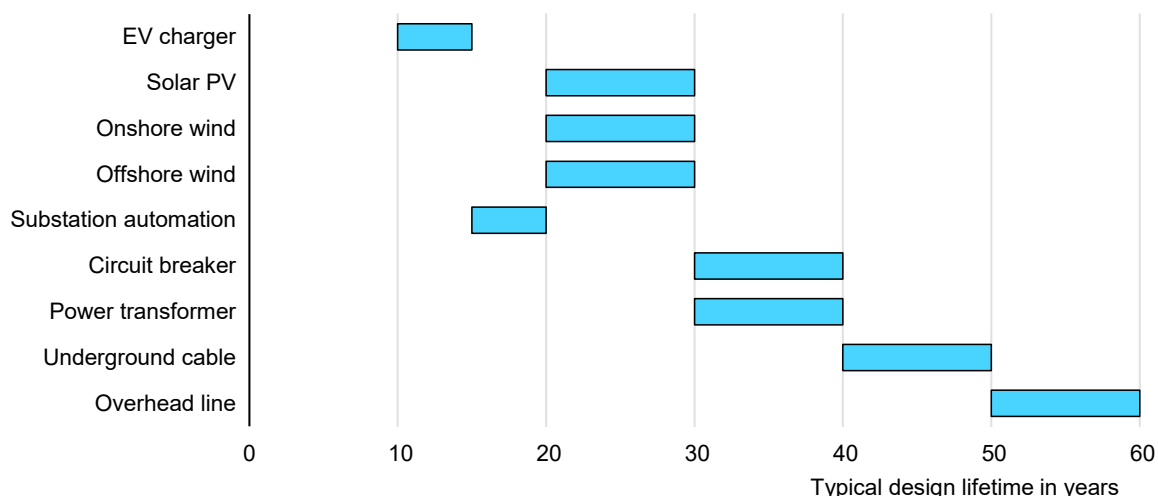

IEA. CC BY 4.0.

Transformers, which play a critical role in electricity grids, typically have a design lifetime of 30 to 40 years, the same as circuit breakers and other switchgear in substations. Underground and subsea cables are generally designed for 40 years, newer generations even for 50 years, while overhead transmission lines can endure for up to 60 years before requiring a major revision to replace ageing parts. However, it is worth noting that equipment older than this, particularly expensive assets as [power transformers](#), can still be found within electricity grids. With proper maintenance and service, the equipment lifetime can be significantly extended, while inadequate or deferred maintenance can lead to premature failure. If grid assets are consistently operated near or above their rated capacity, they can deteriorate faster and have a shorter lifespan. Overloading can cause excessive stress on the assets, leading to premature failure. Grids experience physical wear and tear due to exposure to weather conditions, temperature fluctuations and mechanical stress. These factors can degrade the structural integrity and performance of the assets.

These ageing electrical assets can present significant safety and reliability risks. Over time, insulation materials – for example in transformers – can degrade, resulting in an increased likelihood of electrical faults, short circuits and even fires. Circuit breakers, as they age, may become less reliable in their ability to trip during faults. The reliability of electrical assets diminishes as they age, particularly when they operate beyond their rated lifetime. This unreliability can lead not only to power outages, but also potential equipment damage if safety tripping mechanisms fail to function correctly.

Moreover, ageing electrical equipment poses safety risks to operating staff who work near failing equipment. Older equipment often lacks modern safety features, and this increases the risk of accidents and human error. Additionally, the maintenance and repair costs for ageing assets tend to be higher as these assets require more frequent maintenance and repairs to maintain proper functionality. When equipment ages, replacement parts may become scarce or expensive, and specialised technicians with knowledge of outdated technologies may be necessary, resulting in higher costs and longer maintenance times.

The digital elements of power grids have a much shorter lifetime, but also have much faster innovation cycles. These control and protection systems are often designed for 15 to 20 years before replacement, which offers significant opportunities to update to devices with new functions that increase the flexibility and reliability of grid operation. Modern devices offer features such as asset health assessment and allow detailed monitoring of the stress to which critical assets such as circuit breakers and transformers are exposed throughout their operational lifetime. These advances allow for a more complete picture of equipment condition and expected reliability. This enables new strategies of preventive maintenance, extension of service life and ultimately cost savings –

benefiting not only system operators but customers too. However, issues such as software life cycles and cybersecurity also need to be addressed with the updated equipment.

Share of grid length by age by country/region, 2021

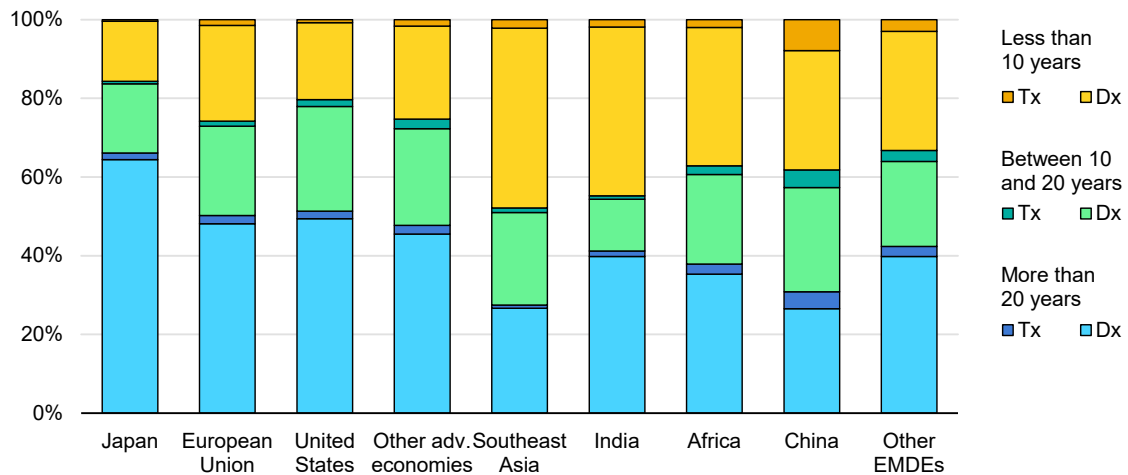

IEA. All rights reserved.

Notes: Tx = transmission lines; Dx = distribution lines, adv. = advanced.

Sources: IEA analysis based on [Global Transmission](#).

In advanced economies, electricity grids tend to be older, with infrastructure that has sometimes been operational for 50 years or more, mainly due to early electrification. However, there is a growing need to modernise this ageing infrastructure to enhance efficiency and reliability, and accommodate new energy resources. In total, only around 23% of the grid infrastructure in advanced economies is less than 10 years old, and more than 50% is more than 20 years old. In contrast, EMDEs have newer grids that were developed more recently to meet the increasing demand for electricity. About 40% of their total grid infrastructure is less than 10 years old, and less than 38% is more than 20 years old.

Certain countries, such as Japan, the United States and those in Europe, have a high proportion of their grids dating back over 20 years. In the European Union, more than 50% of the grid has been in operation for over 20 years, which is approximately half of its average lifespan. These countries have experienced modest growth in their grid lengths, resulting in a substantial proportion of their grids consisting of old assets. The connection of distant renewable energy sources is the main reason for deployment of newer transmission grids.

The African continent has significant regional variation in the status of its electricity infrastructure, with some countries such as [Ghana, Kenya and Rwanda making notable progress in grid modernisation](#) and expansion, while others continue to

face significant challenges in developing and maintaining their grids. India has a mix of older and newer grid infrastructure, with urban centres having more modernised grids compared to rural areas. The country has been actively working on upgrading and expanding its grid to improve electricity access and facilitate the integration of renewable energy sources. As a result, around 45% of India's lines and assets are 10 years old or less. China has achieved significant advancements in rural electrification, extending grids to remote and underserved areas. Projects like the West-East Electricity Transmission Project have improved grid connectivity by transferring electricity from resource-rich western provinces to power-hungry eastern regions. China is also the world's largest investor in renewable energy and has successfully integrated wind and solar power into its grid. The deployment of UHV transmission lines enables efficient long-distance electricity transfer, thereby supporting renewable energy development. China has the highest proportion of transmission lines under 10 years old, with more than 710 000 km built in the past decade.

Power system interconnection is being used to strengthen grids to accelerate renewables integration

In the early stages of electrification, power systems primarily operated independently. However, as the demand for electricity grew and regional co-operation developed, interconnections between neighbouring systems became increasingly common. Europe witnessed the first international interconnections in 1906 when Switzerland constructed transmission links to connect with France and Italy. This marked a significant milestone in the development of interconnected power systems, setting the stage for future cross-border collaborations. Interconnections across continents, between countries and between regions within a country are becoming more prevalent, especially in countries of continental dimensions such as Brazil and the United States.

Interconnections involve the construction and operation of transmission lines, substations and, in most cases, flexible AC transmission system (FACTS) equipment. In synchronous grids, all interconnected systems maintain the same precise electrical frequency, needing a high level of technical compatibility and operational co-ordination. In situations where frequency asynchrony exists between grids, HVDC technology is employed as it can adapt to any rated voltage and frequency, making it suitable for interconnections through transmission lines or back-to-back converter stations. It is also used when a high level of flexibility is needed or when offshore interconnection is involved.

The advantages of interconnected grids include improved grid stability, increased energy security and enhanced flexibility in managing power demand and supply fluctuations. Additionally, interconnected grids enable the integration of renewable energy sources like solar and wind, allowing regions with excess clean energy to

transfer it to areas with higher demand or less generation capacity. A good example is the interconnector between Germany and Norway, known as the North Sea Link, which supports the integration of renewable generation by enabling the efficient exchange of clean electricity between the two countries. It facilitates the utilisation of surplus renewable energy, such as hydropower from Norway and wind power from Germany, to balance supply and demand, enhance energy security, reduce carbon emissions and assist both nations in achieving their renewable energy goals.

While renewables integration and optimisation are a major factor, interconnecting power systems can also serve an important storage purpose and enable electricity trading. From an economic perspective, interconnections lead to cost savings, revenue generation and market optimisation through power trading and integration. IEA has published several reports on this topic, such as [Large-scale Electricity Interconnection](#), [Integrating Power Systems across Borders](#) and [Power Systems in Transition](#).

An emerging approach to regional interconnection is using meshed HVDC offshore grids that link offshore assets to different jurisdictions, allowing the grid connection of the generator also to act as an interconnector. This is currently a European-driven concept, where projects like [offshore wind farms](#) and [energy islands](#) are being connected to different countries. Meshed offshore grids are expected to play a critical role in European energy systems in the next 10 to 20 years.

Examples of interconnected grids

The synchronous grid of continental Europe, the largest of its kind globally, operates as a unified system with a frequency of 50 Hz supported by flexible HVDC links, supplying electricity to over 500 million customers in 27 countries under a Synchronous Area Framework Agreement, including most of the European Union. The interconnected grid ensures efficient and reliable power transmission across the region. The interconnectors foster cross-border energy trade and collaboration among participating countries, resulting in a high degree of market integration. More than 40 new interconnections are under development or planned for completion by 2030 according to the [Ten-Year Development Plan 2022](#) issued by ENTSO-E.

The SIEPAC (Central American Electrical Interconnection System) is an interconnection project that links the power grids of six Central American nations. The project was initiated in 1987 and became operational in 2013. The transmission lines of SIEPAC connect around 50 million consumers. The grid

includes a [1 790 km 230 kV transmission line with an initial capacity of 300 MW](#), expected to be expanded to 600 MW in the future.

Africa has a total of five regional power pools. In addition to the [West African Power Pool](#), they include the [Southern African Power Pool](#) with 12 member countries, the [Eastern Africa Power Pool](#) with 13 member countries, the [North African Power Pool](#) with 5 countries, and the [Central African Power Pool](#) with 10 countries. The West African Power Pool is a collaborative initiative among national electricity companies under the umbrella of the Economic Community of West African States (ECOWAS). Founded in 1999, the power pool's primary objectives are to establish a reliable power grid for the region, including the construction of cross-border transmission lines, and to create a common market for electricity. With 38 member utilities from 14 countries and one observer country, it aims to integrate national power systems into a unified regional electricity market, fostering electricity trade among ECOWAS member states. As of 2020, the West African Power Pool's installed capacity reached 23.3 GW, and the energy exchanged between member states [amounted to 6.2 TWh](#).

Digitalisation is increasingly becoming paramount

Lines, cables and transformer capacity will remain the mainstays of electricity grids, but the significance of investing in digital technologies cannot be overlooked, showing a progressive increase from about [12% of total grid investment in 2016 to about 20% in 2022](#). The need to manage a growing number of distributed energy resources (e.g. EVs, small-scale renewable energy plants and electric heat pumps) as well as new active players (e.g. aggregators and prosumers) is requiring system operators to implement new digital solutions to enhance the observability of the grid for real-time monitoring and control of energy flows, especially in distribution grids, where about [75% of digital investment in 2022](#) was directed.

Most operational decisions are based on load flow analysis using local monitoring systems. This approach to system operations works well when the power flows from centralised generation capacity to consumers are largely predictable within a local or national framework. With the rising penetration of distributed generation from renewable sources, the direction of energy flows within the grid is becoming less predictable, often characterised by a reversal of power flow, even from distribution to transmission grids, requiring the deployment of new digital technologies. These are assuming a pivotal role, as shown by the increasing amount of investment in the recent years.

Investment in digital technologies, 2015-2022

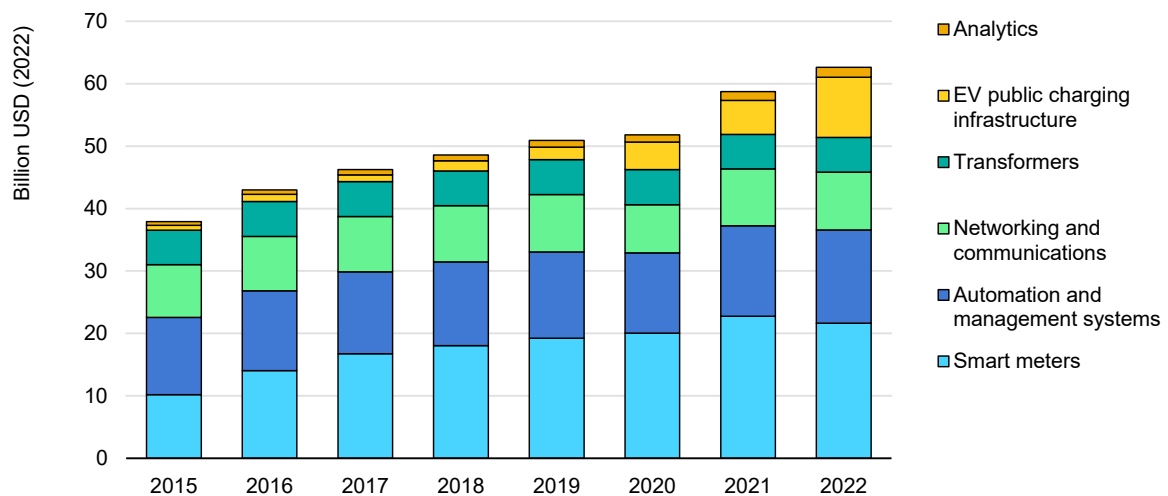

IEA. CC BY 4.0.

Note: Digital includes transmission and distribution automation, networking and communications, analytics (asset performance management, power quality and grid operations), smart meters, advanced distribution management systems, energy management systems, transmission line sensors, vegetation management, dynamic line rating and digitalisation of power transformers and substations.

Sources: IEA analysis based on data from [Guidehouse](#).

Distribution grids

The manifestation of bidirectional energy flows over longer distances, and the growing presence of variable generation sources, are altering the predictability of electricity flows within the system. Increasing power injections from distributed generation facilities can result in more dynamic system conditions and local line overloads, depending on the equipment involved.

Digital technologies play a crucial role in addressing these changes as they arise in the energy context, requiring the full deployment of smart grids features, as stressed by the [3DEN: Digital Demand-Driven Electricity Networks Initiative](#) on electricity grid modernisation and digitalisation. Smart grids co-ordinate the needs and capabilities of all the power systems actors (generators, grid operators, end users and other market players) to operate all parts of the system as efficiently as possible, minimising costs and environmental impacts while maximising system reliability, resilience, flexibility and stability, addressing both short-term as well as long-term grid challenges.

Within smart grids, the smart meter represents the first point from which the visibility of load flows in the distribution grid can be enhanced, even at the low-voltage level, while making customers more aware of their own electricity consumption and enabling new billing structures, such as dynamic and time-of-use tariffs. Additionally, they provide a first measure of grid health for grid operators.

Digital solutions to tackle short- and long-term grid challenges

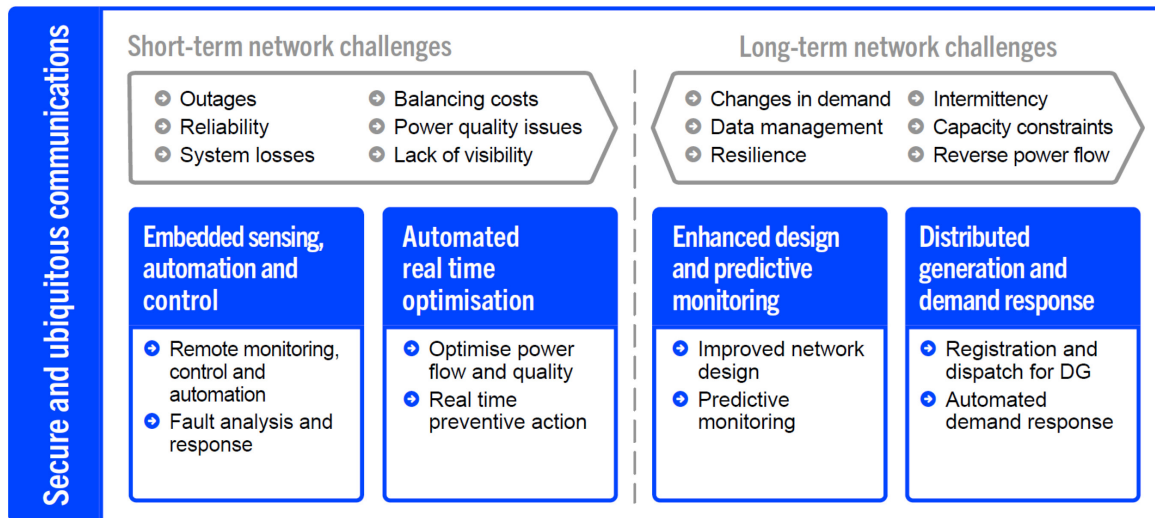

IEA. CC BY 4.0.

Note: DG = distributed generation.

Sources: IEA analysis based on 3DEN, [Unlocking Smart Grid Opportunities in Emerging Markets and Developing Economies](#) (2023), World Economic Forum, [Accelerating Smart grid Investments](#) (2010).

In addition, advanced monitoring and control devices, along with their corresponding software, have the capability to improve real-time system information monitoring and grid management. Remote control of the grid minimises intervention times and the number of operations that need to be performed locally on the grid, making operation of the grid possible from a single control centre using dedicated supervisory control and data acquisition (SCADA). Advanced automation tools allow the grid to act autonomously, quickly identifying and isolating the faulty element. For example, self-healing automation of the medium- and low-voltage grid, already implemented by [Enel in Italy](#) and [Duke Energy in the United States](#), ensures the automatic containment of the duration of an outage and the number of customers involved, thereby preventing cascading power outages.

Moreover, the possibility of accessing real-time knowledge about the health of the system enables more efficient utilisation of existing resources, allowing grids to operate closer to their true limits without compromising reliability, as well as identifying optimal time for equipment renewal, in particular for those with extended operational use.

Transmission grids

Digital technologies play a significant role in modern transmission grids. These technologies can increase the capacity and enhance the efficiency, reliability and flexibility of the grid, allowing it to handle higher loads and transmit electricity more

effectively. This can also help avoid the construction of new lines or assist in cases where line extension deployment is not fast enough.

Dynamic line rating involves real-time monitoring of weather conditions and line temperatures to adjust the current carrying capacity of transmission lines accordingly. This technology allows lines to operate closer to their thermal limits safely instead of using fixed values, optimising and increasing transmission capacity.

FACTS such as static VAR compensators (SVCs) or Static Synchronous Compensators (STATCOMs) are power electronics-based devices that enable real-time control of power flows, voltage levels and other stability characteristics. They can modulate the generation of reactive power depending on need, further enhancing power transmission capacity and grid stability. Currently, these power electronics devices are relatively uncommon, with higher deployment observed in Europe and Australia. However, as the share of renewable energy sources increases and demand grows for load flow control and grid quality assurance, they will become increasingly prevalent. Combined with energy storage systems, such as batteries and supercapacitors, these systems can provide rapid response capabilities to support grid frequency as they can quickly inject or absorb power to balance supply and demand variations and act as virtual inertia to stabilise the grid.

HVDC is another significant technology that supports system operations by efficiently transporting large amounts of electricity and can provide functionalities for bidirectional load flow control and reactive power control, as well as assist with black-start processes. In particular the ability to control the power flow on the HVDC line provides a significant benefit in optimising the power flow distribution across the overall grid.

Even if monitoring systems are already in place in transmission grids, such as the wide area management system (WAMS), they are now necessarily becoming larger and more integrated than in the past. This includes expanding to incorporate the monitoring of connected distribution grids whose complexity is increasing with the growing renewables penetration. In these systems embedded advanced analytics and artificial intelligence (AI) algorithms can process vast amounts of data to predict electricity demand patterns and potential grid issues. By anticipating demand peaks and identifying potential transmission bottlenecks, operators can take proactive measures to reinforce the grid and enhance its capacity.

By attaching sensors to critical but also expensive assets such as transformers and circuit breakers, valuable feedback can be obtained regarding their health status. This enables proactive and preventive maintenance, as issues can be identified and addressed before they lead to costly failures. Consequently, having

a better understanding of the condition of these expensive assets helps optimise their usage, allowing them to be utilised to their limits without incurring additional risk of power shutdowns.

The use of new technologies, such as drones and satellite-based technology, has revolutionised the inspection of power lines, both in transmission and distribution grids. Instead of relying on expensive helicopter rides, drones and satellite imaging can be deployed for line inspections. They capture pictures, videos and thermal images that can be automatically evaluated. This not only saves significant effort, but also enhances the safety of operational staff by minimising their exposure to potentially hazardous conditions during inspections.

Cybersecurity

Hand in hand with the development of digitalisation, it is also essential to look at the risks that it brings to the electricity grid. While digital technology brings numerous benefits, the increasing connection of digital devices means that the cyberattack surface will increase dramatically. At the same time, the system is becoming ever more complex with the rise of decentralised power sources and the interconnection of many entities through communication technologies.

Electricity transmission systems are considered to be critical national infrastructure. Increasingly, cyberattacks are seen as a threat to their integrity. The [2023 UK National Risk Register](#), for example, puts the likelihood of a cyberattack on critical infrastructure between 5% and 25%, ranking as moderate, with a potential impact of hundreds of millions of pounds in losses.

In recent years, the number of cyber incidents has been increasing along with the progress of digitalisation, and there have been many cases in which cyberattacks on key infrastructure have caused major social disruption around the world. In the electricity sector in particular, it is essential to respond appropriately and promptly to these changes, as large-scale power outages directly affect human lives and property.

A prominent example of this concern is the power outages that occurred in Ukraine in 2015 and 2016: the first outage in western Ukraine, including Kyiv, took up to six hours to restore and affected 225 000 people; in the second outage in Kyiv in December 2016, attackers disrupted power grid control equipment through unauthorised access, resulting in a [200 MW outage](#) for about an hour. It should be noted that while the 2015 attack consisted of a multi-stage attack in which malware stole information and used it to remotely operate the control system, the 2016 attack is believed to have involved malware directly manipulating power grid equipment. This indicates a marked increase in the sophistication of attack methods even within a short period.

Total and electricity-related significant cybersecurity incidents per year

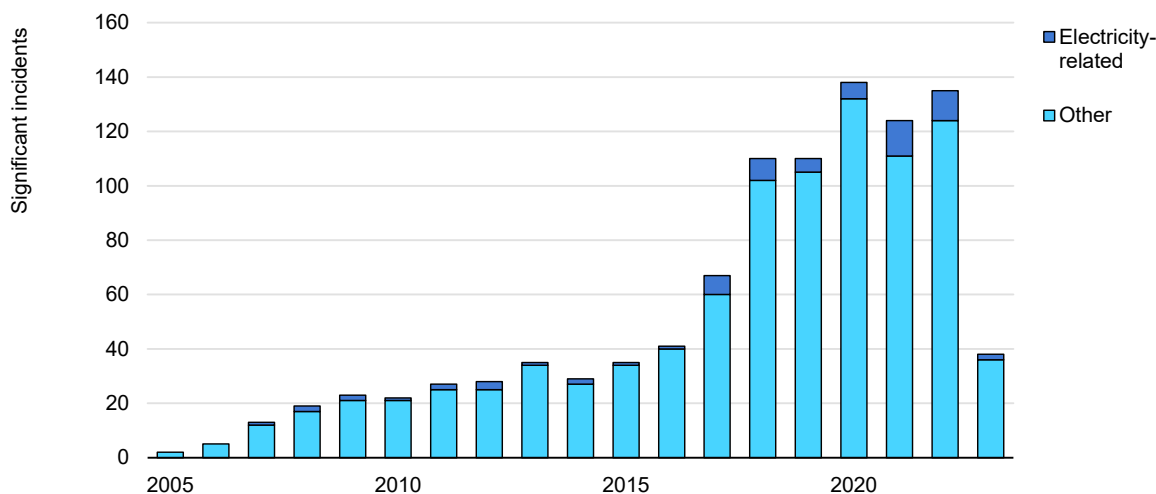

IEA. CC BY 4.0.

Source: IEA analysis based on [CSIS \(2023\)](#).

Another example of the unmanaged risks that growing digitalisation and interconnectivity bring to secure electricity supply is the military cyberattack on a satellite in February 2022, which caused as collateral damage approximately [5 800 wind turbines in Germany](#) to lose their internet connections, making remote monitoring and control difficult.

Energy generators requiring internet connectivity need proactive assessment to identify and address any cybersecurity weaknesses. In solar PV and wind turbine control portals, [security gaps have been observed related to the internet access router and lack of encrypted VPN connection usage](#). During load shedding, the communication signals used to transmit the ripple technique for adjusting the electrical output have been exposed to the risk of possible decryption and override by third parties. This demonstrates a lack of sufficient cybersecurity protocols to ensure the security of the power system as it expands.

Electrification and electricity security

Electrification accentuates the ever-increasing importance of electricity security. We are starting to see the impacts of the rapidly changing energy landscape on electricity grids and power system security. Unless we keep ahead of the changes, we put at risk not only the achievement of decarbonisation targets, but also the safeguarding of a secure electricity supply.

Society and the economy are increasingly reliant on electricity

Electricity is critical to all aspects of our lives: it drives our machinery and transport systems, it powers our IT and medical equipment and increases our comfort by providing light, cooling and heating. In short, electricity is [essential for our societies' prosperity](#), at the same level of priority as food and drinkable water. This reliance is only becoming more pronounced as electricity consumption and its share of final energy consumption continue to grow.

In 2021, 43% of total final electricity consumption globally was consumed by the industrial sector, followed by the residential (27%) and service (20%) sectors. Global final consumption of electricity has nearly doubled since 2000 and has been growing continuously every year since 1990, with the exception of 2009 and 2020 when the financial crisis and the Covid-19 pandemic, respectively, led to a decrease in demand. In 2022, despite the global energy crisis, electricity demand grew [2% year-on-year](#), driven by increases in EMDEs.

Global final electricity consumption by sector and electrification rate, 1992-2021

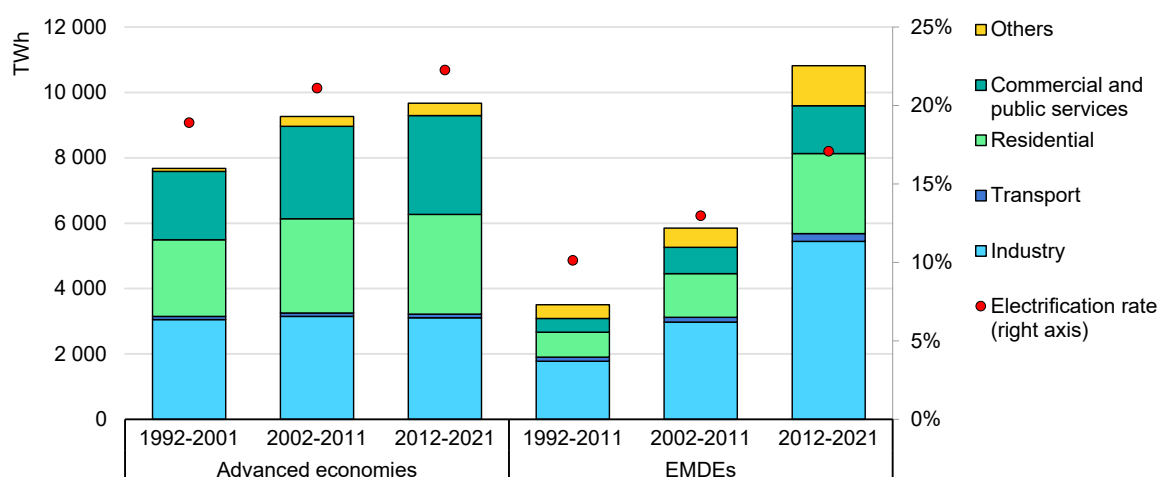

IEA. CC BY 4.0.

Note: "Others" includes agriculture/forestry, fishing and final consumption not specified elsewhere.

Source: IEA (2023), [World Energy Statistics](#).

Electricity's share of global final energy consumption has grown to 21%, up from 16% in 2000, and is the second highest after oil. This reflects its increasing importance in the global energy mix, a trend that is expected to continue. The growth in electricity demand is driven by increased electrification of end uses, as well as [growing electricity access rates](#) worldwide. Of the electricity used in buildings, [20% is used for cooling](#) – increased activity and the use of air conditioning has led the use of cooling energy in buildings to more than [double since 2000](#). Furthermore, the electrification of heating is on the rise as high gas

prices and concerns for energy security have fuelled a strong uptake in heat pumps, with global sales [growing at double-digit rates](#) for the second year in a row in 2022. Growing electrification reduces total energy use through efficiency and therefore augments national energy security and hedges against fossil fuel price volatility.

The transport sector's electricity consumption currently accounts for only a small share of total electricity consumption, and the [global EV fleet accounted](#) for less than half a percent of total final electricity consumption in 2022. However, the uptake of electrified transport, especially road transport, is well underway, with [new EV sales records](#) set every year. In places with high uptake, this can challenge grid hosting capacity – for example, in the Netherlands 3 000 neighbourhoods [will be unable to host new charging stations](#) until 2025.

Despite [significant progress in the past decade](#), 10% of the population worldwide still lacks access to electricity, implying the need to keep expanding grid infrastructure and supply.

These trends combined mean electricity is more central to our societies than ever. With growth in the electrification of end uses and electricity access set to continue, electricity's importance is only expected to increase. Grid infrastructure must foster the use of electricity by becoming smart, inclusive and participatory platforms, promoting the engagement and interaction of all stakeholders, at the same time unlocking new, innovative business models, electricity services and shared value opportunities.

Grids are central to many power supply interruptions

Increasing reliance on electricity adds to our vulnerability to outages and makes electricity security a growing priority. [Power supply interruptions can lead to](#) the loss of means of communication, safety mechanisms, life support devices, food storage, and temperature and light control, as well as – especially in urban environments – ventilation, sewage disposal and transport. In many countries, a majority of outages originate in distribution grids.

Power outages are caused by the failure or insufficiency of generation or grids. They can be the result of technical and supply issues, natural threats, human interference, or a combination of these causes. In our assessment, the most common source of outages are localised failures of grid infrastructure, of which most occur on distribution grids. These are commonly caused by minor incidents such as tree growth interfering with power lines, equipment failure and weather conditions. While these outages typically do not have the severe consequences of the larger events that receive news coverage, they are often the largest determinant of service reliability.

Potential direct causes for power supply interruptions by segment of origin

	Generation	Grid
Examples by cause	Technical/equipment: <ul style="list-style-type: none"> • Lack of fuel supply • Maintenance • Failure due to ageing Nature: <ul style="list-style-type: none"> • Water freezing problems • Damage due to storm/wildfire/earthquake Human interference: <ul style="list-style-type: none"> • Disruption of control systems 	Technical/equipment: <ul style="list-style-type: none"> • Maintenance • Failure due to ageing Nature: <ul style="list-style-type: none"> • Ice on power lines • Damage due to storm/wildfire/earthquake Human interference: <ul style="list-style-type: none"> • Damage to conductors/pylons/transformers

IEA. CC BY 4.0.

More widespread outages can be classified into three main categories depending on their characteristics: cascading blackouts, load shedding and long periods of electricity rationing. While these events typically account for a lower share of service interruptions in well-developed power systems, they require attention due to their potentially devastating consequences.

Cascading blackouts or black system events refer to the large-scale collapse of all or part of the power system, triggered by an initial outage (generation or grid) that results in an increasing series of line overloads and tripping generators. For example, in October 2022 a [tripped transmission line](#) in Bangladesh resulted in a cascading series of power plants tripping, resulting in a blackout affecting around 130 million customers. A high-voltage [transmission line fire](#) in March 2023 in Argentina triggered a safety system to turn off several power plants and lines, affecting 20 million people. Chinese Taipei also [experienced a cascading blackout](#) in May 2021 triggered by a transmission line fault. And a major power line in Kazakhstan was disconnected and caused a cross-border [outage affecting Kazakhstan, Kyrgyzstan and Uzbekistan](#).

Load shedding is a last-resort measure where system operators disconnect load in a part of the power system to safeguard system balance. It is employed to arrest situations of cascading outage, to stabilise the system and minimise the number of customers affected. Load shedding can also be used to manage reduced generation availability, such as widespread outages in 2022 in [Bangladesh and Pakistan](#) due to fuel supply shortages, and high levels of demand that cannot be met by existing generation or grid capacity.

Finally, long periods of electricity rationing occur due to chronic underinvestment in the power system, such as in South Africa, where factors such as supply

shortages and ageing grid infrastructure have resulted in increasingly high levels of load shedding since 2007, [estimated at around 5% in 2022](#).

Climate change is increasing the risk of outages due to the increased [frequency, severity and distribution of extreme weather events](#). Electricity networks are the [leading cause of climate-driven outages](#) in many countries and are considered the element of the power system most vulnerable to climate impacts. For instance, cyclones, [extreme cold spells and heatwaves can cause power outages](#) due to grid damage and supply-demand imbalances, risking loss of life due to the inability to provide power for heating or cooling. The IEA's [Climate Resilience for Energy Security](#) report shows that around one-quarter of global electricity networks are exposed to severe storms, and over 10% of the networks are exposed to tropical cyclones, notably in North America, Australia and East Asia. At the same time, close to half of global electricity networks are currently exposed to fire weather conditions for more than 50 days per year – and close to 18% of the global electricity network sees more than 200 fire weather days annually.

Grid reliability varies significantly around the world

The reliability of electricity supply varies significantly between advanced economies and even more so when comparing EMDEs. Comparing the reliability of grids in different countries is challenging as datasets have varying levels of completeness and rarely explicitly differentiate between interruptions originating from generators or from transmission and distribution grids. In four countries that do provide this information – the [United States](#), [Japan](#), [Australia](#) and [Chile](#) – over 90% of power supply interruptions originate in distribution grids. In the [European Union](#), although comprehensive data for individual outage events is not available, when comparing reliability indicators across voltage levels it is evident that most outages originate in low-voltage grids. We would expect a similar pattern in regions that do not have significant power supply issues, such as chronic generation inadequacy or fuel shortages. In regions that do experience these issues, the share of supply interruptions due to grids is expected to be lower but remain significant.

Overall outages for end users, commonly reported using the System Average Interruption Duration Index (SAIDI) in annual outage hours per customer, show huge variations in supply reliability. Customers in high-outage EMDEs such as Iraq and Papua New Guinea experience around 40 times the average outage levels of most other EMDEs, which in turn are still around three times the interruptions of India and the United States and around fifteen times China and the European Union.

There are also considerable differences in reliability between advanced economies, which typically range from well below one to around six hours of

outage on average per year, although these may be affected by a lack of harmonisation in data collection and reporting. For instance, the duration threshold (in minutes) after which a non-momentary outage is integrated into the reporting can vary significantly, as can the mechanisms to detect outages and the [weighting method of the event impacts](#) to reach the overall distribution area indicator. A lack of complete and harmonised outage data collection is a barrier to improving reliability through targeted measures as well as international knowledge sharing. For example, the increasing trend of power supply interruptions in the United States (which more than doubled between 2013 and 2021) led the government to launch an [initiative to improve reliability through better outage monitoring data](#).

End-user power supply interruption indicators by country/region, 2016-2020 average

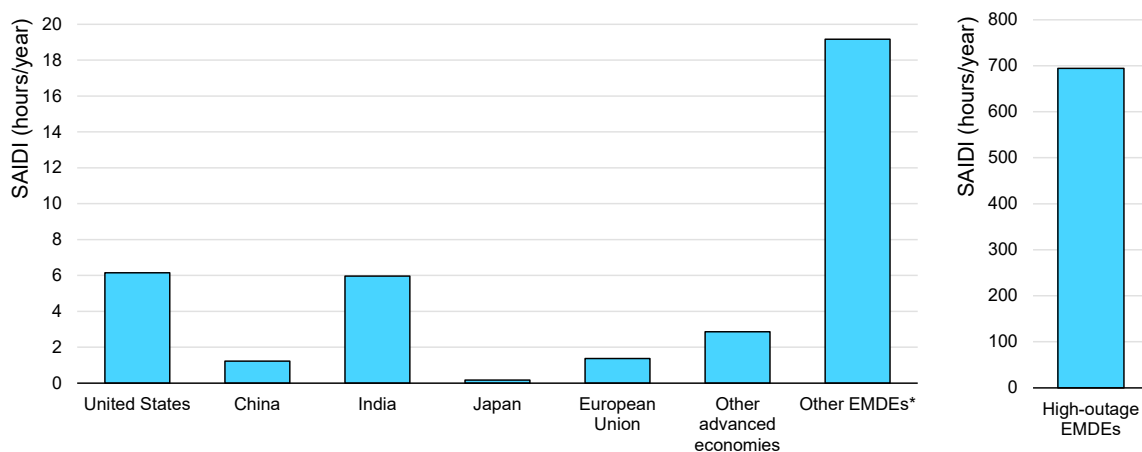

IEA. All rights reserved.

* “Other EMDEs” exclude high-outage EMDEs.

Notes: High-outage EMDEs comprise all countries with more than 100 annual outage hours on average per customer, over the 2016-2020 period. SAIDI = System Average Interruption Duration Index. EIA data were used for the United States and World Bank data were used for all other countries. World Bank data are based on surveys. Given the possible differences in reporting standards and coverage, the values presented refer to general trends and do not necessarily reflect precise comparisons between countries.

Sources: IEA analysis based on World Bank (2020), [Doing Business 2020](#); EIA (2023), [Reliability Metrics of U.S. Distribution System](#).

Grid-originated outages cause significant economic losses

Grid-related outages are having major economic impacts around the world. Our estimates indicate that grid-originated technical/equipment failures alone caused outages that amounted to a global economic loss of at least USD 100 billion in 2021. The majority of the direct economic losses due to outages arise from lost productivity at businesses due to interruptions, supply chain interruptions and potential damage to equipment. More indirect economic losses, such as those

from fuel consumption in back-up diesel generators, can also be significant depending on the region – for example, in Nigeria [40% of electricity is produced from back-up generation](#).

Estimated economic impact of grid-related outages by cause as a share of GDP in selected countries, 2021

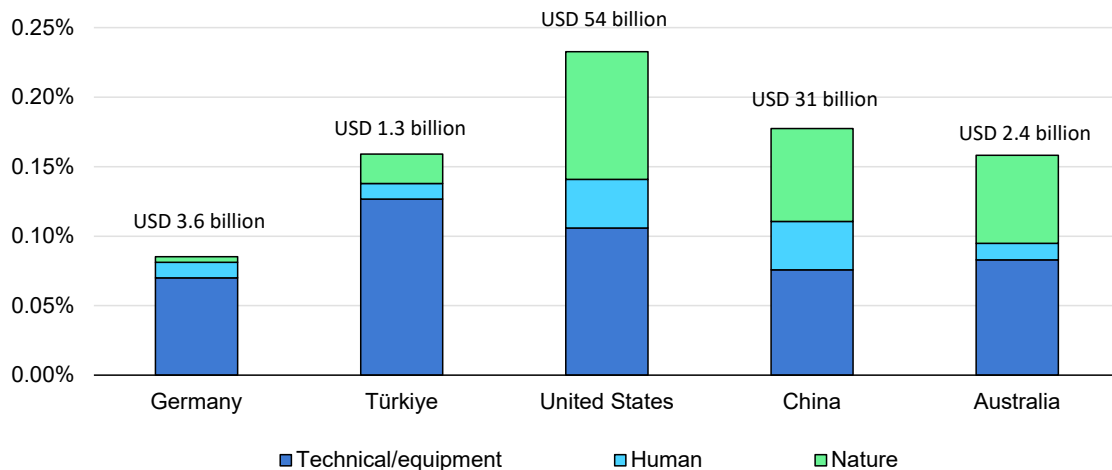

IEA. All rights reserved.

Note: The reasons for outages can be grouped into three main categories: technical failures due to equipment, outages caused by human interference, and outages due to uncontrollable nature-related factors such as weather, animals, trees and natural catastrophes.

Sources: IEA analysis based on Bundesnetzagentur (2021), [Electricity Metrics](#); Epiş Seffalık Platformu (2021), [Failure Information](#); Department of Energy (2021), [Annual Summaries](#); Power Reliability Management and Project Quality Supervision Center, National Energy Administration (2022), [2021 National Electric Power Reliability Annual Report](#); AusGrid (2021), [Past Outage Data](#); World Bank (2021), Value lost due to electrical outages ([% of sales for affected firms](#)).

The main causes of these impacts can vary significantly between countries. In regions that face less frequent extreme weather events (for example, Europe), a large share of grid-related outages can be traced back to technical failure related to ageing equipment. Common sources of technical failure are power transformers, instrument transformers and cables. In other regions more subject to natural phenomena such as high precipitation levels, storms, monsoons and tornadoes, natural disasters and weather events can account for a comparatively higher share of the grid-level outages. Human-related factors such as accidental damage, faulty installations and vandalism remain significant in many regions, with a notable trend in some countries toward increasing theft, vandalism and cyberattacks on grids.

This highlights the role of grid infrastructure in minimising power outages and the associated economic loss. As the specific cause and segment of origin of those grid-level failures can vary significantly between countries, the priorities for electricity security and resilience may lie in different directions, for example network redundancy, reinforcement, modernisation or digitalisation. Harmonised

and comprehensive data on outages – including where they originated and their cause – help to identify these priorities. Overall, secure power supply can only be achieved with sufficient, well-maintained and well-monitored grid infrastructure in combination with sufficient generation resources, at the same time supported by advancing system efficiency, demand-side measures and the benefit of new technologies.

Electricity decarbonisation and grid connectivity

Delays in grid development are hindering the connection of new wind and solar projects

Policy incentives and declining costs have led to dramatic increases in solar and wind capacity, helping to decarbonise the power sector. New projects need to apply for grid connection and then wait for approval before they can proceed. Some projects in the connection approval queue are at an advanced stage in the connection process and provide a strong indication of the project pipeline. However, other projects may only give an indication of developer interest, since in many countries grid queue applications may require minimal paperwork and fees.

Combined, the United States, Spain, Brazil, Italy, Japan, the United Kingdom, Germany, Australia, Mexico, Chile, India and Colombia currently have grid connection requests totalling nearly 3 TW of solar PV, wind, hydropower and bioenergy capacity. We estimate that around 1 500 GW of this total are wind and solar projects at an advanced stage with a connection agreement in place or under active review, equivalent to 5 times the capacity additions of solar PV and wind in 2022. Of these, 500 GW are late-stage projects that have either signed connection agreements or are in the final stages of this process and have a high chance of grid connection in the next five years if they continue to be financially pursued by developers. The late-stage projects are equivalent to around 40% of total renewable energy capacity that is currently installed in all the surveyed countries. Unsurprisingly, considerable investment in grid infrastructure is needed to accommodate many of these new renewable projects.

Meanwhile, around 1 000 GW of projects are under active connection review to determine their viability and what, if any, grid upgrades would be required – the need for additional grid development could potentially stall these projects. Finally, the remaining nearly 1 500 GW of wind and solar PV plants are still in early-stage development and are less likely to become operational in the medium term. In many cases these applications may only represent an early expression of interest and projects may require additional feasibility studies, which could prolong the process and increase the financial burden for developers.

Connecting the significant capacity of advanced PV and wind projects requesting grid connection would require major transmission and distribution grid expansion in the short term. For instance, in Spain building all solar and wind projects that have been granted grid clearance today would nearly triple current installed capacity. Deploying solar and wind projects currently at the late stage would increase year-end 2022 installed capacity by over 45% in Italy and the United States, over 35% in the United Kingdom, nearly 35% in Japan, 22% in Mexico, 16% in Brazil, 10% in Australia, Germany, India and Chile, and 1% in Colombia. This large number of renewable projects at a late connection study stage testifies to both the strong interest of developers and the success of recent policies in spurring renewable energy development. While not all these projects are guaranteed to connect, the high levels of new capacity from those that do connect will put further strain on transmission and distribution grids in these markets.

Capacity of renewable energy projects in connection queues, selected countries by technology

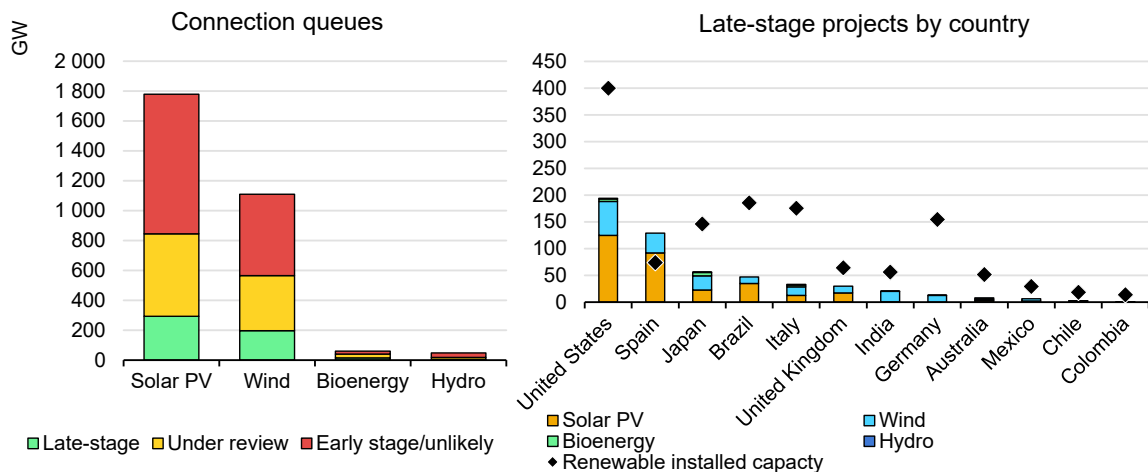

IEA. CC BY 4.0.

Notes (right): All capacity presented is sourced from publicly available country-level connection queue data. US capacity comprises connection queue data from the CAISO, ERCOT, MISO, PJM, NYISO, ISO-NE and SPP interconnections, Appalachian Electric Cooperative, Arizona Public Service, Black Hills Colorado Electric, Bonneville Power District, Cheyenne Light, Fuel & Power, City of Los Angeles Department of Water and Power, Duke Carolinas, Duke Florida, Duke Progress, El Paso Electric, Florida Light and Power, Georgia Transmission Company, Imperial Irrigation District, Idaho Power, Jacksonville Electric Department, Louisville Gas and Electric Company and Kentucky Utilities Company, NV Energy, Portland General Electric, Public Service Company of New Mexico, Platte River Power Authority, Santee Cooper, Southern Electric Corporation of Mississippi, Southern Company, Salt River Project, Tucson Electric Power, Tri-State Generation and Transmission, Tennessee Valley Authority, and Western Power Administration; Spain: RED Eléctrica; Japan: Hokkaido Electric Power Network, Grid connection status of renewable energy projects; Tohoku Electric Power Network, Grid connection status of renewable energy projects; TEPCO Power Grid, Grid connection status of renewable energy projects; Chubu Electric Power Grid, Grid connection status of renewable energy projects; Hokuriku Electric Power Transmission & Distribution, Grid connection status of renewable energy projects; Kansai Transmission and Distribution, Grid connection status of renewable energy projects; Chugoku Electric Power Transmission & Distribution, Grid connection status of renewable energy projects; Shikoku Electric Power Transmission & Distribution, Grid connection status of renewable energy projects; Kyushu Electric Power Transmission and Distribution, Grid connection status of renewable energy projects; Okinawa Electric Power, Grid connection status of renewable energy projects; Brazil: ANEEL; Italy: TERNA; UK: Ofgem; Germany: Bundesnetzagentur; Australia: AEMO; Mexico: CENACE; Chile: CEN; Colombia: UPME; India: connection data estimated based on CEA transmission build-out planning.

At the moment, the rapid development of generation capacity, and particularly renewables, is outpacing investment in the necessary transmission and distribution grid upgrades, potentially impacting long-term expansion of renewables. This surge in capital flows and investment signifies a crucial outcome of the global energy crisis, as it has expedited the adoption of clean energy technologies.

Lack of grid availability has hindered rapid renewable energy growth in some markets. In the Netherlands, grid congestion due to high solar PV and wind capacity additions has made some regions [unable to accept new capacity](#) during the period 2021-2029, with grid upgrades planned for 2026-2029. In Hawaii, rooftop solar installations were [effectively halted](#) in 2013 due to system concerns, but were [later resumed](#) after potential grid upgrades were found to enable additional capacity. In South Africa, the latest renewable energy auction round [awarded no onshore wind capacity](#), as all proposed projects were in areas with no grid availability. In the United States, the interconnection backlog in the PJM region has resulted in the regional transmission organisation [suspending the review of new connection applications](#) until 2026.

Current policy initiatives that have increased the share of renewable energy in the power mix will add to the amount of capacity waiting to connect to the grid. This will require grids to be upgraded so that they can accept new capacity, move generation from areas of high potential to demand centres, and have the ability to provide flexibility services. Interim policy solutions to enable capacity deployment in the short term must be matched with longer-term planning and investment efforts to facilitate future development.

Grid congestion is increasing system operation costs and renewable curtailment

Grid congestion is increasingly becoming a concern among system operators and policy makers alike. This issue arises when electricity transfer capacity is not enough to transmit all available power from one point on the grid to another.

The optimal dispatch of a generation fleet, that is, deciding how much power each plant produces at any moment, is typically determined on a cost minimisation principle, although not all countries necessarily apply economic least-cost dispatch. The cost minimisation principle means that the cheapest generation is dispatched as much as possible before the next expensive one. When there are constraints in the grid (lack of transfer capacity), however, a divergence may occur. If the cheapest generation cannot be transferred, it should not be produced because it would compromise grid security. In that case, more expensive generation needs to be dispatched to meet power demand, accounting for grid congestion. This is an example of what is referred to as congestion management.

Other specific examples include curtailment of power generation, the use of storage technologies and local flexibility markets, and flexible connection agreements.

Where the system operator owns and operates the generators as well as the grid, in a vertically integrated utility structure, it may simply control the output of the power plants to achieve a dispatch that balances power flows in the grid. This is prevalent in EMDEs. In cases where the grid operator and generation owner/operator are separate entities, the co-ordination of the dispatch and grid constraints may be managed by zonal price signals, or by calling for divergence from generation schedules – such as by using redispatch and curtailment.

Although some level of congestion can be present in cost-optimised dispatch, persistently high congestion indicates a structural imbalance that can endanger electricity security, substantially increase operational costs and affect the development of new power plants. In recognition of its increasing impact, and to understand better how to design a common framework to approach the issue, [ACER carried out a consultation process in 2023 on the definition of structural congestion](#). Indeed, designing a solution requires first an adequate measurement of the problem.

Grid congestion management

Regardless of the existence (and design) of a market, grid congestion typically incurs system operation costs, implying an increase in the costs of electricity itself and what consumers pay. This is because measures need to be taken in moments of congestion to avoid inadvertent overloading of grid assets, which could lead to a breach of grid security.

Overloading of transmission and distribution lines can be caused by several factors, including insufficient infrastructure capacity, but also temporary events – for example, extreme weather – leading to surges in electricity demand or supply or causing equipment failure. System operators take several measures to manage these kinds of overloading risks in transmission grids, either ahead of dispatch or through remedial actions in real-time operation. All of these measures come with associated costs.

First, when making dispatch decisions, system operators can take into account grid constraints and reduce overload risks. Market designs such as zonal or nodal pricing (for example, the PJM nodal market in the United States) incorporate grid capacities to some extent. The initial dispatch under a uniform pricing market scheme within a large bidding zone (such as in Germany) can require more real-time modifications since it does not consider grid constraints within a sub-area. In Australia, constraint equations are applied in the dispatch process to take into account structural grid constraints. Similarly, in Europe the transmission constraints at country borders are considered when harmonising national level

dispatches across the region. Yet again in some cases, [locational signals in tariff systems](#) may be used to steer development of new generation and load to avoid congestion. In this case the congestion management cost is a higher dispatch cost compared to a situation without any grid constraints.

Second, in real time, remedial actions can be taken by system operators to avoid overloads. Any system operator can implement command and control measures such as curtailing generation, activating demand response reserves, implementing load shedding, and other power flow control techniques. Further, operators in markets such as [the integrated European electricity market](#) can leverage market trading techniques such as countertrading (cross-zonal exchange) initiated by system operators between two bidding zones to alleviate physical constraints. The costs of these measures are in lost production revenues for generators, and higher cost of the procurement of electrical energy by system operators from markets, which is passed through to consumers in the electricity tariff.

Congestion management cost data are not always explicitly collected and reported. Especially in countries where the system operator owns/operates the generators as well as the grid, the costs are considered a matter of internal accounting. In markets where system operators are obliged to report the costs, the indicators may also differ based on the prevalent congestion management technique. Nevertheless, for the reduced group of systems that do report them, an estimate of the grid congestion costs can be obtained by adding up the direct costs of remedial actions implemented, and the congestion rents collected by operators due to nodal/zonal price differences.

Annual transmission grid congestion cost estimates for selected markets, 2019-2022

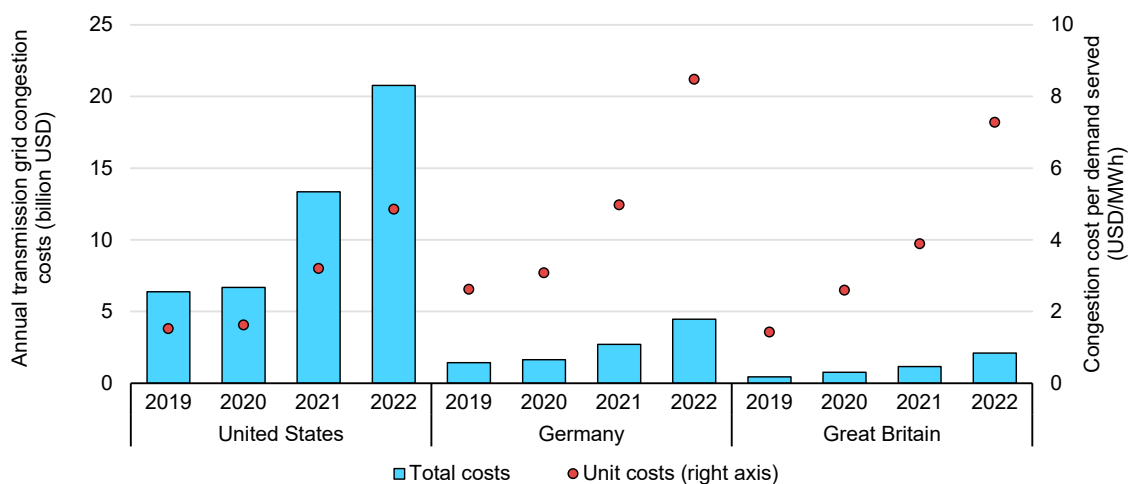

IEA. All rights reserved.

Notes: The transmission grid congestion cost estimates presented refer to the values reported by the corresponding sources, and due to differing market characteristics, they should not be used for direct comparison of congestion levels across countries. For Great Britain's cost estimates, the costs reflect only the transmission constraint expenses of its Balancing Mechanism.

Sources: IEA analysis based on Grid Strategies (2023), [Transmission Congestion Costs in the U.S. RTOs](#); Bundesnetzagentur (2023), [Netzengpassmanagement](#); National Grid ESO (2023), [Monthly Balancing Services Summary](#).

In Germany, congestion management costs have shown an increasing trend, reaching [more than EUR 4 billion](#) per year in 2022 – equivalent to investing in about 4.5¹ GW of new solar PV capacity. At the same time, a [recent United States study](#) estimated that transmission grid congestion costs in the country more than tripled from over USD 6 billion in 2019 to almost USD 21 billion in 2022 – equivalent to about 18.5² GW of new solar PV capacity. In winter 2021/22 alone (November-March), Great Britain spent almost GBP 1 billion due to balancing in response to transmission constraints.

The transmission congestion cost estimates presented highlight the relevance of adequate levels of investment in grids to reduce system costs. More grid capacity would resolve congestion and the need to apply costly congestion management measures. Although the operational costs are only a fraction of the cost of building a new transmission line, cumulative operational costs from structural congestion need to be actively assessed as they can be high enough to justify investment in infrastructure additions or upgrades. Therefore, it can be relevant to incorporate a total expenditure approach – not just capital or operational costs – together with an assessment of the potential benefits, to decide if further grid upgrades are the most efficient measure to mitigate cost increases in each particular case.

Besides, on top of additional operational costs with existing infrastructure, many generation projects, particularly renewables, could see worsening (or simply infeasible) business cases due to congestion. Grid congestion can result in the curtailment of renewables in certain areas, which usually means firing more expensive and carbon-intensive thermal plants elsewhere. This can lead to [increasing connection queues](#) for generation projects if there is already congestion, or to project developers cancelling plans if they deem their investment too risky – both potentially resulting in lost value of renewable resources. Recognising this, at least within the European Union, full compensation for grid-related curtailment [was declared mandatory in 2019](#).

Particularly at the distribution level, it is challenging to address congestion with pricing mechanisms. The congestion point in a distribution grid can be managed only by the specific resources in the right location, which requires high levels of digitalisation such as an information platform, supervising/monitoring system and remote control system. This means that distribution grids must be expanded and reinforced in order to deliver the output generated from the renewable energy sources connected at that level to the higher voltage level grid, as it is difficult to resolve congestion by managing local resources.

¹ Based on an [estimated installation cost](#) for solar PV in Germany of USD 996/kW.

² Based on an [estimated installation cost](#) for solar PV in the United States of USD 1 119/kW.

Curtailment of variable renewables

One of the measures available to system operators, both before and during real-time operation, is to curtail renewable electricity. This can happen, for example, due to a system-wide demand-supply imbalance (either due to unusually low demand or excess supply), due to grid congestion in particular corridors, or to preserve system stability. While lower levels of curtailment can be considered part of the normal operation of a power system, high levels of curtailment can indicate the need for new measures to be implemented. As curtailment may result in a significant loss of value, particularly as variable renewables have zero marginal costs and produce low-emission electricity, renewable curtailment should generally be one of the last-resort options used by system operators.

Renewable electricity curtailment has reached significant levels in some countries in recent years, resulting in significant lost value of renewable resources. From a sample of ten markets with strong renewable power uptake in recent years, representing about 55% of global solar PV and wind generation, renewable curtailment stood at a share of 3% in 2021. This amounted to about 40 TWh – equivalent to the annual electricity demand of New Zealand.

Annual technical curtailment of variable renewables in selected countries, 2022

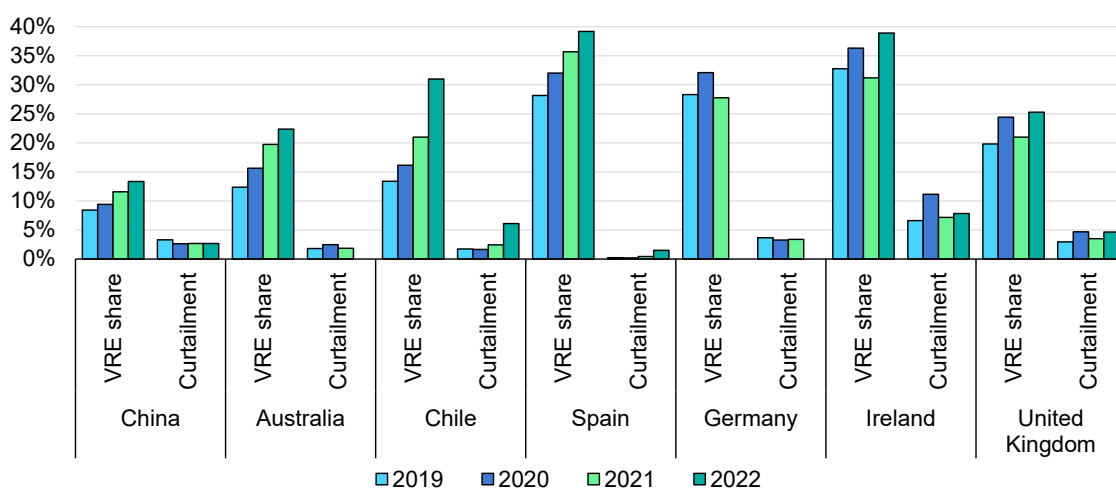

IEA. CC BY 4.0.

Notes: Values for Australia only consider the National Electricity Market. Values for Spain include wind, solar PV, biomass and solar thermal generation. Estimates for the United Kingdom only include wind power. Technical curtailment refers to the dispatch-down of renewable electricity for network or system reasons. Dispatched-down energy due to economic or market conditions is not included in this chart.

Sources: IEA (2023), [Renewables Market Update June 2023](#).

There is a direct link between renewable curtailment caused by grid congestion and (the lack of) progress on transmission and distribution capacity deployment. Even though some complementary solutions such as electricity storage via flexible EV charging can be beneficial, investing in grids will in many cases be essential

to unlock the full potential of renewable resources. For instance, strong deployment of transmission capacity in China from 2013 was a key element in enabling the country to reduce VRE curtailment rates from over 15% in 2012 to less than 5% today. In other markets, such as the United Kingdom and Chile, slow progress in transmission projects connecting areas with strong variable renewable resources has led to high VRE shares translating into high rates of VRE curtailment. Generally, well-targeted grid enhancements on specific corridors could help alleviate this issue significantly, as resource-endowed areas for renewable production are generally far from consumption centres.

Technical grid losses are stabilising around the world, while non-technical losses remain to be addressed

Losses in transmission and distribution systems are the result of several factors and many years of development. As system losses increase, so does the electricity generation required to meet the same level of demand. While they remain region-specific and vary widely, lower levels of losses typically indicate a more efficient system. Factors including population density, climate, grid planning, levels of investment, share of renewables and the structure of electricity demand all affect the percentage of total generation that reaches end users. However, as these factors and their relative weight are different for each balancing zone, there is no single ideal number for grid losses.

In regions with a lower population density, the grid is often more spread out, meaning that electricity travels further from generation stations to end-use centres. While technologies such as HVDC lines are designed to minimise losses related to long-distance transmission, spread out systems nonetheless typically incur higher losses compared to more compact ones, in particular due to longer, more radial distribution networks. Climate has an impact here too, wherein higher temperatures increase losses, especially for overhead lines, which are more exposed to these shifts than underground cables. Temperature fluctuations as well as weather-related incidents affect annual losses, and for this reason single-year data may diverge from regional averages.

Grid planning and investment play a key role in setting out a path for minimising future losses, especially as levels of demand and renewables are set to increase. Without proper planning to reduce congestion and adapt grids for higher demand met by more distributed renewable electricity generation, losses in future grids will increase. In systems with adequate transmission and distribution development planning, the overall percentage of losses typically decreases as the system becomes more advanced. An exception to the decrease in losses occurs when higher loading of existing equipment is tolerated through the application of technologies like dynamic line rating and high-temperature low-sag (HTLS) conductors. These technologies can increase losses but offset them by avoiding the need for new infrastructure buildout.

Technical grid losses as a share of total electricity generation by country/region, 2022

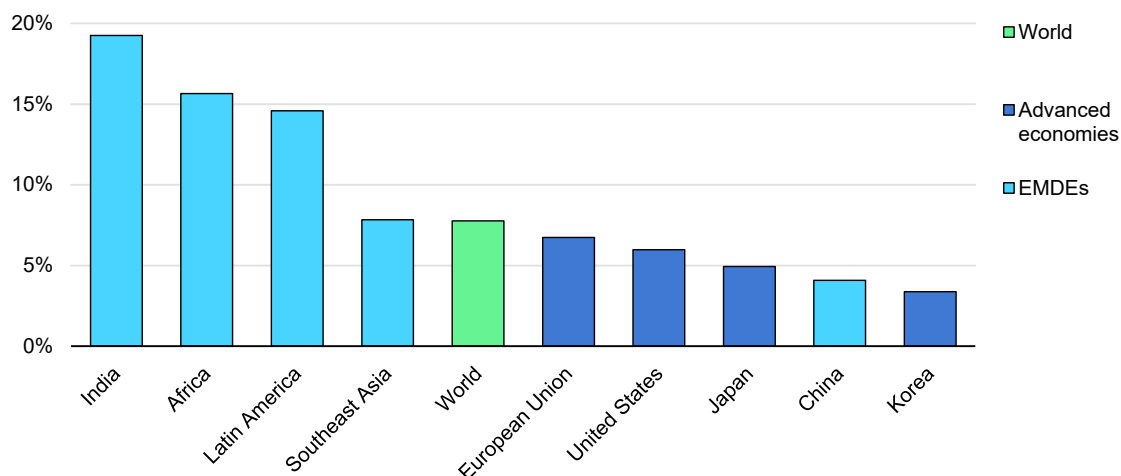

IEA. CC BY 4.0.

Globally, technical grid losses accounted for over 2 100 TWh of generation in 2022 which corresponds with global average losses of just under 8%. This reflects quite high efficiency for many systems today, but these levels vary between countries and reducing losses in the long term remains a key objective of grid planning for many regions. Advanced economies have recorded losses just over 6% in 2022, while the average for EMDEs was just under 9%. Within these, however, there are notable examples, with India reporting one of the highest level of losses at close to 20%, while losses in China have fallen to around 4%, within the range of advanced economies. Korea and Japan consistently record some of the lowest level of losses, with both under 5% in recent years. This wide variation between regions reflects not simply the level of grid development, but also the combination of factors that determine overall technical losses.

Beyond technical losses in the physical grid equipment, there are also non-technical losses in distribution grids that primarily include theft and non-metered consumption. Non-technical losses are a more significant concern in EMDEs, although they can occur in any region as they are related to the efficiency of the monitoring and control of electricity consumption. They often occur as a result of bypassing or tampering with meters and illegal connections, which may be linked to socio-economic conditions. They can also be the result of metering errors, often a consequence of automatic/manual error in meter reading or due to defects, breakdown or incorrect installation and configuration of the meter.

Grid permitting and construction times

As energy generation increasingly relies on utility-scale wind and solar PV systems, which are often situated far from heavily populated cities and

consumption hubs, the transmission of this energy over long distances becomes essential. Deploying these critical links between generation and electricity service is complex, involves multiple stakeholders and can take many years. Large transmission system projects can take a decade or more to complete, often much longer than the new wind and solar PV assets that connect to them.

Typical approval and construction times for power lines vary widely. It is not uncommon for a single extra-high-voltage overhead line (above 220 kV) to take 5 to 13 years to go through permitting and construction in advanced economies, depending on the length of the line and other factors. Lower-voltage projects are generally faster and can last four to eight years, while distribution grid projects are usually completed within four years.

Typical deployment time for electricity grids, solar PV, wind and EV charging stations

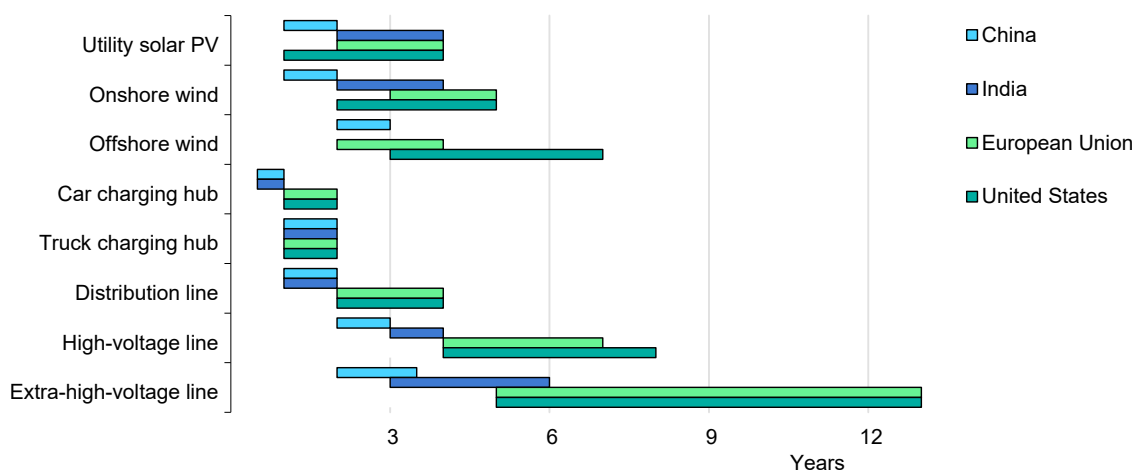

IEA. CC BY 4.0.

Notes: Ranges reflect typical projects commissioned in the last three years. Distribution line = 1-36 kV overhead line. Transmission is split between high-voltage line = 36-220 kV overhead line; and extra-high-voltage line = 220-765 kV overhead line. To date, India has not developed offshore wind projects.

Significantly shorter lead times for transmission lines are observed in China and India compared to advanced economies. In China, this is primarily due to centralised decision-making and the government's prioritisation strategy aiming to connect the eastern load centres with renewable energy-rich northern and western provinces through UHV lines. Similarly in India, the government has been prioritising the rapid development of inter- and intra-state transmission capacity through national programmes (e.g. Green Energy Corridor), supported by significant investment. Dedicated policy tools have helped fast-track the buildout of thousands of kilometres of lines in record time, driven initially by pressing concerns about electricity security and more recently by ambitious targets to evacuate green power from renewable energy zones.

In advanced economies, like the United States and the European Union, more attention is paid to permitting and public engagement processes, which explains a significant share of the differences in lead times. These processes include tools that can be used by stakeholders to legally oppose new infrastructure projects, which can produce delays in the establishment of new projects, while being essential to ensure adequate consideration of citizens’ perspectives.

Grid expansion projects are associated with a high risk of delays

Power grid project development typically goes through three phases, comprising scoping, permitting and construction. Delays are frequently encountered in each of these phases, especially for high-voltage interconnections, which further add to the already long lead times associated with these projects.

Phases of grid infrastructure project development and potential causes of delay

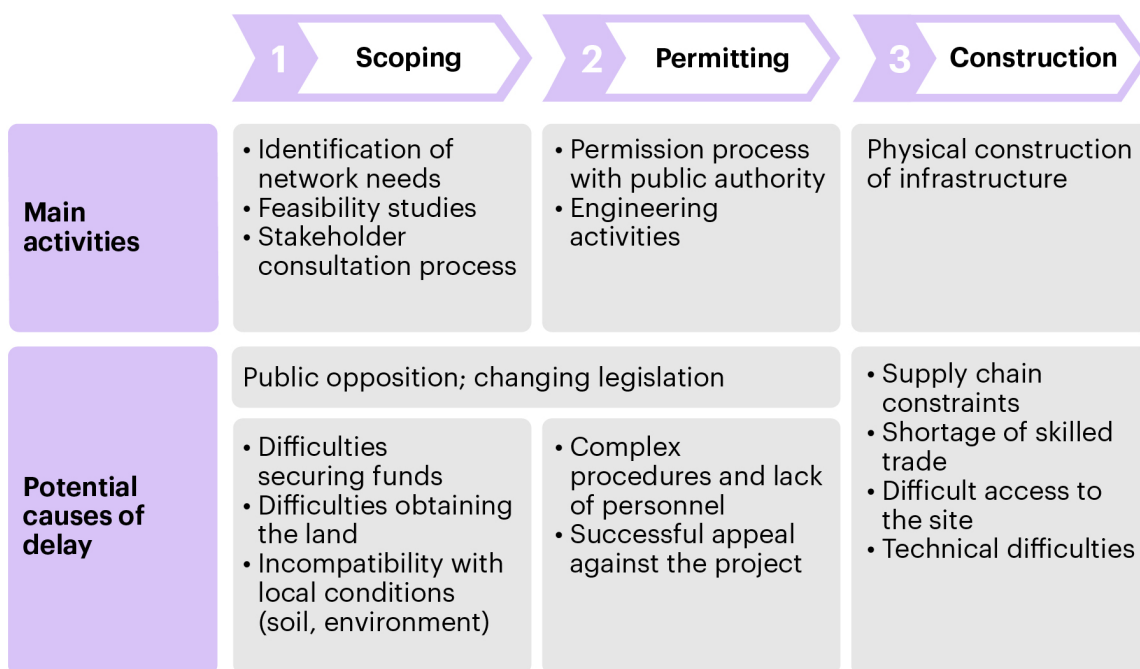

IEA. CC BY 4.0.

Source: IEA analysis, [ENTSO-E](#), [European Commission](#).

In the scoping phase, infrastructure projects, regardless of their nature, can encounter financial challenges depending on the business model they rely on. Power transmission and distribution projects, for instance, often operate within a regulated assets business model that imposes controls on revenues and investment returns. While several developed economies have established mechanisms to support the financing of such projects, emerging markets often face obstacles due to the high cost of capital and struggles in attracting private

investment. In Africa, where many state-owned utilities are in a precarious financial state, private participation in grids is not widely authorised and high risks related to political instability, corruption and vandalism often come with grid projects.

Unlike local projects, such as wind farms and solar PV systems, power grid projects often involve multiple authorities and jurisdictions along the entire route, which all need to review and accept the plans before granting approval. Route plans and reports, feasibility studies and soil reports must be prepared, conditions and specifications must be evaluated, and stakeholders involved over the entire planned path. For instance, the construction of the 340 km long Ultratnet direct current line in Germany [requires around 13 500 permits](#). Significant delays can result from complexities in the permitting procedure, such as overloaded staff members at permitting agencies, flawed government agency review processes, subjective interpretation or insufficient review of relevant regulations by government officials, complex land use change requirements, and estimation errors. In Europe, [over a quarter](#) of electricity projects of common interest (PCIs) are subject to delay, most frequently due to permit granting. Similar difficulties are observed in countries like the United States and Australia as well.

A lack of societal support can also considerably increase lead times, including the absence of a broad consensus among political parties and interest groups on long-term goals and a strategic vision for energy infrastructure. In particular, changes in government can slow down or halt project development. Opposition from local stakeholders and environmentalists, and indigenous groups, frequently impede or halt projects, especially when there is inadequate prior communication and consultation. According to [ENTSO-E](#), the most discussed issues driving public opposition include the visual aspects, human and animal health, audible noise and biodiversity. In such cases, it may become necessary to reassess and replan the route, and give consideration to the use of undergrounding of some sections, essentially restarting the entire process and work involved.

Additionally, delays can occur due to equipment delivery limitations and technical constraints. The duration of the construction phase is mainly reliant on the manufacturing slots available for key components such as power transformers and cables or highly specialised equipment like HVDC valves, which typically have long production lead times. A shortage of transformers has been ongoing since 2021 amid supply chain disruption and rising demand, resulting in projects delays and skyrocketing prices (a [400%](#) price increase has been reported for pad-mounted transformers, compared with 2020). The US power utility sector warned authorities in late 2022 about the [shortage of distribution-level transformers](#), for which procurement times had risen from between two and four months to more than a year.

Moreover, the limited availability of specialised equipment and skilled trades during the installation process of transmission lines is often a bottleneck. This is especially noticeable for offshore infrastructure installation, where specialised vessels and working platforms are typically reserved well in advance, sometimes more than a year ahead. Although the worldwide fleet of cable-laying vessels has been increasing consistently over the past 20 years in response to growing demand, the construction workers and technicians typically need specific certifications and training, such as those for operating offshore, working at elevated heights, or dealing with electrical systems.

Examples of large transmission grid projects facing major delays

The Südlink transmission project, expected to carry wind power from northern to southern Germany, was the subject of early planning discussions back in 2014. It had to be revised to employ underground cables in place of the planned overhead lines to gain public acceptance, a configuration which was not considered from the outset of the project. The revision led to an estimated [threefold increase](#) in project costs and a [three-year delay](#) on the initial 2022 deadline, initially set to match the shutting down of the last German nuclear reactors. Completion is now targeted in 2026 and [could be further delayed](#).

The 400 km Bay of Biscay interconnector between France and Spain announced in 2017 [is now expected for 2028](#) instead of 2025 after seeing a revision in its planned route due to instability of the seabed. This diversion from the original route and the current tensions in the commodity market led to a 63% increase in project costs and a [new cost allocation](#) between France and Spain.

In the United States, the [SunZia](#) HVDC line between New Mexico and Arizona is due to enter the construction phase during summer 2023, 17 years after the project started, having struggled to obtain right-of-way permits along its 885 km planned route. On the east coast, the construction of the [Avangrid](#) transmission line from Canada to New England was interrupted in 2021 following a referendum by Maine residents in 2021, before a court overturned the referendum decision in April 2023.

The Australian Energy Market Operator highlighted in its [2022 Integrated System Plan](#) the further postponement of the Marinus link whose [feasibility studies](#) date back to 2017. This HVDC line, connecting Tasmania to the mainland, is now projected to achieve full operation no earlier than 2031. The project also faces [opposition from an Aboriginal group](#) residing in the areas traversed by the planned route, which claimed not to have been adequately included in the planning process.

In Africa, a high-voltage transmission line to export electricity from the Inga Dam III in the Democratic Republic of the Congo to South Africa has yet to start construction, a [decade after an agreement was signed](#) between the two countries. The megaproject has been facing financing hurdles due to the withdrawal of initial investors and is suffering from a lack of support by local communities.

The [intra-state transmission system](#) component of India’s Green Energy Corridor programme started in 2015, consisting of more than 9 700 km of lines. Despite having been very efficient at driving forward the country’s grid expansion, the project has been delayed and given multiple extensions due to several factors, including right-of-way issues, delays in substation land acquisition, court cases and forest clearances.

Grids and employment

Grid-related employment is concentrated in regions where project expansion is taking place. China and India currently account for around half of all jobs in transmission and distribution grids, where grid networks have grown by over 40% over the past decade.

Grid-related jobs by regional distribution and economic sector, 2022

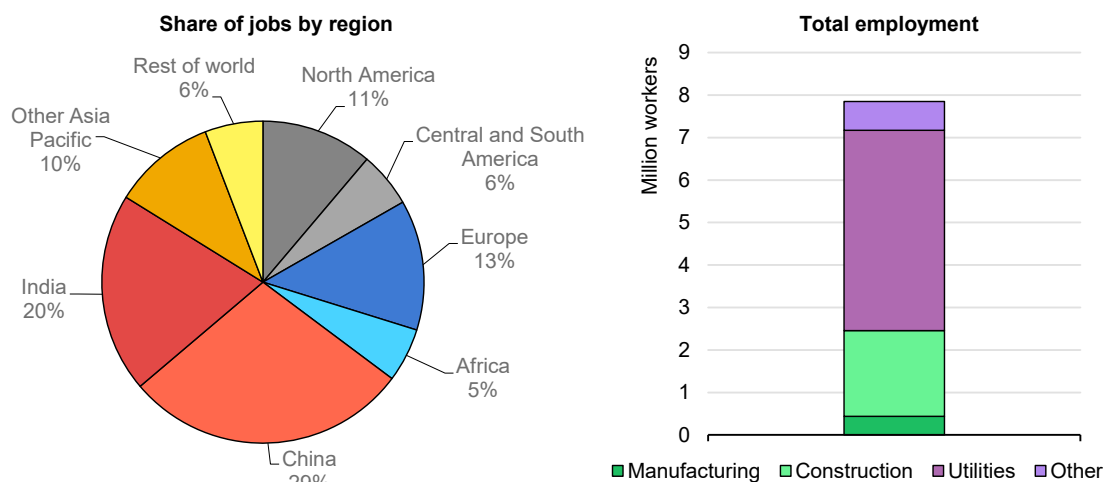

IEA. CC BY 4.0.

Globally, most of the jobs in transmission and distribution are concentrated in the utilities sector, followed by the construction sector. The split across these economic sectors is similar in both EMDEs and developed economies. Yet, in countries that have experienced rapid expansion of their power grids in recent years, such as China, both construction and manufacturing sectors account for a

much higher share of total grid-related jobs compared to the global average. Global employment in the sector is around 8 million jobs, representing over 10% of total energy employment.

In Africa, power sector employment is also driven by objectives to achieve universal access to electricity, making the production and especially the deployment of mini- and off-grid solutions major employment drivers for the continent. Additionally, the modest manufacturing hub in the continent has significant room to grow amid expanding and upgrading power grids.

The bulk of grid-related jobs in the utilities sector involves operation and maintenance activities, including meter reading. The uptick in smart metering and broader grid digitalisation reduces the labour intensity of operating and maintaining grids while increasing the need for IT skills. Regions with low levels of smart grid deployment can have three times higher labour intensity than regions with greater deployment levels. As grids become more digitised there will be an increasing need for utilities to employ workers highly skilled in IT in the sector. To do this, companies need to be aware of compensation packages in other industries to make sure that they can offer competitive incentives to attract the necessary talent.

Historically, given the regulated nature of the industry, grid-related employment has experienced minimal fluctuations in headcount. Looking ahead, there is a real possibility of the sector facing labour shortages as plans announced after the Covid-19 pandemic and the Russian invasion of Ukraine drive up new expansion projects, especially in China, Europe and the United States.

Chapter 2: Regulation and policy

Power grids are natural monopolies, and as such their development is particularly influenced by the regulatory and policy framework under which they operate. While the previous chapter presents a global view of current infrastructure and the status of the sector, in this chapter we address power grid regulation and policy, with a particular focus on selected regions around the world.

In the first part of this chapter we look at remuneration and investment mechanisms for grids. The diversity of ways to manage transmission and distribution grids across the world is reflected in a similar variety of ways to finance their operation and expansion, depending – above all – on the market structure and the existence of any unbundling of the sector. Energy transitions, including technological change and growing concerns over climate resilience, are driving the evolution on many of these mechanisms.

The second part of the chapter looks at existing policies for planning the expansion of power grids towards 2030. While our focus is on the current status of these plans, it is important to highlight they will define most of the sector's evolution for the remainder of the current decade, given its long lead times as presented in the previous chapter. Here, lack of data availability and comparability are the challenge – there are significant differences in the planning horizons, mechanisms and scope of the investment plans of different countries. Nonetheless, the gathered data provide an idea of the status of grid expansion plans today, which will define the near future and can serve as a basis for the forward-looking analysis in Chapter 3: Identifying the gap.

Remuneration and investment mechanisms for grids

Across the world, the management of transmission and distribution grids varies according to the industry structure in place, which can range all the way from a vertically integrated state-owned national utility to a fully restructured industry where the transmission and distribution businesses are designated as separate activities and open to private participation.

As the grid is the backbone of the power system, the objective of oversight is to ensure service availability, cost efficiency and affordability to end consumers, and increasingly a greater availability of services and technological innovation. In integrated state-owned utilities, oversight and remuneration are often carried out by the respective energy or finance ministries. In countries where an unbundling

and/or privatisation process has been undertaken, and transmission and distribution have been designated as natural monopolies, it is increasingly the task of a national regulatory authority (NRA) to define the mechanisms for remunerating grid operators. This body usually works alongside a regulatory framework that enables the unbundling of ownership and ensures independence of system operation, maintenance and investment from the supply company.

Historically these models have been determined by wider energy policy goals – such as energy access or cross-subsidies between consumer groups. In recent years, mechanisms have emerged to encourage a higher level of private involvement in the power system. We can find several business structures that allow private-public partnerships for grid development, ownership and operation, as well as different remuneration systems to encourage private investment. Involving private participation in the power system can be done using different structures that provide flexibility in risk allocation and competition through tendering.

One way to structure the grid system is through privatisation, in this way extending the participation of new stakeholders and stimulating competition in the sector, where revenues are regulated to ensure reasonable development and returns. This approach has been adopted in transmission and distribution grids in the United Kingdom, Australia and some parts of Latin America, among others. In the latter, private investment has accounted for more than half of overall expenditure in recent years, emerging as a pivotal source of capital. Successful grid privatisation may require a minimum market or grid size to ensure effective unbundling and privatisation.

An alternative method involves the awarding of long-term concessions through competitive bidding processes, accompanied by regulated remuneration, as often adopted in a distribution sector open to privatisation. These agreements capitalise on the expertise of the private sector, enhance budget predictability and facilitate risk sharing. However, effective regulation and incentives are necessary to ensure the alignment of objectives among all involved parties.

In Brazil, concessions have been a significant mechanism for involving private entities in the expansion and operation of the transmission grid since 2004. The transmission company Eletrobras, which was initially fully state-owned, has gradually seen its importance diminish as the national transmission grid has expanded. In 2023 Eletrobras' ownership stake in the transmission grid has fallen to around 40% due to the increasing participation of national and international investors through competitive bidding. Brazil intends to go from nearly 160 000 km of transmission lines to 200 000 km by 2032, with total investment in transmission lines [projected to reach USD 18 billion](#).

Remuneration structures are evolving to incentivise the right balance between affordability and quality of service

Following a decision on the preferred model for private participation – privatisation or concession – policy makers can steer the behaviour and management of these natural monopolies through the design of remuneration mechanisms. In the early years of deregulation, so-called “cost-of-service” remuneration was the most predominant option as it ensured full cost recovery for grid operators and provided certainty for investors. This, however, created the incentive to overinvest in infrastructure and resulted in higher bills for consumers without providing an incentive to innovate.

Regulatory framework for distribution and transmission operators

Regulatory framework	Grid operator					Customers		Both
	Cost recovery	Cost minimisation	Planning optimisation for total costs	Performance and operational efficiency	Innovation and best practice deployment	Affordability – cost minimisation	Quality of service improvement	Dynamically aligned cost and price
Cost of service/Cost-plus Rules are set to cover costs, with allowed earnings defined <i>a priori</i> (rate of return) starting from the determination of total cost of service	●	●	●	●	●	●	●	●
Price cap/Revenue cap Remuneration is based on a yearly cap that the grid operator can charge for each specific service (price cap) or on the amount that can be earned for each cluster of service (revenue cap)	●	●	●	●	●	●	●	●
Yardstick competition The operator’s performance is compared with the other operators’ performance of the sector, with penalties/awards consequently defined	●	●	●	●	●	●	●	●
Output/Performance-based Remuneration is based on performance monitoring for each service (e.g. quality, losses) to incentivise continuous improvement	●	●	●	●	●	●	●	●
Impact on indicator								

● Poor ● Moderate ● Beneficial

Note: “Dynamically aligned cost and price” refers to the frequency of updating the information used to set the operators’ remuneration based on the actual costs they sustain. Very infrequent updates, for example until the end of a five-year regulatory period, can result in customers paying higher prices or grid companies suffering financial losses for an extended period until the imbalance is corrected in the next cycle.

Price or revenue cap mechanisms, which set a maximum price or revenue for each recognised item of the company's expenditure, have followed as a way to incentivise operators to lower their costs and increase profits. However, if not correctly combined with other mechanisms, such as performance-based schemes, price cap mechanisms can fail to give sufficient priority to the investment needed to increase the quality of service and innovation levels.

Yardstick competition incentivises cost reductions by inducing competition between grid operators relative to the industry's average cost. Because of the lack of monitoring of how these costs are reduced and the high degree of competition among operators, it may distort the incentives and lead to excessive cost reductions that impact the quality of service. It is commonly combined with price cap regulation.

Finally, output-based regulation includes monitoring of performance and is often used to target specific outcomes, for example by defining rewards or penalties based on the quality of service. In an increasing number of jurisdictions it has been rolled out as part of efforts to remove capital bias and encourage investment in improving operations and quality of service, contributing to a more neutral view on CAPEX and OPEX. Cost minimisation is not as incentivised as in the other approaches, but quality and innovation are equally favoured and so customers can benefit from service improvement.

Most advanced economies, due to liberalisation of the power sector, have seen the progressive evolution of their regulatory context with periodic adjustment following consultation among stakeholders. These economies often have a hybrid structure, with multiple schemes adopted in combination to better exploit their different characteristics (e.g. yardstick to fix a cap and an output/revenue cap to design the improvement path) or with different schemes applied to specific items (e.g. CAPEX and OPEX remuneration, as well as quality of service and loss targets). For example, in Japan a revenue cap mechanism was adopted in April 2023. While the country faces stagnating demand growth due to population decline, the growth of renewables in power supply and the need to increase climate resilience require grid investments. This approach was brought in to replace rate of return regulation in order to facilitate grid companies investing efficiently in grid enhancements and maintaining secure delivery of supply.

It is worth highlighting that, despite it being possible to have a similar regulatory principle for both transmission system operators (TSOs) and distribution system operators (DSOs), there are differences due to the contrasting characteristics of the grids and their primary scope (TSO: energy security and adequacy of the network; DSO: quality and continuity of supply to the final customers).

Within different regulatory frameworks, the regulators and policy makers have the crucial role of establishing a properly designed electricity tariff to prevent financial

pressure on the grid operator and higher costs for more vulnerable customers. One key point to be considered is the assumptions that are used to evaluate the economic value of the grid assets. One approach for remunerating DSOs that is particularly applied [in Latin America \(Peru, Chile and Argentina\) is the so-called *Empresa Modelo* approach](#), where the costs and revenues of real companies are compared with those of a model company: an efficient ideal operator with optimised assets and capacity, which is considered the benchmark on which tariffs and thus remuneration are established. From the grid operator's point of view any cost savings mean higher profits, as the remuneration is totally independent from operators' decisions. This creates a higher risk of operators favouring investment that creates cost reductions rather than operational improvement, penalising quality of supply. For example, in Chile [a number of studies](#) highlight that the country's current implementation of the *Empresa Modelo* approach needs changes to better incentivise aspects such as innovation, proactive investments and improved quality of supply. In the worst cases, despite cost reduction measures, remuneration can even be insufficient to cover expenses, putting at risk the grid operators' financial position.

The contrasting approach considers the actual costs of the network company, termed the regulated asset base (RAB), whereby the net value of the company's assets and operating capacity is recognised and valued. This framework ensures operators receive a fair and stable remuneration. However, it can pose challenges in ensuring that the incentives do not encourage a focus on overstating investment for higher returns, rather than a focus on operational efficiency. An increasing number of NRAs are integrating this approach with incentives for boosting innovative and efficient investment, approving specific investment plans and monitoring their performance.

Within an evolving energy context, regulators are shifting to output-based schemes

The reason why NRAs in advanced economies are gravitating towards performance-based regulation is their aim of fostering innovation and economic and operational efficiency, since the traditional approach, mainly the cost-plus framework, could favour CAPEX over OPEX even when an OPEX solution is more efficient. This shift is mainly driven by the energy transition, which calls for a high level of investment especially in innovative and digital assets. This leads to regulators needing a scheme that promotes the implementation of new technical and market solutions.

The United Kingdom was the first country to adopt a full TOTEX scheme (TOTAl EXpenditure, meaning CAPEX + OPEX) for electricity, which has been in place for DSOs since 2015. This is the so-called RIIO (Revenue = Investment + Innovation + Output incentives), which was recently extended for the [five-year](#)

[period 2023-2028](#). In Italy, where [CAPEX and OPEX are respectively addressed via cost-plus and price cap schemes for both DSOs and TSOs](#), the NRA introduced ad hoc output-based features from 2015. The second-generation smart meter rollout was launched following a [performance-based approach](#), with penalties/rewards for DSOs according to their adherence to the established rollout timeline (a specific percentage rollout to be achieved by the end of each year of the plan). In the [same direction in 2017](#), initially for DSOs and [later for TSOs](#), the Italian NRA implemented a resilience regulation with a reward scheme based on a project timeline. Italy is also evaluating a move towards a [complete output-based approach](#) in a step-by-step process involving all players. Portugal introduced performance-based regulation for low-voltage grids in 2019 and extended this to the transmission system in 2022.

A number of innovative regulatory approaches are available to pursue specific policy objectives or test new technologies that are particularly well suited for regulators struggling with cost recovery, as is often the case in emerging market and developing economies (EMDEs). For example, [Colombia](#) introduced the concept of the Special Construction Unit [within the distribution grid operator regulatory framework](#) in order to foster investment in new digital and advanced technology. The network operator can, upon NRA approval, obtain ad hoc remuneration for a non-standard asset. In India, the [Revamped Distribution Sector Scheme \(RDSS\)](#) has been developed to address state-specific needs: reducing grid losses, improving the reliability and affordability of power supply to consumers, and ensuring a financially sustainable and operationally efficient distribution sector. Among other projects, the smart meter rollout, delayed several times, is finally going to be launched ([250 million units by FY 2025/2026](#)) thanks to a proposed mechanism to be implemented through a public-private partnership (PPP) using the TOTEX principle.

Another option to test innovative approaches is the introduction of regulatory sandboxes. For example, in Brazil, the [NRA may approve special pilot projects](#) within an experimental regulatory environment (regulatory sandbox). Positive ex post monitoring of their performance could bring full integration into the standard remuneration process. One limitation of pilots is the difficulty of transitioning innovative approaches into the main business case after successful trial.

Cross-border transmission developments introduce an additional layer of complexity and may require regulatory solutions as well as increased co-ordination in operations and planning to align incentives and fairly distribute risks between the different stakeholders over time. In the European context, [CBCA \(Cross-Border Cost Allocation\) has been introduced](#) as a regulatory tool for key cross-border infrastructure projects. CBCA shares investment costs relating to

projects of common interest (PCIs) efficiently among the countries involved. The role of the NRA is to closely examine project proposals and determine financing proportions.

Despite the different contexts of advanced economies as compared with EMDEs, once the remuneration scheme for TSOs and DSOs has been set, the NRAs have another crucial responsibility: to determine how to cover these costs by allocation within the final customer tariff.

Electricity grid component and total electricity tariffs for households by country, 2021

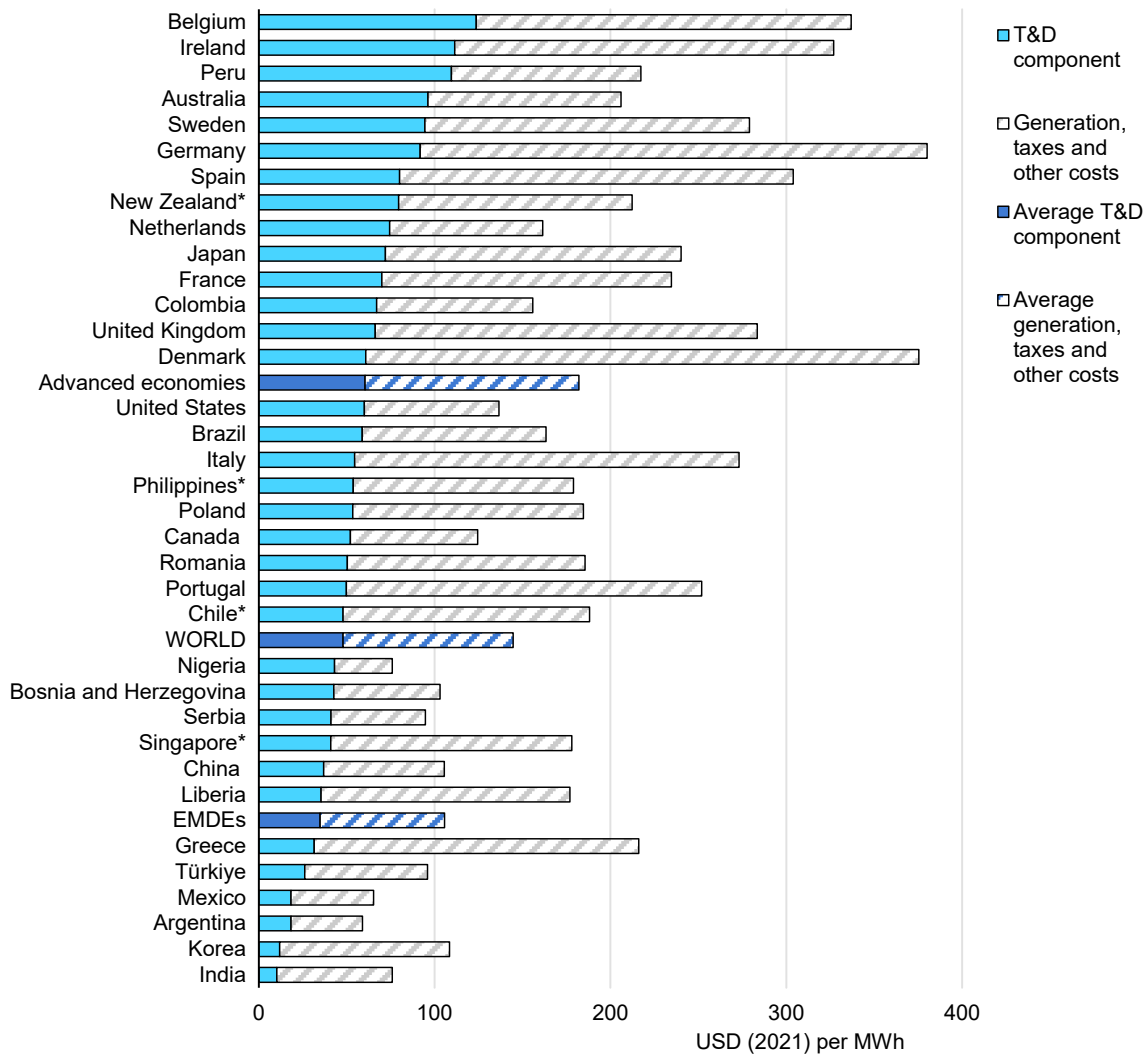

IEA. CC BY 4.0.

* Data for Singapore, Philippines, Chile and New Zealand are from 2020.

Notes: T&D = transmission and distribution. Data for China are for the smallest commercial cluster (connection < 1kV). The generation, taxes and other costs also include subsidies, social funds and some specific measures (e.g. Covid support measures), where foreseen in the regulation.

Sources: IEA analysis based on official data from country and national regulatory authorities.

The electricity grid tariff paid by consumers spans a wide range in countries around the world, from as low as USD 12/MWh in Korea up to well over USD 100/MWh in several countries in Europe. Of the total residential electricity tariff, the portion attributable to electricity grids represents 20-30% in most cases, with some exceptions due to the particularities of certain countries. In places, the generation mix and/or higher costs of transmission and distribution can bring this share near to 50% (e.g. Peru, Australia and the United States). It is worth highlighting that in most cases the distribution segment accounts for around two-thirds of the T&D share.

Another relevant aspect to take into account when setting an adequate tariff relates to the point in time that investment is recognised, because the NRA can set the rules to pay the system operator *ex ante* (based on planned expenditure, as designed by the DSO and TSO and then approved by regulator) rather than *ex post* (based on actual expenses remunerated after investment plan implementation). The latter approach could encourage the operator to extend the operation of grid assets beyond their useful life, with the risk of postponing new investment and worsening grid conditions. The first approach, recognising investment in advance instead, allows for a timely and predictable remuneration procedure, helping the operator's financial management and avoiding the deferral of investment over time. This approach requires monitoring, audits and controls on the part of the regulator, but ensures DSOs receive stable and predictable remuneration, while encouraging them to enhance their financing planning. This is particularly relevant for countries such as India, Indonesia and Korea where the financial health of utilities is a central challenge.

The rapid pace of change in power systems is motivating the deployment of new models of investment

The rapid pace of system transformation is driving the need for grid expansion in both advanced economies and EMDEs. EMDEs, however, need to invest in grid expansion while also strengthening their existing grids. This compounds broader financial challenges, such as utilities' limited resources due to the lack of cost-reflective tariffs, and a greater need for equity-based investment by the utilities themselves as the cost of capital can be [several times higher](#) than in advanced economies, with higher capital costs [particularly in Sub-Saharan Africa](#). As such, the priority for enhancing grids in EMDEs is to de-risk investment to lower the cost of borrowing. In specific cases this can be enabled by allowing for greater involvement of private actors, which can develop projects building on their lower cost of capital.

A model that is gaining relevance for private capital involvement, especially in EMDEs, is independent power transmission (IPT), which represents a more modular approach as it involves tendering for specific sections and thus allows

greater flexibility in piloting different models. Revenue is typically determined by the winning bid from the offtaker, and incentives are tied to the line's availability rather than meeting demand, thus mitigating demand risk. This model has seen success in various regions, including Latin America, the United States and India.

There are alternative approaches to structuring an IPT project, depending on the sources of finance, whether the asset is transferred to a state-owned entity once commissioned, how the risk of the project is to be allocated, and also the project's viability and the specific industry structure where it is being implemented. Approaches include BOOT (build, own, operate and transfer), BOO (build, own and operate), BTO (build, transfer and operate), BOT (build, operate and transfer). New models are also being developed for offshore transmission, such as the OFTO (offshore transmission network owner) regime in the United Kingdom. Under this approach, licences are awarded through competitive tenders granting the OFTO a regulated return on the building and operating costs.

Similarly, the private sector can be part of a joint venture in collaboration with a state-owned transmission company and be granted specific participation in the project. This is more suitable in lower-income countries where there is no prior experience of transmission development through the private sector.

India, for example, has emphasised the development of mechanisms to transition from state-owned centralised systems to IPT models. Different regions have implemented various administrative bidding procedures and remuneration models. Private companies in India have established [a range of joint venture projects](#) in collaboration with the state-owned Indian Power Grid Corporation (POWERGRID). These collaborations have also extended to neighbouring countries like Nepal.

In 2023 Kenya made a significant announcement stating its intention to introduce IPT structures to finance and extend its electricity transmission lines for the first time, marking a notable departure from its previous reliance solely on a state-owned company (KETRACO). Kenya's first IPT project – a [165 km 400 kV line from Lessos to Loosuk and the 72 km 220 kV line from Kisumu to Musaga](#) – is with POWERGRID and is due to reach financial close by end of 2023, at a total estimated cost of USD 298 million. It is the first time that a transmission line on the African continent will be built via a PPP.

Another aspect under discussion, particularly in Europe, is a shift towards enabling anticipatory investments – those that are not immediately needed for current projects, but which can address near-future needs. The United Kingdom [carried out a consultation](#) on the need for and risk allocation of anticipatory investments in 2023, focusing on the co-ordination of offshore wind development. The new electricity market design proposal of the European Union also considers a [revision to tariff methodologies to enable anticipatory investments](#).

Stocktake of current policies towards 2030

Investment plans are evolving, complemented by greater co-ordination

In grid investment planning, a selected entity outlines feasible options to meet the future needs of the grid for the provision of electricity, and regulators or ministries authorise the plan and cost allocations. The main objectives in the past have been to ensure [reliable, secure and cost-effective delivery of power](#), while today climate goals play an increasing role.

Traditionally, power systems were dominated by dispatchable generation sources such as fossil fuel, hydro or nuclear plants. Grid expansion was driven by major generation projects coming online or increases in peak demand. Clean electricity transitions require a shift in grid planning processes for multiple reasons: the increase in renewable generation; the increased role of distributed resources; the need for digitalisation for better operations and to improve customer activation and participation; and the need to bring together targets for multiple sectors that link to the power sector, from the electrification of heat and transport to efficiency targets across all sectors and overall emissions. In addition, the development of renewables far from load centres and demand-side resources can often occur faster than the lead times for deploying grid assets, so considering grid planning now is critical to delivering electricity security in the future.

Clean transitions are driving new and updated grid planning studies

To prepare a grid investment plan, the system planner conducts studies every one to five years to forecast demand and identify the type and location of energy resources needed [to meet system needs typically around ten years](#) into the future. These planning cycles face challenges in meeting the needs of clean transitions, in part because renewable energy and technology deployment may proceed very rapidly, making it difficult for grid development to keep pace, particularly where plans are updated infrequently. In addition, as new clean energy targets are introduced, there may be a lag before the development plan is aligned with targets.

In addition, the planning horizon of these studies is typically shorter than the timeline of high-level climate targets such as net zero goals. This [creates challenges](#) in ensuring that grid planning is aligned efficiently with the needs of longer-term ambitions. There is also an increased need to co-ordinate planning for the power sector and other sectors (including transport, heating, natural gas and hydrogen), to align generation and transmission development, and to consider different potential development pathways. Clear overall estimates of the

investment needed in all parts of the grid, which act as an important investment signal, may also be lacking. To address these challenges, many countries have introduced changes to their planning practices in recent years.

Length of planning horizons and update frequency for grid planning studies

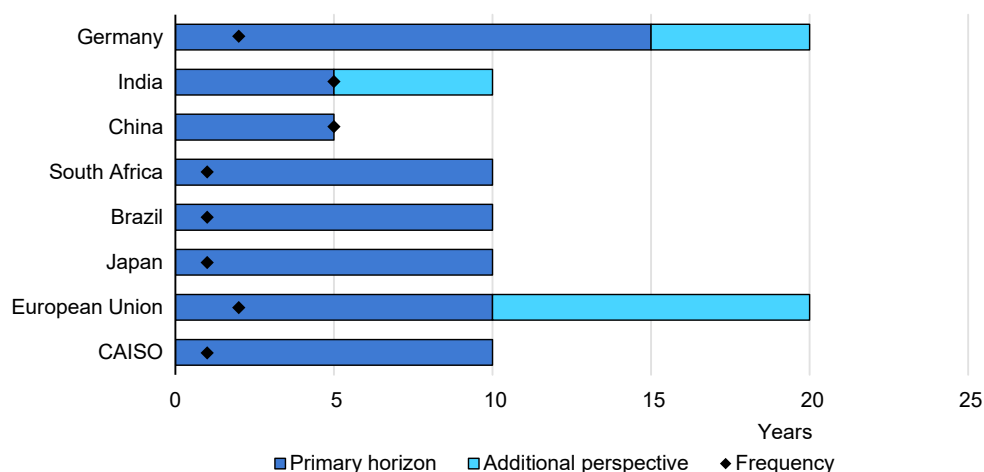

IEA. CC BY 4.0.

Note: Horizons are based on the main transmission planning study for each region, noting that some have additional longer-term studies used to inform the main plan.

Sources: The [National Transmission Needs Study](#) for the United States; the [Ten Year Network Development Plan](#) for the European Union; the [Electricity Supply Plan](#) for Japan; the [Plano Decenal de Expansão de Energia](#) for Brazil; the [Transmission Development Plan](#) for South Africa; the Five-Year Plans for China; and the [National Electricity Plan Volume II \(Transmission\)](#) for India.

One approach adopted in many power markets is to introduce additional studies that provide guidance for transmission and generation development in line with climate targets. For example, in Chile the energy ministry introduced a new annual [long-term energy planning process](#), first published in 2018 and with a 30-year horizon, which [is considered](#) in the 20-year [national transmission plan](#). In early 2020 the Ontario system operator published the [Annual Planning Outlook](#) for the first time, which provides a 20-year outlook as part of its [provincial planning processes](#). The outlook also informed the [Pathways to Decarbonisation](#) report, which was published in December 2022 with a horizon to 2050.

In Australia, the annual 20-year National Transmission Network Development Plan became a part of the [Integrated System Plan](#) (ISP) from 2018. The ISP is prepared every two years and provides a whole-of-system plan for the National Electricity Market with outlooks to 2050. The United States recently introduced the [National Transmission Planning Study](#), with an outlook to 2035. The US triennial national state of the grid report, formerly the National Transmission Congestion Study, which considered only historical congestion, was also updated from 2023 to include outlooks to 2030 and 2035 and was renamed the [National Transmission Needs Study](#).

Japan's cross-regional co-ordinator, OCCTO, also published a [national grid master plan](#) for the first time in 2023 with a view to carbon neutrality in 2050, to complement the annual ten-year [Electricity Supply Plan](#). In 2021 the system operators of Ireland (Eirgrid) and Northern Ireland (SONI) published the [Shaping Our Electricity Future Roadmap](#), which provides an outline of key developments in grids, engagement and operations and a market perspective to 2030, to support a secure long-term net zero transition. This is in addition to the ten-year Transmission Development Plans prepared annually by [Eirgrid](#) and [SONI](#).

In India, the Central Electricity Authority (CEA) is responsible for generation and transmission planning across the whole country and makes a National Electricity Plan every five years, with the first volume dedicated to generation and the second to [transmission planning](#). In 2022 the CEA published an additional study to support India's clean transition pathway, [Transmission System for Integration of over 500 GW RE Capacity by 2030](#).

In 2020 Brazil prepared an integrated National Energy Plan for the second time, with a longer horizon than the first plan prepared in 2007. The plan will now be prepared every five years to support Brazil's regular grid planning exercises, which include the [Transmission Expansion Programme/Long-Term Expansion Plan \(PET/PELP\)](#), the Medium-Term National Grid Operation Plan (PAR/PEL), the Electric Power Transmission Concession Plan (POTEE) and the [Ten-Year Energy Expansion Plan \(PDE\)](#).

China formulates a comprehensive national power plan and national energy plan every five years (e.g. [14th Five-Year Plan for Energy for 2021-2025](#)). Power grid planning is a submodule of the national power plan, which is formulated by the National Energy Administration of China, while the three major grid operators, State Grid Corporation of China, China Southern Power Grid Company and Inner Mongolia Power Company, independently conduct research and provide relevant opinions and suggestions to the grid planning process.

In regions with vertically integrated utilities, which include parts of Russia, some US states, much of Africa, the Middle East and Southeast Asia, as well as some South American countries, generation and transmission planning are typically both undertaken by the integrated utility. Such regions also require a shift in planning practice to reflect government climate targets in system plans. For example [Indonesia's RUPTL](#) covers both generation and grid development. The latest plan reflected targets to become carbon neutral in 2060, and is currently being updated to incorporate [Indonesia's net zero target, announced in 2022](#). Similarly, the Electricity Generating Authority of Thailand (EGAT) reviews the Power Development Plan every one to two years to prepare a new or revised edition. The last plan, released in 2020 (PDP 2018-2037 Revision 1), incorporated renewable

energy targets from Thailand's [Alternative Energy Development Plan](#) and is currently being updated to reflect Thailand's [net zero pledge](#).

Renewables and distributed resources are prompting new approaches

Another aspect receiving attention is an increased need for [proactive co-ordination](#) between generation and grid planning for effective renewables deployment. Traditional approaches, where grid expansion would typically only be considered following individual generator project proposals, can create barriers to efficient and timely grid development – and also limit renewables deployment. To address this, regions such as [Texas](#), [Australia](#), [South Africa](#) and [India](#) have introduced renewable energy zones (REZs) and adopted similar approaches to identify regions with high renewables potential suitable for developing transmission connections. This can both speed up and reduce the cost of renewable energy deployment. In Denmark, the energy agency acts as a [one-stop shop](#) for operators and ensures a smooth licensing procedure, where the interests of other authorities including grid planning are co-ordinated internally.

Some governments have introduced capacity availability requirements into their auction schemes or included transmission provision in long-term planning. In the Netherlands, in response to high levels of grid congestion, projects applying to the [SDE++ programme](#) must receive a [transmission capacity indication](#) from the local grid operator. In Brazil, transmission auctions are used to connect areas with [high renewable energy generation](#) to areas of high consumption.

On distribution grids, anticipatory planning for the needs of distributed energy resources can help ensure grids are not a barrier to their deployment, as demonstrated by [Hokkaido electric power network company's planning](#) for hosting grid-connected batteries.

With regard to integrating distributed energy resources into power systems, one of the main obstacles is [a lack of sufficient visibility](#) and transparency of behind-the-meter resources. The International Smart Grid Action Network is [working on TSO-DSO co-ordination](#), and the EU DSO Entity (representing DSOs) and European Network of Transmission System Operators for Electricity (ENTSO-E, representing TSOs) [signed a memorandum of understanding](#) in 2022 to enhance co-operation.

As the challenges faced in operating the system diversify, new methods such as digitalisation and demand-side response need to be taken into account when evaluating the development of electricity grids. A number of initiatives exist to advance these solutions, such as the [European Smart Grids Task Force](#) and the

[Digital Demand Driven Networks initiative](#) (3DEN). DSOs need a substantial amount of investment to [address surging demand on distribution grids](#).

Co-ordination within and between regions is a growing opportunity

The benefits of extending the footprint of connected grids over larger areas are [well recognised](#), including reduced costs and [increased reliability of power delivery](#), but there are difficulties in co-ordinating different countries. In the context of clean transitions, [grid connections between regions](#) are also critical to allow the sharing of both renewables and flexibility resources and lower the cost of transitions. Ideally, [grid expansion plans should co-optimize factors](#) such as generation connections, system operations, near-term planning, and long-term planning for local, regional and interregional projects.

This need is being recognised through measures to improve national and subnational regional co-ordination. In Japan, for example, OCCTO was created in 2015 to directly co-ordinate national grid development interests from a higher viewpoint. Planning studies can also serve to improve regional co-ordination, as seen in [Germany](#), the [United States](#) and [Ontario](#).

The geographical scope of grid planning is also being extended as the need to co-ordinate cross-border interconnections increases. Co-ordination between interconnectors and domestic planning is essential because interconnectors can affect domestic grids, particularly with regard to stability and trading behaviours. In the United States, [the Western Interconnection](#) covers all or part of 14 states, 2 Canadian provinces (British Columbia and Alberta) and the northern part of Baja California in Mexico. The region largely comprises vertically integrated utilities, many of them municipal or rural co-operatives, and they are gradually moving towards greater co-operation. Many jurisdictions with historically limited interconnection, such as [EU member states](#), [Southern African countries](#), [Central American countries](#) and [ASEAN countries](#), have taken the initiative to co-ordinate increased cross-border interconnections to ensure adequacy and facilitate electricity exchange with increasing renewable energy resources.

For example, in Europe ENTSO-E adopts a non-binding Ten-Year Network Development Plan (TYNDP) considering all its members, which builds on the national investment plans prepared by the TSOs and private developers in each country. [The main processes of the TYNDP](#) are developing scenarios for the future, screening needs for infrastructure expansion and conducting project assessments based on cost-benefit analysis. The [TYNDP 2022 reviews](#) 141 transmission and 23 storage projects corresponding to 2030 and 2040 scenarios. The [TYNDP System Needs](#) study identifies the opportunity for 88 GW of beneficial capacity increases from 2025 to 2040 across over 65 borders.

ASEAN countries created the [ASEAN Power Grid \(APG\) programme in 1997](#) under the ASEAN Plan of Action for Energy Cooperation (APAEC). Under the APG, the [ASEAN Interconnection Masterplan Study](#) has identified numerous benefits to increased interconnection in ASEAN. [APAEC 2016-2025](#) reviews the achievements and action plans to enhance grid development in ASEAN countries.

An increasing number of cross-regional initiatives and institutions are being created to improve regional co-ordination and attract investment and political support, including new global initiatives such as [Global Energy Interconnection](#), [Green Grids Initiative](#) and [One Sun One World One Grid](#). Increasing global consensus on grid development is highly likely to improve recognition of the importance of grids across different countries.

Recent policy commitments seek to boost grid investment

In response to the growing recognition that grid development needs to accelerate to support energy transitions, policy makers in many regions have introduced measures to support their deployment. While investment in grids is growing at a stable pace in advanced economies, governments are recognising the need for further grid investment to support energy transitions. While most of the funding committed to grids is typically associated with regular expansion plans, some countries have introduced new policies to further support grid development.

Investment (billion USD) and time horizon for current transmission grid plans in selected regions

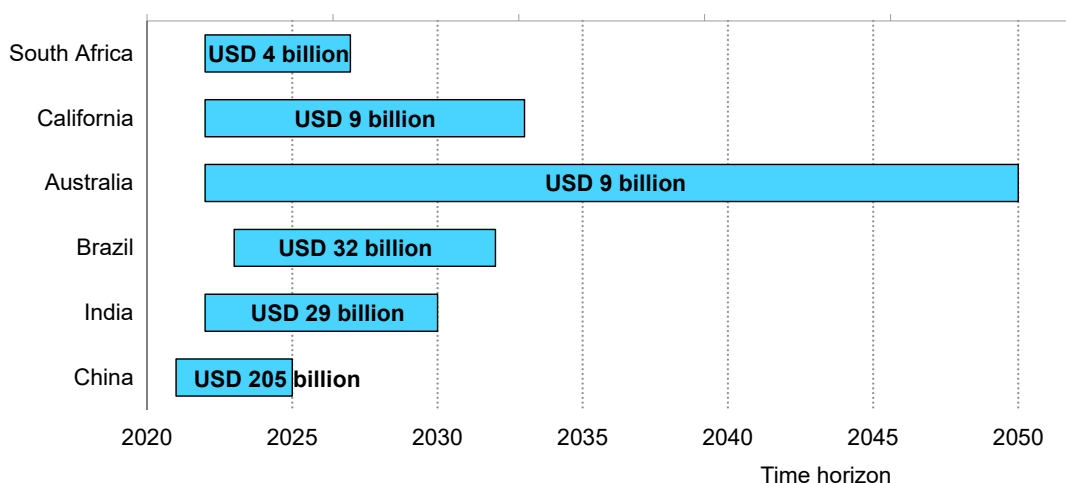

IEA. CC BY 4.0.

Note: Selected regions are included with specific cost estimates for the entire transmission grid, excluding distribution. Sources: IEA analysis based on South Africa, [Transmission Development Plan 2023-2032](#); California, [2022-2023 transmission plan](#); Australia, [2022 Integrated System Plan](#); Brazil, [Plano Decenal de Expansão de Energia 2032](#); India, [Transmission System for Integration of over 500 GW RE Capacity by 2030](#); China, [14th Five-Year Plan](#).

One approach is to explicitly dedicate a grid development budget that can be allocated to different projects. The US Congressional Budget Office estimates that total support from the Inflation Reduction Act of 2022 (IRA) and the Infrastructure Investment and Jobs Act of 2021 will surpass [USD 430 billion from 2022 through to 2031](#), of which the IRA provides [USD 760 million](#) in grants to siting authorities to facilitate the siting and permitting of transmission projects. The [National Renewable Energy Laboratory estimates](#) that the US IRA could enable 24 TW-miles of transmission capacity by 2030, which is a 16% increase in total installed capacity relative to the current level.

The REPower EU Plan is estimated to provide an additional [EUR 29 billion of investment](#) for power grids, with plans to accelerate the deployment of projects by 2030. In Australia, the parliament approved a [AUD 20 billion](#) Rewiring the Nation plan to finance new transmission projects. As for international projects, a number of international transmission lines have been planned under the dedicated frameworks of respective regional economic communities and financed by related participants and/or international development banks (e.g. [Inter-American Development Bank](#), [African Development Bank](#) and [Asian Development Bank](#)). Some funding is also being explicitly allocated to digitalisation, such as India's [Revamped Distribution Sector Scheme](#), which targets more than half of its funding to better metering.

Regulatory reform can speed up grid development

Beyond financial support, some policies also target the removal of administrative barriers to new transmission projects by giving key infrastructure priority status and simplifying the permit issuance procedures. In the United States, in parallel to the IRA grants for siting and permitting transmission projects, in 2022 the administration released [a permitting action plan](#) aimed at expediting federal permitting and environmental assessments for infrastructure projects funded under the Infrastructure Investment and Jobs Act. Also in 2022, the Netherlands introduced a [national action programme](#), which includes plans to speed grid development through better co-ordination.

Regulatory experimental sandboxes are used as a tool to promote flexibility in regulation. In the United Kingdom, [Ofgem's Innovation Link](#) provides innovators with support on energy regulation to facilitate the launch of new products, services, methodologies and business models. In Italy, the Italian Regulatory Authority for Energy, Networks and Environment (ARERA) allows DSOs to be involved in [large-scale regulatory experiments](#) as a tool for innovation. Sandboxes are also used as a small-scale tool for retail suppliers and third parties. A regulatory sandbox was also introduced in France where the NRA, [CRE, allows exemptions to facilitate the innovative technologies](#) that promote energy transitions and smart grids and infrastructure. In Australia, the [Energy Innovation Toolkit](#) provides an

innovation enquiry service, trial waiver and trial rule change process to help innovators navigate the complex regulatory frameworks.

The European Union has established the Trans-European Networks for Energy (TEN-E) regulation as a new approach to EU-wide infrastructure planning, and has announced every two years since 2013 a [list of projects of common interest \(PCIs\)](#) to reduce administrative costs and improve regulatory conditions for key transmission projects. The [revised version of the TEN-E](#), which entered into force in 2022, aims to accelerate the permitting and authorisation procedure of the 11 priority corridors already identified, including offshore and onshore interconnections. In addition, in response to the Russian invasion of Ukraine, a [temporary emergency regulation](#) sets maximum timelines for permit-granting procedures for renewables, its relevant storage and grid connection.

In India, the [Gatishakti Sanchar Portal](#) was launched in 2021 to centralise and accelerate the issuance of right-of-way permits for infrastructure development, including transmission lines.

Targeted reforms are also being used to address the queues of projects awaiting grid connection. The system operator of Great Britain [is now requiring](#) that applicants meet specific milestones to progress in the queue, to avoid speculative applications. Conditions that must be met to apply for connection permits can also be strengthened to prioritise projects that are the most likely to be built, such as requiring developers to have already obtained planning permission before applying, which is the case in France and Germany. [Parallelising permitting procedures](#) for the construction of generating assets and their connection to the grid is good practice to streamline the approval of new projects, as applied in Austria and the Netherlands. The US Federal Regulatory Energy Commission (FERC) has approved [a new rule](#) to streamline the interconnection process.

Speeding up permitting applications also involves having sufficient trained staff within permitting agencies and departments. They must also be equipped with adequate equipment and software to deal with digital permitting processes, which are more efficient than paper-based systems.

Societal support is critical to timely grid deployment

As social opposition can be a significant source of delays in project deployment, efforts need to be made towards early and frequent stakeholder involvement in project planning. This starts by establishing effective communication channels to ensure stakeholders are heard, making sure to engage the local population and authorities through public consultation and information meetings, where the benefits brought by the project can be made clear. In Australia, for instance, the [Energy Grid Alliance](#) was established to improve community engagement and advocate best planning processes in new transmission projects. The World

Economic Forum's [Clean Power and Electrification programme](#) is collating models to accelerate and scale clean power infrastructure deployment while simultaneously creating shared value for people and communities, and protecting biodiversity.

On the technical side, best practices can be adopted to limit the impact of new lines and related equipment on their environment. For instance, the utilisation of underground cables instead of overhead lines where possible can effectively mitigate concerns related to visual and environmental impact, albeit at a [significantly higher cost](#) (underground cables are generally at least five times more expensive than overhead lines). In that case, the price difference is likely to be borne by citizens through higher tariffs.

Solutions to make better use of existing right-of-way corridors to site new transmission projects can be further explored, like the [NextGen Highways](#) initiative in the United States, which aims at collocating electric and communication infrastructure along highways and railways. Another option to increase community acceptance is to create combined projects that both add new underground infrastructure and reroute existing above-ground lines in the same location so that the overall impact is to reduce visible electricity infrastructure. Moreover, so that new projects can have a net positive impact on the environment, green corridors to protect biodiversity can be created under overhead lines, as with the [Life Elia-RTE project](#).

In urban areas, local acceptance of substations can be increased by concealing them behind aesthetically pleasing facades, placing them inside attractive buildings or moving them underground. Noise protection walls reduce disturbance for local residents and gas-insulated switchgear helps to reduce space requirements.

Transparent and fair compensation for landowners and local communities also contributes to the acceptance of grid projects. In Australia, compensation payments set by kilometre of line (AUD 200 000/km [around USD 140 000/km] in [New South Wales](#) and [Victoria](#), and an estimated AUD 300 000/km [around USD 210 000/km] in [Queensland](#)) and paid out in annual instalments were recently introduced for landowners hosting new transmission infrastructure. In Ireland, the grid operator determines a [community fund](#) for each transmission line and substation project, the amount of which is based on the voltage and length of the line. In India, in 2015 the Ministry of Power released detailed guidelines on compensation payments for acquiring rights of way, supplemented in 2020 by guidelines specific to urban areas, although they have yet to be implemented in the majority of states.

Chapter 3: Identifying the gap – the pathway to future grids

For grids to be an enabler of a secure energy transition, they need to be maintained, updated and adapted to the needs of the future energy system. In this chapter we quantify the need for grid development under the Announced Pledges Scenario (APS), in which countries fully implement their national targets to 2030 and 2050, including ambitions to reach net zero emissions. We assess whether current grid investment commitments are on track to deliver this scenario and explore the consequences if grid development falls short. Where appropriate, we also include comparisons with the Net Zero Emissions by 2050 (NZE) Scenario, which provides a comprehensive global roadmap to achieve net zero emissions within the energy sector by 2050, with an emissions trajectory that is consistent with the Paris Agreement and limiting the long-term global average temperature increase to 1.5°C.

In the APS, the electricity sector is a driving force of clean energy transitions and undergoes deep transformations. Electricity is the fastest growing form of final energy over the next 10 years, growing by 20% more per year than it did over the past decade, but is doing so in a different manner. The deployment of electric vehicles, greater use of electric heating and cooling, and developing of hydrogen production via electrolysis are new drivers of demand growth, adding to the conventional growth in emerging market and developing economies. Wind and solar PV account for over 80% of the total increase in global power capacity over the next two decades in the APS, compared with less than 40% over the past two decades. Effectively integrating renewables demands that the structure and operations of power systems evolve with equal pace. To meet growing power system flexibility needs, which double by 2030 in the APS, calls on unlocking the potential of demand response and energy storage. Modernising and digitalising grid infrastructure, particularly distribution grids, paired with updated grid management and operations critically underpin the dynamic power systems in the APS.

Drivers of grid development

Economic growth and electrification drive significant increases in demand

Increasing electricity demand is one of three key drivers of grid expansion across all regions and scenarios, [as represented in the Global Energy and Climate Model](#), alongside the growth of renewables and replacement of ageing grid components. Electricity demand growth is itself driven by a number of factors, including population, economic and income growth. They lead to greater use of electricity in traditional applications such as cooling and appliances in buildings, the internet and entertainment, and industrial motors. In addition, new applications for electricity are set to drive future growth, including the electrification of transport through EVs, heat through heat pumps and electric water heating, and hydrogen production via electrolysis.

Electricity demand growth has historically been accompanied by grid expansion and reinforcement, and while distributed options are becoming more prevalent, development and investment plans around the world indicate that centralised grids will remain of primary importance to support growing needs. Grid expansion includes not only line and cable extensions, but also non-line components such as substations, stability and load flow control devices (e.g. synchronous condensers and static synchronous compensators), energy storage and digitalisation technologies for better utilisation of grid assets. Understanding how demand increases across scenarios allows insight into grid expansion needs.

Global electricity demand is projected to increase at a rate of 2.7% per year in the APS, more than doubling from just under 25 000 TWh in 2021 to nearly 54 000 TWh in 2050. The buildings sector continues to consume the most electricity, followed closely by industry, each accounting for more than one-third of total demand throughout the period. Transport makes up just 2% of global electricity demand currently, but this rises to 15% in 2050. Hydrogen production via electrolysis adds significantly to electricity demand growth, from less than 2 TWh in 2021 to over 5 700 TWh in 2050 in the APS. More rapid electrification of end uses in the NZE Scenario further accelerates electricity demand growth to 3.2% per year to 2050, reaching over 62 000 TWh in 2050. Demand growth is expected to be accompanied by improvements in efficiency.

In advanced economies, electricity demand grows at 2.1% per year in the APS, increasing by over 80% from 2021 to 2050. This is below the world average, as traditional uses of electricity in industry and buildings in advanced economies are already well developed. Hydrogen production and EVs account for more than half the growth in electricity demand to 2050.

Electricity demand in advanced economies and EMDEs in the Announced Pledges Scenario, 2021-2050

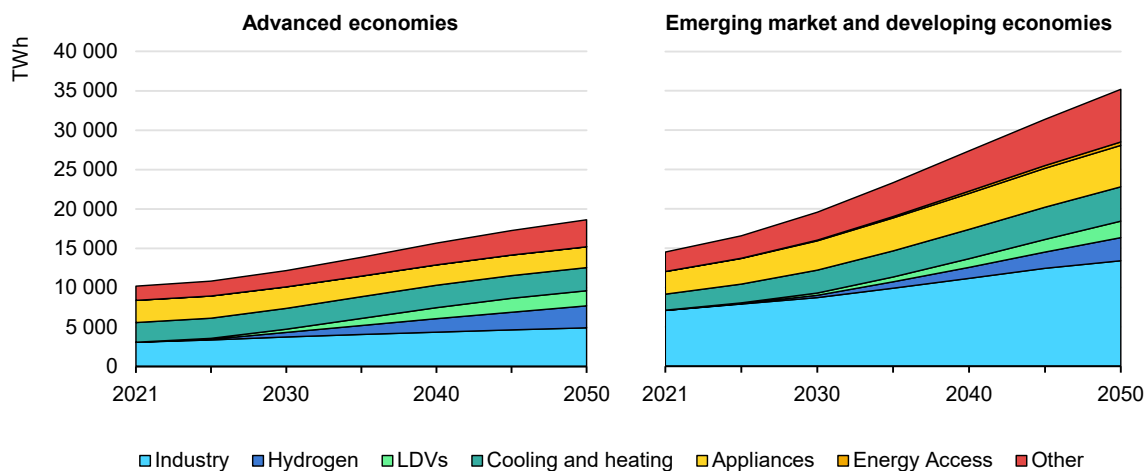

IEA. CC BY 4.0.

Note: LDVs = light-duty vehicles.

Source: IEA (2022), [World Energy Outlook 2022](#).

In emerging market and developing economies (EMDEs), electricity demand grows by 3.1% per year, faster than the global average, from 15 000 TWh in 2022 to over 35 000 TWh in 2050. As a result, EMDEs account for two-thirds of global electricity demand by 2050, following population growth of 1.7 billion over the period and 170% economic growth. Buildings account for one-third of electricity demand growth to 2050 in EMDEs in the APS, followed by industry at about 30%, transport at 20% and hydrogen production at about 15%.

In order to model the dynamic relationship between electricity demand growth and grid expansion, detailed analysis was carried out to consider the historical data for both elements in regions around the world, plus other related factors including population and GDP. As a result, robust equations were established to represent the relationship between grid line length per TWh of electricity demand and GDP per capita. Transmission and distribution were treated separately, with relationships established for each, as they capture different factors including geography and economic structure. The integration of GDP per capita into the equation is of paramount importance, as it serves as a valuable proxy for economic development and prosperity. In lower-income economies, electricity demand growth is likely to be the result of connecting many new households and businesses, calling for significant grid expansion. Meanwhile, in high-income economies the data indicate that a unit of electricity demand growth requires less grid expansion. This can be explained by existing consumers raising their level of consumption, for example through increased electrification of transport or heat, a growing trend in many advanced economies.

Relationship between grid length per unit of electricity demand and GDP per capita

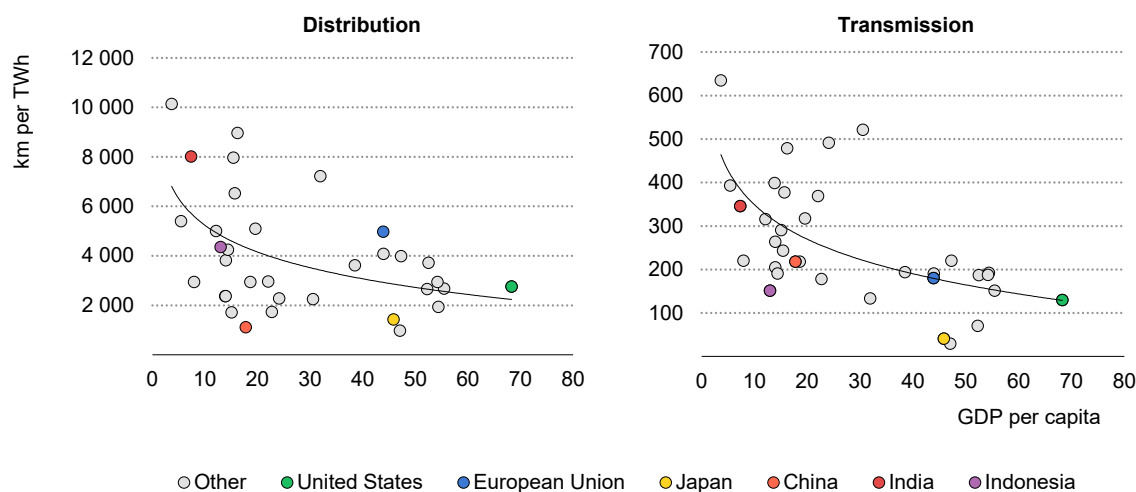

IEA. CC BY 4.0.

Sources: IEA analysis based on [Global Transmission](#).

The fundamental driver of economic development is then represented in the long-term energy outlook for each region by employing the derived dynamic relationship in the Global Energy and Climate Model. Within this framework, GDP is projected through to 2050 for each region. GDP projections are regularly updated, informed by the latest developments and expectations for economic development around the world. Projections for population are also updated regularly and electricity demand by region is projected in detail for each scenario, culminating from in-depth analysis for end uses within each sector. The combination of all these elements then enables electricity grid expansion to be derived from electricity demand growth projections in the *World Energy Outlook*. While the stylised representation of electricity grid expansion employed in the modelling is not comparable to the kind of detailed grid expansion planning carried out over years by system operators and planners, it can provide insights for policy makers into the broad developments needed for electricity grids to help fulfil policy ambitions and enable clean energy transitions.

Distributed energy resources need to be integrated in a smart way

The deployment of distributed energy resources can create challenges for system operators, particularly considering that higher levels of electrification result in higher peak loads and potential congestion on distribution grids. Distributed energy resources add to system complexity, and, without active monitoring, increase the difficulty of anticipating and managing flows on the distribution grid.

Nonetheless, they can also actively support grid management through increased visibility and controllability, allowing them to provide flexibility services that support efficient grid management.

Heat pumps and distributed generation

The electrification trend in the buildings sector is driven by heat pump installations, the number of which is increasing [each year \(annual sales up by 11% in 2022 alone\)](#); heat pumps will have to meet nearly 20% of global heating needs in buildings by 2030 to align with current climate pledges, up from 10% in 2022. Beyond this, the decarbonisation process boosted by Russia's invasion of Ukraine is driving many European countries to [further incentivise distributed solar PV deployment](#).

A detailed analysis [carried out by Eurelectric](#) for the European Union and United Kingdom showed that DSOs need to allocate at least EUR 85-95 billion in the period 2020 to 2030 to integrate renewables, about a quarter of the total investment in distribution. The study identified the need for significant development of distribution grids, including the deployment of digitalisation, to manage the increasing complexity of systems due to distributed resources. This includes investment in smart meters, remote control, and communication and automation across the low- and medium-voltage grids.

Impacts of electric vehicles on grid infrastructure

Electrification of the transport sector is expected to make a significant contribution to electricity demand growth, particularly in advanced economies, as governments incentivise the switch to electric transport as part of their decarbonisation strategies. Sales of electric cars have been breaking new records every year, and [exceeded 10 million in 2022](#), or 14% of new cars sold.

In most of the more developed EV markets today, the vehicles are mainly charged in residential areas in the evening or overnight. When left unmanaged, EV charging can result in higher peak demand. Therefore, [adequately sized and equipped](#) transmission and distribution grids, combined with managed charging measures such as time-of-use tariffs and V1G (smart charging), will be increasingly crucial as EV penetration increases. Furthermore, it will be key to take into account the different charging profiles that could be associated with varying types of charging infrastructure, such as slower home charging or fast charging along highways.

When EV ownership exceeds 20%, the adaptation needs of grids, especially at the distribution level, can become significant, as illustrated by [analysis on Germany undertaken by the IEA and RWTH Aachen University](#). The ease of integrating EVs into the grid [will depend on its ability to be balanced with other distributed energy resources](#), such as heat pumps, air conditioning and rooftop

solar. As such, grid upgrades will be [particularly important at the local level](#) and in [urban environments](#) where grid congestion due to clustered residential charging can be exacerbated by the combination of space heating/cooling and distributed solar.

Lastly, ensuring a just deployment of charging infrastructure will require development in rural environments, further away from existing grids, and hence with higher investment costs. In Australia, up to [80% EV uptake is possible](#) without grid upgrades in urban areas, but in certain rural grids, in which transformers are already overloaded, this can drop to 0%.

In EMDEs particularly, growing electricity demand for appliances and transport electrification, sometimes combined with [poor infrastructure quality](#), will strain distribution systems and require both upgrades and expansion. Grids in these countries are already facing challenges such as transformer failure and high losses. This is especially true in rural areas where loads are served over long distances, and where the additional EV load may hence increase the risk of overloading and voltage deviation issues. Minimising the impact of EV charging in developing urban environments will also be crucial to avoid local congestion issues, as shown by a [simulation of a distribution system in Brazil](#).

Framework for grid integration of EVs

PHASE 1: No noticeable impact	PHASE 2: EV load noticeable with low flexibility demand	PHASE 3: Flexible EV load is significant with high flexibility demand	PHASE 4: Flexible EV load is highly available with high flexibility demand
No significant impact yet. Encourage higher EV uptake through incentives and public EVSE deployment.	Distinct variability observed, caused by EV charging, but demand for flexibility is low enough that simple flexibility measures suffice.	Demand for flexibility is high, matching the availability of flexible EV load and paving the way for aggregated smart charging.	High flexibility demand along with highly available flexible EV load can provide energy back to the system in periods of deficit.
Co-ordinate charging station deployment in areas beneficial to the grid	Passive measures: time-of-use tariffs, vehicle-based charging time delays	Deploy active measures: unidirectional charging (V1G)	Deploy active measures: bidirectional charging (V2G)
Most countries	Norway	France, Netherlands, United States	Island power systems, certain vehicle segments

IEA. CC BY 4.0.

Notes: This figure represents a summarised version of the framework for EV grid integration developed by the IEA. EVSE = electric vehicle supply equipment; V1G = active control with unidirectional charging; V2G = active control with bidirectional charging.

Source: IEA (2022), [Grid integration of electric vehicles – a policy manual](#).

To avoid delays in the deployment of EVs, grid deployment should be [planned proactively](#) and in an integrated manner across sectors. Another important lever to consider is the use of managed charging techniques, which, thanks to digital technologies, can turn [EV charging into an opportunity](#) for power system flexibility, hence reducing their impact on the grid. Implementing these measures will require policy makers to address technical barriers together with market design choices.

To minimise the impacts of EV charging on grids, it is hence crucial for policy makers to take them into account in planning and promote the use of managed charging techniques. The IEA has developed a [policy manual](#) and [an EV charging and integration tool](#) to assist policy makers in their planning.

DERs as a source of flexibility

As they are mainly connected to distribution grids, the increasing volume of distributed energy resources is pushing DSOs to explore the flexibility services these resources can provide rather than only seeing them as additional complexity to manage. Rather than exacerbating problems such as grid congestion, outages and voltage violation, they can be adopted as solutions to provide crucial support to address these network issues. To tap into the value of distributed energy resources, incentives for their uptake must be considered in the context of broader system objectives to ensure they respond to actual system needs and do not internalise the benefits solely to the end user.

Distributed energy resources can provide services to the system by voluntarily adjusting generation and/or consumption in response to an external signal, which can be a price signal or direct activation, e.g. by an aggregator. They can be targeted at a defined time and duration at a specific location within the specific portion of grid to enhance security of supply and service quality in the most efficient way, and thereby reduce costs for consumers. Regions are testing ways to obtain these services through different approaches (see box).

Beyond helping grid operators with short-term grid issues, flexibility services provided by distributed energy resources can be integrated into the grid planning phase to help to meet long-term needs more cost-effectively by avoiding or delaying new grid reinforcements. For example, [non-wire alternatives](#) such as [developing solar PV in an area of high demand](#) can reduce daily peak demand and limit the need to reinforce the transmission grid, thus reducing overall system costs, whether the distributed energy resources are utility or third-party owned. This could be cost-effective even if the available solar resource is lower than in other areas.

Flexibility services can be enhanced by grid digitalisation: one example is the distributed energy resources management system (DERMS). This is a software tool that enables DSOs to proactively and efficiently optimise the grid and

distributed energy resources, even in real time, to prevent or manage congestion and voltage violations, and also to support post-fault recovery actions. DERMS addresses network issues by identifying which distributed energy resources, based on their characteristics, can offer flexibility services within a critical portion of the network, by modulating their consumption or production at the request of the DSO.

The APS indicates that by 2050 [nearly half of the world's grid flexibility needs](#) would be met by demand response and battery storage. With the growing use of electricity for air conditioners, heat pumps, EVs, electrolyzers and other potentially flexible sources of demand, there is potential for significant load shifting. Demand-side flexibility is equally important in advanced economies as well as in EMDEs.

EMDEs will need to integrate growing renewable generation and other distributed energy resources using flexibility services in parallel with further deployment of enabling technologies to fully exploit their potential. One concrete example is the [EnelFlex](#) project in Colombia, launched within the [3DEN: Digital Demand-Driven Electricity Networks Initiative](#). The project aims to implement a voluntary demand disconnection mechanism to manage congestion and supply interruptions, and by developing grid digitalisation features such as DERMS.

Regional approaches to procure flexibility resources from distributed energy resources

Regulators around the world are testing different approaches to allow grid operators to procure flexibility resources in specific areas, beyond the resources that develop from pure wholesale market price signals. The most developed markets for flexibility today are in the United Kingdom and the United States, but other examples are currently in the early or advanced phases of deployment, often thanks to pilot projects and regulatory sandboxes.

Since [late 2017](#) the United Kingdom has developed a well-structured local flexibility market, with all the DSOs participating. The market uses open public tenders, has standardised flexibility services and compares the costs and benefits of flexibility solutions and grid reinforcement in a [shared tool](#). Since the first tenders, the awarded volumes have increased every year, with [116 MW in 2018 increasing to 2.4 GW contracted so far for 2023-2024](#).

In the United States, grid utilities are able to directly procure, access and control distributed energy resources, including storage, to defer or avoid grid investment, referred to as [non-wire alternatives](#). The DSOs can launch tenders asking third parties to build new distributed energy resources, often battery energy storage systems, to solve grid constraints. Remuneration is mainly based on mid- to long-

term bilateral power purchase agreements (generally for seven to ten years) based on monthly predetermined performance in specific time slots. In some states (e.g. [New York](#)) the distributed energy resources can join other markets outside the agreed timeslots, with profits shared between DSOs and distributed energy resources. In 2020 [FERC ordered the Independent System Operators](#) (ISOs) to open all their wholesale markets to enable distributed energy resource aggregators to participate.

In the European Union, pilot projects have been introduced to test co-ordination schemes between transmission system operators (TSOs) and DSOs, and innovative approaches to exploiting flexibility markets ([Coordinet](#), [Eu-Sysflex](#)), including all stakeholders (R&D, suppliers, DSOs, TSOs and regulators). [Directive 2019/944](#) puts significant limitations on DSO ownership of storage facilities, limiting the ability to directly procure storage as in the United States. The potential of distributed energy resources has been exploited by TSOs through ancillary services for frequency regulation, voltage control and congestion management. One of the largest projects was launched in 2017 by the Italian regulator, with [Resolution 300/2017](#), where aggregators – which include distributed generation plants, loads and storage larger than 1 MW – are awarded contracts in tenders based on fees covering availability and utilisation.

Initial discussions are occurring in EMDEs: in Brazil the NRA [launched a public consultation in June 2021](#) to develop regulatory models for the integration of distributed energy resources. Similarly, in Colombia since 2021 the [Energy Transition Roadmap](#) has included the need to develop a flexibility market to support distributed energy resource integration.

The design of an efficient flexibility market has to take into account criteria for distributed energy resource eligibility and may need to include ad hoc conditions to avoid distortions, such as [increase-decrease strategic bidding](#) (gaming the market). This example mainly relates to resources that, by joining both spot and flexibility markets, can overbid in the spot market to earn a higher price on the local flexibility market.

Increased climate risks require grid resilience

The impact of climate change is evident through rising global temperatures, irregular precipitation patterns, sea level rise, and the increasing frequency and intensity of extreme weather events. These changes have significant implications for the security of electricity systems worldwide. The anomalous climate patterns pose a considerable challenge to electricity systems and amplify the risk of

climate-driven disruption. Among the extreme weather events, heatwaves, wildfires, cyclones, heavy precipitation and floods are the primary culprits behind large-scale power outages in many countries.

Future extension of transmission and distribution grids could increase exposure to climate change impacts, thereby increasing the possibility of climate-driven disruption, and require greater investment in maintenance, upgrades and switching to more resilient options. Several strategies and technologies can be employed to increase resilience and ensure a reliable power supply, even in the face of climate-driven disruption.

One aspect to consider is the vulnerability of overhead transmission and distribution lines. These lines are more susceptible to climate hazards such as wildfires, floods and cyclones. To address this, underground transmission and distribution cables can be installed, despite much higher upfront cost. However, underground networks are also affected by heatwaves, which can [increase the risk of faults](#), in particular in urban areas. Another approach involves implementing higher design standards for distribution poles and towers. Distribution poles, typically made of wood, can be strengthened with guy wires in areas where stronger winds are expected. Changing the route of overhead lines away from trees and rigorous tree pruning can prevent potential damage from wildfires and high winds. Using covered or insulated conductors and enhanced cooling mechanisms for transformers would enhance resilience against heatwaves.

Improving the resilience of substations involves factors such as installing equipment with higher specifications, enhanced cooling mechanisms for transformers and improved flood protection measures for ground-mounted equipment, as well as flood risk assessments and favouring less exposed areas in the design phase.

To enhance overall resilience, it is important to design flexibility into transmission and distribution grids. [Implementing meshed distribution grids](#), which offer multiple paths for power flow, enhances redundancy and reduces the impact of localised outages. Increasing interconnections between different parts of the grid through a meshed topology enables efficient power rerouting during emergencies, thereby reducing the number of affected customers. Some distributed energy resources, such as embedded generation, microgrids and mobile generating units, provide localised power sources that can support critical loads during outages and reduce dependence on centralised generation. They also enable islanding mechanisms by locating generation closer to the load, bypassing the transmission grid. Battery storage is increasingly being adopted for frequency regulation purposes, replacing traditional methods, whereas pumped-storage power plants offer large-scale energy storage capabilities and can compensate for temporary loss of generation facilities.

Remote sensing technologies, including drones, light detection and ranging (LiDAR), aerial imagery and geographic information systems (GIS), offer valuable capabilities for vegetation management, infrastructure inspection, risk assessment and real-time damage tracking. These technologies improve maintenance prioritisation, enhance vegetation clearance near power lines, and provide critical insights for optimised decision-making.

Demand response programmes and robust communication infrastructure are essential elements for resilience. They allow grid stress to be reduced during unplanned events by enabling end-use customers to change their consumption patterns in response to price changes or incentives. Grid digitalisation can further help in preventing outages by adopting remote control at distribution substations via automated grid components (e.g. switches, sensors) able to automatically configure supply restoration within a few minutes, so promptly isolating the fault. This reduces the number of customers affected, as well as the number of field operations in extreme conditions, improving the safety conditions of the workers.

Technology suppliers are continuously seeking innovative solutions to address specific challenges. For example, the spark prevention unit (SPU) surge arrester monitors overloads and disconnects a power line from the grid to prevent sparks that can cause bushfires. Deploying such technologies in wildfire-prone areas can significantly reduce the risk of bushfires and improve system reliability.

Grid development is needed to improve electricity access

While access to electricity is part of [Sustainable Development Goal 7: Ensure access to affordable, reliable, sustainable and modern energy for all](#), for the first time in decades in 2022 the number of people around the world without access to electricity increased, [reaching about 774 million, 20 million more people than in 2021](#). There are two main reasons for this: on one side consumers are facing rising inflation levels, while on the other investment in the expansion of grids and new connections is slowing, mainly due to the growing debt levels that most utilities are facing as a result of recent disruptions (e.g. the Covid-19 pandemic, Russia's invasion of Ukraine).

The rise in the number of those without access occurred largely in sub-Saharan Africa, where the number exceeded 600 million for the first time since 2014. This worrying trend – mainly concentrated in EMDEs – must be reversed, starting with grid expansion, to achieve 100% electricity access. Expanding the grid to increase electricity access also implies new household grid connections. In the APS, 67% of households in Africa that currently do not have access to electricity are connected by 2030, with around 45 million households connected to the main grid, 32 million to mini-grids and 26 million households supplied by means of stand-alone solutions.

Achieving universal access to electricity in Africa by 2030 [requires a tripling of the current rate of progress](#), and strongly relies on stand-alone and mini-grid systems. Under the NZE Scenario this means reaching about 65 million cumulative household connections to the main grid, with a further 48 million households connected to mini-grid solutions and about 42 million to stand-alone grids. Rapid progress is not guaranteed; for comparison, in a scenario taking account of existing policies and measures and those under development (the Stated Policies Scenario) the total only reaches about 32 million households by 2030.

Cumulative new household grid connections in Africa, 2022-2030

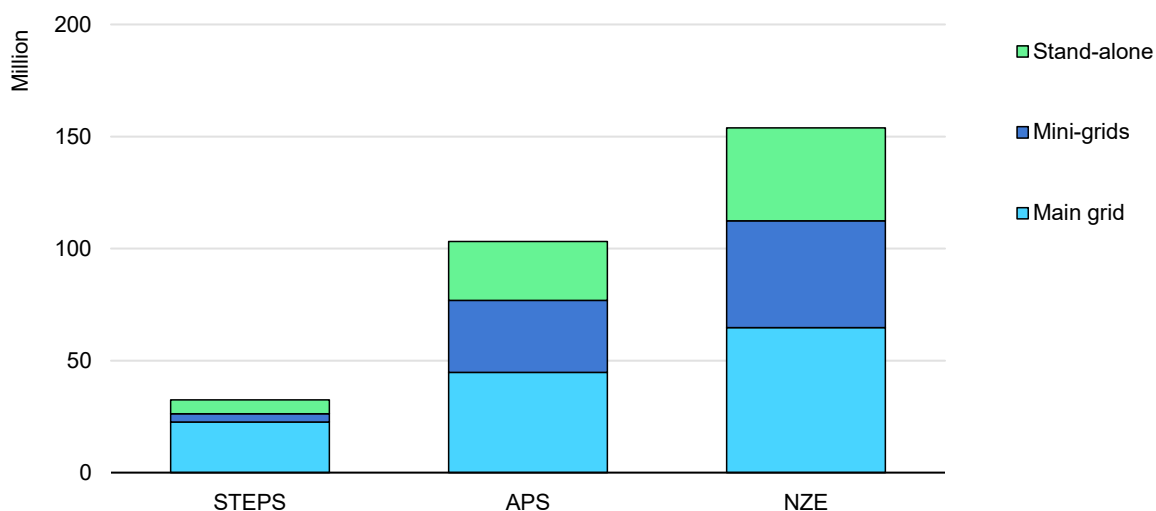

IEA. CC BY 4.0.

Notes: STEPS = Stated Policies Scenario, APS = Announced Pledges Scenario, NZE = Net Zero Emissions by 2050 Scenario. Stand-alone grids are home energy systems.

Source: IEA (2022), [World Energy Outlook 2022](#).

Initiatives to drive up electricity access are going ahead in EMDEs, with programmes in [Côte d'Ivoire](#) and [Ethiopia](#) targeting 100% electrification by 2025, and [Kenya](#) and [Nigeria](#) targeting total electrification by 2030.

Grid expansion

Grid investment needs to accelerate and match investment in supply

The past seven years has seen average annual investment in electricity grids of nearly USD 320 billion, reflecting increased demand, uptake of renewables and replacement of existing infrastructure. This was an increase of only around 10% on the average for the decade 2006-2015 and is far short of the average annual funding required through to 2030. In the APS, widespread electrification of end-

use sectors, increased demand and rapid deployment of renewables all contribute to significantly higher average grid investment to 2030, with an average value in the period 2023-2030 of around USD 500 billion per year, exceeding USD 600 billion by 2030, almost double the level in recent years. If grid investment to 2030 stays at the current level, it will fall short of this decade's required average by around 35% for the APS and by 42% for the NZE Scenario.

Beyond 2030, grid investment needs to ramp up even faster, reaching USD 775 billion/year under the APS in the decade 2031-2040 and USD 870 billion/year for 2041-2050. Grid investment under the NZE Scenario climbs even higher, surpassing the USD 1 trillion per year mark around 2035 onwards.

Average annual transmission and distribution investment in EMDEs and advanced economies in the Announced Pledges Scenario and Net Zero Scenario, 2016-2050

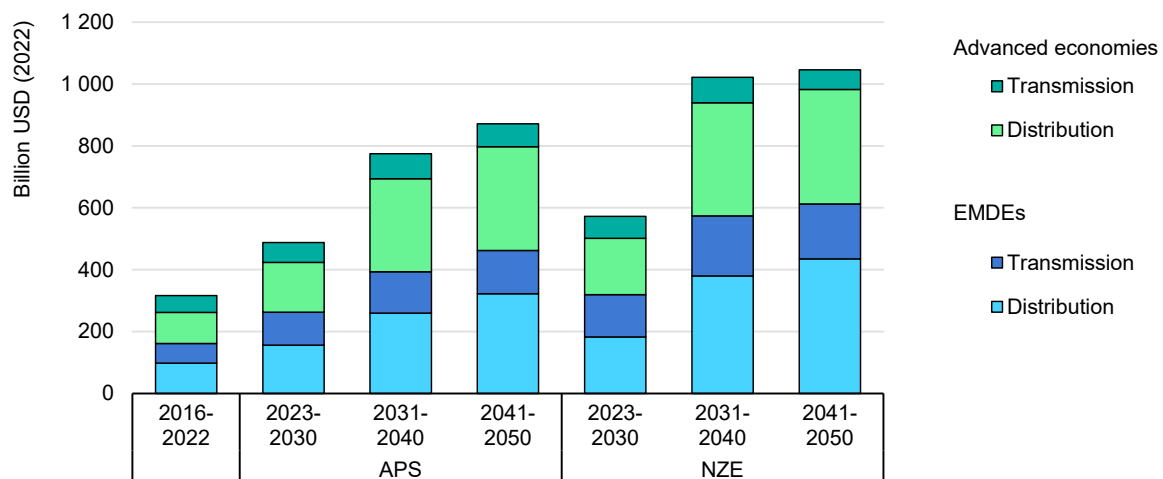

IEA. CC BY 4.0.

Note: EMDEs = emerging market and developing economies.
Source: IEA (2022), [World Energy Outlook 2022](#).

Through to 2050 in these scenarios, distribution grid investment maintains its majority share of total grid investment in both advanced economies and EMDEs. In fact, in 2041-2050 in the APS annual distribution system investment alone reaches around USD 330 billion in both advanced economies and EMDEs, comparable to current total global grid investment. As a whole, EMDE investment represents a majority of total grid investment in every decade under both scenarios. In particular, EMDEs see a much higher share of transmission grid investment than advanced economies – a result of higher-voltage lines being built out for the first time in many cases and ultra-high-voltage corridors, as seen in China. In advanced economies, distribution system investment in the APS is driven by swift electrification of end-use sectors, distributed renewables and

replacement of the vast existing grid, whereas the need for long-distance interconnections further drives transmission-level investment.

In the years leading up to 2030, a significant gap remains between recent levels of growth and the 2030 NZE Scenario milestone investment level. Given the current compound annual growth rate (CAGR), expected investment levels would reach around USD 400 billion in 2030, just over half of the USD 750 billion required for 2030 in the NZE Scenario. In meeting this 2030 NZE Scenario level, USD 400 billion would need to be met six years earlier, in 2024.

The global length of grids more than doubles to 2050, and more than half of existing grids need to be replaced

The total length of grids worldwide more than doubles from 2021 to 2050 in the APS, reaching 166 million km. Distribution continues to represent over 90% of the total line length, connecting billions of consumers to meet daily needs. Transmission grids total 12.7 million km by 2050, up from 5.3 million km in 2021. Each region has its own grid development path, distinguished by underlying changes in the economy and electrification. In advanced economies, total grid length increases by 50% from 2021 to 2050, while EMDEs see over 150% growth. EMDE lines reach nearly 120 million km by 2050, which is more than 50% greater than the total installed line length globally in 2021.

Installed line length, transmission and distribution, by region in the Announced Pledges Scenario (million km)

	Transmission			Distribution			Total		
	2021	2030	2050	2021	2030	2050	2021	2030	2050
United States	0.5	0.6	1.0	11.1	11.5	15.2	11.6	12.1	16.1
European Union	0.5	0.6	0.9	10.3	11.0	14.0	10.8	11.7	14.9
Japan	0.04	0.04	0.05	1.3	1.3	1.7	1.4	1.4	1.8
Other advanced economies	0.5	0.6	1.0	6.9	8.0	13.7	7.4	8.5	14.7
Southeast Asia	0.2	0.3	0.8	4.7	6.3	11.9	4.9	6.6	12.7
India	0.5	0.7	1.7	11.3	14.0	25.6	11.8	14.7	27.2
Africa	0.3	0.4	1.1	3.9	5.0	14.0	4.2	5.3	15.0
China	1.6	2.4	3.7	7.8	12.3	27.6	9.4	14.8	31.4
Other EMDEs	1.2	1.5	2.5	14.4	16.8	30.0	15.6	18.3	32.5
World	5.3	7.2	12.7	71.7	86.1	153.7	77.1	93.4	166.4

IEA. CC BY 4.0.

Sources: IEA analysis and [Global Transmission](#).

In addition to expansion, two-thirds of grid length worldwide in 2021 is replaced in the APS by 2050, in accordance with component lifetimes. Depending on the pace

of grid expansion in recent decades, the significance of grid replacement varies by region and scenario, although it remains one of three primary drivers of grid investment in all regions across scenarios. As grid components have an average lifetime of around 40 years, the amount of grid replacement in projection years is a function of grid development over the past several decades. In advanced economies, over 70% of transmission and distribution grids are replaced between 2021 and 2050 in the APS, a direct result of older grid infrastructure built to meet robust electricity demand growth in the 1970s, 1980s and 1990s. In EMDEs, about 60% of grid lengths in place in 2021 are replaced by 2050.

Over the next two decades, over 80 million km of transmission and distribution length is either replaced or added worldwide. This is more than the total length of all grids worldwide in 2021. It also means that, of the global total line length in 2040 in the APS, two-thirds are yet to be built.

Grid length development in the Announced Pledges Scenario by regional grouping, 2021-2050

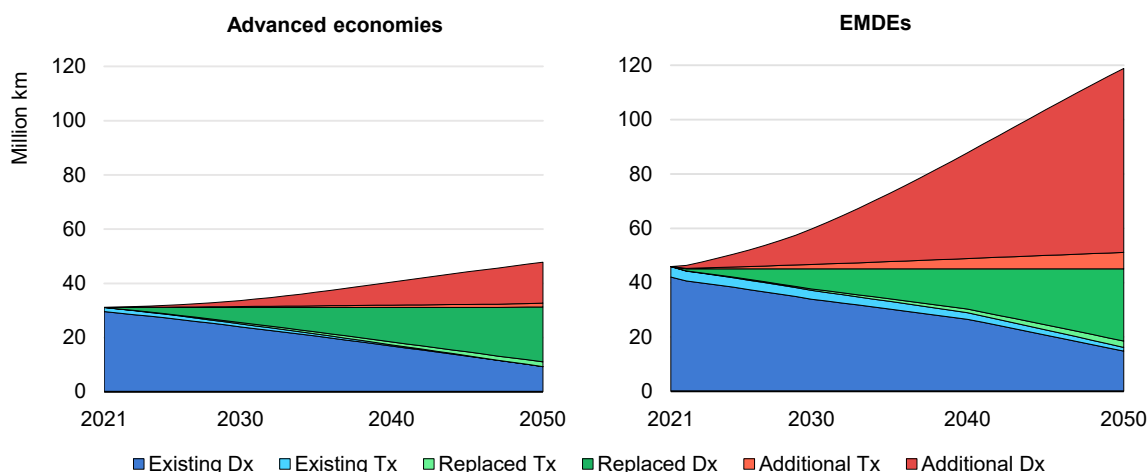

IEA. CC BY 4.0.

Notes: Dx = distribution; Tx = transmission.
 Source: IEA (2022), [World Energy Outlook 2022](#).

Besides overhead lines and cables, the associated substations with their switchgear, transformers and control and protection equipment need to expand accordingly. Annual additions and replacements of power transformer capacity, a major component of substations, are projected to experience steady growth in the APS. Over the ten years to 2021 the rate of additions and replacements was 2.4 TW per year. Between 2022 and 2030 it increases to 3.5 TW per year, requiring a significant uplift in activity. Subsequently, from 2031 to 2040, annual additions rise further to 4.5 TW per year where they stabilise till 2050, reflecting a consistent level of growth in the power transformer industry. In all years, emerging market and developing economies account for the majority of new transformers.

Average annual transformer capacity additions and replacements by scenario, 2012-50

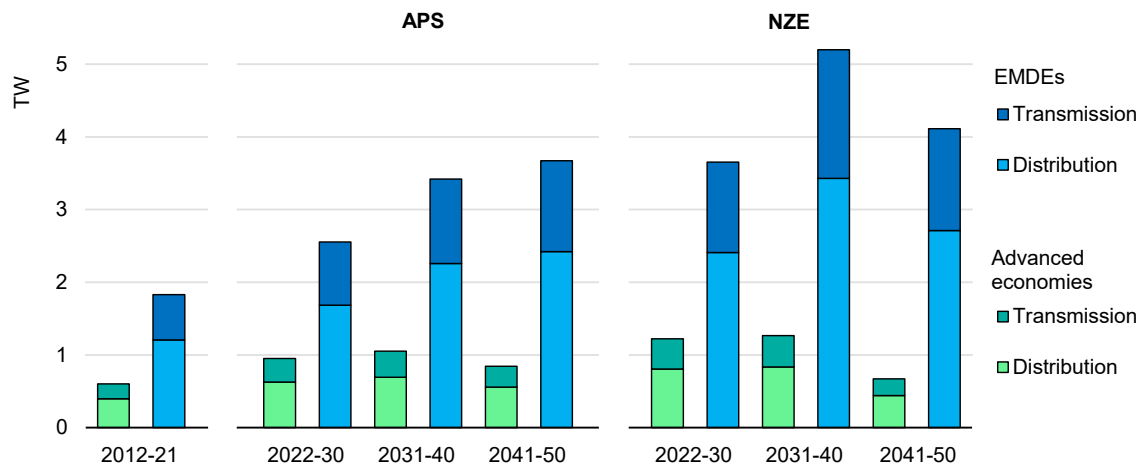

IEA. CC BY 4.0.

In the NZE Scenario, the annual additions and replacements of power transformer capacity are significantly higher. Between 2022 and 2030, the pace reaches 4.9 TW per year, and accelerates further to 6.5 TW per year from 2031 to 2040. The rapid expansion in power infrastructure is needed to support the rapid energy transitions in pursuit of net zero emissions goal. From 2041 to 2050 additions and replacements decrease to 4.8 TW per year as demand growth begins to slow and energy efficiency measures take effect.

Grid investment needs to step up alongside rising investment in renewable energy

Over the past five years, investment in power capacity has seen a significant increase of nearly 40%, surpassing USD 750 billion in 2022. In contrast, spending on grid infrastructure has remained relatively stable, hovering around USD 300 billion annually. Global renewable energy investment has been increasing rapidly, nearly doubling over the last decade to reach an all-time high of USD 600 billion in 2022. Solar PV and wind power are leading the way, particularly in China, despite challenges related to costs and supply chains. Moreover, major markets such as the United States, China, Europe and India have witnessed a remarkable surge in the adoption of renewable energy in recent years.

Annual investment in power capacity and grids, 2011-2022

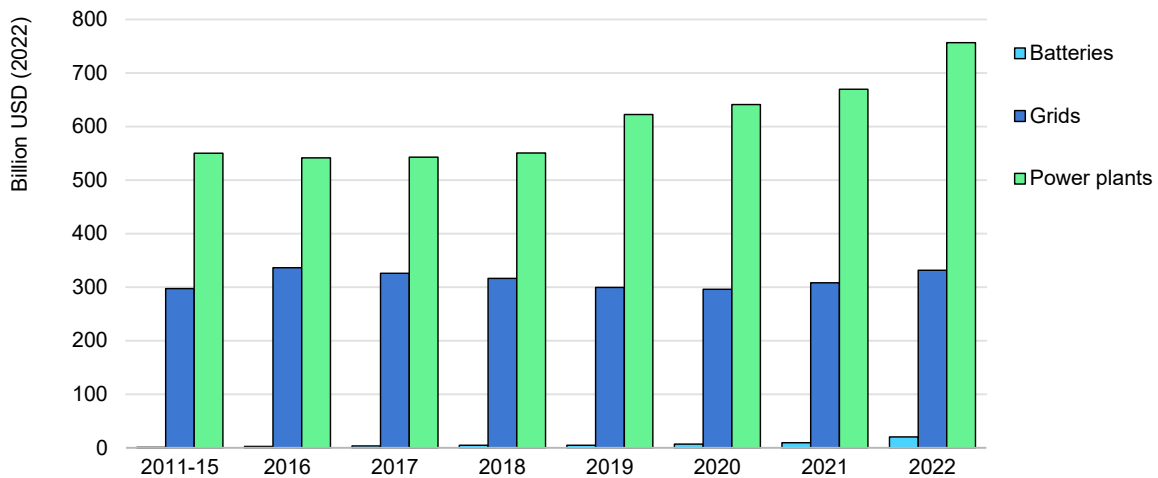

IEA. CC BY 4.0.

Source: IEA (2023), [World Energy Investment](#).

In the APS, investment in renewable energy installations continues to rise and, in contrast to the recent trend, grid investment increases in lockstep. In 2022, investment in grids comprised 30% of the combined investment in renewable energy and grids. A key enabler of the transition to further renewable power generation during the decade 2021-2030 in the APS, average annual grid investment rises to 40% of the combined investment in renewables and grids at about USD 450 billion, and 50% in the period 2041-2050 at USD 870 billion.

Average annual investment in grids and renewables by regional grouping in the Announced Pledges Scenario, 2011-2050

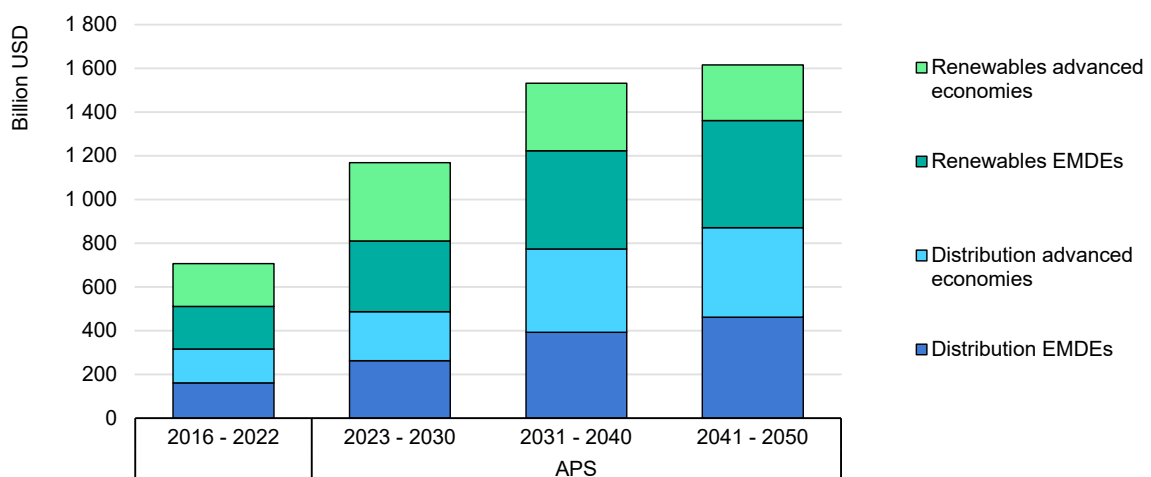

IEA. CC BY 4.0.

Sources: IEA (2022), [World Energy Outlook 2022](#), IEA (2023), [World Energy Investment 2023](#).

In 2022 advanced economies invested 20% more in grids than EMDEs, at USD 180 billion. However, by 2030 EMDEs invest almost 20% more in grids than advanced economies in the APS and maintain a higher share through to 2050. In advanced economies, investment in grids is consistently higher than investment in renewables in the APS beyond 2030, reaching almost USD 300 billion in 2030 and averaging over USD 400 billion per year for the period 2041-2050. In EMDEs, despite even higher grid investment, the rapid deployment of renewables means that they continue to see higher investment levels than grids through to 2050 in the APS. This comes even as grid investment passes USD 400 billion after 2035 and averages around USD 460 billion from 2041 to 2050 in EMDEs.

Risks of delayed grid expansion

Plans need to evolve to align with country targets

Globally, investment in grids must increase continuously over the coming years and decades to ensure secure delivery of clean electricity. Advanced economies need to increase annual investment by one-third compared with 2022 in the period 2025 to 2030 to achieve the APS, and by about 50% to match the NZE Scenario. Even more noticeably, EMDEs require a doubling of their annual investment compared with 2022 in the period 2025 to 2030 to meet the APS and NZE Scenario.

In order to achieve the required expansion of grids, and to drive the necessary investment, this ambition needs to be reflected in national grid expansion plans. Typically, grid planning studies define the need for investment in the short to medium term – usually 10 years in advance – considering the expected evolution in technology, demand and supply requirements. They must account both for the business case of building new grids, and the technical impacts and requirements. Ideally, expansion plans should also be aligned with other relevant policies, such as decarbonisation and climate targets, and harmonised across the distribution and transmission systems.

The methodology and timelines for grid expansion studies vary significantly between countries. The cost of transmission expansion is estimated according to characteristics such as length of lines, GW of capacity, voltage level and type of technology. When looking at ongoing and upcoming transmission grid expansion plans globally, there are striking differences in their scope and time horizon, as well as the criteria utilised for determining the system needs. Additionally, many may be subject to revision based on other grid-specific or cross-sectoral policy initiatives. This makes comparison and evaluation of the suitability of plans challenging.

Summary of expansion plans in selected countries

Country and horizon	Expansion capacity	Investment	Methodology and factors
United States •By 2030, 2035 and 2040 (National Transmission Needs Study 2023)	•Regional transmission: 47 300 GW-mi (2035), 115 000 GW-mi (2040) •Interregional capacity: 157 GW (2030), 655 GW (2040)	•The highest is Larson et al. USD 2 210 billion with a 98% clean energy share in 2050	•Expansion modelling studies by certain institutions •Congestion, voltage limit, stability limit, thermal limit •Others: adequacy, clean energy, curtailment, resilience, electrification and non-wire alternatives
European Union* •2025-2040 (TYNDP 2022)	• TYNDP (mainly cross-border): 88 GW; 18 000 km (AC), 25 000 km (DC)	• TYNDP (mainly cross-border): EUR 140 billion (USD 147 billion) • REPowerEU (full grid): EUR 583.8 billion (USD 614 billion) by 2030	1. Scenario building, 2. System needs study and 3. CBA (zone clustering, climatic year) •Sustainability criteria (renewables integration, CO ₂ , etc)
Japan •Toward 2050 (Master plan)	•Interregional: 14 GW (Eastern), 2.8 GW (Western), 2.7 GW (FC) •Interregional: N/A	•Interregional: JPY 6-7 trillion (USD 46-53 billion)	•Interregional: CBA (fuel cost, GHG cost, adequacy, loss, etc.) •Intraregional: revenue cap (reliability, peak demand, power flow, N-1)
China •2025 (14th Five-Year Plan 2030)	•Interprovincial, to 2025: 60 GW •Interregional and interprovincial 2025-2030: 70 GW	• CNY 2.4 trillion (Chinese Yuan) (USD 356 billion) (SGCC 2021-2025) • CNY 0.67 trillion (USD 99 billion) (CSG 2021-2025)	•System cost analysis based on geographical allocation of resources (e.g. clean energy bases) and different scenarios for demand forecast. Planning done at the provincial and national levels
India •2022-2027 (NEP Volume-II [Transmission], 2019)	•Interregional: around 60 GW	•N/A	•Consider certain criteria (N-1, thermal ratings, voltage ratings, etc.) •Surplus/deficit (for long term)
Brazil •2023-2032 (PDE 2032)	•41 000 km, 120 000 MVA	• BRL 158.3 billion (Brazilian Real) (USD 31 billion)	•The plan considers the economic aspect and technical aspect to compare with alternatives
Korea •2022-2036 (10th BPLE 2023)	•35 190 C-km (2021) -> 57 681 C-km (2036) •348 580 MVA (2021) -> 517 500 MVA (2036)	•N/A	•N/A
Indonesia •2021-2030 (RUPTL 2021)	•47 723 km •76 662 MVA	•N/A	•Consider some criteria (N-1, regional substation and transformer needs, demand, land use) to meet Indonesian and international standards
Australia •2022-2050 (2022 ISP)	•10 000 km (Step Change scenario as a central scenario)	•AUD 12.7 billion (scenario weighted) (USD 9 billion)	•Scenario building •Modelling analysis •CBA analysis

Notes: CBA = cost-benefit analysis; C-km = circuit kilometres; CSG = China Southern Grid; FC = frequency converter; FYP = Five-Year Plan; GHG = greenhouse gas; GW-mi = gigawatt-miles; MVA = megavolt amperes; SGCC = State Grid Corporation of China; TYNDP = Ten Year Network Development Plan; NEP = National Electricity Plan; PDE = Ten-Year Energy Expansion Plan; BPLE = Basic Plan for Long-term Electricity Supply and Demand; RUPTL = National Electricity Supply Business Plan; ISP = Integrated System Plan.

Although data availability is a challenge for developing global estimates, looking at the planned yearly investments in selected countries shows that while investment in grids seems to be accelerating, this is overall not aligned with the APS, and much less with the investment needed for the NZE Scenario, particularly in EMDEs. The planned investment in China implies a 17% increase from 2022 level, but still falls short of the level required in the APS, and in particular the planning horizon only gives an indication out to 2025. The apparent increase in Brazil is due to a decline in investment since 2020, as the plan actually represents a 14% decrease when compared with the transmission investment average for the past 5 years, indicating a need for greater efforts – which are also required in other EMDEs. By contrast, transmission planning in some advanced economies does reflect strong increases in investment. In the European Union, investment in transmission increases from USD 16.9 billion in 2022 to roughly USD 29 billion, a 70% increase that exceeds the increase in advanced economies in the NZE Scenario, driven by a context with strong policy impetus. Japan’s transmission investment planning is also aligned with the NZE Scenario, with a 41% increase to reach USD 4.8 billion.

Planned and historical average annual investment in transmission grids in selected countries and regions

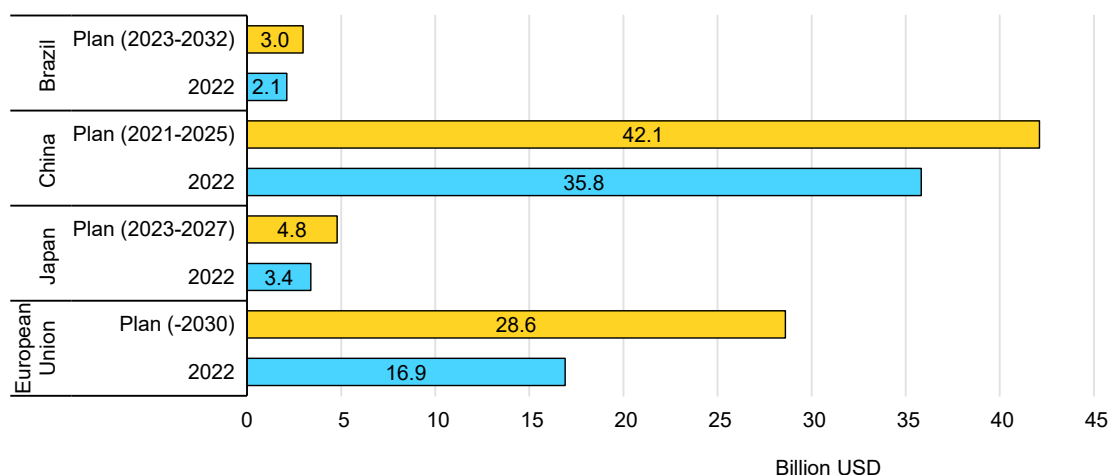

IEA. CC BY 4.0.

Sources: IEA analysis based on Brazil, [Ten-Year Energy Expansion Plan](#); China, [SGCC investment plan](#) and [CSG investment plan](#) for the 14th Five-Year-Plan period; Japan, TSO applications for approval of wheeling charges; European Union, [REPowerEU Plan](#); 2022 values are from IEA (2023), [World Energy Investment 2023](#).

Planned investments in transmission grids show a stark difference between advanced economies and EMDEs. In the APS the volume of investment needed in transmission grids in EMDEs is roughly twice that of advanced economies, while

investment plans today show much greater growth in investment in advanced economies. Significant support will be required in EMDEs to expand transmission grid plans and accelerate investment.

In the future, investment in transmission grids will need to continue growing. In advanced economies in the APS transmission investment grows most rapidly to 2030 and peaks in around 2035. For EMDEs, investment grows strongly out to its peak around 2040. This means that policies aiming to drive investment in grids need to do so not only in the short term, but also need to maintain and increase the pace in the coming years. This will be of even higher importance for EMDEs, where growth will need to be maintained for almost two decades.

Transmission system investment in the Announced Pledges Scenario by regional grouping, 2025-2050

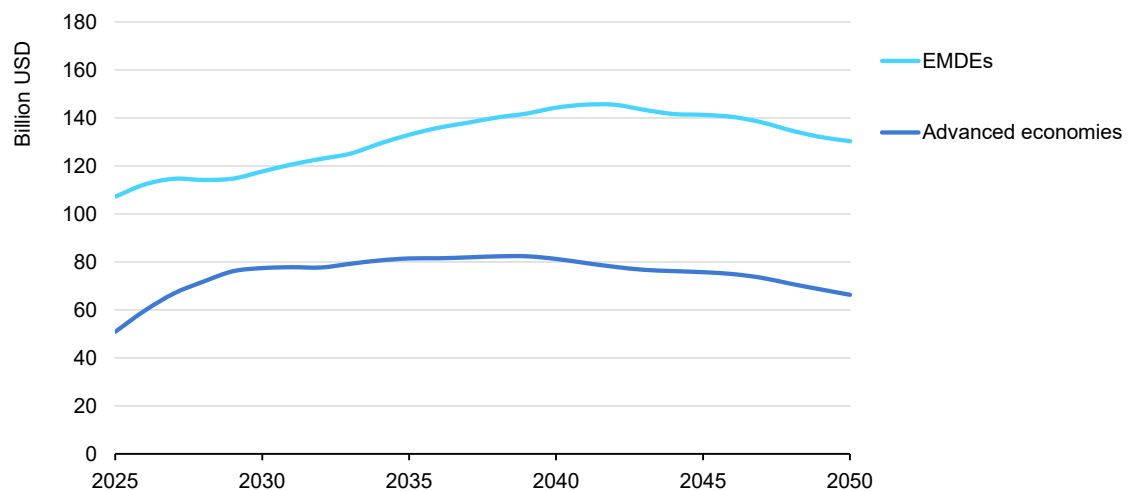

IEA. CC BY 4.0.

Source: IEA (2022), [World Energy Outlook 2022](#).

While existing plans show a trend towards an increase in investment in grids globally, the pace falls far short of the investment levels needed in the APS, a challenge that is made greater when considering the need for continued growth until the peak year, particularly in EMDEs. Without an additional policy focus on accelerating investment beyond existing plans, there is a risk of delays to the grid expansions needed around the globe.

Is the supply chain ready for accelerating grid development?

Moving towards a low-carbon energy system and achieving net zero emissions will require an extraordinary acceleration of global deployment of electricity grids and the facilities to support their supply chains. Rapid deployment of the supply

chains for these technologies is crucial in the next decade and any delays will mean that reaching net zero by mid-century will become increasingly difficult.

Grid-related supply chains must meet the needs of clean energy transitions and at the same time should ensure and enhance their security, resilience and sustainability. The risks in these supply chains can be associated with both short-term shocks and long-term changes. They include climate change, natural disasters, reliance on supplies from a very small number of countries and the surging demand for critical minerals and for raw materials generally.

The demand for materials to manufacture power system equipment rises significantly in the coming decades in the APS, and becomes even more intense in the NZE Scenario. In particular, demand for aluminium and copper sees higher increases as they are the main materials for making electricity cables and power lines. Copper has better electrical conductivity than aluminium, more than 1.5 times higher, but aluminium is lighter, making it a better solution for overhead power lines.

Average annual material needs for transmission and distribution lines in the Announced Pledges Scenario and Net Zero Scenario, 2012-2050

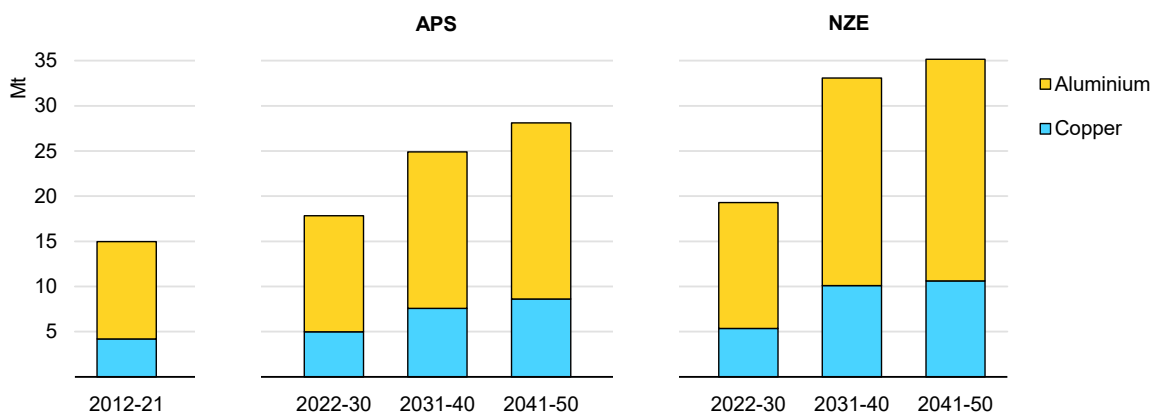

IEA. CC BY 4.0.

Notes: Mt = million tonnes. Material demands for transmission and distribution lines include conductor cables and wires, but not steel for towers and poles. For transmission and distribution lines, aluminium is used for overhead lines and copper for cables.

Demand for copper and aluminium for use in transmission lines, distribution grids and transformers combined almost doubles in the decade 2041-2050 in the APS compared with the decade 2012-2021. The use of copper for such infrastructure increases from an average of 5 Mt/year in 2012-2021 to 5.5 Mt/year over 2022-2030, while the use of aluminium grows from 12 Mt/year (2012-2021) to 13 Mt/year (2022-2030). In 2022-2030 this source of copper demand is almost 18% of total global copper production in 2021, and the aluminium demand is almost 23% of global aluminium production in 2021. In the decade 2041-2050, the

average annual copper demand for these applications reaches 9 Mt/year while aluminium reaches 21 Mt/year. Growth is even more pronounced in the NZE Scenario, reaching 12 Mt/year for copper and almost 27 Mt/year for aluminium in 2041-2050.

Demand for electrical steel (GOES) and construction steel for transformer production sees a significant increase in the coming decade. Steel demand for transformers starts from an average of 5 Mt/year in 2012-2021 and doubles (9 Mt/year) in the APS during 2031-2040, while in the NZE Scenario it reaches a peak of 13 Mt/year in the same period.

Average annual material needs for transformers in the Announced Pledges Scenario and Net Zero Scenario, 2012-2050

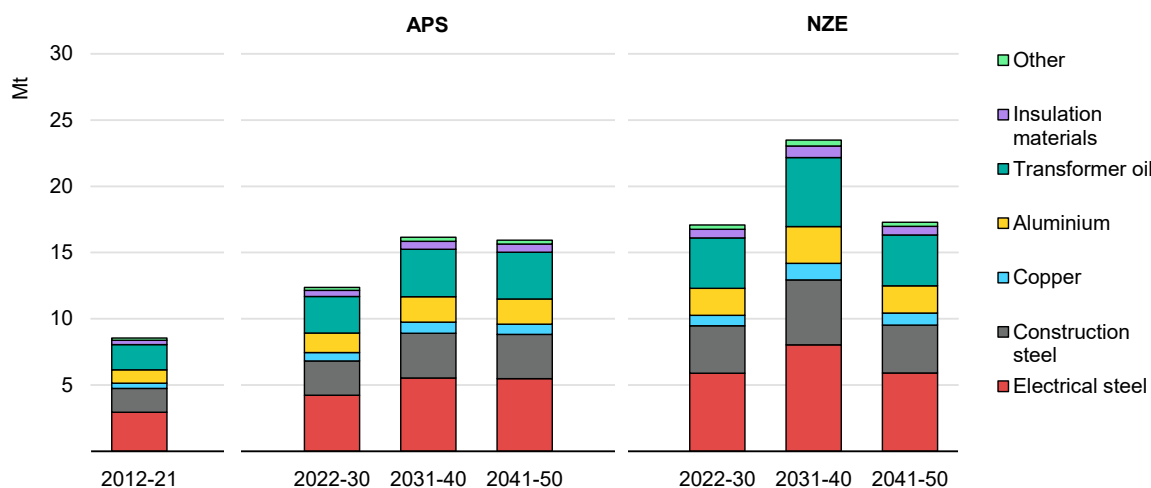

IEA. CC BY 4.0.

The clean energy transition requires an increase in the extraction of raw materials and critical minerals at higher rates than in the past. Mine expansion needs will be particularly high in the coming decades to meet the material requirements not only of electrical grid expansion, but also the development of other clean energy technologies. Global aluminium reserves are at the level of 32 Gt, while extraction in 2021 was almost 390 Mt. Similarly for copper and steel, global reserves are 880 Mt and 85 Gt respectively, while 21 Mt of copper and 1 600 Mt of steel were mined in 2021. The leading regions today in aluminium extraction are Asia Pacific (including China) and Africa, which produce more than 85% of the global supply, and in steel extraction they are Asia Pacific (including China) and Central and South America, which produce almost 80% of steel globally. Copper, by contrast, is the least geographically concentrated metal and the three leading producers, Chile, Peru and China, account for less than half of the global supply.

Meeting the growing demand for materials such as copper requires increasing production by expanding the output of existing mines or developing new mines. Significant investment is required for the opening of a new mine, which on average takes 17 years from discovery to production. The whole process includes mine engineering and construction phases, as well as administrative procedures related to environmental assessments, permitting and negotiation with local communities. Expanding the production capacity of existing mines generally takes much less time, because large parts of the infrastructure and equipment are already in place and administrative procedures are more straightforward and less at risk of being stalled by public opposition. However, the scope for expanding output at existing mines in most cases is relatively limited; therefore, investment in new mining projects needs to be realised.

Reusing and recycling materials can reduce the need for additional mining capacity, slowing the need for the development of new mines. Most grid components can be recycled. Around three-quarters of a transformer's materials can be recycled, especially the steel, copper and oil, while for overhead lines, every part of the materials used, including the conductor, is easy to reclaim and recycle. The cable conductor, which consists of copper or aluminium, as well as the polyethylene used as insulation material, can also be recycled. A small proportion of the transformer cannot be reused or recycled, including plastic joints and buffers and silica connectors.

The steel and semiconductor industries will need to expand their production capacity. Global manufacturing capacity for GOES was around 3.8 Mt in 2020, while the annual average demand in the APS in the coming decade 2031-2040 is more than 5.5 Mt/year. Manufacturing is limited to a few producers in China, Japan, France, Germany, India, Poland, the Czech Republic, Russia, Brazil, Korea and the United States. Building a steel mill for the production of GOES and construction steel can take three to five years, including the time required for permits, engineering and manufacture of the equipment. Similarly, building a new semiconductor plant needs at least four years to reach production.

Ramping up manufacturing capacity to produce the different technologies used in electrical grids (i.e. lines, cables, substations, transformers, FACTS etc.) needs to happen simultaneously and in a co-ordinated way. Most of the technologies incorporated in electrical grids are mature, often modular and can be mass produced. Therefore, increasing manufacturing capacity could be more rapid. Commissioning new manufacturing capacity for grid technologies requires around three to four years on average. A critical part of the expansion of manufacturing capacity is the availability of a skilled workforce. Currently, labour shortages are affecting all industries, which also impacts supply chains. Construction workers usually require specific certifications and training.

The geographical locations of existing manufacturing facilities, as well as those of future investments, play a significant role in the delivery of the final products. Currently, manufacturing plants for cables and transformers are mainly located close to demand centres (i.e. Europe, the United States, India and China) to avoid expensive long-distance transport. However, EMDEs are expected to continue making significant progress in expanding access to electricity. The share of the distribution and transmission line additions taking place in EMDEs (excluding India and China) reaches 45% in 2042-2050 in the NZE Scenario, and 40% in the same period in the APS. Domestic manufacturing in these regions could help to reduce the lead times for grid projects as well as the total cost. Shipping a 200 km-long cable weighing 10 000 tonnes from Europe to Asia can take approximately one month, while for the large power transformers, which are extremely heavy at 100-400 tonnes, up to six months may be needed for international shipping. Transporting large power transformers from the manufacturing plant to the final destination, usually in parts, is a considerable undertaking, representing up to one-fifth of the total cost.

Given the pace of growth of manufacturing capacity, the sector would also benefit from adopting sustainability criteria, reducing the carbon footprint of grid assets. This approach should start from the design and engineering phase, promoting the adoption of low-impact grid components and technologies through standardisation (e.g. SF₆-free, eco-design devices, use of secondary raw materials, life-extension initiatives), as well as new construction methods and criteria to reduce environmental impacts by embracing circularity, with dedicated metrics and KPIs to set the baseline and goals. For example, the implementation of circular economy solutions can extend the useful life of grid components, reintroducing them within the same or in other supply chains to create new products. For example, Enel's [Circular Smart Meter](#) project started in 2020 with the installation of second-generation smart meters in Italy, with new meters produced reusing materials (e.g. plastic) recovered from the disposal of first-generation smart meters and other field devices.

The availability of materials, manufacturing capacity and technical constraints are already causing some tightness in today's supply chains. In the future, given the growth in clean energy technologies and infrastructure, the availability of materials and manufacturing capacity is expected to become a significant challenge for supply chains. Governments must ensure that supply chains are secure, resilient and sustainable while accelerating the deployment of clean energy technologies and related infrastructure. Policies therefore need to be redesigned to address these vulnerabilities, taking care to avoid practices that may deter investment. Governments should go about designing policies on supply chains and set out broad recommendations for priority action.

Delays in grid development would slow clean energy transitions, raise costs and heighten security concerns

Should electricity grid development fail to accelerate in line with the APS – with more limited investment, modernisation, digitalisation, and operational changes than envisioned – there would be a significant risk of stalled clean energy transitions around the world. The lack of grid infrastructure development could slow clean energy transitions in several ways. A key risk is potentially failing to connect new renewable energy projects in a timely manner, slowing their deployment. Failing to properly connect new segments of electricity demand could also present challenges to the electrification of industry and heating/cooling in households, EV uptake and development of electrolysers for hydrogen production. Insufficient grid infrastructure development could also increase grid congestion and the curtailment of renewables, as well requiring additional backup capacity, in turn making energy transitions more expensive. Greater reliance on fossil fuels would lead to higher CO₂ emissions and long-term temperature increases, while exposing importing countries to higher import bills and market volatility. Beyond impacts on affordability, slower grid development could also exacerbate the risk of power shortages or outages, which come with enormous costs to modern economies.

Impact on renewables deployment

The Grid Delay Case was developed for this report to explore the potential impacts of failing to modernise existing infrastructure and deliver new grid infrastructure in a timely manner. In this case, which is a variation of the APS, slower development of grid infrastructure puts a major brake on scaling up the deployment and integration of solar PV and wind power in all regions. In the Grid Delay Case, global solar PV capacity additions rise from 220 GW in 2022 to about 340 GW by 2030, 10% below the APS level, and 490 GW by 2050, almost 20% below the APS level. Wind capacity additions rise from 74 GW in 2022 to 180 GW in 2030 and 230 GW in 2050, both 15% or more below the APS. For both technologies, there is continued market growth in both advanced economies and EMDEs, though not as much as in the APS.

The Grid Delay Case, though modest in its effect on solar PV and wind deployment, would significantly slow clean energy transitions around the world. The solar PV and wind share of electricity generation would continue to increase globally, rising from 12% in 2022 to 30% in 2030 and almost 45% in 2050. This would represent major changes for the global power system and require progress in many areas related to renewables integration, including market design and storage development. But it would fall well short of the nearly 60% share reached in the APS that is needed to deliver long-term ambitions, including net zero targets.

Global solar PV and wind annual capacity additions in the Grid Delay Case and Announced Pledges Scenario, 2010-2050

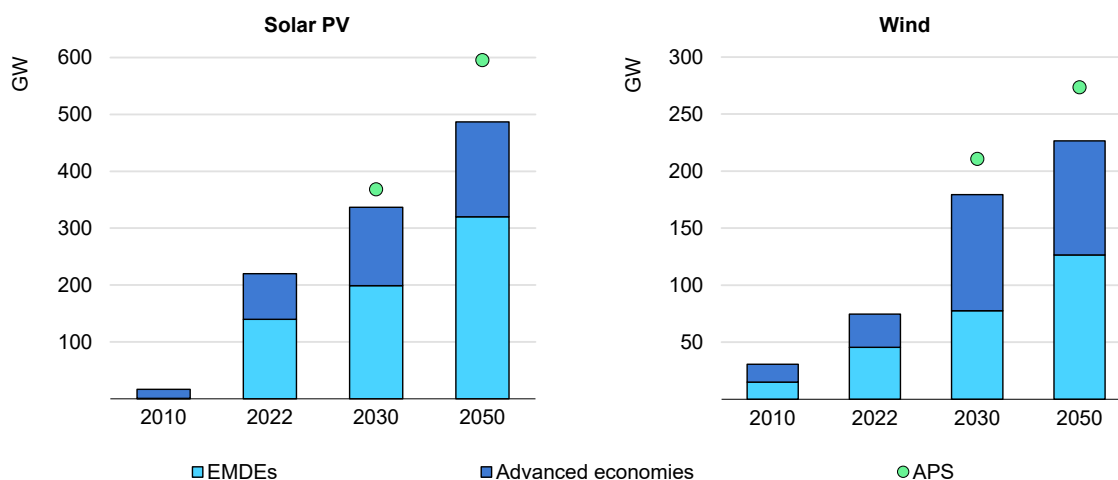

IEA. CC BY 4.0.

Sources: IEA analysis based on IEA (2022), [World Energy Outlook 2022](#), IEA (2023), [Renewable Energy Market Update](#).

To compensate for lower contributions from solar PV and wind power in the Grid Delay Case, output is increased from other available capacity of various sources, including other low-emission sources like nuclear power or fossil-fuel power plants equipped with carbon capture, as well as unabated coal- and natural gas-fired power plants. Where necessary, additional capacity is added to ensure the adequacy of electricity supply, considering the available resources and technology preferences of each region. For example, nuclear power is added only in regions open to the technology that also have existing nuclear energy development programmes. Also in this case, where other low-emission options are more limited, additional unabated coal or natural gas power capacity is added. In the selection of technologies, the analysis of this case places a primary emphasis on the affordability of electricity, over and above fulfilling emission reduction targets.

Impact on fossil fuels and CO₂ emissions

Globally, the Grid Delay Case has twice the amount of coal and natural gas use in 2050 compared with the APS, slowing clean energy transitions and leading to higher power sector emissions than in the APS. Coal use in the power sector declines by an average of about 3% per year from 2022 to 2030, as it does in the APS, before the pace of reductions slows to 1.3% per year over the period to 2050 in the Grid Delay Case. Natural gas use for power also declines to 2030, at a rate of 1.7% per year. However, after 2030 the Grid Delay Case leads to natural gas use returning to growth through to 2050. In turn, power sector CO₂ emissions are significantly higher than in the APS, with the pace of annual reductions slowing after 2030. In 2050 power sector CO₂ emissions are 8.3 Gt in the Grid Delay Case, more than two-and-a-half times higher than the 3.2 Gt in the APS in that year.

Over the period 2031 to 2050, the cumulative addition of CO₂ emissions in the Grid Delay Case is 58 Gt higher than the APS, equivalent to the total of the last four years of power sector CO₂ emissions.

Total energy sector CO₂ emissions in 2050 in the Grid Delay Case are around 17.5 Gt CO₂, compared to 12.4 Gt CO₂ in the APS. If CO₂ emissions continue their trend after 2050, and if there are similar changes in energy related methane emissions as well as non-energy-related greenhouse gas (GHG) emissions, the median rise in temperature in 2100 would be around 1.9°C. This means that there is a 50% probability of remaining below 1.9°C. However, due to uncertainties in the earth's response to warming, there is about a 40% chance that the temperature rise could exceed 2.0°C in the Grid Delay Case, compared with a median increase of 1.7°C in the APS.

Share of solar PV and wind, coal and natural gas use in power generation, and power sector CO₂ emissions worldwide in the Grid Delay Case and the Announced Pledges Scenario, 2010-2050

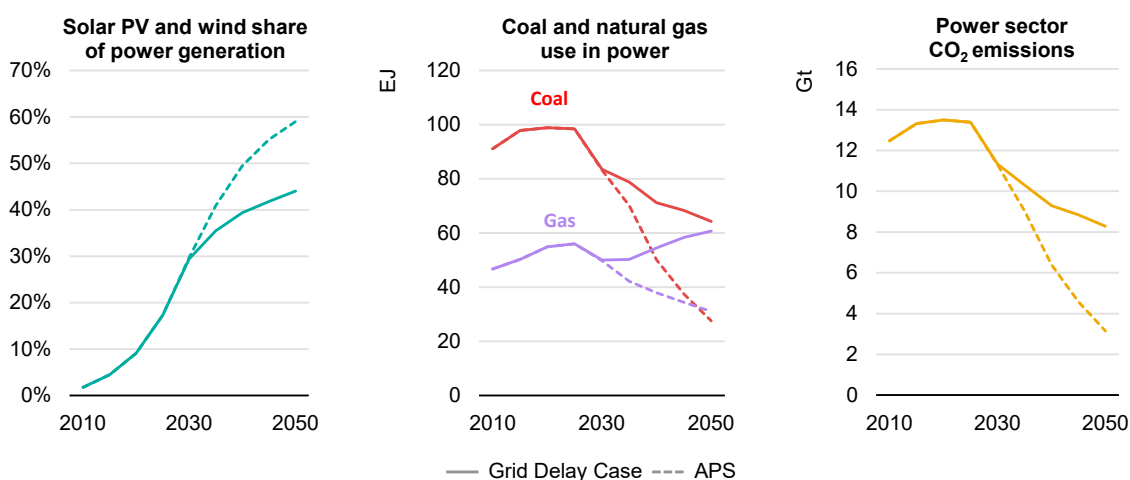

IEA. CC BY 4.0.

Notes: EJ = exajoules; Gt = gigatonnes.

Sources: IEA analysis based on IEA (2022), [World Energy Outlook 2022](#).

In advanced economies, the Grid Delay Case results in much higher natural gas use beyond 2030, which puts a stop to emission reductions in the power sector. Clean energy transitions are set to make rapid progress to 2030 in advanced economies, raising the share of wind and solar PV in power generation to over 40%, close to triple the level in 2022, and sharply reducing the amount of coal-fired generation. To date, a 40% share of variable renewables in annual electricity generation is at the frontier of experience for large power systems. Moving beyond that level would require several advanced technologies and approaches, including more flexible power plants, energy storage and tapping demand response potential, all which would benefit from robust grid modernisation and development.

In the Grid Delay Case, some of these elements are delivered, supporting the share of wind and solar PV to approach 55% of electricity generation in 2050, although this is well short of the 65% reached in the APS.

The options to compensate for the slower deployment of wind and solar PV are often limited in advanced economies. Most other renewable energy resources have been tapped extensively, including hydropower, or have proven costly to date such as concentrating solar power. While nuclear power is a viable option in several advanced economies, other options generally come at lower cost (even if we assume significant cost reductions from recent nuclear projects). As a result of these factors, in our analysis, less wind and solar PV would mean greater reliance on natural gas. The use of natural gas in power hits a floor around 2035 in the Grid Delay Case and rises again to 2050. In turn, CO₂ emissions from the power sector hit a floor as well, staying at about 0.8 Gt per year to 2050.

Among advanced economies, the largest impacts are in the European Union and United States, as both look to rely heavily on solar PV and wind to decarbonise electricity. In the European Union, the Grid Delay Case leads to over eight times the level of natural gas use in power in 2050 than in the APS, leading to 80 Mt higher CO₂ emissions. In the United States, natural gas use is over four times as high in 2050 as in the APS, and power sector CO₂ emissions are about 400 Mt higher in 2050. Australia, Mexico, Japan and Korea would also see significant impacts on natural gas and CO₂ emissions from slower grid development.

Share of solar PV and wind, coal and natural gas use in power generation, and power sector CO₂ emissions in advanced economies in the Grid Delay Case and the Announced Pledges Scenario, 2010-2050

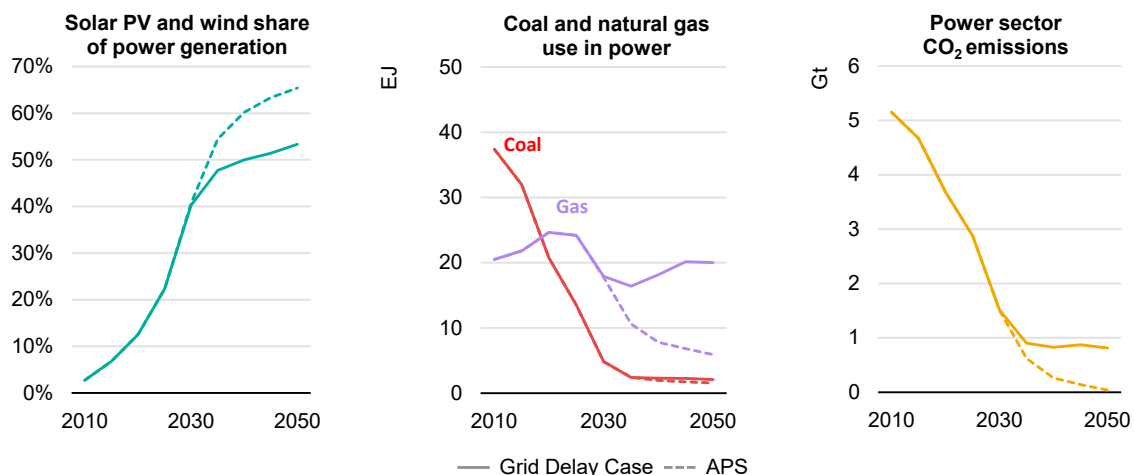

IEA. CC BY 4.0.

Notes: EJ = exajoules; Gt = gigatonnes.

Sources: IEA analysis based on IEA (2022), [World Energy Outlook 2022](#).

In EMDEs, the Grid Delay Case would stifle transitions away from unabated coal-fired power and lead to rising natural gas use for power. Although EMDEs are set for substantial uptake of solar PV and wind to 2030, rising from 10% of electricity generation in 2022 to nearly one-quarter in 2030, a lack of grid development could create significant barriers to holding that pace of transition, including more limited regional integration (between countries) and weaker connections within countries. In the Grid Delay Case, the share of solar PV and wind continues rising to 2050, but stays below 40%, whereas in the APS it moves past 55%.

To compensate for less solar PV and wind, EMDEs would need to invest significantly in other new power plants to meet growing demand, and many would be fossil-fuelled when affordability is the primary concern. While there is more untapped hydropower potential in EMDEs, there is growing public resistance to their development and their costs are not particularly low. Expanding nuclear power could play a role, but projects have long lead times, and they are often more expensive than alternatives. As a result, the continued use of coal-fired power and continued growth for natural gas-fired power are part of the cost-effective replacement for solar PV and wind in EMDEs. Coal use in power in 2050 in the Grid Delay Case is more than double the level in the APS, and natural gas use is 60% higher. In turn, the power sector does not deliver the steep CO₂ emissions reductions in the APS, but rather steady and modest annual reductions to 2050. In the year 2050 power sector CO₂ emissions in EMDEs in the Grid Delay Case are two-and-a-half times the level of the APS.

Share of solar PV and wind, coal and natural gas use in power generation, and power sector CO₂ emissions in EMDEs in the Grid Delay Case and the Announced Pledges Scenario, 2010-2050

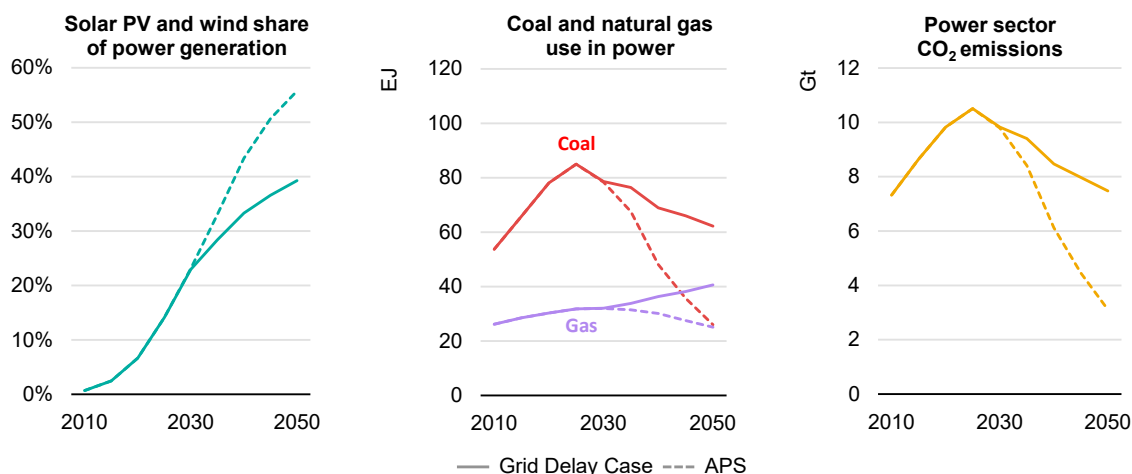

IEA. CC BY 4.0.

Notes: EJ = exajoules; Gt = gigatonnes.

Sources: IEA analysis based on IEA (2022), [World Energy Outlook 2022](#).

Among EMDEs, the largest effects of the Grid Delay Case are in China and India. These two countries have by far the largest power systems in EMDEs by total generation, and they also rely heavily on coal-fired power today. Where wind and solar PV have difficulty scaling up to the levels in the APS, those transitions away from coal would be disrupted. In China, the reductions for coal use in power to 2050 in the Grid Delay Case are only half as much as in the APS, while in India the result could be for coal-fired power to return to growth in the long term. Countries in Southeast Asia and Africa would also face headwinds in the transition away from coal if grid development hampers solar PV and wind growth.

Impacts beyond CO₂ emissions

Alternatively, a lack of timely development of grid infrastructure could lead to higher-cost solutions for those regions or countries that focus primarily on achieving their emission reductions targets. As solar PV and wind power are now the most competitive new sources of electricity in most regions, the cost of decarbonisation faces strong upward pressure when shifting to other low-emission options. For example, an [analysis by NREL](#) found that in the United States, constrained grid infrastructure would contribute to a high-cost transition scenario and, when paired with other constraints on generation, could double the total power system cost compared with an unconstrained case.

In the Grid Delay Case, the additional use of natural gas and coal would raise fossil fuel import bills for importing countries by over USD 500 billion from 2031 to 2050. This would make energy less affordable for consumers and economies more vulnerable to market price variability and disruptions. The additional annual import bill of USD 25 billion would go to import an average of 80 billion cubic metres more natural gas and nearly 50 million tonnes more coal. Natural gas would account for almost 90% of the additional import bills, with the remainder for coal. The burden of additional fossil fuel import costs would be borne roughly equally between advanced economies, mainly Japan, Korea and the European Union, and emerging market and developing economies, primarily in India, Southeast Asia and other developing economies in Asia.

Additional annual fossil fuel import bills by fuel in the Grid Delay Case compared with the Announced Pledges Scenario, 2030, 2040 and 2050

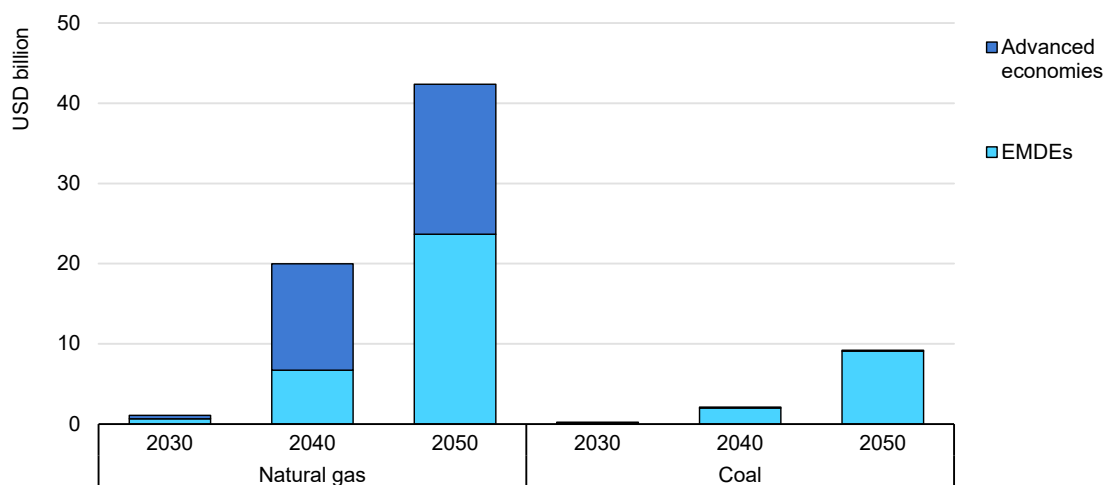

IEA. CC BY 4.0.

Sources: IEA analysis based on IEA (2022), [World Energy Outlook 2022](#).

Beyond higher emissions or higher costs, slower grid development could also raise the likelihood and expected duration of power outages, with potentially massive effects on the economy and individuals’ daily lives. These risks would expand over time as more end uses are electrified, including transport and heating/cooling, adding to the reliance today on electricity in health care, information technology and entertainment. Less reliable grids can also add to disparities between wealthy sectors and households and poorer ones, as the more affluent can invest in autonomous backup or primary power supplies to a greater extent than poorer communities.

Chapter 4: Policy recommendations

Grid development is currently falling short of the pace needed to ensure secure, reliable and cost-effective energy transitions. Urgent action is needed to create the policy, regulatory and investment environment that will enable grids to keep up. Policy makers have a central role to play in creating this enabling framework and carrying out the necessary regulatory overhaul. At the same time, industry across the entire supply chain will need to stand ready to deliver at the speed and scale required. Interaction between the full range of stakeholders will require strengthening to ensure that plans are carried out swiftly, securely and democratically.

As we have seen previously in Chapter 1 and Chapter 2, power grid development will depend on contexts that can be highly localised. While some aspects, such as supply chains, are global, many of the key policies and regulations will depend on the particularities of the country and region. In many cases, differences between advanced economies and EMDEs will be significant, and even between countries of similar economic development but different market structures. Grids in EMDEs are currently falling the furthest behind and need particular attention so that lack of development does not lead to clean transitions facing delays and higher costs. At the same time, it is recognised that they face unique challenges.

Notwithstanding local context, we have identified six priority areas with broad applicability where policy makers can act to ensure grids enable energy transitions rather than becoming a bottleneck: improving grid planning, enabling investment, improving the speed and efficiency of grid deployment and operation, securing future supply chains, harnessing digitalisation and cultivating skilled workforces. The recommendations that follow are grouped under these main topics, and can serve as guiding principles to be considered when developing policies and regulations, adapted to the local realities and requirements.

Key policy recommendations to boost grid capacity development

Policy maker action is needed across six key areas to ensure grids do not become a bottleneck in clean energy transitions:

- **Bring planning up to date.** To support energy transitions, grid planning needs to be significantly improved. Increased co-ordination of planning across different parts of the power system and the economy will be essential, as well

as improved regional co-ordination. Incorporating high-quality long-term scenario development that reflects climate goals and engages all relevant stakeholders is key to enable coordination between sectors and manage uncertainty in the path and pace of development.

- **Unlock investment.** Investment is one of the key barriers to accelerated development of grid capacity. Here, EMDEs face special challenges related to the cost of capital and budget restrictions. Improving the way grid companies are remunerated, driving targeted funding for grids and improving cost transparency can lift investment. In some cases, enabling private participation could provide additional investment.
- **Address barriers to grid development.** Grid expansion and modernisation needs to happen at speed and scale, and building new grids needs to go hand in hand with improved use of existing infrastructure and new technologies. Policy makers can speed up progress on grids by ensuring regulatory risk assessments allow for anticipatory investments, streamlining administrative processes, fostering societal support, and ensuring there are incentives for better use of existing infrastructure, as well as for new capacity.
- **Secure supply chains.** Accelerated grid capacity development and deployment of new technologies will place increasing strain on supply chains. Governments can support expansion of these supply chains by creating firm and transparent project pipelines and by standardising procurement and technical installations. At the same time, a focus on interoperability of different solutions will support flexibility in the future, while cybersecurity concerns for grid components should be addressed.
- **Leverage digitalisation.** Digitalisation of transmission and distribution grids can continue supporting efficiency and security. Ensuring transparent frameworks for collection and handling of data, as well as the development of AI and machine learning tools, can increase the value obtained from these solutions. At the same time, increased focus on cybersecurity risk assessments and proactive and reactive capabilities is essential to ensure the security of power systems.
- **Build a skilled workforce.** There is already a significant need for a high number of skilled white- and blue-collar workers across the entire supply chain, as well as at operators and in regulating institutions. Building out a pipeline of talent is essential, as is ensuring digital skills are integrated into power industry-related curricula. At the same time, governments need to ensure they manage the impacts of increased automation on workers through reskilling and incentivising on-the-job training.

We need to step up planning to be social, ambitious, robust and visionary

Power system planning provides information about system needs in the long term and guidance for investment and policy making. The power sector needs to be planned with a long-term perspective since components of the power grid and large power plants remain in place for decades. Demand growth used to be the main driver for power sector planning: linking GDP forecasts to demand growth and then planning investment in power supply, transmission and distribution capacity to serve it. Now, energy transitions require a rapid evolution of the way electricity is produced and used, which calls for important changes in the way the development of power grids is planned.

In the coming years, multiple factors will affect the sufficiency of grid capacity, stability and strength. Demand growth will be driven or intensified by electrification of other sectors like transport and buildings. Generation characteristics are changing and will prompt a need for grids to modernise, to get better use out of existing infrastructure, to expand, and to host more distributed sources of flexibility. Grids will also need to become more interconnected across regions and sectors, making them interdependent on neighbouring systems, and linkages with infrastructure in other sectors like gas and hydrogen will increase.

In this context, power grid planning has become conceptually much more complex, and there is an increasing need to align with the needs and outlooks of a wider range of stakeholders, including the public. This will require more integrated approaches that address the linkages within the power sector and between sectors. Co-ordination between the distribution and transmission levels will be much more important than in the past as distribution grids increasingly host generation and flexibility resources. Due to grid deployment's slower timeframes relative to renewables and distributed energy resources, grid planning will need to support anticipatory investment to ensure grid infrastructure does not act as a barrier.

While energy transitions will drive a need for similar overall evolutions in grid planning around the globe, country contexts will define the most urgent priorities. In EMDEs, electrification will add to the increases in demand already being driven by GDP and population growth. A key priority for planning will be to support an environment where the necessary investments in infrastructure can take place. From this perspective broad stakeholder engagement and transparency and regularity in the planning process are critical. The tools, methodologies and processes used to analyse and indicate the new infrastructure needs will be different from those of the past. Policy makers, regulators and utilities need to put

in place appropriate institutions, regulations, technical requirements and capabilities, and collaboration platforms so that consensus on new planning approaches is reached.

Many advanced economies will need to cater to electrification-driven demand growth after decades of flat or declining demand. The planning process will need to ensure that well-developed but ageing grid infrastructure can be upgraded and modernised to function efficiently under new paradigms, such as allowing for two-way power flows and high inputs from non-synchronous sources. Extensive infrastructure expansion will be needed again for the first time in many years, requiring engagement with society to secure their buy-in; the link between clean energy transitions and grid expansion needs to be just as clear as the link with wind turbines and solar panels. The planning process will need to navigate these changes in the context of unbundled power sectors with many players and incorporate the perspectives of diverse stakeholders to create robust, effective planning. Scenario analysis will be needed to inform debate around options that are not least-cost but may have higher social acceptability.

Important positive developments in grid planning have been achieved in recent years. Many regions are introducing new long-term planning exercises that help to bridge the gaps between traditional planning and the needs of energy transitions. However, these are initial steps towards a new paradigm, with most regions still needing to improve planning integration across multiple fronts. Many of these plans do not have regular schedules, but currently exist as one-off studies. There is still a lack of robust scenario analysis that accounts for multiple plausible pathways based on timely, comprehensive and regular stakeholder consultation. The level of close co-ordination that will be needed between planners within and between regions is still not there.

These are the priorities to enable planning studies to step up and effectively guide energy transitions:

- **Improve co-ordination between grid planning and generation planning.** Many regions are still dependent on grid planning processes that follow a traditional sequence where generation projects are planned first and grids are put in place to connect them, an approach that is no longer fit for purpose. The deployment of more diverse and distributed generation sources in regions without grid access will not take place without anticipatory investments in grid infrastructure. In particular, new resources such as offshore wind or remote renewables-rich areas may need dedicated grid development, and the planning process needs to assess the benefits of building shared infrastructure in advance of generation project planning.
- **Enhance scenario development to account for growing sectoral linkages and different technology pathways using a multidimensional approach.** Currently, the scenario development underlying grid planning studies is often

simplified and may mainly account for uncertainty in total electricity demand growth. Grid planning studies need a robust process for scenario development to reflect the main likely development trajectories, incorporating climate policy and linkages with the transport, heating and industrial sectors as well as natural gas and hydrogen, while also linking medium-term plans to the long-term view. Scenario analysis is also critical to inform public debate and quantify the costs and benefits of relevant technology pathways that might have higher costs but also greater acceptability. Reflecting sectoral linkages is a particular priority in advanced economies where electrification is the main driver of demand growth and the development of clean hydrogen demand will come earlier.

- **Improve the efficacy of stakeholder engagement through transparency and clearly defined, regular processes.** While most power system planning exercises have stakeholder engagement processes, these are highly challenging to get right and in many regions they are currently not delivering the level of consensus and confidence in future grid development that is needed. Planning processes need to proactively engage relevant groups early and often to benefit from a wide range of perspectives as well as helping to build investor confidence and public trust. Transparency in the analytical approaches used as a basis for robust, informed exchange is a key component to ensure engagement is effective. Planning bodies that do not publish their models and input assumptions and allow for multiple rounds of engagement on this basis during each planning cycle should make efforts to do so. In EMDEs, defining clear engagement processes and increasing transparency are priorities to build investor confidence.
- **Increase co-ordination between distribution and transmission grid planning to reflect greater complexity and potential at the distribution level.** Most distribution and transmission planning processes are geared towards a context where power is generated away from demand centres and transported through the transmission system to the distribution network. This is not fit for purpose for the distribution grids of the future, hosting distributed generation and flexibility resources that can provide services to the system and even lead to bidirectional power flows or self-sufficiency. To fully tap the potential of these resources, transmission and distribution planning needs to be more co-ordinated, so that all potential solutions are considered in a technology-neutral way. The flexibility solutions provided by distributed energy resources, including storage, microgrids and other non-wire options, can be an alternative to network reinforcement, avoiding some expensive and often hard-to-implement structural investment, with possible positive effects on affordability and sustainability. The fast pace of demand growth in EMDEs makes co-ordination between distribution and transmission planning a key priority.
- **Improve co-ordination of grid planning between regions to tap into the benefits and manage the complexities of cross-border interdependencies.** Energy transitions and particularly the rising share of variable renewable generation increase the benefits of sharing resources across wider regions, while adding to the complexity of cross-border power flows, which become more

bidirectional. This prompts a greater need for co-ordinated planning for grids and renewables across national boundaries. Countries with little interconnection, including many EMDEs, will benefit from accelerating cross-border infrastructure and need to step up co-ordinated planning to enable this. Establishing common practices for cross-border financing of projects to ensure the fair sharing of benefits will be an important step to delivering efficient cross-border infrastructure. Well-interconnected countries will also need to ensure co-ordinated planning with neighbours for transition plans that increase the reliance on trade for renewables integration and generation adequacy.

- **Enhance the assessment of multiple risks within planning studies.** While the need for risk assessment as part of grid planning is not new, potential threats to security of supply come from multiple angles with many risks increasing, including climate change and natural risks, cybersecurity, supply chain security, geopolitical risk, social acceptance risks, variable generation uncertainty with multi-year weather analysis, and hard-to-predict events such as the Covid-19 pandemic. To address these, the suite of planning studies will need to include advanced assessment of credible risks as well as appropriate measures for mitigation and resilience. Such analysis is essential to support decisions to invest in projects that are worthwhile on the basis of their benefits in a range of credible risk scenarios, rather than only considering typical criteria of necessity under normal operating conditions. This will be important in all countries, with EMDEs facing the most extreme impacts from climate change, and advanced economies confronting important climate and geopolitical risks.

Financing and investment overhauls are key to accelerating and optimising grid capacity expansion

The major trends reshaping power systems – decarbonisation, the rapid decentralisation of generation, and the deployment of new loads at the grid edge – also entail a redefinition of the role of transmission and distribution networks and therefore how we pay for them. Across the globe, investment in grids needs to accelerate; this can be done by setting up targeted programmes for grid investment, updating regulatory frameworks to support the right investments and identifying new sources of value. However, the context for these investments and specific improvements varies between advanced economies and EMDEs. For example, in advanced economies the priority should be updating remuneration schemes and enhancing grid operations. For a significant share of EMDEs, the main problem with financing investment relates to the limited resources of utilities that cannot recover their costs from consumers, and the double task of both upgrading the quality of the grid and accommodating rapidly increasing demand.

The priorities for overhauling grid investment and financing are as follows:

- **Target funding for grids where needed to accelerate development to the level required to support efficient energy transitions.** To date, the pace of investment has been hampered by the lack of a clear perspective on the level of grid expansion that is necessary and the amount of financing that is available to undertake these investments. Government initiatives are now recognising the need for targeted funding to boost grid investment that currently sits well below the levels needed to achieve energy transitions at least cost. This funding should not be limited to just grids, but also flexibility and integration of distributed energy resources through all means available.
- **Remove barriers to innovation and operational improvements in networks that are currently embedded in existing remuneration structures.** Current remuneration mechanisms tend to be biased towards capital investment, which discourages investment in operational practices that improve the efficiency of grids. Across both restructured power markets and vertically integrated power systems, adding remuneration components based on the outcomes or quality of the service they deliver can contribute to reducing the material requirement for investing in hard infrastructure, while remunerating new services. For example, these might enable improved line utilisation, better grid visibility or reduced outage times.
- **Improve the visibility of future remuneration within investment plans to accelerate and ensure the delivery of necessary grid investment.** At present the practice of remunerating investment costs retroactively at the end of each regulatory period leads networks to undertake investment at the end of each period, which delays progress in grid expansion. Introducing ex ante processes and defining the scope of expected investments ahead of each regulatory period have been seen to encourage investment throughout the regulatory period and accelerate grid development.
- **Review remuneration mechanisms to ensure their compatibility with specific policy objectives.** In specific cases, the drive to reduce the overall cost of managing the grid can reduce network operators' ability to invest in innovation or the roll-out of specific technologies. To address this, regulators and grid operators can collaborate to identify priority programmes, and regulators can allocate funds through special innovation or outcome-based remuneration mechanisms. For example, allocating special tranches of remuneration to innovation programmes (e.g. in Brazil) or introducing a remuneration element contingent on smart meter roll-out indicators (e.g. in Italy and recently introduced in India) can accelerate grid modernisation.

While the above recommendations apply to most countries, specific actions should be a priority for countries with integrated power industries and particularly for EMDEs, where accelerating grid investment requires improving existing infrastructure while meeting grid expansion needs. Besides this double challenge,

there are specific context-dependent factors that need to be taken into account to ensure effective investment. These investments need to consider utilities' limited resources due to the lack of cost-reflective tariffs, and the typically greater share of equity in grid investment due to a cost of capital that can be several times higher than in advanced economies.

This brings about the need to improve the financing conditions for new grid projects and introduce instruments that help de-risk investments in network infrastructure and reduce the cost of capital:

- **Improve the transparency of the different cost drivers for integrated utilities by accounting separately for generation, network and retail costs.** For many integrated utilities, the lack of separate accounts for the different activities often enables cross-financing of the various productive activities, which makes it harder to identify where the greatest cost burden lies and where targeted investment may deliver greater savings. Unbundled accounting can also provide an opportunity for greater transparency in contexts where private participation is not legally allowed or restricted to very specific instances. For governments interested in gradually bringing additional investment into the power system, clearly identifying cost-optimisation opportunities can help them identify areas suitable for private participation, guide investment plans and reduce cross-subsidies.
- **Develop clear methodologies for the allocation of interconnection costs and streamline permitting to reduce the cost of financing.** In power systems where network investments are mainly carried out by the incumbent utility, banks may not be familiar with the type and length of investment required. Uncertainties around project development will only add to the cost of financing new projects. Clarifying licensing, the allocation of costs, and the expected revenues can not only help streamline the development of grid projects themselves, but also guide investment in new generation to areas where they maximise the utilisation of the existing network.
- **Identify areas where additional funding is a key barrier and assess whether private participation can accelerate investment.** Lack of resources due to tariffs that do not reflect costs and the high cost of borrowing may impede utilities in EMDEs from undertaking grid expansion investment on their own. In such cases bringing some level of private participation into the industry can draw in additional funds. Full restructuring or privatisation may not always be politically feasible, so targeted programmes for investment in transmission, such as in Brazil and Kenya, allow the engagement of private capital to achieve specific policy goals.
- **Establish a balance between revenue certainty and oversight to facilitate private participation.** Because network infrastructure projects are the backbone of the power system and long-duration investments, both governments and utilities need to have certainty over the delivery and service quality of projects where private actors are engaged. At the same time investors will prefer mechanisms that provide clarity over the revenue streams and contract terms. Experience in a number of countries provides examples of models that have shown success in

driving private investment. Models for private participation such as concessions and BOOT can enable investment in grid infrastructure while providing certainty for investors and remaining accountable to government. As with other mechanisms, it is important that this is complemented by effective regulatory monitoring tools to ensure that the projects are indeed delivered in a timely manner and cost-effectively.

Stronger grids will require both rapid expansion and improved use of assets

Even if grid strengthening projects are planned and financed appropriately, they can block the energy transition if they cannot be implemented, or slow it down where there are significant delays. Either way, this affects our ability to meet existing climate pledges. It takes years longer to implement grid projects, particularly for transmission, than it does to expand distributed energy resources and renewables. The public will expect unrestricted uptake of EVs and electric space cooling/heating. The smooth delivery of grid projects that are built on time is crucial not only for the timely and secure integration of distributed energy resources and renewables, but also to cater for the increase in consumption from economic growth and electrification.

Advanced economies with well-developed grids are facing the need to replace ageing assets, increase the capacity of existing transmission and distribution lines, and build new infrastructure to access bulk renewable energy such as offshore wind. This means the priorities are to efficiently manage maintenance outages for upgrading work, redesign elements to cope with increased power flows (uprating), and at the same time build new transmission corridors. Co-ordinating these types of projects, including [scheduling the works and preparing operational measures to ensure grid security](#), is a major challenge because of the volume of projects that need to be managed. In addition, where there are cross-jurisdictional interconnections as in Europe and North America, the co-ordination of projects across borders is also required. When delays or changes to the schedule of works occur, for example due to permitting, supply delivery, weather or contractor availability, they affect a whole chain of other projects that need co-ordination and adjustment.

Where new grid infrastructure or significant upgrades are required, obtaining the necessary permits from local authorities and residents can be a challenge. It can be particularly difficult, expensive and time-consuming to obtain permissions to build and fulfil the environmental impact mitigation requirements for long transmission lines that cross multiple properties and municipal areas, through geographically diverse landscapes. Even for distribution, particularly for underground systems, works can be a disturbance to local residents and must be

anticipated and planned in an acceptable manner. In the case of offshore grids, there is a need to clarify who should be responsible for building the transmission infrastructure: the onshore TSO, the wind farm owner or someone else. Several studies have shown that inviting a TSO to lead development can minimise costs due to economies of scale and risk reduction.

In EMDEs, where demand growth and decarbonisation objectives concurrently drive the need for grid expansion, delays in implementation not only hamper the energy transition but also hold back economic growth.

Priorities for accelerating grid development and improving the use of existing assets are:

- **Improve regulatory risk assessments.** Regulation surrounding the requirements to meet when building new grids has usually focused on avoiding the risk of stranded assets as much as possible, and has not managed to capture the risk of insufficient grid development. Adjustments to the regulatory framework can better capture the value that new projects add and open the door to needed anticipatory investments. This equally applies to cross-border projects, such as new offshore wind hubs, where cost allocation should be based not only on the location of the infrastructure, but the expected benefits coming from it.
- **Address administrative barriers to new grid projects to accelerate the pace of grid development.** Permitting and other approvals are a key barrier contributing to the long development lead times for grids seen in many regions. Targeted policies and digitalisation to streamline and accelerate approval processes are essential to enable grid development to support the energy transition, rather than acting as a bottleneck to the deployment of clean generation and other technologies.
- **Actively foster and account for societal support for grid development when planning for power system development.** Many grid projects see significant delays due to social opposition. In addition to active public engagement, best practices can be adopted to limit the impact of grid infrastructure on communities and the environment. Clear and continuous information sharing and a structured long-term communication plan can help reduce misinformation. Transparent and fair compensation measures for landowners and local communities can also improve acceptance. Moreover, new forms of collaboration between governments and developers can be leveraged to explore nature-positive outcomes and minimise land use, for instance combining grids with existing infrastructure such as pipelines.
- **Increase the focus on improved use of infrastructure within remuneration frameworks.** Simply building grids is not enough to solve existing issues, and better utilising existing and future infrastructure will be key. For this to be properly incentivised, remuneration frameworks must be compatible with this new paradigm. Similar shifts have already been observed in the evolution of remuneration frameworks, from cost-of-service to outcomes-based remuneration.

Investing in operational improvements can contribute to increasing hosting capacity in the short term, buying time for more comprehensive grid expansion. In systems with liberalised power markets, the use of locational signals is paramount for efficient operation of the system.

Secure, diverse supply chains for grid infrastructure are critical

Even if the necessary investments are identified and secured, there is risk of jeopardising climate goals if essential grid components cannot be delivered on time.

Transmission and distribution capacity reinforcement requires both commodity and niche components, which correspond with different likely stress points in the supply chain. Commodity components like wires and distribution transformers have a diverse range of suppliers, but increased demand will squeeze the raw material supply chain. In contrast, niche components like transmission grid transformers, subsea cables and grid support devices are supplied by a limited number of manufacturers and delivery capacity becomes a concern. Moreover, construction capacity – particularly for transmission and offshore infrastructure – will become a constraint because they rely on special skills and equipment.

Diversifying supply chains is a typical measure to improve their robustness and secure the timely delivery of infrastructure. With a lack of local manufacturing capacity, EMDEs largely rely on imported components, which increases the delivery cost. They also tend to lack capable construction capacity. Higher risk of timely delivery impacts the cost of capital. Countries with constrained capital tend to opt for cheaper suppliers that can deliver locally, making diversification a prohibitively expensive strategy.

Niche components have limited total demand but are critically important to electricity supply globally. The limited volume means that the manufacturing capacity tends to be geographically concentrated and the manufacturing process difficult to standardise. Orders with large volumes of standardised technical specifications are cheaper to manufacture with quality assurance. This makes them difficult to access even for countries with capital if the orders are few, have specialised technical requirements or are located far from the place of component manufacture.

For both commodity and niche components, suppliers of grid equipment need to step up production capacity to meet the expected delivery timelines. Governments can take a number of actions to help strengthen the supply chain and improve robust delivery capability:

- **Support a sustainable and firm project pipeline with government-endorsed long-term grid investment plans.** Current firm pipelines for grids do not reflect the pace of grid expansion required for energy transitions, despite being a requirement for manufacturing firms to commit investment in sufficient new manufacturing capacity. Governments should request long-term grid investment plans to be prepared domestically and regionally, against a delivery timeline. Endorsing these plans and tracking their implementation can improve the security and pace of grid investment and incentivise the development of supply chains.
- **Standardise procurement procedures, technical specifications and installation where possible to accelerate the pace of delivery.** Currently, a lack of certainty about the precise specifications for future projects and significant diversity across markets are barriers to manufacturers setting up the needed delivery capacity. While not all aspects of grid projects can be standardised, governments can increase alignment between future projects by forging alliances across regions to firm up technical requirements. For example, long-term framework agreements [to build grid connections for the North Sea Hub](#) define "core components" of the grid equipment needed to transport offshore wind power to onshore demand centres. With the assurance that a large volume of standard components will be purchased, manufacturers are incentivised to set up dedicated and efficient delivery capacity to ensure timely production.
- **Introduce standards to ensure interoperability between grid components from different manufacturers, particularly for DC technology.** DC grids have much greater potential for interoperability challenges than AC technology, which risks causing delays to new grid projects if components from different manufacturers do not work well together. This is becoming more relevant during energy transitions, especially with the increased development of meshed offshore grids. Policy makers should ensure that standards for interoperability are introduced as soon as possible to avoid future delays and increased costs arising from incompatible technologies.
- **Support the diversified supply of grid components that have a very limited number of top-tier suppliers.** The manufacture of some grid components currently has a high concentration among only a handful of top-tier suppliers, which makes diversification of the supply chain challenging. This is particularly seen in components such as HVDC converter stations, extra-high-voltage transformers, niche equipment like synchronous condensers and STATCOMs, and alternatives to SF₆ in switchgear. Particularly in EMDEs and countries outside the European Union and United States, accessing suppliers can prove difficult. Governments may overcome this by pooling their procurement as a region, or working together with second-tier suppliers so that they can increase their competitiveness. Improving the global diversity of specialised component suppliers will improve the pace of grid deployment and possibly reduce the costs.
- **Consider measures to incentivise sustainable practices in supply chains.** For components with a high emissions intensity or constituents considered to be a pollutant in their life cycle, it makes sense to encourage sustainable practices.

Regulators can reward the circular economy and CO₂ impact reduction when evaluating proposed investments by DSOs and TSOs. Governments can encourage the industry to adopt more sustainable practices through their own procurement and by supporting industries and initiatives that are developing alternative sustainable solutions. For example, the [AmpUp](#) programme in the United States introduces a dedicated framework to implement circular solutions for electric utilities, and a workstream launched by the [municipality of Amsterdam](#) includes a project aiming to achieve a 100% use of circular economy materials in underground infrastructure by 2040. Furthermore, requirements for phasing out SF₆ components in order to limit carbon emissions could be adopted globally, but doing this without having developed adequate alternative solutions first would be a risk. Governments can encourage manufacturers to develop valid alternative solutions in a timely manner so that the industry can transition faster to non-SF₆ components globally.

- **Implement cybersecurity measures with increasingly complex industrial and service supply chains in mind.** Instances of malware being planted in the manufacturing process or in update programmes, known as software supply chain attacks, is on the rise. For example, malicious code or a backdoor embedded in critical hardware or software can cause massive security vulnerabilities, with consequences ranging from data breaches all the way to causing power outages. To mitigate these risks, it is important to take measures to ensure the reliability of the supply chain, such as developing guidelines for procurement protocols that take cybersecurity into account (e.g. the screening programme in [the United States](#) and [Germany](#)), and certification for the procurement of critical equipment (e.g. [EDSA certification](#)). Encouraging diversity in procurement sources for general-purpose products, such as semiconductors, smart meters and power conditioners, is effective at avoiding the risk of certain vulnerabilities or intervention by malicious entities.

Data streamlining, transparency, digitalisation and observability are no-regrets enablers

Digital technologies can help resolve current operational challenges, supporting the integration of VRE and distributed energy resources, and reduce investment costs by optimising system efficiency. Fully leveraging the benefits of digitalisation constitutes a significant evolution in the role of system operators as they need to develop new, sophisticated data-handling capabilities. Greater co-ordination will be needed between different stakeholders and their assets. This relies on data collection, streamlining and transparency for exchange and analysis.

There are multitudes of measurement possibilities with sensors and meters that can be deployed to make grid operations more secure and efficient – from the consumer level, throughout grids, at power plants and in the environment beyond.

There is an equally large range of applications, including renewables forecasting, estimating unregistered distributed energy resource capacity, managing flexible demand in real time, and identifying the onset and cause of grid limit violations and failures to improve prevention and recovery measures.

Digitalisation is typically a higher priority at the distribution level, in part because transmission grid digitalisation is largely more advanced, and in part because of the opportunities that new technologies present at the distribution level. Where development of distributed energy resources is taking place at a rapid pace, and advanced metering infrastructure and smart devices are prevalent, it is a priority to link them with the other systems and develop co-ordination mechanisms that tap into the value of flexibility and efficiency. Where digitalisation has not yet occurred in one or more of these areas, distributed energy resources and smart devices are currently the most accessible and fastest to develop. This means that system operators should be aware of the prevailing development trends and act to capture the available information by setting up data collection and management capabilities.

In parallel, expansion of the grid and its growing digitalisation add to the risks from cyberthreats, and both proactive and reactive cybersecurity measures accordingly need increased attention. Cyberattacks on the grid start from intended system infiltration through malware and co-ordinated attacks, facilitated by technical vulnerabilities and the increased electrification of end uses. The many parts of grid infrastructure and grid-connected technologies with different lifetimes, paired with the continuous digitalisation of end uses, translate into multiple potential points of infiltration. Once successfully infiltrated, the impact of a cyberattack on the grid can result in physical damage and widespread service disruption, such as cascade tripping, voltage or frequency collapse, and loss of synchronisation. This means that holistic risk management is needed to counter existing and emerging threats, encompassing the actions to be taken by grid operators and the requirements grid-connected assets need to meet.

Policy makers can take a number of actions to support no-regrets enablers, promote broader advancement of digitalisation, and ensure proper defence against cyberthreats throughout power grids:

- **Ensure grid companies start collecting data and develop the tools and skills to navigate it.** Grid companies in the past have not needed, and so typically do not have, the digital infrastructure, practices and skillsets required to deal with large, complex datasets that have become possible through digital technologies. Even where digitalisation progress is relatively limited, policy makers and regulators need to ensure that grid companies start to collect data as early as possible and build up the capabilities needed to leverage the data. This will be a critical foundation for the more advanced possibilities and can already begin in contexts with limited digitalisation progress.

- **Prioritise streamlining and transparency alongside privacy protection in grid company data collection and storage as early as possible.** In the absence of specific measures, data collection activities may be geared towards internal use and employ specialised solutions that may be inefficient and make scale-up and data sharing challenging. At the same time, some of the data collected will be sensitive and privacy and security need to be ensured. Oversight by energy regulators needs to be enhanced to ensure that data are collected, stored and used in a responsible, efficient and scalable manner. Data management standards and audits are needed to ensure ongoing compliance, penalties are in place for breaches of data privacy, and fair access by relevant market participants. In order to advance digitalisation more efficiently, the sharing of experiences in data collection and handling should be promoted so that standards for practices and technology types can be developed. Data sharing will be crucial to amass databases large and diverse enough to leverage the benefits of artificial intelligence and machine learning for predictive analytics. For data relating to cyberattacks and security breaches, data sharing is also critical but needs to account for the fact that these events are often classified. Focusing on industry dialogue and establishing anonymised information sharing frameworks between industry actors and the public sector can help improve reporting numbers to build a knowledge base. Legislative support by policy makers to incentivise anonymised reporting would help relieve remaining legal and reputational concerns.
- **Ensure that policies and regulations for encouraging innovation promote digitalisation.** Current policies and frameworks for enabling innovation are not always well suited to fostering the digitalisation of power grids. Within broader measures to encourage innovation, such as performance-based regulation and market-based mechanisms, policy makers should ensure the development and deployment of digital technologies and approaches are advancing appropriately. For example, the “[smart grid indicator](#)” in Europe is a good example of an initiative to measure how digitalisation is scaling up in all its dimensions. The [Digitalisation Action Plan by the European Commission](#) is a concrete example of a government communiqué to define the steps needed for digitalisation to progress.
- **Consider targeted funding for digital solutions.** At present, digital solutions are progressing at a sub-optimal pace in many power grids. Targeted funding to harness the benefits of digitalisation can therefore be efficient and cost-effective. A number of initiatives already recognise this – for example, of the [EUR 584 billion](#) (around USD 615 billion) of investment that the European Commission anticipates in the European electricity grid by 2030, almost 30% (EUR 170 billion, around USD 180 billion) is expected to be allocated to digitalisation. Similarly, in 2022 Japan announced a [funding programme of USD 155 billion](#) that will include a focus on smart grids. In 2022 the United States announced the [Grid Resilience Innovative Partnership \(GRIP\)](#) Program, with a funding opportunity of USD 10.5 billion to support the upgrade of power grid reliability and resilience, dedicating USD 3 billion of grants to smart grid deployment. In EMDEs this boost needs to be further encouraged by policy makers, such as in India’s [Revamped Distribution Sector Scheme \(RDSS\)](#), which allocates about USD 40 billion to

support power distribution companies and improve distribution infrastructure, with the target to reach [250 million smart meters](#) by FY 2025/2026.

- **Enhance cyber security risk assessments, encompassing vulnerabilities in grid operators and grid-connected assets.** With the growing reliance on an expanding and more digitalised grid, cyberattacks have become a greater concern, posing threats to their physical infrastructure, security and economic integrity. While the exact format of the next cyberthreat is difficult to predict, the grid and its connected entities are often unaware of malware infiltration and response possibilities. Gaps in effective legislative requirements to enforce cyber risk procedures are also hindering the grid's cybersecurity. In the absence of enforced network code requirements, risk assessment practices by grid operators can map out weaknesses within a network and be combined with proactive measures to decrease the likelihood of cyberattacks. The EU Agency for the Cooperation of Energy Regulators (ACER) cybersecurity-specific network code proposal includes risk assessment for critical and high-risk entities within the European interconnected power g. It found the combination of bottom-up and top-down approaches effective in managing cyber risk scenarios covering operational reliability within cross-border electricity flows. Certifying these efforts through recognised methodologies, such as ISO/IEC on information security management (ISO/IEC 27001, 27005, 27019, followed by 31000), can help to determine internal cyber practices and demonstrate compliance with accepted practices. Following assessment and certification, system operators can for example set up multi-factor authentication, monitoring systems for unauthorised system behaviour, procedures for backing up data, or the ability to manually override compromised systems. Policy makers can additionally support the industry's efforts by enforcing specific cybersecurity network codes for grid operators and its users, paving the way for a more secure grid within the expansion and digitalisation process.

A skilled grids workforce needs to be cultivated

A lack of skilled labour is commonly cited by the private sector as a major barrier to ramping up operations. Utilities and grid equipment manufacturers are no different. Firms will need to bring in new talent and reskill current employees to manage the expansion and upgrade of networks. The grid sector requires a greater share of highly skilled workers, with many occupations requiring substantial post-secondary schooling. The sector is increasingly requiring a high degree of digital skilling, as the number of digital devices and their sophistication grows. Bringing in new skillsets will need to be balanced against pressures to maintain cost efficiency, especially in regions with regulated utilities. Utilities in EMDEs still often employ a number of low-skilled workers and need to consider how increasing levels of automation could make these workers redundant.

Priority actions for policy makers to expand and upskill the power grid workforce are:

- **Work with educational institutions to add the necessary digital skills to the curriculum.** Many of the certification programmes for electricians, tradespeople, engineers and system operators do not cover key digital skills in depth. Industry can work with educators to incorporate these new elements into curricula, and work with authorities to introduce new requirements into existing certifications where needed. Pruning antiquated elements can help build a pipeline of appropriately skilled workers, while rigorous on-the-job training programmes remain important.
- **Introduce apprenticeships, scholarships and incentive schemes to build a pipeline of new talent.** The number of skilled electricians, tradespeople and other blue-collar positions will need to increase the most when upgrading and building new grid infrastructure – and all these occupations are facing shortages in many parts of the world. The right incentives and programmes can help draw young people into these occupations. Many workers, such as electricians, may have the majority of the skills needed, but need additional training in specific areas. Minimising the transaction costs for them to upskill and recertify can help quickly expand the eligible labour force for these positions.
- **Support workforce capacity development across the entire field.** It is not only grid operators that require professional and skilled workers, but the entire sector. Regulatory authorities, policymaking institutions, financial institutions and planning bodies all require workers that are skilled and versed in the topic of energy and power grids. Given its technical nature, special attention should be given to support the development of worker capabilities in these institutions.
- **Manage the effects of increased automation on workers.** Many regions have utility workers who may be made redundant by the shift to a more digital grid, especially those working as meter readers, customer service representatives and some tradespeople. Helping these workers access economy-wide reskilling programmes can help ease this transition. Additionally, governments can put in place incentives for large multinational suppliers to provide on-the-job training and employ local workers during the construction of these systems to create a domestic labour force with valuable knowhow, which can then work in other parts of the economy..

Annex

Abbreviations and acronyms

3DEN	Digital Demand Driven Networks
AC	alternating current
ACER	Agency for the Cooperation of Energy Regulators
AI	artificial intelligence
APAEC	ASEAN Plan of Action for Energy Cooperation
APG	ASEAN Power Grid
APS	Announced Pledges Scenario
ARERA	Italian Regulatory Authority for Energy, Networks and Environment
ASEAN	Association of Southeast Asian Nations
BOO	build, own and operate
BOOT	build, own, operate and transfer
BOT	build, operate and transfer
BTO	build, transfer and operate
BPLE	Korean Basic Plan for Long-term Electricity Supply and Demand
CAGR	compound annual growth rate
CAPEX	capital expenditure
CBA	cost benefit analysis
CBCA	Cross-Border Cost Allocation
CEA	Central Electricity Authority
CRE	Commission de régulation de l'énergie
CSG	China Southern Grid
DC	direct current
DG	distributed generation
DER	distributed energy resources
DERMS	distributed energy resources management system
DSO	distribution system operators
ECOWAS	Economic Community of West African States
EDSA	Embedded Device Security Assurance
EGAT	Electricity Generating Authority of Thailand
EMDEs	emerging market and developing economies
ENTSO-E	European Network of Transmission System Operators for Electricity
ESO	Electricity System Operator
EU	European Union
EV	electric vehicle
FACTS	flexible AC transmission system
FERC	US Federal Regulatory Energy Commission
GIS	geographic information systems
GOES	grain-oriented electrical steel
GRIP	Grid Resilience Innovative Partnership

GDP	gross domestic product
GHG	greenhouse gas
HTLS	high-temperature low-sag
HVAC	high-voltage alternating current
HVDC	high-voltage direct current
IEA	International Energy Agency
IEC	International Electrotechnical Commission
IPT	independent power transmission
IRA	Inflation Reduction Act of 2022
ISO	independent system operators
ISP	Australian Integrated System Plan
IT	information technology
LCC	line commutated converters
LDV	light-duty vehicles
LiDAR	light detection and ranging
NEP	Indian National Electricity Plan
NOES	non-oriented electrical steel
NRA	national regulatory authority
NZE	Net Zero Emissions by 2050 Scenario
OCCTO	Organization for Cross-regional Coordination of Transmission Operators
OFGEM	Office of Gas and Electricity Market
OFTO	offshore transmission network owner
OPEX	operational expenditure
PAR/PEL	Brazilian Medium-Term National Grid Operation Plan
PCI	projects of common interest
PDE	Brazilian Ten-Year Energy Expansion Plan
PET	Brazilian Transmission Expansion Programme
PELP	Brazilian Long-Term Expansion Plan
PDP	power development plan
POTEE	Electric Power Transmission Concession Plan
PPP	public-private partnership
PV	photovoltaics
RAB	regulated asset base
RDSS	Revamped Distribution Sector Scheme
REZ	renewable energy zones
RTE	Réseau de Transport d'Électricité
RUPTL	Indonesian National Electricity Supply Business Plan
SAIDI	System Average Interruption Duration Index
SCADA	supervisory control and data acquisition
SGCC	State Grid Corporation of China
SIEPAC	Central American Electrical Interconnection System
SOE	state-owned enterprises
SPU	spark prevention unit
STATCOM	static synchronous compensators
SVC	static VAR compensators

T&D	transmission and distribution
TEN-E	Trans-European Networks for Energy
TOTEX	total expenditure
TSO	transmission system operators
TYNDP	European Ten-Year Network Development Plan
UHV	ultra-high-voltage
US	United States
VAR	volt-ampere reactive
VPN	virtual private network
VRE	variable renewable energy
VSC	voltage source converters
WAMS	wide area management system

Glossary

AUD	Australian dollar
BRL	Brazilian Real. Exchange rate: 1 BRL = EUR 0.20 = USD 0.19 (2022 average)
C-km	circuit kilometres
CNY	Chinese Yuan. Exchange rate: 1 CNY = EUR 0.16 = USD 0.15 (2022 average)
CO ₂	carbon dioxide
EJ	exajoules
EUR	Euros. Exchange rate: 1 EUR = USD 1.05 (2022 average)
Gt	gigatonne
Gt CO ₂	gigatonne of carbon dioxide
GBP	British Pound Sterling. Exchange rate: 1 GBP = EUR 1.30 = USD 1.23 (2022 average)
GW	gigawatt
GW-mi	gigawatt-miles
GWh	gigawatt hour
Hz	Hertz
kg	kilogramme
kg/MW/km	kilogrammes per megawatt per kilometre
km	kilometre
kV	kilovolt
Mt	million tonnes
MVA	megavolt ampere
MW	megawatt
MWh	megawatt hour
SF ₆	sulfur hexafluoride
TW	terawatt
TWh	terawatt hour
USD	United States Dollars

International Energy Agency (IEA).

This work reflects the views of the IEA Secretariat but does not necessarily reflect those of the IEA's individual member countries or of any particular funder or collaborator. The work does not constitute professional advice on any specific issue or situation. The IEA makes no representation or warranty, express or implied, in respect of the work's contents (including its completeness or accuracy) and shall not be responsible for any use of, or reliance on, the work.



Subject to the IEA's [Notice for CC-licensed Content](#), this work is licenced under a [Creative Commons Attribution 4.0 International Licence](#).

This document and any map included herein are without prejudice to the status of or sovereignty over any territory, to the delimitation of international frontiers and boundaries and to the name of any territory, city or area.

Unless otherwise indicated, all material presented in figures and tables is derived from IEA data and analysis.

IEA Publications
International Energy Agency
Website: www.iea.org
Contact information: www.iea.org/contact

Typeset in France by IEA - October 2023
Cover design: IEA
Photo credits: © Shutterstock

Revised version, September 2023
Information notice found at: www.iea.org/corrections

