

CLICK ANYWHERE on THIS PAGE to RETURN to RELIANCE WATER HEATER AGE & MANUALS at [InspectApedia.com](http://InspectApedia.com)

# Installation Instructions and Use & Care Guide RESIDENTIAL GAS WATER HEATERS

For Manufactured (Mobile) Homes

## FVIR GAS WATER HEATER (FLAMMABLE VAPOR IGNITION RESISTANT)

FOR POTABLE WATER HEATING ONLY.  
NOT SUITABLE FOR SPACE HEATING

FOR USE ONLY IN A MANUFACTURED  
(MOBILE) HOME AND SHALL NOT BE INSTALLED IN THE  
OCCUPIED SPACE OF THAT MOBILE HOME

SHIPPED SET FOR NATURAL GAS AND CONVERTIBLE TO  
L.P. PROPANE GAS  
(ALL PARTS INCLUDED)

This water heater complies with ANSI Z21.10.1-current edition regarding the accidental or unintended ignition of flammable vapors, such as those emitted by gasoline.

- Safety Instructions
- Installation
- Operation
- Care and Maintenance
- Troubleshooting
- Parts List

### INSTALLER:

- AFFIX THESE INSTRUCTIONS TO OR ADJACENT TO THE WATER HEATER.

### OWNER:

- RETAIN THESE INSTRUCTIONS AND WARRANTY FOR FUTURE REFERENCE. RETAIN THE ORIGINAL RECEIPT AS PROOF OF PURCHASE.

**WARNING:** Gas leaks can not always be detected by smell.

Gas suppliers recommend that you use a gas detector approved by UL or CSA.

For more information, contact your gas supplier.

If a gas leak is detected, follow the "WHAT TO DO IF YOU SMELL GAS" instructions.

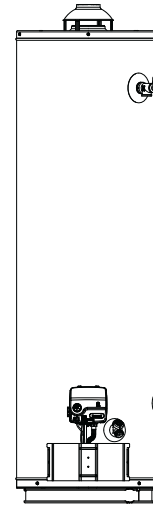

### For Your Safety





AN ODORANT IS ADDED TO THE GAS USED BY THIS WATER HEATER.

**WARNING:** If the information in these instructions is not followed exactly, a fire or explosion may result causing property damage, personal injury or death.

- Do not store or use gasoline or other flammable vapors and liquids in the vicinity of this or any other appliance.
- WHAT TO DO IF YOU SMELL GAS
  - Do not try to light any appliance.
  - Do not touch any electrical switch; do not use any phone in your building.
  - Immediately call your gas supplier from a neighbor's phone. Follow the gas supplier's instructions.
  - If you cannot reach your gas supplier, call the fire department.
- Installation and service must be performed by a qualified installer, service agency or the gas supplier.

ALL TECHNICAL AND WARRANTY QUESTIONS: SHOULD BE DIRECTED TO THE LOCAL DEALER FROM WHOM THE WATER HEATER WAS PURCHASED. IF YOU ARE UNSUCCESSFUL, CONTACT THE COMPANY LISTED ON THE RATING PLATE ON THE WATER HEATER.

## SAFE INSTALLATION, USE AND SERVICE

	This is the safety alert symbol. It is used to alert you to potential personal injury hazards. Obey all safety messages that follow this symbol to avoid possible injury or death.
 <b>DANGER</b>	<b>DANGER</b> indicates an imminently hazardous situation which, if not avoided, will result in death or injury.
 <b>WARNING</b>	<b>WARNING</b> indicates a potentially hazardous situation which, if not avoided, could result in death or injury.
 <b>CAUTION</b>	<b>CAUTION</b> indicates a potentially hazardous situation which, if not avoided, could result in minor or moderate injury.
<b>CAUTION</b>	<b>CAUTION</b> used without the safety alert symbol indicates a potentially hazardous situation which, if not avoided, could result in property damage.

Your safety and the safety of others is extremely important in the installation, use and servicing of this water heater.

Many safety-related messages and instructions have been provided in this manual and on your own water heater to warn you and others of a potential injury hazard. Read and obey all safety messages and instructions throughout this manual. It is very important that the meaning of each safety message is understood by you and others who install, use or service this water heater.

**All safety messages will generally tell you about the type of hazard, what can happen if you do not follow the safety message and how to avoid the risk of injury.**



The California Safe Drinking Water and Toxic Enforcement Act requires the Governor of California to publish a list of substances known to the State of California to cause cancer, birth defects, or other reproductive harm, and requires businesses to warn of potential exposure to such substances. **WARNING:** This product contains a chemical known to the State of California to cause cancer, birth defects, or other reproductive harm. This appliance can cause low-level exposure to some of the substances included in the act.

This product is certified to comply with a maximum weighted average of 0.25% lead content as required in some areas.

### IMPORTANT DEFINITIONS

- **Qualified Technician:** A qualified technician must have ability equivalent to a licensed tradesman in the fields of plumbing, air supply, venting, and gas supply, including a thorough understanding of the requirements of the National Fuel Gas Code as it relates to the installation of gas fired water heaters. The qualified technician must also be familiar with the design features and use of flammable vapor ignition resistant water heaters, and have a thorough understanding of this instruction manual.
- **Service Agency:** A service agency also must have ability equivalent to a licensed tradesman in the fields of plumbing, air supply, venting and gas supply, including a thorough understanding of the requirements of the National Fuel Gas Code as it relates to the installation of gas fired water heaters. The service agency must also have a thorough understanding of this instruction manual, and be able to perform repairs strictly in accordance with the service guidelines provided by the manufacturer.
- **Gas Supplier:** The natural gas or propane utility or service who supplies gas for utilization by the gas burning appliances within this application. The gas supplier typically has responsibility for the inspection and code approval of gas piping up to and including the natural gas meter or propane storage tank of a building. Many gas suppliers also offer service and inspection of appliances within the building.

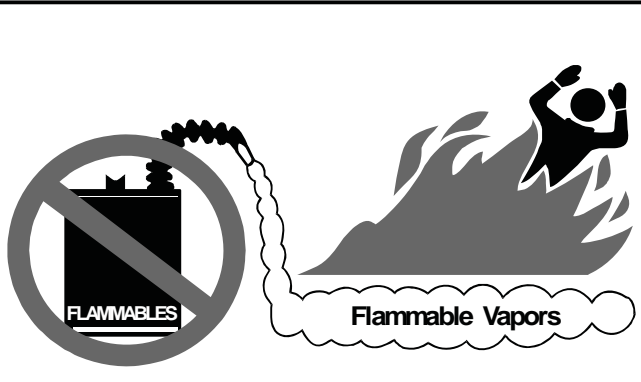
## SAFETY PRECAUTIONS

	<div style="text-align: center; background-color: black; color: white; padding: 5px;"><b> WARNING</b></div> <div style="text-align: center; font-weight: bold; padding: 5px;"><b>FIRE AND EXPLOSION HAZARD</b></div> <p style="text-align: center;">Can result in serious injury or death</p> <p> <b>Do not store or use gasoline or other flammable vapors and liquids in the vicinity of this or any other appliance. Storage of or use of gasoline or other flammable vapors or liquids in the vicinity of this or any other appliance can result in serious injury or death.</b></p>
<p><b>Read and follow water heater warnings and instructions.</b></p>	



**⚠ WARNING**

Read and understand instruction manual and safety messages before installing, operating or servicing this water heater.

Failure to follow instructions and safety messages could result in death or serious injury.

Instruction manual must remain with water heater.



**⚠ WARNING**

**Fire Hazard**

For continued protection against risk of fire:

- Do not install water heater on carpeted floor.
- Do not operate water heater if flood damaged.

**⚠ DANGER**

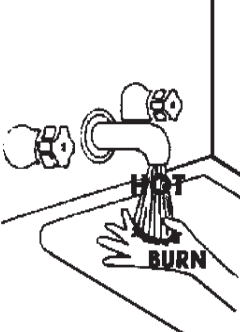

Water temperature over 125°F (52°C) can cause severe burns instantly resulting in severe injury or death.

Children, the elderly, and the physically or mentally disabled are at highest risk for scald injury.

Feel water before bathing or showering.

Temperature limiting valves are available.

Read instruction manual for safe temperature setting.

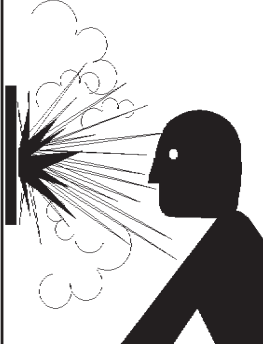

**⚠ WARNING**

**Explosion Hazard**



- Overheated water can cause water tank explosion.
- Properly sized temperature and pressure relief valve must be installed in opening provided.

**⚠ WARNING**

**Fire or Explosion Hazard**

- Do not store or use gasoline or other flammable vapors and liquids in the vicinity of this or any other appliance.
- Avoid all ignition sources if you smell Natural or LP gas.
- Do not expose water heater control to excessive gas pressure.
- Use only gas shown on rating plate.
- Maintain required clearances to combustibles.
- Keep ignition sources away from faucets after extended period of non-use.

Read instruction manual before installing, using or servicing water heater.

**⚠ WARNING**

**Breathing Hazard - Carbon Monoxide Gas**



- Install vent system in accordance with codes.
- Do not operate water heater if flood damaged.
- High altitude orifice must be installed for operation above 10,100 feet (3,078 m)
- Do not operate if soot is present.
- Do not obstruct water heater air intake with insulating jacket.
- Do not place chemical vapor emitting products near water heater.
- Gas and carbon monoxide detectors are available.



Breathing carbon monoxide can cause brain damage or death. Always read and understand instruction manual.

**⚠ WARNING**

**Fire or Explosion Hazard**

- Hydrogen gas can be produced in a hot water system after a period of non-use (generally two or more weeks).
- Hydrogen gas is extremely flammable and can ignite.
- To return hot water system to service, open a hot water faucet in kitchen for several minutes before using electrical appliances.
- Do not smoke or have open flame near faucet while it is open.
- Leave hot water faucet open until the sound of escaping air stops.

After extended period of non-use, purge gases from hot water system.

**CAUTION**

**Improper installation and use may result in property damage.**

- Do not operate water heater if flood damaged.
- Inspect and replace anode.
- Install in location with drainage.
- Fill tank with water before operation.
- Be alert for thermal expansion.

Refer to instruction manual for installation and service.

# TABLE OF CONTENTS

SAFE INSTALLATION, USE AND SERVICE.....	2
SAFETY PRECAUTIONS.....	2-3
TABLE OF CONTENTS.....	4
TYPICAL INSTALLATION.....	5
INSTALLING YOUR GAS WATER HEATER.....	6
Important Information About Your Water Heater.....	6
Consumer Information.....	6
Consumer Responsibilities.....	6
Unpacking the Water Heater.....	6
Location Requirements.....	7
Site Location.....	7-8
Securing Water Heater to Floor and Wall.....	8
Clearances and Accessibility.....	8
Filling the Water Heater.....	9
GAS CONVERSION.....	9-10
GAS SUPPLY.....	11-12
Gas Requirements.....	11
Gas Piping.....	11
Gas Pressure.....	11
Gas Pressure Testing.....	11
LP Gas Only.....	12
COMBUSTION AIR SUPPLY AND VENTILATION.....	13-14
Vent Pipe System.....	13
Draft Hood Installation.....	13
Roof Jack Installation.....	13
Enclosure Installations.....	14
WATER SYSTEM PIPING.....	15-17
Piping Installation.....	15
Water Piping Pressure Test.....	16
Closed System/Thermal Expansion.....	16
Temperature and Pressure Relief Valve.....	16
T&P Relief Valve and Pipe Insulation (Some Models).....	17
IMPORTANT INFORMATION ABOUT THIS WATER HEATER.....	18
OPERATING YOUR WATER HEATER.....	19-23
Lighting Instructions.....	19-20
Checking the Draft.....	21
Burner Flames.....	21
Emergency Shut Down.....	21
Water Temperature Regulation.....	21-22
Operational Conditions.....	22-23
MAINTENANCE OF YOUR WATER HEATER.....	24-29
Routine Preventive Maintenance.....	24
Anode Rod Inspection.....	24
Temperature-Pressure Relief Valve Operation.....	24-25
Draining and Flushing.....	25
Replacement Parts.....	25
External Inspection & Cleaning of the Base-Ring Filter.....	25
Removing the Manifold/Burner Assembly.....	25-26
Removing the Burner from the Manifold/Burner Assembly.....	26
Replacing the Pilot/Thermopile Assembly.....	26-27
Cleaning the Combustion Chamber and Flame-arrestor.....	27
Replacing the Manifold/Burner Assembly.....	27-28
Piezoelectric Igniter System.....	28
Testing the Igniter System.....	28
Removing and Replacing the Gas Control Valve/Thermostat.....	28-29
FVIR System Operational Checklist.....	29
TROUBLESHOOTING CHART.....	30-31
PILOT LIGHT TROUBLESHOOTING FLOWCHART.....	32
STATUS LIGHT AND DIAGNOSTIC CODE TROUBLESHOOTING CHART.....	33-34
REPAIR PARTS ILLUSTRATION.....	35

# TYPICAL INSTALLATION

## GET TO KNOW YOUR WATER HEATER - GAS MODELS

- |                             |                                     |  |
|-----------------------------|-------------------------------------|--|
| A Vent Pipe                 | J Inner Door                        | S Gas Control Valve/Thermostat   |
| B Draft Hood                | K Outer Door                        | T Drain Valve  |
| C Anode (Not Shown)         | L Union                             | U Manifold/Burner Assembly   |
| D Hot Water Outlet          | M Inlet Water Shut-off Valve        | V Flue   |
| E Insulation                | N Cold Water Inlet                  | W Metal Drain Pan  |
| F Gas Supply Piping         | O Inlet Dip Tube (Not Shown)        | X Piezo Igniter (bottom, Left-hand Side of Gas Control Valve/Thermostat) |
| G Manual Gas Shut-off Valve | P Temperature-Pressure Relief Valve | Y Base-Ring Filter   |
| H Ground Joint Union        | Q Rating Plate                      | Z Roof Jack (Various Models)   |
| I Sediment Trap             | R Flue Baffle                       |  |

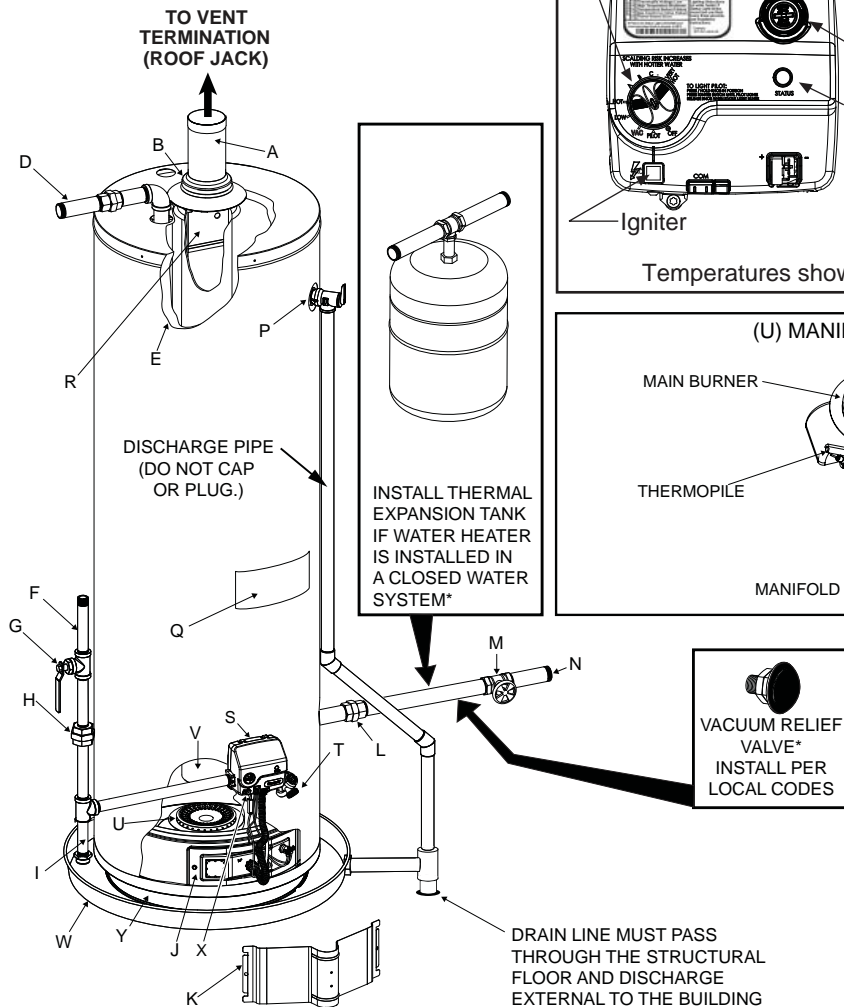
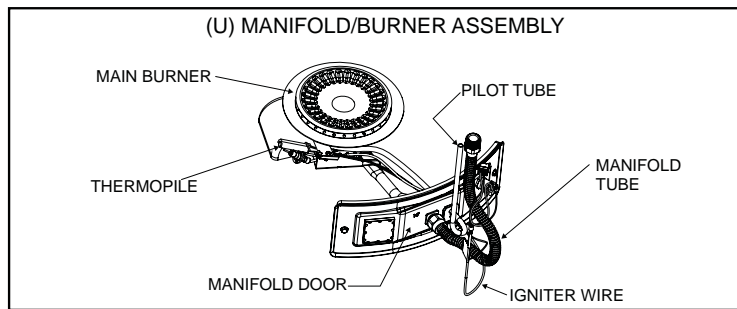
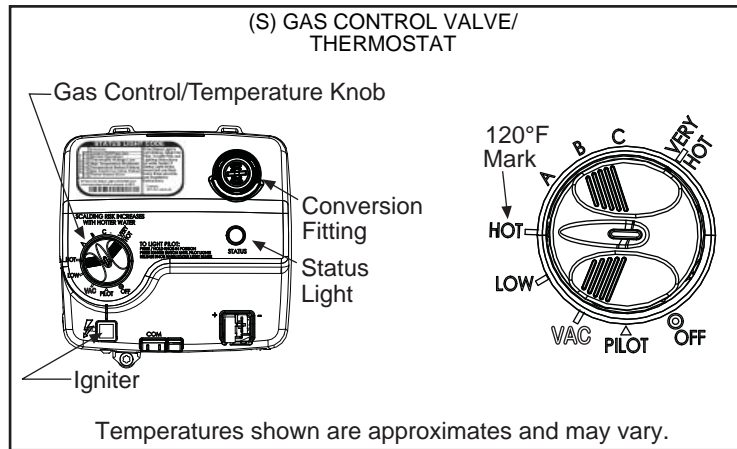
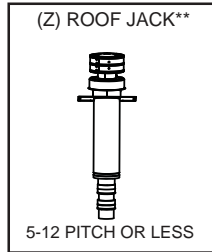
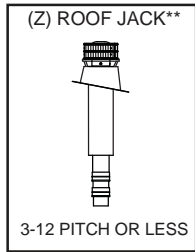

\* ALL PIPING MATERIALS TO BE SUPPLIED BY CUSTOMERS.

\*\* ROOF JACK NOT FURNISHED.

FIGURE 1.

- \* INSTALL IN ACCORDANCE WITH LOCAL CODES.
- \* SEDIMENT TRAP AS REQUIRED BY LOCAL CODES.
- \* SECURE WATER HEATER TO FLOOR AND WALL AS DESCRIBED IN THIS MANUAL.
- \* INSTALLATION SHOULD COMPLY WITH THE "ENCLOSURE INSTALLATION" SECTION OF THIS MANUAL.



# INSTALLING YOUR GAS WATER HEATER

## Important Information About Your Water Heater

This gas water heater was manufactured to voluntary safety standards to reduce the likelihood of a flammable vapor ignition incident. New technology used in meeting these standards makes this product more sensitive to installation errors or improper installation environments. Please review the Installation Checklist section and make any required installation upgrades or changes. **IMPORTANT:** This water heater is shipped from the factory as a natural gas unit. However, it may be converted to use LP gas. See the Gas Conversion section for more information.

## Consumer Information

- The installation must conform with these instructions and the local code authority having jurisdiction. In the absence of local and state codes, installations shall comply with the "National Fuel Gas Code," ANSI Z223.1 (NFPA 54) -current edition.

Manufactured home manufacturers: The installation must conform to "The Manufactured Home Construction and Safety Standard, Title 24 CFR, Part 3280."

These publications are available as follows:

The "National Fuel Gas Code" is available through The Canadian Standards Association, 8501 East Pleasant Valley Rd, Cleveland, Ohio 44131 or The National Fire Protection Association, 1 Batterymarch Park, Quincy, MA 02269.

"The Manufactured Home Construction and Safety Standard, Title 24 CFR, Part 3280" is available through The U.S. Department of Housing and Urban Development (HUD), 451 7th Street S.W., Washington, DC 20410. Offices are also located throughout the United States.

Check your phone listings for the local authorities having jurisdiction over your installation.

- For California installation, this water heater must be braced, anchored, or strapped to avoid falling or moving during an earthquake. See instructions for correct installation procedures. Instructions may be obtained from California's Office of the State Architect, 1102 Q Street, Suite 5100, Sacramento, CA 95811. Instructions can also be downloaded to your computer at [www.dsa.dgs.ca.gov/Pubs](http://www.dsa.dgs.ca.gov/Pubs).
- Massachusetts Code requires this water heater to be installed in accordance with Massachusetts 248-CMR 2.00: State Plumbing Code and 248-CMR 5.00.
- Complies with 40 Ng/J NOx requirements of Texas and most California AQM Districts.

## Consumer Responsibilities

- Carefully plan the place where you are going to put the water heater. Correct combustion, vent action, and vent pipe installation are very important in preventing death from possible carbon monoxide poisoning and fires. See Figures 1, 9, and 10.

Examine the location to ensure the water heater complies

with the installation instructions in this manual.

- Do not discard this manual. You or future users of this water heater will need it for future reference.
- Service to the FVIR System should only be performed by a qualified technician. Examples of a qualified technician include: licensed plumbers, authorized gas company personnel, and authorized service personnel.
- **IMPORTANT:** The manufacturer and seller of this water heater will not be liable for any damages, injuries, or deaths caused by failure to comply with the installation and operating instructions outlined in this manual. If you lack the necessary skills required to properly install this water heater, or you have difficulty following the instructions, you should not proceed, but have a qualified technician perform the installation of this water heater.
- A rating plate identifying your water heater can be found on the front of your water heater. When referring to your water heater, always have the information listed on the rating plate readily available. Retain your original receipt as proof of purchase.

## Unpacking the Water Heater

<p><b>⚠ WARNING</b></p> <p><b>Excessive Weight Hazard</b></p> <p>Use two or more people to move and install the water heater. Failure to do so can result in injury (including back injury).</p>
--

**IMPORTANT:** Do not remove any permanent instructions, labels, or the data label from either the outside of the water heater or on the inside of water heater panels.

- Remove exterior packaging and place installation components aside.
- Inspect all parts for damage prior to installation and start-up.
- Completely read all instructions before attempting to assemble and install this product.
- After installation, dispose of/recycle all packaging materials.

<p><b>⚠ DANGER</b></p> <p>Do not use this water heater with any gas other than the one listed on the data plate unless the water heater has been properly converted.</p> <p>Refer to the "Gas Conversion" section of this manual to convert from one gas to another. Failure to use the correct gas can cause problems which can result in death, serious bodily injury or property damage. If you have any questions or doubts, consult your gas supplier or gas utility company. Water heaters using bottled propane or liquefied petroleum gas (LPG) are different from natural gas models. A natural gas water heater will not function safely on bottled propane or liquefied petroleum gas (LPG) and a propane gas water heater will not function safely on natural gas.</p>
--

## Location Requirements

<b>⚠ WARNING</b>
<b>Carbon Monoxide Poisoning Hazard</b>
Do not install this water heater in any occupied space of the manufactured (mobile) home.
Doing so can result in carbon monoxide poisoning and death.

The FVIR System is designed to reduce the risk of flammable vapor-related fires. The patented system protects your family by trapping the burning vapors within the water heater combustion chamber through the special flame-arrestor. The burning vapors literally “burn themselves out” without escaping back into the room. In the event of a flammable vapor incident, the FVIR System disables the water heater by shutting off the gas supply to the water heater’s burner and pilot, preventing re-ignition of any remaining flammable vapors in the area. This will not prevent a possible fire/explosion if the igniter is depressed and flammable vapors have accumulated in the combustion chamber with the pilot light off. If you suspect a flammable vapor incident has occurred, do not use this appliance. Do not attempt to light this appliance, or depress the igniter button if you suspect flammable vapors have accumulated inside or outside the appliance. Immediately call a qualified technician to inspect the appliance. Water heaters subjected to a flammable vapors incident will show a discoloration on the flame-arrestor and require replacement of the entire water heater.

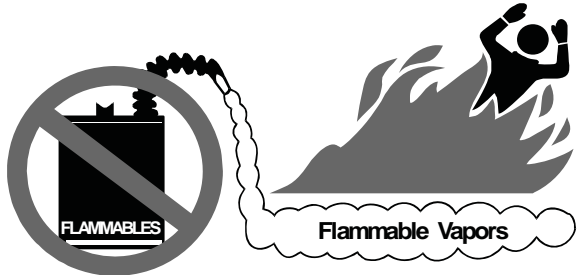
<b>⚠ WARNING</b>

<b>FIRE AND EXPLOSION HAZARD</b> Can result in serious injury or death
<b>⚠ Do not store or use gasoline or other flammable vapors and liquids in the vicinity of this or any other appliance. Storage of or use of gasoline or other flammable vapors or liquids in the vicinity of this or any other appliance can result in serious injury or death.</b>
<b>Read and follow water heater warnings and instructions.</b>

Do not use or store flammable products such as gasoline, solvents, or adhesives in the same room or area near the water heater. If such flammables must be used, all gas burning appliances in the vicinity must be shut off and their pilot lights extinguished. Open the doors and windows for ventilation while flammable substances are in use.

If flammable liquids or vapors have spilled or leaked in the area of the water heater, leave the area immediately and call the fire department from a neighbor’s home. Do not attempt to clean the spill until all ignition sources have been extinguished.

<b>⚠ WARNING</b>
<b>Fire or Explosion Hazard</b>
<ul style="list-style-type: none"><li>• Read instruction manual before installing, using or servicing water heater.</li><li>• Improper use may result in fire or explosion.</li><li>• Maintain required clearances to combustibles.</li></ul>

Keep combustibles such as boxes, magazines, clothes, etc. away from the water heater area.

## Site Location

- DO NOT install this water heater in any occupied space of the manufactured (mobile) home. There shall be no openings between the occupied space of the manufactured (mobile) home and the water heater enclosure.
- The water heater must be installed indoors and in a vertical position on a level surface. Do not install in bathrooms, bedrooms, or any occupied room normally kept closed.
- Locate the water heater near the existing gas piping. If installing a new gas line, locate the water heater to minimize the pipe length and elbows.
- The water heater should be located in an area not subject to freezing temperatures. Water heaters located in unconditioned spaces may require insulation of the water piping and drain piping to protect against freezing. The drain and controls must be easily accessible for operation and service. Maintain proper clearances as specified on the rating plate.
- Do not locate the water heater near an air-moving device. The operation of air-moving devices such as exhaust fans, ventilation systems, clothes dryers, fireplaces, etc., can affect the proper operation of the water heater. Special attention must be given to conditions these devices may create. Flow reversal of flue gases may cause an increase of carbon monoxide inside of the dwelling.
- If the water heater is located in an area that is subjected to lint and dirt, it may be necessary to periodically clean the base-ring filter and flame-arrestor (see Cleaning the Combustion Chamber and Flame-arrestor).
- See also “Enclosure Installations” later in this manual.

NOTE: This water heater must be installed according to all local and state codes or, in the absence of local and state codes, the “National Fuel Gas Code”, ANSI Z223.1 (NFPA 54)-current edition. Manufactured home manufacturers must conform with “The Manufactured Home Construction and Safety Standard, Title 24 CFR, Part 3280”.

# CAUTION

## Property Damage Hazard

- All water heaters eventually leak
- Do not install without adequate drainage.

**IMPORTANT:** The water heater should be located in an area where leakage of the tank or connections will not result in damage to the area adjacent to the water heater or to lower floors of the structure. Due to the normal corrosive action of water, the tank will eventually leak after an extended period of time. Also any external plumbing leak, including those from improper installation, may cause early failure of the tank due to corrosion if not repaired. If the homeowner is uncomfortable with making the repair, a qualified technician should be contacted. A suitable metal drain pan should be installed under the water heater as shown below, to help protect the property from damage which may occur from condensate formation or leaks in the piping connections or tank. The pan must limit the water level to a maximum depth of 1-3/4" and be two inches wider than the heater and piped to an adequate drain. **NOTE:** The pan must not restrict combustion air flow. Locate the water heater near an adequate drain (Figure 1). In cold climates, it is recommended that the drain pipe be terminated at an adequate drain inside the building. The piping should be at least 3/4" ID and pitched for proper drainage.

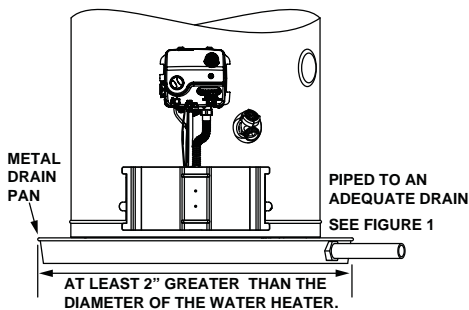

FIGURE 2.

Water heater life depends upon water quality, water usage, water temperature and the environment in which the water heater is installed. Water heaters are sometimes installed in locations where leakage may result in property damage, even with the use of a metal drain pan piped to a drain. However, unanticipated damage can be reduced or prevented by a leak detector or water shut-off device used in conjunction with a piped metal drain pan. These devices are available from some plumbing supply wholesalers and retailers, and detect and react to leakage in various ways:

- Sensors mounted in the metal drain pan that trigger an alarm or turn off the incoming water to the water heater when water is detected.
- Sensors mounted in the metal drain pan that turn off the water supply to the entire home when water is detected in the drain pan.
- Water supply shut-off devices that activate based on the water pressure differential between the cold water and hot water pipes connected to the water heater.
- Devices that will turn off the gas supply to a gas water heater while at the same time shutting off its water supply.

## Securing Water Heater to Floor and Wall

The water heater must be secured to the floor and to the wall of the enclosure as described below. See also "Enclosure Installations."

1. After properly locating the water heater, fasten it to the floor with the brackets and screws that were provided (Figure 3). Simply pre-drill each screw location in the metal drain pan and water heater jacket with a 1/8" drill bit. Because of installation variances, these brackets can be located at any points around the circumference of the jacket. However, they should be spaced apart at equal distances.

**CAUTION:** When making pilot holes in the water heater itself, ensure that you drill only the outer jacket. Also, to prevent leaks in the metal drain pan, seal each drill location with a heavy bead of silicone sealant.

2. Secure the top of the water heater with the provided bracket and screws or install other acceptable means of support (e.g., support strap).

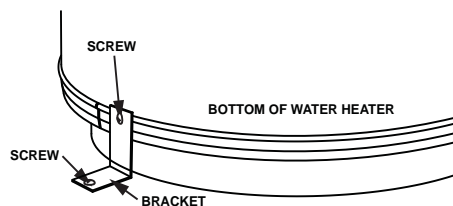

FIGURE 3.

## Clearances and Accessibility

**NOTE:** Minimum clearances from combustible surfaces are stated on the label adjacent to the gas control valve/thermostat of the water heater. The water heater is certified for installation on a combustible floor.

- **IMPORTANT:** If installing over carpeting, the carpeting must be protected by a metal or wood panel beneath the water heater. The protective panel must extend beyond the full width and depth of the water heater by at least three inches (76.2mm) in any direction; or if in an alcove or closet installation, the entire floor must be covered by the panel.
- Figure 4 may be used as a reference guide to locate the specific clearance locations. A minimum of 24 inches of front clearance should be provided for inspection and service.

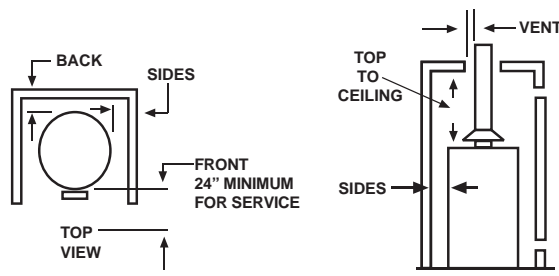

FIGURE 4.



## Filling the Water Heater

---

Never use this water heater unless it is completely full of water. To prevent damage to the tank, the tank must be filled with water. Water must flow from the hot water faucet before turning "ON" gas to the water heater.

### CAUTION

#### Property Damage Hazard

- Avoid water heater damage.
- Fill tank with water before operating.

To fill the water heater with water:

- Close the water heater drain valve by turning the handle to the right (clockwise). The drain valve is on the lower front of the water heater.
- Open the cold water supply valve to the water heater.  
**NOTE: The cold water supply valve must be left open when the water heater is in use.**
- To ensure complete filling of the tank, allow air to exit by opening the nearest hot water faucet. Allow water to run until a constant flow is obtained. This will let air out of the water heater and the piping.
- Check all water piping and connections for leaks. Repair as needed.

---

## GAS CONVERSION

This water heater is originally shipped for use with **Natural Gas** but can be converted to LP (Propane) Gas by following the instructions outlined below. To convert this water heater you must change both the conversion fitting in the gas control valve/thermostat AND manifold/burner assembly (supplied). Both the gas valve and the manifold burner assembly must be correct for the type of gas used. If you are unsure about converting this water heater to use a different type of gas, contact a qualified person such as a plumber or your gas supplier.

1. Contact your gas company to determine the type of gas supplied to your home.
2. Check the setting of the conversion fitting in the gas control valve (see diagram).
3. Check the label on the manifold burner assembly door.
4. Make sure both the conversion fitting (figure 6) and the manifold burner assembly (see door label) are for the type of gas supplied to your home.
5. If you are converting this water heater from Natural to LP or from LP to Natural follow these steps:
  - Remove manifold burner assembly (see instructions on page 10)
  - Install correct conversion manifold burner assembly (see instructions on page 10).
  - Convert the gas control valve/thermostat to same type of gas (see instructions on page 10).
  - Place sticker next to data plate showing the type of gas this water heater has been converted to.

## GAS CONVERSION (Con't)

### ⚠ WARNING

- For your safety, the following procedures should be performed by a qualified technician as it involves disconnection of gas piping and leak testing.
- Do not connect a natural gas water heater to an L.P. gas supply.
- Do not connect an L.P. gas water heater to a natural gas supply.

### A. Remove the Manifold/Burner Assembly

1. Turn off the gas supply to the water heater at the manual gas shut-off valve. This valve is typically located beside the water heater. Note the position of the shut-off valve in the open/on position, then proceed to turn it off.
2. On the lower front of the water heater, locate the gas control valve/thermostat.
3. Turn the gas control/temperature knob to the "OFF" position. With the unit shut-off, allow sufficient time for the water heater to cool before performing any maintenance.
4. Remove the outer door.
5. Remove the two screws securing the installed manifold door assembly to the combustion chamber (Figure 5).
6. Disconnect the following from the gas control valve/thermostat: pilot tube, igniter wire, and manifold tube. See Figure 5.
7. Using needle nose pliers, disconnect the white and red thermopile wires from the gas control valve/thermostat (Figure 5).
8. Grasp the manifold tube and push down slightly to free the manifold tube and pilot tube.
9. Carefully remove the manifold/burner assembly from the burner compartment. NOTE: Be sure not to damage internal parts.

### B. Convert the Gas Control Valve/Thermostat

1. Remove the cap (shown in Figure 6).
2. Remove the conversion fitting by turning it counter-clockwise with a flathead screwdriver.
3. Thread the opposite end of the conversion fitting into the opening by turning it clockwise, then tighten it with a flathead screwdriver.
  - a. LP GAS: If you are converting the unit to use LP gas (propane), verify that "LP" is marked on the exposed end of the fitting.

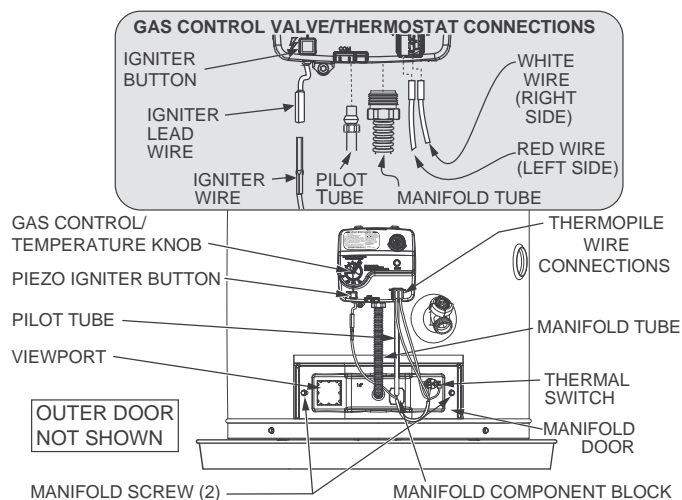

FIGURE 5.

of the fitting. "LP" must face outward (toward you.) See Figure 6. If "NAT" faces outward, repeat step 2.

- b. NATURAL GAS: If you are converting the unit to use natural gas, verify that "NAT" is marked on the exposed end of the fitting. "NAT" must face outward (toward you.) See Figure 6. If "LP" faces outward, repeat step 2.

4. Replace the cap.

### C. Install the Conversion Manifold/Burner Assembly

1. Check the door gasket for damage or imbedded debris prior to installation.
2. Inspect the view port for damage and replace as required.
3. Insert the conversion manifold/burner assembly into the burner compartment, making sure that the tip of the manifold tube engages in the slot of the bracket inside the combustion chamber.
4. Inspect the door gasket and make sure there is no fiberglass insulation between the gasket and the combustion chamber.
5. Replace the two screws that secure the manifold/burner assembly door to the combustion chamber, then tighten them securely. There should be no space between the gasket part of the manifold door and the combustion chamber. IMPORTANT: Do not operate the water heater if the door gasket does not create a seal between the manifold door and the combustion chamber.
6. Reconnect the manifold tube and pilot tube to the gas control valve/thermostat (Figure 5). Do not cross-thread or apply any thread sealant to the fittings. IMPORTANT: If you were supplied with a new ferrule nut in a parts kit, follow these steps to connect the pilot tube:
  - A.) Install the ferrule nut into the gas valve at the pilot tube location, hand tight only. B.) Insert the pilot tube into the ferrule nut until the tube bottoms out, then tighten the nut with a 7/16" wrench until the crimp connection seals to the pilot tube. C.) Continue to tighten until the nut is tight in the gas valve.
7. Connect the white and red thermopile wires to the gas control valve/thermostat. See Figure 5.
8. Reconnect the igniter wire.
9. Turn the gas supply on and follow the Lighting Instructions.
10. With the main burner lit, check for leaks at the manifold and pilot connections by brushing on an approved non-corrosive leak detection solution. If such a solution is not available, use a mixture of hand dish washing soap and water (one part soap to 15 parts water). Bubbles forming indicate a leak. Correct any leak found.
11. Verify proper operation; replace outer door.

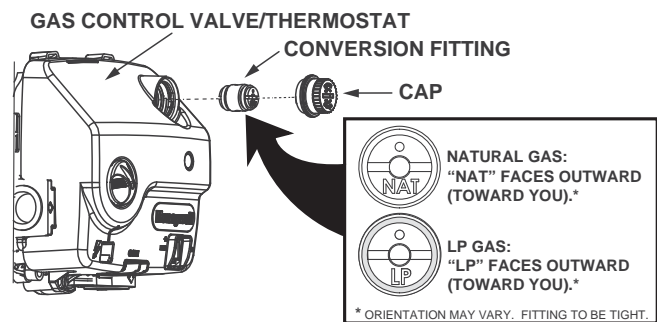

FIGURE 6.

## GAS SUPPLY

### ⚠ WARNING



#### Explosion Hazard

- Use a new CSA approved gas supply line.
- Install a shut-off valve.
- Do not connect a natural gas water heater to an L.P. gas supply.
- Do not connect an L.P. gas water heater to a natural gas supply.
- Failure to follow these instructions can result in death, explosion, or carbon monoxide poisoning.

### Gas Requirements

**IMPORTANT:** Read the rating plate to be sure the water heater is made for the type of gas you will be using in your home. This information will be found on the rating plate located near the gas control valve/thermostat. If the information does not agree with the type of gas available, do not install or light. Call your dealer.

**NOTE:** An odorant is added by the gas supplier to the gas used by this water heater. This odorant may fade over an extended period of time. Do not depend upon this odorant as an indication of leaking gas.

### Gas Piping

The gas piping must be installed according to all local and state codes or, in the absence of local and state codes, the "National Fuel Gas Code", ANSI Z223.1 (NFPA 54)-current edition. Manufactured home manufacturers must conform with "The Manufactured Home Construction and Safety Standard, Title 24 CFR, Part 3280".

Tables 1 and 2 on the following page provide a sizing reference for commonly used gas pipe materials. Consult the "National Fuel Gas Code" for the recommended gas pipe size of other materials.

**NOTE:** Use pipe joint compound or teflon tape marked as being resistant to the action of petroleum [Propane (L.P.)] gases. (See Figure 7.)

1. Install a readily accessible manual shut-off valve in the gas supply line as recommended by the local utility. Know the location of this valve and how to turn off the gas to this unit.
2. Install a drip leg (if not already incorporated as part of the water heater) as shown. The drip leg must be no less than three inches long for the accumulation of dirt, foreign material, and water droplets.
3. Install a ground joint union between the gas control valve/thermostat and the manual shut-off valve. This is to allow easy removal of the gas control valve/ thermostat.
4. Turn the gas supply on and check for leaks. Test all connections by brushing on an approved noncorrosive leak-detection solution. Bubbles will show a leak. Correct any leak found.

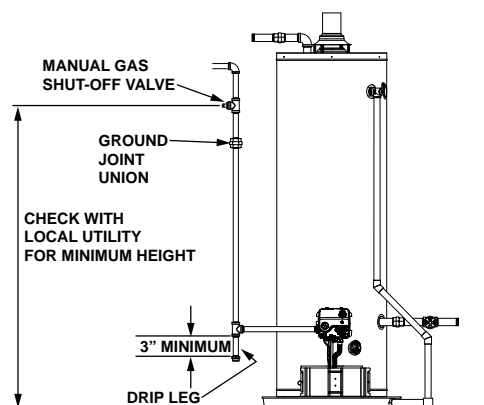

FIGURE 7.

### Gas Pressure

### ⚠ WARNING



#### Explosion Hazard

- Gas leaks can not always be detected by smell.
- Gas suppliers recommend that you use a gas detector approved by UL or CSA.
- For more information, contact your gas supplier.
- If a gas leak is detected, follow the "What to do if you smell gas" instructions on the cover of this manual.

**IMPORTANT:** The gas supply pressure must not exceed the maximum supply pressure as stated on the water heater's rating plate. The minimum supply pressure is for the purpose of input adjustment.

### Gas Pressure Testing

**IMPORTANT:** This water heater and its gas connection must be leak tested before placing the appliance in operation.

- If the code requires the gas lines to be tested at a pressure exceeding 14" W.C., the water heater and its manual shut-off valve must be disconnected from the gas supply piping system and the line capped.
- If the gas lines are to be tested at a pressure less than 14" W.C., the water heater must be isolated from the gas supply piping system by closing its manual shut-off valve.

U.L. recognized fuel gas and carbon monoxide (CO) detectors are recommended in all applications and should be installed using the manufacturer's instructions and local codes, rules and regulations.

**NOTE:** Air may be present in the gas lines and could prevent the pilot from lighting on initial start-up. The gas lines should be purged of air by a qualified technician after installation of the gas piping system. While purging the gas piping system of air, ensure that the fuel is not spilled in the area of the water heater installation, or any source of ignition. If the fuel is spilled while purging the piping system of air follow the "WHAT TO DO IF YOU SMELL GAS" instructions on the cover of this manual.

## LP Gas Only

Liquefied petroleum gas is over 50% heavier than air and in the occurrence of a leak in the system, the gas will settle at floor level. Basements, crawl spaces, skirted areas under mobile homes (even when ventilated), closets and areas below ground level will serve as pockets for the accumulation of gas. Before lighting an L.P. gas water heater, smell all around the appliance at floor level. If you smell gas, follow the instructions as given in the warning on the front page.

When your L.P. tank runs out of fuel, turn off the gas at all gas appliances including pilot lights. After the tank is refilled, all appliances must be re-lit according to their manufacturer's instructions.

**⚠ WARNING**



**Explosion Hazard**

**Have a qualified technician make sure that the L.P. gas operating pressure does not exceed 13" water column.**

**Failure to do so can result in death, explosion, or fire.**

**Table 1**  
**Natural Gas Pipe Capacity Table (Cu. Ft./Hr.)**  
 Capacity of gas pipe of different diameters and lengths in cu. ft. per hr. with pressure drop of 0.3 in. and specific gravity of 0.60 (natural gas).

Nominal Iron Pipe Size, in.	Length of Pipe, Feet													
	10	20	30	40	50	60	70	80	90	100	125	150	175	200
1/2	132	92	73	63	56	50	46	43	40	38	34	31	28	26
3/4	278	190	152	130	115	105	96	90	84	79	72	64	59	55
1	520	350	285	245	215	195	180	170	160	150	130	120	110	100
1-1/4	1050	730	590	500	440	400	370	350	320	305	275	250	225	210
1-1/2	1600	1100	890	760	670	610	560	530	490	460	410	380	350	320

After the length of pipe has been determined, select the pipe size which will provide the minimum cubic feet per hour required for the gas input rating of the water heater. By formula:

$$\text{Cu. Ft. Per Hr. Required} = \frac{\text{Gas Input of Water Heater (BTU/HR)}}{\text{Heating Value of Gas (BTU/FT}^3\text{)}}$$

The gas input of the water heater is marked on the water heater data plate. The heating value of the gas (BTU/FT<sup>3</sup>) may be determined by consulting the local natural gas utility.

**Table 2**  
**LP Gas Capacity Table**  
 Maximum capacity of pipe in thousands of BTU per hour of undiluted liquefied petroleum gases (at 11 inches water column pressure). Based on a pressure drop of 0.5 inch water column.

Nominal Iron Pipe Size, in.	Length of Pipe, Feet												
	10	20	30	40	50	60	70	80	90	100	125	150	
1/2	275	189	152	129	114	103	96	89	83	78	69	63	
3/4	576	393	315	267	237	217	196	185	173	162	146	132	
1	1071	732	590	504	448	409	378	346	322	307	275	252	
1-1/4	2205	1496	1212	1039	913	834	771	724	677	630	567	511	

Example: Input BTU requirement of the water heater 100,000 BTUH.  
 Total pipe length, 80 feet = 3/4" IPS required.

Additional tables are available in the latest edition of the "National Fuel Gas Code", ANSI Z223.1.

## COMBUSTION AIR SUPPLY AND VENTILATION

### ⚠️ WARNING

#### Carbon Monoxide Warning

**The vent system must be installed according to all local and state codes or, in the absence of local and state codes, the “National Fuel Gas Code”, ANSI Z223.1 (NFPA 54)-current edition. Manufactured home manufacturers must comply with the “Manufactured Home Construction and Safety Standard, Title 24 CFR, Part 3280.”**

**Failure to do so can result in death, explosion, or carbon monoxide poisoning.**

**IMPORTANT:** Air for combustion and ventilation must not come from a corrosive atmosphere. Any failure due to corrosive elements in the atmosphere is excluded from warranty coverage.

The following types of installation (not limited to the following) will require outdoor air for combustion due to chemical exposure and may reduce but not eliminate the presence of corrosive chemicals in the air:

- beauty shops
- photo processing labs
- buildings with indoor pools
- water heaters installed in laundry, hobby, or craft rooms
- water heaters installed near chemical storage areas

Combustion air must be free of acid-forming chemicals such as sulfur, fluorine, and chlorine. These elements are found in aerosol sprays, detergents, bleaches, cleaning solvents, air fresheners, paint, and varnish removers, refrigerants, and many other commercial and household products. When burned, vapors from these products form highly corrosive acid compounds. These products should not be stored or used near the water heater or air inlet.

### Vent Pipe System

This water heater uses a non-direct, single-pipe vent system to remove exhaust gases created by the burning of fossil fuels. Air for combustion is taken from the outside (see “Enclosure Installations”).

This water heater must be properly vented for the removal of exhaust gases to the outside atmosphere. Correct installation of the vent pipe system is mandatory for the proper and efficient operation of this water heater and is an important factor in the life of the unit.

The vent pipe must be installed according to all local and state codes or, in the absence of local and state codes, the “National Fuel Gas Code”, ANSI Z223.1 (NFPA 54)-current edition. Manufactured home manufacturers must conform with “The Manufactured Home Construction and Safety Standard, Title 24 CFR, Part 3280.” The vent pipe installation must not be obstructed so as to prevent the removal of exhaust gases to the outside atmosphere.

**IMPORTANT:** The use of vent dampers is not recommended by the manufacturer of this water heater. Although some vent dampers are certified by CSA International, this certification applies to the vent damper device only and does not mean they are certified for use on this water heater.

U.L. recognized fuel gas and carbon monoxide (CO) detectors are recommended in all applications and should be installed using the manufacturer’s instructions and local codes, rules, or regulations.

**IMPORTANT:**

- If you lack the necessary skills required to properly install this venting system, you should not proceed, but get help from a qualified technician.
- DO NOT common vent this water heater with any other appliance.

### Draft Hood Installation

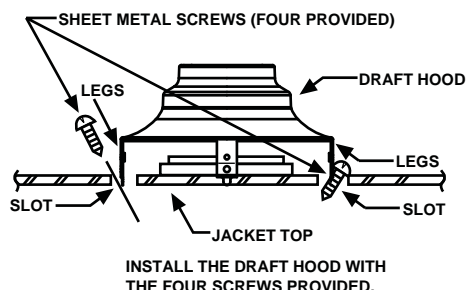

**FIGURE 8.**

Align the legs of the draft hood with the slots provided. Insert the legs and secure the draft hood to the water heater’s top with the four screws provided as shown in Figure 8. Do not alter the draft hood in any way. If you are replacing an existing water heater, be sure to use the draft hood supplied with this water heater.

### Roof Jack Installation

This water heater must have a properly-installed draft hood and be connected to a listed roof jack that terminates to the outdoors. The roof jack vent pipe must be secured to the draft hood with sheet metal screws. (Roof jack not furnished.)

The following roof jack models are certified for use with this water heater and are available from your water heater supplier:

Field Controls No. 987 for roof pitch of 5-12 or less:

KIT NUMBER	MAXIMUM LENGTH BETWEEN ROOF AND CEILING
9002964005	12”
9002965005	32”
9002966005	60”
9002967005	95”

White Metal Products 3RJ for roof pitch of 3-12 or less:

KIT NUMBER	MAXIMUM LENGTH BETWEEN ROOF AND CEILING
9007941005	14”
9007942005	30”

Install the roof jack according to its manufacturer’s instructions.



## Enclosure Installation

Air for combustion and ventilation must not be supplied from the occupied spaces of the manufactured (mobile) home. **IMPORTANT:** The opening that provides outside air to your water heater must have a minimum free area of 20 square inches. Also, ensure that your installation complies with all applicable code requirements.

The following methods may be used to provide sufficient combustion and ventilation air to the water heater when it is installed in the enclosure.

### Method I (Figure 9)

Provide a single air opening in the exterior door of the enclosure. The opening must have a minimum free area of 20 square inches. The bottom of the opening must be within 6 inches from the bottom edge of the door. Cover the opening with 1/4 inch wire mesh screen or louvers.

### Method II (Figure 10)

For enclosures with a solid exterior door, provide an air opening in the floor. The opening must have a minimum diameter of 5 inches (20 square inches minimum free area) and be covered with 1/4-inch wire mesh screen.

Also, if the manufactured home is skirted, an air intake opening with a minimum free area of 32 square inches must be provided in the skirt. Other gas fired appliances in the home may require additional free air openings. Consult the manufacturers for correct sizing.

#### IMPORTANT:

- When using Method II, ensure that the drain pan does not cover the air intake opening in the floor.
- A discharge line must be installed as described in the "Temperature and Pressure Relief Valve" section.
- Do not obstruct the combustion and ventilation air openings.
- Do not use the enclosure as a storage area.
- Secure the water heater as described in "Securing Water Heater to Floor and Wall."

**Method I:  
Door Opening**

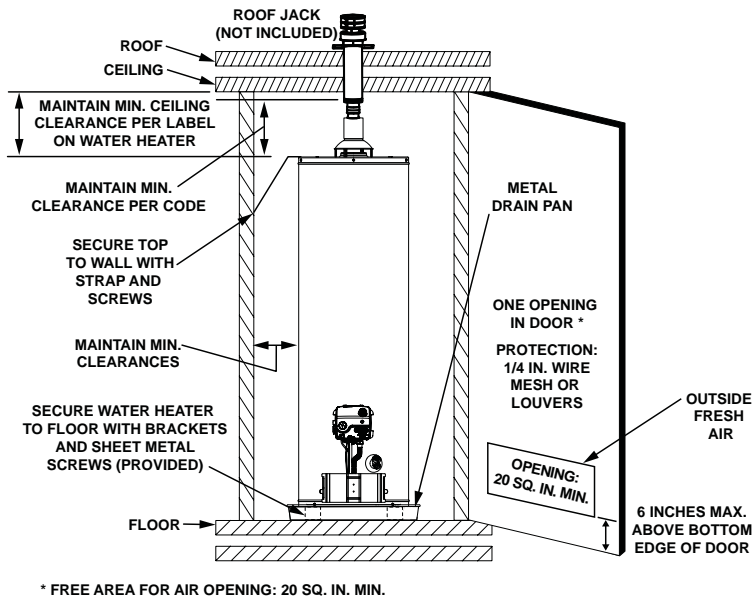

**FIGURE 9.**

**Method II:  
Floor Opening**

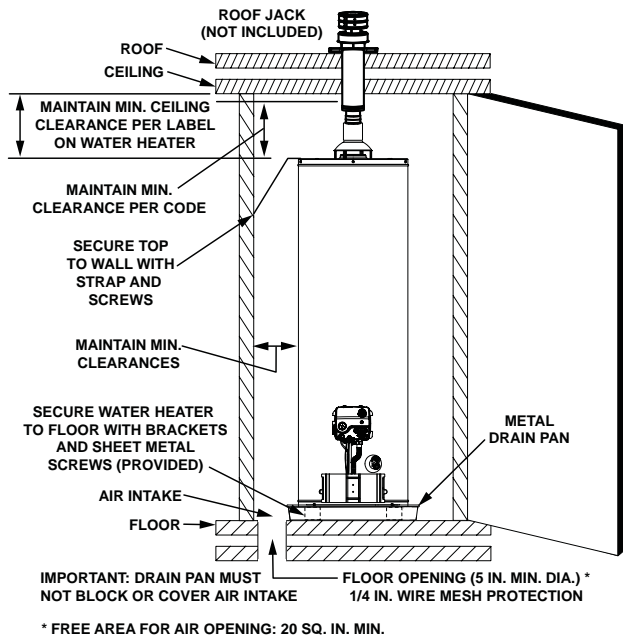

**FIGURE 10.**

# WATER SYSTEM PIPING

## Piping Installation

Piping, fittings, and valves should be installed according to the installation drawing (Figure 11). If the indoor installation area is subject to freezing temperatures, the water piping must be protected by insulation.

The water supply pressure should not exceed 80 psi. If this occurs, a pressure reducing valve with a bypass may need to be installed in the cold water inlet line. This should be placed on the supply to the entire house in order to maintain equal hot and cold water pressures.

**IMPORTANT:** Heat cannot be applied to the water fittings on the heater as they may contain nonmetallic parts. If solder connections are used, solder the pipe to the adapter before attaching the adapter to the hot and cold water fittings.

**IMPORTANT:** Always use a good grade of joint compound and be certain that all fittings are drawn up tight.

1. Install the water piping and fittings as shown in Figure 11. Connect the cold water supply (3/4" NPT) to the cold water inlet fitting. Connect the hot water supply (3/4" NPT) to the hot water outlet fitting.

**IMPORTANT:** Some models may contain energy saving heat traps to prevent the circulation of hot water within the pipes. Do not remove the inserts within the heat traps.

2. The installation of unions in both the hot and cold water supply lines is recommended for ease of removing the water heater for service or replacement.
3. The manufacturer of this water heater recommends installing a mixing valve or an anti-scald device in the domestic hot water line as shown in Figure 12. These valves reduce the point-of-use temperature of the water by mixing cold and hot water and are readily available for use.
4. If installing the water heater in a closed water system, install an expansion tank in the cold water line as specified under "Closed System/Thermal Expansion."
5. Install a shut-off valve in the cold water inlet line. It should be located close to the water heater and be easily accessible. Know the location of this valve and how to shut off the water to the heater.
6. A temperature and pressure relief valve must be installed in the opening marked "Temperature and Pressure (T & P) Relief Valve" on the water heater. A discharge line must be added to the opening of the T&P Relief Valve. Follow the instructions under "Temperature and Pressure Relief Valve."
7. After piping has been properly connected to the water heater, remove the aerator at the nearest hot water faucet. Open the hot water faucet and allow the tank to completely fill with water. To purge the lines of any excess air, keep the hot water faucet open for 3 minutes after a constant flow of water is obtained. Close the faucet and check all connections for leaks.

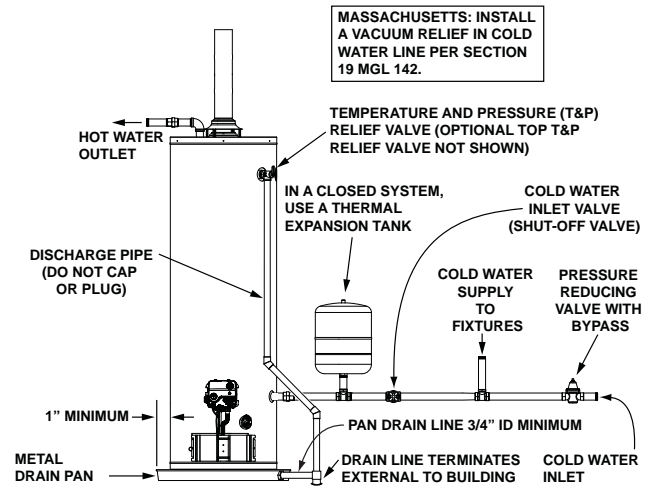

FIGURE 11.

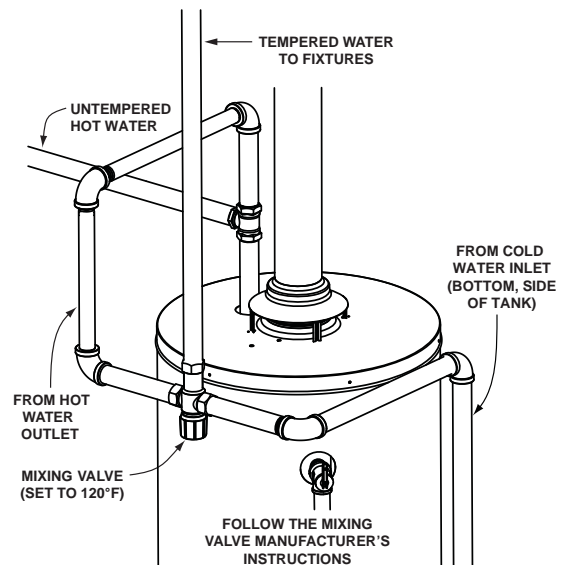

FIGURE 12.

Please note the following:

- The system should be installed only with piping that is suitable for potable (drinkable) water such as copper, CPVC, or polybutylene. This water heater must not be installed using iron piping or PVC water piping.
- Use only pumps, valves, or fittings that are compatible with potable water.
- It is recommended that only full flow ball or gate valves are used in water piping installations. The use of valves that may cause excessive restriction to water flow is not recommended.
- Use only 95/5 tin-antimony or other equivalent solder. Any lead based solder must not be used.
- Piping that has been treated with chromates, boiler seal, or other chemicals must not be used.
- Chemicals that may contaminate the potable water supply must not be added to the piping system.

## Water Piping Pressure Test

### ⚠ WARNING

If the water piping system is to be air pressure tested, the water heater must be disconnected from the water piping system. Failure to disconnect the water heater during air pressure testing of the water piping system could result in **DEATH, SERIOUS BODILY INJURY, OR PROPERTY DAMAGE.**

This section is only for the manufacturer installing the water heater when the installation is to comply with H.U.D. Standards. When testing the water ways, H.U.D. standards state: "Water distribution system. All water piping in the water distribution system shall be subjected to a pressure test. The test shall be made by subjecting the system to air or water at 100 psi for 15 minutes without loss of pressure. **When air pressure is used, the water heater shall not be connected during the test.**"

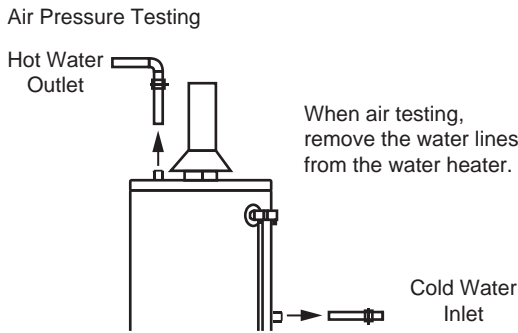

FIGURE 13.

## Closed System/Thermal Expansion

### CAUTION

#### Property Damage Hazard

- All water heaters eventually leak
- Do not install without adequate drainage.

As water is heated, it expands (thermal expansion). In a closed system, the volume of water will increase. As the volume of water increases, there will be a corresponding increase in water pressure due to thermal expansion. Thermal expansion can cause premature tank failure (leakage). This type of failure is not covered under the limited warranty. Thermal expansion can also cause intermittent temperature-pressure relief valve operation: water discharged from the valve due to excessive pressure build up. The temperature-pressure relief valve is not intended for the constant relief of thermal expansion. This condition is not covered under the limited warranty.

A properly-sized thermal expansion tank should be installed on all closed systems to control the harmful effects of thermal expansion. Contact a plumbing service agency or your retail supplier regarding the installation of a thermal expansion tank.

## Temperature and Pressure Relief Valve

### ⚠ WARNING

#### Explosion Hazard

- Temperature-pressure relief valve must comply with ANSI Z21.22-CSA 4.4 and ASME code.
- Properly sized temperature-pressure relief valve must be installed in opening provided.
- Do not plug, block, or cap the discharge line.
- Failure to follow this warning can result in excessive tank pressure, serious injury or death.

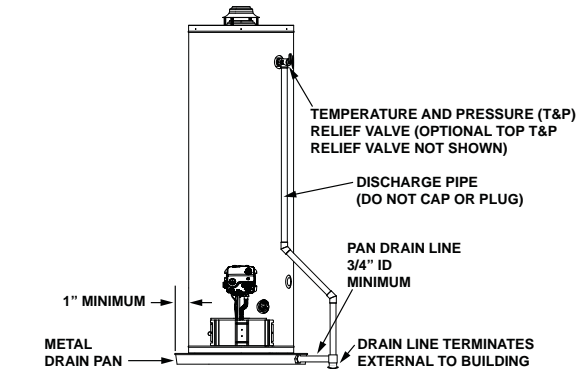

FIGURE 14.

For protection against excessive pressures and temperatures, a temperature and pressure relief valve must be installed in the opening marked "T & P RELIEF VALVE." (See Figure 14). This valve must be design certified by a nationally recognized testing laboratory that maintains periodic inspection of the production of listed equipment or materials as meeting the requirements for Relief Valves for Hot Water Supply Systems, ANSI Z21.22. The function of the temperature and pressure relief valve is to discharge water in large quantities in the event of excessive temperature or pressure developing in the water heater. The valve's relief pressure must not exceed the working pressure of the water heater as stated on the rating plate.

**IMPORTANT:** Only a new temperature and pressure relief valve should be used with your water heater. Do not use an old or existing valve as it may be damaged or not adequate for the working pressure of the new water heater. Do not place any valve between the relief valve and the tank.

#### The Temperature & Pressure Relief Valve:

- Must not be in contact with any electrical part.
- Must be connected to an adequate discharge line.
- Must not be rated higher than the working pressure shown on the rating plate of the water heater.

#### The Discharge Line:

- Must not be smaller than the pipe size of the relief valve or have any reducing coupling installed in the discharge line.
- Must not be capped, blocked, plugged or contain any valve between the relief valve and the end of the discharge line.
- Must pass through the structural floor and terminate external to the building. In cold climates, it is recommended that the discharge pipe be terminated at an adequate drain inside the building.
- Must be capable of withstanding 250°F (121°C) without distortion.
- Must be installed to allow complete drainage of both the valve and discharge line.

## **T&P Relief Valve and Pipe Insulation (Some Models)**

1. Locate the temperature and pressure relief valve on the water heater (also known as a T&P relief valve). See Figure 15.
2. Locate the slit running the length of the T&P relief valve insulation.
3. Spread the slit open and fit the insulation over the T&P relief valve. See Figure 15. Apply gentle pressure to the insulation to ensure that it is fully seated on the T&P Relief Valve. Once seated, secure the insulation with duct tape, electrical tape, or equivalent. **IMPORTANT:** The insulation and tape must not block the discharge opening or hinder access to the manual relief lever (Figure 15). Ensure a discharge pipe is installed into the T&P valve discharge opening per the instructions in this manual.
4. Locate the hot water (outlet) & cold water (inlet) pipes to the water heater.
5. Locate the slit running the length of a section of pipe insulation.
6. Spread the slit open and slip the insulation over the cold water (inlet) pipe. Apply gentle pressure along the length of the insulation to ensure that it is fully seated around the pipe. Also, ensure that the base of the insulation is flush with the water heater. Once seated, secure the insulation with duct tape, electrical tape, or equivalent.
7. Repeat steps 5 and 6 for the hot water (outlet) pipe.
8. Add additional sections of pipe insulation as needed.

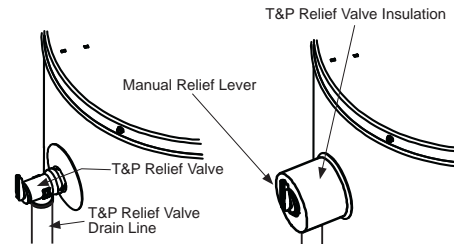

**FIGURE 15.**

## IMPORTANT INFORMATION ABOUT THIS WATER HEATER

This gas water heater was manufactured to voluntary safety standards to reduce the likelihood of a flammable vapor ignition incident. The new technology used in meeting these standards makes this product more sensitive to installation errors. Please review the following checklist and make any required installation upgrades or changes.

**Questions? Contact Residential Technical Assistance.**

### Installation Checklist

#### Water Heater Location

Water heater location is important and can affect system performance. Please check the following:

- Installation area free of corrosive elements and flammable materials.
- Centrally located with the water piping system (For new installations). Located as close to the gas piping and vent pipe system as possible.
- Located indoors and in a vertical position. Protected from freezing temperatures.
- Proper clearances from combustibles surfaces maintained and not installed directly on a carpeted floor.
- Provisions made to protect the area from water damage. Metal drain pan installed and piped to an adequate drain.
- Sufficient room to service the water heater. See Clearances and Accessibility section of this manual.
- Water heater not located near an air moving device.
- Is the installed environment dirty (excessive amounts of lint, dirt, dust, etc.)? If so, the base-ring filter located on the bottom of the water heater will need to be cleaned periodically. Refer to the "Maintenance of your Water Heater" section of this manual for information on cleaning the base-ring filter.

#### Combustion Air Supply and Ventilation

Check for sufficient combustion air supply. Insufficient air for the combustion of gas will result in the flame becoming "lazy", thereby allowing heat to build up in the combustion chamber. This excessive heat will cause a thermal switch on the door assembly to trip. Is the water heater installed in a closet or other small, enclosed space? If so:

- Are there openings for make-up air to enter and exit the room/area?
- Are the openings of sufficient size? Remember, if there are other gas-fired or air-consuming appliances in the same room, you need more make-up air. Refer to the "Installing Your Gas Water Heater" and "Combustion Air Supply and Ventilation" sections for specific requirements.
- Make sure that fresh air is not taken from areas that contain negative pressure producing devices such as exhaust fans, dryers, fireplaces, etc.
- Is there a furnace/air handler in the same room space as the water heater? If so, has a return air duct system been attached that exits the room? If so, check for leaks on the air duct system. If no air duct system is present, correct immediately by contacting a local Heating, Ventilation, Air-Conditioning & Refrigeration (HVAC-R) authorized service provider.
- Use a fresh air supply that is free of corrosive elements and flammable vapors.

- Fresh air openings must be sized correctly with consideration given to the blocking effect of louvers and grilles.

#### Vent Pipe System

Check for proper drafting at the water heater draft hood. Refer to the "Checking the Draft" section of this manual for the test procedure. If the procedure shows insufficient draft is present, please check the following:

- Draft hood properly installed.
- Vent connectors securely fastened with screws and supported properly to maintain six inch clearance.
- Vent connector made of approved material and sized correctly.
- Vent pipe system installed according to all local and state codes or, in the absence of local and state codes, the "National Fuel Gas Code", ANSI Z223.1 (NFPA 54)-current edition. Manufactured home manufacturers must conform with the "Manufactured Home Construction and Safety Standard, Title 24 CFR, Part 3280."
- Flue baffle properly positioned in the flue tube.
- Check the vent system for restrictions/obstructions and check the vent termination height. Refer to the "Combustion Air Supply and Ventilation" section of this water heater manual for specific requirements.
- Recheck for sufficient combustion air supply.

#### Water System Piping

- Temperature and pressure relief valve properly installed with a discharge line run to an adequate drain and protected from freezing.
- All piping properly installed and free of leaks.
- Heater completely filled with water.
- Closed system pressure build-up devices installed.
- Mixing valve (when applicable) installed per manufacturer's instructions (See "Water Temperature Regulation" section).

#### Gas Supply and Piping

- Gas type is the same as that listed on the water heater rating plate unless the water heater has been properly converted. Refer to the "Gas Conversion" section of this manual.
- Gas line equipped with shut-off valve, union, and drip leg.
- Use pipe joint compound or teflon tape marked as being resistant to the action of petroleum [Propane (L.P.)] gases.
- Adequate pipe size and approved pipe material.
- An approved noncorrosive leak detection solution used to check all connections and fittings for possible gas leaks. Correct any leak found.



## OPERATING YOUR WATER HEATER

### Lighting Instructions

Read and understand these directions thoroughly before attempting to light or re-light the pilot. Make sure that the view port (sight glass) is not missing or damaged. (See Figure 23.) Make sure the tank is completely filled with water before lighting the pilot. Check the rating plate near the gas control valve/thermostat for the correct gas. Do not use this water heater with any gas other than the one listed on the rating plate unless the water heater has been properly converted. Refer to the "Gas Conversion" section of this manual. If you have any questions or doubts, consult your gas supplier or gas utility company.

#### Lighting the Pilot:

1. Read and follow the lighting instructions on the water heater's label.
2. Turn the Control Knob to Pilot. Press the Knob in fully and hold it in. (The knob will travel in about 1/4-inch if it is set to Pilot correctly.)
3. Click the Igniter button continuously for up to 90 seconds or until the Status Light begins to blink.

If the Status Light does not begin to blink after 90 seconds, STOP. Wait 10 minutes before attempting to relight the Pilot. Repeat these steps 2-3 times, if necessary.

The circuitry in this gas valve requires that you wait 10 minutes between lighting attempts.

If the Status Light blinks, release the Control Knob and turn it to the desired setting. ("Hot" is approximately 120°F.)

#### If the Status Light Does Not Blink:

1. Wait 10 minutes before another lighting attempt.
2. If the Status Light did not blink, repeat the lighting procedure by following the lighting instructions on the water heater's label. Remove the outer door. The Control Knob must be set to Pilot and held in continuously while clicking the igniter button (about once per second for up to 90 seconds). To observe the Pilot, remove the outer door and look through the view port (sight glass). See Figure 23.
3. Continue clicking the Igniter button (for up to 90 seconds) until Pilot lights.
4. Once the Pilot is lit, continue to hold the Control Knob in until the Status Light begins to blink.
5. Release Control Knob and set Knob to desired temperature setting. ("Hot" is approximately 120°F.)
6. Replace the outer door.

#### If the Pilot Does Not Light:

1. Wait 10 minutes before another lighting attempt.  
If the pilot does not light, the Igniter may not be sparking or the unit may not be getting gas (or for a new installation, there may still be air in the gas line).

Each time you click the igniter button, you should be able to see the spark by looking through the view port. See Figure 23. (You may have to darken the room lights to see the spark.) You do not have to push the Control Knob in to check the Igniter button. Simply look through the sight glass while clicking the Igniter button and look for a spark. If you

	<b>⚠ WARNING</b>
	<b>Explosion Hazard</b> Replace view port if glass is missing or damaged. Failure to do so can result in death, explosion or fire.

can't see a spark when the Igniter button is clicked, check the wiring connections from the Igniter button and make sure that they are tight.

2. If you see the Igniter spark, try relighting the pilot by following the instructions on the water heater's label. Ensure that the gas supply is turned on. There may be air in the gas line, and several lighting attempts may be needed to completely fill the line with gas and successfully light the pilot.

#### If the Pilot Lights but the Status Light Does Not Blink:

1. If the pilot lights, continue to hold the Control Knob in until the Status Light blinks. If the pilot is lit and remains lit for 90 seconds and the Status Light still does not blink, the thermopile connections may be loose, the thermal switch may need to be reset, or the thermopile may be defective.
2. Remove the outer door.
3. Press the reset button on the thermal switch (Figure 23).
4. If switch clicks, it may have tripped. Do not light the Pilot if flammable vapors are present. Check flame arrester for signs of discoloration (which could be caused by flammable vapors). If the flame arrester is discolored, do not attempt to relight the Pilot. Have the water heater inspected by a qualified service technician.
5. Check the wiring connections from the thermopile and the thermal switch to the gas control valve/thermostat. Ensure that all wiring connections are tight. See Figure 23.
6. Replace the outer door.
7. Wait 10 minutes and try to light the Pilot according to the instructions on the water heater's label.
8. While clicking the Igniter button continuously, the Control Knob must be set to Pilot and held in until the Status Light blinks. Once the Status Light blinks, release the Control Knob and set the Knob to the desired temperature setting. ("Hot" is approximately 120°F.)

## FOR YOUR SAFETY READ BEFORE LIGHTING



**WARNING:** If you do not follow these instructions exactly, a fire or explosion may result causing property damage, personal injury or loss of life.



### BEFORE LIGHTING: ENTIRE SYSTEM MUST BE FILLED WITH WATER AND AIR PURGED FROM ALL LINES

- A. This appliance has a pilot which is lit by a piezo-electric spark gas ignition system. Do **not** open the inner door of the appliance and try to light the pilot by hand.
- B. BEFORE LIGHTING smell all around the appliance area for gas. Be sure to smell next to the floor because some gas is heavier than air and will settle on the floor.
- WHAT TO DO IF YOU SMELL GAS
- Do not try to light any appliance.
  - Do not touch any electric switch; do not use any phone in your building.
  - Immediately call your gas supplier from a neighbor's phone. Follow the gas supplier's instructions.
  - If you cannot reach your gas supplier, call the fire department.
- C. Use only your hand to push in or turn the gas control knob. Never use tools. If the knob will not push in or turn by hand, don't try to repair it, call a qualified service technician. Force or attempted repair may result in a fire or explosion.
- D. Do not use this appliance if any part has been under water. Immediately contact a qualified installer or service agency to replace a flooded water heater. Do not attempt to repair the unit! It must be replaced!
- E. DO NOT USE THIS APPLIANCE IF THERE HAS BEEN AN IGNITION OF VAPORS. Immediately call a qualified service technician to inspect the appliance. Water heaters subjected to a flammable vapors ignition will show a discoloration on the air intake grid and require replacement of the entire water heater.

## LIGHTING INSTRUCTIONS

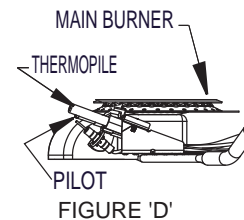
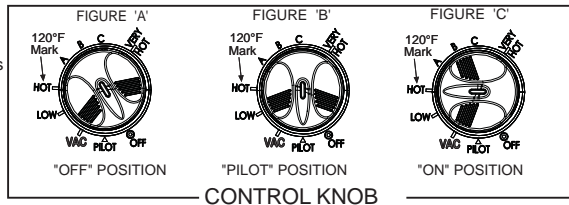
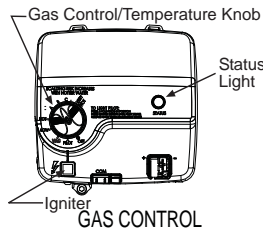

1. STOP! It is imperative that you read all safety warnings before lighting the pilot.
2. Turn the gas control/temperature knob counterclockwise ↶ to the "OFF" setting.
3. Wait ten (10) minutes to clear out any gas. If you then smell gas, STOP! Follow "B" in the safety information above on this label. If you do not smell gas, go to the next step.
4. Turn the gas control/temperature knob clockwise ↷ to "PILOT". See Figure 'B'.
5. Press the gas control/temperature knob all the way in and hold it in. The knob should travel in about 1/4 inch (6.35 mm) if it is set to "PILOT" correctly. While holding the gas control/temperature knob in, click the igniter button continuously (about once a second) for up to 90 seconds or until Status Light begins to blink.
6. When the status light starts blinking, release the gas control/temperature knob. Set the gas control/

temperature knob to the desired setting. See Figure 'C'.

If the status light does not start blinking within 90 seconds, repeat steps 2 through 5 up to THREE (3) times, waiting 10 minutes between lighting attempts. The circuitry in this advanced gas valve requires that you wait 10 minutes between lighting attempts.

If the status light turns solid, release the gas control/temperature knob and repeat steps 2 through 5 (waiting 10 minutes before attempting to relight the pilot).

If the status light does not start blinking after three lighting attempts, turn the gas control/temperature knob to "OFF" and call a qualified service technician or your gas supplier.



**DANGER:** Hotter water increases the risk of scald injury. Consult the instruction manual before changing temperature.

Refer to the Lighting Instructions in the Installation Manual for more detailed troubleshooting information.

## TO TURN OFF GAS TO APPLIANCE

1. Turn the gas control/temperature knob counterclockwise ↶ to the "OFF" setting. The status light will stop blinking and stay on for a short time after the water heater is turned off. See Figure 'A'.

## Checking the Draft

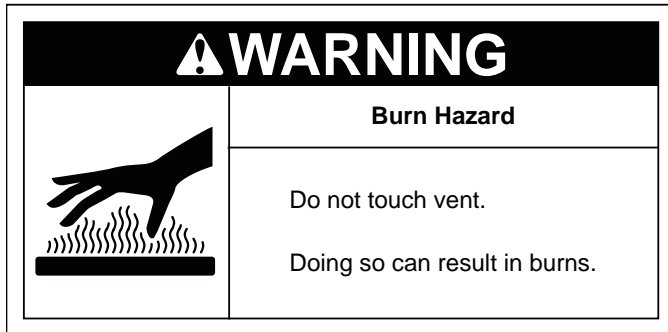

After successfully lighting the water heater, allow the unit to operate for 15 minutes and check the draft hood relief opening for proper draft (Figure 16). Make sure all other appliances in the area are operating and all doors are closed when performing the draft test. Pass a match flame around the relief opening of the draft hood. A steady flame drawn into the opening indicates proper draft.

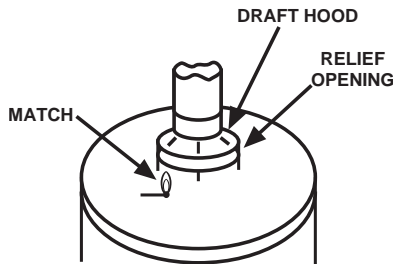

FIGURE 16.

If the flame flutters or is blown out, combustion products are escaping from the relief opening. If this occurs, do not operate the water heater until proper adjustments or repairs are made to the vent pipe system and/or air supply requirements.

## Burner Flames

Inspect the burner flames through the viewport and compare them to the drawing in Figure 17. A properly operating burner should produce a soft blue flame. Blue tips with yellow inner cones are satisfactory. The tips of the flame may have a slight yellow tint. The flame should not be all yellow or have a sharp blue-orange color. Contaminated air may cause an orange colored flame. Contact a qualified technician if the flame is not satisfactory.

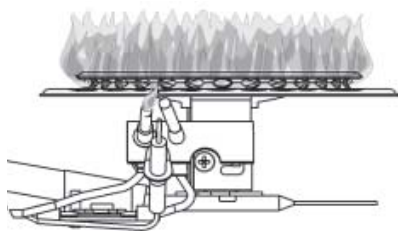
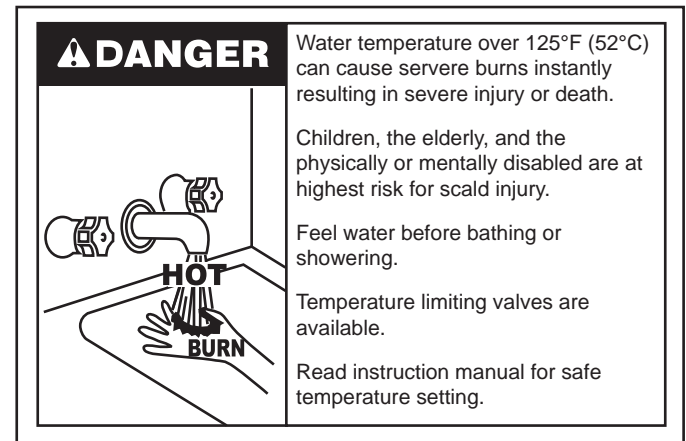

FIGURE 17.

## Emergency Shut Down

**IMPORTANT:** Should overheating occur or the gas supply fails to shut off, turn off the water heater's manual gas control valve and call a qualified technician.

## Water Temperature Regulation



Due to the nature of the typical gas water heater, the water temperature in certain situations may vary up to 30°F (16.7 °C) higher or lower at the point of use such as, bathtubs, showers, sink, etc.

**HOTTER WATER CAN SCALD:** Water heaters are intended to produce hot water. Water heated to a temperature which will satisfy space heating, clothes washing, dish washing, and other sanitizing needs can scald and permanently injure you upon contact. Some people are more likely to be permanently injured by hot water than others. These include the elderly, children, the infirm, or physically/mentally handicapped. If anyone using hot water in your home fits into one of these groups or if there is a local code or state law requiring a certain temperature water at the hot water tap, then you must take special precautions. In addition to using the lowest possible temperature setting that satisfies your hot water needs, a means such as a mixing valve should be used at the hot water taps used by these people or at the water heater. Mixing valves are available at plumbing supply or hardware stores. See Figure 12. Follow manufacturer's instructions for installation of the valves. Before changing the factory setting on the gas control valve/thermostat, see Figure 18. Using the lowest hot water temperature that meets your needs will also provide the most energy efficient operation of the water heater.

Never allow small children to use a hot water tap, or to draw their own bath water. Never leave a child or handicapped person unattended in a bathtub or shower.

**NOTE:** A water temperature range of 120°F-140°F (49°C-60°C) is recommended by most dishwasher manufacturers.

The gas control valve/thermostat is adjusted to the pilot position when it is shipped from the factory. Water temperature can be regulated by moving the temperature dial to the preferred setting. The preferred starting point is 120°F at the "HOT" setting. Align the knob with the desired water temperature as shown in Figure 18. There is a hot water scald potential if the gas control valve/thermostat is set too high.

**NOTE:**

- If the knob is set to a higher temperature setting than 120°F, a mixing valve should be installed to limit the temperature of the water to 120°F at the fixtures.
- Temperatures shown on the gas control valve/thermostat are approximates. The actual temperature of the heated water may vary.

**IMPORTANT:** Adjusting the thermostat past the 120°F mark on the temperature dial will increase the risk of scald injury. Hot water can produce first degree burns within:

Water Temperature °F	Time for 1st Degree Burn (Less Severe Burns)	Time for Permanent Burns 2nd & 3rd Degree (Most Severe Burns)
110	(normal shower temp.)	
116	(pain threshold)	
116	35 minutes	45 minutes
122	1 minute	5 minutes
131	5 seconds	25 seconds
140	2 seconds	5 seconds
149	1 second	2 seconds
154	Instantaneous	1 second

(U.S. Government Memorandum, C.P.S.C., Peter L. Armstrong, Sept. 15, 1978)

### Water Temperature Adjustment

The water temperature setting can be adjusted from 55°F to 155°F. Turn the Gas Control/Temperature Knob to the desired setting/temperature.

**NOTE:**

The temperatures indicated are approximates. The actual temperature of the heated water may vary.

### Operating Modes and Settings

- Standard Mode - The controller adjusts the water heater to maintain the temperature set by the user.
- Vacation Setting - The Vacation setting (VAC) sets the controller at approximately 55°F. This setting is recommended when the water heater is not in use for a long period of time. This effectively turns the controller temperature setting down to a temperature that prevents the water in the water heater from freezing while still conserving energy.

### Status Light Code

Normal Flashes:

- 0 Flashes Indicates Control Off/Pilot Out.
- 1 Flash Indicates Normal Operation.
- A solid status light indicates that the gas control valve/thermostat is shutting down.

Diagnostic Flashes:

If the water heater is not working, look for the following diagnostic flashes after lighting the pilot. For more details, see "Status Light and Diagnostic Code Troubleshooting Chart."

- 2 Flashes Indicates Thermopile Voltage Low
- 4 Flashes Indicates Overheat Failure
- 5 Flashes Indicates Sensor Failure
- 7 Flashes Indicates Electronic Control Failure
- 8 Flashes See "Status Light and Diagnostic Code Troubleshooting Chart."

GAS CONTROL VALVE/THERMOSTAT SETTINGS

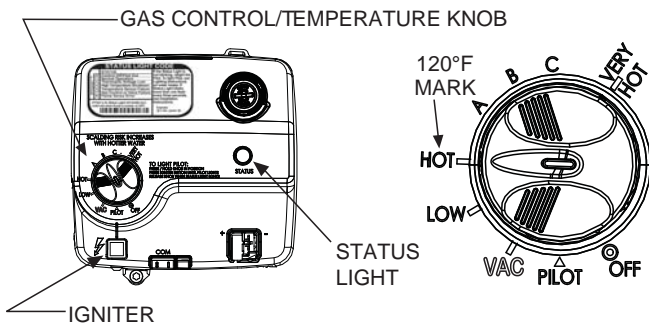

FIGURE 18.

Should overheating occur or the gas supply fail to shut off, turn off the manual gas control valve to the appliance.

**NOTE:** During low demand periods when hot water is not being used, a lower thermostat setting will reduce energy losses and may satisfy your normal hot water needs. If hot water use is expected to be more than normal, a higher thermostat setting may be required to meet the increased demand. When leaving your home for extended periods (vacations, etc.) turn the temperature dial to its lowest setting. This will maintain the water at low temperatures with minimum energy losses and prevent the tank from freezing during cold weather.

## Operational Conditions

### Condensation

Whenever the water heater is filled with cold water, some condensate will form while the burner is on. A water heater may appear to be leaking when in fact the water is condensation. This usually happens when:

- A new water heater is filled with cold water for the first time.
- Burning gas produces water vapor in water heaters, particularly high efficiency models where flue temperatures are lower.
- Large amounts of hot water are used in a short time and the refill water in the tank is very cold.

Moisture from the products of combustion condense on the cooler tank surfaces and form drops of water which may fall onto the burner or other hot surfaces to produce a "sizzling" or "frying" noise.

Excessive condensation can cause pilot outage due to water running down the flue tube onto the main burner and putting out the pilot.

Because of the suddenness and amount of water, condensation water may be diagnosed as a "tank leak". After the water in the

## Operating the Temperature Control System

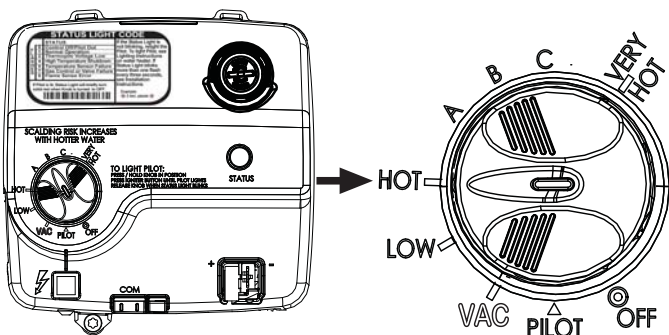

FIGURE 19.



tank warms up (about 1-2 hours), the condition should disappear.

Do not assume the water heater is leaking until there has been enough time for the water in the tank to warm up.

An undersized water heater will cause more condensation. The water heater must be sized properly to meet the family's demands for hot water including dishwashers, washing machines and shower heads.

Excessive condensation may be noticed during the winter and early spring months when incoming water temperatures are at their lowest.

Good venting is essential for a gas fired water heater to operate properly as well as to carry away products of combustion and water vapor.



It is always recommended that a suitable metal drain pan be installed under the water heater to protect the area from water damage resulting from normal condensation production, a leaking tank or piping connections. Refer to the "Site Location" section.

### Water Heater Sounds

During the normal operation of the water heater, sounds or noises may be heard. These noises are common and may result from the following:

1. Normal expansion and contraction of metal parts during periods of heat-up and cool-down.
2. Condensation causes sizzling and popping within the burner area and should be considered normal.
3. Sediment buildup in the tank bottom will create varying amounts of noise and may cause premature tank failure. Drain and flush the tank as directed under the "Draining and Flushing" section.

### Smoke/Odor

The water heater may give off a small amount of smoke and odor during the initial start-up of the unit. This is due to the burning off of oil from metal parts of a new unit and will disappear after a brief period of operation.

### Safety Shut-off and Thermal Switch

This water heater is designed to automatically shut-off in the event of the following:

1. The pilot flame is extinguished for any reason.
2. The water temperature exceeds 189°F (87°C).
3. Excessive combustion chamber temperatures.
4. The ignition of flammable vapors.

A thermopile is used to determine if a pilot flame is present, and will shut off the gas supply to the main burner and the pilot if the flame is absent. This unit is also equipped with a thermal switch,

designed to shut off the gas supply in the event the heater has been exposed to flammable vapors (spilled gasoline or paint fumes, for example), poor combustion caused by insufficient combustion air, or improper venting. If the switch opens, check the flame arrestor for signs of high temperature (blue or black discoloration), and inspect your installation for any problems with venting or combustion air. (See Pilot Light Troubleshooting Flowchart). Reset the switch by depressing the small button in the center of the switch.

**IMPORTANT:** Correct any issues prior to resetting the switch. Contact a qualified technician to request service.

The gas control valve/thermostat includes a temperature limiting ECO (Energy Cut Off) system that will shut off the water heater if the water temperature exceeds 189°F (87°C).

Should the water temperature get too high, the diagnostic status light will flash a code (4 flashes), indicating an over-temperature condition and the main burner will be shut off. If a high temperature condition occurs, turn the main gas supply OFF and have the water heater repaired by a qualified service technician.

### "Air" in Hot Water Faucets

**HYDROGEN GAS:** Hydrogen gas can be produced in a hot water system that has not been used for a long period of time (generally two weeks or more). Hydrogen gas is extremely flammable and explosive. To prevent the possibility of injury under these conditions, we recommend the hot water faucet, located farthest away, be opened for several minutes before any electrical appliances which are connected to the hot water system are used (such as a dishwasher or washing machine). If hydrogen gas is present, there will probably be an unusual sound similar to air escaping through the pipe as the hot water faucet is opened. There must be no smoking or open flame near the faucet at the time it is open.

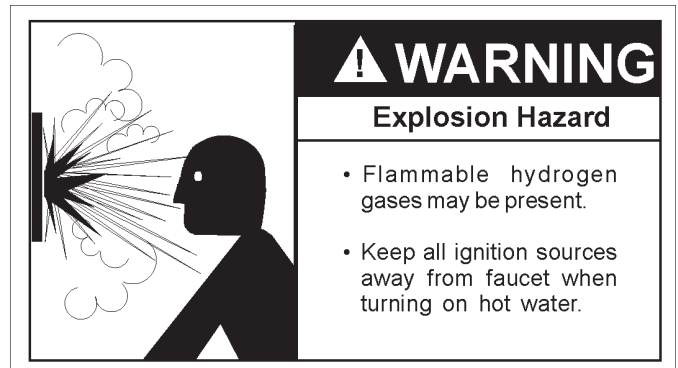



## MAINTENANCE OF YOUR WATER HEATER

### Routine Preventive Maintenance

At least annually, a visual inspection should be made of the venting and air supply system, piping systems, main burner, pilot burner, and flame-arrestor. Check the water heater for the following:

- Obstructions, damage, or deterioration in the venting system. Make sure the ventilation and combustion air supplies are not obstructed.
- Clean any dust or debris from the base-ring filter.
- Soot and/or carbon on the main burner and pilot burner. Contact a qualified technician.
- Leaking or damaged water and gas piping.
- Presence of flammable or corrosive materials in the installation area.
- Presence of combustible materials near the water heater.
- After servicing this water heater, check to make sure it is working properly. (See "Operating Your Water Heater" section of this manual.)

**IMPORTANT:** If you lack the necessary skills required to properly perform this visual inspection, you should not proceed, but get help from a qualified technician.

### Anode Rod Inspection

Each water heater contains at least one anode rod, which will slowly deplete (due to electrolysis) prolonging the life of the water heater by protecting the glass-lined tank from corrosion. Adverse water quality, hotter water temperatures, high hot water usage, and water softening methods can increase the rate of anode rod depletion. Once the anode rod is depleted, the tank will start to corrode, eventually developing a leak.

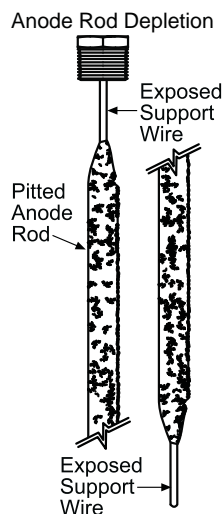

FIGURE 20.

Certain water conditions will cause a reaction between the anode rod and the water. The most common complaint associated with the anode rod is a "rotten egg smell" produced from the presence of hydrogen sulfide gas dissolved in the water. **IMPORTANT:** Do not remove this rod permanently as it will void any warranties. A special anode rod may be available if water odor or discoloration occurs. **NOTE:** This rod may

reduce but not eliminate water odor problems. The water supply system may require special filtration equipment from a water conditioning company to successfully eliminate all water odor problems.

Artificially softened water is exceedingly corrosive because the process substitutes sodium ions for magnesium and calcium ions. The use of a water softener may decrease the life of the water heater tank.

The anode rod should be inspected after a maximum of three years and annually thereafter until the condition of the anode rod dictates its replacement. **NOTE:** Artificially softened water requires the anode rod to be inspected annually. The following are typical (but not all) signs of a depleted anode rod:

- The majority of the rods diameter is less than 3/8".
- Significant sections of the support wire (approx. 1/3 or more of the anode rod's length) are visible.

If the anode rod show signs of either or both it should be replaced. **NOTE:** Whether re-installing or replacing the anode rod, check for any leaks and immediately correct if found. In replacing the anode:

1. Turn off gas supply to the water heater.
2. Shut off the water supply and open a nearby hot water faucet to depressurize the water tank.
3. Drain approximately 5 gallons of water from tank. (Refer to "Draining and Flushing" for proper procedures). Close drain valve.
4. Remove old anode rod.
5. Use Teflon® tape or approved pipe sealant on threads and install new anode rod.
6. Turn on water supply and open a nearby hot water faucet to purge air from water system. Check for any leaks and immediately correct any if found.
7. Restart the water heater as directed in this manual. See the Repair Parts Illustration for anode rod location.

### Temperature-Pressure Relief Valve Operation

**WARNING**  
**Explosion Hazard**

- Temperature-pressure relief valve must comply with ANSI Z21.22-CSA 4.4 and ASME code.
- Properly sized temperature-pressure relief valve must be installed in opening provided.
- Can result in overheating and excessive tank pressure.
- Can cause serious injury or death.

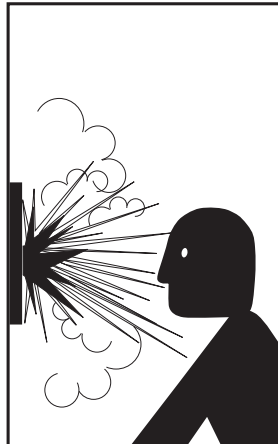

Manually operate the temperature and pressure relief valve at least once a year to make sure it is working properly. To

prevent water damage, the valve must be properly connected to a discharge line which terminates at an adequate drain (see Figure 1). Standing clear of the outlet (discharged water may be hot), slowly lift and release the lever handle on the temperature and pressure relief valve to allow the valve to operate freely and return to its closed position. See Figure 21. If the valve fails to completely reset and continues to release water, immediately close the manual gas shut-off valve and the cold water inlet valve and call a qualified technician. Do not plug the temperature-pressure relief valve or discharge line.

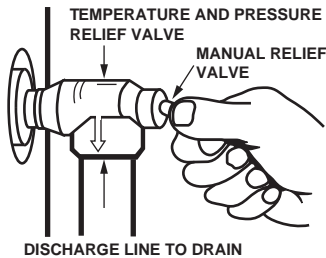

FIGURE 21.

## Draining and Flushing

	<ul style="list-style-type: none"> <li>• Hot water discharge burn hazard.</li> <li>• Keep clear of relief valve discharge unit.</li> <li>• Temperature limiting valves are available.</li> <li>• Read instruction manual for safe temperature setting.</li> </ul>
--	---

It is recommended that the tank be drained and flushed every 6 months to remove sediment which may build up during operation. The water heater should be drained if being shut down during freezing temperatures. To drain the tank, perform the following steps:

1. Turn off the gas to the water heater at the manual gas shut-off valve.
2. Open a nearby hot water faucet until the water is no longer hot.
3. Close the cold water inlet valve.
4. Connect a hose to the drain valve and terminate it to an adequate drain or external to the building.
5. Open the water heater drain valve and allow all of the water to drain from the tank. Flush the tank with water as needed to remove sediment.
6. Close the drain valve, refill the tank, and restart the heater as directed in this manual. If the water heater is going to be shut down for an extended period, the drain valve should be left open.

**IMPORTANT:** Condensation may occur when refilling the tank and should not be confused with a tank leak.

## Replacement Parts

**IMPORTANT:** The following maintenance procedures are for the FVIR System components and should be performed by a qualified technician.

Replacement parts may be ordered through your plumber or

the local distributor. Parts will be shipped at prevailing prices and billed accordingly. When ordering replacement parts, always have the following information ready:

1. model, serial, and product number
2. type of gas
3. item number
4. parts description

See Repair Parts Illustration for a list of available repair parts.

## External Inspection & Cleaning of the Base-Ring Filter

1. At least annually, check the base-ring filter (Figure 28) for any dust or debris that may have accumulated on the filter screen. **NOTE:** If the water heater is located in an area that is subjected to lint and dirt, it may be necessary to check the base-ring filter more frequently.
2. Follow the Lighting Instructions to turn off the water heater and allow it to cool for 10 minutes before attempting to clean the base-ring filter.
3. Use a vacuum cleaner with a hose attachment to remove any dust or debris that may have accumulated on the filter. **NOTE:** If unable to inspect or clean the base-ring filter, follow the "Cleaning the Combustion Chamber and Flame-arrestor" instructions.
4. After the base-ring filter has been cleaned, follow the Lighting Instructions to return the water heater to service.

## Removing the Manifold/Burner Assembly

1. Turn the gas control/temperature knob to the "OFF" position (Figure 18).
2. Before performing any maintenance, it is important to turn off the gas supply to the water heater at the manual gas shut-off valve. This valve is typically located beside the water heater. Note the position of the shut-off valve in the open/on position, then proceed to turn it off (Figure 7).
3. With the unit shut-off, allow sufficient time for the water heater to cool before performing any maintenance.

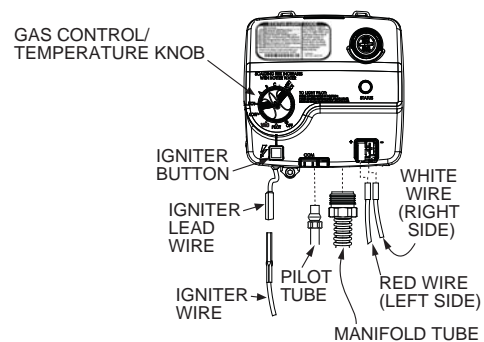

FIGURE 22.

4. Remove the outer door.
5. Disconnect the following from the gas control valve/thermostat: pilot tube (7/16" wrench), igniter wire (from the igniter lead wire), and manifold tube (3/4" wrench). See Figure 22.
6. Disconnect the white and red wires from the gas control valve/thermostat (Figure 22). Use needle nose pliers to grip the connector(s). **IMPORTANT:** Grip the connector carefully to prevent damage. Do not grip or pull the wires themselves.

- Grasp the manifold tube and push down slightly to free the manifold tube and pilot tube.
- Remove the screws (1/4" nut driver) securing the manifold/burner assembly to the combustion chamber. See Figure 23.
- Carefully remove the manifold/burner assembly from the combustion chamber. BE SURE NOT TO DAMAGE ANY INTERNAL PARTS.

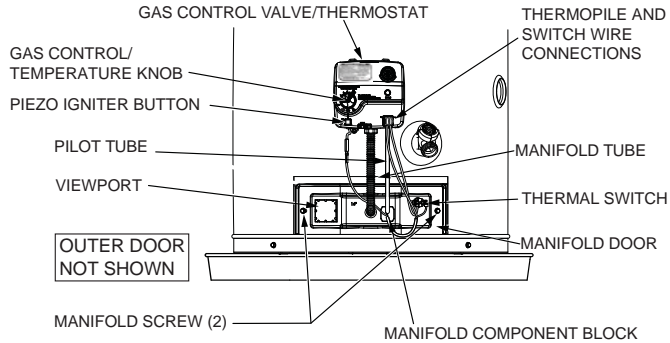

FIGURE 23.

## Removing the Burner from the Manifold/Burner Assembly

### Natural Gas (Low Nox) & L.P. Gas Burner

- Take off the burner by removing the two (2) screws located underneath the burner.
- Check the burner to see if it is dirty or clogged. The burner may be cleaned with soap and hot water (Figure 24).

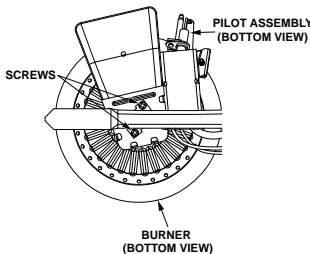

FIGURE 24.

## Replacing the Pilot/Thermopile Assembly

- Remove the manifold door assembly as described in "Removing the Manifold/Burner Assembly" section.
- Remove the burner to access the pilot/thermopile assembly. Remove and keep the screws securing the burner to the manifold (Figure 24). IMPORTANT: DO NOT remove the orifice.
- Remove the screw securing the pilot/thermopile assembly to the pilot bracket and keep for reuse later (Figure 25).
- Lift the retainer clip straight up from the back of the manifold component block (using a flat-blade screwdriver), then remove the manifold component block from the manifold door (Figure 25). IMPORTANT: Be careful not to bend or alter the position of the pilot tube. It will be used as a bending template for the new pilot assembly. Note the placement/order of the wires in the manifold component block.

- Lift the pilot/thermopile assembly (including the igniter wire) from the manifold assembly.

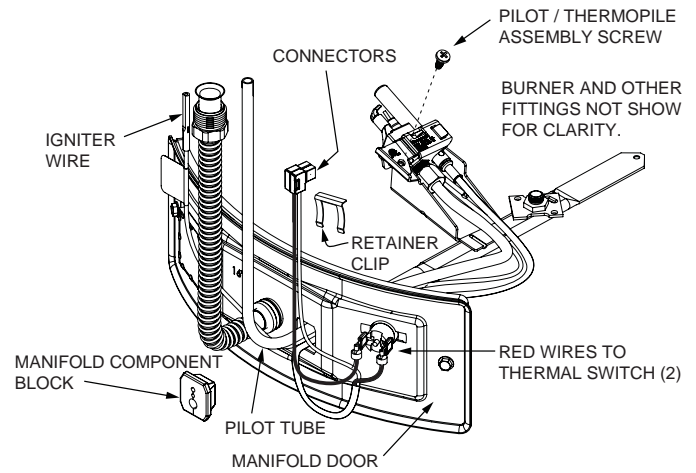

FIGURE 25.

- Read this step carefully before proceeding. Using the old pilot/pilot tube assembly as a guide, bend the new pilot tube to match the old one. Make only the bends closest to the pilot before going to the next step.

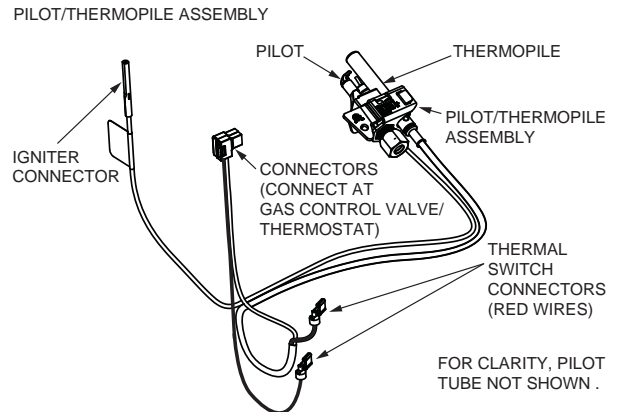

FIGURE 26.

- Route the new pilot tube and wires through the opening in the manifold door. See Figure 25.
- Using the pilot screw removed earlier, attach the new pilot/thermopile assembly. Reattach the burner to the manifold using the screws removed earlier. NOTE: Make sure the burner scoop is oriented to the pilot side of the manifold tube (Figure 24).
- Reinstall the manifold component block in the manifold door. Ensure that the pilot tube and wires are positioned as shown in Figure 27.
- Carefully bend the new pilot tube to match the bend of the manifold tube. NOTE: When bending, DO NOT crimp or crease the pilot tube.
- Before you proceed to the next step, install the new brass ferrule nut in the gas control valve/thermostat's pilot tube opening, HAND TIGHT ONLY.
- Install the manifold/burner assembly. Refer to the "Replacing the Manifold/Burner Assembly" section for instructions.

## Replacing the Manifold/Burner Assembly

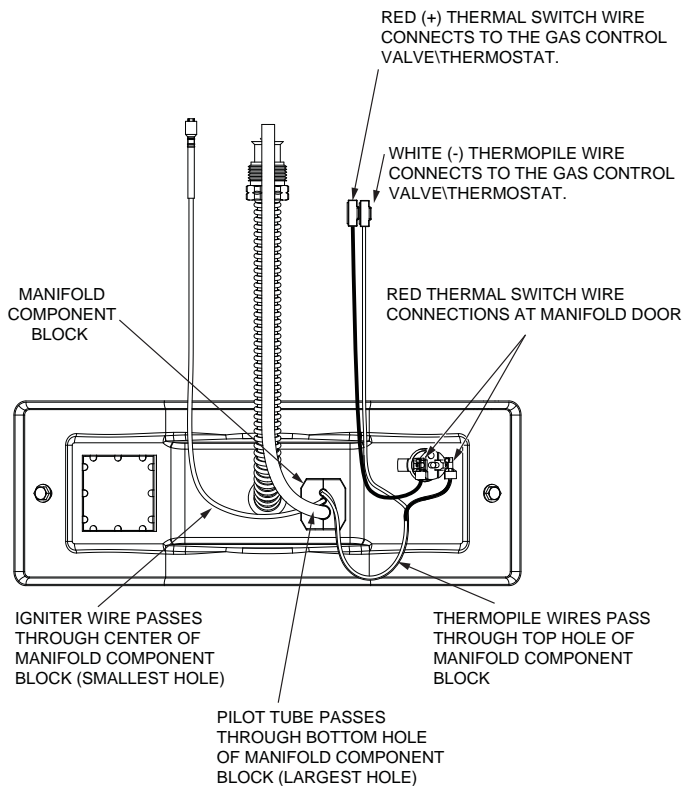

FIGURE 27.

## Cleaning the Combustion Chamber and Flame-arrestor

1. Follow procedure outlined in "Removing the Manifold/Burner Assembly".
2. Use a vacuum cleaner/shop vac to remove all loose debris in the combustion chamber (Figure 28). Use compressed air to clear any dust or debris that may have accumulated in the flame-arrestor.

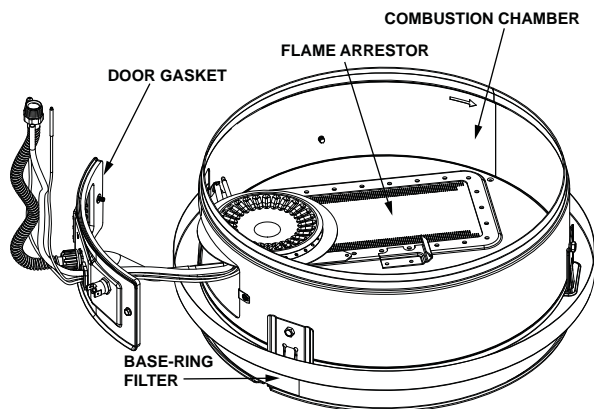

FIGURE 28.

3. Reassemble following the procedure under "Replacing the Manifold/Burner Assembly."

## ⚠ WARNING



### Explosion Hazard

- Tighten both manifold door screws securely.
- Remove any fiberglass between gasket and combustion chamber.
- Replace viewport if glass is missing or damaged.
- Replace manifold component block if missing or removed.
- Replace door gasket if damaged.
- Failure to follow these instructions can result in death, explosion, or fire.

1. Check the door gasket for damage or imbedded debris prior to installation (Figure 28).
2. Inspect the viewport for damage and replace as required (Figure 23).
3. Insert the new manifold/burner assembly into the burner compartment, making sure that the tab of the manifold tube engages the slot of the bracket inside the combustion chamber (Figure 29).
4. Inspect the door gasket and make sure there is no fiberglass insulation between the gasket and the combustion chamber (Figure 28).
5. Tighten the two screws that secure the manifold/burner assembly to the combustion chamber. (Use a 1/4" nut driver.) There should be no space between the gasket part of the manifold door and combustion chamber.

**IMPORTANT:** Do not operate the water heater if the door gasket does not create a seal between the manifold door and the combustion chamber.

6. Reconnect the manifold tube (3/4" wrench) and pilot tube (7/16" wrench) to the gas control valve/thermostat (Figure 22). Do not cross-thread or apply any thread sealant to the fittings.

**IMPORTANT:** If you were supplied with a new ferrule nut in a parts kit, follow these steps to connect the pilot tube:

- 1.) Install the ferrule nut into the gas valve at the pilot tube location, hand tight only. 2.) Insert the pilot tube into the ferrule nut until the tube bottoms out, then tighten the nut with a 7/16" wrench until the crimp connection seals to the pilot tube. 3.) Continue to tighten until the nut is tight in the gas valve.
7. Connect the white and red wires to the gas control valve/thermostat as shown in Figure 22. Also, ensure that the red thermal switch wires are connected to the thermal switch on the manifold door (Figure 27).



8. Reconnect the igniter wire (Figure 22).
9. Turn on the gas supply to the water heater at the manual gas shut-off valve (Figure 7).
10. Follow the lighting instructions on the front of the water heater. With the main burner lit, check for leaks at the manifold and pilot connections by brushing on an approved noncorrosive leak detection solution. If such a solution is not available, use a mixture of hand dish washing soap and water (one part soap to 15 parts water) or children's soap bubble solution. Bubbles forming indicate a leak. Correct any leak found.
11. Verify proper operation, then replace the outer door.

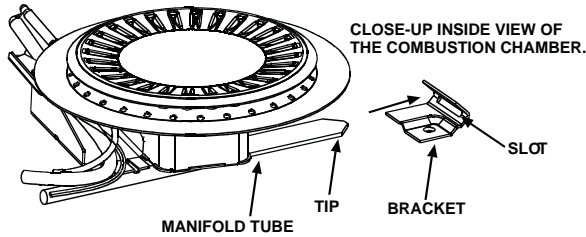

FIGURE 29.

## Piezoelectric Igniter System

The piezoelectric igniter system consists of the igniter button, electrode, and wire. The pilot is ignited by an electric spark generated when the igniter button is pressed. (See Figure 30).

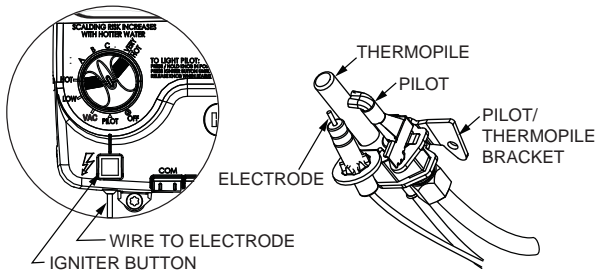

FIGURE 30.

## Testing the Igniter System

Turn off the gas to the water heater at the manual gas shut-off valve. Watch the electrode tip while activating the igniter. A visible spark should jump from the electrode. To avoid shock, do not touch the burner or any metal part on the pilot or pilot assembly. If no spark is visible, check the wire connections and make sure the electrode is not broken. Replace the igniter if defective. Dirt and rust on the pilot or electrode tip can prevent the igniter spark. Wipe clean with a damp cloth and dry completely. Rust can be removed from the electrode tip and metal surfaces by lightly sanding with an emery cloth or fine grit sandpaper.

## Removing and Replacing the Gas Control Valve/Thermostat

**IMPORTANT:** This water heater has a resettable thermal switch installed. Do not attempt to disable or modify this feature in any way. Use only factory authorized replacement parts. **IMPORTANT:** This gas control valve/thermostat is shipped from the factory as a natural gas unit. However, it may be converted to use LP gas. Before installing this gas control valve/ thermostat, make sure that it is configured for the type of gas that you are using. Refer to the "Gas Conversion" section.

### Removing the Gas Control Valve/Thermostat:

1. Turn the gas control/temperature knob to the "OFF" position (Figure 18).
2. Turn off the gas at the manual shut-off valve on the gas supply pipe (Figure 7).
3. Drain the water heater. Refer to the section of "Draining and Flushing" and follow the procedure.
4. Disconnect the igniter wire from the igniter lead wire. Use needle nose pliers to disconnect the red (+) and white (-) thermopile wires. Disconnect the pilot tube (7/16" wrench) and manifold tube (3/4" wrench) at the gas control valve/thermostat (Figure 22).
5. Refer to "Gas Piping" (Figure 7) and disconnect the ground joint union in the gas piping. Disconnect the remaining pipe from the gas control valve/thermostat.



6. To remove the gas control valve/thermostat, thread a 4" section of gas pipe into the inlet and use it to turn the gas control valve/thermostat (counterclockwise.) Do not use a pipe wrench or equivalent to grip body. Damage may result, causing leaks. Do not insert any sharp objects into the inlet or outlet connections. Damage to the gas control valve/thermostat may result.

### **Replacing the Gas Control Valve/Thermostat:**

To replace the gas control valve/thermostat, reassemble in reverse order. When replacing the gas control valve/thermostat, thread a 4" section of gas pipe into the inlet and use it to turn the gas control valve/thermostat (clockwise). DO NOT OVER TIGHTEN; damage may result.

- Be sure to use approved Teflon® tape or pipe joint compound on the gas piping connections and fitting on the back of the gas control valve that screws into the tank.
- Be sure to remove the pilot ferrule nut from the new gas control valve/thermostat.
- Turn the main gas supply on and check the gas supply connections for leaks. Correct any leak found. Next, light the pilot and main burner, then check the manifold tube and pilot tube connections for leaks. Correct any leak found. Use an approved noncorrosive leak detection solution. If such a solution is not available, use a mixture of hand

dish washing soap and water (one part soap to 15 parts water) or children's soap bubble solution. Bubbles forming indicate a leak.

- Be sure tank is completely filled with water before lighting and activating the water heater. Follow the "Lighting Instructions" on the front of the water heater.
- If additional information is required, contact Residential Technical Assistance.

TEFLON® is a registered trademark of E.I. Du Pont De Nemours and Company.

### **FVIR System Operational Checklist**

---

1. Manifold gasket properly sealed.
  2. Viewport not damaged or cracked.
  3. Flame-arrestor free of debris and undamaged.
  4. Manifold component block properly installed.
  5. No leaks at pilot and manifold connection.
  6. Manifold door screws securely tightened.
  7. Depress the button on the thermal switch.
-

## TROUBLESHOOTING CHART

PROBLEM	POSSIBLE CAUSE(S)	CORRECTIVE ACTION
BURNER WILL NOT IGNITE	<ol style="list-style-type: none"> <li>1. Pilot not lit</li> <li>2. Thermostat set too low</li> <li>3. Main burner line clogged</li> <li>4. Non-functioning thermostat</li> <li>5. Base-Ring Filter blocked with lint/dust</li> <li>6. Heater installed in a confined area</li> <li>7. FVIR Flame Arrestor blocked with lint/dust.</li> </ol>	<ol style="list-style-type: none"> <li>1. Light pilot</li> <li>2. Turn temp. dial to desired temperature</li> <li>3. Clean, locate source and correct</li> <li>4. Test Gas Control Valve/Thermostat</li> <li>5. Clean filter, See "External Inspection &amp; Cleaning of the Base-Ring Filter" section.</li> <li>6. Provide fresh air ventilation</li> <li>7. Clean filter, See "Cleaning the Combustion Chamber and Flame-Arrestor" section.</li> </ol>
SMELLY WATER	<ol style="list-style-type: none"> <li>1. Sulfides in the water</li> </ol>	<ol style="list-style-type: none"> <li>1. Replace the anode with a special anode</li> </ol>
BURNER FLAME YELLOW-LAZY	<ol style="list-style-type: none"> <li>1. Insufficient combustion air</li> <li>2. Low gas pressure</li> <li>3. Water heater flue or vent system blocked</li> <li>4. Main burner line clogged</li> <li>5. Base-Ring Filter blocked with lint/ dust</li> <li>6. Heater installed in a confined area</li> <li>7. FVIR Flame Arrestor blocked with lint/dust.</li> <li>8. Obstruction in main burner orifice</li> <li>9. Incorrect gas conversion (if unit was converted to use a different type of gas)</li> </ol>	<ol style="list-style-type: none"> <li>1. Provide ventilation to water heater</li> <li>2. Check with gas utility company</li> <li>3. Clean, locate source and correct</li> <li>4. Clean, locate source and correct</li> <li>5. Clean filter, See "External Inspection &amp; Cleaning of the Base-Ring Filter" section.</li> <li>6. Proper fresh air ventilation</li> <li>7. Clean filter, See "Cleaning the Combustion Chamber and Flame-Arrestor" section.</li> <li>8. Clean or replace orifice</li> <li>9. Contact a qualified technician</li> </ol>
PILOT WILL NOT LIGHT OR REMAIN LIT	<ol style="list-style-type: none"> <li>1. Non-functioning igniter</li> <li>2. The thermal switch tripped</li> <li>3. Wire lead connection at thermal switch loose</li> <li>4. Thermopile connection loose</li> <li>5. Air in gas line</li> <li>6. Low gas pressure</li> <li>7. No gas</li> <li>8. Dirt in gas lines</li> <li>9. Cold drafts</li> <li>10. Thermostat temperature limit was exceeded. Status light will blink 4 flashes.</li> <li>11. Pilot line or orifice clogged</li> <li>12. Non-functioning thermopile</li> <li>13. Air for combustion obstructed</li> <li>14. FVIR Flame Arrestor blocked with lint/dust</li> <li>15. Flammable vapors incident, FVIR function actuated</li> <li>16. Base-Ring Filter blocked with lint/dust</li> </ol>	<ol style="list-style-type: none"> <li>1. Replace igniter pilot assembly</li> <li>2. See Pilot Light Troubleshooting Flowchart section</li> <li>3. Remove and reconnect the wire leads at thermal switch, confirm connections are tight and not loose</li> <li>4. Seat connector firmly in socket</li> <li>5. Bleed the air from the gas line</li> <li>6. Check with gas utility company</li> <li>7. Check with gas utility company</li> <li>8. Notify utility-install dirt trap in gas line</li> <li>9. Locate source and correct</li> <li>10. Replace thermostat</li> <li>11. Clean, locate source and correct</li> <li>12. Replace thermopile</li> <li>13. See maintenance section for inspection and cleaning of flame arrester</li> <li>14. Clean filter, See "Cleaning the Combustion Chamber and Flame-Arrestor" section.</li> <li>15. Replace water heater, eliminate flammable vapors source. Contact Technical Assistance.</li> <li>16. Clean filter, See "External Inspection &amp; Cleaning of the Base-Ring Filter" section.</li> </ol>
HIGH OPERATION COSTS	<ol style="list-style-type: none"> <li>1. Thermostat set too high</li> <li>2. Sediment or lime in tank</li> <li>3. Water heater too small for job</li> <li>4. Wrong piping connections</li> <li>5. Leaking faucets</li> <li>6. Gas leaks</li> <li>7. Wasted hot water</li> <li>8. Long runs of exposed piping</li> <li>9. Hot water piping in exposed wall</li> </ol>	<ol style="list-style-type: none"> <li>1. Set temperature dial to lower setting</li> <li>2. Drain/flush-provide water treatment if needed</li> <li>3. Install adequate heater</li> <li>4. Correct piping-inlet tube must be in cold inlet</li> <li>5. Repair faucets</li> <li>6. Check with utility-repair at once</li> <li>7. Advise customer</li> <li>8. Insulate piping</li> <li>9. Insulate piping</li> </ol>
INSUFFICIENT HOT WATER	<ol style="list-style-type: none"> <li>1. Thermostat set too low</li> <li>2. Sediment or lime in tank</li> <li>3. Water heater too small</li> <li>4. Wrong piping connections</li> <li>5. Leaking faucets</li> <li>6. Wasted hot water</li> <li>7. Long runs of exposed piping</li> <li>8. Hot water piping in outside wall</li> <li>9. Low gas pressure</li> <li>10. Incorrect gas conversion (if unit was converted to use a different type of gas)</li> </ol>	<ol style="list-style-type: none"> <li>1. Turn temperature dial to desired setting</li> <li>2. Drain/flush-provide water treatment if needed</li> <li>3. Install adequate heater</li> <li>4. Correct piping-inlet tube must be in cold inlet</li> <li>5. Repair faucets</li> <li>6. Advise customer</li> <li>7. Insulate piping</li> <li>8. Insulate piping</li> <li>9. Check with gas utility company</li> <li>10. Contact a qualified technician</li> </ol>

## TROUBLESHOOTING CHART (CONTINUED)

PROBLEM	POSSIBLE CAUSE(S)	CORRECTIVE ACTION
SLOW HOT WATER RECOVERY	<ol style="list-style-type: none"> <li>1. Insufficient combustion air</li> <li>2. Water heater flue or vent system blocked</li> <li>3. Low gas pressure</li> <li>4. Improper calibration</li> <li>5. Base-Ring Filter blocked with lint/dust</li> <li>6. FVIR Flame Arrestor blocked with lint/dust.</li> <li>7. Incorrect gas conversion (if unit was converted to use a different type of gas)</li> </ol>	<ol style="list-style-type: none"> <li>1. Provide ventilation to water heater. Check flue way, flue baffle, and burner</li> <li>2. Clean flue, locate source and correct</li> <li>3. Check with gas utility company</li> <li>4. Replace thermostat</li> <li>5. Clean filter, See "External Inspection &amp; Cleaning of the Base-Ring Filter" section.</li> <li>6. Clean filter, See "Cleaning the Combustion Chamber and Flame-Arrestor" section.</li> <li>7. Contact a qualified technician</li> </ol>
DRIP FROM RELIEF VALVE	<ol style="list-style-type: none"> <li>1. Excessive water pressure</li> <li>2. Heater stacking</li> <li>3. Closed water system</li> </ol>	<ol style="list-style-type: none"> <li>1. Use a pressure reducing valve and relief valve</li> <li>2. Lower the thermostat setting</li> <li>3. See "Closed System/Thermal Expansion"</li> </ol>
THERMOSTAT FAILS TO SHUT-OFF	<ol style="list-style-type: none"> <li>1. Thermostat not functioning properly</li> <li>2. Improper calibration</li> </ol>	<ol style="list-style-type: none"> <li>1. Replace thermostat</li> <li>2. Replace thermostat</li> </ol>
COMBUSTION ODORS	<ol style="list-style-type: none"> <li>1. Insufficient combustion air</li> <li>2. Water heater flue or vent system blocked</li> <li>3. Heater installed in a confined area</li> <li>4. Base-Ring Filter blocked with lint/dust</li> <li>5. FVIR Flame Arrestor blocked with lint/dust.</li> </ol>	<ol style="list-style-type: none"> <li>1. Provide ventilation to water heater. Check flue way, flue baffle, and burner</li> <li>2. Clean, locate source and correct</li> <li>3. Provide fresh air ventilation</li> <li>4. Clean filter, See "External Inspection &amp; Cleaning of the Base-Ring Filter" section.</li> <li>5. Clean filter, See "Cleaning the Combustion Chamber and Flame-Arrestor" section.</li> </ol>
SMOKING AND CARBON FORMATION (SOOTING)	<ol style="list-style-type: none"> <li>1. Insufficient combustion air</li> <li>2. Low gas pressure</li> <li>3. Water heater flue or vent system blocked</li> <li>4. Thermostat not functioning properly</li> <li>5. Heater installed in a confined area</li> <li>6. Burner flame yellow-lazy</li> <li>7. Base-Ring Filter blocked with lint/dust</li> <li>8. FVIR Flame Arrestor blocked with lint/dust.</li> <li>9. Incorrect gas conversion (if unit was converted to use a different type of gas)</li> </ol>	<ol style="list-style-type: none"> <li>1. Provide ventilation to water heater. Check flue way, flue baffle, burner</li> <li>2. Check with gas utility company</li> <li>3. Clean, locate source and correct</li> <li>4. Replace thermostat</li> <li>5. Provide fresh air ventilation</li> <li>6. See "Burner Flame Yellow-Lazy"</li> <li>7. Clean filter, See "External Inspection &amp; Cleaning of the Base-Ring Filter" section.</li> <li>8. Clean filter, See "Cleaning the Combustion Chamber and Flame-Arrestor" section.</li> <li>9. Contact a qualified technician</li> </ol>
CONDENSATION	<ol style="list-style-type: none"> <li>1. Temperature setting too low</li> </ol>	<ol style="list-style-type: none"> <li>1. Increase the temperature setting. Refer to the "Condensation" sub-section of this manual's Troubleshooting Guide.</li> </ol>
BURNER FLAME FLOATS AND LIFTS OFF PORTS	<ol style="list-style-type: none"> <li>1. Orifice too large</li> <li>2. High gas pressure</li> <li>3. Water heater flue or vent system blocked</li> <li>4. Cold drafts</li> <li>5. Incorrect gas conversion (if unit was converted to use a different type of gas)</li> </ol>	<ol style="list-style-type: none"> <li>1. Replace with correct orifice</li> <li>2. Check with gas utility company</li> <li>3. Clean flue and burner-locate source and correct</li> <li>4. Locate source and correct</li> <li>5. Contact a qualified technician</li> </ol>
BURNER FLAME TOO HIGH	<ol style="list-style-type: none"> <li>1. Orifice too large</li> <li>2. Incorrect gas conversion (if unit was converted to use a different type of gas)</li> </ol>	<ol style="list-style-type: none"> <li>1. Replace with correct orifice</li> <li>2. Contact a qualified technician</li> </ol>
FLAME BURNS AT ORIFICE	<ol style="list-style-type: none"> <li>1. Thermostat not functioning properly</li> <li>2. Low gas pressure</li> <li>3. Incorrect gas conversion (if unit was converted to use a different type of gas)</li> </ol>	<ol style="list-style-type: none"> <li>1. Replace thermostat</li> <li>2. Check with gas utility company</li> <li>3. Contact a qualified technician</li> </ol>
PILOT FLAME TOO SMALL	<ol style="list-style-type: none"> <li>1. Pilot line or orifice clogged</li> <li>2. Low gas pressure</li> </ol>	<ol style="list-style-type: none"> <li>1. Clean, locate source and correct</li> <li>2. Check with gas utility company</li> </ol>

# PILOT LIGHT TROUBLESHOOTING FLOWCHART

## Section A: Pilot light will not light (new installation).

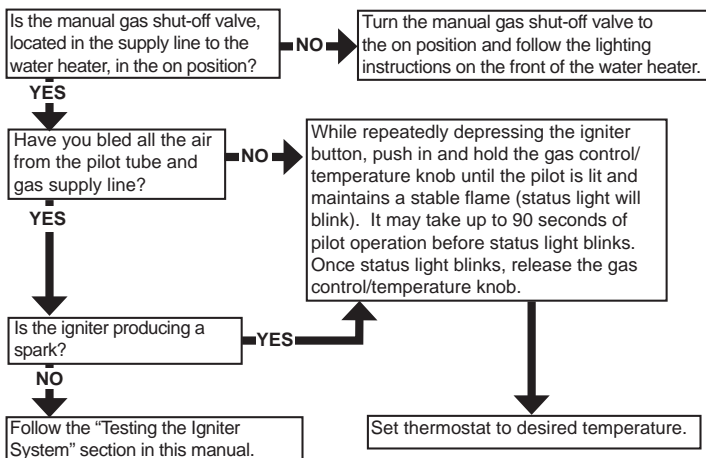

## Section B: Pilot light repeatedly goes out.

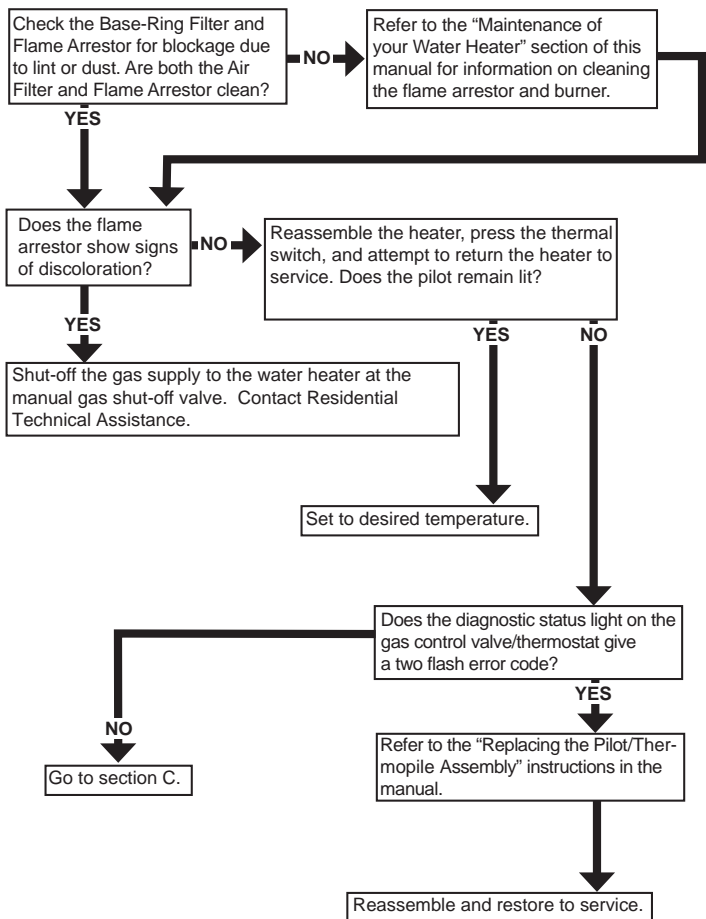

## Section C: Pilot light will not remain lit.

*Complete this section after completing Section B.*

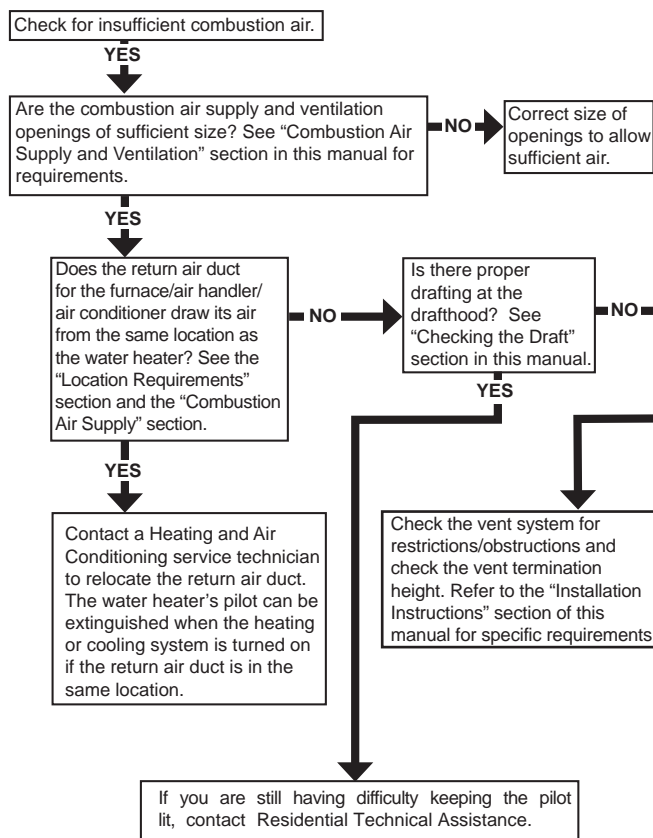

**NOTE:** If you are still experiencing difficulties after following the steps in sections A, B, and C, please contact Residential Technical Assistance.

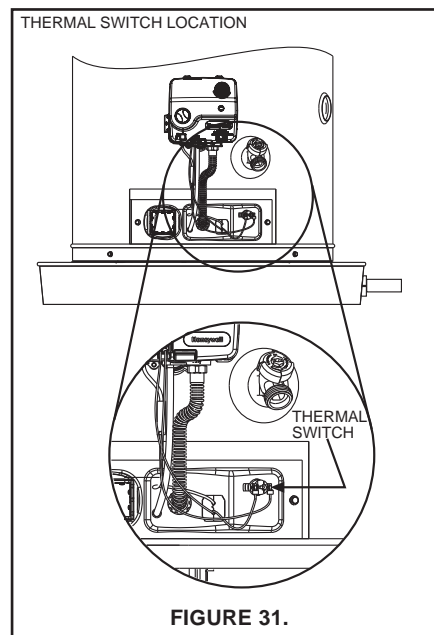

**FIGURE 31.**

## STATUS LIGHT AND DIAGNOSTIC CODE TROUBLESHOOTING CHART

LED STATUS	PROBLEM	CORRECTIVE ACTION
0 FLASHES (LED NOT LIT)	Pilot light is not lit or Thermopile has not yet reached normal operating temperature.	<p>Turn Gas Control Valve/Thermostat knob to OFF. Wait 10 minutes, then attempt to relight Pilot by following the lighting instructions on the water heater's label. Until the Thermopile reaches its normal operating temperature, the Status Light will not blink, even if the Pilot is lit. It may take up to 90 seconds of continuous Pilot operation before the Thermopile reaches normal operating temperature and the Status Light starts to blink.</p> <p>If the Status Light does not blink after three lighting attempts, check to make sure unit is getting gas. Remove the outer door. Press reset button. Replace outer door. Turn Gas Control Valve/Thermostat knob to OFF. Wait 10 minutes, then attempt to light Pilot by following the lighting instructions on the water heater's label. Look through the view port for the Pilot flame. If Pilot is not visible, the spark igniter or gas supply to the Pilot should be checked.</p> <p>If the Pilot is visible and the Status Light does not blink after 90 seconds of continuous Pilot operation, the Pilot flame may not be heating the Thermopile sufficiently (weak Pilot), the Thermopile may be defective, or wiring connectors may be loose.</p> <p>NOTE: If the water heater has been operating but has stopped and will not re-light, check the flame-arrestor for signs of high temperature (blue or black) discoloration indicating a flammable vapor incident. If you suspect a flammable vapor incident has occurred, do not use this appliance. Immediately call a qualified technician to inspect the appliance. Water heaters subjected to a flammable vapors ignition will require replacement of the entire water heater.</p>
STATUS LIGHT ON (SOLID)	Pilot light was recently extinguished and the Thermopile is cooling down.	<p>Turn Gas Control Valve/Thermostat knob to OFF. Wait 10 minutes for the Thermopile to cool, then attempt to relight Pilot by following the lighting instructions on the water heater's label. NOTE: This gas control valve/thermostat has built-in circuitry that requires waiting 10 minutes between lighting attempts.</p> <p>Until the Thermopile reaches its normal operating temperature, the Status Light will not blink, even if the Pilot is lit. It may take up to 90 seconds of continuous Pilot operation before the Thermopile reaches normal operating temperature and the Status Light starts to blink.</p>
1 FLASH (EVERY 3 SECONDS)	Normal operation.	No corrective action necessary.
2 FLASHES	Pilot is lit but the Thermopile is not producing the required output voltage.	Turn Gas Control Valve/Thermostat knob to OFF. The Thermopile is probably defective, but loose wiring connections or a weak Pilot flame can also cause this symptom.



## STATUS LIGHT AND DIAGNOSTIC CODE TROUBLESHOOTING CHART (Continued)

LED STATUS	PROBLEM	CORRECTIVE ACTION
4 FLASHES	The Gas Control Valve's temperature sensor has detected that the water temperature was too high. Once this condition occurs, the Main Burner and the Pilot Light will be shut off. Since the Pilot light will be off, should this condition occur, this Flash Code will only be displayed immediately after the Pilot has been relit. Turn Gas Control Valve/Thermostat knob to OFF.	Relight pilot and verify 4 flashes. If 4 flashes are observed, turn Gas Control Valve/Thermostat knob to OFF. Turn Main Gas Supply OFF. Replace the Gas Control Valve/Thermostat. See "Removing and Replacing the Gas Control Valve/Thermostat."
5 FLASHES	The temperature sensor (thermistor) is defective.	Turn Gas Control Valve/Thermostat knob to OFF. Replace the temperature sensor (thermistor).
7 FLASHES	Gas Control Valve failure.	Turn Gas Control Valve/Thermostat knob to OFF. Turn Main Gas Supply OFF. Replace the Gas Control Valve/Thermostat. See "Removing and Replacing the Gas Control Valve/Thermostat."
8 FLASHES	This condition only appears if the gas control/temperature knob has been turned off and the thermopile continued to produce electric power. This condition can occur if the thermopile does not cool down as quickly as expected when the unit is shut off. This condition can also occur if the gas control/temperature knob has been turned off and the pilot continues to operate because the pilot valve is stuck in the open position.	<p>Make sure that the gas control valve/thermostat knob is set to OFF. Wait one minute. Remove the outer door. Look through the sight glass for a pilot flame. If a pilot flame is observed with the gas control valve/thermostat knob set to the OFF position, the pilot valve is stuck open. Turn the main gas supply OFF. Replace the gas control valve/thermostat. For instructions, see "Removing and Replacing the Gas Control Valve/Thermostat."</p> <p>If the pilot flame is not observed when the gas control valve/thermostat knob is set to the OFF position, wait 10 minutes for the thermopile to cool, then attempt to relight the pilot by following the lighting instructions on the water heater's label. If this condition returns, replace the gas control valve/thermostat. See "Removing and Replacing the Gas Control Valve/Thermostat" for instructions.</p>

## REPAIR PARTS ILLUSTRATION

When ordering repair parts always give the following information:

1. Model, serial, and product number
2. Type of gas
3. Item number
4. Parts description

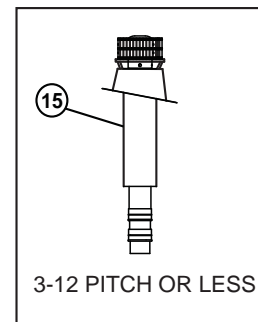
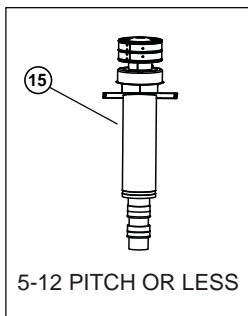
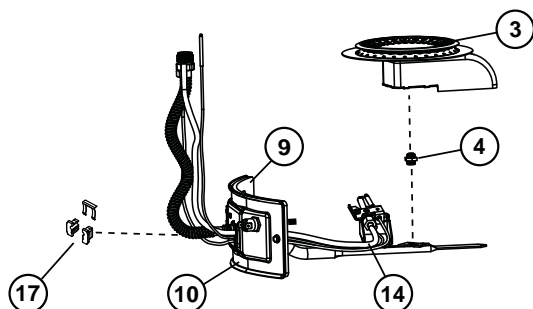

Item No.	Part Description	
1	Anode Rod	▲
2	Base-Ring Filter	★
3	Burner Head (natural gas or LP gas)	★
4	Burner Orifice (natural gas or LP gas)	★
5	Draft Hood	
6	Drain Valve	
7	Gas Control Valve/Thermostat	★
8	Inlet Tube w/ Heat Trap	
9	Inner Door Gasket	★
10	Manifold Door Assembly - (natural gas or LP gas) Contains: Manifold Tube, Gasket, Door, Pilot Tube, Thermopile, Manifold Component Block w/ Clip, Thermal Switch, Burner Head, Burner Orifice, and Pilot Assembly.	★
11	Mounting Bracket Kit (not shown)	
12	Nipple w/Heat Trap	
13	Outer Door	
14	Pilot Assembly w/ Tubing and Fittings (natural gas or LP gas)	★
15	Roof Jack 5-12 Pitch or Less-12" (9002964)	
15	Roof Jack 5-12 Pitch or Less-32" (9002965)	
15	Roof Jack 5-12 Pitch or Less-60" (9002966)	
15	Roof Jack 5-12 Pitch or Less-95" (9002967)	
15	Roof Jack 3-12 Pitch or Less-14" (9007941)	
15	Roof Jack 3-12 Pitch or Less-30" (9007942)	
16	Temperature and Pressure Relief Valve (located top or side)	■
17	Manifold Component Block w/ Clip	★

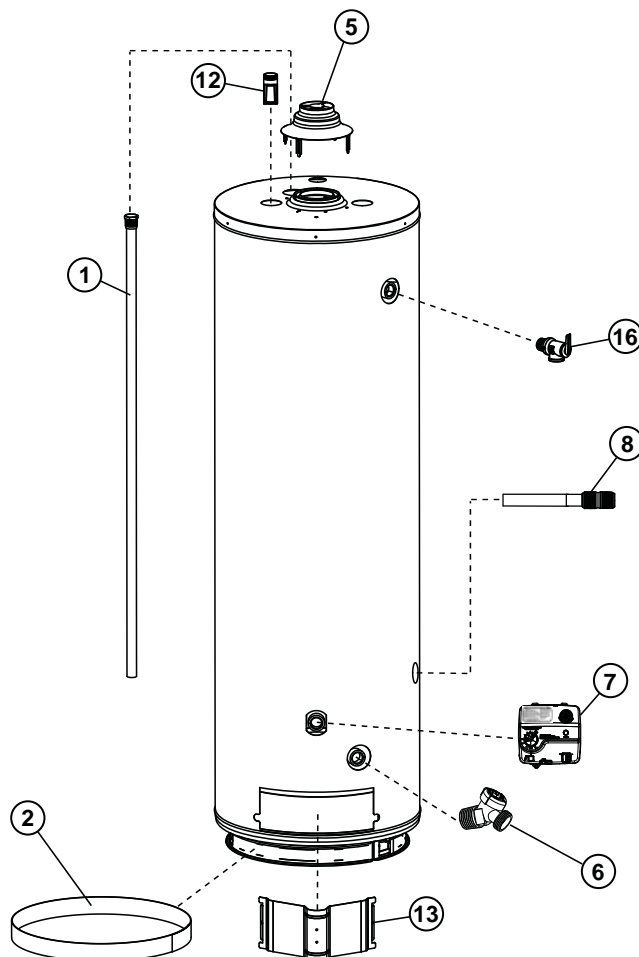

### LEGEND

- ▲ Special anode rod (see Anode Rod Inspection section)
- Temperature and Pressure Relief Valve is required, but may not be factory installed
- ★ Unique: FVIR System parts

