

17
FILE COPY

Serial No. 146 (2d ed.)

DEPARTMENT OF COMMERCE
U. S. COAST AND GEODETIC SURVEY
E. LESTER JONES, Director

ELEMENTS OF MAP PROJECTION

WITH

APPLICATIONS TO MAP AND CHART
CONSTRUCTION

BY

CHARLES H. DEETZ
AND
OSCAR S. ADAMS

Special Publication No. 68
(Revised May 1, 1928)



PRICE 50 CENTS

Sold only by the Superintendent of Documents, Government Printing Office
Washington, D. C.

UNITED STATES
GOVERNMENT PRINTING OFFICE
WASHINGTON
1928

G. & G. SURVEY
L. & A.
OCT 24 1928
Acc. No.

QB
275
.435
no. 68
(1928)

LIBRARY
JAN 24 1992
N.O.A.A.
U.S. Dept. of Commerce

National Oceanic and Atmospheric Administration

ERRATA NOTICE

One or more conditions of the original document may affect the quality of the image, such as:

Discolored pages

Faded or light ink

Binding intrudes into the text

This has been a co-operative project between the NOAA Central Library and the Climate Database Modernization Program, National Climate Data Center (NCDC). To view the original document, please contact the NOAA Central Library in Silver Spring, MD at (301) 713-2607 x124 or www.reference@nodc.noaa.gov.

LASON

Imaging Contractor

12200 Kiln Court

Beltsville, MD 20704-1387

January 1, 2006

PREFACE.

In this publication it has been the aim of the authors to present in simple form some of the ideas that lie at the foundation of the subject of map projections. Many people, even people of education and culture, have rather hazy notions of what is meant by a map projection, to say nothing of the knowledge of the practical construction of such a projection.

The two parts of the publication are intended to meet the needs of such people; the first part treats the theoretical side in a form that is as simple as the authors could make it; the second part attacks the subject of the practical construction of some of the most important projections, the aim of the authors being to give such detailed directions as are necessary to present the matter in a clear and simple manner.

Some ideas and principles lying at the foundation of the subject, both theoretical and practical, are from the very nature of the case somewhat complicated, and it is a difficult matter to state them in simple manner. The theory forms an important part of the differential geometry of surfaces, and it can only be fully appreciated by one familiar with the ideas of that branch of science. Fortunately, enough of the theory can be given in simple form to enable one to get a clear notion of what is meant by a map projection and enough directions for the construction can be given to aid one in the practical development of even the more complicated projections.

It is hoped that this publication may meet the needs of people along both of the lines indicated above and that it may be found of some interest to those who may already have a thorough grasp of the subject as a whole.

PREFACE TO SECOND EDITION.

In the preparation of a second edition no effort has been made to revise the general text, only a few necessary corrections having been incorporated. Some new material listed in the index to addenda on page 163 continues the discussion of world maps. General observations on the azimuthal equidistant projection and on some recent contributions to mathematical cartography are also included.

CONTENTS.

PART I.

	Page.
General statement.....	7
Analysis of the basic elements of map projection.....	9
Problem to be solved.....	9
Reference points on the sphere.....	11
Determination of latitude.....	12
Determination of longitude.....	13
Plotting points by latitude and longitude on a globe.....	14
Plotting points by latitude and longitude on a plane map.....	14
How to draw a straight line.....	15
How to make a plane surface.....	16
How to draw the circles representing meridians and parallels on a sphere.....	17
The terrestrial globe.....	19
Representation of the sphere upon a plane.....	22
The problem of map projection.....	22
Definition of map projection.....	22
Distortion.....	22
Conditions fulfilled by a map projection.....	25
Classification of projections.....	25
The ideal map.....	27
Projections considered without mathematics.....	28
Elementary discussion of various forms of projection.....	30
Cylindrical equal-area projection.....	30
Cylindrical equal-spaced projection.....	30
Projection from the center upon a tangent cylinder.....	30
Mercator projection.....	32
Geometrical azimuthal projections.....	35
Stereographic polar projection.....	35
Central or gnomonic projection.....	37
Lambert azimuthal equal-area projection.....	38
Orthographic polar projection.....	38
Azimuthal equidistant projection.....	40
Other projections in frequent use.....	42
Construction of a stereographic meridional projection.....	44
Construction of a gnomonic projection with point of tangency on the equator.....	45
Conical projections.....	46
Central projection upon a cone tangent at latitude 30°	47
Bonne projection.....	49
Polyconic projection.....	49
Illustrations of relative distortions.....	51

PART II.

Introduction.....	53
Projections described in Part II.....	53
The choice of projection.....	54
Comparison of errors of scale and errors of area in a map of the United States on four different projections.....	54
The polyconic projection.....	58
Description.....	58
Construction of a polyconic projection.....	60
Transverse polyconic projection.....	62
Polyconic projection with two standard meridians, as used for the international map of the world, scale 1:1 000 000.....	62

	Page.
The Bonne projection.....	67
Description.....	67
The Sanson-Flamsteed projection.....	68
Construction of a Bonne projection.....	68
The Lambert zenithal (or azimuthal) equal-area projection.....	71
Description.....	71
The Lambert equal-area meridional projection.....	73
Table for the construction of a Lambert zenithal equal-area projection with center on parallel 40°	73
Table for the construction of a Lambert zenithal equal-area meridional projection.....	75
The Lambert conformal conic projection with two standard parallels.....	77
Description.....	77
Construction of a Lambert conformal conic projection.....	83
Table for the construction of a Lambert conformal conic projection with standard parallels at 36° and 54°	85
Table for the construction of a Lambert conformal conic projection with standard parallels at 10° and $48^\circ 40'$	86
The Grid system of military mapping.....	87
Grid system for progressive maps in the United States.....	87
The Albers conical equal-area projection with two standard parallels.....	91
Description.....	91
Mathematical theory of the Albers projection.....	93
Construction of an Albers projection.....	99
Table for the construction of a map of the United States on Albers equal-area projection with two standard parallels.....	100
The Mercator projection.....	101
Description.....	101
Development of the formulas for the coordinates of the Mercator projection.....	105
Development of the formulas for the transverse Mercator projection.....	108
Construction of a Mercator projection.....	109
Construction of a transverse Mercator projection for the sphere with the cylinder tangent along a meridian.....	114
Mercator projection table.....	116
Fixing position by wireless directional bearings.....	137
The gnomonic projection.....	140
Description.....	140
Mathematical theory of the gnomonic projection.....	141
WORLD MAPS.	
The Mercator projection.....	146
The stereographic projection.....	147
The Aitoff equal-area projection of the sphere.....	150
Table for the construction of an Aitoff equal-area projection of the sphere.....	152
The Mollweide homalographic projection.....	153
Construction of the Mollweide homalographic projection of a hemisphere.....	154
Homalographic projection of the sphere.....	155
Table for the construction of the Mollweide homalographic projection.....	155
Goode's homalographic projection (interrupted) for the continents and oceans.....	156
Lambert projection of the northern and southern hemispheres.....	158
Conformal projection of the sphere within a two-cusped epicycloid.....	160
Guyou's doubly periodic projection of the sphere.....	160
Index.....	161

ILLUSTRATIONS.

FIGURES.

	Page.
Frontispiece. Diagram showing lines of equal scale error or linear distortion in the polyconic, Lambert zenithal, Lambert conformal, and Albers projections.....(facing page)	7
1. Conical surface cut from base to apex.....	9
2. Development of the conical surface.....	10
3. Cylindrical surface cut from base to base.....	10
4. Development of the cylindrical surface.....	11
5. Determination of the latitude of a place.....	12
6. Construction of a straight edge.....	16
7. Constructing the circles of parallels and meridians on a globe.....	18
8. Covering for a terrestrial globe.....	20
9. Pack of cards before "shearing".....	23
10. Pack of cards after "shearing".....	23
11. Square "sheared" into an equivalent parallelogram.....	23
12. The Mollweide equal-area projection of the sphere.....	24
13. Earth considered as formed by plane quadrangles.....	28
14. Earth considered as formed by bases of cones.....	29
15. Development of the conical bases.....	29
16. Cylindrical equal-area projection.....	31
17. Cylindrical equal-spaced projection.....	31
18. Modified cylindrical equal-spaced projection.....	32
19. Perspective projection upon a tangent cylinder.....	33
20. Mercator projection.....	34
21. Determination of radii for stereographic polar projection.....	35
22. Stereographic polar projection.....	36
23. Determination of radii for gnomonic polar projection.....	37
24. Gnomonic polar projection.....	38
25. Determination of radii for Lambert equal-area polar projection.....	39
26. Lambert equal-area polar projection.....	39
27. Determination of radii for orthographic polar projection.....	40
28. Orthographic polar projection.....	40
29. Azimuthal equidistant polar projection.....	41
30. Stereographic projection of the Western Hemisphere.....	41
31. Gnomonic projection of part of the Western Hemisphere.....	42
32. Lambert equal-area projection of the Western Hemisphere.....	42
33. Orthographic projection of the Western Hemisphere.....	43
34. Globular projection of the Western Hemisphere.....	43
35. Determination of the elements of a stereographic projection on the plane of a meridian.....	44
36. Construction of a gnomonic projection with plane tangent at the Equator.....	45
37. Cone tangent to the sphere at latitude 30°	46
38. Determination of radii for conical central perspective projection.....	47
39. Central perspective projection on cone tangent at latitude 30°	48
40. Bonne projection of the United States.....	49
41. Polyconic projection of North America.....	50
42. Man's head drawn on globular projection.....	51
43. Man's head plotted on orthographic projection.....	51
44. Man's head plotted on stereographic projection.....	51
45. Man's head plotted on Mercator projection.....	51
46. Gnomonic projection of the sphere on a circumscribed cube.....	52
47. Polyconic development of the sphere.....	58
48. Polyconic development.....	59
49. Polyconic projection—construction plate.....	61
50. International map of the world—junction of sheets.....	65
51. Bonne projection of hemisphere.....	67
52. Lambert conformal conic projection.....	77
53. Scale distortion of the Lambert conformal conic projection with the standard parallels at 29° and 45°	79

	Page.
54. Scale distortion of the Lambert conformal conic projection with the standard parallels at 33° and 45°.....	80
55. Diagram for constructing a Lambert projection of small scale.....	84
56. Grid zones for progressive military maps of the United States.....	88
57. Diagram of zone C, showing grid system.....	89
58. Part of a Mercator chart showing a rhumb line and a great circle.....	102
59. Part of a gnomonic chart showing a great circle and a rhumb line.....	102
60. Mercator projection—construction plate.....	111
61. Transverse Mercator projection—cylinder tangent along a meridian—construction plate.....	115
62. Fixing positions by wireless directional bearings..... (facing page)	138
63. Diagram illustrating the theory of the gnomonic projection.....	140
64. Gnomonic projection—determination of the radial distance.....	142
65. Gnomonic projection—determination of the coordinates on the mapping plane.....	142
66. Gnomonic projection—transformation triangle on the sphere.....	143
67. Mercator projection, from latitude 60° south, to latitude 78° north.....	146
68. Stereographic meridional projection.....	148
69. Stereographic horizon projection on the horizon of Paris.....	149
70. The Aitoff equal-area projection of the sphere with the Americas in center.....	151
71. The Mollweide homalographic projection of the sphere.....	153
72. The Mollweide homalographic projection of a hemisphere.....	154
73. Homalographic projection (interrupted) for ocean units.....	157
74. Guyou's doubly periodic projection of the sphere.....	159
75. Sinusoidal or Mercator equal-area projection..... (facing page)	164
76. Azimuthal equidistant projection of the world..... (facing page)	166

FOLDED PLATES.

	Following page.
I. Lambert conformal conic projection of the North Atlantic Ocean.....	167
II. Transverse polyconic projection of the North Pacific Ocean, showing Alaska and its relation to the United States and the Orient, scale 1:40 000 000.....	167
III. Albers projection of the United States.....	167
IV. Gnomonic projection of part of the North Atlantic Ocean.....	167
V. The Aitoff equal-area projection of the sphere.....	167
VI. The world on the homalographic projection (interrupted for the continents).....	167
VII. Lambert projection of the Northern and Southern Hemispheres.....	167
VIII. Conformal projection of the sphere within a two cusped epicycloid.....	167

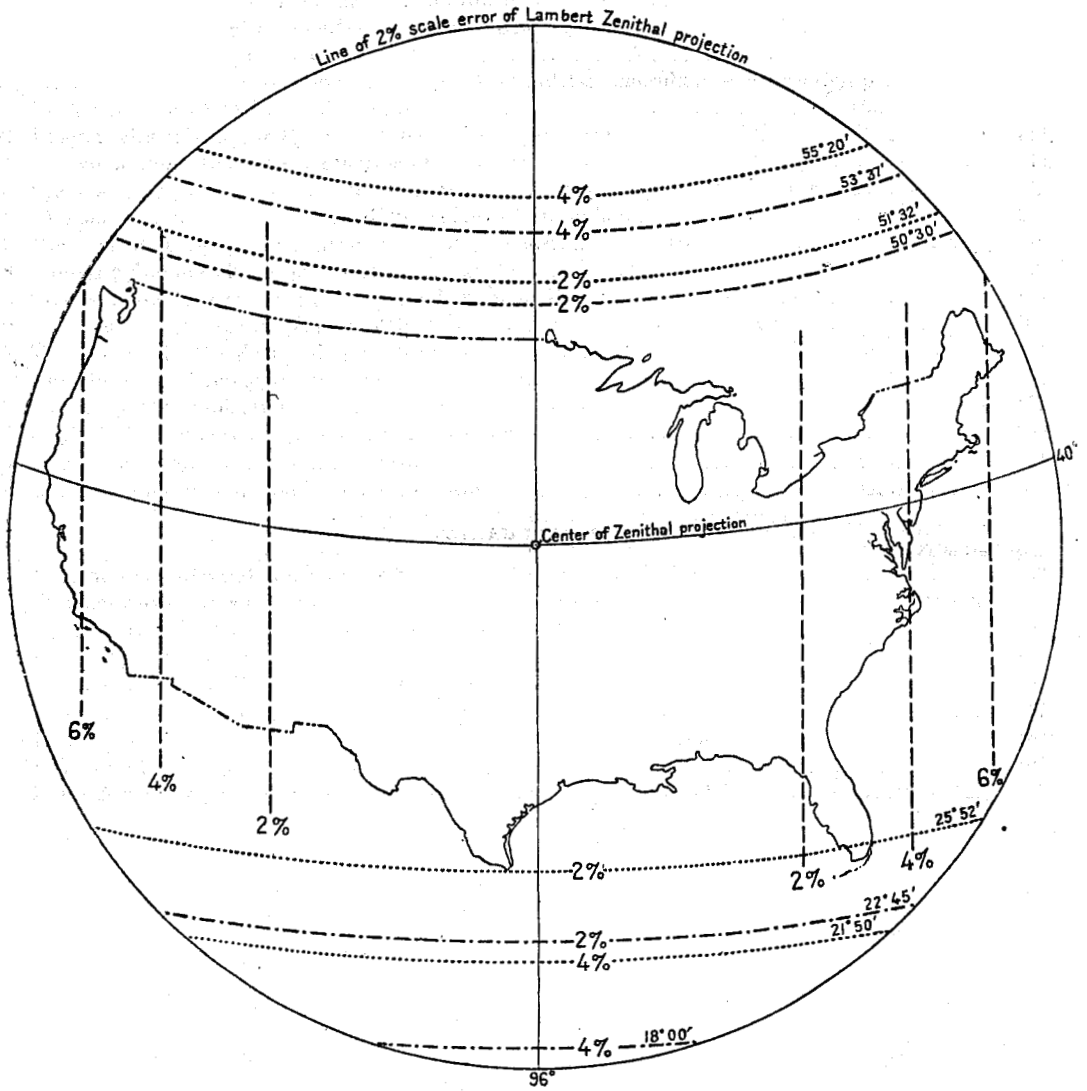

Lines of scale error or linear distortion

- Polyconic projection.....2%, 4% and 6%, shown by vertical broken lines
- Lambert Conformal.....2% and 4%, shown by dotted lines (east and west)
- Lambert Zenithal.....2%, shown by bounding circle
- Albers.....2% and 4%, shown by dot and dash lines (east and west)

FRONTISPIECE.—Diagram showing lines of equal scale error or linear distortion in the polyconic, Lambert zenithal, Lambert conformal, and Albers projections. (See statistics on pp. 54, 55.)

ELEMENTS OF MAP PROJECTIONS WITH APPLICATIONS TO MAP AND CHART CONSTRUCTION.

By CHARLES H. DEETZ, *Cartographer*, and OSCAR S. ADAMS, *Geodetic Computer*.

PART I.

GENERAL STATEMENT.¹

Whatever may be the destiny of man in the ages to come, it is certain that for the present his sphere of activity is restricted to the outside shell of one of the smaller planets of the solar system—a system which after all is by no means the largest in the vast universe of space. By the use of the imagination and of the intellect with which he is endowed he may soar into space and investigate, with more or less certainty, domains far removed from his present habitat; but as regards his actual presence, he can not leave, except by insignificant distances, the outside crust of this small earth upon which he has been born, and which has formed in the past, and must still form, the theater upon which his activities are displayed.

The connection between man and his immediate terrestrial surroundings is therefore very intimate, and the configuration of the surface features of the earth would thus soon attract his attention. It is only reasonable to suppose that, even in the most remote ages of the history of the human race, attempts were made, however crude they may have been, to depict these in some rough manner. No doubt these first attempts at representation were scratched upon the sides of rocks and upon the walls of the cave dwellings of our primitive forefathers. It is well, then, in the light of present knowledge, to consider the structure of the framework upon which this representation is to be built. At best we can only partially succeed in any attempt at representation, but the recognition of the possibilities and the limitations will serve as valuable aids in the consideration of any specific problem.

We may reasonably assume that the earliest cartographical representations consisted of maps and plans of comparatively small areas, constructed to meet some need of the times, and it would be later on that any attempt would be made to extend the representation to more extensive regions. In these early times map making, like every other science or art, was in its infancy, and probably the first attempts of the kind were not what we should now call plans or maps at all, but rough perspective representations of districts or sketches with hills, forests, lakes, etc., all shown as they would appear to a person on the earth's surface. To represent these features in plan form, with the eye vertically over the various objects, although of very early origin, was most likely a later development; but we are now never likely to know who started the idea, since, as we have seen, it dates back far into antiquity.

Geography is many-sided, and has numerous branches and divisions; and though it is true that map making is not the whole of geography, as it would be well for us

¹ Paraphrased from "Maps and Map-making," by E. A. Reeves, London, 1910.

to remind ourselves occasionally, yet it is, at any rate, a very important part of it, and it is, in fact, the foundation upon which all other branches must necessarily depend. If we wish to study the structure of any region we must have a good map of it upon which the various land forms can be shown. If we desire to represent the distribution of the races of mankind, or any other natural phenomenon, it is essential, first of all, to construct a reliable map to show their location. For navigation, for military operations, charts, plans, and maps are indispensable, as they are also for the demarcation of boundaries, land taxation, and for many other purposes. It may, therefore, be clearly seen that some knowledge of the essential qualities inherent in the various map structures or frameworks is highly desirable, and in any case the makers of maps should have a thorough grasp of the properties and limitations of the various systems of projection.

ANALYSIS OF THE BASIC ELEMENTS OF MAP PROJECTION.^{1a}

PROBLEM TO BE SOLVED.

A map is a small-scale, flat-surface representation of some portion of the surface of the earth. Nearly every person from time to time makes use of maps, and our ideas with regard to the relative areas of the various portions of the earth's surface are in general derived from this source. The shape of the land masses and their positions with respect to one another are things about which our ideas are influenced by the way these features are shown on the maps with which we become familiar.

It is fully established to-day that the shape of the earth is that of a slightly irregular spheroid, with the polar diameter about 26 miles shorter than the equatorial. The spheroid adopted for geodetic purposes is an ellipsoid of revolution formed by revolving an ellipse about its shorter axis. For the purpose of the present discussion the earth may be considered as a sphere, because the irregularities are very small compared with the great size of the earth. If the earth were represented by a spheroid with an equatorial diameter of 25 feet, the polar diameter would be approximately 24 feet 11 inches.

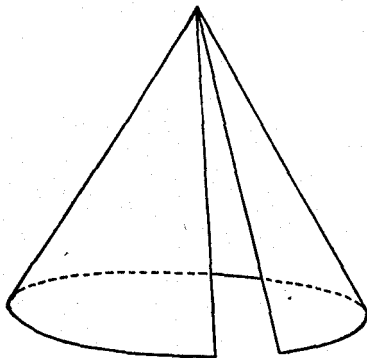

FIG. 1.—Conical surface cut from base to apex.

The problem presented in map making is the question of representing the surface of the sphere upon a plane. It requires some thought to arrive at a proper appreciation of the difficulties that have to be overcome, or rather that have to be dealt with and among which there must always be a compromise; that is, a little of one desirable property must be sacrificed to attain a little more of some other special feature.

In the first place, no portion of the surface of a sphere can be spread out in a plane without some stretching or tearing. This can be seen by attempting to flatten out a cap of orange peel or a portion of a hollow rubber ball; the outer part must be stretched or torn, or generally both, before the central part will come into the plane with the outer part. This is exactly the difficulty that has to be contended with in map making. There are some surfaces, however, that can be spread out in a plane without any stretching or tearing. Such surfaces are called developable surfaces and those like the sphere are called nondevelopable. The cone and the

^{1a} Some of the elementary text in Part I and a number of the illustrations were adapted from a publication issued by G. Philip & Son (Ltd.), of London, England. The work is entitled "A Little Book on Map Projection," and its author is William Garnett writing under the pseudonym of Mary Adams. We wish to acknowledge our indebtedness to this work which sets forth in simple illustrations some of the fundamental facts in regard to map construction.

cylinder are the two well-known surfaces that are developable. If a cone of revolution, or a right circular cone as it is called, is formed of thin material like paper

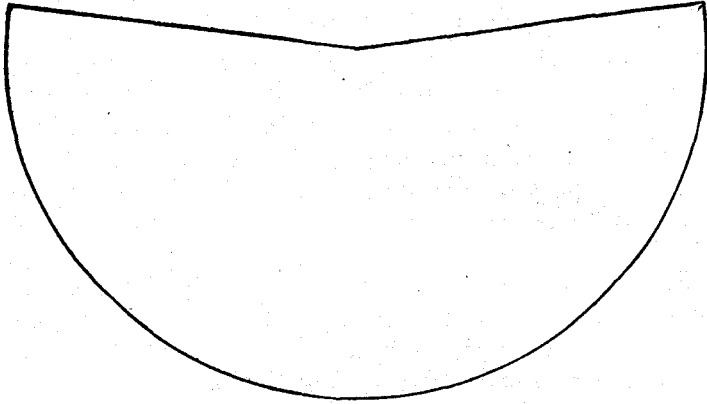

FIG. 2.—Development of the conical surface.

and if it is cut from some point in the curve bounding the base to the apex, the conical surface can be spread out in a plane with no stretching or tearing. (See figs. 1 and 2.) Any curve drawn on the surface will have exactly the same length after development that it had before. In the same way, if a cylindrical surface is

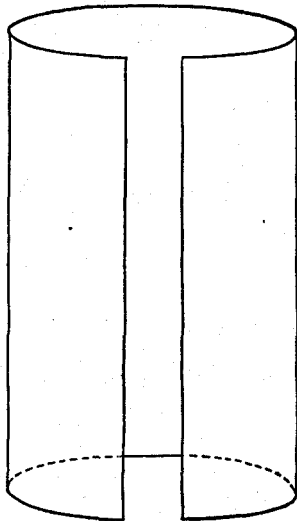

FIG. 3.—Cylindrical surface cut from base to base.

cut from base to base the whole surface can be rolled out in the plane, if the surface consists of thin pliable material. (See figs. 3 and 4.) In this case also there is no stretching or tearing of any part of the surface. Attention is called to the developable property of these surfaces, because use will be made of them in the later discussion of the subject of map making.

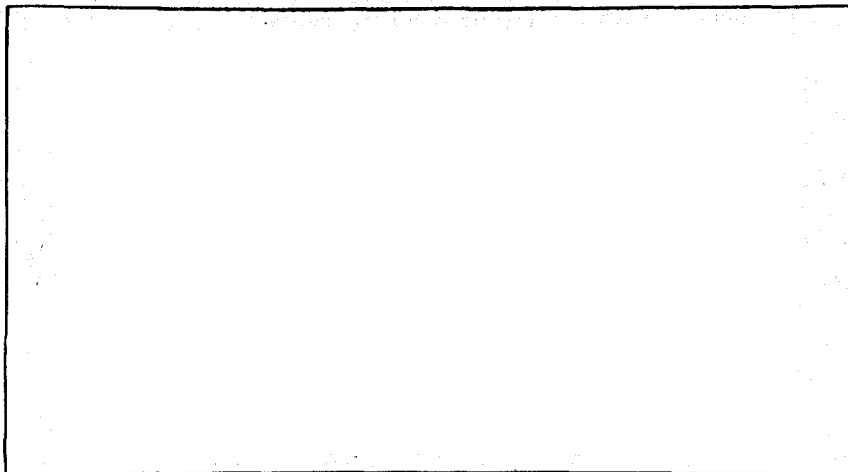

FIG. 4.—Development of the cylindrical surface.

REFERENCE POINTS ON THE SPHERE.

A sphere is such that any point of it is exactly like any other point; there is neither beginning nor ending as far as differentiation of points is concerned. On the earth it is necessary to have some points or lines of reference so that other points may be located with regard to them. Places on the earth are located by latitude and longitude, and it may be well to explain how these quantities are related to the terrestrial sphere. The earth sphere rotates on its axis once a day, and this axis is therefore a definite line that is different from every other diameter. The ends of this diameter are called the poles, one the North Pole and the other the South Pole. With these as starting points, the sphere is supposed to be divided into two equal parts or hemispheres by a plane perpendicular to the axis midway between the poles. The circle formed by the intersection of this plane with the surface of the earth is called the Equator. Since this line is defined with reference to the poles, it is a definite line upon the earth. All circles upon the earth which divide it into two equal parts are called great circles, and the Equator, therefore, is a great circle. It is customary to divide the circle into four quadrants and each of these into 90 equal parts called degrees. There is no reason why the quadrant should not be divided into 100 equal parts, and in fact this division is sometimes used, each part being then called a grade. In this country the division of the quadrant into 90° is almost universally used; and accordingly the Equator is divided into 360° .

After the Equator is thus divided into 360° , there is difficulty in that there is no point at which to begin the count; that is, there is no definite point to count as zero or as the origin or reckoning. This difficulty is met by the arbitrary choice of some point the significance of which will be indicated after some preliminary explanations.

Any number of great circles can be drawn through the two poles and each one of them will cut the Equator into two equal parts. Each one of these great circles may be divided into 360° , and there will thus be 90° between the Equator and each pole on each side. These are usually numbered from 0° to 90° from the Equator to the pole, the Equator being 0° and the pole 90° . These great circles through the poles are called meridians. Let us suppose now that we take a point on one of these 30° north of the Equator. Through this point pass a plane perpendicular

to the axis, and hence parallel to the plane of the Equator. This plane will intersect the surface of the earth in a small circle, which is called a parallel of latitude, this particular one being the parallel of 30° north latitude. Every point on this parallel will be in 30° north latitude. In the same way other small circles are determined to represent 20° , 40° , etc., both north and south of the Equator. It is evident that each of these small circles cuts the sphere, not into two equal parts, but into two unequal parts. These parallels are drawn for every 10° , or for any regular interval that may be selected, depending on the scale of the sphere that represents the earth. The point to bear in mind is that the Equator was drawn as the great circle midway between the poles; that the parallels were constructed with reference to the Equator; and that therefore they are definite small circles referred to the poles. Nothing is arbitrary except the way in which the parallels of latitude are numbered.

DETERMINATION OF LATITUDE.

The latitude of a place is determined simply in the following way: Very nearly

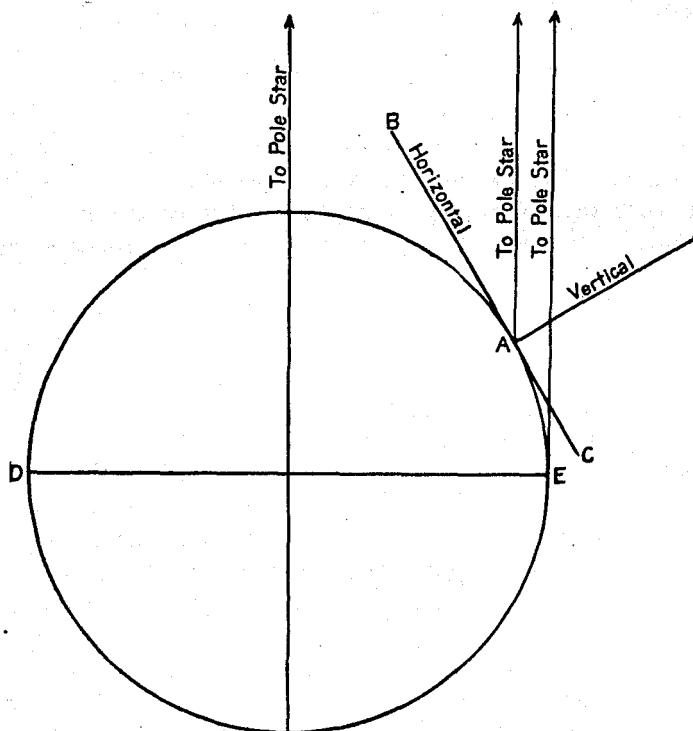

FIG. 5.—Determination of the latitude of a place.

in the prolongation of the earth's axis to the north there happens to be a star, to which the name polestar has been given. If one were at the North Pole, this star would appear to him to be directly overhead. Again, suppose a person to be at the Equator, then the star would appear to him to be on the horizon, level with his eye. It might be thought that it would be below his eye because it is in line with the earth's axis, 4,000 miles beneath his feet, but the distance of the star is so enormous that the radius of the earth is exceedingly small as compared with it. All lines to the star from different points on the earth appear to be parallel.

Suppose a person to be at A (see fig. 5), one-third of the distance between the Equator and the North Pole, the line BC will appear to him to be horizontal and he will see the star one-third of the way up from the horizon to the point in the heavens directly overhead. This point in the line of the vertical is called the zenith. It is now seen that the latitude of any place is the same as the height of the polestar above the horizon. Most people who have traveled have noticed that as they go south the polestar night by night appears lower in the heavens and gradually disappears, while the Southern Cross gradually comes into view.

At sea the latitude is determined every day at noon by an observation of the sun, but this is because the sun is brighter and more easily observed. Its distance from the pole, which varies throughout the year, is tabulated for each day in a book called the Nautical Almanac. When, therefore, an observation of the sun is made, its polar distance is allowed for, and thus the latitude of the ship is determined by the height of the pole in the heavens. Even the star itself is directly observed upon from time to time. This shows that the latitude of a place is not arbitrary. If the star is one-third of the way up, measured from the horizon toward the zenith, then the point of observation is one-third of the way up from the Equator toward the pole, and nothing can alter this fact. By polestar, in the previous discussion, is really meant the true celestial pole; that is, the point at which the prolongation of the earth's axis pierces the celestial sphere. Corrections must be made to the observations on the star to reduce them to this true pole. In the Southern Hemisphere latitudes are related in a similar way to the southern pole.

Strictly speaking, this is what is called the astronomical latitude of a place. There are other latitudes which differ slightly from that described above, partly because the earth is not a sphere and partly on account of local attractions, but the above-described latitude is not only the one adopted in all general treatises but it is also the one employed on all general maps and charts, and it is the latitude by which all navigation is conducted; and if we assume the earth to be a homogeneous sphere, it is the only latitude.

DETERMINATION OF LONGITUDE.

This, however, fixes only the parallel of latitude on which a place is situated. If it be found that the latitude of one place is 10° north and that of another 20° north, then the second place is 10° north of the first, but as yet we have no means of showing whether it is east or west of it.

If at some point on the earth's surface a perpendicular pole is erected, its shadow in the morning will be on the west side of it and in the evening on the east side of it. At a certain moment during the day the shadow will lie due north and south. The moment at which this occurs is called noon, and it will be the same for all points exactly north or south of the given point. A great circle passing through the poles of the earth and through the given point is called a meridian (from *merides*, midday), and it is therefore noon at the same moment at all points on this meridian. Let us suppose that a chronometer keeping correct time is set at noon at a given place and then carried to some other place. If noon at this latter place is observed and the time indicated by the chronometer is noted at the same moment, the difference of time will be proportional to the part of the earth's circumference to the east or west that has been passed over. Suppose that the chronometer shows 3 o'clock when it is noon at the place of arrival, then the meridian through the new point is situated one-eighth of the way around the world to the westward from the first point. This difference is a definite quantity and has nothing arbitrary about it, but it would be

exceedingly inconvenient to have to work simply with differences between the various places, and all would be chaos and confusion unless some place were agreed upon as the starting point. The need of an origin of reckoning was evident as soon as longitudes began to be thought of and long before they were accurately determined. A great many places have in turn been used; but when the English people began to make charts they adopted the meridian through their principal observatory of Greenwich as the origin for reckoning longitudes and this meridian has now been adopted by many other countries. In France the meridian of Paris is most generally used. The adoption of any one meridian as a standard rather than another is purely arbitrary, but it is highly desirable that all should use the same standard.

The division of the Equator is made to begin where the standard meridian crosses it and the degrees are counted 180 east and west. The standard meridian is sometimes called the prime meridian, or the first meridian, but this nomenclature is slightly misleading, since this meridian is really the zero meridian. This great circle, therefore, which passes through the poles and through Greenwich is called the meridian of Greenwich or the meridian of 0° on one side of the globe, and the 180th meridian on the other side, it being 180° east and also 180° west of the zero meridian.

By setting a chronometer to Greenwich time and observing the hour of noon at various places their longitude can be determined, by allowing 15° of longitude to each hour of time, because the earth turns on its axis once in 24 hours, but there are 360° in the entire circumference. This description of the method of determining differences of longitude is, of course, only a rough outline of the way in which they can be determined. The exact determination of a difference of longitude between two places is a work of considerable difficulty and the longitudes of the principal observatories have not even yet been determined with sufficient degree of accuracy for certain delicate observations.

PLOTTING POINTS BY LATITUDE AND LONGITUDE ON A GLOBE.

If a globe has the circles of latitude and longitude drawn upon it according to the principles described above and the latitude and longitude of certain places have been determined by observation, these points can be plotted upon the globe in their proper positions and the detail can be filled in by ordinary surveying, the detail being referred to the accurately determined points. In this way a globe can be formed that is in appearance a small-scale copy of the spherical earth. This copy will be more or less accurate, depending upon the number and distribution of the accurately located points.

PLOTTING POINTS BY LATITUDE AND LONGITUDE ON A PLANE MAP.

If, in the same way, lines to represent latitude and longitude be drawn on a plane sheet of paper, the places can be plotted with reference to these lines and the detail filled in by surveying as before. The art of making maps consists, in the first place, in constructing the lines to represent latitude and longitude, either as nearly like the lines on the globe as possible when transferred from a nondevelopable surface to a flat surface, or else in such a way that some one property of the lines will be retained at the expense of others. It would be practically impossible to transfer the irregular coast lines from a globe to a map; but it is comparatively easy to transfer the regular lines representing latitude and longitude. It is possible to lay down on a map the lines representing the parallels and meridians on a globe many feet in diameter. These lines of latitude and longitude may be laid down for every 10° , for every degree, or for any other regular interval either greater or smaller.

In any case, the thing to be done is to lay down the lines, to plot the principal points, and then to fill in the detail by surveying. After one map is made it may be copied even on another kind of projection, care being taken that the latitude and longitude of every point is kept correct on the copy. It is evident that if the lines of latitude and longitude can not be laid down correctly upon a plane surface, still less can the detail be laid down on such a surface without distortions.

Since the earth is such a large sphere it is clear that, if only a small portion of a country is taken, the surface included will differ but very little from a plane surface. Even two or three hundred square miles of surface could be represented upon a plane with an amount of distortion that would be negligible in practical mapping. The difficulty encountered in mapping large areas is gotten over by first making many maps of small area, generally such as to be bounded by lines of latitude and longitude. When a large number of these maps have been made it will be found that they can not be joined together so as to lie flat. If they are carefully joined along the edges it will be found that they naturally adapt themselves to the shape of the globe. To obviate this difficulty another sheet of paper is taken and on it are laid down the lines of latitude and longitude, and the various maps are copied so as to fill the space allotted to them on this larger sheet. Sometimes this can be done by a simple reduction which does not affect the accuracy, since the accuracy of a map is independent of the scale. In most cases, however, the reduction will have to be unequal in different directions and sometimes the map has to be twisted to fit into the space allotted to it.

The work of making maps therefore consists of two separate processes. In the first place, correct maps of small areas must be made, which may be called surveying; and in the second place these small maps must be fitted into a system of lines representing the meridians and parallels. This graticule of the orderly arrangement of lines on the plane to represent the meridians and parallels of the earth is called a map projection. A discussion of the various ways in which this graticule of lines may be constructed so as to represent the meridians and parallels of the earth and at the same time so as to preserve some desired feature in the map is called a treatise on map projections.

HOW TO DRAW A STRAIGHT LINE.

Few people realize how difficult it is to draw a perfectly straight line when no straightedge is available. When a straightedge is used to draw a straight line, a copy is really made of a straight line that is already in existence. A straight line is such that if any part of it is laid upon any other part so that two points of the one part coincide with two points of the other the two parts will coincide throughout. The parts must coincide when put together in any way, for an arc of a circle can be made to coincide with any other part of the same circumference if the arcs are brought together in a certain way. A carpenter solves the problem of joining two points by a straight line by stretching a chalk line between them. When the line is taut, he raises it slightly in the middle portion and suddenly releases it. Some of the powdered chalk flies off and leaves a faint mark on the line joining the points. This depends upon the principle that a stretched string tends to become as short as possible unless some other force is acting upon it than the tension in the direction of its length. This is not a very satisfactory solution, however, since the chalk makes a line of considerable width, and the line will not be perfectly straight unless extra precautions are taken.

A straightedge can be made by clamping two thin boards together and by planing the common edge. As they are planed together, the edges of the two will be alike, either both straight, in which case the task is accomplished, or they will be both convex, or both concave. They must both be alike; that is, one can not be convex and the other concave at any given point. By unclamping them it can be seen whether the planed edges fit exactly when placed together, or whether they need some more planing, due to being convex or concave or due to being convex in places and concave in other places. (See fig. 6.) By repeated trials and with sufficient patience, a straightedge can be made in this way. In practice, of course, a straightedge in process of construction is tested by one that has already been made. Machines for drawing straight lines can be constructed by linkwork, but they are seldom used in practice.

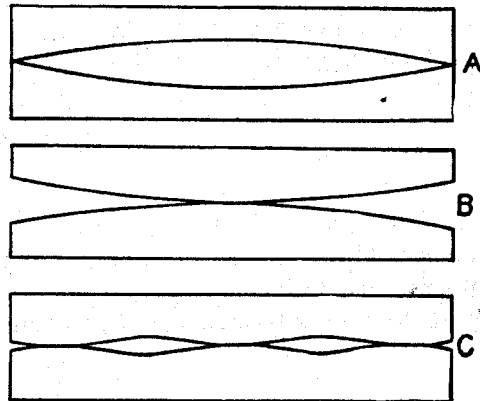

FIG. 6.—Construction of a straight edge.

It is in any case difficult to draw straight lines of very great length. A straight line only a few hundred meters in length is not easy to construct. For very long straight lines, as in gunnery and surveying, sight lines are taken; that is, use is made of the fact that when temperature and pressure conditions are uniform, light travels through space or in air, in straight lines. If three points, *A*, *B*, and *C*, are such that *B* appears to coincide with *C* when looked at from *A*, then *A*, *B*, and *C* are in a straight line. This principle is made use of in sighting a gun and in using the telescope for astronomical measurements. In surveying, directions which are straight lines are found by looking at the distant object, the direction of which from the point of view we want to determine, through a telescope. The telescope is moved until the image of the small object seen in it coincides with a mark fixed in the telescope in the center of the field of view. When this is the case, the mark, the center of the object glass of the telescope, and the distant object are in one straight line. A graduated scale on the mounting of the telescope enables us to determine the direction of the line joining the fixed mark in the telescope and the center of the object glass. This direction is the direction of the distant object as seen by the eye, and it will be determined in terms of another direction assumed as the initial direction.

HOW TO MAKE A PLANE SURFACE.

While a line has length only, a surface has length and breadth. Among surfaces a plane surface is one on which a straight line can be drawn through any point in any direction. If a straightedge is applied to a plane surface, it can be turned around, and it will in every position coincide throughout its entire length with the

surface. Just as a straightedge can be used to test a plane, so, equally well, can a plane surface be used to test a straightedge, and in a machine shop a plate with plane surface is used to test accurate workmanship.

The accurate construction of a plane surface is thus a problem that is of very great practical importance in engineering. A very much greater degree of accuracy is required than could be obtained by a straightedge applied to the surface in different directions. No straightedges in existence are as accurate as it is required that the planes should be. The method employed is to make three planes and to test them against one another two and two. The surfaces, having been made as truly plane as ordinary tools could render them, are scraped by hand tools and rubbed together from time to time with a little very fine red lead between them. Where they touch, the red lead is rubbed off, and then the plates are scraped again to remove the little elevations thus revealed, and the process is continued until all the projecting points have been removed. If only two planes were worked together, one might be convex (rounded) and the other concave (hollow), and if they had the same curvature they might still touch at all points and yet not be plane; but if three surfaces, *A*, *B*, and *C*, are worked together, and if *A* fits both *B* and *C* and *A* is concave, then *B* and *C* must be both convex, and they will not fit one another. If *B* and *C* both fit *A* and also fit one another at all points, then all three must be truly plane.

When an accurate plane-surface plate has once been made, others can be made one at a time and tested by trying them on the standard plate and moving them over the surface with a little red lead between them. When two surface plates made as truly plane as possible are placed gently on one another without any red lead between them, the upper plate will float almost without friction on a very thin layer of air, which takes a very long time to escape from between the plates, because they are everywhere so very near together.

HOW TO DRAW THE CIRCLES REPRESENTING MERIDIANS AND PARALLELS ON A SPHERE.

We have seen that it is difficult to draw a straight line and also difficult to construct a plane surface with any degree of accuracy. The problem of constructing circles upon a sphere is one that requires some ingenuity if the resulting circles are to be accurately drawn. If a hemispherical cup is constructed that just fits the sphere, two points on the rim exactly opposite to one another may be determined. (See fig. 7.) To do this is not so easy as it appears, if there is nothing to mark the center of the cup. The diameter of the cup can be measured and a circle can be drawn on cardboard with the same diameter by the use of a compass. The center of this circle will be marked on the cardboard by the fixed leg of the compass and with a straight edge a diameter can be drawn through this center. This circle can then be cut out and fitted just inside the rim of the cup. The ends of the diameter drawn on the card then mark the two points required on the edge of the cup. With some suitable tool a small notch can be made at each point on the edge of the cup. Marks should then be made on the edge of the cup for equal divisions of a semicircle. If it is desired to draw the parallels for every 10° of latitude, the semicircle must be divided into 18 equal parts. This can be done by dividing the cardboard circle by means of a protractor and then by marking the corresponding points on the edge of the cup. The sphere can now be put into the cup and points on it marked corresponding to the two notches in the edge of the cup. Pins can be driven into these points and allowed to rest in the notches. If the diameter of the cup is such that

the sphere just fits into it, it can be found whether the pins are exactly in the ends of a diameter by turning the sphere on the pins as an axis. If the pins are not correctly placed, the sphere will not rotate freely. The diameter determined by the pins may now be taken as the axis, one of the ends being taken as the North Pole

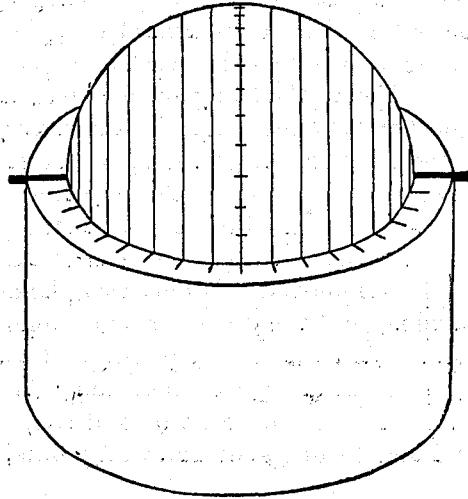

FIG. 7.—Constructing the circles of parallels and meridians on a globe.

and the other as the South Pole. With a sharp pencil or with an engraving tool circles can be drawn on the sphere at the points of division on the edge of the cup by turning the sphere on its axis while the pencil is held against the surface at the correct point. The circle midway between the poles is a great circle and will represent the Equator. The Equator is then numbered 0° and the other eight circles on either side of the Equator are numbered 10° , 20° , etc. The poles themselves correspond to 90° .

Now remove the sphere and, after removing one of the pins, insert the sphere again in such a way that the Equator lies along the edge of the cup. Marks can then be made on the Equator corresponding to the marks on the edge of the cup. In this way the divisions of the Equator corresponding to the meridians of 10° interval are determined. By replacing the sphere in its original position with the pins inserted, the meridians can be drawn along the edge of the cup through the various marks on the Equator. These will be great circles passing through the poles. One of these circles is numbered 0° and the others 10° , 20° , etc., both east and west of the zero meridian and extending to 180° in both directions. The one hundred and eightieth meridian will be the prolongation of the zero meridian through the poles and will be the same meridian for either east or west.

This sphere, with its two sets of circles, the meridians and the parallels, drawn upon it may now be taken as a model of the earth on which corresponding circles are supposed to be drawn. When it is a question only of supposing the circles to be drawn, and not actually drawing them, it will cost no extra effort to suppose them drawn and numbered for every degree, or for every minute, or even for every second of arc, but no one would attempt actually to draw them on a model globe for intervals of less than 1° . On the earth itself a second of latitude corresponds to a little more than 100 feet. For the purpose of studying the principles of map projection it is quite enough to suppose that the circles are drawn at intervals of 10° .

It was convenient in drawing the meridians and parallels by the method just described to place the polar axis horizontal, so that the sphere might rest in the cup by its own weight. Hereafter, however, we shall suppose the sphere to be turned so that its polar axis is vertical with the North Pole upward. The Equator and all the parallels of latitude will be horizontal, and the direction of rotation corresponding to the actual rotation of the earth will carry the face of the sphere at which we are looking from left to right; that is, from west to east, according to the way in which the meridians were marked. As the earth turns from west to east a person on its surface, unconscious of its movement and looking at the heavenly bodies, naturally thinks that they are moving from east to west. Thus, we say that the sun rises in the east and sets in the west.

THE TERRESTRIAL GLOBE.

With the sphere thus constructed with the meridians and parallels upon it, we get a miniature representation of the earth with its imaginary meridians and parallels. On this globe the accurately determined points may be plotted and the shore line drawn in, together with the other physical features that it is desirable to show. This procedure, however, would require that each individual globe should be plotted by hand, since no reproductions could be printed. To meet this difficulty, ordinary terrestrial globes are made in the following way: It is well known that a piece of paper can not be made to fit on a globe but a narrow strip can be made to fit fairly well by some stretching. If the strip is fastened upon the globe when it is wet, the paper will stretch enough to allow almost a perfect fit. Accordingly 12 gores are made as shown in figure 8, such that when fastened upon the globe they will reach from the parallel of 70° north to 70° south. A circular cap is then made to extend from each of these parallels to the poles. Upon these gores the projection lines and the outlines of the continents are printed. They can then be pasted upon the globe and with careful stretching they can be made to adapt themselves to the spherical surface. It is obvious that the central meridian of each gore is shorter than the bounding meridians, whereas upon the globe all of the meridians are of the same length. Hence in adapting the gores to the globe the central meridian of each gore must be slightly stretched in comparison with the side meridians. The figure 8 shows on a very small scale the series of gores and the polar caps printed for covering a globe. These gores do not constitute a map. They are as nearly as may be on a plane surface, a facsimile of the surface of the globe, and only require bending with a little stretching in certain directions or contraction in others or both to adapt themselves precisely to the spherical surface. If the reader examines the parts of the continent of Asia as shown on the separate gores which are almost a facsimile of the same portion of the globe, and tries to piece them together without bending them over the curved surface of the sphere, the problem of map projection will probably present itself to him in a new light.

It is seen that although the only way in which the surface of the earth can be represented correctly consists in making the map upon the surface of a globe, yet this is a difficult task, and, at the best, expedients have to be resorted to unless the work of construction is to be prohibitive. It should be remembered, however, that the only source of true ideas regarding the mapping of large sections of the surface of the earth must of necessity be obtained from its representation on a globe. Much good would result from making the globe the basis of all elementary teaching in geography. The pupils should be warned that maps are very generally used because of their convenience. Within proper limitations they serve every purpose for

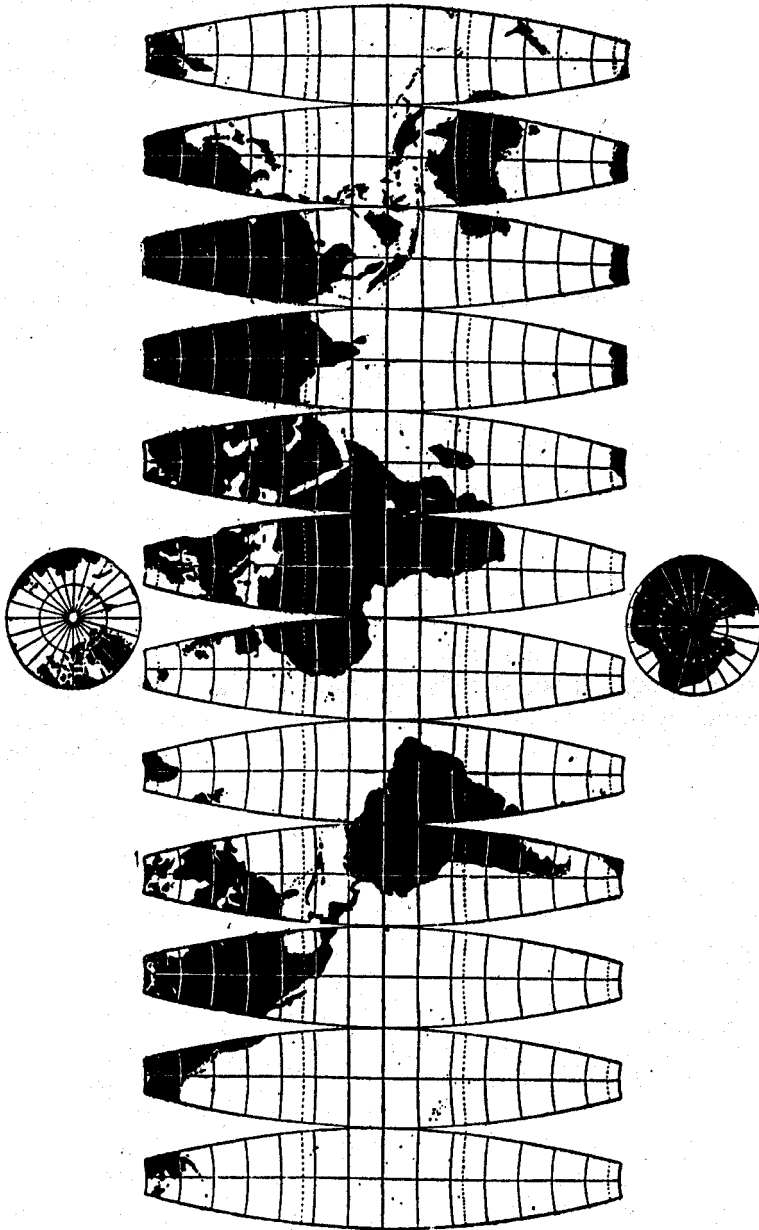

Fig. 8.—Covering for a terrestrial globe.

which they are intended. Errors are dependent upon the system of projection used and when map and globe² do not agree, the former is at fault. This would seem to be a criticism against maps in general and where large sections are involved and where unsuitable projections are used, it often is such. Despite defects which are inherent in the attempt to map a spherical surface upon a plane, maps of large areas, comprising continents, hemispheres or even the whole sphere, are employed because of their convenience both in construction and handling. However, before globes come into more general use it will be necessary for makers to omit the line of the ecliptic, which only leads to confusion for old and young when found upon a

² Perfect globes are seldom seen on account of the expense involved in their manufacture.

terrestrial globe. It was probably copied upon a terrestrial globe from a celestial globe at some early date by an ignorant workman, and for some inexplicable reason it has been allowed to remain ever since. However, there are some globes on the market to-day that omit this anomalous line.

Makers of globes would confer a benefit on future generations if they would make cheap globes on which is shown, not as much as possible, but essential geographic features only. If the oceans were shown by a light blue tint and the continents by darker tints of another color, and if the principal great rivers and mountain chains were shown, it would be sufficient. The names of oceans and countries, and a few great cities, noted capes, etc., are all that should appear. The globe then would serve as the index to the maps of continents, which again would serve as indexes to the maps of countries. Globes as made at present are so full of detail, and are so mounted, that they are puzzling to anyone who does not understand the subject well enough to do without them, and are in most cases hindrances as much as helpers to instruction.

REPRESENTATION OF THE SPHERE UPON A PLANE.

THE PROBLEM OF MAP PROJECTION.

It seems, then, that if we have the meridians and parallels properly drawn on any system of map projection, the outline of a continent or island can be drawn in from information given by the surveyors respecting the latitude and longitude of the principal capes, inlets, or other features, and the character of the coast between them. Copies of maps are commonly made in schools upon blank forms on which the meridians and parallels have been drawn, and these, like squared paper, give assistance to the free-hand copyist. Since the meridians and parallels can be drawn as closely together as we please, we can get as many points as we require laid down with strict accuracy. The meridians and parallels being drawn on the globe, if we have a set of lines upon a plane sheet to represent them we can then transfer detail from the globe to the map. The problem of map projection, therefore, consists in finding some method of transferring the meridians and parallels from the globe to the map.

DEFINITION OF MAP PROJECTION.

The lines representing the meridians and parallels can be drawn in an arbitrary manner, but to avoid confusion we must have a one-to-one correspondence. In practice all sorts of liberties are taken with the methods of drawing the meridians and parallels in order to secure maps which best fulfill certain required conditions, provided always that the methods of drawing the meridians and parallels follow some law or system that will give the one-to-one correspondence. Hence a map projection may be defined as a systematic drawing of lines representing meridians and parallels on a plane surface, either for the whole earth or for some portion of it.

DISTORTION.

In order to decide on the system of projection to be employed, we must consider the purpose for which the map is to be used and the consequent conditions which it is most important for the map to fulfill. In geometry, size and shape are the two fundamental considerations. If we want to show without exaggeration the extent of the different countries on a world map, we do not care much about the shape of the country, so long as its area is properly represented to scale. For statistical purposes, therefore, a map on which all areas are correctly represented to scale is valuable, and such a map is called an "equal-area projection." It is well known that parallelograms on the same base and between the same parallels, that is of the same height, have equal area, though one may be rectangular or upright and the other very oblique. The sloping sides of the oblique parallelograms must be very much longer than the upright sides of the other, but the areas of the figures will be the same though the shapes are so very different. The process by which the oblique parallelogram can be formed from the rectangular parallelogram is called by engineers "shearing." A pack of cards as usually placed together shows as profile a rectangular parallelogram. If a book be stood up against the ends of the cards as in figure 9 and then made to slope as in figure 10 each card will slide a little over the one below and the profile of the pack will be the oblique parallelogram shown in figure 10. The height of the parallelogram will be the same, for it is the

thickness of the pack. The base will remain unchanged, for it is the long edge of the bottom card. The area will be unchanged, for it is the sum of the areas of the edges of the cards. The shape of the parallelogram is very different from its original shape.

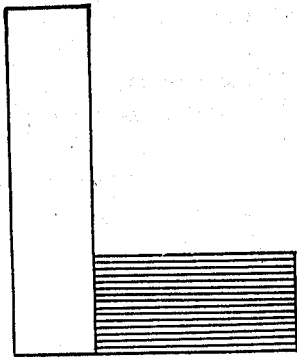

FIG. 9.—Pack of cards before “shearing.”

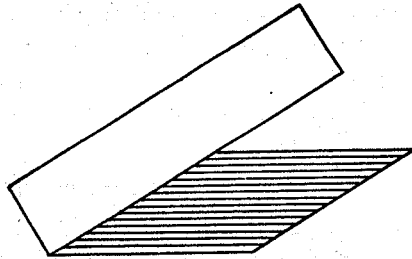

FIG. 10.—Pack of cards after “shearing.”

The sloping sides, it is true, are not straight lines, but are made up of 52 little steps, but if instead of cards several hundred very thin sheets of paper or metal had been used the steps would be invisible and the sloping edges would appear to be straight lines. This sliding of layer upon layer is a “simple shear.” It alters the shape without altering the area of the figure.

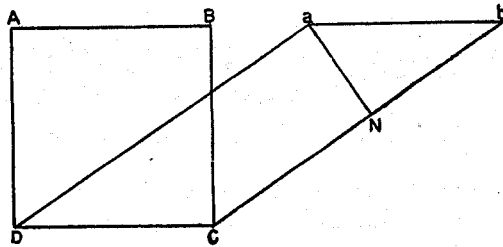

FIG. 11.—Square “sheared” into an equivalent parallelogram.

This shearing action is worthy of a more careful consideration in order that we may understand one very important point in map projection. Suppose the square $ABCD$ (see fig. 11) to be sheared into the oblique parallelogram $abCD$. Its base and height remain the same and its area is unchanged, but the parallelogram $abCD$ may be turned around so that Cb is horizontal, and then Cb is the base, and the line aN drawn from a perpendicular to bC is the height. Then the area is the product of bC and aN , and this is equal to the area of the original square and is constant whatever the angle of the parallelogram and the extent to which the side BC has been stretched. The perpendicular aN , therefore, varies inversely as the length of the side bC , and this is true however much BC is stretched. Therefore in an equal-area projection, if distances in one direction are increased, those measured in the direction at right angles are reduced in the corresponding ratio if the lines that they represent are perpendicular to one another upon the earth.

If lines are drawn at a point on an equal-area projection nearly at right angles to each other, it will in general be found that if the scale in the one direction is increased that in the other is diminished. If one of the lines is turned about the

point, there must be some direction between the original positions of the lines in which the scale is exact. Since the line can be turned in either of two directions, there must be two directions at the point in which the scale is unvarying. This is true at every point of such a map, and consequently curves could be drawn on such a projection that would represent directions in which there is no variation in scale (isoperimetric curves).

In maps drawn on an equal-area projection, some tracts of country may be sheared so that their shape is changed past recognition, but they preserve their area unchanged. In maps covering a very large area, particularly in maps of the whole world, this generally happens to a very great extent in parts of the map which are distant from both the horizontal and the vertical lines drawn through the center of the map. (See fig. 12.)

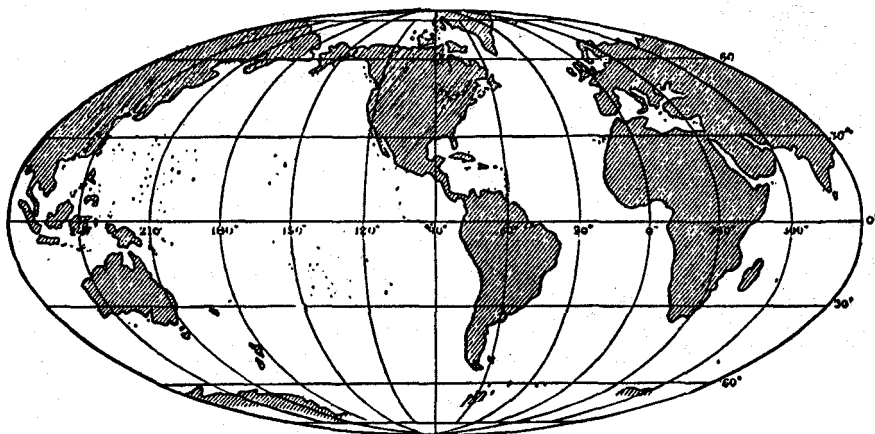

FIG. 12.—The Mollweide equal-area projection of the sphere.

It will be noticed that in the shearing process that has been described every little portion of the rectangle is sheared just like the whole rectangle. It is stretched parallel to BC (see fig. 11) and contracted at right angles to this direction. Hence when in an equal-area projection the shape of a tract of country is changed, it follows that the shape of every square mile and indeed of every square inch of this country will be changed, and this may involve a considerable inconvenience in the use of the map. In the case of the pack of cards the shearing was the same at all points. In the case of equal-area projections the extent of shearing or distortion varies with the position of the map and is zero at the center. It usually increases along the diagonal lines of the map. It may, however, be important for the purpose for which the map is required, that small areas should retain their shape even at the cost of the area being increased or diminished, so that different scales have to be used at different parts of the map. The projections on which this condition is secured are called "conformal" projections. If it were possible to secure equality of area and exactitude of shape at all points of the map, the whole map would be an exact counterpart of the corresponding area on the globe, and could be made to fit the globe at all points by simple bending without any stretching or contraction, which would imply alteration of scale. But a plane surface can not be made to fit a sphere in this way. It must be stretched in some direction or contracted in others (as in the process of "raising" a dome or cup by hammering sheet metal) to fit the sphere, and this means that the scale must be altered in one direction or in the

other or in both directions at once. It is therefore impossible for a map to preserve the same scale in all directions at all points; in other words a map can not accurately represent both size and shape of the geographical features at all points of the map.

CONDITIONS FULFILLED BY A MAP PROJECTION.

If, then, we endeavor to secure that the shape of a very small area, a square inch or a square mile, is preserved at all points of the map, which means that if the scale of the distance north and south is increased the scale of the distance east and west must be increased in exactly the same ratio, we must be content to have some parts of the map represented on a greater scale than others. The conformal projection, therefore, necessitates a change of scale at different parts of the map, though the scale is the same in all directions at any one point. Now, it is clear that if in a map of North America the northern part of Canada is drawn on a much larger scale than the southern States of the United States, although the shape of every little bay or headland, lake or township is preserved, the shape of the whole continent on the map must be very different from its shape on the globe. In choosing our system of map projection, therefore, we must decide whether we want—

(1) To keep the area directly comparable all over the map at the expense of correct shape (equal-area projection), or

(2) To keep the shapes of the smaller geographical features, capes, bays, lakes, etc., correct at the expense of a changing scale all over the map (conformal projection) and with the knowledge that large tracts of country will not preserve their shape, or

(3) To make a compromise between these conditions so as to minimize the errors when both shape and area are taken into account.

There is a fourth consideration which may be of great importance and which is very important to the navigator, while it will be of much greater importance to the aviator when aerial voyages of thousands of miles are undertaken, and that is that directions of places taken from the center of the map, and as far as possible when taken from other points of the map, shall be correct. The horizontal direction of an object measured from the south is known as its azimuth. Hence a map which preserves these directions correctly is called an "azimuthal projection." We may, therefore, add a fourth object, viz:

(4) To preserve the correct directions of all lines drawn from the center of the map (azimuthal projection).

Projections of this kind are sometimes called zenithal projections, because in maps of the celestial sphere the zenith point is projected into the central point of the map. This is a misnomer, however, when applied to a map of the terrestrial sphere.

We have now considered the conditions which we should like a map to fulfill, and we have found that they are inconsistent with one another. For some particular purpose we may construct a map which fulfills one condition and rejects another, or vice versa; but we shall find that the maps most commonly used are the result of compromise, so that no one condition is strictly fulfilled, nor, in most cases, is it extravagantly violated.

CLASSIFICATION OF PROJECTIONS.

There is no way in which projections can be divided into classes that are mutually exclusive; that is, such that any given projection belongs in one class, and only in one. There are, however, certain class names that are made use of in practice principally as a matter of convenience, although a given projection may fall in two

or more of the classes. We have already spoken of the equivalent or equal-area type and of the conformal, or, as it is sometimes called, the orthomorphic type.

The equal-area projection preserves the ratio of areas constant; that is, any given part of the map bears the same relation to the area that it represents that the whole map bears to the whole area represented. This can be brought clearly before the mind by the statement that any quadrangular-shaped section of the map formed by meridians and parallels will be equal in area to any other quadrangular area of the same map that represents an *equal* area on the earth. This means that all sections between two given parallels on any equal-area map formed by meridians that are equally spaced are equal in area upon the map just as they are equal in area on the earth. In another way, if two silver dollars are placed upon the map one in one place and the other in any other part of the map the two areas upon the earth that are represented by the portions of the map covered by the silver dollars will be equal. Either of these tests forms a valid criterion provided that the areas selected may be situated on *any* portion of the map. There are other projections besides the equal-area ones in which the same results would be obtained on *particular* portions of the map.

A conformal projection is one in which the shape of any small section of the surface mapped is preserved on the map. The term orthomorphic, which is sometimes used in place of conformal, means right shape; but this term is somewhat misleading, since, if the area mapped is large, the shape of any continent or large country will not be preserved. The true condition for a conformal map is that the scale be the same at any point in all directions; the scale will change from point to point, but it will be independent of the azimuth at all points. The scale will be the same in all directions at a point if two directions upon the earth at right angles to one another are mapped in two directions that are also at right angles and along which the scale is the same. If, then, we have a projection in which the meridians and parallels of the earth are represented by curves that are perpendicular each to each, we need only to determine that the scale along the meridian is equal to that along the parallel. The meridians and parallels of the earth intersect at right angles, and a conformal projection preserves the angle of intersection of any two curves on the earth; therefore, the meridians of the map must intersect the parallels of the map at right angles. The one set of lines are then said to be the orthogonal trajectories of the other set. If the meridians and parallels of any map do not intersect at right angles in all parts of the map, we may at once conclude that it is not a conformal map.

Besides the equal-area and conformal projections we have already mentioned the azimuthal or, as they are sometimes called, the zenithal projections. In these the azimuth or direction of all points on the map as seen from some central point are the same as the corresponding azimuths or directions on the earth. This would be a very desirable feature of a map if it could be true for all points of the map as well as for the central point, but this could not be attained in any projection; hence the azimuthal feature is generally an incidental one unless the map is intended for some special purpose in which the directions from some one point are very important.

Besides these classes of projections there is another class called perspective projections or, as they are sometimes called, geometric projections. The principle of these projections consists in the direct projection of the points of the earth by straight lines drawn through them from some given point. The projection is generally made upon a plane tangent to the sphere at the end of the diameter joining the point of projection and the center of the earth. If the projecting point is the

center of the sphere, the point of tangency is chosen in the center of the area to be mapped. The plane upon which the map is made does not have to be tangent to the earth, but this position gives a simplification. Its position anywhere parallel to itself would only change the scale of the map and in any position not parallel to itself the same result would be obtained by changing the point of tangency with mere change of scale. Projections of this kind are generally simple, because they can in most cases be constructed by graphical methods without the aid of the analytical expressions that determine the elements of the projection.

Instead of using a plane directly upon which to lay out the projection, in many cases use is made of one of the developable surfaces as an intermediate aid. The two surfaces used for this purpose are the right circular cone and the circular cylinder. The projection is made upon one or the other of these two surfaces, and then this surface is spread out or developed in the plane. As a matter of fact, the projection is not constructed upon the cylinder or cone, but the principles are derived from a consideration of these surfaces, and then the projection is drawn upon the plane just as it would be after development. The developable surfaces, therefore, serve only as guides to us in grasping the principles of the projection. After the elements of the projections are determined, either geometrically or analytically, no further attention is paid to the cone or cylinder. A projection is called conical or cylindrical, according to which of the two developable surfaces is used in the determination of its elements. Both kinds are generally included in the one class of conical projections, for the cylinder is just a special case of the cone. In fact, even the azimuthal projections might have been included in the general class. If we have a cone tangent to the earth and then imagine the apex to recede more and more while the cone still remains tangent to the sphere, we shall have at the limit the tangent cylinder. On the other hand, if the apex approaches nearer and nearer to the earth the circle of tangency will get smaller and smaller, and in the end it will become a point and will coincide with the apex, and the cone will be flattened out into a tangent plane.

Besides these general classes there are a number of projections that are called conventional projections, since they are projections that are merely arranged arbitrarily. Of course, even these conform enough to law to permit their expression analytically, or sometimes more easily by geometric principles.

THE IDEAL MAP.

There are various properties that it would be desirable to have present in a map that is to be constructed. (1) It should represent the countries with their true shape; (2) the countries represented should retain their relative size in the map; (3) the distance of every place from every other should bear a constant ratio to the true distances upon the earth; (4) great circles upon the sphere—that is, the shortest distances joining various points—should be represented by straight lines which are the shortest distances joining the points on the map; (5) the geographic latitudes and longitudes of the places should be easily found from their positions on the map, and, conversely, positions should be easily plotted on the map when we have their latitudes and longitudes. These properties could very easily be secured if the earth were a plane or one of the developable surfaces. Unfortunately for the cartographer, it is not such a surface, but is a spherical surface which can not be developed in a plane without distortion of some kind. It becomes, then, a matter of selection from among the various desirable properties enumerated above, and even some of these can not in general be attained. It is necessary, then, to decide what purpose the map to be constructed is to fulfill, and then we can select the projection that comes nearest to giving us what we want.

PROJECTIONS CONSIDERED WITHOUT MATHEMATICS.

If it is a question of making a map of a small section of the earth, it will so nearly conform to a plane surface that a projection can be made that will represent the true state to such a degree that any distortion present will be negligible. It is thus possible to consider the earth made up of a great number of plane sections of this kind, such that each of them could be mapped in this way. If the parallels and meridians are drawn each at 15° intervals and then planes are passed through the points of intersection, we should have a regular figure made up of plane quadrangular figures as in figure 13. Each of these sections could be made into a self-consistent map, but if we attempt to fit them together in one plane map, we shall find that they will not join together properly, but the effect shown in figure 13 will

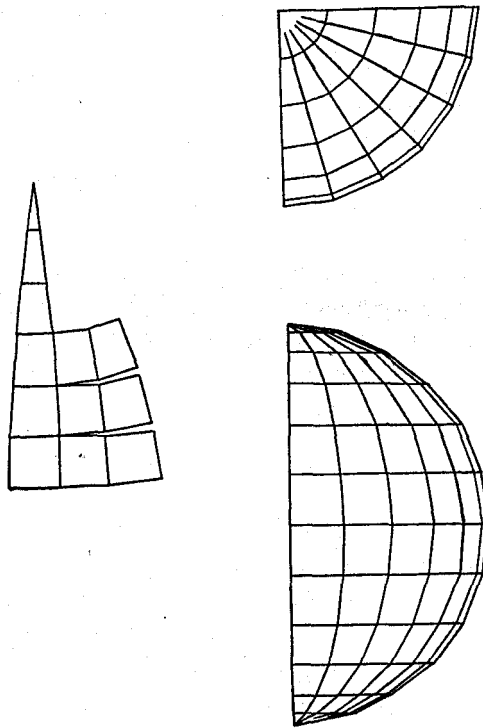

FIG. 13.—Earth considered as formed by plane quadrangles.

be observed. A section 15° square would be too large to be mapped without error, but the same principle could be applied to each square degree or to even smaller sections. This projection is called the polyhedral projection and it is in substance very similar to the method used by the United States Geological Survey in their topographic maps of the various States.

Instead of considering the earth as made up of small regular quadrangles, we might consider it made by narrow strips cut off from the bases of cones as in figure 14. The whole east-and-west extent of these strips could be mapped equally accurately as shown in figure 15. Each strip would be all right in itself, but they would not fit together, as is shown in figure 15. If we consider the strips to become very narrow while at the same time they increase in number, we get what is called the polyconic projections. These same difficulties or others of like nature are met with in every projection in which we attempt to hold the scale exact in some part. At

best we can only adjust the errors in the representation, but they can never all be avoided.

Viewed from a strictly mathematical standpoint, no representation based on a system of map projection can be perfect. A map is a compromise between the

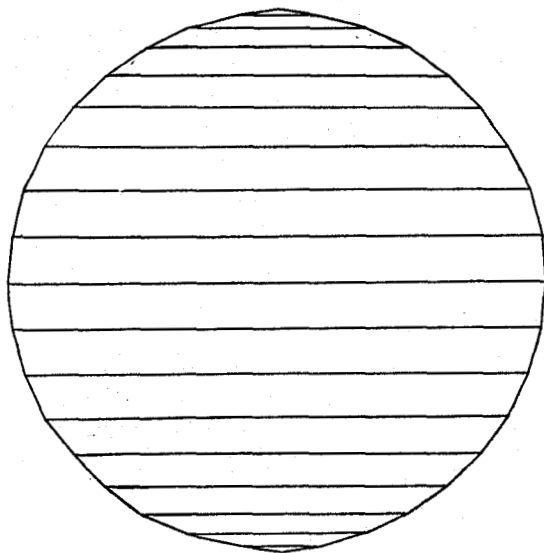

FIG. 14.—Earth considered as formed by bases of cones.

various conditions not all of which can be satisfied, and is the best solution of the problem that is possible without encountering other difficulties that surpass those due to a varying scale and distortion of other kinds. It is possible only on a globe to represent the countries with their true relations and our general ideas should be continually corrected by reference to this source of knowledge.

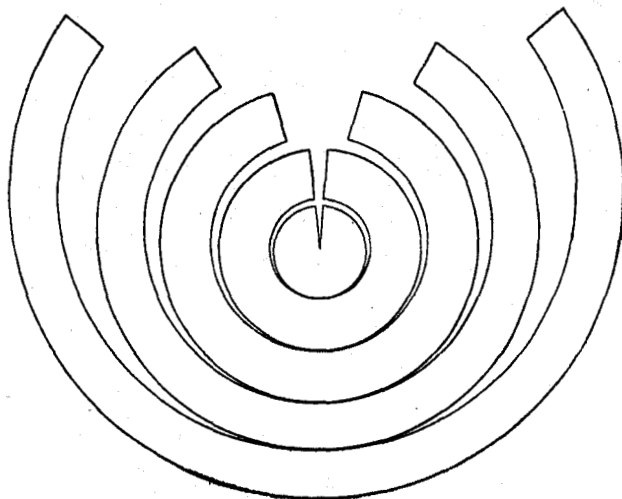

FIG. 15.—Development of the conical bases.

In order to point out the distortion that may be found in projections, it will be well to show some of those systems that admit of easy construction. The perspective or geometrical projections can always be constructed graphically, but it is sometimes easier to make use of a computed table, even in projections of this class.

ELEMENTARY DISCUSSION OF VARIOUS FORMS OF PROJECTION.

CYLINDRICAL EQUAL-AREA PROJECTION.

This projection is one that is of very little use for the construction of a map of the world, although near the Equator it gives a fairly good representation. We shall use it mainly for the purpose of illustrating the modifications that can be introduced into cylindrical projections to gain certain desirable features.

In this projection a cylinder tangent to the sphere along the Equator is employed. The meridians and parallels are straight lines forming two parallel systems mutually perpendicular. The lines representing the meridians are equally spaced. These features are in general characteristic of all cylindrical projections in which the cylinder is supposed to be tangent to the sphere along the Equator. The only feature as yet undetermined is the spacing of the parallels. If planes are passed through the various parallels they will intersect the cylinder in circles that become straight lines when the cylinder is developed or rolled out in the plane. With this condition it is evident that the construction given in figure 16 will give the network of meridians and parallels for 10° intervals. The length of the map is evidently π (about 3.14) times the diameter of the circle that represents a great circle of the sphere. The semicircle is divided by means of a protractor into 18 equal arcs, and these points of division are projected by lines parallel to the line representing the Equator or perpendicular to the bounding diameter of the semicircle. This gives an equivalent or equal-area map, because, as we recede from the Equator, the distances representing differences of latitude are decreased just as great a per cent as the distances representing differences of longitude are increased. The result in a world map is the appearance of contraction toward the Equator, or, in another sense, as an east-and-west stretching of the polar regions.

CYLINDRICAL EQUAL-SPACED PROJECTION.

If the equal-area property be disregarded, a better cylindrical projection can be secured by spacing the meridians and parallels equally. In this way we get rid of the very violent distortions in the polar regions, but even yet the result is very unsatisfactory. Great distortions are still present in the polar regions, but they are much less than before, as can be seen in figure 17. As a further attempt, we can throw part of the distortion into the equatorial regions by spacing the parallels equally and the meridians equally, but by making the spacings of the parallels greater than that of the meridians. In figure 18 is shown the whole world with the meridians and parallel spacings in the ratio of two to three. The result for a world map is still highly unsatisfactory even though it is slightly better than that obtained by either of the former methods.

PROJECTION FROM THE CENTER UPON A TANGENT CYLINDER.

As a fourth attempt we might project the points by lines drawn from the center of the sphere upon a cylinder tangent to the Equator. This would have a tendency to stretch the polar regions north and south as well as east and west. The result of this method is shown in figure 19, in which the polar regions are shown up to 70° of latitude. The poles could not be shown, since as the projecting line approaches them

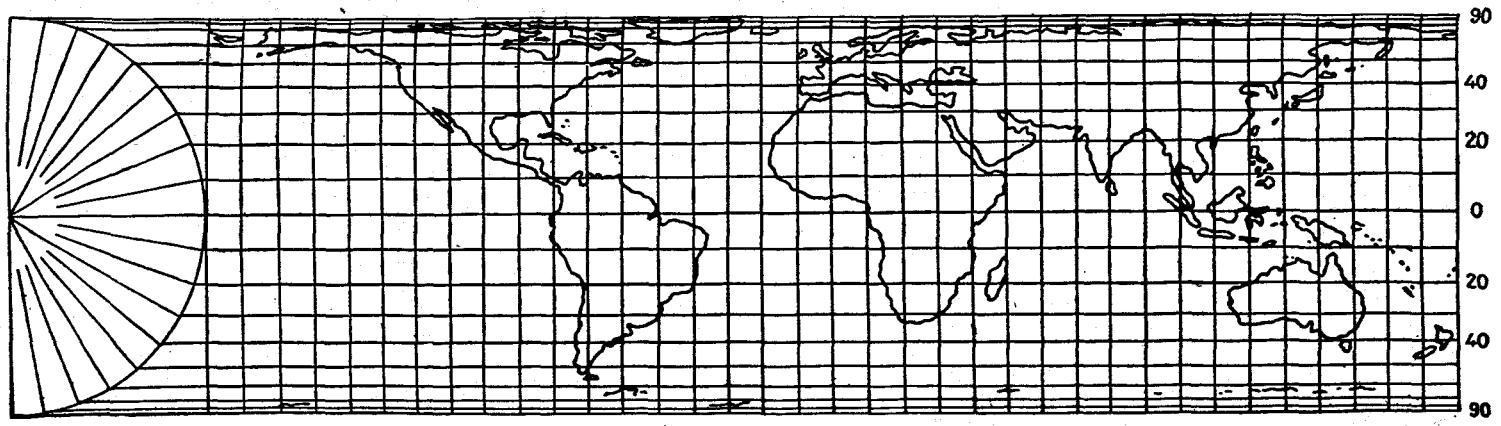

FIG. 16.—Cylindrical equal-area projection.

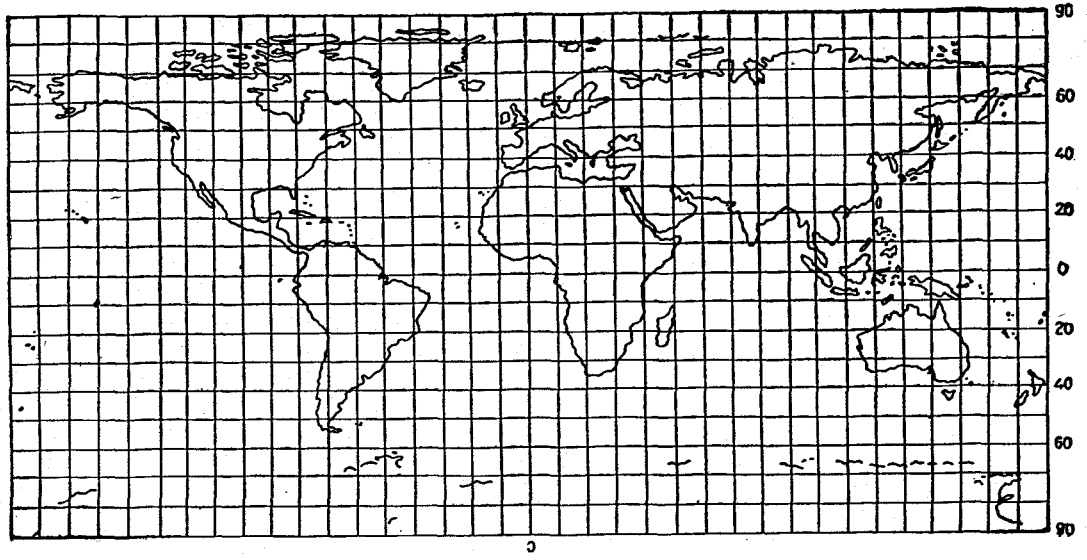

FIG. 17.—Cylindrical equal-spaced projection.

indefinitely, the required intersection with the cylinder recedes indefinitely, or, in mathematical language, the pole is represented by a line at an infinite distance.

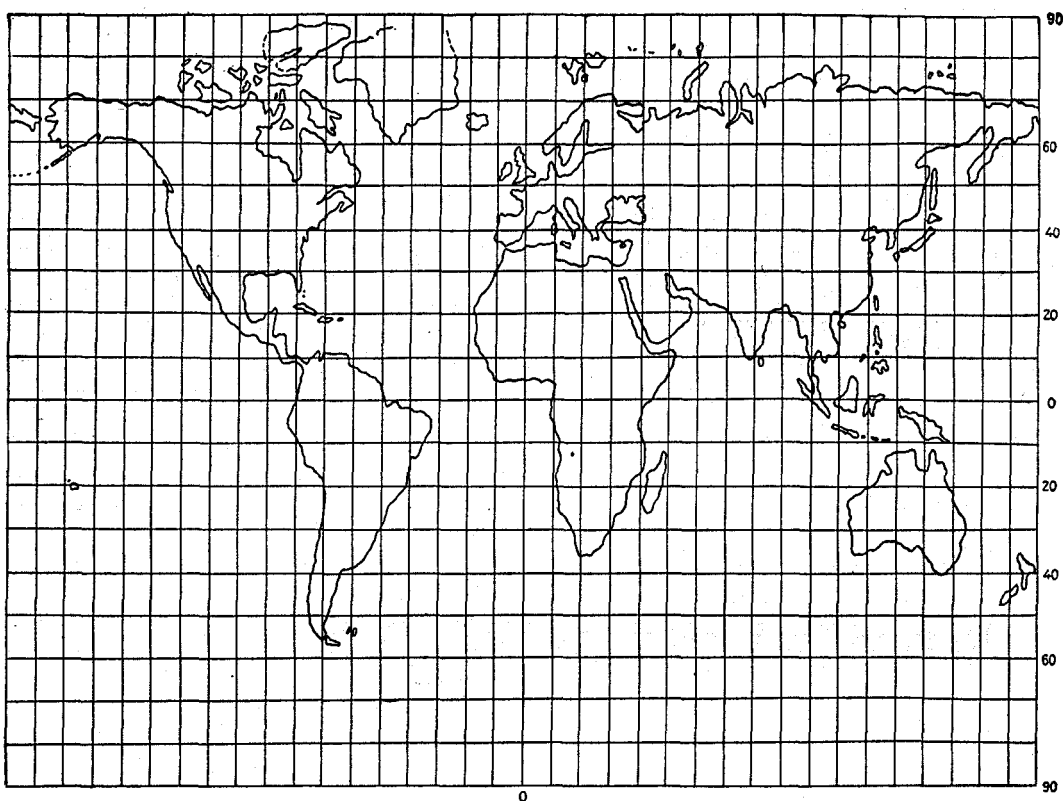

FIG. 18.—Modified cylindrical equal-spaced projection.

MERCATOR PROJECTION.

Instead of stretching the polar regions north and south to such an extent, it is customary to limit the stretching in latitude to an equality with the stretching in longitude. (See fig. 20.) In this way we get a conformal projection in which any small area is shown with practically its true shape, but in which large areas will be distorted by the change in scale from point to point. In this projection the pole is represented by a line at infinity, so that the map is seldom extended much beyond 80° of latitude. This projection can not be obtained directly by graphical construction, but the spacings of the parallels have to be taken from a computed table. This is the most important of the cylindrical projections and is widely used for the construction of sailing charts. Its common use for world maps is very misleading, since the polar regions are represented upon a very enlarged scale.

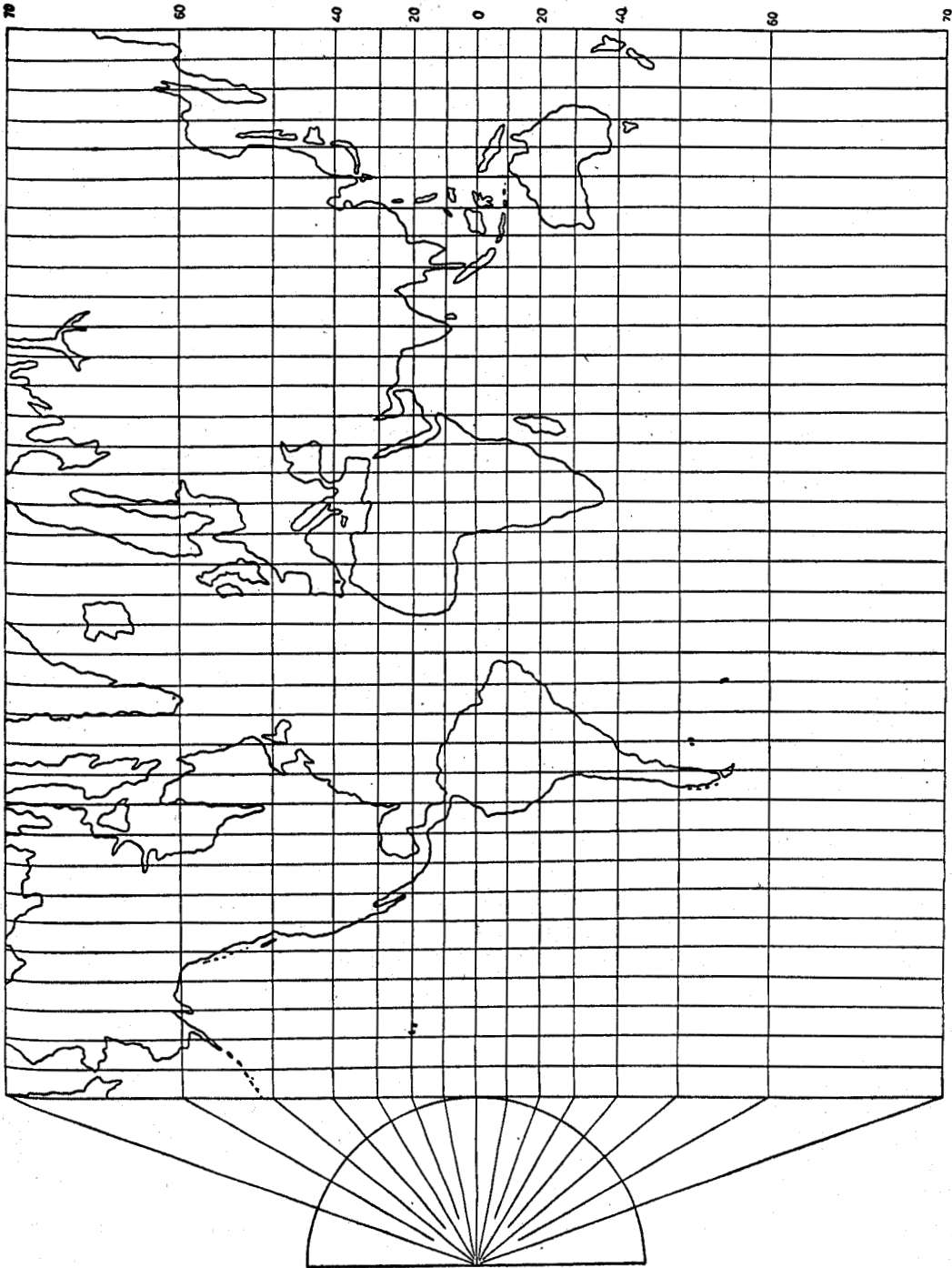

Fig. 19.—Perspective projection upon a tangent cylinder

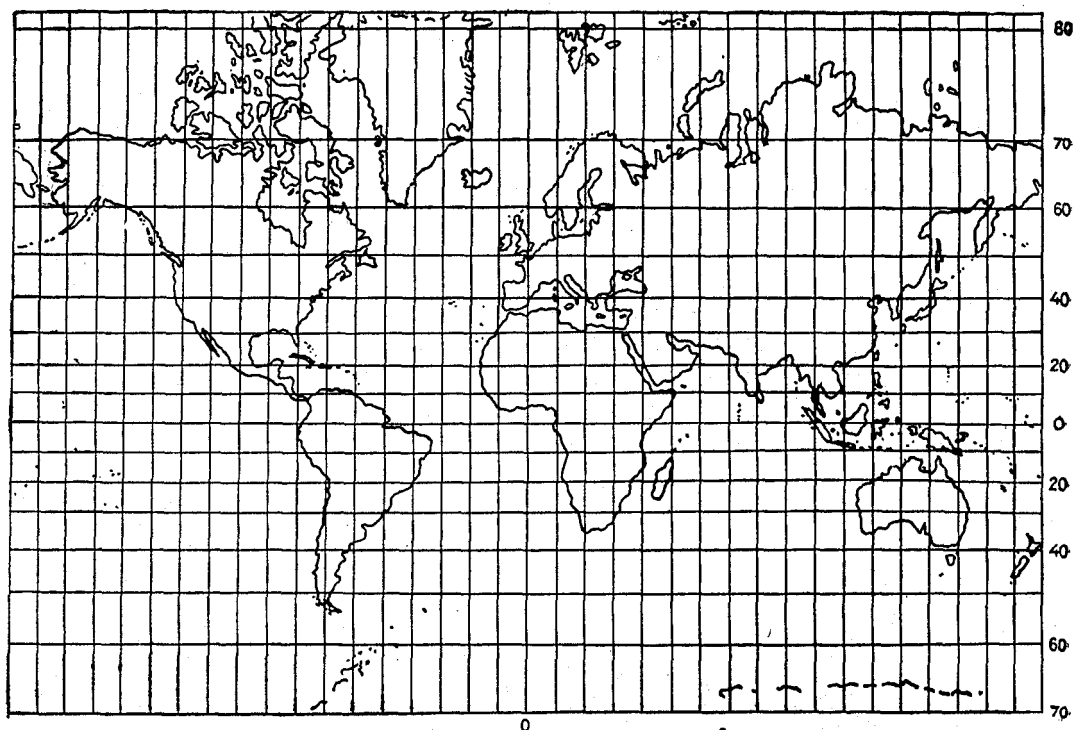

FIG. 20.—Mercator projection.

Since a degree is one three-hundred-and-sixtieth part of a circle, the degrees of latitude are everywhere equal on a sphere, as the meridians are all equal circles. The degrees of longitude, however, vary in the same proportion as the size of the parallels vary at the different latitudes. The parallel of 60° latitude is just one-half of the length of the Equator. A square-degree quadrangle at 60° of latitude has the same length north and south as has such a quadrangle at the Equator, but the extent east and west is just one-half as great. Its area, then, is approximately one-half the area of the one at the Equator. Now, on the Mercator projection the longitude at 60° is stretched to double its length, and hence the scale along the meridian has to be increased an equal amount. The area is therefore increased fourfold. At 80° of latitude the area is increased to 36 times its real size, and at 89° an area would be more than 3000 times as large as an equal-sized area at the Equator.

This excessive exaggeration of area is a most serious matter if the map be used for general purposes, and this fact ought to be emphasized because it is undoubtedly true that in the majority of cases peoples' general ideas of geography are based on Mercator maps. On the map Greenland shows larger than South America, but in reality South America is nine times as large as Greenland. As will be shown later, this projection has many good qualities for special purposes, and for some general purposes it may be used for areas not very distant from the Equator. No suggestion is therefore made that it should be abolished, or even reduced from its position among the first-class projections, but it is most strongly urged that no one should use it without recognizing its defects, and thereby guarding against being misled by false appearances. This projection is often used because on it the whole inhabited world can be shown on one sheet, and, furthermore, it can be prolonged

in either an east or west direction; in other words, it can be repeated so as to show part of the map twice. By this means the relative positions of two places that would be on opposite sides of the projection when confined to 360° can be indicated more definitely.

GEOMETRICAL AZIMUTHAL PROJECTIONS.

Many of the projections of this class can be constructed graphically with very little trouble. This is especially true of those that have the pole at the center. The meridians are then represented by straight lines radiating from the pole and the parallels are in turn represented by concentric circles with the pole as center. The angles between the meridians are equal to the corresponding longitudes, so that they are represented by radii that are equally spaced.

STEREOGRAPHIC POLAR PROJECTION.

This is a perspective conformal projection with the point of projection at the South Pole when the northern regions are to be projected. The plane upon which

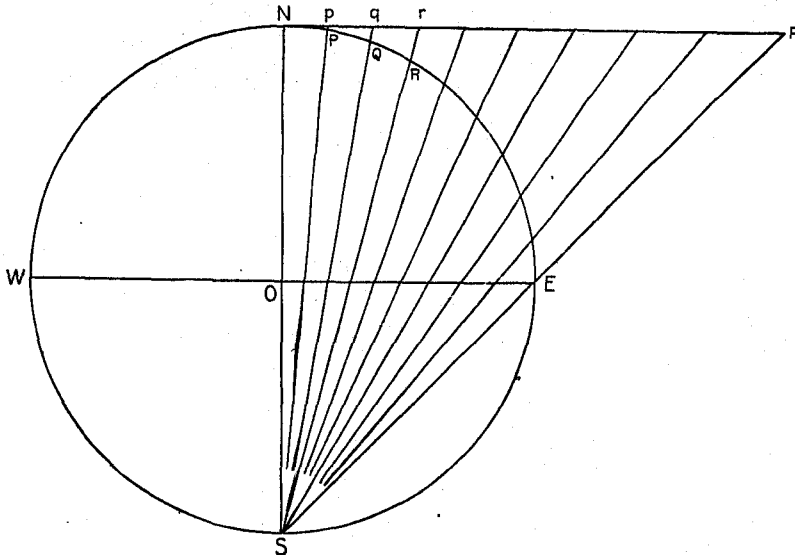

FIG. 21.—Determination of radii for stereographic polar projection.

the projection is made is generally taken as the equatorial plane. A plane tangent at the North Pole could be used equally well, the only difference being in the scale of the projection. In figure 21 let $NESW$ be the plane of a meridian with N representing the North Pole. Then NP will be the trace of the plane tangent at the North Pole. Divide the arc NE into equal parts, each in the figure being for 10° of latitude. Then all points at a distance of 10° from the North Pole will lie on a circle with radius np , those at 20° on a circle with radius nq , etc. With these radii we can construct the map as in figure 22. On the map in this figure the lines are drawn for each 10° both in latitude and longitude; but it is clear that a larger map could be constructed on which lines could be drawn for every degree. We have seen that a practically correct map can be made for a region measuring 1° each way, because curvature in such a size is too slight to be taken into account. Suppose, then, that correct maps were made separately of all the little quadrangular portions. It would be found that by simply reducing each of them to the requisite scale it could be fitted almost exactly into the space to which it belonged. We say almost exactly, because the edge

nearest the center of the map would have to be a little smaller in scale, and hence would have to be compressed a little if the outer edges were reduced the exact amount, but the compression would be so slight that it would require very careful measurement to detect it.

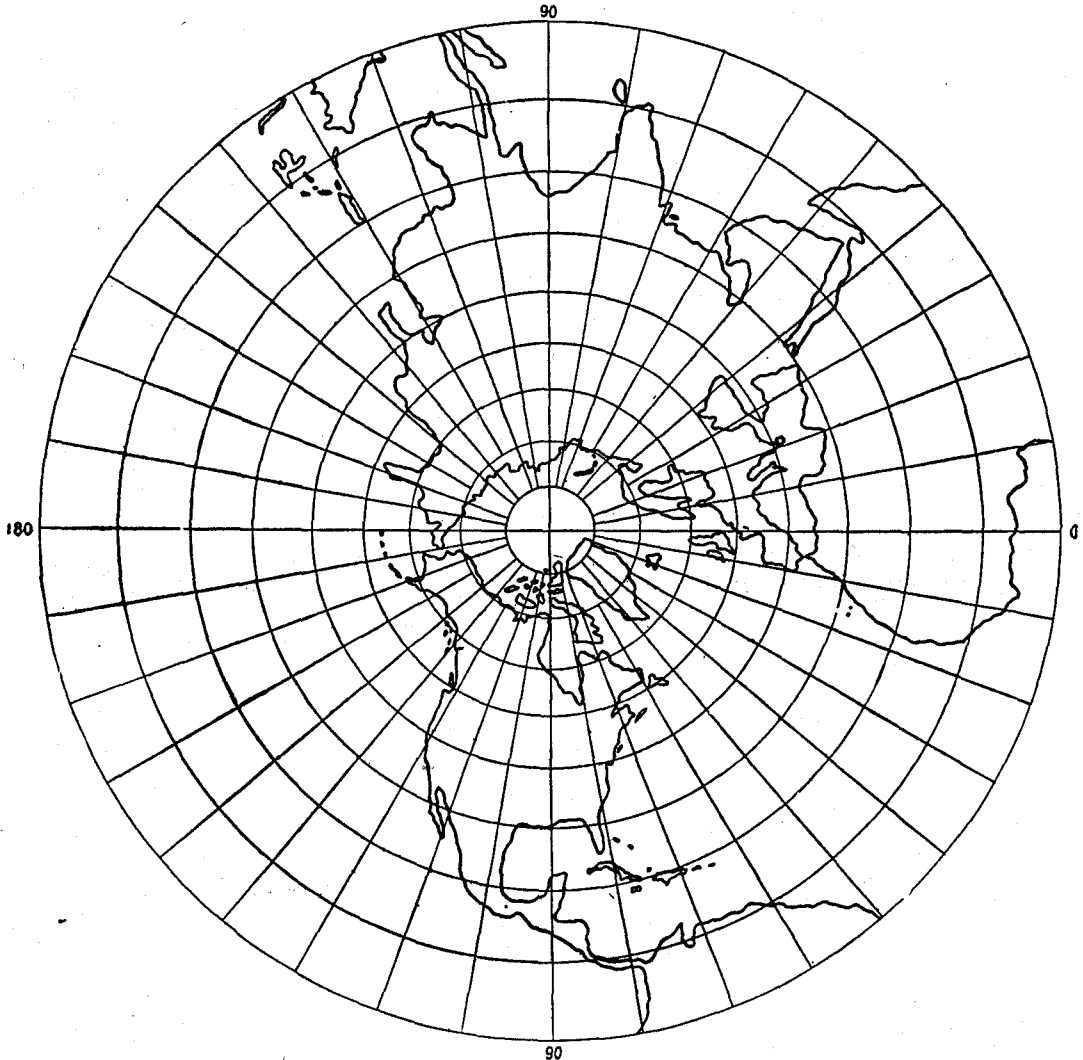

FIG. 22.—Stereographic polar projection.

It would seem, then, at first sight that this projection is an ideal one, and, as a matter of fact, it is considered by most authorities as the best projection of a hemisphere for general purposes, but, of course, it has a serious defect. It has been stated that each plan has to be compressed at its inner edge, and for the same reason each plan in succession has to be reduced to a smaller average scale than the one outside of it. In other words, the *shape* of each space into which a plan has to be fitted is practically correct, but the size is less in proportion at the center than at the edges; so that if a correct plan of an area at the edge of the map has to be reduced, let us say to a scale of 500 miles to an inch to fit its allotted space, then a plan of an area at the center has to be reduced to a scale of more than 500 miles to an inch. Thus a moderate area has its true shape, and even an area as large as one of the States is not distorted to such an extent as to be visible to the ordinary observer, but to obtain this advantage

relative size has to be sacrificed; that is, the property of equivalence of area has to be entirely disregarded.

CENTRAL OR GNOMONIC PROJECTION.

In this projection the center of the sphere is the point from which the projecting lines are drawn and the map is made upon a tangent plane. When the plane is tangent at the pole, the parallels are circles with the pole as common center and the meridians

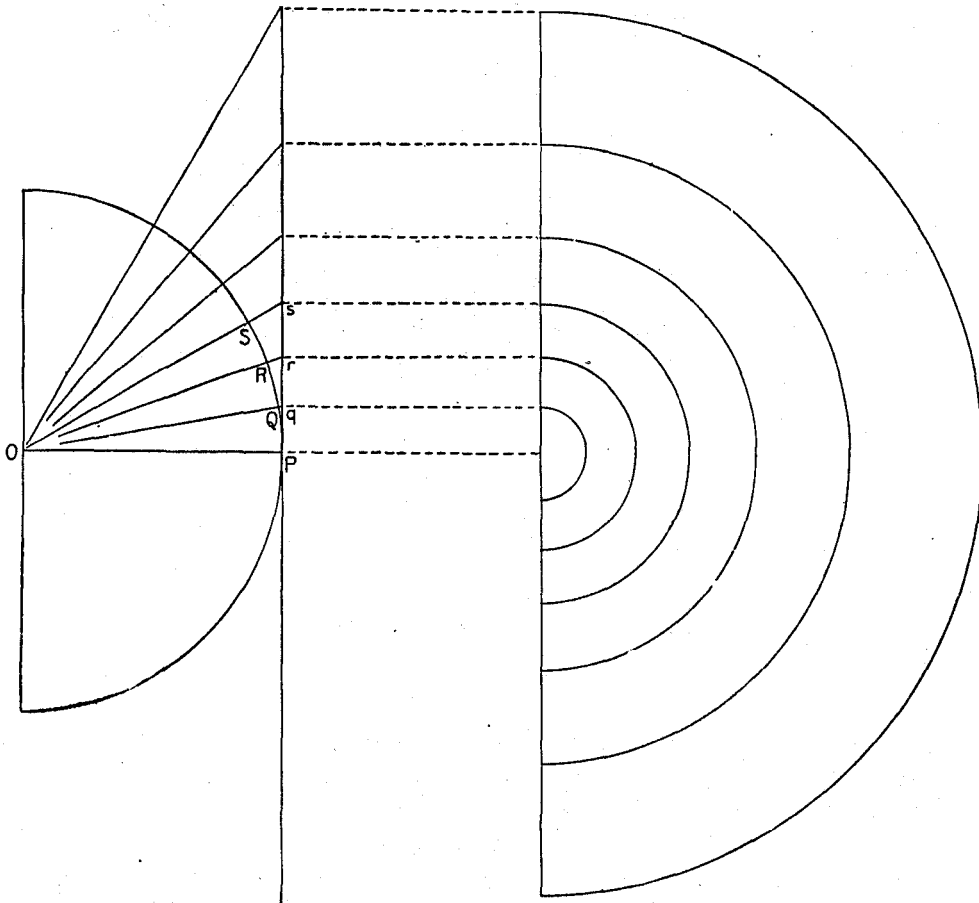

FIG. 23.—Determination of radii for gnomonic polar projection.

are equally spaced radii of these circles. In figure 23 it can be seen that the length of the various radii of the parallels are found by drawing lines from the center of a circle representing a meridian of the sphere and by prolonging them to intersect a tangent line. In the figure let P be the pole and let $PQ, QR, \text{etc.}$, be arcs of 10° , then $Pq, Pr, \text{etc.}$, will be the radii of the corresponding parallels. It is at once evident that a complete hemisphere can not be represented upon a plane, for the radius of 90° from the center would become infinite. The North Pole regions extending to latitude 30° is shown in figure 24.

The important property of this projection is the fact that all great circles are represented by straight lines. This is evident from the fact that the projecting lines would all lie in the plane of the circle and the circle would be represented by the intersection of this plane with the mapping plane. Since the shortest distance be-

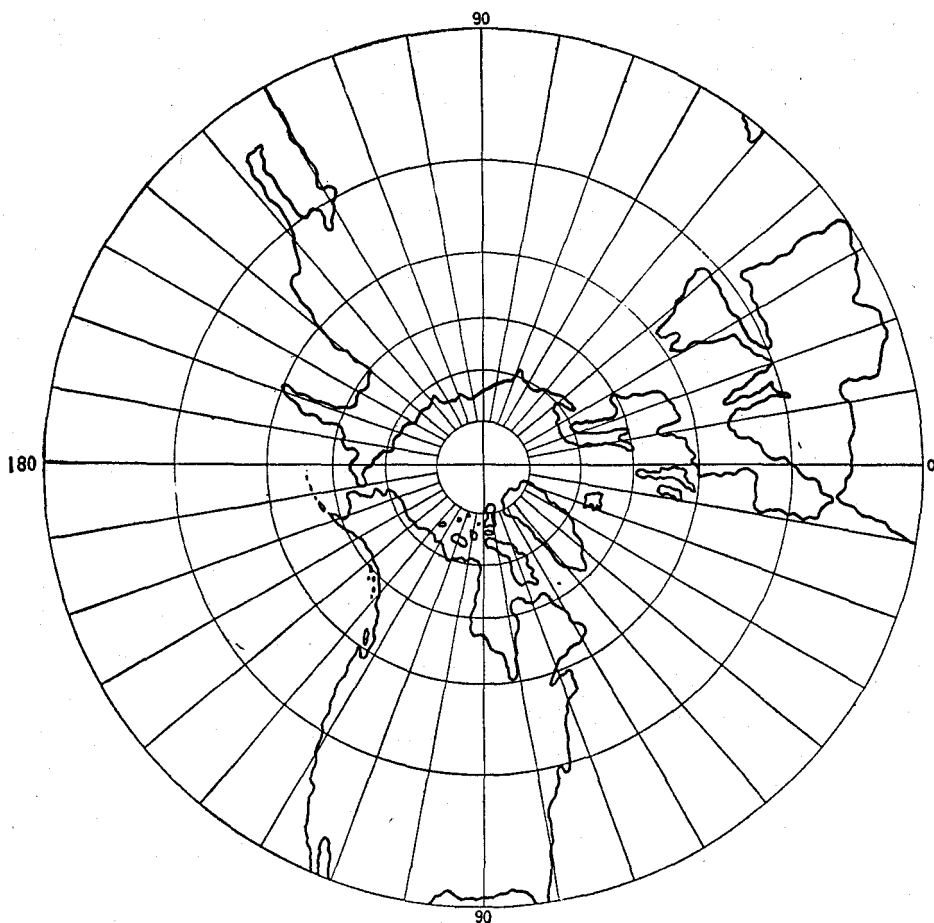

FIG. 24.—Gnomonic polar projection.

tween two given points on the sphere is an arc of a great circle, the shortest distance between the points on the sphere is represented on the map by the straight line joining the projection of the two points which, in turn, is the shortest distance joining the projections; in other words, shortest distances upon the sphere are represented by shortest distances upon the map. The change of scale in the projection is so rapid that very violent distortions are present if the map is extended any distance. A map of this kind finds its principal use in connection with the Mercator charts, as will be shown in the second part of this publication.

LAMBERT AZIMUTHAL EQUAL-AREA PROJECTION.

This projection does not belong in the perspective class, but when the pole is the center it can be easily constructed graphically. The radius for the circle representing a parallel is taken as the chord distance of the parallel from the pole. In figure 25 the chords are drawn for every 10° of arc, and figure 26 shows the map of the Northern Hemisphere constructed with these radii.

ORTHOGRAPHIC POLAR PROJECTION.

When the pole is the center, an orthographic projection may be constructed graphically by projecting the parallels by parallel lines. It is a perspective projection in which the point of projection has receded indefinitely, or, speaking mathematically,

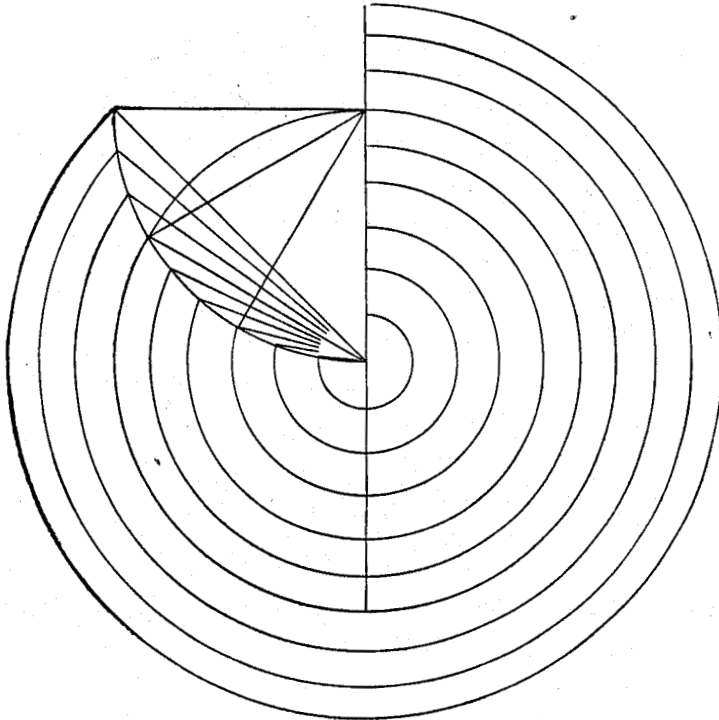

FIG. 25.—Determination of radii for Lambert equal-area polar projection.

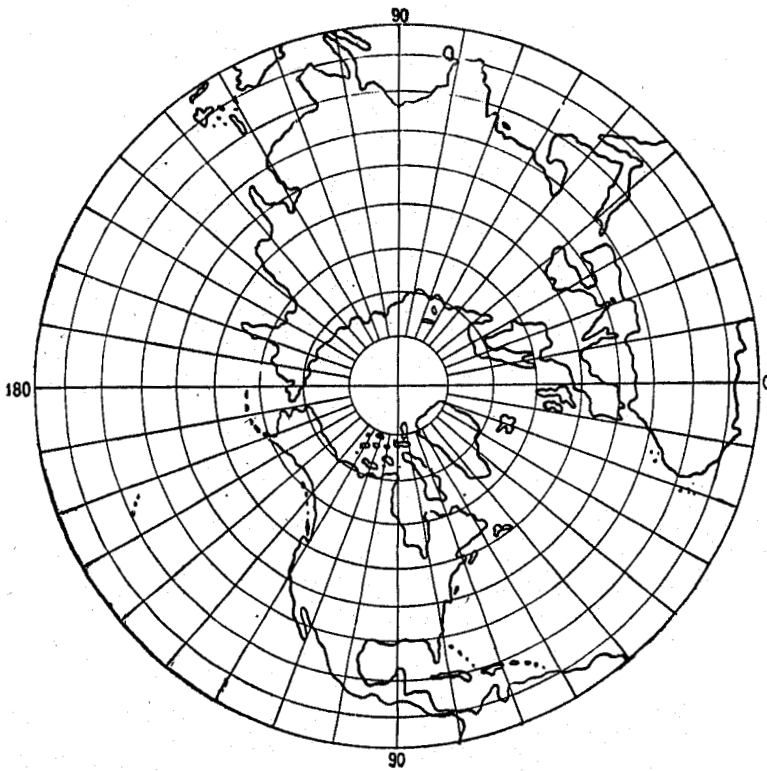

FIG. 26.—Lambert equal-area polar projection.

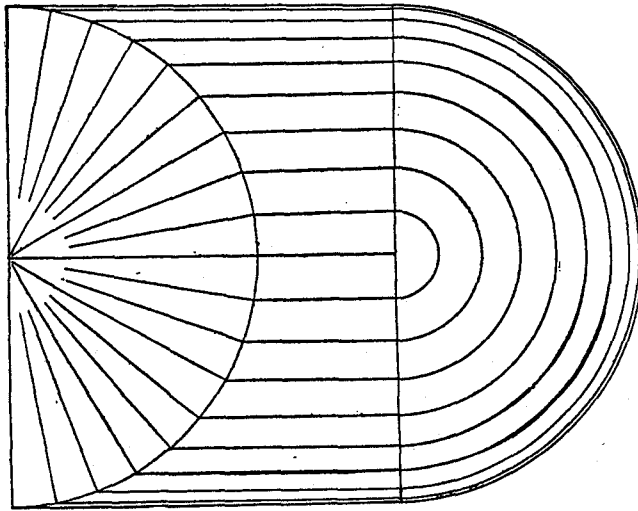

FIG. 27.—Determination of radii for orthographic polar projection.

the point of projection is at infinity. Each parallel is really constructed with a radius proportional to its radius on the sphere. It is clear, then, that the scale along the parallels is unvarying, or, as it is called, the parallels are held true to scale. The

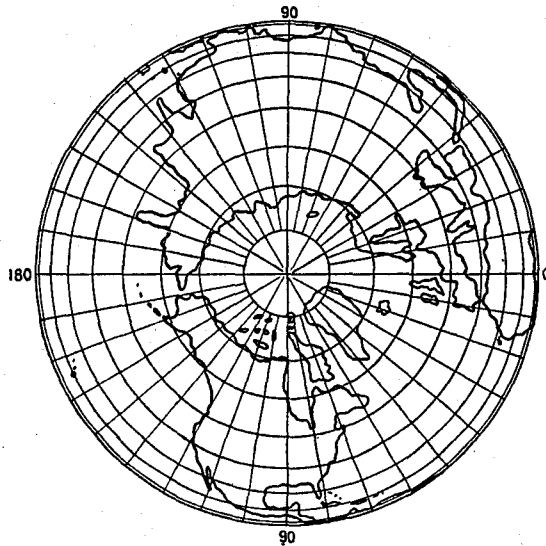

FIG. 28.—Orthographic polar projection.

method of construction is indicated clearly in figure 27, and figure 28 shows the Northern Hemisphere on this projection. Maps of the surface of the moon are usually constructed on this projection, since we really see the moon projected upon the celestial sphere practically as the map appears.

AZIMUTHAL EQUIDISTANT PROJECTION.

In the orthographic polar projection the scale along the parallels is held constant, as we have seen. We can also have a projection in which the scale along the meridians is held unvarying. If the parallels are represented by concentric circles equally spaced, we shall obtain such a projection. The projection is very easily constructed,

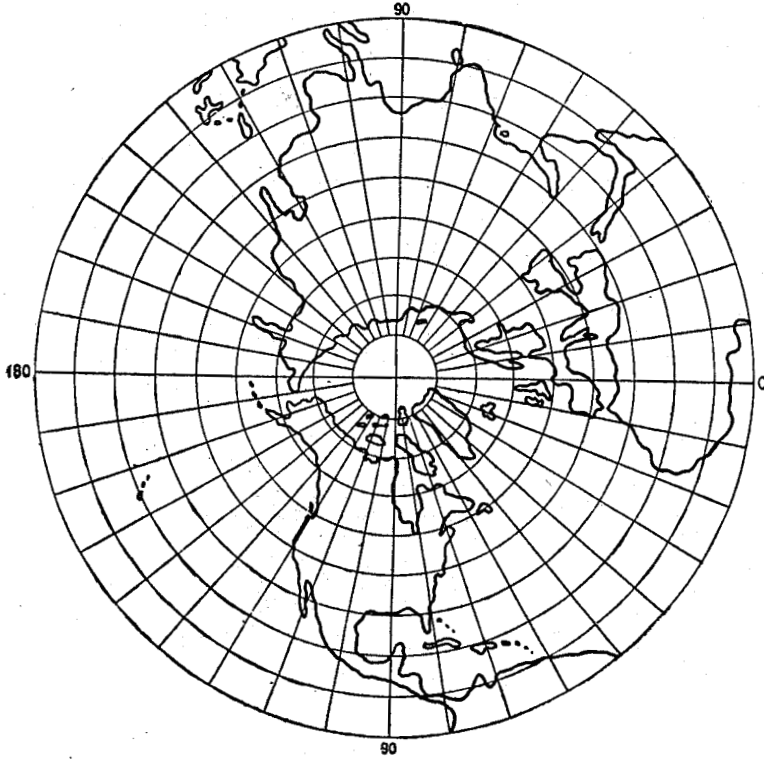

FIG. 29.—Azimuthal equidistant polar projection.

since we need only to draw the system of concentric, equally spaced circles with the meridians represented, as in all polar azimuthal projections, by the equally spaced



FIG. 30.—Stereographic projection of the Western Hemisphere.

radii of the system of circles. Such a map of the Northern Hemisphere is shown in figure 29. This projection has the advantage that it is somewhat a mean between the stereographic and the equal area. On the whole, it gives a fairly good repre-

sentation, since it stands as a compromise between the projections that cause distortions of opposite kind in the outer regions of the maps.

OTHER PROJECTIONS IN FREQUENT USE.

In figure 30 the Western Hemisphere is shown on the stereographic projection. A projection of this nature is called a meridional projection or a projection on the

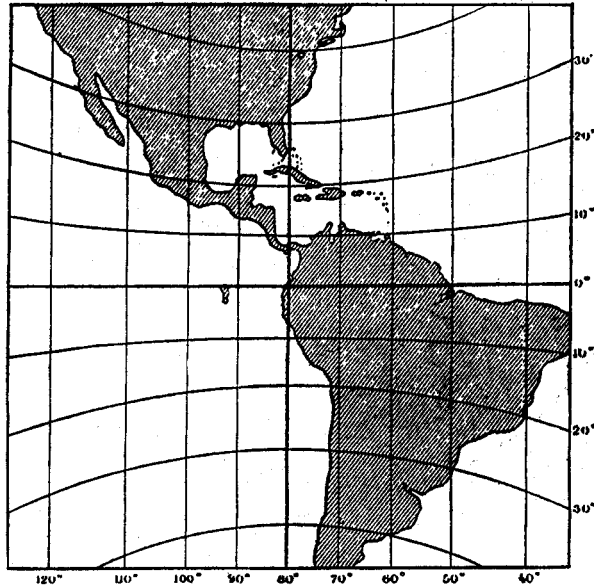

FIG. 31.—Gnomonic projection of part of the Western Hemisphere.

plane of a meridian, because the bounding circle represents a meridian and the North and South Poles are shown at the top and the bottom of the map, respectively.

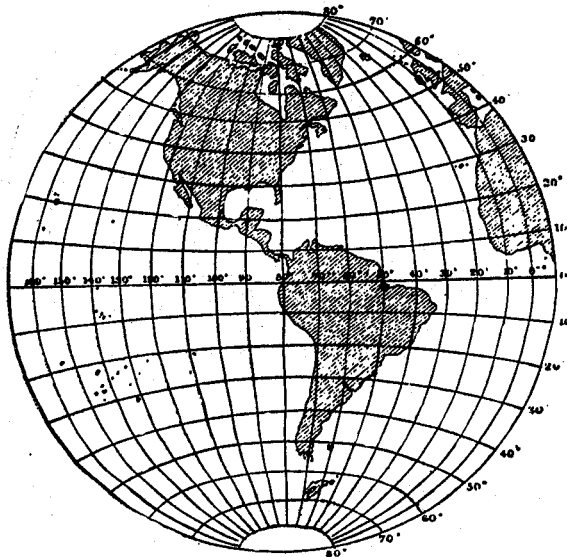

FIG. 32.—Lambert equal-area projection of the Western Hemisphere.

The central meridian is a straight line and the Equator is represented by another straight line perpendicular to the central meridian; that is, the central meridian and the Equator are two perpendicular diameters of the circle that represents the outer meridian and that forms the boundary of the map.



FIG. 33.—Orthographic projection of the Western Hemisphere.

In figure 31 a part of the Western Hemisphere is represented on a gnomonic projection with a point on the Equator as the center.



FIG. 34.—Globular projection of the Western Hemisphere.

A meridian equal-area projection of the Western Hemisphere is shown in figure 32.

An orthographic projection of the same hemisphere is given in figure 33. In this the parallels become straight lines and the meridians are arcs of ellipses.

A projection that is often used in the mapping of a hemisphere is shown in figure 34. It is called the globular projection. The outer meridian and the central meridian are divided each into equal parts by the parallels which are arcs of circles. The Equator is also divided into equal parts by the meridians, which in turn are arcs of circles. Since all of the meridians pass through each of the poles, these conditions are sufficient to determine the projection. By comparing it with the stereographic it will be seen that the various parts are not violently sheared out of shape, and a comparison with the equal-area will show that the areas are not badly represented. Certainly such a representation is much less misleading than the Mercator which is too often employed in the school geographies for the use of young people.

CONSTRUCTION OF A STEREOGRAPHIC MERIDIONAL PROJECTION.

Two of the projections mentioned under the preceding heading—the stereographic and the gnomonic—lend themselves readily to graphic construction. In figure 35 let the circle PQP' represent the outer meridian in the stereographic

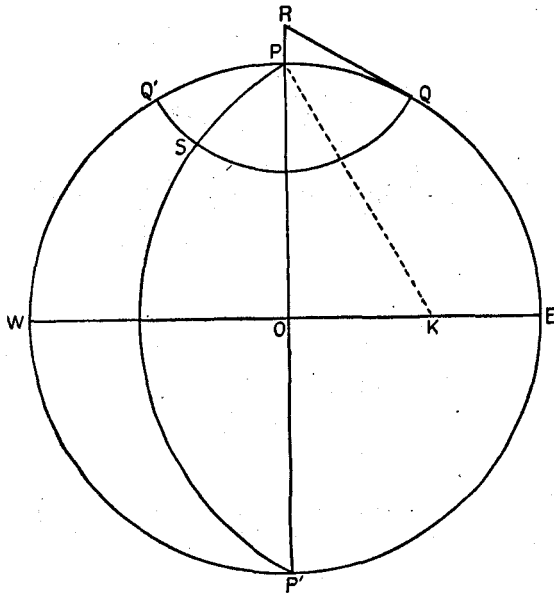

FIG. 35.—Determination of the elements of a stereographic projection on the plane of a meridian.

projection. Take the arc PQ , equal to 30° ; that is, Q will lie in latitude 60° . At Q construct the tangent RQ ; with R as a center, and with a radius RQ construct the arc QSQ' . This arc represents the parallel of latitude 60° . Lay off OK equal to RQ ; with K as a center, and with a radius KP construct the arc PSP' ; then this arc represents the meridian of longitude 60° reckoned from the central meridian POP' . In the same way all the meridians and parallels can be constructed so that the construction is very simple. Hemispheres constructed on this projection are very frequently used in atlases and geographies.

CONSTRUCTION OF A GNOMONIC PROJECTION WITH POINT OF TANGENCY ON THE EQUATOR.

In figure 36 let $PQP'Q'$ represent a great circle of the sphere. Draw the radii $OA, OB, \text{etc.}$, for every 10° of arc. When these are prolonged to intersect the tangent at P , we get the points on the equator of the map where the meridians inter-

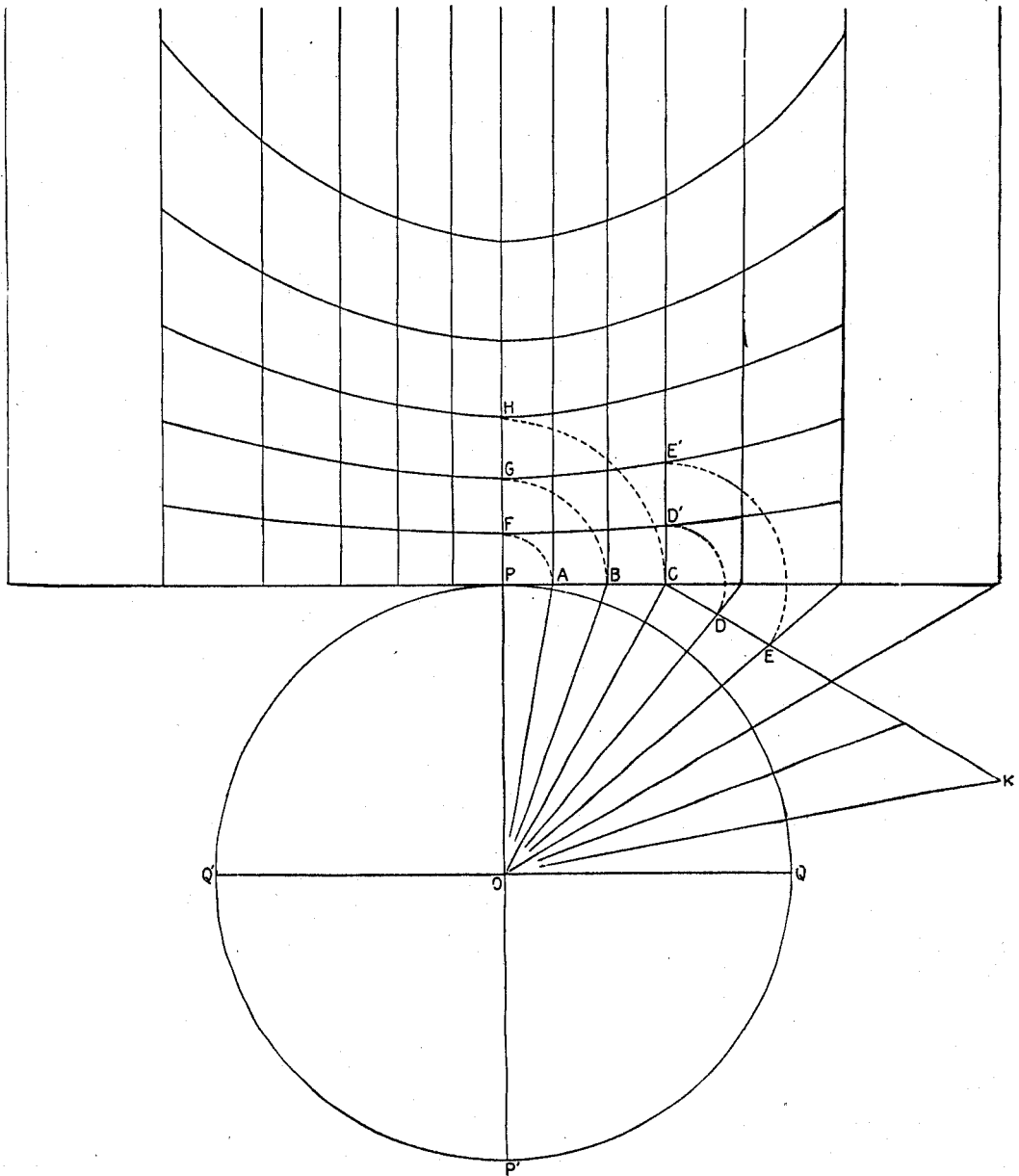

FIG. 36.—Construction of a gnomonic projection with plane tangent at the Equator.

sect it. Since the meridians of the sphere are represented by parallel straight lines perpendicular to the straight-line equator, we can draw the meridians when we know their points of intersection with the equator.

The central meridian is spaced in latitude just as the meridians are spaced on the equator. In this way we determine the points of intersection of the parallels with

the central meridian. The projection is symmetrical with respect to the central meridian and also with respect to the equator. To determine the points of intersection of the parallels with any meridian, we proceed as indicated in figure 36, where the determination is made for the meridian 30° out from the central meridian. Draw CK perpendicular to OC ; then CD' , which equals CD , determines D' , the intersection of the parallel of 10° north with the meridian of 30° in longitude east of the central meridian. In like manner $CE' = CE$, and so on. These same values can be transferred to the meridian of 30° in longitude west of the central meridian. Since the projection is symmetrical to the equator, the spacings downward on any meridian are the same as those upward on the same meridian. After the points of intersection of the parallels with the various meridians are determined, we can draw a smooth curve through those that lie on any given parallel, and this curve will represent the parallel in question. In this way the complete projection can be constructed. The distortions in this projection are very great, and the representation must always be less than a hemisphere, because the projection extends to infinity in all directions. As has already been stated, the projection is used in connection with Mercator sailing charts to aid in plotting great-circle courses.

CONICAL PROJECTIONS.

In the conical projections, when the cone is spread out in the plane, the 360 degrees of longitude are mapped upon a sector of a circle. The magnitude of the angle at the center of this sector has to be determined by computation from the condition imposed

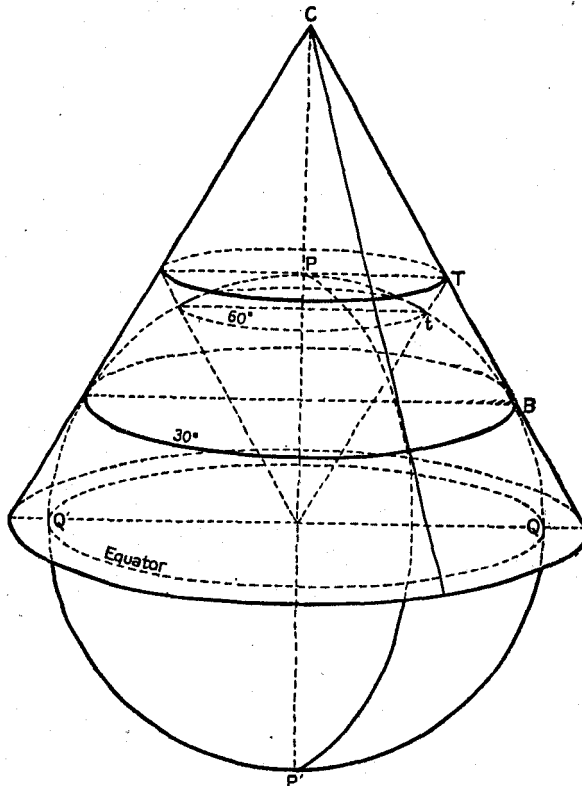

FIG. 37.—Cone tangent to the sphere at latitude 30° .

upon the projection. Most of the conical projections are determined analytically; that is, the elements of the projection are expressed by mathematical formulas

instead of being determined projectively. There are two classes of conical projections—one called a projection upon a tangent cone and another called a projection upon a secant cone. In the first the scale is held true along one parallel and in the second the scale is maintained true along two parallels.

CENTRAL PROJECTION UPON A CONE TANGENT AT LATITUDE 30°.

As an illustration of conical projections we shall indicate the construction of one which is determined by projection from the center upon a cone tangent at latitude 30°. (See fig. 37.) In this case the full circuit of 360° of longitude will be

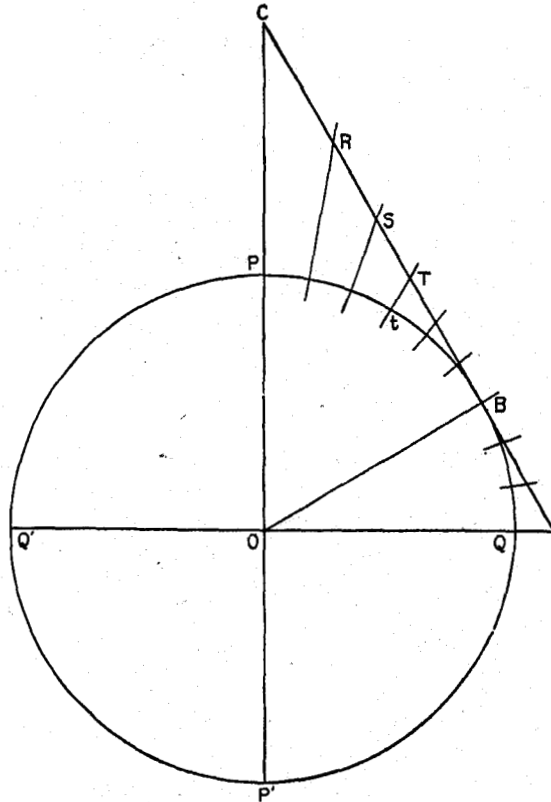

FIG. 38.—Determination of radii for conical central perspective projection.

mapped upon a semicircle. In figure 38 let $PQ P' Q'$ represent a meridian circle; draw CB tangent to the circle at latitude 30°, then CB is the radius for the parallel of 30° of latitude on the projection. CR, CS, CT , etc., are the radii for the parallels of 80°, 70°, 60°, etc., respectively. The map of the Northern Hemisphere on this projection is shown in figure 39; this is, on the whole, not a very satisfactory projection, but it serves to illustrate some of the principles of conical projection. We might determine the radii for the parallels by extending the planes of the same until they intersect the cone. This would vary the spacings of the parallels, but would not change the sector on which the projection is formed.

A cone could be made to intersect the sphere and to pass through any two chosen parallels. Upon this we could project the sphere either from the center or from any other point that we might choose. The general appearance of the projection would be similar to that of any conical projection, but some computation would

be required for its construction. As has been stated, almost all conical projections in use have their elements determined analytically in the form of mathematical formulas. Of these the one with two standard parallels is not, in general, an intersecting cone, strictly speaking. Two separate parallels are held true to scale,

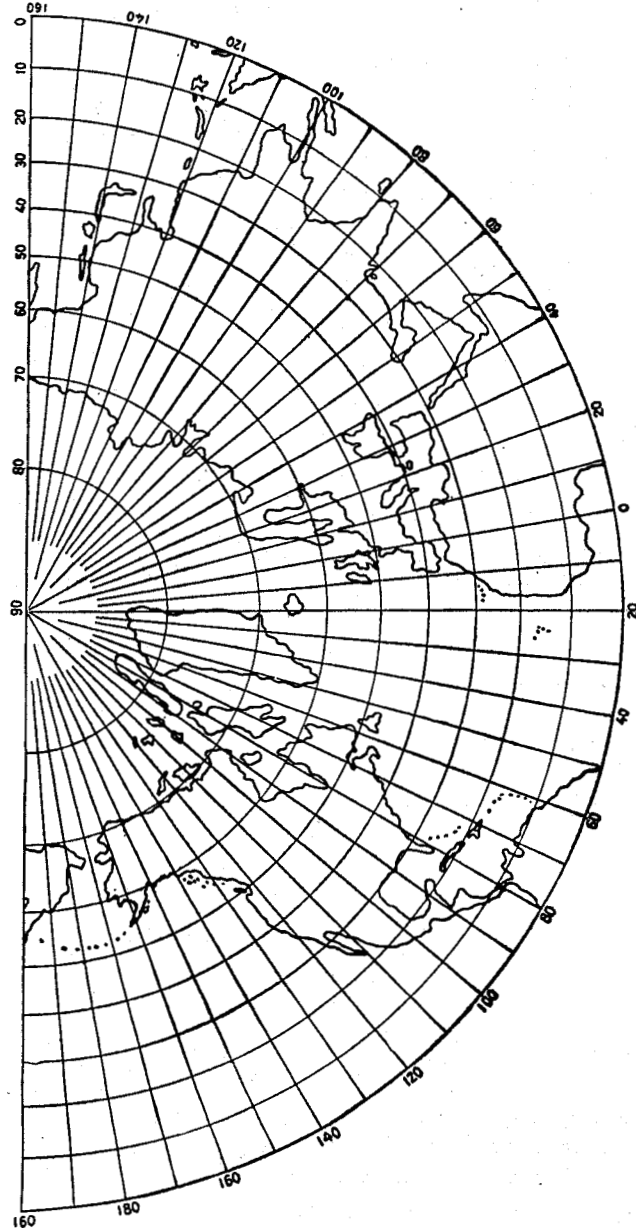

Fig. 39.—Central perspective projection on cone tangent at latitude 30° .

but if they were held equal in length to their length on the sphere the cone could not, in general, be made to intersect the sphere so as to have the two parallels coincide with the circles that represent them. This could only be done in case the distance between the two circles on the cone was equal to the chord distance between the parallels on the sphere. This would be true in a perspective projection, but it would ordinarily not be true in any projection determined analytically. Probably the two most important conical projections are the Lambert conformal conical pro-

jection with two standard parallels and the Albers equal-area conical projection. The latter projection has also two standard parallels.

BONNE PROJECTION.

There is a modified conical equal-area projection that has been much used in map making called the Bonne projection. In general a cone tangent along the parallel in the central portion of the latitude to be mapped gives the radius for the arc representing this parallel. A system of concentric circles is then drawn to represent the other parallels with the spacings along the central meridian on the same scale as that of the standard parallel. Along the arcs of these circles the longitude distances are laid off on the same scale in both directions from the central meridian,

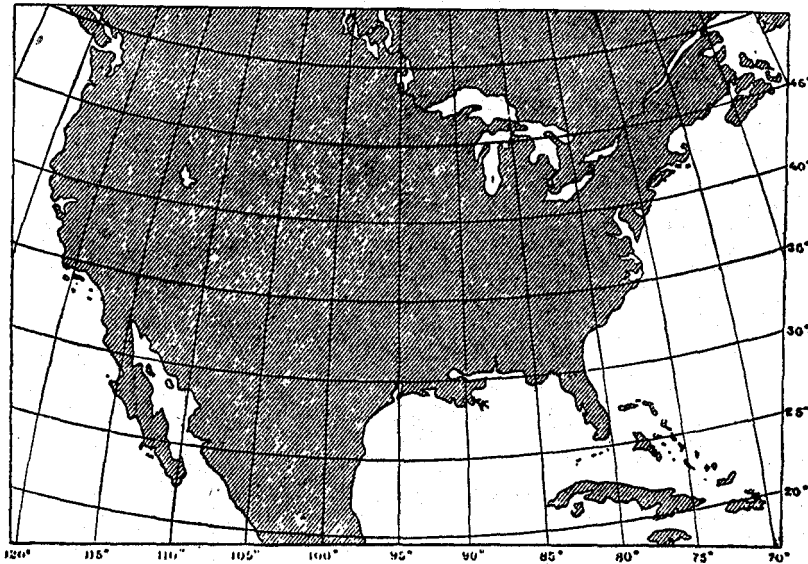

FIG. 40.—Bonne projection of the United States.

which is a straight line. All of the meridians except the central one are curved lines concave toward the straight-line central meridian. This projection has been much used in atlases partly because it is equal-area and partly because it is comparatively easy to construct. A map of the United States is shown in figure 40 on this projection.

POLYCONIC PROJECTION.

In the polyconic projection the central meridian is represented by a straight line and the parallels are represented by arcs of circles that are not concentric, but the centers of which all lie in the extension of the central meridian. The distances between the parallels along the central meridian are made proportional to the true distances between the parallels on the earth. The radius for each parallel is determined by an element of the cone tangent along the given parallel. When the parallels are constructed in this way, the arcs along the circles representing the parallels are laid off proportional to the true lengths along the respective parallels. Smooth curves drawn through the points so determined give the respective meridians. In figure 15 it may be seen in what manner the exaggeration of scale is introduced by this method of projection. A map of North America on this projection is shown in

figure 41. The great advantage of this projection consists in the fact that a general table can be computed for use in any part of the earth. In most other projections there are certain elements that have to be determined for the region to be mapped.



FIG. 41.—Polyconic projection of North America.

When this is the case a separate table has to be computed for each region that is under consideration. With this projection, regions of narrow extent of longitude can be mapped with an accuracy such that no departure from true scale can be detected. A quadrangle of 1° on each side can be represented in such a manner, and in cases where the greatest accuracy is either not required or in which the error in scale may be taken into account, regions of much greater extent can be successfully mapped. The general table is very convenient for making topographic maps of limited extent in which it is desired to represent the region in detail. Of course, maps of neighboring regions on such a projection could not be fitted together exactly to form an extended map. This same restriction would apply to any projection on which the various regions were represented on an unvarying scale with minimum distortions.

ILLUSTRATIONS OF RELATIVE DISTORTIONS.

A striking illustration of the distortion and exaggerations inherent in various systems of projection is given in figures 42-45. In figure 42 we have shown a man's head drawn with some degree of care on a globular projection of a hemisphere. The other three figures have the outline of the head plotted, maintaining the latitude and longitude the same as they are found in the globular projection. The distortions and exaggerations are due solely to those that are found in the projection in question.

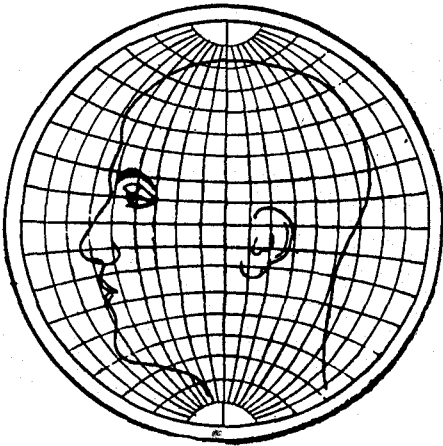

FIG. 42.—Man's head drawn on globular projection.

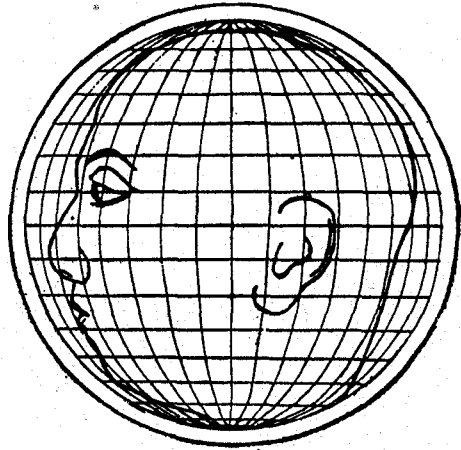

FIG. 43.—Man's head plotted on orthographic projection.

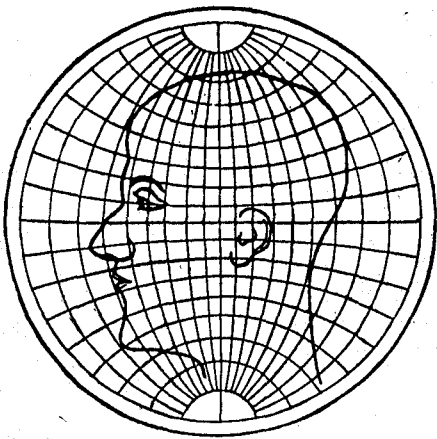

FIG. 44.—Man's head plotted on stereographic projection.

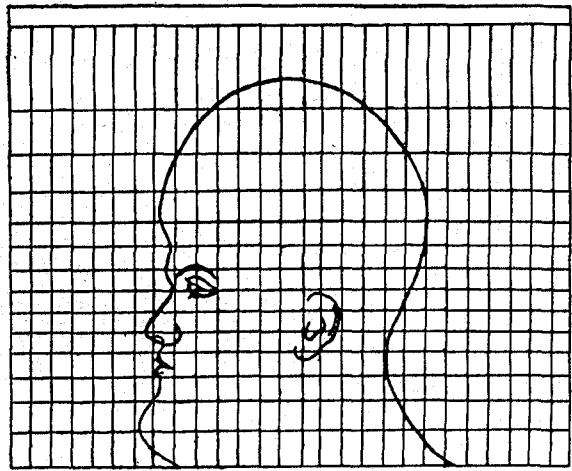

FIG. 45.—Man's head plotted on Mercator projection.

This does not mean that the globular projection is the best of the four, because the symmetrical figure might be drawn on any one of them and then plotted on the others. By this method we see shown in a striking way the relative differences in distortion of the various systems. The principle could be extended to any number of projections that might be desired, but the four figures given serve to illustrate the method.

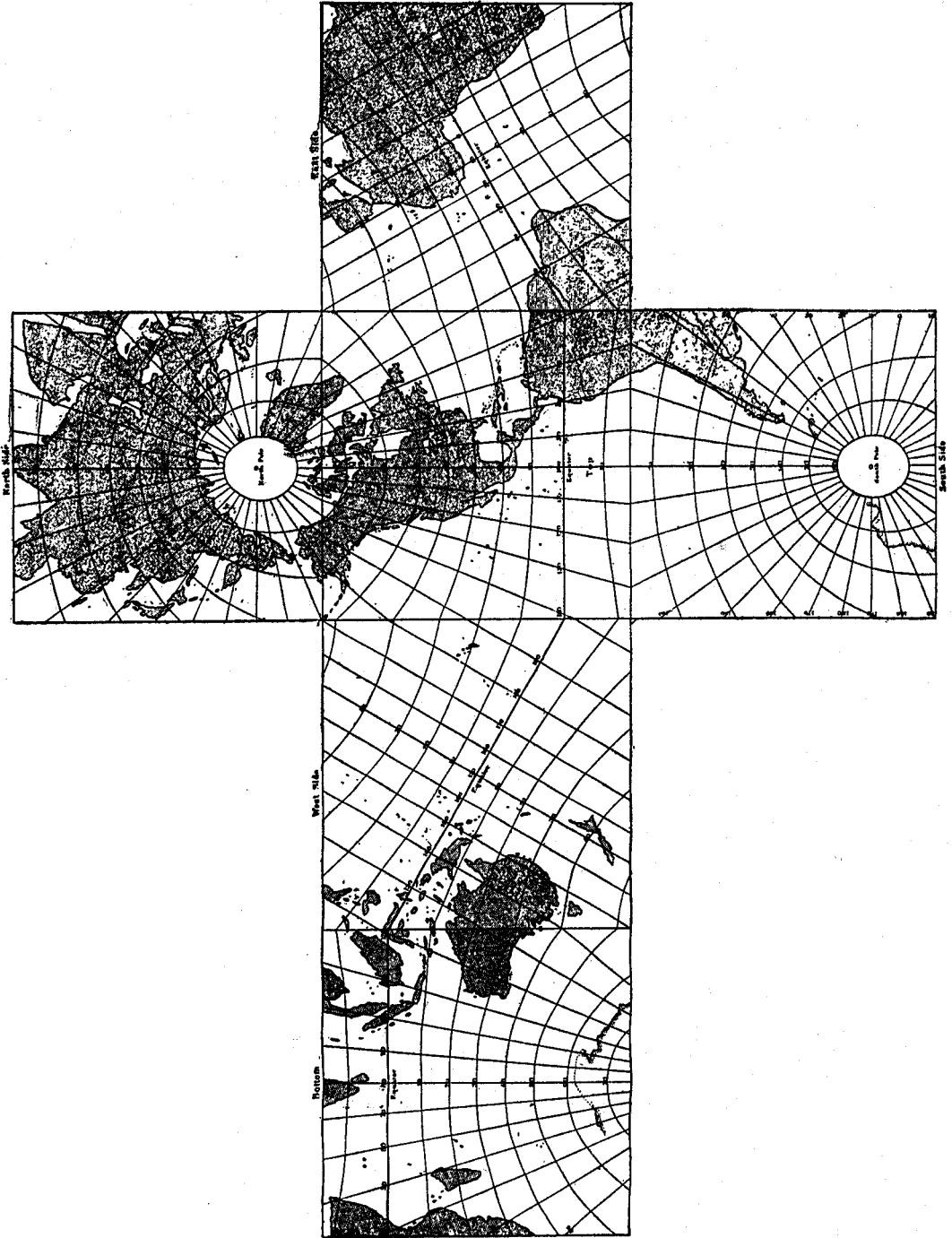

FIG. 46.—Gnomonic projection of the sphere on a circumscribed cube.

PART II.

INTRODUCTION.

It is the purpose in Part II of this review to give a comprehensive description of the nature, properties, and construction of the better systems of map projection in use at the present day. Many projections have been devised for map construction which are nothing more than geometric trifles, while others have attained prominence at the expense of better and oftentimes simpler types.

It is largely since the outbreak of the World War that an increased demand for better maps has created considerable activity in mathematical cartography, and, as a consequence, a marked progress in the general theory of map projections has been in evidence.

Through military necessities and educational requirements, the science and art of cartography have demanded better draftsmanship and greater accuracy, to the extent that many of the older studies in geography are not now considered as worthy of inclusion in the present-day class.

The whole field of cartography, with its component parts of history and surveys, map projection, compilation, nomenclature and reproduction is so important to the advancement of scientific geography that the higher standard of to-day is due to a general development in every branch of the subject.

The selection of suitable projections is receiving far more attention than was formerly accorded to it. The exigencies of the problem at hand can generally be met by special study, and, as a rule, that system of projection can be adopted which will give the best results for the area under consideration, whether the desirable conditions be a matter of correct angles between meridians and parallels, scaling properties, equivalence of areas, rhumb lines, etc.

The favorable showing required to meet any particular mapping problem may oftentimes be retained at the expense of other less desirable properties, or a compromise may be effected. A method of projection which will answer for a country of small extent in latitude will not at all answer for another country of great length in a north-and-south direction; a projection which serves for the representation of the polar regions may not be at all applicable to countries near the Equator; a projection which is the most convenient for the purposes of the navigator is of little value to the Bureau of the Census; and so throughout the entire range of the subject, particular conditions have constantly to be satisfied and special rather than general problems to be solved. The use of a projection for a purpose to which it is not best suited is, therefore, generally unnecessary and can be avoided.

PROJECTIONS DESCRIBED IN PART II.

In the description of the different projections and their properties in the following pages the mathematical theory and development of formulas are not generally included where ready reference can be given to other manuals containing these features. In several instances, however, the mathematical development is given in somewhat closer detail than heretofore.

In the selection of projections to be presented in this discussion, the authors have, with two exceptions, confined themselves to two classes, viz, *conformal projections* and

equivalent or equal-area projections. The exceptions are the polyconic and gnomonic projections—the former covering a field entirely its own in its general employment for field sheets in any part of the world and in maps of narrow longitudinal extent, the latter in its application and use to navigation.

It is within comparatively recent years that the demand for equal-area projections has been rather persistent, and there are frequent examples where the mathematical property of conformality is not of sufficient practical advantage to outweigh the useful property of equal area.

The critical needs of conformal mapping, however, were demonstrated at the commencement of the war, when the French adopted the Lambert conformal conic projection as a basis for their new battle maps, in place of the Bonne projection heretofore in use. By the new system, a combination of minimum of angular and scale distortion was obtained, and a precision which is unique in answering every requirement for knowledge of orientation, distances, and quadrillage (system of kilometric squares).

CONFORMAL MAPPING is not new since it is a property of the stereographic and Mercator projections. It is, however, somewhat surprising that the comprehensive study and practical application of the subject as developed by Lambert in 1772 and, from a slightly different point of view, by Lagrange in 1779, remained more or less in obscurity for many years. It is a problem in an important division of cartography which has been solved in a manner so perfect that it is impossible to add a word. This rigid analysis is due to Gauss, by whose name the Lambert conformal conic projection is sometimes known. In the representation of any surface upon any other by similarity of infinitely small areas, the credit for the advancement of the subject is due to him.

EQUAL-AREA MAPPING.—The problem of an equal-area or equivalent projection of a spheroid has been simplified by the introduction of an intermediate equal-area projection upon a sphere of equal surface, the link between the two being the authalic³ latitude. A table of authalic latitudes for every half degree has recently been computed (see U. S. Coast and Geodetic Survey, Special Publication No. 67), and this can be used in the computations of any equal-area projection. The coordinates for the Albers equal-area projection of the United States were computed by use of this table.

THE CHOICE OF PROJECTION.

Although the uses and limitations of the different systems of projections are given under their subject headings, a few additional observations may be of interest. (See frontispiece.)

COMPARISON OF ERRORS OF SCALE AND ERRORS OF AREA IN A MAP OF THE UNITED STATES ON FOUR DIFFERENT PROJECTIONS.

	MAXIMUM SCALE ERROR.	Per cent.
Polyconic projection.....		7
Lambert conformal conic projection with standard parallels of latitude at 33° and 45°.....		2½
(Between latitudes 30½° and 47½°, only one-half per cent. Strictly speaking, in the Lambert conformal conic projection these percentages are not <i>scale error</i> but <i>change of scale</i> .)		
Lambert zenithal equal-area projection.....		1½
Albers projection with standard parallels at 29° 30' and 45° 30'.....		1½

³ The term *authalic* was first employed by Tissot, in 1881, signifying *equal area*.

	MAXIMUM ERROR OF AREA.	Per cent.
Polyconic.....	7
Lambert conformal conic.....	5
Lambert zenithal.....	0
Albers.....	0

	MAXIMUM ERROR OF AZIMUTH.	
Polyconic.....	1° 56'
Lambert conformal conic.....	0° 00'
Lambert zenithal.....	1° 04'
Albers.....	0° 43'

An improper use of the polyconic projection for a map of the North Pacific Ocean during the period of the Spanish-American War resulted in distances being distorted along the Asiatic coast to double their true amount, and brought forth the query whether the distance from Shanghai to Singapore by straight line was longer than the combined distances from Shanghai to Manila and thence to Singapore.

The polyconic projection is not adapted to mapping areas of predominating longitudinal extent and should not generally be used for distances east or west of its central meridian exceeding 500 statute miles. Within these limits it is sufficiently close to other projections that are in some respects better, as not to cause any inconvenience. The extent to which the projection may be carried in latitude is not limited. On account of its tabular superiority and facility for constructing field sheets and topographical maps, it occupies a place beyond all others.⁴

Straight lines on the polyconic projection (excepting its central meridian and the Equator) are neither great circles nor rhumb lines, and hence the projection is not suited to navigation beyond certain limits. This field belongs to the Mercator and gnomonic projections, about which more will be given later.

The polyconic projection has no advantages in scale; neither is it conformal or equal-area, but rather a compromise of various conditions which determine its choice within certain limits.

The modified polyconic projection with two standard meridians may be carried to a greater extent of longitude than the former, but for narrow zones of longitude the Bonne projection is in some respects preferable to either, as it is an equal-area representation.

For a map of the United States in a single sheet the choice rests between the *Lambert conformal conic* projection with two standard parallels and the *Albers equal-area* projection with two standard parallels. The selection of a polyconic projection for this purpose is indefensible. The longitudinal extent of the United States is too great for this system of projection and its errors are not readily accounted for. The Lambert conformal and Albers are peculiarly suited to mapping in the Northern Hemisphere, where the lines of commercial importance are generally east and west.

In Plate I about one-third of the Northern Hemisphere is mapped in an easterly and westerly extent. With similar maps on both sides of the one referred to, and with suitably selected standard parallels, we would have an interesting series of the Northern Hemisphere.

The *transverse polyconic* is adapted to the mapping of comparatively narrow areas of considerable extent along any great circle. (See Plate II.) A *Mercator projection* can be turned into a transverse position in a similar manner and will give us conformal mapping.

⁴ The polyconic projection has always been employed by the Coast and Geodetic Survey for field sheets, and general tables for the construction of this projection are published by this Bureau. A projection for any small part of the world can readily be constructed by the use of these tables and the accuracy of this system within the limits specified are good reasons for its general use.

The Lambert conformal and Albers projections are desirable for areas of predominating east-and-west extent, and the choice is between *conformality*, on the one hand, or *equal area*, on the other, depending on which of the two properties may be preferred. The authors would prefer Albers projection for mapping the United States. A comparison of the two indicates that their difference is very small, but the certainty of definite equal-area representation is, for general purposes, the more desirable property. When latitudinal extent increases, conformality with its preservation of shapes becomes generally more desirable than equivalence with its resultant distortion, until a limit is reached where a large extent of area has equal dimensions in both or all directions. Under the latter condition—viz, the mapping of large areas of approximately equal magnitudes in all directions approaching the dimensions of a hemisphere, combined with the condition of preserving azimuths from a central point—the Lambert zenithal equal-area projection and the stereographic projection are preferable, the former being the equal-area representation and the latter the conformal representation.

A study in the distortion of scale and area of four different projections is given in frontispiece. Deformation tables giving errors in scale, area, and angular distortion in various projections are published in Tissot's *Mémoire sur la Représentation des Surfaces*. These elements of the Polyconic projection are given on pages 166–167, U. S. Coast and Geodetic Survey Special Publication No. 57.

The mapping of an entire hemisphere on a secant conic projection, whether conformal or equivalent, introduces inadmissible errors of scale or serious errors of area, either in the center of the map or in the regions beyond the standard parallels. It is better to reserve the outer areas for title space as in Plate I rather than to extend the mapping into them. The polar regions should in any event be mapped separately on a suitable polar projection. For an equatorial belt a *cylindrical conformal* or a *cylindrical equal-area* projection intersecting two parallels equidistant from the Equator may be employed.

The lack of mention of a large number of excellent map projections in Part II of this treatise should not cause one to infer that the authors deem them unworthy. It was not intended to cover the subject *in toto* at this time, but rather to caution against the misuse of certain types of projections, and bring to notice a few of the interesting features in the progress of mathematical cartography, in which the theory of functions of a complex variable plays no small part to-day. Without the elements of this subject a proper treatment of conformal mapping is impossible.

On account of its specialized nature, the mathematical element of cartography has not appealed to the amateur geographer, and the number of those who have received an adequate mathematical training in this field of research are few. A broad gulf has heretofore existed between the geodesist, on the one hand, and the cartographer, on the other. The interest of the former too frequently ceases at the point of presenting with sufficient clearness the value of his labors to the latter, with the result that many chart-producing agencies resort to such systems of map projection as are readily available rather than to those that are ideal.

It is because of this utilitarian tendency or negligence, together with the manifest aversion of the cartographer to cross the threshold of higher mathematics, that those who care more for the theory than the application of projections have not received the recognition due them, and the employment of autogonal⁵ (conformal)

⁵ Page 75, Tissot's *Mémoire sur la Représentation des Surfaces*, Paris, 1881—"Nous appellerons *autogonales* les projections qui conservent les angles, et *authaliques* celles qui conservent les aires."

projections has not been extensive. The labors of Lambert, Lagrange, and Gauss are now receiving full appreciation.

In this connection, the following quotation from volume IV, page 408, of the collected mathematical works of George William Hill is of interest:

Maps being used for a great variety of purposes, many different methods of projecting them may be admitted; but when the chief end is to present to the eye a picture of what appears on the surface of the earth, we should limit ourselves to projections which are conformal. And, as the construction of the réseau of meridians and parallels is, except in maps of small regions, an important part of the labor involved, it should be composed of the most easily drawn curves. Accordingly, in a well-known memoir, Lagrange recommended circles for this purpose, in which the straight line is included as being a circle whose center is at infinity.

An attractive field for future research will be in the line in which Prof. Goode, of the University of Chicago, has contributed so substantially. Possibilities of other combinations or interruptions in the same or different systems of map projection may solve some of the other problems of world mapping. Several interesting studies given in illustration at the end of the book will, we hope, suggest ideas to the student in this particular branch.

On all recent French maps the name of the projection appears in the margin. This is excellent practice and should be followed at all times. As different projections have different distinctive properties, this feature is of no small value and may serve as a guide to an intelligible appreciation of the map.

THE POLYCONIC PROJECTION.

DESCRIPTION.

[See fig. 47.]

The polyconic projection, devised by Ferdinand Hassler, the first Superintendent of the Coast and Geodetic Survey, possesses great popularity on account of mechanical ease of construction and the fact that a general table⁶ for its use has been calculated for the whole spheroid.

It may be interesting to quote Prof. Hassler⁷ in connection with two projections, viz, the intersecting conic projection and the polyconic projection:

1. *Projection on an intersecting cone.*—The projection which I intended to use was the development of a part of the earth's surface upon a cone, either a tangent to a certain latitude, or cutting two given parallels and two meridians, equidistant from the middle meridian, and extended on both sides of the

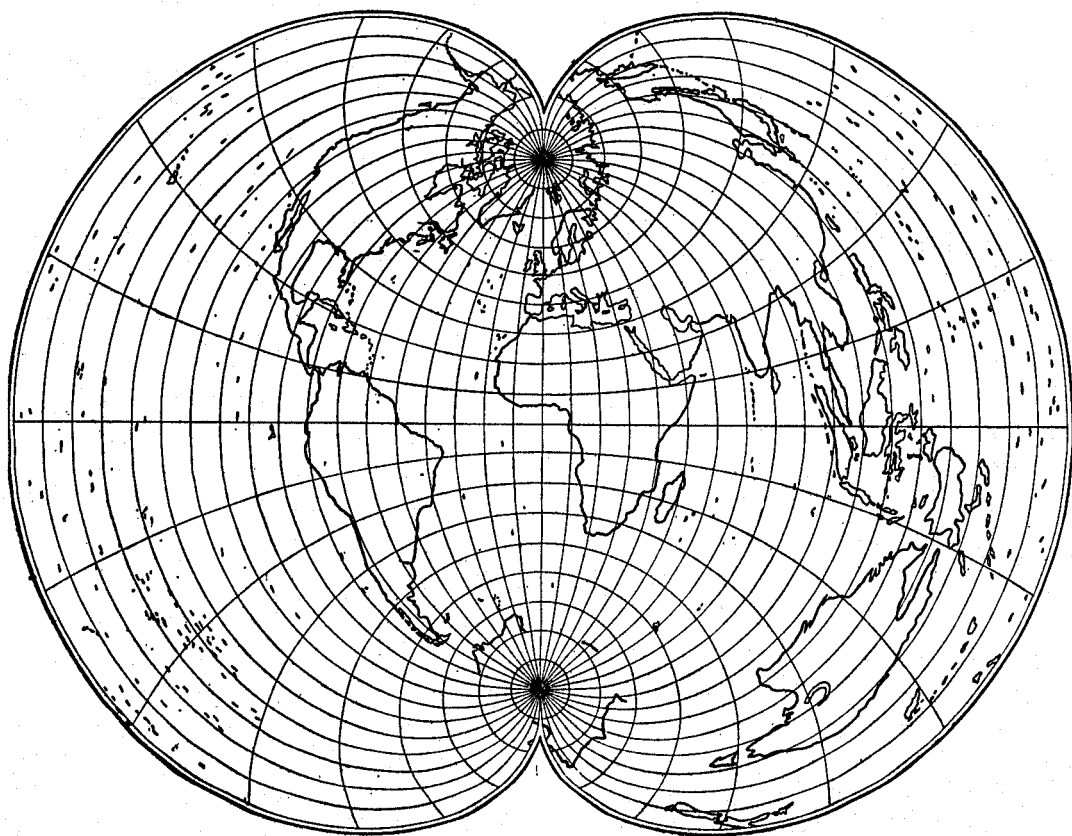

FIG. 47.—Polyconic development of the sphere.

meridian, and in latitude, only so far as to admit no deviation from the real magnitudes, sensible in the detail surveys.

2. *The polyconic projection.*—* * * This distribution of the projection, in an assemblage of sections of surfaces of successive cones, tangents to or cutting a regular succession of parallels, and upon

⁶ Tables for the polyconic projection of maps, Coast and Geodetic Survey, Special Publication No. 5.

⁷ Papers on various subjects connected with the survey of the coast of the United States, by F. R. Hassler; communicated Mar. 3, 1820 (in Trans. Am. Phil. Soc., new series, vol. 2, pp. 406-408, Philadelphia, 1825).

regularly changing central meridians, appeared to me the only one applicable to the coast of the United States.

Its direction, nearly diagonal through meridian and parallel, would not admit any other mode founded upon a single meridian and parallel without great deviations from the actual magnitudes and shape, which would have considerable disadvantages in use.

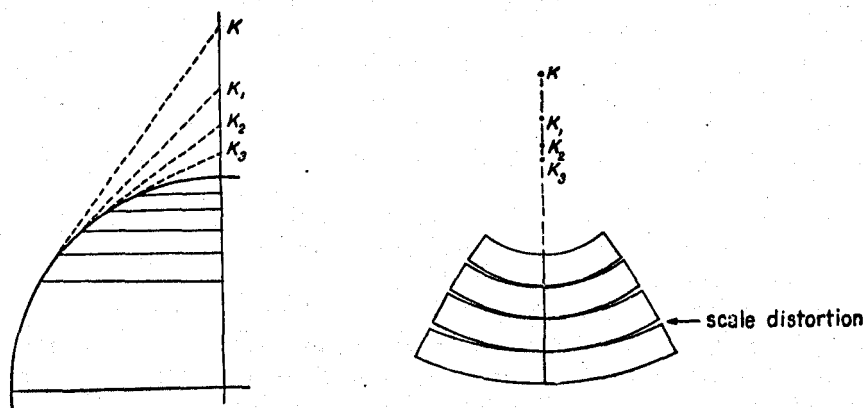

FIG. 48.—Polyconic development.

Figure on left above shows the centers (K, K_1, K_2, K_3) of circles on the projection that represent the corresponding parallels on the earth. Figure on right above shows the distortion at the outer meridian due to the varying radii of the circles in the polyconic development.

A central meridian is assumed upon which the intersections of the parallels are truly spaced. Each parallel is then separately developed by means of a tangent cone, the centers of the developed arcs of parallels lying in the extension of the central meridian. The arcs of the developed parallels are subdivided to true scale and the meridians drawn through the corresponding subdivisions. Since the radii for the parallels decrease as the cotangent of the latitude, the circles are not concentric, and the lengths of the arcs of latitude gradually increase as we recede from the meridian.

The central meridian is a right line; all others are curves, the curvature increasing with the longitudinal distance from the central meridian. The intersections between meridians and parallels also depart from right angles as the distance increases.

From the construction of the projection it is seen that errors in meridional distances, areas, shapes, and intersections increase with the longitudinal limits. It therefore should be restricted in its use to maps of wide latitude and narrow longitude.

The *polyconic* projection may be considered as in a measure *only compromising* various conditions impossible to be represented on any one map or chart, such as relate to—

First. Rectangular intersections⁸ of parallels and meridians.

⁸ The errors in meridional scale and area are expressed in percentage very closely by the formula

$$E = + \left(\frac{l^2 \cos \varphi}{8.1} \right)^2$$

in which l° = distance of point from central meridian expressed in degrees of longitude, and φ = latitude.

EXAMPLE.—For latitude 39° the error for $10^\circ 25' 22''$ (560 statute miles) departure in longitude is 1 per cent for scale along the meridian and the same amount for area.

The angular distortion is a variable quantity not easily expressed by an equation. In latitude 30° this distortion is $1^\circ 27'$ on the meridian 15° distant from the central meridian; at 30° distant it increases to $5^\circ 36'$.

The greatest angular distortion in this projection is at the Equator, decreasing to zero as we approach the pole. The distortion of azimuth is one-half of the above amounts.

Second. Equal scale⁹ over the whole extent (the error in scale not exceeding 1 per cent for distances within 560 statute miles of the great circle used as its central meridian).

Third. Facilities for using great circles and azimuths within distances just mentioned.

Fourth. Proportionality of areas⁹ with those on the sphere, etc.

The polyconic projection is by construction not conformal, neither do the parallels and meridians intersect at right angles, as is the case with all conical or single-cone projections, whether these latter are conformal or not.

It is sufficiently close to other types possessing in some respects better properties that its great tabular advantages should generally determine its choice within certain limits.

As stated in Hinks' Map Projections, it is a link between those projections which have some definite scientific value and those generally called conventional, but possess properties of convenience and use.

The three projections, polyconic, Bonne, and Lambert zenithal, may be considered as practically identical within areas not distant more than 3° from a common central point, the errors from construction and distortion of the paper exceeding those due to the system of projection used.

The general theory of polyconic projections is given in Special Publication No. 57, U. S. Coast and Geodetic Survey.

CONSTRUCTION OF A POLYCONIC PROJECTION.

Having the area to be covered by a projection, determine the scale and the interval of the projection lines which will be most suitable for the work in hand.

SMALL-SCALE PROJECTIONS (1-500 000 AND SMALLER).

Draw a straight line for a central meridian and a construction line (*a b* in the figure) perpendicular thereto, each to be as central to the sheet as the selected interval of latitude and longitude will permit.

On this central meridian and from its intersection with the construction line lay off the extreme intervals of latitude, north and south (*mm₂* and *mm₄*) and subdivide the intervals for each parallel (*m₁* and *m₃*) to be represented, all distances¹⁰ being taken from the table (p. 7, Spec. Pub. No. 5, "Lengths of degrees of the meridian").

Through each of the points (*m₁*, *m₂*, *m₃*, *m₄*) on the central meridian draw additional construction lines (*cd*, *ef*, *gh*, *if*) perpendicular to the central meridian, and mark off the ordinates (*x*, *x₁*, *x₂*, *x₃*, *x₄*, *x₅*) from the central meridian corresponding to the values¹⁰ of "X" taken from the table under "Coordinates of curvature" (pp. 11 to 189 Spec. Pub. No. 5), for every meridian to be represented.

At the points (*x*, *x₁*, *x₂*, *x₃*, *x₄*, *x₅*) lay off from each of the construction lines the corresponding values¹⁰ of "Y"¹¹ from the table under "Coordinates of curvature"

⁹ Footnote on preceding page.

¹⁰ The lengths of the arcs of the meridians and parallels change when the latitude changes and all distances must be taken from the table opposite the latitude of the point in use.

¹¹ Approximate method of deriving the values of *y* intermediate between those shown in the table.

The ratio of any two successive ordinates of curvature equals the ratio of the squares of the corresponding arcs.

Examples.—Latitude 60° to 61°. Given the value of *y* for longitude 50', 292.^m8 (see table), to obtain the value of *y* for longitude 55'.

$$\frac{(55')^2}{(60')^2} = \frac{y}{292.8}; \text{ hence } y = 354.^m3 \text{ (see table).}$$

Similarly, *y* for 3° = 3795^m.

$$\frac{4^2}{3^2} = \frac{y}{3795}; \text{ hence } y \text{ for } 4^\circ = 6747.^m$$

which differs 2^m from the tabular value, a negligible quantity for the intermediate values of *y* under most conditions.

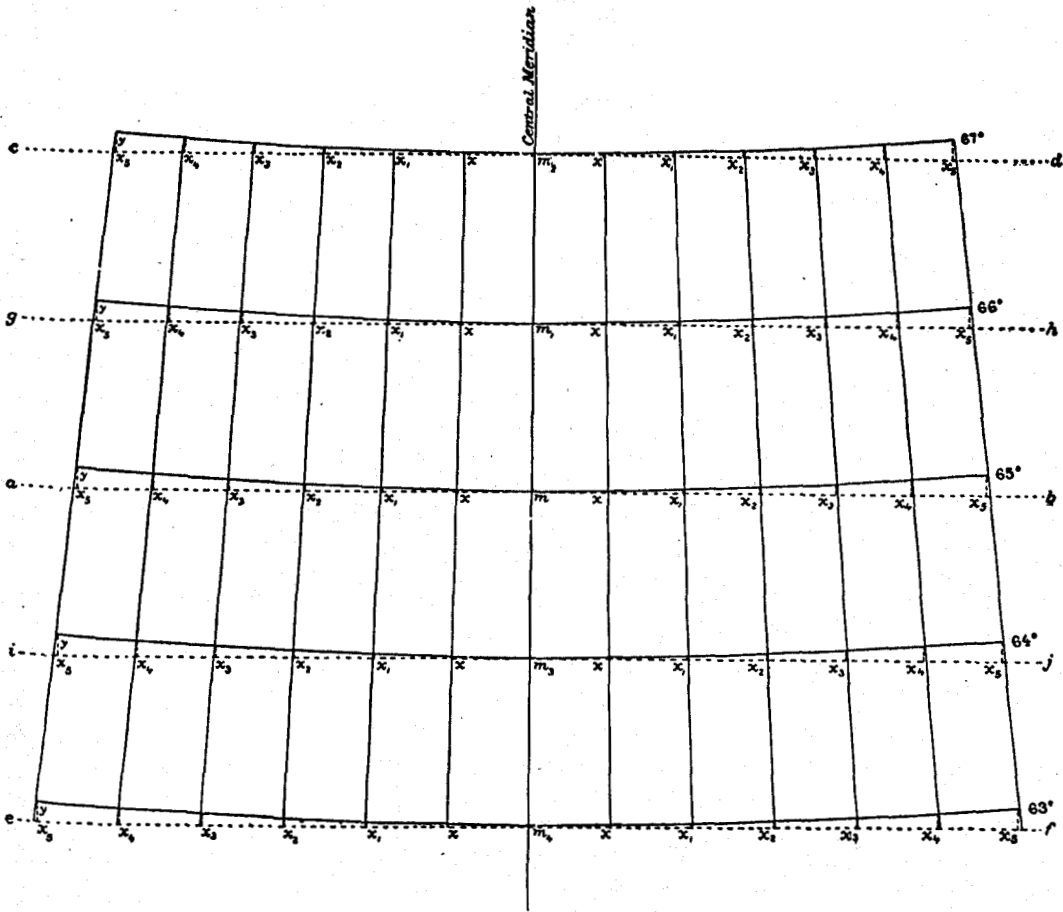

Fig. 49.—Polyconic projection—construction plate.

(pp. 11 to 189, Spec. Pub. No. 5), in a direction parallel to the central meridian, above the construction lines if north of the Equator, to determine points on the meridians and parallels.

Draw curved lines through the points thus determined for the meridians and parallels of the projection.

LARGE-SCALE PROJECTIONS (1-10 000 AND LARGER).

The above method can be much simplified in constructing a projection on a large scale. Draw the central meridian and the construction line *ab*, as directed above. On the central meridian lay off the distances¹² *mm*₂ and *mm*₄ taken from the table under "Continuous sums of minutes" for the intervals in minutes between the middle parallel and the extreme parallels to be represented, and through the points *m*₂ and *m*₄ draw straight lines *cd* and *ef* parallel to the line *ab*. On the lines *ab*, *cd*, and *ef* lay off the distances¹² *m*₂*x*₂, *m*₂*x*₃, and *m*₄*x*₅ on both sides of the central meridian, taking the values from the table under "Arcs of the parallel in meters" corresponding to the latitude of the points *m*, *m*₂, and *m*₄, respectively. Draw straight lines through the points thus determined, *x*_s, for the extreme meridians.

¹² The lengths of the arcs of the meridians and parallels change when the latitude changes and all distances must be taken from the table opposite the latitude of the point in use.

At the points x_6 on the line ab lay off the value¹³ of y corresponding to the interval in minutes between the central and the extreme meridians, as given in the table under "Coordinates of curvature," in a direction parallel with the central meridian and above the line, if north of the Equator, to determine points in the central parallel. Draw straight lines from these points to the point m for the middle parallel, and from the points of intersection with the extreme meridians lay off distances¹³ on the extreme meridians, above and below, equal to the distances mm_2 and mm_4 to locate points in the extreme parallels.

Subdivide the three meridians and three parallels into parts corresponding to the projection interval and join the corresponding points of subdivision by straight lines to complete the projection.

To construct a projection on an intermediate scale, follow the method given for small-scale projections to the extent required to give the desired accuracy.

Coordinates for the projection of maps on various scales with the inch as unit, are published by the U. S. Geological Survey in Bulletin 650, Geographic Tables and Formulas, pages 34 to 107.

TRANSVERSE POLYCONIC PROJECTION.

(See Plate II.)

If the map should have a predominating east-and-west dimension, the polyconic properties may still be retained, by applying the developing cones in a transverse position. A great circle at right angles to a central meridian at the middle part of the map can be made to play the part of the central meridian, the poles being transferred (in construction only) to the Equator. By transformation of coordinates a projection may be completed which will give all polyconic properties in a transverse relation. This process is, however, laborious and has seldom been resorted to.

Since the distance across the United States from north to south is less than three-fifths of that from east to west, it follows, then, by the above manipulation that the maximum distortion can be reduced from 7 to $2\frac{1}{2}$ per cent.

A projection of this type (plate II) is peculiarly suited to a map covering an important section of the North Pacific Ocean. If a great circle¹⁴ passing through San Francisco and Manila is treated in construction as a central meridian in the ordinary polyconic projection, we can cross the Pacific in a narrow belt so as to include the American and Asiatic coasts with a very small scale distortion. By transformation of coordinates the meridians and parallels can be constructed so that the projection will present the usual appearance and may be utilized for ordinary purposes.

The configuration of the two continents is such that all the prominent features of America and eastern Asia are conveniently close to this selected axis, viz, Panama, Brito, San Francisco, Straits of Fuca, Unalaska, Kiska, Yokohama, Manila, Hongkong, and Singapore. It is a typical case of a projection being adapted to the configuration of the locality treated. A map on a transverse polyconic projection as here suggested, while of no special navigational value, is of interest from a geographic standpoint as exhibiting in their true relations a group of important localities covering a wide expanse.

For method of constructing this modified form of polyconic projection, see *Coast and Geodetic Survey*, Special Publication No. 57, pages 167 to 171.

POLYCONIC PROJECTION WITH TWO STANDARD MERIDIANS, AS USED FOR THE INTERNATIONAL MAP OF THE WORLD, ON THE SCALE 1:1 000 000.

The projection adopted for this map is a modified polyconic projection devised by Lallemand, and for this purpose has advantages over the ordinary polyconic projection in that the meridians are straight lines and meridional errors are lessened and distributed somewhat the same (except in an opposite direction) as in a conic

¹³ The lengths of the arcs of the meridians and parallels change when the latitude changes and *all distances* must be taken from the table opposite the latitude of the point in use.

¹⁴ A great circle tangent to parallel 45° north latitude at 160° west longitude was chosen as the axis of the projection in this plate.

projection with two standard parallels; in other words, it provides for a distribution of scale error by having two standard meridians instead of the one central meridian of the ordinary polyconic projection.

The scale is slightly reduced along the central meridian, thus bringing the parallels closer together in such a way that the meridians 2° on each side of the center are made true to scale. Up to 60° of latitude the separate sheets are to include 6° of longitude and 4° of latitude. From latitude 60° to the pole the sheets are to include 12° of longitude; that is, two sheets are to be united into one. The top and bottom parallel of each sheet are constructed in the usual way; that is, they are circles constructed from centers lying on the central meridian, but not concentric. These two parallels are then truly divided. The meridians are straight lines joining the corresponding points of the top and bottom parallels. Any sheet will then join exactly along its margins with its four neighboring sheets. The correction to the length of the central meridian is very slight, amounting to only 0.01 inch at the most, and the change is almost too slight to be measured on the map.

In the resolutions of the International Map Committee, London, 1909, it is not stated how the meridians are to be divided; but, no doubt, an equal division of the central meridian was intended. Through these points, circles could be constructed with centers on the central meridian and with radii equal to $\rho_n \cot \varphi$, in which ρ_n is the radius of curvature perpendicular to the meridian. In practice, however, an equal division of the straight-line meridians between the top and bottom parallels could scarcely be distinguished from the points of parallels actually constructed by means of radii or by coordinates of their intersections with the meridians. The provisions also fail to state whether, in the sheets covering 12° of longitude instead of 6° , the meridians of true length shall be 4° instead of 2° on each side of the central meridian; but such was, no doubt, the intention. In any case, the sheets would not exactly join together along the parallel of 60° of latitude.

The appended tables give the corrected lengths of the central meridian from 0° to 60° of latitude and the coordinates for the construction of the 4° parallels within the same limits. Each parallel has its own origin; i. e., where the parallel in question intersects the central meridian. The central meridian is the Y axis and a perpendicular to it at the origin is the X axis; the first table, of course, gives the distance between the origins. The y values are small in every instance. In terms of the parameters these values are given by the expressions

$$x = \rho_n \cot \varphi \sin (\lambda \sin \varphi)$$

$$y = \rho_n \cot \varphi [1 - \cos (\lambda \sin \varphi)] = 2\rho_n \cot \varphi \sin^2 \left(\frac{\lambda \sin \varphi}{2} \right).$$

The tables as given below are all that are required for the construction of all maps up to 60° of latitude. This fact in itself shows very clearly the advantages of the use of this projection for the purpose in hand.

A discussion of the numerical properties of this map system is given by Lallemand in the *Comptes Rendus*, 1911, tome 153, page 559.

TABLES FOR THE PROJECTION OF THE SHEETS OF THE INTERNATIONAL MAP OF THE WORLD.

[Scale: 1:1 000 000. Assumed figure of the earth: $a=6378.24$ km.; $b=6356.56$ km.]

TABLE 1.—Corrected lengths on the central meridian, in millimeters.

Latitude	Natural length	Correc-tion	Corrected length
From 0 to 4	442.27	-0.27	442.00
4 to 8	442.31	.26	442.05
8 to 12	442.40	.26	442.14
12 to 16	442.53	.26	442.27
16 to 20	442.69	.24	442.45
20 to 24	442.90	.24	442.66
24 to 28	443.13	.22	442.91
28 to 32	443.39	.20	443.19
32 to 36	443.68	.19	443.49
36 to 40	443.98	.17	443.81
40 to 44	444.29	.15	444.14
44 to 48	444.60	.13	444.47
48 to 52	444.92	.11	444.81
52 to 56	445.22	.09	445.13
56 to 60	445.52	-0.08	445.44

TABLE 2.—Coordinates of the intersections of the parallels and the meridians, in millimeters.

Latitude	Coordi-nates	Longitude from central meridian		
		1°	2°	3°
0	<i>x</i>	111.32	222.64	333.96
	<i>y</i>	0.00	0.00	0.00
4	<i>x</i>	111.05	222.10	333.16
	<i>y</i>	0.07	0.27	0.61
8	<i>x</i>	110.24	220.49	330.73
	<i>y</i>	0.13	0.54	1.21
12	<i>x</i>	108.90	217.81	326.71
	<i>y</i>	0.20	0.79	1.78
16	<i>x</i>	107.04	214.07	321.10
	<i>y</i>	0.28	1.08	2.32
20	<i>x</i>	104.65	209.29	313.93
	<i>y</i>	0.31	1.25	2.81
24	<i>x</i>	101.75	203.50	305.24
	<i>y</i>	0.36	1.45	3.25
28	<i>x</i>	98.36	196.72	295.06
	<i>y</i>	0.40	1.61	3.63
32	<i>x</i>	94.50	188.98	283.45
	<i>y</i>	0.44	1.75	3.93
36	<i>x</i>	90.16	180.32	270.46
	<i>y</i>	0.46	1.85	4.16
40	<i>x</i>	85.40	170.78	256.14
	<i>y</i>	0.48	1.92	4.31
44	<i>x</i>	80.21	160.40	240.58
	<i>y</i>	0.49	1.95	4.38
48	<i>x</i>	74.63	149.24	223.83
	<i>y</i>	0.48	1.94	4.36
52	<i>x</i>	68.68	137.34	205.98
	<i>y</i>	0.47	1.89	4.25
56	<i>x</i>	62.39	124.77	187.13
	<i>y</i>	0.45	1.81	4.06
60	<i>x</i>	55.80	111.59	167.35
	<i>y</i>	0.42	1.69	3.80

In the debates on the international map, the ordinary polyconic projection was opposed on the ground that a number of sheets could not be fitted together on account of the curvature of both meridians and parallels. This is true from the nature of things, since it is impossible to make a map of the world in a series of flat sheets which shall fit together and at the same time be impartially representative of all meridians and parallels. Every sheet edge in the international map has an exact fit with the corresponding edges of its four adjacent sheets. (See fig. 50.)

The corner sheets to complete a block of nine will not make a perfect fit along their two adjacent edges simultaneously; they will fit one or the other, but the

angles of the corners are not exactly the same as the angles in which they are required to fit; and there will be in theory a slight wedge-shaped gap unfilled, as shown in the figure. It is, however, easy to calculate that the discontinuity at the points *a* or *b* in a block of nine sheets, will be no more than a tenth of an inch if the paper

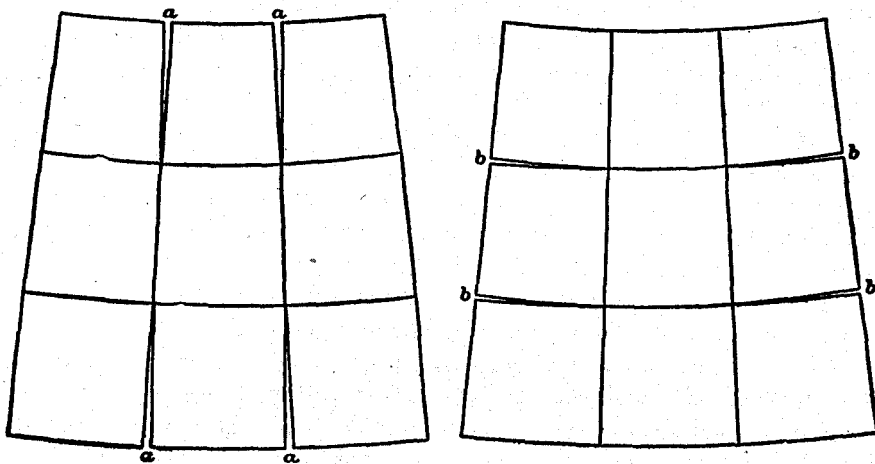

FIG. 50.—International map of the world—junction of sheets.

preserves its shape absolutely unaltered. What it will be in practice depends entirely on the paper, and a map moulder will have no difficulty in squeezing his sheets to make the junction practically perfect. If more than nine sheets are put together, the error will, of course, increase somewhat rapidly; but at the same time the sheets will become so inconveniently large that the experiment is not likely to be made very often. If the difficulty does occur, it must be considered an instructive example at once of the proposition that a spheroidal surface can not be developed on a plane without deformation, and of the more satisfying proposition that this modified projection gives a remarkably successful approximation to an unattainable ideal.

Concerning the modified polyconic projection for the international map, Dr. Frischauf has little to say that might be considered as favorable, partly on account of errors that appeared in the first publication of the coordinates.

The claim that the projection is not mathematically quite free from criticism and does not meet the strictest demands in the matching of sheets has some basis. The system is to some extent conventional and does not set out with any of the better scientific properties of map projections, but, within the limits of the separate sheets or of several sheets joined together, should meet all ordinary demands.

The contention that the Albers projection is better suited to the same purpose raises the problem of special scientific properties of the latter with its limitations to separate countries or countries of narrow latitudinal extent, as compared with the modified polyconic projection, which has no scientific interest, but rather a value of expediency.

In the modified polyconic projection the separate sheets are sufficiently good and can be joined any one to its four neighbors, and fairly well in groups of nine throughout the world; in the Albers projection a greater number of sheets may be joined exactly if the latitudinal limits are not too great to necessitate new series to

the north or south, as in the case of continents. The latter projection is further discussed in another chapter.

The modified polyconic projection loses the advantages of the ordinary polyconic in that the latter has the property of indefinite extension north or south, while its gain longitudinally is offset by loss of scale on the middle parallels. The system does not, therefore, permit of much extension in other maps than those for which it was designed, and a few of the observations of Prof. Rosén, of Sweden, on the limitations¹⁵ of this projection are of interest:

The junction of four sheets around a common point is more important than junctions in Greek-cross arrangement, as provided for in this system.

The system does not allow a simple calculation of the degree scale, projection errors, or angular differences, the various errors of this projection being both lengthy to compute and remarkably irregular.

The length differences are unequal in similar directions from the same point, and the calculation of surface differences is specially complicated.

For simplicity in mathematical respects, Prof. Rosén favors a conformal conic projection along central parallels. By the latter system the sheets can be joined along a common meridian without a seam, but with a slight encroachment along the parallels when a northern sheet is joined to its southern neighbor. The conformal projection angles, however, being right angles, the sheets will join fully around a corner. Such a system would also serve as a better pattern in permitting wider employment in other maps.

On the other hand, the modified polyconic projection is sufficiently close, and its adaptability to small groups of sheets in any part of the world is its chief advantage. The maximum meridional error in an equatorial sheet, according to Lallemand¹⁶ is only $\frac{1}{3000}$, or about one-third of a millimeter in the height of a sheet; and in the direction of the parallels $\frac{1}{5000}$, or one-fifth of a millimeter, in the width of a sheet. The error in azimuth does not exceed six minutes. Within the limits of one or several sheets these errors are negligible and inferior to those arising from drawing, printing, and hygrometric conditions.

¹⁵ See *Atti del X Congresso Internazionale di Geografia, Roma, 1913*, pp. 37-42.

¹⁶ *Ibid.*, p. 681.

THE BONNE PROJECTION.

DESCRIPTION.

[See fig. 51.]

In this projection a central meridian and a standard parallel are assumed with a cone tangent along the standard parallel. The central meridian is developed along that element of the cone which is tangent to it and the cone developed on a plane.

BONNE PROJECTION OF HEMISPHERE

Development of cone tangent along parallel 45° N.

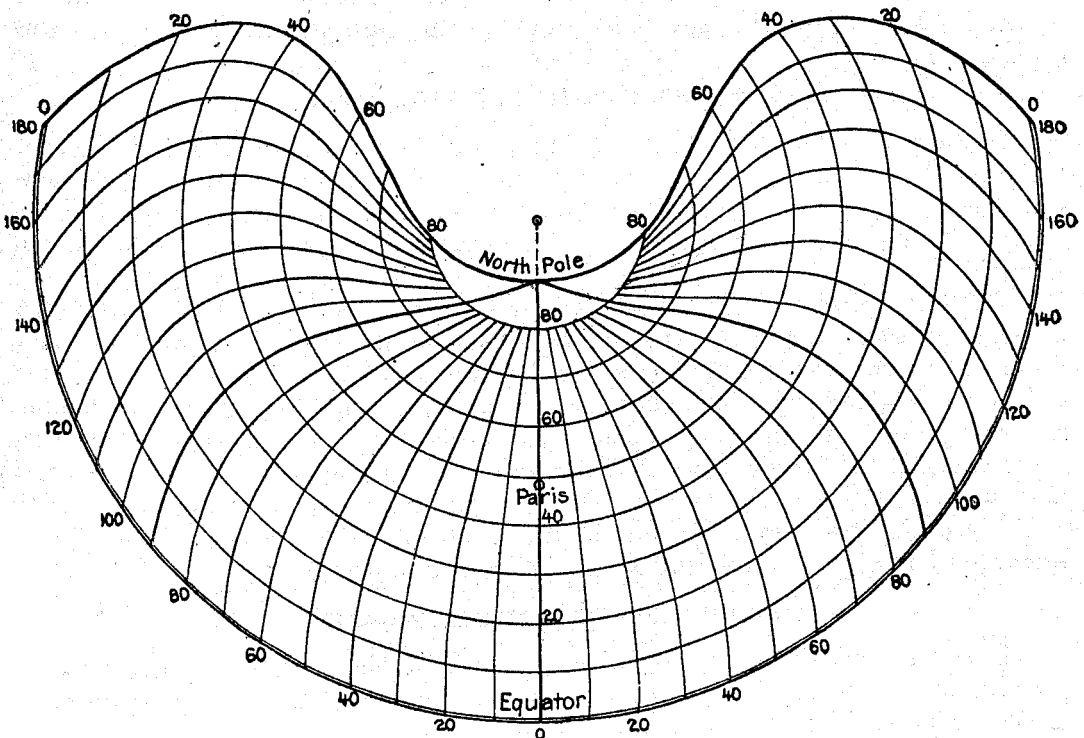

FIG. 51.

The standard parallel falls into an arc of a circle with its center at the apex of the developing cone, and the central meridian becomes a right line which is divided to true scale. The parallels are drawn as concentric circles at their true distances apart, and all parallels are divided truly and drawn to scale.

Through the points of division of the parallels the meridians are drawn. The central meridian is a straight line; all others are curves, the curvature increasing with the difference in longitude.

The scale along all meridians, excepting the central, is too great, increasing with the distance from the center, and the meridians become more inclined to the parallels,

thereby increasing the distortion. The developed areas preserve a strict equality, in which respect this projection is preferable to the polyconic.

USES.—The Bonne¹⁷ system of projection, still used to some extent in France, will be discontinued there and superseded by the Lambert system in military mapping.

It is also used in Belgium, Netherlands, Switzerland, and the ordnance surveys of Scotland and Ireland. In Stieler's Atlas we find a number of maps with this projection; less extensively so, perhaps, in Stanford's Atlas. This projection is strictly equal-area, and this has given it its popularity.

In maps of France having the Bonne projection, the center of projection is found at the intersection of the meridian of Paris and the parallel of latitude 50° ($=45^{\circ}$). The border divisions and subdivisions appear in grades, minutes (centesimal), seconds, or tenths of seconds.

LIMITATIONS.—Its distortion, as the difference in longitude increases, is its chief defect. On the map of France the distortion at the edges reaches a value of 18' for angles, and if extended into Alsace, or western Germany, it would have errors in distances which are inadmissible in calculations. In the rigorous tests of the military operations these errors became too serious for the purposes which the map was intended to serve.

THE SANSON-FLAMSTEED PROJECTION.

In the particular case of the Bonne projection, where the Equator is chosen for the standard parallel, the projection is generally known under the name of Sanson-Flamsteed, or as the sinusoidal equal-area projection. All the parallels become straight lines parallel to the Equator and preserve the same distances as on the spheroid.

The latter projection is employed in atlases to a considerable extent in the mapping of Africa and South America, on account of its property of equal area and the comparative ease of construction. In the mapping of Africa, however, on account of its considerable longitudinal extent, the Lambert zenithal projection is preferable in that it presents less angular distortion and has decidedly less scale error. Diercke's Atlas employs the Lambert zenithal projection in the mapping of North America, Europe, Asia, Africa, and Oceania. In an equal-area mapping of South America, a Bonne projection, with center on parallel of latitude 10° or 15° south, would give somewhat better results than the Sanson-Flamsteed projection.

CONSTRUCTION OF A BONNE PROJECTION.

Due to the nature of the projection, no general tables can be computed, so that for any locality special computations become necessary. The following method involves no difficult mathematical calculations:

Draw a straight line to represent the central meridian and erect a perpendicular to it at the center of the sheet. With the central meridian as *Y* axis, and this perpendicular as *X* axis, plot the points of the middle or standard parallel. The coordinates for this parallel can be taken from the polyconic tables, Special Publication No. 5. A smooth curve drawn through these plotted points will establish the standard parallel.

The radius of the circle representing the parallel can be determined as follows: The coordinates in the polyconic table are given for 30° from the central meridian.

¹⁷ Tables for this projection for the map of France were computed by Plessis.

With the x and y for 30° , we get

$$\tan \frac{\theta}{2} = \frac{y}{x}; \text{ and } r_1 = \frac{x}{\sin \theta}$$

(θ being the angle at the center subtended by the arc that represents 30° of longitude). By using the largest values of x and y given in the table, the value of r_1 is better determined than it would be by using any other coordinates.

This value of r_1 can be derived rigidly in the following manner:

$$r_1 = N \cot \phi$$

(N being the length of the normal to its intersection with the Y axis); but

$$N = \frac{1}{A' \sin 1''}$$

(A' being the factor tabulated in Special Publication No. 8, U. S. Coast and Geodetic Survey). Hence,

$$r_1 = \frac{\cot \phi}{A' \sin 1''}$$

From the radius of this central parallel the radii for the other parallels can now be calculated by the addition or subtraction of the proper values taken from the table of "Lengths of degrees," U. S. Coast and Geodetic Survey Special Publication No. 5, page 7, as these values give the spacings of the parallels along the central meridian.

Let r represent the radius of a parallel determined from r_1 by the addition or subtraction of the proper value as stated above. If θ denotes the angle between the central meridian and the radius to any longitude out from the central meridian, and if P represents the arc of the parallel for 1° (see p. 6, Spec. Pub. No. 5), we obtain

$$\theta \text{ in seconds for } 1^\circ \text{ of longitude} = \frac{P}{r \sin 1''};$$

$$\text{chord for } 1^\circ \text{ of longitude} = 2r \sin \frac{\theta}{2}.$$

Arcs for any longitude out from the central meridian can be laid off by repeating this arc for 1° .

θ can be determined more accurately in the following way by the use of Special Publication No. 8:

$\lambda'' =$ the longitude in seconds out from the central meridian; then

$$\theta \text{ in seconds} = \frac{\lambda'' \cos \phi}{r A' \sin 1''}.$$

This computation can be made for the greatest λ , and this θ can be divided proportional to the required λ .

If coordinates are desired, we get

$$x = r \sin \theta.$$

$$y = 2r \sin^2 \frac{\theta}{2}.$$

The X axis for the parallel will be perpendicular to the central meridian at the point where the parallel intersects it.

If the parallel has been drawn by the use of the beam compass, the chord for the λ farthest out can be computed from the formula

$$\text{chord} = 2r \sin \frac{\theta}{2}.$$

The arc thus determined can be subdivided for the other required intersections with the meridians.

The meridians can be drawn as smooth curves through the proper intersections with the parallels. In this way all of the elements of the projection may be determined with minimum labor of computation.

THE LAMBERT ZENITHAL (OR AZIMUTHAL) EQUAL-AREA PROJECTION.

DESCRIPTION.

[See Frontispiece.]

This is probably the most important of the azimuthal projections and was employed by Lambert in 1772. The important property being the preservation of azimuths from a central point, the term zenithal is not so clear in meaning, being obviously derived from the fact that in making a projection of the celestial sphere the zenith is the center of the map.

In this projection the zenith of the central point of the surface to be represented appears as pole in the center of the map; the azimuth of any point within the surface, as seen from the central point, is the same as that for the corresponding points of the map; and from the same central point, in all directions, equal great-circle distances to points on the earth are represented by equal linear distances on the map.

It has the additional property that areas on the projection are proportional to the corresponding areas on the sphere; that is, any portion of the map bears the same ratio to the region represented by it that any other portion does to its corresponding region, or the ratio of area of any part is equal to the ratio of area of the whole representation.

This type of projection is well suited to the mapping of areas of considerable extent in all directions; that is, areas of approximately circular or square outline. In the frontispiece, the base of which is a Lambert zenithal projection, the line of 2 per cent scale error is represented by the bounding circle and makes a very favorable showing for a distance of $22^{\circ} 44'$ of arc-measure from the center of the map. Lines of other given errors of scale would therefore be shown by concentric circles (or almucantars), each one representing a small circle of the sphere parallel to the horizon.

Scale error in this projection may be determined from the scale factor of the almucantar as represented by the expression $\frac{1}{\cos \frac{1}{2} \theta}$ in which θ = actual distance in arc measure on osculating sphere from center of map to any point.

Thus we have the following percentages of scale error:

Distance in arc from center of map	Scale error
<i>Degrees</i>	<i>Per cent</i>
5	0.1
10	0.4
20	1.2
30	3.5
40	6.4
50	10.3
60	15.5

In this projection azimuths from the center are true, as in all zenithal projections. The scale along the parallel circles (almucantars) is too large by the amounts indicated in the above table; the scale along their radii is too small in inverse proportion, for the projection is equal-area. The scale is increasingly erroneous as the distance from the center increases.

The Lambert zenithal projection is valuable for maps of considerable world areas, such as North America, Asia, and Africa, or the North Atlantic Ocean with its somewhat circular configuration. It has been employed by the Survey Department, Ministry of Finance, Egypt, for a wall map of Asia, as well as in atlases for the delineation of continents.

The projection has also been employed by the Coast and Geodetic Survey in an outline base map of the United States, scale 1 : 7 500 000. On account of the inclusion of the greater part of Mexico in this particular outline map, and on account of the extent of area covered and the general shape of the whole, the selection of this system of projection offered the best solution by reason of the advantages of equal-area representation combined with practically a minimum error of scale. Had the limits of the map been confined to the borders of the United States, the advantages of minimum area and scale errors would have been in favor of Albers projection, described in another chapter.

The maximum error of scale at the eastern and western limits of the United States is but $1\frac{1}{2}$ per cent (the polyconic projection has 7 per cent), while the maximum error in azimuths is $1^{\circ} 04'$.

Between a *Lambert Zenithal* projection and a *Lambert conformal conic projection*, which is also employed for base-map purposes by the Coast and Geodetic Survey, on a scale 1 : 5 000 000, the choice rests largely upon the property of *equal areas* represented by the zenithal, and *conformality* as represented by the conformal conic projection. The former property is of considerable value in the practical use of the map, while the latter property is one of mathematical refinement and symmetry, the projection having two parallels of latitude of true scale, with definite scale factors available, and the advantages of straight meridians as an additional element of prime importance.

For the purposes and general requirements of a base map of the United States, disregarding scale and direction errors which are conveniently small in both projections, either of the above publications of the U. S. Coast and Geodetic Survey offers advantages over other base maps heretofore in use. However, under the subject heading of Albers projection, there is discussed another system of map projection which has advantages deserving consideration in this connection and which bids fair to supplant either of the above. (See frontispiece and table on pp. 54, 55.)

Among the disadvantages of the Lambert zenithal projection should be mentioned the inconvenience of computing the coordinates and the plotting of the double system of complex curves (quartics) of the meridians and parallels; the intersection of these systems at oblique angles; and the consequent (though slight) inconvenience of plotting positions. The employment of degenerating conical projections, or rather their extension to large areas, leads to difficulties in their smooth construction and use. For this reason the Lambert zenithal projection has not been used so extensively, and other projections with greater scale and angular distortion are more frequently seen because they are more readily produced.

The center used in the frontispiece is latitude 40° and longitude 96° , corresponding closely to the geographic center¹⁸ of the United States, which has been determined by means of this projection to be approximately in latitude $39^{\circ} 50'$, and longitude $98^{\circ} 35'$. Directions from this central point to any other point being true, and the law of radial distortion in all azimuthal directions from the central point being the same, this type of projection is admirably suited for the determination of the geographic center of the United States.

¹⁸ "Geographic center of the United States" is here considered as a point analogous to the center of gravity of a spherical surface equally weighted (per unit area), and hence may be found by means similar to those employed to find the center of gravity.

The coordinates for the following tables of the Lambert zenithal projection¹⁹ were computed with the center on parallel of latitude 40°, on a sphere with radius equal to the geometric mean between the radius of curvature in the meridian and that perpendicular to the meridian at center. The logarithm of this mean radius in meters is 6.8044400.

THE LAMBERT EQUAL-AREA MERIDIONAL PROJECTION.

This projection is also known as the Lambert central equivalent projection upon the plane of a meridian. In this case we have the projection of the parallels and meridians of the terrestrial sphere upon the plane of any meridian; the center will be upon the Equator, and the given meridional plane will cut the Equator in two points distant each 90° from the center.

It is the Lambert zenithal projection already described, but with the center on the Equator. While in the first case the bounding circle is a horizon circle, in the meridional projection the bounding circle is a meridian.

Tables for the Lambert meridional projection are given on page 75 of this publication, and also, in connection with the requisite transformation tables, in Latitude Developments Connected with Geodesy and Cartography, U. S. Coast and Geodetic Survey Special Publication No. 67.

The useful property of equivalence of area, combined with very small error of scale, makes the Lambert zenithal projection admirably suited for extensive areas having approximately equal magnitudes in all directions.

TABLE FOR THE CONSTRUCTION OF THE LAMBERT ZENITHAL EQUAL-AREA PROJECTION WITH CENTER ON PARALLEL 40°.

Latitude	Longitude 0°		Longitude 5°		Longitude 10°		Longitude 15°		Longitude 20°		Longitude 25°	
	x	y	x	y	x	y	x	y	x	y	x	y
	<i>Meters</i>	<i>Meters</i>	<i>Meters</i>	<i>Meters</i>	<i>Meters</i>	<i>Meters</i>	<i>Meters</i>	<i>Meters</i>	<i>Meters</i>	<i>Meters</i>	<i>Meters</i>	<i>Meters</i>
90°	0	+5 387 885	0	+5 387 885	0	+5 387 885	0	+5 387 885	0	+5 387 885	0	+5 387 885
85°	0	+4 878 763	52 414	+4 880 599	104 453	+4 886 085	155 742	+4 895 196	205 914	+4 907 863	254 004	+4 924 009
80°	0	+4 360 354	102 679	+4 363 859	204 665	+4 374 361	305 266	+4 391 792	403 799	+4 416 058	499 587	+4 447 015
75°	0	+3 833 644	150 800	+3 838 672	300 777	+3 855 490	448 560	+3 878 743	593 609	+3 913 587	734 842	+3 958 086
70°	0	+3 299 637	196 770	+3 306 041	392 357	+3 325 225	585 579	+3 357 113	775 258	+3 401 565	960 222	+3 458 391
65°	0	+2 759 350	240 571	+2 766 994	479 775	+2 789 898	716 248	+2 827 981	948 624	+2 881 110	1 175 542	+2 949 088
60°	0	+2 213 809	282 175	+2 222 561	562 835	+2 248 789	840 467	+2 292 419	1 113 555	+2 358 321	1 380 581	+2 431 312
55°	0	+1 664 056	321 546	+1 673 787	641 463	+1 702 962	958 118	+1 751 509	1 269 876	+1 819 313	1 575 035	+1 906 212
50°	0	+1 111 133	358 645	+1 121 723	715 572	+1 153 474	1 069 062	+1 206 328	1 417 387	+1 280 187	1 758 808	+1 374 910
45°	0	+556 096	393 422	+567 424	785 065	+601 395	1 173 148	+657 961	1 555 870	+737 046	1 931 430	+838 536
40°	0	0	425 827	+1 951	849 835	+4 792	1 270 200	+1 07 490	1 685 088	+1 190 989	2 092 644	+2 298 207
35°	0	-556 096	455 800	-543 637	909 782	-506 266	1 360 044	-444 005	1 804 787	-356 887	2 242 115	-244 963
30°	0	-1 111 133	483 280	-1 098 277	964 722	-1 059 712	1 442 480	-995 443	1 914 696	-905 490	2 379 489	-789 868
25°	0	-1 664 056	508 200	-1 650 911	1 014 578	-1 611 480	1 617 303	-1 545 757	2 014 529	-1 453 735	2 504 389	-1 335 405
20°	0	-2 213 809	530 490	-2 200 485	1 059 186	-2 160 506	1 584 288	-2 093 872	2 103 978	-2 000 539	2 616 420	-1 880 485
15°	0	-2 759 350	550 072	-2 745 953	1 098 391	-2 705 752	1 643 198	-2 638 727	2 182 718	-2 544 835	2 715 156	-2 424 020
10°	0	-3 299 637	566 893	-3 286 269	1 132 024	-3 246 157	1 693 776	-3 179 267	2 250 398	-3 085 552	2 800 148	-2 964 935
5°	0	-3 833 644	580 775	-3 820 408	1 159 907	-3 780 690	1 735 750	-3 714 453	2 306 644	-3 621 639	2 870 912	-3 502 166
0°	0	-4 360 354	591 710	-4 347 349	1 181 844	-4 308 330	1 768 820	-4 243 252	2 351 051	-4 152 060	2 926 925	-4 034 658
-5°	0	-4 878 763	599 582	-4 866 090	1 197 621	-4 828 068	1 792 661	-4 704 647	2 383 170	-4 675 776	2 967 618	-4 561 366
-10°	0	-5 387 885										

¹⁹ A mathematical account of this projection is given in: Zöppritz, Prof. Dr. Karl, Leitfaden der Kartenentwurfslehre, Erster Theil, Leipzig, 1890, pp. 38-44.

**TABLE FOR THE CONSTRUCTION OF THE LAMBERT ZENITHAL EQUAL-AREA
MERIDIONAL PROJECTION—Continued.**

[Coordinates in units of the earth's radius.]

Latitude	Longitude 75°		Longitude 80°		Longitude 85°		Longitude 90°	
	<i>x</i>	<i>y</i>	<i>x</i>	<i>y</i>	<i>x</i>	<i>y</i>	<i>x</i>	<i>y</i>
0.....	1.217523	0.000000	1.285575	0.000000	1.351180	0.000000	1.414214	0.000000
5.....	1.213365	0.109901	1.281044	0.113806	1.346245	0.118231	1.408832	0.123257
10.....	1.200903	0.219222	1.267469	0.226937	1.331607	0.235695	1.392729	0.245576
15.....	1.180179	0.327383	1.244912	0.338721	1.306926	0.351527	1.366025	0.366025
20.....	1.151257	0.433805	1.213472	0.448481	1.272775	0.465022	1.328926	0.483690
25.....	1.114235	0.537905	1.173287	0.555553	1.229210	0.575380	1.281713	0.597872
30.....	1.069235	0.639100	1.124542	0.659270	1.176491	0.681843	1.224745	0.707107
35.....	1.016411	0.736805	1.067459	0.758974	1.114934	0.783687	1.158456	0.811160
40.....	0.955952	0.830435	1.002308	0.854010	1.044910	0.880132	1.083351	0.909039
45.....	0.888073	0.919401	0.929400	0.943738	0.966848	0.970541	1.000000	1.000000
50.....	0.813035	1.003117	0.849094	1.027521	0.881231	1.054223	0.909039	1.083351
55.....	0.731128	1.080994	0.761799	1.104745	0.788602	1.130542	0.811160	1.158456
60.....	0.642692	1.152445	0.667970	1.174806	0.689552	1.198901	0.707107	1.224745
65.....	0.548109	1.216887	0.568115	1.237122	0.584727	1.258741	0.597673	1.281713
70.....	0.447808	1.273745	0.462796	1.291138	0.474823	1.309551	0.483690	1.328926
75.....	0.342275	1.322449	0.352628	1.336326	0.360588	1.350874	0.366025	1.366025
80.....	0.232051	1.362449	0.238279	1.372193	0.242811	1.382308	0.245576	1.392729
85.....	0.117736	1.393206	0.120476	1.398291	0.122324	1.403512	0.123257	1.408832
90.....	0.000000	1.414214	0.000000	1.414214	0.000000	1.414214	0.000000	1.414214

THE LAMBERT CONFORMAL CONIC PROJECTION WITH TWO STANDARD PARALLELS.

DESCRIPTION.

[See Plate I.]

This projection, devised by Johann Heinrich Lambert, first came to notice in his *Beiträge zum Gebrauche der Mathematik und deren Anwendung*, volume 3, Berlin, 1772.

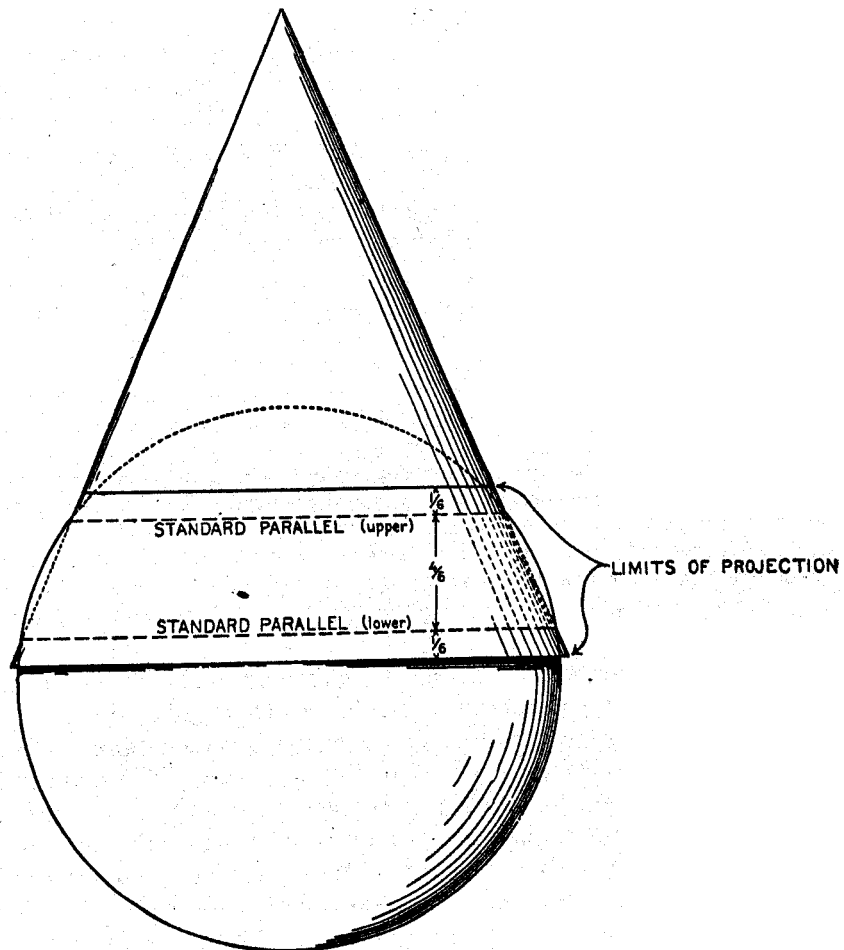

FIG. 52.—Lambert conformal conic projection.

Diagram illustrating the intersection of a cone and sphere along two standard parallels. The elements of the projection are calculated for the tangent cone and afterwards reduced in scale so as to produce the effect of a secant cone. The parallels that are true to scale do not exactly coincide with those of the earth, since they are spaced in such a way as to produce conformality.

Although used for a map of Russia, the basin of the Mediterranean, as well as for maps of Europe and Australia in Debes' Atlas, it was not until the beginning of the World War that its merits were fully appreciated.

The French armies, in order to meet the need of a system of mapping in which a combination of minimum angular and scale distortion might be obtained, adopted this system of projection for the battle maps which were used by the allied forces in their military operations.

HISTORICAL OUTLINE.

Lambert, Johann Heinrich (1728-1777), physicist, mathematician, and astronomer, was born at Mülhausen, Alsace. He was of humble origin, and it was entirely due to his own efforts that he obtained his education. In 1764, after some years in travel, he removed to Berlin, where he received many favors at the hand of Frederick the Great, and was elected a member of the Royal Academy of Sciences of Berlin, and in 1774 edited the Ephemeris.

He had the facility for applying mathematics to practical questions. The introduction of hyperbolic functions to trigonometry was due to him, and his discoveries in geometry are of great value, as well as his investigations in physics and astronomy. He was also the author of several remarkable theorems on conics, which bear his name.

We are indebted to A. Wangerin, in Ostwald's *Klassiker*, 1894, for the following tribute to Lambert's contribution to cartography:

The importance of Lambert's work consists mainly in the fact that he was the first to make general investigations upon the subject of map projection. His predecessors limited themselves to the investigations of a single method of projection, especially the perspective, but Lambert considered the problem of the representation of a sphere upon a plane from a higher standpoint and stated certain general conditions that the representation was to fulfill, the most important of these being the preservation of angles or conformality, and equal surface or equivalence. These two properties, of course, can not be attained in the same projection.

Although Lambert has not fully developed the theory of these two methods of representation, yet he was the first to express clearly the ideas regarding them. The former—conformality—has become of the greatest importance to pure mathematics as well as the natural sciences, but both of them are of great significance to the cartographer. It is no more than just, therefore, to date the beginning of a new epoch in the science of map projection from the appearance of Lambert's work. Not only is his work of importance for the generality of his ideas but he has also succeeded remarkably well in the results that he has attained.

The name Lambert occurs most frequently in this branch of geography, and, as stated by Craig, it is an unquestionable fact that he has done more for the advancement of the subject in the way of inventing ingenious and useful methods than all of those who have either preceded or followed him. The manner in which Lambert analyzes and solves his problems is very instructive. He has developed several methods of projection that are not only interesting, but are to-day in use among cartographers, the most important of these being the one discussed in this chapter.

Among the projections of unusual merit, devised by Lambert, in addition to the conformal conic, is his zenithal (or azimuthal) equivalent projection already described in this paper.

DEFINITION OF THE TERM "CONFORMALITY."

A conformal projection or development takes its name from the property that all small or elementary figures found or drawn upon the surface of the earth retain their original forms upon the projection.

This implies that—

All angles between intersecting lines or curves are preserved;

For any given point (or restricted locality) the ratio of the length of a linear element on the earth's surface to the length of the corresponding map element is constant for all azimuths or directions in which the element may be taken.

Arthur R. Hinks, M. A., in his treatise on "Map projections," defines *orthomorphic*, which is another term for *conformal*, as follows:

If at any point the scale along the meridian and the parallel is the same (not correct, but the same in the two directions) and the parallels and meridians of the map are at right angles to one another, then the shape of any very small area on the map is the same as the shape of the corresponding small area upon the earth. The projection is then called orthomorphic (right shape).

The Lambert Conformal Conic projection is of the simple conical type in which all meridians are straight lines that meet in a common point beyond the limits of the map, and the parallels are concentric circles whose center is at the point of intersection of the meridians. Meridians and parallels intersect at right angles and the angles formed by any two lines on the earth's surface are correctly represented on this projection.

It employs a cone intersecting the spheroid at two parallels known as the standard parallels for the area to be represented. In general, for equal distribution of scale error, the standard parallels are chosen at one-sixth and five-sixths of the total length of that portion of the central meridian to be represented. It may be advisable in some localities, or for special reasons, to bring them closer together in order to have greater accuracy in the center of the map at the expense of the upper and lower border areas.

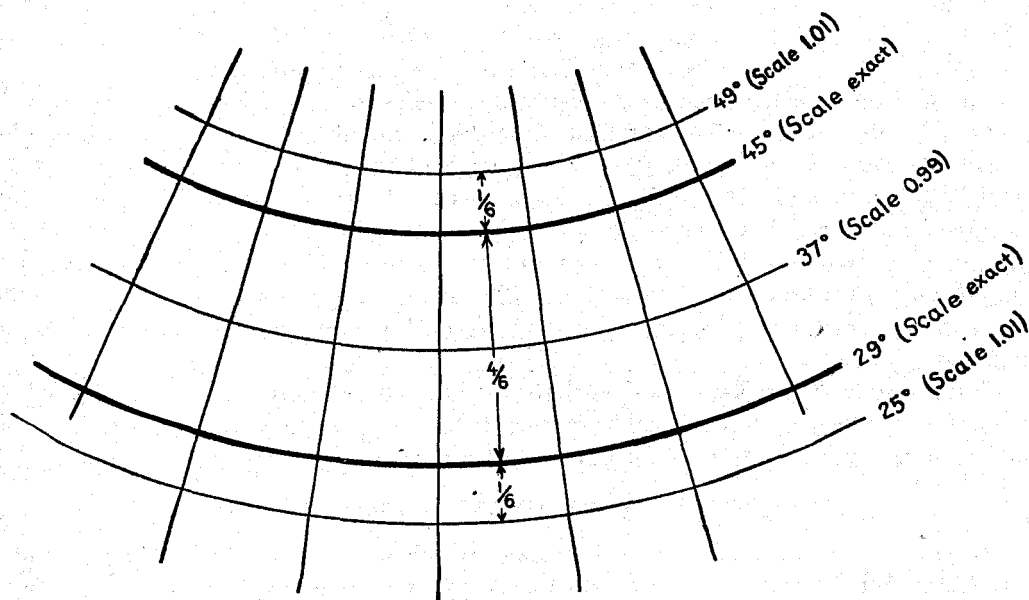

FIG. 53.—Scale distortion of the Lambert conformal conic projection with the standard parallels at 29° and 45°.

On the two selected parallels, arcs of longitude are represented in their true lengths, or to exact scale. Between these parallels the scale will be too small and beyond them too large. The projection is specially suited for maps having a predominating east-and-west dimension. For the construction of a map of the United States on this projection, see tables in U. S. Coast and Geodetic Survey Special Publication No. 52.

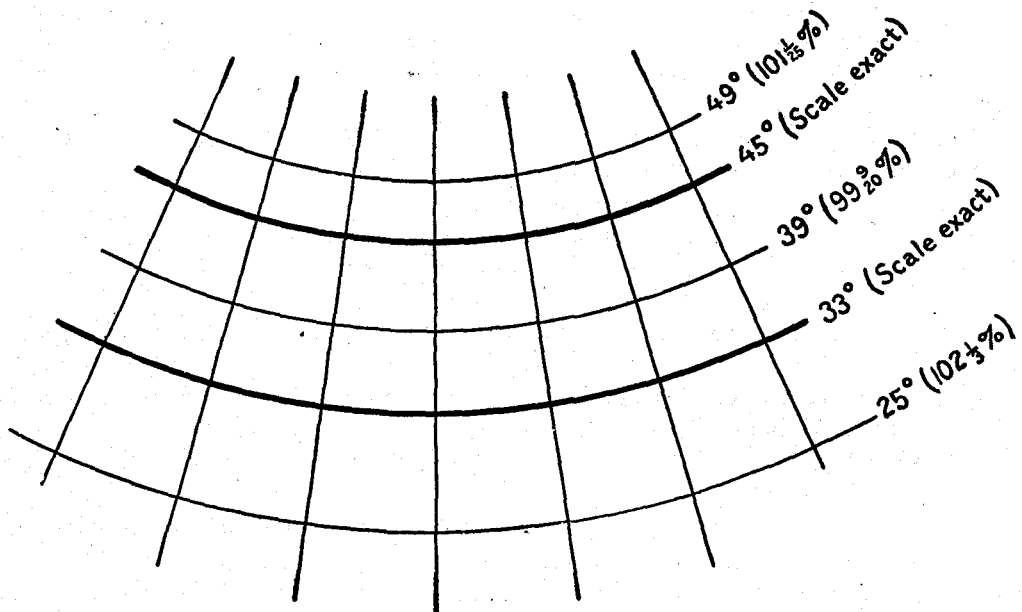

FIG. 54.—Scale distortion of the Lambert conformal conic projection with the standard parallels at 33° and 45°.

The chief advantage of this projection over the polyconic, as used by several Government bureaus for maps of the United States, consists in reducing the scale error from 7 per cent in the polyconic projection to $2\frac{1}{2}$ or $1\frac{1}{2}$ per cent in the Lambert projection, depending upon what parallels are chosen as standard.

The maximum scale error of $2\frac{1}{2}$ per cent, noted above, applies to a base map of the United States, scale 1:5 000 000, in which the parallels 33° and 45° north latitude (see fig. 54) were selected as standards in order that the scale error along the central parallel of latitude might be small. As a result of this choice of standards, the maximum scale error between latitudes $30\frac{1}{2}^\circ$ and $47\frac{1}{2}^\circ$ is but one-half of 1 per cent, thus allowing that extensive and most important part of the United States to be favored with unusual scaling properties. The maximum scale error of $2\frac{1}{2}$ per cent occurs in southernmost Florida. The scale error for southernmost Texas is somewhat less.

With standard parallels at 29° and 45° (see fig. 53), the maximum scale error for the United States does not exceed $1\frac{1}{2}$ per cent, but the accuracy at the northern and southern borders is acquired at the expense of accuracy in the center of the map.

GENERAL OBSERVATIONS ON THE LAMBERT PROJECTION.

In the construction of a map of France, which was extended to 7° of longitude from the middle meridian for purposes of comparison with the polyconic projection of the same area, the following results were noted:

Maximum scale error, Lambert = 0.05 per cent.

Maximum scale error, polyconic = 0.32 per cent.

Azimuthal and right line tests for orthodrome (great circle) also indicated a preference for the Lambert projection in these two vital properties, these tests indicating accuracies for the Lambert projection well within the errors of map construction and paper distortion.

In respect to areas, in a map of the United States, it should be noted that while in the polyconic projection they are misrepresented along the western margin in one

dimension (that is, by meridional distortion of 7 per cent), on the Lambert projection²⁰ they are distorted along both the parallel and meridian as we depart from the standard parallels, with a resulting maximum error of 5 per cent.

In the Lambert projection for the map of France, employed by the allied forces in their military operations, the maximum scale errors do not exceed 1 part in 2000 and are practically negligible, while the angles measured on the map are practically equal to those on the earth. It should be remembered, however, that in the Lambert conformal conic, as well as in all other conic projections, the scale errors vary increasingly with the range of latitude north or south of the standard parallels. It follows, then, that this type of projections is not suited for maps having extensive latitudes.

AREAS.—For areas, as stated before, the Lambert projection is somewhat better than the polyconic for maps like the one of France or for the United States, where we have wide longitude and comparatively narrow latitude. On the other hand, areas are not represented as well in the Lambert projection or in the polyconic projection as they are in the Bonne or in other conical projections.

For the purpose of equivalent areas of large extent the Lambert zenithal (or azimuthal) equal-area projection offers advantages desirable for census or statistical purposes superior to other projections, excepting in areas of wide longitudes combined with narrow latitudes, where the Albers conical equal-area projection with two standard parallels is preferable.

In measuring areas on a map by the use of a planimeter, the distortion of the paper, due to the method of printing and to changes in the humidity of the air, must also be taken into consideration. It is better to disregard the scale of the map and to use the quadrilaterals formed by the latitude and longitude lines as units. The areas of quadrilaterals of the earth's surface are given for different extents of latitude and longitude in the Smithsonian Geographical Tables, 1897, Tables 25 to 29.

It follows, therefore, that for the various purposes a map may be put to, if the property of areas is slightly sacrificed and the several other properties more desirable are retained, we can still by judicious use of the planimeter or Geographical Tables overcome this one weaker property.

The idea seems to prevail among many that, while in the polyconic projection every parallel of latitude is developed upon its own cone, the multiplicity of cones so employed necessarily adds strength to the projection; but this is not true. The ordinary polyconic projection has, in fact, only one line of strength; that is, the central meridian. In this respect, then, it is no better than the Bonne.

The Lambert projection, on the other hand, employs two lines of strength which are parallels of latitude suitably selected for the region to be mapped.

A line of strength is here used to denote a singular line characterized by the fact that the elements along it are truly represented in shape and scale.

COMPENSATION OF SCALE ERROR.

In the Lambert conformal conic projection we may supply a border scale for each parallel of latitude (see figs. 53 and 54), and in this way the scale variations may be accounted for when extreme accuracy becomes necessary.

²⁰ In the Lambert projection, every point has a scale factor characteristic of that point, so that the area of any restricted locality is represented by the expression

$$\text{Area} = \frac{\text{measured area on map}}{(\text{scale factor})^2}$$

Without a knowledge of scale errors in projections that are not equivalent, erroneous results in areas are often obtained. In the table on p. 55, "Maximum error of area," only the Lambert zenithal and the Albers projections are equivalent, the polyconic and Lambert conformal being projections that have errors in area.

With a knowledge of the scale factor for every parallel of latitude on a map of the United States, any sectional sheet that is a true part of the whole may have its own graphic scale applied to it. In that case the small scale error existing in the map as a whole becomes practically negligible in its sectional parts, and, although these parts have graphic scales that are slightly variant, they fit one another exactly. The system is thus truly progressive in its layout, and with its straight meridians and properties of conformality gives a precision that is unique and, within sections of 2° to 4° in extent, answers every requirement for knowledge of orientation and distances.

Caution should be exercised, however, in the use of the Lambert projection, or any conic projection, in large areas of wide latitudes, the system of projection not being suited to this purpose.

The extent to which the projection may be carried in longitude²¹ is not limited, a property belonging to this general class of single-cone projections, but not found in the polyconic, where adjacent sheets have a "rolling fit" because the meridians are curved in opposite directions.

The question of choice between the Lambert and the polyconic system of projection resolves itself largely into a study of the shapes of the areas involved. The merits and defects of the Lambert and the polyconic projections may briefly be stated as being, in a general way, in opposite directions.

The Lambert conformal conic projection has unquestionably superior merits for maps of extended longitudes when the property of conformality outweighs the property of equivalence of areas. All elements retain their true forms and meridians and parallels cut at right angles, the projection belonging to the same general formula as the Mercator and stereographic, which have stood the test of time, both being likewise conformal projections.

It is an obvious advantage to the general accuracy of the scale of a map to have two standard parallels of true lengths; that is to say, two axes of strength instead of one. As an additional asset all meridians are straight lines, as they should be. Conformal projections, except in special cases, are generally of not much use in map making unless the meridians are straight lines, this property being an almost indispensable requirement where orientation becomes a prime element.

Furthermore, the projection is readily constructed, free of complex curves and deformations, and simple in use.

It would be a better projection than the Mercator in the higher latitudes when charts have extended longitudes, and when the latter (Mercator) becomes objectionable. It can not, however, displace the latter for general sailing purposes, nor can it displace the gnomonic (or central) projection in its application and use to navigation.

Thanks to the French, it has again, after a century and a quarter, been brought to prominent notice at the expense, perhaps, of other projections that are not conformal—projections that misrepresent forms when carried beyond certain limits.

²¹ A map (chart No. 3070, see Plate I) on the Lambert conformal conic projection of the North Atlantic Ocean, including the eastern part of the United States and the greater part of Europe, has been prepared by the Coast and Geodetic Survey. The western limits are Duluth to New Orleans; the eastern limits, Bagdad to Cairo; extending from Greenland in the north to the West Indies in the south; scale 1:10 000 000. The selected standard parallels are 36° and 54° north latitude, both these parallels being, therefore, true scale. The scale on parallel 45° (middle parallel) is but $1\frac{1}{4}$ per cent too small; beyond the standard parallels the scale is increasingly large. This map, on certain other well-known projections covering the same area, would have distortions and scale errors so great as to render their use inadmissible. It is not intended for navigational purposes, but was constructed for the use of another department of the Government, and is designed to bring the two continents vis-à-vis in an approximately true relation and scale. The projection is based on the rigid formula of Lambert and covers a range of longitude of 165 degrees on the middle parallel. Plate I is a reduction of chart No. 3070 to approximate scale 1 : 25 500 000.

Unless these latter types possess other special advantages for a subject at hand, such as the polyconic projection which, besides its special properties, has certain tabular superiority and facilities for constructing field sheets, they will sooner or later fall into disuse.

On all recent French maps the name of the projection appears in the margin. This is excellent practice and should be followed at all times. As different projections have different distinctive properties, this feature is of no small value and may serve as a guide to an intelligible appreciation of the map.

In the accompanying plate (No. 1),²² North Atlantic Ocean on a Lambert conformal conic projection, a number of great circles are plotted in red in order that their departure from a straight line on this projection may be shown.

GREAT-CIRCLE COURSES.—A great-circle course from Cape Hatteras to the English Channel, which falls within the limits of the two standard parallels, indicates a departure of only 15.6 nautical miles from a straight line on the map, in a total distance of about 3,200 nautical miles. The departure of this line on a polyconic projection is given as 40 miles in Lieut. Pillsbury's Charts and Chart Making.

DISTANCES.—The computed distance from Pittsburgh to Constantinople is 5,277 statute miles. The distance between these points as measured by the graphic scale on the map without applying the scale factor is 5,258 statute miles, a resulting error of less than four-tenths of 1 per cent in this long distance. By applying the scale factor true results may be obtained, though it is hardly worth while to work for closer results when errors of printing and paper distortion frequently exceed the above percentage.

The parallels selected as standards for the map are 36° and 54° north latitude. The coordinates for the construction of a projection with these parallels as standards are given on page 85.

CONSTRUCTION OF A LAMBERT CONFORMAL CONIC PROJECTION

FOR A MAP OF THE UNITED STATES.

The mathematical development and the general theory of this projection are given in U. S. Coast and Geodetic Survey Special Publications Nos. 52 and 53. The method of construction is given on pages 20-21, and the necessary tables on pages 68 to 87 of the former publication.

Another simple method of construction is the following one, which involves the use of a long beam compass and is hardly applicable to scales larger than 1:2 500 000.

Draw a line for a central meridian sufficiently long to include the center of the curves of latitude and on this line lay off the spacings of the parallels, as taken from Table 1, Special Publication No. 52. With a beam compass set to the values of the radii, the parallels of latitude can be described from a common center.

(By computing chord distances for 25° of arc on the upper and lower parallels of latitude, the method of construction and subdivision of the meridians is the same as that described under the heading, *For small scale maps*, p. 84.)

However, instead of establishing the outer meridians by chord distances on the upper and lower parallels we can determine these meridians by the following simple process:

Assume 39° of latitude as the central parallel of the map (see fig. 55), with an upper and lower parallel located at 24° and 49° . To find on parallel 24° the

²² See footnote on p. 82.

intersection of the meridian 25° distant from the central meridian, lay off on the central meridian the value of the y coordinate (south from the thirty-ninth parallel 1 315 273 meters, as taken from the tables, page 69, second column, opposite 25°), and from this point strike an arc with the x value (2 581 184 meters, first column).

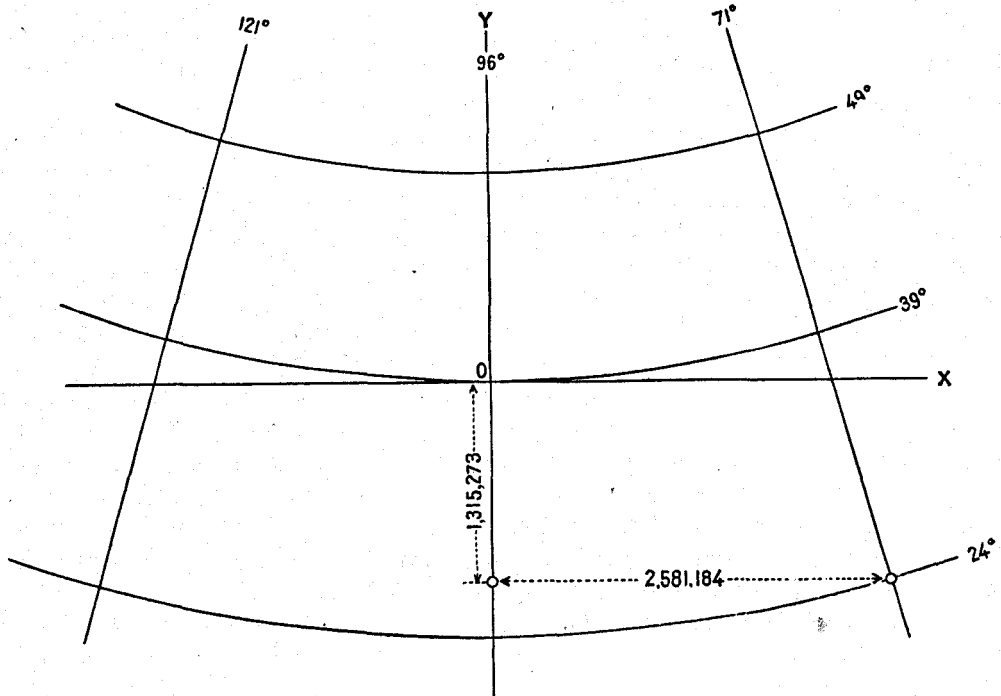

FIG. 55.—Diagram for constructing a Lambert projection of small scale.

The intersection with parallel 24° establishes the point of intersection of the parallel and outer meridian.

In the same manner establish the intersection of the upper parallel with the same outer meridian. The projection can then be completed by subdivision for intermediate meridians or by extension for additional ones.

The following values for radii and spacings in addition to those given in Table 1, Special Publication No. 52, may be of use for extension of the map north and south of the United States:

Latitude	Radius	Spacings from 39°
51	6 492 973	1 336 305
50	6 605 970	1 223 308
*	* * *	* * *
*	* * *	* * *
23	9 615 911	1 786 633
22	9 730 456	1 901 178

FOR SMALL SCALE MAPS.

In the construction of a map of the North Atlantic Ocean (see reduced copy on Plate I), scale 1:10 000 000, the process of construction is very simple.

Draw a line for a central meridian sufficiently long to include the center of the curves of latitude so that these curves may be drawn in with a beam compass set to the respective values of the radii as taken from the tables given on page 85.

To determine the meridians, a chord distance ($\text{chord} = 2r \sin \frac{\theta}{2}$) may be computed and described from and on each side of the central meridian on a lower parallel of latitude; preferably this chord should reach an outer meridian. The angle θ equals $l\lambda$, in which λ is the longitude out from the central meridian and r is the radius of the parallel in question. On parallel 30° , the chord of 65 degrees = 6 230 277 meters.

By means of a straightedge the points of intersection of the chords at the outer ends of a lower parallel can be connected with the same center as that used in describing the parallels of latitude. This, then, will determine the outer meridians of the map. The lower parallel can then be subdivided into as many equal spaces as the meridional interval of the map may require, and the meridians can then be drawn in as straight lines to the same center as the outer ones.

If a long straightedge is not available, the spacings of the meridians on the upper parallel can be obtained from chord distance and subdivision in a similar manner to that employed on the lower parallel. Lines drawn through corresponding points on the upper and lower parallels will then determine the meridians of the map.

This method of construction for small-scale maps is far more satisfactory than the one involving rectangular coordinates.

Another method for determining the meridians without the computation of chord distances has already been described.

TABLE FOR THE CONSTRUCTION OF A LAMBERT CONFORMAL CONIC PROJECTION WITH STANDARD PARALLELS AT 36° AND 54° .

[This table was used in the construction of U. S. Coast and Geodetic Survey Chart No. 3070, North Atlantic Ocean, scale 1:10 000 000. See Plate I for reduced copy.]

[$l=0.710105$; $\log l=0.8513225$; $\log K=7.0685567$.]

Latitude	Radii		Spacings of parallels	
	Meters	Meters	Meters	Meters
75	2 787 926.3	3 495 899.8	3 495 899.8	2 787 926.3
70	3 430 293.7	2 853 532.4	2 853 532.4	3 430 293.7
65	4 035 253.3	2 248 572.3	2 248 572.3	4 035 253.3
60	4 615 578.7	1 668 247.4	1 668 247.4	4 615 578.7
55	5 179 773.8	1 104 052.3	1 104 052.3	5 179 773.8
50	5 734 157.3	549 668.8	549 668.8	5 734 157.3
45	6 283 826.1	000 000.0	000 000.0	6 283 826.1
40	6 833 182.5	549 356.4	549 356.4	6 833 182.5
35	7 386 250.0	1 102 423.9	1 102 423.9	7 386 250.0
30	7 946 910.9	1 663 094.8	1 663 094.8	7 946 910.9
25	8 519 064.7	2 235 238.6	2 235 238.6	8 519 064.7
20	9 106 795.8	2 822 969.7	2 822 969.7	9 106 795.8
15	9 714 515.9	3 430 689.8	3 430 689.8	9 714 515.9

Longitude	Coordinates of parallel 60°		Coordinates of parallel 30°		Coordinates of parallel 40°	
	x	y	x	y	x	y
5	285 837	8 859	492 142	15 253		
10	570 576	35 403	982 394	60 955		
15	853 125	79 529	1 468 876	136 930		
20	1 132 400	141 069	1 949 718	242 887		
25	1 407 327	219 785	2 423 076	378 417		
30	1 676 851	315 377	2 887 132	543 002		
35	1 939 939	427 476	3 340 105	736 010		
40	2 195 579	555 652	3 780 256	950 699		
45	2 442 790	699 415	4 205 894	1 204 222		
50	2 680 625	858 210	4 615 387	1 477 630		
55	2 908 160	1 031 430	5 007 163	1 775 872		
60	3 124 549	1 218 408	5 379 716	2 097 804		
65	3 328 933	1 418 428	5 731 616	2 442 190		
70	3 520 539	1 630 721	6 061 515	2 807 708		
75	3 698 630	1 854 473	6 368 146	3 192 953		
80	3 862 522	2 088 825			5 718 312	3 092 422
85	4 011 588	2 332 875			5 938 997	3 453 729
90	4 145 251	2 585 689			6 136 881	3 828 010

SCALE ALONG THE PARALLELS.

Latitude—Degrees.	Scale factor.	Latitude—Degrees.	Scale factor.
20.....	1. 079	50.....	0. 991
30.....	1. 021	54.....	1. 000
36.....	1. 000	60.....	1. 022
40.....	0. 992	70.....	1. 113
45.....	0. 988		

(To correct distances measured with graphic scale, divide by scale factor.)

TABLE FOR THE CONSTRUCTION OF A LAMBERT CONFORMAL CONIC PROJECTION WITH STANDARD PARALLELS AT 10° AND 48° 40'.

[This table was used in the construction of a map of the Northern and Southern Hemispheres. See Plate VII.]

$[l = \frac{1}{2}; \log K = 7.1369624.]$

Latitude	Radius	Difference	Scale along the parallel	Latitude	Radius	Difference	Scale along the parallel
<i>Degrees</i>	<i>Meters</i>	<i>Meters</i>		<i>Degrees</i>	<i>Meters</i>	<i>Meters</i>	
0.....	13 707 631	118 306	1. 0746	40.....	9 380 896	106 629	0. 9586
1.....	13 589 325	117 319	1. 0655	41.....	9 274 267	107 031	0. 9619
2.....	13 472 006	116 378	1. 0567	42.....	9 167 236	107 473	0. 9656
3.....	13 355 628	115 479	1. 0484	43.....	9 059 763	107 961	0. 9696
4.....	13 240 149	114 623	1. 0404	44.....	8 951 802	108 491	0. 9740
5.....	13 125 526	113 807	1. 0328	45.....	8 843 311	109 059	0. 9787
6.....	13 011 719	113 026	1. 0256	46.....	8 734 252	109 683	0. 9839
7.....	12 898 693	112 287	1. 0187	47.....	8 624 569	110 349	0. 9896
8.....	12 786 406	111 587	1. 0121	48.....	8 514 220	111 072	0. 9956
9.....	12 674 819	110 920	1. 0059	49.....	8 403 148	111 846	1. 0021
10.....	12 563 899	110 294	1. 0000	50.....	8 291 302	112 672	1. 0092
11.....	12 453 605	109 699	0. 9944	51.....	8 178 630	113 560	1. 0167
12.....	12 343 906	109 140	0. 9891	52.....	8 065 070	114 510	1. 0248
13.....	12 234 766	108 613	0. 9842	53.....	7 950 560	115 518	1. 0334
14.....	12 126 148	108 123	0. 9795	54.....	7 835 042	116 604	1. 0426
15.....	12 018 025	107 668	0. 9751	55.....	7 718 438	117 759	1. 0525
16.....	11 910 357	107 243	0. 9711	56.....	7 600 679	118 993	1. 0630
17.....	11 803 114	106 850	0. 9673	57.....	7 481 686	120 308	1. 0743
18.....	11 696 264	106 486	0. 9638	58.....	7 361 378	121 713	1. 0863
19.....	11 589 778	106 164	0. 9606	59.....	7 239 665	123 211	1. 0992
20.....	11 483 614	105 863	0. 9576	60.....	7 116 454	124 812	1. 1129
21.....	11 377 751	105 598	0. 9550	61.....	6 991 642	126 525	1. 1276
22.....	11 272 153	105 361	0. 9526	62.....	6 865 117	128 355	1. 1433
23.....	11 166 792	105 164	0. 9505	63.....	6 736 762	130 316	1. 1601
24.....	11 061 628	104 986	0. 9487	64.....	6 606 446	132 418	1. 1782
25.....	10 956 642	104 847	0. 9471	65.....	6 474 028	134 676	1. 1975
26.....	10 851 795	104 736	0. 9459	66.....	6 339 352	137 103	1. 2184
27.....	10 747 059	104 659	0. 9449	67.....	6 202 249	139 718	1. 2408
28.....	10 642 400	104 609	0. 9442	68.....	6 062 531	142 545	1. 2650
29.....	10 537 791	104 594	0. 9437	69.....	5 919 986	145 602	1. 2912
30.....	10 433 197	104 610	0. 9436	70.....	5 774 384	148 922	1. 3195
31.....	10 328 587	104 658	0. 9437	71.....	5 625 462	152 538	1. 35
32.....	10 223 929	104 743	0. 9442	72.....	5 472 924	156 491	1. 38
33.....	10 119 186	104 852	0. 9449	73.....	5 316 433	160 829	1. 42
34.....	10 014 334	105 002	0. 9459	74.....	5 155 604	165 612	1. 46
35.....	9 909 332	105 181	0. 9473	75.....	4 989 992	170 919	1. 51
36.....	9 804 151	105 400	0. 9489	76.....	4 819 073	176 836	1. 56
37.....	9 698 751	105 651	0. 9508	77.....	4 642 237	183 485	1. 61
38.....	9 593 100	105 939	0. 9531	78.....	4 458 752	191 025	1. 67
39.....	9 487 161	106 265	0. 9557	79.....	4 267 727	199 652	1. 75
40.....	9 380 896	106 629	0. 9586	80.....	4 068 075	209 656	1. 83
				81.....	3 858 419	221 422	1. 93
				82.....	3 636 907		2. 04
				48° 30'.....	8 458 879		0. 9988

THE GRID SYSTEM OF MILITARY MAPPING.

A grid system (or quadrillage) is a system of squares determined by the rectangular coordinates of the projection. This system is referred to one origin and is extended over the whole area of the original projection so that every point on the map is coordinated both with respect to its position in a given square as well as to its position in latitude and longitude.

The orientation of all sectional sheets or parts of the general map, wherever located, and on any scale, conforms to the initial meridian of the origin of coordinates. This system adapts itself to the quick computation of distances between points whose grid coordinates are given, as well as the determination of the azimuth of a line joining any two points within artillery range and, hence, is of great value to military operations.

The system was introduced by the First Army in France under the name "Quadrillage kilométrique système Lambert," and manuals (Special Publications Nos. 47 and 49, now out of print) containing method and tables for constructing the quadrillage, were prepared by the Coast and Geodetic Survey.

As the French divide the circumference of the circle into 400 grades instead of 360° , certain essential tables were included for the conversion of degrees, minutes, and seconds into grades, as well as for miles, yards, and feet into their metric equivalents, and vice versa.

The advantage of the decimal system is obvious, and its extension to practical cartography merits consideration. The quadrant has 100 grades, and instead of $8^\circ 39' 56''$, we can write decimally 9.6284 grades.

GRID SYSTEM FOR PROGRESSIVE MAPS IN THE UNITED STATES.

The French system (Lambert) of military mapping presented a number of features that were not only rather new to cartography but were specially adapted to the quick computation of distances and azimuths in military operations. Among these features may be mentioned: (1) A conformal system of map projection which formed the basis. Although dating back to 1772, the Lambert projection remained practically in obscurity until the outbreak of the World War; (2) the advantage of one reference datum; (3) the grid system, or system of rectangular coordinates, already described; (4) the use of the centesimal system for graduation of the circumference of the circle, and for the expression of latitudes and longitudes in place of the sexagesimal system of usual practice.

While these departures from conventional mapping offered many advantages to an area like the French war zone, with its possible eastern extension, military mapping in the United States presented problems of its own. Officers of the Corps of Engineers, U. S. Army, and the Coast and Geodetic Survey, foreseeing the needs of as small allowable error as possible in a system of map projection, adopted a succession of zones on the polyconic projection as the best solution of the problem.

These zones, seven in number, extend north and south across the United States, covering each a range of 9° of longitude, and have overlaps of 1° of longitude with adjacent zones east and west.

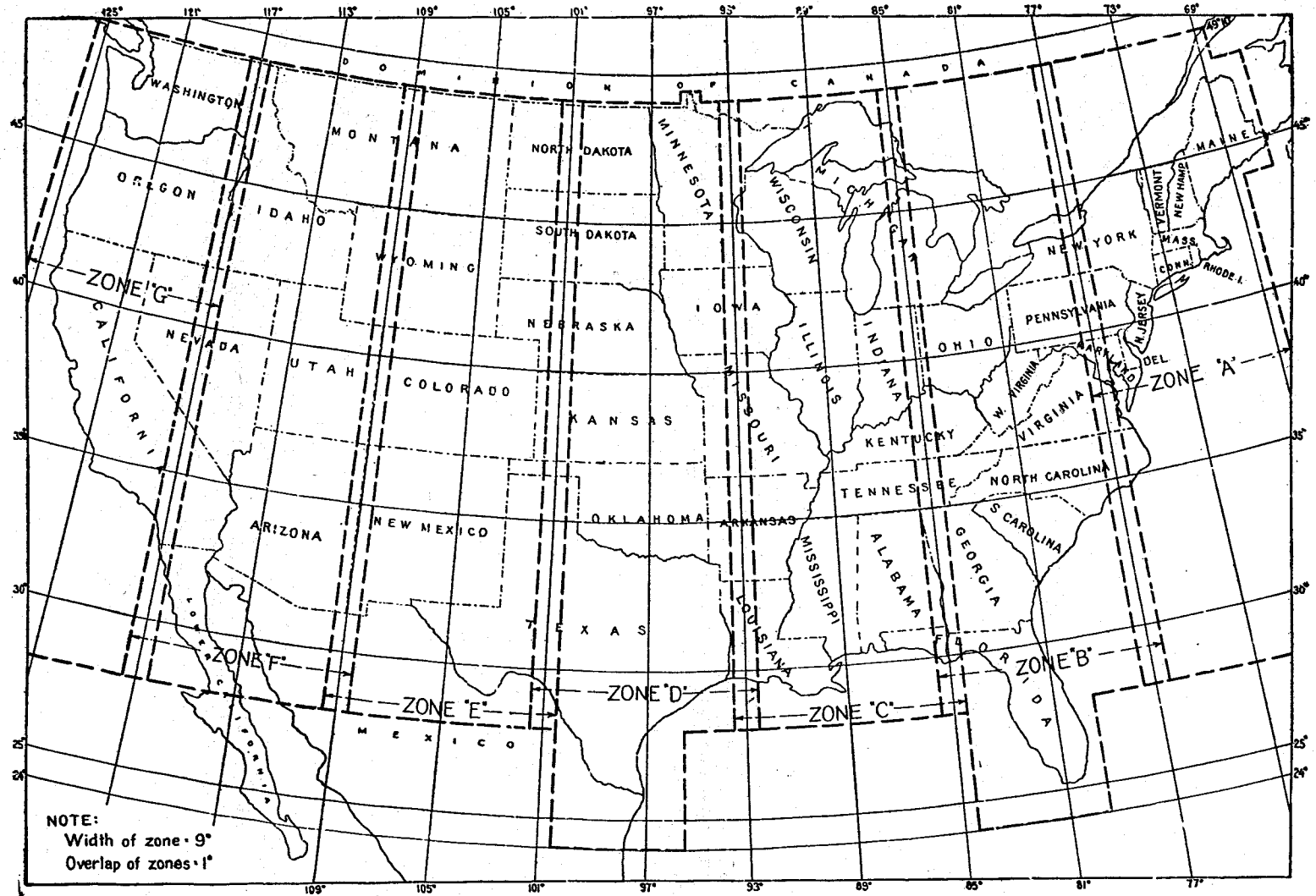

FIG. 56.—Grid zones for progressive military maps of the United States.

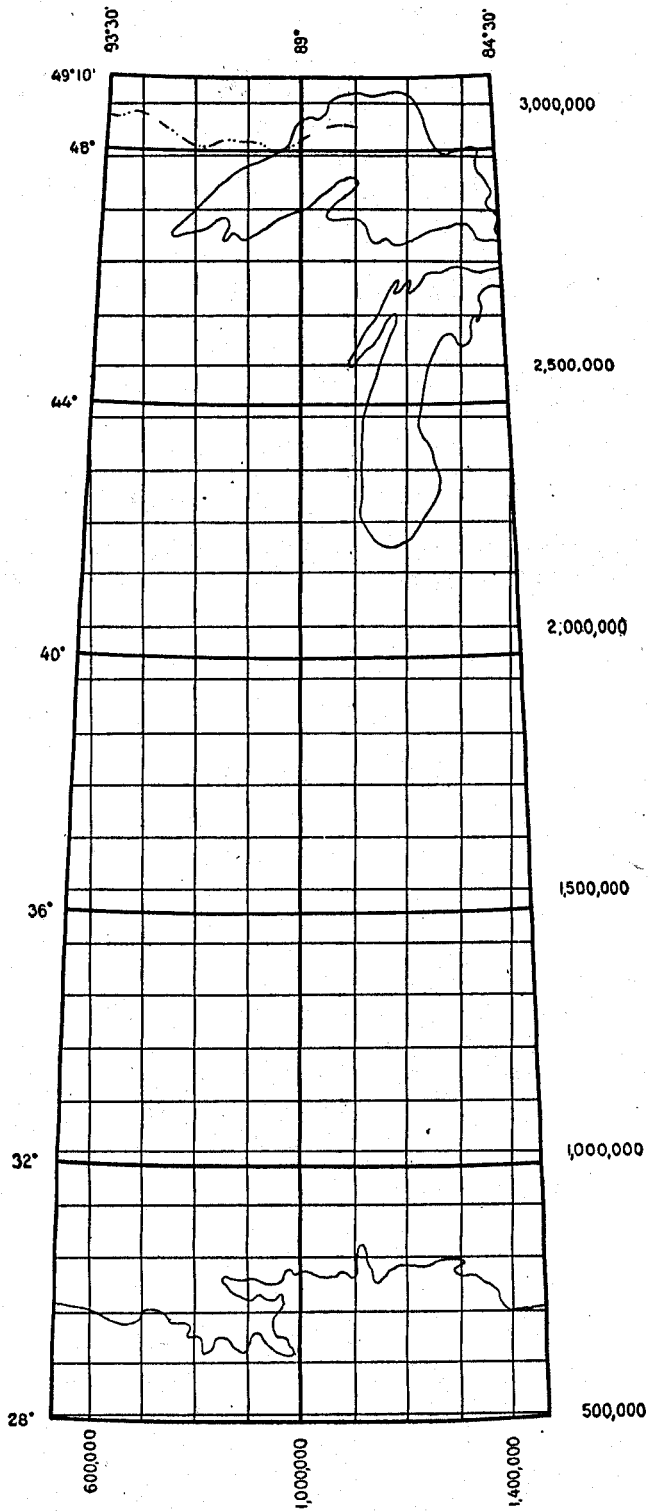

FIG. 57.—Diagram of zone C, showing grid system.

A grid system similar to the French, as already described, is projected over the whole area of each zone. The table of coordinates for one zone can be used for any other zone, as each has its own central meridian.

The overlapping area can be shown on two sets of maps, one on each grid system, thus making it possible to have progressive maps for each of the zones; or the two grid systems can be placed in different colors on the same overlap. The maximum scale error within any zone will be about one-fifth of 1 per cent and can, therefore, be considered negligible.

The system is styled progressive military mapping, but it is, in fact, an interrupted system, the overlap being the stepping-stone to a new system of coordinates. The grid system instead of being kilometric, as in the French system, is based on units of 1000 yards.

For description and coordinates, see U. S. Coast and Geodetic Survey Special Publication No. 59. That publication gives the grid coordinates in yards of the intersection of every fifth minute of latitude and longitude. Besides the grid system, a number of formulas and tables essential to military mapping appear in the publication.

Tables have also been about 75 per cent completed, but not published, giving the coordinates of the minute intersections of latitude and longitude.

THE ALBERS CONICAL EQUAL-AREA PROJECTION WITH TWO STANDARD PARALLELS.

DESCRIPTION.

[See Plate III.]

This projection, devised by Albers²³ in 1805, possesses advantages over others now in use, which for many purposes give it a place of special importance in cartographic work.

In mapping a country like the United States with a predominating east-and-west extent, the Albers system is peculiarly applicable on account of its many desirable properties as well as the reduction to a minimum of certain unavoidable errors.

The projection is of the conical type, in which the meridians are straight lines that meet in a common point beyond the limits of the map, and the parallels are concentric circles whose center is at the point of intersection of the meridians. Meridians and parallels intersect at right angles and the arcs of longitude along any given parallel are of equal length.

It employs a cone intersecting the spheroid at two parallels known as the standard parallels for the area to be represented. In general, for equal distribution of scale error, the standard parallels are placed within the area represented at distances from its northern and southern limits each equal to one-sixth of the total meridional distance of the map. It may be advisable in some localities, or for special reasons, to bring them closer together in order to have greater accuracy in the center of the map at the expense of the upper and lower border areas.

On the two selected parallels, arcs of longitude are represented in their true lengths. Between the selected parallels the scale along the meridians will be a trifle too large and beyond them too small.

The projection is specially suited for maps having a predominating east-and-west dimension. Its chief advantage over certain other projections used for a map of the United States consists in the valuable property of equal-area representation combined with a scale error²⁴ that is practically the minimum attainable in any system covering this area in a single sheet.

In most conical projections, if the map is continued to the pole the latter is represented by the apex of the cone. In the Albers projection, however, owing to the fact that conditions are imposed to hold the scale exact along two parallels instead of one, as well as the property of equivalence of area, it becomes necessary to give up the requirement that the pole should be represented by the apex of the cone; this

²³ Dr. H. C. Albers, the inventor of this projection, was a native of Lüneburg, Germany. Several articles by him on the subject of map projections appeared in Zach's *Monatliche Correspondenz* during the year 1805. Very little is known about him, not even his full name, the title "doctor" being used with his name by Germain about 1865. A book of 40 pages, entitled *Unterricht im Schachspiel* (Instruction in Chess Playing) by H. C. Albers, Lüneburg, 1821, may have been the work of the inventor of this projection.

²⁴ The standards chosen for a map of the United States on the Albers projection are parallels $29\frac{1}{2}^\circ$ and $45\frac{1}{2}^\circ$, and this selection provides for a scale error slightly less than 1 per cent in the center of the map, with a maximum of $1\frac{1}{2}$ per cent along the northern and southern borders. This arrangement of the standards also places them at an even 30-minute interval.

The standards in this system of projection, as in the Lambert conformal conic projection, can be placed at will, and by not favoring the central or more important part of the United States a maximum scale error of somewhat less than $1\frac{1}{2}$ per cent might be obtained. Prof. Hartl suggests the placing of the standards so that the total length of the central meridian remain true, and this arrangement would be ideal for a country more rectangular in shape with predominating east-and-west dimensions.

means that if the map should be continued to the pole the latter would be represented by a circle, and the series of triangular graticules surrounding the pole would be represented by quadrangular figures. This can also be interpreted by the statement that the map is projected on a truncated cone, because the part of the cone above the circle representing the pole is not used in the map.

The desirable properties obtained in mapping the United States by this system may be briefly stated as follows:

1. As stated before, it is an equal-area, or equivalent, projection. This means that any portion of the map bears the same ratio to the region represented by it that any other portion does to its corresponding region, or the ratio of any part is equal to the ratio of area of the whole representation.

2. The maximum scale error is but $1\frac{1}{2}$ per cent, which amount is about the minimum attainable in any system of projection covering the whole of the United States in a single sheet. Other projections now in use have scale errors of as much as 7 per cent.

The scale along the selected standard parallels of latitude $29\frac{1}{2}^\circ$ and $45\frac{1}{2}^\circ$ is true. Between these selected parallels, the meridional scale will be too great and beyond them too small. The scale along the other parallels, on account of the compensation for area, will always have an error of the opposite sign to the error in the meridional scale. It follows, then, that in addition to the two standard parallels, there are at any point two diagonal directions or curves of true-length scale approximately at right angles to each other. Curves possessing this property are termed isoperimetric curves.

With a knowledge of the scale factors for the different parallels of latitude it would be possible to apply corrections to certain measured distances, but when we remember that the maximum scale error is practically the smallest attainable, any greater refinement in scale is seldom worth while, especially as errors due to distortion of paper, the method of printing, and to changes in the humidity of the air must also be taken into account and are frequently as much as the maximum scale error.

It therefore follows that for scaling purposes, the projection under consideration is superior to others with the exception of the Lambert conformal conic, but the latter is not equal-area. It is an obvious advantage to the general accuracy of the scale of a map to have two standard parallels of latitude of true lengths; that is to say, two axes of strength instead of one.

Caution should be exercised in the selection of standards for the use of this projection in large areas of wide latitudes, as scale errors vary increasingly with the range of latitude north or south of the standard parallels.

3. The meridians are straight lines, crossing the parallels of concentric circles at right angles, thus preserving the angle of the meridians and parallels and facilitating construction. The intervals of the parallels depend upon the condition of equal-area.

The time required in the construction of this projection is but a fraction of that employed in other well-known systems that have far greater errors of scale or lack the property of equal-area.

4. The projection, besides the many other advantages, does not deteriorate as we depart from the central meridian, and by reason of straight meridians it is easy at any point to measure a direction with the protractor. In other words it is adapted to indefinite east-and-west extension, a property belonging to this general class of single-cone projections, but not found in the polyconic, where adjacent sheets con-

structed on their own central meridians have a "rolling fit," because meridians are curved in opposite directions.

Sectional maps on the Albers projection would have an exact fit on all sides, and the system is, therefore, suited to any project involving progressive equal-area mapping. The term "sectional maps" is here used in the sense of separate sheets which, as parts of the whole, are not computed independently, but with respect to the one chosen prime meridian and fixed standards. Hence the sheets of the map fit accurately together into one whole map, if desired.

The first notice of this projection appeared in Zach's *Monatliche Correspondenz zur Beförderung der Erd- und Himmels-Kunde*, under the title "Beschreibung einer neuen Kegelprojection von H. C. Albers," published at Gotha, November, 1805, pages 450 to 459.

A more recent development of the formulas is given in *Studien über flächentreue Kegelprojectionen* by Heinrich Hartl, *Mittheilungen des K. u. K. Militär-Geographischen Institutes*, volume 15, pages 203 to 249, Vienna, 1895-96; and in *Lehrbuch der Landkartenprojectionen* by Dr. Norbert Herz, page 181, Leipzig, 1885.

It was employed in a general map of Europe by Reichard at Nuremberg in 1817 and has since been adopted in the Austrian general-staff map of Central Europe; also, by reason of being peculiarly suited to a country like Russia, with its large extent of longitude, it was used in a wall map published by the Russian Geographical Society.

An interesting equal-area projection of the world by Dr. W. Behrmann appeared in *Petermanns Mitteilungen*, September, 1910, plate 27. In this projection equidistant standard parallels are chosen 30° north and south of the Equator, the projection being in fact a limiting form of the Albers.

In view of the various requirements a map is to fulfill and a careful study of the shapes of the areas involved, the incontestable advantages of the Albers projection for a map of the United States have been sufficiently set forth in the above description. By comparison with the Lambert conformal conic projection, we gain the practical property of equivalence of area and lose but little in conformality, the two projections being otherwise closely identical; by comparison with the Lambert zenithal we gain simplicity of construction and use, as well as the advantages of less scale error; a comparison with other familiar projections offers nothing of advantage to these latter except where their restricted special properties become a controlling factor.

MATHEMATICAL THEORY OF THE ALBERS PROJECTION.

If a is the equatorial radius of the spheroid, ϵ the eccentricity, and φ the latitude, the radius of curvature of the meridian ²⁵ is given in the form

$$\rho_m = \frac{a(1-\epsilon^2)}{(1-\epsilon^2 \sin^2 \varphi)^{3/2}}$$

and the radius of curvature perpendicular to the meridian ²⁵ is equal to

$$\rho_n = \frac{a}{(1-\epsilon^2 \sin^2 \varphi)^{1/2}}$$

²⁵ See U. S. Coast and Geodetic Survey Special Publication No. 57, pp. 9-10.

The differential element of length of the meridian is therefore equal to the expression

$$dm = \frac{a(1-\epsilon^2)d\varphi}{(1-\epsilon^2\sin^2\varphi)^{3/2}},$$

and that of the parallel becomes

$$dp = \frac{a\cos\varphi d\lambda}{(1-\epsilon^2\sin^2\varphi)^{1/2}},$$

in which λ is the longitude.

The element of area upon the spheroid is thus expressed in the form

$$dS = dm dp = \frac{a^2(1-\epsilon^2)\cos\varphi d\varphi d\lambda}{(1-\epsilon^2\sin^2\varphi)^2}.$$

We wish now to determine an equal-area projection of the spheroid in the plane.

If ρ is the radius vector in the plane, and θ is the angle which this radius vector makes with some initial line, the element of area in the plane is given by the form

$$dS' = \rho d\rho d\theta.$$

ρ and θ must be expressed as functions of φ and λ , and therefore

$$d\rho = \frac{\partial\rho}{\partial\varphi} d\varphi + \frac{\partial\rho}{\partial\lambda} d\lambda$$

and

$$d\theta = \frac{\partial\theta}{\partial\varphi} d\varphi + \frac{\partial\theta}{\partial\lambda} d\lambda.$$

We will now introduce the condition that the parallels shall be represented by concentric circles; ρ will therefore be a function of φ alone,
or

$$d\rho = \frac{\partial\rho}{\partial\varphi} d\varphi.$$

As a second condition, we require that the meridians be represented by straight lines, the radii of the system of concentric circles. This requires that θ should be independent of φ ,
or

$$d\theta = \frac{\partial\theta}{\partial\lambda} d\lambda.$$

Furthermore, if θ and λ are to vanish at the same time and if equal differences of longitude are to be represented at all points by equal arcs on the parallels, θ must be equal to some constant times λ ,
or

$$\theta = n\lambda,$$

in which n is the required constant.

This gives us

$$d\theta = n d\lambda.$$

By substituting these values in the expression for dS' , we get

$$dS' = \rho \frac{\partial\rho}{\partial\varphi} n d\varphi d\lambda.$$

Since the projection is to be equal-area, dS' must equal $-dS$,

or

$$\rho \frac{\partial \rho}{\partial \varphi} n \, d\varphi \, d\lambda = - \frac{a^2(1-\epsilon^2) \cos \varphi \, d\varphi \, d\lambda}{(1-\epsilon^2 \sin^2 \varphi)^2}.$$

The minus sign is explained by the fact that ρ decreases as φ increases. By omitting the $d\lambda$, we find that ρ is determined by the integral

$$\int_0^\varphi \rho \frac{\partial \rho}{\partial \varphi} \, d\varphi = - \frac{a^2(1-\epsilon^2)}{n} \int_0^\varphi \frac{\cos \varphi \, d\varphi}{(1-\epsilon^2 \sin^2 \varphi)^2}.$$

If R represents the radius for $\varphi = 0$, this becomes

$$\rho^2 - R^2 = - \frac{2a^2(1-\epsilon^2)}{n} \int_0^\varphi \frac{\cos \varphi \, d\varphi}{(1-\epsilon^2 \sin^2 \varphi)^2}.$$

If β is the latitude on a sphere of radius c , the right-hand member would be represented by the integral

$$u = - \frac{2c^2}{n} \int_0^\beta \cos \beta \, d\beta = - \frac{2c^2}{n} \sin \beta.$$

We may define β by setting this quantity equal to the above right-hand member,

or

$$\begin{aligned} c^2 \sin \beta &= a^2(1-\epsilon^2) \int_0^\varphi \frac{\cos \varphi \, d\varphi}{(1-\epsilon^2 \sin^2 \varphi)^2} \\ &= a^2(1-\epsilon^2) \int_0^\varphi (\cos \varphi + 2\epsilon^2 \sin^2 \varphi \cos \varphi + 3\epsilon^4 \sin^4 \varphi \cos \varphi + 4\epsilon^6 \sin^6 \varphi \cos \varphi + \dots) \, d\varphi. \end{aligned}$$

Therefore,

$$c^2 \sin \beta = a^2(1-\epsilon^2) \left(\sin \varphi + \frac{2\epsilon^2}{3} \sin^3 \varphi + \frac{3\epsilon^4}{5} \sin^5 \varphi + \frac{4\epsilon^6}{7} \sin^7 \varphi + \dots \right).$$

As yet c is an undetermined constant. We may determine it by introducing the condition that,

$$\text{when } \varphi = \frac{\pi}{2}, \beta \text{ shall also equal } \frac{\pi}{2}.$$

This gives

$$c^2 = a^2(1-\epsilon^2) \left(1 + \frac{2\epsilon^2}{3} + \frac{3\epsilon^4}{5} + \frac{4\epsilon^6}{7} + \dots \right).$$

The latitude on the sphere is thus defined in the form

$$\sin \beta = \sin \varphi \left(\frac{1 + \frac{2\epsilon^2}{3} \sin^2 \varphi + \frac{3\epsilon^4}{5} \sin^4 \varphi + \frac{4\epsilon^6}{7} \sin^6 \varphi + \dots}{1 + \frac{2\epsilon^2}{3} + \frac{3\epsilon^4}{5} + \frac{4\epsilon^6}{7} + \dots} \right).$$

This latitude on the sphere has been called the authalic latitude, the term authalic meaning equivalent or equal-area. A table of these latitudes for every half degree of geodetic latitude is given in U. S. Coast and Geodetic Survey Special Publication No. 67.

With this latitude the expression for ρ becomes

$$\rho^2 = R^2 - \frac{2c^2}{n} \sin \beta.$$

The two constants n and R are as yet undetermined.

Let us introduce the condition that the scale shall be exact along two given parallels. On the spheroid the length of the parallel for a given longitude difference λ is equal to the expression

$$P = \frac{a \lambda \cos \varphi}{(1 - \epsilon^2 \sin^2 \varphi)^{3/2}}.$$

On the map this arc is represented by

$$\rho \theta = \rho n \lambda.$$

On the two parallels along which the scale is to be exact, if we denote them by subscripts, we have

$$\rho_1 n \lambda = \frac{a \lambda \cos \varphi_1}{(1 - \epsilon^2 \sin^2 \varphi_1)^{3/2}},$$

or, on omitting λ , we have

$$\rho_1 = \frac{a \cos \varphi_1}{n(1 - \epsilon^2 \sin^2 \varphi_1)^{3/2}},$$

and

$$\rho_2 = \frac{a \cos \varphi_2}{n(1 - \epsilon^2 \sin^2 \varphi_2)^{3/2}}.$$

Substituting these values in turn in the general equation for ρ , we get

$$R^2 - \frac{2c^2}{n} \sin \beta_1 = \frac{a^2 \cos^2 \varphi_1}{n^2 (1 - \epsilon^2 \sin^2 \varphi_1)}$$

and

$$R^2 - \frac{2c^2}{n} \sin \beta_2 = \frac{a^2 \cos^2 \varphi_2}{n^2 (1 - \epsilon^2 \sin^2 \varphi_2)}.$$

In U. S. Coast and Geodetic Survey Special Publication No. 8 a quantity called A' is defined as

$$A' = \frac{(1 - \epsilon^2 \sin^2 \varphi')^{1/2}}{a \sin 1''};$$

and is there tabulated for every minute of latitude.

Hence

$$\frac{a^2}{(1 - \epsilon^2 \sin^2 \varphi_1)} = \frac{1}{A_1'^2 \sin^2 1''}.$$

(The prime on A is here omitted for convenience.)

The equations for determining R and n , therefore, become

$$R^2 - \frac{2c^2}{n} \sin \beta_1 = \frac{\cos^2 \varphi_1}{A_1'^2 n^2 \sin^2 1''}$$

and

$$R^2 - \frac{2c^2}{n} \sin \beta_2 = \frac{\cos^2 \varphi_2}{A_2'^2 n^2 \sin^2 1''}.$$

By subtracting these equations and reducing, we get

$$n = \frac{\frac{\cos^2 \varphi_1}{A_1^2 \sin^2 1''} - \frac{\cos^2 \varphi_2}{A_2^2 \sin^2 1''}}{2c^2 (\sin \beta_2 - \sin \beta_1)}$$

$$= \frac{\frac{\cos^2 \varphi_1}{A_1^2 \sin^2 1''} - \frac{\cos^2 \varphi_2}{A_2^2 \sin^2 1''}}{4c^2 \sin \frac{1}{2} (\beta_2 - \beta_1) \cos \frac{1}{2} (\beta_2 + \beta_1)} = \frac{r_1^2 - r_2^2}{4c^2 \sin \frac{1}{2} (\beta_2 - \beta_1) \cos \frac{1}{2} (\beta_2 + \beta_1)}$$

r_1 and r_2 being the radii of the respective parallels upon the spheroid.

By substituting the value of n in the above equations, we could determine R , but we are only interested in canceling this quantity from the general equation for ρ .

Since n is determined, we have for the determination of ρ_1

$$\rho_1 = \frac{a \cos \varphi_1}{n (1 - \epsilon^2 \sin^2 \varphi_1)^{\frac{1}{2}}} = \frac{\cos \varphi_1}{n A_1 \sin 1''} = \frac{r_1}{n}$$

But

$$\rho_1^2 = R^2 - \frac{2c^2}{n} \sin \beta_1.$$

By subtracting this equation from the general equation for the determination of ρ , we get

$$\rho^2 - \rho_1^2 = \frac{2c^2}{n} (\sin \beta_1 - \sin \beta)$$

or

$$\rho^2 = \rho_1^2 + \frac{4c^2}{n} \sin \frac{1}{2} (\beta_1 - \beta) \cos \frac{1}{2} (\beta_1 + \beta).$$

In a similar manner we have

$$\rho_2 = \frac{a \cos \varphi_2}{n (1 - \epsilon^2 \sin^2 \varphi_2)^{\frac{1}{2}}} = \frac{\cos \varphi_2}{n A_2 \sin 1''} = \frac{r_2}{n}$$

and

$$\rho^2 = \rho_2^2 + \frac{4c^2}{n} \sin \frac{1}{2} (\beta_2 - \beta) \cos \frac{1}{2} (\beta_2 + \beta).$$

The radius c is the radius of a sphere having a surface equivalent to that of the spheroid. For the Clarke spheroid of 1866 (c in meters)

$$\log c = 6.80420742$$

To obviate the difficulty of taking out large numbers corresponding to logarithms, it is convenient to use the form

$$\frac{\rho^2}{c^2} = \frac{\rho_1^2}{c^2} + \frac{4}{n} \sin \frac{1}{2} (\beta_1 - \beta) \cos \frac{1}{2} (\beta_1 + \beta),$$

until after the addition is performed in the right-hand member, and then ρ can be found without much difficulty.

For the authalic latitudes use the table in U. S. Coast and Geodetic Survey Special Publication No. 67.

Now, if λ is reckoned as longitude out from the central meridian, which becomes the Y axis, we get

$$\begin{aligned}\theta &= n\lambda, \\ x &= \rho \sin \theta, \\ y &= -\rho \cos \theta.\end{aligned}$$

In this case the origin is the center of the system of concentric circles, the central meridian is the Y axis, and a line perpendicular to this central meridian through the origin is the X axis. The y coordinate is negative because it is measured downward.

If it is desired to refer the coordinates to the center of the map as a single system of coordinates, the values become

$$\begin{aligned}x &= \rho \sin \theta, \\ y &= \rho_0 - \rho \cos \theta,\end{aligned}$$

in which ρ_0 is the radius of the parallel passing through the center of the map.

The coordinates of points on each parallel may be referred to a separate origin, the point in which the parallel intersects the central meridian. In this case the coordinates become

$$\begin{aligned}x &= \rho \sin \theta, \\ y &= \rho - \rho \cos \theta = 2\rho \sin^2 \frac{1}{2} \theta.\end{aligned}$$

If the map to be constructed is of such a scale that the parallels can be constructed by the use of a beam compass, it is more expeditious to proceed in the following manner:

If λ' is the λ of the meridian farthest out from the central meridian on the map, we get

$$\theta' = n\lambda'.$$

We then determine the chord on the circle representing the lowest parallel of the map, from its intersection with the central meridian to its intersection with the meridian represented by λ' ,

$$\text{chord} = 2\rho \sin \frac{1}{2} \theta'.$$

With this value set off on the beam compass, and with the intersection of the parallel with the central meridian as center, strike an arc intersecting the parallel at the point where the meridian of λ' intersects it. The arc on the parallel represents λ' degrees of longitude, and it can be divided proportionately for the other intersections.

Proceed in the same manner for the upper parallel of the map. Then straight lines drawn through corresponding points on these two parallels will determine all of the meridians.

The scale along the parallels, k_p , is given by the expression

$$k_p = \frac{n\rho_s}{r_s},$$

in which ρ_s is the radius of the circle representing the parallel of φ_s , and r_s is the radius of the same parallel on the spheroid; hence

$$r_s = \frac{\cos \varphi_s}{A'_s \sin 1''}.$$

The scale along the meridians is equal to the reciprocal of the expression for the scale along the parallels, or

$$k_m = \frac{r_s}{n\rho_s}.$$

CONSTRUCTION OF AN ALBERS PROJECTION.

This projection affords a remarkable facility for graphical construction, requiring practically only the use of a scale, straightedge, and beam compass. In a map for the United States the central or ninety-sixth meridian can be extended far enough to include the center of the curves of latitude, and these curves can be drawn in with a beam compass set to the respective values of the radii taken from the tables.

To determine the meridians, a chord of 25° of longitude (as given in the tables) is laid off from and on each side of the central meridian, on the lower or 25° parallel of latitude. By means of a straightedge the points of intersection of the chords with parallel 25° can be connected with the same center as that used in drawing the parallels of latitude. This, then, will determine the two meridians distant 25° from the center of the map. The lower parallel can then be subdivided into as many equal spaces as may be required, and the remaining meridians drawn in similarly to the outer ones.

If a long straightedge is not available, the spacings of the meridians on parallel 45° can be obtained from chord distance and subdivision of the arc in a similar manner to that employed on parallel 25°. Lines drawn through corresponding points on parallels 25° and 45° will then determine the meridians of the map.

This method of construction is far more satisfactory than the one involving rectangular coordinates, though the length of a beam compass required for the construction of a map of the United States on a scale larger than 1:5 000 000 is rather unusual.

In equal-area projections it is a problem of some difficulty to make allowance for the ellipticity of the earth, a difficulty which is most readily obviated by an intermediate equal-area projection of the spheroid upon a sphere of equal surface. This amounts to the determination of a correction to be applied to the astronomic latitudes in order to obtain the corresponding latitudes upon the sphere. The sphere can then be projected equivalently upon the plane and the problem is solved.

The name of authalic latitudes has been applied to the latitudes of the sphere of equal surface. A table²⁶ of these latitudes has been computed for every half degree and can be used in the computations of any equal area projection. This table was employed in the computations of the following coordinates for the construction of a map of the United States.

²⁶ Developments Connected with Geodesy and Cartography, U. S. Coast and Geodetic Survey Special Publication No. 67.

TABLE FOR THE CONSTRUCTION OF A MAP OF THE UNITED STATES ON ALBERS EQUAL-AREA PROJECTION WITH TWO STANDARD PARALLELS.

Latitude φ	Radius of parallel ρ	Spacings of parallels Δ	Additional data.		
	<i>Meters</i>	<i>Meters</i>	$\frac{\rho^2}{c^2} = 1.3592771$ $\text{colog } n = 0.2197522$ $\log c = 6.8042075$		
20°	10 253 177	107 598	Longitude from central meridian.	Chords on latitude 25°.	Chords on latitude 45°.
21°	10 145 579	108 039			
22°	10 037 540	108 480			
23°	9 929 080	108 862			
24°	9 820 218	109 249			
25°	9 710 969	109 608			
26°	9 601 361	109 952			
27°	9 491 409	110 270			
28°	9 381 139	110 563			
29°	9 270 576	110 838			
29° 30'	9 215 188				
30°	9 159 738	111 090			
31°	9 048 648	111 311			
32°	8 937 337	111 510			
33°	8 825 827	111 677			
34°	8 714 150	111 822			
35°	8 602 328	111 936			
36°	8 490 392	112 015			
37°	8 378 377	112 065			
38°	8 266 312	112 084			
39°	8 154 228	112 065			
40°	8 042 163	112 011			
41°	7 930 152	111 921			
42°	7 818 231	111 787			
43°	7 706 444	111 616			
44°	7 594 828	111 402			
45°	7 483 426				
45° 30'	7 427 822	111 138			
46°	7 372 288	110 829			
47°	7 261 459	110 472			
48°	7 150 987	110 062			
49°	7 040 925	109 592			
50°	6 931 333	109 069			
51°	6 822 264	108 484			
52°	6 713 780				
			Latitude.	Scale factor along the parallel	Scale factor along the meridian
			49° 00'	1. 0126	0. 9876
			45° 30'	1. 0000	1. 0000
			37° 30' 9904	1. 0097
			29° 30'	1. 0000	1. 0000
			25° 00'	1. 0124	. 9878
			20° 00'	1. 0310	. 9699

THE MERCATOR PROJECTION.

DESCRIPTION.

[See fig. 67, p. 146.]

This projection takes its name from the Latin surname of Gerhard Krämer, the inventor, who was born in Flanders in 1512 and published his system on a map of the world in 1569. His results were only approximate, and it was not until 30 years later that the true principles or the method of computation and construction of this type of projection were made known by Edward Wright, of Cambridge, in a publication entitled "Certain Errors in Navigation."

In view of the frequent misunderstanding of the properties of this projection, a few words as to its true merits may be appropriate. It is by no means an equal-area representation, and the mental adjustment to meet this idea in a map of the world has caused unnecessary abuse in ascribing to it properties that are peculiarly absent. But there is this distinction between it and others which give greater accuracy in the relative size or outline of countries—that, while the latter are often merely intended to be looked at, the Mercator projection is meant seriously to be worked upon, and it alone has the invaluable property that any bearing from any point desired can be laid off with accuracy and ease. It is, therefore, the only one that meets the requirements of navigation and has a world-wide use, due to the fact that the ship's track on the surface of the sea under a constant bearing is a straight line on the projection.

GREAT CIRCLES AND RHUMB LINES.

The shortest line between any two given points on the surface of a sphere is the arc of the great circle that joins them; but, as the earth is a spheroid, the shortest or minimum line that can be drawn on its ellipsoidal surface between any two points is termed a geodetic line. In connection with the study of shortest distances, however, it is customary to consider the earth as a sphere and for ordinary purposes this approximation is sufficiently accurate.

A rhumb line, or loxodromic curve, is a line which crosses the successive meridians at a constant angle. A ship "sailing a rhumb" is therefore on one course²⁷ continuously following the rhumb line. The only projection on which such a line is represented as a straight line is the Mercator; and the only projection on which the great circle is represented as a straight line is the gnomonic; but as any oblique great circle cuts the meridians of the latter at different angles, to follow such a line would necessitate constant alterations in the direction of the ship's head, an operation that would be impracticable. The choice is then between a *rhumb line*, which is longer than the arc of a great circle and at every point of which the direction is the same, or the *arc of a great circle* which is shorter than the rhumb line, but at every point of which the direction is different.

The solution of the problem thus resolves itself into the selection of points at convenient course-distances apart along the great-circle track, so that the ship may be steered from one to the other along the rhumb lines joining them; the closer the

²⁷ A ship following always the same oblique course, would continuously approach nearer and nearer to the pole without ever theoretically arriving at it.

points selected to one another,—that is, the shorter the sailing chords—the more nearly will the track of the ship coincide with the great circle, or shortest sailing route.

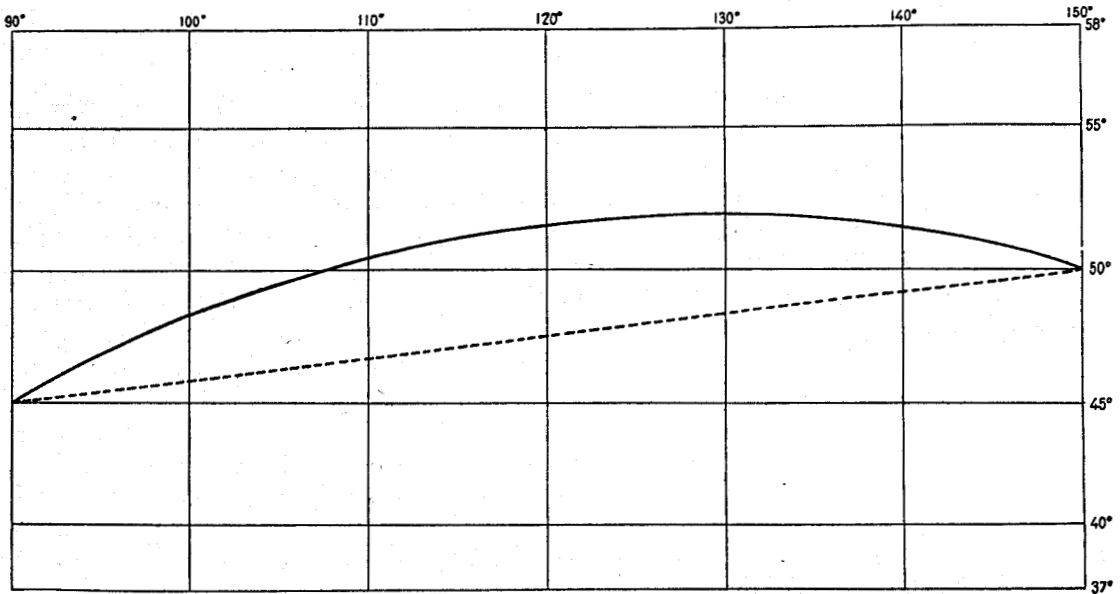

FIG. 58.—Part of a Mercator chart showing a rhumb line and a great circle.

The dotted line shows the rhumb line which is a straight line on this projection. The curve shown by a full line is the great circle track which lies on the polar side of the rhumb line. Any great circle or straight line drawn between two given points on the gnomonic projection may be plotted on the Mercator projection by noting the latitudes of the points where the track crosses the various meridians.

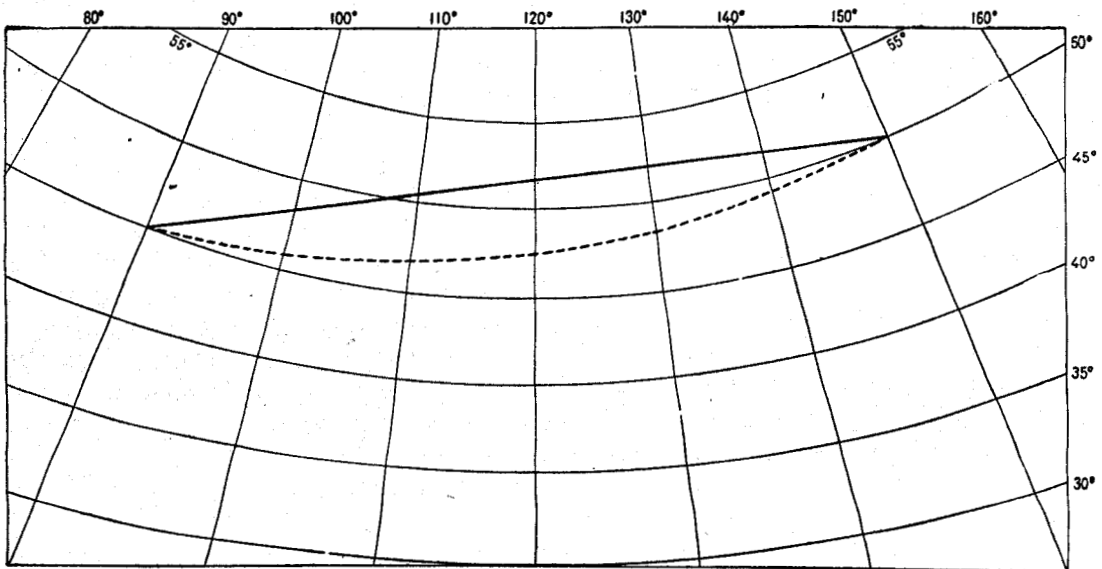

FIG. 59.—Part of a gnomonic chart showing a great circle and a rhumb line.

The full line shows the great circle track. The curve shown by a dotted line is the rhumb line which lies on the equatorial side of the great circle track.

For this purpose the Mercator projection, except in high latitudes, has attained an importance beyond all others, in that the great circle can be plotted thereon from a gnomonic chart, or it may be determined by calculation, and these arcs can then be subdivided into convenient sailing chords, so that, if the courses are carefully followed, the port bound for will in due time be reached by the shortest practicable route.

It suffices for the mariner to measure by means of a protractor the angle which his course makes with any meridian. With this course corrected for magnetic variation and deviation his compass route will be established.

It may here be stated that the Hydrographic Office, U. S. Navy, has prepared a series of charts on the gnomonic projection which are most useful in laying off great circle courses. As any straight line on these charts represents a great circle, by taking from them the latitudes and longitudes of a number of points along the line, the great-circle arcs may be transferred to the Mercator system, where bearings are obtainable.

It should be borne in mind, moreover, that in practice the shortest course is not always necessarily the shortest passage that can be made. Alterations become necessary on account of the irregular distribution of land and water, the presence of rocks and shoals, the effect of set and drift of currents, and of the direction and strength of the wind. It, therefore, is necessary in determining a course to find out if the rhumb line (or lines) to destination is interrupted or impracticable, and, if so, to determine intermediate points between which the rhumb lines are uninterrupted. The resolution of the problem at the start, however, must set out with the great circle, or a number of great circles, drawn from one objective point to the next. In the interests of economy, a series of courses, or composite sailing, will frequently be the solution.

Another advantage of the Mercator projection is that meridians, or north and south lines, are always up and down, parallel with the east-and-west borders of the map, just where one expects them to be. The latitude and longitude of any place is readily found from its position on the map, and the convenience of plotting points or positions by straightedge across the map from the marginal divisions prevents errors, especially in navigation. Furthermore, the projection is readily constructed.

A true compass course may be carried by a parallel ruler from a compass rose to any part of the chart without error, and the side borders furnish a distance scale²⁸ convenient to all parts of the chart, as described in the chapter of "Construction of a Mercator projection". In many other projections, when carried too far, spherical relations are not conveniently accounted for.

From the nature of the projection any narrow belt of latitude in any part of the world, reduced or enlarged to any desired scale, represents approximately true form for the ready use of any locality.

All charts are similar and, when brought to the same scale, will fit exactly. Adjacent charts of uniform longitude scale will join exactly and will remain oriented when joined.

The projection provides for longitudinal repetition so that continuous sailing routes east or west around the world may be completely shown on one map.

Finally, as stated before, for a nautical chart, if for no other purpose, the Mercator projection, except in high latitudes, has attained an importance which puts all others in the background.

²⁸ The border latitude scale will give the correct distance in the corresponding latitude. If sufficiently important on the smaller scale charts, a diagrammatic scale could be placed on the charts, giving the scale for various latitudes, as on a French Mercator chart of Africa, No. 2A, published by the Ministère de la Marine.

MERCATOR PROJECTION IN HIGH LATITUDES.

In latitudes above 60° , where the meridional parts of a Mercator projection increase rather rapidly, charts covering considerable area may be constructed advantageously on a Lambert conformal projection, if the locality has a predominating east-and-west extent; and on a polyconic projection, or a transverse Mercator, if the locality has predominating north-and-south dimensions. In regard to suitable projections for polar regions, see page 147.

Difficulties in navigation in the higher latitudes, often ascribed to the use of the Mercator projection, have in some instances been traced to unreliable positions of landmarks due to inadequate surveys and in other instances to the application of corrections for variation and deviation in the wrong direction.

For purposes of navigation in the great commercial area of the world the Mercator projection has the indorsement of all nautical textbooks and nautical schools, and its employment by maritime nations is universal. It is estimated that of the 15 000 or more different nautical charts published by the various countries not more than 1 per cent are constructed on a system of projection that is noticeably different from Mercator charts.

The advantages of the Mercator system over other systems of projection are evident in nautical charts of small scale covering extensive areas,²⁹ but the larger the scale the less important these differences become. In harbor and coast charts of the United States of scales varying from 1:10 000 to 1:80 000 the difference of the various types of projection is almost inappreciable.

This being the case, there is a great practical advantage to the mariner in having one uniform system of projection for all scales and in avoiding a sharp break that would require successive charts to be constructed or handled on different principles at a point where there is no definite distinction.

The use of the Mercator projection by the U. S. Coast and Geodetic Survey is, therefore, not due to the habit of continuing an old system, but to the desirability of meeting the special requirements of the navigator. It was adopted by this Bureau within comparatively recent years, superseding the polyconic projection formerly employed.

The middle latitudes employed by the U. S. Coast and Geodetic Survey in the construction of charts on the Mercator system, are as follows:

Coast and harbor charts, scales 1:80 000 and larger, are constructed to the scale of the middle latitude of each chart. This series includes 86 coast charts of the Atlantic and Gulf coasts, each on the scale 1:80 000. The use of these charts in series is probably less important than their individual local use, and the slight break in scale between adjoining charts will probably cause less inconvenience than would the variation in the scale of the series from 1:69 000 to 1:88 000 if constructed to the scale of the middle latitude of the series.

General charts and sailing charts of the Atlantic coast, scales 1:400 000 and 1:1 200 000 are constructed to the scale of latitude 40° . The scales of the different charts of the series are therefore variant, but the adjoining charts join exactly. This applies likewise to the following three groups:

General charts of the Pacific coast, San Diego to Puget Sound, are constructed to the scale of 1:200 000 in latitude 41° .

²⁹ On small scale charts in the middle or higher latitudes, the difference between the Mercator and polyconic projections is obvious to the eye and affects the method of using the charts. Latitude must not be carried across perpendicular to the border of a polyconic chart of small scale.

General charts of the Alaska coast, Dixon Entrance to Dutch Harbor, are constructed to the scale of 1:200 000 in latitude 60°.

General sailing charts of the Pacific coast, San Diego to the western limit of the Aleutian Islands, are constructed to the scale of 1:1 200 000 in latitude 49°.

Some of the older charts still issued on the polyconic projection will be changed to the Mercator system as soon as practicable. Information as to the construction of nautical charts in this Bureau is given in Rules and Practice, U. S. Coast and Geodetic Survey, Special Publication No. 66.

DEVELOPMENT OF THE FORMULAS FOR THE COORDINATES OF THE MERCATOR PROJECTION.

The Mercator projection is a conformal projection upon a cylinder tangent to the spheroid at the Equator. The Equator is, therefore, represented by a straight line when the cylinder is developed or rolled out into the plane. The meridians are represented by straight lines perpendicular to this line which represents the Equator; they are equally spaced in proportion to their actual distances apart upon the Equator. The parallels are represented by a second system of parallel lines perpendicular to the family of lines representing the meridians; or, in other words, they are straight lines parallel to the line representing the Equator. The only thing not yet determined is the spacings between the lines representing the parallels; or, what amounts to the same thing, the distances of these lines from the Equator.

Since the projection is conformal, the scale at any point must be the same in all directions. When the parallels and meridians are represented by lines or curves that are mutually perpendicular, the scale will be equal in all directions at a point, if the scale is the same along the parallel and meridian at that point. In the Mercator projection the lines representing the parallels are perpendicular to the lines representing the meridians. In order, then, to determine the projection, we need only to introduce the condition that the scale along the meridians shall be equal to the scale along the parallels.

An element of length along a parallel is equal to the expression

$$dp = \frac{a \cos \varphi d\lambda}{(1 - \epsilon^2 \sin^2 \varphi)^{1/2}},$$

in which a is the equatorial radius, φ the latitude, λ the longitude, and ϵ the eccentricity.

For the purpose before us we may consider that the meridians are spaced equal to their actual distances apart upon the earth at the Equator. In that case the element of length dp along the parallel will be represented upon the map by $a d\lambda$, or the scale along the parallel will be given in the form

$$\frac{dp}{a d\lambda} = \frac{\cos \varphi}{(1 - \epsilon^2 \sin^2 \varphi)^{1/2}}.$$

An element of length along the meridian is given in the form

$$dm = \frac{a (1 - \epsilon^2) d\varphi}{(1 - \epsilon^2 \sin^2 \varphi)^{3/2}}.$$

Now, if ds is the element of length upon the projection that is to represent this element of length along the meridian, we must have the ratio of dm to ds equal to the scale along the parallel, if the projection is to be conformal.

Accordingly, we must have

$$\frac{dm}{ds} = \frac{a(1-\epsilon^2) d\varphi}{(1-\epsilon^2 \sin^2 \varphi)^{3/2}} = \frac{\cos \varphi}{(1-\epsilon^2 \sin^2 \varphi)^{1/2}},$$

or,

$$ds = \frac{a(1-\epsilon^2) d\varphi}{(1-\epsilon^2 \sin^2 \varphi) \cos \varphi}.$$

The distance of the parallel of latitude φ from the Equator must be equal to the integral

$$\begin{aligned} s &= \int_0^\varphi \frac{a(1-\epsilon^2) d\varphi}{(1-\epsilon^2 \sin^2 \varphi) \cos \varphi} \\ &= a \int_0^\varphi \frac{d\varphi}{\cos \varphi} + \frac{a\epsilon}{2} \int_0^\varphi \frac{-\epsilon \cos \varphi d\varphi}{1-\epsilon \sin \varphi} - \frac{a\epsilon}{2} \int_0^\varphi \frac{\epsilon \cos \varphi d\varphi}{1+\epsilon \sin \varphi} \\ &= a \int_0^\varphi \frac{d\varphi}{\sin\left(\frac{\pi}{2} + \varphi\right)} + \frac{a\epsilon}{2} \int_0^\varphi \frac{-\epsilon \cos \varphi d\varphi}{1-\epsilon \sin \varphi} - \frac{a\epsilon}{2} \int_0^\varphi \frac{\epsilon \cos \varphi d\varphi}{1+\epsilon \sin \varphi} \\ &= a \int_0^\varphi \frac{\cos\left(\frac{\pi}{4} + \frac{\varphi}{2}\right) d\varphi}{\sin\left(\frac{\pi}{4} + \frac{\varphi}{2}\right)} - a \int_0^\varphi \frac{-\sin\left(\frac{\pi}{4} + \frac{\varphi}{2}\right) d\varphi}{\cos\left(\frac{\pi}{4} + \frac{\varphi}{2}\right)} + \frac{a\epsilon}{2} \int_0^\varphi \frac{-\epsilon \cos \varphi d\varphi}{1-\epsilon \sin \varphi} - \frac{a\epsilon}{2} \int_0^\varphi \frac{\epsilon \cos \varphi d\varphi}{1+\epsilon \sin \varphi}. \end{aligned}$$

On integration this becomes

$$\begin{aligned} s &= a \log_e \sin\left(\frac{\pi}{4} + \frac{\varphi}{2}\right) - a \log_e \cos\left(\frac{\pi}{4} + \frac{\varphi}{2}\right) + \frac{a\epsilon}{2} \log_e (1-\epsilon \sin \varphi) - \frac{a\epsilon}{2} \log_e (1+\epsilon \sin \varphi) \\ &= a \log_e \tan\left(\frac{\pi}{4} + \frac{\varphi}{2}\right) + \frac{a\epsilon}{2} \log_e \left(\frac{1-\epsilon \sin \varphi}{1+\epsilon \sin \varphi}\right) \\ &= a \log_e \left[\tan\left(\frac{\pi}{4} + \frac{\varphi}{2}\right) \cdot \left(\frac{1-\epsilon \sin \varphi}{1+\epsilon \sin \varphi}\right)^{\epsilon/2} \right]. \end{aligned}$$

The distance of the meridian λ from the central meridian is given by the integral

$$\begin{aligned} s' &= a \int_0^\lambda d\lambda \\ &= a\lambda. \end{aligned}$$

The coordinates of the projection referred to the intersection of the central meridian and the Equator as origin are, therefore, given in the form

$$\begin{aligned} x &= a\lambda, \\ y &= a \log_e \left[\tan\left(\frac{\pi}{4} + \frac{\varphi}{2}\right) \cdot \left(\frac{1-\epsilon \sin \varphi}{1+\epsilon \sin \varphi}\right)^{\epsilon/2} \right]. \end{aligned}$$

In U. S. Coast and Geodetic Survey Special Publication No. 67, the isometric or conformal latitude is defined by the expression

$$\tan \left(\frac{\pi}{4} + \frac{\chi}{2} \right) = \tan \left(\frac{\pi}{4} + \frac{\varphi}{2} \right) \cdot \left(\frac{1 - \epsilon \sin \varphi}{1 + \epsilon \sin \varphi} \right)^{1/2},$$

or, if

$$\chi = \frac{\pi}{2} - z \text{ and } \varphi = \frac{\pi}{2} - p,$$

$$\tan \frac{z}{2} = \tan \frac{p}{2} \cdot \left(\frac{1 + \epsilon \cos p}{1 - \epsilon \cos p} \right)^{1/2}.$$

With this value we get

$$y = a \log_e \cot \frac{z}{2},$$

or, expressed in common logarithms,

$$y = \frac{a}{M} \log \cot \frac{z}{2},$$

in which M is the modulus of common logarithms.

$$M = 0.4342944819,$$

$$\log M = 9.6377843113.$$

A table for the isometric colatitudes for every half degree of geodetic latitude is given in U. S. Coast and Geodetic Survey Special Publication No. 67.

The radius a is usually expressed in units of minutes on the Equator,

or

$$a = \frac{10800}{\pi},$$

$$\log a = 3.5362738828,$$

$$\log \left(\frac{a}{M} \right) = 3.8984895715.$$

$$\log y = 3.8984895715 + \log \left(\log \cot \frac{z}{2} \right),$$

or,

$$y = 7915'.704468 \log \cot \frac{z}{2}.$$

The value of x now becomes

$$x = \frac{10800}{\pi} \lambda,$$

with λ expressed in radians;

or,

$$x = \lambda,$$

with λ expressed in minutes of arc.

The table of isometric latitudes given in U. S. Coast and Geodetic Survey Special Publication No. 67 was computed for the Clarke spheroid of 1866. If it is desired

to compute values of y for any other spheroid, the expansion of y in series must be used. In this case

$$y = 7915'.704468 \log \tan \left(\frac{\pi}{4} + \frac{\varphi}{2} \right) \\ - 3437'.747 \left(\epsilon^2 \sin \varphi + \frac{\epsilon^4}{3} \sin^3 \varphi + \frac{\epsilon^6}{5} \sin^5 \varphi + \frac{\epsilon^8}{7} \sin^7 \varphi + \dots \right),$$

or, in more convenient form,

$$y = 7915'.704468 \log \tan \left(\frac{\pi}{4} + \frac{\varphi}{2} \right) - 3437'.747 \left[\left(\epsilon^2 + \frac{\epsilon^4}{4} + \frac{\epsilon^6}{8} + \frac{5\epsilon^8}{64} + \dots \right) \sin \varphi \right. \\ \left. - \left(\frac{\epsilon^4}{12} + \frac{\epsilon^6}{16} + \frac{3\epsilon^8}{64} + \dots \right) \sin 3\varphi + \left(\frac{\epsilon^6}{80} + \frac{\epsilon^8}{64} + \dots \right) \sin 5\varphi - \left(\frac{\epsilon^8}{448} + \dots \right) \sin 7\varphi \dots \right].$$

If the given spheroid is defined by the flattening, ϵ^2 may be computed from the formula

$$\epsilon^2 = 2f - f^2,$$

in which f is the flattening.

The series for y in the sines of the multiple arcs can be written with coefficients in closed form, as follows:

$$y = 7915'.704468 \log \tan \left(\frac{\pi}{4} + \frac{\varphi}{2} \right) - 3437'.747 \left(2f \sin \varphi - \frac{2f^3}{3\epsilon^2} \sin 3\varphi \right. \\ \left. + \frac{2f^5}{5\epsilon^4} \sin 5\varphi - \frac{2f^7}{7\epsilon^6} \sin 7\varphi + \dots \right),$$

in which f denotes the flattening and ϵ the eccentricity of the spheroid.

DEVELOPMENT OF THE FORMULAS FOR THE TRANSVERSE MERCATOR PROJECTION.

The expressions for the coordinates of the transverse Mercator projection can be determined by a transformation performed upon the sphere. If p is the great-circle radial distance, and ω is the azimuth reckoned from a given initial, the transverse Mercator projection in terms of these elements is expressed in the form

$$x = a \omega, \\ y = a \log_e \cot \frac{p}{2}.$$

But, from the transformation triangle (Fig. 66 on page 143), we have

$$\cos p = \sin \alpha \sin \varphi + \cos \alpha \cos \varphi \cos \lambda, \\ \tan \omega = \frac{\cos \alpha \sin \varphi - \sin \alpha \cos \varphi \cos \lambda}{\sin \lambda \cos \varphi},$$

in which α is the latitude of the point that becomes the pole in the transverse projection.

By substituting these values in the equations above, we get

$$x = a \tan^{-1} \left(\frac{\cos \alpha \sin \varphi - \sin \alpha \cos \varphi \cos \lambda}{\sin \lambda \cos \varphi} \right)$$

and

$$y = a \log_e \cot \frac{p}{2} = \frac{a}{2} \log_e \left(\frac{1 + \cos p}{1 - \cos p} \right) \\ = \frac{a}{2} \log_e \left(\frac{1 + \sin \alpha \sin \varphi + \cos \alpha \cos \varphi \cos \lambda}{1 - \sin \alpha \sin \varphi - \cos \alpha \cos \varphi \cos \lambda} \right).$$

If we wish the formulas to yield the usual values when α converges to $\frac{\pi}{2}$, we must replace λ by $\lambda - \frac{\pi}{2}$ or, in other words, we must change the meridian from which λ is reckoned by $\frac{\pi}{2}$. With this change the expressions for the coordinates become

$$x = a \tan^{-1} \left(\frac{\sin \alpha \cos \varphi \sin \lambda - \cos \alpha \sin \varphi}{\cos \varphi \cos \lambda} \right)$$

$$y = \frac{a}{2} \log_e \left(\frac{1 + \sin \alpha \sin \varphi + \cos \alpha \cos \varphi \sin \lambda}{1 - \sin \alpha \sin \varphi - \cos \alpha \cos \varphi \sin \lambda} \right).$$

With common logarithms the y coordinate becomes

$$y = \frac{a}{2M} \log \left(\frac{1 + \sin \alpha \sin \varphi + \cos \alpha \cos \varphi \sin \lambda}{1 - \sin \alpha \sin \varphi - \cos \alpha \cos \varphi \sin \lambda} \right),$$

in which M is the modulus of common logarithms.

A study of the transverse Mercator projections was made by A. Lindenkohl, U. S. Coast and Geodetic Survey, some years ago, but no charts in the modified form have ever been issued by this office.

In a transverse position the projection loses the property of straight meridians and parallels, and the loxodrome or rhumb line is no longer a straight line. Since the projection is conformal, the representation of the rhumb line must intersect the meridians on the map at a constant angle, but as the meridians become curved lines the rhumb line must also become a curved line. The transverse projection, therefore, loses this valuable property of the ordinary Mercator projection.

The distortion, or change of scale, increases with the distance from the great circle which plays the part of the Equator in the ordinary Mercator projection, but, considering the shapes and geographic location of certain areas to be charted, a transverse position would in some instances give advantageous results in the property of conformal mapping.

CONSTRUCTION OF A MERCATOR PROJECTION.

On the Mercator projection, meridians are represented by parallel and equidistant straight lines, and the parallels of latitude are represented by a system of straight lines at right angles to the former, the spacings between them conforming to the condition that at every point the angle between any two curvilinear elements upon the sphere is represented upon the chart by an equal angle between the representatives of these elements.

In order to retain the correct shape and comparative size of objects as far as possible, it becomes necessary, therefore, in constructing a Mercator chart, to increase every degree of latitude toward the pole in precisely the same proportion as the degrees of longitude have been lengthened by projection.

TABLES.

The table at present employed by the U. S. Coast and Geodetic Survey is that appearing in *Traité d'Hydrographie* by A. Germain, 1882, Table XIII. This table is as good as any at present available and is included in this publication, beginning on page 117.

The outer columns of *minutes* give the notation of minutes of latitude from the Equator to 80°.

The column of meridional distances gives the total distance of any parallel of latitude from the Equator in terms of a minute or unit of longitude on the Equator.

The column of *differences* gives the value of 1 minute of latitude in terms of a minute or unit of longitude on the Equator; thus, the length of any minute of latitude on the map is obtained by multiplying the length of a minute of longitude by the value given in the column of differences between adjacent minutes.

The first important step in the use of Mercator tables is to note the fact that a minute of longitude on the Equator is the unit of measurement and is used as an expression for the ratio of any one minute of latitude to any other. The method of construction is simple, but, on account of different types of scales employed by different chart-producing establishments, it is desirable to present two methods: (1) The diagonal metric scale method; (2) the method similar to that given in Bowditch's American Practical Navigator.

DIAGONAL METRIC SCALE METHOD AS USED IN THE U. S. COAST AND GEODETIC SURVEY.

Draw a straight line for a central meridian and a construction line perpendicular thereto, each to be as central to the sheet as the selected interval of latitude and longitude will permit. To insure greater accuracy on large sheets, the longer line of the two should be drawn first, and the shorter line erected perpendicular to it.

Example: Required a Mercator projection, Portsmouth, N. H., to Biddeford, Me., extending from latitude 43° 00' to 43° 30'; longitude 70° 00' to 71° 00', scale on middle parallel 1:400 000, projection interval 5 minutes.

The middle latitude being 43° 15', we take as the unit of measurement the true value of a minute of longitude as given in the Polyconic Projection Tables, U. S. Coast and Geodetic Survey Special Publication No. 5 (general spherical coordinates not being given in the Germain tables). Entering the proper column on page 96, we find the length of a minute of longitude to be 1353.5 meters.

As metric diagonal scales of 1:400 000 are neither available nor convenient, we ordinarily use a scale 1:10 000; this latter scale, being 40 times the former, the length of a unit of measurement on it will be one-fortieth of 1353.5, or 33.84.

Lines representing 5-minute intervals of longitude can now be drawn in on either side of the central meridian and parallel thereto at intervals of 5×33.84 or 169.2 apart on the 1:10 000 scale. (In practice it is advisable to determine the outer meridians first, 30 minutes of longitude being represented by 6×169.2 , or 1015.2; and the 5-minute intervals by 169.2, successively.)

THE PARALLELS OF LATITUDE.

The distance between the bottom parallel of the chart 43° 00' and the next 5-minute parallel—that is, 43° 05'—will be ascertained from the Mercator tables by taking the difference between the values opposite these parallels and multiplying this difference by the unit of measurement. Thus:

Latitude.	Meridional distance.
43 05	2853.987
43 00	2847.171
	6.816

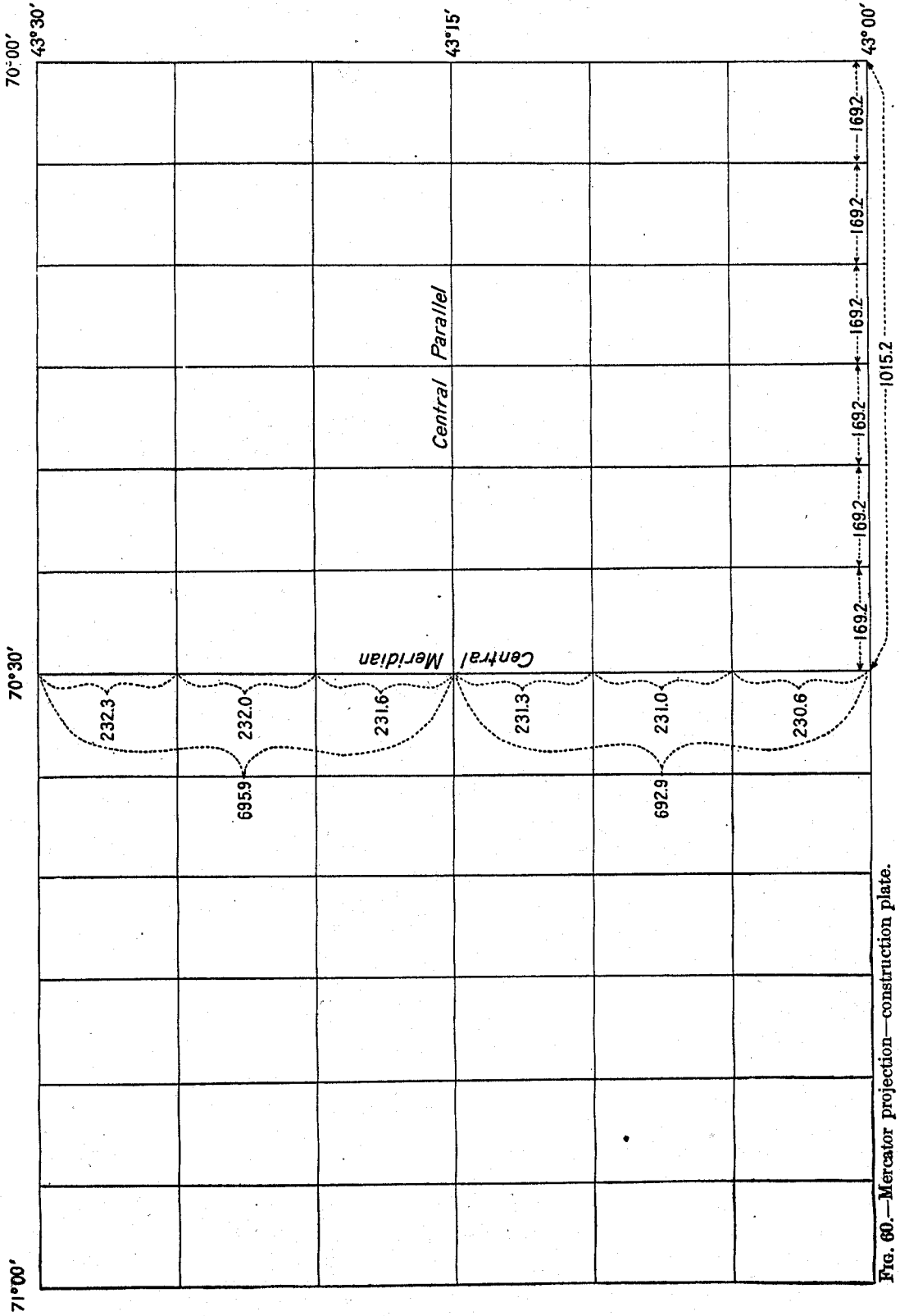

FIG. 60.—Mercator projection—construction plate.

6.816 multiplied by 33.84 = 230.6, which is the spacing from the bottom parallel to 43° 05'.

The spacings of the other 5-minute intervals obtained in the same way are as follows:

Latitude.	Spacings.
43 30	232.3
43 25	232.0
43 20	231.6
43 15	231.3
43 10	231.0
43 05	230.6
43 00	230.6
Total height of chart.....	1388.8

From the central parallel, or 43° 15', the other parallels can now be stepped off and drawn in as straight lines and the projection completed. Draw then the outer neat lines of the chart at a convenient distance outside of the inner neat lines and extend to them the meridians and parallels already constructed. Between the inner and outer neat lines of the chart subdivide the degrees of latitude and longitude as minutely as the scale of the chart will permit, the subdivisions of the degrees of longitude being found by dividing the degrees into equal parts; and the subdivisions of the degrees of latitude being accurately found in the same manner as the 5-minute intervals of latitude already described, though it will generally be sufficiently exact on large-scale charts to make even subdivisions of these intervals of latitude, as in the case of the longitude.

In northern latitudes, where the meridional increments are quite noticeable, care should be taken so as to have the latitude intervals or subdivisions computed with sufficient closeness, so that their distances apart will increase progressively.

The subdivisions along the eastern, as well as those along the western neat line, will serve for measuring or estimating terrestrial distances. Distances between points bearing north and south of each other may be ascertained by referring them to the subdivisions between their latitudes. Distances represented by lines (rhumb or loxodromic) at an angle to the meridians may be measured by taking between the dividers a small number of the subdivisions near the middle latitude of the line to be measured, and stepping them off on that line. If, for instance, the terrestrial length of a line running at an angle to the meridians, between the parallels of latitude 24° 00' and 29° 00' be required, the distance shown on the neat space between 26° 15' and 26° 45' (= 30 nautical miles)³⁰ may be taken between the dividers and stepped off on that line. An oblique line of considerable length may well be divided into parts and each part referred to its middle latitude for a unit of measurement.

TO CONSTRUCT A MERCATOR PROJECTION BY A METHOD SIMILAR TO THAT GIVEN IN BOWDITCH'S AMERICAN PRACTICAL NAVIGATOR.

If the chart includes the Equator, the values found in the tables will serve directly as factors for any properly divided diagonal scale of yards, feet, meters, or miles, these factors to be reduced proportionally to the scale adopted for the chart.

If the chart does not include the Equator then the parallels of latitude should be referred to a *principal parallel*, preferably the central or the lowest parallel to be

³⁰ Strictly speaking, a minute of latitude is equal to a nautical mile in latitude 45° 15' only. The length of a minute of latitude varies from 1842.8 meters at the Equator to 1861.7 meters at the pole.

drawn upon the chart. The distance of any other parallel of latitude from the principal parallel is the difference of the values of the two taken from the tables and reduced to the scale of the chart.

If, for example, it be required to construct a chart on a scale of one-fourth of an inch to 5 minutes of arc on the Equator, the minute or unit of measurement will be $\frac{1}{4}$ of $\frac{1}{5}$ inch, or $\frac{1}{20}$ of an inch, and 10 minutes of longitude on the Equator (or 10 meridional parts) will be represented by $\frac{1}{20}$ or 0.5 inch; likewise 10 minutes of latitude north or south of the Equator will be represented by $\frac{1}{20} \times 9.932$ or 0.4966 inch. The value 9.932 is the difference between the *meridional distances* as given opposite latitudes $0^\circ 00'$ and $0^\circ 10'$.

If the chart does not include the Equator, and if the middle parallel is latitude 40° , and the scale of this parallel is to be one-fourth of an inch to 5 minutes, then the measurement for 10 minutes on this parallel will be the same as before, but the measurement of the interval between $40^\circ 00'$ and $40^\circ 10'$ will be $\frac{1}{20} \times 13.018$, or 0.6509 inch. The value 13.018 is the difference of the *meridional distances* as given opposite these latitudes, i. e., the difference between 2620.701 and 2607.683.

(It may often be expedient to construct a diagonal scale of inches on the drawing to facilitate the construction of a projection on the required scale.)

Sometimes it is desirable to adapt the scale of a chart to a certain allotment of paper.

Example: Let a projection be required for a chart of 14° extent in longitude between the parallels of latitude $20^\circ 30'$ and $30^\circ 25'$, and let the space allowable on the paper between these parallels be 10 inches.

Draw in the center of the sheet a straight line for the central meridian of the chart. Construct carefully two lines perpendicular to the central meridian and 10 inches apart, one near the lower border of the sheet for parallel of latitude $20^\circ 30'$ and an upper one for parallel of latitude $30^\circ 25'$.

Entering the tables in the column *meridional distance* we find for latitude $20^\circ 30'$ the value 1248.945, and for latitude $30^\circ 25'$ the value 1905.488. The difference, or $1905.488 - 1248.945 = 656.543$, is the value of the meridional arc between these latitudes, for which 1 minute of arc of the Equator is taken as a unit. On the projection, therefore, 1 minute of arc of longitude will measure $\frac{10 \text{ in.}}{656.543} = 0.0152$ inch, which will be the unit of measurement. By this quantity all the values derived from the table must be multiplied before they can be used on a diagonal scale of inches for this chart.

As the chart covers 14° of longitude, the 7° on either side of the central meridian will be represented by $0.0152 \times 60 \times 7$, or 6.38 inches. These distances can be laid off from the central meridian east and west on the upper and lower parallel. Through the points thus obtained draw lines parallel to the central meridian, and these will be the eastern and western neat lines of the chart.

In order to obtain the spacing, or interval, between the parallel of latitude $21^\circ 00'$ and the bottom parallel of $20^\circ 30'$, we find the difference between their meridional distances and multiply this difference by the unit of measurement, which is 0.0152.

Thus:

$$(1280.835 - 1248.945) \times 0.0152$$

$$\text{or } 31.890 \times 0.0152 = 0.485 \text{ inch.}$$

On the three meridians already constructed lay off this distance from the bottom parallel, and through the points thus obtained draw a straight line which will be the parallel $21^{\circ} 00'$.

Proceed in the same manner to lay down all the parallels answering to full degrees of latitude; the distances for 22° , 23° , and 24° from the bottom parallel will be, respectively:

$$\begin{aligned} 0.0152 \times (1344.945 - 1248.945) &= 1.459 \text{ inches} \\ 0.0152 \times (1409.513 - 1248.945) &= 2.441 \text{ inches} \\ 0.0152 \times (1474.566 - 1248.945) &= 3.429 \text{ inches, etc.} \end{aligned}$$

Finally, lay down in the same way the parallel $30^{\circ} 25'$, which will be the northern inner neat line of the chart.

A degree of longitude will measure on this chart $0.0152 \times 60 = 0.912$ inch. Lay off, therefore, on the lowest parallel of latitude, on the middle one, and on the highest parallel, measuring from the central meridian toward either side, the distances 0.912 inch, 1.824 inches, 2.736 inches, 3.648 inches, etc., in order to determine the points where meridians answering to full degrees cross the parallels drawn on the chart. Through the points thus found draw the straight lines representing the meridians.

If it occurs that a Mercator projection is to be constructed on a piece of paper where the size is controlled by the limits of longitude, the case may be similarly treated.

CONSTRUCTION OF A TRANSVERSE MERCATOR PROJECTION FOR THE SPHERE WITH THE CYLINDER TANGENT ALONG A MERIDIAN.

The Anti-Gudermannian table given on pages 309 to 318 in "Smithsonian Mathematical Tables—Hyperbolic Functions" is really a table of meridional distances for the sphere. By use of this table an ordinary Mercator projection can be constructed for the sphere. Upon this graticule the transverse Mercator can be plotted by use of the table, "Transformation from geographical to azimuthal coordinates—Center on the Equator" given in U. S. Coast and Geodetic Survey Special Publication No. 67, "Latitude Developments Connected with Geodesy and Cartography, with Tables, Including a Table for Lambert Equal-Area Meridional Projection."

Figure 61 shows such a transverse Mercator projection for a hemisphere; the pole is the origin and the horizontal meridian is the central meridian. The dotted lines are the lines of the original Mercator projection. Since the projection is turned 90° in azimuth, the original meridians are horizontal lines and the parallels are vertical lines, the vertical meridian of the transverse projection being the Equator of the original projection. The numbers of the meridians in the transverse projection are the complements of the numbers of the parallels in the original projection. The same thing is true in regard to the parallels in the transverse projection and the meridians in the original projection. That is, where the number 20 is given for the transverse projection, we must read 70 in the original projection.

The table in Special Publication No. 67 consists of two parts, the first part giving the values of the azimuths reckoned from the north and the second part giving the great-circle central distances. From this table we get for the intersection of latitude 10° with longitude 10° ,

	°	/	"
azimuth	=44	33	41.2
radial distance	=14	06	21.6

To the nearest minute these become

$$\alpha = 44^{\circ} 34'$$

$$\zeta = 14 06$$

The azimuth becomes longitude in the original projection and is laid off upward from the origin, or the point marked "pole" in the figure. The radial distance is the complement of the latitude on the original projection; hence the chosen intersection lies in longitude $44^{\circ} 34'$ and latitude $75^{\circ} 54'$ on the original projection.

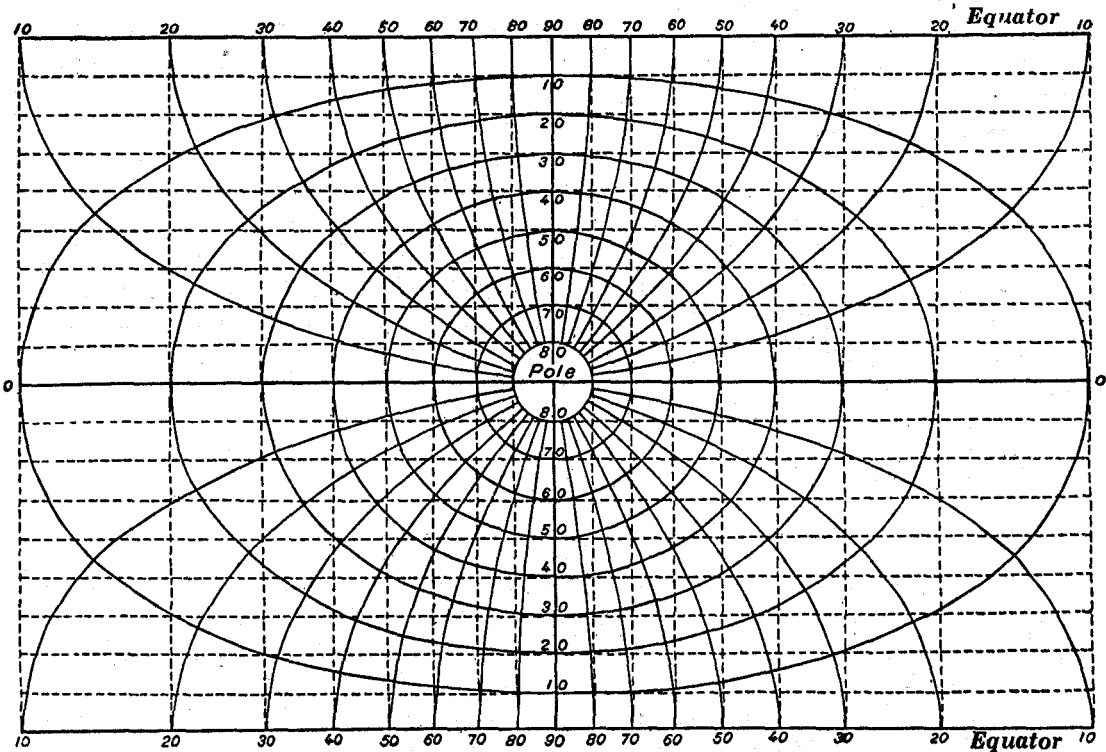

FIG. 61.—Transverse Mercator projection—cylinder tangent along a meridian—construction plate.

It can be seen from the figure that there are three other points symmetrically situated with respect to this point, one in each of the other three quadrants. If the intersections in one quadrant are actually plotted, the other quadrants may be copied from this construction. Another hemisphere added either above or below will complete the sphere, with the exception, of course, of the part that passes off to infinity.

In practice the original projection need not be drawn, or, if it is drawn, the lines should be light pencil lines used for guidance only. If longitude $44^{\circ} 34'$ is laid off upward along a vertical line from an origin, and the meridional distance for $75^{\circ} 54'$ is laid off to the right, the intersection of the meridian of 10° with the parallel of 10° is located upon the map. In a similar manner, by the use of the table in Special Publication No. 67, the other intersections of the parallel of 10° can be located; then a smooth curve drawn through these points so determined will be the parallel of 10° . Also the other intersections of the meridian of 10° can be located, and a smooth curve drawn through these points will represent the meridian of 10° .

The table in Special Publication No. 67 gives the intersections for 5° intervals in both latitude and longitude for one-fourth of a hemisphere. This is sufficient for the construction of one quadrant of the hemisphere on the map. As stated above, the remaining quadrants can either be copied from this construction, or the values may be plotted from the consideration of symmetry. In any case figure 61 will serve as a guide in the process of construction.

In the various problems of *conformal* and *equal-area* mapping, any solution that will satisfy the shapes or extents of the areas involved in the former system has generally a counterpart or natural complement in the latter system. Thus, where we map a given locality on the Lambert conformal conic projection for purposes of conformality, we may on the other hand employ the Albers projection for equal-area representation of the same region; likewise, in mapping a hemisphere, the stereographic meridional projection may be contrasted with the Lambert meridional projection, the stereographic horizon projection with the Lambert zenithal; and so, with a fair degree of accuracy, the process above described will give us conformal representation of the sphere suited to a zone of predominating meridional dimensions as a counterpart of the Bonne system of equal-area mapping of the same zone. Such a zone would, of course, for purposes of conformality, be more accurately mapped by the more rigid transverse method on the spheroid which has also been described and which may be adapted to any transverse relation.

MERCATOR PROJECTION TABLE.

[Reprinted from *Traité d'Hydrographie*, A. Germain, Ingénieur Hydrographe de la Marine, Paris, MDCCLXXXII, to latitude 80° only.]

NOTE.

It is observed in this table that the meridional differences are irregular and that second differences frequently vary from plus to minus. The tables might well have been computed to one more place in decimals to insure the smooth construction of a projection.

In the use of any meridional distance below latitude $50^\circ 00'$ the following process will eliminate irregularities in the construction of large scale maps and is within scaling accuracy:

To any meridional distance add the one above and the one below and take the mean, thus:

Latitude.	Meridional distances.
° ' "	
28 35	1779.745
28 36	1780.877
28 37	1782.011
	5342.633

The mean to be used for latitude $28^\circ 36'$ is 1780.877

MERCATOR PROJECTION TABLE.

[Meridional distances for the spheroid. Compression $\frac{1}{254}$]

Min-utes.	0°		1°		2°		3°		Min-utes.
	Meridional distance.	Difference.	Meridional distance.	Difference.	Meridional distance.	Difference.	Meridional distance.	Difference.	
0	0.000	0.993	59.596	0.994	119.210	0.994	178.862	0.994	0
1	0.993	993	60.590	993	120.204	994	179.856	995	1
2	1.986	994	61.583	993	121.198	994	180.851	994	2
3	2.980	993	62.576	994	122.192	994	181.845	995	3
4	3.973	993	63.570	993	123.186	994	182.840	994	4
5	4.966	993	64.563	993	124.180	994	183.834	995	5
6	5.959	993	65.556	994	125.174	994	184.829	995	6
7	6.952	994	66.550	993	126.168	994	185.824	994	7
8	7.946	993	67.543	994	127.162	993	186.818	995	8
9	8.939	993	68.537	993	128.155	994	187.813	995	9
10	9.932	0.993	69.530	0.993	129.149	0.994	188.808	0.994	10
11	10.925	993	70.523	994	130.143	994	189.802	995	11
12	11.918	994	71.517	993	131.137	994	190.797	995	12
13	12.912	993	72.510	994	132.131	994	191.792	995	13
14	13.905	993	73.504	993	133.125	994	192.787	995	14
15	14.898	993	74.497	994	134.119	994	193.782	995	15
16	15.891	993	75.491	993	135.113	994	194.777	995	16
17	16.884	994	76.484	993	136.107	994	195.772	995	17
18	17.878	993	77.477	994	137.101	994	196.767	995	18
19	18.871	993	78.471	993	138.095	994	197.762	995	19
20	19.864	0.993	79.464	0.994	139.089	0.994	198.757	0.995	20
21	20.857	994	80.458	993	140.083	994	199.752	995	21
22	21.851	993	81.451	994	141.077	995	200.747	995	22
23	22.844	993	82.445	993	142.072	994	201.742	995	23
24	23.837	994	83.438	994	143.066	994	202.737	995	24
25	24.831	993	84.432	993	144.060	994	203.732	995	25
26	25.824	993	85.425	994	145.054	994	204.727	995	26
27	26.817	993	86.419	994	146.048	994	205.722	995	27
28	27.810	994	87.413	993	147.042	994	206.717	995	28
29	28.804	993	88.406	994	148.036	994	207.712	995	29
30	29.797	0.993	89.400	0.993	149.030	0.994	208.707	0.995	30
31	30.790	993	90.393	994	150.024	995	209.702	995	31
32	31.783	994	91.387	993	151.019	994	210.697	995	32
33	32.777	993	92.380	994	152.013	994	211.692	995	33
34	33.770	993	93.374	994	153.007	994	212.687	995	34
35	34.763	994	94.368	993	154.001	995	213.682	995	35
36	35.757	993	95.361	994	154.996	994	214.677	996	36
37	36.750	993	96.355	993	155.990	994	215.673	995	37
38	37.743	993	97.348	994	156.984	994	216.668	995	38
39	38.736	994	98.342	994	157.978	995	217.663	995	39
40	39.730	0.993	99.336	0.993	158.973	0.994	218.658	0.996	40
41	40.723	993	100.329	994	159.967	994	219.654	995	41
42	41.716	994	101.323	993	160.961	995	220.649	995	42
43	42.710	993	102.316	994	161.956	994	221.644	996	43
44	43.703	993	103.310	994	162.950	994	222.640	995	44
45	44.696	993	104.304	994	163.944	995	223.635	996	45
46	45.689	994	105.298	993	164.939	994	224.631	995	46
47	46.683	993	106.291	994	165.933	995	225.626	996	47
48	47.676	993	107.285	994	166.928	994	226.622	995	48
49	48.669	994	108.279	994	167.922	995	227.617	996	49
50	49.663	0.993	109.273	0.993	168.917	0.994	228.613	0.995	50
51	50.656	993	110.266	994	169.911	994	229.608	995	51
52	51.649	994	111.260	994	170.905	995	230.603	996	52
53	52.643	993	112.254	993	171.900	994	231.599	995	53
54	53.636	993	113.247	994	172.894	995	232.594	996	54
55	54.629	994	114.241	994	173.889	994	233.590	995	55
56	55.623	993	115.235	994	174.883	995	234.585	996	56
57	56.616	993	116.229	994	175.878	994	235.581	996	57
58	57.609	994	117.223	993	176.872	995	236.577	995	58
59	58.603	0.993	118.216	0.994	177.867	0.995	237.572	0.996	59
60	59.596		119.210		178.862		238.568		60

MERCATOR PROJECTION TABLE—Continued.

[Meridional distances for the spheroid. Compression $\frac{1}{294}$]

Min-utes.	4°		5°		6°		7°		Min-utes.
	Meridional distance.	Difference.	Meridional distance.	Difference.	Meridional distance.	Difference.	Meridional distance.	Difference.	
0	238.568	0.996	298.348	0.997	358.222	0.998	418.206	1.001	0
1	239.564	995	299.345	997	359.220	999	419.207	001	1
2	240.559	996	300.342	998	360.219	999	420.208	001	2
3	241.555	996	301.340	997	361.218	999	421.209	000	3
4	242.551	996	302.337	997	362.217	999	422.209	001	4
5	243.547	996	303.334	997	363.216	999	423.210	001	5
6	244.543	995	304.331	997	364.215	998	424.211	001	6
7	245.538	996	305.328	998	365.213	999	425.212	001	7
8	246.534	996	306.326	997	366.212	0.999	426.213	001	8
9	247.530	996	307.323	997	367.211	1.000	427.214	002	9
10	248.526	0.996	308.320	0.998	368.211	0.999	428.216	1.001	10
11	249.522	996	309.318	997	369.210	999	429.217	001	11
12	250.518	996	310.315	997	370.209	999	430.218	001	12
13	251.514	996	311.312	998	371.208	999	431.219	001	13
14	252.510	996	312.310	997	372.207	0.999	432.220	002	14
15	253.506	996	313.307	998	373.206	1.000	433.222	001	15
16	254.502	996	314.305	997	374.206	0.999	434.223	001	16
17	255.498	996	315.302	998	375.205	0.999	435.224	002	17
18	256.494	996	316.300	998	376.204	1.000	436.226	001	18
19	257.490	996	317.298	997	377.204	0.999	437.227	002	19
20	258.486	0.996	318.295	0.998	378.203	1.000	438.229	1.001	20
21	259.482	996	319.293	998	379.203	0.999	439.230	002	21
22	260.478	996	320.291	997	380.202	1.000	440.232	002	22
23	261.474	996	321.288	998	381.202	0.999	441.234	001	23
24	262.470	997	322.286	998	382.201	1.000	442.235	002	24
25	263.467	996	323.284	997	383.201	0.999	443.237	002	25
26	264.463	996	324.281	998	384.200	1.000	444.239	002	26
27	265.459	996	325.279	998	385.200	1.000	445.241	001	27
28	266.455	996	326.277	998	386.200	0.999	446.242	002	28
29	267.451	997	327.275	998	387.199	0.999	447.244	002	29
30	268.448	0.996	328.273	0.997	388.198	1.000	448.246	1.002	30
31	269.444	996	329.270	998	389.198	000	449.248	002	31
32	270.440	997	330.268	998	390.198	000	450.250	002	32
33	271.437	996	331.266	998	391.198	000	451.252	002	33
34	272.433	997	332.264	998	392.198	000	452.254	002	34
35	273.430	996	333.262	998	393.198	000	453.256	002	35
36	274.426	997	334.260	998	394.198	000	454.258	002	36
37	275.423	996	335.258	998	395.198	000	455.260	002	37
38	276.419	997	336.256	998	396.198	000	456.262	002	38
39	277.416	996	337.254	999	397.198	000	457.264	003	39
40	278.412	0.997	338.253	0.998	398.198	1.000	458.267	1.002	40
41	279.409	997	339.251	998	399.198	000	459.269	003	41
42	280.406	996	340.249	998	400.198	000	460.272	002	42
43	281.402	997	341.247	998	401.198	000	461.274	003	43
44	282.399	997	342.245	999	402.198	000	462.277	002	44
45	283.396	996	343.244	998	403.198	001	463.279	003	45
46	284.392	997	344.242	998	404.199	000	464.282	002	46
47	285.389	997	345.240	999	405.199	000	465.284	003	47
48	286.386	997	346.239	998	406.199	001	466.287	002	48
49	287.383	997	347.237	999	407.200	000	467.289	003	49
50	288.380	0.996	348.236	0.998	408.200	1.001	468.292	1.003	50
51	289.376	997	349.234	999	409.201	000	469.295	002	51
52	290.373	997	350.233	998	410.201	001	470.297	003	52
53	291.370	997	351.231	999	411.202	000	471.300	003	53
54	292.367	996	352.230	998	412.202	001	472.303	003	54
55	293.363	997	353.228	999	413.203	000	473.306	003	55
56	294.360	997	354.227	999	414.203	001	474.309	003	56
57	295.357	997	355.226	998	415.204	001	475.312	002	57
58	296.354	997	356.224	999	416.205	001	476.314	003	58
59	297.351	0.997	357.223	0.999	417.206	1.000	477.317	1.004	59
60	298.348		358.222		418.206		478.321		60

MERCATOR PROJECTION TABLE—Continued.

[Meridional distances for the spheroid. Compression $\frac{1}{294}$]

Minutes.	8°		9°		10°		11°		Minutes.
	Meridional distance.	Difference.	Meridional distance.	Difference.	Meridional distance.	Difference.	Meridional distance.	Difference.	
0	478.321		538.585		599.019		659.641		0
1	479.324	1.003	539.591	1.006	600.028	1.009	660.653	1.012	1
2	480.327	003	540.597	006	601.037	009	661.665	012	2
3	481.330	003	541.603	006	602.046	009	662.678	012	3
4	482.333	004	542.609	006	603.054	009	663.690	012	4
5	483.337	003	543.615	006	604.063	009	664.702	013	5
6	484.340	003	544.621	006	605.072	009	665.715	012	6
7	485.343	004	545.627	006	606.081	010	666.727	013	7
8	486.347	003	546.633	006	607.091	009	667.740	012	8
9	487.350	004	547.639	007	608.100	009	668.752	013	9
10	488.354	1.003	548.646	1.006	609.109	1.009	669.765	1.013	10
11	489.357	004	549.652	006	610.118	010	670.778	012	11
12	490.361	004	550.658	006	611.128	009	671.790	013	12
13	491.365	004	551.664	007	612.137	009	672.803	013	13
14	492.369	003	552.671	006	613.146	010	673.816	013	14
15	493.372	004	553.677	007	614.156	010	674.829	013	15
16	494.376	004	554.684	006	615.166	009	675.842	013	16
17	495.380	004	555.690	007	616.175	010	676.855	013	17
18	496.384	004	556.697	006	617.185	010	677.868	013	18
19	497.388	004	557.703	007	618.195	009	678.881	013	19
20	498.392	1.004	558.710	1.007	619.204	1.010	679.894	1.013	20
21	499.396	004	559.717	007	620.214	010	680.907	013	21
22	500.400	004	560.724	007	621.224	010	681.920	014	22
23	501.404	004	561.731	006	622.234	010	682.934	013	23
24	502.408	004	562.737	007	623.244	010	683.947	014	24
25	503.412	004	563.744	007	624.254	010	684.961	013	25
26	504.416	004	564.751	007	625.264	011	685.974	014	26
27	505.420	004	565.758	008	626.275	010	686.988	014	27
28	506.424	005	566.766	007	627.285	010	688.002	013	28
29	507.429	004	567.773	007	628.295	010	689.015	014	29
30	508.433	1.004	568.780	1.007	629.305	1.011	690.029	1.014	30
31	509.437	005	569.787	008	630.316	010	691.043	014	31
32	510.442	004	570.795	007	631.326	011	692.057	014	32
33	511.446	005	571.802	007	632.337	010	693.071	014	33
34	512.451	004	572.809	008	633.347	011	694.085	014	34
35	513.455	005	573.817	007	634.358	011	695.099	014	35
36	514.460	005	574.824	008	635.369	010	696.113	015	36
37	515.465	004	575.832	007	636.379	011	697.128	014	37
38	516.469	005	576.839	008	637.390	011	698.142	014	38
39	517.474	005	577.847	008	638.401	011	699.156	015	39
40	518.479	1.005	578.855	1.007	639.412	1.011	700.171	1.014	40
41	519.484	005	579.862	008	640.423	011	701.185	015	41
42	520.489	005	580.870	008	641.434	011	702.200	015	42
43	521.494	005	581.878	008	642.445	011	703.215	014	43
44	522.499	005	582.886	008	643.456	011	704.229	015	44
45	523.504	005	583.894	008	644.467	011	705.244	015	45
46	524.509	005	584.902	008	645.478	011	706.259	015	46
47	525.514	005	585.910	008	646.489	011	707.274	015	47
48	526.519	006	586.918	008	647.500	012	708.289	015	48
49	527.525	005	587.926	008	648.512	011	709.304	015	49
50	528.530	1.005	588.934	1.008	649.523	1.012	710.319	1.015	50
51	529.535	005	589.942	009	650.535	011	711.334	015	51
52	530.540	006	590.951	008	651.546	012	712.349	015	52
53	531.546	005	591.959	009	652.558	012	713.364	015	53
54	532.551	006	592.968	008	653.570	011	714.379	016	54
55	533.557	006	593.976	009	654.581	012	715.395	015	55
56	534.563	005	594.985	008	655.593	012	716.410	015	56
57	535.568	006	595.993	009	656.605	012	717.425	016	57
58	536.574	006	597.002	008	657.617	012	718.441	016	58
59	537.580	1.005	598.010	1.009	658.629	1.012	719.457	1.015	59
60	538.585		599.019		659.641		720.472		60

MERCATOR PROJECTION TABLE—Continued.

[Meridional distances for the spheroid. Compression $\frac{1}{294}$]

Min-utes.	12°		13°		14°		15°		Min-utes.
	Meridional distance.	Difference.	Meridional distance.	Difference.	Meridional distance.	Difference.	Meridional distance.	Difference.	
0	720. 472		781. 532		842. 842		904. 422		0
1	721. 488	1. 016	782. 552	1. 020	843. 866	1. 024	905. 451	1. 029	1
2	722. 504	016	783. 572	020	844. 890	024	906. 480	029	2
3	723. 520	016	784. 592	020	845. 915	025	907. 509	029	3
4	724. 535	015	785. 612	020	846. 939	024	908. 538	029	4
		016		020		024		029	
5	725. 551	016	786. 632	020	847. 963	025	909. 567	029	5
6	726. 567	017	787. 652	020	848. 988	024	910. 596	030	6
7	727. 584	016	788. 672	020	850. 012	025	911. 626	029	7
8	728. 600	016	789. 692	020	851. 037	024	912. 655	029	8
9	729. 616	016	790. 712	021	852. 061	025	913. 684	030	9
10	730. 632		791. 733		853. 086		914. 714		10
11	731. 649	1. 017	792. 753	1. 020	854. 111	1. 025	915. 743	1. 029	11
12	732. 665	016	793. 773	020	855. 136	025	916. 773	030	12
13	733. 682	017	794. 794	021	856. 161	025	917. 803	030	13
14	734. 698	016	795. 814	020	857. 186	025	918. 832	029	14
		017		021		025		030	
15	735. 715	017	796. 835	021	858. 211	025	919. 862	030	15
16	736. 732	017	797. 856	021	859. 236	026	920. 892	030	16
17	737. 749	017	798. 877	021	860. 262	026	921. 922	030	17
18	738. 765	016	799. 898	021	861. 287	025	922. 953	031	18
19	739. 782	017	800. 919	021	862. 312	025	923. 983	030	19
		017		021		025		030	
20	740. 799		801. 940		863. 337		925. 013		20
21	741. 816	1. 017	802. 961	1. 021	864. 363	1. 026	926. 044	1. 031	21
22	742. 833	017	803. 982	021	865. 389	026	927. 074	030	22
23	743. 850	017	805. 003	021	866. 415	026	928. 105	031	23
24	744. 868	018	806. 025	022	867. 440	025	929. 135	030	24
		017		021		026		031	
25	745. 885	017	807. 046	022	868. 466	026	930. 166	031	25
26	746. 902	017	808. 068	021	869. 492	026	931. 197	031	26
27	747. 919	018	809. 089	022	870. 518	026	932. 228	031	27
28	748. 937	017	810. 111	022	871. 544	027	933. 259	031	28
29	749. 954	018	811. 133	022	872. 571	026	934. 290	031	29
		018		022		026		031	
30	750. 972		812. 155		873. 597		935. 321		30
31	751. 990	1. 018	813. 177	1. 022	874. 623	1. 026	936. 352	1. 031	31
32	753. 007	017	814. 199	022	875. 649	026	937. 384	032	32
33	754. 025	018	815. 221	022	876. 676	027	938. 415	031	33
34	755. 043	018	816. 243	022	877. 702	026	939. 447	032	34
		018		022		027		031	
35	756. 061	018	817. 265	022	878. 729	027	940. 478	032	35
36	757. 079	018	818. 287	022	879. 756	026	941. 510	032	36
37	758. 097	018	819. 309	022	880. 782	027	942. 542	032	37
38	759. 115	018	820. 332	023	881. 809	027	943. 573	031	38
39	760. 134	019	821. 354	022	882. 836	027	944. 605	032	39
		018		023		027		032	
40	761. 152		822. 377		883. 863		945. 637		40
41	762. 170	1. 018	823. 399	1. 022	884. 891	1. 028	946. 669	1. 032	41
42	763. 189	019	824. 422	023	885. 918	027	947. 702	033	42
43	764. 207	018	825. 444	022	886. 946	028	948. 734	032	43
44	765. 226	019	826. 467	023	887. 973	027	949. 766	032	44
		018		023		028		033	
45	766. 244	019	827. 490	023	889. 001	027	950. 799	033	45
46	767. 263	019	828. 513	023	890. 028	028	951. 832	032	46
47	768. 282	019	829. 536	023	891. 056	028	952. 864	032	47
48	769. 301	019	830. 559	023	892. 084	028	953. 896	032	48
49	770. 320	019	831. 582	023	893. 112	028	954. 929	033	49
		019		023		028		033	
50	771. 339		832. 605		894. 140		955. 962		50
51	772. 358	1. 019	833. 629	1. 024	895. 168	1. 028	956. 995	1. 033	51
52	773. 377	019	834. 652	023	896. 196	028	958. 028	033	52
53	774. 396	019	835. 676	024	897. 224	028	959. 061	033	53
54	775. 415	019	836. 699	023	898. 252	028	960. 095	034	54
		019		024		028		033	
55	776. 434	020	837. 723	024	899. 280	028	961. 128	033	55
56	777. 454	019	838. 747	024	900. 308	029	962. 161	034	56
57	778. 473	020	839. 771	023	901. 337	028	963. 195	033	57
58	779. 493	020	840. 794	023	902. 365	028	964. 228	033	58
59	780. 513	020	841. 818	024	903. 394	029	965. 262	034	59
60	781. 532	1. 019	842. 842	1. 024	904. 422	1. 028	966. 296	1. 034	60

MERCATOR PROJECTION TABLE—Continued.

[Meridional distances for the spheroid. Compression $\frac{1}{294}$]

Minutes.	16°		17°		18°		19°		Minutes.
	Meridional distance.	Difference.	Meridional distance.	Difference.	Meridional distance.	Difference.	Meridional distance.	Difference.	
0	966.296		1028.483		1091.007		1153.893		0
1	967.330	1.034	29.522	1.039	92.052	1.045	54.943	1.052	1
2	968.364	034	30.561	039	93.098	046	55.994	051	2
3	969.398	034	31.600	039	94.143	045	57.046	052	3
4	970.432	034	32.640	040	95.188	045	58.097	051	4
5	971.466	034	33.680	039	96.234	046	59.149	052	5
6	972.500	034	34.719	040	97.279	045	60.201	052	6
7	973.534	034	35.759	040	98.325	045	61.253	052	7
8	974.568	035	36.799	040	1099.370	046	62.305	052	8
9	975.603	035	37.839	040	1100.416	046	63.357	052	9
10	976.638		1038.879		1101.462		1164.411		10
11	977.673	1.035	39.920	1.041	02.508	1.046	65.461	1.052	11
12	978.707	034	40.960	040	03.554	046	66.514	053	12
13	979.742	035	42.000	040	04.601	047	67.566	052	13
14	980.777	035	43.041	041	05.647	046	68.619	053	14
15	981.812	035	44.082	040	06.693	047	69.672	052	15
16	982.847	035	45.122	041	07.740	047	70.724	053	16
17	983.882	036	46.163	041	08.787	047	71.777	053	17
18	984.918	036	47.204	041	09.833	046	72.830	053	18
19	985.953	035	48.245	041	10.880	047	73.884	054	19
20	986.988		1049.286		1111.927		1174.939		20
21	988.024	1.036	50.327	1.041	12.974	1.047	75.990	1.053	21
22	989.060	036	51.368	041	14.021	047	77.044	054	22
23	990.095	035	52.409	041	15.069	048	78.097	053	23
24	991.131	036	53.451	042	16.116	047	79.151	054	24
25	992.167	036	54.493	042	17.163	047	80.205	054	25
26	993.203	036	55.534	041	18.211	048	81.259	054	26
27	994.239	036	56.576	042	19.259	048	82.313	054	27
28	995.276	037	57.618	042	20.307	048	83.367	054	28
29	996.312	036	58.660	042	21.354	047	84.421	054	29
30	997.348		1059.702		1122.402		1185.478		30
31	998.385	1.037	60.744	1.042	23.451	1.049	86.530	1.054	31
32	999.421	036	61.786	042	24.499	048	87.585	055	32
33	1000.458	037	62.828	042	25.547	048	88.640	055	33
34	01.495	037	63.870	042	26.595	048	89.695	055	34
35	02.532	037	64.913	043	27.644	049	90.750	055	35
36	03.569	037	65.956	043	28.693	048	91.805	055	36
37	04.606	037	66.998	042	29.741	048	92.860	055	37
38	05.643	037	68.041	043	30.790	049	93.915	055	38
39	06.680	038	69.084	043	31.839	049	94.971	056	39
40	1007.718		1070.127		1132.888		1196.028		40
41	08.755	1.037	71.170	1.043	33.937	1.049	97.082	1.056	41
42	09.793	038	72.213	043	34.987	050	98.137	055	42
43	10.830	037	73.257	044	36.036	049	99.193	056	43
44	11.878	038	74.300	043	37.086	050	1199.193	056	44
45	12.906	037	75.343	044	38.135	049	1200.249	056	45
46	13.943	038	76.387	044	39.185	050	01.305	056	46
47	14.981	038	77.431	044	40.235	050	02.361	056	47
48	16.019	038	78.475	044	41.285	050	03.417	057	48
49	17.058	039	79.518	043	42.335	050	04.474	056	49
50	1018.096		1080.562		1143.385		1206.589		50
51	19.134	1.038	81.607	1.045	44.435	1.050	05.530	1.056	51
52	20.172	038	82.651	044	45.485	050	07.643	057	52
53	21.210	038	83.695	044	46.536	051	08.700	057	53
54	22.249	039	84.739	044	47.586	050	09.757	057	54
55	23.288	039	85.784	045	48.637	051	10.814	057	55
56	24.327	039	86.828	044	49.688	051	11.871	058	56
57	25.366	039	87.873	045	50.738	050	12.929	057	57
58	26.405	039	88.918	045	51.789	051	13.986	058	58
59	27.444	039	89.963	045	52.840	051	15.044	057	59
60	1028.483	1.039	1091.007	1.044	1153.891	1.051	16.101	1.058	60
							1217.159		

MERCATOR PROJECTION TABLE—Continued.

[Meridional distances for the spheroid. Compression $\frac{1}{294}$]

Min-utes.	20°		21°		22°		23°		Min-utes.
	Meridional distance.	Difference.	Meridional distance.	Difference.	Meridional distance.	Difference.	Meridional distance.	Difference.	
0	1217.161	1.058	1280.835	1.065	1344.945	1.072	1409.513	1.080	0
1	18.217	058	81.900	065	46.017	072	10.593	080	1
2	19.275	058	82.965	065	47.089	073	11.673	081	2
3	20.333	059	84.030	065	48.162	073	12.754	080	3
4	21.392	058	85.095	066	49.235	072	13.834	081	4
5	22.450	059	86.161	065	50.307	073	14.915	081	5
6	23.509	058	87.226	066	51.380	073	15.996	081	6
7	24.567	059	88.292	065	52.453	073	17.077	081	7
8	25.626	059	89.357	066	53.526	074	18.158	081	8
9	26.685	059	90.423	066	54.600	073	19.239	082	9
10	1227.744	1.059	1291.489	1.066	1355.673	1.074	1420.321	1.081	10
11	28.803	059	92.555	066	56.747	073	21.402	082	11
12	29.862	059	93.621	067	57.820	074	22.484	082	12
13	30.921	059	94.688	066	58.894	074	23.566	081	13
14	31.980	060	95.754	067	59.968	074	24.647	082	14
15	33.040	059	96.821	066	61.042	074	25.729	083	15
16	34.099	060	97.887	057	62.116	075	26.812	082	16
17	35.159	059	1298.954	067	63.191	074	27.894	082	17
18	36.218	060	1300.021	067	64.265	075	28.976	083	18
19	37.278	060	01.088	067	65.340	075	30.059	083	19
20	1238.340	1.061	1302.155	1.068	1366.415	1.074	1431.142	1.083	20
21	39.399	060	03.223	067	67.489	075	32.225	083	21
22	40.459	060	04.290	068	68.564	076	33.308	083	22
23	41.519	061	05.358	067	69.640	075	34.391	083	23
24	42.580	060	06.425	068	70.715	075	35.474	083	24
25	43.640	061	07.493	068	71.790	076	36.557	084	25
26	44.701	061	08.561	068	72.866	076	37.641	084	26
27	45.762	061	09.629	068	73.942	075	38.725	084	27
28	46.823	061	10.697	068	75.017	076	39.809	084	28
29	47.884	061	11.765	069	76.093	076	40.893	084	29
30	1248.945	1.061	1312.834	1.068	1377.169	1.076	1441.977	1.084	30
31	50.006	062	13.902	069	78.245	077	43.061	085	31
32	51.068	061	14.971	069	79.322	076	44.146	084	32
33	52.129	062	16.040	069	80.398	077	45.230	085	33
34	53.191	061	17.109	069	81.475	076	46.315	085	34
35	54.252	062	18.178	069	82.551	077	47.400	085	35
36	55.314	062	19.247	069	83.628	077	48.485	085	36
37	56.376	062	20.316	070	84.705	077	49.570	085	37
38	57.438	063	21.386	069	85.782	078	50.655	086	38
39	58.501	062	22.455	070	86.860	077	51.741	085	39
40	1259.563	1.063	1323.525	1.070	1387.937	1.077	1452.826	1.086	40
41	60.626	062	24.595	070	89.014	078	53.912	086	41
42	61.688	063	25.665	070	90.092	078	54.998	086	42
43	62.751	063	26.735	070	91.170	078	56.084	086	43
44	63.814	063	27.805	070	92.248	078	57.170	086	44
45	64.877	063	28.875	070	93.326	078	58.256	087	45
46	65.940	063	29.945	071	94.404	078	59.343	086	46
47	67.003	064	31.016	070	95.482	079	60.429	087	47
48	68.067	063	32.086	071	96.561	078	61.516	087	48
49	69.130	064	33.157	071	97.639	079	62.603	087	49
50	1270.192	1.063	1334.228	1.071	1398.718	1.079	1463.690	1.086	50
51	71.257	064	35.299	071	1399.797	079	64.776	088	51
52	72.321	064	36.370	072	1400.876	079	65.864	087	52
53	73.385	064	37.442	071	01.955	079	66.951	087	53
54	74.449	064	38.513	072	03.034	080	68.038	088	54
55	75.513	064	39.585	072	04.114	079	69.126	088	55
56	76.577	065	40.657	071	05.193	080	70.214	088	56
57	77.642	064	41.728	072	06.273	080	71.302	088	57
58	78.706	065	42.800	072	07.353	080	72.390	088	58
59	79.771	1.064	43.872	1.073	08.433	080	73.478	088	59
60	1280.835		1344.945		1409.513	1.080	1474.566	1.088	60

MERCATOR PROJECTION TABLE—Continued.

[Meridional distances for the spheroid. Compression $\frac{1}{294}$]

Min-utes.	24°		25°		26°		27°		Min-utes.
	Meridional distance.	Difference.	Meridional distance.	Difference.	Meridional distance.	Difference.	Meridional distance.	Difference.	
0	1474.566	1.089	1540.134	1.097	1606.243	1.106	1672.923	1.117	0
1	75.655	088	41.231	097	07.349	107	74.040	116	1
2	76.743	089	42.328	098	08.456	107	75.156	117	2
3	77.832	089	43.426	098	09.563	107	76.273	117	3
4	78.921	089	44.524	098	10.670	107	77.390	117	4
5	80.010	089	45.622	098	11.777	107	78.507	117	5
6	81.099	090	46.720	098	12.884	108	79.624	117	6
7	82.189	089	47.818	098	13.992	107	80.741	118	7
8	83.278	090	48.916	099	15.099	108	81.859	117	8
9	84.368	090	50.015	098	16.207	108	82.976	118	9
10	1485.458	1.090	1551.113	1.099	1617.315	1.108	1684.094	1.118	10
11	86.548	090	52.212	099	18.423	109	85.212	119	11
12	87.638	090	53.311	099	19.532	108	86.331	118	12
13	88.728	091	54.410	099	20.640	109	87.449	118	13
14	89.819	090	55.509	100	21.749	109	88.567	119	14
15	90.909	091	56.609	099	22.858	109	89.686	119	15
16	92.000	091	57.708	100	23.967	109	90.805	119	16
17	93.091	091	58.808	100	25.076	109	91.924	119	17
18	94.182	091	59.908	100	26.185	110	93.043	120	18
19	95.273	091	61.008	100	27.295	109	94.163	119	19
20	1496.364	1.091	1562.108	1.101	1628.404	1.110	1695.282	1.120	20
21	97.455	092	63.209	100	29.514	110	96.402	120	21
22	98.547	092	64.309	101	30.624	110	97.522	120	22
23	1499.639	091	65.410	101	31.734	110	98.642	120	23
24	1500.730	092	66.511	101	32.844	111	1699.762	121	24
25	01.822	092	67.612	101	33.955	110	1700.883	120	25
26	02.914	093	68.713	101	35.065	111	02.008	121	26
27	04.007	092	69.814	101	36.176	111	03.124	121	27
28	05.099	093	70.915	102	37.287	111	04.245	121	28
29	06.192	092	72.017	102	38.398	111	05.366	121	29
30	1507.284	1.093	1573.119	1.102	1639.509	1.112	1706.487	1.122	30
31	08.377	093	74.221	102	40.621	112	07.609	121	31
32	09.470	093	75.323	102	41.733	111	08.730	122	32
33	10.563	093	76.425	102	42.844	112	09.852	122	33
34	11.656	094	77.527	102	43.956	112	10.974	122	34
35	12.750	093	78.629	103	45.068	113	12.096	123	35
36	13.843	094	79.732	103	46.181	112	13.219	122	36
37	14.937	094	80.835	103	47.293	113	14.341	123	37
38	16.031	094	81.938	103	48.406	112	15.464	122	38
39	17.125	094	83.041	103	49.518	113	16.586	123	39
40	1518.219	1.094	1584.144	1.104	1650.631	1.113	1717.709	1.124	40
41	19.313	095	85.248	103	51.744	113	18.833	123	41
42	20.408	094	86.351	104	52.857	114	19.956	124	42
43	21.502	095	87.455	104	53.971	113	21.080	123	43
44	22.597	095	88.559	104	55.084	114	22.203	124	44
45	23.692	095	89.663	104	56.198	114	23.327	124	45
46	24.787	095	90.767	104	57.312	114	24.451	124	46
47	25.882	096	91.871	105	58.426	114	25.575	125	47
48	26.978	095	92.976	105	59.540	114	26.700	125	48
49	28.073	096	94.081	105	60.654	115	27.824	125	49
50	1529.169	1.096	1595.186	1.105	1661.769	1.115	1728.949	1.125	50
51	30.265	096	96.291	105	62.884	114	30.074	125	51
52	31.361	096	97.396	105	63.998	115	31.199	125	52
53	32.457	096	98.501	106	65.113	116	32.324	126	53
54	33.553	097	1599.607	105	66.229	115	33.450	125	54
55	34.650	096	1600.712	106	67.344	115	34.575	126	55
56	35.746	097	01.818	106	68.459	116	35.701	126	56
57	36.843	097	02.924	106	69.575	116	36.827	126	57
58	37.940	097	04.030	106	70.691	116	37.953	127	58
59	39.037	1.097	05.136	1.107	71.807	1.116	39.080	1.126	59
60	1540.134		1606.243		1672.923		1740.206		60

MERCATOR PROJECTION TABLE—Continued.

[Meridional distances for the spheroid. Compression $\frac{1}{294}$]

Min-utes.	28°		29°		30°		31°		Min-utes.
	Meridional distance.	Difference.	Meridional distance.	Difference.	Meridional distance.	Difference.	Meridional distance.	Difference.	
0	1740.206		1808.122		1876.706		1945.992		0
1	41.333	1.127	09.260	1.138	77.855	1.149	47.153	1.161	1
2	42.460	127	10.398	138	79.004	149	48.314	161	2
3	43.587	127	11.535	137	80.153	149	49.476	162	3
4	44.714	127	12.673	138	81.303	150	50.637	161	4
5	45.841	127	13.812	139	82.453	150	51.799	162	5
6	46.969	128	14.950	138	83.603	150	52.961	162	6
7	48.096	127	16.089	139	84.753	150	54.123	162	7
8	49.224	128	17.228	139	85.903	150	55.285	162	8
9	50.352	129	18.367	139	87.053	151	56.448	163	9
10	1751.481		1819.506		1888.204		1957.611		10
11	52.609	1.128	20.645	1.139	89.355	1.151	58.774	1.163	11
12	53.738	129	21.785	140	90.506	151	59.937	163	12
13	54.866	128	22.924	139	91.657	151	61.100	163	13
14	55.995	129	24.064	140	92.809	152	62.263	163	14
15	57.124	129	25.204	140	93.960	151	63.427	164	15
16	58.254	130	26.345	141	95.112	152	64.591	164	16
17	59.383	129	27.485	140	96.264	152	65.756	165	17
18	60.513	130	28.626	141	97.416	152	66.920	164	18
19	61.643	130	29.767	141	98.569	153	68.085	165	19
20	1762.773		1830.908		1899.721		1969.249		20
21	63.903	1.130	32.049	1.141	1900.874	1.153	70.414	1.165	21
22	65.033	130	33.190	141	02.027	153	71.580	166	22
23	66.164	131	34.332	142	03.181	154	72.745	166	23
24	67.295	131	35.474	142	04.334	153	73.911	166	24
25	68.426	131	36.616	142	05.488	154	75.077	166	25
26	69.557	131	37.758	142	06.642	154	76.243	166	26
27	70.688	132	38.900	143	07.796	154	77.409	166	27
28	71.820	131	40.043	143	08.950	155	78.575	166	28
29	72.951	132	41.186	143	10.105	154	79.742	167	29
30	1774.083		1842.329		1911.259		1980.909		30
31	75.215	1.132	43.472	1.143	12.414	1.155	82.076	1.167	31
32	76.347	132	44.615	143	13.569	155	83.244	168	32
33	77.479	132	45.759	144	14.724	155	84.411	167	33
34	78.612	133	46.902	143	15.880	156	85.579	168	34
35	79.745	133	48.046	144	17.035	155	86.747	168	35
36	80.877	132	49.190	144	18.191	156	87.915	168	36
37	82.011	134	50.335	145	19.347	156	89.084	169	37
38	83.144	133	51.479	144	20.503	156	90.252	168	38
39	84.277	133	52.624	145	21.660	157	91.421	169	39
40	1785.411		1853.769		1922.816		1992.590		40
41	86.545	1.134	54.914	1.145	23.973	1.157	93.759	1.169	41
42	87.679	134	56.059	145	25.130	157	94.929	170	42
43	88.813	134	57.204	145	26.287	157	96.098	169	43
44	89.948	135	58.350	146	27.445	158	97.268	170	44
45	91.082	134	59.496	146	28.603	158	98.438	170	45
46	92.217	135	60.642	146	29.760	157	99.609	171	46
47	93.352	135	61.788	146	30.918	158	2000.779	170	47
48	94.487	135	62.934	146	32.077	159	01.950	171	48
49	95.622	136	64.081	147	33.235	158	03.121	171	49
50	1796.758		1865.228		1934.394		2004.292		50
51	97.893	1.135	66.375	1.147	35.553	1.159	05.463	1.171	51
52	1799.029	136	67.522	147	36.712	159	06.635	172	52
53	1800.165	136	68.669	147	37.871	159	07.807	172	53
54	01.301	137	69.817	148	39.031	160	08.979	172	54
55	02.438	137	70.964	147	40.191	160	10.151	172	55
56	03.574	136	72.112	148	41.351	160	11.323	173	56
57	04.711	137	73.260	148	42.511	160	12.496	173	57
58	05.848	137	74.409	149	43.671	160	13.669	173	58
59	06.985	137	75.557	148	44.832	161	14.842	173	59
60	1808.122	1.137	1876.706	1.149	1945.992	1.160	2016.015	1.173	60

MERCATOR PROJECTION TABLE—Continued.

[Meridional distances for the spheroid. Compression $\frac{1}{284}$]

Minutes.	32°		33°		34°		35°		Minutes.
	Meridional distance.	Difference.	Meridional distance.	Difference.	Meridional distance.	Difference.	Meridional distance.	Difference.	
0	2016.015		2086.814		2158.428		2230.898		0
1	17.189	1.174	88.001	1.187	59.629	1.201	32.113	1.215	1
2	18.363	174	89.188	187	60.830	201	33.329	216	2
3	19.537	174	90.376	188	62.031	201	34.545	216	3
4	20.711	174	91.563	188	63.232	202	35.761	216	4
5	21.885	175	92.751	188	64.434	202	36.977	217	5
6	23.060	175	93.939	188	65.636	202	38.194	217	6
7	24.235	175	95.127	188	66.838	203	39.411	217	7
8	25.410	175	96.315	189	68.041	202	40.628	217	8
9	26.585	176	97.504	189	69.243	203	41.845	218	9
10	2027.761		2098.693		2170.446		2243.063		10
11	28.936	1.175	2099.882	1.189	71.649	1.203	44.281	1.218	11
12	30.112	176	2101.071	189	72.853	203	45.499	218	12
13	31.288	176	02.260	190	74.056	203	46.717	218	13
14	32.464	177	03.450	190	75.260	204	47.936	219	14
15	33.641	177	04.640	190	76.464	204	49.155	219	15
16	34.818	177	05.830	191	77.668	205	50.374	219	16
17	35.995	177	07.021	190	78.873	204	51.593	220	17
18	37.172	177	08.211	191	80.077	205	52.813	220	18
19	38.349	178	09.402	191	81.282	206	54.033	220	19
20	2039.527		2110.593		2182.488		2255.253		20
21	40.705	1.178	11.785	1.192	83.693	1.205	56.473	1.220	21
22	41.883	178	12.976	191	84.899	206	57.693	220	22
23	43.061	178	14.168	192	86.105	206	58.914	221	23
24	44.239	179	15.360	192	87.311	206	60.135	221	24
25	45.418	179	16.552	193	88.518	206	61.357	221	25
26	46.597	179	17.745	193	89.724	207	62.578	222	26
27	47.776	179	18.937	192	90.931	207	63.800	222	27
28	48.955	179	20.130	193	92.138	207	65.022	222	28
29	50.134	180	21.323	193	93.346	208	66.245	222	29
30	2051.314		2122.517		2194.554		2267.467		30
31	52.495	1.181	23.711	1.194	95.762	1.208	68.690	1.223	31
32	53.675	180	24.904	193	96.970	208	69.913	223	32
33	54.856	181	26.098	194	98.178	208	71.137	224	33
34	56.036	181	27.293	195	99.386	208	72.361	224	34
35	57.217	181	28.487	194	2199.386	209	73.585	224	35
36	58.399	182	29.682	195	2200.595	209	74.809	224	36
37	59.580	181	30.877	195	01.804	210	76.033	224	37
38	60.762	182	32.072	195	03.014	209	77.258	225	38
39	61.944	182	33.268	196	04.223	210	78.483	225	39
40	2063.126		2134.464		2206.643		2279.708		40
41	64.308	1.182	35.660	1.196	07.854	1.211	80.934	1.226	41
42	65.491	183	36.856	196	09.065	211	82.159	225	42
43	66.674	183	38.052	196	10.276	211	83.385	226	43
44	67.857	183	39.249	197	11.487	211	84.612	227	44
45	69.040	183	40.446	197	12.698	212	85.838	227	45
46	70.223	184	41.643	198	13.910	212	87.065	227	46
47	71.407	184	42.841	198	15.122	212	88.292	227	47
48	72.591	184	44.038	197	16.334	212	89.519	227	48
49	73.775	184	45.236	198	17.546	212	90.747	228	49
50	2074.959		2146.434		2218.759		2291.975		50
51	76.144	1.185	47.633	1.199	19.972	1.213	93.203	1.228	51
52	77.328	184	48.831	198	21.185	213	94.431	228	52
53	78.513	185	50.030	199	22.398	213	95.660	229	53
54	79.698	185	51.229	199	23.611	213	96.889	229	54
55	80.884	186	52.428	199	24.825	214	98.118	229	55
56	82.069	186	53.627	1.199	26.039	214	2299.347	229	56
57	83.255	186	54.827	1.200	27.253	214	2300.577	230	57
58	84.441	187	56.027	200	28.468	215	01.807	230	58
59	85.628	187	57.227	200	29.683	215	03.037	230	59
60	2086.814	1.186	2158.428	1.201	2230.898	1.215	2304.267	1.230	60

MERCATOR PROJECTION TABLE—Continued.

[Meridional distances for the spheroid. Compression $\frac{1}{294}$]

Min-utes.	36°		37°		38°		39°		Min-utes.
	Meridional distance.	Difference.	Meridional distance.	Difference.	Meridional distance.	Difference.	Meridional distance.	Difference.	
0	2304.267		2378.581		2453.888		2530.238		0
1	05.498	1.231	79.828	1.247	55.152	1.264	31.519	1.282	1
2	06.729	231	81.075	247	56.416	264	32.801	282	2
3	07.960	231	82.323	248	57.680	264	34.083	282	3
4	09.192	232	83.570	247	58.945	265	35.366	283	4
		231		248		265		283	
5	10.423	232	84.818	248	60.210	265	36.649	283	5
6	11.655	232	86.066	249	61.475	266	37.932	283	6
7	12.887	233	87.315	249	62.741	266	39.215	284	7
8	14.120	233	88.564	249	64.007	266	40.499	284	8
9	15.353	233	89.813	249	65.273	266	41.783	285	9
10	2316.586		2391.062		2466.539		2543.068		10
11	17.819	1.233	92.312	1.250	67.806	1.267	44.352	1.284	11
12	19.053	234	93.562	250	69.073	267	45.637	285	12
13	20.287	234	94.812	250	70.340	267	46.922	285	13
14	21.521	234	96.062	251	71.608	268	48.208	286	14
		234		251		268		286	
15	22.755	235	97.313	251	72.876	268	49.494	287	15
16	23.990	235	98.564	252	74.144	269	50.781	286	16
17	25.225	235	2399.816	251	75.413	268	52.067	287	17
18	26.460	235	2401.067	252	76.681	269	53.354	287	18
19	27.695	236	02.319	252	77.950	270	54.641	288	19
20	2328.931		2403.571		2479.220		2555.929		20
21	30.167	1.236	04.824	1.253	80.489	1.269	57.216	1.287	21
22	31.404	237	06.076	252	81.759	270	58.504	288	22
23	32.640	236	07.329	253	83.030	271	59.793	289	23
24	33.877	237	08.582	254	84.300	271	61.081	288	24
		237		254		271		289	
25	35.114	237	09.836	254	85.571	271	62.370	290	25
26	36.351	238	11.090	254	86.842	272	63.660	289	26
27	37.589	238	12.344	254	88.114	271	64.949	290	27
28	38.827	238	13.598	255	89.385	272	66.239	290	28
29	40.065	238	14.853	255	90.657	273	67.529	291	29
30	2341.303		2416.108		2491.930		2568.820		30
31	42.542	1.239	17.363	1.255	93.202	1.272	70.111	1.291	31
32	43.781	239	18.618	255	94.475	273	71.402	291	32
33	45.020	239	19.874	256	95.748	273	72.694	292	33
34	46.260	240	21.130	256	97.022	274	73.986	292	34
		240		256		274		292	
35	47.500	240	22.386	257	98.296	274	75.278	292	35
36	48.740	240	23.643	257	2499.570	274	76.570	293	36
37	49.980	241	24.900	257	2500.844	275	77.863	293	37
38	51.221	241	26.157	258	02.119	275	79.156	293	38
39	52.462	241	27.415	257	03.394	275	80.449	294	39
40	2353.703		2428.672		2504.669		2581.743		40
41	54.944	1.241	29.930	1.258	05.945	1.276	83.037	1.294	41
42	56.185	241	31.189	259	07.221	276	84.331	294	42
43	57.427	242	32.448	259	08.497	276	85.626	295	43
44	58.669	243	33.707	259	09.773	277	86.921	295	44
		243		259		277		295	
45	59.912	242	34.966	259	11.050	277	88.216	295	45
46	61.154	243	36.225	260	12.327	277	89.511	296	46
47	62.397	244	37.485	260	13.604	278	90.807	296	47
48	63.641	243	38.745	261	14.882	278	92.103	297	48
49	64.884	244	40.006	260	16.160	278	93.400	297	49
50	2366.128		2441.266		2517.438		2594.697		50
51	67.372	1.244	42.527	1.261	18.717	1.279	95.994	1.297	51
52	68.616	244	43.788	261	19.996	279	97.292	298	52
53	69.861	245	45.050	262	21.275	279	98.590	298	53
54	71.106	245	46.311	262	22.554	280	2599.888	298	54
		245		262		280		298	
55	72.351	246	47.573	263	23.834	280	2601.186	299	55
56	73.597	245	48.836	262	25.114	281	02.485	1.299	56
57	74.842	246	50.098	263	26.395	280	03.784	1.300	57
58	76.088	247	51.361	263	27.675	281	05.084	1.299	58
59	77.335	1.246	52.624	1.264	28.956	1.282	06.383	1.299	59
60	2378.581		2453.888		2530.238		2607.683		60

MERCATOR PROJECTION TABLE—Continued.

[Meridional distances for the spheroid. Compression $\frac{1}{294}$]

Min-utes.	40°		41°		42°		43°		Min-utes.
	Meridional distance.	Difference.	Meridional distance.	Difference.	Meridional distance.	Difference.	Meridional distance.	Difference.	
0	2607.683		2686.280		2766.089		2847.171		0
1	08.984	1.301	87.600	1.320	67.430	1.341	48.533	1.362	1
2	10.284	300	88.920	320	68.771	341	49.896	363	2
3	11.585	301	90.241	321	70.112	341	51.260	364	3
4	12.886	302	91.562	322	71.454	342	52.623	363	4
5	14.188	302	92.884	322	72.796	342	53.987	364	5
6	15.490	302	94.206	322	74.138	343	55.352	365	6
7	16.792	303	95.528	322	75.481	343	56.716	364	7
8	18.095	303	96.850	323	76.824	344	58.081	365	8
9	19.398	303	98.173	323	78.168	344	59.447	366	9
10	2620.701		2699.496		2779.512		2860.813		10
11	22.004	1.303	2700.820	1.324	80.856	1.344	62.179	1.366	11
12	23.308	304	02.143	323	82.201	345	63.546	367	12
13	24.612	304	03.467	324	83.546	345	64.913	367	13
14	25.917	305	04.792	325	84.891	345	66.280	367	14
15	27.222	305	06.117	325	86.237	346	67.648	368	15
16	28.527	306	07.442	325	87.583	346	69.016	368	16
17	29.833	306	08.767	326	88.930	347	70.384	368	17
18	31.139	306	10.093	326	90.277	347	71.753	369	18
19	32.445	306	11.419	327	91.624	347	73.123	370	19
20	2633.751		2712.746		2792.971		2874.492		20
21	35.058	1.307	14.073	1.327	94.319	1.348	75.862	1.370	21
22	36.365	307	15.400	327	95.667	348	77.233	371	22
23	37.672	307	16.727	327	97.016	349	78.604	371	23
24	38.980	308	18.055	328	98.365	349	79.975	371	24
25	40.288	308	19.383	328	2799.714	349	81.347	372	25
26	41.597	309	20.712	329	2801.064	350	82.719	372	26
27	42.906	309	22.041	329	02.414	350	84.091	373	27
28	44.215	309	23.370	329	03.764	350	85.464	373	28
29	45.524	310	24.700	330	05.115	351	86.837	373	29
30	2646.834		2726.080		2806.466		2888.211		30
31	48.144	1.310	27.360	1.330	07.818	1.352	89.585	1.374	31
32	49.454	310	28.690	330	09.170	352	90.959	374	32
33	50.765	311	30.021	331	10.522	352	92.333	374	33
34	52.076	311	31.352	331	11.875	353	93.708	375	34
35	53.388	312	32.684	332	13.228	353	95.084	376	35
36	54.700	312	34.016	332	14.581	354	96.460	376	36
37	56.012	312	35.348	332	15.935	354	97.836	376	37
38	57.324	313	36.681	333	17.289	354	2899.212	376	38
39	58.637	313	38.014	333	18.643	355	2900.589	377	39
40	2659.950		2739.347		2819.998		2901.966		40
41	61.263	1.313	40.681	1.334	21.353	1.355	03.344	1.378	41
42	62.577	314	42.015	334	22.709	356	04.722	378	42
43	63.891	314	43.350	335	24.065	356	06.100	378	43
44	65.205	315	44.684	334	25.421	356	07.479	379	44
45	66.520	315	46.019	335	26.777	356	08.858	379	45
46	67.835	315	47.355	336	28.134	357	10.238	380	46
47	69.150	316	48.691	336	29.492	358	11.618	380	47
48	70.466	316	50.027	336	30.850	358	12.998	380	48
49	71.782	317	51.363	337	32.208	358	14.379	381	49
50	2673.099		2752.700		2833.566		2915.760		50
51	74.415	1.316	54.038	1.338	34.925	1.359	17.142	1.382	51
52	75.732	317	55.375	337	36.284	359	18.524	382	52
53	77.049	317	56.713	338	37.643	359	19.906	382	53
54	78.367	318	58.052	339	39.003	360	21.289	383	54
55	79.685	318	59.390	338	40.364	361	22.672	383	55
56	81.003	319	60.729	339	41.724	360	24.056	384	56
57	82.322	319	62.069	340	43.085	361	25.440	384	57
58	83.641	319	63.409	340	44.447	362	26.824	384	58
59	84.960	319	64.749	340	45.809	362	28.209	385	59
60	2686.280	1.320	2766.089	1.340	2847.171	1.362	2929.594	1.385	60

MERCATOR PROJECTION TABLE—Continued.

[Meridional distances for the spheroid. Compression $\frac{1}{294}$]

Min-utes.	44°		45°		46°		47°		Min-utes.
	Meridional distance.	Difference.	Meridional distance.	Difference.	Meridional distance.	Difference.	Meridional distance.	Difference.	
0	2929.594	1.385	3013.427	1.410	3098.747	1.435	3185.634	1.462	0
1	30.979	386	14.837	410	3100.182	435	87.096	462	1
2	32.365	386	16.247	410	01.617	436	88.558	463	2
3	33.751	387	17.657	411	03.053	437	90.021	463	3
4	35.138	387	19.068	411	04.490	437	91.484	464	4
5	36.525	388	20.479	412	05.927	437	92.948	464	5
6	37.913	387	21.891	412	07.364	438	94.412	464	6
7	39.300	388	23.303	413	08.802	438	95.876	465	7
8	40.688	389	24.716	413	10.240	438	97.341	466	8
9	42.077	389	26.129	413	11.678	439	3198.807	466	9
10	2943.466	1.389	3027.542	1.414	3113.117	1.440	3200.273	1.466	10
11	44.855	390	28.956	414	14.557	440	01.739	467	11
12	46.245	390	30.370	414	15.997	440	03.206	468	12
13	47.635	391	31.784	415	17.437	441	04.674	468	13
14	49.026	391	33.199	416	18.878	441	06.142	468	14
15	50.417	391	34.615	416	20.319	442	07.610	469	15
16	51.808	392	36.031	416	21.761	442	09.079	469	16
17	53.200	392	37.447	416	23.203	442	10.548	470	17
18	54.592	393	38.863	417	24.645	443	12.018	470	18
19	55.985	393	40.280	418	26.088	443	13.488	471	19
20	2957.378	1.393	3041.698	1.418	3127.531	1.444	3214.959	1.471	20
21	58.771	394	43.116	418	28.975	444	16.430	472	21
22	60.165	394	44.534	419	30.419	445	17.902	472	22
23	61.559	394	45.953	420	31.864	445	19.374	472	23
24	62.953	395	47.373	419	33.309	446	20.846	473	24
25	64.348	396	48.792	420	34.755	446	22.319	474	25
26	65.744	396	50.212	421	36.201	446	23.793	474	26
27	67.140	396	51.633	421	37.647	447	25.267	474	27
28	68.536	396	53.054	421	39.094	447	26.741	475	28
29	69.932	397	54.475	422	40.541	448	28.216	475	29
30	2971.329	1.398	3055.897	1.422	3141.989	1.449	3229.691	1.476	30
31	72.727	397	57.319	423	43.438	448	31.167	476	31
32	74.124	398	58.741	423	44.886	449	32.643	477	32
33	75.522	399	60.164	424	46.335	450	34.120	477	33
34	76.921	399	61.588	424	47.785	450	35.597	478	34
35	78.320	399	63.012	424	49.235	451	37.075	478	35
36	79.719	400	64.436	424	50.686	451	38.553	479	36
37	81.119	400	65.860	426	52.137	451	40.032	479	37
38	82.519	401	67.286	425	53.588	452	41.511	480	38
39	83.920	401	68.711	426	55.040	452	42.991	480	39
40	2985.321	1.401	3070.137	1.427	3156.492	1.453	3244.471	1.480	40
41	86.722	402	71.564	427	57.945	453	45.951	481	41
42	88.124	403	72.991	427	59.398	454	47.432	482	42
43	89.527	402	74.418	428	60.852	454	48.914	482	43
44	90.929	403	75.846	428	62.306	455	50.396	482	44
45	92.332	404	77.274	428	63.761	455	51.878	483	45
46	93.736	404	78.702	429	65.216	455	53.361	483	46
47	95.140	404	80.131	430	66.671	456	54.844	484	47
48	96.544	405	81.561	430	68.127	457	56.328	485	48
49	97.949	405	82.991	430	69.584	457	57.813	485	49
50	2999.354	1.405	3084.421	1.431	3171.041	1.457	3259.298	1.485	50
51	3000.759	406	85.852	431	72.498	458	60.783	486	51
52	02.165	407	87.283	431	73.956	458	62.269	486	52
53	03.572	406	88.714	432	75.414	459	63.755	487	53
54	04.978	407	90.146	432	76.873	459	65.242	487	54
55	06.385	408	91.578	433	78.332	459	66.729	488	55
56	07.793	408	93.011	433	79.791	460	68.217	488	56
57	09.201	408	94.444	434	81.251	461	69.705	489	57
58	10.609	409	95.878	434	82.712	461	71.194	489	58
59	12.018	1.409	97.312	1.435	84.173	1.461	72.683	1.490	59
60	3013.427		3098.747		3185.634		3274.173		60

MERCATOR PROJECTION TABLE—Continued.

[Meridional distances for the spheroid. Compression $\frac{1}{294}$]

Min-utes.	48°		49°		50°		51°		Min-utes.
	Meridional distance.	Difference.	Meridional distance.	Difference.	Meridional distance.	Difference.	Meridional distance.	Difference.	
0	3274.173	1.490	3364.456	1.520	3456.581	1.551	3550.654	1.585	0
1	75.663	491	65.976	521	58.132	552	52.239	585	1
2	77.154	491	73.497	521	59.684	553	53.824	586	2
3	78.645	491	69.018	521	61.237	553	55.410	587	3
4	80.136	493	70.539	522	62.790	554	56.997	587	4
5	81.629	492	72.061	523	64.344	555	58.584	588	5
6	83.121	493	73.584	523	65.899	555	60.172	589	6
7	84.614	494	75.107	524	67.454	555	61.761	589	7
8	86.108	494	76.631	524	69.009	556	63.350	589	8
9	87.602	494	78.155	525	70.565	557	64.939	590	9
10	3289.096	1.495	3379.680	1.525	3472.122	1.557	3566.529	1.591	10
11	90.591	496	81.205	526	73.679	557	68.120	592	11
12	92.087	496	82.731	526	75.236	558	69.712	592	12
13	93.583	496	84.257	526	76.794	559	71.304	592	13
14	95.079	497	85.783	527	78.353	559	72.896	593	14
15	96.576	498	87.310	528	79.912	560	74.489	594	15
16	98.074	498	88.838	529	81.472	561	76.083	594	16
17	3299.572	498	90.367	529	83.033	561	77.677	595	17
18	3301.070	499	91.896	529	84.594	561	79.272	596	18
19	02.569	500	93.425	530	86.155	562	80.868	596	19
20	3304.069	1.500	3394.955	1.530	3487.717	1.563	3582.464	1.596	20
21	05.569	500	96.485	531	89.280	563	84.060	597	21
22	07.069	501	98.016	531	90.843	563	85.657	598	22
23	08.570	501	3399.547	532	92.406	564	87.255	598	23
24	10.071	502	3401.079	533	93.970	565	88.853	599	24
25	11.573	502	02.612	533	95.535	565	90.452	600	25
26	13.075	503	04.145	533	97.100	566	92.052	600	26
27	14.578	504	05.678	534	3498.666	567	93.652	600	27
28	16.082	504	07.212	535	3500.233	567	95.252	601	28
29	17.586	504	08.747	535	01.800	567	96.853	602	29
30	3319.090	1.505	3410.282	1.535	3503.367	1.568	3598.455	1.603	30
31	20.595	505	11.817	536	04.935	569	3600.058	603	31
32	22.100	506	13.353	537	06.504	569	01.661	604	32
33	23.606	507	14.890	537	08.073	570	03.265	604	33
34	25.113	507	16.427	538	09.643	570	04.869	605	34
35	26.620	507	17.965	538	11.213	571	06.474	605	35
36	28.127	508	19.503	539	12.784	571	08.079	606	36
37	29.635	508	21.042	539	14.355	572	09.685	607	37
38	31.143	509	22.581	540	15.927	573	11.292	607	38
39	32.652	510	24.121	540	17.500	573	12.899	607	39
40	3334.162	1.510	3425.661	1.541	3519.073	1.574	3614.506	1.609	40
41	35.672	510	27.202	542	20.647	574	16.115	609	41
42	37.182	511	28.744	542	22.221	575	17.724	610	42
43	38.693	511	30.286	542	23.796	575	19.334	610	43
44	40.204	512	31.828	543	25.371	576	20.944	611	44
45	41.716	512	33.371	544	26.947	577	22.555	611	45
46	43.228	513	34.915	544	28.524	577	24.166	612	46
47	44.741	514	36.459	545	30.101	577	25.778	612	47
48	46.255	514	38.004	545	31.678	577	27.390	613	48
49	47.769	514	39.549	546	33.256	578	29.003	614	49
50	3349.283	1.515	3441.095	1.546	3534.835	1.580	3630.617	1.614	50
51	50.798	516	42.641	547	36.415	580	32.231	615	51
52	52.314	516	44.188	547	37.995	580	33.846	616	52
53	53.830	516	45.735	548	39.575	581	35.462	616	53
54	55.346	517	47.283	548	41.156	581	37.078	617	54
55	56.863	518	48.831	549	42.737	582	38.695	617	55
56	58.381	518	50.380	549	44.319	583	40.312	618	56
57	59.899	518	51.929	550	45.902	583	41.930	618	57
58	61.417	519	53.479	551	47.485	584	43.548	619	58
59	62.936	1.520	55.030	1.551	49.069	1.585	45.167	1.620	59
60	3364.456		3456.581		3550.654		3646.787		60

MERCATOR PROJECTION TABLE—Continued.

[Meridional distances for the spheroid. Compression $\frac{1}{294}$]

Min-utes.	52°		53°		54°		55°		Min-utes.
	Meridional distance.	Difference.	Meridional distance.	Difference.	Meridional distance.	Difference.	Meridional distance.	Difference.	
0	3646.787	1.621	3745.105	1.658	3845.738	1.698	3948.830	1.740	0
1	48.408	621	46.763	658	47.436	698	50.570	741	1
2	50.029	621	48.421	659	49.134	699	52.311	741	2
3	51.650	622	50.080	660	50.833	700	54.052	742	3
4	53.272	623	51.740	661	52.533	701	55.794	743	4
5	54.895	624	53.401	661	54.234	701	57.537	744	5
6	56.519	624	55.062	662	55.935	702	59.281	744	6
7	58.143	624	56.724	662	57.637	702	61.025	745	7
8	59.767	626	58.386	663	59.339	703	62.770	746	8
9	61.393	626	60.049	664	61.042	704	64.516	746	9
10	3663.019	1.626	3761.713	1.664	3862.746	1.704	3966.262	1.747	10
11	64.645	627	63.377	665	64.450	705	68.009	748	11
12	66.272	628	65.042	666	66.155	706	69.757	749	12
13	67.900	628	66.708	666	67.861	707	71.506	749	13
14	69.528	629	68.374	667	69.568	707	73.255	750	14
15	71.157	630	70.041	668	71.275	708	75.005	751	15
16	72.787	630	71.709	668	72.983	708	76.756	752	16
17	74.417	631	73.377	669	74.691	709	78.508	752	17
18	76.048	631	75.046	669	76.400	710	80.260	753	18
19	77.679	632	76.715	670	78.110	711	82.013	754	19
20	3679.311	1.633	3778.385	1.671	3879.821	1.712	3983.767	1.755	20
21	80.944	633	80.056	672	81.533	712	85.522	755	21
22	82.577	634	81.728	672	83.245	713	87.277	756	22
23	84.211	634	83.400	673	84.958	714	89.033	757	23
24	85.845	635	85.073	673	86.672	714	90.790	758	24
25	87.480	636	86.746	674	88.386	715	92.548	758	25
26	89.116	636	88.420	675	90.101	715	94.306	759	26
27	90.752	637	90.095	676	91.816	717	96.065	760	27
28	92.389	638	91.771	676	93.533	717	97.825	761	28
29	94.027	638	93.447	677	95.250	717	3999.586	761	29
30	3695.665	1.639	3795.124	1.677	3896.967	1.719	4001.347	1.762	30
31	97.304	639	96.801	678	3898.686	719	03.109	763	31
32	3698.943	640	3798.479	679	3900.405	720	04.872	763	32
33	3700.583	641	3800.158	679	02.125	720	06.635	764	33
34	02.224	642	01.837	680	03.845	721	08.399	765	34
35	03.866	642	03.517	681	05.566	722	10.164	766	35
36	05.508	642	05.198	681	07.288	723	11.930	767	36
37	07.150	643	06.879	682	09.011	723	13.697	767	37
38	08.793	644	08.561	683	10.734	724	15.464	768	38
39	10.437	645	10.244	684	12.458	725	17.232	769	39
40	3712.082	1.645	3811.928	1.684	3914.183	1.726	4019.001	1.769	40
41	13.727	646	13.612	685	15.909	726	20.770	771	41
42	15.373	646	15.297	685	17.635	727	22.541	771	42
43	17.019	647	16.982	686	19.362	728	24.312	772	43
44	18.666	648	18.668	687	21.090	728	26.084	772	44
45	20.314	648	20.355	688	22.818	729	27.856	774	45
46	21.962	649	22.043	688	24.547	730	29.630	774	46
47	23.611	650	23.731	689	26.277	731	31.404	775	47
48	25.261	650	25.420	689	28.008	731	33.179	776	48
49	26.911	651	27.109	690	29.739	732	34.955	776	49
50	3728.562	1.651	3828.799	1.691	3931.471	1.732	4036.731	1.777	50
51	30.213	652	30.490	692	33.203	734	38.508	778	51
52	31.865	653	32.182	692	34.937	734	40.286	779	52
53	33.518	653	33.874	693	36.671	735	42.065	779	53
54	35.171	654	35.567	694	38.406	736	43.844	780	54
55	36.825	655	37.261	694	40.142	736	45.624	781	55
56	38.480	655	38.955	695	41.878	737	47.405	782	56
57	40.135	656	40.650	695	43.615	738	49.187	783	57
58	41.791	656	42.345	696	45.353	738	50.970	783	58
59	43.447	1.658	44.041	1.697	47.091	738	52.753	784	59
60	3745.105		3845.738		3948.830		4054.537		60

MERCATOR PROJECTION TABLE—Continued.

[Meridional distances for the spheroid. Compression $\frac{1}{294}$]

Min-utes.	56°		57°		58°		59°		Min-utes.
	Meridional distance.	Difference.	Meridional distance.	Difference.	Meridional distance.	Difference.	Meridional distance.	Difference.	
0	4054.537	1.784	4163.027	1.833	4274.485	1.884	4389.113	1.939	0
1	56.321	785	64.860	833	76.369	885	91.052	939	1
2	58.106	786	66.693	834	78.254	885	92.991	939	2
3	59.892	787	68.527	836	80.139	887	94.932	941	3
4	61.679	788	70.363	836	82.026	887	96.873	942	4
5	63.467	788	72.199	837	83.913	888	4398.815	944	5
6	65.255	789	74.036	837	85.801	890	4400.759	944	6
7	67.044	790	75.873	839	87.691	890	02.703	945	7
8	68.834	791	77.712	839	89.581	891	04.648	946	8
9	70.625	792	79.551	840	91.472	892	06.594	947	9
10	4072.417	1.793	4181.391	1.841	4293.364	1.892	4408.541	1.948	10
11	74.210	794	83.232	842	95.256	894	10.489	949	11
12	76.004	795	85.074	843	97.150	895	12.438	950	12
13	77.799	795	86.917	844	4299.045	895	14.388	951	13
14	79.594	796	88.761	844	4300.940	896	16.339	952	14
15	81.390	797	90.605	846	02.836	898	18.291	953	15
16	83.187	797	92.451	846	04.734	898	20.244	953	16
17	84.984	799	94.297	847	06.632	899	22.197	955	17
18	86.783	799	96.144	848	08.531	900	24.152	956	18
19	88.582	800	97.992	848	10.431	901	26.108	956	19
20	4090.382	1.800	4199.840	1.850	4312.332	1.901	4428.064	1.958	20
21	92.182	801	4201.690	850	14.233	903	30.022	959	21
22	93.983	802	03.540	851	16.136	904	31.981	959	22
23	95.785	803	05.391	852	18.040	904	33.940	961	23
24	97.588	804	07.243	852	19.944	905	35.901	961	24
25	4099.392	805	09.095	854	21.849	906	37.862	963	25
26	4101.197	805	10.949	854	23.755	908	39.825	963	26
27	03.002	806	12.804	855	25.663	908	41.788	965	27
28	04.808	807	14.659	856	27.571	909	43.753	965	28
29	06.615	808	16.515	857	29.480	909	45.718	966	29
30	4108.423	1.808	4218.372	1.858	4331.339	1.911	4447.684	1.968	30
31	10.231	809	20.230	859	33.300	912	49.652	968	31
32	12.040	810	22.089	860	35.212	913	51.620	969	32
33	13.850	811	23.949	860	37.125	913	53.589	971	33
34	15.661	812	25.809	862	39.038	915	55.560	971	34
35	17.473	812	27.671	862	40.953	915	57.531	972	35
36	19.285	813	29.533	863	42.868	916	59.503	973	36
37	21.098	814	31.396	864	44.784	917	61.476	975	37
38	22.912	815	33.260	865	46.701	918	63.451	975	38
39	24.727	816	35.125	866	48.619	919	65.426	976	39
40	4126.543	1.817	4236.991	1.866	4350.538	1.920	4467.402	1.977	40
41	28.360	817	38.857	867	52.458	921	69.379	978	41
42	30.177	818	40.724	868	54.379	922	71.357	979	42
43	31.995	819	42.592	869	56.301	923	73.336	981	43
44	33.814	820	44.461	870	58.224	924	75.317	981	44
45	35.634	820	46.331	871	60.148	924	77.298	982	45
46	37.454	821	48.202	872	62.072	925	79.280	983	46
47	39.275	822	50.074	872	63.997	927	81.263	984	47
48	41.097	823	51.946	873	65.924	927	83.247	985	48
49	42.920	824	53.819	875	67.851	928	85.232	986	49
50	4144.744	1.825	4255.694	1.875	4369.779	1.930	4487.218	1.987	50
51	46.569	825	57.569	876	71.709	930	89.205	988	51
52	48.394	826	59.445	877	73.639	931	91.193	989	52
53	50.220	827	61.322	878	75.570	932	93.182	990	53
54	52.047	828	63.200	879	77.502	932	95.172	991	54
55	53.875	829	65.079	879	79.434	934	97.163	992	55
56	55.704	830	66.958	881	81.368	935	4499.155	993	56
57	57.534	830	68.839	881	83.303	936	4501.148	994	57
58	59.364	831	70.720	882	85.239	936	03.142	994	58
59	61.195	831	72.602	882	87.175	936	05.137	995	59
60	4163.027	1.832	4274.485	1.883	4389.113	1.938	4507.133	1.996	60

MERCATOR PROJECTION TABLE—Continued.

[Meridional distances for the spheroid. Compression $\frac{1}{294}$]

Min-utes.	60°		61°		62°		63°		Min-utes.
	Meridional distance.	Difference.	Meridional distance.	Difference.	Meridional distance.	Difference.	Meridional distance.	Difference.	
0	4507.133		4628.789	2.060	4754.350		4884.117	2.200	0
1	09.130	1.997	30.849	061	56.478	2.128	86.317	201	1
2	11.123	998	32.910	062	58.607	129	88.518	203	2
3	13.127	1.999	34.972	063	60.736	129	90.721	204	3
4	15.123	2.001	37.035	064	62.867	133	92.925	205	4
5	17.129	002	39.099	066	65.000	133	95.130	206	5
6	19.131	003	41.165	066	67.133	135	97.336	208	6
7	21.134	005	43.231	068	69.268	135	4899.544	209	7
8	23.139	005	45.299	069	71.403	137	4901.753	211	8
9	25.144	006	47.368	069	73.540	138	03.964	211	9
10	4527.150	2.007	4649.437	2.071	4775.678	2.139	4906.175	2.213	10
11	29.157	009	51.508	072	77.817	141	08.388	215	11
12	31.166	009	53.580	073	79.958	141	10.603	215	12
13	33.175	010	55.653	074	82.099	143	12.818	217	13
14	35.185	012	57.727	075	84.242	144	15.035	218	14
15	37.197	012	59.802	077	86.386	145	17.253	219	15
16	39.209	013	61.879	077	88.531	146	19.472	221	16
17	41.222	015	63.956	079	90.677	148	21.693	222	17
18	43.237	015	66.035	079	92.825	148	23.915	223	18
19	45.252	017	68.114	081	94.973	150	26.138	224	19
20	4547.269	2.017	4670.195	2.082	4797.123	2.151	4928.362	2.226	20
21	49.286	019	72.277	083	4799.274	153	30.588	227	21
22	51.305	019	74.360	084	4801.427	153	32.815	228	22
23	53.324	021	76.444	085	03.580	155	35.043	230	23
24	55.345	022	78.529	086	05.735	156	37.273	231	24
25	57.367	022	80.615	088	07.891	157	39.504	232	25
26	59.389	024	82.703	088	10.048	158	41.736	234	26
27	61.143	025	84.791	090	12.206	160	43.970	234	27
28	63.438	026	86.881	091	14.366	160	46.204	237	28
29	65.464	027	88.972	092	16.526	162	48.441	237	29
30	4567.491	2.028	4691.064	2.093	4818.688	2.163	4950.678	2.239	30
31	69.519	028	93.157	094	20.851	165	52.917	240	31
32	71.547	030	95.251	095	23.016	165	55.157	241	32
33	73.577	032	97.346	097	25.181	167	57.398	243	33
34	75.609	032	4699.443	097	27.348	168	59.641	244	34
35	77.641	033	4701.540	099	29.516	169	61.885	245	35
36	79.674	034	03.639	100	31.685	171	64.130	247	36
37	81.708	035	05.739	101	33.856	171	66.377	248	37
38	83.743	037	07.840	102	36.027	173	68.625	249	38
39	85.780	037	09.942	103	38.200	174	70.874	251	39
40	4587.817	2.039	4712.045	2.104	4840.374	2.176	4973.125	2.252	40
41	89.856	039	14.149	106	42.550	176	75.377	253	41
42	91.895	041	16.255	106	44.726	178	77.630	255	42
43	93.936	042	18.361	108	46.904	179	79.885	256	43
44	95.978	042	20.469	109	49.083	180	82.141	257	44
45	4598.020	044	22.578	110	51.263	182	84.398	259	45
46	4600.064	045	24.688	111	53.445	183	86.657	260	46
47	02.109	046	26.799	113	55.628	184	88.917	261	47
48	04.155	047	28.912	113	57.812	185	91.178	263	48
49	06.202	048	31.025	115	59.997	186	93.441	263	49
50	4608.250	2.049	4733.140	2.116	4862.183	2.188	4995.704	2.266	50
51	10.299	050	35.256	117	64.371	189	4997.970	266	51
52	12.349	051	37.373	118	66.560	190	5000.236	268	52
53	14.400	052	39.491	119	68.750	192	02.504	270	53
54	16.452	054	41.610	121	70.942	192	04.774	271	54
55	18.506	054	43.731	121	73.134	194	07.045	272	55
56	20.560	056	45.852	123	75.328	196	09.317	273	56
57	22.616	056	47.975	124	77.524	196	11.590	275	57
58	24.672	058	50.099	125	79.720	198	13.865	276	58
59	26.730	2.059	52.224	2.126	81.918	2.199	16.141	2.278	59
60	4628.789		4754.350		4884.117		5018.419		60

MERCATOR PROJECTION TABLE—Continued.

[Meridional distances for the spheroid. Compression $\frac{1}{254}$]

Minutes.	64°		65°		66°		67°		Minutes.
	Meridional distance.	Difference.	Meridional distance.	Difference.	Meridional distance.	Difference.	Meridional distance.	Difference.	
0	5018.419	2.279	5157.629	2.364	5302.164	2.457	5452.493	2.558	0
1	20.698	280	59.993	366	04.621	458	55.051	559	1
2	22.978	281	62.359	367	07.079	459	57.610	561	2
3	25.259	283	64.726	368	09.538	461	60.171	563	3
4	27.542	285	67.094	370	11.999	464	62.734	564	4
5	29.827	286	69.464	371	14.463	465	65.298	567	5
6	32.113	287	71.835	373	16.928	466	67.865	568	6
7	34.400	288	74.208	375	19.394	468	70.433	570	7
8	36.688	290	76.583	376	21.862	469	73.003	571	8
9	38.978	291	78.959	378	24.331	471	75.574	574	9
10	5041.269	2.293	5181.337	2.379	5326.802	2.473	5478.148	2.576	10
11	43.562	294	83.716	380	29.275	475	80.724	577	11
12	45.856	295	86.096	382	31.750	476	83.301	579	12
13	48.151	296	88.478	383	34.226	478	85.880	581	13
14	50.447	298	90.861	385	36.704	479	88.461	582	14
15	52.745	300	93.246	386	39.183	481	91.043	584	15
16	55.045	301	95.632	388	41.664	483	93.627	586	16
17	57.346	302	5198.020	390	44.147	484	96.213	588	17
18	59.648	304	5200.410	391	46.631	486	5498.801	589	18
19	61.952	305	02.801	393	49.117	488	5501.390	591	19
20	5064.257	2.306	5205.194	2.394	5351.605	2.489	5503.981	2.592	20
21	66.563	308	07.588	395	54.094	491	06.573	593	21
22	68.871	309	09.983	397	56.585	491	09.166	595	22
23	71.180	311	12.380	399	59.078	493	11.761	597	23
24	73.491	312	14.779	400	61.572	496	14.358	599	24
25	75.803	314	17.179	402	64.068	497	16.957	602	25
26	78.117	315	19.581	403	66.565	499	19.559	603	26
27	80.432	316	21.984	405	69.064	501	22.162	605	27
28	82.748	318	24.389	406	71.565	503	24.767	608	28
29	85.066	320	26.795	408	74.068	504	27.375	610	29
30	5087.386	2.320	5229.203	2.409	5376.572	2.506	5529.985	2.612	30
31	89.706	322	31.612	411	79.078	508	32.597	615	31
32	92.028	323	34.023	412	81.586	509	35.212	617	32
33	94.351	325	36.435	414	84.095	512	37.829	618	33
34	96.676	326	38.849	416	86.607	512	40.447	620	34
35	5099.002	328	41.265	417	89.119	515	43.067	621	35
36	5101.330	329	43.682	419	91.634	516	45.688	624	36
37	03.659	330	46.101	420	94.150	518	48.312	625	37
38	05.989	332	48.521	421	96.668	519	50.937	627	38
39	08.321	334	50.942	424	5399.187	522	53.564	628	39
40	5110.655	2.335	5253.366	2.425	5401.709	2.522	5556.192	2.630	40
41	12.990	336	55.791	426	04.231	525	58.822	632	41
42	15.326	338	58.217	428	06.756	526	61.454	634	42
43	17.664	339	60.645	429	09.282	528	64.088	635	43
44	20.003	341	63.074	431	11.810	530	66.723	637	44
45	22.344	342	65.506	433	14.340	531	69.360	640	45
46	24.686	343	67.938	435	16.871	533	72.000	641	46
47	27.029	345	70.373	436	19.404	535	74.641	643	47
48	29.374	347	72.809	437	21.939	537	77.284	645	48
49	31.721	348	75.246	440	24.476	538	79.929	647	49
50	5134.069	2.350	5277.686	2.440	5427.014	2.540	5582.576	2.649	50
51	36.419	351	80.126	442	29.554	542	85.225	650	51
52	38.770	352	82.568	444	32.096	544	87.875	653	52
53	41.122	354	85.012	445	34.640	545	90.528	654	53
54	43.476	355	87.457	448	37.185	547	93.182	657	54
55	45.831	357	89.905	449	39.732	549	95.839	658	55
56	48.188	358	92.354	449	42.281	551	5598.497	660	56
57	50.545	359	94.803	452	44.832	552	5601.157	662	57
58	52.905	361	97.255	454	47.384	554	03.819	664	58
59	55.266	2.363	5299.709	2.455	49.938	554	06.483	666	59
60	5157.629		5302.164		5452.493	2.555	5609.149	2.666	60

MERCATOR PROJECTION TABLE—Continued.

[Meridional distances for the spheroid. Compression $\frac{1}{294}$]

Min-utes.	68°		69°		70°		71°		Min-utes
	Meridional distance.	Difference.	Meridional distance.	Difference.	Meridional distance.	Difference.	Meridional distance.	Difference.	
0	5609.149	2.668	5772.739	2.789	5943.955	2.923	6123.602	3.071	0
1	11.817	670	75.528	791	46.878	925	26.673	073	1
2	14.487	672	78.319	793	49.803	927	29.746	076	2
3	17.159	673	81.112	795	52.730	929	32.822	078	3
4	19.832	676	83.907	798	55.659	932	35.900	081	4
5	22.508	678	86.705	800	58.591	935	38.981	084	5
6	25.186	679	89.505	801	61.526	937	42.065	086	6
7	27.865	682	92.306	804	64.463	939	45.151	089	7
8	30.547	683	95.110	807	67.402	941	48.240	092	8
9	33.230	685	5797.917	808	70.343	944	51.332	094	9
10	5635.915	2.687	5800.725	2.810	5973.287	2.947	6154.426	3.097	10
11	38.602	690	03.535	813	76.234	948	57.523	099	11
12	41.292	691	06.348	814	79.182	951	60.622	102	12
13	43.983	693	09.162	817	82.133	954	63.724	105	13
14	46.676	695	11.979	819	85.087	956	66.829	108	14
15	49.371	697	14.798	822	88.043	958	69.937	110	15
16	52.068	699	17.620	823	91.001	960	73.047	113	16
17	54.767	701	20.443	826	93.961	964	76.160	115	17
18	57.468	703	23.269	827	96.925	965	79.275	119	18
19	60.171	705	26.096	830	5999.890	968	82.394	120	19
20	5662.876	2.707	5828.926	2.832	6002.858	2.970	6185.514	3.124	20
21	65.583	709	31.758	835	05.828	973	88.638	126	21
22	68.292	711	34.593	836	08.801	975	91.764	129	22
23	71.003	713	37.429	838	11.776	977	94.893	132	23
24	73.716	715	40.267	841	14.753	980	6198.025	134	24
25	76.431	717	43.108	843	17.733	983	6201.159	137	25
26	79.148	719	45.951	846	20.716	985	04.296	140	26
27	81.867	721	48.797	847	23.701	987	07.436	143	27
28	84.588	723	51.644	850	26.688	990	10.579	145	28
29	87.311	725	54.494	852	29.678	992	13.724	148	29
30	5690.036	2.727	5857.346	2.854	6032.670	2.995	6216.872	3.151	30
31	92.763	729	60.200	857	35.665	997	20.023	153	31
32	95.492	731	63.057	858	38.662	2.999	23.176	156	32
33	5698.223	733	65.915	861	41.661	3.003	26.332	159	33
34	5700.956	735	68.776	863	44.664	004	29.491	162	34
35	03.691	738	71.639	866	47.668	007	32.653	165	35
36	06.429	739	74.595	867	50.675	010	35.818	167	36
37	09.168	741	77.372	870	53.685	012	38.985	170	37
38	11.909	743	80.242	872	56.697	015	42.155	173	38
39	14.652	746	83.114	875	59.712	017	45.328	175	39
40	5717.398	2.747	5885.989	2.876	6062.729	3.019	6248.503	3.179	40
41	20.145	749	88.865	879	65.748	022	51.682	181	41
42	22.894	752	91.744	881	68.770	024	54.863	184	42
43	25.646	753	94.625	883	71.794	027	58.047	187	43
44	28.399	756	5897.508	886	74.821	030	61.234	190	44
45	31.155	758	5900.394	888	77.851	032	64.424	192	45
46	33.913	759	03.282	890	80.883	035	67.616	195	46
47	36.672	762	06.172	893	83.918	037	70.811	199	47
48	39.434	764	09.065	895	86.955	040	74.010	201	48
49	42.198	766	11.960	897	89.995	043	77.211	203	49
50	5744.964	2.768	5914.857	2.899	6093.038	3.045	6280.414	3.207	50
51	47.732	770	17.756	902	96.083	047	83.621	210	51
52	50.502	772	20.658	904	6099.130	050	86.831	212	52
53	53.274	775	23.562	906	6102.180	052	90.043	215	53
54	56.049	776	26.468	909	05.232	055	93.258	218	54
55	58.825	779	29.377	911	08.287	058	96.476	221	55
56	61.604	780	32.288	913	11.345	061	6299.697	224	56
57	64.384	783	35.201	916	14.406	063	6302.921	227	57
58	67.167	785	38.117	918	17.469	065	06.148	230	58
59	69.952	2.787	41.035	918	20.534	3.068	09.378	230	59
60	5772.739		5943.955	2.920	6123.602		6312.610	3.232	60

MERCATOR PROJECTION TABLE—Continued.

[Meridional distances for the spheroid. Compression $\frac{1}{254}$]

Min-utes.	72°		73°		74°		75°		Min-utes.
	Meridional distance.	Difference.	Meridional distance.	Difference.	Meridional distance.	Difference.	Meridional distance.	Difference.	
0	6312.610	3.235	6512.071	3.420	6723.275	3.628	6947.761	3.864	0
1	15.845	238	15.491	423	26.903	631	51.625	868	1
2	19.083	242	18.914	426	30.534	635	55.493	872	2
3	22.325	244	22.340	430	34.169	639	59.365	877	3
4	25.569	247	25.770	433	37.808	643	63.242	881	4
5	28.816	250	29.203	437	41.451	646	67.123	885	5
6	32.066	253	32.640	439	45.097	650	71.008	890	6
7	35.319	256	36.079	443	48.747	654	74.898	894	7
8	38.575	259	39.522	446	52.401	658	78.792	898	8
9	41.834	262	42.968	450	56.059	662	82.690	902	9
10	6345.096	3.264	6546.418	3.453	6759.721	3.665	6986.592	3.906	10
11	48.360	267	49.871	456	63.386	669	90.498	911	11
12	51.627	271	53.327	459	67.055	673	94.409	915	12
13	54.898	273	56.786	463	70.728	676	6998.324	919	13
14	58.171	277	60.249	466	74.404	680	7002.243	924	14
15	61.448	279	63.715	470	78.084	684	06.167	928	15
16	64.727	283	67.185	473	81.768	688	10.095	933	16
17	68.010	286	70.658	476	85.456	692	14.028	937	17
18	71.296	288	74.134	480	89.148	696	17.965	941	18
19	74.584	292	77.614	483	92.844	699	21.906	946	19
20	6377.876	3.295	6581.097	3.486	6796.543	3.703	7025.852	3.949	20
21	81.171	297	84.583	490	6800.246	707	29.801	954	21
22	84.468	300	88.073	493	03.953	710	33.755	959	22
23	87.768	304	91.566	497	07.663	715	37.714	963	23
24	91.072	307	95.063	500	11.377	718	41.677	968	24
25	94.379	310	6598.563	504	15.096	722	45.645	972	25
26	6397.689	313	6602.067	507	18.812	726	49.617	977	26
27	6401.002	315	05.574	510	22.545	730	53.594	981	27
28	04.317	319	09.084	514	26.275	734	57.575	985	28
29	07.636	322	12.598	518	30.009	738	61.561	990	29
30	6410.958	3.325	6616.116	3.520	6833.747	3.742	7065.551	3.994	30
31	14.283	328	19.636	524	37.489	747	69.545	3.999	31
32	17.611	331	23.160	528	41.236	750	73.544	4.003	32
33	20.942	334	26.688	531	44.986	754	77.547	008	33
34	24.276	337	30.219	535	48.740	758	81.555	013	34
35	27.613	341	33.754	538	52.498	762	85.568	017	35
36	30.954	344	37.292	541	56.260	766	89.585	022	36
37	34.298	347	40.833	545	60.027	770	93.607	026	37
38	37.645	350	44.378	549	63.797	774	7097.633	031	38
39	40.995	353	47.927	552	67.571	778	7101.664	035	39
40	6444.348	3.356	6651.479	3.556	6871.349	3.782	7105.699	4.039	40
41	47.704	359	55.035	559	75.131	785	09.739	045	41
42	51.063	362	58.594	563	78.916	790	13.784	049	42
43	54.425	365	62.157	566	82.706	794	17.833	054	43
44	57.790	369	65.723	570	86.500	798	21.887	059	44
45	61.159	372	69.293	574	90.298	802	25.946	063	45
46	64.531	375	72.866	577	94.100	806	30.009	068	46
47	67.906	378	76.443	581	6897.906	810	34.077	072	47
48	71.284	381	80.024	585	6901.716	815	38.149	077	48
49	74.665	385	83.609	588	05.531	819	42.226	082	49
50	6478.050	3.387	6687.197	3.591	6909.350	3.822	7146.308	4.086	50
51	81.437	391	90.788	595	13.172	826	50.394	091	51
52	84.828	394	94.383	599	16.998	831	54.485	096	52
53	88.222	397	6697.982	602	20.829	835	58.581	101	53
54	91.619	401	6701.584	606	24.664	839	62.682	105	54
55	95.020	404	05.190	610	28.503	843	66.787	110	55
56	6498.424	407	08.800	613	32.346	847	70.897	115	56
57	6501.831	410	12.413	617	36.193	852	75.012	120	57
58	05.241	413	16.030	621	40.045	856	79.132	125	58
59	08.654	3.417	19.651	3.625	43.901	860	83.257	4.130	59
60	6512.071		6723.275		6947.761		7187.387		60

MERCATOR PROJECTION TABLE—Continued.

[Meridional distances for the spheroid. Compression $\frac{1}{292}$]

Min-utes.	76°		77°		78°		79°		Min-utes.
	Meridional distance.	Difference.	Meridional distance.	Difference.	Meridional distance.	Difference.	Meridional distance.	Difference.	
0	7187.387		7444.428		7721.700		8022.758		0
1	91.521	4.134	48.875	4.447	26.511	4.811	28.001	5.243	1
2	95.660	139	53.327	452	31.329	818	33.252	251	2
3	7199.804	144	57.785	458	36.154	825	38.511	259	3
4	7203.953	149	62.248	463	40.985	831	43.778	267	4
		154		469		838		275	
5	08.107	159	66.717	475	45.823	845	49.053	283	5
6	12.266	163	71.192	481	50.668	852	54.336	292	6
7	16.429	169	75.673	487	55.520	858	59.628	299	7
8	20.598	174	80.160	492	60.378	865	64.927	307	8
9	24.772	178	84.652	498	65.243	872	70.234	316	9
10	7228.950		7489.150		7770.115		8075.550		10
11	33.133	4.183	93.654	4.504	74.993	4.878	80.873	5.323	11
12	37.321	188	7498.163	509	79.878	885	86.203	330	12
13	41.514	193	7502.678	515	84.770	892	91.542	339	13
14	45.712	198	07.199	521	89.669	899	8096.890	348	14
		203		527		906		356	
15	49.915	208	11.726	532	94.575	912	8102.246	364	15
16	54.123	213	16.258	539	7799.487	920	07.610	373	16
17	58.336	219	20.797	544	7804.407	927	12.983	381	17
18	62.555	223	25.341	550	09.334	933	18.364	389	18
19	66.778	229	29.891	556	14.267	941	23.753	397	19
20	7271.007		7534.447		7819.208		8129.150		20
21	75.240	4.233	39.008	4.561	24.155	4.947	34.555	5.405	21
22	79.478	238	43.575	567	29.109	954	39.969	414	22
23	83.721	243	48.149	574	34.070	961	45.391	422	23
24	87.970	249	52.728	579	39.038	968	50.821	430	24
		254		585		975		439	
25	92.224	258	57.313	592	44.013	983	56.260	448	25
26	7296.482	265	61.905	597	48.996	990	61.708	457	26
27	7300.747	269	66.502	604	53.986	997	67.165	465	27
28	05.016	274	71.106	610	58.983	4.997	72.630	474	28
29	09.290	280	75.716	616	63.987	5.004	78.104	482	29
						011			
30	7313.570		7580.332		7868.998		8183.586		30
31	17.854	4.284	84.953	4.621	74.016	5.018	89.076	5.490	31
32	22.144	290	89.581	628	79.041	025	8194.575	499	32
33	26.439	295	94.215	634	84.073	032	8200.082	507	33
34	30.739	300	7598.855	640	89.113	040	05.598	516	34
		306		647		047		525	
35	35.045	311	7603.502	652	94.160	054	11.123	534	35
36	39.356	316	08.154	659	7899.214	062	16.657	543	36
37	43.672	322	12.813	665	7904.276	069	22.200	552	37
38	47.994	327	17.478	671	09.345	076	27.752	561	38
39	52.321	332	22.149	678	14.421	084	33.313	570	39
40	7356.653		7626.827		7919.505		8238.883		40
41	60.990	4.337	31.510	4.683	24.596	5.091	44.461	5.578	41
42	65.332	342	36.199	689	29.694	098	50.047	586	42
43	69.680	348	40.895	696	34.799	105	55.642	595	43
44	74.033	353	45.597	702	39.912	113	61.247	605	44
		359		708		121		614	
45	78.392	364	50.305	715	45.033	128	66.861	623	45
46	82.756	370	55.020	721	50.161	136	72.484	633	46
47	87.126	375	59.741	728	55.297	144	78.117	642	47
48	91.501	381	64.469	734	60.441	151	83.759	650	48
49	7395.882	386	69.203	740	65.592	159	89.409	660	49
50	7400.268		7673.943		7970.751		8295.069		50
51	04.659	4.391	78.689	4.746	75.917	5.166	8300.737	5.668	51
52	09.055	396	83.442	753	81.090	173	06.414	677	52
53	13.457	402	88.201	759	86.271	181	12.101	687	53
54	17.865	408	92.967	766	91.460	189	17.798	697	54
		413		773		196		706	
55	22.278	419	7697.740	779	7996.656	205	23.504	715	55
56	26.697	424	7702.519	785	8001.861	213	29.219	725	56
57	31.121	430	07.304	792	07.074	220	34.944	734	57
58	35.551	436	12.096	799	12.294	228	40.678	744	58
59	39.987	441	16.895	4.805	17.522	5.236	46.422	754	59
60	7444.428		7721.700		8022.758		8352.176		60

FIXING POSITION BY WIRELESS DIRECTIONAL BEARINGS.³¹

A very close approximation for plotting on a Mercator chart the position of a ship receiving wireless bearings is given in Admiralty Notice to Mariners, No. 952, June 19, 1920, as follows:

I.—GENERAL.

Fixing position by directional wireless is very similar to fixing by cross bearings from visible objects, the principal difference being that, when using a chart on the Mercator projection allowance has to be made for the curvature of the earth, the wireless stations being generally at very much greater distances than the objects used in an ordinary cross bearing fix.

Although fixing position by wireless directional bearings is dependent for its accuracy upon the degree of precision with which it is at present possible to determine the direction of wireless waves, confirmation of the course and distance made good by the receipt of additional bearings, would afford confidence to those responsible in the vessel as the land is approached under weather conditions that preclude the employment of other methods.

At the present time, from shore stations with practiced operators and instruments in good adjustment, the maximum error in direction should not exceed 2° for day working, but it is to be noted that errors at night may be larger, although sufficient data on this point is not at present available.

II.—TRACK OF WIRELESS WAVE.

The track of a wireless wave being a great circle is represented on a chart on the Mercator projection by a flat curve, concave toward the Equator; this flat curve is most curved when it runs in an east and west direction and flattens out as the bearing changes toward north and south. When exactly north and south it is quite flat and is then a straight line, the meridian. The true bearing of a ship from a wireless telegraph station, or vice versa, is the angle contained by the great circle passing through either position and its respective meridian.

III.—CONVERGENCY.

Meridians on the earth's surface not being parallel but converging at the poles, it follows that a great circle will intersect meridians as it crosses them at a varying angle unless the great circle itself passes through the poles and becomes a meridian. The difference in the angles formed by the intersection of a great circle with two meridians (that is, convergency) depends on the angle the great circle makes with the meridian, the middle latitude between the meridians, and the difference of longitude between the meridians.

This difference is known as the convergency and can be approximately calculated from the formula—

$$\text{Convergency in minutes} = \text{diff. long. in minutes} \times \sin \text{mid. lat.}$$

Convergency may be readily found from the convergency scale (see fig. 62), or it may be found by traverse table entering the diff. long. as distance and mid. lat. as course; the resulting departure being the convergency in minutes.

IV.—TRUE AND MERCATORIAL BEARINGS.

Meridians on a Mercator chart being represented by parallel lines, it follows that the *true bearing* of the ship from the station, or vice versa, can not be represented by a straight line joining the two positions, the straight line joining them being the *mean mercatorial bearing*, which differs from the true bearing

³¹ A valuable contribution to this subject by G. W. Littlehales, appeared in the Journal of the American Society of Naval Engineers, February, 1920, under the title: "The Prospective Utilization of Vessel-to-Shore Radiocompass Bearings in Aerial and Transoceanic Navigation."

Since going to press our attention has been called to a diagram on Pilot Chart No. 1400, February, 1921, entitled "Position Plotting by Radio Bearings" by Elmer B. Collins, nautical expert, U. S. Hydrographic Office. On this diagram there is given a method of fixing the position of a vessel on a Mercator chart both by plotting and by computation.

The Admiralty uses dead-reckoning position for preliminary fix whereas by the Hydrographic Office method the preliminary fix is obtained by laying the radiocompass bearings on the Mercator chart. The Hydrographic Office also gives a method of computation wherein the radiocompass bearings are used in a manner very similar to Sumner lines.

See also the paragraph *wireless directional bearings* under the chapter *Gnomonic Projection*, p. 141.

by $\pm \frac{1}{2}$ the convergency. As it is this mean mercatorial bearing which we require, all that is necessary when the true bearing is obtained from a W/T station is to add to or subtract from it $\frac{1}{2}$ the convergency and lay off this bearing from the station.

NOTE.—Charts on the gnomonic projection which facilitate the plotting of true bearings are now in course of preparation by the Admiralty and the U. S. Hydrographic Office.

V.—SIGN OF THE $\frac{1}{2}$ CONVERGENCY.

Provided the bearings are always measured in degrees north 0° to 360° (clockwise) the sign of this $\frac{1}{2}$ convergency can be simply determined as follows:

N. lat. $\frac{1}{2}$ convergency is + to the bearing given by the W/T station when ship is E. of station.

N. lat. $\frac{1}{2}$ convergency is - to the bearing given by the W/T station when ship is W. of station.

S. lat. The opposite.

When the W/T station and the ship are on opposite sides of the Equator, the factor \sin mid. lat. is necessarily very small and the convergency is then negligible. All great circles in the neighborhood of the Equator appear on the chart as straight lines and the convergency correction as described above is immaterial and unnecessary.

VI.—EXAMPLE.

A ship is by D. R.³² in lat. $48^\circ 45' N.$, long. $25^\circ 30' W.$, and obtains wireless bearings from Sea View $244\frac{1}{2}^\circ$ and from Ushant $277\frac{1}{2}^\circ$. What is her position?

Sea View.....	Lat. $55^\circ 22' N.$	Long. $7^\circ 19\frac{1}{2}' W.$
D. R.....	Lat. $48^\circ 45' N.$	Long. $25^\circ 30' W.$
Mid. lat.	$52^\circ 03' N.$	Diff. long. $1090.\overset{1}{5}$
	Convergency= $1090.5 \times \sin 52^\circ = 859'$,	
	or $\frac{1}{2}$ convergency= $7^\circ 09'$	

The true bearing signaled by Sea View was $244\frac{1}{2}^\circ$; as ship is west of the station (north lat., see Par. V) the $\frac{1}{2}$ convergency will be "minus" to the true bearing signaled.

Therefore the mercatorial bearing will be $237\frac{1}{2}^\circ$ nearly.

Similarly with Ushant.

Lat. D. R.....	$48^\circ 45' N.$	Long. $25^\circ 30' W.$
Lat. Ushant.....	$48^\circ 26\frac{1}{2}' N.$	Long. $5^\circ 05\frac{1}{2}' W.$
Mid. lat.....	$48^\circ 36' N.$	Diff. long. $1224.\overset{1}{5} W.$
	Convergency= $1224.5 \times \sin 48^\circ 36' = 919'$,	
	or $\frac{1}{2}$ convergency= $7^\circ 40'$	

The true bearing signaled by Ushant was $277\frac{1}{2}^\circ$; as ship is west of the station (north lat., see Par. V) the $\frac{1}{2}$ convergency will be "minus" to the true bearing signaled. Therefore the mercatorial bearing will be 270° nearly.

Laying off $237\frac{1}{2}^\circ$ and 270° on the chart from Sea View and Ushant, respectively, the intersection will be in:

Lat. $48^\circ 27\frac{1}{2}' N.$, long. $25^\circ 05' W.$, which is the ship's position.

NOTE.—In plotting the positions the largest scale chart available that embraces the area should be used. A station pointer will be found convenient for laying off the bearings where the distances are great.

The accompanying chartlet (see Fig. 62), drawn on the Mercator projection, shows the above positions and the error involved by laying off the true bearings as signaled from Sea View W/T station and Ushant W/T station.

The black curved lines are the great circles passing through Sea View and ship's position, and Ushant and ship's position.

The red broken lines are the true bearings laid off as signaled, their intersection "B" being in latitude $50^\circ 14' N.$, longitude $25^\circ 46' W.$, or approximately $110'$ from the correct position.

The red firm lines are the mean mercatorial bearings laid off from Sea View and Ushant and their intersection "C" gives the ship's position very nearly; that is, latitude $48^\circ 27\frac{1}{2}' N.$, longitude $25^\circ 05' W.$

³² Dead reckoning.

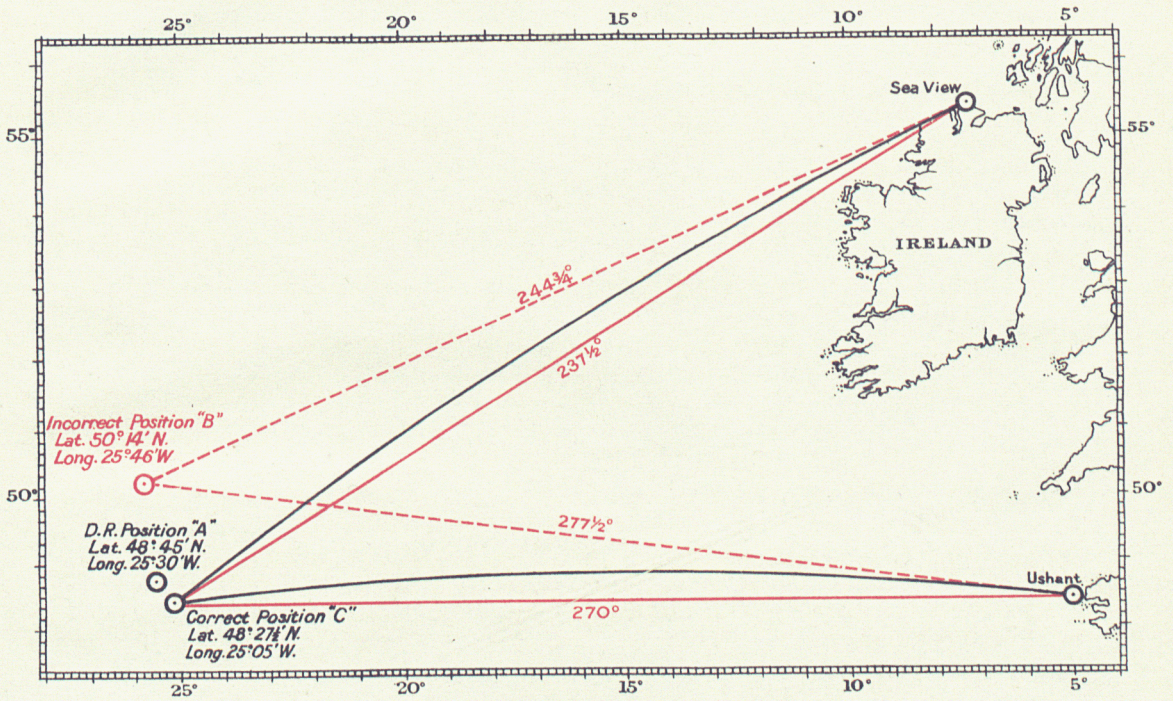

Scales for obtaining the Convergency for 10' Diff. Longitude in different Latitudes.

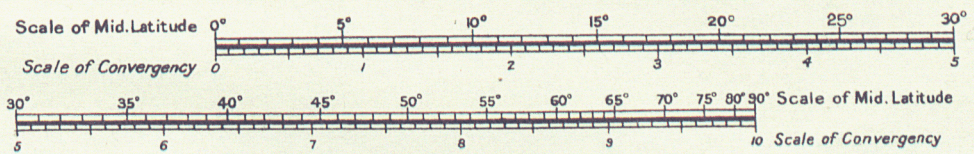

Example:- Mid. Lat. $50^{\circ}30'$, diff. long. 282; To find the Convergency.
 Under $50^{\circ}30'$, on Mid. Lat. scale read 7.7 on scale of Convergency
 which multiplied by 28.2 gives $217 \frac{1}{2}$ the Convergency.

Fig 62 -

Position "A" is the ship's D. R. position, latitude $48^{\circ} 45' N.$, longitude $25^{\circ} 30' W.$, which was used for calculating the $\frac{1}{2}$ convergency.

NOTE.—As the true position of the ship should have been used to obtain the $\frac{1}{2}$ convergency, the quantity found is not correct, but it could be recalculated using lat. and long. "C" and a more correct value found. This, however, is only necessary if the error in the ship's assumed position is very great,

VII.—ACCURACY OF THIS METHOD OF PLOTTING.

Although this method is not rigidly accurate, it can be used for all practical purposes up to 1,000 miles range, and a very close approximation found to the lines of position on which the ship is, at the moment the stations receive her signals.

VIII.—USE OF W/T BEARINGS WITH OBSERVATIONS OF HEAVENLY BODIES.

It follows that W/T bearings may be used in conjunction with position lines obtained from observations of heavenly bodies, the position lines from the latter being laid off as straight lines (although in this case also they are not strictly so), due consideration being given to the possible error of the W/T bearings. Moreover, W/T bearings can be made use of at short distances as "position lines," in a similar manner to the so-called "Sumner line" when approaching port, making the land, avoiding dangers, etc.

IX.—CONVERSE METHOD.

When ships are fitted with apparatus by which they record the wireless bearings of shore stations whose positions are known, the same procedure for laying off bearings from the shore stations can be adopted, but it is to be remembered that in applying the $\frac{1}{2}$ convergency to these bearings it must be applied in the converse way, in both hemispheres, to that laid down in paragraph V.

THE GNOMONIC PROJECTION.

DESCRIPTION.

[See Plate IV.]

The gnomonic projection of the sphere is a perspective projection upon a tangent plane, with the point from which the projecting lines are drawn situated at the center of the sphere. This may also be stated as follows:

The eye of the spectator is supposed to be situated at the center of the terrestrial sphere, from whence, being at once in the plane of every great circle, it will see these circles projected as straight lines where the visual rays passing through them intersect the plane of projection. A straight line drawn between any two points or places on this chart represents an arc of the great circle passing through them, and is, therefore, the shortest possible *track line* between them and shows at once all the geographical localities through which the most direct route passes.

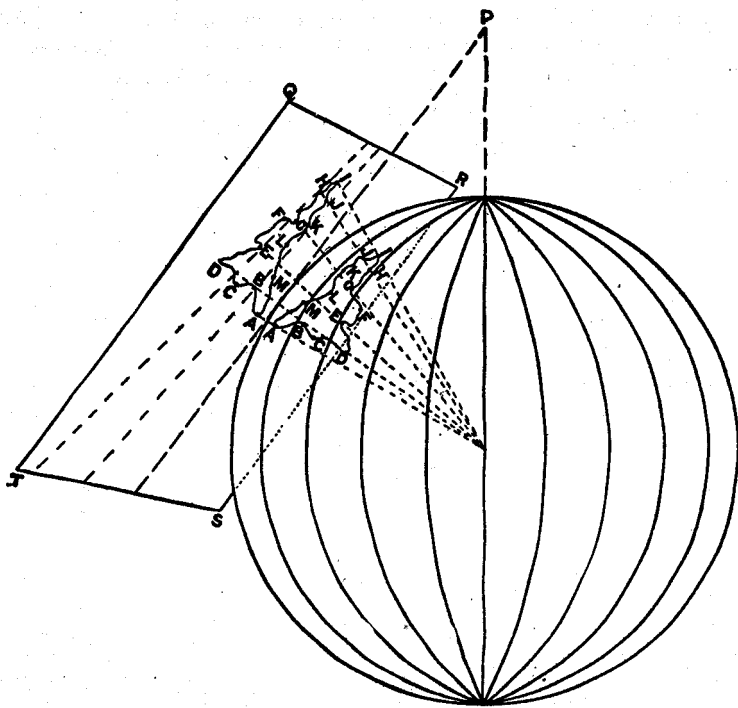

FIG. 63.—Diagram illustrating the theory of the gnomonic projection.

The four-sided figure *QRST* is the imaginary paper forming a "tangent plane," which touches the surface of the globe on the central meridian of the chart. The N.-S. axis of the globe is conceived as produced to a point *P* on which all meridians converge. Where imaginary lines drawn from the center of the earth through points on its surface fall on the tangent plane, these points can be plotted. The tangent paper being viewed in the figure from underneath, the outline of the island is reversed as in a looking glass; if the paper were transparent, the outline, when seen from the further side (the chart side) would be in its natural relation.—From charts, Their Use and Meaning, by G. Herbert Fowler, Ph. D., University College, London.

Obviously a complete hemisphere can not be constructed on this plan, since, for points 90° distant from the center of the map, the projecting lines are parallel

to the plane of projection. As the distance of the projected point from the center of the map approaches 90° the projecting line approaches a position of parallelism to the plane of projection and the intersection of line and plane recedes indefinitely from the center of the map.

The chief fault of the projection and the one which is incident to its nature is that while those positions of the sphere opposite to the eye are projected in approximately their true relations, those near the boundaries of the map are very much distorted and the projection is useless for distances, areas, and shapes.

The one special property, however, that any great circle on the sphere is represented by a straight line upon the map, has brought the gnomonic projection into considerable prominence. For the purpose of facilitating great-circle sailing the Hydrographic Office, U. S. Navy, and the British Admiralty have issued gnomonic charts covering in single sheets the North Atlantic, South Atlantic, Pacific, North Pacific, South Pacific, and Indian Oceans.

This system of mapping is now frequently employed by the Admiralty on plans of harbors, polar charts, etc. Generally, however, the area is so small that the difference in projections is hardly apparent and the charts might as well be treated as if they were on the Mercator projection.

The use and application of gnomonic charts as supplementary in laying out ocean sailing routes on the Mercator charts have already been noted in the chapter on the Mercator projection. In the absence of charts on the gnomonic projection, great-circle courses may be placed upon Mercator charts either by computation or by the use of tables, such as Lecky's General Utility Tables. It is far easier and quicker, however, to derive these from the gnomonic chart, because the route marked out on it will show at a glance if any obstruction, as an island or danger, necessitates a modified or composite course.

WIRELESS DIRECTIONAL BEARINGS.

The gnomonic projection is by its special properties especially adapted to the plotting of positions from wireless directional bearings.

Observed directions may be plotted by means of a protractor, or compass rose, constructed at each radiocompass station. The center of the rose is at the radio station, and the true azimuths indicated by it are the traces on the plane of the projection of the planes of corresponding true directions at the radio station.

MATHEMATICAL THEORY OF THE GNOMONIC PROJECTION.

A simple development of the mathematical theory of the projection will be given with sufficient completeness to enable one to compute the necessary elements.

In figure 64, let $PQP'Q'$ represent the meridian on which the point of tangency lies; let ACB be the trace of the tangent plane with the point of tangency at C ; and let the radius of the sphere be represented by R ; let the angle COD be denoted by p ; then, $CD = OC \tan COD = R \tan p$.

All points of the sphere at arc distance p from C will be represented on the projection by a circle with radius equal to CD , or

$$\rho = R \tan p.$$

To reduce this expression to rectangular coordinates, let us suppose the circle drawn on the plane of the projection. In figure 65, let YY' represent the projection of the central meridian and XX' that of the great circle through C (see fig. 64) perpendicular to the central meridian.

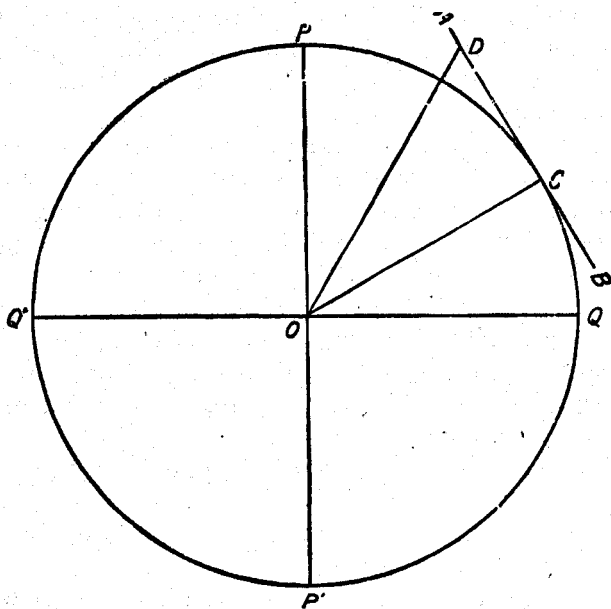

FIG. 64.—Gnomonic projection—determination of the radial distance

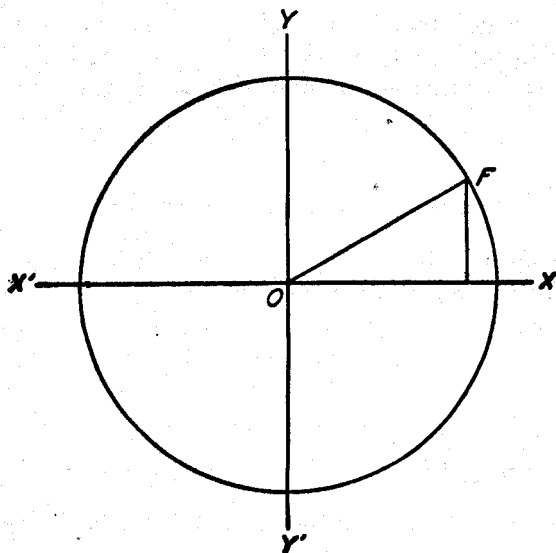

FIG. 65.—Gnomonic projection—determination of the coordinates on the mapping plane.

If the angle XOF is denoted by ω , we have

$$x = \rho \cos \omega = R \tan p \cos \omega$$

$$y = \rho \sin \omega = R \tan p \sin \omega;$$

or,

$$x = \frac{R \sin p \cos \omega}{\cos p}$$

$$y = \frac{R \sin p \sin \omega}{\cos p}.$$

Now, suppose the plane is tangent to the sphere at latitude α . The expression just given for x and y must be expressed in terms of latitude and longitude, or φ and λ , λ representing, as usual, the longitude reckoned from the central meridian.

In figure 66, let T be the pole, Q the center of the projection, and let P be the point whose coordinates are to be determined.

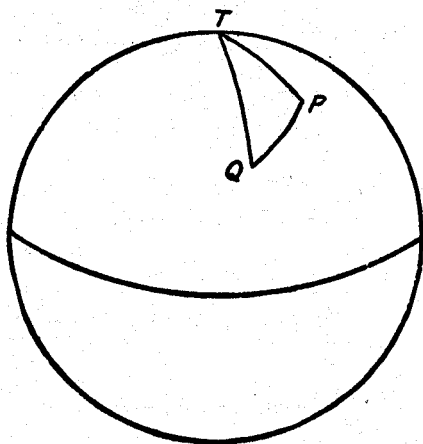

FIG. 66.—Gnomonic projection—transformation triangle on the sphere.

The angles between great circles at the point of tangency are preserved in the projection so that ω is the angle between QP and the great circle perpendicular to TQ at Q ;

or,

$$\angle TQP = \frac{\pi}{2} - \omega.$$

Also,

$$TQ = \frac{\pi}{2} - \alpha.$$

$$TP = \frac{\pi}{2} - \varphi,$$

$$QP = p,$$

and,

$$\angle QTP = \lambda$$

From the trigonometry of the spherical triangle we have

$$\cos p = \sin \alpha \sin \varphi + \cos \alpha \cos \lambda \cos \varphi,$$

$$\frac{\sin p}{\cos \varphi} = \frac{\sin \lambda}{\cos \omega}, \text{ or } \sin p \cos \omega = \sin \lambda \cos \varphi,$$

and

$$\sin p \sin \omega = \cos \alpha \sin \varphi - \sin \alpha \cos \lambda \cos \varphi.$$

On the substitution of these values in the expressions for x and y , we obtain as definitions of the coordinates of the projection—

$$x = \frac{R \sin \lambda \cos \varphi}{\sin \alpha \sin \varphi + \cos \alpha \cos \lambda \cos \varphi},$$

$$y = \frac{R (\cos \alpha \sin \varphi - \sin \alpha \cos \lambda \cos \varphi)}{\sin \alpha \sin \varphi + \cos \alpha \cos \lambda \cos \varphi}.$$

The Y axis is the projection of the central meridian and the X axis is the projection of the great circle through the point of tangency and perpendicular to the central meridian.

These expressions are very unsatisfactory for computation purposes. To put them in more convenient form, we may transform them in the following manner:

$$x = \frac{R \sin \lambda \cos \varphi}{\sin \alpha (\sin \varphi + \cos \varphi \cot \alpha \cos \lambda)}$$

$$y = \frac{R \cos \alpha (\sin \varphi - \cos \varphi \tan \alpha \cos \lambda)}{\sin \alpha (\sin \varphi + \cos \varphi \cot \alpha \cos \lambda)}$$

Let

$$\cot \beta = \cot \alpha \cos \lambda,$$

$$\tan \gamma = \tan \alpha \cos \lambda,$$

then

$$x = \frac{R \sin \lambda \cos \varphi}{\frac{\sin \alpha}{\sin \beta} (\sin \varphi \sin \beta + \cos \varphi \cos \beta)}$$

$$y = \frac{\frac{R \cos \alpha}{\cos \gamma} (\sin \varphi \cos \gamma - \cos \varphi \sin \gamma)}{\frac{\sin \alpha}{\sin \beta} (\sin \varphi \sin \beta + \cos \varphi \cos \beta)}$$

But

$$\cos (\varphi - \beta) = \sin \varphi \sin \beta + \cos \varphi \cos \beta,$$

and

$$\sin (\varphi - \gamma) = \sin \varphi \cos \gamma - \cos \varphi \sin \gamma.$$

Hence

$$x = \frac{R \sin \beta \sin \lambda \cos \varphi}{\sin \alpha \cos (\varphi - \beta)}$$

$$y = \frac{R \cot \alpha \sin \beta \sin (\varphi - \gamma)}{\cos \gamma \cos (\varphi - \beta)}$$

These expressions are in very convenient form for logarithmic computation, or for computation with a calculating machine. For any given meridian β and γ are constants; hence the coordinates of intersection along a meridian are very easily computed. It is known, *a priori*, that the meridians are represented by straight lines; hence to draw a meridian we need to know the coordinates of only two points. These should be computed as far apart as possible, one near the top and the other near the bottom of the map. After the meridian is drawn on the projection it is sufficient to compute only the y coordinate of the other intersections. If the map extends far enough to include the pole, the determination of this point will give one point on all of the meridians.

Since for this point $\lambda = 0$ and $\varphi = \frac{\pi}{2}$, we get

$$\beta = \alpha,$$

$$\gamma = \alpha,$$

$$x = 0,$$

$$y = R \cot \alpha.$$

If this point is plotted upon the projection and another point on each meridian is determined near the bottom of the map, the meridians can be drawn on the projection.

If the map is extensive enough to include the Equator, the intersections of the straight line which represents it, with the meridians can be easily computed. When $\varphi=0$, the expressions for the coordinates become

$$\begin{aligned}x &= R \tan \lambda \sec \alpha, \\y &= -R \tan \alpha.\end{aligned}$$

A line parallel to the X axis at the distance $y = -R \tan \alpha$ represents the Equator. The intersection of the meridian λ with this line is given by

$$x = R \tan \lambda \sec \alpha.$$

When the Equator and the pole are both on the map, the meridians may thus be determined in a very simple manner. The parallels may then be determined by computing the y coordinate of the various intersections with these straight-line meridians.

If the point of tangency is at the pole, $\alpha = \frac{\pi}{2}$ and the expressions for the coordinates become

$$\begin{aligned}x &= R \cot \varphi \sin \lambda, \\y &= -R \cot \varphi \cos \lambda.\end{aligned}$$

In these expressions λ is reckoned from the central meridian from south to east. As usually given, λ is reckoned from the east point to northward. Letting $\lambda = \frac{\pi}{2} + \lambda'$ and dropping the prime, we obtain the usual forms:

$$\begin{aligned}x &= R \cot \varphi \cos \lambda, \\y &= R \cot \varphi \sin \lambda.\end{aligned}$$

The parallels are represented by concentric circles each with the radius

$$\rho = R \cot \varphi.$$

The meridians are represented by the equally spaced radii of this system of circles.

If the point of tangency is on the Equator, $\alpha=0$, and the expressions become

$$\begin{aligned}x &= R \tan \lambda, \\y &= R \tan \varphi \sec \lambda.\end{aligned}$$

The meridians in this case are represented by straight lines perpendicular to the X axis and parallel to the Y axis. The distance of the meridian λ from the origin is given by $x = R \tan \lambda$.

Any gnomonic projection is symmetrical with respect to the central meridian or to the Y axis, so that the computation of the projection on one side of this axis is sufficient for the complete construction. When the point of tangency is at the pole, or on the Equator, the projection is symmetrical both with respect to the Y axis and to the X axis. It is sufficient in either of these cases to compute the intersections for a single quadrant.

Another method for the construction of a gnomonic chart is given in the Admiralty Manual of Navigation, 1915, pages 31 to 38.

WORLD MAPS.

As stated concisely by Prof. Hinks, "the problem of showing the sphere on a single sheet is intractable," and it is not the purpose of the authors to enter this field to any greater extent than to present a few of the systems of projection that have at least some measure of merit. The ones herein presented are either conformal or equal-area projections.

THE MERCATOR PROJECTION.

The projection was primarily designed for the construction of nautical charts, and in this field has attained an importance beyond all others. Its use for world maps has brought forth continual criticism in that the projection is responsible for many false impressions of the relative size of countries differing in latitude. These details have been fully described under the subject title, "Mercator projection," page 101.

The two errors to one or both of which all map projections are liable, are changes of area and distortion as applying to portions of the earth's surface. The former

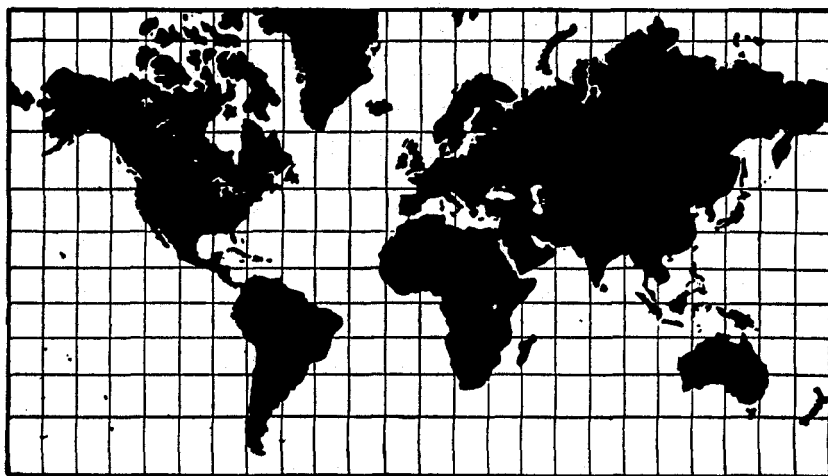

FIG. 67.—Mercator projection, from latitude 60° south, to latitude 78° north.

error is well illustrated in a world map on this projection where a unit of area at the Equator is represented by an area approximating infinity as we approach the pole. Errors of distortion imply deviation from right shape in the graticules or network of meridians and parallels of the map, involving deformation of angles, curvature of meridians, changes of scale, and errors of distance, bearing, or area.

In the Mercator projection, however, as well as in the Lambert conformal conic projection, the changes in scale and area can not truly be considered as distortion or as errors. A mere alteration of size in the same ratio in all directions is not considered distortion or error. These projections being conformal, both scale and area are correct in any restricted locality when referred to the scale of that locality, but as the scale varies with the latitude large areas are not correctly represented.

USEFUL FEATURES OF THE MERCATOR PROJECTION IN WORLD MAPS.—Granting that on the Mercator projection, distances and areas *appear* to be distorted relatively

when sections of the map differing in latitude are compared, an intelligent use of the marginal scale will determine these quantities with sufficient exactness for any given section. In many other projections the scale is not the same in all directions, the scale of a point depending upon the azimuth of a line.

As proof of the impossibilities of a Mercator projection in world maps, the critics invariably cite the exaggeration of Greenland and the polar regions. In the consideration of the various evils of world maps, the polar regions are, after all, the best places to put the maximum distortion. Generally, our interests are centered between 65° north and 55° south latitude, and it is in this belt that other projections present difficulties in spherical relations which in many instances are not readily expressed in analytic terms.

Beyond these limits a circumpolar chart like the one issued by the Hydrographic Office, U. S. Navy, No. 2560, may be employed. Polar charts can be drawn on the gnomonic projection, the point of contact between plane and sphere being at the pole. In practice, however, they are generally drawn, not as true gnomonic projections, but as polar equidistant projections, the meridians radiating as straight lines from the pole, the parallels struck as concentric circles from the pole, with all degrees of latitude of equal length at all parts of the chart.

However, for the general purposes of a circumpolar chart from latitude 60° to the pole, the polar stereographic projection or the Lambert conformal with two standard parallels would be preferable. In the latter projection the 360 degrees of longitude would not be mapped within a circle, but on a sector greater than a semicircle.

NOTE.—The Mercator projection has been employed in the construction of a hydrographic map of the world in 24 sheets, published under the direction of the Prince of Monaco under the title "Carte Bathymétrique des Océans." Under the provisions of the Seventh International Geographic Congress held at Berlin in 1899, and by recommendation of the committee in charge of the charting of suboceanic relief, assembled at Wiesbaden in 1903, the project of Prof. Thoulet was adopted. Thanks to the generous initiative of Prince Albert, the charts have obtained considerable success, and some of the sheets of a second edition have been issued with the addition of continental relief. The sheets measure 1 meter in length and 60 centimeters in height. The series is constructed on 1:10 000 000 equatorial scale, embracing 16 sheets up to latitude 72° . Beyond this latitude, the gnomonic projection is employed for mapping the polar regions in four quadrants each.

The Mercator projection embodies all the properties of conformality, which implies true shape in restricted localities, and the crossing of all meridians and parallels at right angles, the same as on the globe. The cardinal directions, north and south, east and west, always point the same way and remain parallel to the borders of the chart. For many purposes, meteorological charts, for instance, this property is of great importance. Charts having correct areas with cardinal directions running every possible way are undesirable.

While other projections may contribute their portion in special properties from an educational standpoint, they cannot entirely displace the Mercator projection which has stood the test for over three and a half centuries. It is the opinion of the authors that the Mercator projection, not only is a fixture for nautical charts, but that it plays a definite part in giving us a continuous conformal mapping of the world.

THE STEREOGRAPHIC PROJECTION.

The most widely known of all map projections are the Mercator projection already described, and the stereographic projection, which dates back to ancient Greece, having been used by Hipparchus (160–125 B. C.).

The stereographic projection is one in which the eye is supposed to be placed at the surface of the sphere and in the hemisphere opposite to that which it is desired to project. The exact position of the eye is at the extremity of the diameter passing through the point assumed as the center of the map.

It is the only azimuthal projection which has no angular distortion and in which every circle is projected as a circle. It is a conformal projection and the most familiar form in which we see it, is in the *stereographic meridional* as employed to represent the Eastern and Western Hemispheres. In the stereographic meridional projection the center is located on the Equator; in the stereographic horizon projection the center is located on any selected parallel.

Another method of projection more frequently employed by geographers for representing hemispheres is the globular projection, in which the Equator and central meridian are straight lines divided into equal parts, and the other meridians are

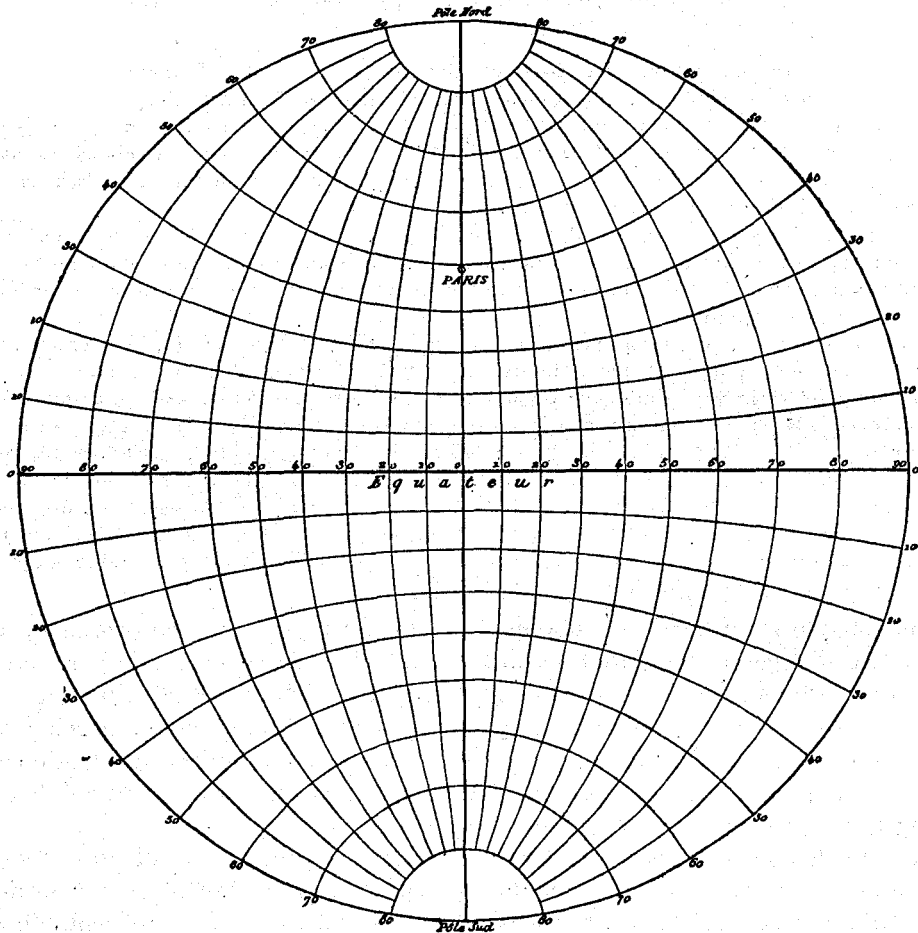

FIG. 68.—Stereographic meridional projection.

circular arcs uniting the equal divisions of the Equator with the poles; the parallels, except the Equator, are likewise circular arcs, dividing the extreme and central meridians into equal parts.

In the globular representation, nothing is correct except the graduation of the outer circle, and the direction and graduation of the two diameters; distances and directions can neither be measured nor plotted. It is not a projection defined for the preservation of special properties, for it does not correspond with the surface of the sphere according to any law of cartographic interest, but is simply an arbitrary distribution of curves conveniently constructed.

The two projections, stereographic and globular, are noticeably different when seen side by side. In the stereographic projection the meridians intersect the parallels at right angles, as on the globe, and the projection is better adapted to the plotting and measurement of all kinds of relations³³ pertaining to the sphere than any other projection. Its use in the conformal representation of a hemisphere is not fully appreciated.

In the stereographic projection of a hemisphere we have the principle of Tehebicheff, namely, that a map constructed on a conformal projection is the best possible when the scale is constant along the whole boundary. This, or an approxi-

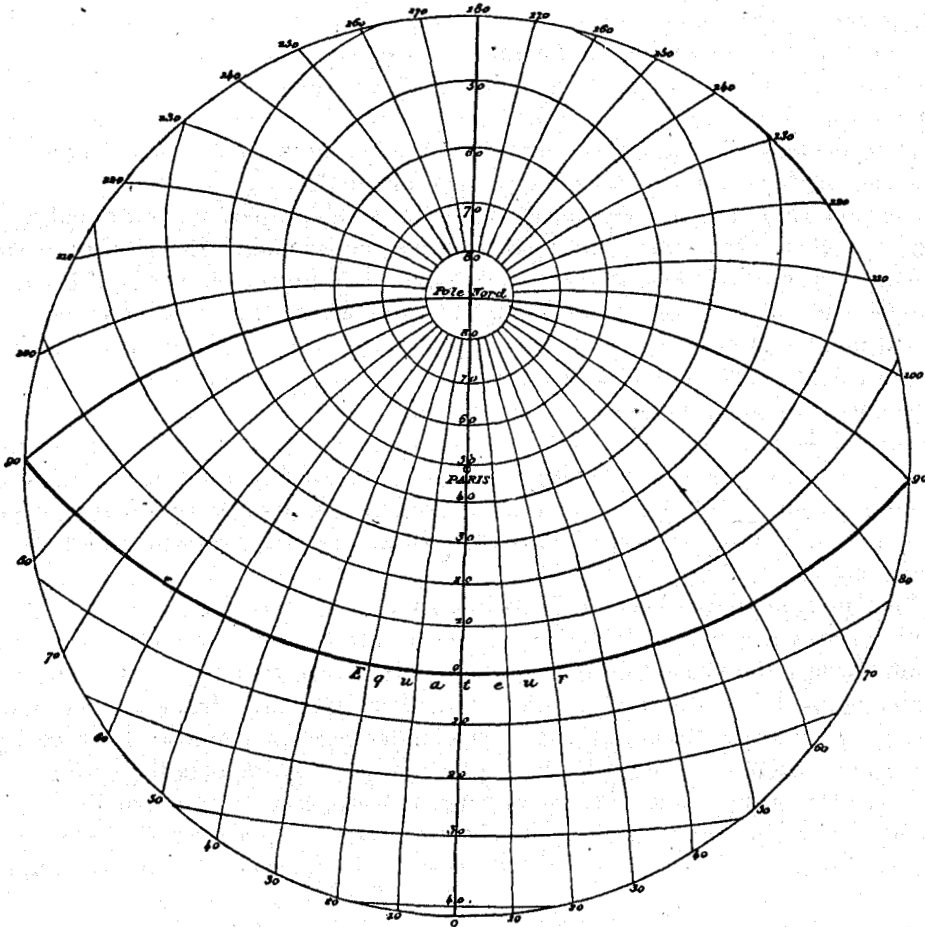

FIG. 69.—Stereographic horizon projection on the horizon of Paris.

mation thereto, seems to be the most satisfactory solution that has been suggested in the problem of conformal mapping of a hemisphere.

The solution of various problems, including the measurement of angles, directions, and distances on this projection, is given in U. S. Coast and Geodetic Survey Special Publication No. 57. The mathematical theory of the projection, the con-

³³ An interesting paper on this projection appeared in the American Journal of Science, Vol. XI, February, 1901, The Stereographic Projection and its Possibilities from a Graphical Standpoint, by S. L. Penfield.

The application of this projection to the solution of spherical problems is given in Notes on Stereographic Projection, by Prof. W. W. Henderickson, U. S. N., Annapolis, U. S. Naval Institute, 1905.

A practical use of the stereographic projection is illustrated in the Star Finder devised by G. T. Rude, hydrographic and geodetic engineer, U. S. Coast and Geodetic Survey:

struction of the stereographic meridional and stereographic horizon projection, and tables for the construction of a meridional projection are also given in the same publication.

THE AITOFF EQUAL-AREA PROJECTION OF THE SPHERE.

(See Plate V and fig. 70.)

The projection consists of a Lambert azimuthal hemisphere converted into a full sphere by a manipulation suggested by Aitoff.³⁴

It is similar to Mollweide's equal-area projection in that the sphere is represented within an ellipse with the major axis twice the minor axis; but, since the parallels are curved lines, the distortion in the polar regions is less in evidence. The representation of the shapes of countries far east and west of the central meridian is not so distorted, because meridians and parallels are not so oblique to one another. The network of meridians and parallels is obtained by the orthogonal or perpendicular projection of a Lambert meridional equal-area hemisphere upon a plane making an angle of 60° to the plane of the original.

The fact that it is an equivalent, or equal-area, projection, combined with the fact that it shows the world in one connected whole, makes it useful in atlases on physical geography or for statistical and distribution purposes. It is also employed for the plotting of the stars in astronomical work where the celestial sphere may be represented in one continuous map which will show at a glance the relative distribution of the stars in the different regions of the expanse of the heavens.

OBSERVATIONS ON ELLIPSOIDAL PROJECTIONS.—Some criticism is made of ellipsoidal projections, as indeed, of all maps showing the entire world in one connected whole. It is said that erroneous impressions are created in the popular mind either in obtaining accuracy of area at the loss of form, or the loss of form for the purpose of preserving some other property; that while these are not errors in intent, they are errors in effect.

It is true that shapes become badly distorted in the far-off quadrants of an Aitoff projection, but the continental masses of special interest can frequently be mapped in the center where the projection is at its best. It is true that the artistic and mathematically trained eye will not tolerate "the world pictured from a comic mirror," as stated in an interesting criticism; but, under certain conditions where certain properties are desired, these projections, after all, play an important part.

The mathematical and theoretically elegant property of conformality is not of sufficient advantage to outweigh the useful property of equal area if the latter property is sought, and, if we remove the restriction for *shape of small areas* as applying to conformal projections, the general shape is often better preserved in projections that are not conformal.

The need of critical consideration of the system of projection to be employed in any given mapping problem applies particularly to the equal-area mapping of the entire sphere, which subject is again considered in the following chapters.

A base map without shoreline, size 11 by 22½ inches, on the Aitoff equal-area projection of the sphere, is published by the U. S. Coast and Geodetic Survey, the radius of the projected sphere being 1 decimeter. Tables for the construction of this projection directly from x and y coordinates follow. These coordinates were obtained from the Lambert meridional projection by doubling the x 's of half the longitudes, the y 's of half the longitudes remaining unchanged.

³⁴ Also written, D. Aitow. A detailed account of this projection is given in Petermanns Mitteilungen, 1892, vol. 33, pp. 85-87.

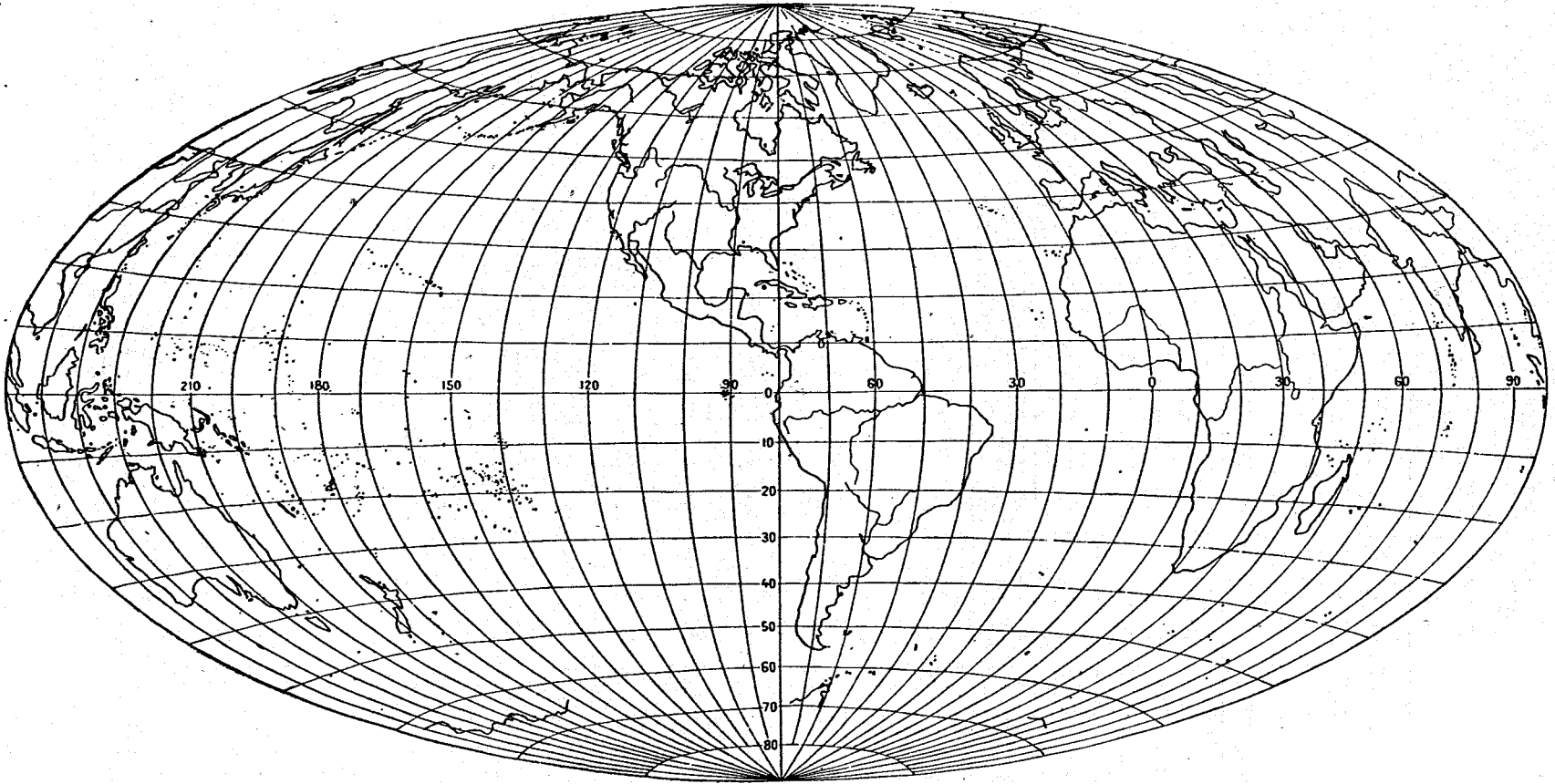

FIG. 70.—The Aitoff equal-area projection of the sphere with the Americas in center.

TABLE FOR THE CONSTRUCTION OF AN AITOFF EQUAL-AREA PROJECTION OF THE SPHERE.

[Radius of projected sphere equals 1 decimeter. Rectangular coordinates in decimillimeters.]

Longitude		0°	10°	20°	30°	40°	50°	60°	70°	80°	90°	100°	110°	120°	130°	140°	150°	160°	170°	180°
Equator.....	x	0.0	174.5	348.6	522.1	694.6	865.7	1035.3	1202.8	1368.1	1530.7	1690.5	1847.0	2000.0	2149.2	2294.3	2435.0	2571.2	2702.4	2828.4
	y	0.0	0.0	0.0	0.0	0.0	0.0	0.0	0.0	0.0	0.0	0.0	0.0	0.0	0.0	0.0	0.0	0.0	0.0	0.0
Latitude 10°.....	x	0.0	172.5	344.6	516.1	686.6	855.7	1023.2	1188.6	1351.8	1512.2	1669.8	1824.0	1974.6	2121.3	2263.8	2401.8	2534.9	2663.2	2785.5
	y	174.3	174.5	175.0	175.8	177.0	178.5	180.4	182.7	185.4	188.6	192.2	196.3	201.0	206.4	212.4	219.2	226.9	235.7	245.6
Latitude 20°.....	x	0.0	166.5	332.6	498.1	662.5	825.5	986.7	1146.0	1302.7	1456.7	1607.6	1755.0	1898.6	2037.9	2172.7	2302.5	2426.9	2545.6	2657.9
	y	347.3	347.6	348.6	350.2	352.5	355.5	359.1	363.6	368.8	374.9	381.9	389.9	399.0	409.2	420.8	433.8	448.5	465.0	483.7
Latitude 30°.....	x	0.0	156.4	312.5	467.8	622.1	774.9	925.8	1074.6	1220.8	1364.0	1504.0	1640.1	1772.1	1899.4	2021.7	2138.5	2249.1	2353.0	2449.5
	y	517.6	518.1	519.5	521.8	525.0	529.3	534.5	540.8	548.3	556.9	566.7	578.0	590.7	605.0	621.1	639.1	659.3	681.8	707.1
Latitude 40°.....	x	0.0	142.2	284.1	425.1	565.1	703.5	840.0	974.2	1105.6	1233.9	1358.7	1479.4	1595.6	1706.8	1812.4	1911.9	2004.6	2089.8	2166.7
	y	684.0	684.6	686.3	689.2	693.2	698.4	704.8	712.6	721.6	732.1	744.1	757.7	773.0	790.1	809.2	830.4	854.0	880.1	909.0
Latitude 50°.....	x	0.0	123.7	247.0	369.6	491.0	610.8	728.6	844.0	956.6	1066.0	1171.6	1273.0	1369.7	1461.2	1546.8	1626.1	1698.2	1762.5	1818.1
	y	845.2	845.9	847.8	850.9	855.4	861.2	868.3	876.8	886.8	898.3	911.3	926.0	942.4	960.7	980.9	1003.1	1027.5	1054.2	1083.4
Latitude 60°.....	x	0.0	100.7	201.0	299.9	399.0	495.8	590.7	682.7	773.0	859.5	942.4	1021.2	1095.4	1164.6	1228.1	1285.4	1335.9	1379.1	1414.2
	y	1000.0	1000.6	1002.5	1005.7	1010.2	1016.0	1023.1	1030.8	1041.4	1052.7	1065.4	1079.7	1095.4	1112.8	1131.8	1152.4	1174.8	1198.9	1224.7
Latitude 70°.....	x	0.0	72.8	145.3	217.1	287.8	357.2	424.8	490.4	553.5	613.8	669.4	724.5	774.2	819.5	860.1	895.6	925.6	949.6	967.4
	y	1147.2	1147.7	1149.4	1152.2	1156.1	1161.1	1167.3	1174.5	1183.0	1192.5	1203.2	1215.1	1228.1	1242.2	1257.4	1273.7	1291.1	1309.6	1328.9
Latitude 80°.....	x	0.0	39.5	78.8	117.6	155.8	192.9	229.0	263.6	296.6	327.8	356.8	383.7	408.0	429.6	448.4	464.1	476.6	485.6	491.2
	y	1285.6	1285.9	1287.0	1288.8	1291.4	1294.6	1298.5	1303.1	1308.4	1314.4	1321.0	1328.2	1335.9	1344.3	1353.1	1362.4	1372.2	1382.3	1392.7
Latitude 90°.....	x	0.0																		
	y	1414.2																		

Thus, in the Lambert meridional projection, the coordinates at latitude 20° , longitude 20° , are

$$x = 0.33123 \text{ decimeter, or } 331.23 \text{ decimillimeters.}$$

$$y = 0.35248 \text{ decimeter, or } 352.48 \text{ decimillimeters.}$$

For the Aitoff projection, the coordinates at latitude 20° , longitude 40° , will be

$$x = 2 \times 331.23 = 662.5 \text{ decimillimeters.}$$

$$y = 352.5 \text{ decimillimeters.}$$

The coordinates for a Lambert equal-area meridional projection are given on page 75.

THE MOLLWEIDE HOMALOGRAPHIC PROJECTION.

This projection is also known as Babinet's equal-surface projection and its distinctive character is, as its name implies, a proportionality of areas on the sphere with the corresponding areas of the projection. The Equator is developed into a straight line and graduated equally from 0° to 180° either way from the central meridian, which is perpendicular to it and of half the length of the representative line of the Equator. The parallels of latitude are all straight lines, on each of which the degrees of longitude are equally spaced, but do not bear their true proportion in length to those on the sphere. Their distances from the Equator are determined by the law of equal surfaces, and their values in the table have been tabulated between the limits 0 at the Equator and 1 for the pole.

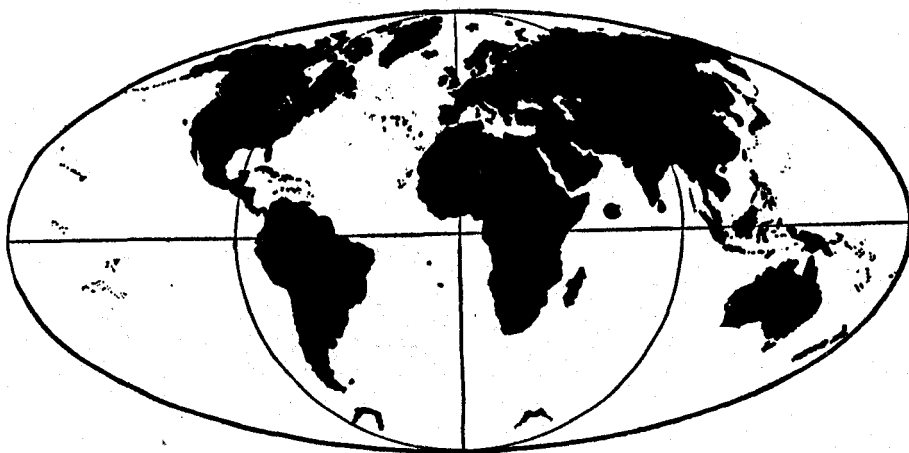

FIG. 71.—The Mollweide homalographic projection of the sphere.

The meridian of 90° on either side of the central meridian appears in the projection as a circle, and by intersection determines the length of 90° from the central meridian on all the parallels; the other meridians are parts of elliptical arcs.

Extending the projection to embrace the whole surface of the sphere, the bounding line of the projection becomes an ellipse; the area of the circle included by the meridians of 90° equals that of the hemisphere, and the crescent-shaped areas lying outside of this circle between longitudes $\pm 90^\circ$ and $\pm 180^\circ$ are together equal to that of the circle; also the area of the projection between parallels $\pm 30^\circ$ is equal to the same.

In the ellipse outside of the circle, the meridional lengths become exaggerated and infinitely small surfaces on the sphere and the projection are dissimilar in form.

The distortion in shape or lack of conformality in the equatorial belt and polar regions is the chief defect of this projection. The length which represents 10 degrees of latitude from the Equator exceeds by about 25 per cent the length along the Equator. In the polar regions it does not matter so much if distortions become excessive in the bounding circle beyond 80 degrees of latitude.

The chief use of the Mollweide homolographic projection is for geographical illustrations relating to area, such as the distribution and density of population or the extent of forests, and the like. It thus serves somewhat the same purpose as the Aitoff projection already described.

The mathematical description and theory of the projection are given in *Lehrbuch der Landkartenprojektionen* by Dr. Norbert Herz, 1885, pages 161 to 165; and Craig (Thomas), *Treatise on Projections*, U. S. Coast and Geodetic Survey, 1882, pages 227 to 228.

CONSTRUCTION OF THE MOLLWEIDE HOMOLOGRAPHIC PROJECTION OF A HEMISPHERE.

Having drawn two construction lines perpendicular to each other, lay off north and south from the central point on the central meridian the lengths, $\sin \theta$, which are given in the third column of the tables³⁵ and which may be considered as y coor-



FIG. 72.—The Mollweide homolographic projection of a hemisphere.

dinates, these lengths being in terms of the radius as unity. The points so obtained will be the points of intersection of each parallel of latitude with the central meridian.

With a compass set to the length of the radius and passing through the upper and lower divisions on the central meridian, construct a circle, and this will represent the outer meridian of a hemisphere. Through the points of intersection on the central meridian previously obtained, draw lines parallel to the Equator and they will represent the other parallels of latitude.

³⁵ These tables were computed by Jules Bourdin.

For the construction of the meridians, it is only necessary to divide the Equator and parallels into the necessary number of equal parts which correspond to the unit of subdivision adopted for the chart.

HOMOLOGRAPHIC PROJECTION OF THE SPHERE.

In the construction of a projection including the entire sphere (fig. 71), we proceed as before, excepting that the parallels are extended to the limiting ellipse, and their lengths may be obtained by doubling the lengths of the parallels of the hemisphere, or by the use of the second column of the tables under the values for $\cos \theta$, in which $\cos \theta$ represents the total distance out along a given parallel from the central to the outer meridian of the hemisphere, or 90 degrees of longitude. In the projection of a sphere these distances will be doubled on each side of the central meridian, and the Equator becomes the major axis of an ellipse.

Equal divisions of the parallels corresponding to the unit of subdivision adopted for the chart will determine points of intersection of the ellipses representing the meridians.

TABLE FOR THE CONSTRUCTION OF THE MOLLWEIDE HOMOLOGRAPHIC PROJECTION.

$[\pi \sin \varphi = 2 \theta + \sin 2 \theta.]$

Latitude φ	$\cos \theta$	$\sin \theta$	Difference $\sin \theta$	Latitude φ	$\cos \theta$	$\sin \theta$	Difference $\sin \theta$
0 00	1.0000000	0.0000000		22 30	0.9522324	0.30537390	
0 30	0.9999767	0.00685431	685431	23 00	0.9500753	0.31201940	664550
1 00	0.9999060	0.01370813	685382	23 30	0.9478704	0.31865560	663620
1 30	0.9997884	0.02056114	685331	24 00	0.9456170	0.32528210	662650
2 00	0.9996240	0.02741423	685279	24 30	0.9433152	0.33189860	661650
			685199				660660
2 30	0.9994127	0.03426622		25 00	0.9409846	0.33850520	
3 00	0.9991542	0.04111710	685088	25 30	0.9385654	0.34510150	659630
3 30	0.9988489	0.04796660	684950	26 00	0.9361174	0.35168730	658580
4 00	0.9984967	0.05481465	684805	26 30	0.9336210	0.35826250	657520
4 30	0.9980970	0.06166115	684655	27 00	0.9310764	0.36482680	656430
							655320
5 00	0.9976507	0.06850600		27 30	0.9284809	0.37138000	
5 30	0.9971572	0.07534890	684280	28 00	0.9258374	0.37792200	654200
6 00	0.9966169	0.08218950	684070	28 30	0.9231446	0.38445240	653040
6 30	0.9960289	0.08902780	683830	29 00	0.9204030	0.39097120	651880
7 00	0.9953942	0.09586340	683560	29 30	0.9176119	0.39747840	650720
			683270				649540
7 30	0.9947127	0.10269610		30 00	0.9147706	0.40397380	
8 00	0.9939839	0.10952580	682970	30 30	0.9118800	0.41045670	648290
8 30	0.9932080	0.11635235	682655	31 00	0.9089400	0.41692680	647010
9 00	0.9923847	0.12317565	682330	31 30	0.9059504	0.42338400	645720
9 30	0.9915144	0.12999545	681990	32 00	0.9029108	0.42982800	644400
			681610				643040
10 00	0.9905970	0.13681155		32 30	0.8998216	0.43625840	
10 30	0.9896322	0.14362350	681195	33 00	0.8966820	0.44267510	641670
11 00	0.9886204	0.15043095	680745	33 30	0.8934924	0.44907810	640300
11 30	0.9875614	0.15723380	680285	34 00	0.8902524	0.45546720	638910
12 00	0.9864550	0.16403190	679810	34 30	0.8869620	0.46184240	637520
			679330				636110
12 30	0.9853012	0.17082520		35 00	0.8836206	0.46820350	
13 00	0.9841004	0.17761365	678845	35 30	0.8802282	0.47455020	634670
13 30	0.9828517	0.18440710	678345	36 00	0.8767850	0.48088240	633220
14 00	0.9815556	0.19117535	677825	36 30	0.8732908	0.48719920	631680
14 30	0.9802124	0.19794810	677275	37 00	0.8697454	0.49350080	630160
			676690				628590
15 00	0.9788217	0.20471500		37 30	0.8661484	0.49978670	
15 30	0.9773830	0.21147590	676090	38 00	0.8625002	0.50605670	627000
16 00	0.9758970	0.21823050	675460	38 30	0.8588002	0.51231090	625420
16 30	0.9743637	0.22497845	674795	39 00	0.8550482	0.51854850	623760
17 00	0.9727827	0.23171900	674115	39 30	0.8512442	0.52476980	622130
			673430				620440
17 30	0.9711537	0.23845390		40 00	0.8473879	0.53097420	
18 00	0.9694770	0.24518120	672730	40 30	0.8434792	0.53716160	618740
18 30	0.9677529	0.25190120	672000	41 00	0.8395179	0.54333170	617010
19 00	0.9659809	0.25861370	671250	41 30	0.8355020	0.54948450	615280
19 30	0.9641609	0.26531840	670470	42 00	0.8314364	0.55561960	613510
			669680				611700
20 00	0.9622929	0.27201520		42 30	0.8273120	0.56173660	
20 30	0.9603770	0.27870400	668880	43 00	0.8231420	0.56783530	609870
21 00	0.9584130	0.28538430	668030	43 30	0.8189142	0.57391550	608020
21 30	0.9564009	0.29205610	667180	44 00	0.8146326	0.57997710	606160
22 00	0.9543409	0.29871950	666340	44 30	0.8102966	0.58602010	604300
22 30	0.9522324	0.30537390	665440	45 00	0.8059058	0.59204370	602380

TABLE FOR THE CONSTRUCTION OF THE MOLLWEIDE HOMALOGRAPHIC PROJECTION—
continued.

$$[\pi \sin \varphi = 2\theta + \sin 2\theta.]$$

Latitude φ	$\cos \theta$	$\sin \theta$	Difference $\sin \theta$	Latitude φ	$\cos \theta$	$\sin \theta$	Difference $\sin \theta$
45 00	0.8059058	0.59204370		67 30	0.5451794	0.83831940	
45 30	0.8014604	0.59804760	600390	68 00	0.5377379	0.84311240	479300
46 00	0.7969604	0.60403170	598410	68 30	0.5302071	0.84786820	475580
46 30	0.7924049	0.60999530	596360	69 00	0.5225861	0.85258680	471840
47 00	0.7877940	0.61593870	594340	69 30	0.5148715	0.85726740	468080
			592320				464320
47 30	0.7831270	0.62188190		70 00	0.5070603	0.86191060	
48 00	0.7784035	0.62776410	590220	70 30	0.4991511	0.86651480	460420
48 30	0.7736235	0.63364540	588130	71 00	0.4911423	0.87107920	456440
49 00	0.7687865	0.63950560	586020	71 30	0.4830314	0.87560300	452380
49 30	0.7638925	0.64534360	583900	72 00	0.4748167	0.88008460	448160
			581600				443940
50 00	0.7589409	0.65115960		72 30	0.4664942	0.88452400	
50 30	0.7539317	0.65695270	579310	73 00	0.4580613	0.88892040	439640
51 00	0.7488643	0.66272350	577080	73 30	0.4495146	0.89327300	435260
51 30	0.7437375	0.66847200	574850	74 00	0.4408511	0.89758020	430720
52 00	0.7385513	0.67419710	572510	74 30	0.4320659	0.90184180	426160
			570200				421440
52 30	0.7333054	0.67999910		75 00	0.4231614	0.90605620	
53 00	0.7279905	0.68577440	567830	75 30	0.4141156	0.91022420	416800
53 30	0.7226332	0.69152180	565440	76 00	0.4049354	0.91434520	412100
54 00	0.7172058	0.69724630	562950	76 30	0.3956158	0.91841600	407080
54 30	0.7117175	0.70296580	560450	77 00	0.3861534	0.92243460	401860
			557880				396550
55 00	0.7061676	0.70864460		77 30	0.3765409	0.92640010	
55 30	0.7005530	0.71359830	555370	78 00	0.3667705	0.93031150	391140
56 00	0.6948790	0.71842550	552820	78 30	0.3568322	0.93416860	385710
56 30	0.6891390	0.72462920	550270	79 00	0.3467146	0.93797060	380200
57 00	0.6833342	0.73010570	547650	79 30	0.3364137	0.94171410	374550
			545000				368190
57 30	0.6774641	0.73555570		80 00	0.3259234	0.94539600	
58 00	0.6715285	0.74097870	542300	80 30	0.3152285	0.94901590	361990
58 30	0.6655270	0.74637350	539480	81 00	0.3043189	0.95257020	355430
59 00	0.6594590	0.75174020	536670	81 30	0.2921755	0.95605840	348820
59 30	0.6533232	0.75707900	533880	82 00	0.2817763	0.95948020	342180
			530970				334980
60 00	0.6471191	0.76238870		82 30	0.2701079	0.96283000	
60 30	0.6408456	0.76766950	528080	83 00	0.2581516	0.96610470	327470
61 00	0.6345019	0.77292120	525170	83 30	0.2458837	0.96929940	319470
61 30	0.6280869	0.77814310	522190	84 00	0.2332737	0.97240900	311150
62 00	0.6216001	0.78333450	519140	84 30	0.2202700	0.97543880	302800
			516070				293630
62 30	0.6150407	0.78849520		85 00	0.2068365	0.97837520	
63 00	0.6084076	0.79362470	512950	85 30	0.1929149	0.98121520	284000
63 30	0.6016988	0.79872290	509820	86 00	0.1784407	0.98395070	273550
64 00	0.5949143	0.80378900	506610	86 30	0.1633412	0.98656970	261900
64 30	0.5880519	0.80882300	503400	87 00	0.1474833	0.98906470	249500
			500120				236180
65 00	0.5811107	0.81382420		87 30	0.1306660	0.99142650	
65 30	0.5740894	0.81879250	496830	88 00	0.1126372	0.99333620	220970
66 00	0.5669870	0.82372660	493410	88 30	0.0929962	0.99506640	203020
66 30	0.5598024	0.82852600	489940	89 00	0.0710530	0.99747270	180630
67 00	0.5525339	0.83349040	486440	89 30	0.0447615	0.99899770	152500
67 30	0.5451794	0.83831940	482900	90 00	0.0000000	1.00000000	100230

GOODE'S HOMALOGRAPHIC PROJECTION (INTERRUPTED) FOR THE CONTINENTS AND OCEANS.

[See Plate VI and fig. 73.]

Through the kind permission of Prof. J. Paul Goode, Ph. D., we are able to include in this paper a projection of the world devised by him and copyrighted by the University of Chicago. It is an adaptation of the homalographic projection and is illustrated by Plate VI and by figure 73, the former study showing the world on the *homalographic projection (interrupted) for the continents*, the latter being the same projection interrupted for *ocean units*.

The homalographic projection (see fig. 71) which provides the base for the new modification was invented by Prof. Mollweide, of Halle, in 1805, and is an equal-area representation of the entire surface of the earth within an ellipse of which the ratio of major axis to minor axis is 2:1. The first consideration is the construction of an equal-area hemisphere (see fig. 72) within the limits of a circle, and in this pro-

jection the radius of the circle is taken as the square root of 2, the radius of the sphere being unity. The Equator and mid-meridian are straight lines at right angles to each other, and are diameters of the map, the parallels being projected in right lines parallel to the Equator, and the meridians in ellipses, all of which pass through two fixed points, the poles.

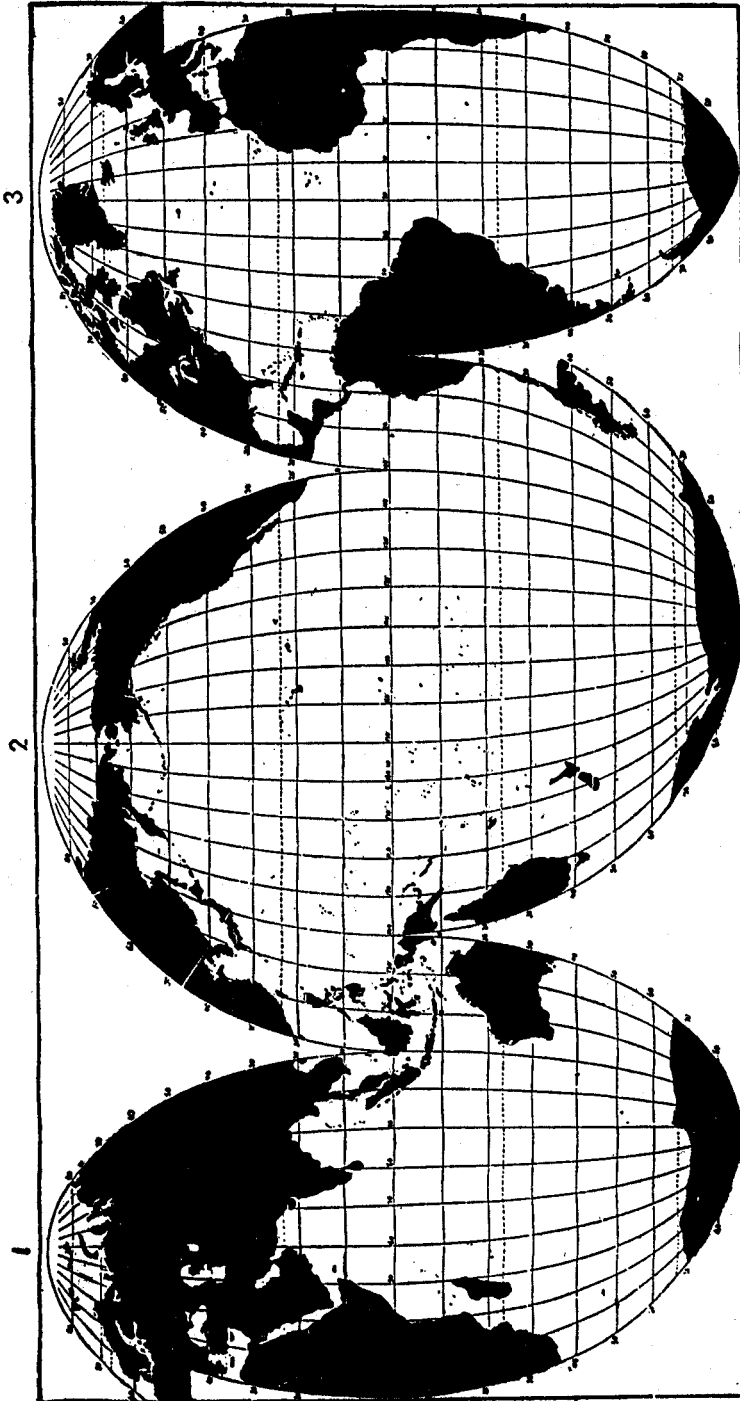

FIG. 73.—Homalographic projection (interrupted) for ocean units.

In view of the above-mentioned properties, the Mollweide projection of the hemisphere offers advantages for studies in comparative latitudes, but shapes become badly distorted when the projection is extended to the whole sphere and becomes ellipsoidal. (See fig. 71.)

In Prof. Goode's adaptation each continent is placed in the middle of a quadrillage centered on a mid-meridian in order to secure for it the best form. Thus North America is best presented in the meridian 100° west, while Eurasia is well taken care of in the choice of 60° east; the other continents are balanced as follows: South America, 60° west; Africa, 20° east; and Australia, 150° east.

Besides the advantage of equal area, each continent and ocean is thus balanced on its own axis of strength, and world relations are, in a way, better shown than one may see them on a globe, since they are all seen at one glance on a flat surface.

In the *ocean units* a middle longitude of each ocean is chosen for the mid-meridian of the lobe. Thus the North Atlantic is balanced on 30° west, and the South Atlantic on 20° west; the North Pacific on 170° west, and the South Pacific on 140° west; the Indian Ocean, northern lobe on 60° east, and southern lobe 90° east.

We have, then, in one setting the continents in true relative size, while in another setting the oceans occupy the center of interest.

The various uses to which this map may be put for statistical data, distribution diagrams, etc., are quite evident.

Section 3 (the eastern section) of figure 73, if extended slightly in longitude and published separately, suggests possibilities for graphical illustration of long-distance sailing routes, such as New York to Buenos Aires with such intermediate points as may be desired. While these could not serve for nautical charts—a province that belongs to the Mercator projection—they would be better in form to be looked at and would be interesting from an educational standpoint.

As a study in world maps on an equal-area representation, this projection is a noteworthy contribution to economic geography and modern cartography.

LAMBERT PROJECTION OF THE NORTHERN AND SOUTHERN HEMISPHERES.

[See Plate VII.]

This projection was suggested by Commander A. B. Clements of the U. S. Shipping Board and first constructed by the U. S. Coast and Geodetic Survey. It is a conformal conic projection with two standard parallels and provides for a repetition of each hemisphere, of which the bounding circle is the Equator.

The condition that the parallel of latitude 10° be held as one of the standards combined with the condition that the hemispheres be repeated, fixes the other standard parallel at $48^{\circ} 40'$.

The point of tangency of the two hemispheres can be placed at will, and the repetition of the hemispheres provides ample room for continuous sailing routes between any two continents in either hemisphere.

A map of the world has been prepared for the U. S. Shipping Board on this system, scale 1:20 000 000, the diameter of a hemisphere being 54 inches. By a gearing device the hemispheres may be revolved so that a sailing route or line of commercial interest will pass through the point of contact and will appear as a continuous line on the projection.

Tables for the construction of this projection are given on page 86. The scale factor is given in the last column of the tables and may be used if greater accuracy in distances is desired. In order to correct distances measured by the graphic

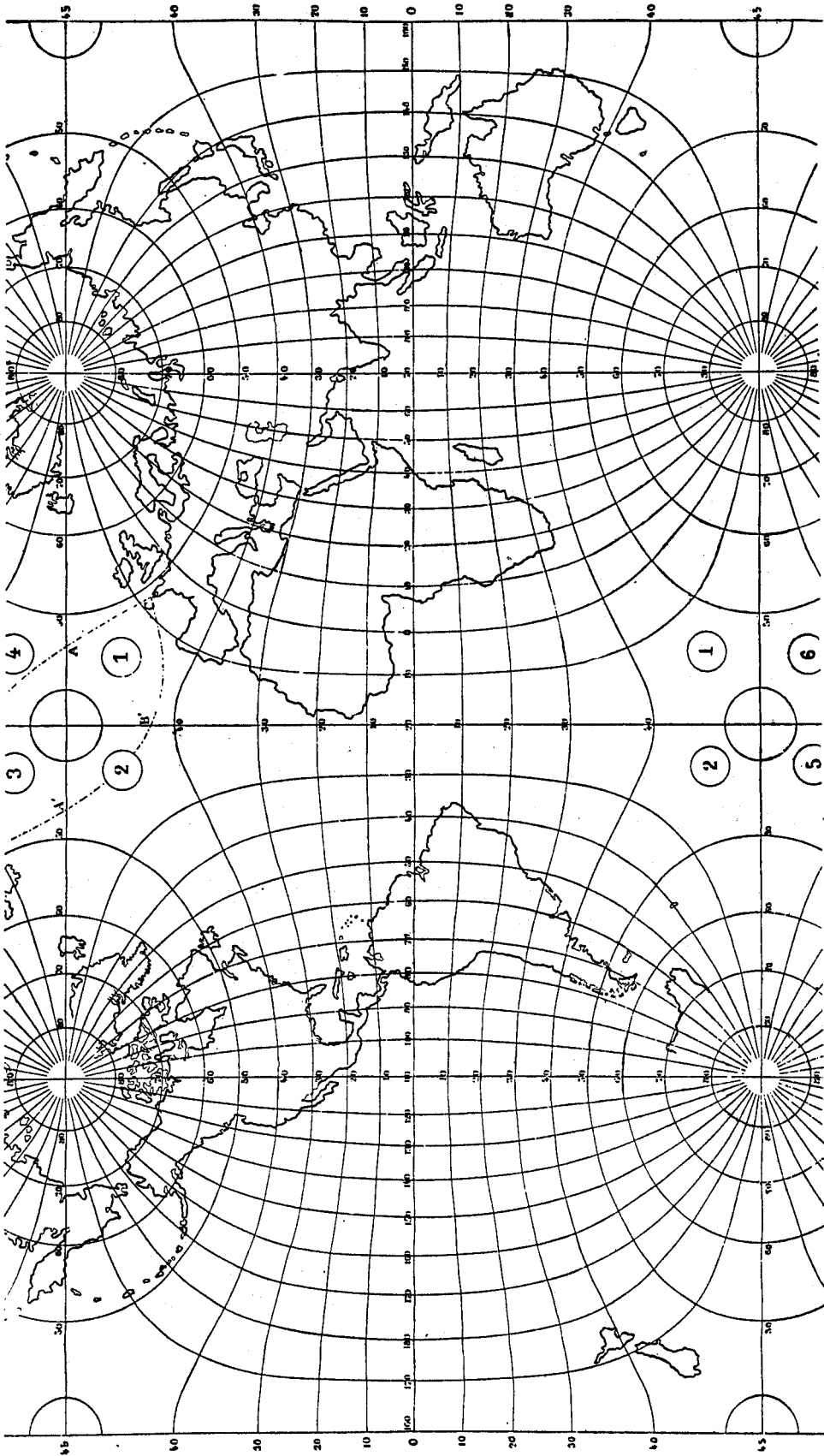

FIG. 74.—Guyou's doubly periodic projection of the sphere.

scale of the map, divide them by the scale factor. Corrections to area may be applied in accordance with the footnote on page 81. With two of the parallels true to scale, and with scale variant in other parts of the map, care should be exercised in applying corrections.

In spite of the great extent covered by this system of projection, the property of form, with a comparatively small change of scale, is retained, and a scale factor for the measurement of certain spherical relations is available.

CONFORMAL PROJECTION OF THE SPHERE WITHIN A TWO-CUSPED EPICYCLOID.

[See Plate VIII.]

The shape of the sphere when developed on a polyconic projection (see fig. 47) suggested the development of a conformal projection within the area inclosed by a two-cusped epicycloid. The distortions in this case appear in the distant quadrants, or regions, of lesser importance.

Notwithstanding the appearance of similarity in the bounding meridians of the polyconic and the conformal development, the two projections are strikingly different and present an interesting study, the polyconic projection, however, serving no purpose in the mapping of the entire sphere.

For the above system of conformal representation we are indebted to Dr. F. August and Dr. G. Bellermann. The mathematical development appears in *Zeitschrift der Gesellschaft für Erdkunde zu Berlin*, 1874, volume 9, part 1, No. 49, pages 1 to 22.

GUYOU'S DOUBLY PERIODIC PROJECTION OF THE SPHERE.

[See fig. 74.]

In *Annales Hydrographiques*, second series, volume 9, pages 16-35, Paris, 1887, we have a description of an interesting projection of the entire sphere by Lieut. E. Guyou. It is a conformal projection which provides for the repetition of the world in both directions—east or west, north or south, whence the name *doubly periodic*. The necessary deformations are, in this projection, placed in the oceans in a more successful manner than in some other representations.

The accompanying illustration shows the Eastern and Western Hemispheres without the duplicature noted above.

The above projection is the last one in this brief review of world-map projections. In the representation of moderate areas no great difficulties are encountered, but any attempt to map the world in one continuous sheet presents difficulties that are insurmountable.

Two interesting projections for conformal mapping of the world are not included in this review as they have already been discussed in United States Coast and Geodetic Survey Special Publication No. 57, pages 111 to 114. Both of these are by Lagrange, one being a double circular projection in which Paris is selected as center of least alteration with variation as slow as possible from that point; the other shows the earth's surface within a circle with the center on the Equator, the variations being most conspicuous in the polar regions.

For conformal mapping of the world the Mercator projection, for many purposes, is as good as any, in that it gives a definite measure of its faults in the border scale; for equal-area mapping, Prof. Goode's interrupted homalographic projection accomplishes a great deal toward the solution of a most difficult problem.

INDEX.

	Page.		Page.
Aitoff equal-area projection.....	150-153	Conformal projection—Continued.	
Table.....	152	Stereographic meridional.....	42, 44, 51, 116, 147-149
Albers, H. C.....	91	Stereographic polar.....	35, 147
Albers projection.....	55, 56	Conformality.....	78
Comparison with Lambert conformal....	92-	Conical projections (<i>see also</i> Albers and Lam- bert).....	46
Construction.....	93, 116	Craig, Thomas.....	78, 154
Description.....	99	Cylindrical conformal projection (<i>see also</i> Mercator).....	32, 51, 56
Mathematical theory.....	91-93	Cylindrical equal-area projection.....	30, 56, 93
Table for United States.....	93-99	Cylindrical equal-spaced projection.....	30
Anti-Gudermannian.....	100	Deformation tables.....	54, 56
August, Dr. F.....	114	Earth:	
Authalic latitude.....	160	Polyhedron.....	28
Azimuthal projection:		Reference lines.....	11
Gnomonic meridional.....	54, 56, 99	Shape.....	9
Gnomonic (or central).....	43, 45	Truncated cone.....	28
45, 52, 101-103, 140-145		Ellipsoidal projections.....	150
Lambert meridional equal-area... 43, 73, 74, 116		Equal-area mapping.....	54, 116
Lambert polar equal-area.....	38	Equal-area projections.....	24, 26
Lambert zenithal equal-area... 56, 71-74, 116		Aitoff.....	150-153
Orthographic meridional.....	43, 51	Albers.....	55, 56, 91-100, 116
Orthographic polar.....	38	Bonne.....	49, 60, 67-70, 81, 116
Polar equidistant.....	40, 147	Cylindrical.....	30, 56, 93
Polar gnomonic.....	37, 147	Goode's homalographic.....	57, 156-158, 160
Stereographic horizon.....	116, 147-149	Lambert meridional azimuthal.....	43, 73, 116
Stereographic meridional.....	42, 44, 51, 116, 147-149	Lambert polar azimuthal.....	38
Stereographic polar.....	35, 147	Lambert zenithal (or azimuthal) projec- tion.....	56, 71-74, 116
Behrmann, Dr. W.....	93	Mollweide.....	24, 153-156
Bonne projection.....	49, 60, 81, 116	Sanson-Flamsteed.....	68
Construction.....	68-70	Equal-spaced projection, cylindrical.....	30
Description.....	67-68	Equidistant polar projection.....	40, 147
Bourdin, J., tables.....	154	Errors of projections.....	54-56, 59, 80-82, 91, 146
Bowditch, American Practical Navigator... 112		Compensation.....	81-82
British Admiralty:		Fowler, G. H.....	140
Fixing positions by wireless.....	137	Frischauf, Dr.....	65
Gnomonic charts.....	141	Gauss.....	54, 57
Manual of navigation.....	145	Geological Survey, tables.....	62
Central projection (<i>see also</i> Gnomonic)..... 37		Geometrical azimuthal projections.....	35
Gnomonic meridional.....	43, 45	Germain, A., tables (Mercator).....	116-136
Gnomonic polar.....	37	Globe:	
Tangent cone.....	47	Plotting points.....	14
Tangent cylinder.....	30	Terrestrial.....	19
Choice of projection.....	54	Globular projection.....	43, 44, 51, 148
Clements, A. B.....	158	Gnomonic (or central) projection.....	101-103
Collins, E. B.....	137	Description.....	140-141
Conformal mapping.....	26, 54, 116	Mathematical theory.....	140-145
Conformal projection:		Meridional.....	43, 45
Lambert. <i>See</i> Lambert.		Polar.....	37
Mercator. <i>See</i> Mercator.		Tangent cube.....	52
Sphere.....	160		
Stereographic horizon.....	116, 147-149		

	Page.		Page.
Goode, Prof. J. P.....	57, 160	Map projection—Continued.	
Homalographic projection.....	156-158	Geometrical azimuthal.....	35
Great circles (<i>see also</i> Plate 1).....	83, 101-103	Perspective.....	26
Grid system of military mapping.....	87	Polar equidistant.....	40, 147
France.....	87	Problem.....	22
United States.....	87-90	Mercator projection.....	32, 51,
Guyou's doubly periodic projection.....	159-160	101-137, 141, 145-147, 160	
Hartl, Prof.....	91, 93	Advantages.....	103-105
Hassler, Ferdinand.....	58	Construction.....	109-114
Hendrickson, W. W.....	149	Description.....	101-105
Herz, Dr. Norbert.....	93, 154	Development of formulas.....	105-109
Hill, George William.....	57	Distances measured.....	103, 112
Hinks, A. R.....	60, 79, 146	Employed by Coast and Geodetic Sur- vey.....	104, 105
Hydrographic Office, U. S.....	103, 137, 138, 147	High latitudes.....	82, 104
International map. <i>See</i> Polyconic projec- tion with two standard meridians.		Tables.....	109, 110, 116, 117-136
Isometric latitude.....	107	Transverse.....	104, 108, 109, 116
Isoperimetric curves.....	24, 92	Transverse construction for sphere....	114-116
Lagrange.....	54, 160	Useful features.....	146, 147
Lallemand.....	62, 63, 66	Ministère de la Marine.....	103
Lambert azimuthal projection, polar.....	38	Mollweide homalographic projection... 24, 153-156	
Lambert conformal conic projection.....	55, 56, 77-86, 116	Construction.....	154
Comparison with Lambert zenithal....	72	Table.....	155, 156
Compensation of scale error.....	81	Monaco, Prince Albert of.....	147
Construction.....	83	North Atlantic Ocean map.....	82-84
General observations.....	80	Table.....	85
Table for hemispheres.....	86	Orthographic projection:	
Table for North Atlantic.....	85	Meridional.....	43, 51
Tables for United States, reference....	83, 84	Polar.....	38
Lambert equal-area meridional projection... 43, 56, 71-73, 116		Penfield, S. L.....	149
Table for construction.....	73, 74	Perspective projection.....	26
Lambert, Johann Heinrich.....	78	Central on tangent cone.....	47
Lambert projection of the northern and southern hemispheres.....	158-160	Gnomonic meridional.....	43, 45
Table.....	86	Gnomonic (or central).....	101-103, 140-145
Lambert zenithal (or azimuthal) projection.. 56, 71-73, 116		Gnomonic polar.....	37, 147
Comparison with Lambert conformal... 72		Orthographic meridional.....	43, 51
Table for construction.....	73, 74	Orthographic polar.....	38
Latitude determination.....	12	Stereographic horizon.....	116, 148, 149
Lecky, reference to tables.....	141	Stereographic meridional.....	42, 44, 51, 116, 147-149
Littlehales, G. W.....	137	Stereographic polar.....	35, 147
Longitude determination.....	13	Tangent cylinder.....	30
Map:		Petermanns Mitteilungen.....	150
Definition.....	9	Pillsbury, Lieut. J. E.....	83
Ideal, the.....	27	Polar charts.....	35-40, 147
Plotting points.....	14	Polyconic projection.....	49, 55, 58-60
Problem.....	9	Compromise.....	59-60
Process of making.....	15	Construction.....	61
Map projection:		International map.....	62-66
Azimuthal.....	26	Tables.....	64
Condition fulfilled.....	25	Transverse.....	62
Conformal.....	26	With two standard meridians.....	62-66
Conventional.....	27	Tables.....	64
Definition.....	22	Reference lines:	
Distortion.....	22, 51	Earth.....	11
		Globe.....	14, 17
		Plane map.....	14

	Page.		Page.
Rhumb lines.....	101-103	Surface:	
Rosén, Prof.....	66	Developable and nondevelopable.....	9
Rude, G. T.....	149	Developable, use.....	27
Sanson-Flamsteed projection.....	68	Plane, construction.....	16
Smithsonian tables.....	81, 114	Tchebicheff.....	149
Sphere:		Tissot.....	54, 56
Construction of meridians and parallels.....	17	United States, map.....	54, 55, 72, 79-85, 91-93, 99
Nature.....	11	Table:	
Stereographic projection.....	56, 147	Albers.....	100
Horizon.....	116, 147-149	Lambert conformal.....	85, 86
Meridional.....	42, 44, 51, 116, 147-149	Lambert zenithal.....	73, 74
Construction.....	44	Wangerin, A.....	78
Polar.....	35, 147	Wireless directional bearings.....	137-139, 141
Straightedge, construction.....	16	World maps.....	57, 146-160
Straight line, how to draw.....	15	Zöpplitz, Prof. Dr. Karl.....	73

INDEX TO ADDENDA.

Azimuthal equidistant projection.....	166	Nordisk Världs Atlas.....	166
Doubly azimuthal projection.....	167	Postel projection.....	166
Doubly equidistant projection.....	167	Sanson-Flamsteed projection.....	164
Lambert equal-area meridional projection...	166	Sinusoidal projection.....	164
Mercator equal-area projection.....	164		
Modified sinusoidal and Mollweide projec- tions.....	165		

ADDENDA.

The growing interrelation of countries of the Orient and Occident and the tremendous importance of scientific research have recently given an intellectual stimulus to the art and science of cartography, especially as applied to the greater problems which arise in the mapping of areas of continental or world proportions.

Brief mention will here be made of a few of the more important studies or contributions to the subject which have appeared since the publication of the first edition of this book. The first projection to be described with its application to world mapping is the so-called sinusoidal.

SINUSOIDAL OR MERCATOR EQUAL-AREA PROJECTION.

This projection has already been mentioned on page 68 under the heading "Sanson-Flamsteed projection." It was employed in the Mercator-Hondius atlases as early as 1606 for a map of South America. In the following years its use was extended to the mapping of Africa and to groups of continents of hemispherical proportions.

The projection as employed in the Mercator atlases appeared without a name but was subsequently called the Sanson-Flamsteed, and, later on, the sinusoidal projection, the latter term being appropriate only from the viewpoint that the meridians are sine curves. Sanson, however, did not use this projection until 1650 and Flamsteed used it first in 1729.

Such, then, is its brief history and one of its applications is illustrated by the accompanying diagram (see fig. 75) as taken from the *Nordisk Världs Atlas*, Stockholm, 1927.

DESCRIPTION.

1. The sinusoidal is an equal-area projection; that is, the projection is true for area scale throughout. A square inch on any part of the map covers the same ground area as a square inch on any other part.
2. It gives true linear scale for all measurements paralleling the Equator and on the vertical (or, as in this case, the central) meridian of each figure. Other linear measurements, however, are variable.
3. It provides an unusually convenient base for plotting data, since the intervals between parallels are true and the meridional divisions along each parallel are true and equal.
4. It allows the map to be divided into three tangential groupings—North and South America, Europe and Africa, Asia and Australia—thus covering as much of the earth's surface as may be desired.

This same system of projection is employed by the Bureau of Foreign and Domestic Commerce, Washington, D. C., for purposes of statistical comparisons, such as population densities, natural resources, etc. The arrangement employed by the American bureau is slightly different and perhaps better than that of the atlas mentioned, due to the fact that this system adapts itself to an interrupted alignment as between the northern and southern continents. Whereas in the atlas we have three vertical groupings, in the bureau's we have the benefit of five different

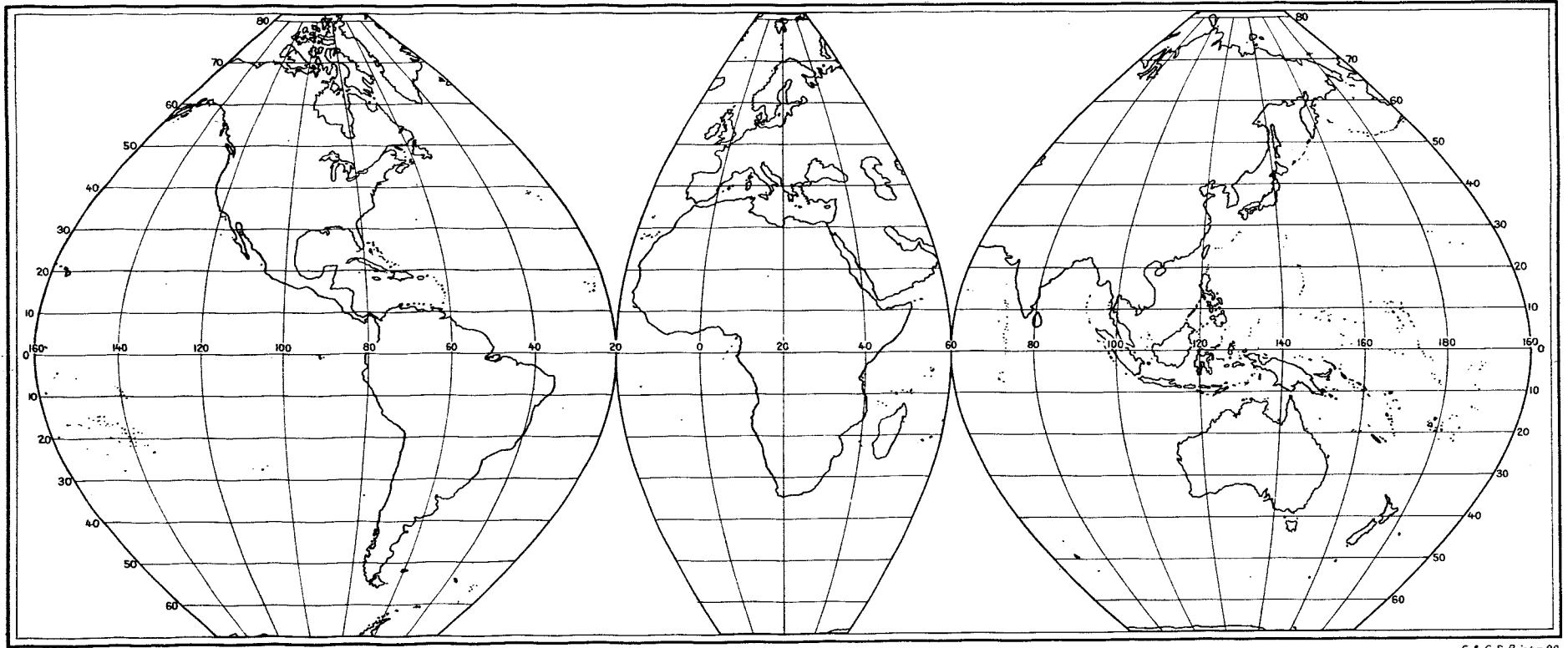

C. & G. S. Print - 89

FIG. 75 - SINUSOIDAL OR MERCATOR EQUAL-AREA PROJECTION

orientations to the north and south, North America being centered on meridian 100° west of Greenwich, South America on 70° west, Europe and Africa on 20° east, Asia on 120° east, and Australia on 140° east.

In the various groupings of continental masses to be charted, to which this system of projection is applicable, it may be suggested that inasmuch as our interest in world mapping is confined within the limits of 70° north latitude and 70° south latitude, ordinary maps need not be extended beyond those latitudes. Polar caps covering the remaining 20° can be placed in the vacant spaces of the map on a circular equal-area projection on the same scale as the general map, or the main projection itself may be continued to include the poles.

CONSTRUCTION OF THE PROJECTION.

The construction of this projection is exceedingly simple and is carried out as follows: Draw a straight line to represent the Equator and erect a perpendicular to it at the center of the sheet. On this central meridian lay off to the given scale the true distances of latitude north and south for every parallel to be represented on the map. These distances are given in Tables for a Polyconic Projection of Maps, U. S. Coast and Geodetic Survey Special Publication No. 5 (fourth edition). For small-scale maps, intervals of 1° are given on page 7; for large-scale maps the general tables which follow may be used. Through the points thus determined draw lines parallel to the Equator and these will represent the parallels of latitude of the map.

The meridians can be located by laying off to the given scale east and west from the central meridian their true intervals on each parallel. These intervals are given on page 6 of the publication mentioned above. By connecting the corresponding points thus established on the successive parallels, all of the meridians can be drawn and the projection completed.

This useful projection which has appeared under so many names, none of which are definitely satisfactory either from the viewpoint of authorship or description, might well have been termed "Mercator equal-area projection" in the first place, from the fact that the early atlases bearing his name gave us the first substantial maps in which it was employed. Mercator's name has, however, been so clearly linked with his nautical conformal projection that it becomes necessary to include with his name the words *equal-area* if we wish to disregard the later claimants of its invention, and call it the Mercator *equal-area* projection. At the present day the name sinusoidal, though meager in definition, is rather customary and can not be disregarded.

MODIFIED SINUSOIDAL AND MOLLWEIDE PROJECTIONS.

An interesting projection for world maps somewhat similar to the one just described has been devised by S. W. Boggs, of the Department of State, Washington, D. C. This projection is in a sense a mathematical mean between the sinusoidal and Mollweide projections. Its appearance at the poles is more pleasing than the sinusoidal in that the polar points are not so conspicuous as in the former. While this feature is an improvement to the general appearance of the map, the scale and shape of land masses in the equatorial regions are not as good as in the sinusoidal projection. The properties of the projection are in a general way a mean of the properties of the two projections from which it is derived.

The mathematical theory that forms the basis of the projection was developed by Mr. Adams, one of the authors of this publication, and the first computations were made by Mr. Boggs under his supervision.

LAMBERT EQUAL-AREA MERIDIONAL PROJECTION.

This projection has already been described on page 73 of this publication. It has been used successfully for hemispheres, and we find an interesting example in the Eastern and Western Hemispheres placed tangent to each other in *Comptes Rendus, L'Association Géodésique Internationale*, vol. III, 1911. This arrangement of the land masses of the world probably presents a more graceful appearance than any other.

The *Nordisk Världs Atlas* shows a map of the Pacific Ocean where the projection is extended to cover 210° of longitude and serves as an ideal arrangement for this particular extensive configuration.

AZIMUTHAL EQUIDISTANT PROJECTION.

In the solution of various problems for determining true distances and azimuths from a given point, the azimuthal equidistant projection has in recent years come into prominent use. This type of projection was first employed by Postel in 1581; afterwards by Lambert in 1772, who regarded it as a zenithal projection; then again in 1799 by Antonio Cagnoli, who believed that he had invented it and gave it his name. We shall here adopt the name *Azimuthal equidistant projection* because the straight lines radiating from the center represent great circles in their true azimuths from it, and the distances along these lines are true to scale. The projection is neither equal-area nor conformal.

No projection can be devised which will give all distances to the correct scale, but this projection gives the distances correct from one point, the center of the map; and for a limited area, even one as large as the United States which has arc distances of 21° , the maximum error in distance is much less on this than on many other projections, not excepting the polyconic.

The question often arises as to the degree of success of a given projection and the percentage of error of the bearings and distances from a given point. Such a question is oftentimes difficult to answer and we may find it useful to test each projection by finding out how nearly it approximates the azimuthal equidistant projection.

The greatest errors in scale on this projection are found along the bounding almucantar or circle of greatest radial distance. Along this circle distance measurements are in excess of true distances, and on all almucantars the scale is increasingly too large as the distance from the center increases.

A map on this projection is easy to construct when the center is one of the poles, since all that is required is to take to the given scale a radius equal to the distance along a meridian from the pole to a given parallel and construct a circle with the pole as center. This circle then represents the parallel.

When the center of the map is any other point, the arc distances and the azimuths from the central point must be computed for the various intersections of the meridians and parallels. Coordinates for these intersections can then be computed to facilitate the construction of the projection. This is generally done on the supposition of the earth as a sphere. The computation for the spheroid is laborious and would only be warranted in cases where extreme accuracy is sought and when the computation of the map in other respects is done with the utmost care. By considering the earth as a sphere with a mean radius, sufficient accuracy can generally be attained.

The projection is of use for maps from which it is desired to scale accurately the distance and azimuth from the central point to any other point, and its use in aeronautics and for various other purposes is apparent. The chief difficulty lies in the fact that a separate computation and map are required for each central city.

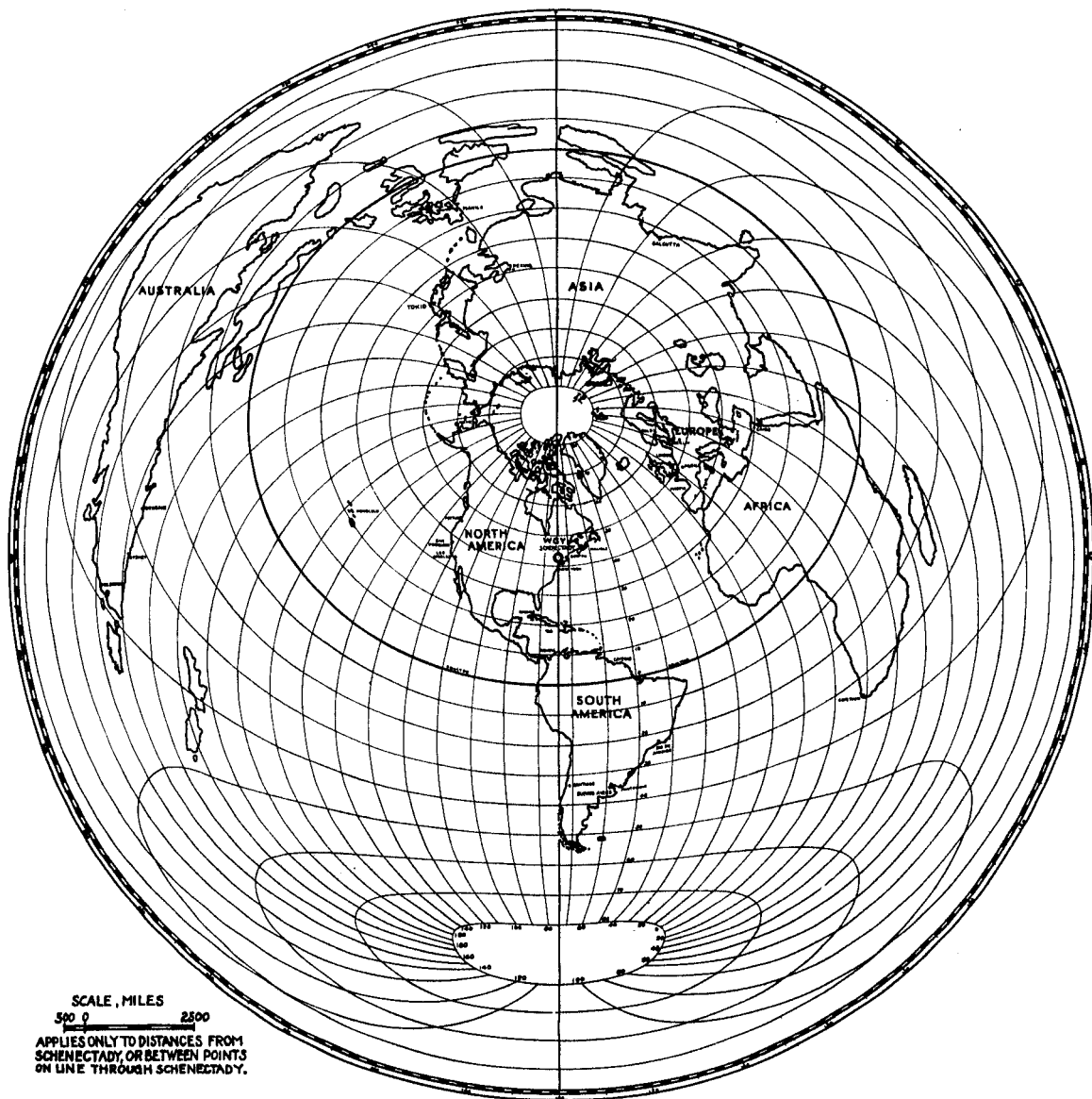

FIG. 76 — AZIMUTHAL EQUIDISTANT PROJECTION OF THE WORLD

The computation is simple, however, and when once made for any given city would serve for all time for the construction of maps on any desired scale.

The projection has been employed in celestial maps, in problems of crystalloptics by the Carnegie Geophysical Laboratory, by the National Geographic Society for maps of the Arctic Regions, North America, Asia, and Africa, and by the General Electric Co. for a map of the world.

The accompanying illustration (see fig. 76) shows, in a diagrammatic form, a map of the world on this projection with center at Schenectady, N. Y., and is used by permission of the General Electric Co. This map was prepared for the convenience of radio engineers of the General Electric Co. in interpreting transmission tests. Besides affording an easy means for measuring the distances from the point which is represented by the center of the map to any other point on the earth's surface, the map is supplied with a periphery scale so that any bearing from the center may be read directly in degrees. The map is valuable also in that it shows the nature of the intervening territory in a straight line between Schenectady and any other point. This feature is important for the radio engineer inasmuch as the distance over which radio signals can be transmitted depends, among other things, on the nature of the intervening territory, especially as to whether it is land or water.

TRUE GREAT CIRCLE DISTANCES FROM TWO POINTS.

A projection can be constructed on which great circle distances from two points can be mapped as straight lines true to scale but the azimuths will not be true. For example, a doubly equidistant projection based on New York and San Francisco can be computed so that the distances of all other cities from these two points will be true to scale but the azimuths will not be correct from either of these two points to any other point.

In a similar way true azimuths from two points can be maintained but the distances will not then be true to scale.

Possibilities of the extensive use of the gyroscopic compass and the employment of radio signals in the fixing of positions by wireless directional bearings present new problems in the navigation of ships and aircraft. The various uses and tests to which nautical and aerial charts are subjected may still further try the patience of the mathematical cartographer in devising more suitable systems of projection, or in supplying short-cut mathematical or automatic expedients as convenient adjuncts to the Mercator chart. Additional special charts on the gnomonic projection or the azimuthal equidistant projection may serve a useful purpose in the solution of the various problems of great-circle sailing or in determining true distances and azimuths.

There is a modern tendency in many places to exploit projections of various types, generally known as "balance of error," or "minimum error" projections, projections sacrificing conformality, equal-area, and other useful properties, and for which there is no easy geometric accounting. These degenerating types can serve no useful purpose other than picture maps, which become untrustworthy in the derivation or application of spherical relations.

The day may come when the preparation of our charts and their use may be further simplified by the employment of the centesimal system for the graduation of the circumference of the circle, and for the expression of latitudes and longitudes, in place of the sexagesimal system of usual practice. In this the French have taken the lead as they did in the introduction of the metric system, the commensurable advantages of which are universally recognized.



NORTH ATLANTIC OCEAN WITH EASTERN NORTH AMERICA AND EUROPE

LAMBERT CONFORMAL CONIC PROJECTION

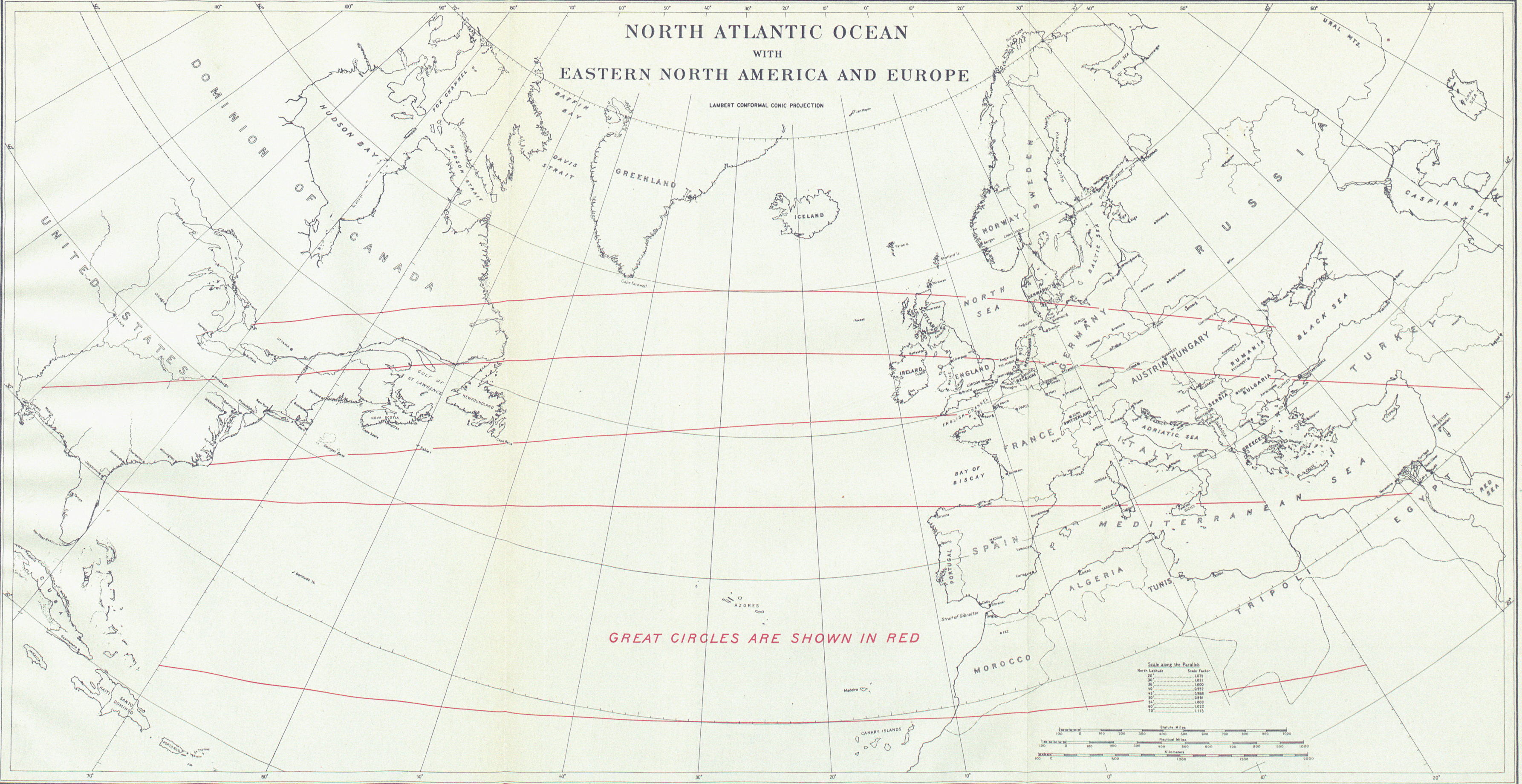

GREAT CIRCLES ARE SHOWN IN RED

Scale along the Parallels

North Latitude	Scale Factor
20°	1.078
30°	1.071
40°	1.060
50°	1.045
60°	1.025
70°	1.000
80°	0.972
90°	0.941

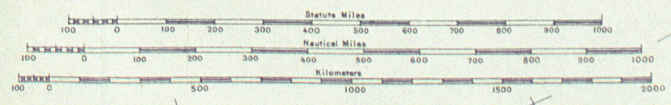

ALASKA AND ITS RELATION TO THE UNITED STATES AND THE ORIENT

Scale 40,000,000
(Transverse Polyconic Projection)

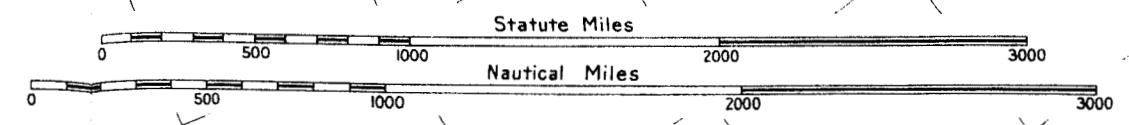
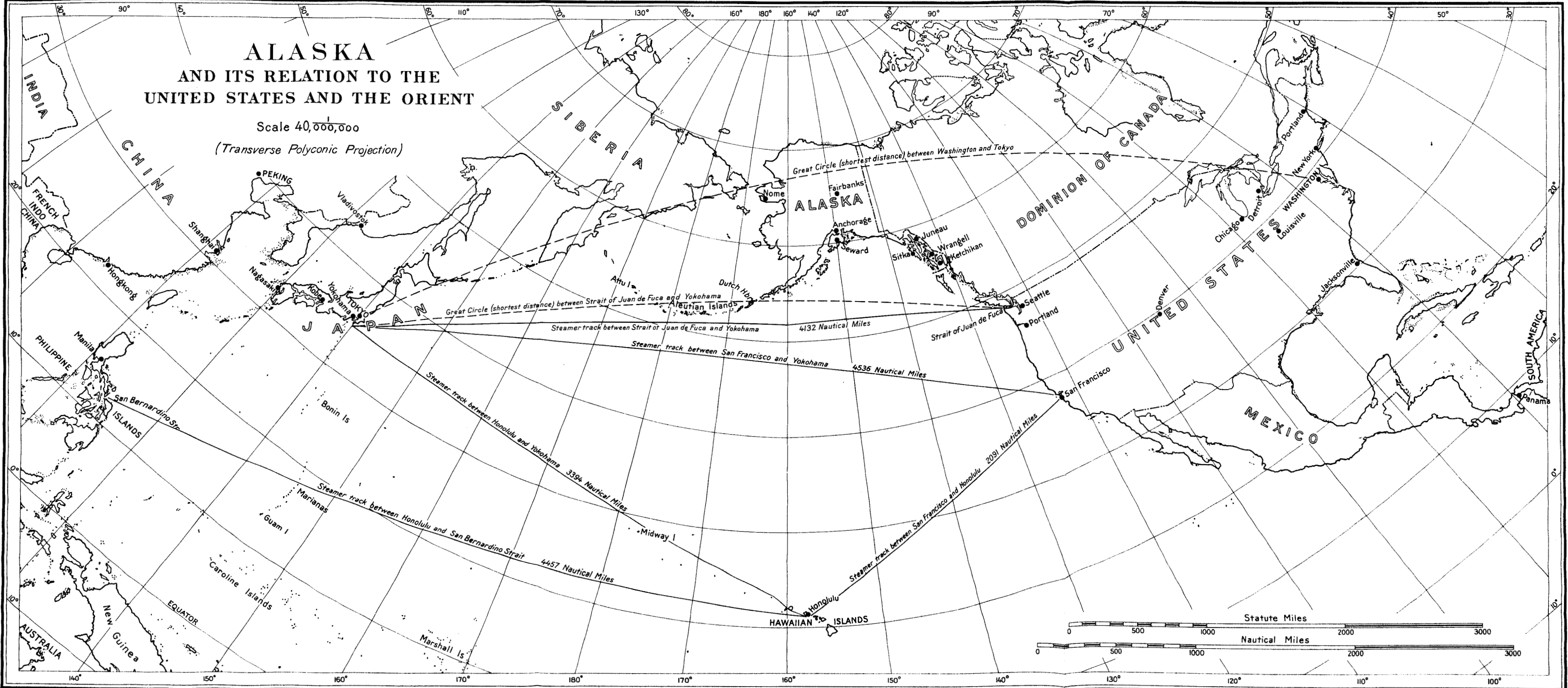

ALBERS EQUAL AREA PROJECTION

STANDARD PARALLELS 29° 30' AND 45° 30'

Plate III

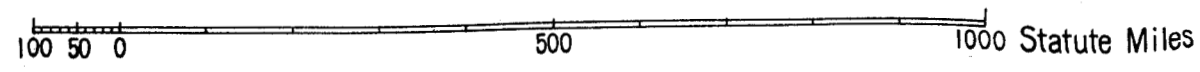
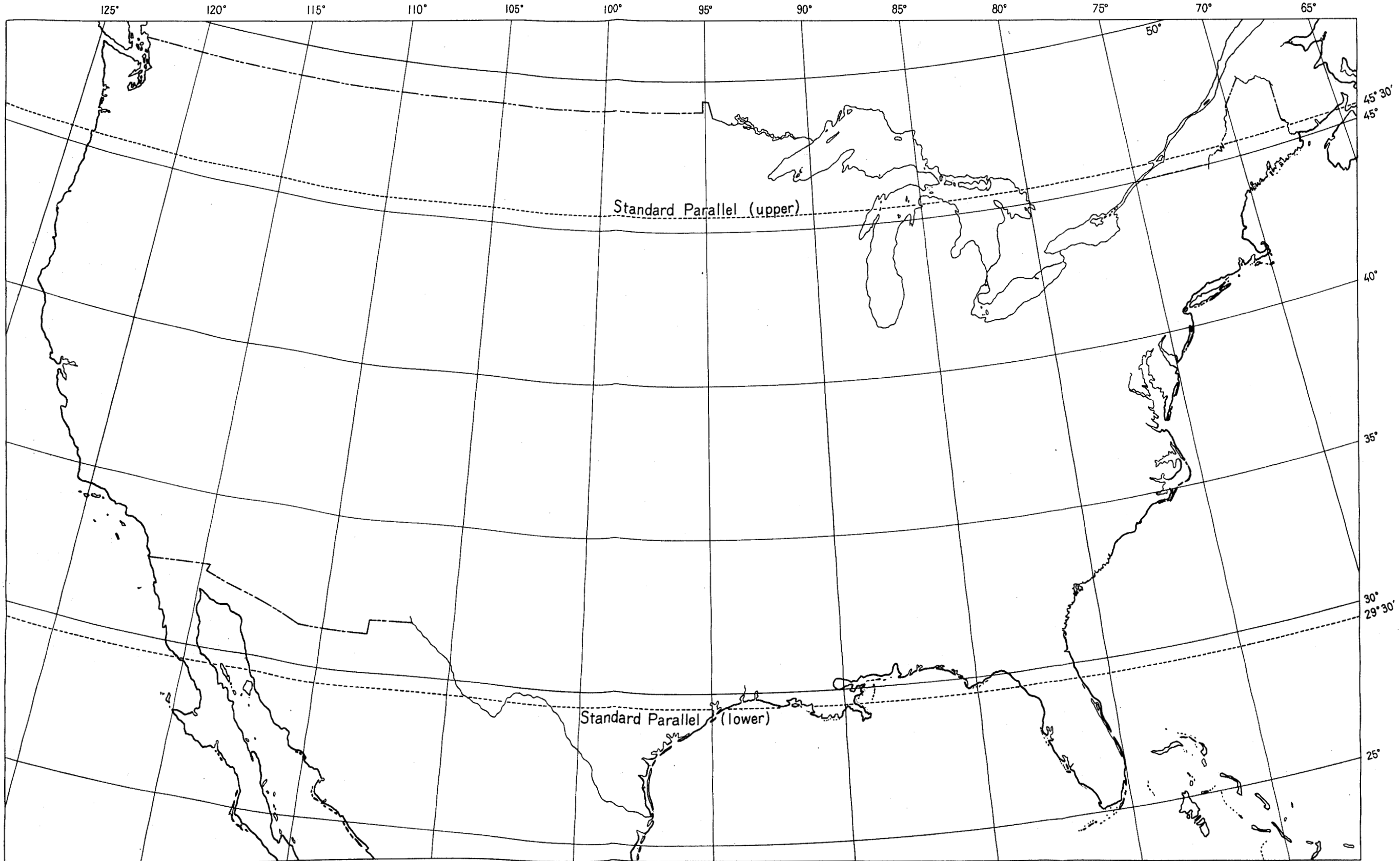

GNOMONIC PROJECTION OF THE NORTH ATLANTIC OCEAN; POINT OF TANGENCY 30°N. AND 30°W.

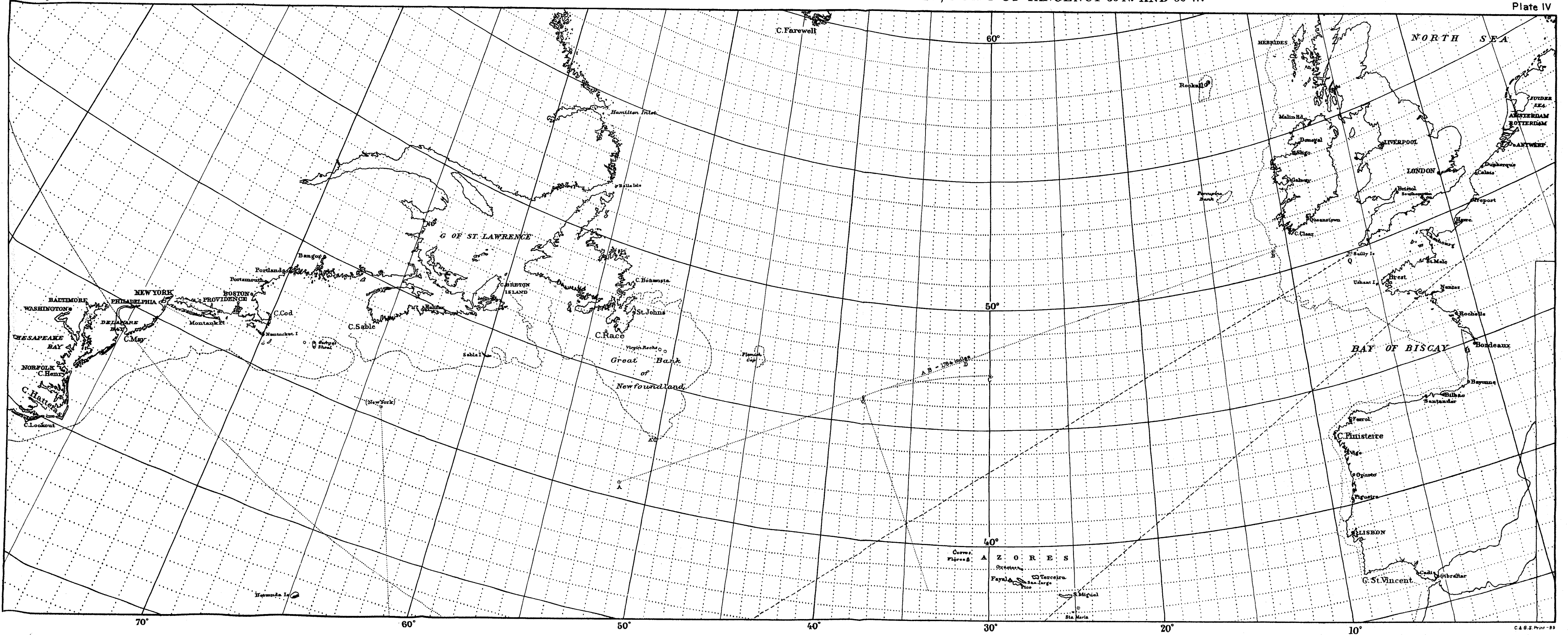

AITOFF'S EQUAL AREA PROJECTION OF THE SPHERE

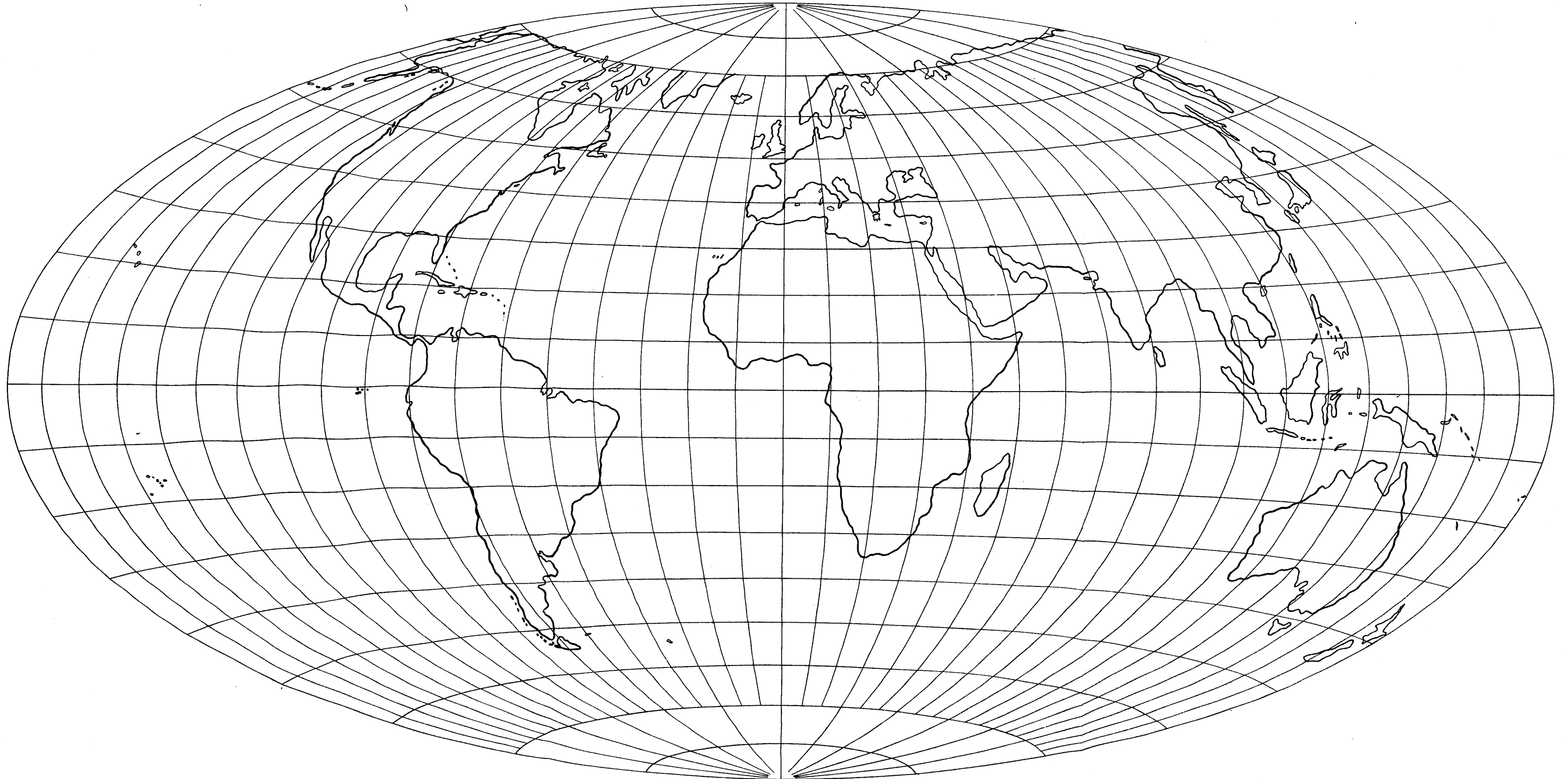

THE WORLD ON THE HOMALOGRAPHIC PROJECTION (INTERRUPTED) FOR THE CONTINENTS (GOODE)

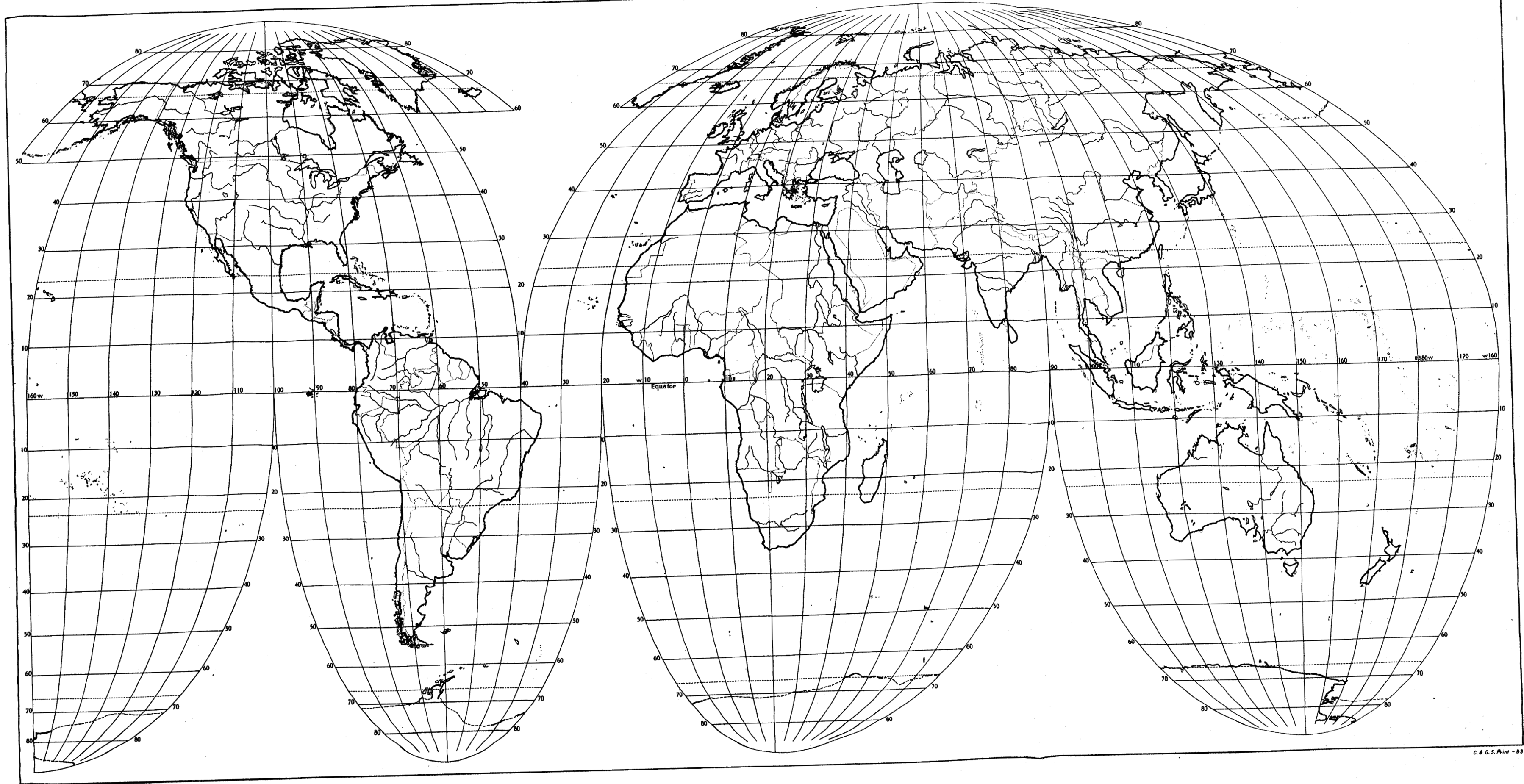

LAMBERT PROJECTION OF THE NORTHERN AND SOUTHERN HEMISPHERES

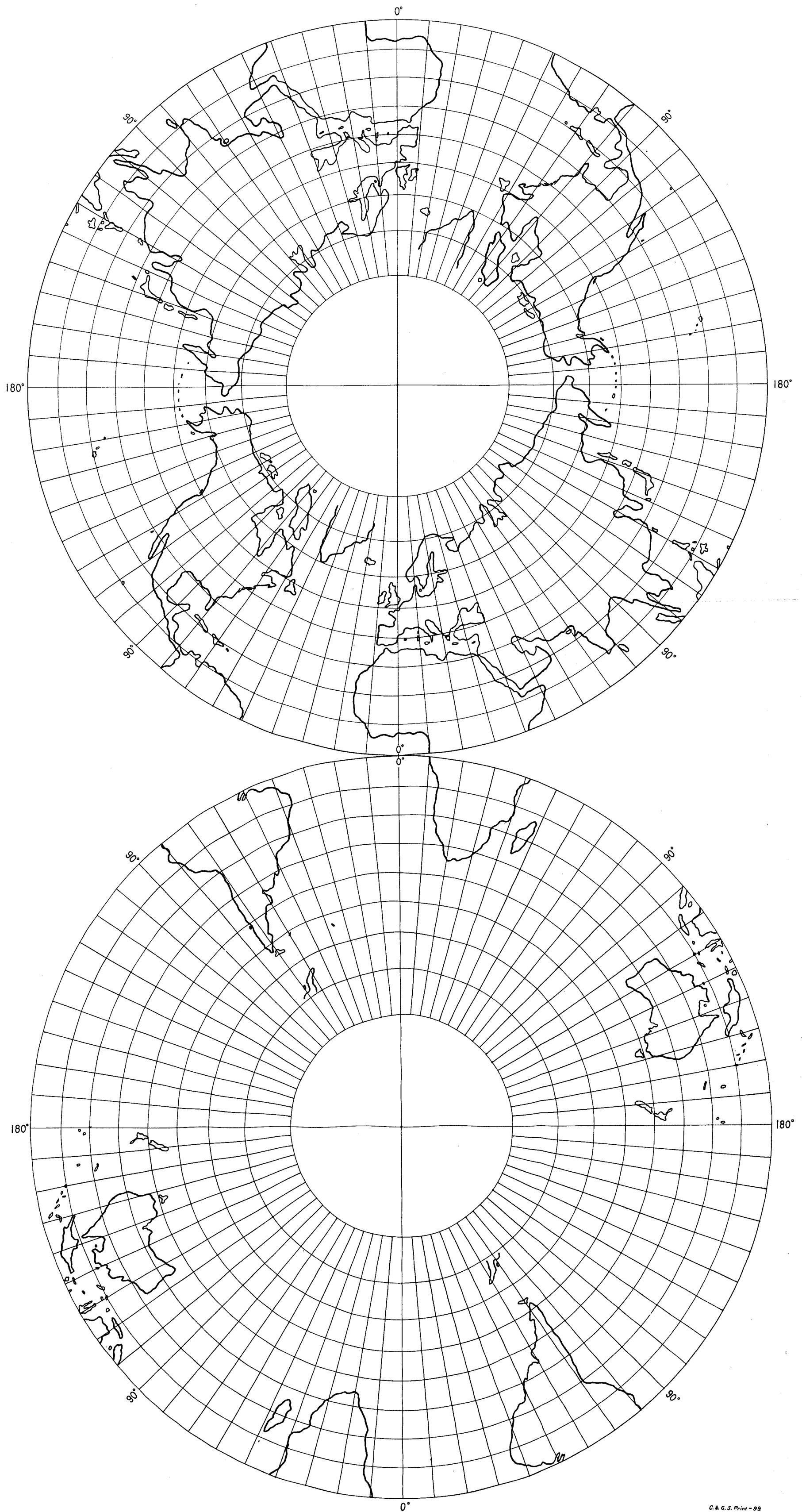

CONFORMAL PROJECTION OF THE SPHERE

WITHIN A TWO CUSPED EPICYCLOID

Devised by Dr. F. August

