



Generator

OWNER'S MANUAL

 **Read this manual carefully before operating your Yamaha generator.**

EF5500DE
EF5500D

CO SENSOR

LIT-19626-02-82
7P5-F8199-14



WARNING: This product can expose you to chemicals including engine exhaust, which is known to the State of California to cause cancer, and carbon monoxide, which is known to the State of California to cause birth defects or other reproductive harm. For more information go to www.P65Warnings.ca.gov.



Read this manual carefully before operating your Yamaha generator. This manual should stay with this generator if it is sold.

INTRODUCTION

Congratulations on your purchase of your new Yamaha Generator.

This manual will provide you with a good basic understanding of the operation and maintenance of this generator.

If you have any questions regarding the operation or maintenance of your generator, please consult a Yamaha dealer.

EF5500DE/EF5500D

OWNER'S MANUAL

© 2021 by Yamaha Motor Corporation, U.S.A.

1st Edition, June 2021

All rights reserved.

**Any reprinting or unauthorized use
without the written permission of
Yamaha Motor Corporation, U.S.A.**

is expressly prohibited.

Printed in China

P/N LIT-19626-02-82

IMPORTANT MANUAL INFORMATION

Particularly important information is distinguished in this manual by the following notations.



This is the safety alert symbol. It is used to alert you to potential personal injury hazards. Obey all safety messages that follow this symbol to avoid possible injury or death.

WARNING

A **WARNING** indicates a hazardous situation which, if not avoided, could result in death or serious injury.

NOTICE

A **NOTICE** indicates special precautions that must be taken to avoid damage to the generator or other property.

TIP

A **TIP** provides key information to make procedures easier or clearer.

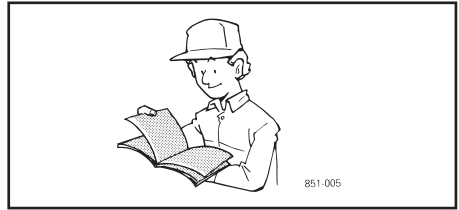

WARNING

PLEASE READ AND UNDERSTAND THIS MANUAL COMPLETELY BEFORE OPERATING THE GENERATOR.

TIP

- Yamaha continually seeks advancements in product design and quality. Therefore, while this manual contains the most current product information available at the time of printing, there may be minor discrepancies between your generator and this manual. If there is any question concerning this manual, please consult a Yamaha dealer.
- This manual should be considered a permanent part of this generator and should remain with this generator when resold.

* Product and specifications are subject to change without notice.

CONTENTS

SAFETY INFORMATION	1	PERIODIC MAINTENANCE	38
Exhaust Fumes are Poisonous	1	Maintenance Chart.....	38
Carbon Monoxide Poisoning	2	Carburetor Adjustment.....	40
Fuel is Highly Flammable and Poisonous.....	3	Spark Plug Inspection	40
Engine and Muffler May be Hot.....	3	Engine Oil Replacement	41
Electric Shock Prevention	4	Muffler Screen and Spark Arrester...	43
Connection Notes.....	5	Air Filter.....	45
Connection.....	5	Fuel Cock.....	46
Extension Cord Notes	5	Fuel Tank Filter.....	47
LOCATION OF IMPORTANT LABELS	6	Battery (For EF5500DE)	48
DESCRIPTION	7	Recommended Battery (For EF5500DE).....	48
Control Panel (For EF5500DE)	8	Fuse Replacement (For EF5500DE).....	49
Control Panel (For EF5500D).....	8	G.F.C.I. Receptacle Test.....	50
CONTROL FUNCTION	9	STORAGE	51
Engine Switch	9	Drain The Fuel.....	51
Oil Warning Light (Red).....	9	Engine	53
CO SENSOR.....	10	Battery (For EF5500DE)	54
AC Switch (N.F.B.).....	14	TROUBLESHOOTING	55
Fuel Tank Cap	14	SPECIFICATIONS	60
Fuel Cock Lever	14	Dimensions	60
Ground (Earth) Terminal.....	15	Engine	60
Economy Control Switch	15	Generator	60
Choke Lever.....	15	CONSUMER INFORMATION	61
Recoil Starter	16	Identification Number Records.....	61
Starter Switch (For EF5500DE)	16	Generator Identification.....	61
G.F.C.I. Receptacle	17	EXHAUST EMISSION CONTROL SYSTEM AND COMPONENTS	62
PREPARATION	18	WIRING DIAGRAM	63
Two Wheel Kit Installation	18	EF5500DE.....	63
Fuel	23	EF5500D	64
Engine Oil.....	25	YAMAHA EXTENDED SERVICE (Y.E.S.)	65
Battery (For EF5500DE)	26		
Ground (Earth) Terminal.....	27		
PRE-OPERATION CHECK	28		
Pre-Operation Check	28		
OPERATION	29		
Starting The Engine	29		
Stopping The Engine.....	32		
Connection	34		
Application Range.....	36		
High Altitude Operation	37		

SAFETY INFORMATION

- This generator is not designed for on-board use. Do not use it while installed on the vehicle.
- Do not modify the generator or use it with its parts removed.
- Do not allow children to operate the generator.
- Do not place any obstacles on the generator.

Exhaust Fumes are Poisonous

- Using a generator indoors **CAN KILL YOU IN MINUTES**. Generator exhaust contains carbon monoxide. This is a poison you cannot see or smell.
- **NEVER** use inside a home or garage, **EVEN IF** doors and windows are open.
- Only use **OUTSIDE** and far away from windows, doors, and vents with engine exhaust directed away from any structures.

Carbon Monoxide Poisoning

- CO gas is toxic and can cause serious injury or death.
- Get fresh air and seek medical care immediately, if you are suspected to be inhaled carbon monoxide.
- Early symptoms of carbon monoxide exposure include headache, fatigue, shortness of breath, nausea, and dizziness and so on. Continued exposure to carbon monoxide can cause loss of muscular coordination, loss of consciousness, and then result in death.
- This generator is equipped with the CO SENSOR system that automatically stops the engine before the surrounding carbon monoxide concentration increases to a dangerous concentration.
- Do not remove or modify the CO SENSOR system.
- Make sure that the CO SENSOR system works correctly.
- The CO SENSOR cannot prevent all danger associated with or caused by carbon monoxide. Pay careful attention to the location of the generator.
- If the CO SENSOR stopped the generator, relocate the generator and address symptoms of carbon monoxide poisoning prior to restart the generator.
- Install battery-operated or plug-in carbon monoxide alarms to alert you to potentially dangerous levels of carbon monoxide in accordance with the alarm's instructions.

Fuel is Highly Flammable and Poisonous

- Always turn off the engine when refuelling.
- Never refuel while smoking or in the vicinity of an open flame.
- Take care not to spill any fuel on the engine or muffler when refuelling.
- Do not leave the generator inside the vehicle or in the trunk.
- If you swallow any fuel, inhale fuel vapor, or allow any to get in your eye(s), see your doctor immediately. If any fuel spills on your skin or clothing, immediately wash with soap and water and change your clothes.
- When operating or transporting the generator, be sure it is kept upright. If it tilts, fuel may leak from the carburetor or fuel tank.

Engine and Muffler May be Hot

- Place the generator in a place where pedestrians or children are not likely to touch the generator.
- Avoid placing any flammable materials near the exhaust outlet during operation.
- In order to prevent overheating, ensure adequate airflow by keeping the generator at least 1 m (3 ft) from objects or other equipment.
- Do not operate the engine with a dust cover or other objects covering it.
- When covering the generator, be sure to do so only after the engine and muffler have completely cooled down.

Electric Shock Prevention

- Never operate the engine in rain or snow.
- Never touch the generator with wet hands or electrical shock will occur.
- When the connected electric device is grounded (earthed), always ground (earth) the generator.
- Connect the ground (earth) terminal to a ground source. In order to prevent electrical shock, the generator must be grounded when using a grounded electrical device.

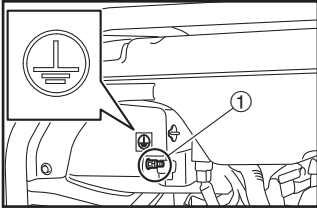

① Ground (earth) terminal

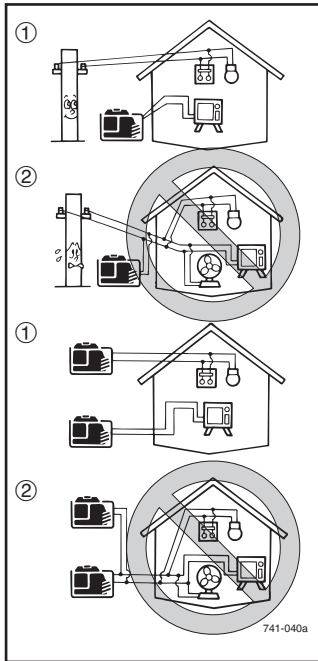

Connection Notes

- Avoid connecting the generator to commercial power outlet.
- Avoid connecting the generator in parallel with any other generator.

- ① Correct
- ② Incorrect

Connection

! WARNING

Before the generator can be connected to a building's electrical system, a licensed electrician must install an isolation (transfer) switch in the building's main fuse box. The switch is the connection point for generator power and allows selection of generator or main line power to the building. This will prevent the generator from charging the main power line (backfeeding) when the main power supply has failed or has been turned off for line repair. Backfeeding can electrocute or injure line maintenance personnel. Also, generator and building electrical system damage can occur when normal operating power returns if unit is used without an isolation switch.

Extension Cord Notes

Extension cords should be protected by a tough flexible rubber sheath (IEC 245) or the equivalent to withstand mechanical stresses.

LOCATION OF IMPORTANT LABELS

Please read the following labels carefully before operating this generator.

TIP

Maintain or replace safety and instruction labels, as necessary.

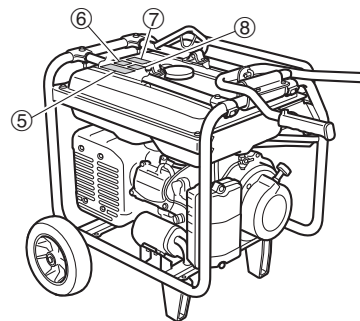
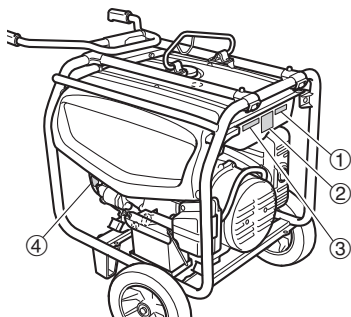

①

⚠ WARNING

- The exhaust and the area around the exhaust become hot when operating, which can lead to severe burns and fire.

7PC-F1876-10

②

YAMAHA	EF5500
AC OUTPUT	60Hz
RATED	240V/120V 4.9kW
PHASE	SINGLE
POWER FACTOR	1
INSULATION CLASS	B
FUEL	GASOLINE
RATED REVOLUTION	3600rpm
RATED AMBIENT TEMPERATURE	40°C
YAMAHA MOTOR POWERED PRODUCTS CO., LTD. MADE IN CHINA	
7P5- []	

③

EMISSION CONTROL INFORMATION
YAMAHA MOTOR CO., LTD.

THIS ENGINE MEETS U.S. EPA EXH / EVP REGS AND CALIFORNIA EXH / EVP SOURCE REGS FOR *****
EMISSION COMPLIANCE PERIOD: ***** HOURS
EF : ***** DISPLACEMENT : ** cc
EVAP F CARB : ***** EVAP F EPA : ***** EM

The air index of this engine is 3

FOR EXTENDED
Check owner's manual for further details.
No other adjustments needed.

④



⑤

⚠ WARNING

- Read the owner's manual and all labels before operating.
- Only operate in well-ventilated areas.
- Exhaust gas contains poisonous carbon monoxide.
- Gasoline is highly flammable and explosive.
- Serious burns and/or injury could occur if spilled.
- Always turn off the engine when refueling.
- Never refuel while smoking or in the vicinity of an open flame.
- Immediately wipe off spilled fuel with a clean, dry, soft cloth.
- Do not over-fill the fuel tank over the red level.
- Be careful not to leak gasoline before starting the engine.
- Do not operate near flammable materials.
- Electroshock can occur if generator is used in rain, snow, or near water. Keep this unit dry at all times.
- Never touch the generator with wet hands or electrical stock will occur.
- Do not modify the generator or use it with its parts removed.
- Electroshock or property damage can occur.
- Do not connect this generator to any building's electrical system unless an isolation switch has been installed by a licensed electrician. Refer to the owner's manual.
- When operating the generator:
 - Never place a partition or other barrier around the generator.
 - Do not cover the generator with a box.
 - Do not place any objects on the generator.
 - Direct generator exhaust away from any windows, doors, or vents.
- Be sure carbon monoxide (CO) detectors are installed indoors.

7PC-F1876-10

⑥

⚠ DANGER

Using a generator indoors **CAN KILL YOU IN MINUTES.**
Generator exhaust contains carbon monoxide.
This is a poison you cannot see or smell.

NEVER use inside a home or garage, EVEN IF doors and windows are open.

Only use **OUTSIDE** and far away from windows, doors, and vents.

7C2-44877-00

⑦

CO SENSOR

- Refer to the AUTOMATIC SHUTOFF label and the owner's manual.
- When you start the generator, the "WARNING" and "ERR" indicators will flash 5 times. If not, discontinue use immediately and have it inspected at a service shop.

⚠ DANGER

- Do not remove or modify the CO SENSOR system. CO gas is toxic and can cause serious injury or death.

7PC-F1876-00

⑧

AUTOMATIC SHUTOFF - YOU MUST:

MOVE GENERATOR TO AN OPEN, OUTDOOR AREA.
POINT EXHAUST AWAY. DON'T RUN GENERATOR IN ENCLOSED AREAS (E.G. NOT IN HOUSE OR GARAGE).

MOVE TO FRESH AIR AND GET MEDICAL HELP IF SICK, DIZZY OR WEAK.

- If the generator stops while the CO SENSOR is activated, it cannot be started again for about 5 minutes.

7PC-F1876-00

EF5500DE

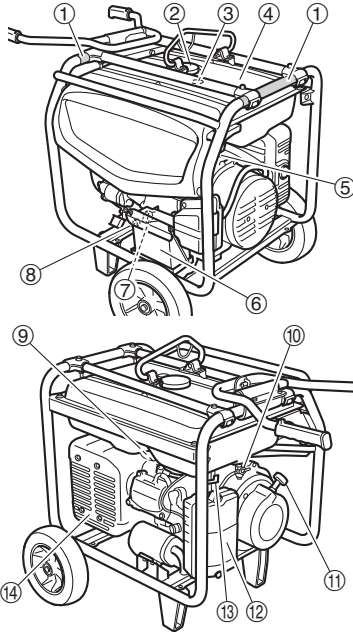

DESCRIPTION

- ① Carrying handles (shaded)
- ② Fuel tank cap
- ③ Fuel level gauge
- ④ Fuel tank
- ⑤ Ground (earth) terminal
- ⑥ Battery (For EF5500DE)
- ⑦ Oil filler cap
- ⑧ Oil drain bolt
- ⑨ Spark plug
- ⑩ Fuel cock
- ⑪ Recoil starter handle
- ⑫ Air filter case cover
- ⑬ Choke lever
- ⑭ Muffler

EF5500D

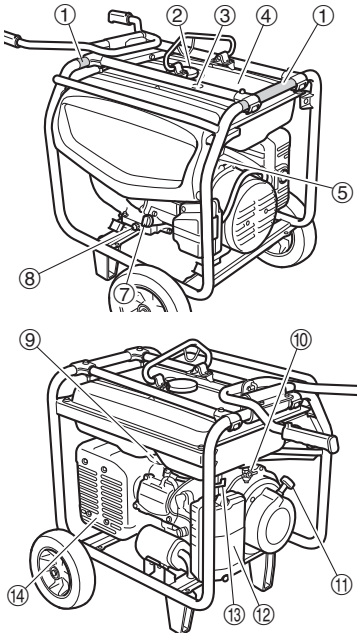

EF5500DE

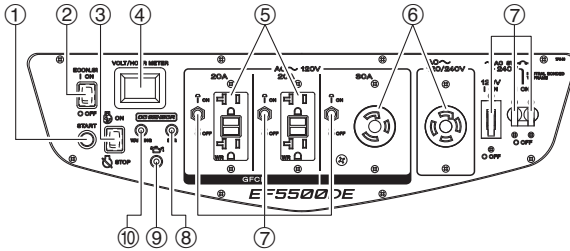

Control Panel (For EF5500DE)

- ① Starter switch
- ② Economy control switch
- ③ Engine switch
- ④ Voltage/hour meter
- ⑤ G.F.C.I. receptacle
- ⑥ AC receptacle
- ⑦ AC switch (N.F.B.)
- ⑧ ERR (Error) indicator light (Orange)
- ⑨ Oil warning light (Red)
- ⑩ WARNING indicator light (Red)

EF5500D

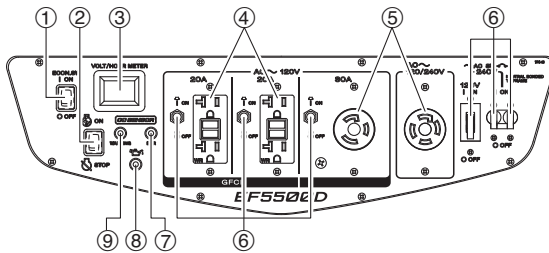

Control Panel (For EF5500D)

- ① Economy control switch
- ② Engine switch
- ③ Voltage/hour meter
- ④ G.F.C.I. receptacle
- ⑤ AC receptacle
- ⑥ AC switch (N.F.B.)
- ⑦ ERR (Error) indicator light (Orange)
- ⑧ Oil warning light (Red)
- ⑨ WARNING indicator light (Red)

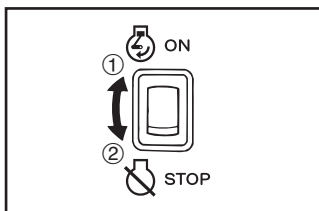

CONTROL FUNCTION

Engine Switch

The engine switch controls the ignition system.

① “ON” (ON)

Ignition circuit is switched on.

The engine can be started.

② “STOP” (STOP)

Ignition circuit is switched off.

The engine will not run.

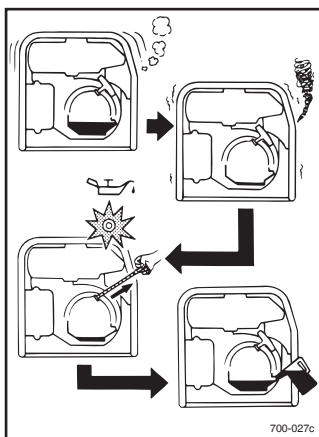

Oil Warning Light (Red)

When the oil level falls below the lower level, the oil warning light comes on and then the engine stops automatically. Unless you refill with oil, the engine will not start again.

TIP

If the engine stalls or does not start, turn the engine switch to “ON” (ON) and then push the starter switch (for EF5500DE) or pull the recoil starter. If the oil warning light flickers for a few seconds, the engine oil is insufficient. Add oil and restart.

CO SENSOR

The CO SENSOR is a system that automatically stops the engine before the surrounding CO concentration exceeds a certain level.

WARNING

- Do not remove or modify the CO SENSOR system.
- The CO SENSOR cannot prevent all danger associated with or caused by carbon monoxide. Pay careful attention to the location of the generator.
- Do not spray any organic solvent on the CO SENSOR.

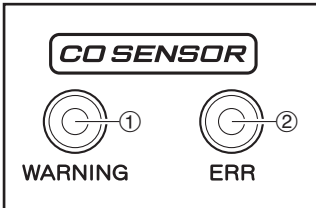

There are two indicator lights in relation to the CO SENSOR.

- ① WARNING indicator light (Red)
- ② ERR (Error) indicator light (Orange)

WARNING indicator light (Red)

If the CO SENSOR detects a high carbon monoxide concentration, the engine will stop and the WARNING indicator light will flash for approximately 5 minutes.

WARNING

Continuous use of the generator in areas with high concentrations of carbon monoxide can cause serious health hazards due to carbon monoxide poisoning. If you are in the same area as the generator, evacuate the area immediately. Get fresh air and seek medical attention immediately, if you feel sick or suspect you have inhaled carbon monoxide. Ventilate the area or space where the generator is located.

If the engine is stopped by the CO SENSOR system, change the operating location of the generator to well-ventilated area.

TIP

- Place the generator so that the muffler is pointed in the same direction as the wind is blowing, and the exhaust gas is directed away from buildings, other structures, or vehicles.
 - Avoid placing the generator near devices that emit carbon monoxide, such as other generators.
-

 **WARNING**

- **Do not operate the generator in an enclosed or partly enclosed area such as a garage.**
 - **Do not enclose or cover the generator with boards or a tent, even if it is outside and away from of a building.**
-

While this indicator light is flashing and the CO SENSOR is activated, the engine cannot be restarted for approximately 5 minutes. Restarting the generator is possible only after the WARNING indicator light is turned off.

ERR (Error) indicator light (Orange)

If the CO SENSOR detects a system malfunction or service life over, the engine will stop automatically and the ERR (Error) indicator will come on approximately 5 minutes.

TIP

- The CO SENSOR has a limited service life and must be replaced when it no longer functions. The battery is non-replaceable battery.
 - The generator stopping period and storage period are also in the useful service life of the CO SENSOR.
 - The lithium battery adopted on this sensor contains perchlorate, a toxic substance controlled in perchlorate Best Management Practices (BMP) regulations passed by the California legislature. When you discard the lithium battery in California, USA, please follow the related regulations in advance.
Perchlorate material-special handling may apply, see www.dtsc.ca.gov/hazardouswaste/perchlorate
 - Consult a Yamaha dealer for the CO SENSOR replacement.
-

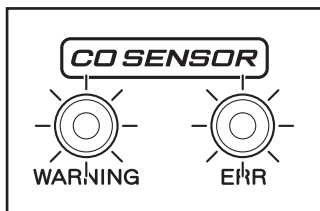

On starting the engine

Each indicator light flashes 5 times upon starting. When starting the engine, make sure that each indicator light flashes 5 times.

! WARNING

- If the indicator lights do not flash 5 times upon starting, discontinue generator use immediately and consult a Yamaha dealer. The CO SENSOR system may be malfunctioning.
- If the CO SENSOR WARNING indicator light (red) is flashing, immediately clear the area of all people and animals while moving the generator to an open, outdoor area. Once the generator is relocated to a well-ventilated area, it can be restarted after 5 minutes. Be sure to point the exhaust away from people and buildings. Thoroughly ventilate the location where the generator had stopped.
- If the CO SENSOR system is malfunctioning, it cannot warn you of potential high concentrations of carbon monoxide. Move the generator to a well-ventilated location and consult a Yamaha dealer.
- While the CO SENSOR is activated, the engine cannot be restarted for approximately 5 minutes. Relocate the generator and address symptoms of carbon monoxide poisoning prior to restart the generator.

NOTICE

If you stop the engine in the following situations, the CO SENSOR system may not be able to restart the engine immediately. Wait approximately 15 seconds before restarting the engine.

- By the engine switch.
- By the oil level warning device.
- By running out of gasoline.

TIP

If the indicator lights come on or flash abnormally, check “TROUBLESHOOTING” (See page 56).

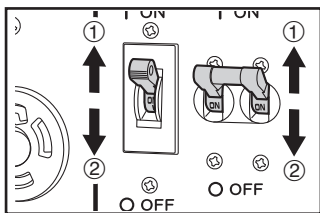

AC Switch (N.F.B.)

The AC switch (Non-Fuse Breaker) turns off automatically when the load exceeds the generator rated output.

- ① "I" (ON)
- ② "O" (OFF)

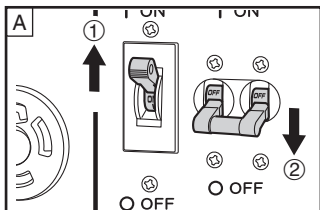

A Supplies AC 120 V

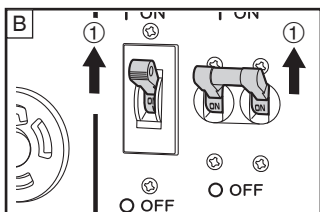

B Supplies AC 120 V and 240 V

NOTICE

Reduce the load to the specified generator rated output if the AC switch (N.F.B.) turns off. If it turns off again, consult a Yamaha dealer.

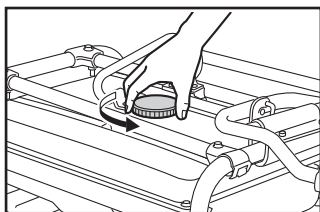

Fuel Tank Cap

Remove the fuel tank cap by turning it counterclockwise.

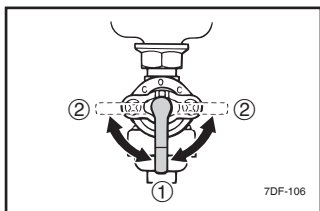

Fuel Cock Lever

The fuel cock supplies fuel from the fuel tank to the carburetor.

The fuel cock has two positions.

- ① ON

With the lever in this position, fuel flows to the carburetor. Normal using is done with the lever in this position.

- ② OFF

With the lever in this position, fuel will not flow. Always turn the lever to this position when the engine is not running.

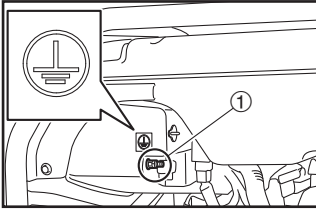

Ground (Earth) Terminal

Ground (earth) terminal connects the earth line for prevention of electric shock.

When the electric device is earthed, always the generator must be earthed.

① Ground (earth) terminal

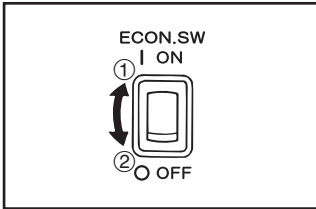

Economy Control Switch

① “I” (ON)

When the economy control switch is turned to “I” (ON), the economy control unit controls the engine speed according to the connected load. The results are better fuel consumption and less noise.

② “O” (OFF)

When the economy control switch is turned to “O” (OFF), the engine runs at the rated r/min (3600 r/min) regardless of whether there is a load connected or not.

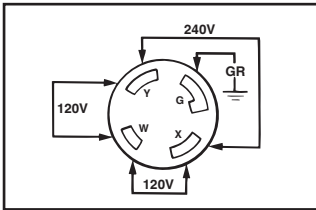

TIP

- The economy control switch must be turned to “O” (OFF) when using electric devices that require a large starting current, such as a compressor or a submersible pump.
- The economy control switch must be turned to “O” (OFF) to increase engine speed to rated r/min when:
 - using a load of 0.8 A or less.
 - supplying AC 120 V only from W with X.

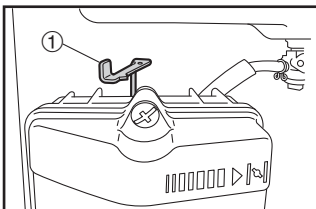

Choke Lever

Starting a cold engine requires a richer air-fuel mixture, which is supplied by the choke lever.

① Choke lever

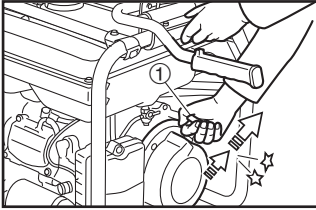

Recoil Starter

The recoil starter is used to start the engine.

Grasp the recoil starter handle and pull slowly until resistance is felt. Give the starter handle and rope a short, brisk pull to start the engine.

① Recoil starter handle

NOTICE

- Grasp the carrying handle firmly to prevent the generator from falling over when pulling the recoil starter.
 - Pull the recoil starter handle straight out. Pulling at an angle could damage the recoil starter rope or other generator parts.
 - Do not allow the starter handle and rope to snap back after starting; return it gently to its original place. Letting go of the handle while the starter rope is extended will allow the recoil starter to rewind rapidly, which can cause damage to the generator.
 - Do not touch the recoil starter handle while the generator is operating.
-

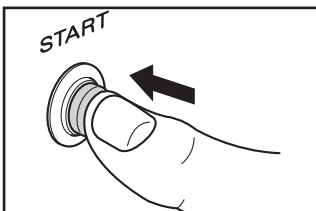

Starter Switch (For EF5500DE)

The starter switch controls the following item.

Push:

Starting circuit is switched on.

Release:

Starting circuit is switched off.

NOTICE

Take your hand off the switch immediately after the engine starts.

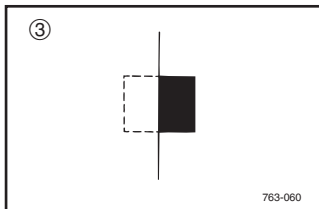
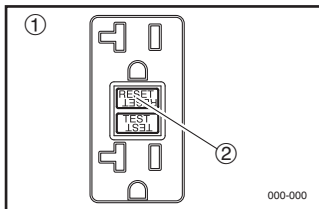

G.F.C.I. Receptacle

WARNING

TO REDUCE THE CHANCE OF ELECTRICAL SHOCK:

- Do not attempt to operate electric devices if the ground fault circuit interrupter reset button pops out repeatedly during use.
- Test the ground fault circuit interrupter during the pre-operation checks according to the maintenance instructions on page 50.
- Remember that only receptacle labeled “GFCI” have ground fault circuit interrupter protection.

The G.F.C.I. (Ground Fault Circuit Interrupter) shuts off power to the protected receptacles if a ground fault (electrical leak) is detected.

If the reset button pops out, the electric devices connected into the receptacle may be faulty. If this happens, check the electric devices carefully. If the electric devices appears to be in good condition, press the reset button firmly until a click is heard. This will restore power. If the reset button pops out again, disconnect all the electric devices immediately. Have the electric devices inspected and repaired by a qualified repairperson before attempting to use them again.

- ① G.F.C.I. (Ground Fault Circuit Interrupter)
- ② Reset button
- ③ Pop out

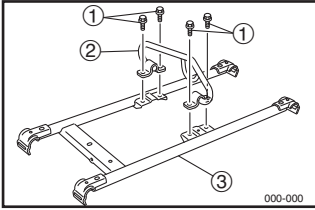

PREPARATION

Two Wheel Kit Installation

1. Fasten the engine hanger to the carrier frame with the bolts.

TIP

Match the punch marks as shown in the illustration.

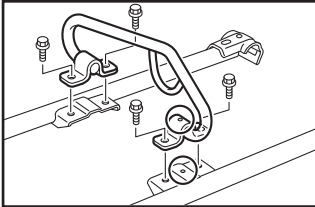

- ① Bolt (8 × 16 mm Flange bolt)
- ② Engine hanger
- ③ Carrier frame

Tightening torque:

16 N·m (1.6 kgf·m, 12 lb·ft)

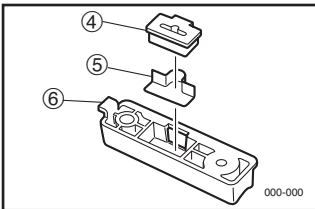

2. Install the damper and plate into the stopper, and tightly fasten it to carrier frame with the bolt.

- ④ Damper
- ⑤ Plate
- ⑥ Stopper
- ⑦ Bolt (6 × 16 mm Flange bolt)

Tightening torque:

7 N·m (0.7 kgf·m, 5.2 lb·ft)

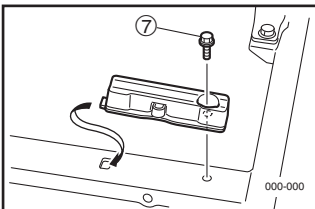

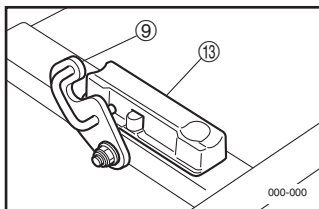
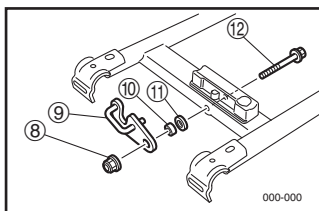

3. Insert the bolt into the carrier frame, and then put the washer, collar, and lock lever in this order, and tighten the nut.

TIP _____

- Make sure that the collar is placed into the washer.
- Lock lever pin should be above stopper.

- ⑧ Nut (8 mm Flange nut [Self-locking nut])
- ⑨ Lock lever
- ⑩ Collar
- ⑪ Washer (Plastic)
- ⑫ Bolt (8 × 60 mm Flange bolt)
- ⑬ Stopper

Tightening torque:
16 N·m (1.6 kgf·m, 12 lb·ft)

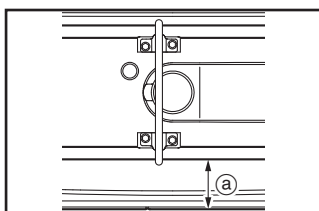

4. Place the carrier frame on the generator body so that the lock lever is positioned on the left side of the control panel. Fasten the plate to the carrier frame with the bolts.

TIP _____

Place the carrier frame 10 cm (3.94 in) from the end of generator body.

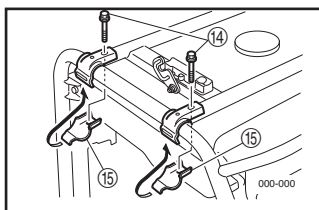

a) 10 cm (3.94 in)

Tightening torque:
16 N·m (1.6 kgf·m, 12 lb·ft)

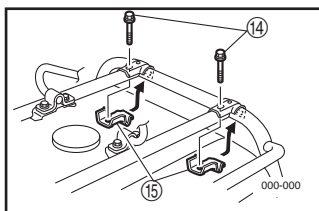

- ⑭ Bolt (8 × 45 mm Flange bolt)
- ⑮ Plate

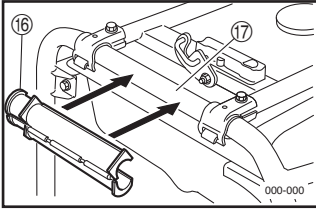

5. Install the sleeve on the generator frame.

TIP

Refer to the illustration to be sure that the sleeve is installed properly.

- ⑩ Sleeve
- ⑪ Generator frame

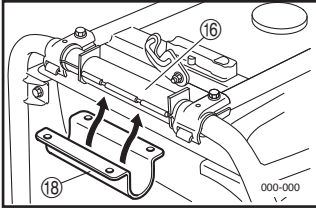

6. Install the bracket handle to the sleeve.

- ⑫ Bracket handle

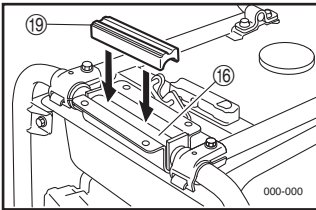

7. Install the locating damper on the sleeve.

- ⑬ Locating damper

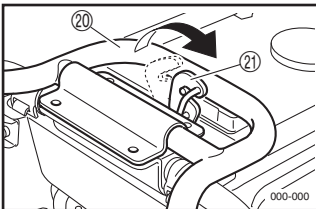

8. Place the handle on the carrier frame, and then fasten the handle with the lock lever.

- ⑭ Handle
- ⑮ Lock lever

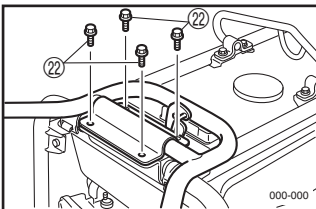

9. Tighten the bolts.

- ⑯ Bolt (8 × 16 mm Flange bolt)

Tightening torque:
16 N·m (1.6 kgf·m, 12 lb·ft)

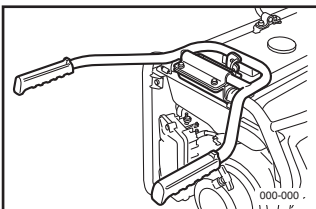

10. Lift the generator 20 cm (7.87 in) off the ground using a winch or other suitable lifting device.

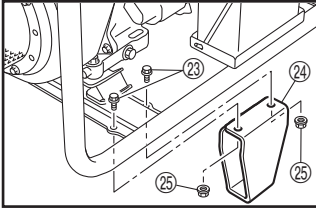

11. Fasten the main stand to the left side of the generator frame as viewed when looking at the control panel with the bolts and nuts.

- Ⓒ Bolt (8 × 16 mm Flange bolt)
- Ⓓ Main stand
- Ⓔ Nut (8 mm Flange nut)

Tightening torque:
16 N·m (1.6 kgf·m, 12 lb·ft)

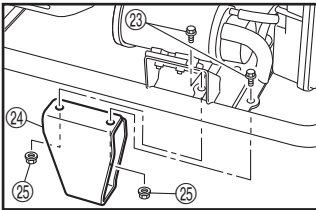

12. Install the wheels into wheel axle frame.

TIP

Make sure the installation direction of the wheels are correct.

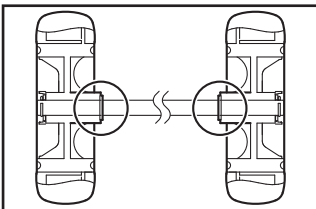
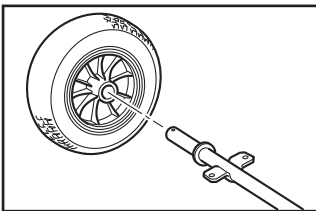
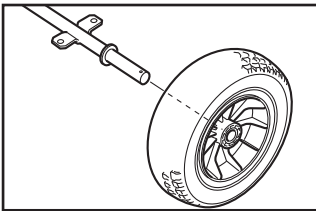

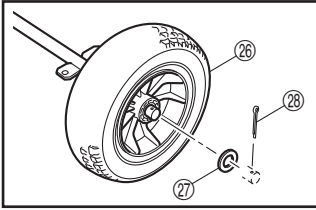

13. Install the washers into wheel axle.
14. Insert cotter pins into wheel axle frame, and then bend as shown in the illustration.

- ②6 Wheel
- ②7 Washer
- ②8 Cotter pin

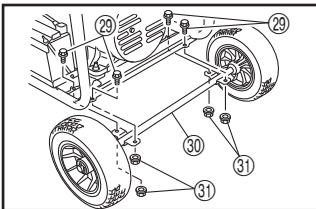
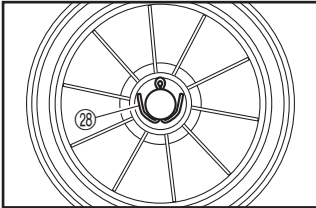
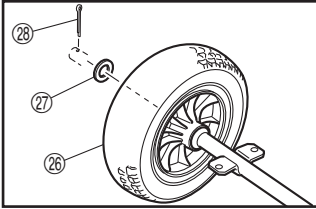

15. Fasten the wheel axle frame to the generator frame with the bolts and nuts. Make sure that the wheel axle frame is on the right side of the control panel.

- ②9 Bolt (8 × 16 mm Flange bolt)
- ③0 Wheel axle frame
- ③1 Nut (8 mm Flange nut)

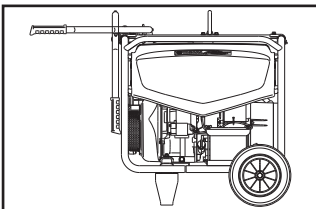

Tightening torque:
16 N·m (1.6 kgf·m, 12 lb·ft)

TIP _____
Refer to the illustration and confirm the position of the wheel kit.

Fuel

WARNING

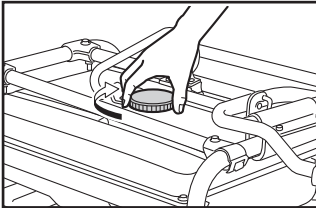
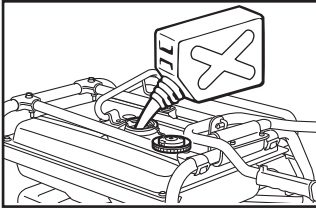

- Fuel is highly flammable and poisonous. Check “SAFETY INFORMATION” (See page 3) carefully before filling.
- Do not overfill the fuel tank, otherwise it may overflow when the fuel warms up and expands.
- Wipe up any spilled fuel immediately.
- Never refuel while smoking or in the vicinity of an open flame.
- Touch a metal surface on the generator before refueling to discharge any static electricity. Sparks could cause fire or explosion.
- After adding fuel, make sure the fuel tank cap is tightened securely.

1. Stop the engine.
2. Place the generator on a level surface.
3. Remove the fuel tank cap.
4. Check the fuel level.
5. If low, fill the tank with fuel.

NOTICE

- Immediately wipe off spilled fuel with a clean, dry, soft cloth, since fuel may deteriorate painted surfaces or plastic parts.
- Use only unleaded gasoline. The use of leaded gasoline will cause severe damage to internal engine parts.
- If foreign materials enter the fuel tank, they may clog the fuel line. Be sure the fuel tank filter is installed before adding fuel.

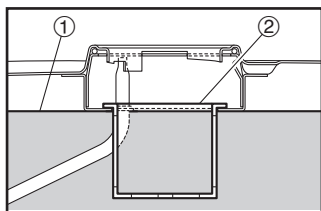

Make sure there is sufficient fuel in the tank.
When refueling, do not fill the tank up above the top edge of the fuel tank filter.

- ① Fuel level
- ② Fuel tank filter
- ③ Fuel level gauge

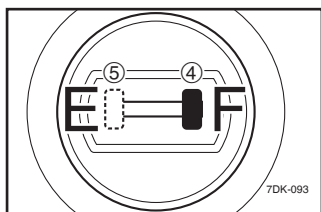
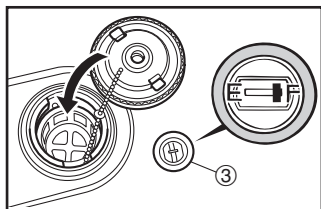

④ "F"	Full
⑤ "E"	Empty

Recommended fuel:
Unleaded gasoline
Fuel tank capacity:
Total:
26 L (6.87 US gal, 5.72 Imp gal)

Your Yamaha engine has been designed to use regular unleaded gasoline with a pump octane number ((R + M)/2) of 86 or higher, or research octane number of 91 or higher.

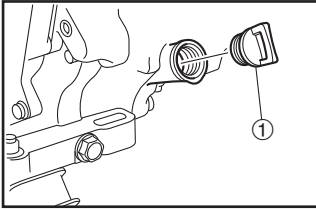

Engine Oil

Make sure the engine oil is at the correct level of the oil filler hole.

- ① Oil filler cap
- ② Correct level

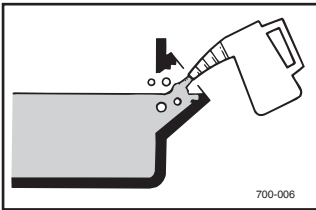
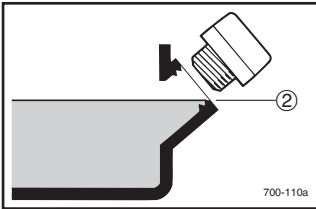

Recommended engine oil:

Recommended oil brand:

YAMALUBE

Available oil grade:

API SE type or higher JASO MA or MB

Available viscosity index:

10W-30 or 10W-40

Engine oil quantity:

1.1 L (1.16 US qt, 37.2 oz)

NOTICE

The generator was shipped from the factory without engine oil. Do not start the engine for the first time until the oil level has been checked and oil added if necessary.

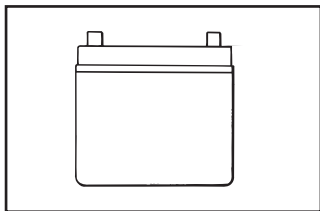

Battery (For EF5500DE) (See page 48 for more details)

This generator is designed to be equipped with a VRLA (Valve Regulated Lead Acid) battery. There is no need to check the electrolyte or to add distilled water.

Installation

1. Turn the engine switch to “⏹” (STOP) to prevent accidental short circuiting.

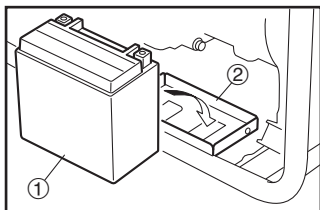

2. Place the battery on the battery mount tray.

- ① Battery
- ② Battery mount tray

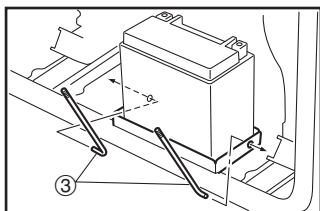

3. Install the battery mounting rods and battery mounting plate, and then install and tighten the wing nuts.

- ③ Battery mounting rod
- ④ Wing nut
- ⑤ Battery mounting plate

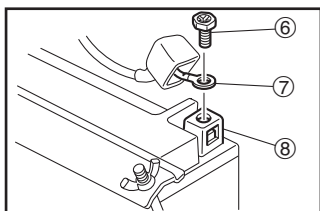
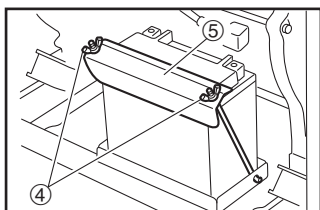

4. Connect the positive lead (Red) to the positive (+) battery terminal.

- ⑥ Screw
- ⑦ Positive lead (Red)
- ⑧ Positive battery terminal

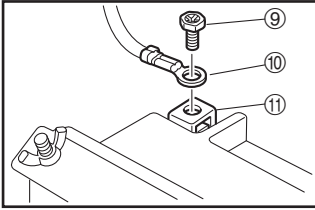

5. Connect the negative lead (Black) to the negative (-) battery terminal.

- ⑨ Screw
- ⑩ Negative lead (Black)
- ⑪ Negative battery terminal

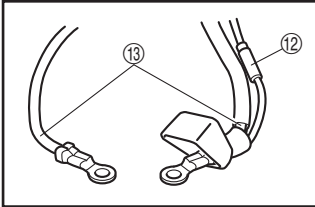

TIP _____
 Connect the positive lead (Red) to the positive (+) battery terminal first, then the negative lead (Black) to the negative (-) battery terminal. Do not reverse these positions.

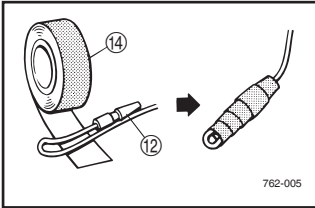

! WARNING _____

- **Be sure to insulate battery leads to prevent arcing when the battery is not installed.**
- **Disconnect the battery charging output lead. Then insulate the connector by folding it back on itself and carefully wrapping it with electrical tape to prevent electrical contact with ground (earth) or any other leads.**
- **Remove the battery leads from the generator.**

- ⑫ Connector
- ⑬ Battery lead
- ⑭ Electrical tape

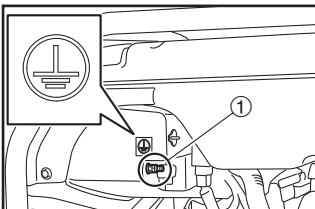

Ground (Earth) Terminal
 Make sure to ground (earth) the generator.
 Check “SAFETY INFORMATION” (See page 4).

- ① Ground (earth) terminal

PRE-OPERATION CHECK



If any item in the pre-operation check is not working properly, have it inspected and repaired before operating the generator.

The condition of a generator is the owner's responsibility. Vital components can start to deteriorate quickly and unexpectedly, even if the generator is unused.

TIP

Pre-operation checks should be made each time the generator is used.

Pre-Operation Check

Fuel (See page 23)

- Check fuel level in fuel tank.
- Refuel if necessary.

Fuel Line

- Check fuel hose for crack or damage.
- Replace if necessary.

Engine Oil (See page 25)

- Check oil level in engine.
- If necessary, add recommended oil to specified level.
- Check generator for oil leakage.

Abnormal Running Conditions

- If any abnormal running conditions are observed, please consult a Yamaha dealer.

OPERATION

⚠ WARNING

- Never operate the engine in a closed area or it may cause unconsciousness and death within a short time. Operate the engine in a well ventilated area.
- Before starting the engine, do not connect any electric devices.
- Clean dust, dirt or water off the receptacle before use.

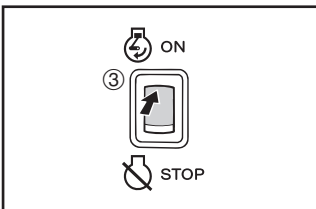
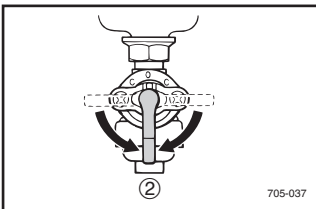
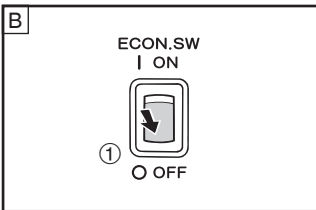
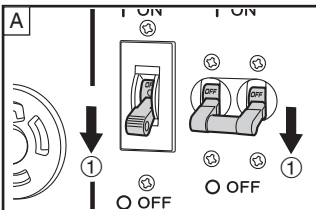
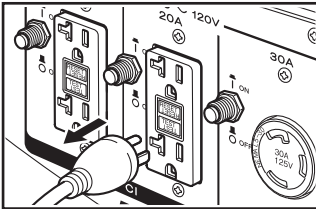

NOTICE

The generator was shipped from the factory without engine oil. Do not start the engine for the first time until the oil level has been checked and oil added if necessary.

Starting The Engine

1. Turn the AC switch (N.F.B.) and economy control switch to "O" (OFF).

① "O" (OFF)

A] AC switch (N.F.B.)

B] Economy control switch

2. Turn the fuel cock lever to ON.

② ON

3. Turn the engine switch to "E" (ON).

③ "E" (ON)

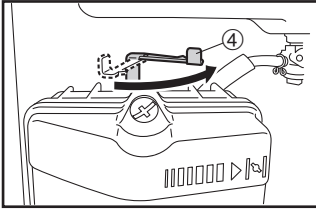

4. Turn the choke lever to “|”.

④ Choke lever

TIP _____

The choke is not required to start a warm engine. Turn the choke lever to the original position.

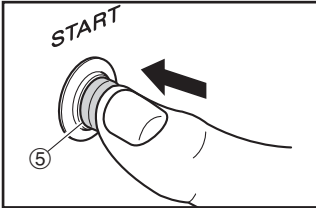

Electric Starting (For EF5500DE):

5. Push the starter switch to start the engine.

⑤ Starter switch

NOTICE _____

- Take your hand off the switch immediately after the engine starts.
 - If the engine fails to start, release the switch, wait a few seconds, then try again. Each attempt should be as short as possible to preserve the battery. Do not crank the engine more than 5 seconds on any one attempt.
-

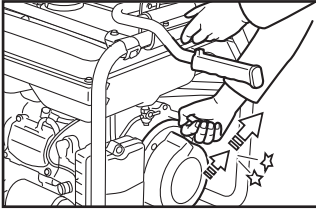

Manual Starting:

5. Grasp the recoil starter handle and pull slowly until resistance is felt. Give the starter handle and rope a short, brisk pull to start the engine.

WARNING

Be careful when using recoil starter. In rare cases, the recoil starter handle can be drawn back quickly by the engine kickback.

NOTICE

- **Pull the recoil starter handle straight out. Pulling at an angle could damage the recoil starter rope or other generator parts.**
 - **Do not allow the starter handle and rope to snap back after starting; return it gently to its original place. Letting go of the handle while the starter rope is extended will allow the recoil starter to rewind rapidly, which can cause damage to the generator.**
 - **Grasp the carrying handle firmly to prevent the generator from falling over when pulling the recoil starter.**
-

TIP

Soon after the purchase or after draining the fuel from the carburetor with the drain screw, the fuel will not be supplied to the entire starting system automatically. Thus, the recoil starter handle may have to be pulled a few times until the engine starts.

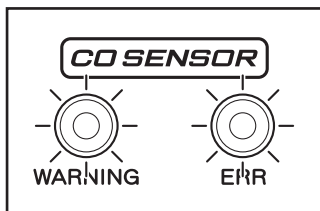

- When pushing the starter switch or pulling the recoil starter handle, make sure that both the red and orange indicators are flashing.

NOTICE

If either of them does not flash, consult a Yamaha dealer since the CO SENSOR system is most likely malfunctioning.

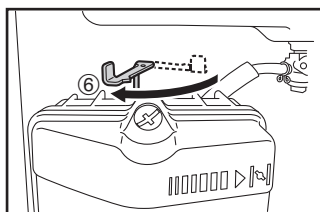

- After the engine starts, warm up the engine until the engine does not stop when the choke lever is returned to the original position.

⑥ Original position

Stopping The Engine

TIP

After the engine is stopped the engine cannot be restarted for approximately 15 seconds.

- Turn off any electric devices.
- Turn the AC switch (N.F.B.) and economy control switch to “O” (OFF).

① “O” (OFF)

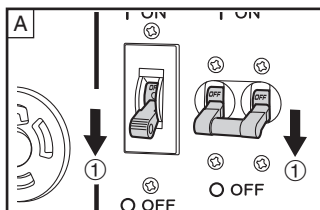

A AC switch (N.F.B.)

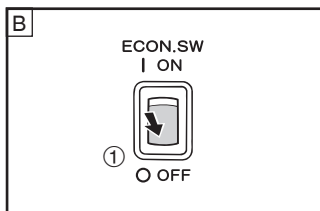

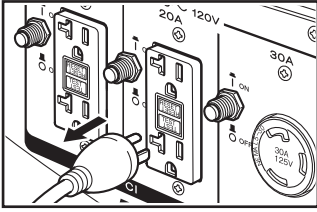

B Economy control switch

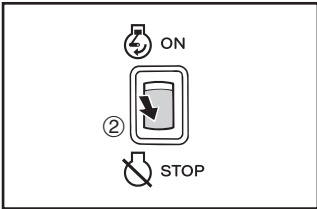

3. Disconnect any electric devices.



4. Turn the engine switch to “” (STOP).

② “” (STOP)

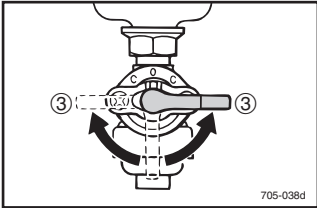

5. Turn the fuel cock lever to OFF.

③ OFF

Connection Alternating Current (AC)

WARNING

Be sure any electric devices are turned off before plugging them in.

NOTICE

- Be sure all electric devices including the lines and plug connections are in good condition before connection to the generator.
- Be sure the total load is within generator rated output.
- Be sure the receptacle load current is within receptacle rated current.

TIP

- Make sure to ground (earth) the generator. When the electric device is grounded, be sure to ground the generator, too.
- The power output lead of the portable generator (stator winding) is insulated from the frame and ground pin of the AC receptacles. Therefore, an electric device that requires grounding through the AC receptacle when plugged in to one of the output leads might not operate correctly.

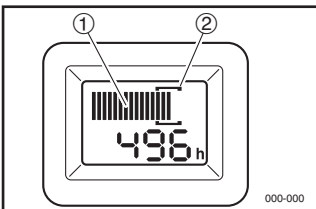
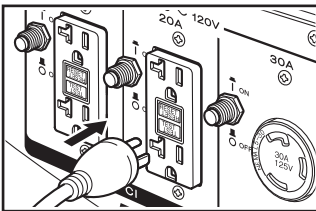

1. Start the engine.
2. Plug into AC receptacle.
3. Make sure the voltage/hour meter indicates the rated voltage.

- ① Voltage/hour meter
- ② Rated voltage

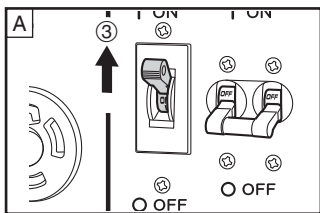

4. Turn the AC switch (N.F.B.) and economy control switch to “I” (ON) and turn on any electric devices.

③ “I” (ON)

A AC 120 V can be used.

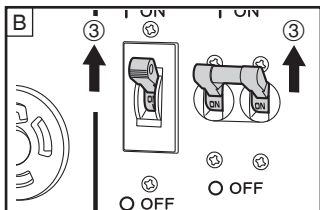

B AC 120 V and 240 V can be used.

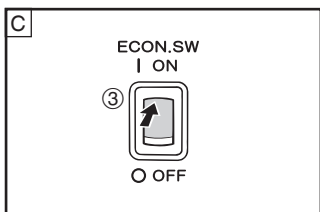

C Economy control switch

NOTICE

Reduce the load to the specified generator rated output if the AC switch (N.F.B.) turns off. If it turns off again, consult a Yamaha dealer.

TIP

- The 4-blade plug receptacle can supply both 120 V and 240 V power sources.
- The economy control switch must be turned to “○” (OFF) to increase engine speed to rated r/min when:
 - using a load of 0.8 A or less.
 - supplying AC 120 V only from W with X.

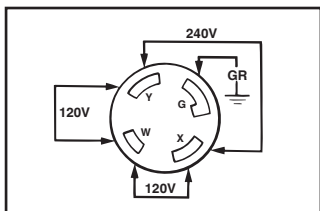

5. Turn the individual AC switch (N.F.B.) to “I” (ON).

④ “I” (ON)

A Individual AC switch (N.F.B.) for AC receptacle

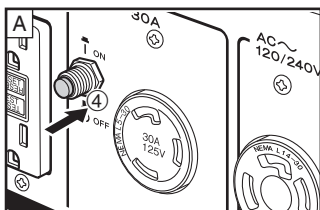

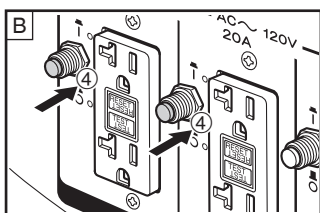

B Individual AC switch (N.F.B.) for G. F. C. I. receptacle



Application Range

When using the generator, make sure the total load is within rated output of a generator. Otherwise, generator damage may occur.

AC			
Power factor	1	0.8–0.95	0.4–0.75 (Efficiency 0.85)
	–4500 W	–3600 W	–1530 W

Approximate Wattages of Common Tools or Equipment

Tools	Wattage	Equipment	Wattage
Chain saw	1000–1800	Space heater	1500
Circular saw	1200–1600	Hot plate	1200
Sanders	250–1500	Crock pot	1200
Router	100–1500	Television	250
Leaf blower	1000–1400	Lights	250
Shop vacuum	700–1400	Fan	100
Drill (depends on size)	250–1200		
String trimmer	600–1100		
Paint sprayer	500–1000		
Miter saw	500–1000		
Hedge clippers	300–1000		
Planer	300–900		

TIP

- “_” means below.
- Application wattage indicates when each device is used by itself.

NOTICE

- **Do not overload.** The total load of all electrical appliances must not exceed the supply range of the generator. Overloading could result in damage to the generator.
 - **Some types of precision equipment such as electronic controllers, PCs, electronic computers, microcomputer-based equipment and battery chargers are sensitive to voltage fluctuations and may require more stable voltage supply than the voltage supplied from the portable generator.**
When using such equipment, consult with a Yamaha dealer.
 - **When supplying precision equipment, electronic controllers, PCs, electronic computers, microcomputer-based equipment or battery chargers, keep the generator a sufficient distance away to prevent electrical interference from the engine. Also ensure that electrical noise from the engine does not interfere with any other electrical devices located near the generator.**
 - **If the generator is to supply medical equipment, advice should first be obtained from the equipment manufacturer, a medical professional or hospital.**
 - **Some electrical appliances or general-purpose electric motors have high starting currents, that may exceed the total capacity of your Yamaha generator. Consult the equipment manufacturer for further advice.**
-

High Altitude Operation

This engine may require a high altitude carburetor kit to ensure correct engine operation at altitudes above 4000 ft. (1219 meters). If you operate your engine at altitudes above 4000 ft. (1219 meters) consistently, have your local Yamaha dealer perform the necessary carburetor modification. This engine should be operated in its original configuration below 4000 ft. (1219 meters) as damage may occur if high altitude carburetor kit is installed and operated below 4000 ft. (1219 meters).

PERIODIC MAINTENANCE

Safety is an obligation of the owner. Periodic inspection, adjustment and lubrication will keep your generator in the safest and most efficient condition possible. The most important points of generator inspection, adjustment, and lubrication are explained on the following pages.



WARNING

If you are not familiar with maintenance work, have a Yamaha dealer do it for you.

Maintenance Chart



WARNING

Stop the engine before starting maintenance work.

NOTICE

Use only Yamaha specified genuine parts for replacement. Ask an authorized Yamaha dealer for further attention.

Item	Routine	Pre-operation check	Every	
			6 months or 100 Hr	12 months or 300 Hr
Spark plug	<ul style="list-style-type: none"> • Check condition. • Clean and replace if necessary. 		✓	
Fuel	<ul style="list-style-type: none"> • Check fuel level and leakage. 	✓		
Fuel hose	<ul style="list-style-type: none"> • Check fuel hose for cracks or damage. • Replace if necessary. 	✓		
Engine oil	<ul style="list-style-type: none"> • Check oil level in engine. 	✓		
	<ul style="list-style-type: none"> • Replace. 		✓(*1)	
Air filter element	<ul style="list-style-type: none"> • Check condition. • Clean. 		✓(*2)	
Muffler screen	<ul style="list-style-type: none"> • Check condition. • Clean and replace if necessary. 		✓	
Spark arrester	<ul style="list-style-type: none"> • Check condition. • Clean and replace if necessary. 		✓	
Fuel tank filter	<ul style="list-style-type: none"> • Clean and replace if necessary. 			✓

Item	Routine	Pre-operation check	Every	
			6 months or 100 Hr	12 months or 300 Hr
Fuel strainer	<ul style="list-style-type: none"> • Clean and replace if necessary. 			✓
Crankcase breather hose	<ul style="list-style-type: none"> • Check breather hose for cracks or damage. • Replace if necessary. 			✓
Cylinder head	<ul style="list-style-type: none"> • Decarbonize cylinder head. • More frequently if necessary. 	After every 500 Hrs.		
Valve clearance	<ul style="list-style-type: none"> • Check and adjust when engine is cold. 			★
Idle speed	<ul style="list-style-type: none"> • Check and adjust idle speed. 			★
Recoil starter	<ul style="list-style-type: none"> • Check recoil starter for damage. 			★
Fittings/fasteners	<ul style="list-style-type: none"> • Check all fittings and fasteners. • Correct if necessary. 			★
Visual inspection for potential damage		✓		

*1..... Initial replacement of the engine oil is after one month or 20 hours of operation.

*2..... The air filter element needs to be replaced more frequently when using in unusually wet or dusty areas.

★..... Since these items require special tools, data and technical skills, have a Yamaha dealer perform the service.

Carburetor Adjustment

The carburetor is a vital part of the engine. Adjusting should be left to a Yamaha dealer with the professional knowledge, specialized data, and equipment to do so properly.

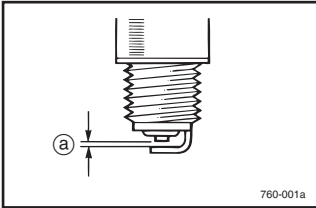
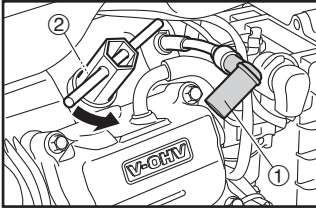

Spark Plug Inspection

The spark plug is an important engine component, which should be checked periodically.

1. Remove the spark plug cap and the spark plug.

- ① Spark plug cap
- ② Spark plug

2. Check for discoloration and remove the carbon. The porcelain insulator around the center electrode of spark plug should be a medium-to-light tan color.
3. Check the spark plug type and gap.

Standard spark plug:
BPR4ES (NGK)
Spark plug gap:
0.7–0.8 mm (0.028–0.031 in)

- Ⓐ Spark plug gap

TIP

The spark plug gap should be measured with a wire thickness gauge and, if necessary, adjusted to specification.

4. Install the spark plug.

Spark plug tightening torque:
20 N·m (2.0 kgf·m, 15 lb·ft)

TIP

If a torque wrench is not available when installing a spark plug, a good estimate of the correct torque is 1/4–1/2 turn past finger tight. However, the spark plug should be tightened to the specified torque as soon as possible.

5. Install the spark plug cap.

Engine Oil Replacement

WARNING

Avoid draining the engine oil immediately after stopping the engine. The oil is hot and should be handled with care to avoid burns.

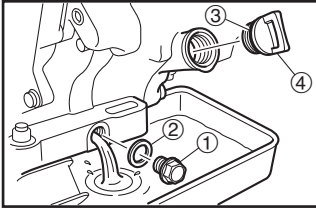

1. Place the generator on a level surface and warm up the engine for several minutes. Then stop the engine.
2. Remove the oil filler cap.
3. Place an oil pan under the engine. Remove the oil drain bolt so that the oil can be completely drained.

TIP

When dispose of the used engine oil, always comply with the local laws or regulations to protect the environment.

4. Check the oil drain bolt, oil filler cap and O-ring. Replace them if damaged.

- ① Oil drain bolt
- ② Gasket
- ③ O-ring
- ④ Oil filler cap

5. Install a new gasket and the oil drain bolt, and then tighten the bolt.

Oil drain bolt tightening torque:
27 N·m (2.7 kgf·m, 20 lb·ft)

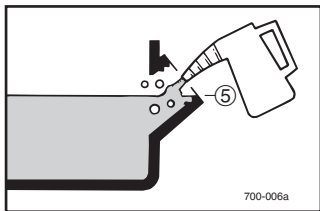

6. Add engine oil to the correct level.

NOTICE

Be sure no foreign material enters the crankcase.

⑤ Correct level

Recommended engine oil:

Recommended oil brand:

YAMALUBE

Available oil grade:

API SE type or higher JASO MA or MB

Available viscosity index:

10W-30 or 10W-40

Engine oil quantity:

1.1 L (1.16 US qt, 37.2 oz)

7. Install the oil filler cap.

Muffler Screen and Spark Arrester

WARNING

The engine and muffler will be very hot after the engine has been run.

Avoid touching the engine and muffler while they are still hot with any part of your body or clothing during inspection or repair.

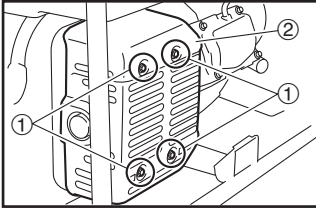

1. Remove the muffler cover bolts and then remove the muffler cover.

- ① Muffler cover bolt
- ② Muffler cover

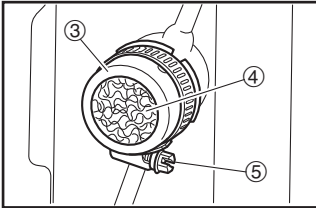

2. Loosen the muffler cap bolt and then remove the muffler cap and muffler screen.

- ③ Muffler cap
- ④ Muffler screen
- ⑤ Muffler cap bolt

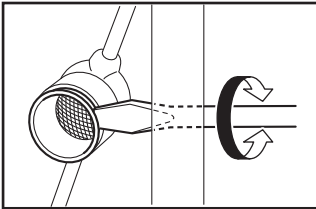

3. Use a flathead screw driver to pry the spark arrester out from the muffler.

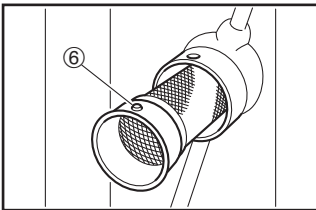

4. Remove the spark arrester.

- ⑥ Spark arrester

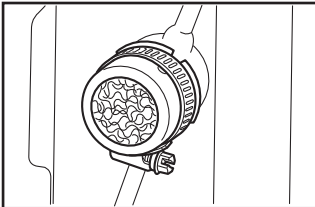
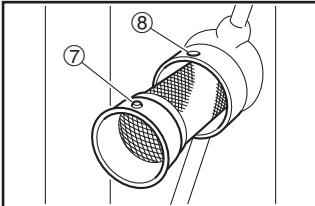
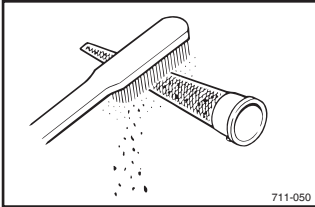
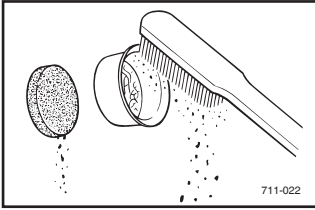

5. Remove the carbon deposits on the muffler screen and spark arrester using a wire brush.

NOTICE

When cleaning, use the wire brush lightly to avoid damaging or scratching of the muffler screen and spark arrester.

6. Check the muffler screen and spark arrester. Replace them if damaged.

7. Install the spark arrester.

TIP

Align the spark arrester lump to the hole in the muffler pipe.

- ⑦ Spark arrester lump
- ⑧ Hole

8. Install the muffler screen and muffler cap, and then tighten the muffler cap bolt.

Muffler cap bolt tightening torque:
2.5 N·m (0.25 kgf·m, 1.8 lb·ft)

9. Install the muffler cover and then tighten the muffler cover bolts.

Muffler cover bolt tightening torque:
12 N·m (1.2 kgf·m, 8.9 lb·ft)

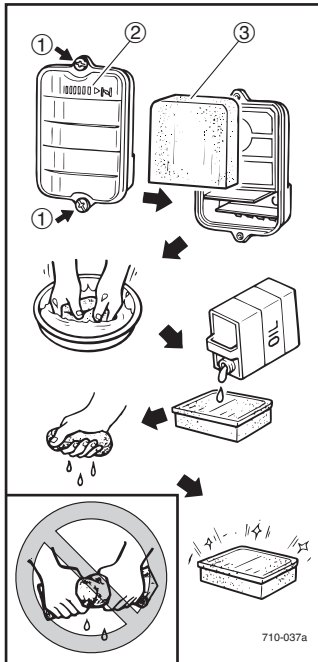

Air Filter

1. Remove the screws, and then remove the air filter case cover.
2. Remove the foam element.

- ① Screw
- ② Air filter case cover
- ③ Foam element

3. Wash the foam element in white kerosene and dry it.

WARNING

Never use white kerosene while smoking or in the vicinity of an open flame.

4. Oil the foam element and squeeze out excess oil. The foam element should be wet but not dripping.

Recommended oil:
Foam-air-filter oil or engine oil (See page 42)

NOTICE

Do not wring out the foam element when squeezing it. This could cause it to tear.

5. Insert the foam element into the air filter case.

TIP

Be sure the foam element sealing surface matches the air filter case so there is no air leak.

NOTICE

The engine should never run without the foam element; excessive piston and cylinder wear may result.

6. Install the air filter case cover and tighten the screws.

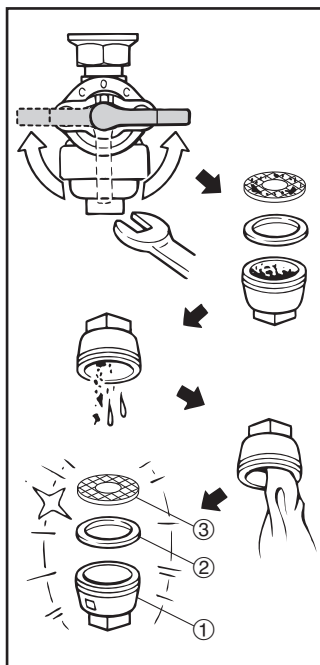

Fuel Cock

! WARNING

Never use the gasoline while smoking or in the vicinity of an open flame.

1. Stop the engine.
2. Turn the fuel cock lever to OFF.
3. Remove the fuel cock cup, gasket and fuel strainer.
4. Clean the cup and fuel strainer with gasoline and wipe it off.
5. Check the gasket. Replace it if damaged.
6. Install the fuel strainer, gasket and fuel cock cup.

! WARNING

Be sure the fuel cock cup is tightened securely.

- ① Fuel cock cup
- ② Gasket
- ③ Fuel strainer

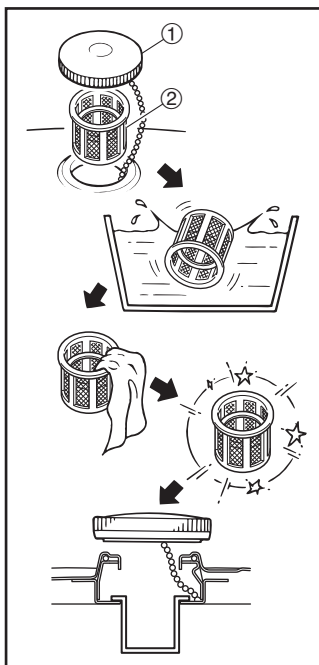

Fuel Tank Filter

⚠ WARNING

Never use the gasoline while smoking or in the vicinity of an open flame.

1. Remove the fuel tank cap and fuel tank filter.

- ① Fuel tank cap
- ② Fuel tank filter

2. Clean the fuel tank filter with gasoline.
Replace it if damaged.
3. Wipe the fuel tank filter and insert it.
4. Install the fuel tank cap.

⚠ WARNING

Be sure the fuel tank cap is tightened securely.

Battery (For EF5500DE)

This generator is designed to be equipped with a VRLA (Valve Regulated Lead Acid) battery. There is no need to check the electrolyte or to add distilled water.

To Charge The Battery

Have a Yamaha dealer charge the battery as soon as possible if it seems to have discharged.

NOTICE

To charge a VRLA battery, a special (constant-voltage) battery charger is required. Using a conventional battery charger will damage the battery. If you do not have access to a constant-voltage battery charger, have a Yamaha dealer charge your battery.

WARNING

- Electrolyte is poisonous and dangerous since it contains sulfuric acid, which causes severe burns. Avoid any contact with skin, eyes or clothing and always shield your eyes when working near batteries. In case of contact, administer the following FIRST AID.
 - EXTERNAL: Flush with plenty of water.
 - INTERNAL: Drink large quantities of water or milk and immediately call a physician.
 - EYES: Flush with water for 15 minutes and seek prompt medical attention.
- Batteries produce explosive hydrogen gas. Therefore, keep sparks, flames, cigarettes, etc., away from the battery and provide sufficient ventilation when charging it in an enclosed space.
- **KEEP THIS AND ALL BATTERIES OUT OF THE REACH OF CHILDREN.**

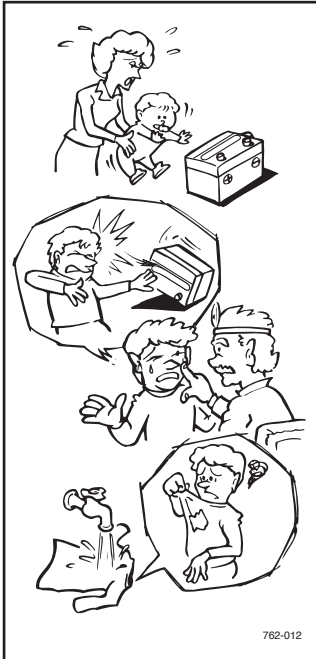

Recommended Battery (For EF5500DE)

Recommended battery:
Capacity: 12 V/12 Ah

Fuse Replacement (For EF5500DE)

WARNING

Be sure to use specified fuse. A wrong fuse will cause electrical system damage and A FIRE HAZARD.

NOTICE

Be sure the engine switch is turned to “” (STOP) to prevent accidental short circuiting.

1. Remove the control panel screws and then remove the control panel.

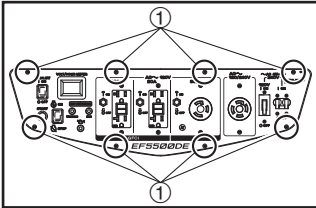

- ① Control panel screw

2. Replace the blown fuse with one of proper amperage.

Specified fuse: 20 A

TIP

If the fuse immediately blows again, consult a Yamaha dealer.

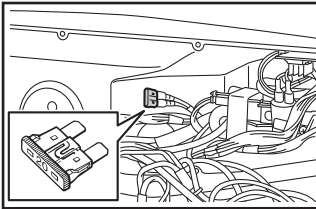

G.F.C.I. Receptacle Test

1. Start the engine.
2. Turn the AC switch (N.F.B.) to "I" (ON).
3. Press the test button, then check the position of the reset button.

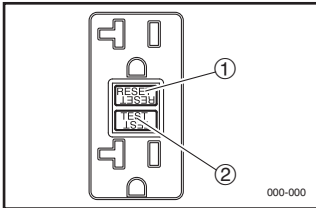

- ① Reset button
- ② Test button

G.F.C.I. reset button position after test	G.F.C.I. receptacle operation
③ Pop out	Correct
④ Stay in	Incorrect

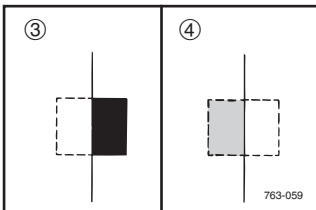

4. If G.F.C.I. operation is correct, push in the reset button.
If the G.F.C.I. operates incorrectly, consult a Yamaha dealer.

WARNING

Do not operate the generator with a faulty G.F.C.I. circuit. Electric shock could occur. Have the generator repaired by a qualified mechanic.

STORAGE

Long term storage of your generator will require some preventive procedures to guard against deterioration.

Drain The Fuel

1. Turn the engine switch to “” (STOP).

① “” (STOP)

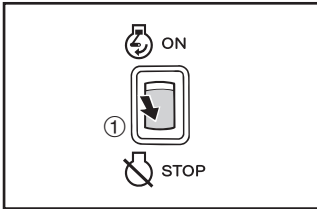

2. Remove the fuel tank cap and fuel tank filter. Extract the fuel from the fuel tank into an approved gasoline container using a commercially available hand siphon. Then, install the fuel tank filter and the fuel tank cap.

WARNING

Fuel is highly flammable and poisonous. Check “SAFETY INFORMATION” (See page 3) carefully.

NOTICE

Immediately wipe off spilled fuel with a clean, dry, soft cloth, since fuel may deteriorate painted surfaces or plastic parts.

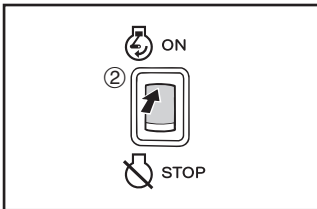

3. Turn the engine switch to “” (ON).

② “” (ON)

4. Turn the fuel cock lever to ON.

③ ON

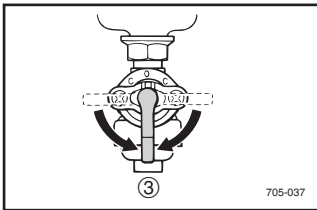

5. Start the engine and leave it run until it stops. The engine stops in approximately 20 minutes time by running out of fuel.

TIP

- Do not connect with any electrical devices. (unloaded operation)
- Duration of the running engine depends on the amount of the fuel left in the tank.

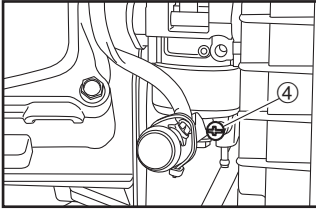

6. Drain the fuel remaining in the carburetor into an approved container by loosening the drain screw on the carburetor float chamber.

④ Drain screw

7. Tighten the drain screw.



8. Turn the engine switch to “” (STOP).

9. Turn the fuel cock lever to OFF.

10. Tighten further if any screws, bolts and nuts are loose.

11. Store the generator in a dry, well-ventilated place, with the cover placed over it.

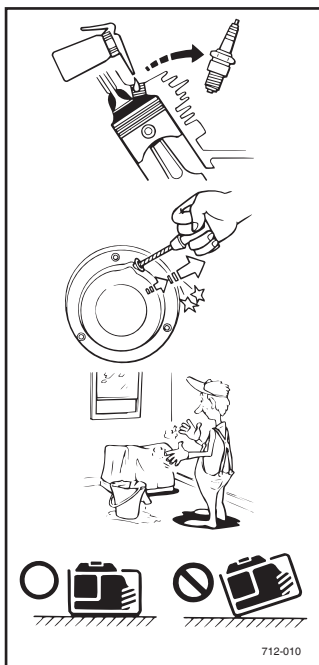

Engine

Perform the following steps to protect the cylinder, piston ring, etc. from corrosion.

1. Remove the spark plug, pour about one tablespoon of engine oil (See page 42) into the spark plug hole and reinstall the spark plug only. Recoil start the engine by turning over several times (with ignition off) to coat the cylinder walls with oil.
2. Pull the recoil starter until you feel compression. Then stop pulling. (This prevents the cylinder and valves from rusting.)
3. Clean exterior of the generator and apply a rust inhibitor.

NOTICE

Do not spray any organic solvent on the CO SENSOR.

4. Store the generator in a dry, well-ventilated place, with the cover placed over it.

NOTICE

Do not use a plastic cover as a dust cover. Rust and corrosion will occur since a non porous cover will trap moisture around the engine.

5. The generator must remain in a vertical position when stored, carried or operated.

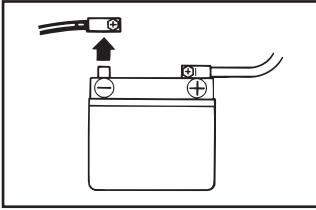

Battery (For EF5500DE)

1. Remove the battery.
2. Store the battery in a cool, dark and dry place and charge it once a month. Do not store the battery in an excessively warm or cold place [i.e., less than 0 °C (32 °F) or more than 30 °C (86 °F)].



WARNING

- **Disconnect the negative lead (Black) first, then the positive lead (Red) from the battery.**
 - **Connect the positive lead (Red) first, then the negative lead (Black) to the battery when installing the battery.**
-

NOTICE

- **Do not disconnect the battery during engine operation.**
 - **Avoid operating the generator with the battery removed.**
-

TROUBLESHOOTING

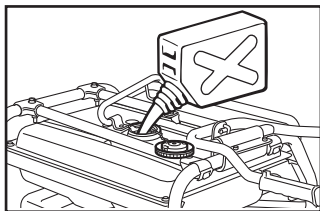

Engine Won't Start

1. Fuel systems

No fuel supplied to combustion chamber.

- No fuel in tank Supply fuel.
- Fuel in tank Fuel cock lever to ON.
- Clogged fuel line Clean fuel line.
- Foreign matter in fuel cock Clean fuel cock.
- Clogged carburetor Clean carburetor.



2. Engine oil system

Insufficient

- Oil level is low Add engine oil.

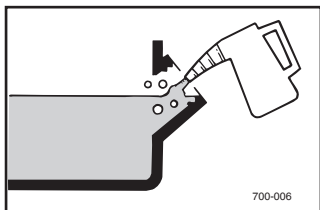

3. Electrical systems

- Engine switch to "Ⓜ" (ON).

- ① "Ⓜ" (ON)

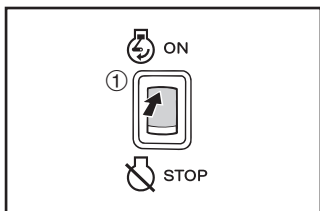

Poor spark

- Spark plug dirty with carbon or wet Remove carbon or wipe spark plug dry.
- Faulty ignition system Consult a Yamaha dealer.

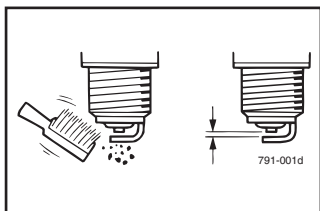

Generator Won't Produce Power

- Safety device (AC switch) to "○" (OFF) Turn the AC switch (N.F.B.) to "I" (ON).

CO SENSOR Indicator Lights flash or come on abnormally

If the generator shows any of the following conditions upon starting or during operation, consider your own safety, stop the generator, and then please consult a Yamaha dealer.



Status	Check	Engine
Upon starting	Upon starting, both the “CO SENSOR WARNING indicator light” and the “CO SENSOR ERR (Error) indicator light” do not flash 5 times, or either one does not flash 5 times.	Starts
During operation	During operation, the “CO SENSOR WARNING indicator light” flashes for approximately 5 minutes.	Runs
	During operation, the “CO SENSOR ERR (Error) indicator light” comes on for approximately 5 minutes.	Runs



For any other abnormal operating conditions not covered here, please consult a Yamaha dealer.

For EF5500DE

ENGINE DOES NOT START



Turn the engine switch to “” (ON), then push the starter switch. And check if the starter motor cranks.

 ON

 STOP

 START



Cranks	Does not crank
--------	----------------

Push the starter switch, and check if the oil warning light flickers.

Does not flicker	Flickers
------------------	----------

Push the starter switch, and check the spark plug for spark strength. (See “WARNING”)



! WARNING

- To prevent **FIRE HAZARDS** be sure fuel is not present in the spark plug area.
- To prevent **FIRE HAZARDS** be sure to place the spark plug as far way as possible from the spark plug hole and carburetor area.
- To prevent **ELECTRIC SHOCK** do not hold spark plug lead with hand while testing.

OK	Does not spark
----	----------------

Check the following.

- Fuel line clogging
- Air filter element clogging

	Clogged		
	OK	Clean or replace.	OK
			Engine does not start.

Consult a Yamaha dealer.

Faulty battery and/or starter motor.
Consult a Yamaha dealer.

Check engine oil level.

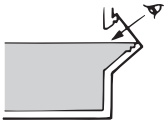

OK

Consult a
Yamaha dealer.

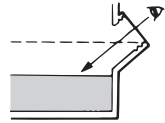

Level low

Add engine oil.

Check the spark plug.

- Type: BPR4ES (NGK)
- Gap: 0.7–0.8 mm (0.028–0.031 in)

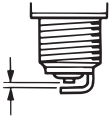

Incorrect

Replace or
adjust gap.



OK

Clean the spark
plug.

For EF5500D

ENGINE DOES NOT START

Turn the engine switch to “” (ON), then pull the recoil starter and check if the oil warning light flickers.

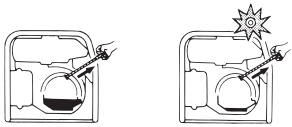

Does not flicker

Flickers

Check engine oil level.

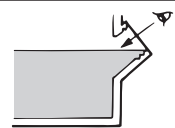

OK

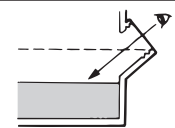

Level low

Consult a Yamaha dealer.

Add engine oil.

Pull the recoil starter and check the spark plug for spark strength. (See “WARNING”)



! WARNING

- To prevent FIRE HAZARDS be sure fuel is not present in the spark plug area.
- To prevent FIRE HAZARDS be sure to place the spark plug as far way as possible from the spark plug hole and carburetor area.
- To prevent ELECTRIC SHOCK do not hold spark plug lead with hand while testing.

OK

Does not spark

Check the spark plug.

- Type: BPR4ES (NGK)
- Gap: 0.7–0.8 mm (0.028–0.031 in)

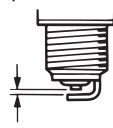

Incorrect

Replace or adjust gap.



OK

Clean the spark plug.

Check the following.

- Fuel line clogging
- Air filter element clogging

Clogged

Clean or replace.

OK

Engine does not start.

OK

Consult a Yamaha dealer.

SPECIFICATIONS

Dimensions

	Unit	EF5500DE	EF5500D
Overall length (*1)	mm (in)	740 (29.1)	740 (29.1)
Overall length (*2)	mm (in)	1070 (42.1)	1070 (42.1)
Overall width	mm (in)	736 (29.0)	736 (29.0)
Overall height	mm (in)	800 (31.5)	800 (31.5)
Dry weight	kg (lb)	108 (238.1)	98 (216.1)

Engine

	Unit	EF5500DE/EF5500D
Type		Air cooled 4-stroke gasoline OHV
Cylinder arrangement		Inclined, 1 cylinder
Displacement	cm ³	358
Bore × Stroke	mm (in)	85.0 × 63.2 (3.35 × 2.49)
Operation hours	Hr	9.0 (Rated load)
Fuel		Unleaded gasoline
Fuel tank capacity	L (US gal, Imp gal)	26 (6.87, 5.72)
Engine oil quantity	L (US qt, oz)	1.1 (1.16, 37.2)
Ignition system		TCI
Spark plug: Type		BPR4ES (NGK)
Gap	mm (in)	0.7–0.8 (0.028–0.031)
Noise level*	dB/LWA	99.4
	dB (A)/7 m	74.1

* : Noise level is measured when the economy control switch is turned to “I” (ON).

LWA shows the sound power level under the ISO3744 satisfied test conditions.

The noise level in “dB (A)/7 m” is the arithmetic mean value in four directions measured 7 meters away from each side of the generator.

The noise level may vary in different environments.

(*1) : Handle folded, with two wheel kit installed.

(*2) : Handle deployment, with two wheel kit installed.

Generator

	Unit	EF5500DE/EF5500D
AC output		
Rated voltage	V	120/240
Rated frequency	Hz	60
Rated current	A	37.5/18.8
Rated output	kVA	4.5
Safety device: Type		N.F.B.

CONSUMER INFORMATION

PRI-I.D. NUMBER:

	MODEL	
	<input type="text"/>	
PRI-I.D. CODE		SERIAL No.
<input type="text"/>		<input type="text"/>

Identification Number Records

Record your Primary I.D., and serial numbers in the spaces provided, to assist you in ordering spare parts from a Yamaha dealer.

Also record and keep these I.D. numbers in a separate place in case your generator is stolen.

Generator Identification

The generator serial number is stamped in the location as shown.

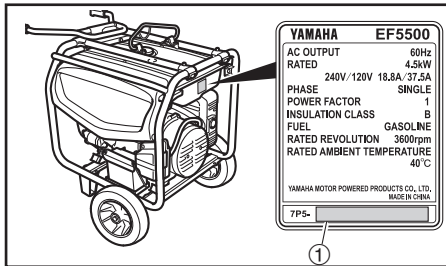

① Generator serial number

TIP

The first three digits of these numbers are for model identification; the remaining digits are the unit production number. Keep a record of these numbers for reference when ordering parts from a Yamaha dealer.

EXHAUST EMISSION CONTROL SYSTEM AND COMPONENTS

Item	Acronym
• CARB. ASSY., LH. & JT., CARBURETOR2	CARB (Carburetor)
• T.C.I. MAGNETO ASSY. & PLUG, SPARK	EI (Electronic Ignition)
• CRANKCASE1 & HEAD, CYLINDER1	PCV (Positive Crankcase Ventilation)
• AIR FILTER ASSY.	ACL (Air Cleaner)
• MUFF., 2, CAP, NET, WIRE2 & ARRESTER, SPARK	

The above items and the corresponding acronyms are provided in accordance with U.S. EPA REGULATIONS FOR NEW NONROAD SPARK-IGNITION NONHANDHELD ENGINES and the CALIFORNIA REGULATIONS FOR 1995 AND LATER SMALL OFF-ROAD ENGINES.

The acronyms conform to the latest version of the SAE's recommended practice document J1930, "Diagnostic Acronyms, Terms, and Definitions For Electrical/Electronic System".

It is recommended that these items be serviced by a Yamaha dealer.

WIRING DIAGRAM

EF5500DE

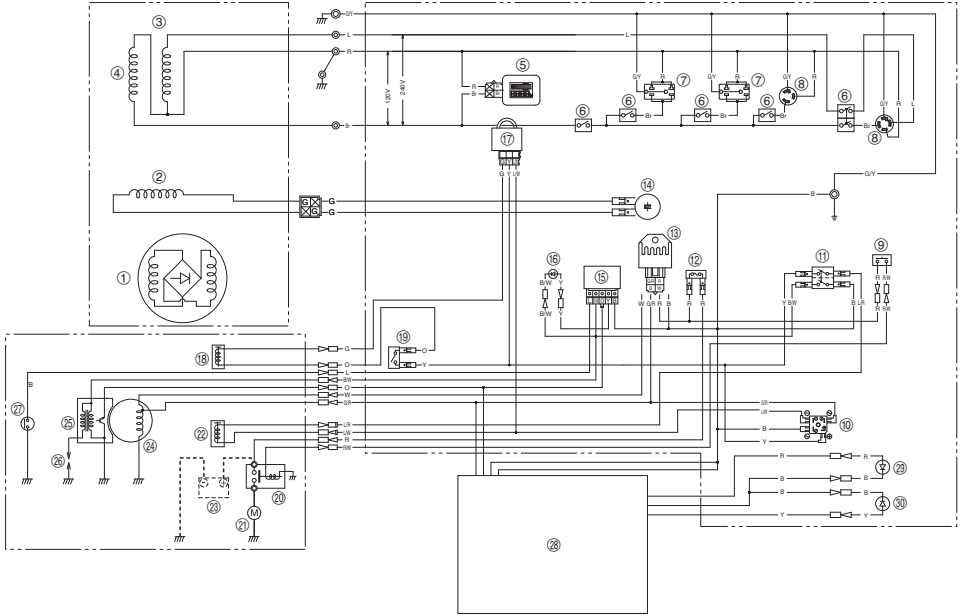

- ① Rotor assembly
- ② Sub coil
- ③ Main coil
- ④ Stator assembly
- ⑤ Voltage/hour meter
- ⑥ AC switch (N.F.B.)
- ⑦ G.F.C.I. receptacle
- ⑧ AC receptacle
- ⑨ Starter switch
- ⑩ Rectifier
- ⑪ Engine switch
- ⑫ Fuse
- ⑬ Rectifier/regulator
- ⑭ Condenser
- ⑮ Oil warning unit
- ⑯ Oil warning light
- ⑰ Economy control unit
- ⑱ Solenoid valve

- ⑲ Economy control switch
- ⑳ Starter relay
- ㉑ Starter motor
- ㉒ Carburetor solenoid valve
- ㉓ Battery
- ㉔ Charging coil
- ㉕ TCI unit
- ㉖ Spark plug
- ㉗ Oil level switch
- ㉘ CO SENSOR
- ㉙ WARNING indicator light (Red)
- ㉚ ERR (Error) indicator light (Orange)

Color code

B	Black
Br	Brown
G	Green
L	Blue
O	Orange
R	Red
W	White
Y	Yellow
B/W	Black/White
G/R	Green/Red
G/Y	Green/Yellow
L/R	Blue/Red
L/W	Blue/White
R/W	Red/White

EF5500D

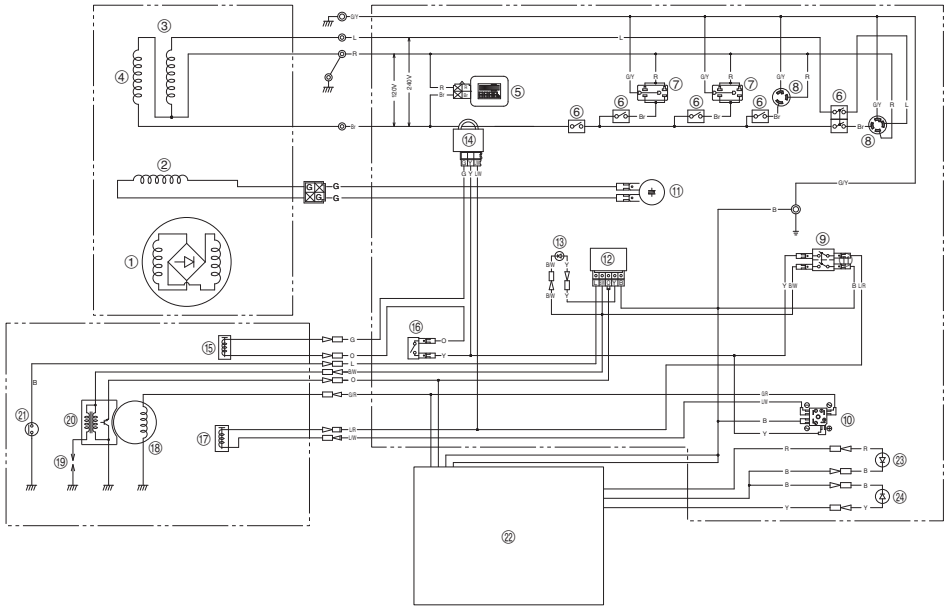

- ① Rotor assembly
- ② Sub coil
- ③ Main coil
- ④ Stator assembly
- ⑤ Voltage/hour meter
- ⑥ AC switch (N.F.B.)
- ⑦ G.F.C.I. receptacle
- ⑧ AC receptacle
- ⑨ Engine switch
- ⑩ Rectifier
- ⑪ Condenser

- ⑫ Oil warning unit
- ⑬ Oil warning light
- ⑭ Economy control unit
- ⑮ Solenoid valve
- ⑯ Economy control switch
- ⑰ Carburetor solenoid valve
- ⑱ Charging coil
- ⑲ Spark plug
- ⑳ TCI unit
- ㉑ Oil level switch
- ㉒ CO SENSOR
- ㉓ WARNING indicator light (Red)
- ㉔ ERR (Error) indicator light (Orange)

Color code

- B Black
- Br Brown
- G Green
- L Blue
- O Orange
- R Red
- Y Yellow
- B/W Black/White
- G/R Green/Red
- G/Y Green/Yellow
- L/R Blue/Red
- L/W Blue/White

YAMAHA EXTENDED SERVICE (Y.E.S.)

Keep your Yamaha Generator protected even after your warranty expires with genuine Yamaha Extended Service (Y.E.S.).

- Y.E.S. is designed and administered by Yamaha Motor Corporation to provide maximum owner satisfaction. You get uninterrupted factory-backed coverage for extra peace of mind.
- Y.E.S. is flexible. You can choose the plan that's right for you: 12 months, 24 months or 36 months coverage.
- Y.E.S. is administered by the same Yamaha people that handle your warranty - and it shows in the comprehensive coverage benefits. There are no hour limitations and Y.E.S. covers manufacturing defects just like your warranty. See a sample contract at your Yamaha dealer and see how comforting uninterrupted factory backed protection can be.
- There are no "out-of-pocket" expenses for covered repairs. Yamaha will never ask you to pay a deductible.
- Nationwide coverage. Y.E.S. coverage is honored at any authorized Yamaha Outdoor Power Equipment Service dealer.
- Y.E.S. coverage is transferable to a new owner if you sell or trade-in. That can make you Yamaha much more valuable.

This excellent Y.E.S. plan coverage is only available to Yamaha owners like you, and only while your Yamaha is still within the Yamaha Limited Warranty period. So visit your authorized Yamaha dealer to get all the facts. He can show you how easy it is to protect your investment with Yamaha Extended Service.

Special note:

If visiting your dealer isn't convenient, contact Yamaha with your Primary ID number (machine serial number). We'll be happy to help you get the Y.E.S. coverage you need.

Yamaha Service Marketing
P.O. Box 6555
Cypress, CA 90630
1-866-YES-EXTD
(1-866-937-3983)



PRINTED IN CHINA
2021.06x1 
(E)