

Top Loader Washing Machine, 10kg

Series 5 | Top Load

White



With plenty of room for large loads, and 6 wash cycles including Allergy, this top loader caters to every type of load.

- SmartDrive™ technology delivers a gentle, quiet and reliable wash
- Six wash cycles including Allergy, Easy Iron and Handwash
- Soft-close lid for hands-free operation
- 4 star energy and 3.5 star water rating

DIMENSIONS

Height	1060 - 1090mm
Width	685mm
Depth	700mm

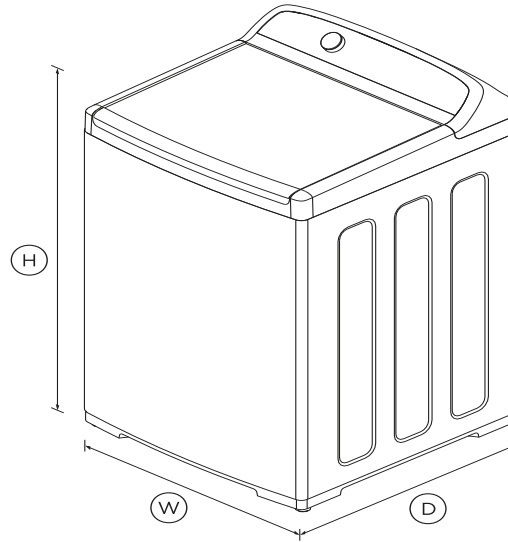

FEATURES & BENEFITS

EASY TO USE

This machine has a cycle to suit every type of load including Allergy, Easy Iron and Handwash. Select a cycle with easy-to-use SmartTouch™ controls.

CARES FOR CLOTHES

The flexible finned agitator ensures less tangling for superior clothes care.

SOFT CLOSE LID

The robust plastic lid has a soft close mechanism that makes it family safe, avoids slamming and allows for hands-free operation.

SAVE TIME WITH LARGE CAPACITY

The 10kg capacity top loader is ideal for larger families and can wash bulky items with ease.

QUICKER DRYING

Drying times are reduced due to a fast spin speed of 1100RPM which helps remove more water.

ENERGY SAVING

Eco-Active™ recirculates water and detergent through clothes so less hot water is used to remove stains, dirt and bacteria.

SPECIFICATIONS

Consumption

Annual energy consumption	350kWh
Energy rating	4 star
Water consumption per cycle	123L
Water rating	3.5 star (WELS)

Features

Agitator	Flexible finned
Auto out of balance correction	•
Automatic water level	•
Controlled cold	•
Delay start	•
Detergent dispenser	•
Fabric softener dispenser	•
Lid lock	•
No spin / Spin Hold	•
Rinse options	3
SmartTouch™ control dial	•
Soak	•

Spin speeds	3
Stainless steel drum	•
Water temperature controls	5

SKU 92282

The product dimensions and specifications in this page apply to the specific product and model. Under our policy of continuous improvement, these dimensions and specifications may change at any time. You should therefore check with Fisher & Paykel's Customer Care Centre to ensure this page correctly describes the model currently available. ? Fisher & Paykel Appliances Ltd 2020

Performance

Auto-Lint disposal	•
Load sensing	•
Maximum spin speed	1100 rpm
Number of spin speeds	3
SmartDrive™ technology	•

Product dimensions

Depth	700mm
Height	1060 - 1090mm
Height (Lid open)	1440 - 1470mm
Width	685mm

Warranty

Parts and labour	2 years
Parts only SmartDrive™ Motor	10 years

Wash Cycles

Allergy	•
Eco	•
Handwash	•
Heavy	•
Number of wash cycles	6
Quick	•
Regular	•

Other product downloads available at fisherpaykel.com



User Guide



Service & Warranty



Installation Guide



A PEACE OF MIND SALE

24 Hours 7 Days a Week Customer Support

T 1300 650 590 W www.fisherpaykel.com